

# Toon Boom Animate Pro 3 Getting Started Guide



# Legal Notices

Toon Boom Animation Inc.  
4200 Saint-Laurent, Suite 1020  
Montreal, Quebec, Canada  
H2W 2R2

Tel: +1 514 278 8666  
Fax: +1 514 278 2666

[toonboom.com](http://toonboom.com)

## Disclaimer

The content of this guide is covered by a specific limited warranty and exclusions and limit of liability under the applicable License Agreement as supplemented by the special terms and conditions for Adobe®Flash® File Format (SWF). For details, refer to the License Agreement and to those special terms and conditions.

The content of this guide is the property of Toon Boom Animation Inc. and is copyrighted.

Any reproduction in whole or in part is strictly prohibited.

## Trademarks

## Credits

Art Development: Shabana Ali, Marie-Eve Chartrand, Christopher Diaz, Tania Gray, Annie Rodrigue, Anouk Whissell

Technical Editor: Peter Cawthorne, Pamela Grimaud, Liven Tam

Technical Reviewer: Joel Baril, Lindsay Brown, Steven Masson, Lori Sponagle, Elke Starck, Lilly Vogelesang

Technical Writer: Shabana Ali, Marie-Eve Chartrand, Christopher Diaz, Annie Rodrigue, Liven Tam, Phoebe Wang-Chao, Anouk Whissell

## Publication Date

2013-07-03

Copyright © 2013 Toon Boom Animation Inc., a Corus® Entertainment Inc. company. All rights reserved.

PGSG101ANP3EN



# Contents

<b>Toon Boom Animate Pro 3 Getting Started Guide</b> .....	<b>0</b>
Legal Notices .....	11
Contents .....	1
<b>Chapter 1: Introduction</b> .....	<b>3</b>
<b>Chapter 2: Interface</b> .....	<b>5</b>
Adding a View .....	5
Tool Properties View .....	7
Interface Navigation .....	8
<b>Chapter 3: How to Draw</b> .....	<b>9</b>
<b>Chapter 4: How to Animate</b> .....	<b>11</b>
Cleaning Up .....	14
<b>Chapter 5: How to Paint</b> .....	<b>17</b>
Closing Gaps .....	19
<b>Chapter 6: How to Morph Drawings</b> .....	<b>21</b>
<b>Chapter 7: How to Import Bitmap Images</b> .....	<b>25</b>
<b>Chapter 8: How to Build a Cut-out Character</b> .....	<b>29</b>
Drawing the Pieces .....	29
Parenting Layers .....	32
Master Peg .....	34
<b>Chapter 9: How to Use Bone Deform</b> .....	<b>37</b>
Rigging .....	37
Optimizing the Deformation Chain .....	39
Display the Deformers' Controls .....	41
Animation .....	42
<b>Chapter 10: How to Animate a Cut-out Character</b> .....	<b>45</b>
Animation .....	45
Navigating the Hierarchy .....	47
Easing .....	48
<b>Chapter 11: How to Create Templates</b> .....	<b>51</b>
Creating a Template from the Network View .....	52
<b>Chapter 12: How to Setup a Scene</b> .....	<b>55</b>
Positioning the Camera .....	55
Positioning Objects .....	57
Repositioning the Pivot .....	59

<b>Chapter 13: How to Animate Objects and the Camera</b> .....	<b>61</b>
Animating a Layer .....	61
Animating the Camera .....	63
<b>Chapter 14: How to Create a Multiplane</b> .....	<b>67</b>
Positioning Elements in the Top and Side Views .....	68
<b>Chapter 15: How to Set-up Objects in the 3D Space</b> .....	<b>71</b>
<b>Chapter 16: How to Import Sound and Add Lip-Sync</b> .....	<b>75</b>
Lip-Sync .....	76
Automatic Lip-Sync Detection .....	77
<b>Chapter 17: How to Add Effects to your Scene</b> .....	<b>81</b>
About Effects .....	81
Adding Effects .....	83
Module Library View Toolbar .....	84
Module Tabs .....	84
Tone Effect .....	86
Animating an Effect Over Time .....	88
<b>Chapter 18: How to Export a Movie</b> .....	<b>91</b>

# Chapter 1: Introduction

Animate Pro is a complete animation software allowing you to do endless creative projects. It comes with a very wide variety of tools and features. In the Getting Started guide, you will learn about the main top features allowing you to cover the basic concepts and features found in Toon Boom Animate Pro to quickly bring you up to speed with the software. Refer to the complete Toon Boom Animate Pro User Guide to learn about all the tools and options as well as advanced techniques.

This guide is divided as follows:

- [Interface on page 5](#)
- [How to Draw on page 9](#)
- [How to Animate on page 11](#)
- [How to Paint on page 17](#)
- [How to Morph Drawings on page 21](#)
- [How to Import Bitmap Images on page 25](#)
- [How to Build a Cut-out Character on page 29](#)
- [How to Use Bone Deform on page 37](#)
- [How to Animate a Cut-out Character on page 45](#)
- [How to Create Templates on page 51](#)
- [How to Setup a Scene on page 55](#)
- [How to Create a Multiplane on page 67](#)
- [How to Set-up Objects in the 3D Space on page 71](#)
- [How to Animate Objects and the Camera on page 61](#)
- [How to Import Sound and Add Lip-Sync on page 75](#)
- [How to Add Effects to your Scene on page 81](#)
- [How to Export a Movie on page 91](#)





# Chapter 2: Interface

It's important that you become familiar with the following elements of the user interface, this will help you to start using Toon Boom Animate Pro. You can learn more about the highlights described here, and how to use them in a production context, throughout this guide.

When you start Toon Boom Animate Pro for the first time, the default workspace is displayed. It contains all of the main elements you need to use.

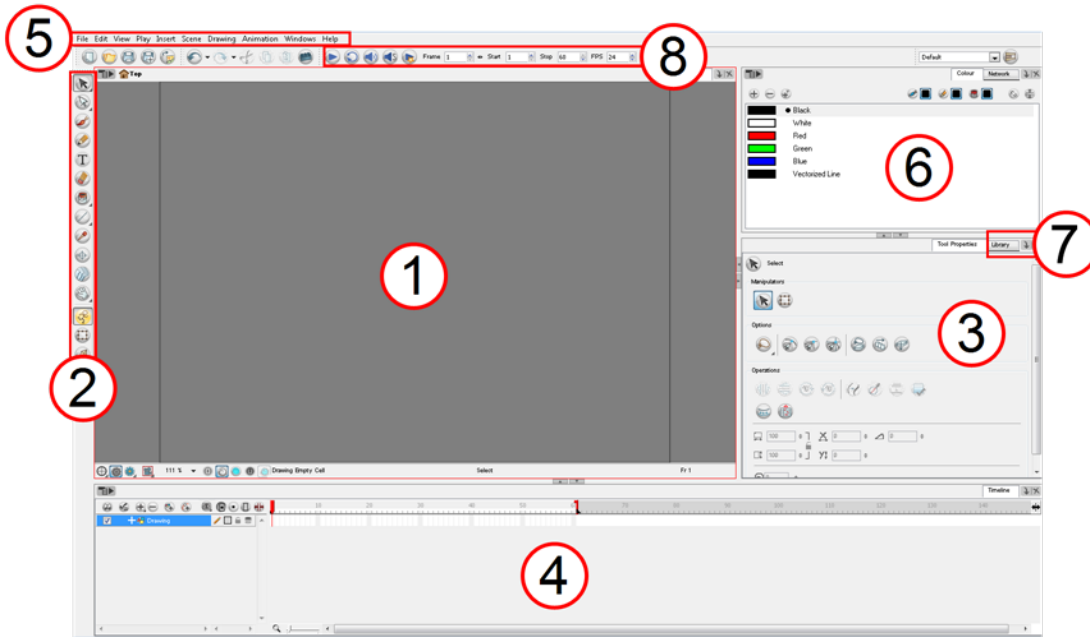

1. Camera View
2. Tools Toolbar
3. Tool Properties View
4. Timeline View
5. Menus
6. Colour View
7. Library View
8. Playback Toolbar

## Adding a View

To add a view:

1. Select the view you want to add from **Windows > The desired view.**

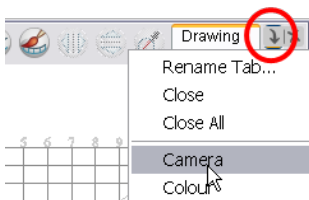
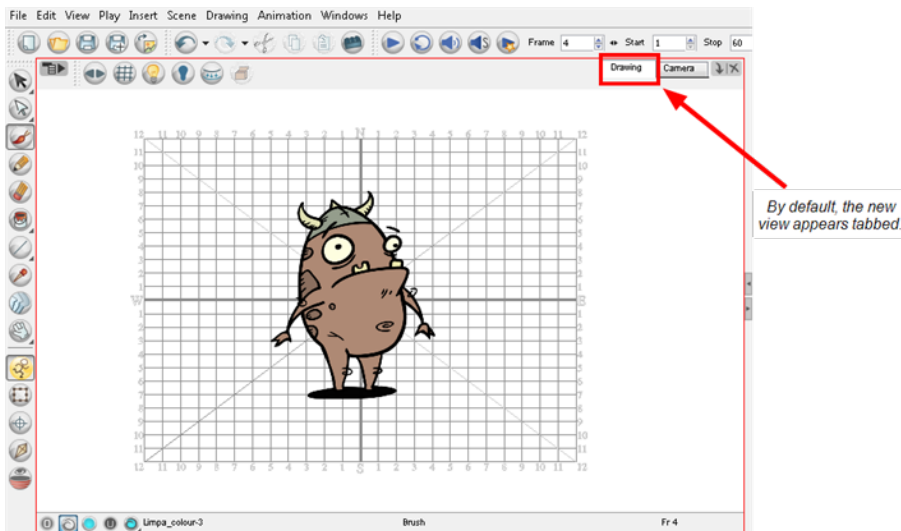

You can also use the Window drop-down menu button included in each view already available in the workspace. Click on the button and select a view from the list. You can only open one instance of the same view. In other words, you cannot have two Camera views open at the same time.

You can open several instances of the same view except for the Timeline, Tool Properties, Colour and Drawing views.

2. To dock a floating window in your workspace, drag the window's tab onto one of the workspace's views.



When a view is undocked, the view toolbar will automatically be displayed.

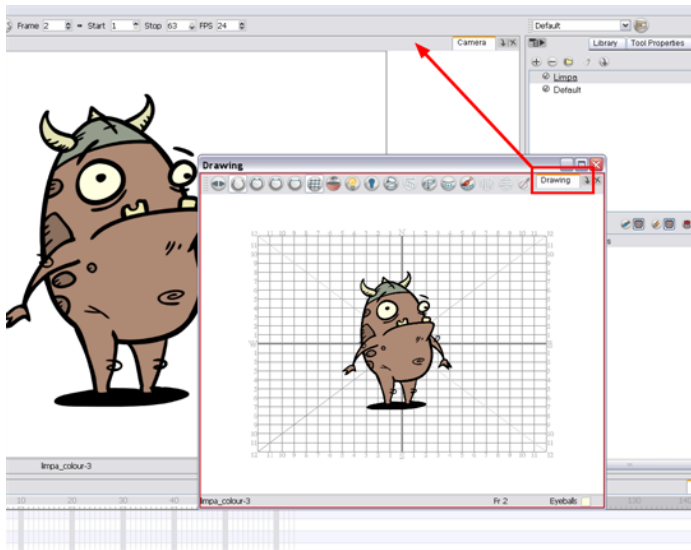

## Tool Properties View

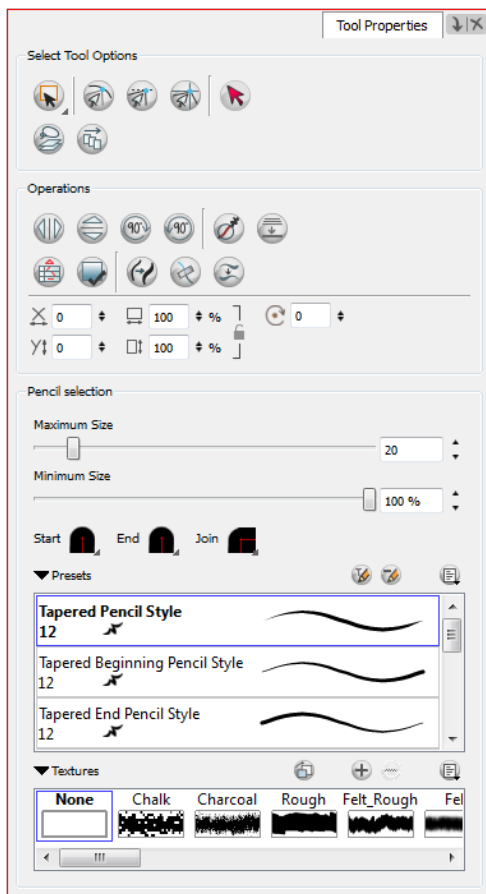

The contextual Tool Properties view contains the most common options and operations related to the currently selected tool. As soon as you select a tool from the Tools toolbar, the Tool Properties view will be updated.

For example, if you choose the Select  tool in the Tools toolbar, the Tool Properties view will display the options and operations related to the Select tool such as Snap to Contour, Apply to All Drawings, Flip Horizontal and Flatten.

## Interface Navigation

Toon Boom Animate Pro supports zoom in, zoom out, rotate, pan and reset view position for easy interface navigation.

- **Zoom In:** Zooms into the view. From the top menu, select **View > Zoom In** or press [2].
- **Zoom Out:** Zooms out of the view. From the top menu, select **View > Zoom Out** or press [1].
- To zoom in and zoom out, hold down [Spacebar] and your middle mouse button while moving the mouse up or down.
- To pan the view, hold down the keyboard shortcut [Spacebar] and drag your mouse in the direction you want to pan the view.
- **To Recentre the view:** recentres the view on your mouse cursor or press [N].
- **Reset View:** Resets the view to its default position. From the top menu, select **View > Reset View** or press [Shift] + [M].
- **Reset Rotation:** Resets the view's rotation to its default position. From the top menu, select **View > Reset Rotation** or press [Shift] + [X].
- **Reset Pan:** Resets the view's pan to its default position. From the top menu, select **View > Reset Pan** or press [Shift] + [N].
- **Reset Zoom:** Resets the view's zoom to its default position. From the top menu, select **View > Reset Zoom**.
- **Toggle Full Screen:** Enlarges the selected view to full screen. The full screen process is done in three stages. From the top menu, select **View > Toggle Full Screen** or press [Ctrl] + [F] (Windows/Linux) or [⌘] + [F] (Mac OS X).
  - First, the selected view enlarges to the maximum width or height, but keeps the tool views such as Colour or Tool Properties view.
  - Second, the view enlarges to full screen.
  - Third, the view returns to its original size.
- **Rotate 90 CW:** Rotates the Camera view 90 degrees clockwise, like an animation table. From the top menu, select **View > Rotate View CW**.
- **Rotate 90 CCW:** Rotates the Camera view 90 degrees counter-clockwise, like an animation table. From the top menu, select **View > Rotate View CCW**.



If you're using a tablet or trackpad that supports touch, then you can also use standard two-finger gestures for zoom, rotate, and pan of the canvas.

# Chapter 3: How to Draw

As soon as Toon Boom Animate Pro is started, you can start to draw straight away using the default drawing layer.

## How to draw:

1. In the Tools toolbar, select the Brush  tool or press [Alt] + [B].
2. In the Timeline or Xsheet view, click in the first cell of the drawing layer.

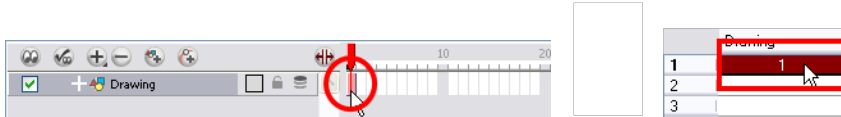

3. In the Drawing or Camera view, start drawing.

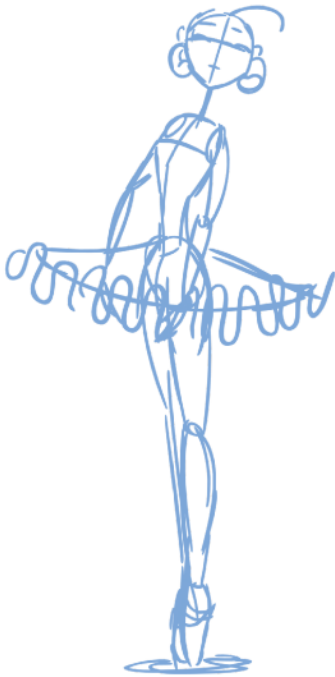

4. To select a different colour, in the Colour view, select the a different colour swatch. Double-click on the colour swatch to open the Colour Picker window and modify the colour. Remember that anything already painted with that colour swatch will update to the new colour.

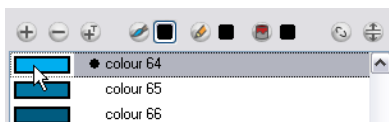



# Chapter 4: How to Animate



Now that you know about the existing tools, you can start your animation.

The first step to complete is the rough animation, which is the skeleton of your animation. You would usually start with the main action. For example, to animate a walk-cycle, you will start with the torso moves and the legs. Head, arms and clothes will be added later, during the secondary animation.

For a satisfactory animation, complete the main action before adding all of the details. If you start animating all of the details right away, you will lose a lot of time if you have to do corrections, and your animation will often look too rigid.

## To animate:

1. In the Preferences panel, you can set your preferences to Use Current Frame as Drawing Name.
2. In the Tools toolbar, select the Brush  tool or press [Alt] + [B].
3. In the Colour view, select the colour you will use to draw. It is a good idea to choose a light colour for your rough animation to help for the following task, the clean up process.

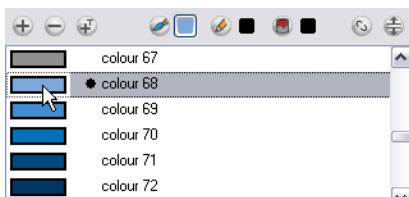

4. In the Timeline or Xsheet view, select the cell where the first drawing will appear.
5. In the Camera or Drawing view, draw the first key drawing.



6. Make sure your first key drawing is still selected, and in the Mark Drawing toolbar, click on the **Mark Selected Drawings as Key** button.
  - In the Xsheet view, you can also select **Animation > Mark Drawing As > Key Drawing** to identify your drawing.

Drawing	
1	1 <b>K</b>
2	
3	
4	
5	

7. In the Tools toolbar, click on the **Enable Onion Skin**  button.
8. In the Timeline view, click and drag the onion skin blue markers to extend the number of previous and next visible drawings to fit your need.



9. In the Timeline or Xsheet view, select the cell where your next key drawing will appear.

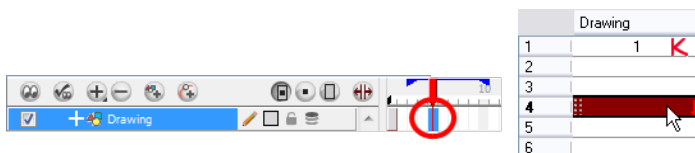

10. In the Camera or Drawing view, draw your second key drawing.



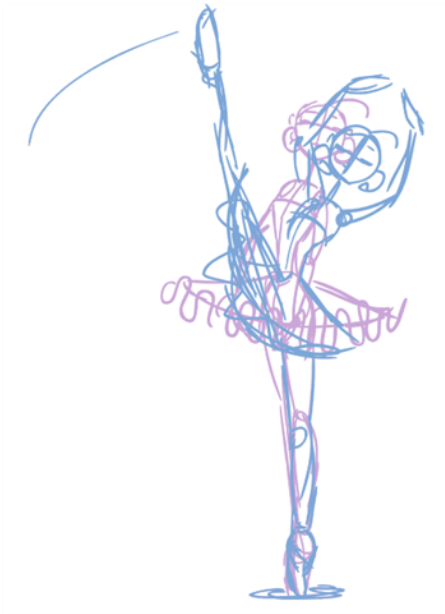

11. In the Xsheet view, identify the drawing as a key drawing.

Drawing		
1	1	K
2		
3		
4	4	K
5		

12. In the Xsheet view, select a cell between your two key drawings.



13. From the Timeline View toolbar, click  to create an empty drawing or press [Alt] + [Shift] + [R].

- ▶ In the Xsheet view, right-click and select **Drawings > Create Empty Drawing** or press [Alt] + [Shift] + [R].





14. Draw your new drawing.



15. If necessary, in the Xsheet view, identify the new drawing as a Key, Breakdown or In-between drawing.

Drawing		
1	1	K
2	2	B
3		
4	4	K
5		

16. In the Timeline or Xsheet view, select a new cell and repeat step 9 to step 15 for each new drawing.
17. In the Timeline view, disable the layers you do not want to show during playback.
18. In the Playback toolbar, click on the **Loop**  button if you want the playback to loop.
19. In the Playback toolbar, click on the **Play**  button to start the animation.

## Cleaning Up



When your rough animation is ready, it is time to clean it up and ink it. The clean-up is also called tracing. It consists of tracing solid and clean lines over the rough animation to get closed zones. This is the final paperless animation step before the ink and paint step.

You will need to add a new drawing layer to draw your clean. This is the equivalent of adding a sheet of paper and tracing the rough using the animation disk.





If you plan on tracing your animation in the Drawing view, you will need to enable the Light Table feature in order to display all the layers of your project.

---

### To trace your animation in a new layer:

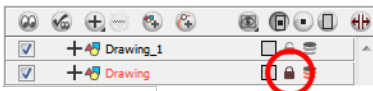
1. In the Timeline View toolbar, click on the **Add Drawing Layer**  button.
2. In the Timeline view, click on the lock icon of the layer containing your rough animation to prevent any accidental changes.



- 1.
2. In the Timeline or Xsheet view, select the new layer's cell corresponding to the first key drawing of your rough animation.
3. In the Tools toolbar, select the drawing tool of your choice. We recommend the Pencil  tool.
4. In the Colour view, select the colour you will use to trace your animation. Pick a dark bold colour such as black to make sure it contrasts well with the light colour of your rough animation.
5. In the Camera or Drawing view, start tracing the first key drawing.

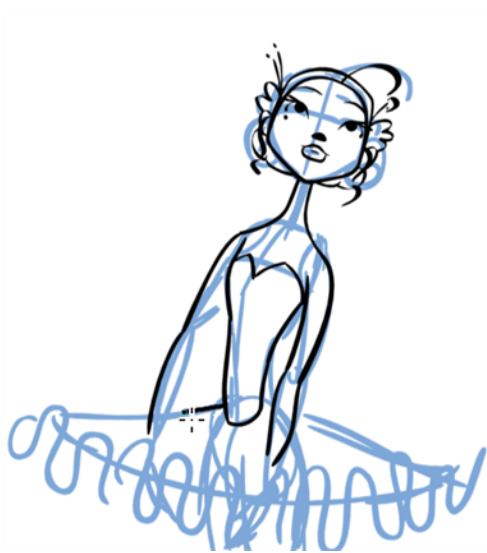

6. If you have some other layers in the way, you can disable them temporarily from the Timeline view so that only your rough animation and your clean up layer are displayed in the Camera view.

7. In the Tools toolbar, click on the **Enable Onion Skin**  button and extend the Onion Skin in the Timeline view.



8. In the Timeline or Xsheet view, select the next cell corresponding to a rough drawing.
9. In the Camera view, trace your next drawing.



10. Repeat the previous steps for each drawing.



This method allows you to keep the roughs and the cleans intact. You only need to disable the rough layer to prevent it from appearing in the scene.

# Chapter 5: How to Paint

Toon Boom Animate Pro has some very powerful colouring features when it comes to painting. To paint your drawings you will use different colour swatches, unlike some paint programs where you modify one swatch each time you want to paint with a different colour.



In the Colour view, you choose a different colour swatch for each colour you want to paint in your drawing. You can add as many swatches as you want. You can also rename them and modify existing ones.

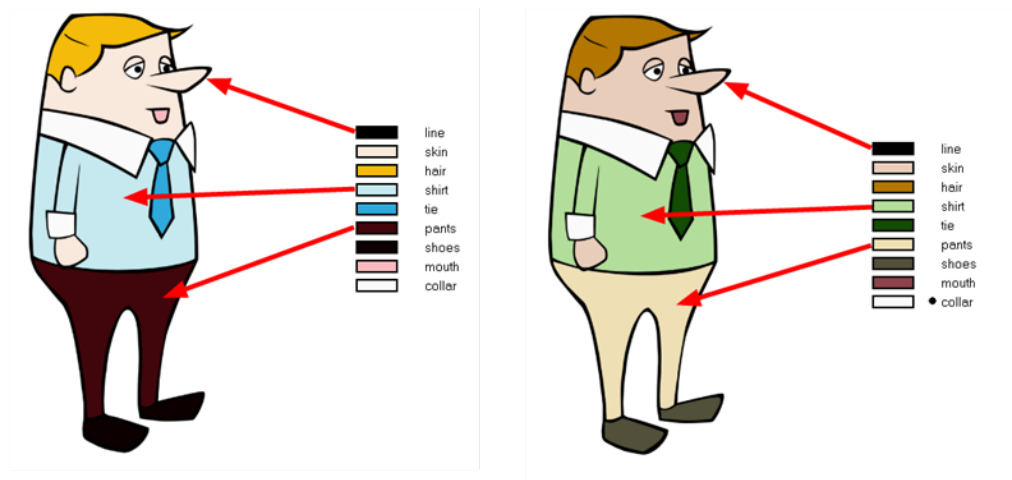

When you modify the colour of an existing swatch it automatically updates all the zones painted with this swatch throughout the entire project. The colour swatch has a unique ID number that associates it with the painted zones. This way, you can change the look of your character at anytime without having to repaint it!

In colour animation, specific colours are used to paint each particular character. In order to maintain absolute consistency, a colour palette is created for each character, prop and effect throughout the production. These are referred to as master palettes.

Master palettes contain a colour swatch for each zone to colour with a precise RGBA colour value.

Using a master colour palette has many benefits, including:

- Each character consistently retains their dedicated colours.
- You cannot accidentally use a colour which is not in the master palette.
- Standardization and colour consistency throughout the production

- Multiple artists can use the same colour palette and produce the same results.

Toon Boom Animate Pro uses palettes to hold all of the colours needed to paint your elements, allowing complete control and consistency in your painting process.

A palette is created by assigning a set of colours to each character, prop or effect. You will create a new palette and add a new colour, known as a colour swatch, for each zone of the character, such as the skin, hair, tongue, shirt, pants, etc.

Learn how to paint your drawings by following these instructions.

### To paint your drawings:

1. In the Tools toolbar, select the Paint  tool or press [Alt] + [I].
2. In the Colour view, select a colour from the palette.
  - Double-click on a colour swatch to open the Colour Picker window and modify the colour.

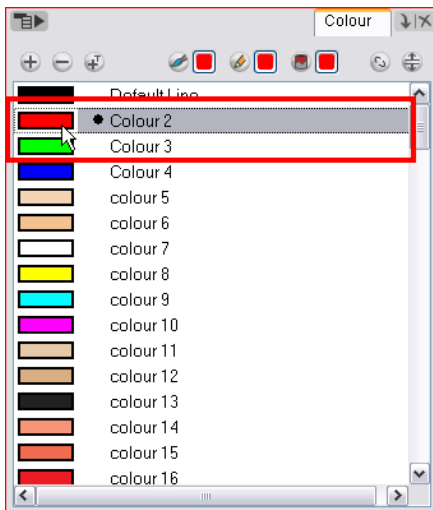



The colour palette will only appear in the Colour view once a drawing element has been selected.

3. In the Camera or Drawing view, start painting the colours on your drawing.



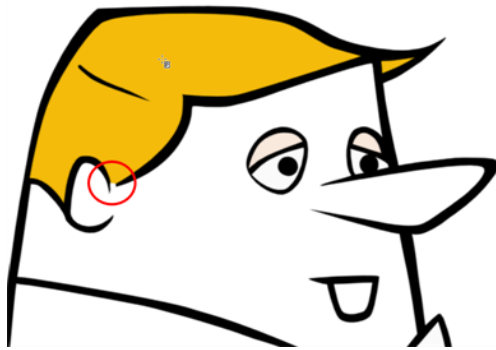

## Closing Gaps



When painting, you will notice that some of your drawing areas are not closed. To close the zone you can either draw the missing line with the Brush or Pencil tool, but you can also close the gap with an invisible line. To do so, you will use the Close Gap  tool.

The Close Gap tool is used to close small gaps in a drawing. The Paint tool only paints closed areas. The Close Gap tool will create a small, invisible stroke between the two closest points to close the colour zone. You do not need to trace directly over the gap. You can draw it a few millimetres away and the Close Gap will automatically choose the two closest points and close the gap.

### To use the Close Gap tool:

1. In the **Tools** toolbar, select the **Close Gap**  tool. You can also select the **Close Gap** tool from the top menu under **Drawing > Tools > Close Gap** or press [Alt] + [C].
  - ▶ Enable the **Auto-Flatten**  option in the Tool Properties view if you want the stroke you will draw to be flattened in your drawing instead to be on top.
  - ▶ You can display the invisible lines with the Show Strokes option under **View > Show Strokes** or press [K].
  - ▶ If you do not display the strokes, a Message dialog box will appear.



Enabling the Don't Show This Message Again option prevents this Message dialog box from appearing.

2. In the Camera or Drawing view, trace an invisible line near to the gap to be closed. The gap will automatically close.





# Chapter 6: How to Morph Drawings

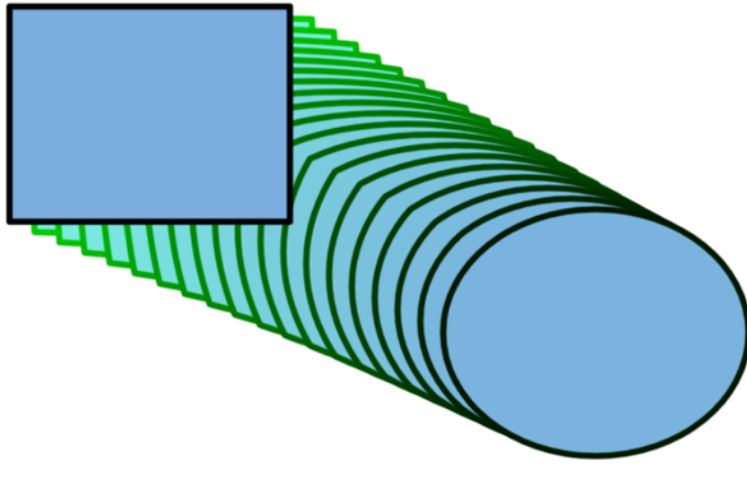



Once you are familiar with the basic rules, you can start creating morphing sequences. You need to practice and become at ease with the Morphing feature. To begin, start with simple elements, once you become confident with the morphing process you can move on to complex and advanced morphing techniques, such as head rotation or full characters.

## To create a basic morphing:

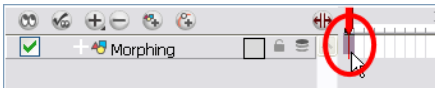
1. In the Timeline view, click on the Add Drawing Layer  button to add a new layer to your project.
2. Rename the new layer **Morphing**.
3. In the Timeline or Xsheet view, select the first cell in your layer.



4. In the Tools toolbar, select the Rectangle  tool or press [Alt] + [7].
5. In the Tool Properties view, enable the Auto Fill  option.
6. In the Colour view, click on the Set Paint Current Colour  button.
7. In the Colour list, select a colour to fill your rectangle with.

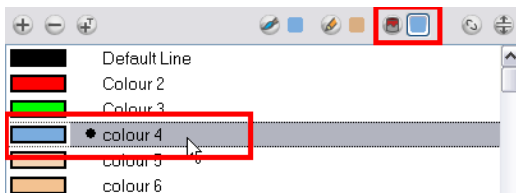

8. In the Colour view, click on the Set Pencil Current Colour  button.

9. In the Colour list, select a colour to trace your rectangle's outline with.

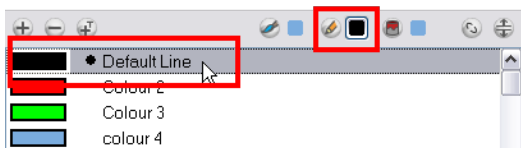

10. In the Camera or Drawing view, draw a rectangle.

- ▶ Hold down the [Shift] key if you want to draw a square.
- ▶ Hold down the [Alt] key if you want to draw the rectangle from its centre.



11. In the Xsheet or Timeline view, select the last cell.

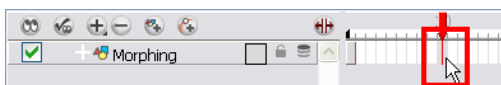

12. Repeat Step 5 to Step 10 using the Ellipse tool instead of the Rectangle tool or press [Alt] + [=].

- ▶ Draw an ellipse using the same outline colour as the rectangle ("Outline").
- ▶ Paint the ellipse with the same fill colour as the rectangle ("Fill").

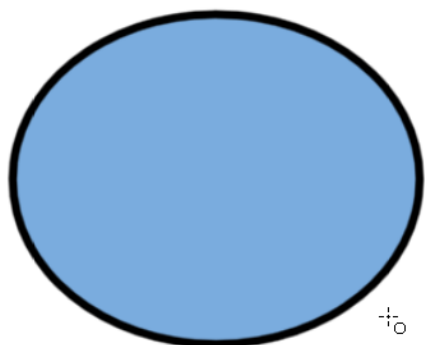

13. In the Xsheet or Timeline view, select your first drawing's cell, the rectangle drawing.

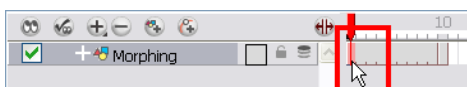

14. In the Xsheet or Timeline view, right-click on the selection and select **Morphing > Create Morphing** or press [Alt] + [M].

- ▶ In the top menu, you can also select **Animation > Morphing > Create Morphing**.

Arrows appear between the two key drawings to show they are computer generated.

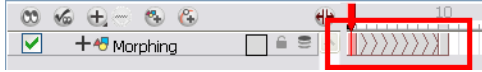

15. Use the Playback toolbar to play the morphing sequence. To flip through the in-betweens toggle between [,] and [.] or press [F4] to toggle between the two key drawings.



# Chapter 7: How to Import Bitmap Images

A bitmap image is an image composed of pixels that is both size and resolution-dependant.

To import a bitmap image:

- From the top menu select **File > Import > Images**. You can also click on the **Import Images**  button in the File toolbar.
  - In the Xsheet view, you can right-click anywhere in the frame area and select **Import > Drawings**. The Import Images dialog box opens.

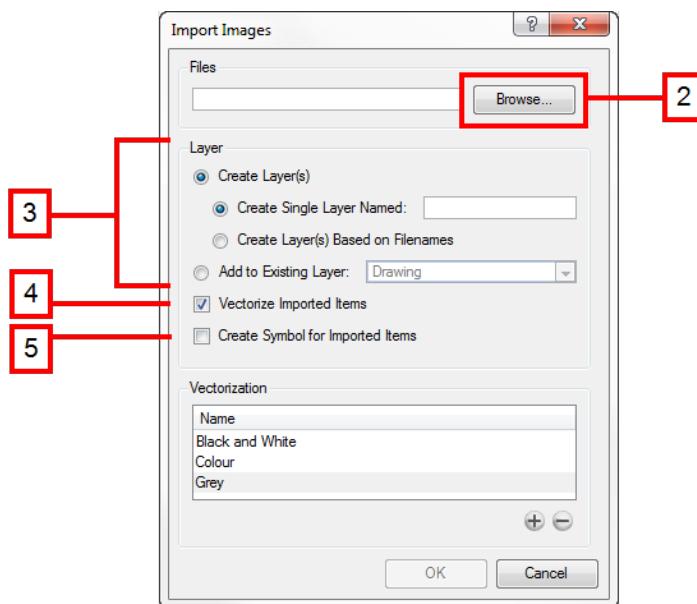

- In the Files section, click Browse to find and select one or several images on your computer.
- In the Layer section, you have the option of creating a whole new layer for your image or adding the image to an existing layer.
  - To create a new layer, select **Layer > Create Layer(s) > Create Single Layer Named** and name your layer accordingly.

OR

  - To create a new layer using the file name, select **Layer > Create Layer(s) > Create Layer(s) Based on Filenames**.

OR

  - To add the image to an existing layer, select **Layer > Add to Existing Layer** and select the layer already created in your Animate Pro file from the drop-down menu. If only vector  layers are available in your scene (and therefore the drop-down menu), you will either have to Vectorize Imported Items, Create Symbols for imported Items or check both options to put your bitmap image on a vector layer.



If you vectorize your image using the Vectorize as Colour option, you can import it on a vector layer, and use vector tools on it.

4. In this case, uncheck the **Vectorize Imported Items** option.

The vectorization options are hidden and the Transparency section appears.

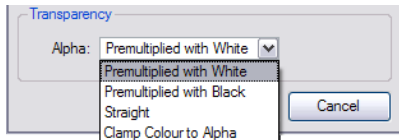

5. In Toon Boom Animate Pro, if you want your bitmap images to be encapsulated in a symbol, enable the **Create Symbol for Imported Items** option. If not, disable the option. If you chose to add your image to an existing vector layer then the Create Symbol for Imported Items will automatically be checked and greyed out.
6. Next, in the Alignment section, you must decide on the size and placement of your image within the camera frame. Depending on the Scene Settings (the height and width in pixels that you chose for your project), an image that you import may get scaled to the point where all its individual pixels become visible.



Be sure that you are in the Camera view's Render Mode when judging an imported image, otherwise it may appear blurry. When judging an imported image, otherwise it may appear blurry.

The following three options are available

- Alignment > Rules > Fit
  - If your image orientation is portrait format, this selection will enlarge or shrink (but not distort) to your image height to match the full height of the camera frame.
  - If your image orientation is landscape format, this selection will enlarge or shrink (but not distort) your image width matches that of the camera frame.
- Alignment > Rules > Pan
 

This selection achieves the opposite result of the Fit command.

  - If your image orientation is portrait, its width will be made to match the width of the camera frame. As a result, part of the image's height will extend beyond the height of the frame.
  - This can be useful if you want to make your background move up and down, or from left to right to make it appear as if the camera is panning, or to actually perform a camera pan.
- Alignment > Rules > Project Resolution

This selection will scale the image in proportion to the scene's resolution. The system looks at the resolution of the bitmap image, for example 4000 x 2000, then compares it to the scene's resolution, for example 1920 x 1080, and adjusts the scale factor in proportion. So in this example the bitmap would appear at 208% (4000/1920). If you import a bitmap that is 960 x 540 it will be displayed at 50% (960/1920) of the size of the project resolution.

- The last step is to decide on the image's transparency from the Alpha drop-down menu. For this, there are four options available. These options deal with the way that the bitmap image will be antialiased, more specifically the way that the pixels along the edge are blended in the RGBA (red, green, blue, alpha (transparent)) channels.

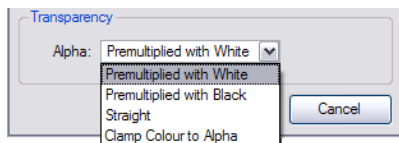

The options are:

- Premultiplied with White

Individual pixels at the edge of an image are blended with white.

- Premultiplied with Black

Pixels at the edge of an image are blended with black.

- Straight

Pixels at the edge of an image are blended with black, white and greys.

- Clamp Colour to Alpha

Select this option if you want to premultiply the colour value with the alpha value. When the colour is clamped to the alpha, the colour value cannot be higher than the alpha value. If you have a pixel of value R=247, G=188, B=29 and the alpha is 50% (the image is 50% transparent, then the actual RGB value output would be half of the amounts listed above).

- Click OK.

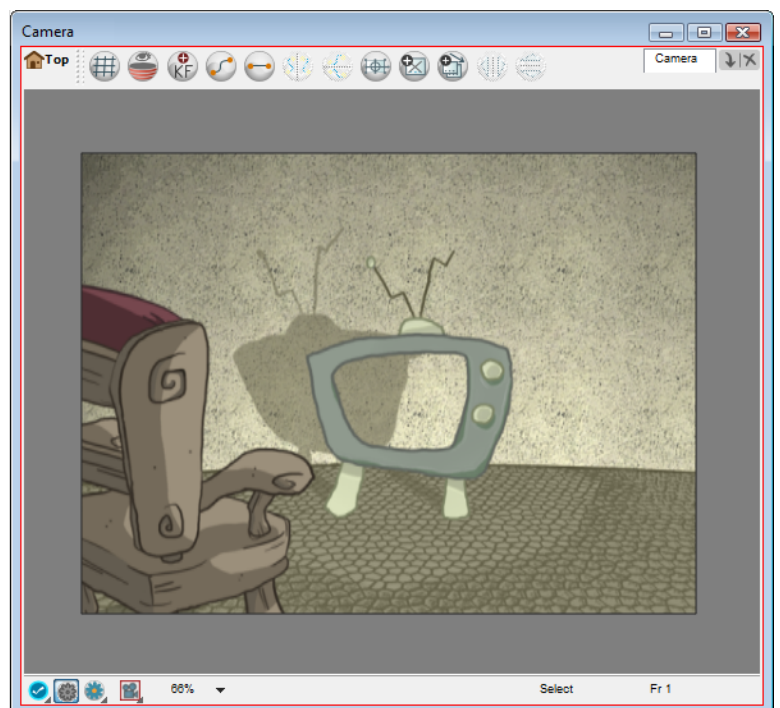
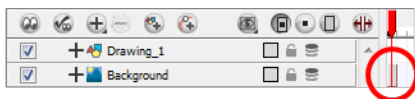





# Chapter 8: How to Build a Cut-out Character



There are many techniques you can use to break down a puppet. In this section, you will learn about one of the most common and simplest method. For your first character break down, follow these instructions to get an idea of the way Animate Pro works. Once you are used to the software and understand its basic functions and commands, you will be able to create your own techniques to satisfy the needs of your production.

## Drawing the Pieces

The main break down technique shown here is to trace your model, completing the hidden lines and filling the gaps.

### To trace over your model:

1. In the Timeline view, add a new drawing layer for each body part to separate. You can press [Ctrl] + [R] (Windows/Linux) or [⌘] + [R] (Mac OS X).

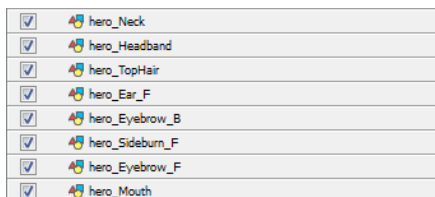

2. In the Timeline view, select the layer's first cell in which you want to draw the part.

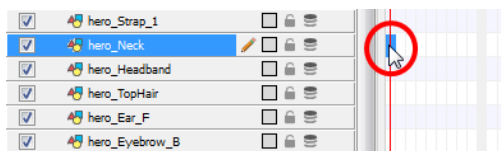

3. In the Tools toolbar, select the drawing tool needed.

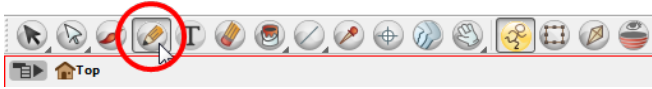

4. In the Colour view, select the desired colour swatch.

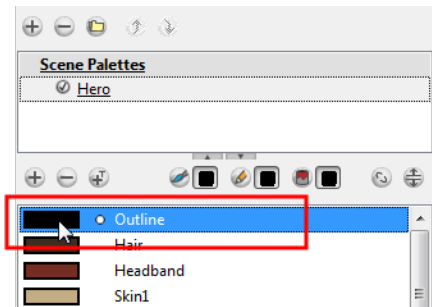

5. In the Camera or Drawing view, draw the new part.



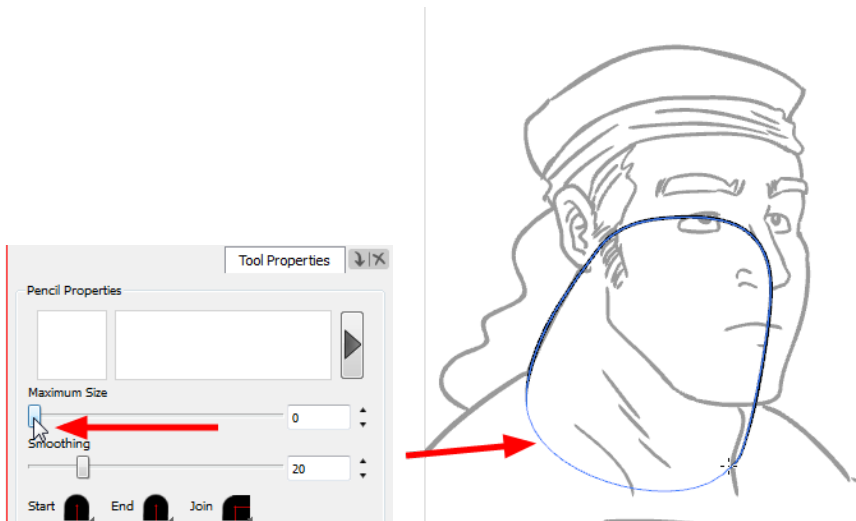

If you are working in the Drawing view, click on the Light Table button located in the Drawing View toolbar to display the other layers as washed out colours. You can also press [Shift] + [L].

6. In the Tool Properties view, you can set the Pencil tool width to 0 to create invisible hairline if you want to close a shape without drawing an actual stroke.

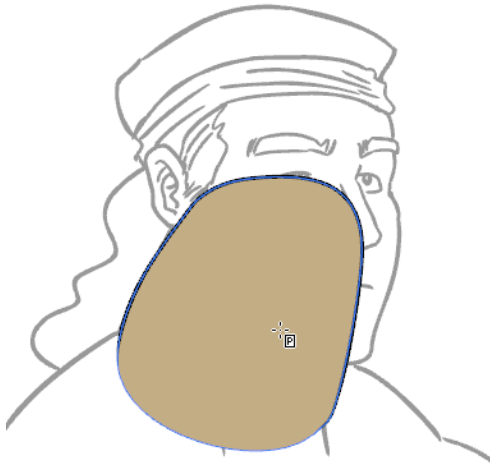

7. In the Tools toolbar, select the Paint or Paint Unpainted tool to colour your drawing.
8. In the Colour view, select the corresponding colour.
9. In the Camera or Drawing view, paint your drawing.



10. Using the Select tool, select your drawing and flatten your lines by clicking on the **Flatten**  button located in the Tool Properties view.

11. If your lines are composed of several pencil strokes, you might want to combine them into one single smooth pencil line using the Merge Pencil Lines option. Using the Select tool, select the pencil lines to be merged and in the Tool Properties view, click on the **Merge Pencil Lines**  button.

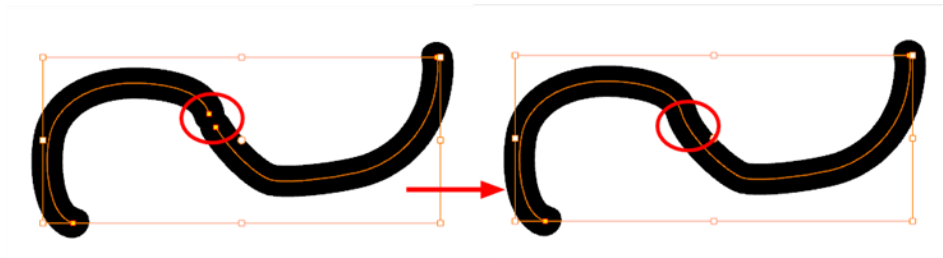

12.Repeat the entire process until the breakdown is completed.

<input checked="" type="checkbox"/>	hero_Body_1
<input checked="" type="checkbox"/>	hero_BodyDetails_F
<input checked="" type="checkbox"/>	hero_BodyDetails_B
<input checked="" type="checkbox"/>	hero_Body_Lines
<input checked="" type="checkbox"/>	hero_SideBuckleTop
<input checked="" type="checkbox"/>	hero_SideBuckleBottom
<input checked="" type="checkbox"/>	hero_Vest_1
<input checked="" type="checkbox"/>	hero_Strap
<input checked="" type="checkbox"/>	hero_UpperArm_F
<input checked="" type="checkbox"/>	hero_Tattoo
<input checked="" type="checkbox"/>	hero_Bracer_F
<input checked="" type="checkbox"/>	hero_Arm_F_1
<input checked="" type="checkbox"/>	hero_Trap_F
<input checked="" type="checkbox"/>	hero_Arm_F_2
<input checked="" type="checkbox"/>	hero_Hand_F
<input checked="" type="checkbox"/>	hero_Strap_1
<input checked="" type="checkbox"/>	hero_Neck
<input checked="" type="checkbox"/>	hero_Headband
<input checked="" type="checkbox"/>	hero_TopHair
<input checked="" type="checkbox"/>	hero_Ear_F
<input checked="" type="checkbox"/>	hero_Eyebrow_B
<input checked="" type="checkbox"/>	hero_Sideburn_F
<input checked="" type="checkbox"/>	hero_Eyebrow_F
<input checked="" type="checkbox"/>	hero_Mouth
<input checked="" type="checkbox"/>	hero_Eye_F_1
<input checked="" type="checkbox"/>	hero_Eye_F
<input checked="" type="checkbox"/>	hero_Iris_F
<input checked="" type="checkbox"/>	hero_Nose
<input checked="" type="checkbox"/>	hero_Eye_B
<input checked="" type="checkbox"/>	hero_Eye_B_1
<input checked="" type="checkbox"/>	hero_Iris_B
<input checked="" type="checkbox"/>	hero_Head
<input checked="" type="checkbox"/>	hero_Hair_1
<input checked="" type="checkbox"/>	hero_Trap_B
<input checked="" type="checkbox"/>	hero_UpperArm_B
<input checked="" type="checkbox"/>	hero_Bracer_B
<input checked="" type="checkbox"/>	hero_Arm_B_1
<input checked="" type="checkbox"/>	hero_Arm_B_2
<input checked="" type="checkbox"/>	hero_Hand_B
<input checked="" type="checkbox"/>	hero_UpperLeg_F
<input checked="" type="checkbox"/>	hero_Knee_F
<input checked="" type="checkbox"/>	hero_Leg_F_1
<input checked="" type="checkbox"/>	hero_Shoe_F
<input checked="" type="checkbox"/>	hero_Foot_F
<input checked="" type="checkbox"/>	hero_Ankle_F
<input checked="" type="checkbox"/>	hero_Shoe_F_1
<input checked="" type="checkbox"/>	hero_Strap_F
<input checked="" type="checkbox"/>	hero_AnkleBand_F

## Parenting Layers

Animate Pro lets you extend your rigging techniques beyond normal boundaries and sets new standards. You can create hierarchies without encapsulating pieces inside each other by creating a linked structure between your layers.

You should create a hierarchy on your arms and legs and keep the arms and legs separated from the body. This gives you more animation freedom. This way, when you need to scale or skew the torso, it will not affect the entire body.

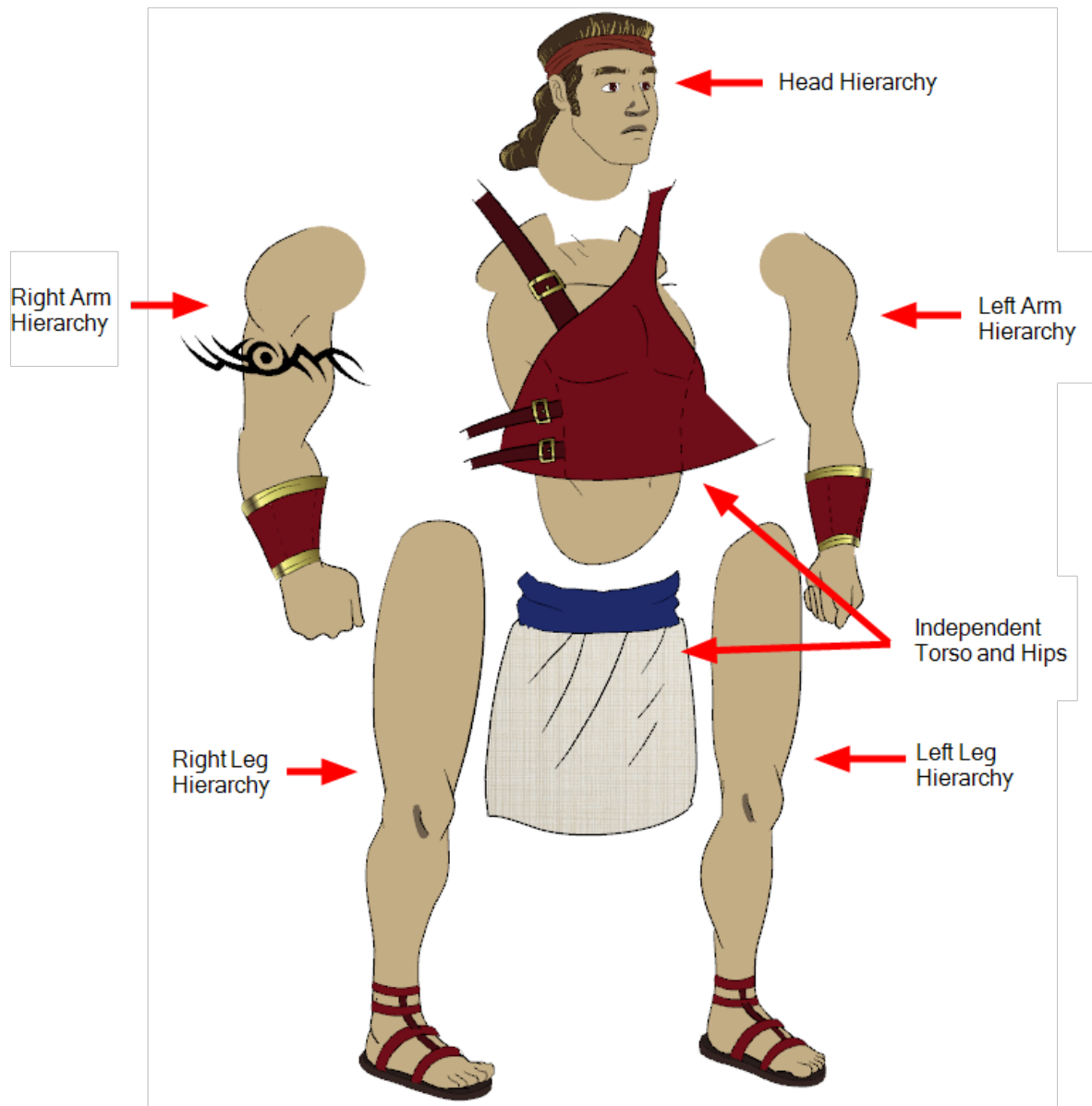

**To create a hierarchy in the Timeline view:**

- ▶ Drag the child piece (hand) and drop it **ON** the parent piece (forearm). Then, you can drag the parent (forearm) piece onto another parent piece (arm).

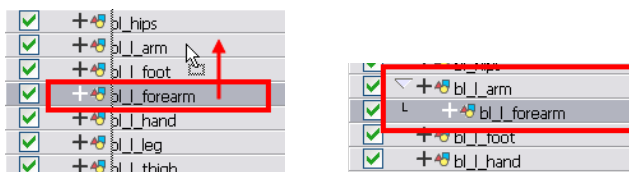

### To create a hierarchy in the Network view:

- ▶ From the parent part, drag a new cable connection out of the module's output port (bottom) and connect it to the child part module's input port (top).

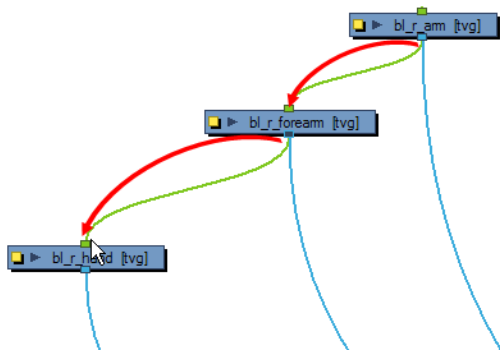

Here is an example of a rig with a simple hierarchy:

## Master Peg

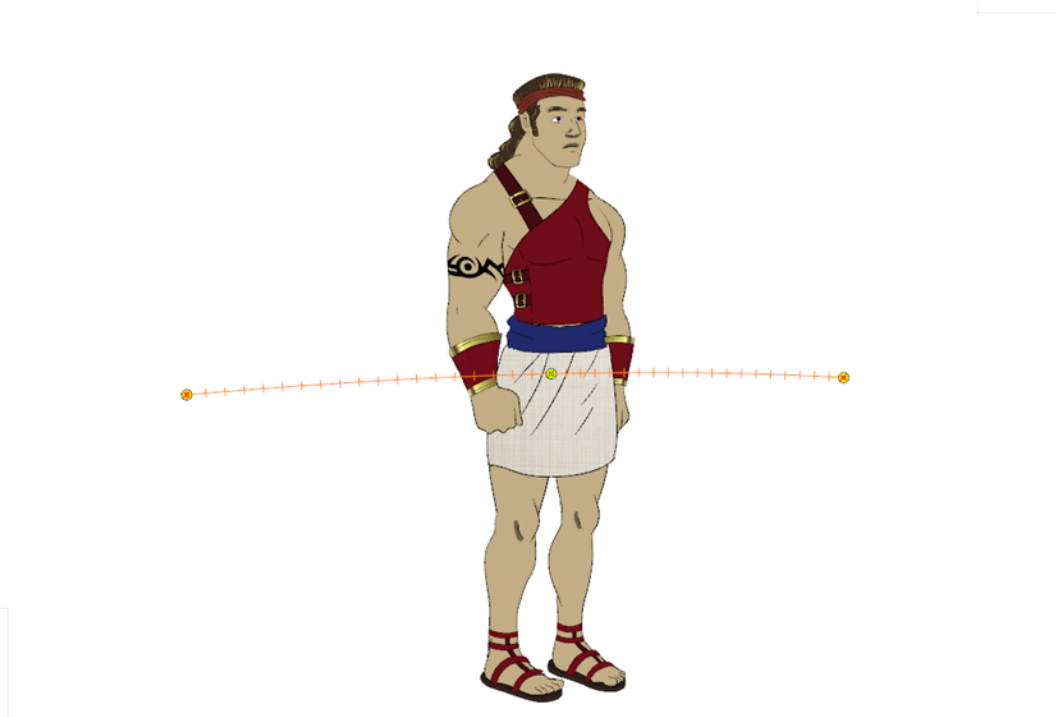

When you animate your character, you will probably need to resize and reposition it to fit your scene. When you need to scale down or move your character, it is a good idea to hook (attach) the whole puppet to a trajectory.

Attaching your puppet to a peg will allow you to scale it and reposition it without having to do this to your different parts and pieces. Only one layer will contain the position information, this makes your animation easier to modify and control.

### To add a Master peg:

1. In the Timeline view, deselect any selected layers and click on the Add Peg  button located in the Timeline Layers toolbar.
2. Name the new peg **Master** plus the character's name.
3. In the Timeline view, select all of the layers you want to attach to your new peg.
4. Drag your selection **ON** the peg layer to parent all your character's pieces to the peg.

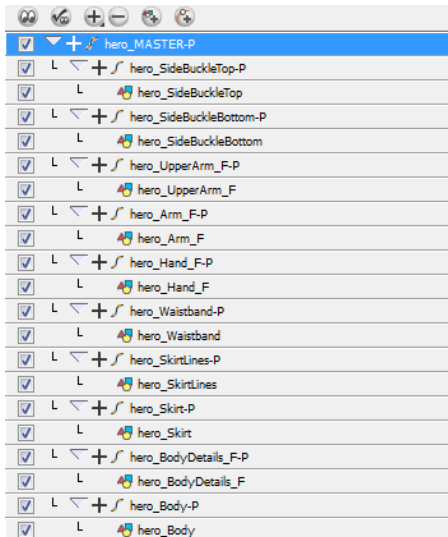

For more information about rigging a character, refer to the Toon Boom Online Help at [docs.toonboom.com/help/animate-pro](https://docs.toonboom.com/help/animate-pro).

---





# Chapter 9: How to Use Bone Deform

This chapter is divided as follows:

- [Rigging below](#)
- [Optimizing the Deformation Chain on page 39](#)
- [Display the Deformers' Controls on page 41](#)
- [Animation on page 42](#)

## Rigging

This topic explains how you can quickly use the Rigging tool to create a basic Bone and Articulation rig. Before you can create a Basic Deformation rig, you must set up the performance preferences which are necessary to allow the system to process the deformation effect efficiently.

**To create a basic deformation rig:**

1. You must set up the Performance Preferences. See note above. After you have done this continue to step 2.
2. In the Preferences panel, under the Deformation tab, disable the **Automatically Create New Deformer Structure for each Pose/Drawing**.

Disabling this preference will result in a simpler Network rigging structure.



But remember that this option must be re-enabled when rigging a multi pose (front, quarter, side and back) character.

3. From the Deformation toolbar, select the Rigging  tool.
4. In the Network or Timeline view, select the element that you want to add a deformation to.



5. In the Camera view, you can start to create a Bone rig.
  - ▶ To create a Bone rig:
    - ▶ Place the cursor at the far end of your element, click once and release. For example, on the shoulder.



- ▶ Click again at the location where you want your first bone to finish and your second bone to start. An articulation will automatically be inserted between each bones you create.

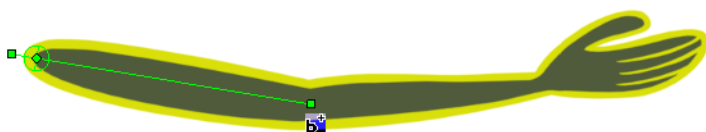

- ▶ Repeat this until you are finished creating the Bone chain.

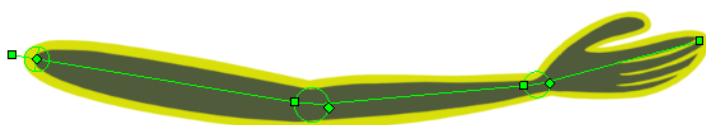

This will automatically create a Deformation Group connected to the top node of the selected element. This group includes all the necessary deformation modules as well as the Bones and Articulations you created.

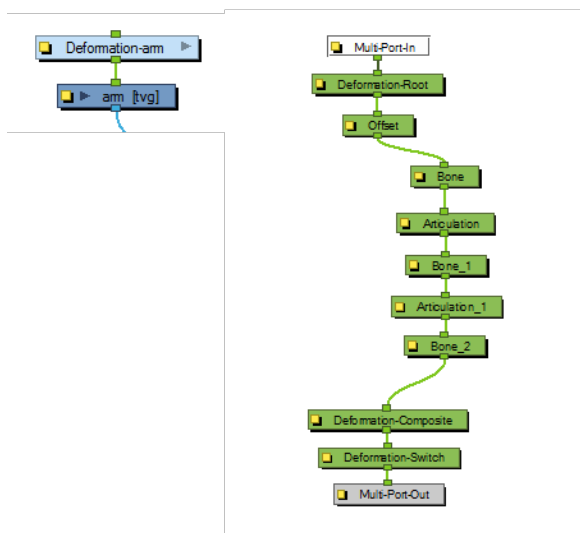

Note that this Network structure is the result of a simple rigging which was a created with the Create Posed Deformer in Create Deformation Above/Under preference disabled.

## Optimizing the Deformation Chain



Once you have a deformation chain created, you can optimize its positioning to fit the element it will deform. This task is done in the Setup Mode . The Setup Mode lets you set the resting position of the deformers to

make sure it is at the optimal position.

**To setup a bone and articulation deformation chain:**

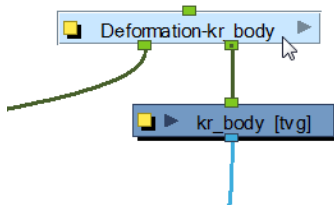
1. In the Network view, select the Deformation Group you want to setup.



2. In the Deformation toolbar, click on the Show Selected Deformers and Hide All Others  button to display the deformer controls in the Camera view. This also hides all the deformer controls that were displayed.
3. In the Deformation toolbar, enable the Setup Mode .

The chain will turn from light green to red. If the chain is displayed in green, it means the Setup Mode is disabled, click on the button once more to enabled it.

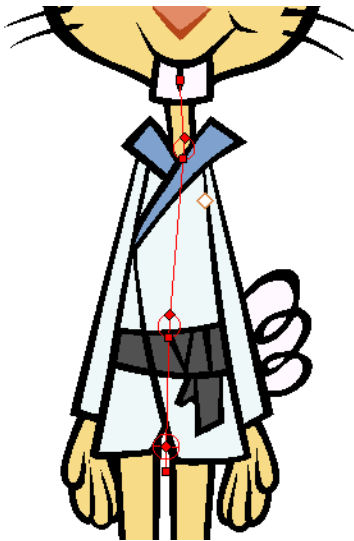

4. In the Tools toolbar, select the Transform  tool.
5. In the Camera view, setup the deformation chain.
  - Use the Pivot rotation handle to change the angle of the chain.

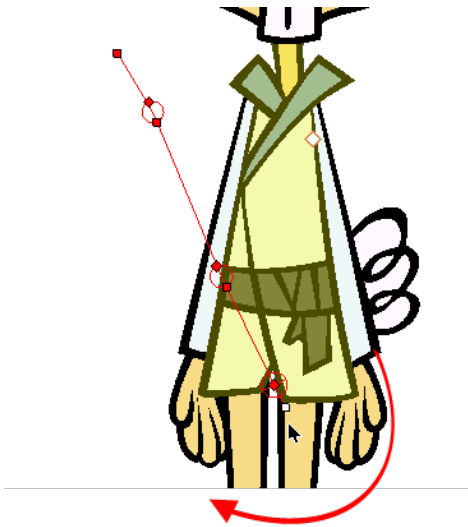

- Use the Pivot centre control point to reposition the entire chain.

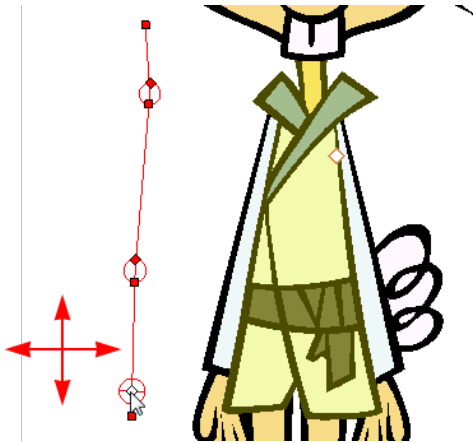

- Use the Articulation control point, the square at the bottom, to reposition the articulation. This will elongate, shorten or change the direction of the first bone.

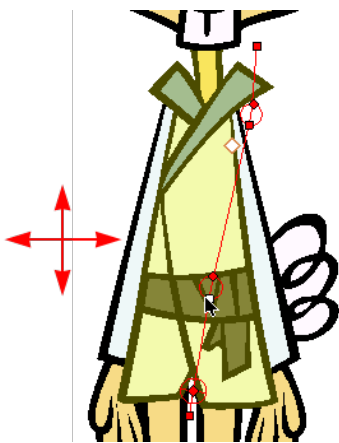

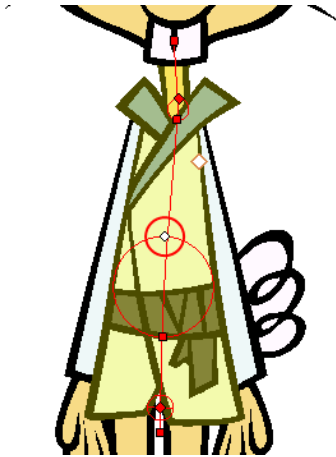

- Use the Articulation, top diamond-shaped, control point to change the size of the articulation. For quality purposes it is recommended to have an articulation which fits the diameter of the part it controls.

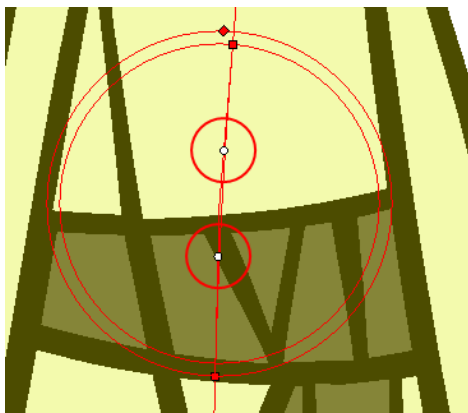

- In the Deformation toolbar, disable the Show Simplified Manipulators option to display all the manipulators. You will notice two extra square control points appearing in the middle of the articulation circle. Drag these up and down to modify the steepness (bias) of the articulation.



6. Repeat until all the articulations and bones of the chain are correctly aligned to the element it is linked to.
7. With the Deformation Group still selected, click on the Copy Resting Position to Current  button. This will make sure to set the current resting position as the current frame one.
8. In the Deformation toolbar, disable the Setup Mode  and test your modifications using the Transform  tool.



For optimal results, make sure the size of the articulation is about the same size as the drawing.

## Display the Deformers' Controls

To be able to manipulate the deformer outside of the Setup Mode, you must enable the Deformation Controls.



If you have just created the bone rig, the controls will still be showing. However, whenever you close your project the deformers are turned off, so when you reopen the project you can show the ones you need while you're animating.

You can also select all the modules from your Network view and select **View > Show > Controls** from the top menu.

#### To display the selected deformation controls:

1. In the Network view, select the Deformation Group containing the deformation chain you want to display.
2. In the Camera View toolbar, click on the Show Control  button. You can also select **View > Show > Control** from the top menu or press [Shift] + [F11].

#### To display the selected deformation controls and hide all the others:

1. In the Network view, select the Deformation Group containing the deformation chain you want to display.
2. In the Deformation toolbar, click on the Show Selected Deformers and Hide All Others  button.

The selected deformation controls will appear in the Camera view and all the others will be hidden.

#### To display all the deformer controls at the same time:

1. In the Top level of the Network view, select **Edit > Select All** from the top menu to select all the modules or press [Ctrl] + [A] (Windows/Linux) or [⌘] + [A] (Mac OS X).
2. In the Camera View toolbar, select Show Control  or press [Shift] + [F11]. This will display all the deformation controls in your scene.

#### To hide the deformer controls:

- ▶ In the Camera View toolbar, click on the Hide All Controls  button. You can also select **View > Hide All Controls** from the top menu or press [Shift] + [C].

## Animation

The Bone deformer operates the same as a human limb does and is composed of a pivot, as a starting point, and bones and articulations.

#### To manipulate a Bone and Articulation deformer:



1. In the Deformation toolbar, disable Setup Mode . When Setup Mode is disabled, the default colour of the deformation control is light green.



If you leave Setup Mode on, you will modify the resting position of the deformer chain, instead of animating it.



If you had made changes to your rig in Setup mode, you can select the deform group and click on **Copy Resting Position to Current** button. This resets the rig outside Setup mode to match what the rig looks like in Setup mode.

2. In the Tools toolbar, if you want to create keyframes, enable the Animate  mode.
3. In the Tools toolbar, select the Transform  tool.
4. In the Top level of the Network view, press [Ctrl] + [A] (Windows/Linux) or [⌘] + [A] (Mac OS X) to select all the modules, you can also select **Edit > Select All** from the top menu.
5. In the Camera View toolbar, select Show Control  or press [Shift] + [F11]. This will display all the deformation controls in your scene.
6. In the Camera view:

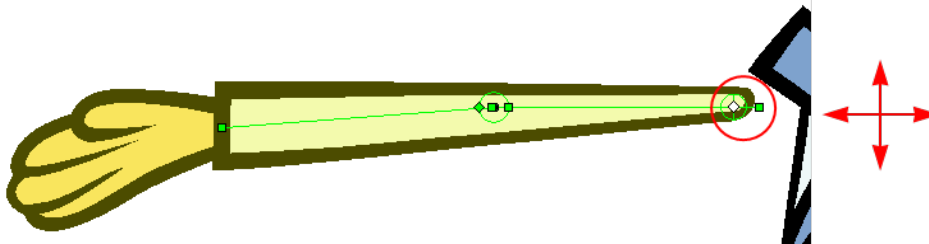

- ▶ Click on the centre of the Deformation-Root pivot and drag it around to reposition the entire limb.

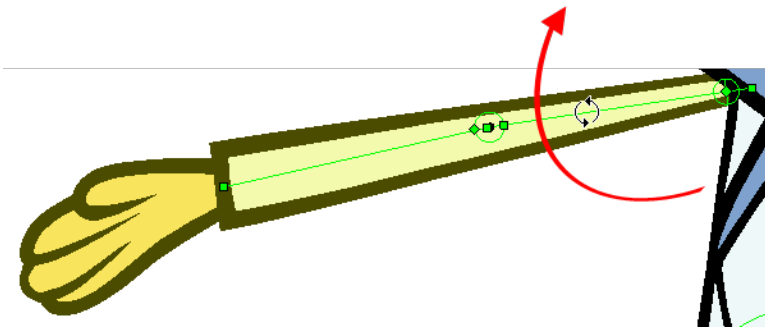

- ▶ Use the first bone or the pivot square handle to rotate the entire limb.

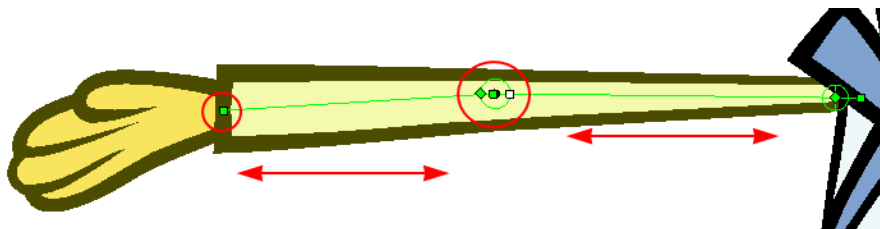

- ▶ Use the square control point located at the extremity of a bone to stretch or shorten its length.

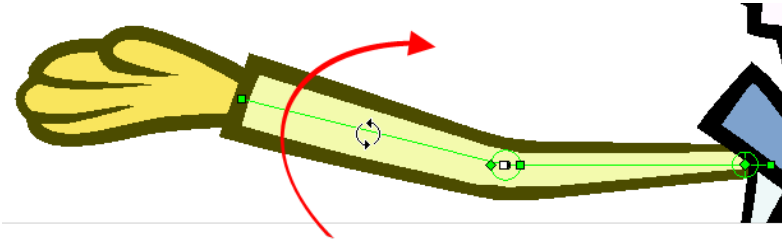

- ▶ Use a bone next to an articulation to rotate it. You can also hold down the [Alt] key, this will lock all the controls and movement and only allow the rotation of the articulation.

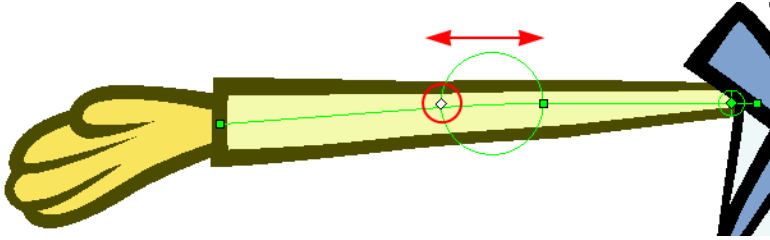

- ▶ Click and drag the articulation's diamond-shaped control point to modify its radius.



# Chapter 10: How to Animate a Cut-out Character

This chapter is divided as follows:



- [Animation](#) below
- [Navigating the Hierarchy](#) on page 47
- [Easing](#) on page 48

## Animation



To create a simple cut-out animation, follow these steps so you can try out the animation tools you will learn in the next topics.

### To create a simple cut-out animation:

1. In the Tools toolbar, select the Transform  tool. You can also press [Shift] + [T].
2. In the Tools toolbar, enable the Animate  mode so that everything you move will be keyframed automatically.
3. In the top menu, select **Animation > Stop-Motion Keyframe** so that the interpolation is not created automatically between your keyframes.
4. In the Timeline view, collapse your character.

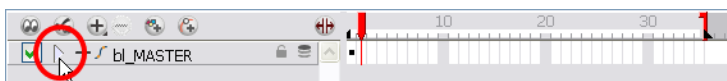

- In the Timeline view, go to the frame where you want to set your first pose.

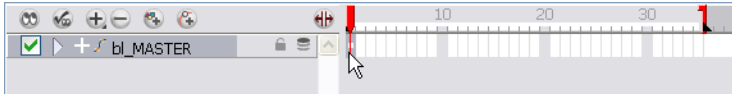

- In the Camera view, select the parts to animate.



- Using the Transform  tool, rotate, skew, scale or translate the selection to its new position.

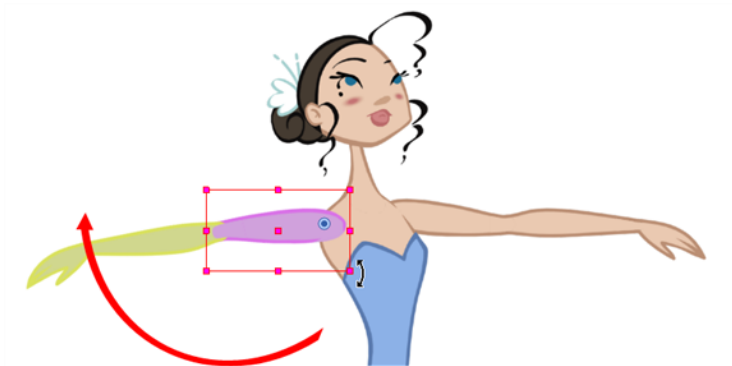

A new keyframe appears in the Timeline view.

- If you want to make sure that nothing will move on your new pose, in the Timeline view, select the frame corresponding to the pose, right-click and select Add Keyframe. You can also press [F6].
- In the Tools toolbar, enable the Onion Skin  feature.
- In the Timeline view, go to the frame where you want to set your second keyframe.



- In the Camera view, animate your character.

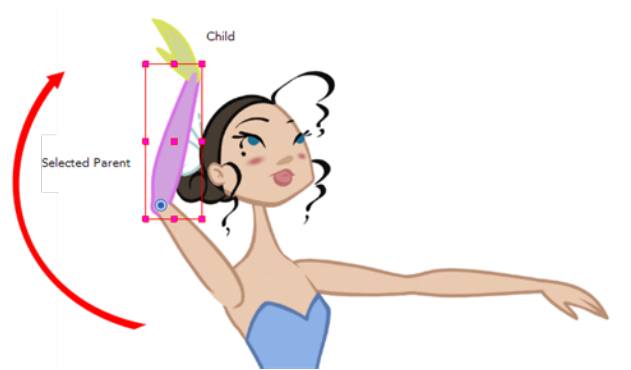

12. Repeat this process until all your poses are done.

## Navigating the Hierarchy

If you created a layer hierarchy when you built your puppet, you can use the keyboard shortcuts to travel up and down the parent-child chain. You can also travel between the children in a layer.

**To select the parent or child layer:**

1. In the Tools toolbar, select the **Transform**  tool.
2. In the Camera or Timeline view, select a layer attached to a hierarchy.

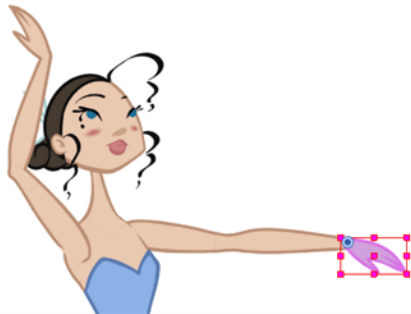

3. Select **Animation > Select Parent Skipping Effects** to select the parent layer and select **Animation > Select Child Skipping Effects** to select the child layer. The keyboard shortcuts are [B] and [Shift] + [B].



That these keyboard shortcuts will ignore any effect module encountered in the Network or Timeline view. Only drawing and peg modules will be considered. If you would like to navigate the hierarchy including the effect modules, you create a custom keyboard shortcut in the Preferences panel for the Select Parent Skipping Effects and Select Child Skipping Effects commands under the General category.

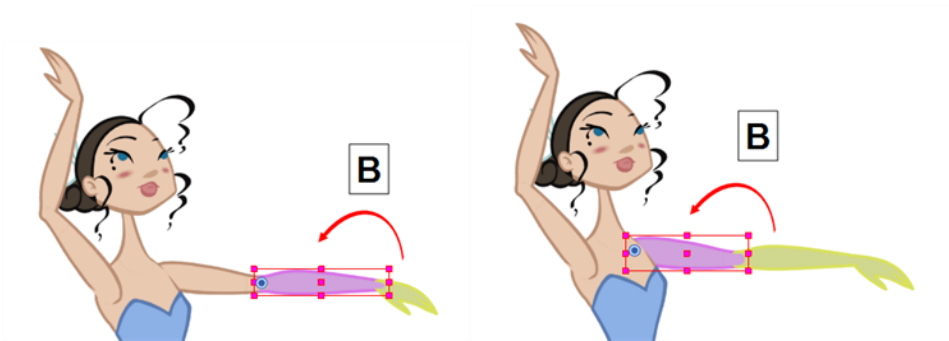

## Easing

If you have several functions you would like to adjust the velocity for at the same time, such as the hand, forearm and arm of a cut-out character, you can use the Set Ease for Multiple Parameters dialog box. It allows you to apply the same velocity parameters to all the selected keyframes in one frame.

**To set an ease for multiple parameters:**

1. In the Timeline view, select a keyframe from one or many layers.

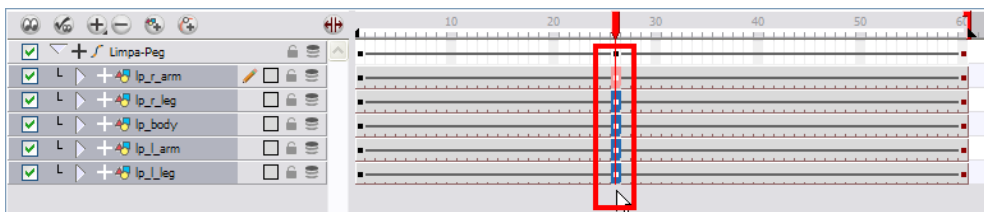

Only the first keyframe selected on a given layer will be considered when using the Set Ease For Multiple Parameter function. If many keyframes are selected on the same layer, the ease values will only be applied to the first one, the rest will be ignored.

2. In the Timeline view, right-click and select **Set Ease For Multiple Parameters**. In the Timeline View toolbar, you can click on the **Set Ease For Multiple Parameters**  button. If the button is not in the Timeline View menu by default, you can add it through the Toolbar Manager (Customize).

The Set Ease For Multiple Parameters dialog box opens.

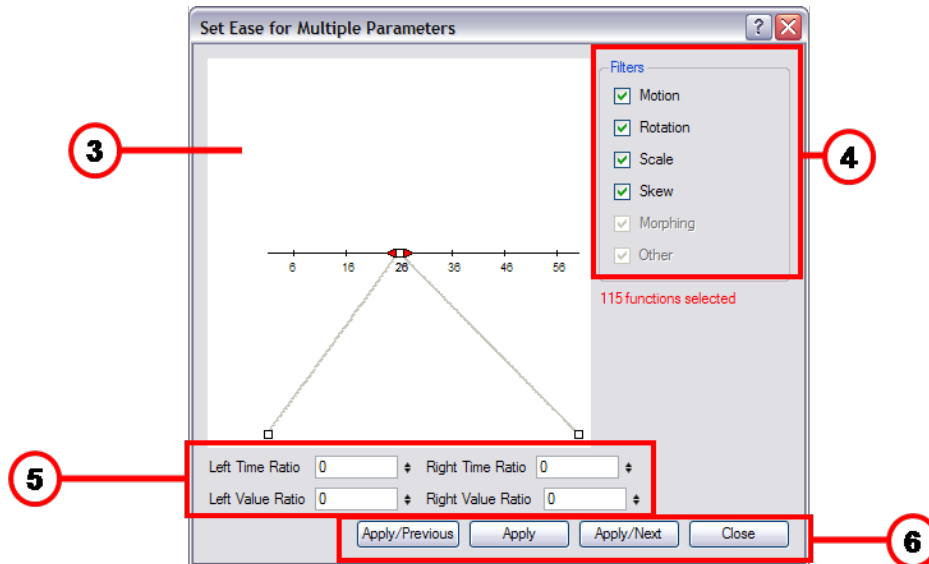

3. In the graph interface, pull on the Bezier handle to adjust the velocity for all the selected functions.

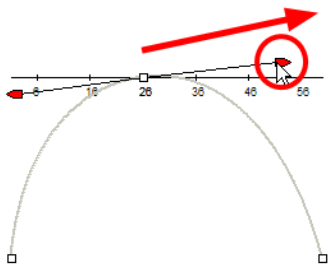

4. If you want to apply these easing parameters to a certain type of function only, such as Rotation or Scale, in the Filters section, disable the function types you do not want to affect.
  - ▶ **Motion:** If this option is enabled, the easing parameters will be applied to the selected Position X, Position Y, Position Z and 3D Path functions
  - ▶ **Rotation:** If this option is enabled, the easing parameters will be applied to the selected Angle functions.
  - ▶ **Scale:** If this option is enabled, the easing parameters will be applied to the selected Scale functions.
  - ▶ **Skew:** If this option is enabled, the easing parameters will be applied to the selected Skew functions.
  - ▶ **Morphing:** If this option is enabled, the easing parameters will be applied to the selected Morphing Velocity functions. Note that it applied to the Morphing velocity function found in the Layer Properties dialog and not to the basic morphing ease in the Tool Properties view.
  - ▶ **Other:** If this option is enabled, the easing parameters will be applied to all the other selected functions such as all functions created to animate effect parameters.
5. You can also adjust the easing by typing values in the Time Ratio and Value Ratio fields. The values are calculated in percentage.
  - ▶ In the Left Time Ratio and Right Time Ratio fields, type the percentage value corresponding to the length of time you want the easing to last for. The value must be between 0% and 100%.
  - ▶ In the Left Value Ratio and Right Value Ratio fields, type the percentage value of how strong you want the easing out to be. The value must be between 0% and 100%.
  - ▶ If your Time Ratio and Value Ratio values are equal, you will have a linear motion.
6. Once done, click on one of the following button:

- ▶ **Apply:** This will apply the easing parameters to the selected keyframes.
- ▶ **Apply/Previous:** This will apply the easing parameters to the selected keyframes and then selects the previous keyframe in the timeline.
- ▶ **Apply/Next:** This will apply the easing parameters to the selected keyframes and then selects the next keyframe in the timeline.
- ▶ **Close:** This closes the dialog box. If you did not apply the modifications, they will be cancelled.

# Chapter 11: How to Create Templates

You can create a template out of a layer or cells. You can store anything available in the Timeline view as a template.



When creating a template from the Timeline view, it will lose the extra connections, effects and groupings from the Network view.



Creating a template selecting a layer will incorporate the layer and all the drawings that were created in it, even if they're not exposed in the Timeline view. Selecting cells will only save those specific drawings in the template.

## To create a template from the Timeline view:

1. In the Timeline view, select some cells or layers.
2. In the Library view, select the folder in which you want to store the template.
3. If the library folder is locked, right-click and select **Right to Modify**.
4. Drag the selection to the Animate Pro Library folder or to any other library folder.

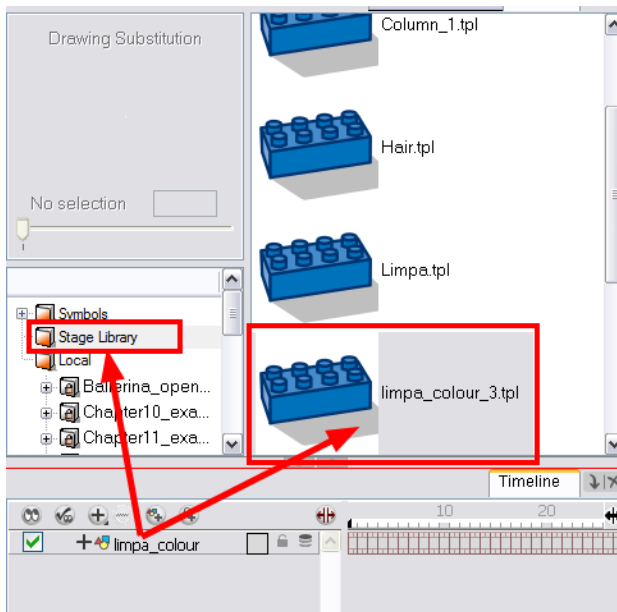

5. In the Rename dialog box, rename the new template.

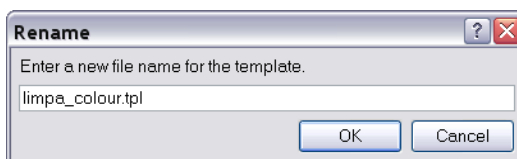

If you want to rename a template once it is created, right-click on it and select Rename.

- Click OK.

### To import a template in the Timeline view:

- In the Library view, select the template you want to import.
- Drag the selected template to the Camera view or Timeline view's left side.

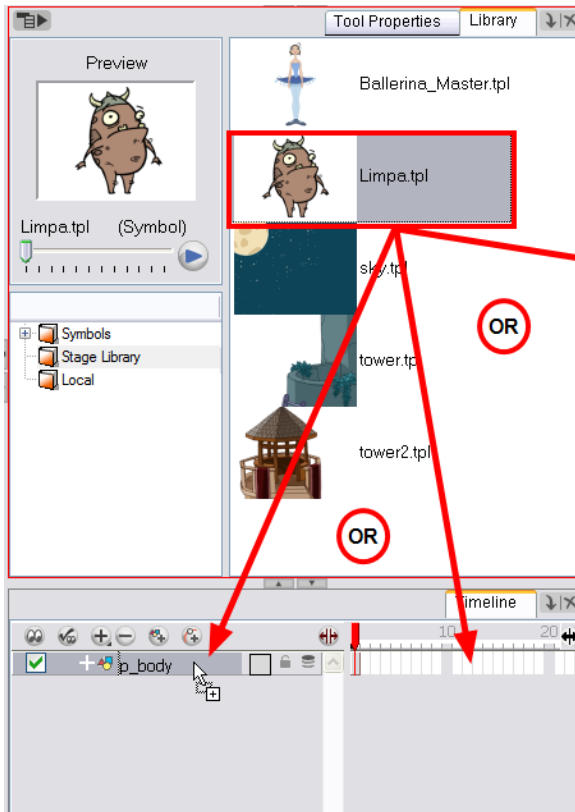

- You can also drag a template to the Timeline view's right side into existing layers if the layer structure is the same as the existing one.

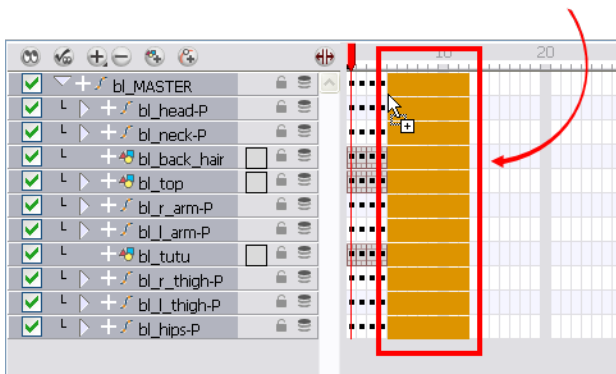

## Creating a Template from the Network View

The Timeline and the Network views have different ways to display the scene, each view displaying different information.

A main character's template, also known as master template, is created from the Network view. This template contains all of the connections, effects, composites, modules, pegs, advanced groupings, function columns,



scene lengths, drawings, timings, etc. The template is saved in the Library view and must be imported back into the scene for use, either into the Network view or into the left side of the Timeline view.

#### To create a template from the Network view:

1. In the Library view, select the folder in which you want to store the template.
2. If the library folder is locked, right-click and select **Right to Modify**.
3. In the Network view, select the modules you want to create a template with and group them. It is very important to group your cut-out character rig, previous to storing it in the Library.
4. Select **Edit > Group > Group Selected Layers** or press [Ctrl] + [G] (Windows/Linux) or [⌘] + [G] (Mac OS X).

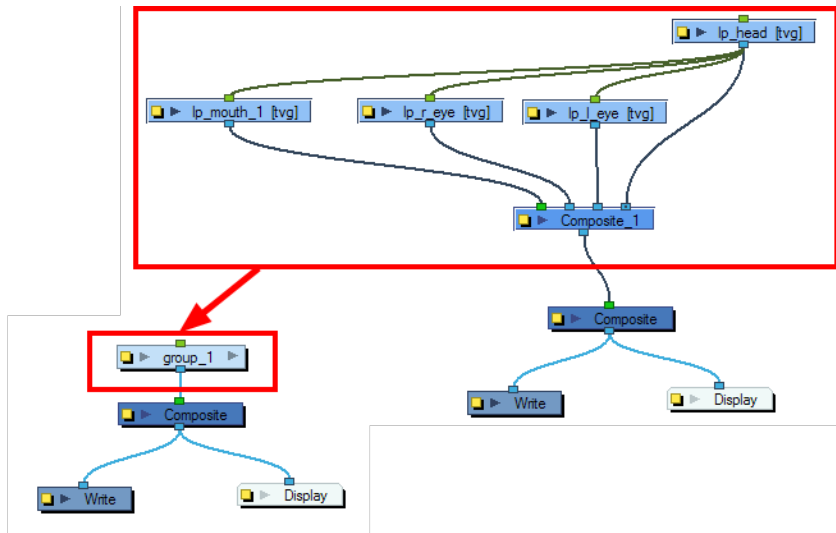

5. In the Network view, click on the group module's yellow button to rename it. The Layer Properties dialog box opens.

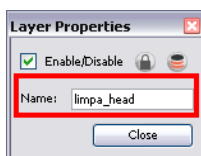

6. In the Network view, select your group module and copy and paste it inside the template folder in the Library view or press [Ctrl] + [C] and [Ctrl] + [V] (Windows/Linux) or [⌘] + [C] and [⌘] + [V] (Mac OS X).

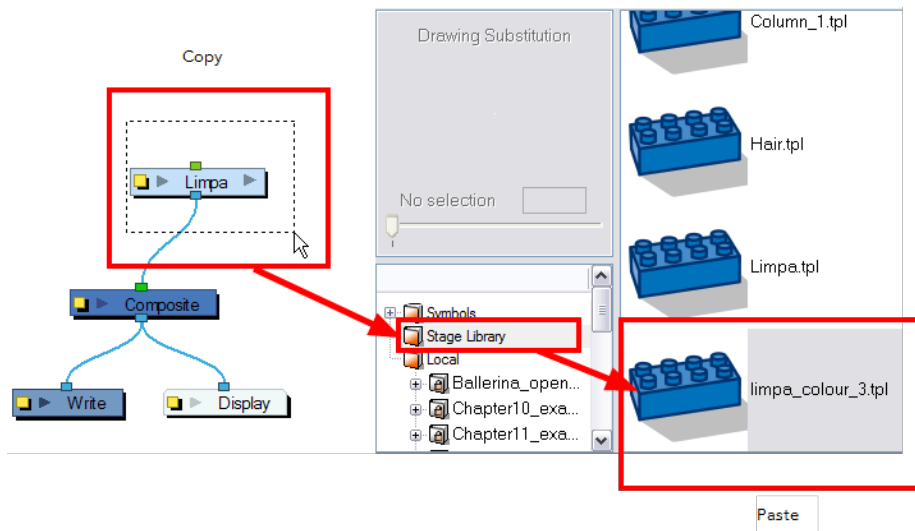

7. In the Rename dialog box, rename the new template.

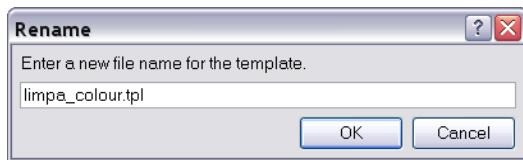

- ▶ To rename a template, right-click on it and select Rename.

8. Click OK.

# Chapter 12: How to Setup a Scene

This chapter is divided as follows:

- [Positioning the Camera below](#)
- [Positioning Objects on page 57](#)
- [Repositioning the Pivot on page 59](#)

## Positioning the Camera



Refer to [How to Animate Objects and the Camera on page 61](#) to learn how to animate the camera.

To set the camera frame, add a Camera layer into your scene so you can edit the default camera frame.

**To add a Camera layer in the Timeline view:**

1. In the Timeline view, click the Add Layer  button or select **Insert > Camera** from the top menu.
2. Select Camera from the drop-down menu.

A new camera layer is added to your scene and appears in the Timeline view.

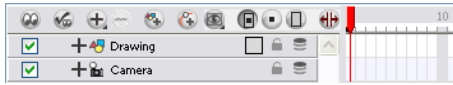

You cannot add a camera inside a symbol. If you try to do so, a warning message will pop-up and inform you that this operation is not possible.



If you've added more than one camera to your scene, you can switch the active camera by going to **Scene > Camera** and selecting the camera you want to use.

In Toon Boom Animate Pro, you can also use the Network and Module Library views to add a camera layer into your scene.

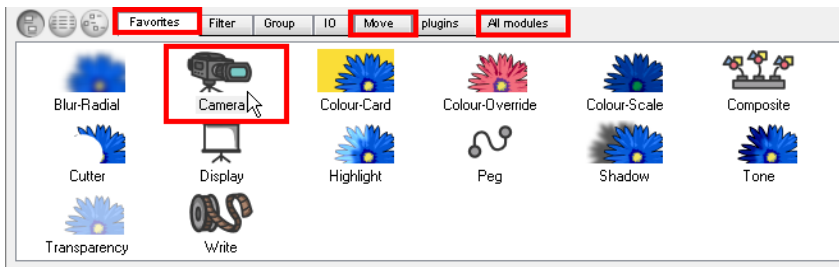

**To add a Camera module in the Network view:**

1. Display the **Network** view.
2. In the **Module Library** view, select a **Camera** module from the **Favorites**, **Move** or **All Modules** tab.

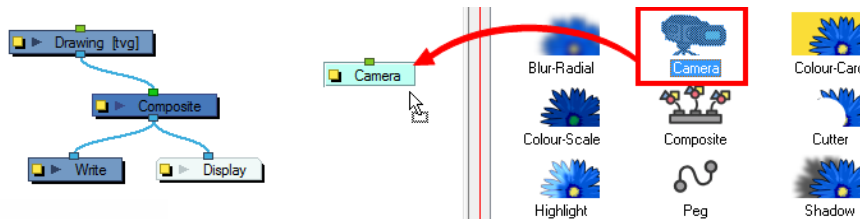

3. Drag the **Camera** module into the **Network** view.



You can reposition your camera frame directly in the Camera view, using the Translate  and Rotate  tools.

To reposition the camera frame directly in the Camera view:

1. Select **Animation > Tools > Translate** or press [Alt] + [2].
2. In the Camera view, click on the camera frame to select it. You can also select the camera layer from the **Timeline** view.

The selected camera frame is highlighted in purple.

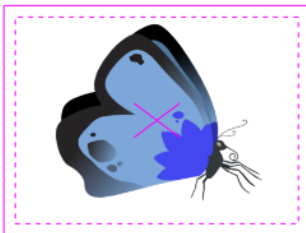

3. Drag the camera frame to a new position.

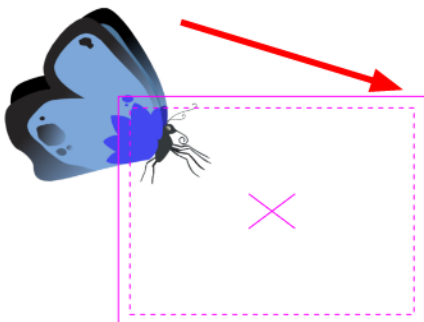

4. To tilt the camera frame, select **Animation > Tools > Rotate** or press [Alt] + [3].
5. In the Camera view, click on the camera frame to select it and rotate the camera frame until it reaches the desired rotation angle.

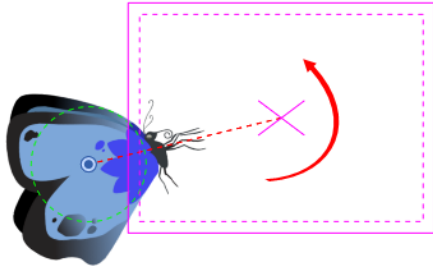

The Translate and Rotate tools can also be found in the Advanced Animation toolbar.

---

## Positioning Objects

---





Refer to [How to Animate Objects and the Camera on page 61](#) to learn how to animate objects.

---

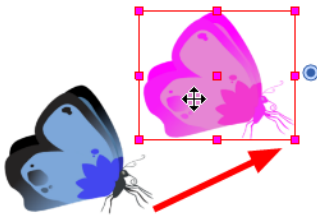

To pan a layer using the Transform tool:

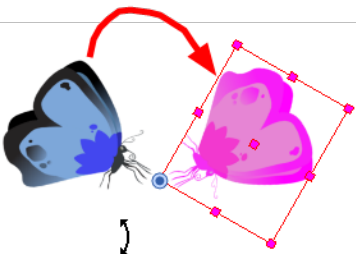

1. In the Tools toolbar, select the Transform  tool.
2. In the Transform tool Tool Properties view, make sure that the Peg Selection Mode  is disabled.
3. In the Camera view, select a drawing layer and drag the selection to a new area.

To rotate a layer using the Transform tool:





1. In the Tools toolbar, select the Transform  tool.
2. In the Transform tool Tool Properties view, make sure that the Peg Selection Mode  is disabled.
3. In the Camera view, select the drawing layer and rotate the transform bonding box handle.

A preference found in the Camera tab will add a rotation handle to your object's bounding box. This preference is off by default.



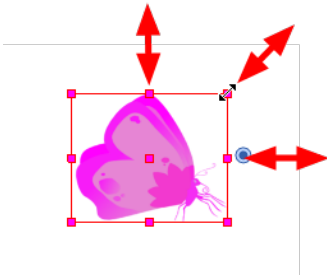

**To scale a layer using the Transform tool:**

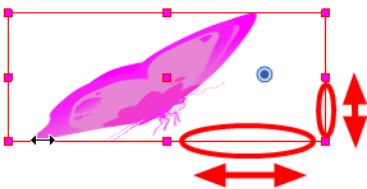

1. In the Tools toolbar, select the Transform  tool or press [Shift] + [T]
2. In the Transform tool Tool Properties view, make sure the Peg Selection Mode  is disabled.
3. In the Camera view, select the drawing layer and then pull or push either on the size, top or corner control point. Hold down [Shift] to lock the selection's ratio.

**To skew a layer using the Transform tool:**





1. In the Tools toolbar, select the Transform  tool.
2. In the Transform tool Tool Properties view, make sure that the Peg Selection Mode  is disabled.
3. In the Camera view, select the drawing layer and drag sideways or up and down the sides or top and bottom segments, between the control points.

## Repositioning the Pivot

Some transformations, such as the rotation, scale, skew and flip, are made relative to the pivot point position. Reposition this pivot point anywhere using the current Advanced Animation tool.

**To permanently reposition the pivot point:**

1. In the Advanced Animation toolbar, select the **Rotate** , **Scale**  or **Skew**  tool.
2. In the Camera view, [Ctrl] + click (Windows/Linux) or [⌘] + click (Mac OS X) to select your element. The pivot point appears in the Camera view.

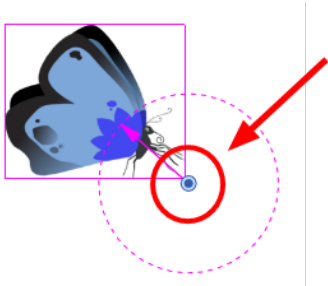

3. Click the pivot point and drag it to a new position.

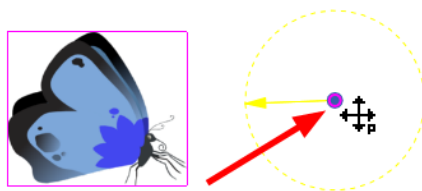

This is the new position of the pivot point for future transformations until you reposition it.



Using the Advanced Animation tools to reposition your pivot permanently overrides the existing pivot point position until you change its position again.

---





# Chapter 13: How to Animate Objects and the Camera

This topic is divided as follows:

- [Animating a Layer below](#)
- [Animating the Camera on page 63](#)

## Animating a Layer

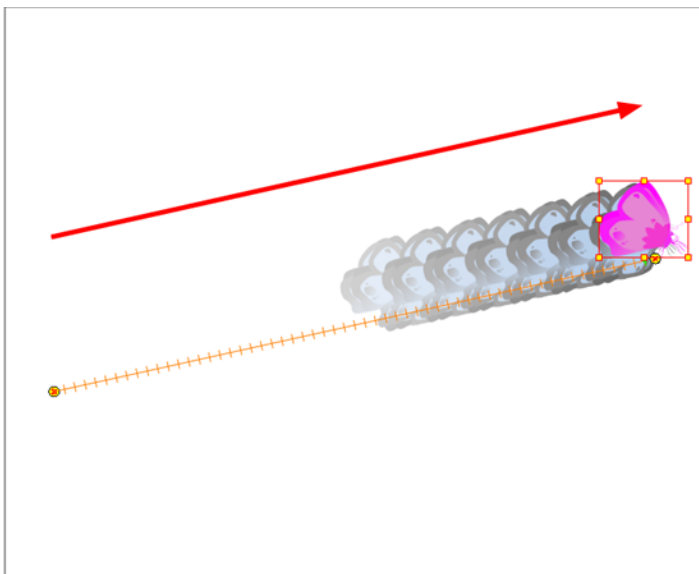

You can create a motion path directly on your layers.

Drawing layers can house drawings and symbols. Also, in that same layer you can create a motion path using keyframes and all the artwork contained in the layer will follow.

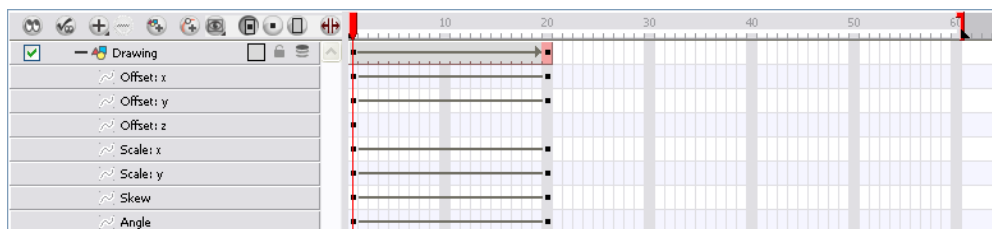

You can control and define your trajectory using several different parameters. These parameters are:

- X, Y and Z positions
- Angle (rotation)
- Skew
- X and Y scales



Each parameter has its own function curve where you can add keyframes and control the easing.

Do not worry about using graphs and function curves if you are not familiar with this concept. Animate Pro has a series of easy-to-use tools for visually controlling your trajectories in the **Camera** view.

To animate a simple object such as an arrow in flight or a wheel spinning, you can use the integrated trajectory. Also, each part of a cut-out puppet will be animated directly on the drawing layer.

Follow these simple steps to perform a basic layer animation.

#### To animate a layer:

1. In the Tools toolbar, select the Transform  tool or press [Shift] + [T].
  - ▶ In the Tool Properties view, make sure the Peg Selection Mode  button is disabled so you can select your drawing layer directly and not the pegs. Refer to the section to learn more about this option.
2. In the Tools toolbar, enable the Animate  mode .
3. In the Timeline view, go to the first frame.

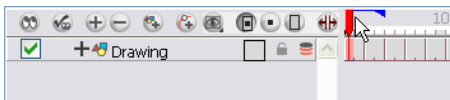

4. In the Camera view, select the element to animate and move it to its first position.



5. In the Timeline view, go to the frame where you would like to set the second position.

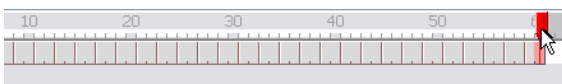

6. In the Camera view, move the selected element to its new position.

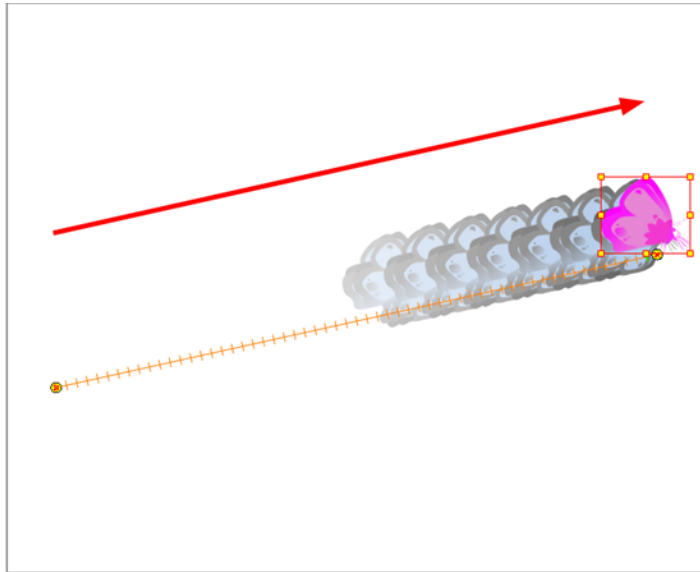

7. In the Playback toolbar, click the Play  button to view your work.

## Animating the Camera

The camera is treated the same way as any other element. The same tools and selection modes are used to offset or animate it. To animate the camera, you need to connect it to a peg element.

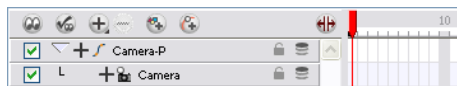

This means that you can animate the camera visually, with the function curve, or by typing values in the Xsheet column.

### To add a camera with a peg to your scene:

1. If you do not already have a camera layer, add one in one of two ways:
  - From the top menu, select **Insert > Camera**
  - From the Timeline View Layers toolbar, click the Add Layers  button and select Camera.
  - From the Library view, select a Camera module and drag it to the Network view.

A new camera layer is added to your scene and appears in the Timeline view.
2. From the Timeline View Layer toolbar, click the Add Peg  button.

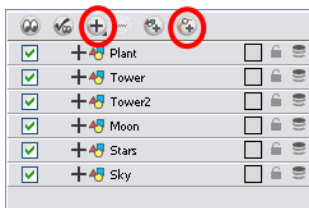

A peg layer appears directly above the camera layer so that the camera layer is automatically attached to it. The peg layer automatically takes on the name of the camera and adds the suffix **-P** to indicate that it is a peg layer, for example **Camera-P**.

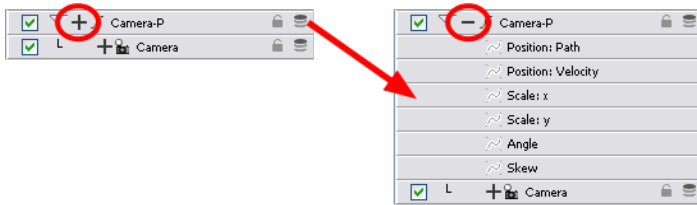

If the new peg layer did not appear directly above the camera, you may have clicked elsewhere in the scene, deactivating the layer on which you want to add the peg layer.

- ▶ Select the camera layer and drag and drop in under the new peg layer.

OR

- ▶ Delete the misplaced peg layer, select the camera layer and click the Add Peg  button again.
- ▶ Select a Peg module from the Library view and drag it to the Network view and then you can connect the peg's out port to the camera's input port.

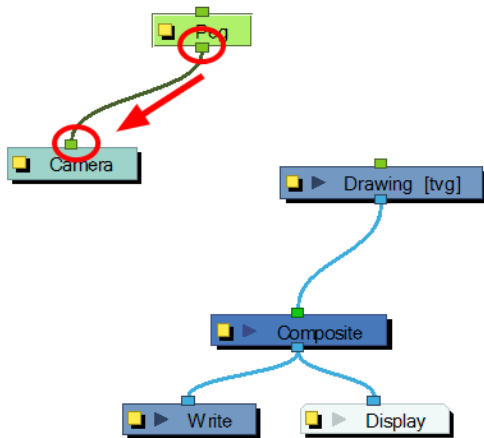



You are now ready to animate your camera.

It is recommended to use both the Top and Camera views while making camera moves. You can open this view is one of two ways:

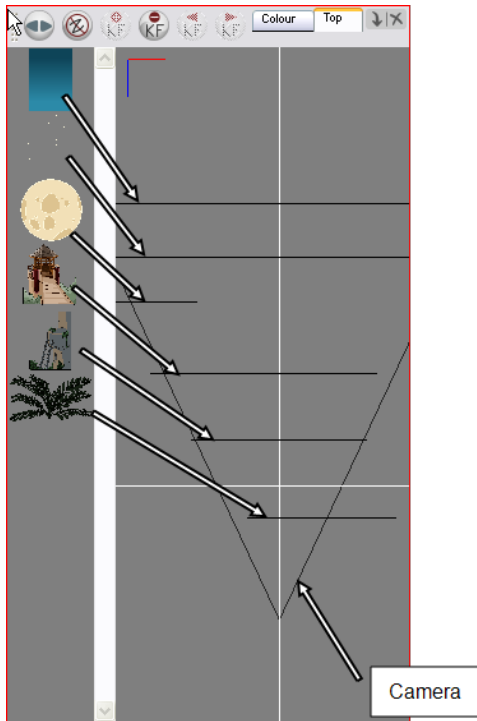
- From the top menu, select **Windows > Top**.
- From any existing window already open in your project, click the arrow  button in the top-right corner and select **Top**.



**To animate your camera:**

1. Make sure that the Animate  button and Transform  tool are activated.
2. In the Top, Side or Camera view, select the camera and move it to the desired position.
  - ▶ In the Top and Side view, the camera is the large V cone. You need to click directly on one of the edge.
  - ▶ In the Camera view, the camera is represented by a thin frame. You need to click directly on one of the edge.

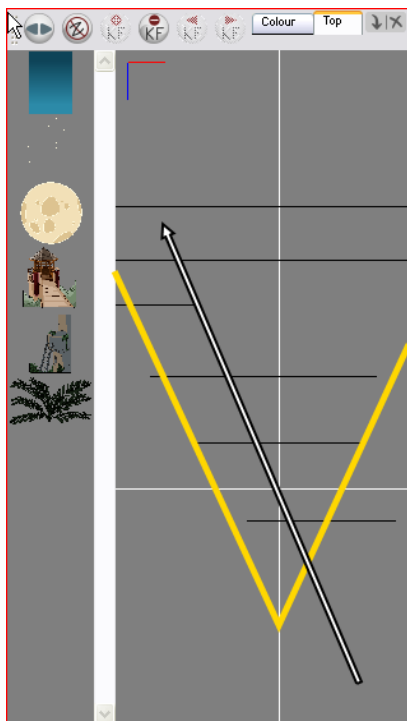

3. In the Timeline view, click on a cell in the Camera Peg layer where you want the camera move to begin.
4. Right-click and select Insert Keyframe.



A keyframe appears in that cell. Any frames preceding this keyframe cell will hold the same camera position as in this keyframe.

5. Click on another cell, further down your scene's Timeline, where you want the camera move to end.
6. Select the camera in the Top view and move it to the desired position.

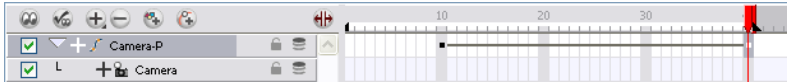

A second keyframe appears and a line is created between the two frames to indicate that the subsequent motion between the frames will be calculated and rendered by the program.

7. Play back  the camera move in the Camera view to watch the results.

# Chapter 14: How to Create a Multiplane



To construct a multiplane, you must imagine what a real environment is like. Take a look at your background picture and imagine a camera moving across the space. You will notice that objects in the picture would move at different speeds depending on where they are in relation to the camera lens.

Building a multiplane requires an understanding of the scene's background as well as the positioning of the elements on different layers.

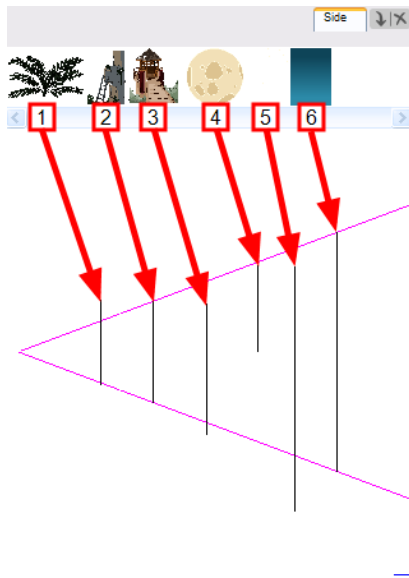

For example, in this background, the main objects to be separated are:

1. Fern
2. Front tower
3. Second tower
4. Moon
5. Stars
6. Sky



Although the bottom of the tower is hidden behind the plant and the ladder, each of your multiplane layers should be a complete scene. This is because hidden portions may show up during a camera movement later on in the scene

Now is the time to distribute the layers composing your multiplane along the Z-axis, maintaining their distance. You can position your layers on the Z-axis in the Side and Top view.

Positioning your element toward the camera will make your element bigger. Using the Maintain Size  tool, you will be able to drag your element toward the camera while keeping the same size aspect in the Camera view. This tool is available in the Advanced Animation toolbar.



It is a good idea to keep a Camera view opened to see what your scene looks like while positioning your element in the Top or Side view.

## Positioning Elements in the Top and Side Views

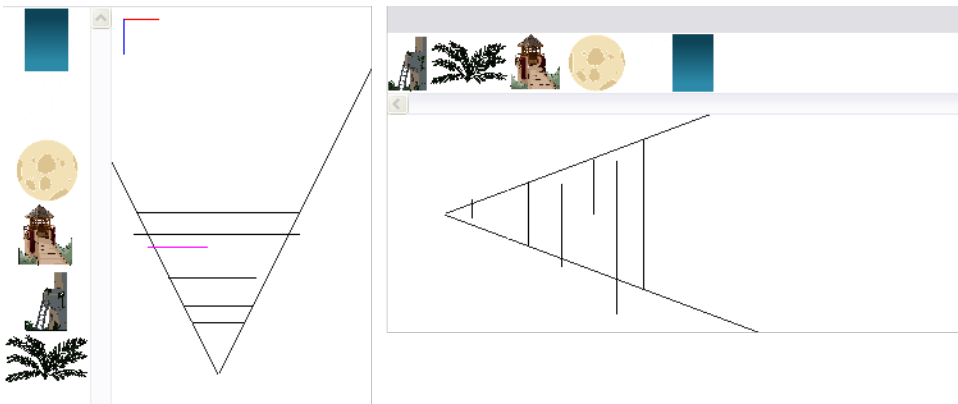

To be able to distribute the layers along the Z-axis using the Top and Side views, disable the No Z Dragging option by selecting **Animation > No Z Dragging**.

### To position your element in the Top and Side views:

1. In the Advanced Animation toolbar, click the Maintain Size  tool or press [Alt] + [6].
2. In the Side view, select one of the layers in the thumbnails section of the Top or Side view. You can also select your layer from the Timeline view.

The selected layer will be highlighted in the camera cone.



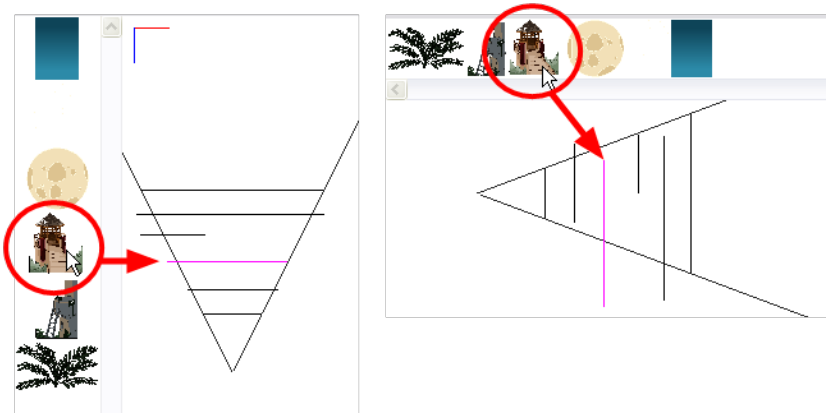

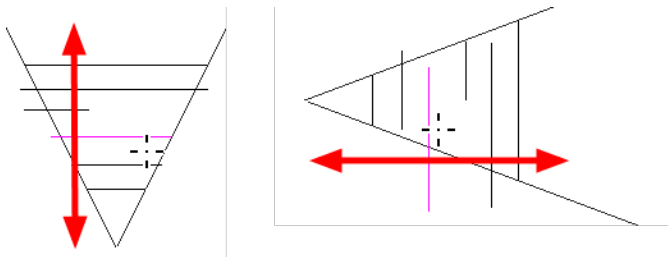

3. Click and drag the layer to the correct depth position in the camera cone. Your element aspect will remain the same in the Camera view.



4. In the Tools toolbar, click the Transform  tool, or select the Translate  tool in the Advanced

Animation toolbar and select a layer from the thumbnails section of the Top or Side view. You can also select your layer from the Timeline view.

- If you choose the Transform  tool, make sure that the Peg Selection Mode  option is disabled in the Transform tool's Tool Properties view.

The selected layer will be highlighted in the camera cone.

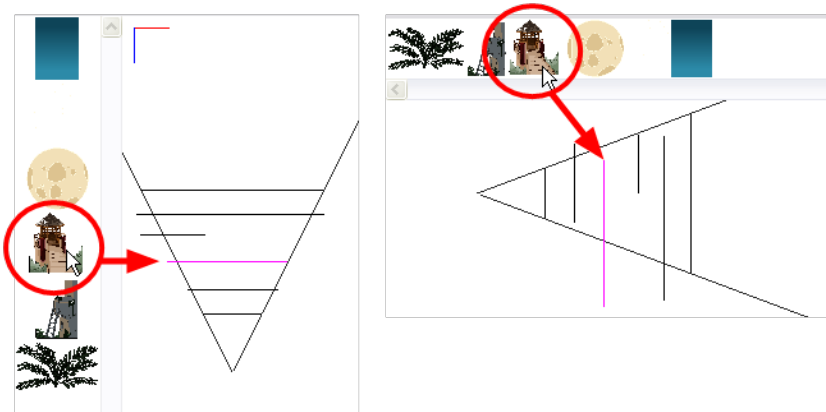

5. In the TOP view, drag the element sideways to position horizontally. You can press and hold [Shift] while dragging the element to make sure it only moves along the X-axis.
6. In the Side view, drag the selected element up or down to position it vertically. You can press and hold [Shift] while dragging the element to make sure it only moves along the Y-axis.



# Chapter 15: How to Set-up Objects in the 3D Space

Once you have your drawings and symbols assembled, it is time to position them. This section explains how this is done using the simple room shown previously.

To position your layers, you require the following elements:

- Camera View
- Top View
- Side View
- Perspective View
- Library View
- Timeline View
- 3D Transformation Tools
- Layer Properties View or dialog box

To position layers in the 3D space:

1. In the Timeline view, double-click on the new layer to open the Layer Properties dialog box.
2. In the Transformation tab, check the **Enable 3D** option.

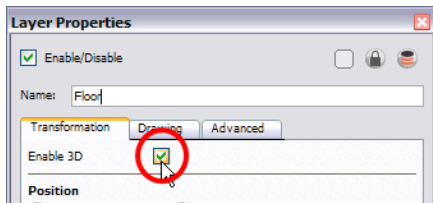

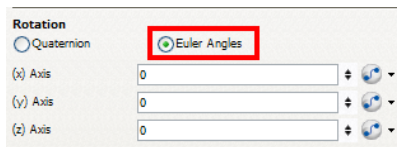

3. In the Rotation section, enable the Euler Angle option.

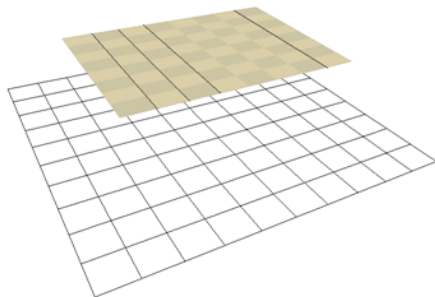

4. Type **90** in the Rotation's (x) Axis field to flip the floor so that it is flat on the ground.



5. To position the height of the floor, you can either type values in the Position section of the Layer Properties, use the 3D Translate  tool or the 3D Transform  tool.
6. Repeat the process for the other pieces to import.
7. If you have parallel walls, once you have positioned one, select the Wall layer in the Timeline view.
8. In the top menu, select **Edit > Duplicate** to duplicate the layer.



If the drawing is contained inside a symbol, the symbol will not be duplicated, only the layer containing the symbol. This way you are still using the same drawing.

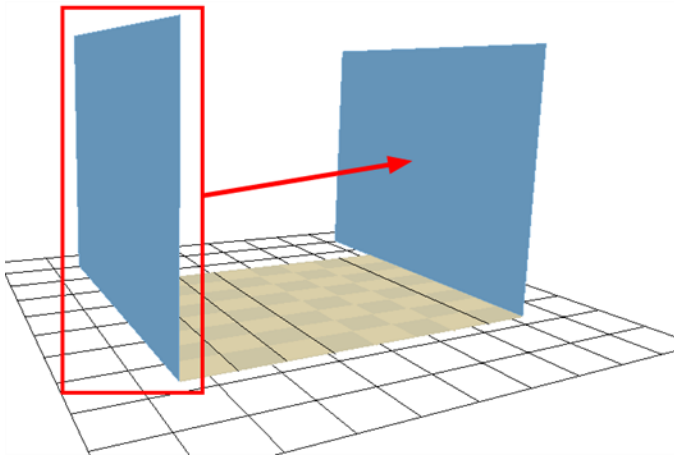

9. Once the layer is duplicated, use either the Layer Properties window to type the positioning values, or use the 3D transformation tools.
10. When you are using the transformation tools, use the Camera, Top or Side view to position the elements instead of the Perspective view to position your layers precisely.

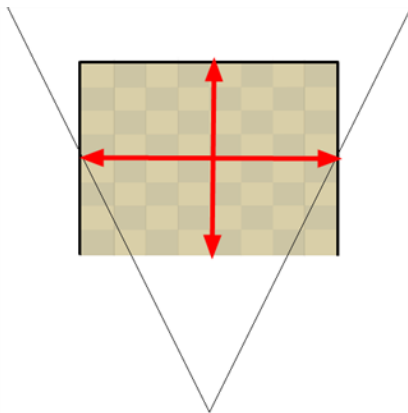

11. If your walls are touching each others, you should have them intersect by extending one end of the wall through the other wall. This prevents seeing a small gap in-between them.

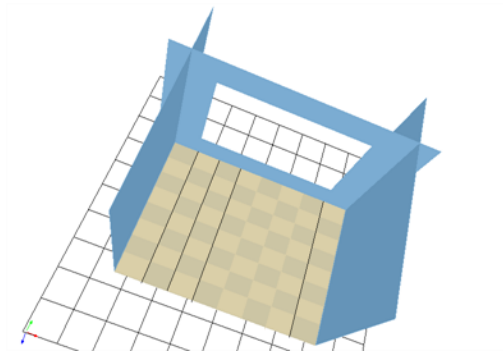

There you go, you now have a complete 3D room.

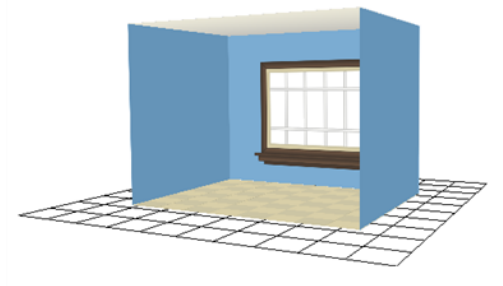



# Chapter 16: How to Import Sound and Add Lip-Sync

If you decide to add sound to your movie, you must first prepare this sound outside of Animate Pro. When this is done you must add a sound element in Animate Pro to the organize sound files in your animation. Sound will play in the movie until it reaches the end of the file or a stop frame that you have created in the Sound Element Editor.



If you first create your project in Toon Boom Storyboard Pro, the sound will be cut up into the different scenes for you automatically.

You can import WAV, AIFF or MP3 sound files using any of the methods listed below.

## To import a sound file:

### 1. Select **File > Import > Sound**

- ▶ Right-click anywhere in the frame zone of the Xsheet view.
- ▶ From the Top menu
- ▶ From the Xsheet View menu
- ▶ From the Timeline View menu

The Select Sound File dialog box opens.

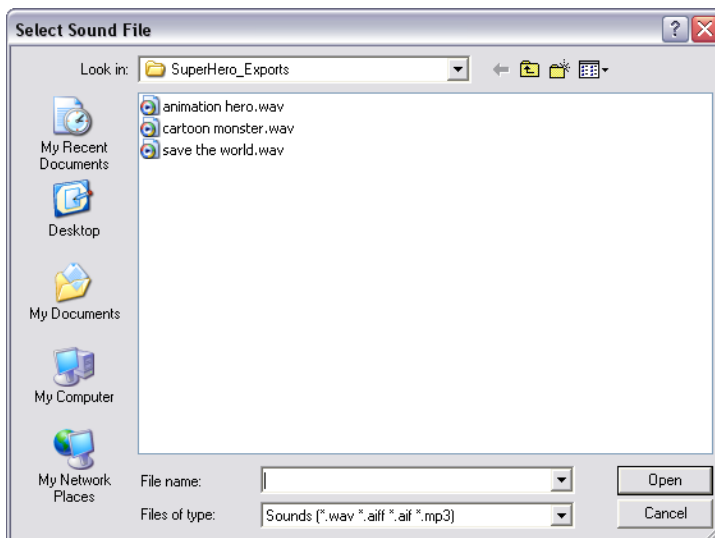

### 2. From the Select Sound File dialog box find and select your sound file from your computer.

Your sound file appears as a layer in both the Timeline and Xsheet view.

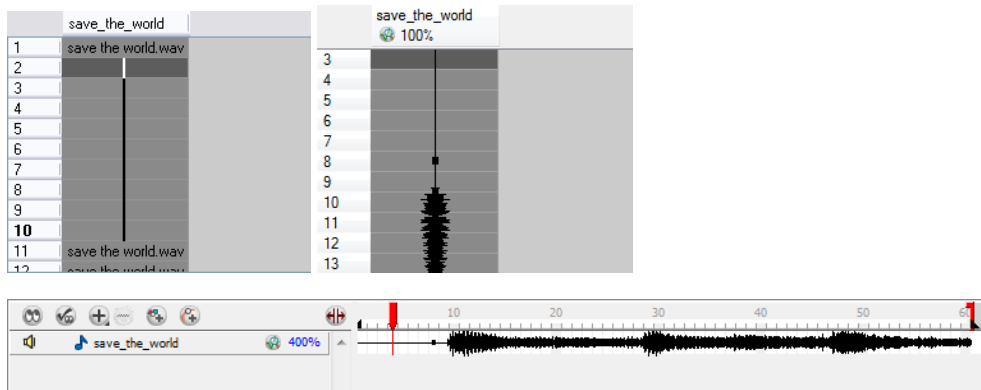

## Lip-Sync



Adding a lip-sync to a project can really enhance its quality and storytelling. However, it can be difficult to shape a character's mouth so that it matches the sound at the precise frame.

To solve this problem Animate Pro provides a lip-sync feature which analyzes the contents of a sound element and generates a mouth chart (see below) based on the eight animation phonemes (A, B, C, D, E, F, G, and X, which is used to represent silence).

The mouth shapes used by Animate Pro are based on the conventional mouth chart used in the animation industry.



The letters used to represent the shapes do **NOT** correspond to an actual sound.



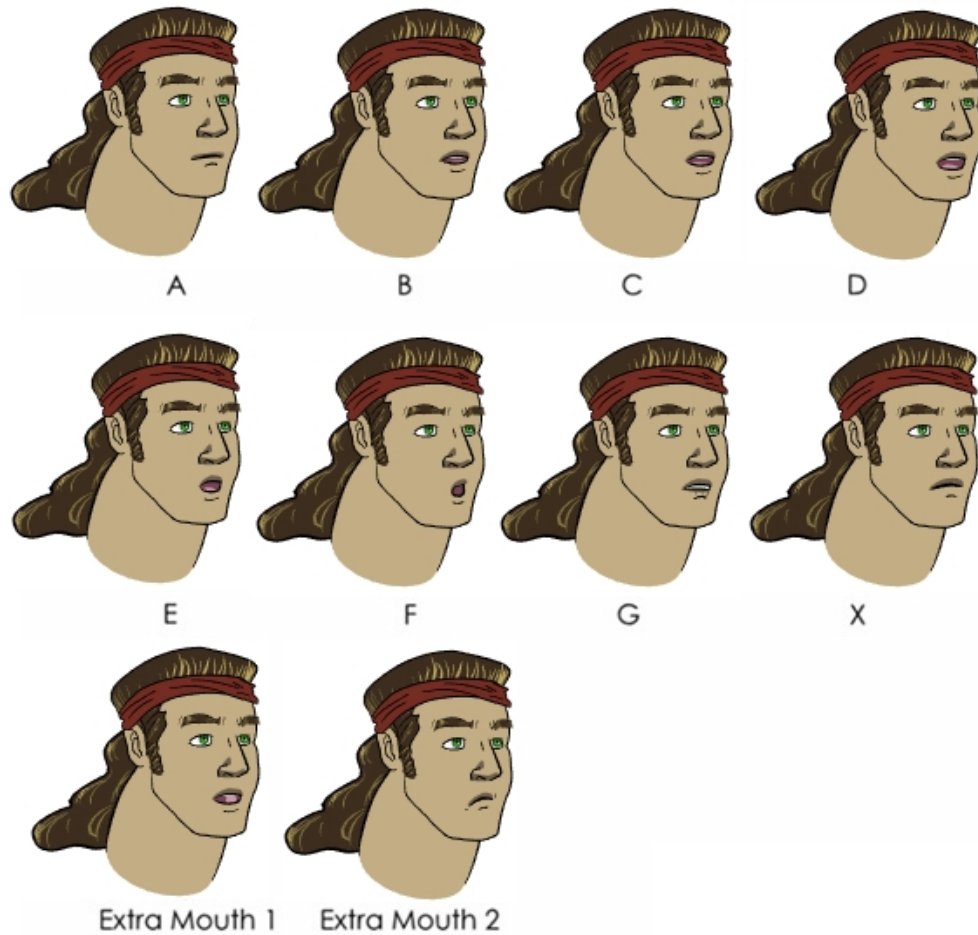

Here is an approximation of which sound each mouth shape can produce:

- **A:** m, b, p, h
- **B:** s, d, j, i, k, t
- **C:** e, a
- **D:** A, E
- **E:** o
- **F:** u, oo
- **G:** f, ph
- **X:** Silence, undetermined sound

You can lip-sync the traditional way or let the system automatically create the basic detection.

You can refer to the mouth chart positions as you draw the shape of your character's mouth.

## Automatic Lip-Sync Detection

To generate a sound detection for your lip-sync using the **Layer Properties view**:

1. In the Timeline or Xsheet view, select your sound layer.

2. In the Layer Properties, click on the Detect button.

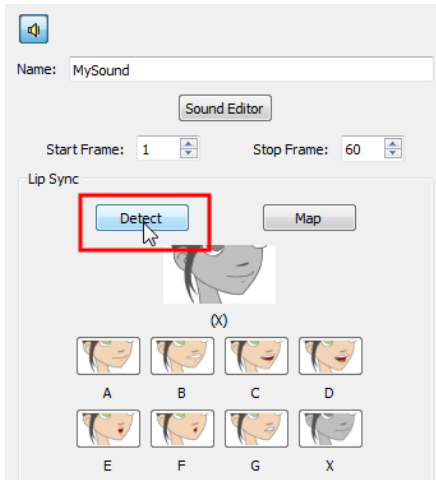

A progress bar appears while Animate Pro analyzes the selected sound clips and assigns a lip-sync letter to each sound cell.

Animate Pro can automatically map drawings in an element to the mouth chart you have generated for a sound. This can save time when you are lip-syncing a voice track.

In the Lip-Sync Mapping dialog box, you can identify each lip drawing of a character. Animate Pro then automatically labels all of the cells in the character's element with the appropriate name.

#### To automatically map lip-sync drawings to a mouth layer:

1. To open the Lip-Sync Mapping dialog box:
  - ▶ In the Timeline view, right-click on any cell in the sound sample layer. From the pop-up menu, select **Lip-Sync > Map Lip-Sync**. You can also select **Animation > Lip-Sync > Map Lip-Sync** from the top menu. **OR**
  - ▶ In the Timeline view, select your sound layer and in the Layer Properties view, click on the Map button.

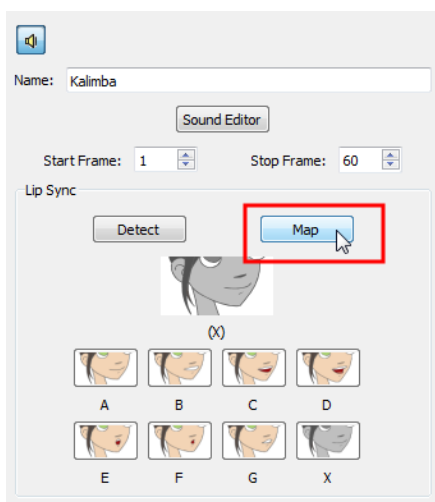

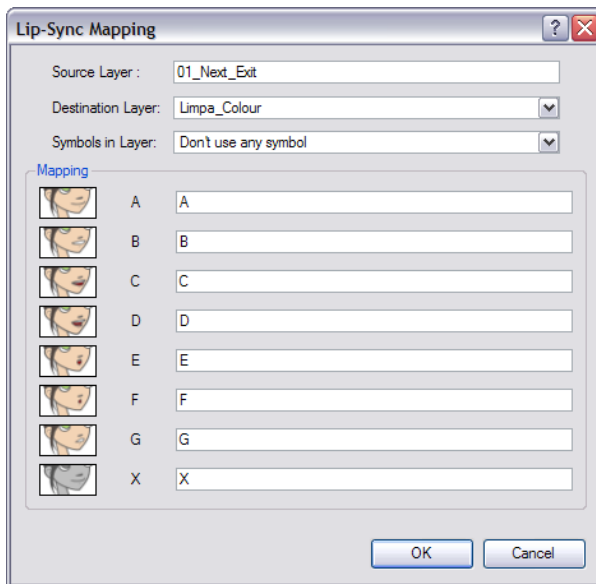

The Lip-Sync Mapping dialog box opens.

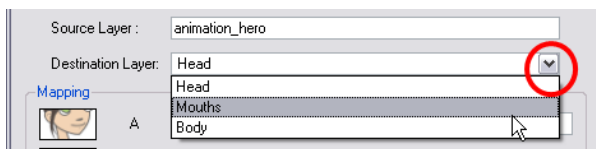

2. From the **Destination Layer** drop-down list, select the layer that contains the mouth positions for the character's voice track.



3. If the selected layer contains symbols, you can map the lip-sync using drawings located directly on the layer or use the symbol's frames. In the Symbol Layer field select **Don't Use Any Symbol** if you want to use the drawings or select the desired symbol from the drop-down menu.
4. In the Mapping section, type the drawing name or Symbol frames in the field to the right of the phoneme it represents. If your drawings are already named with the phoneme letters, you do not have to do anything.
5. Click on the OK button.
6. Press the Play  button in the Playback toolbar to see and hear the results in the Camera view. To play back your scene with sound, enable the Sound  button in the Playback toolbar.



# Chapter 17: How to Add Effects to your Scene



Once your animation is completed, you can add effects such as blurs and glows to make your project look even better! Animate Pro provides you with a series of essential effects that you can add to your layers.

This chapter is divided as follows:

- [About Effects](#) below
- [Adding Effects](#) on page 83
- [Tone Effect](#) on page 86
- [Animating an Effect Over Time](#) on page 88

## About Effects

An effect always needs a drawing connection and sometime a matte or shape connection. A matte provides drawing information that will be used to determine the area where the effect will be applied on the drawing. The details and colours within the matte drawing do not matter, as the system will only use the shape and transparencies in it. A matte is also known as mask.

The matte principle can be demonstrated on the Tone effect.

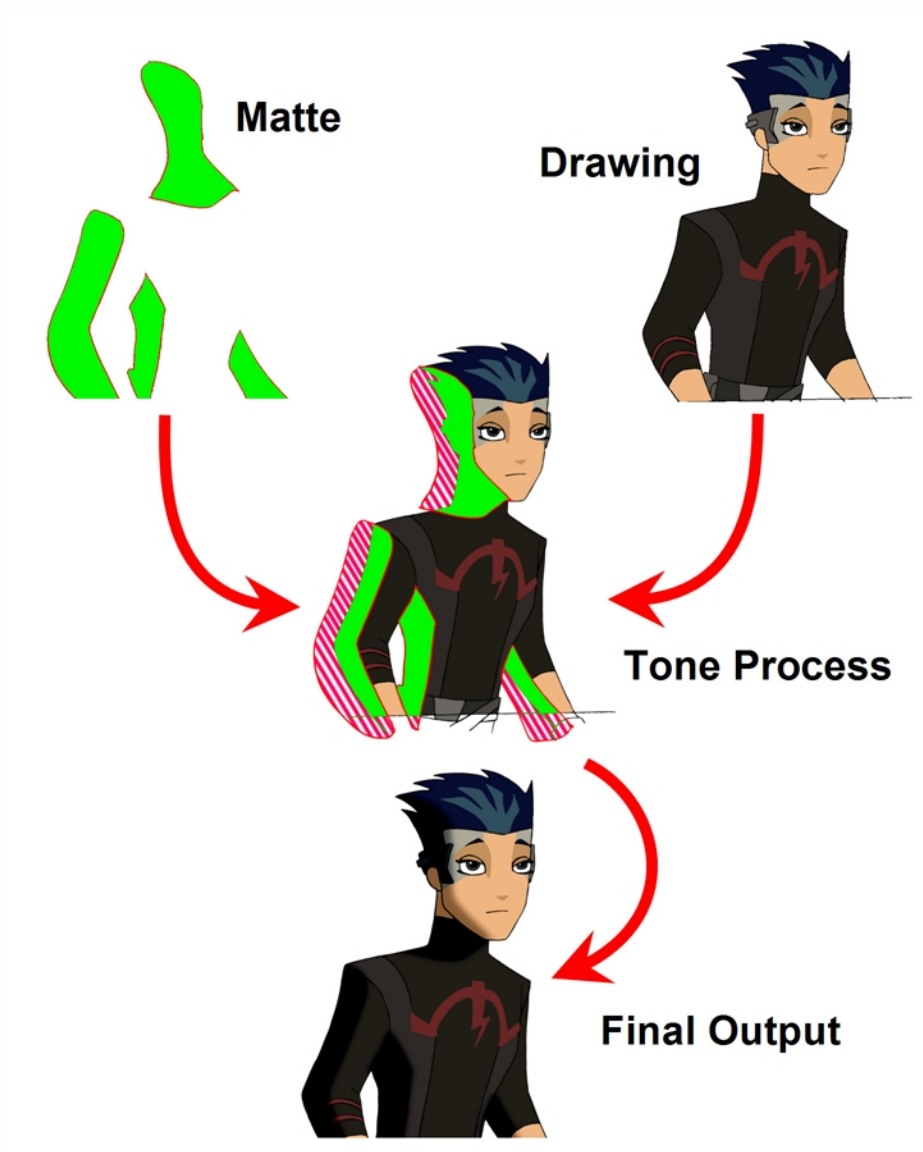

The drawing layer is connected in the right port of the effect and the matte (mask) in the left port. The Tone effect then applies darker colours where the matte overlaps the image, blurs the tone edge, and finally clips out the extra tone zone outside of the drawing before outputting a final drawing with a tone.

The tone's parameters can be adjusted in the Layer Properties view and any of them can be linked to a function column to be animated over time. This means that all of the effects can be customized.

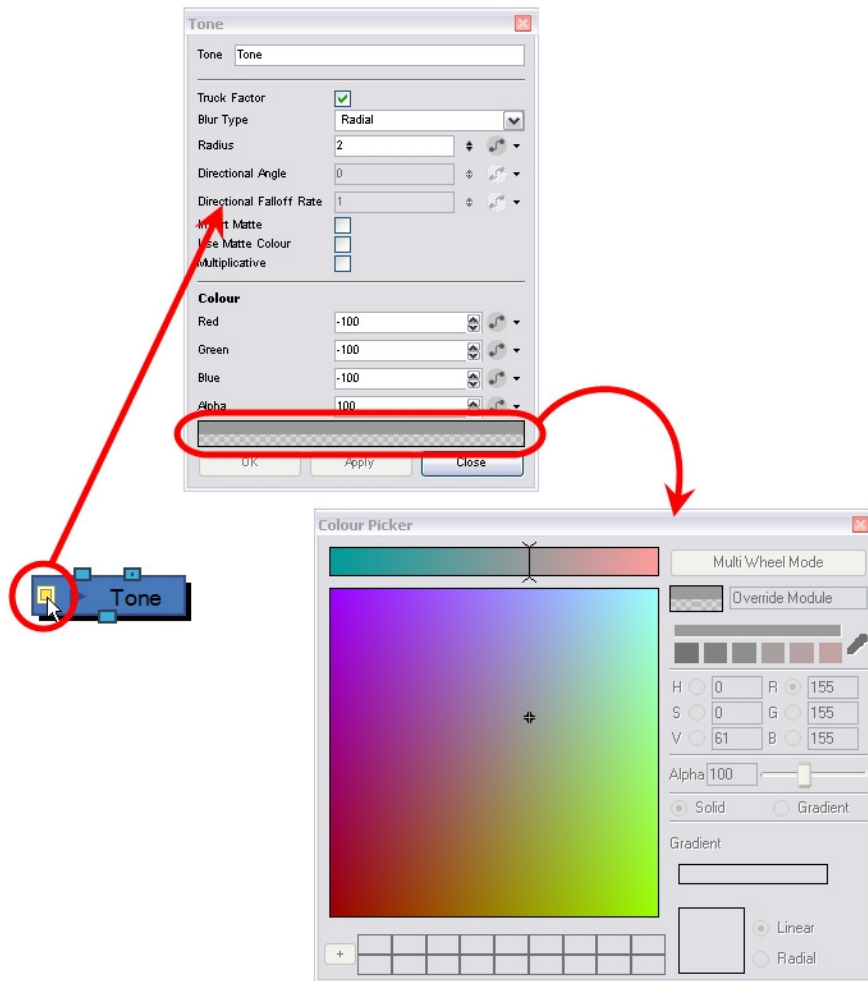

## Adding Effects

If you need to add new effects and other modules to the Network view, you will need to get them from the Module Library.

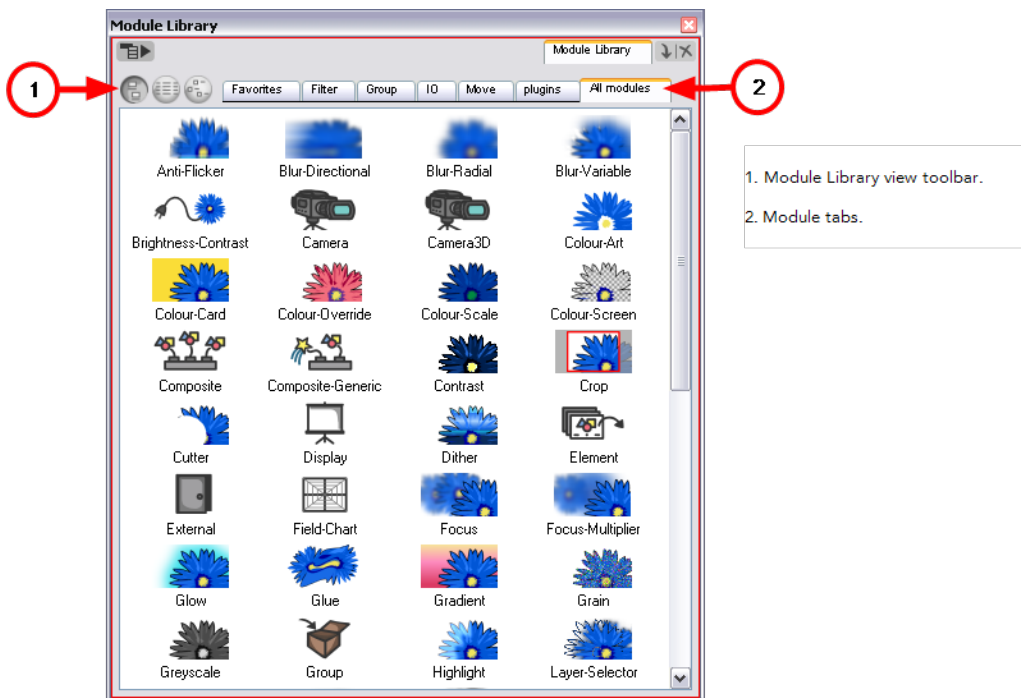

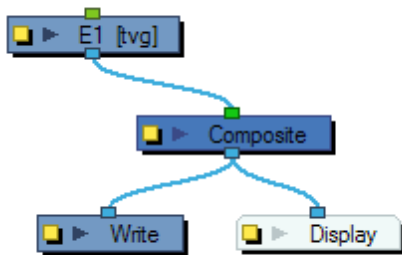

When you create a new project in Animate Pro, the default network that appears in the Network view looks similar to the diagram below.



## Module Library View Toolbar

In the Module Library View toolbar, you can switch the display mode of the effect icons:

-  View as Icons
-  View as List
-  View as Icons with Names

## Module Tabs

The Module Library is conveniently broken up into several sections or tabs:

- **Favorites**



Includes the most common modules.

- To add extra modules to the Favorites tab, select any module from any other section and drag it onto the Favorites tab.

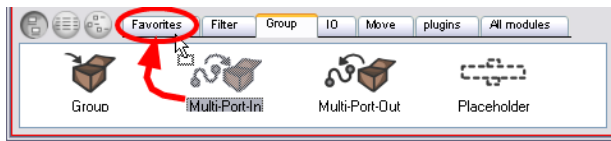

- **Filter**

Includes effect modules, such as blurs.

- **Group**

Includes modules used for grouping, like Group modules and Multi-Port modules.

- **IO**

Includes Display, Drawing, Write and Note modules.

- **Move**

Includes modules used to change elements over time, like Peg modules, as well as certain transformations.

- **Plug-ins**

Includes plug-in modules.

- **All modules**

Lists all of the modules available.

To bring a module into your Network view, just drag it from the Module Library and drop it into the Network view. Once in the Network view, you can click on either the Input Port or Output Port of a module and drag out a cable. You can then connect this cable to either the Output Port or Input Port of another module.

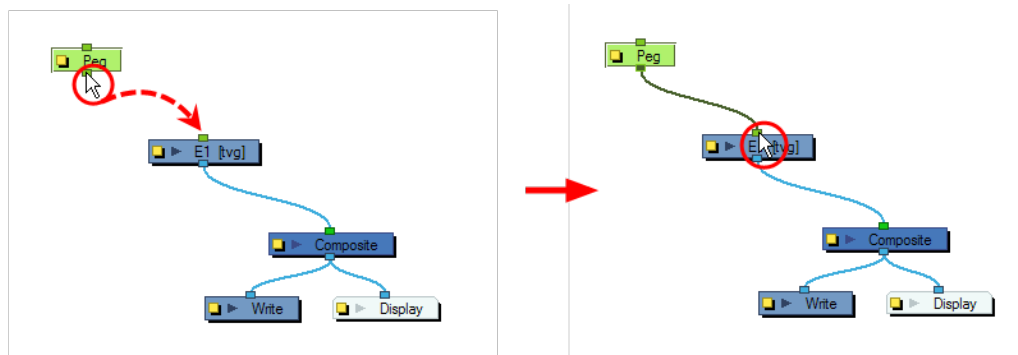

If you would like to connect a module between two connected modules, you can use the [Alt] key as you drag the new module over the existing cable connection. Using the same [Alt] key, you can also disconnect a module.

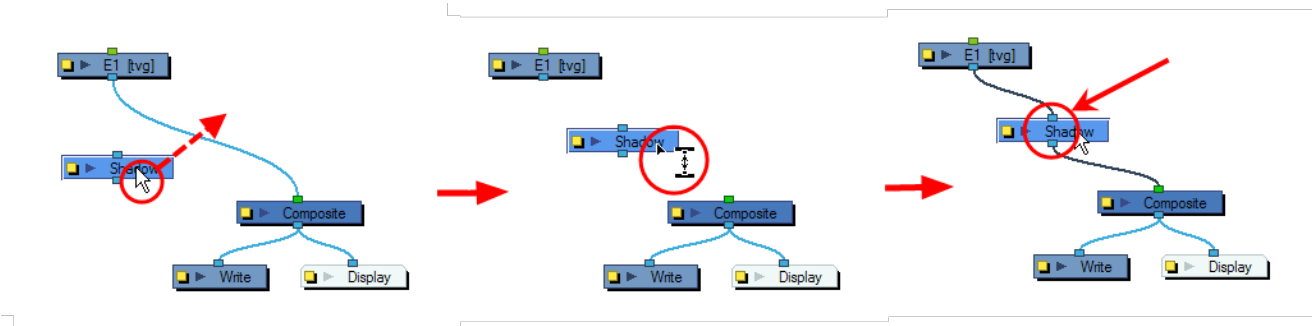

If you want to remove a module you can click on it to select it and press [Delete] to remove it from the Network view.

## Tone Effect



Use a Tone effect to add a dark-coloured region to your drawing and simulate the shaded area away from a light source. To produce the tone effect, create a drawing to control where the tone will appear. The Tone effect uses a matte to determine the shape and position of the tone on your drawing and can be blurred at the edges to create a softer effect.



For information on all effects, check out the [Online Help](#). The Tone Effect is shown here as an example.

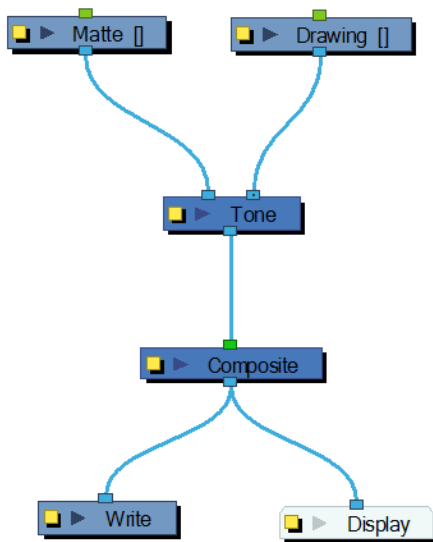

Use the Tone editor to control the type and amount of blur, as well as the colour of the tone.

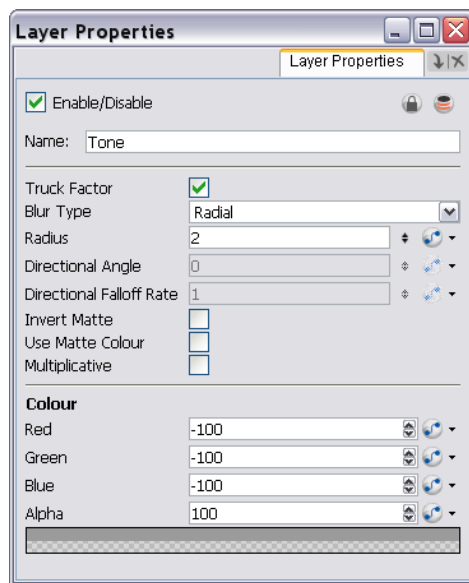

- **Truck Factor:** Activated by default, this option readjusts the blur when the elements undergo a change of depth or scale. When this option is disabled, the effect's values will remain unchanged regardless of depth or scale changes. It is recommended that this option be disabled when multiple drawings are composited and attached this effect.
- **Blur Type (Directional or Radial):**
  - If Directional is selected, Animate Pro will blur the matte in the direction you select.
  - If Radial is selected, Animate Pro will blur the edges of the matte evenly around points that make up the edge of the matte.
- **Radius:** Enter a value for the size of the blur. The larger the value, the greater the blur effect. The blur radius is affected by the drawing scale and camera position.
- **Directional Angle:** If you select a Directional Blur Type, you can select the direction of the blur by entering a value from 0 to 360 in this field.

- **0**: Blurs the image to the west.
- **90**: Blurs the image to the south.
- **180**: Blurs the image to the east.
- **270**: Blurs the image to the north.
- **Directional Fall-off Rate**: The distance where the blur fades from the edge of the image. Select a value between 0 and 1.
  - A fall-off rate of 0 causes the blur to fade out slowly, distributing the blur evenly from the edge of the character to the farthest edge of the blur.
  - A fall-off rate of 1 causes the blur to fade out quickly so that the blur is heaviest closer to the edge of the image.
- **Invert Matte**: Activate this option to invert the matte used to create the tone.
- **Use Matte Colour**: Uses the matte shape colour to create the tone.
- **Multiplicative**: Multiplies the tone colours with the background.
- **Red/Green/Blue/Alpha**: In the RGBA fields, you can enter the value you want added to or subtracted from the colour channels in the drawings or you can attach these values to function curves.

## Animating an Effect Over Time

When compositing your scene, it will often happen that you want to animate the parameters of an effect over time. You might want to have an object fading in or out by changing the transparency level over time or increasing the colour contrast on one of your drawings over a certain frame range.

To animate an effect over time, create a function curve by adding keyframes to the parameters you want to animate. To do this, you will use the Layer Properties view, the Network view and the Timeline view. You can fine tune your animation using the Function view.

### To animate an effect over time:

1. In the Network view, drag an effect module from the Module Library view and drop it into the Network view.

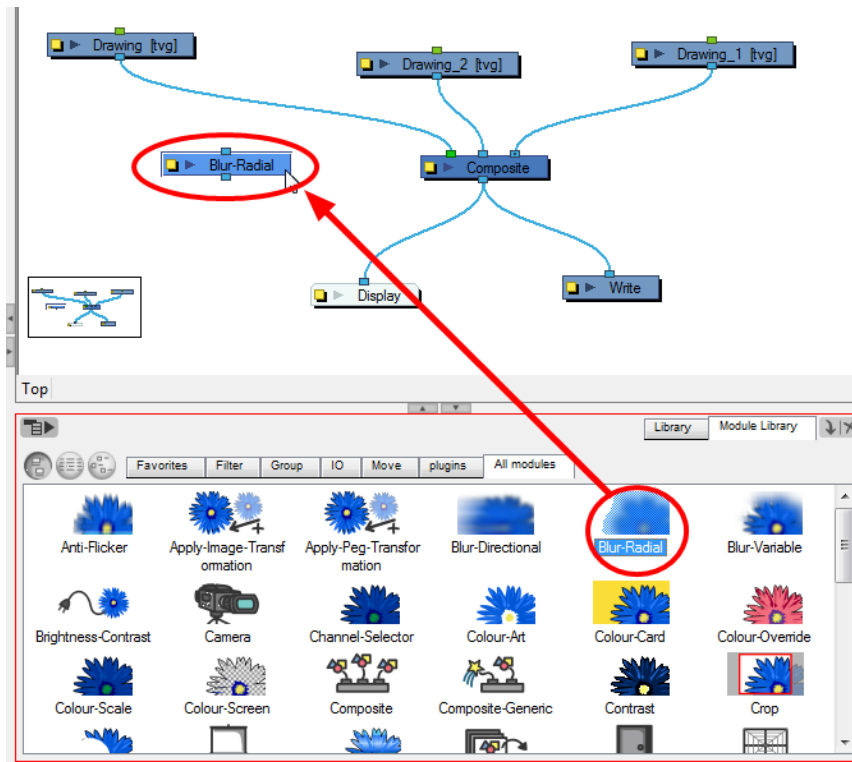

2. Plug the effect element between the drawing element that you would like to apply the effect to and a composite module. You can either do this manually by unplugging and plugging, or by holding down [Alt] as you drag it through a connection.

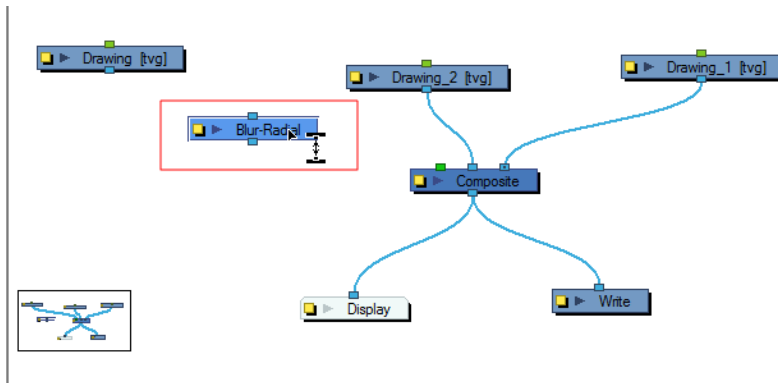

The effect should also appear in the Timeline view as well.

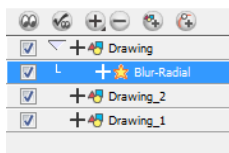

3. To animate the value of the parameter, you must create a function curve and add keyframes on it. For example, you could get the Blur-Radial effect to have no blur on the first frame and become very blurry by the end of the scene by animating its Radius parameter. To create the function curve:
  - In the Layer Properties view, click on the Function  button you want to animate to create a function curve.

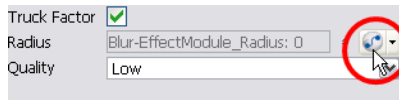

▶

OR

- ▶ You can also expand the effect layer's parameters in the Timeline view by clicking on the **Expand Function**  $+$  button and add a keyframe to the parameter you want to animate or press [F6].

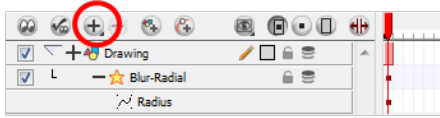

▶

4. In the Timeline view, click on the **Show Data View**  $\leftarrow \rightarrow$  button.
5. In the Timeline view, go to the frame where you want to start animating the effect.

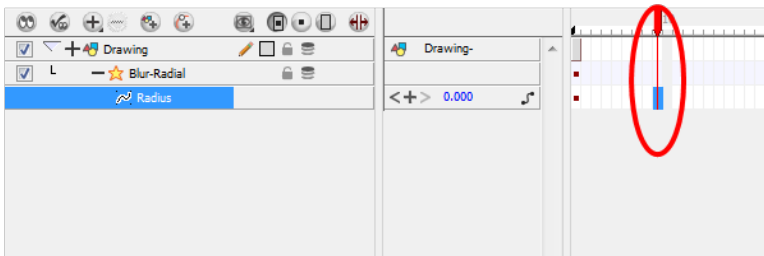

6. In the Data view, click on the **Add Keyframe**  $+$  button.

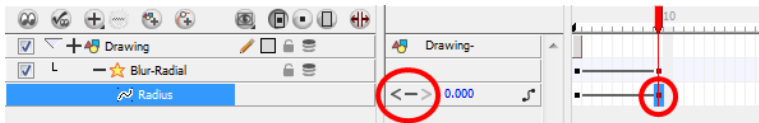

7. In the Value field scroll to the keyframe value or type the value in the field.

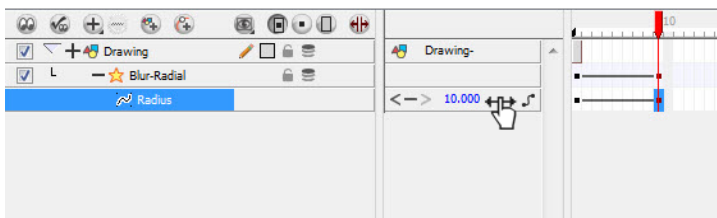

- ▶ If your keyframes are stop-motion keyframes, in the Timeline view, select the new keyframes. Right-click on the selection and select **Set Motion Keyframe**.

8. Repeat this process for each keyframe to be added.

# Chapter 18: How to Export a Movie

To export a QuickTime Movie:

1. From the top menu, select **File > Export > Movie**.  
The Export to QuickTime Movie dialog box opens.

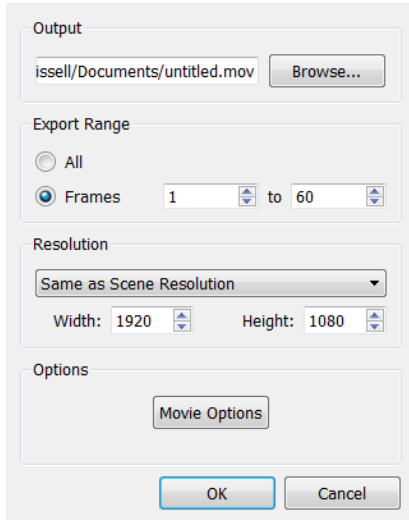

2. From the dialog box, click **Browse** to choose a destination path to where your movie will be saved and an appropriate filename for the export.
3. Click **Save** when you are finished.

