

# Toon Boom Animate 3 User Guide



# Legal Notices

Toon Boom Animation Inc.  
4200 Saint-Laurent, Suite 1020  
Montreal, Quebec, Canada  
H2W 2R2

Tel: +1 514 278 8666  
Fax: +1 514 278 2666

[toonboom.com](http://toonboom.com)

## Disclaimer

The content of this guide is covered by a specific limited warranty and exclusions and limit of liability under the applicable License Agreement as supplemented by the special terms and conditions for Adobe®Flash® File Format (SWF). For details, refer to the License Agreement and to those special terms and conditions.

The content of this guide is the property of Toon Boom Animation Inc. and is copyrighted.

Any reproduction in whole or in part is strictly prohibited.

## Trademarks

Toon Boom® is a registered trademark, and Animate™ and the Toon Boom logo are trademarks of Toon Boom Animation Inc.

## Credits

Art Development: Shabana Ali, Marie-Eve Chartrand, Christopher Diaz, Tania Gray, Annie Rodrigue, Anouk Whissell

Technical Editor: Peter Cawthorne, Pamela Grimaud, Liven Tam

Technical Reviewer: Joel Baril, Lindsay Brown, Steven Masson, Lori Sponagle, Elke Starck, Lilly Vogelesang

Technical Writer: Shabana Ali, Marie-Eve Chartrand, Christopher Diaz, Annie Rodrigue, Liven Tam, Phoebe Wang-Chao, Anouk Whissell

## Publication Date

2013-07-08

Copyright © 2013 Toon Boom Animation Inc., a Corus® Entertainment Inc. company. All rights reserved.

PUSG101AN3EN



# Contents

<b>Toon Boom Animate 3 User Guide</b> .....	<b>0</b>
Legal Notices .....	II
Contents .....	1
<b>Chapter 1: Introduction</b> .....	<b>33</b>
Visual Markers .....	34
Related Topics .....	34
Note .....	34
<b>Chapter 2: Getting Started</b> .....	<b>35</b>
Topics Covered .....	35
Starting Toon Boom Animate .....	36
Preference Style .....	36
Welcome Screen .....	38
Accessing the Documentation .....	38
Creating and Opening a Scene .....	40
Creating a Scene Using the Welcome Screen .....	40
Creating a Scene Using the File Menu .....	41
Saving a Scene .....	43
Setting the Scene Length .....	44
Scene Settings .....	45
Resolution Tab .....	45
Resolution .....	46
Alignment Tab .....	47
Alignment Rules .....	48
Advanced Tab .....	49
Adding a Drawing Layer .....	50
Basic Commands .....	51
Preferences .....	55
Preference Highlights .....	56
Getting Started Preferences .....	57
General Tab .....	57
Auto-Save .....	57
Timeline Tab .....	57
Keyboard Shortcuts .....	57
Selecting a Keyboard Shortcut Set .....	58

---

Customizing a Keyboard Shortcut .....	58
<b>Chapter 3: Interface .....</b>	<b>61</b>
Topics Covered .....	61
User Interface .....	62
Views and Toolbars .....	62
Views .....	62
Top Toolbars .....	62
View Toolbars .....	63
Interface Highlights .....	63
Camera View .....	64
Update Preview .....	65
OpenGL View Mode .....	66
Render View Mode .....	66
Matte View Mode .....	67
Camera View Options Menu .....	67
Safe Area .....	68
Camera Mask .....	68
Outline Locked Drawings .....	68
Current Drawing On Top .....	68
Show Strokes .....	69
Show Strokes with Colour Wash .....	69
Light Table .....	69
Reset View .....	69
Reset Rotation .....	69
Zoom Drop-down Menu .....	69
Toggle Quick Close-up .....	69
Overlay, Line Art, Colour Art, Underlay and Preview Mode .....	70
Drawing Name .....	70
Tool Name .....	70
Frame Number .....	70
Editing Stack Menu .....	70
Tools Toolbar .....	71
Tool Properties View .....	71
Timeline View .....	72
Enable/Disable All .....	73
Show Selection and Hide All Others .....	74

Add Layers .....	74
Delete Layers .....	74
Add Drawing Layer .....	75
Add Peg .....	75
Show/Hide Data View .....	75
Hidden Data View .....	75
Visible Data View .....	75
Current Drawing Displayed .....	75
Current Frame .....	76
Split .....	76
Show/Hide Children .....	76
Show/Hide Functions .....	76
Change Track Colour .....	77
Lock/Unlock Layer .....	77
Onion Skin .....	78
Drawing Substitution .....	79
Keyframe Value .....	79
Zoom .....	80
Keyframe .....	80
Drawing Exposure .....	80
Symbol Exposure .....	80
Dragging and Pasting Modes .....	80
Menus .....	81
Top Menu .....	81
Quick Access Menu .....	82
Colour View .....	83
Add Colour .....	84
Remove Colour .....	84
Add Texture .....	85
Set Current Brush Colour .....	85
Set Current Pencil Colour .....	85
Set Current Paint Colour .....	85
Link/Unlink Three Colours .....	85
Show/Hide Palette List View .....	86
Colour Swatch Name .....	86
Colour Swatch .....	86

---

Colour View Menu .....	87
Library View .....	87
Library View Menu .....	88
Preview Window .....	88
Preview Playback .....	88
Library Folder List .....	88
Template/Symbol List .....	88
Playback Toolbar .....	88
Play Menu .....	89
Managing the Views .....	90
Adding a New View .....	90
Closing a View .....	91
Swapping Views .....	91
Resizing a View .....	92
Managing the Toolbars .....	94
Showing or Hiding Toolbars .....	94
Moving Toolbars .....	95
Flat Tool Toolbar Preference .....	95
Toolbar Manager .....	96
Managing the Workspace .....	98
Loading a Workspace .....	98
Workspace Manager .....	98
Creating a New Workspace .....	99
Renaming a Workspace .....	100
Saving a Workspace .....	100
Deleting a Workspace .....	101
Showing and Hiding a Workspace .....	101
Reordering the Workspace List .....	102
Restoring the Default Workspaces .....	102
Interface Navigation .....	103
Zoom .....	103
Zoom Tool Properties .....	104
Zoom In .....	104
Zoom Out .....	104
Perform Zoom In .....	104
Perform Zoom Out .....	104



Reset Zoom .....	104
Reset View .....	104
Interface Preferences .....	105
User Interface Preferences - General Tab .....	105
Automatically Save Workspace .....	105
Focus on Mouse Enter .....	106
Flat Tool Toolbar .....	106
Levels of Undo .....	107
Colours .....	107
Current View Border .....	107
Current View Border in Template Edit .....	107
Edit Colours Button .....	107
User Interface Preferences - Camera Tab .....	109
Zoom Settings .....	109
Full Scene Antialiasing Preference in the OpenGL tab .....	109
<b>Chapter 4: Drawing .....</b>	<b>111</b>
Topics Covered .....	111
How to Draw .....	113
Tool Properties View .....	114
Options .....	114
Operations .....	114
Drawing View .....	115
Drawing Area .....	115
Zoom Drop-down Menu .....	115
Overlay, Line Art, Colour Art, Underlay and Preview Mode .....	116
Drawing Name .....	116
Tool Name .....	116
Current Frame .....	116
Cursor Coordinates .....	116
Drawing Name .....	117
Colour Picker .....	117
Camera View .....	118
Zoom Drop-down Menu .....	119
Overlay, Line Art, Colour Art, Underlay and Preview Mode .....	120
Drawing Name .....	120
Tool Name .....	120

---

Current Frame .....	120
Current Colour .....	121
Show Current Drawing on Top .....	121
Drawing with the Brush or the Pencil .....	123
Working with Tool Presets .....	125
The Tool Presets Toolbar .....	125
Viewing the Final Lines as you Draw .....	128
Full Scene Antialiasing .....	128
Drawing Using the Pencil Tool .....	130
Pencil Tool Options .....	131
Draw Behind .....	132
Auto-Flatten Mode .....	132
Auto-Close Gap .....	133
Line Building Mode .....	133
Auto Adjust Thickness .....	134
Line Pushing Mode .....	135
Pencil Thickness Stencils .....	135
Minimum and Maximum Size .....	135
Central Line Smoothness .....	136
Contour Optimization .....	136
Changing the Line Shape .....	136
Previewing the Stroke .....	137
Pencil Line Texture .....	137
Working with Thickness Stencils .....	137
Selecting a Thickness Stencil .....	138
Creating a Thickness Stencil .....	138
Creating a Pencil Thickness Stencil with the Select Tool .....	139
Renaming a Thickness Stencil .....	139
Deleting a Thickness Stencil .....	139
Locking a Thickness Stencil .....	140
Pencil Line Texture .....	140
Applying Texture to a Pencil Line .....	141
Creating a Pencil Texture Template with the Pencil Tool .....	142
Creating a Pencil Texture Template with the Select Tool .....	143
Adding a Texture to the Preferences .....	144
Applying a Preset Texture to a Pencil Line .....	145

Drawing with the Brush Tool .....	146
Brush Tool Options .....	147
Normal Brush Mode .....	148
Previewing the Stroke .....	148
Maximum Size and Smoothing .....	148
Brush Presets .....	148
Draw Behind .....	148
Repaint Brush Mode .....	149
Auto-Flatten Mode .....	149
Respect Protected Colour .....	149
Use Stored Colour Gradient .....	149
Brush Styles .....	150
Dynamic Brush .....	150
Brush Tips .....	150
Line Texture .....	150
Brush Styles .....	150
Selecting a Brush Style .....	151
Adding a Brush Style .....	151
Deleting a Brush Style .....	152
Dynamic Brush .....	152
Drawing with Line Texture .....	155
How to Draw with Texture .....	155
Creating Texture Brushes .....	157
Erasing Textured Lines .....	158
Hiding the Line Texture .....	160
Adjusting the Line Texture Opacity .....	161
Selecting Drawing Objects .....	162
Inverting a Selection .....	163
Repositioning a Pivot Point .....	164
Selection on Single or Multiple Layers .....	165
Select Tool Properties .....	165
Lasso and Marquee .....	167
Snap Options .....	167
Permanent Selection .....	168
Apply to All Drawings in Layer .....	168
Apply to All Visible Drawings .....	169

---

Apply to Line and Colour Art .....	169
Select by Colour .....	169
Flip Horizontal and Vertical .....	170
Rotate 90 Degrees CW and CCW .....	170
Pencil to Brush .....	171
Smooth .....	171
Flatten .....	171
Store Colour Gradient .....	171
Merge Pencil Lines .....	172
Reverse Pencil Thickness .....	172
Create Colour Art from Line Art .....	173
Distribute to Layers .....	173
Width and Height .....	174
Offset X and Y .....	174
Angle .....	174
Adjusting the Pencil Line Thickness .....	175
Adjusting the Pencil Line Style .....	175
Pencil Stencils .....	175
Adding Texture to a Pencil Line .....	176
Adjusting the Text Selection .....	176
Erasing Parts of a Drawing .....	177
Eraser Tool Options .....	177
Tip Style .....	178
Previewing the Stroke .....	179
Maximum Size and Smoothing .....	179
Brush Presets .....	180
Eraser Styles .....	180
Eraser Blur Parameters .....	180
Reshaping a Drawing Using the Contour Editor Tool .....	181
Contour Editor Tool Properties .....	183
Lasso and Marquee .....	183
Show Contour Editor Controls .....	184
Apply to Line and Colour Art .....	184
Snap to Contour .....	184
Snap and Align .....	185
Smooth Selection .....	185

Reshaping Pencil Lines with the Pencil Editor Tool .....	187
Pencil Editor Properties .....	189
Lasso and Marquee .....	189
Smooth .....	190
Pump Pencil Pressure .....	190
Deflate Pencil Pressure .....	190
Merge Pencil Lines .....	191
Reverse Pencil Thickness .....	191
Adjusting the Pencil Line Style .....	191
Thickness Stencils .....	192
Adding Texture to a Pencil Line .....	192
Drawing with Shapes .....	193
Shape Tool Options .....	194
Line, Rectangle and Ellipse .....	195
Draw Behind .....	195
Snap Options .....	195
Line Building Mode .....	196
Automatic Filling .....	196
Create Colour Art Automatically .....	197
Auto-Flatten Mode .....	197
Auto-Close Gap .....	198
Use Stored Colour Gradient .....	198
Keep Proportion .....	198
Pencil Templates .....	198
Thickness Adjustment .....	199
Adjusting the Pencil Line Style .....	199
Applying Texture to a Pencil Line .....	199
Drawing with the Polyline Tool .....	200
Polyline Tool Options .....	201
Previewing the Stroke .....	201
Size .....	202
Polyline Presets .....	202
Size and Smoothness .....	202
Adjusting Polyline Style .....	202
Working with Line Textures .....	202
Snap to Contour .....	203

---

Create Colour Art Automatically .....	203
Pencil Templates .....	203
Drawing Using Invisible Lines .....	204
Pencil Tool .....	204
Stroke Tool .....	205
Stroke Tool Options .....	205
Draw Stroke as Straight Lines .....	206
Connect Line Ends .....	206
Auto-Flatten Mode .....	206
Central Line Smoothness .....	206
Deforming a Drawing Using the Perspective Tool .....	207
Perspective Tool Properties .....	208
Lasso and Marquee .....	208
Snap to Contour .....	209
Snap and Align .....	209
Snap to Grid .....	209
Apply to Line and Colour Art .....	209
Flip Horizontal and Vertical .....	209
Rotate 90 Degrees CW and CCW .....	210
Cutting Drawing Parts .....	211
Cutter Tool Options .....	212
Lasso and Marquee .....	212
Apply to Line and Colour Art .....	212
Use Mouse Gesture .....	212
Use Mouse Gesture Breaker Mode .....	213
Tip Style .....	213
Flip Horizontal and Vertical .....	214
Rotate 90 Degrees CW and CCW .....	214
Smoothing Lines .....	215
Smooth Editor Tool Options .....	216
Brush, Marquee and Lasso Smoothing Style .....	216
Show Control Points .....	216
Minimum Size and Maximum Size .....	216
Smoothness .....	217
Colour .....	217
Working With Text .....	219

Formatting the Text .....	219
Font Type .....	220
Font Style .....	220
Alignment .....	221
Font Size .....	221
Kerning .....	221
Indent .....	222
Line Spacing .....	222
Resizing the Text Box .....	222
Converting Text into Separate Objects .....	223
Override Tool .....	224
More Drawing Tools .....	225
Arrange .....	225
Convert Brush Strokes to Pencil Lines .....	226
Pencil Lines to Brush Strokes .....	226
Strokes to Pencil Lines .....	226
Optimize .....	227
Remove Extra Strokes .....	227
Reduce Drawing Texture Resolution .....	227
Crop Brush Textures .....	228
Create Contour Stroke .....	229
Remove Contour Stroke .....	229
Grid .....	229
Group/Ungroup .....	230
Hand .....	230
Rotate View .....	230
Drawing Pivot Tool .....	231
Setting the Drawing Pivot for Symbols on All Frames .....	231
Snapping .....	232
Reset Pivot .....	232
Copying Pivot on Parent Symbol .....	232
Drawing Preferences .....	233
OpenGL Drawing Preferences .....	233
Full Scene Antialiasing .....	233
Support Transparency in Pencil Lines .....	234
Drawing .....	234

Light Table .....	234
Options .....	235
Zoom .....	235
Advanced Tab Preferences .....	235
Advanced Options .....	236
<b>Chapter 5: Traditional Animation .....</b>	<b>237</b>
Topics Covered .....	237
Traditional Animation Tools .....	238
Onion Skin .....	238
Light Table .....	240
Drawing Identification .....	241
Custom Marks in the Xsheet View .....	242
Create Empty Drawing .....	244
Reposition All Drawings .....	244
Basic Traditional Animation .....	247
Animating .....	247
Cleaning Up .....	251
Setting the Timing .....	253
Advanced Traditional Animation .....	254
Flip and Easy Flipping Toolbars .....	254
Onion Skin Toolbar .....	256
Enabling the Onion Skin in Other Layers .....	257
Shift and Trace .....	258
Shift and Trace Linked Drawings .....	265
Enabling and Disabling Individual Drawing Shift and Trace Onion Skin .....	267
Drawing Layers .....	268
Line Art .....	268
Colour Art .....	268
Multiple Drawings in the Drawing View .....	269
Traditional Animation Preferences .....	271
General > Edit Colours .....	271
Edit Colours for Onion Skin in Other Elements .....	271
Exposure Sheet .....	272
Current Frame as Drawing Name .....	272
<b>Chapter 6: Colour .....</b>	<b>273</b>
Topics Covered .....	273



How to Paint .....	274
Colours .....	276
Adding a Colour Swatch .....	276
Solid Colour Swatch .....	277
Default Colour Swatch .....	279
Gradient Colour Swatch .....	280
Bitmap Texture Swatch .....	282
Deleting a Colour Swatch .....	284
Colour Display Modes .....	286
Switching Between Thumbnails and List Display modes .....	286
Displaying Colour Values .....	286
Selecting the Current Colour of a Tool .....	288
Painting Using the Paint Tool .....	290
Create Breaking Triangles to Paint Brush Strokes .....	291
Paint Tool Properties .....	292
Lasso and Marquee .....	292
Painting Mode .....	293
Paint Mode .....	293
Paint Unpainted Mode .....	293
Repaint Mode .....	294
Unpaint Mode .....	294
Automatic Close Gap .....	294
Paint and Remove Texture .....	295
Apply to Multiple Drawings .....	295
Apply to All Visible Drawings .....	296
Respect Protected Colour .....	296
Use Stored Colour Gradient .....	297
Select Newly Painted/Repainted/Unpainted Contours/Lines .....	297
Painting Pencil Lines with the Ink Tool .....	298
Ink Tool Properties .....	299
Lasso and Marquee .....	299
Show Inkable Lines .....	300
Be Smart on Connecting Lines .....	300
Select Mode .....	300
Arrange Ink Lines .....	300
Mitre .....	300

---

Tip Style .....	300
Selecting a Colour in a Drawing .....	302
Editing Gradients and Textures .....	304
Storing Your Favourite Gradient or Texture Settings .....	308
Closing Gaps Manually .....	310
Close Gaps .....	311
Protecting Colours .....	313
Line Art and Colour Art Layers .....	314
Creating Strokes to Paint Your Drawings on a Separated Layer .....	315
Verifying Zones are Painted .....	318
Palettes .....	319
Displaying the Palette List .....	320
Basic Mode .....	320
Advanced Mode .....	320
Creating a Colour Palette .....	321
Basic Palette Lists Mode .....	321
Renaming a Colour Palette .....	322
Copying and Pasting Colours .....	322
Copying Colours from Another Palette .....	323
Removing a Colour Palette .....	323
Duplicating a Colour Palette .....	324
Cloning a Colour Palette .....	325
Cloning a Colour Swatch .....	326
Mixing the Colours .....	327
Importing Palettes .....	329
Importing a Colour Palette .....	329
Ordering the Palette List .....	330
Colour Model .....	331
Loading a Colour Model .....	331
Cutting, Copying and Pasting from a Colour Model .....	334
Colour Preferences .....	336
Drawing Tab .....	336
Default Multiwheel Colour Picker .....	336
Sticky Eye Dropper .....	336
Create New Colour Pots Using Default Colour .....	337
Auto Gap Closing on Startup .....	337

Auto Gap Closing in Pixel Units .....	337
General Tab .....	337
Colour Management .....	338
Shortcuts Tab .....	338
Go to Next/Previous Colour in the Colour Palette .....	338
<b>Chapter 7: Timing .....</b>	<b>339</b>
Topics Covered .....	339
Understanding the Timeline View .....	340
Timeline View .....	340
Layer Section .....	340
Timing Selection .....	341
Data View Section .....	341
Xsheet View .....	342
Xsheet Main Section .....	343
Functions Section .....	344
Column List Section .....	345
Xsheet View Toolbar .....	346
Column Header .....	346
Current Drawing .....	347
Current Frame .....	347
Frame Numbers .....	348
Drawing Exposure .....	349
Current Frame Display .....	349
Function Column .....	349
Increase/Decrease Exposure .....	350
Overwrite/Insert Modes .....	350
Frames .....	351
Adding Frames .....	351
Setting the Scene Length .....	351
Extending the Timeline View .....	351
Adding Frames Before or After a Selection .....	352
Adding Frames to the Beginning or at the End of a Scene .....	352
Deleting Frames .....	353
Reducing the Timeline Length .....	353
Removing Selected Frames .....	353
Deleting a Selected Frame Range .....	354

---

Layers and Columns .....	355
Related Topics .....	355
Layer and Column Concepts .....	355
Layer Types .....	356
Drawing Layer .....	357
Bitmap Layer .....	357
Camera Layer .....	357
Effect Layer .....	358
Colour-Card Layer .....	358
Peg Layer .....	358
Quadmap Layer .....	359
Sound Layer .....	359
Layer Content .....	359
Adding New Drawing Layers .....	360
Adding Drawing Layers in the Timeline View .....	360
Adding a Drawing Layer from the Top Menu .....	361
Adding Drawing Columns in the Xsheet View .....	362
Deleting Layers And Columns .....	363
Deleting a Layer from the Timeline View .....	363
Deleting a Column from the Xsheet View .....	363
To delete layers in the Xsheet view: .....	364
Modifying Layers .....	365
Ordering Layers and Columns .....	365
Reordering Layers in the Timeline View .....	365
Reordering Columns in the Xsheet View .....	365
To reorder columns in the Xsheet view: .....	365
Showing and Hiding Layers From the Timeline View .....	366
Showing and Hiding Columns .....	368
To show and hide columns in the Xsheet view: .....	368
To show a hidden column from the Xsheet view: .....	368
To hide and entire column type: .....	369
Layer Properties .....	370
Renaming Layers and Columns .....	371
Duplicating Layers and Columns .....	372
Related Topics .....	372
Cloning Layers And Columns .....	373

Xsheet Thumbnails .....	374
To display the thumbnails: .....	374
Related Topics .....	374
Changing the Colour of a Layer or Column .....	374
Expanding and Collapsing Layers and Columns .....	377
Filling Exposure .....	379
Filling Exposure Mode .....	379
Overwrite Mode .....	379
Insert Mode .....	380
Typing Exposure .....	380
Typing a Value in the Timeline View .....	380
Typing a Value in the Xsheet View .....	381
To type values in the Xsheet view: .....	381
Extending a Single Exposure .....	382
Extending an Exposure Sequence .....	382
Dragging Cells .....	384
To drag a cell to another location in the Xsheet view: .....	384
Increasing and Decreasing Exposure .....	386
Increasing Exposure .....	386
Decreasing Exposure .....	387
Increase/Decrease Exposure Field .....	388
Clear Exposure and Pull .....	388
Deleting Exposure .....	389
To delete selected exposures: .....	389
Related Topics .....	390
Inserting Blank Cells .....	390
Setting the Exposure .....	391
Filling a Selection with a Single Exposure .....	392
Filling a Selection with a Sequence .....	393
Filling a Selection Randomly .....	395
Creating Cycles .....	396
To use the Paste Cycle command: .....	396
To use the Paste Reverse command: .....	398
Related Topics .....	399
Navigating between Frames and Columns .....	400
Managing Drawings .....	402

---

Renaming a Drawing .....	402
To rename a drawing: .....	402
Renaming Drawings with a Prefix .....	403
Renaming Drawings by Frame Position .....	403
Deleting a Drawing .....	404
Duplicating a Drawing .....	405
To duplicate a drawing: .....	405
Copying and Pasting Drawings .....	406
Tempo Markers .....	408
Annotation Columns .....	410
Adding an Annotation Column .....	410
Drawing and Typing in the Annotation Column .....	411
Drawing in the Annotation Column .....	411
Typing in the Annotation Column .....	412
Erasing Annotation Column Content .....	412
Timing Preferences .....	415
Exposure Sheet Preferences .....	415
Filtering .....	416
Options .....	416
New Element .....	416
Apply/Next .....	416
Timeline Preferences .....	417
Defaults .....	417
Paste/Drag & Drop .....	417
Advanced Preferences .....	418
<b>Chapter 8: Morphing .....</b>	<b>419</b>
Topics Covered .....	419
Understanding Morphing .....	420
Ideas Behind Morphing .....	420
Source and Destination Drawings .....	421
Morphing Rules .....	422
Closest Similar Shape .....	422
Pencil Line to Pencil Line .....	422
Fill Shape to Fill Shape .....	423
Colour Swatch to Same Colour Swatch .....	424
Vanishing and Appearing .....	424

Colour Art to Colour Art and Line Art to Line Art .....	425
Creating a Basic Morphing Sequence .....	426
Deleting a Morphing Sequence .....	428
Tool Properties View .....	429
Hint Type .....	429
Hide Hints .....	430
Show Morphing in Place .....	430
Suggest Hints .....	430
Switch Between Drawings .....	431
Flatten .....	431
Quality .....	431
Easing .....	431
Convert Hints .....	432
Time .....	432
Adjusting the Velocity and Timing .....	433
Changing the Morphing Sequence Length .....	433
Adjusting the Velocity in the Layer Properties Editor .....	433
Morphing Tool and Hints .....	437
Using the Morphing Tool .....	438
Hints .....	440
Contour Hint .....	441
Zone Hint .....	441
Pencil Hint .....	442
Vanishing Point Hint .....	442
Appearing Point Hint .....	443
Copying Hint Points from One Drawing to Another .....	443
Morphing Two Sequences in a Row .....	446
Inserting a Morphing Key Drawing .....	447
Converting Morphing In-betweens to Drawings .....	449
Morphing Holes and Transparencies .....	450
Adjusting the Morphing Quality .....	453
Tips and Tricks .....	454
Morphing Similar Shapes .....	454
Avoiding Crossing Zones During Morphing .....	454
Using the Brush Tool as a Beginner .....	454
Flattening Drawings .....	454

---

Cleaning-up your Drawings .....	454
Using the Same Colour Swatch .....	454
Morphing Preferences .....	455
Drawing Tab .....	455
Morphing Quality .....	455
<b>Chapter 9: Import .....</b>	<b>457</b>
Topics Covered .....	457
Importing Bitmap Images .....	458
Importing a Bitmap Image without Vectorization .....	458
Adding Images to a Bitmap Layer .....	462
Bitmap Image Quality .....	463
Importing and Vectorizing Images .....	463
Importing PSD Files as Separate Layers .....	467
Scanning Images .....	470
Importing AI and PDF Files .....	473
Importing from Adobe Flash .....	476
Distribute To Layers .....	478
Importing QuickTime Movies .....	480
Import Preferences .....	482
Advanced Option .....	482
<b>Chapter 10: Scene Setup .....</b>	<b>483</b>
Topics Covered .....	483
Importing the Scene Components .....	484
Backgrounds, Sounds and Movie .....	484
Templates and Symbols .....	484
Setting the Camera Frame .....	485
Adding a Camera Layer .....	485
Setting the Camera Using the Translate and Rotate Tools .....	486
Setting the Camera using the Camera Layer Properties .....	487
Resetting the Camera Position .....	489
Camera List .....	489
Positioning the Scene Components .....	490
Animate Mode .....	490
Selecting a Layer .....	490
Selecting a Layer from the Camera View using the Transform Tool .....	491
Bounding Box Selection Style .....	491



Finding the Selected Layer in the Timeline View .....	492
Selecting an Element from the Timeline or Xsheet View .....	492
Transform Tool Properties .....	493
Lasso and Marquee .....	493
Peg Selection Mode .....	493
Snap Option .....	494
Hide Manipulator Controls .....	494
Flip Horizontal and Flip Vertical .....	494
Width and Height .....	494
Offset X and Y .....	495
Angle .....	495
Locking Layers in the Timeline View .....	495
Lock .....	496
Unlock .....	496
Lock All .....	497
Unlock All .....	497
Lock All Others .....	497
Positioning an Element using the Transform Tool .....	498
Repositioning the Pivot Point Temporarily .....	498
Panning a Drawing Layer .....	499
Rotating a Drawing Layer .....	500
Scaling an Element .....	500
Skewing an Element .....	501
Using Advanced Animation Tools to Position a Layer .....	501
Permanently Repositioning the Pivot Point .....	501
Panning an Element using the Translate Tool .....	502
Rotating an Element using the Rotate Tool .....	503
Scaling an Element using the Scale Tool .....	503
Skewing an Element using the Skew Tool .....	504
Flipping an Element .....	504
Flip Horizontal and Flip Vertical .....	504
Flip Scale X and Flip Scale Y .....	505
Resetting a Transformation .....	506
Clone Layer .....	507
Creating a Multiplane .....	509
Top View and Side View .....	509

---

Perspective View .....	510
Setting Up the Multiplane .....	512
Distributing Elements on the Z-Axis .....	513
Positioning Elements in the Top and Side Views .....	513
Scene Setup Preferences .....	516
General Tab Preferences .....	516
Camera Tab Preferences .....	517
Tools .....	517
Zoom Settings .....	517
Settings .....	518
Wash Background .....	518
OpenGL Tab Preferences .....	519
Settings .....	519
<b>Chapter 11: Library .....</b>	<b>521</b>
Topics Covered .....	521
Understanding the Library Concept .....	522
What is a Library? .....	522
What is a Symbol? .....	522
What is a Template? .....	523
Library View .....	524
Library View Menu .....	524
Preview and Drawing Substitution .....	524
Library Search Tool .....	525
Library List .....	525
Templates and Symbols List .....	526
Structuring the Library .....	527
Creating a Library .....	527
Opening a Library .....	528
Closing a Library .....	529
Creating a Folder .....	529
Deleting a Folder .....	530
Renaming a Folder .....	530
Refreshing the Library .....	530
Generating Thumbnails .....	531
Symbols .....	532
Creating a Symbol .....	532

Creating a Symbol from a Drawing Selection .....	532
Creating a Symbol from the Timeline View .....	534
Creating an Empty Symbol .....	535
Deleting a Symbol .....	535
Editing a Symbol .....	536
Symbol Hierarchy .....	537
Duplicating a Symbol .....	538
Sharing a Symbol .....	538
Templates .....	540
Creating a Template .....	540
Creating a Template from the Timeline View .....	540
Deleting a Template .....	541
Editing a Template .....	542
Importing Symbols and Templates .....	543
Importing a Template .....	543
Importing a Symbol .....	544
Importing a Template with Symbols .....	544
Opening a Template as a Folder .....	545
Using Paste Special .....	546
Paste Special - Basic Tab .....	547
Drawings .....	547
Cycle .....	548
Paste Special - Advanced Tab .....	548
Drawings .....	548
Add/Remove Keyframes .....	549
Option .....	549
Expanding a Symbol .....	551
<b>Chapter 12: Character Building .....</b>	<b>553</b>
Topics Covered .....	553
Setting the Default Separate Position Preference .....	554
Breaking Down the Character .....	556
Tracing the Model .....	556
Articulations .....	560
Classical Articulation .....	560
Ordering the Layers .....	563
Ordering the Timeline Layers .....	563

---

Nudging Parts Backwards and Forwards .....	564
Rigging .....	566
About Rigging .....	566
Simple Rigging .....	567
Parenting Layers .....	568
Rigging Using Pegs .....	569
Rigging the Head .....	570
Rigging the Body .....	571
Creating a Hierarchy .....	572
Adding the Master Peg .....	575
Creating the Keyframes .....	576
Masking .....	577
Adding Extra Drawings .....	579
Setting the Pivots .....	581
Setting the Pivots Using the Rotate Tool .....	582
Setting the Master Peg Pivot .....	584
Storing the Character in the Library .....	586
Timeline Template .....	586
Key Pose Template .....	587
Appendix .....	588
Break Down: Cutting the Character in Pieces .....	589
Breaking Down the Main Parts .....	589
Breaking Down the Secondary Parts .....	592
Selecting and Incorporating to an Existing Layer .....	595
Breaking Down the Extra View Main Parts .....	595
Breaking Down Secondary Parts in the Extra Views .....	596
Completing the Parts and Articulation .....	597
Cleaning the Parts .....	598
Break Down: Distribute to Layers .....	600
Setting Different Pivots for a Puppet Using Symbols .....	601
Setting Pivots on a Frame Range .....	603
<b>Chapter 13: Sound .....</b>	<b>607</b>
Topics Covered .....	607
Importing a Sound File .....	608
Sound Layer Properties .....	610

Sound Displays .....	612
Sound Playback .....	613
Mute .....	613
Sound Scrubbing .....	614
Analog Sound Scrubbing .....	614
Performing an Analog Sound Scrub in Animate .....	615
Editing a Sound File .....	617
Changing the Start or End Frame of a Sound .....	619
Trimming the Start and End of a Sound File .....	621
Looping a Sound .....	622
Mixing the Sound Volume .....	623
Customizing the Playback Range .....	624
Add Empty Sound Layer .....	626
Lip-sync .....	628
Generating a Lip-sync Detection .....	630
Timeline and Xsheet Views .....	630
Sound Element Editor .....	630
Layer Properties View .....	631
Mapping the Lip-Sync Detection .....	631
Modifying the Lip-sync Detection .....	633
Recomputing the Mouth Chart .....	634
Manual Lip-sync .....	635
Sound Preferences .....	636
Timeline Tab .....	636
Show Sound Waveform .....	636
Sound Tab .....	636
Analog Sound Scrubbing .....	636
Analog Jog Speed .....	636
Analog Jog Dampening .....	636
<b>Chapter 14: Animation Paths .....</b>	<b>637</b>
Topics Covered .....	637
Animating a Layer .....	639
Animate Mode .....	639
Animating a Layer .....	639
Enabling the Playback .....	641
Differences between Pegs and Animated Layers .....	642

---

Animated Layers .....	642
Pegs .....	643
Why Use a Peg Layer? .....	643
The Origins of the Peg .....	644
Adding a Peg to the Timeline View .....	645
Layer Parameters .....	645
3D Path .....	647
Separate Positions .....	648
Locked Scales and Separated Scales .....	648
Setting the Parameters .....	648
Adding and Deleting Keyframes .....	650
Coordinate Keyframe .....	650
Add Keyframe and Duplicate Drawing .....	650
Position Keyframe .....	651
Delete Keyframe .....	651
Stop-motion and Motion Keyframes .....	653
Stop-motion Keyframes .....	653
Motion Keyframes .....	653
Toggling between Motion and Stop-motion Keyframes .....	654
Setting a Different Colour for Stop-motion and Motion Keyframes .....	656
Constant Z .....	657
Animating the Camera .....	658
Basic Camera Move .....	658
Modifying a Path in the Camera View .....	662
Displaying a Path in the Camera View .....	662
Shaping a Path .....	664
Coordinates and Control Points View .....	664
Adding Control Points .....	665
Toggling Between Keyframe and Control Points .....	666
Adjusting the Tension, Bias and Continuity .....	667
Toggling between a Linear or Curved Motion .....	669
Cumulative Z Value .....	670
Offsetting a Trajectory .....	670
Modifying a Path in the Timeline View .....	672
Creating a Function .....	672
Adding and Deleting Keyframes in the Timeline View .....	673

Changing Keyframe Values .....	673
Flipping Between Keyframes .....	675
Modifying a Path in the Function View .....	676
Function View .....	676
Editing a Function in the Function View .....	678
Adding and Deleting Keyframes in the Function View .....	678
Changing a Keyframe's Values .....	680
Modifying a Path in the Xsheet View .....	681
Function Curves .....	683
Creating Function Curves .....	683
Sharing Functions .....	685
Function Drop-down Menu .....	688
Function Types .....	689
Ease and Bezier Functions .....	689
Velobased Functions .....	690
Converting Ease and Bezier Functions .....	690
Copying and Pasting a Motion .....	692
Paste Special .....	692
Paste Special Dialog Box .....	693
Paste Special - Basic Tab .....	694
Drawings .....	694
Cycle .....	694
Paste Special - Advanced Tab .....	695
Drawings .....	695
Add/Remove Keyframes .....	696
Option .....	696
Paste Special .....	698
Pasting Cycles .....	698
Adjusting the Ease .....	701
Displaying the Velocity Curve .....	701
Reshaping a Velocity Function using Bezier Controls .....	702
Reshaping a Velocity Function using Ease Controls .....	703
Creating a Stepped Velocity .....	704
Adjusting the Velocity of Several Layers at the Same Time .....	705
Animation Path Preferences .....	708
General Preferences .....	708

Options .....	708
Settings .....	708
Camera Preferences .....	709
Tools .....	709
Control Points .....	710
Exposure Sheet Preferences .....	710
Function Editors .....	710
<b>Chapter 15: Cut-out Animation .....</b>	<b>713</b>
Topics Covered .....	713
Getting the Character .....	715
Importing a Character from the Library .....	715
Keyframes and Drawing Blocks .....	716
Timeline Behaviour .....	716
Creating a Drawing in the Timeline View .....	716
Creating a Keyframe in the Timeline View .....	717
Creating a Drawing and a Keyframe in the Timeline View at the Same Time .....	717
Creating a Simple Cut-out Animation .....	718
Selecting Layers to Animate or Position .....	721
Animate Mode .....	721
Selecting Drawing Layers using the Transform Tool .....	722
Selecting an element in the Camera View using the Transform Tool .....	723
Selecting a Layer in the Timeline View .....	723
Selecting in the Network View .....	724
Navigating the Hierarchy .....	725
Animating using the Transform Tool .....	727
Animating using Inverse Kinematics .....	730
Topics Covered .....	730
IK Hierarchy Chains .....	731
Single Chains .....	731
Direct Chains .....	731
All Chains .....	732
Where to Start with Inverse Kinematics? .....	732
Inverse Kinematics Tool Properties .....	734
IK Modes .....	734
Bone Selection Mode .....	734
Chain Menu .....	735



IK Manipulation Mode .....	735
Apply IK Constraints Mode .....	735
Bone Editing Mode .....	735
IK Tool Options .....	735
IK Keyframe .....	735
Ease Shape .....	736
Selection .....	736
Enable Translation If Top of Hierarchy .....	737
Enable Rotation .....	737
Exclude From IK .....	737
IK Nails .....	738
Stiffness .....	738
Setting up the Character to use IK .....	738
Connecting any Hierarchy Chain .....	739
Excluding Extra Elements from IK .....	740
Setting Up the Bones for the Extremities .....	740
Nails .....	742
IK Keyframes .....	743
When to use the Inverse Kinematics Tool .....	745
Inverse Kinematics in Toon Boom Animate .....	745
IK Tool and Rigging .....	745
Animating with the Tools .....	746
Inverse Kinematics Philosophy .....	746
Tips and Tricks for Inverse Kinematics .....	746
Animating in Stop-motion .....	748
Creating a Stop-motion Keyframe .....	748
Animating using Computer Generated Interpolation .....	750
Creating a Motion Keyframe .....	750
Adjusting the Ease .....	751
Adjusting the Velocity in the Function View .....	752
Adjusting the Velocity on Multiple Elements Concurrently .....	753
Flipping Through Poses .....	756
Using the Onion Skin in Cut-out Animation .....	758
Add to Onion Skin .....	759
Remove from Onion Skin .....	759
Remove Unselected from Onion Skin .....	759

Add All to Onion Skin .....	760
Remove All from Onion Skin .....	760
Flipping Parts .....	761
Swapping Images .....	763
Adding a New Drawing .....	766
Duplicating a Drawing .....	766
Ordering Layers Over Time .....	767
Resetting a Transformation .....	769
Reset .....	769
Reset All .....	769
Reset All Except Z .....	770
Creating Cycles .....	771
Copying and Pasting Animation .....	774
Adding Pegs .....	776
<b>Chapter 16: Effects .....</b>	<b>779</b>
Topics Covered .....	779
Adding Effects .....	780
Adding Effects Through the Timeline View .....	780
Previewing Effects .....	782
Animating an Effect Over Time .....	784
How Does an Effect Work? .....	786
Using Effects .....	788
Blending .....	789
Blend Mode and SWF Blend Mode .....	790
Blur .....	792
Blur .....	793
Brightness and Contrast .....	794
Colour-Card .....	795
Colour-Override .....	796
Colour-Override Editor Interface .....	797
Palettes .....	797
Colours .....	798
Palette Overrides .....	798
Colour Overrides .....	799
Overriding a Colour .....	799
Overriding a Colour With a Texture .....	800

Texture - Original matrix .....	802
Texture - Global bbox matrix .....	802
Texture - Global bbox centered .....	802
Texture - Contour bbox matrix .....	802
Texture - scale to screen .....	802
Override with this Texture Centered on Overridden Objects Centre .....	802
Texture - Use Input Peg .....	803
Animating a Texture Override with a Peg .....	803
Rendering Selected Colours Only .....	804
Modifying a Texture Fill's Transformation .....	804
Overriding a Colour with a Bitmap Image Sequence .....	806
Overriding a Texture on a Pencil Line .....	808
Modifying a Texture Fill on a Pencil Line .....	808
Modifying a Pencil Texture .....	811
Colour-Scale .....	813
Mask .....	814
Glow .....	815
Highlight .....	817
Quadmap .....	819
Shadow .....	820
Tone .....	822
Transparency .....	824
Previewing and Playing Back Effects .....	826
Preview Resolution .....	826
Effects Preferences .....	828
General .....	828
Options .....	828
OpenGL .....	829
Performance Optimizations .....	829
<b>Chapter 17: Export .....</b>	<b>831</b>
Topics Covered .....	831
Exporting a QuickTime Movie .....	832
Exporting a QuickTime Movie with Transparency .....	835
Exporting an SWF Movie (Flash) .....	837
Exporting an Image Sequence .....	838
Exporting an Image Sequence with Transparency .....	840

---

Export Preferences .....	841
Preview Options .....	841
<b>Chapter 18: Scripting .....</b>	<b>843</b>
Topics Covered .....	843
Creating a Qt Script .....	844
Importing Scripts .....	847
Linking a Script to a Toolbar Button .....	847
<b>Chapter 19: Keyboard Shortcuts for Animate .....</b>	<b>849</b>
<b>Index .....</b>	<b>875</b>

# Chapter 1: Introduction

Toon Boom Animate is a complete animation software with advanced features for all your animation projects. Animate is the ideal paperless animation solution when working with frame-by-frame animation with a drawing tablet. Animate Pro is the ideal cut-out animation solution. Made specifically for creating and animating cut-out characters.

No matter your preferred animation work-style, Animate manages your entire project, from importing assets and content creation, all the way to animation, compositing and multi-platform rendering. Animate boasts a 64-bit engine, allowing you to export content faster, including elaborate scenes, large bitmaps, gradients and complex backgrounds. Output sophisticated scenes at full resolution with effects.



Animate works in conjunction with Toon Boom Storyboard Pro, which allows you to plan your project, and time the scenes to audio before animating in Animate or Animate Pro.

---

To learn all about the features available in Toon Boom Animate and how to use them in a production context, refer to the following chapters:

- [Getting Started on page 35](#)
- [Interface on page 61](#)
- [Drawing on page 111](#)
- [Traditional Animation on page 237](#)
- [Colour on page 273](#)
- [Timing on page 339](#)
- [Morphing on page 419](#)
- [Import on page 457](#)
- [Library on page 521](#)
- [Character Building on page 553](#)
- [Scene Setup on page 483](#)
- [Sound on page 607](#)
- [Animation Paths on page 637](#)
- [Cut-out Animation on page 713](#)
- [Effects on page 779](#)
- [Export on page 831](#)



In all Animate documentation, the default keyboard shortcuts used are the Toon Boom Animate set.

---

# Visual Markers

## Related Topics

The Related Topics sections, located at the end of each section, indicate that there is another section extant in this guide, one that provides further information regarding the current topic. If you are reading the digital version of this guide, you can click on the link to go directly to that section.

## Note



This Note gives important information regarding the current topic.

---

# Chapter 2: Getting Started

Once the software is installed, you are ready to start the application and animate!



## Topics Covered

- [Starting Toon Boom Animate](#) on the facing page
- [Welcome Screen](#) on page 38
- [Creating and Opening a Scene](#) on page 40
- [Setting the Scene Length](#) on page 44
- [Scene Settings](#) on page 45
- [Adding a Drawing Layer](#) on page 50
- [Basic Commands](#) on page 51
- [Preferences](#) on page 55

# Starting Toon Boom Animate

You can run the software on Mac OS X or Windows operating systems.

To start Animate, do one of the following:

- ▶ Windows: Double-click on the Animate  icon or select **Start > Programs/All Programs > Toon Boom Animation > Toon Boom Animate 3**.
- ▶ Mac OS X: Double-click on the Animate  icon or select **Applications > Toon Boom Animate 3 > Animate**.

Toon Boom Animate opens.

## Related Topics

- [Preference Style](#) below
- [Welcome Screen](#) on page 38

## Preference Style

When you start Animate for the first time, the Preference Style dialog box will open. This is the only time you will see this dialog box, however, you can change the styles later on if you like using the Preference panel.

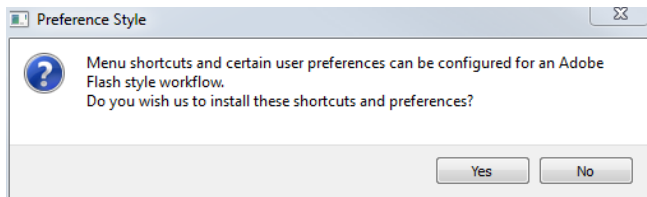

You have two choices. Select the one which fits your work style:

- **Yes:** Sets Animate's default shortcut scheme and preferences to fit the Adobe® Flash® software workflow style. For example, the Select tool is set to Marquee mode.
- **No :** Sets Animate's default shortcut scheme and preferences to fit the Toon Boom professional products workflow style. The Select tool is set to Lasso selection mode.

Once your choice is made, the Welcome Screen is displayed



You can always return to the Preference Style window later on to change the shortcut style.

Refer to the following topics to learn more about preferences and customizing the shortcuts:

- [Preferences](#) on page 55



- [Keyboard Shortcuts](#) on page 57
- [Preference Highlights](#) on page 56

## Related Topics

- [Starting Toon Boom Animate](#) on the previous page

# Welcome Screen



When you open Toon Boom Animate, the Welcome Screen appears. If a scene is already open, you can display the Welcome Screen by selecting **Help > Show Welcome Screen**.

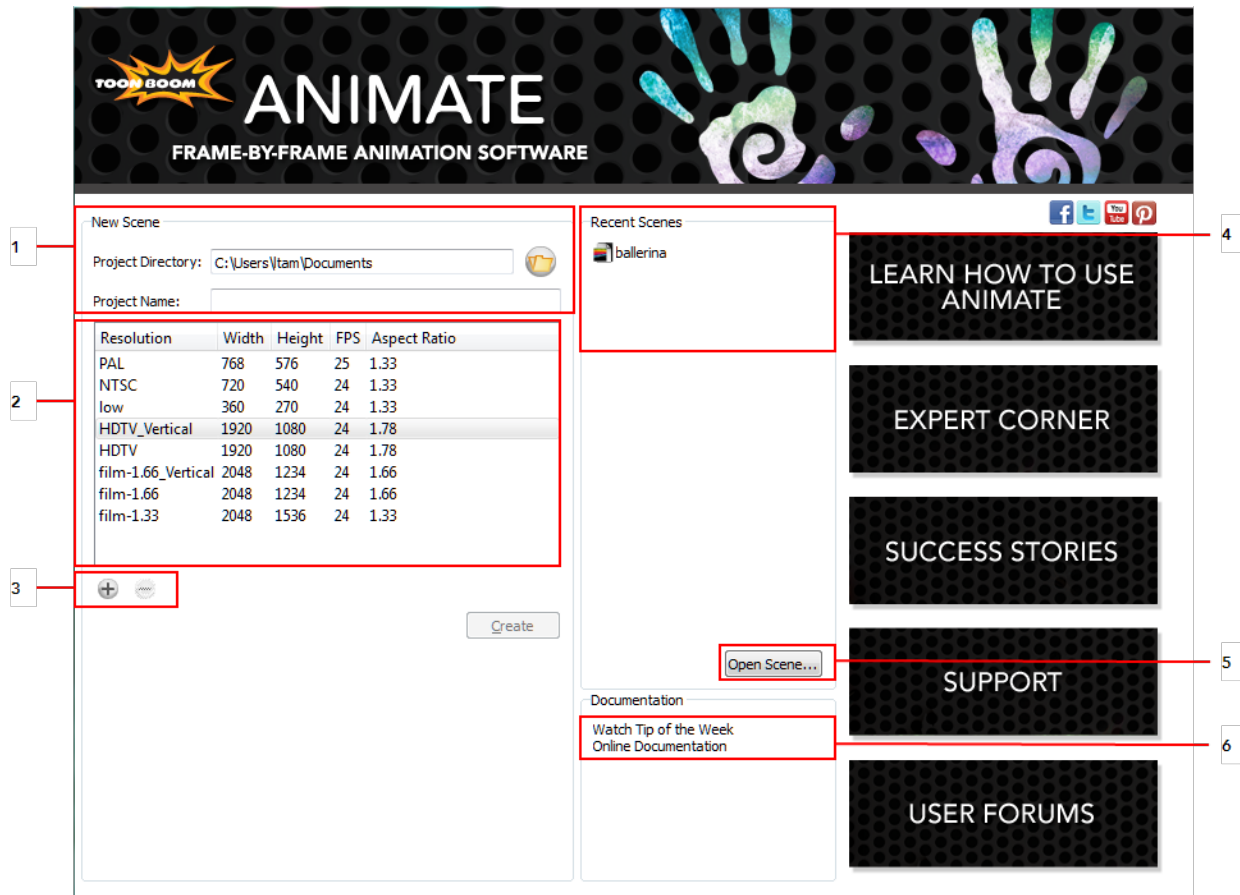

The Welcome Screen allows you to:

1. Create scenes.
2. Choose the scene resolution.
3. Add or delete a custom scene resolution.
4. Open recent scenes from a list.
5. Open scenes by browsing.
6. Open the Help documentation.

## Accessing the Documentation

To access the Animate documentation:

- In the Documentation section, click **Animate Documentation**.

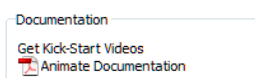

All the Animate guides can also be opened directly in the software, from the top menu, by selecting **Help** > **Help** or press [F1].

## Related Topics

- [Starting Toon Boom Animate on page 36](#)

# Creating and Opening a Scene

All scenes created via Animate are independent and local to the computer.

You can either create a new scene using the Welcome Screen or the File menu:

- [Creating a Scene Using the Welcome Screen](#) below
- [Creating a Scene Using the File Menu](#) on the next page

## Creating a Scene Using the Welcome Screen

To create a scene from the Welcome screen:

1. To select the scene's location, in the Project Directory section, browse the files by clicking **Browse**  button.

Project Directory:    
 Project Name:

2. In the Project Name field, type the scene's name.

Project Directory:    
 Project Name:



The scene name **cannot** exceed 23 characters.

3. Set the scene resolution by doing one of the following:
  - In the Resolution window, select the scene's resolution and click **Create**.
 Your new scene is created.
  - Add a new resolution to list by clicking the **Add**  button.

Resolution	Width	Height	FPS	Aspect Ratio
PAL	768	576	25	1.33
NTSC	720	540	24	1.33
low	360	270	24	1.33
HDTV_Verical	1920	1080	24	1.78
HDTV	1920	1080	24	1.78
film-1.66_Verical	2048	1234	24	1.66
film-1.66	2048	1234	24	1.66
film-1.33	2048	1536	24	1.33



In the New Resolution dialog box, fill in the following fields and click **Create**.

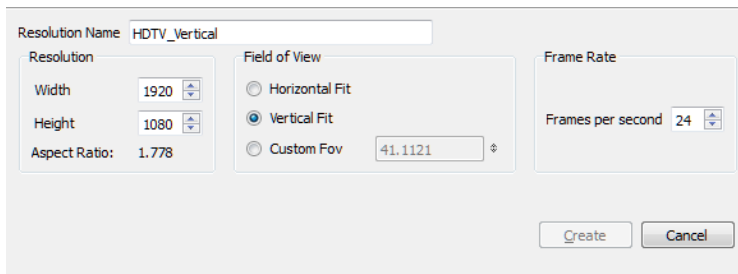

**Resolution Name:** Name your new resolution.

**Resolution:** Set the width, height and aspect ratio of the resolution.

**Field of View:** Set the horizontal fit, vertical fit, or custom Fov.

**Frame Rate:** Type the scene's frame rate per second.



You can delete a custom resolution from the Resolution list by selecting it, and clicking the Delete button under the Resolution window.

#### To open a scene from the Welcome screen:

1. In the Recent Scenes section, click **Open Scene**.  
The Open Scene browser opens.
2. Browse and select the desired \*.anim file.
3. Click **Open** to open the scene.

#### To open a recent scene from the Welcome screen:

- In the Recent Scenes section, select a scene from the list.

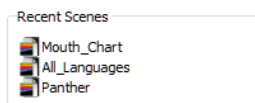

## Creating a Scene Using the File Menu

If a scene is already open and you want to create a new one, you can use the File menu.

#### To create a scene from the File menu:

1. Do one of the following:
  - From the top menu, select **File > New**.
  - In the File toolbar, click the **New**  button.
  - Press [Ctrl] + [N] (Windows) or [⌘] + [N] (Mac OS X).

The New Scene dialog box opens.

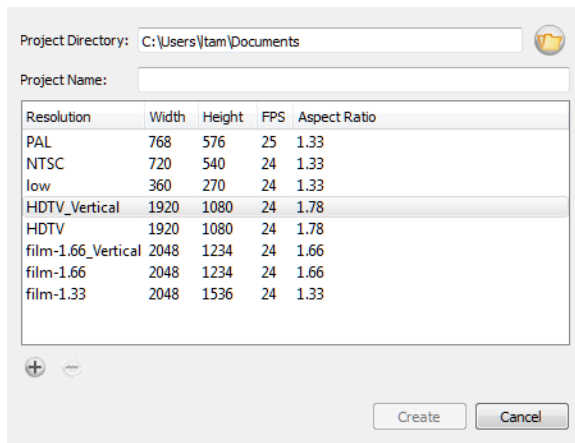

2. Select a scene directory by clicking the **Browse**  button.

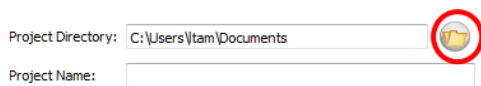

3. In the Project Name field, type the scene's name.

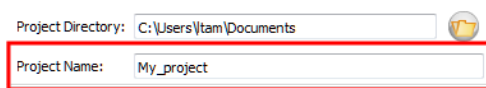

The scene name **cannot** exceed 23 characters.

4. Set the scene resolution by doing one of the following:
  - ▶ In the Resolution window, select the scene's resolution and click **Create**.
 Your new scene is created.
  - ▶ Add a new resolution to list by clicking the **Add**  button.

Resolution	Width	Height	FPS	Aspect Ratio
PAL	768	576	25	1.33
NTSC	720	540	24	1.33
low	360	270	24	1.33
HDTV_Vertical	1920	1080	24	1.78
HDTV	1920	1080	24	1.78
film-1.66_Vertical	2048	1234	24	1.66
film-1.66	2048	1234	24	1.66
film-1.33	2048	1536	24	1.33

In the New Resolution dialog box, fill in the following fields and click **Create**.

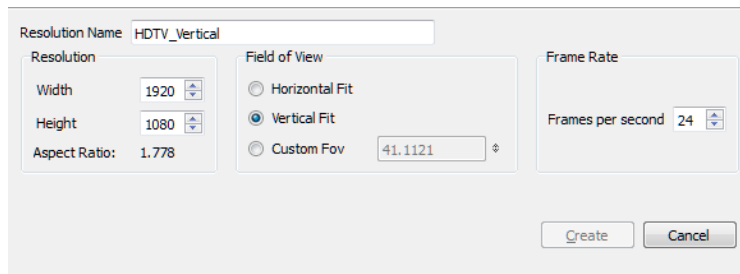

**Resolution Name:** Name your new resolution.

**Resolution:** Set the width, height and aspect ratio of the resolution.

**Field of View:** Set the horizontal fit, vertical fit, or custom Fov.

**Frame Rate:** Type the scene's frame rate per second.

### To open a scene from the File menu:

1. Do one of the following:
  - ▶ From the top menu, select **File > Open**.
  - ▶ In the File toolbar, click the **Browse**  button.
  - ▶ Press [Ctrl] + [N] (Windows) or [⌘] + [N] (Mac OS X).

The Open Scene browser opens.

2. Browse and select the desired \*.anim file.
3. Click **Open**.

## Saving a Scene

It is important to regularly save your scene. As you make changes to a scene, an asterisk (\*) appears in the title bar beside the scene name to indicate that the scene contains unsaved changes.

### To save a scene, do one of the following:

- ▶ Select File > Save.
- ▶ Press [Ctrl] + [S] (Windows) or [⌘] + [S] (Mac OS X).

### Related Topics

- [Welcome Screen on page 38](#)

# Setting the Scene Length

Once you have created your scene, you can set its length.

**To set the scene length from the top menu:**

1. From the top menu, select **Scene > Scene Length**.

The Set Scene Length dialog box opens.

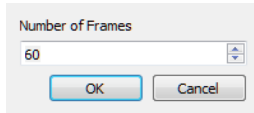

2. In the Number of Frames field, type the number of frames needed.

Refer to the following topics to learn more about adding and removing frames, and extending the scene's length:

- [Adding Frames on page 351](#)
- [Deleting Frames on page 353](#)

## Related Topics

- [Getting Started on page 35](#)
- [Creating and Opening a Scene on page 40](#)



# Scene Settings

When you created your new scene, you set up the resolution and the alignment. However, if you want to change these initial settings later, you can.

To change the scene settings:

From the top menu, select **Scene > Scene Settings**.

The Scene Settings dialog box opens.

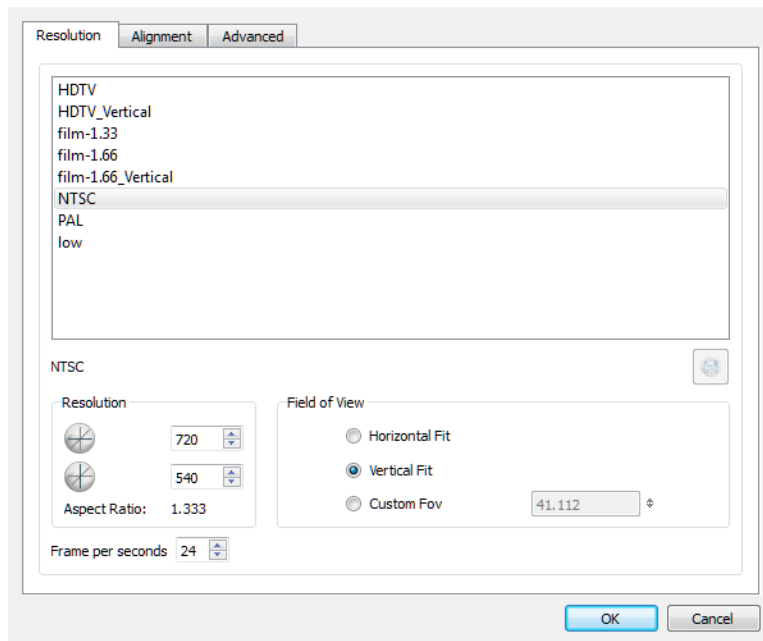

The different Scene Settings options are separated into three tabs.

- [Resolution Tab](#) below
- [Alignment Tab](#) on page 47
- [Advanced Tab](#) on page 49

## Resolution Tab

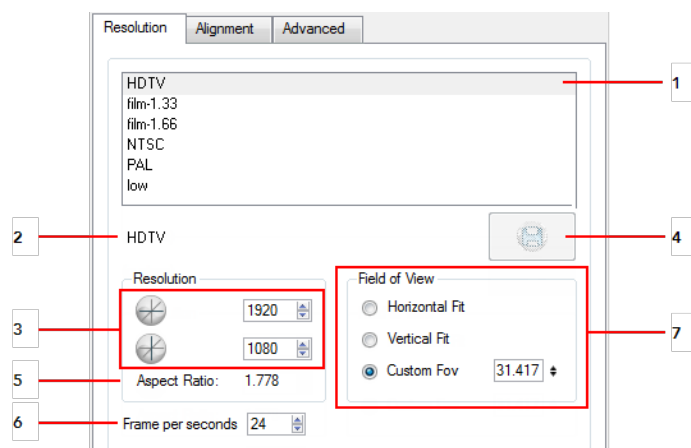

1. Project Resolution Type
2. Scene Resolution Setting
3. Pixel Dimensions
4. Save Custom Resolution
5. Aspect Ratio
6. Project Frame Rate
7. Field of View

## Resolution

1. You can select your project's resolution type from this area so it matches your intended output.
  - ▶ **HDTV:** High definition television delivers a higher quality image than standard television does, because it has a greater number of lines of resolution. To take advantage of the superior quality your output device must be compatible with HDTV technology to make this resolution setting useful.
  - ▶ **HDTV\_Vertical:** The "vertical resolution" of HDTV\_Vertical refers to how the drawing grid is fit into the camera frame. When working with 12 or 16 field drawing grids, the grid is a different aspect ratio from the camera frame. When you fit vertically, you fit the grid with the top and bottom of the camera frame.
  - ▶ **film-1.33:** Use this resolution setting for the academy film format that conforms to the standard 4:3 aspect ratio.
  - ▶ **film-1.66:** Use this resolution setting for the widescreen film format that conforms to the 16:9 aspect ratio.
  - ▶ **film-1.66\_Vertical:** This is essentially the same as film-1.66. Refers to how the drawing grid is fit into the camera frame. When working with 12 or 16 field drawing grids, the grid is a different aspect ratio from the camera frame. When you fit vertically, you fit the grid with the top and bottom of the camera frame.
  - ▶ **NTSC:** This is the standard analogue television broadcasting system used in North America and conforms to the North American standards on how rectangular pixels are displayed for computer and television screens.
  - ▶ **PAL:** This resolution works best with the European format for television and computer screens, as the rectangular pixels are displayed at a different orientation.
  - ▶ **Low:** This format is ideal for videos destined for the web, where size and fast download of a video file might take precedence over quality.
2. Displays the scene resolution setting selection.
3. Displays the pixel dimensions for your resolution selection.
 

If you decide to type in the pixel dimensions, or use the up and down arrows to change the pixel increments, you will have to save your custom selection in order to make it active (4). It will then appear in the resolution selection list (1).
4. Click **Save** to save and create your custom resolution as a setting. This button becomes active when you create a custom resolution type (3).
5. The aspect ratio is the ratio between the horizontal and vertical dimensions of the Camera framing. Each resolution setting has a preset aspect ratio that cannot be changed.
6. Select the frame rate for your project. The higher the frame rate, for example 30 fps, the smoother your animation will look, but the heavier it will become, the lower the frame rate, for example 12 fps, the choppy your animation may look, but the lighter it will be.

7. Use these options to define the FOV of the camera and how the drawing elements (and drawing grid) align to the camera. The drawing grid is always scaled proportionally to a 4:3 (1.33) ratio, therefore changing the Field of View setting may not show a visible difference if your project resolution is also 4:3, such as NTSC.
  - ▶ **Horizontal Fit:** The drawing grid is fitted to the vertical (side) edges of the Camera view, so that the width of the grid matches the width of your project resolution.
  - ▶ **Vertical Fit:** The drawing grid is fitted to the horizontal (top and bottom) edges of the Camera view, so that the height of the grid matches the height of your project resolution.
  - ▶ **Custom Fov:** After selecting this option, use the now-active field to the right to enter a value, in degrees, of the angle that you want the camera cone to be. Increasing this value will make the camera cone wider (the angle is more obtuse), widening the FOV and making the grid and all elements appear farther away. Decreasing the default value will create the opposite effect.

## Alignment Tab

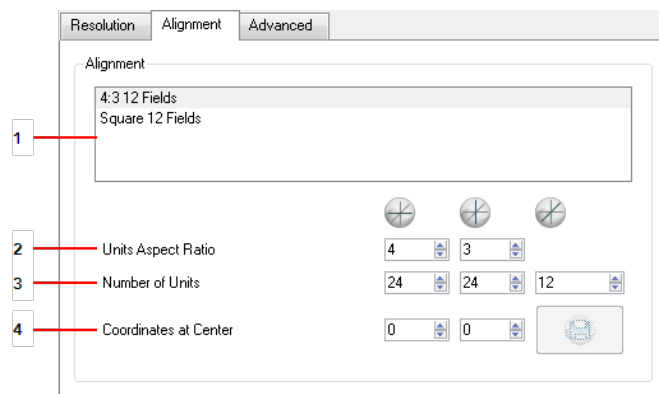

1. Alignment Presets
2. Units Aspect Ratio
3. Number of Units
4. Coordinates at Centre

## Alignment Rules

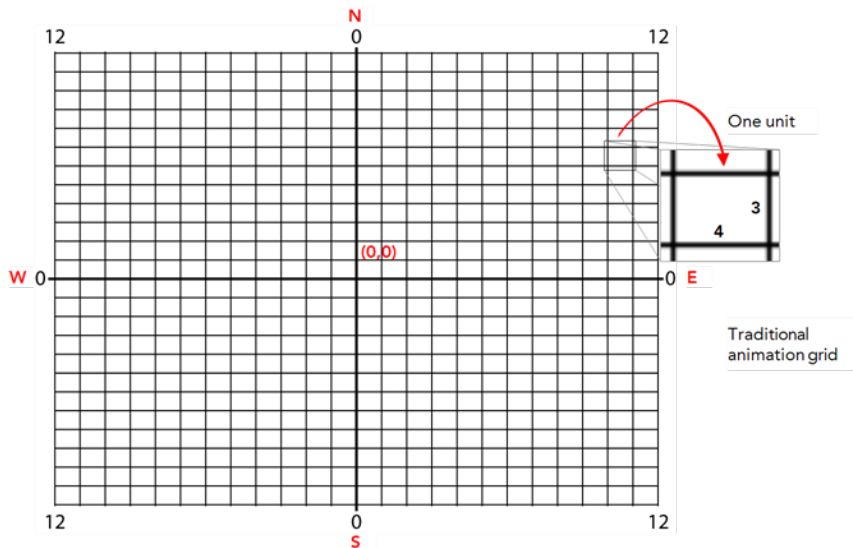

1. The Alignment Presets give you two preset options:
  - **4:3 12 Fields:** Defines the units of your project to have a 4:3 ratio and sets up 12 of these units to run both vertically and horizontally in four cardinal quarters (NW, NE, SW, SE). This Alignment preset is visible in the FOV and drawing grids.
  - **Square 12 Fields:** Defines the units of your project to have a 1:1 or square ratio and sets up 12 units to run both vertically and horizontally in four cardinal quarters (NW, NE, SW, SE). This Alignment preset is NOT visible in the FOV and drawing grids.
2. In the Units Aspect Ratio fields, enter the aspect ratio of the grid you will use. The aspect ratio describes the shape of the grid unit. A square grid unit would have the ratio 1:1, whereas a grid unit of aspect ratio 4:3 is a unit with one side 1.33 times as big as the other side.
  - If the aspect ratio you want to use is 1:1, enter 1 in the Left/Right field (X-axis) and 1 in the Up/Down field (Y-axis). The default Aspect Ratio is set to 4:3 as it is the one used by traditional animators, who are accustomed to working with the grid system described above.
3. In the Number of Units fields, enter the number of horizontal, vertical and depth units for your scene's grid.
 

Animators who prefer to work traditionally will understand the default setting of 24 units horizontal by 24 units vertical as it, once again, corresponds to the grid above. Twelve is a common setting for the field depth.

Those who prefer to work in pixels should enter the pixel dimensions (3) of their project. This way if you want to move something over 600 pixels you just need to type in 600 units.
4. In the Coordinates at Centre, you can enter a new coordinate for the centre of your scene.
 

By default, the (0,0) centre is set in the middle of the grid as shown in the grid above. If you want to change the centre of your grid, for example to the upper left corner, you would enter (-12, 12), -12 units across and 12 units up. That is of course unless you changed the number of units to match the pixel dimensions of your scene. Then you would enter negative half the width and positive half the height.
5. Click **Save** button to save your current Alignment settings and be able to select them later from the list.
 

The Choose Alignment Name dialog box opens.

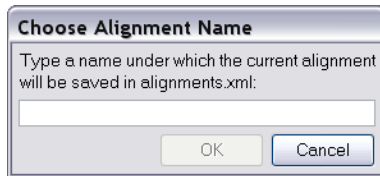

Type in a name for your new alignment settings and click **OK**.



If you change your scene's alignment from 4:3 12 Fields to Square 12 Fields part way through your project, you may find that the Animation grid becomes offset. To correct this, choose the following setting from the Layer Properties panel's **Advanced** tab: **Alignment > Alignment Rule > Centre First Page**.

---

## Advanced Tab

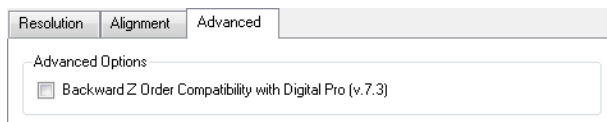

The Advanced tab contains an option for Toon Boom Digital Pro release 7.3 and Animate release 7.3.

Since version 7.8, the method in which Z-Ordering is calculated has been optimized. Enable this option if you want to use the version 7.3 system.

Toon Boom Digital Pro and Toon Boom Animate 7.3 allowed smaller values on the Z-axis such as 0.0001. Since version 7.8, the Z-ordering calculation is now optimized and allows only larger values such as 0.001.

### Related Topics

- [Creating and Opening a Scene on page 40](#)
- [Setting the Scene Length on page 44](#)

# Adding a Drawing Layer

Now that your scene is set up, you can add drawing layers.

To add a drawing layer from the Timeline view:

1. In the Timeline view, click the **Add Drawing Layer**  button.

A new drawing layer is added to the Timeline view.

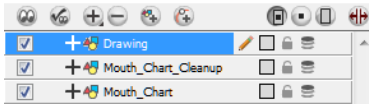

Refer to the following topics to learn more about layers and how to add them.

- [Layers and Columns on page 355](#)
- [Layer and Column Concepts on page 355](#)
- [Adding New Drawing Layers on page 360](#)
- [Deleting Layers And Columns on page 363](#)
- [Modifying Layers on page 365](#)
- [Duplicating Layers and Columns on page 372](#)
- [Cloning Layers And Columns on page 373](#)

## Related Topics

- [Getting Started on page 35](#)

# Basic Commands

This table lists the most common commands used in Animate.

Command	Action	Access Methods
New	Starts a new scene while closing any scene already open. The New Scene dialog box opens, asking for directory, name, and resolution information.	<b>File &gt; New</b> Press [Ctrl] + [N] (Windows) or [⌘] + [N] (Mac OS X).
Open	Displays the Open Scene dialog box. Browse your file system for a scene file.  The Open command is not disabled when a scene is opened. You can open a new scene from the current one and the previous scene will be closed.	<b>File &gt; Open</b> Press [[[Undefined variable Keyboard_Shortcuts.Open1]]].
Open Recent	Displays a quick access list to view and open recently used Animate files.	<b>File &gt; Open Recent</b>
Open Recent > Clear	Clears the recently opened Animate files list.	<b>File &gt; Open Recent &gt; Clear</b>
Close	Closes the currently opened scene, but does not close the Animate application.	<b>File &gt; Close</b>
Save	Saves all changes made to the opened scene, drawings, palettes, and palette lists.	<b>File &gt; Save</b> Press [Ctrl] + [S] (Windows) or [⌘] + [S] (Mac OS X). [[[Undefined variable Keyboard_Shortcuts.New1]]]
Save As	Saves the current state of a scene as another scene. The Save As window prompts you to give a new name and choose a different location to this scene before saving it. This will create a complete scene directory for the new scene.  The scene name <b>cannot</b> exceed 23 characters.	<b>File &gt; Save As</b>

Command	Action	Access Methods
Removed Unused Files		
Import and Export		
Quit	Closes AnimateHarmony Stage.	Windows: <b>File &gt; Quit</b> Mac OS X: <b>Animate &gt; Quit</b>
Show Scan Information	Displays a status bar showing the scanning information at the bottom of the Drawing and Camera view.	<b>Drawing View Menu &gt; View &gt; Show &gt; Show Scan Information</b>
Cut	Removes selected objects. You can then paste the object or its properties to another object.	<b>Edit &gt; Cut</b> Press [Ctrl] + [X] (Windows) or [⌘] + [X] (Mac OS X).
Copy	Copies selected objects and properties.	<b>Edit &gt; Copy</b> Press [Ctrl] + [C] (Windows) or [⌘] + [C] (Mac OS X).
Paste	Places an object you cut or copied into the location you select in the Camera, Drawing and Timeline View.	<b>Edit &gt; Paste</b> Press [Ctrl] + [V] (Windows) or [⌘] + [V] (Mac OS X).
Delete	Removes selected objects.	<b>Edit &gt; Delete</b> [Delete]
Select All	Selects all drawing objects in the current drawing window in the Drawing, Timeline and Camera view. This helps you manage multiple objects as one when moving them.	<b>Edit &gt; Select All</b> Press [Ctrl] + [A] (Windows) or [⌘] + [A] (Mac OS X).
Deselect All	Deselects all selected objects in the Drawing and Camer views.	<b>Edit &gt; Deselect All</b> [Esc]
Undo	Removes remove the last change made to your project. Animate supports multiple undo, so you can undo changes you made in the order you made them.	<b>Edit &gt; Undo</b> Press [Ctrl] + [Z] (Windows) or [⌘] + [Z] (Mac OS X).
Redo	Redoes and operation you	<b>Edit &gt; Redo</b>



Command	Action	Access Methods
	have undone that you later decide to keep. This command is active only after you use the Undo command.	Press [Ctrl] + [Shift] + [Z] (Windows) or [⌘] + [Shift] + [Z] (Mac OS X).
Select Children	Lets you select all elements parented to the selected peg element in the Timeline view.	<b>Animation &gt; Select Children</b>
Select Child	Lets you select the first element parented to the selected peg element in the Timeline View.	<b>Animation &gt; Select Child</b> Press [Shift] + [B].
Select Parent Skipping Effects	Lets you select the parent of the selected element in the Timeline view skipping effects in the hierarchy.	<b>Animation &gt; Select Parent Skipping Effects</b> Press [B].
Select Parent	Lets you select the parent of the selected element in the Timeline view.	<b>Animation &gt; Select Parent</b> Press [B].
Select Previous Brother	Lets you select the next element (above current element) in the Timeline view.	<b>Animation &gt; Select Previous Brother</b> Press [/].
Select Next Brother	Lets you select the next element (below current element) in the Timeline view.	<b>Animation &gt; Select Next Brother</b> Press [?].
Auto Render Write	Use the Auto Render Write command to render a frame each time the current frame is changed.  You must have a Write module in your network to use this command.	<b>Scene &gt; Render &gt;Auto Render Write</b>
Message Log	The Message log view displays information gathered during a render task, like which frames and at what time they were each rendered.	<b>Windows &gt; Message Log</b>
Debug Mode	Enable the Debug Mode option to gather and display	<b>Help &gt; Debug Mode</b>

Command	Action	Access Methods
	precise information about each rendering frame such as the modules encountered and action taken.	
Help	Launches the Toon Boom Animate Help System PDF, complete with instructions on how to use the system.	<b>Help &gt; Help</b>
Toon Boom Animate on the Web	Launches the Toon Boom Animate website, which features a Support and <b>Community &gt; Forum</b> section.	<b>Help &gt; Toon Boom Animate on the Web</b>
About	Use the About command to access general information about the software.	Windows: <b>Help &gt; About</b> Mac OS X: <b>Animate &gt; About</b>
Show Welcome Screen	Brings back the Welcome screen—see <a href="#">Welcome Screen on page 38</a>	<b>Help &gt; Show Welcome Screen</b>

## Related Topics

- [Getting Started on page 35](#)

# Preferences

An important feature of Toon Boom Animate is the Preferences dialog box. From here you can customize your interface, tool behaviour and shortcuts. Throughout this guide, you are often required to go to the Preferences dialog box to set parameters and options.

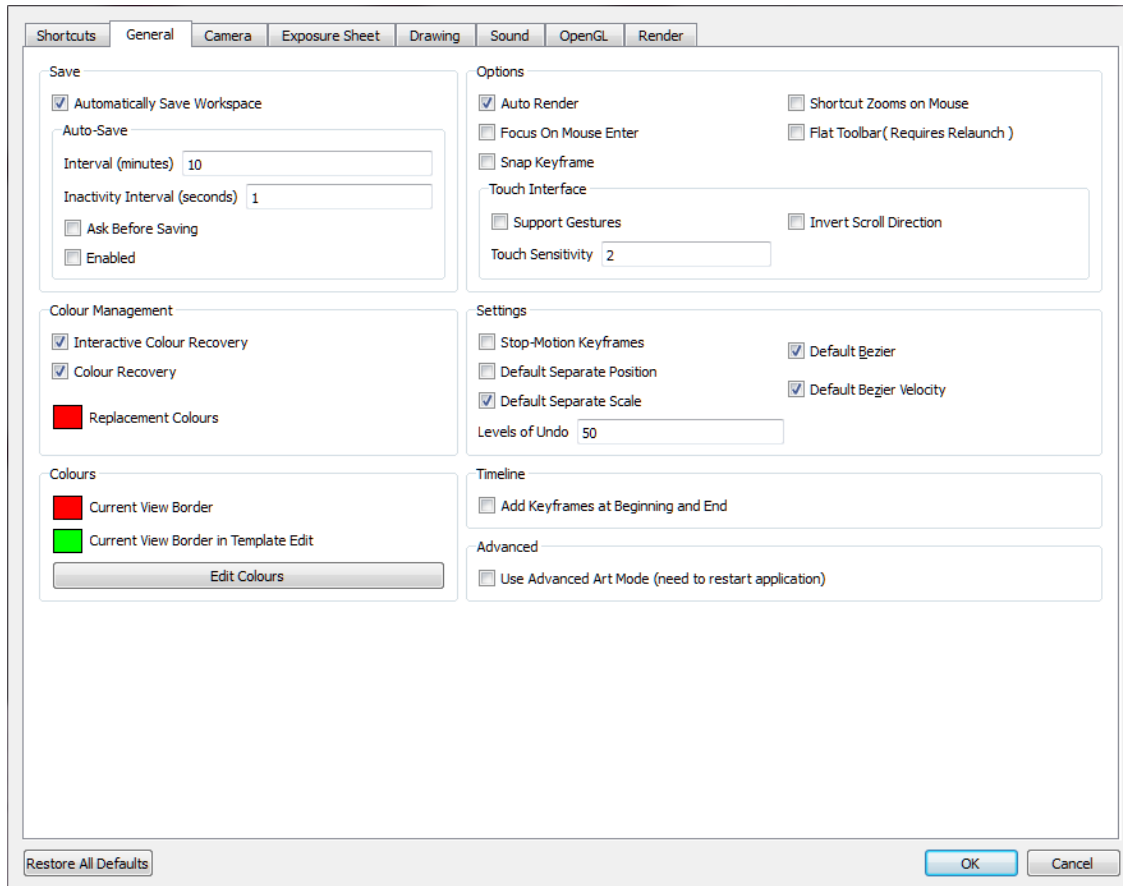

In this section, you will learn how to access the Preferences panel and also find a general description of its functionality.

To learn about the different preferences available and how they are used in a production context, refer to the following topics:

- [Getting Started Preferences on page 57](#)
- [Interface Preferences on page 105](#)
- [Drawing Preferences on page 233](#)
- [Traditional Animation Preferences on page 271](#)
- [Colour Preferences on page 336](#)
- [Timing Preferences on page 415](#)
- [Morphing Preferences on page 455](#)
- [Import Preferences on page 482](#)
- [Library Preferences on page 1](#)

- [Scene Setup Preferences](#) on page 516
- [Sound Preferences](#) on page 636
- [Animation Path Preferences](#) on page 708
- [Cut-out Animation Preferences](#) on page 1
- [Deformation Preferences](#) on page 1
- [Effects Preferences](#) on page 828
- [Export Preferences](#) on page 841

## Related Topics

- [Preference Highlights](#) below
- [Getting Started Preferences](#) on the next page
- [Keyboard Shortcuts](#) on the next page

# Preference Highlights

You can set over 80 preferences in the Preferences dialog box. You will learn about them as you read through this guide and find out how they apply in a production context.

The Preferences panel is divided into the following tabs:

- Shortcuts
- General
- Camera
- Exposure Sheet
- Drawing
- Sound
- OpenGL
- Render
- Advanced



Some preferences require you to exit and restart the application or to close a view and reopen it.

---

## To access the Preferences dialog box:

Do one of the following:

- From the top menu, select **Edit > Preferences** (Windows) or **Animate > Preferences** (Mac OS X).
- Press [Ctrl] + [U] (Windows) or [⌘] + [U] (Mac OS X).

## Related Topics

- [Preferences](#) on page 55
- [Getting Started Preferences](#) below
- [Keyboard Shortcuts](#) below

# Getting Started Preferences

In this section, you will find useful preferences to get you started in the General tab.

- [General Tab](#) below

## General Tab

### Auto-Save

- **Interval (minutes):** This is the frequency at which the auto-save takes place.
- **Inactivity Interval (seconds):** When Auto-save is about to take place, it verify if you are drawing or doing anything in the application. If so, Auto-save waits this number of seconds before attempting another save.
- **Ask Before Saving:** Before performing an auto-save, the system will prompt you with a message to confirm if you want to save or not. You can choose to turn off this option.

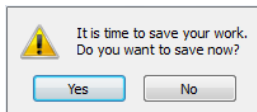

- **Enabled:** This enables the Auto-save feature. If you do not want the system to automatically save your work, deselect this option. The auto-save is off by default.

## Timeline Tab

### Related Topics

- [Keyboard Shortcuts](#) below

# Keyboard Shortcuts

To speed up your work, all of Toon Boom Animate's keyboard shortcuts can be customized. You can even choose other software keyboard shortcut sets.

- [Selecting a Keyboard Shortcut Set](#) on the facing page
- [Customizing a Keyboard Shortcut](#) on the facing page

## Selecting a Keyboard Shortcut Set

In Toon Boom Animate, you can choose a set of default keyboard shortcuts you are familiar with. You can choose between the following:

- Adobe Flash
- Toon Boom Animate
- Toon Boom Studio

To switch keyboard shortcut sets:

1. Select **Edit > Preferences** or press [Ctrl] + [U] (Windows) or [⌘] + [U] (Mac OS X).
2. In the Preferences dialog box, select the **Shortcuts** tab.
3. From the Shortcut Set list, select the desired set.

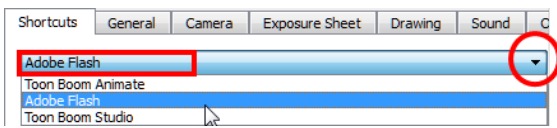

## Customizing a Keyboard Shortcut

You can also customize most of the shortcuts.

To set a shortcut:

1. Select **Edit > Preferences** or press [Ctrl] + [U] (Windows) or [⌘] + [U] (Mac OS X).
2. In the Preferences dialog box, select the **Shortcuts** tab.
3. In the left pane, select a category and then select a command to modify.
4. Click on the shortcut rectangle (above the right pane).

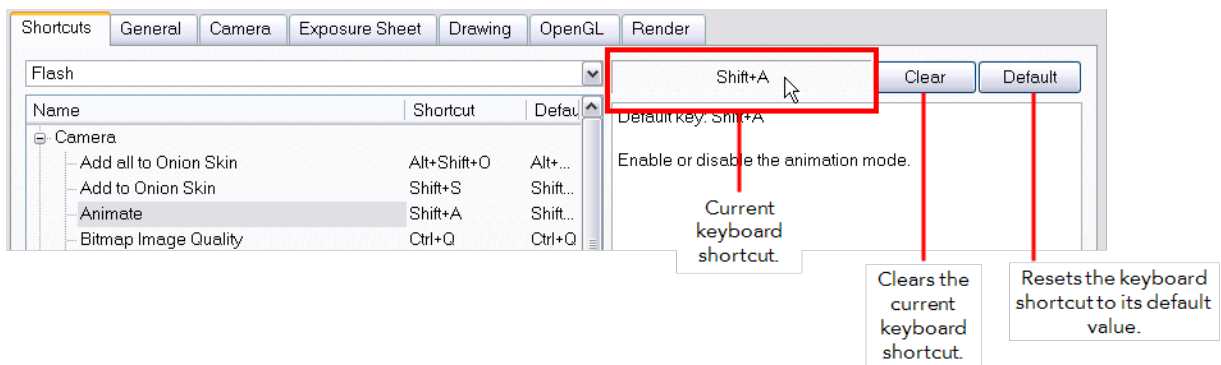

5. On your keyboard, click the desired shortcut.
  - To remove any keyboard shortcut associated to a command, click **Clear**.
  - To reset a command's default keyboard shortcut, click **Default**.
6. Click **OK**.



If a keyboard shortcut is already in use, the **Conflict Detected** dialog box will appear notifying you of the command to which it is already associated. You can continue to associate the shortcut or cancel the operation and choose another command.

---

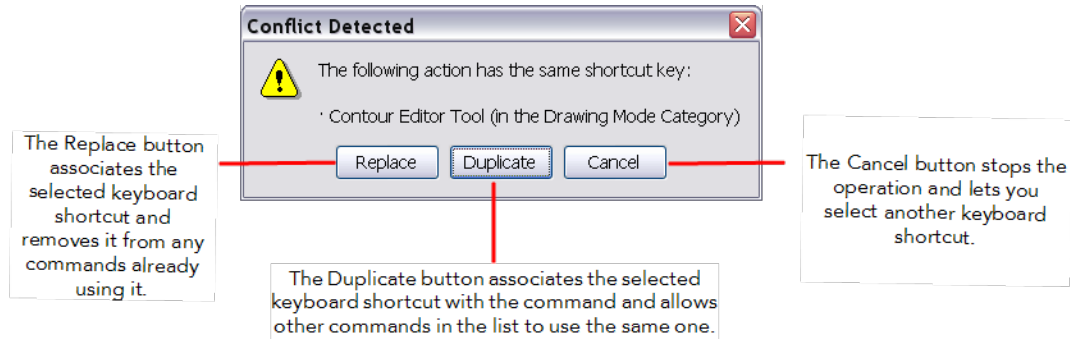

## Related Topics

- [Preferences](#) on page 55





# Chapter 3: Interface

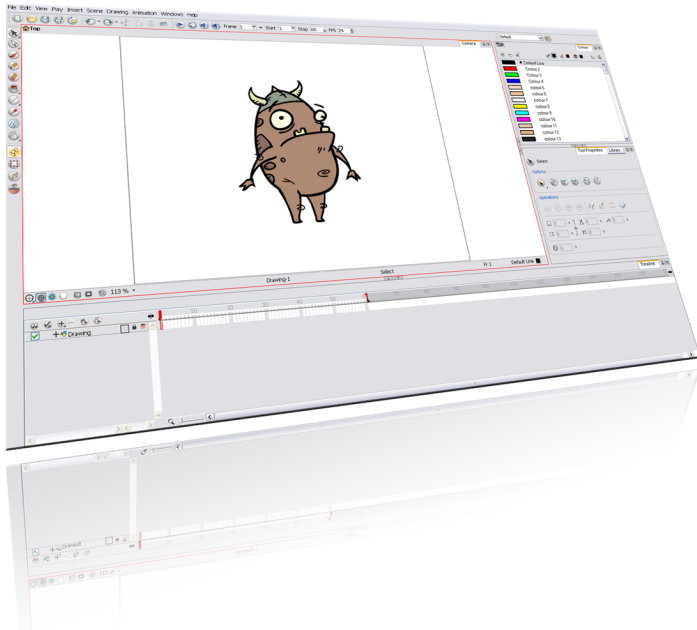

Knowing how to manage the Toon Boom Animate interface helps you to work efficiently and organize your workspace conveniently. There are a series of views and toolbars you can use as you perform different operations. Each user has a preferred way of working in the interface and which views and toolbars they will use. In this chapter, you will learn about the main elements of the interface and how to manage them.

## Topics Covered

- [User Interface on the facing page](#)
- [Managing the Views on page 90](#)
- [Managing the Toolbars on page 94](#)
- [Managing the Workspace on page 98](#)
- [Interface Navigation on page 103](#)
- [Preferences on page 55](#)

# User Interface

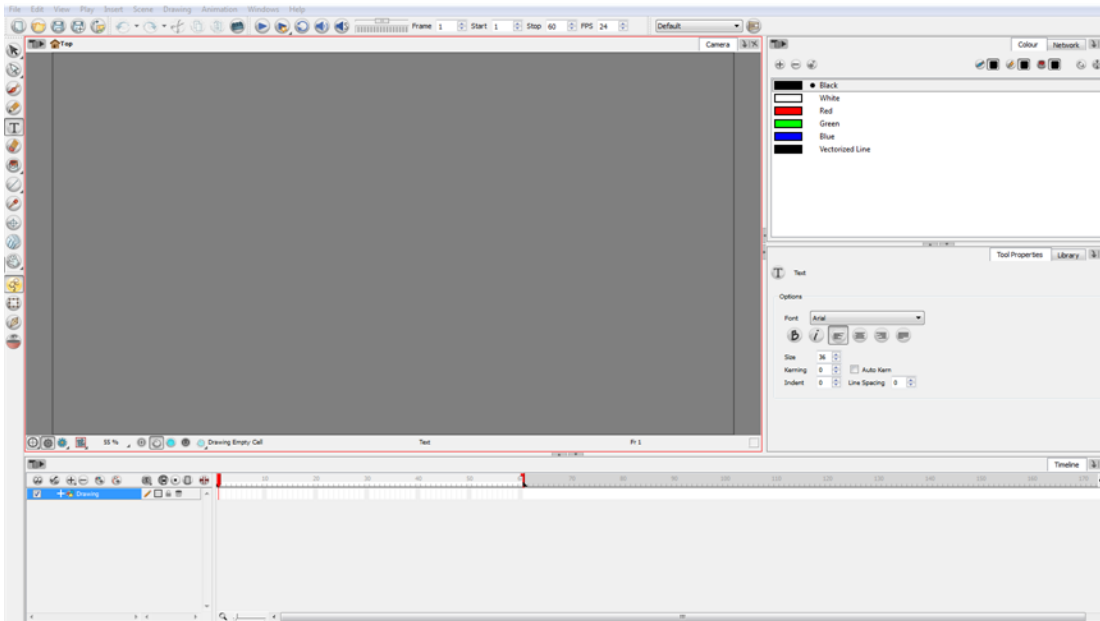

This section takes you through the most common elements of the User Interface. Throughout the user guide, you will learn about each view and toolbar and how and where to use them:

- [Views and Toolbars](#) below
- [Interface Highlights](#) on the next page

## Views and Toolbars

Toon Boom Animate has several views and toolbars. The Top toolbars are available at the top of the interface and the View toolbars are in individual windows. View toolbars are only shown if the particular view is displayed in the workspace.

This is a complete list of the views and toolbars available in Toon Boom Animate.

### Views

- [Camera View](#) on page 64
- [Colour View](#) on page 83
- [Coordinates and Control Points View](#) on page 664
- [Drawing View](#) on page 115
- [Function View](#) on page 676
- Layer Properties View
- [Library View](#) on page 87

### Top Toolbars

- Advanced Animation Toolbar
- Control Point Toolbar
- Coordinate Toolbar
- Easy Flipping Toolbar
- Edit Toolbar
- File Toolbar
- Flip Toolbar

Message Log View	Library Toolbar
Model View	Mark Drawing Toolbar
<a href="#">Module Library View</a> on page 1	Onion Skin Toolbar
<a href="#">Perspective View</a> on page 510	<a href="#">Playback Toolbar</a> on page 88
Script Editor View	Scripting Toolbar
Side View	Tools Toolbar
<a href="#">Timeline View</a> on page 72	Tool Presets Toolbar
Tool Preset View	Workspace Toolbar
<a href="#">Tool Properties View</a> on page 71	
Top View	
<a href="#">Xsheet View</a> on page 342	
<b>View Toolbars</b>	
Camera View Toolbar	
Colour View Toolbar	
Drawing View Toolbar	
Model View Toolbar	
Timeline View Toolbar	
Xsheet View Toolbar	

## Interface Highlights

It's important that you become familiar with the following elements of the user interface, this will help you to start using Toon Boom Animate. You can learn more about the highlights described here, and how to use them in a production context, throughout this guide.

When you start Toon Boom Animate for the first time, the default workspace is displayed. It contains all of the main elements you need to use.

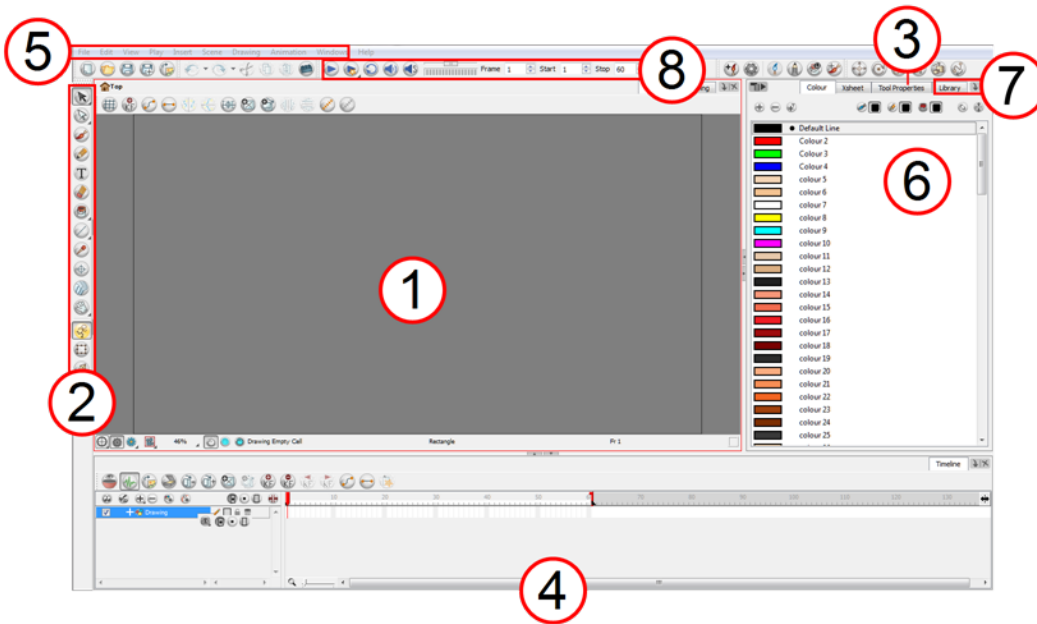

1. [Camera View](#) below
2. [Tools Toolbar](#) on page 71
3. [Tool Properties View](#) on page 71
4. [Timeline View](#) on page 72
5. [Menus](#) on page 81
6. [Colour View](#) on page 83
7. [Library View](#) on page 87
8. [Playback Toolbar](#) on page 88

## Related Topics

- [Managing the Workspace](#) on page 98
- [Managing the Views](#) on page 90

## Camera View

The Camera view is the centre of operations in Toon Boom Animate. It is in this view that you will draw, paint, animate, create animation paths and see your results. You can also move through your symbol's hierarchy.

The Camera view has a top and bottom toolbar that you can use to either navigate in the view, change the display mode or go back up your symbols hierarchy.

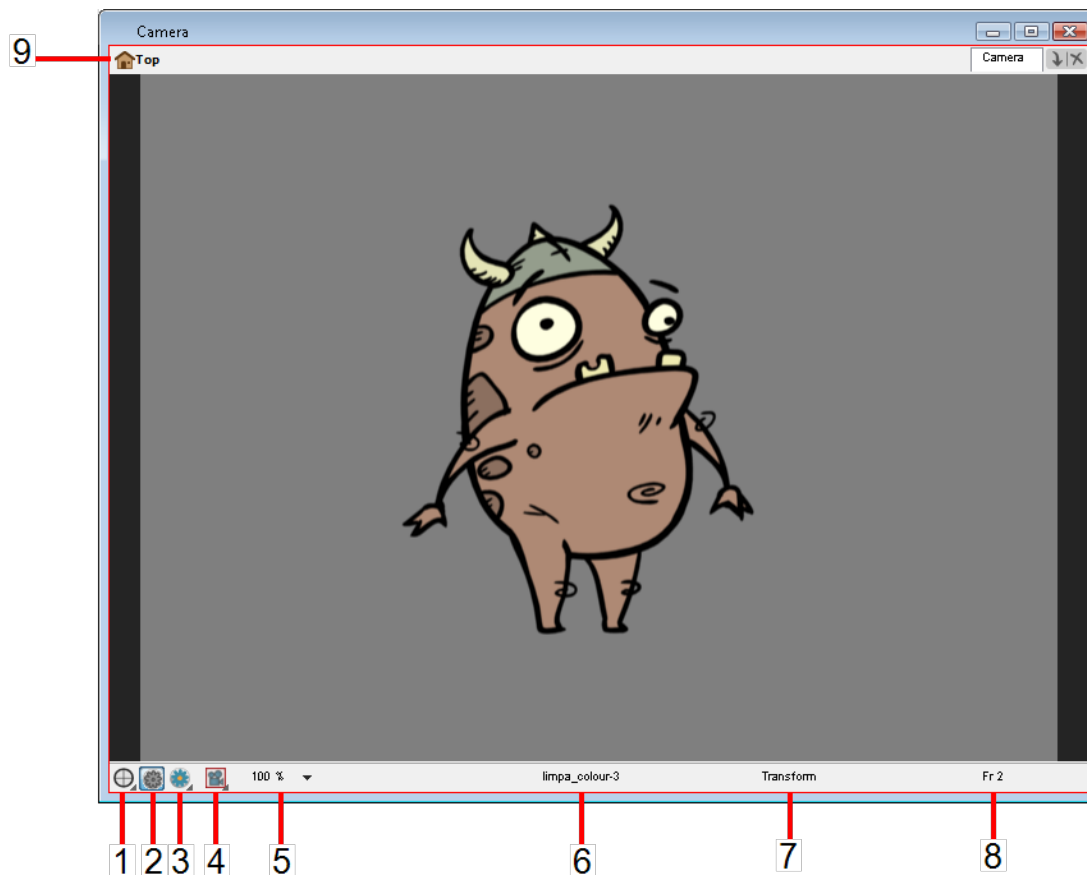

1. [Update Preview](#) below
2. [OpenGL View Mode](#) on the facing page
3. [Render View Mode](#) on the facing page and [Matte View Mode](#) on page 67
4. [Camera View Options Menu](#) on page 67
5. [Zoom Drop-down Menu](#) on page 69 and [Toggle Quick Close-up](#) on page 69
6. [Drawing Name](#) on page 70
7. [Tool Name](#) on page 70
8. [Frame Number](#) on page 70
9. [Editing Stack Menu](#) on page 70

## Update Preview

The Update Preview  button lets you check the final look of your effects and fully antialiased image. When you click the button, Toon Boom Animate calculates the current frame final image. It displays the result in the Render View Mode of the Camera view, it does not output an image.

## OpenGL View Mode



The OpenGL View Mode  button switches the Camera view to fast display, letting you see your animation play in real time. The OpenGL display requires less memory. The final look of your effects is not shown in the OpenGL View Mode. Switch to the Render View Mode to see your effects.

## Render View Mode



The Render View Mode  button switches the Camera view to a fully rendered display showing the final image of the current frame. If a modification is done to your current frame or if you move to a different frame, click on the **Update Preview** button to update the display.

Use the Render View Mode display to see the final look of your frames including effects and antialiasing. You cannot play back your scene in Render View Mode. To see your scene fully rendered and play it back, you must select **File > Export > Render Network** and enable the **Preview** option in the Render Network dialog box.

## Matte View Mode



The Matte View Mode  button switches the Camera view to a matte display showing the alpha channel of the elements in your scene. The transparency level ranges from 0 to 100 percent. Zero percent is completely transparent and represented by black and 100 percent is completely opaque and represented by white. Everything in between these extremes has a transparency level somewhere between 1 and 99 percent and is represented in various shades of grey.

- ▶ To access the Matte View mode, click on the **Render View Mode**  button and select **Matte View** from the drop-down menu.

## Camera View Options Menu

The Camera View Option  menu contains several options related to the camera view display modes. Here are the options contained in the menu:

- Safe Area
- Camera Mask
- Outline Locked Drawings
- Current Drawing On Top
- Show Strokes
- Show Strokes with Colour Wash
- Light Table
- Reset View
- Reset Rotation

## Safe Area

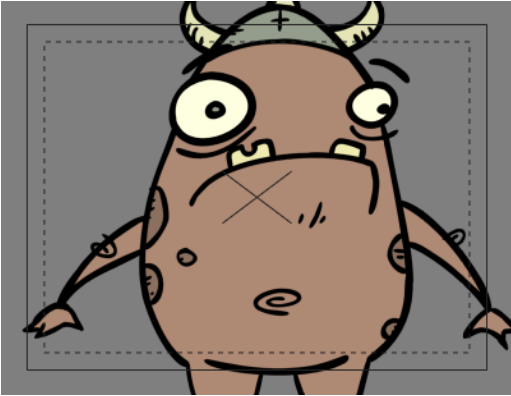

The Safe Area  button shows or hides the TV safety zone and the centre of the camera frame. The Safe Area will adapt to the scene resolution as well as the safety zone and frame's centre.

You can also access this feature from the top menu by selecting **View > Show > Safe Area**.

## Camera Mask

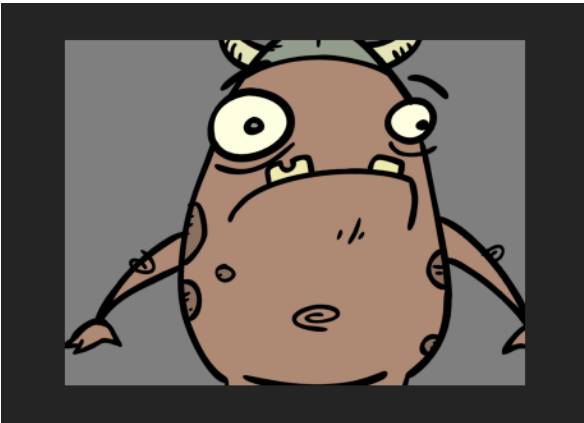

The Camera Mask  button shows or hides a black mask around the scene's frame to avoid seeing the unnecessary artwork. This option is handy when you are animating and setting up the scene. It allows you to see your scene's composition better.

You can also access this feature from the top menu by selecting **View > Show > Camera Mask**.

## Outline Locked Drawings

Drawings that are locked in the Timeline view (cannot be selected in the Camera view) will be displayed as wire frames.

## Current Drawing On Top

If this option is enabled, the drawing that is being currently edited with a drawing tool will be temporarily displayed in front of all the other elements. The actual scene is not modified by this option.



## Show Strokes

When drawing with invisible lines such as with the Pencil tool and a line thickness with a value of "0", the invisible strokes will be displayed as thin blue lines and the tips of the strokes will be displayed as yellow squares which helps indicating where the strokes end and where there are gaps in the outline.

## Show Strokes with Colour Wash

When drawing with invisible lines such as with the Pencil tool and a line thickness with a value of "0", the invisible strokes will be displayed as thin blue lines and the tips of the strokes will be displayed as yellow squares which helps indicating where there are gaps in the outline. The drawing colours will also be washed out to make the invisible lines stick out better.

## Light Table

By default, while using a drawing tool in the Camera view, the layers that are not being edited are washed out. If the Light Table option is disabled, the drawings will all be displayed in normal colours even though they are not being edited.

## Reset View

The Reset View  button will reset any panning, zooming or rotation done in the Camera view and return the display to the initial settings or press [Shift] + [M].

## Reset Rotation

The Reset Rotation  button will reset any rotation done in the Camera view and return the display to the initial rotation settings or press [Shift] + [X].

## Zoom Drop-down Menu

The Zoom menu lets you enlarge or reduce the Camera or Drawing view display.



To make the camera frame size always match the size of your view, select the **Fit to View** option. Click the drop-down arrow and select a zoom level or press [1] and [2].

---

## Toggle Quick Close-up

Use the Magnifier tool to quickly center on the mouse position and zoom in to a pre-defined value such as 4X. Then you can zoom out again. Hold the shift key and press [Z] to zoom in and back out again. Replacing the Reset Zoom by pressing [Shift] + [Z].





The area where you zoom in or out is dependent on the cursor location in the Camera view. If you zoom in and then move the cursor to a different location when you zoom out the mouse will be centered on that location.

## Overlay, Line Art, Colour Art, Underlay and Preview Mode

-  **Line Art:** Switches to the Line Art layer of the drawing. The default keyboard shortcut is [L].

You can display the Line Art view in the Preferences dialog box. Select **Edit > Preferences** ( Windows) or **Animate > Preferences** ( Mac OS X). Select the General tab. In the Advanced box, select the **Use Advanced Art Mode** option and restart the application.

-  **Colour Art:** Switches to the Colour Art layer of the drawing. The default keyboard shortcut is [L].

-  **Preview mode:** Switches to Preview mode, so you can see both Line Art and Colour Art layers simultaneously. The default keyboard shortcut is [Shift] + [P].

You can display the Line Art view in the Preferences dialog box. Select **Edit > Preferences** ( Windows) or **Animate > Preferences** ( Mac OS X). Select the General tab. In the Advanced box, select the **Use Advanced Art Mode** option and restart the application.

## Drawing Name

The Drawing Name field displays the name of the selected drawing, as well as the layer containing it. If the cell does not contain any drawing, an **Empty Cell** text is shown in the field.

## Tool Name

The Tool Name field displays the name of the selected tool. If you override a tool using an overriding keyboard shortcut, the tool's name will be highlighted in red letters—see [Override Tool on page 224](#) to learn how to temporarily override a tool.

## Frame Number

The Frame Number field displays the number of the current frame.

## Editing Stack Menu



The Editing Stack menu displays the names of the symbols and their hierarchy when you are editing a symbol. You can click on the different names to go back up to the different parent symbols or the top/current project.

## Related Topics

- [Interface Highlights on page 63](#)

## Tools Toolbar



The Tools toolbar contains all of the main tools you will use while working in Toon Boom Animate. In the default workspace, you will find this toolbar on the left-most side of the interface.

## Related Topics

- [Drawing](#) on page 111
- [Traditional Animation](#) on page 237
- [Colour](#) on page 273
- [Morphing](#) on page 419
- [Character Building](#) on page 553
- [Scene Setup](#) on page 483
- [Animation Paths](#) on page 637
- [Cut-out Animation](#) on page 713

## Tool Properties View

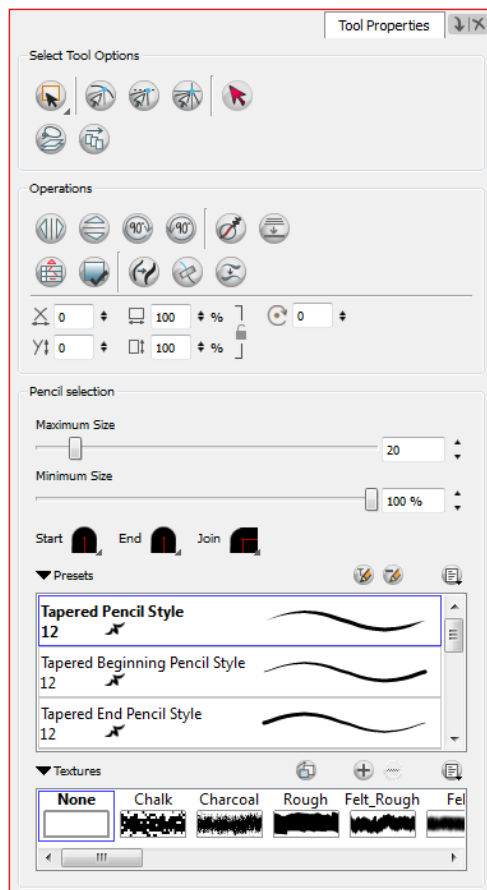

The contextual Tool Properties view contains the most common options and operations related to the currently selected tool. As soon as you select a tool from the Tools toolbar, the Tool Properties view will be updated.

For example, if you choose the Select  tool in the Tools toolbar, the Tool Properties view will display the options and operations related to the Select tool such as Snap to Contour, Apply to All Drawings, Flip Horizontal and Flatten.

**To open the Tool Properties view:**

- Select **Windows > Tool Properties**.



The content of the Tool Properties view is explained in detail in the following chapters:

- [Drawing](#) on page 111
- [Traditional Animation](#) on page 237
- [Colour](#) on page 273
- [Scene Setup](#) on page 483
- [Cut-out Animation](#) on page 713

## Timeline View

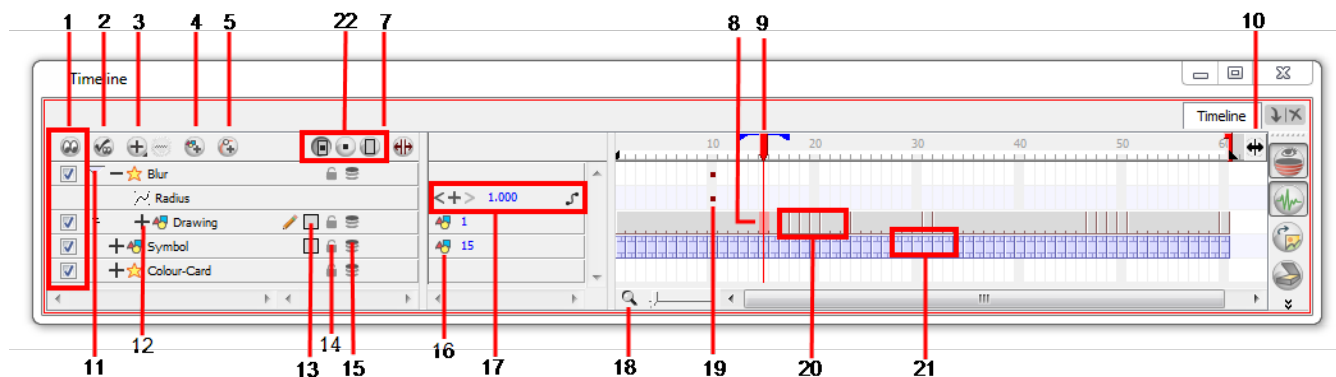

These are described later in this section.

1. [Enable/Disable All](#) on the next page
2. [Show Selection and Hide All Others](#) on page 74
3. [Add Layers](#) on page 74
4. [Delete Layers](#) on page 74
5. [Add Drawing Layer](#) on page 75
6. [Add Peg](#) on page 75
7. [Show/Hide Data View](#) on page 75
8. [Current Drawing Displayed](#) on page 75
9. [Current Frame](#) on page 76

10. [Split](#) on page 76
11. [Show/Hide Children](#) on page 76
12. [Show/Hide Functions](#) on page 76
13. [Change Track Colour](#) on page 77
14. [Lock/Unlock Layer](#) on page 77
15. [Onion Skin](#) on page 78
16. [Drawing Substitution](#) on page 79
17. [Keyframe Value](#) on page 79
18. [Zoom](#) on page 80
19. [Keyframe](#) on page 80
20. [Drawing Exposure](#) on page 80
21. [Symbol Exposure](#) on page 80
22. [Dragging and Pasting Modes](#) on page 80

The Timeline view is the main view used when adjusting the timing of your drawings, connect effects and order your layers. The Timeline view displays the following:

- Layers
- Effects
- Sounds
- Keyframe Values
- Scene Length
- Layer Names
- Drawings
- Keyframes
- Timing
- Frames

## Enable/Disable All

The Enable/Disable All  button is used to show or hide all your layers simultaneously.

To disable a particular layer, uncheck the layer's checkbox or press [D]

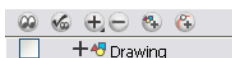

To enable a particular layer, place a checkmark (tick) the layer's checkbox or press [A].

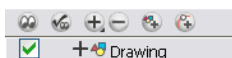





When you disable a layer in the Timeline view, the corresponding column is hidden in the Xsheet view. When a column is hidden in the Xsheet view, the corresponding layer is disabled in the Timeline view.

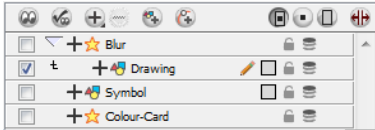

## Show Selection and Hide All Others



The Show Selection and Hide All Others  button is used to show only the currently selected layer in the Timeline view and disable all the other layers.

## Add Layers

The Add Layers  button is used to add new layers to the timeline. When you click on the Add Layers button, a drop-down menu will appear displaying the layer types available. You can add several different types of layers:

-  Camera
-  Colour-Card
-  Drawing
-  Mask
-  Peg
-  Quadmap
-  Effect

## Delete Layers

The Delete Layers  button is used to delete the currently selected layers in the Timeline view. When you click on the Delete Layers button, a Confirm Delete dialog box appears. Click OK to delete the layers or Cancel to stop the operation.

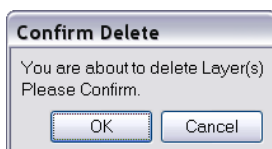

## Add Drawing Layer

The Add Drawing Layer  button is used to automatically add a new drawing layer to your timeline. By default, the layer is named **Drawing**.

## Add Peg

The Add Peg  button is used to add a peg layer to your timeline. There are several ways to use the Add Peg button. Refer to [Animation Paths on page 637](#) for more information about pegs and how to use them.

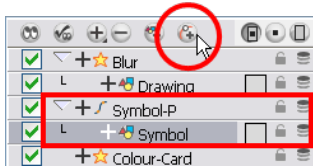

## Show/Hide Data View

The Show/Hide Data View  button is used to display the current frame's drawing exposure and keyframe values corresponding to each individual layer.

### Hidden Data View

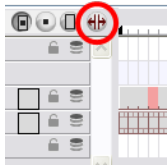

### Visible Data View

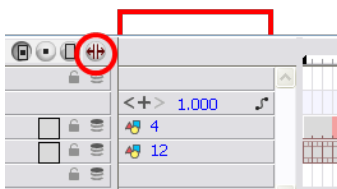

## Current Drawing Displayed

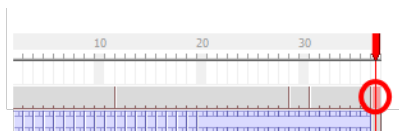

The drawing selected in red represents the drawing currently displayed and is linked to play head position.

## Current Frame

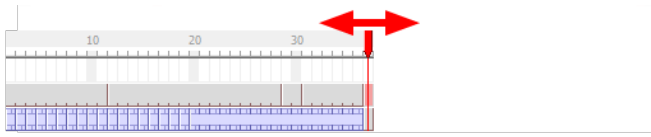

The red play head represents the current frame displayed and marked in the Playback toolbar. If you slide the play head to the left or the right it will scrub through your frames and update the Camera view display.

## Split

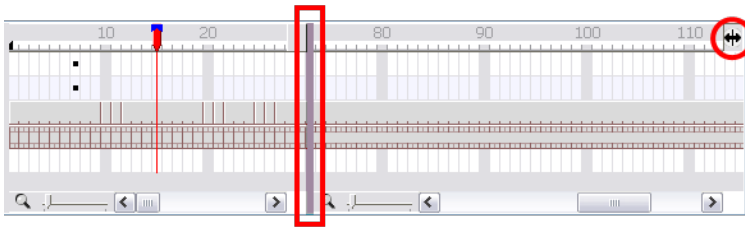

The Split  button is used to split the Timeline view in two sections allowing you to see two different portions of your Timeline view. This way, if your scene length is very long, you can see the beginning and the end at once.

## Show/Hide Children



The Show/Hide Children  button is used to display the children layers of a parent layer. Once a layer is parented to another layer, it is indented to the right and the Show/Hide Children button appears on the parent layer allowing you to show or hide the child layer.

## Show/Hide Functions

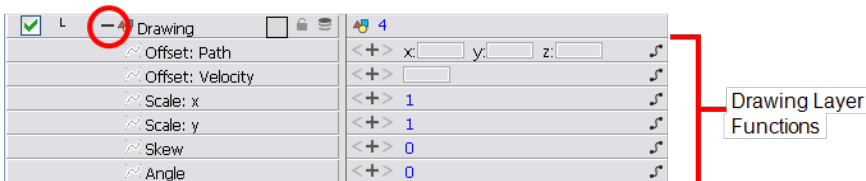

The Show/Hide Functions  button is used to display the functions embedded in each layer. The Functions are the different position and intensity information used to remember a layer's position, scale or rotation as well as



an effect's look on each frame. This information is stored on the function curves using keyframes. Refer to [Animation Paths on page 637](#) for more information about the function layers.

## Change Track Colour



The Change Track Colour  button is used to change the colour of the exposed frames, this helps you to quickly locate a layer in the Timeline view. Double-click on the swatch to open the picking window and choose a new colour.

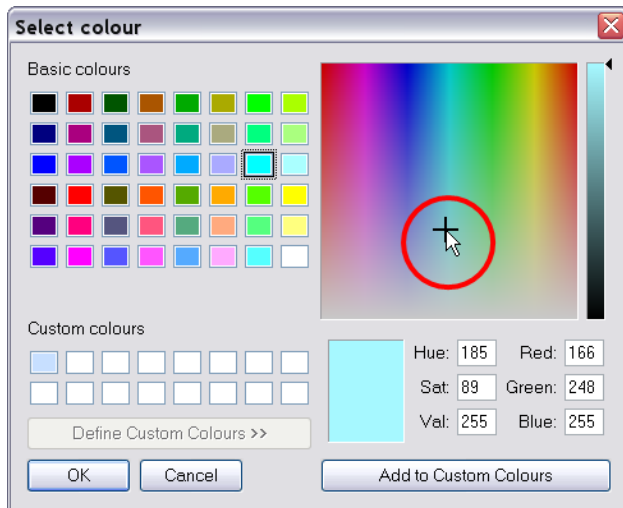

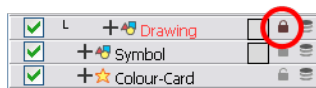

## Lock/Unlock Layer



The Lock/Unlock Layer  button is used to prevent the selection or editing of a layer in the Camera view.

To select some of the layers without selecting others, in the Timeline view, lock the layers you do not want to select.

In the top menu, there are a series of locking options. Select **Animation > Lock > select one of the following actions:**

-  **Lock**  
This option locks the currently selected element.
-  **Unlock**  
This option unlocks the currently selected element.

-  **Lock All**

This option locks all the elements in the Camera view.

-  **Unlock All**

This option unlocks all the elements in the Camera view.

-  **Lock All Others**

This option locks all the elements in the Camera view except the currently selected one.

You can display the locked drawings as outlines in the Camera view if you want to quickly find out which drawings are locked.

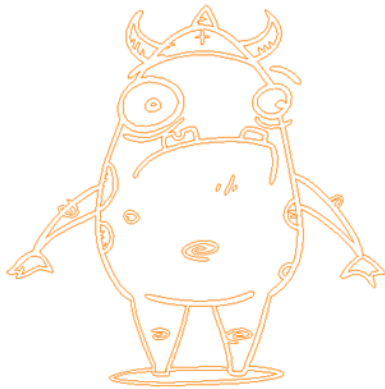

#### To display locked drawings as outline:

1. In the top menu, select **Edit > Preferences** (Windows) or **Animate > Preferences** (Mac OS X).
2. In the Preferences panel, go to the Camera tab.
3. In the Tools section, enable the **Show Locked Drawings As Outlines** option.

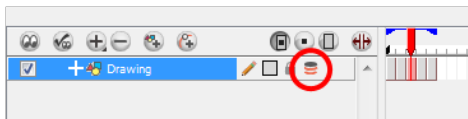

## Onion Skin





The Onion Skin  button is used to enable the Onion Skin option on a particular layer. If you want to see the previous and next frames of a specific layer, go to the Timeline view and click on the Onion Skin button for that particular layer. Blue arrows appear on both sides of the play head. Pull on these blue arrows to add more frames to the onion skin display.

To activate the general Onion Skin preview, in the Tools toolbar, click on the **Onion Skin**  button.

## Drawing Substitution

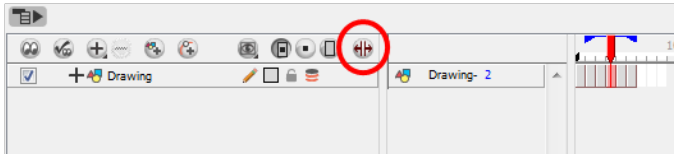
The Drawing Substitution  field is used to change the drawing exposed at the current frame. To access the Drawing Substitution field, you must first expand the Data view by clicking on the **Show/Hide Data View**  button.





To change the current drawing either click and slide your cursor left or right when you see the hand  cursor, or double-click on the drawing name and type a new value.





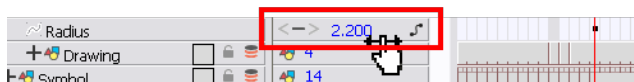



The drawing exposure will be changed for the entire block it is exposed, not just the current frame.

## Keyframe Value



The Keyframe Value field is used to add, remove or modify a keyframe at the current frame. To access the Keyframe Value field, you must first expand the Data view by clicking on the **Show/Hide Data View**  button.

- To add a keyframe at the current frame, click on the **Add Keyframe**  button.
- To remove an existing keyframe at the current frame, click on the **Delete Keyframe**  button.
- To change the current keyframe, either click and slide your cursor left or right when you see the hand  cursor, or double-click on the keyframe value and directly type a new value.
- To navigate through the existing keyframes, click on the **Previous Keyframe**  and the **Next Keyframe**  buttons.
- To link your layer to an existing function or to create a new function, click on the **Show Function Menu**  button to display the drop-down Function menu.



Refer to [Modifying a Path in the Timeline View on page 672](#) to learn more about using the Data view and the Keyframe Value field.

## Zoom



The Zoom tool is used to increase or reduce the width of the frames in the Timeline view. Drag the cursor to the right to increase the width or to the left to reduce it. You can also press [1] and [2].

## Keyframe

A black square is displayed in the Timeline view when a keyframe exists. You are able to select these keyframes and drag them wherever you want on the timeline. You can also copy, cut and delete them.

- To delete a keyframe without deleting the drawing exposure, go to the Timeline view and select the keyframe to be deleted and then select **Animation > Delete Keyframes** from the top menu.

When a parent layer is collapsed and a child layer contains a keyframe, a white square will be displayed.

## Drawing Exposure



In the Timeline view, when a drawing is exposed, it is represented as a grey block. If the drawing is exposed for several frames, the block is extended. When a second drawing is exposed, a new grey block is displayed.

- The exposure's colour can be changed. To pick a new colour, double-click on the **Change Track Colour**  button in the corresponding layer.

## Symbol Exposure



In the Timeline view, when a symbol is exposed it is represented as a small film frame. If the symbol is exposed for several frames, the film frame is extended. When a second symbol's frame is exposed, a new film frame is displayed.



## Dragging and Pasting Modes

As you animate you will find that you may reuse a lot of positions, drawings and keys. However, you may only want to paste the drawings, or just the keys or maybe everything. There are different paste options available in the Timeline view which will give you the maximum flexibility when reusing and pasting.

There are three different modes for pasting your selection:

-  Paste Mode: All Drawing Attributes

Pastes the drawing exposure and keyframes.

-  Paste Mode: Keyframes Only  
Pastes only the keyframes.
-  Paste Mode: Exposures Only  
Pastes only the drawing exposure.

Refer to [Copying and Pasting Animation](#) on page 774

## Related Topics

- [Timing](#) on page 339
- [Character Building](#) on page 553
- [Scene Setup](#) on page 483
- [Animation Paths](#) on page 637
- [Cut-out Animation](#) on page 713
- [Effects](#) on page 779

## Menus

You can access the commands from the following menus:

- [Top Menu](#) below
- [Quick Access Menu](#) on the facing page

## Top Menu

File Edit View Play Insert Scene Drawing Animation Windows Help

The top menu contains most of the commands. Depending on the view you are working in and the element, some commands are available and others not. The top menu is always located at the very top of the user interface.

The top menu contains the following categories:

- File
- Edit
- View
- Play
- Insert
- Scene
- Drawing
- Animation
- Windows
- Help

In the Mac OS X version, there is a Animate category containing the following commands:

- Preferences
- About
- Quit

## Quick Access Menu

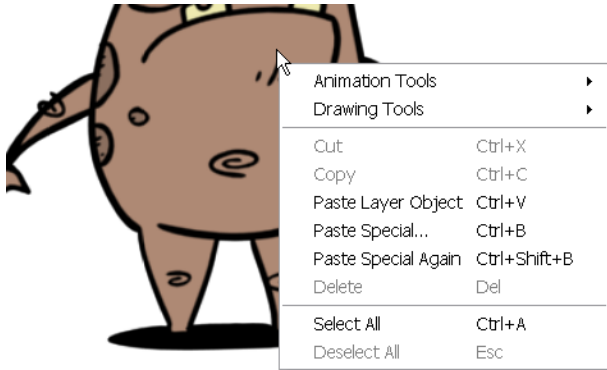

Each view has a Quick Access menu containing recurring actions. This menu is accessed by right-clicking anywhere in the view.

## Related Topics

- [Interface Highlights on page 63](#)

## Colour View

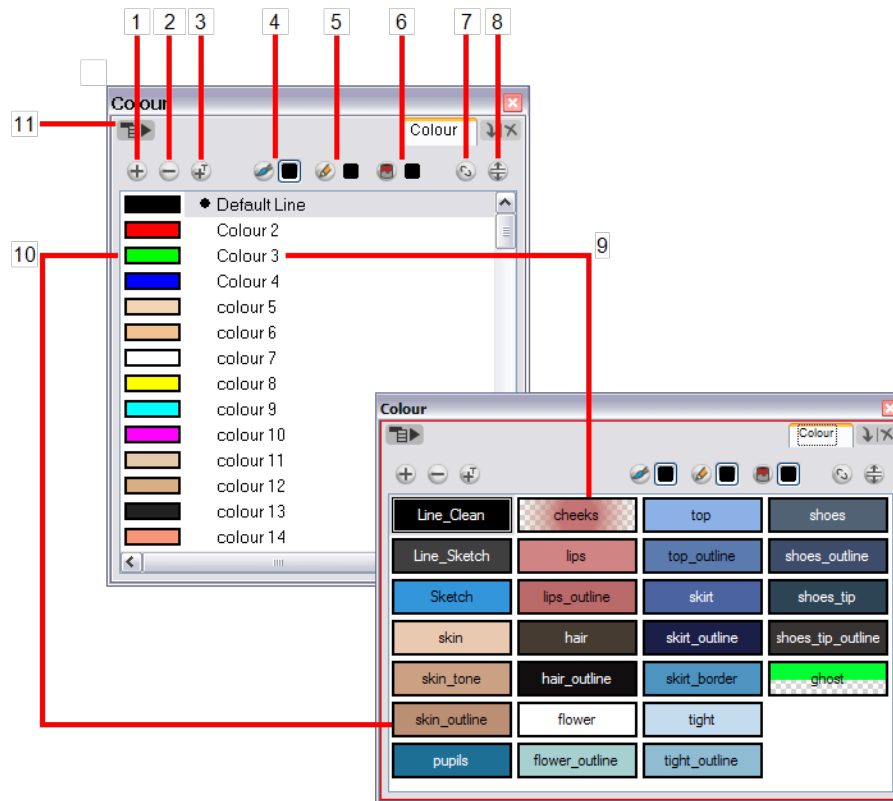

1. [Add Colour](#) on the facing page
2. [Remove Colour](#) on the facing page
3. [Add Texture](#) on page 85
4. [Set Current Brush Colour](#) on page 85
5. [Set Current Pencil Colour](#) on page 85
6. [Set Current Paint Colour](#) on page 85
7. [Link/Unlink Three Colours](#) on page 85
8. [Show/Hide Palette List View](#) on page 86
9. [Colour Swatch Name](#) on page 86
10. [Colour Swatch](#) on page 86
11. [Colour View Menu](#) on page 87

The Colour View is where you create colours and palettes and import existing palettes into your project. The Colour View is also necessary for drawing, painting and creating colour styling.

The Colour View has two display modes:

- List Mode
- Swatch Mode

**To toggle between the display modes:**

1. In the Colour View menu, select **Colours > Swatch Mode**.

- ▶ Enable the option to display the swatches.
- ▶ Disable the option to display the colour list.

## Add Colour

The Add Colour  button is used to add a colour swatch to your palette. Click on the Add Colour button to add a new swatch to the bottom of your colour list.

## Remove Colour

The Remove Colour  button is used to delete the currently selected colour swatches. If the colour swatch is used in your project, the Delete Colour dialog box will pop and will ask you to confirm the operation.

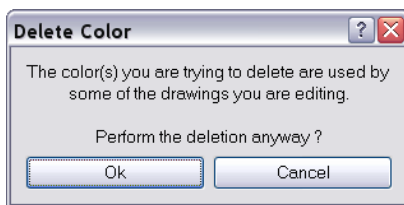

- ▶ Click **OK** to confirm the operation or **Cancel** to cancel it.

Zones painted with colour swatches which have been deleted will turn red, easily identifying them so you can repaint them with another colour swatch.





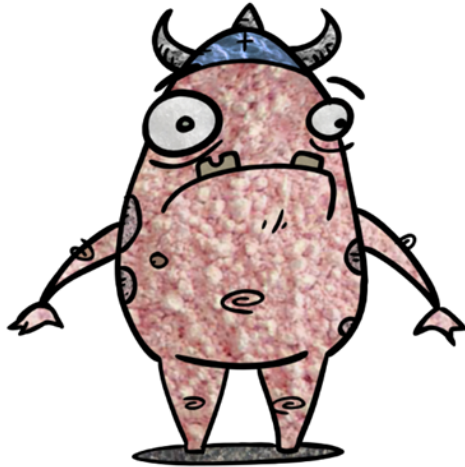

## Add Texture









The Add Texture  button is used to add a bitmap colour swatch to your palette. Use this to load photos and textures and paint your drawings with it. The bitmap image must be a TGA or PSD file format.



## Set Current Brush Colour

The Set Current Brush Colour  button is used to set the currently selected colour swatch as the colour used by the Brush  tool. If you select a new colour in the Colour view while using the Brush tool, the Set Current Brush Colour swatch will be updated.

## Set Current Pencil Colour

The Set Current Pencil Colour  button is used to set the currently selected colour swatch as the colour used by the Pencil , Polyline , Ellipse , Rectangle  and Line  tools. If you select a new colour in the Colour view while using any of these tools, the Set Current Pencil Colour swatch will be updated.

## Set Current Paint Colour

The Set Current Paint Colour  button is used to set the currently selected colour swatch as the colour used by the Brush  tool. If you select a new colour in the Colour view while using the Paint tool, the Set Current Paint Colour swatch will be updated.

## Link/Unlink Three Colours



The Link/Unlink Three Colours  button is used to link the Set Current Brush Colour, Set Current Pencil Colour and Set Current Paint Colour swatches to the currently selected colour swatches in the Colour view.

## Show/Hide Palette List View

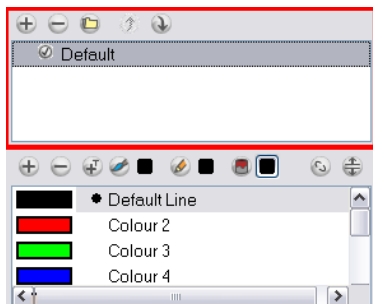

The Show/Hide Palette List View  button is used to display the Palette List view in the Colour view. This option is for the advanced user who wants to create colour palettes for their props and characters.

## Colour Swatch Name

	Skin
	Teeth
	Horns
	Helmet

Each colour swatch available in the Colour view can have its own name, making it easy to identify which colour is used to paint what part of your character or background.



Two colours can have the same name.

## Colour Swatch

	Colour 2
	Colour 3
	Colour 4
	colour 5
	colour 6
	colour 7

A colour swatch is a specific colour used to paint a certain zone of a character or background. Colour palettes are composed of colour swatches. They can also be called colour pots. When you paint a zone with a colour swatch, the zone is linked to the swatch. So if you update the swatch's tint, the zone will be updated along with it. This allows you to modify your animation colours even after it is completely painted.

## Colour View Menu

The Colour View  menu allows you to access commands that are specifically related to the Colour view such as creating new palettes, adding new colour swatches and displaying the Tint panel. The commands listed in the Colour View menu can also be found following a similar path from the top menu categories Colours and Palettes.

## Related Topics

- [Colours on page 276](#)

## Library View

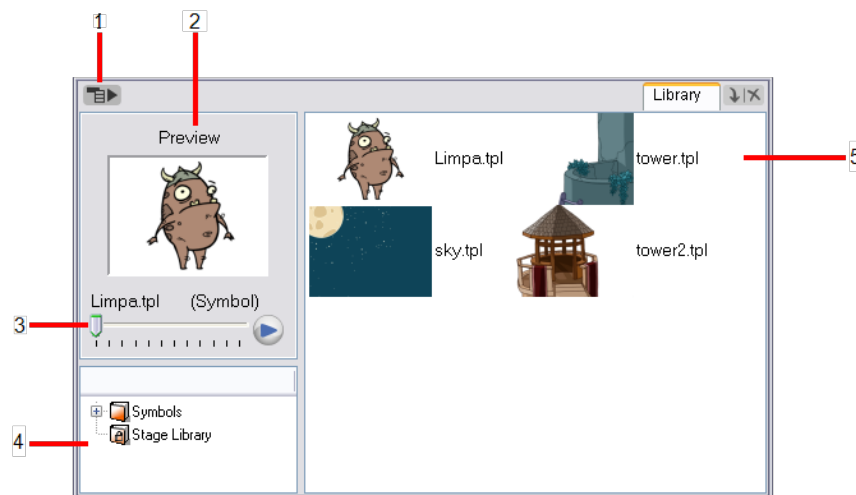

1. [Library View Menu](#) on the facing page
2. [Preview Window](#) on the facing page
3. [Preview Playback](#) on the facing page
4. [Library Folder List](#) on the facing page
5. [Template/Symbol List](#) on the facing page

The Library view is used to store elements such as animation, drawings, backgrounds and puppets to reuse them in your different projects. You also use the Library view to create and store your symbols.

To reuse an element in another project, you must create a template out of your drawings. A template is a mini scene that you import in your other project. A template has no link to the original scene. When you create a template, the full content of your selection is copied in the template.

When you are creating a series of layers all using the same drawings or building puppets, you will create symbols. These can be used as drawing containers when you are creating puppets so that you can store different mouth shapes or hands to use while animating. You can also use symbols when you are building props, such as a skateboard and you want to use the same wheel drawing for the four skateboard wheels.



Refer to [Library on page 521](#) to learn more about using the library, symbols and templates in context.

## Library View Menu

The Library View  menu allows you to access commands that are specifically related to the Library view such as importing SWF movies and Illustrator files, adding a new folder and refreshing the library's content.

## Preview Window

The Preview window is used to see the content of the currently selected template or symbol in the Template/Symbol list.

## Preview Playback

The Preview Playback button is used to play back the content of the selected template or symbol if it contains more than one frame. Press the Play  button to play back the preview.

## Library Folder List

The Library Folder List displays all of the folders linked to the Library view. There are two default folders:

- **Symbols**  
The Symbols folder is the only folder containing symbols. The user can organize it by adding subfolders inside.
- **Animate Library**  
The Animate Library folder is a default library found on the hard drive in the user's documents. This folder can contain templates, but no symbols.

The user can link new library folders to the Library view and organize them with subfolders.

## Template/Symbol List

The Template/Symbol list displays the templates or symbols contained in the selected library folder. If you right-click, you can display the templates and symbols' thumbnails by selecting **View > Thumbnails**.



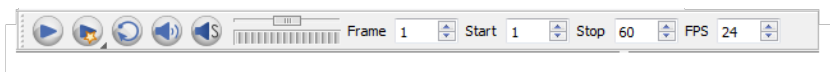

## Related Topics

- [Library on page 521](#)

## Playback Toolbar



Use it to play back your animation and sound. Use it to scrub your sound to create your lip-sync, looping your playback, navigating through your frames, change the playback range and speed.

- Click on the **Play**  button to play and stop the animation. You can also do this from the top menu by selecting **Play > Play Scene Forward** or **Stop**.
- Click on the **Loop**  button to repeat your playback indefinitely. Or do this from the top menu by selecting **Play > Loop**.
- Click on the **Sound**  button to enable sound in the playback. Or do this from the top menu by selecting **Play > Enable Sound**.
- Click on the **Sound Scrubbing**  button to enable sound scrubbing in the playback. Or do this from the top menu by selecting **Play > Enable Sound Scrubbing**.
- Click on the **Render and Play**  button to create a render of your scene to play back the final result including the effects.
- Scroll through the playback's frames using the Jog Frames right and left arrows.



- To change the playback frame range enter new values in the Start and Stop fields.

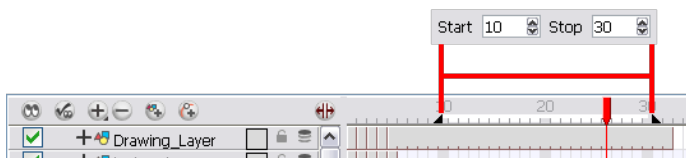

- Enter a new value in the **FPS** field to change the speed of the playback.



## Play Menu

Select any of the following from the top menu Play heading:

- **First Frame** jumps to the first frame. You can also press [**<**].
- **Next Frame** jumps to the frame after the currently selected frame in the Timeline view. You can also press [**.**].
- **Last Frame** jumps the last frame. You can also press [**>**].
- **Previous Frame** jumps to the frame before the frame currently selected in the Timeline view. You can also press [**,**].
- **Go to Frame** or use the **Go**  button, which can be added to the Timeline View toolbar through the Toolbar Manager. Open the Go to Frame dialog box so you can type in the frame number to jump to.
- **Enable Playback** view from either the Top, Side or Perspective views.

# Managing the Views

The Toon Boom Animate user interface is composed of different views, each one designed for a specific purpose. This section explains how you can modify the location and accessibility of the views by adding a new view as a tab or as a window, you can also swap the view locations around.



Workspace modifications are automatically saved when you exit the application unless you disabled the Automatically Save Workspace preference in the Preferences panel.

- [Adding a New View](#) below
- [Closing a View](#) on the next page
- [Swapping Views](#) on the next page
- [Resizing a View](#) on page 92

## Adding a New View

To add a view:

1. Select the view you want to add from **Windows > The desired view**.

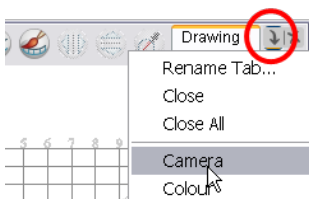
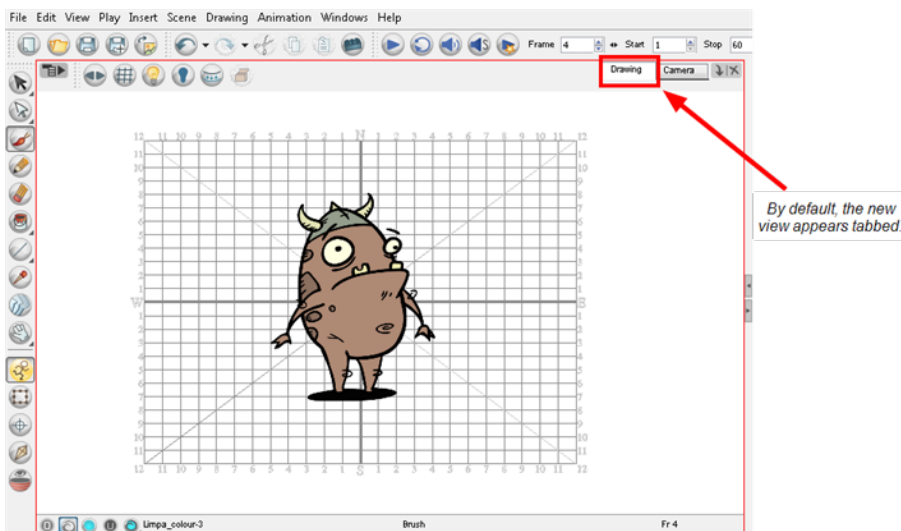

You can also use the Window drop-down menu button included in each view already available in the workspace. Click on the button and select a view from the list. You can only open one instance of the

same view. In other words, you cannot have two Camera views open at the same time.

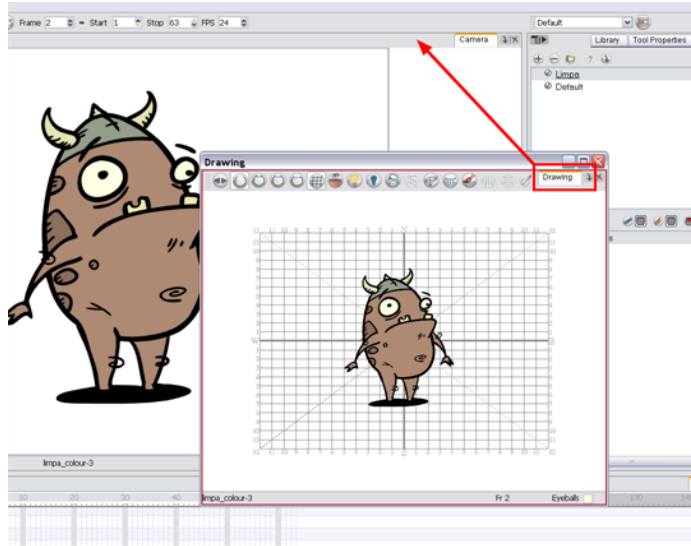

You can open several instances of the same view except for the Timeline, Tool Properties, Colour and Drawing views.

2. To dock a floating window in your workspace, drag the window's tab onto one of the workspace's views.



## Closing a View

To close a view:

1. In the view to close, click on the **Close View**  button.
  - If you have several tabs in the same window, hold [Shift] down and click on the **Close View**  button to close all tabs together.

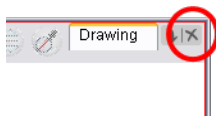

## Swapping Views

With Animate, you can easily swap views around.

To swap views around:

1. Select the view tab and drag it onto one of the view's separators, top area or onto another view's tab.
2. When a rectangle outline appears showing an available location for the view, release the mouse button and drop the view tab into position. One of three things will happen:

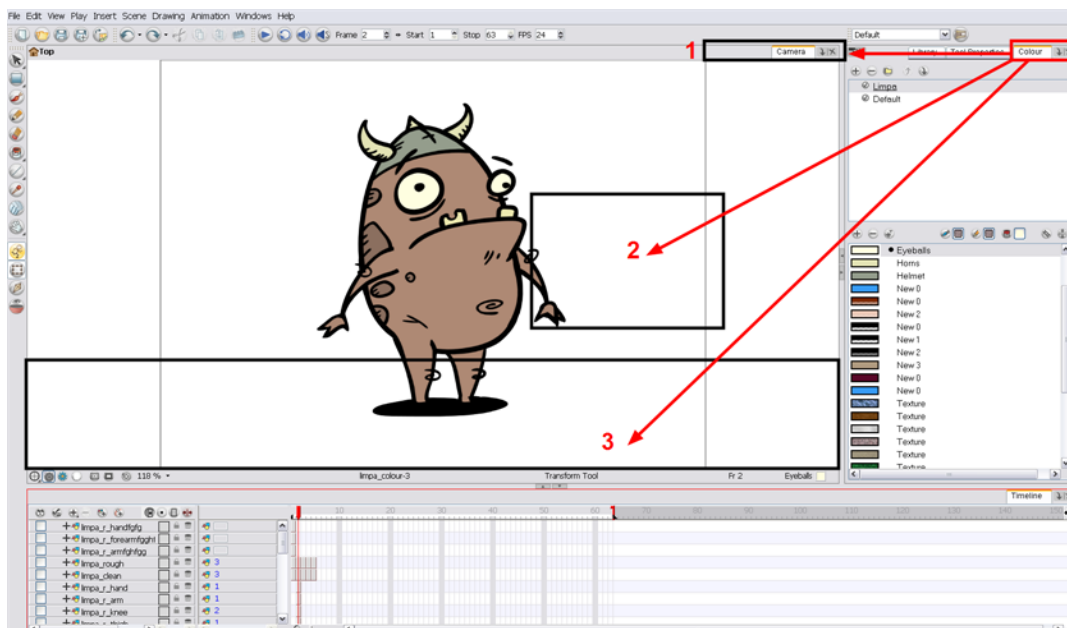

- 1. The view becomes a tabbed window.
- 2. The view becomes a floating window.
- 3. The view becomes a new docked window.

## Resizing a View

To change the width and height of the views in the workspace, drag the side of the view.

**To resize a view:**

1. In the interface, position your cursor on the edge of the view you want to resize.
2. When you see the Resizing  $\pm$  cursor, click and drag the side of the window to the desired width or height.

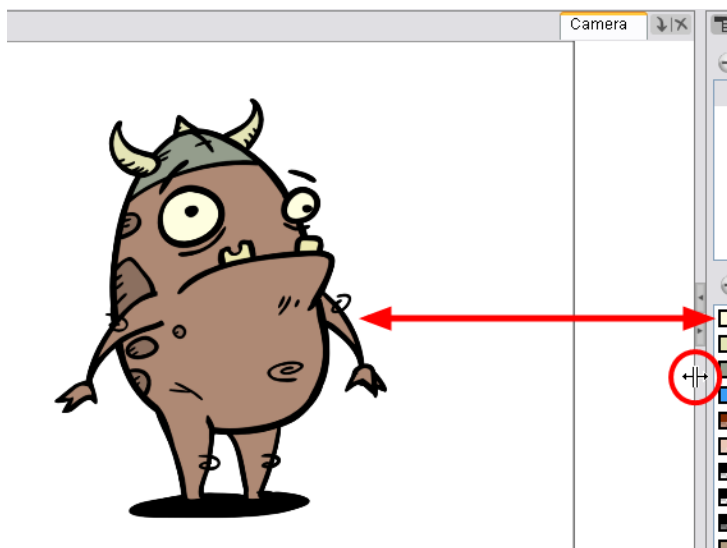

You can also temporarily hide a view to get more working space.



### To temporarily hide a view:

1. On the edge of the window you want to hide click on the **Collapse/Expand** button. The view is compressed and only the Collapse/Expand button is visible.
2. Click on the same **Collapse/Expand** button to display the view again.

### Related Topics

- [Managing the Toolbars on the facing page](#)
- [Managing the Workspace on page 98](#)

# Managing the Toolbars

The Toon Boom Animate user interface contains toolbars which, by default, are located at the top of the interface. Some of the workspace's views also have their own toolbars. These toolbars can be moved around. You can reposition the toolbars to suit your work style or hide unused ones.

- [Showing or Hiding Toolbars below](#)
- [Moving Toolbars on the next page](#)
- [Flat Tool Toolbar Preference on the next page](#)
- [Toolbar Manager on page 96](#)

## Showing or Hiding Toolbars

To show or hide a toolbar:

- ▶ Select **Windows > Toolbars > the desired toolbar**.

You may right-click anywhere in the toolbar area to access Toon Boom Animate toolbars. View toolbars, however, are not available by right-clicking the toolbar area. You can access the toolbar of any open and active view by right-clicking in the workspace area.

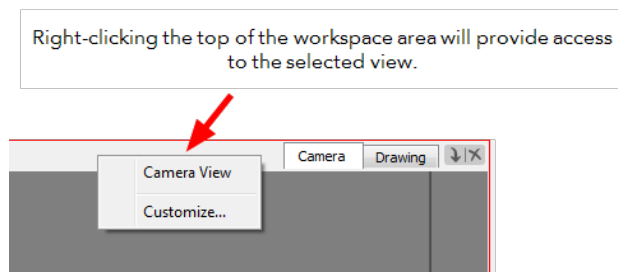
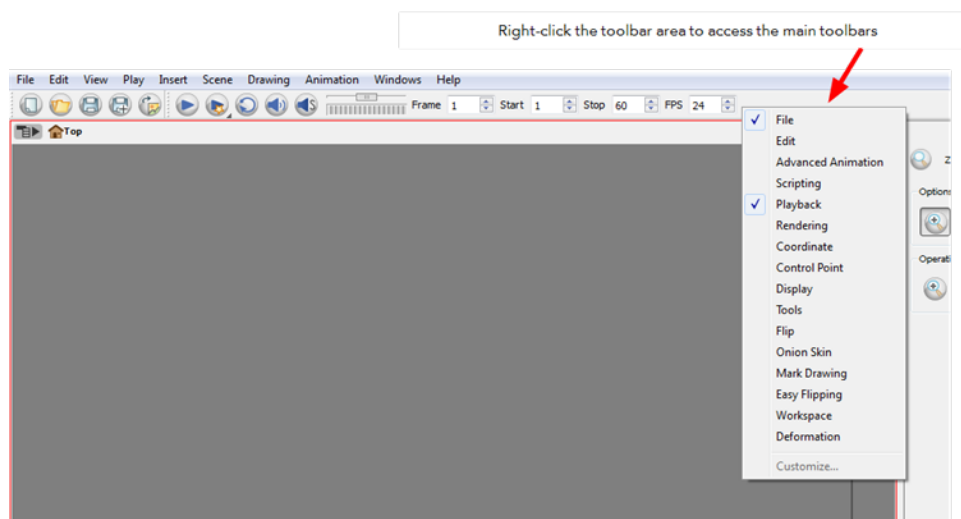

You may also hide a portion of a toolbar by dragging another open toolbar over its tail-end.

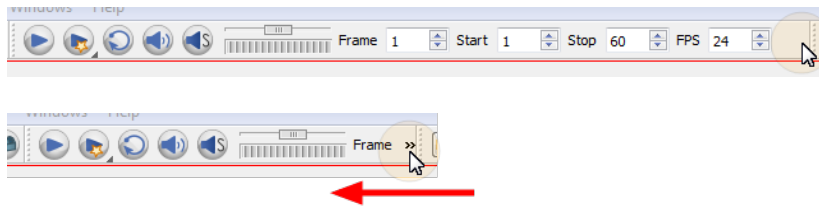

The Toolbar menu only contains the View toolbars of the views that are open in the workspace. As you show or hide views in your workspace, the Toolbar menu will update.

## Moving Toolbars

To move a toolbar:

1. Select the toolbar you want to move by clicking on its anchor point  and dragging it into a view toolbar area or another position in the top or side interface toolbar area.

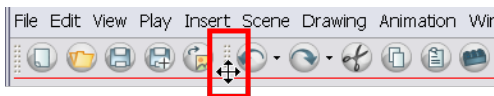

2. When a rectangle outline appears showing an available location for the toolbar, release the mouse button and drop the toolbar into position.

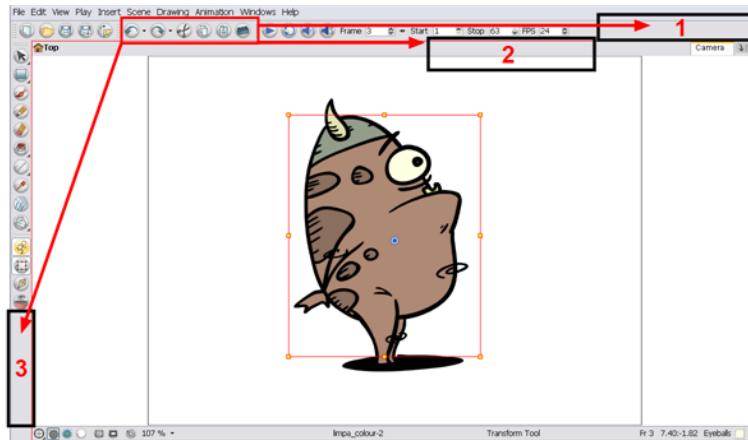

- ▶ 1. Dock to the top toolbar area.
- ▶ 2. Move a toolbar down a row.
- ▶ 3. Dock to the left toolbar area.

## Flat Tool Toolbar Preference

By checking on this option you can expand the toolbar so that there are no nested toolsets in the toolbar. When you check this option you will need to close Animate and relaunch it for the new interface to be displayed. A

default set of tools will appear in the toolbar. However, you can customize which tool icons appear in the toolbar to fit your own work pattern.

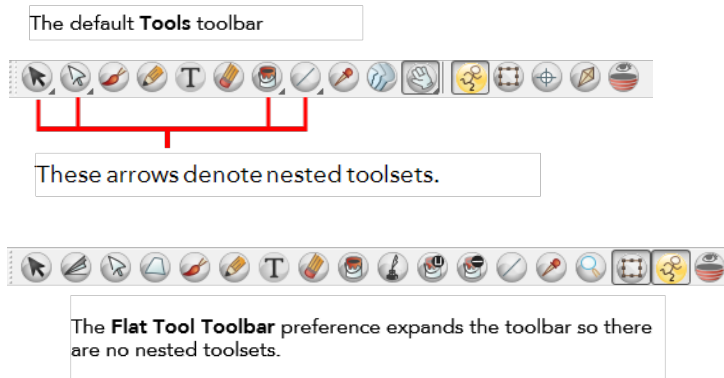

### To use the Flat Tool Toolbar:

1. Open the Preferences window, **Edit > Preferences** (Windows) or **Animate > Preferences** (Mac OS X) and click on the General tab.
2. Enable the **Flat Tool Toolbar** preference by clicking on its checkbox.
3. Click on the **OK** button to apply the change.
4. Save your work and close Toon Boom Animate.
5. Relaunch Toon Boom Animate. You will notice that the Tools toolbar has changed and no longer contains nested tools.

If the default toolbar does not contain the tools you require, you can custom-build the toolbar.

Once you have enabled the Flat Tool Toolbar preference, you can customize the tools which appear in the toolbar. This means that you can change the default set of tools and replace the tools which you use less frequently with ones which are used more often. This customizing is done through the Toolbar Manager.

## Toolbar Manager

The View toolbars can be customized to contain your favourite tools and options. Use the Toolbar Manager window to organize your different toolbars to suit your working preferences.

### To customize your toolbars:

1. In the chosen view, right-click on any button in the toolbar where you wish to add or subtract a new button.
2. From the pop-up menu, select **Customize**.

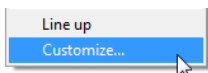

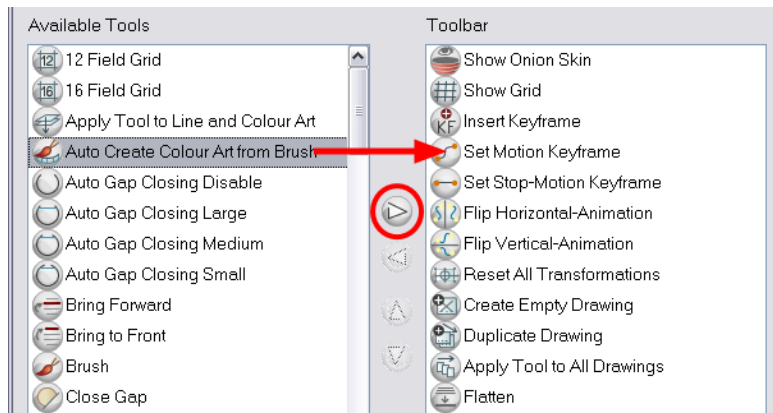

The Toolbar Manager window opens.

3. To add a new icon to your toolbar, select the tool or command from the Available Tools list and click on the **Right Arrow**  button to switch it to the Toolbar list.

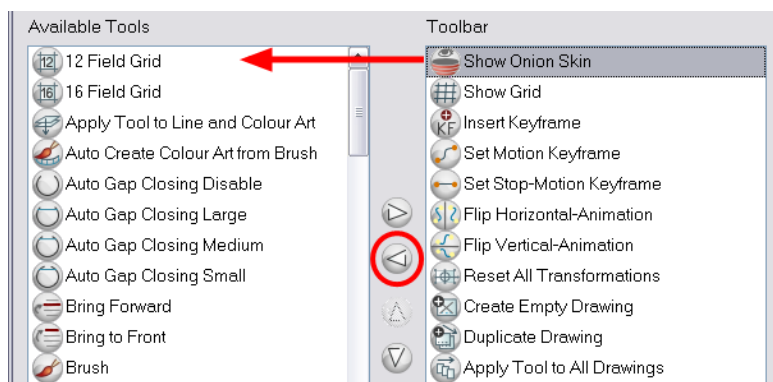

4. To remove an icon from your toolbar, select the tool or command in the Toolbar list and click on the **Left Arrow**  button to switch to the Available Tools list.



5. To reorder your icons in your toolbar, select the command to be moved in the Toolbar list and click on the **Up**  or **Down**  buttons to move it to the correct location.

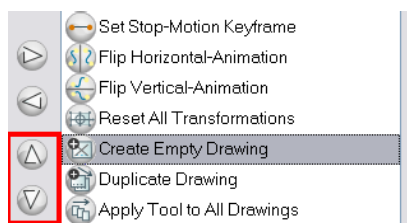

6. Click on the **OK** button when you are finished.

### Related Topics

- [Managing the Workspace on the facing page](#)
- [Managing the Views on page 90](#)

# Managing the Workspace

Toon Boom Animate's user interface is composed of several views. You can customize your workspace to suit your working preferences, save it as a new workspace, and load it from the Workspace toolbar.

- [Loading a Workspace below](#)
- [Workspace Manager below](#)
- [Restoring the Default Workspaces on page 102](#)

## Loading a Workspace

The first time you open Toon Boom Animate, the default workspace is loaded. Other workspaces are available such as the Hand-Drawn Animation and the Compositing workspaces, these display different views and toolbars. You can access these workspaces and any you create, from the Windows menu and the Workspace toolbar.

To load a workspace:

1. In the top menu, select **Windows > Workspace > Workspace** or click on the drop-down arrow in the Workspace toolbar and select a workspace from the list.

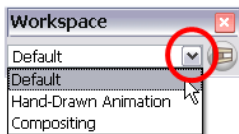

## Workspace Manager

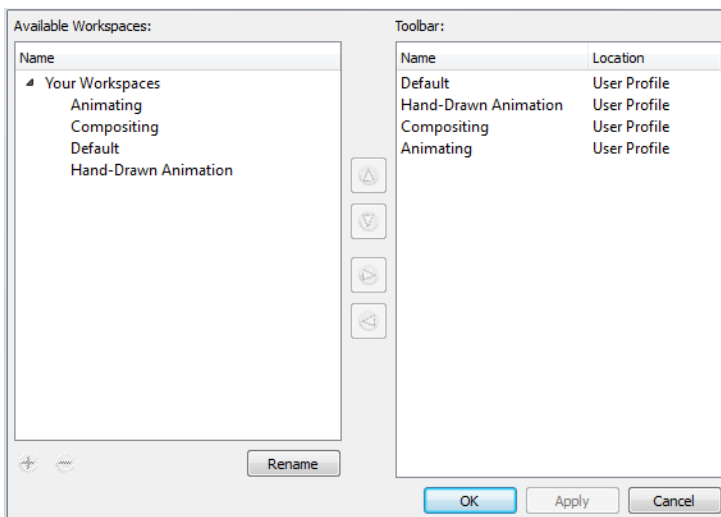

To open the Workspace Manager:

- In the Workspace toolbar, click on the  button.
- In the top menu select **Windows > Workspace > Workspace Manager**.

The Workspace Manager allows you to modify, create, delete, rename and reorder you workspaces.

- [Creating a New Workspace](#) below
- [Renaming a Workspace](#) on the facing page
- [Saving a Workspace](#) on the facing page
- [Deleting a Workspace](#) on page 101
- [Showing and Hiding a Workspace](#) on page 101
- [Reordering the Workspace List](#) on page 102

## Creating a New Workspace

To create a new workspace:

1. Open the Workspace Manager.
2. In the Available Workspaces list, select an existing workspace.

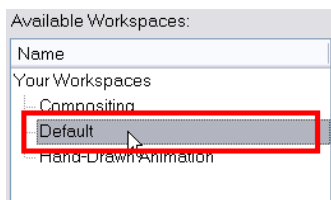

3. At the bottom of the Available Workspaces list, click on the **Add**  button to add a workspace.

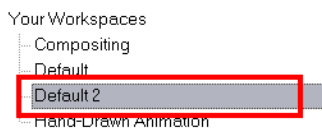

4. Select the new workspace option, then click on the **Rename** button and give it a new name.



5. Select the new workspace and click on the **Right Arrow**  button to send it to the Workspace toolbar.

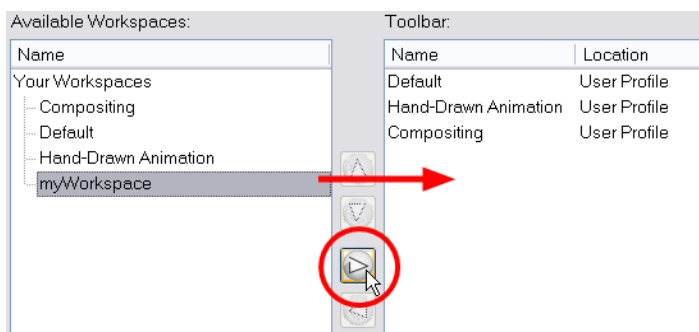

6. Click on the **OK** button.

## Renaming a Workspace

To rename a workspace:

1. Open the Workspace Manager.
2. Choose the workspace to be renamed from the list.
3. Double-click on the workspace to be renamed or click on the **Rename** button. This allows you to edit the name.



4. Type in the new name of the workspace.
5. Press the [Enter/Return] key to validate the name.
6. Click on the **OK** button.

## Saving a Workspace

By default, when you modify the look of a workspace, it is automatically saved. If you prefer to keep your workspaces as they are and only save the modifications when you really want to, you have to disable the Automatically Save Workspace preference.

To disable the Automatically Save Workspace preference:

1. In the top menu, select **Edit > Preferences** (Windows) or **Animate > Preferences** (Mac OS X) to open the Preferences panel.
2. Go to the **General** tab.
3. In the **Save** section, disable the **Automatically Save Workspace** preference.

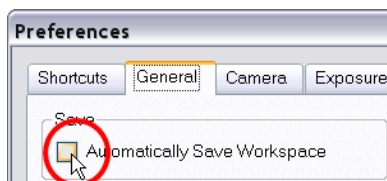

4. Press the **OK** button.  
The **Save Workspace**  button appears in the **Workspace** toolbar.

To save a workspace manually:

1. In the **Workspace** toolbar, click on the **Save Workspace**  button.

You can also select **Windows > Workspace > Save Workspace**.

You can save your workspace as a new version to avoid over-writing the current one.

To save your workspace as a new version:

1. Select **Windows > Workspace > Save Workspace As**.

The **Save Workspace As** dialog box opens.



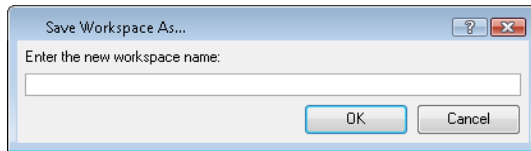



2. In the text field, enter the new workspace name.
3. Click on the **OK** button to validate.

## Deleting a Workspace

### To delete a workspace:

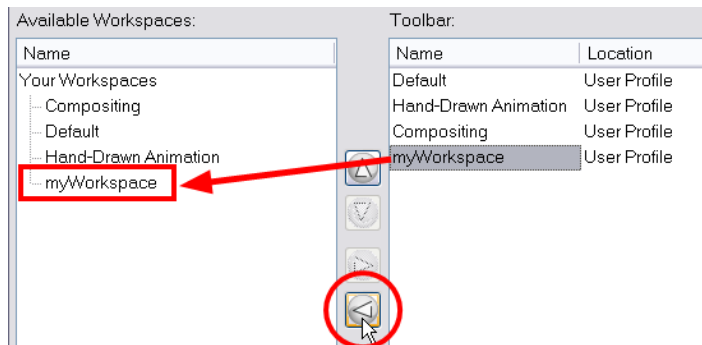
1. Open the Workspace Manager.
2. In the Workspace Manager, select the workspace to be deleted and click on the **Left Arrow**  button to send it to the Available Workspaces list.



3. Select the workspace in the Available Workspaces list then click on the **Delete**  button to delete the workspace.
4. Click on the **OK** button.

## Showing and Hiding a Workspace

### To show a workspace:

1. Open the Workspace Manager.
2. In the Available Workspaces list, select the workspace to be displayed and click on the **Right Arrow**  button to send it to the Workspace toolbar.
3. Click on the **OK** button.



### To hide a workspace:

1. Open the Workspace Manager.
2. In the Workspace Manager, select the workspace to be hidden and click on the **Left Arrow**  button to send it to the Available Workspaces list.
3. Click on the **OK** button.

If you do not want to modify the current workspace, use the Workspace Manager to create another one and then modify that one.

## Reordering the Workspace List

To reorder workspaces:

1. Open the Workspace Manager.
2. In the Workspace toolbar, select the workspace to be reordered and click on the **Up**  or **Down** 

buttons to move it up or down.

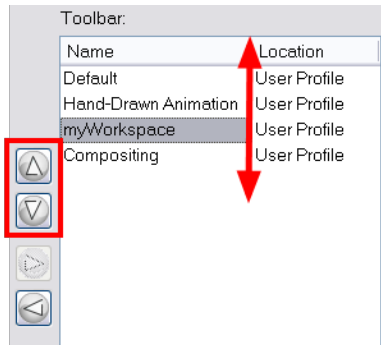

3. Click on the **OK** button.

## Restoring the Default Workspaces

You can restore modified workspaces to their original default layout.

To restore the default workspaces:

- ▶ In the top menu select **Windows > Restore Default Workspace**.

### Related Topics

- [Managing the Views on page 90](#)
- [Managing the Toolbars on page 94](#)

# Interface Navigation

Toon Boom Animate supports zoom in, zoom out, rotate, pan and reset view position for easy interface navigation.

- **Zoom In:** Zooms into the view. From the top menu, select **View > Zoom In** or press [2].
- **Zoom Out:** Zooms out of the view. From the top menu, select **View > Zoom Out** or press [1].
- To zoom in and zoom out, hold down [Spacebar] and your middle mouse button while moving the mouse up or down.
- To pan the view, hold down the keyboard shortcut [Spacebar] and drag your mouse in the direction you want to pan the view.
- **To Recentre the view:** recentres the view on your mouse cursor or press [N].
- **Reset View:** Resets the view to its default position. From the top menu, select **View > Reset View** or press [Shift] + [M].
- **Reset Rotation:** Resets the view's rotation to its default position. From the top menu, select **View > Reset Rotation** or press [Shift] + [X].
- **Reset Pan:** Resets the view's pan to its default position. From the top menu, select **View > Reset Pan** or press [Shift] + [N].
- **Reset Zoom:** Resets the view's zoom to its default position. From the top menu, select **View > Reset Zoom**.
- **Toggle Full Screen:** Enlarges the selected view to full screen. The full screen process is done in three stages. From the top menu, select **View > Toggle Full Screen** or press [Ctrl] + [F] (Windows) or [⌘] + [F] (Mac OS X).
  - First, the selected view enlarges to the maximum width or height, but keeps the tool views such as Colour or Tool Properties view.
  - Second, the view enlarges to full screen.
  - Third, the view returns to its original size.
- **Rotate 90 CW:** Rotates the Camera view 90 degrees clockwise, like an animation table. From the top menu, select **View > Rotate View CW**.
- **Rotate 90 CCW:** Rotates the Camera view 90 degrees counter-clockwise, like an animation table. From the top menu, select **View > Rotate View CCW**.

## Related Topics

- [Zoom below](#)

## Zoom

From the Tools toolbar, use the Zoom  tool to zoom in and zoom out in the Camera or Drawing view.

- The keyboard shortcuts are [1] and [2].
- When the Zoom In mode is selected, hold [Alt] as you click to zoom out.

## Zoom Tool Properties

When you select the Zoom tool, its properties are displayed in the Tool Properties view.

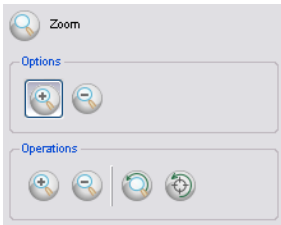

### Zoom In

Enable the Zoom In  mode in the Options section to zoom in when using the Zoom tool.

### Zoom Out

Enable the Zoom Out  mode in the Options section to zoom out when using the Zoom tool.

### Perform Zoom In

Use the Zoom In  operation to perform a zoom in the Camera or Drawing view.

- The keyboard shortcut is [2].

### Perform Zoom Out

Use the Zoom Out  operation to perform a zoom out in the Camera or Drawing view.

- The keyboard shortcut is [1].

### Reset Zoom

Use the Reset Zoom  operation to restore the current zoom level to 100%.

### Reset View

The Reset View  restores the original display by resetting pan, rotation or zoom actions.

### Related Topics

- [Interface Navigation on the previous page](#)
- [Zoom on page 235](#)

# Interface Preferences

Adjusting preferences to suit your work style allows you to work more efficiently.

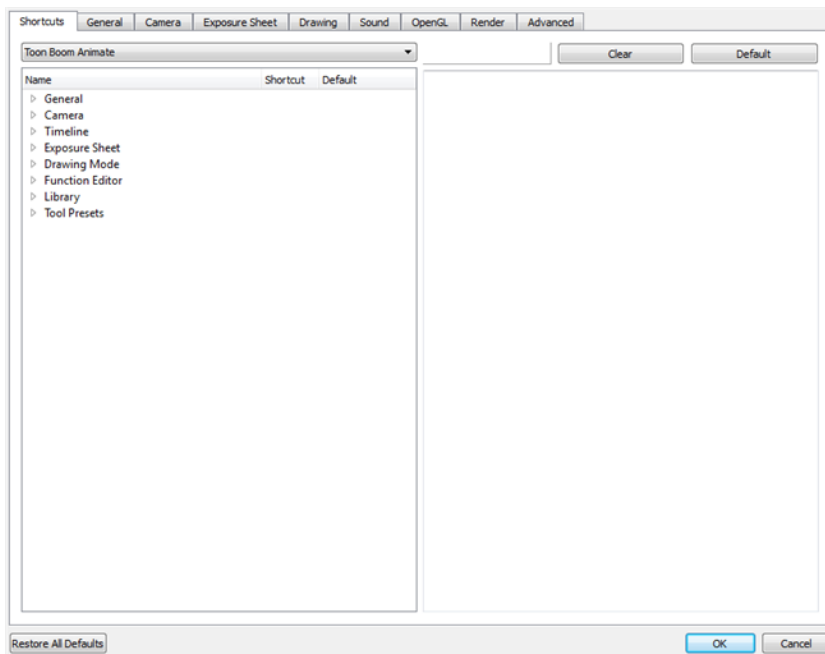

To open the Preferences panel:

- ▶ Windows: Select **Edit > Preferences**.
- ▶ Mac OS X: Select **Animate > Preferences**.
- ▶ Press [Ctrl] + [U] (Windows) or [⌘] + [U] (Mac OS X).

In the Preferences panel, you will find the preference related to the interface in the Camera, OpenGL and General tab.

## Related Topics

- [User Interface Preferences - General Tab below](#)
- [User Interface Preferences - Camera Tab on page 109](#)
- [Full Scene Antialiasing Preference in the OpenGL tab on page 109](#)

## User Interface Preferences - General Tab

To customize your interface, you will use some of the preferences located in the General tab as well as the Camera tab.

### Automatically Save Workspace

The Automatically Save Workspace preference is enabled by default. Every time you add a view to your workspace, remove a toolbar or change a view's width, these modifications are saved when you quit the application. If you do not want the system to save these modifications, disable the preference.

This preference does not require you to restart the application.



Refer to the [Managing the Workspace on page 98](#) section to learn more about this preference.

## Focus on Mouse Enter

The **Focus on Mouse Enter** preference is disabled by default.

In Toon Boom Animate, for the operations or keyboard shortcuts to work in the view in which you are working, the focus must be in that view. When the focus is on a particular view, a red rectangle appears around its frame. You must click in the view or on the view's header for the focus to be done.

If you enable the Focus on Mouse Enter preference, you will not need to click in the view to get the focus. It will be done as soon as your mouse enters the view.

This preference does not require you to restart the application.



If you enable the Focus On Mouse Enter preference, certain operations from the top menu may not be available since the view focus may change as you make your way to the top menu. In this case use keyboard shortcuts and quick access menus (right-click menus).

## Flat Tool Toolbar

By checking on this option you can expand the toolbar so that there are no nested toolsets in the toolbar. When you check this option you will need to close Animate and relaunch it for the new interface to be displayed. A default set of tools will appear in the toolbar. However, you can customize which tool icons appear in the toolbar to fit your own work pattern.

The default **Tools** toolbar

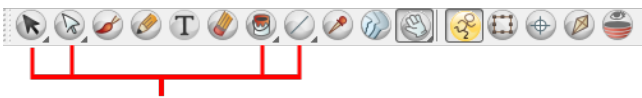

These arrows denote nested toolsets.



The **Flat Tool Toolbar** preference expands the toolbar so there are no nested toolsets.

Once you have enabled the Flat Tool Toolbar preference, you can customize the tools which appear in the toolbar. This means that you can change the default set of tools and replace the tools which you use less frequently with ones which are used more often. This customizing is done through the Toolbar Manager.



To customize the toolbars refer to [Toolbar Manager on page 96](#).

---

## Levels of Undo

The Levels of Undo preference determines the number of actions retained by the Undo list. By default, 50 actions are stored in the list. You can alter the number if you want to.

This preference does not require you to restart the application.

## Colours

The Colours preference allows you to modify the colours of the different user interface views and elements. For example, you can change the Camera view's background colour from grey to white.

Altering these preferences requires you to restart the application or to close a view and reopen it for the modifications to be applied.

## Current View Border

The Current View Border preference sets the colour of the frame around the workspace view you are currently using, also known as focus. By default, the colour is red. Click on the red colour swatch to select a new colour in the Colour Picker window.

## Current View Border in Template Edit

The Current View Border preference sets the colour of the frame around the workspace view you are currently using when editing a template from your library view. By default, the colour is green. Click on the green colour swatch to select a new colour in the Colour Picker window.

## Edit Colours Button

Click on the Edit Colours button to open the Colours window.

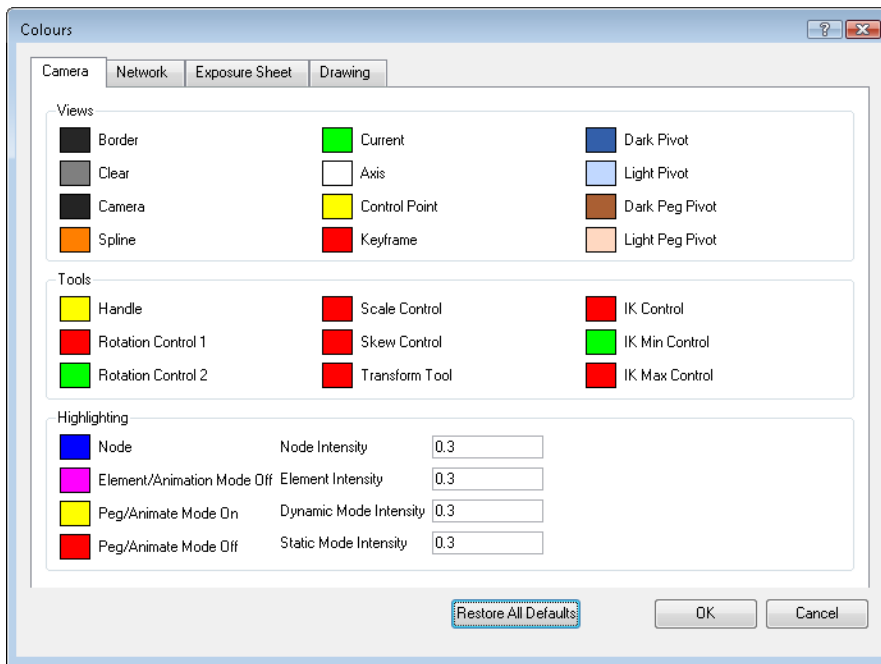

In the Colours window, you can modify any of the colours from the list. Most of the modifications will require you to restart the application or close the view and reopen it to see them.

- To restore all of the default interface's colours, click on the Restore All Defaults button.

The Colours window is divided into the following categories:

- Camera
- Network
- Exposure Sheet
- Drawing

Click on any of the colour swatches and select a new colour from the Colour Picker window.

- **Onion Skin**
  - **Onion Skin After:** Changes the colour display of the next drawing when using the Onion Skin feature.
  - **Onion Skin Before:** Changes the colour display of the previous drawing when using the Onion Skin feature.
- **Others**
  - **Background:** Changes the background colour of the Drawing and Model view.
  - **Backlight:** Changes the display colour of the Backlight option.
  - **Grid:** Changes the display colour of the grid when using the Show Grid option.
  - **Colour View Background:** Changes the background colour of the colour list area of the Colour view.
  - **Colour Highlight Mode Opacity:** Changes the opacity value of the washed out art when using the Highlight Selected Colour option.

To restore all of the default interface's colours, click on the **Restore All Defaults** button.



## Related Topics

- [User Interface Preferences - Camera Tab](#) below
- [Full Scene Antialiasing Preference in the OpenGL tab](#) below

# User Interface Preferences - Camera Tab

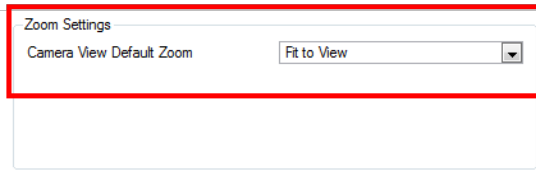

## Zoom Settings

In the Zoom Settings section, you can change the Camera View Default Zoom value from the drop-down menu. This selection sets the Reset View value in the Camera, Top and Side views.

## Related Topics

- [User Interface Preferences - General Tab](#) on page 105
- [Full Scene Antialiasing Preference in the OpenGL tab](#) below

# Full Scene Antialiasing Preference in the OpenGL tab

The Full Scene Antialiasing is generated by your computer's graphic card it provides a smooth line display in OpenGL. This antialiasing will not only antialias your drawings but all your different views in the interface.

This preference can be turned on or off, Full Scene Antialiasing preference is disabled by default.

This option lets you see smooth lines as you draw as well as an antialiased drawing area. You can change the value of the Full Scene Antialiasing using the Preferences dialog box to fit the current level used in the Camera or Drawing view.

### To use Full Scene Antialiasing do the following:

1. Full Scene Antialiasing is accessible from **Edit > Preferences > OpenGL** tab (Windows) or **Animate > Preferences > OpenGL** tab (Mac OS X), go to the **Full Scene Antialiasing** section.
  - **Enable:** Click on the Enable check box to turn on Full Scene Antialiasing. To disable it uncheck the box.
  - **Number or samples (For Mac OS):** If you are using a Mac computer;  
You must enter the number of samples you want to be used for the antialiasing process. the number of samples is basically equivalent to the amount of time a pixel will be enlarged to calculate the antialiasing. This technique is called supersampling. The higher the number of samples, the better the antialiasing quality will be, but the longer it will take to calculate. The recommended value is 4.
2. Once done, you must restart Toon Boom Animate.



If you are using Windows or Linux, you must enable your graphic card's antialiasing parameter. Refer to your graphics card manufacturers user guide to learn how to do so. For example, the parameters for an NVIDIA GeForce card may look like this:

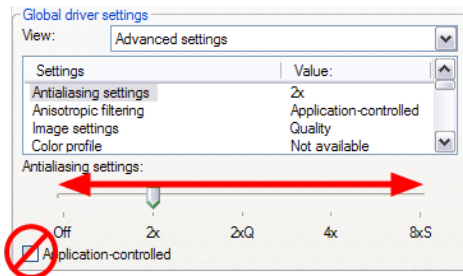

## Related Topics

- [User Interface Preferences - Camera Tab](#) on the previous page
- [User Interface Preferences - General Tab](#) on page 105

# Chapter 4: Drawing



In Toon Boom Animate, many powerful tools, views and features are available so you can design, draw and animate with ease. This chapter explains the main assets needed when drawing and animating in the software as well as tips on how to start and use these tools efficiently.

## Topics Covered

- [How to Draw](#) on page 113
- [Tool Properties View](#) on page 114
- [Drawing View](#) on page 115
- [Camera View](#) on page 118
- [Drawing with the Brush or the Pencil](#) on page 123
- [Working with Tool Presets](#) on page 125
- [Viewing the Final Lines as you Draw](#) on page 128
- [Drawing Using the Pencil Tool](#) on page 130
- [Drawing with the Brush Tool](#) on page 146
- [Drawing with Line Texture](#) on page 155
- [Selecting Drawing Objects](#) on page 162
- [Erasing Parts of a Drawing](#) on page 177
- [Reshaping a Drawing Using the Contour Editor Tool](#) on page 181
- [Reshaping Pencil Lines with the Pencil Editor Tool](#) on page 187

- [Drawing with Shapes](#) on page 193
- [Drawing with the Polyline Tool](#) on page 200
- [Drawing Using Invisible Lines](#) on page 204
- [Deforming a Drawing Using the Perspective Tool](#) on page 207
- [Cutting Drawing Parts](#) on page 211
- [Smoothing Lines](#) on page 215
- [Working With Text](#) on page 219
- [Override Tool](#) on page 224
- [More Drawing Tools](#) on page 225
- [Drawing Pivot Tool](#) on page 231
- [Drawing Preferences](#) on page 233

# How to Draw

As soon as Toon Boom Animate is started, you can start to draw straight away using the default drawing layer.

## How to draw:

1. In the Tools toolbar, select the Brush  tool or press [Alt] + [B].
2. In the Timeline or Xsheet view, click in the first cell of the drawing layer.

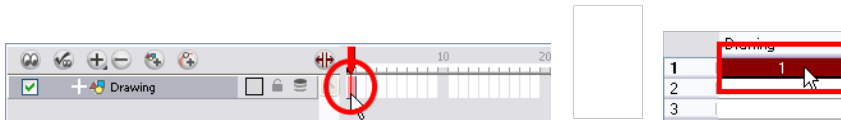

3. In the Drawing or Camera view, start drawing.

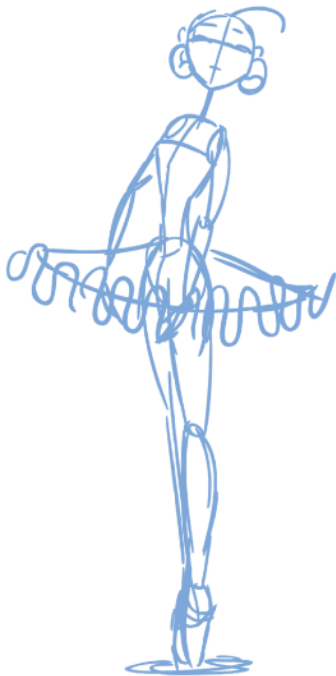

4. To select a different colour, in the Colour view, select the a different colour swatch. Double-click on the colour swatch to open the Colour Picker window and modify the colour. Remember that anything already painted with that colour swatch will update to the new colour.

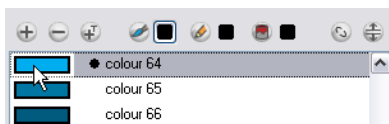

## Related Topics

- [Adding a Colour Swatch](#) on page 276
- [Adding New Drawing Layers](#) on page 360
- [Tool Properties View](#) on the facing page

# Tool Properties View

The **Tool Properties** view is where you can customize the currently selected tool. The options and operations displayed changes according to each tool you select.

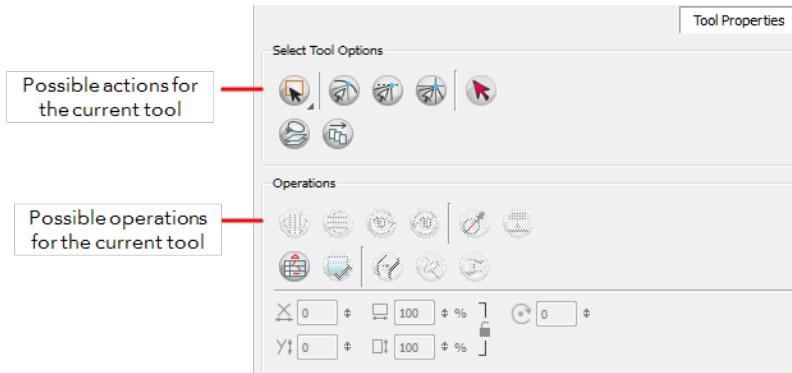

## Options

Options are different modes you can apply to a selected tool to modify its behaviour to fit the current task's needs.

## Operations

**Operations** are actual actions you can perform while using the selected tool.

### Related Topics

- [How to Draw](#) on the previous page

# Drawing View

In Toon Boom Animate, you can draw in the Drawing or Camera view. Although the two views are similar, when it comes to drawing, there are some differences.

Only the selected drawing is displayed by default in the Drawing view. You can use features, such as the light table to display the current frame drawing of all the enabled layers of your scene in washed-out colours, or the Onion Skin to display the previous and next drawings of the currently selected drawing layer.

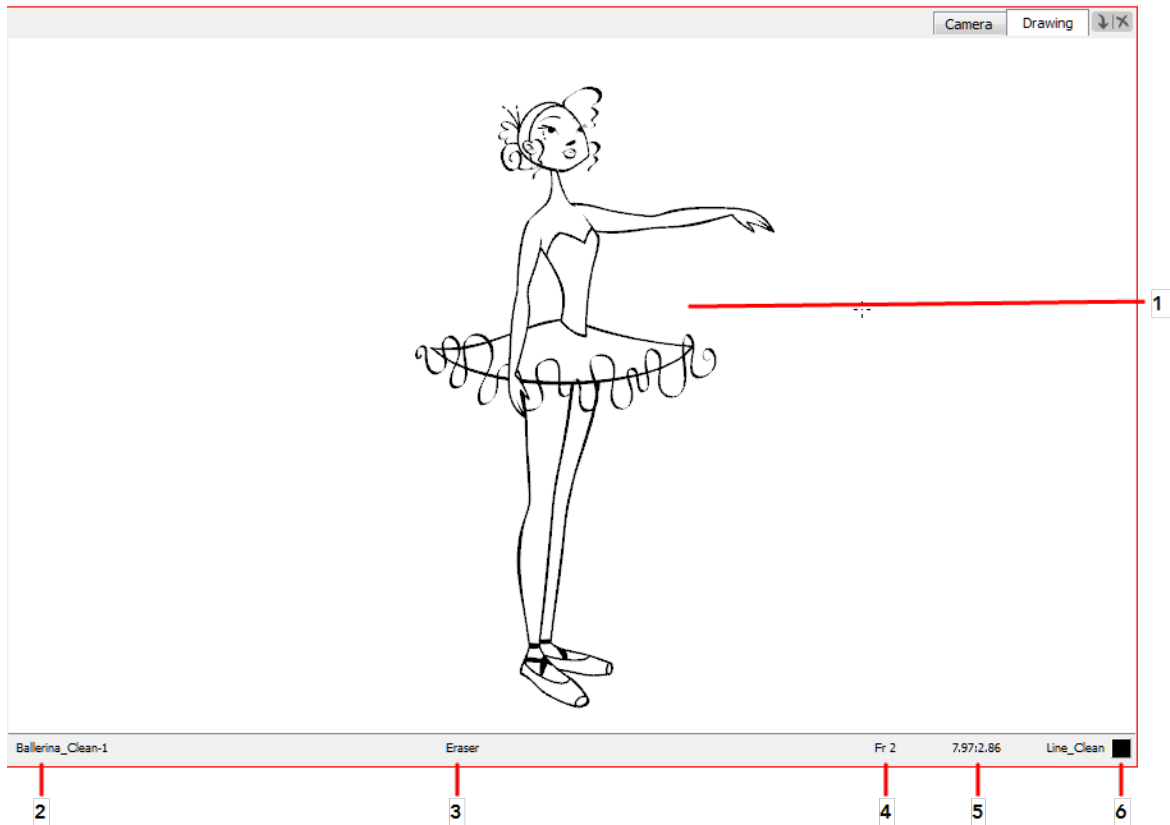

1. [Drawing Area](#) below
2. [Drawing Name](#) on the facing page
3. [Tool Name](#) on the facing page
4. [Current Frame](#) on the facing page
5. [Cursor Coordinates](#) on the facing page
6. [Colour Picker](#) on page 117

## Drawing Area

This is the Drawing view's main space, it is where you draw, and where the drawings are displayed.

## Zoom Drop-down Menu

The Zoom menu lets you enlarge or reduce the Camera or Drawing view display.





To make the camera frame size always match the size of your view, select the **Fit to View** option. Click the drop-down arrow and select a zoom level or press [1] and [2].

## Overlay, Line Art, Colour Art, Underlay and Preview Mode

-  **Line Art:** Switches to the Line Art layer of the drawing. The default keyboard shortcut is [L].

You can display the Line Art view in the Preferences dialog box. Select **Edit > Preferences** ( Windows) or **Animate > Preferences** ( Mac OS X). Select the General tab. In the Advanced box, select the **Use Advanced Art Mode** option and restart the application.

-  **Colour Art:** Switches to the Colour Art layer of the drawing. The default keyboard shortcut is [L].

-  **Preview mode:** Switches to Preview mode, so you can see both Line Art and Colour Art layers simultaneously. The default keyboard shortcut is [Shift] + [P].

You can display the Line Art view in the Preferences dialog box. Select **Edit > Preferences** ( Windows) or **Animate > Preferences** ( Mac OS X). Select the General tab. In the Advanced box, select the **Use Advanced Art Mode** option and restart the application.

## Drawing Name

The Drawing Name field displays the name of the selected drawing, as well as the layer containing it. If the cell does not contain any drawing, an **Empty Cell** text is shown in the field.

## Tool Name

The Tool Name field displays the name of the selected tool. If you override a tool using an overriding keyboard shortcut, the tool's name will be highlighted in red letters—see [Override Tool on page 224](#) to learn how to temporarily override a tool.

## Current Frame

This field displays the current frame of the animation you are working on.

## Cursor Coordinates

This indicates the position of your mouse cursor in the drawing area.



## Drawing Name

Displays the name of the currently selected drawing.

## Colour Picker

The Colour Picker allows you to select a colour to draw with.

### Related Topics

- [Camera View on the facing page](#)

# Camera View

In Toon Boom Animate, you can draw in either the Drawing view or Camera view. Although the two views are similar, when it comes to drawing, there are some differences.

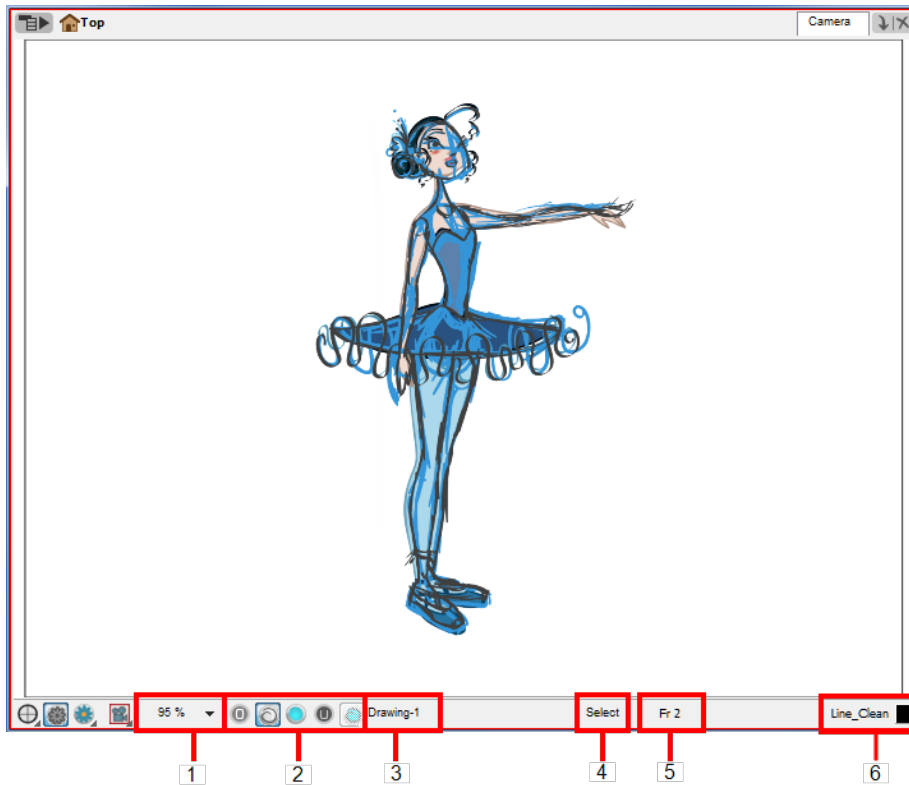

1. [Zoom Drop-down Menu on the next page](#)
2. [Overlay, Line Art, Colour Art, Underlay and Preview Mode on page 120](#)
3. [Drawing Name on page 120](#)
4. [Tool Name on page 120](#)
5. [Current Frame on page 120](#)
6. [Current Colour on page 121](#)



For more details about the Camera view's interface, see [Camera View on page 64](#)

In the Camera view, you can use the Onion Skin feature to display previous and next drawings. By default, all the enabled drawing layers in the selected frame are displayed, letting you edit them together. This way, you can use the **Select**  tool to select many objects from individual layers at once.



To make easier to select objects on a single drawing, you can set a preference. Select **Edit > Preferences** and select the **Camera** tab, then select the **Select tool Works on Single Drawing** option.

### To enable the onion skin from the Timeline view:

- ▶ In the Timeline view, click the **Onion Skin**  icon of the desired layer.

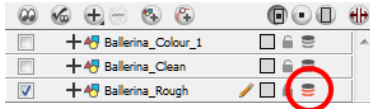

By locking a layer, you can prevent yourself from being able to select it in the Camera view, while keeping the drawing visible as a reference and disabling the layers you don't want to display in the **Camera** view.

### To lock a drawing layer:

- ▶ In the Timeline view, click the **Lock**  icon of the layer you don't want to edit.

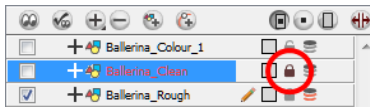

### To hide a drawing layer:

1. In the Timeline view, click the check box corresponding to the layer you want to hide.

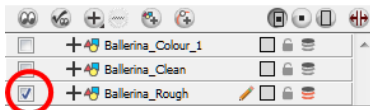

## Zoom Drop-down Menu

The Zoom menu lets you enlarge or reduce the Camera or Drawing view display.





To make the camera frame size always match the size of your view, select the **Fit to View** option. Click the drop-down arrow and select a zoom level or press [1] and [2].

# Overlay, Line Art, Colour Art, Underlay and Preview Mode

-  **Line Art:** Switches to the Line Art layer of the drawing. The default keyboard shortcut is [L].

You can display the Line Art view in the Preferences dialog box. Select **Edit > Preferences** ( Windows) or **Animate > Preferences** ( Mac OS X). Select the General tab. In the Advanced box, select the **Use Advanced Art Mode** option and restart the application.

-  **Colour Art:** Switches to the Colour Art layer of the drawing. The default keyboard shortcut is [L].

-  **Preview mode:** Switches to Preview mode, so you can see both Line Art and Colour Art layers simultaneously. The default keyboard shortcut is [Shift] + [P].

You can display the Line Art view in the Preferences dialog box. Select **Edit > Preferences** ( Windows) or **Animate > Preferences** ( Mac OS X). Select the General tab. In the Advanced box, select the **Use Advanced Art Mode** option and restart the application.



To activate the Preview Mode button in the Camera view bottom toolbar, you must enable the Current Drawing on Top option.

**To enable the Current Drawing On Top option:**

1. In the Camera bottom toolbar, click on the **Camera Option** button.
2. In the drop-down menu, enable the **Current Drawing on Top** option.

See [Show Current Drawing on Top](#) on the next page.

## Drawing Name

The Drawing Name field displays the name of the selected drawing, as well as the layer containing it. If the cell does not contain any drawing, an **Empty Cell** text is shown in the field.

## Tool Name

The Tool Name field displays the name of the selected tool. If you override a tool using an overriding keyboard shortcut, the tool's name will be highlighted in red letters—see [Override Tool](#) on page 224 to learn how to temporarily override a tool.

## Current Frame

This field displays the current displayed frame of the animation.

## Current Colour

This field displays the current colour name and its colour swatch. You can open the Colour Picker by double-clicking the colour swatch—see [Colour](#) on page 273.

### Related Topics

- [Show Current Drawing on Top](#) below
- [Drawing View](#) on page 115

## Show Current Drawing on Top

In Toon Boom Animate, when you draw on a layer, the artwork is displayed in the correct order. For example, if the layer on which you are drawing is located behind an object on another layer, the lines you are drawing will be hidden behind that object.

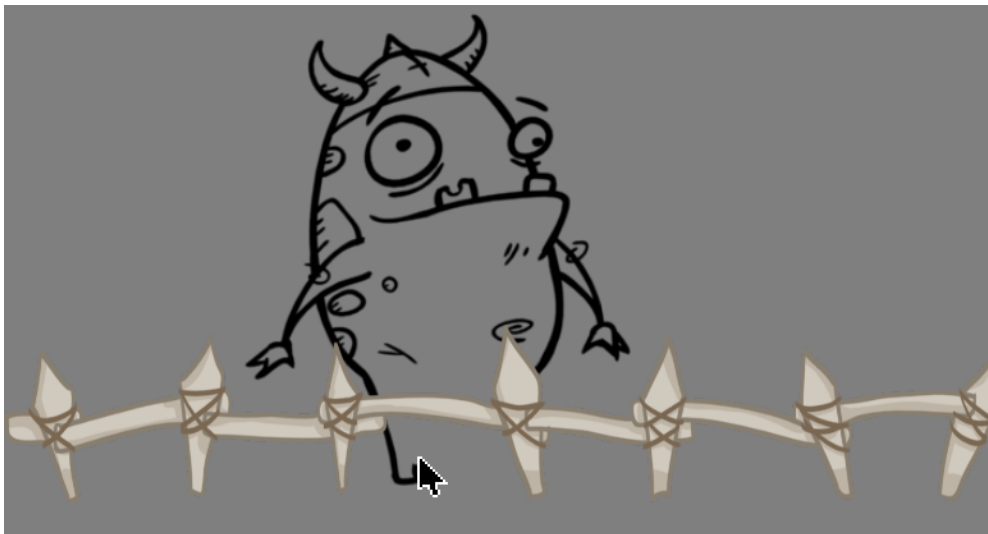

This option lets you display the selected drawing on top of everything while you draw. By enabling this option, each time you select a drawing tool, the selected drawing is displayed in front of everything in the Camera view. The Timeline and Network view ordering remain unchanged.



The **Show Current Drawing on Top** status (enabled or disabled) is remembered when you exit Animate. When you restart the application, the last status will be used.

---

### To display your drawing on top:

1. Do one of the following:
2. From the top menu, select **View > Show > Current Drawing on Top**.
3. In the Camera toolbar, click the **Camera Option** button and select the **Current Drawing on Top** option.

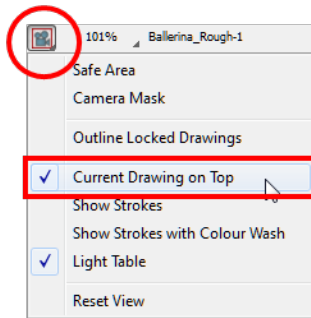

4. In the Tools toolbar, select a drawing tool.
5. In the Camera view, start drawing.

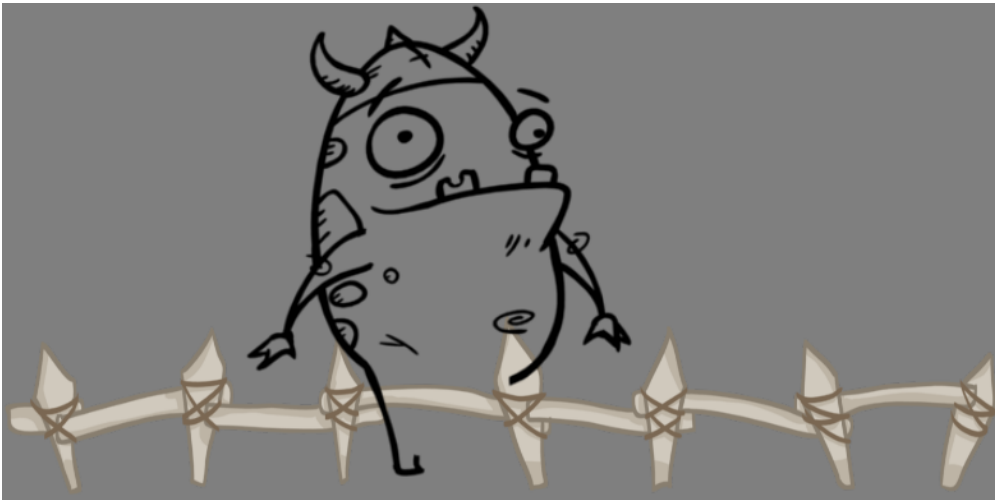



You only need to enable this option once, it is not necessary to do it each time you select a drawing tool.

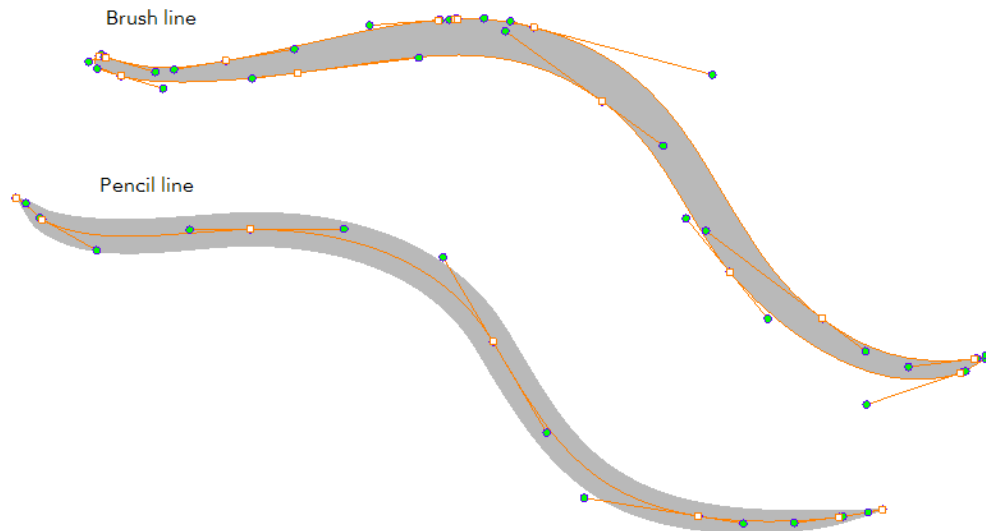

## Related Topics

- [Camera View](#) on page 118
- [How to Draw](#) on page 113

# Drawing with the Brush or the Pencil



The Brush  and Pencil  tools are used to draw and sketch with. Both tools support pressure sensitivity, allowing you to create lines with variable thickness. The Pencil and shape tools produce central vector lines. The Brush tool produces contour vector lines. This means that a pencil line's control points (used to deform its shape) are located along the length of the central spine and the Brush line's control points are located along the contour.

- If you draw with the **Pencil** tool and want to modify the thickness variation, use the **Pencil Editor**  tool.
- If you draw with the **Brush** tool and want to modify the thickness, use the **Contour Editor**  tool.
- You can also convert a brush zone into a pencil line with the **Brush Stroke to Pencil Line**  option.

If you sketch a drawing using a semi-transparent colour to get a paper-like feel, you should use the **Brush** tool as it produces a more realistic and natural feel. The pencil line is very useful for tracing, clean or final drawings.

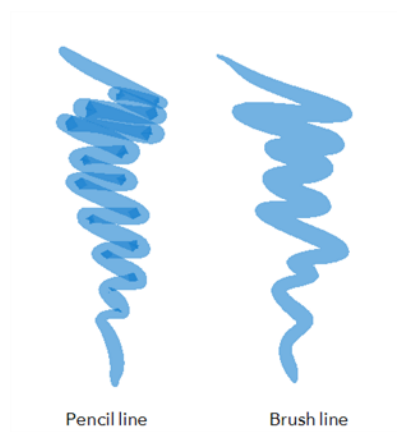

Also, it is recommended to use brush lines when designing cut-out puppets' articulations which use patches.

## Related Topics

- [Drawing Using the Pencil Tool](#) on page 130
- [Drawing with the Brush Tool](#) on page 146
- [Reshaping a Drawing Using the Contour Editor Tool](#) on page 181
- [Drawing with Shapes](#) on page 193
- [How to Draw](#) on page 113



# Working with Tool Presets

Tools presets let you saving a variety of settings and are very handy and efficient for accessing the tools you use most often. That way, the tool is already set with the desired properties, such as colour, line thickness, whether to enable Draw Behind or Auto Flatten mode, and so on. You can create presets for these tools and many more: Brush, Pencil, Eraser, Rectangle, Ellipse, and Line. First, select a tool, adjust the properties, and then create a tool preset for it. Once you have created a tool preset, you can always make adjustments to fine-tune it, as well as create a keyboard shortcut for it.

## The Tool Presets Toolbar

The Tool Presets toolbar lets you create new tool presets and manage them. There are four default brush presets to get you started—Rough Brush, Clean Pencil, Fill Paint, and Inking Brush. Be default, this toolbar is not displayed.

**To display the Tool Presets toolbar:**

- Select **Windows > Toolbars > Tool Presets**.
- Right-click an empty area below the top menu and select **Tool Presets**.

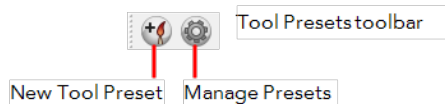
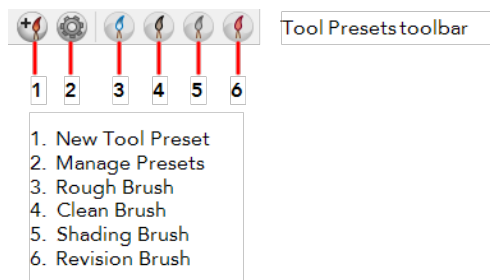

**To create a tool preset:**

1. In the Tools toolbar, select a tool.
2. In the Panel view, use the Tool Properties view and/or the Brush Properties window to customize the tool. Use the Tool Properties view to customize the tool.
3. In the Tool Presets toolbar, click the New Tool Preset  button.
4. In the New Tool Preset dialog box, type a new name for your tool.

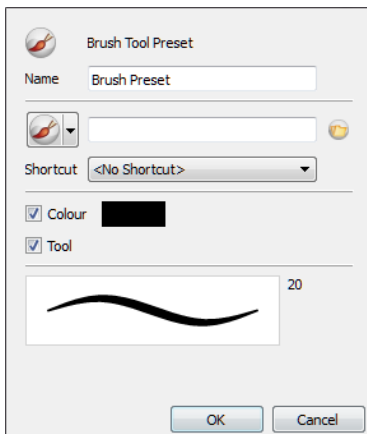

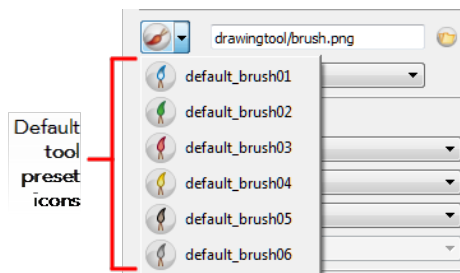

- From the Brush list, select an icon to quickly identify your preset or upload your own by clicking the File  button.



- (Optional) Set a keyboard shortcut to quickly access your preset.
- When you select any of the following options, they will take effect when you use the tool preset. If an option is deselected, then using a tool preset will not override your current settings.
  - ▶ **Colour:** Saves the current colour into the Tool Preset.

#### To delete a tool preset:

- In the Tool Presets toolbar, click the Manage Tool Presets  button.
- From the list of tool presets on the left, select a preset to delete and click the Trash  icon.

#### To import a tool preset:

- In the Tool Presets toolbar, click the Manage Tool Presets  button.
- In the Manage Tool Presets dialog box that opens, click **Import**.

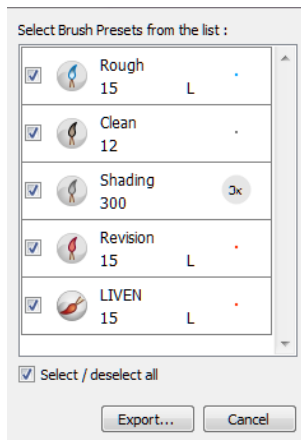

3. In the Import Brush Presets window that opens, locate and select the preset(s) to import and click **Open**. In the Select Folder window that opens, locate and select the preset(s) to import and click **Select Folder**.

#### To export a tool preset:

1. In the Tool Presets toolbar, click the Manage Tool Presets  button.
2. In the Manage Tool Presets dialog box that opens, click **Export**.

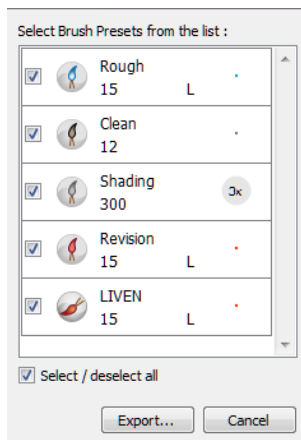

3. In the Export Brush Presets window that opens, click **Export**.
4. Select a folder and click **Select Folder**.

#### To update a tool preset:

1. In the Tool Presets toolbar, click the Manage Tool Presets  button.
2. In the Manage Tool Presets dialog box that opens, select the tool preset from the left side of the dialog box.
3. Make any changes you would like to the preset.
4. Click **Update**.

# Viewing the Final Lines as you Draw



Everything you draw in Toon Boom Animate is vector-based. Although, when you draw in the Camera or Drawing view, you will notice that your lines may be jagged, this is caused by the fast real-time display called OpenGL.

If you prefer to see smooth lines as you draw, you can enable the antialiasing.

## Full Scene Antialiasing

*Not available in Harmony Paint.*

The Full Scene Antialiasing is generated by your computer's graphics card. This antialiasing will not only antialias your drawings, but all your different views in the interface.

Full Scene Antialiasing is a preference you can turn on and off. By default, the Full Scene Antialiasing preference is disabled.



Full Scene Antialiasing parameters are only valid while you work in your scene. The scene will be rendered out to 100% of its resolution regardless of your settings in the preferences or graphic card panel.

### To customize the full scene antialiasing parameters:



This procedure requires that if you have a Mac OS you must restart the Animate after you have changed the parameters.

1. If you are using Windows or Linux, you must enable your graphic card's antialiasing parameter. Refer to your graphics card manufacturers user guide to learn how to do so. For example, the parameters for an NVIDIA GeForce card may look like this:

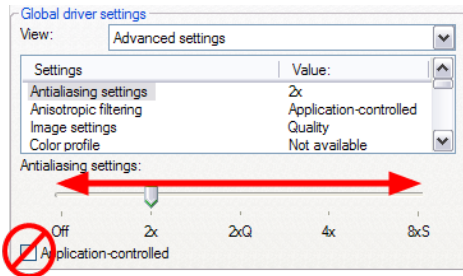

2. In the Animate, do one of the following:
  - ▶ Windows: Select **Edit > Preferences**.
  - ▶ Mac OS X: **Animate > Preferences**.
  - ▶ Press [Ctrl] + [U] (Windows) or [⌘] + [U] (Mac OS X).

The Preferences dialog box opens.

3. In the OpenGL tab, go to the **Full Scene Antialiasing** section.

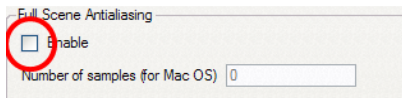

- ▶ **Enable:** Select this option to enable/disable the **Full Scene Antialiasing**.
  - ▶ **Number or samples (For Mac OS):** If you are using a Mac OS X computer, enter the number of samples you want to be used for the antialiasing process. The number of samples is basically equivalent to the amount of time a pixel will be enlarged to calculate the antialiasing. This technique is called *supersampling*. The higher the number of samples, the better the antialiasing quality will be, but the longer it will take to calculate.
4. Restart the Animate.

# Drawing Using the Pencil Tool

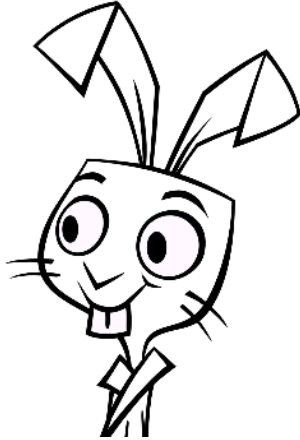

The **Pencil**  tool creates a centreline shape. Pencil lines now support pressure sensitivity and texture.

To draw with the **Pencil** tool:

In the **Timeline** or **Xsheet** view, select the cell on which you want to draw.

*In Harmony Paint, select a drawing in the **Drawing** panel.*



1. In the Tools toolbar, select the **Pencil**  tool or press [Alt] + [/].
2. In the Colour view, click a colour swatch to select a colour.

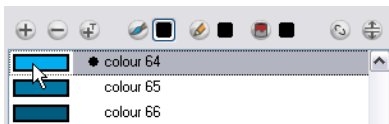

3. In the **Drawing** or **Camera** view, start drawing.
  - ▶ When you get close to an existing pencil line, hold [Alt] to draw connect your stroke to the existing one. Pencil lines are central vector lines and you might think your line is connected, but in fact, only the contour is touching the other one. Also, make sure the central vector crosses the other one. You can use the [Alt] key to connect the start of your stroke or the end of it by holding it when you start drawing or when you finish your line.
  - ▶ To draw a straight line, press [Shift] + [Alt] as you draw.

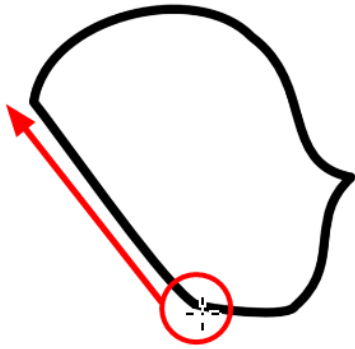

## Related Topics

- [Pencil Tool Options](#) below
- [Drawing with the Brush or the Pencil](#) on page 123
- [Drawing with Shapes](#) on page 193

# Pencil Tool Options

When you select the **Pencil**  tool, its properties and options appears in the **Tool Properties** view.

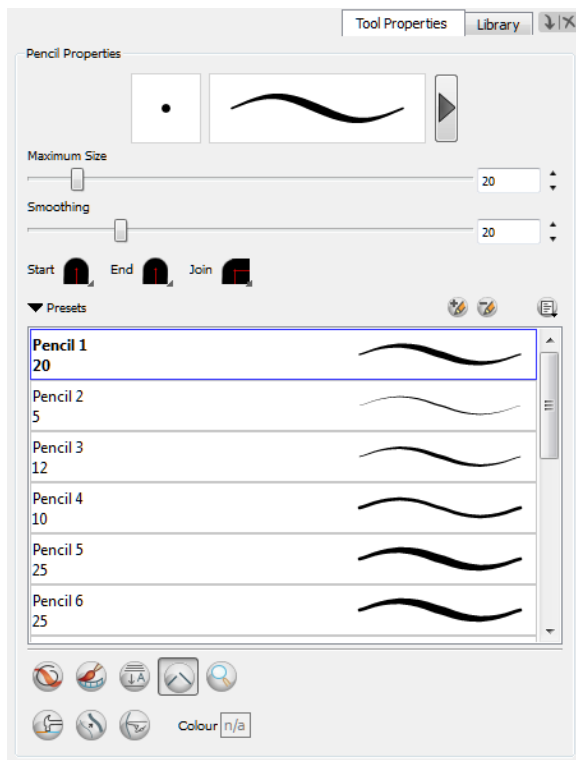

These are the options available for the Pencil tool:

- [Draw Behind](#) on the facing page
- [Pencil Tool Options](#) above

- [Auto-Flatten Mode](#) below
- [Auto-Close Gap](#) on the next page
- [Line Building Mode](#) on the next page
- [Auto Adjust Thickness](#) on page 134
- [Line Pushing Mode](#) on page 135
- [Pencil Thickness Stencils](#) on page 135
- [Minimum and Maximum Size](#) on page 135
- [Central Line Smoothness](#) on page 136
- [Contour Optimization](#) on page 136
- [Changing the Line Shape](#) on page 136
- [Previewing the Stroke](#) on page 137
- [Pencil Line Texture](#) on page 137

## Draw Behind



When drawing on vector layers, the Draw Behind mode lets you paint behind existing art. By default, strokes will appear over your work until you release the tool. If you want to have live preview of your stroke in draw behind mode, you must activate the Realistic Preview option.

## Auto-Flatten Mode

When drawing on vector layers, lines do not usually become one object. The Auto-Flatten mode automatically merges lines created with the existing ones into one single object as you draw.



Using the Select tool, you can use the middle mouse button to select a segment of a flattened pencil line to create a nice finish on the lines and corners of your artwork.

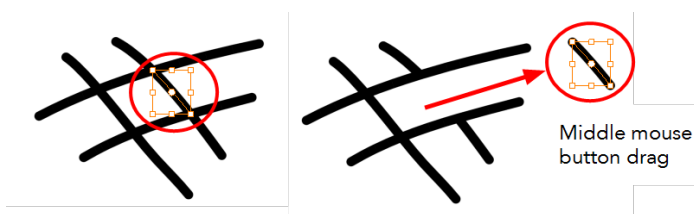



## Auto-Close Gap

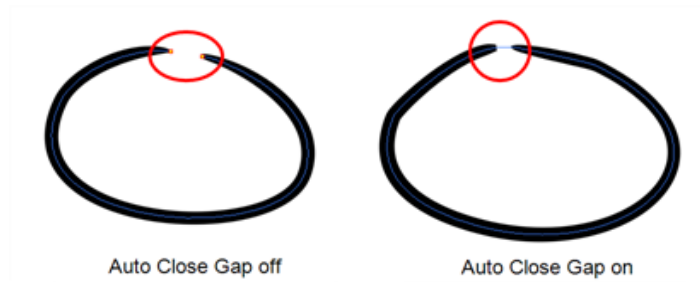

When using the pencil tool, you can automatically close strokes with an invisible stroke.

It is recommended to keep this option enabled when drawing with the Pencil tool.

## Line Building Mode

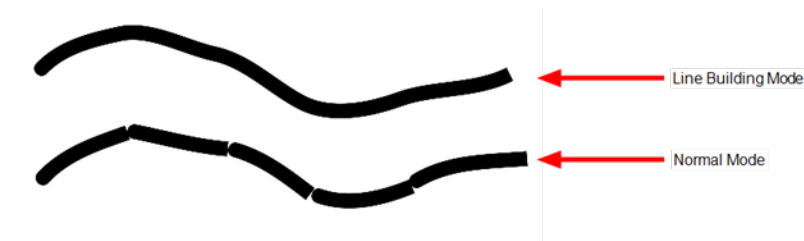

The **Line Building**  mode is very useful when drawing long lines and curves in small increments with pencil lines. As the pencil lines are central vector lines and it may be difficult to align the line tips perfectly to create a uniform stroke and close all gaps.

In this mode, you can draw lines in small increments and the tips merge into one single stroke.



This mode only works with pencil lines.

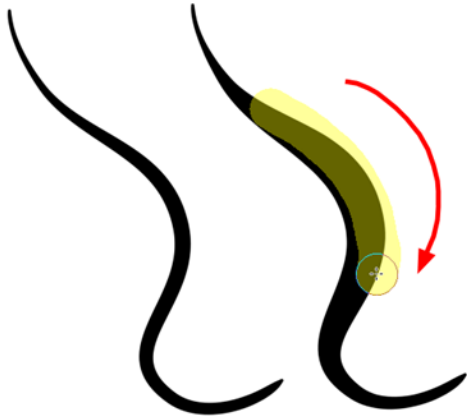

## Auto Adjust Thickness



The **Auto Adjust Thickness**  tool is useful when you want to render a portion of a line thicker. When tracing a drawing on paper, you will often go back to a section of a curve to make it thicker to add dynamism to the line. Using the Auto Adjust Thickness tool, you can draw highlight strokes over the section to make thicker. Once you release the pen or the mouse, the line gets thicker following the shape and curve of the original stroke. This way is much faster and smoother than using the Pencil Editor tool. You do not have to add extra points and adjust the position and Bezier handles.

The default overlay colour is light yellow. If this colour is difficult to see because of your background or drawing colour, you can adjust the colour.

### To change the Auto Adjust Thickness Colour:

1. In the Tools toolbar, select the **Pencil**  tool.
2. In the Tool Properties view, select the **Auto Adjust Thickness**  button.
3. Click the colour swatch.



The Colour Picker window opens.

4. In the Colour Picker window, select a new colour.

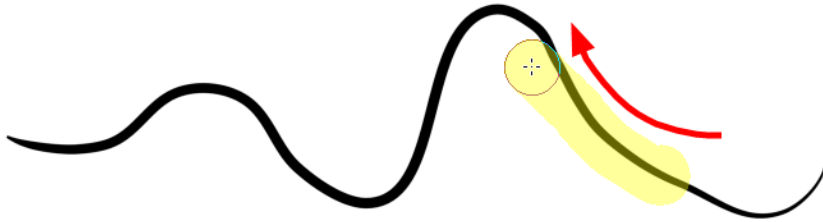

## Line Pushing Mode



The **Line Pushing Mode**  option lets you draw highlight strokes over your existing pencil lines. You can reshape the curves. Depending how you draw the pushing stroke over your line, the highlighted section will be reshaped in one direction or the other.

The default overlay colour is light yellow. If this colour is difficult to see because of your background or drawing colour, you can adjust the colour.

### To change the Line Pushing Mode colour:

1. In the Tools toolbar, select the **Pencil**  tool.
2. In the Tool Properties view, select the **Line Pushing Mode**  button.
3. Click the colour swatch.



The Colour Picker window opens.

4. In the Colour Picker window, select a new colour.

## Pencil Thickness Stencils

Toon Boom Animate provides a variety of thickness stencils and also lets you create and save your own. It is a good idea to create and save pencils with precise sizes and parameters when you draw and design.

A thickness stencil saves a preset of how the thickness information looks across the length of the line. When drawing with a thickness stencil, the pressure sensitivity of the tablet is discarded in order to apply the thickness stencil.

A thickness stencil can be used while drawing, or applied afterwards.

You also have the possibility to apply different textures to your lines by either using the preset ones or importing your own—see [Working with Thickness Stencils on page 137](#)

## Minimum and Maximum Size

This is where you set the minimum and maximum sizes of your drawing tool which will produce the thick and thin effect on your stroke. This works with the pressure sensitivity of a pen tablet.



1. **Minimum Size** field: Type a value in this field to set the minimum width of the line.
2. **Maximum Size** field: Type a value in this field to set the maximum width of the line.
3. **Up/Down arrows**: Use the up and down arrows to set the minimum size value.
4. **Up/Down arrows**: Use the up and down arrows to set the maximum size value.

## Central Line Smoothness

You can modify the **Central Line Smoothness**  of your line using this option. This parameter smoothes the initial movement of your line. Increasing the value will result in a smoother line with fewer control points.

## Contour Optimization

You can optimize the **Contour Line Smoothness** of your line using this option. This parameter will smooth the contour of your line once the line has been traced, the higher the value the less control points will compose your line.



1. **Smoothness** field: Type a value to set the smoothness of the line.
2. **Contour Optimization** field: Type a value to set the contour optimization of the line.
3. **Up/Down arrows**: Use the up and down arrows to set smoothness value.
4. **Up/Down arrows**: Use the up and down arrows to set the contour optimization value.

## Changing the Line Shape

There are several line shapes to choose from. You can select how the start, end, and joints in the pencil line are drawn.

### To change the line shape:

In the Pencil Properties window, click a line shape in the Shape section and select a shape from the menu.

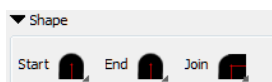

- **Start**: Make the beginning of the line round or flat.
- **End**: Make the end of the line round or flat.
- **Join**: Make joints round, mitred, or bevelled.

## Previewing the Stroke

The Preview area lets you see a preview of the stroke that will be produced after you customize the different parameters in the Tool Properties view.

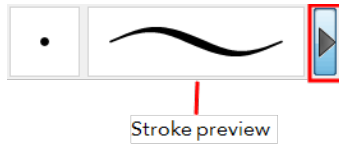

## Pencil Line Texture

You can apply a bitmap texture on your pencil line and adjust it as needed—see [Pencil Line Texture on page 140](#)

### Related Topics

- [Drawing with Line Texture on page 155](#)
- [Pencil Line Texture on page 140](#)
- [Working with Thickness Stencils below](#)
- [Drawing Using the Pencil Tool on page 130](#)

### Working with Thickness Stencils



A thickness stencil is a preset that already set with specific properties. There are two types of thickness stencils.

A Regular thickness stencils allow you to set the size and smoothing of the line or shape. As you draw, the thickness of the line varies according the amount of pressure you use with a pen and tablet.

Thickness stencils that are indicated with this icon  are also set with specific properties but disregards the pressure you use with your pen and tablet. The line thickness varies

You can access thickness stencils from the list of preset on the Tool Properties view, or create your own.

- [Selecting a Thickness Stencil on the facing page](#)
- [Creating a Thickness Stencil on the facing page](#)
- [Creating a Pencil Thickness Stencil with the Select Tool on page 139](#)
- [Renaming a Thickness Stencil on page 139](#)

- [Deleting a Thickness Stencil](#) on the next page
- [Locking a Thickness Stencil](#) on page 140
- [Working with Thickness Stencils](#) on the previous page

## Selecting a Thickness Stencil

Using the drop-down menu, you can select an existing thickness stencil.

To select a pencil thickness stencil:

1. In the Tools toolbar, select the **Pencil** , **Line** , **Ellipse** , or **Rectangle**  tool.
2. In the **Tool Properties** view, in the **Presets** drop-down menu, select the thickness stencil you want to use.

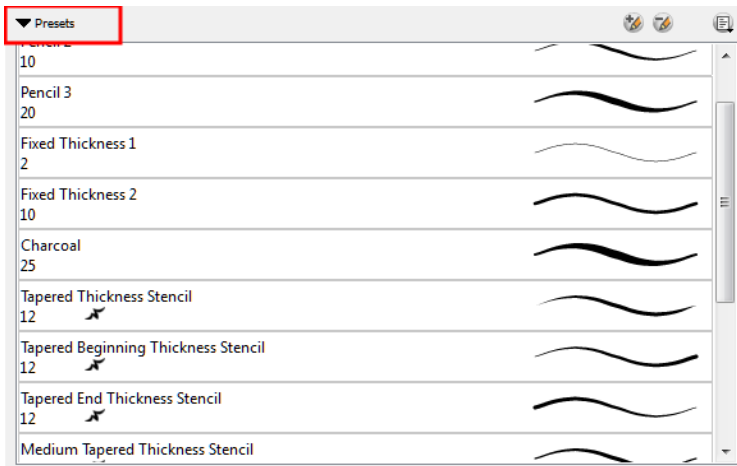

3. In the Drawing or Camera view, draw your pencil line or shape.



## Creating a Thickness Stencil

To create a thickness stencil:

1. In the Tools toolbar, select the **Pencil** , **Line** , **Ellipse** , or **Rectangle**  tool.
2. In the Tool Properties view, click the **New Pencil** or **New Brush**  button.

The New Preset dialog box opens.

3. Enter a name for your new pencil thickness stencil and click OK.
4. Start drawing in the Camera or Drawing view.

## Creating a Pencil Thickness Stencil with the Select Tool

To create a pencil thickness stencil with the Select tool:

1. In the Tools toolbar, select the **Select**  tool.
2. In the Camera view, select the pencil line or shape you want to take the style from.

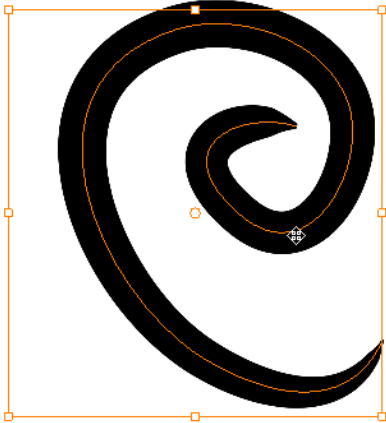





3. In the Tool Properties view, click the **New Preset**  button.

A new thickness stencil is added to the end of the list in the Presets drop-down menu.

4. In the Presets drop-down menu, select your new thickness stencil and click on a line or shape in the Camera view to apply the thickness stencil you created.

## Renaming a Thickness Stencil

To rename a thickness stencil:

1. In the Tools toolbar, select the **Pencil** , **Line** , **Ellipse** , or **Rectangle**  tool.
2. In the Presets drop-down menu, select the thickness stencil you want to rename.
3. From the Brush menu, select **Rename Pencil** or **Rename Brush**, depending on the tool you selected.  
The Rename Preset dialog box opens.

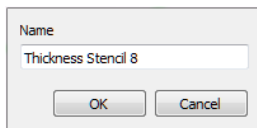

4. In the Name field, type in a name for the selected thickness stencil you are renaming.

## Deleting a Thickness Stencil

To delete a thickness stencil:

1. In the Tools toolbar, select the **Pencil**  tool.
2. In the Presets drop-down menu, select the thickness stencil to delete.

3. Click the **Delete Preset**  button.

## Locking a Thickness Stencil

To avoid modifying your thickness stencil inadvertently, you can lock them by enabling the **Lock Pen**  option.

To apply a thickness stencil to a pencil line or shape:

1. In the Tools toolbar, select the **Select**  tool.
2. In the Camera or Drawing view, select the pencil line or shape on which you want to apply a style.

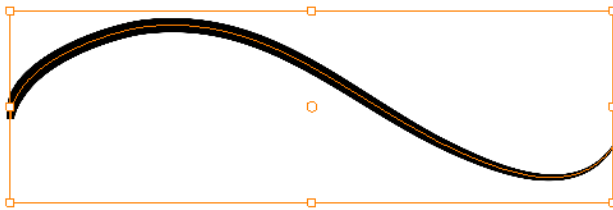

3. In the Tool Properties view, select the style you want to apply from the **Presets** list.

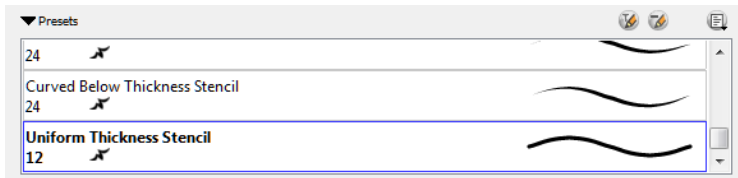

The style you selected is applied to your selection.



## Related Topics

- [Pencil Tool Options](#) on page 131
- [Shape Tool Options](#) on page 194
- [Select Tool Properties](#) on page 165

## Pencil Line Texture

You can apply a texture on a pencil line.

- [Applying Texture to a Pencil Line](#) on the next page
- [Creating a Pencil Texture Template with the Pencil Tool](#) on page 142



- [Adding a Texture to the Preferences](#) on page 144
- [Applying a Preset Texture to a Pencil Line](#) on page 145
- [Creating a Pencil Texture Template with the Select Tool](#) on page 143

## Applying Texture to a Pencil Line

Pencil lines support texture. Before drawing, you can select or import a texture and apply it to your lines. You can also change it afterwards using the Select tool. Textures are independent from pencil templates.

To apply a preset texture to a pencil line:

1. In the Tools toolbar, select the **Pencil**  tool.
2. In the Tool Properties view, the preview area displays the stroke that will be produced after you customize the different parameters in the Tool Properties view. Click the arrow button.

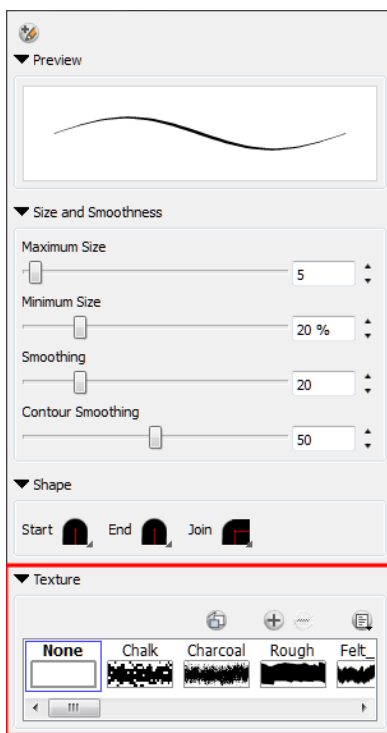
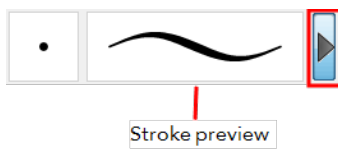

In the Pencil Properties property editor displays.

3. In the Texture section, select a texture for your pencil.
4. In the Camera or Drawing view, draw your pencil line.





## Creating a Pencil Texture Template with the Pencil Tool

To create a pencil texture template with the Pencil tool:

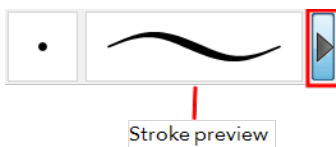
1. In the Tools toolbar, select the **Pencil**  tool.
2. In the Tool Properties view, click the arrow button beside the stroke preview area.



3. In the Pencil Properties property editor, click the **New Texture**  button or select **New Texture** from the Texture menu.
  - To delete a preset style, click the **Delete Texture**  button.
4. Browse for your bitmap texture file.



The file must be a TGA or PSD. Your texture **MUST HAVE** an alpha channel.

5. Click **Open**.  
The imported texture is saved in your scene texture list.

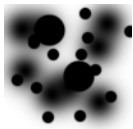

6. In the Pencil Properties property editor, select your new texture.

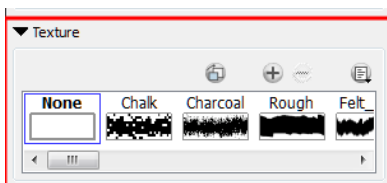

7. In the Tool Properties view, click the Texture menu and select **Rename Texture**.  
The Rename Opacity Texture dialog box opens.

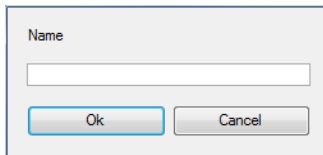



8. In the **Name** field, type the template name and click OK.
9. In the Camera or Drawing view, draw your pencil lines.



### Creating a Pencil Texture Template with the Select Tool

To create a pencil texture template with the Select tool:

1. In the Tools toolbar, select the **Select**  tool.
2. In the Camera view, select a pencil line on which to apply a texture.
3. In the Pencil Properties property editor, click the **New Texture**  button or select **New Texture** from the Texture menu.
  - To delete a preset style, click on the **Delete Texture**  button. Note that you cannot delete the textures stored in your preferences.
4. Browse for a bitmap texture file.



The file must be a TGA or PSD. Your texture **MUST HAVE** an alpha channel.

5. Click **Open**.  
The imported texture is saved in your scene texture list.

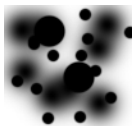

6. In the Pencil Properties property editor, select your new texture template.

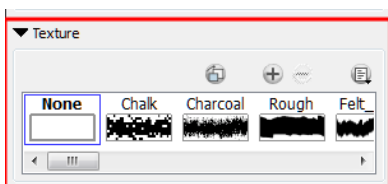

7. In the Tool Properties view, click the Texture menu and select **Rename Texture**.

The Rename Opacity Texture dialog box opens.

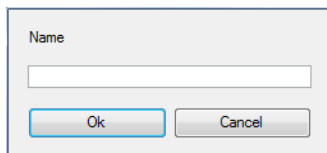

8. In the **Name** field, type the template name and click OK.





## Adding a Texture to the Preferences

When you import a texture in your pencil styles, it is saved in your scene. If you want to add that texture to a bank that you will be able to reuse in different scenes, you can add that texture to your preferences.

**To add a texture to your preferences:**

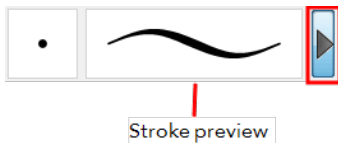
1. In the Tools toolbar, select the **Pencil**  tool.
2. In the Tool Properties view, click the arrow button beside the stroke preview area.



3. In the Pencil Properties property editor, select a texture from the Textures area to add to your preferences.
4. Click the **Copy to Preference**  button.

## Applying a Preset Texture to a Pencil Line

To apply a preset texture to a pencil line:

1. In the Tools toolbar, select the **Select**  tool.
2. In the Camera view, select a pencil line.

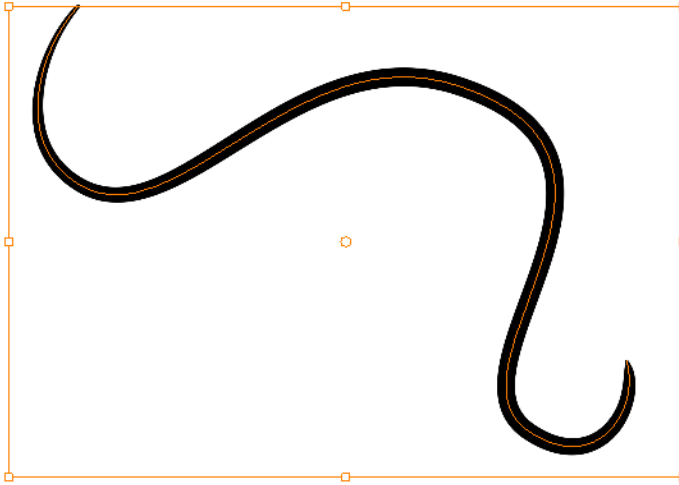

3. In the Tool Properties view, select a texture from the Textures area to apply to the selected stroke.



## Related Topics

- [Pencil Tool Options](#) on page 131
- [Select Tool Properties](#) on page 165
- [Drawing with Line Texture](#) on page 155

# Drawing with the Brush Tool



The **Brush**  tool is pressure sensitive and can create a contour shape which gives a thick and thin line effect, as if the drawing was made with a brush.

**To draw with the Brush tool:**

1. In the **Timeline** or **Xsheet** view, select the cell on which you want to draw.  
*In Harmony Paint, select a drawing in the **Drawing** panel.*

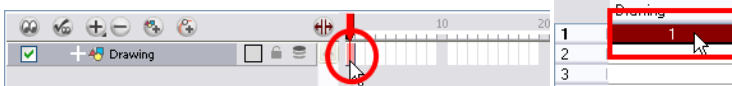

2. In the Tools toolbar, select the **Brush**  tool or press [Alt] + [B].
3. In the Colour view, click a colour swatch to select a colour.

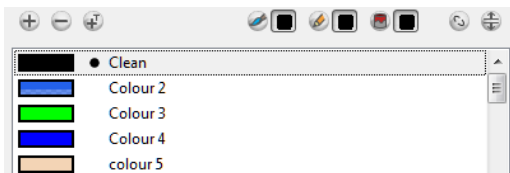

4. In the Drawing or Camera view, start drawing.
  - Hold [Ctrl] (Windows) or [⌘] (Mac OS X) to force a line to join the end and start of your shape while drawing.

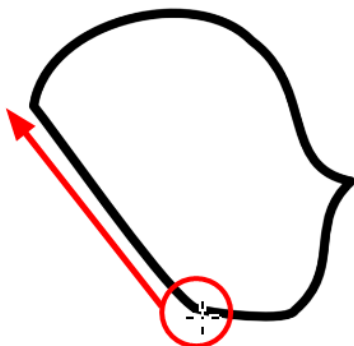



The last colour you select while using the **Brush** tool is recalled the next time you select the **Brush** tool.

## Related Topics

- [Brush Tool Options](#) below

# Brush Tool Options

When you select the **Brush**  tool, its properties and options appear in the **Tool Properties** view.

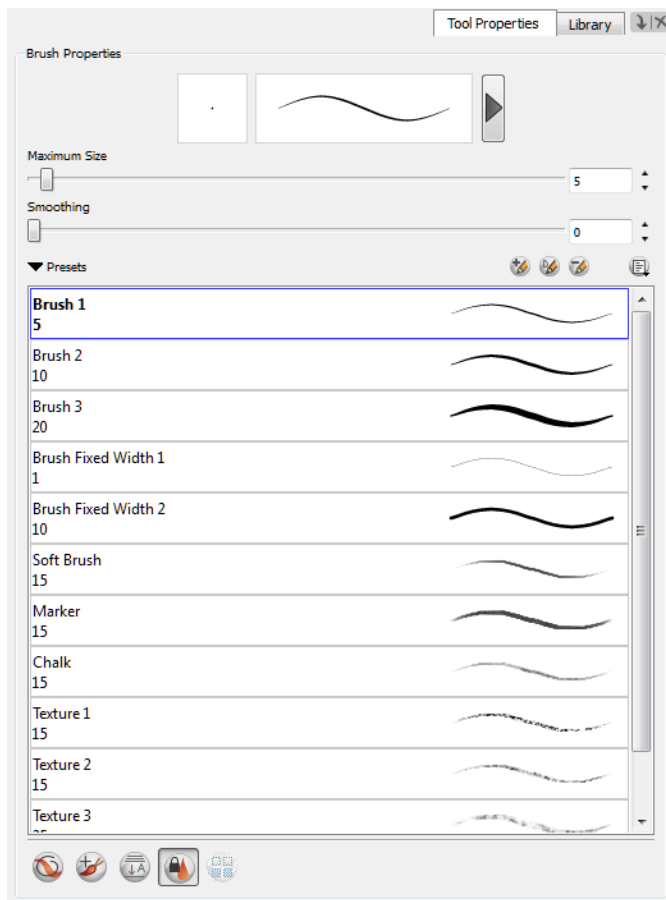

These are the options available for the Brush tool:

- [Normal Brush Mode](#) on the facing page
- [Draw Behind](#) on the facing page
- [Repaint Brush Mode](#) on page 149
- [Auto-Flatten Mode](#) on page 149
- [Respect Protected Colour](#) on page 149
- [Use Stored Colour Gradient](#) on page 149

- [Brush Styles](#) on page 150
- [Dynamic Brush](#) on page 150
- [Brush Tool Options](#) on the previous page
- [Brush Tool Options](#) on the previous page
- [Brush Tool Options](#) on the previous page
- [Brush Tips](#) on page 150
- [Brush Tool Options](#) on the previous page
- [Line Texture](#) on page 150

## Normal Brush Mode

The **Normal Brush Mode**  creates contour lines as you draw, adding each brush lines on top of the last ones.

## Previewing the Stroke

The Preview area lets you see a preview of the stroke that will be produced after you customize the different parameters in the Tool Properties view.

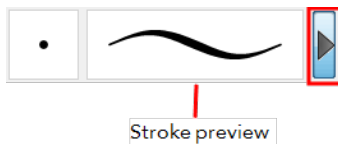

## Maximum Size and Smoothing

This is where you set the minimum and maximum sizes of your drawing tool which will produce the thick and thin effect on your stroke. This works with the pressure sensitivity of a pen tablet.

- **Maximum and Minimum Size:** Defines the maximum width of the stroke.
- **Smoothing:** Defines the number of control points added to the centre line.

## Brush Presets

Brush presets are created by saving the properties of the current brush to a new preset, which you can reuse for repeated tasks. You can create as many brush presets as you need.

## Draw Behind





When the **Draw Behind**  mode is enabled, the lines you draw will appear behind the art that already exists.

## Repaint Brush Mode

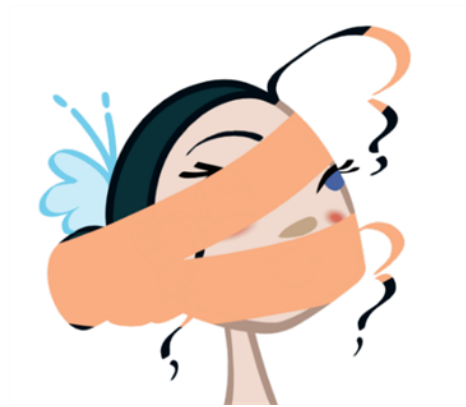

The **Repaint Brush**  is used to repaint zones that have already been painted, it will not affect empty zones or pencil lines. It also automatically flattens each of its brush lines so it does not add new brush lines on top of existing ones. You can use this mode to paint tones or highlights onto your character.

## Auto-Flatten Mode

When enabled, the **Auto-Flatten** mode automatically flattens the new lines created with the existing artwork as you draw in the Drawing or Camera view. Brush strokes will flatten with brush strokes and pencil lines will flatten with pencil lines.

## Respect Protected Colour

The **Respect Protected Colour**  option prevent the colours you marked as protected in the **Colour** view to be repainted using the **Repaint Brush** mode or any of the painting tools.



Refer to [Protecting Colours](#) on page 313 to learn how to use the **Protect Colour** feature.

---

## Use Stored Colour Gradient

The **Use Stored Colour Gradient**  option makes your tool use the previously stored gradient position. This way, every new brush line or colour fill will use the stored gradient position.



Refer to [Storing Your Favourite Gradient or Texture Settings](#) on page 308 to learn how to use the Store Colour Gradient option.

## Brush Styles

A variety of brush styles are provided allowing you to create and save your own. This way you can create brushes with precise sizes and parameters and save them so you can draw and design—see [Brush Styles](#) below

## Dynamic Brush

A **Dynamic Brush**  can be created to allow you to draw using patterns created from your artwork—see

[Dynamic Brush](#) on page 152

## Brush Tips

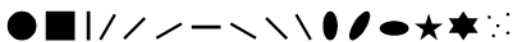

In this drop-down menu, you can find a variety of tip shapes from round and square ones to star shaped, select the one you need.

## Line Texture

In Toon Boom Animate, you can draw with a textured line. Textured lines are a mixed bitmap image contained in a vector frame. This allows you to sketch as if you are drawing on paper.



Refer to the [Drawing with Line Texture](#) on page 155 topic to learn everything about line texture and its parameters.

## Related Topics

- [How to Draw](#) on page 113
- [Drawing with the Brush Tool](#) on page 146
- [Drawing with Line Texture](#) on page 155
- [Working with Thickness Stencils](#)

## Brush Styles

You can create your own brush styles.

- [Selecting a Brush Style](#) on the next page
- [Adding a Brush Style](#) on the next page

- [Brush Styles](#) on the previous page
- [Deleting a Brush Style](#) on the facing page
- [Brush Styles](#) on the previous page

## Selecting a Brush Style

A variety of brush styles are provided allowing you to create and save your own. This way you can create brushes with precise sizes and parameters and save them so you can draw and design.

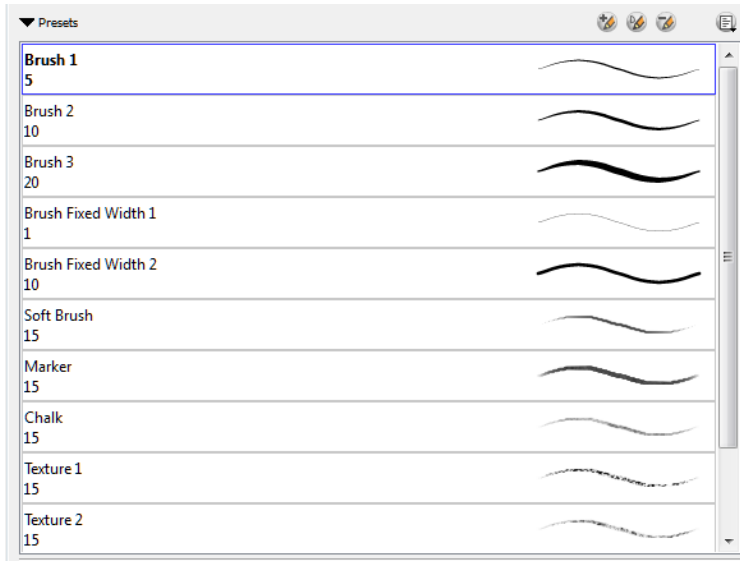

To select a brush style:



- In the Tool Properties, select a brush style from the Brush Presets section.

## Adding a Brush Style

To create a brush preset:



Make sure your current brush has the settings you would like in your preset.

1. Do one of the following:
  - ▶ In the Brush view, click the New Brush  button.
  - ▶ From the Brush  menu, select **New Brush Preset**.
  - ▶ In the Properties window of the tool you are using, click the  button in the upper-left corner—see [Viewing Tool Properties](#) on page 1.
2. In the New Preset window, type a name for your new brush preset.  
The new brush is added to the end of the list of brush preset.



Brush presets cannot be updated. However you can select a preset, which applies those properties to the current brush. Then you can modify the properties, and create a new preset with the new properties. If desired, you can delete the old preset.



Renaming a brush can make it easier to identify and access the brushes you use most frequently.

#### To rename a brush:

1. In the Tool Properties view, select a brush to rename.
2. From the Brush  menu, select **Rename Brush**.
3. Type in a new name for the brush.

#### Deleting a Brush Style

##### To delete a brush preset:

1. Select the brush preset you want to delete.
2. Do one of the following:
  - In the Brush Preset view, click the Delete Brush  button.
  - From the Brush Preset  menu, select **Delete Brush**.

#### Related Topics

- [Brush Tool Options on page 147](#)

#### Dynamic Brush

A **Dynamic Brush**  can be created to allow you to draw using patterns created from your artwork. Create a new **Dynamic Brush** to copy a pattern you have drawn to reproduce it quickly. You can create dynamic brushed using either a single pattern or a multiple one that will automatically switch through the patterns as you draw.



##### To create a new dynamic brush:

1. In the Tools toolbar, select a drawing tool.
2. In the Drawing or Camera view, draw the pattern you want to use as your **Dynamic Brush** stamp.

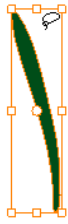

3. In the Tools toolbar, click the **Select**  tool and select the parts of the drawing you want to repeat.



4. In the Tools toolbar, select the **Brush**  tool.
5. In the Tool Properties view, click the **Add Dynamic Brush**  button to add your selection as a new dynamic brush preset.
6. Click the **Rename Brush Style**  button. From the Brush menu, select **Rename Brush**.  
The Rename Preset dialog box opens.
7. Type in a name for the new dynamic brush and click OK.
8. In the Camera or Drawing view, start drawing with your dynamic brush to quickly repeat a pattern.

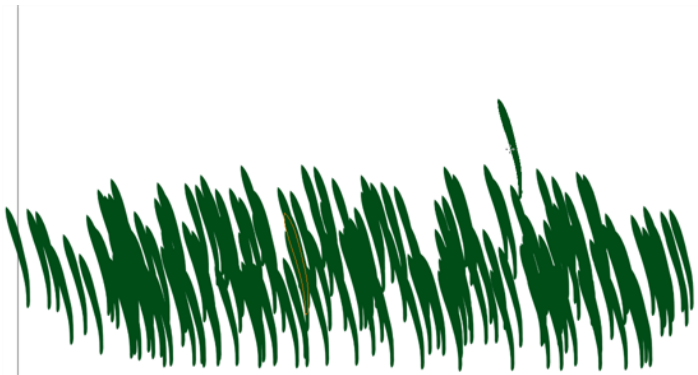

**To create a dynamic brush with multiple drawings:**

1. In the Timeline view, click the **Add Drawing Layers**  button to create as many layers as patterns you want in your dynamic brush. It is recommended to rename your layers.

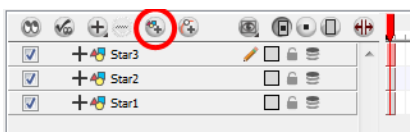

2. In the Camera view, draw your individual pattern on a separated layer.

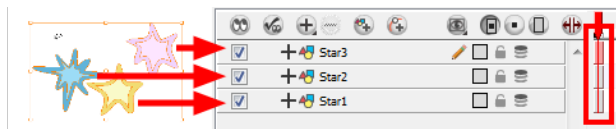

3. In the Tools toolbar, select the **Select**  tool.
4. In the Camera view, select all the drawings you want to add to your new dynamic brush.

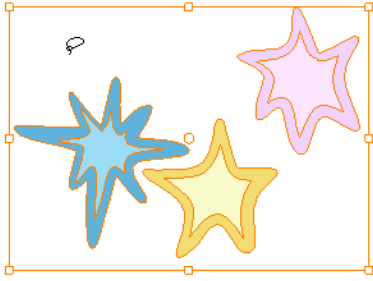

5. In the Tools toolbar, select the **Brush**  tool.
6. Click the **Add Dynamic Brush**  button to add your selection as a new Dynamic Brush preset.

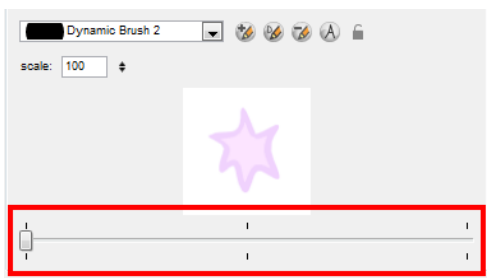

7. Click the **Rename Brush Style**  button. From the Brush menu, select **Rename Brush**.

The Rename Preset dialog box opens.

8. Type in a name for the new dynamic brush and click OK.
9. In the Camera or Drawing view, start drawing with your dynamic brush to quickly repeat a pattern. When you use this brush, you will cycle through the drawings.



## Related Topics

- [Brush Tool Options on page 147](#)

# Drawing with Line Texture



In Toon Boom Animate, you can use the **Brush**  tool to draw with bitmap textured lines.

In the Brush Tool Properties view, you will find a series of default textured brushes but you can also create your own collection by importing either PSD or TGA files in the **Pen** list.



The textured brush only work with the Brush tool. It does not work with the Pencil, Line, Ellipse, Polyline or Rectangle tools.

---

## Related Topics

- [How to Draw with Texture](#) below
- [Adjusting the Line Texture Parameters](#) on page 1
- [Creating Texture Brushes](#) on page 157
- [Erasing Textured Lines](#) on page 158
- [Hiding the Line Texture](#) on page 160
- [Adjusting the Line Texture Opacity](#) on page 161

## How to Draw with Texture

To draw with textured lines, use the **Brush** tool and the correct pen in the list. You can also draw with pencil line texture—see [Pencil Line Texture](#) on page 140

**To draw with textured lines:**

1. In the Tools toolbar, select the Brush  tool or press [Alt]+[B].

- In the Tool Properties view, select a brush and click the Arrow button to open the Brush Properties view.



- In the Texture section, select the **Select Texture** option.

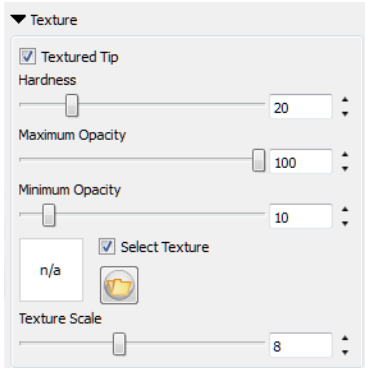

- Set the following parameters:

- Hardness:** The hardness value corresponds to the smoothness of the line edge. The lower the value, the more blurry and smooth the line edge will be. The higher the value, the sharper the line edge will be.



- Minimum Opacity:** This value corresponds to the transparency of the brush when the pressure is very light. Values closer to 0 produce a more transparent line.



- Maximum Opacity:** This value corresponds to the transparency of the brush when the pressure is heavy. Values closer to 1 produce a more opaque line.
- Select Texture:** Lets you use and select a texture for your brush. The thumbnail displays the texture currently in use. You can also browse for a texture file to import. Browsing for a texture file in a brush already using texture will replace the file currently in use, although it will not replace the texture in the lines already drawn.





- ▶ **Texture Scale:** Changes the size of the texture in the lines you draw. If you are using a plaid texture, the squares will be larger if you increase the value and smaller if you decrease it.

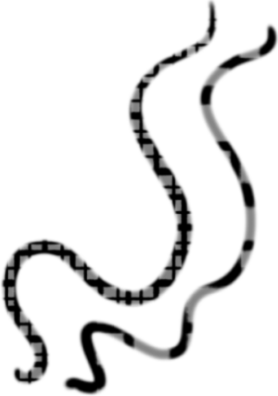

5. In the Camera or Drawing view, start drawing.



## Related Topics

- [Drawing with the Brush Tool on page 146](#)
- [Pencil Line Texture on page 140](#)

## Creating Texture Brushes

To create your own texture brush, you must prepare your tiled texture file in a third-party software, such as Adobe Photoshop. If your image has transparency in it, it will be supported. The texture file must be either a .PSD or .TGA file.



It is recommended that you maintain your texture resolution between 100 x 100 pixels and 400 x 400 pixels.

### To create a texture brush:

1. In the Tools toolbar, select the Brush  tool or press [Alt]+[B].
2. In the Texture section, select the **Select Texture** option.
3. Click the Folder button and browse for a bitmap texture file.

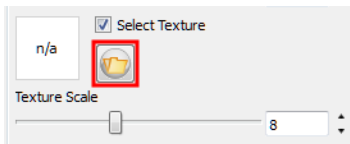

4. In the Tool Properties view, click the New Brush  button to add a new brush to your list.



The colour of your texture will not be used. Instead, the dark and light areas will be used to determine the alpha in your texture. The current colour swatch will be used in conjunction with the pattern and alpha in your texture.

5. In the Camera or Drawing view, draw some lines and adjust the parameters to fit the style you are looking for.

### Related Topics

- [Drawing with Line Texture](#) on page 155

## Erasing Textured Lines

When you use the **Eraser** tool to erase a portion of a textured line, the vector frame is cut straight and you lose the feather created while drawing with the **Brush** tool. In Toon Boom Animate, a special option in the **Eraser** 

tool lets you create a soft edge on your textured lines. You can also cut or keep the vector frame as is.

1. In the Tools toolbar, select the **Eraser**  tool, press [Alt] + [E].
2. In the Tool Properties view, click the arrow button.

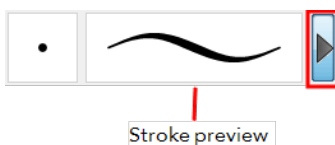

The Brush Properties panel opens.

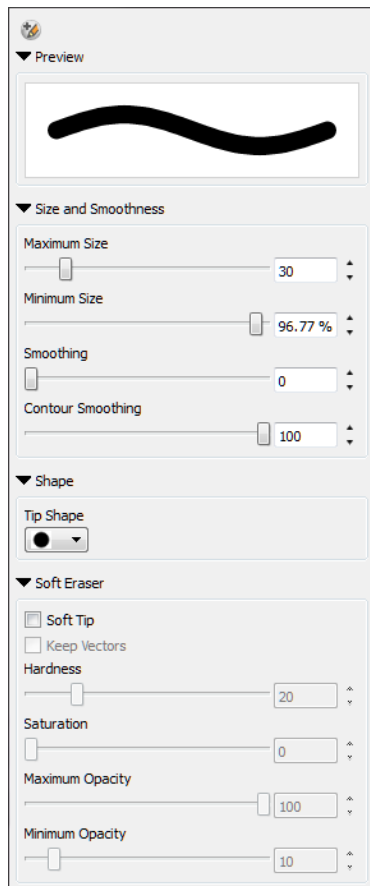

### 3. Adjust the following:

- ▶ **Maximum/Minimum Size:** Defines the minimum and maximum width of the stroke.
- ▶ **Smoothing:** Defines the number of control points added to the centre line.
- ▶ **Contour Smoothing:** Defines the number of control points added to the contour boundaries (around the line). Lower values mean that the line will appear as you draw it (with more control points added along the centre line). Higher values mean that the line will be smoothed out (removing control points from the centre line).
- ▶ **Tip Shape:** Lets you select a shape for the tip of the eraser. There are a variety of tips to choose from: round, square, oval, star-shaped and more.

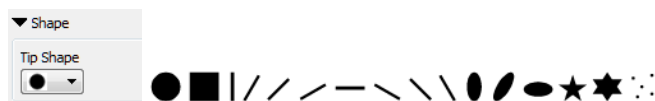

- ▶ **Soft Tip:** Gives the tip of your stroke a soft edge.
- ▶ **Keep Vectors:** Keeps your vector frames and does not cut them.
- ▶ **Hardness:** The hardness value corresponds to the smoothness of the line edge. The lower the value, the more blurry and smooth the line edge will be. The higher the value, the sharper the line edge will be.
- ▶ **Saturation:** Corresponds to the intensity of line color.
- ▶ **Maximum Opacity:** Corresponds to the transparency of the brush when the pressure is heavy. Values closer to 1 produce a more opaque line.
- ▶ **Minimum Opacity:** Corresponds to the transparency of the brush when the pressure is very light. Values closer to 0 produce a more transparent line.

4. In the Camera or Drawing view, erase your textures lines.

## Related Topics

- [Drawing with Line Texture](#) on page 155

## Hiding the Line Texture



Sometimes you need to hide the line texture to see the complete vector frame around your lines. This is useful to help you see any dirt floating around your drawing.



To hide the line texture in the **Camera** view, you must enable the **Show Drawing on Top** option. In the top menu, select **View > Show > Current Drawing on Top**. Refer to the [Show Current Drawing on Top on page 121](#) section to learn more about this option.

### To hide the line texture:

1. If you are in the Camera view, select the **Show Current Drawing on Top** option.
2. In the Camera or Drawing View  menu, select **View > Show > Hide Line Texture** or press [Ctrl] + [Shift] + [H] (Windows) or [⌘] + [Shift] + [H] (Mac OS X).

## Related Topics

- [Drawing with Line Texture](#) on page 155

## Adjusting the Line Texture Opacity



At some point, you may want to modify the look of a textured drawing. Maybe you find that your line is too smooth or too faint. You can adjust those parameters by using the **Adjust Line Texture Opacity** command.



To be able to adjust the line texture in the **Camera** view, you must select the **Show Drawing on Top** option. In the top menu, select **View > Show > Current Drawing on Top**.

Refer to the [Show Current Drawing on Top on page 121](#) section to learn more about this option.

### To adjust the line texture opacity:

1. If you are in **Camera** view, select the **Show Current Drawing on Top** option.
2. In the Timeline or Xsheet view, select the drawing whose opacity you want to adjust.
3. In the Camera or Drawing view menu, select **Drawing > Adjust Line Texture Opacity**.

The Adjust Line Texture Opacity dialog box opens.

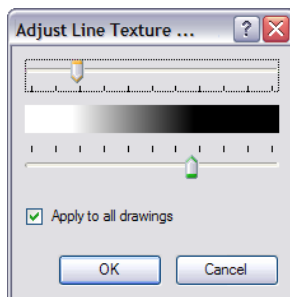



4. Drag the sliders toward the middle to increase the contrast and opacity of the textured lines.
5. If you want to apply the changes to all drawings exposed on the layer, select the **Apply to All Drawings** option and click OK.

### Related Topics

- [Drawing with Line Texture on page 155](#)

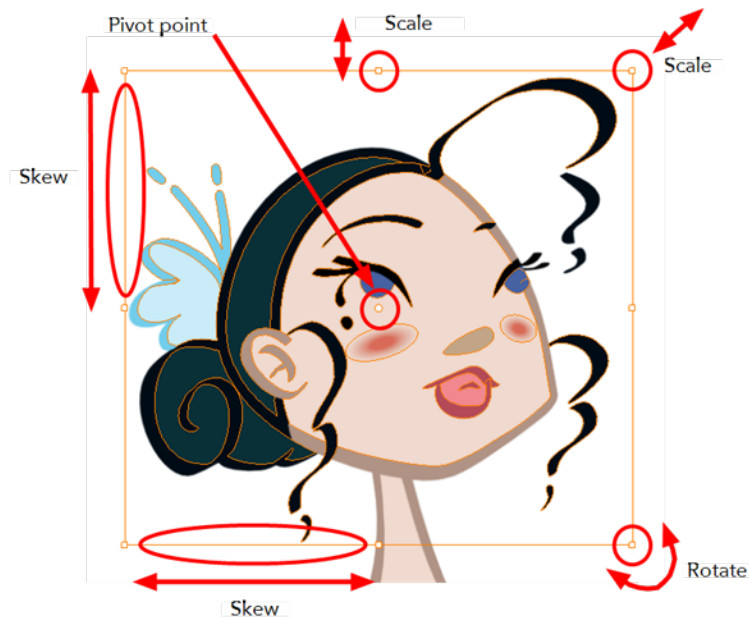
# Selecting Drawing Objects



The **Select**  tool is used to select drawing strokes in both the Drawing and Camera views, and apply basic transformations, such as repositioning, rotating, scaling or skewing, using the different handles of the bounding box.

## To select with the Select tool:

1. In the Timeline view, select the cell on which you want to select drawing objects.  
*In Harmony Paint, select a drawing in the **Drawing** panel.*
2. In the Tools toolbar, select the **Select**  tool or press [Alt] + [S].
3. In the **Camera** or **Drawing** view, select the drawing objects.
  - You can select all the drawing objects in a drawing by using the **Select All** command or press [Ctrl] + [A] (Windows) or [⌘] + [A] (Mac OS X).
4. To deform or reposition a selection:
  - To **reposition**, click on the selected drawing object and drag the selection to a new area.

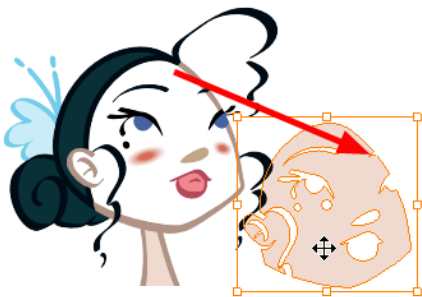

- To **rotate**, grab the selection box handle and rotate it.

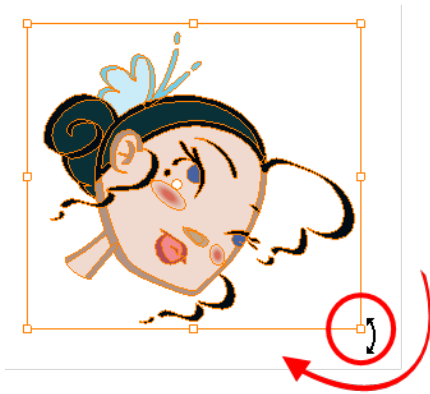

- ▶ To **scale**, pull or push either on the top, side, bottom or corner control point. Hold down [Shift] to lock the selection's ratio.

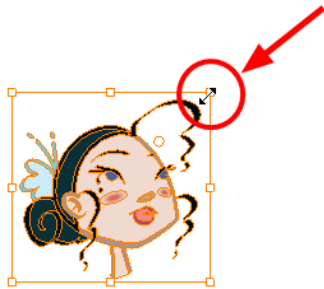

- ▶ To **skew**, drag sideways or up and down the sides or top and bottom segments, between the control points.

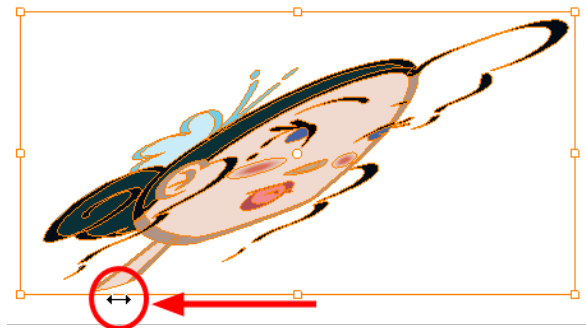

## Inverting a Selection

*Not available in Harmony Paint.*

Sometimes, when you want to select multiple objects, while leaving one unselected, it can be handy to select only the stroke, or line, that you do not want included in your selection. Then, you can invert that selection so that everything else becomes selected. This can be quite a time saver.

### To invert a selection:

1. From the top menu, select **Edit > Invert Selection** or press [Ctrl] + [Shift] + [I] (Windows) or [⌘] + [Shift] + [I] (Mac OS X).



You can also find the Invert Selection option in the **Camera View** or **Drawing View** menu by selecting **Edit > Invert Selection**.

## Related Topics

- [Repositioning a Pivot Point](#) below
- [Selection on Single or Multiple Layers](#) on the next page
- [Select Tool Properties](#) on the next page

## Repositioning a Pivot Point

Some of the transformations such as rotation, scale, skew and flip, are done relative to the position of the pivot point. You can temporarily reposition this pivot point for a transformation using the **Select**  tool.

To temporarily reposition the pivot point:

1. In the Camera or Drawing view, select the drawing object you want to transform.  
The pivot point appears in the middle of your selection.



2. Click the pivot point and drag it to a new position.

This becomes the new position of the pivot point for the current transformation and will remain there until you make a new selection.

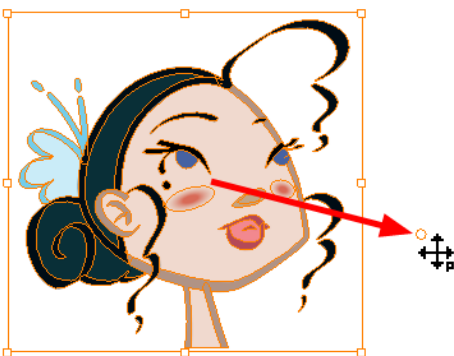



## Related Topics

- [Selecting Drawing Objects on page 162](#)
- [Select Tool Properties below](#)

## Selection on Single or Multiple Layers

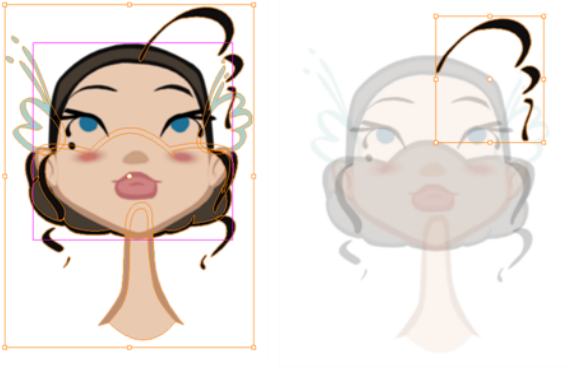

By default, when you draw a selection box in the Camera view, the Select tool will select all the drawing strokes and symbols in its path. If you would prefer the Select tool to only select the current drawing and not the other visible drawings, you can enable the Select Tool Works on Single Drawing preference.

### To enable the Select Tool Works on Single Drawing preference:

1. In the top menu, select **Edit > Preferences** (Windows) or **Animate > Preferences** (Mac OS X).  
The Preferences dialog box opens.
2. In the Camera tab, go to the **Tools** section and select the **Select Tool Works on Single Drawing** preference and click OK.
3. In the Tools toolbar, select the **Select**  tool or select [Alt] + [S].
4. In the Camera view, select your drawing.

## Related Topics

- [Selecting Drawing Objects on page 162](#)
- [Select Tool Properties below](#)

## Select Tool Properties

When you choose the **Select**  tool, its properties and options appear in the Tool Properties view.

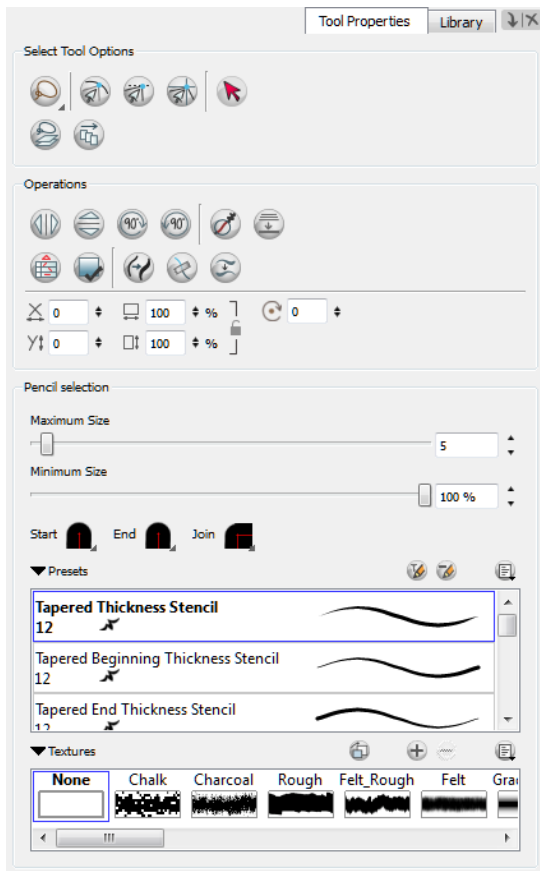

## Related Topics

- [Lasso and Marquee on the next page](#)
- [Snap Options on the next page](#)
- [Permanent Selection on page 168](#)
- [Apply to All Drawings in Layer on page 168](#)
- [Apply to All Visible Drawings on page 169](#)
- [Apply to Line and Colour Art on page 169](#)
- [Select by Colour on page 169](#)
- [Flip Horizontal and Vertical on page 170](#)
- [Rotate 90 Degrees CW and CCW on page 170](#)
- [Pencil to Brush on page 171](#)
- [Smooth on page 171](#)
- [Flatten on page 171](#)
- [Store Colour Gradient on page 171](#)
- [Merge Pencil Lines on page 172](#)
- [Reverse Pencil Thickness on page 172](#)
- [Create Colour Art from Line Art on page 173](#)

- [Distribute to Layers](#) on page 173
- [Width and Height](#) on page 174
- [Offset X and Y](#) on page 174
- [Angle](#) on page 174
- [Adjusting the Pencil Line Thickness](#) on page 175
- [Adjusting the Pencil Line Style](#) on page 175
- [Pencil Stencils](#) on page 175
- [Adding Texture to a Pencil Line](#) on page 176
- [Adjusting the Text Selection](#) on page 176



## Lasso and Marquee

Choose between the **Lasso**  and **Marquee**  options to change the selection style of the tool.

- Click and hold [Alt] to temporarily switch from the current mode to the other.



## Snap Options

You can enable different snapping modes to help you when repositioning your drawings using the **Select** tool.

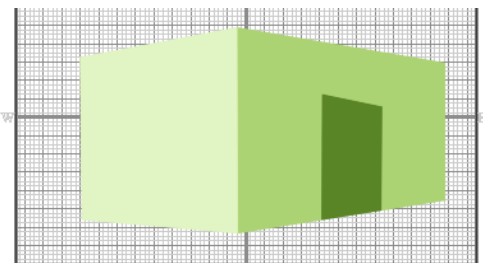
-  **Snap to Contour:** Snaps your selection or point to any line you position it on. As soon as you move it close enough to another line, your point or selection will snap to it.
-  **Snap and Align:** Snaps the selected anchor point to any existing line while displaying temporary rulers as a guide that you can also snap your anchor point to.
-  **Snap to Grid:** Snaps your selection following the currently enabled grid.



**To snap to grid:**

- Select **View > Grid > Show Grid** to display the grid in the **Camera** or **Drawing** view or press [Ctrl] + ['] (Windows) or [⌘] + ['] (Mac OS X).
  - Select **View > Grid > Square Grid, 12 Field Grid** or **16 Field Grid** for your current needs.
1. In the Tools toolbar, select the **Contour Editor**  tool or press [Alt] + [Q].
  2. In the Contour Editor Tool Properties view, click the **Snap to Grid**  button.

3. In the Camera or Drawing view, click on an anchor point you want to snap following the grid, and drag it to the desired position and release.

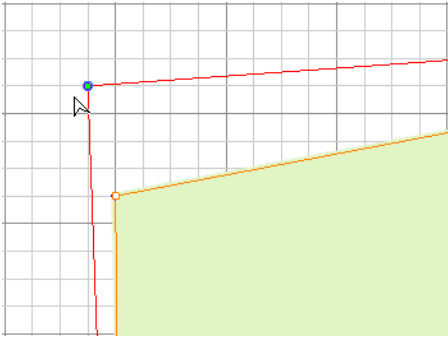

Refer to the [Grid on page 229](#) topic to learn more about the **Grid** feature.

## Permanent Selection

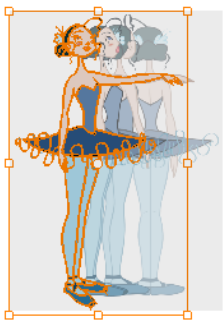

The **Permanent Selection**  option is used to maintain a selection over multiple drawings. Once this option is enabled, the selection zone made using the **Select** tool will remain as you navigate through drawings from a layer and drawings from other drawing layers. This option can be used to simultaneously delete artwork inside or outside of the selection on several drawings when combined with the **Apply to Multiple Drawings** option.

## Apply to All Drawings in Layer

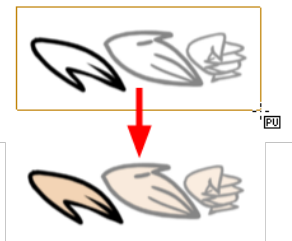

The **Apply to All Drawings in Layer**  option is used to perform an action on all the drawings contained in a layer. For example, you could enable the option to paint a section on all the drawings simultaneously. The **Apply Tool to All Drawings** option must be activated before performing the action and will stay enabled only for the next action.

## Apply to All Visible Drawings

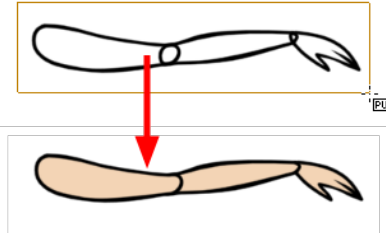

The **Apply to All Visible Drawings**  option is used to perform an action on all the visible drawings in the Camera view. This option is not available in the Drawing view.

## Apply to Line and Colour Art

The **Apply to Line and Colour Art**  option uses the concept of Line Art and Colour Art layers. Use this option to apply an action such as selecting or resizing a drawing on both Line Art and Colour Art layers, as well as the Overlay and Underlay layers.



To access the Apply to Line and Colour Art option, you must be in the Advanced Art mode—see [Overlay, Line Art, Colour Art, Underlay and Preview Mode on page 116](#).

## Select by Colour

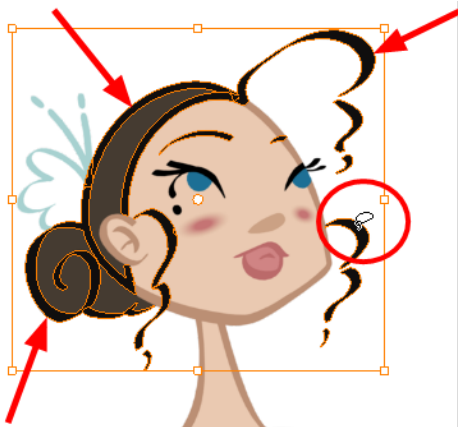



The **Select by Colour** mode lets you select all the zones in your drawing painted with the same colour.



Only the zones painted with the **SAME** colour swatch will be selected. If another zone is coloured with the exact same RGB value (same colour), but not painted with the same colour swatch, it will not be selected.

### To select areas by colour:

1. In the Tools toolbar, select the **Select**  tool or press [Alt] + [S].
2. In the Tool Properties view, click the **Select by Colour**  button.
3. In the view, click on any zone in your drawing.  
All zones of the same colour are selected.
4. Click the Select tool again to return to the regular Select mode.

## Flip Horizontal and Vertical



The **Flip Horizontal**  and **Flip Vertical**  operations flip the current selection horizontally or vertically.

From the top menu, select **Drawing > Transform > Flip Horizontal** and **Flip Vertical**.

## Rotate 90 Degrees CW and CCW





The **Rotate 90 Degrees CW**  and **Rotate 90 Degrees CCW**  operations rotate the current selection 90 degrees clockwise or counter-clockwise.

From the top menu, select **Drawing > Transform > Rotate 90 Degrees CW** and **Rotate 90 Degrees CCW**.

Or press [Ctrl] + [7] and [Ctrl] + [9] (Windows) or [⌘] + [7] and [⌘] + [9] (Mac OS X).

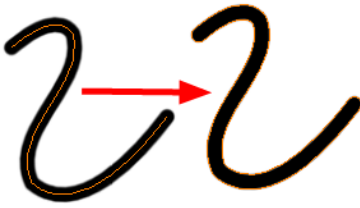
## Pencil to Brush



The **Pencil to Brush**  operation converts the selected centreline pencil strokes into contour strokes brush lines.

From the top menu, select **Drawing > Convert > Pencil Lines to Brush** or press [&].

## Smooth

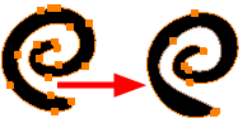

The **Smooth**  operation lets you smooth out selected drawing strokes and remove extra points. You can also access this feature through the top menu, by selecting **Drawing > Optimize > Smooth** or press [Alt] + [Shift] + [S].

## Flatten

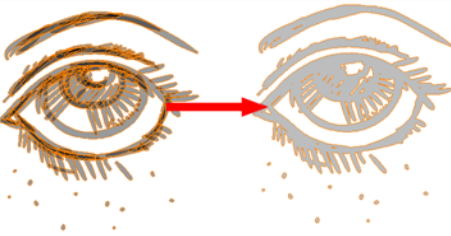

The **Flatten**  operation is used to merge drawing objects and brush strokes into a single layer. If you draw new lines to fix a drawing or a line with many brush strokes, it can be useful to flatten them all into a single shape. By default, lines are drawn one on top of each other, if you intend repainting the lines or modifying their shape, it will be easier if they are flattened.

You can also access this feature through the top menu, by selecting **Drawing > Optimize > Flatten**. The [Alt] + [Shift] + [F].

## Store Colour Gradient

Use the **Store Colour Gradient**  operation to record the selected gradient's position. This reuses the stored position of the gradient when drawing new brush lines or painting colour zones. Enable the **Use Stored Colour**

**Gradient**  option in the **Paint** or **Brush Tool Properties** view to do this.



Refer to [Drawing with the Brush Tool on page 146](#) or [Painting Using the Paint Tool on page 290](#) to learn how to use the **Use Stored Colour Gradient** option.

## Merge Pencil Lines

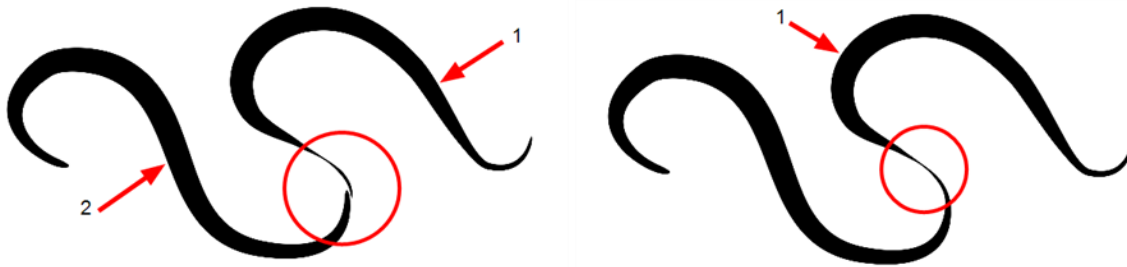



Pencil lines are central vector lines and it might be difficult to match pencil line's tips properly to align them and make it look like it is one single line. With the **Select** tool, you can select several pencil lines and merge them as one single object using the **Merge Pencil Lines**  option. It will take your lines and adjust the ends to form one single line.

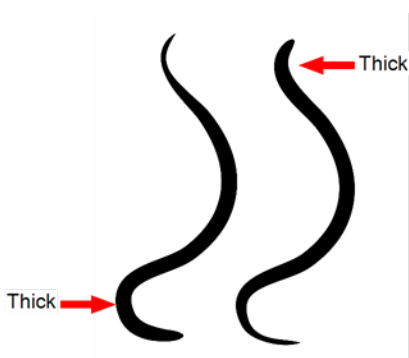

Points have to be close enough to be merge. If there is a big gap between the lines, they will not be merged.

## Reverse Pencil Thickness



The **Reverse Pencil Thickness**  option will invert the thick and thin section on a selected pencil line. This option will take the thickest size on the line and apply it to the thinnest, and it will apply the thinnest to the thickest.



## Create Colour Art from Line Art

You can configure the **Create Colour Art from Line Art** option to suit your requirements.



To access this option, you must be in the Advanced Art mode—see [Overlay, Line Art, Colour Art, Underlay and Preview Mode](#) on page 116.

To configure the **Create Colour Art from Line Art** option:

1. In the Select tool Tool Properties view, [Shift] + click the **Create Colour Art from Line Art** button.

The Configure Line Art to Colour Art dialog box opens.

The dialog box contains the following settings:

- Use rendered version of the drawing
- Maximum Resolution for rendered image: 2500
- Threshold for rendered image: 0.25
- Fitting error for rendered beziers: 1
- Source layer: Line Art
- Destination layer: Colour Art
- Clear Destination Art Layer First
- Perform Line Art to Colour Art Operation Immediately
- Buttons: OK, Cancel

- ▶ **Use rendered version of the drawing:** This option will render the drawing and vectorize it to calculate the position of the centreline that will produce the colour art stroke.
- ▶ **Maximum Resolution for rendered image:** The size of the rendered image.
- ▶ **Threshold for rendered image:** The value of grey processed to create the rendered vectorized arts.
- ▶ **Fitting error for rendered beziers:** This value represents how precise the fitting of the colour art zone in relation to the line art will be.
- ▶ **Source layer:** Select the layer (**Line Art**, **Colour Art**, **Underlay** or **Overlay**) you want the colour art to be created from.
- ▶ **Destination layer:** Select the layer (**Line Art**, **Colour Art**, **Underlay** or **Overlay**) you want the colour art to be created on.
- ▶ **Clear Destination Art Layer First:** Enable this option if you already have artwork on the destination layer and you want the content to be deleted before the colour art is added into it.
- ▶ **Perform Line Art to Colour Art Operation Immediately:** Enable this option to perform the **Create Colour Art from Line Art** command when you click OK.

## Distribute to Layers

The **Distribute to Layers** option is used to separate the selected art strokes and send them to new drawing

layers. In the Camera view, once you have drawn your artwork, you can select the strokes you want to distribute using the **Select** tool and click on the **Distribute to Layer** button, you can also select **Drawing >**

**Distribute to Layer.** It will automatically take every stroke from the drawing selection made in the **Camera** view and separate them into a different layer for each. If an artwork is composed of several strokes, you must group

them using **Edit > Group > Group** before using the **Distribute to Layer** option. This option cannot be done from the **Drawing** view.



Refer to [Break Down: Distribute to Layers on page 600](#) to learn more about the **Distribute to Layer** option.

## Width and Height

Use the **Width** and **Height** operation fields to enter specific values to resize the selected shape with precision.

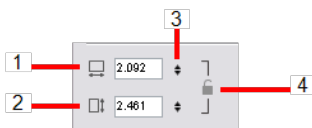

1. **Width:** Type a width value in this field to resize the width of your selection.
2. **Height:** Type a height value in this field to resize the height of your selection.
3. **Up/Down arrows:** Use the up and down arrows to modify the value contained in either the Width or Height value field.
4. **Lock icon:** Click on the lock icon to lock or unlock the ratio between the width and height values.

## Offset X and Y

Use the **Offset X** and **Offset Y** operation fields to enter specific values and precisely reposition the selected shape.

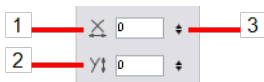

1. **X:** Type an offset value in this field to reposition your selection along the X-axis.
2. **Y:** Type an offset value in this field to reposition your selection along the Y-axis.
3. **Up/Down arrows:** Use the up and down arrows to modify the value contained in either the X or Y value field.

## Angle

Use the **Angle** operation fields to enter specific values and accurately rotate the selected shape.



1. **Angle:** Type a degree value in this field to rotate your selection.
2. **Up/Down arrows:** Use the up and down arrows to modify the value contained in the **Angle** value field.

## Adjusting the Pencil Line Thickness

Use the **Adjusting the Pencil Line Thickness** operation field to resize the selected centreline strokes. This operation is not permitted on contour line shapes, such as brush strokes or shape fills.

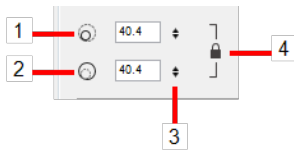

1. **Minimum Size:** Type a value in this field to set the minimum thickness of the selected centreline stroke.
2. **Maximum Size:** Type a value in this field to set the maximum thickness of the selected centreline stroke.
3. **Up/Down arrows:** Use the up and down arrows to modify the value contained in the Thickness value field.
4. **Lock Proportions:** Enable the Lock option for the minimum and maximum size to increase and decrease in proportion.

## Adjusting the Pencil Line Style

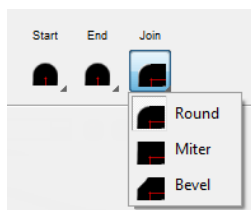

You can adjust the start, end, and joint style of a selected pencil line.

- **Start:** Lets you select the style of the start tip, which is the first tip you drew. You can choose between Round or Flat style.
- **End:** Lets you select the style of the end tip, which is the last tip you drew. You can choose between Round or Flat style.
- **Join:** Lets you select the joint style. The joints are where the line curves abruptly. You could also define the Join style as the corner style. You can choose between Round, Mitre and Bevel style.

## Pencil Stencils



Toon Boom Animate gives you the flexibility to change the style and thickness of your pencil lines even after they are drawn. You can apply preset pencil stencils or create your own.



Refer to [Working with Thickness Stencils on page 137](#), [Creating a Pencil Thickness Stencil with the Select Tool on page 139](#) and [Working with Thickness Stencils on page 137](#).

## Adding Texture to a Pencil Line

Pencil lines support texture. Once a pencil line is drawn, you can apply a preset texture or load your own. Textures are independent from pencil stencils.



Refer to [Pencil Line Texture on page 140](#), [Applying a Preset Texture to a Pencil Line on page 145](#) and [Creating a Pencil Texture Template with the Select Tool on page 143](#).

## Adjusting the Text Selection

When you select text with the Select tool, the tool properties will display the Text tool options on the bottom of the view. You can also press [Alt] + [9] to display only the Text properties in the Tool Properties view.

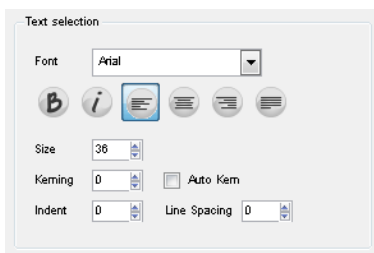

Refer to [Formatting the Text on page 219](#) to learn more about the **Text tool Tool Properties**.

## Related Topics

- [Drawing Using the Pencil Tool on page 130](#)
- [Pencil Tool Options on page 131](#)
- [Working with Thickness Stencils on page 137](#)
- [Pencil Line Texture on page 140](#)

# Erasing Parts of a Drawing



The **Eraser** tool is pressure sensitive, like the Brush tool, giving you more precision when erasing parts of a drawing.

**To erase with the Eraser tool:**

1. In the Timeline or Xsheet view, select the cell where you want to erase.  
*In Harmony Paint, select a drawing in the **Drawing** panel.*



2. In the Tools toolbar, select the **Eraser**  tool or press [Alt] + [E].
3. In the Camera or Drawing view, start erasing.



You can also use the Select tool to select drawing objects and delete them instead of erasing.

## Related Topics

- [Eraser Tool Options](#) below
- [Selecting Drawing Objects](#) on page 162

## Eraser Tool Options

When you select the **Eraser**  tool, its properties and options appear in the Tool Properties view.

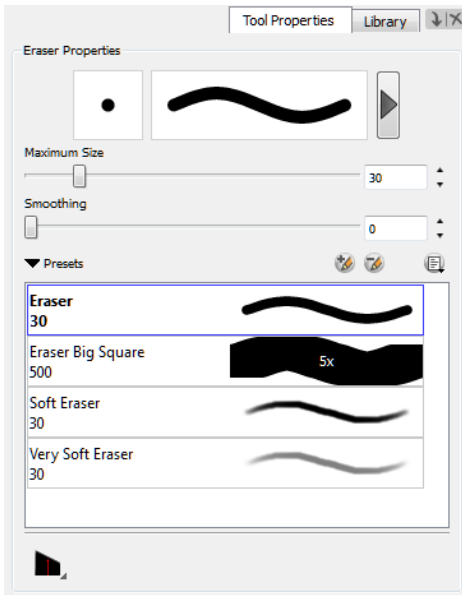

## Related Topics

- [Tip Style below](#)
- [Eraser Tool Options on the previous page](#)
- [Eraser Tool Options on the previous page](#)
- [Eraser Tool Options on the previous page](#)
- [Eraser Tool Options on the previous page](#)
- [Eraser Tool Options on the previous page](#)
- [Eraser Styles on page 180](#)
- [Eraser Blur Parameters on page 180](#)

## Tip Style

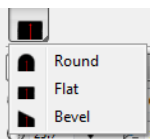

The Tip Style option affects the erased tip of pencil lines made with the Pencil, Ellipse, Rectangle, Line, and Polyline tools.

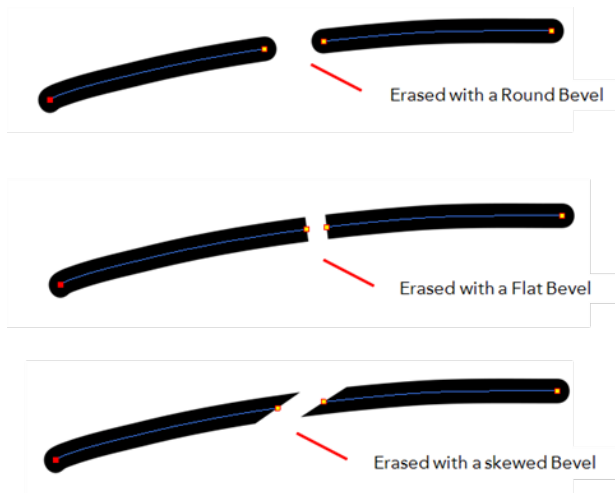

## Previewing the Stroke

The Preview area lets you see a preview of the stroke that will be produced after you customize the different parameters in the Tool Properties view.

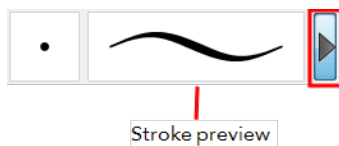

## Maximum Size and Smoothing

This is where you set the minimum and maximum sizes of your drawing tool which will produce the thick and thin effect on your stroke. This works with the pressure sensitivity of a pen tablet.

- ▶ **Maximum/Minimum Size:** Defines the minimum and maximum width of the stroke.
- ▶ **Smoothing:** Defines the number of control points added to the centre line.
- ▶ **Contour Smoothing:** Defines the number of control points added to the contour boundaries (around the line). Lower values mean that the line will appear as you draw it (with more control points added along the centre line). Higher values mean that the line will be smoothed out (removing control points from the centre line).
- ▶ **Tip Shape:** Lets you select a shape for the tip of the eraser. There are a variety of tips to choose from: round, square, oval, star-shaped and more.

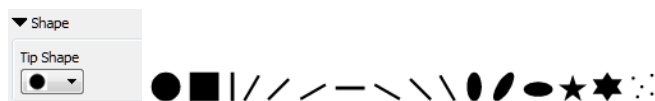

- ▶ **Soft Tip:** Gives the tip of your stroke a soft edge.
- ▶ **Keep Vectors:** Keeps your vector frames and does not cut them.
- ▶ **Hardness:** The hardness value corresponds to the smoothness of the line edge. The lower the value, the more blurry and smooth the line edge will be. The higher the value, the sharper the line edge will be.
- ▶ **Saturation:** Corresponds to the intensity of line color.

- **Maximum Opacity:** Corresponds to the transparency of the brush when the pressure is heavy. Values closer to 1 produce a more opaque line.
- **Minimum Opacity:** Corresponds to the transparency of the brush when the pressure is very light. Values closer to 0 produce a more transparent line.

## Brush Presets

Brush presets are created by saving the properties of the current brush to a new preset, which you can reuse for repeated tasks. You can create as many brush presets as you need.

## Eraser Styles

The Eraser tool uses the same Brush Styles as the Brush tool. Toon Boom Animate provides a variety of eraser styles and allows you to create and save your own. It is a good idea to create and save eraser brushes with precise sizes and parameters to draw and design—see [Brush Styles on page 150](#)

## Eraser Blur Parameters

Since Toon Boom Animate lets you draw with textured lines and create feathered edges on them, you may also want to erase with smooth edges instead of the solid vector based eraser. The Eraser Blur Parameters allow you to adjust the smoothness of your eraser for the textured lines—see [Erasing Textured Lines on page 158](#)







# Reshaping a Drawing Using the Contour Editor Tool



The **Contour Editor** tool is powerful, it allows you to add, remove or modify points on a vector line and to control them with Bezier handles. It is used to correct line shapes and to modify a single part of a colour zone. If a line is too thin or has a gap in it, you can modify and correct it with the **Contour Editor** tool. This tool can also be used to create elaborate shapes.

The Contour Editor displays vector points around a shape and the central vector points in a pencil line. Pulling or pushing on these points adjusts the brush's line thickness. Points can be selected and deleted. Each point has two Bezier handles used to correct the curves between two points. Shapes can be modified by pulling and pushing directly on the segment between the points. You can use it to perfect a central shape pencil line, a contour shape brush line or even create an elaborate shape from a basic ellipse, or square.

## To reshape with the Contour Editor tool:

1. In the Timeline or Xsheet view, select the cell in which you want to draw.  
*In Harmony Paint, select a drawing in the **Drawing** panel.*
2. In the Tools toolbar, select a shape    tool.
3. In the Tool Properties view, click the **Ellipse** mode  button, click the **Auto Fill** mode  button and set the pencil size to 0.
4. In the Drawing or Camera view, draw a circle.

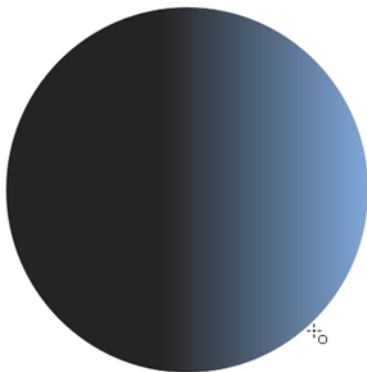

5. In the **Tools** toolbar, select the **Contour Editor**  tool or press [Alt] + [Q].

6. In the Drawing or Camera view, click the line to reshape it.

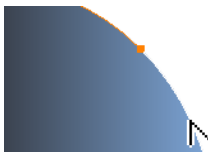

7. Select one or several points by clicking on them or circling around.

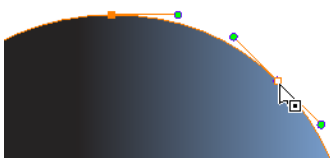

8. Press [Delete] to delete a selected point.

Press [Ctrl] (Windows) or [⌘] (Mac OS X) and click on the contour to add a new point to adjust the contour.

9. To modify the shape, you can:

- ▶ Pull on the Bezier handle. Both point's handles will move as one.

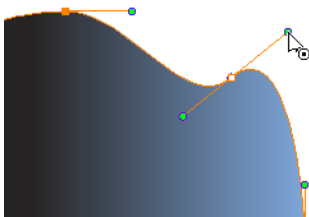

- ▶ Hold down the [Alt] key and pull on one of the Bézier handles. The point's handle will move independently from the other one.

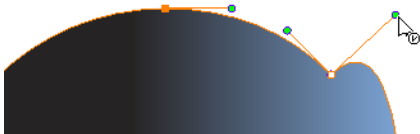

- ▶ Move the selected points to a new area.

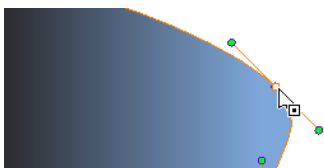

- ▶ Pull directly on the line between two points. No selection is necessary. Holding down the [Shift] key will limit the contour modification to the curve between the two first points.

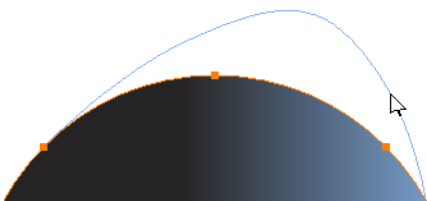

- ▶ If an anchor point has no visible Bezier, hold down the [Alt] key to get them.



To add control points, press [Ctrl] (Windows) or [⌘] (Mac OS X) and click the line.  
To remove control points, select the control point and press [Delete].

---

## Related Topics

- [Contour Editor Tool Properties](#) below

# Contour Editor Tool Properties

When you select the **Contour Editor**  tool, its properties and options appear in the Tool Properties view.

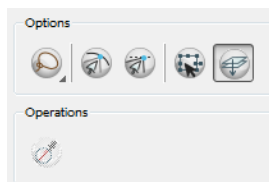

These are the options available for the Contour Editor tool:

- [Lasso and Marquee](#) below
- [Show Contour Editor Controls](#) on the facing page
- [Apply to Line and Colour Art](#) on the facing page
- [Snap to Contour](#) on the facing page
- [Snap and Align](#) on page 185
- [Smooth Selection](#) on page 185

## Lasso and Marquee

Choose between the **Lasso**  and **Marquee**  options to change the selection style of the tool.

- Click and hold [Alt] to temporarily switch from the current mode to the other.

## Show Contour Editor Controls

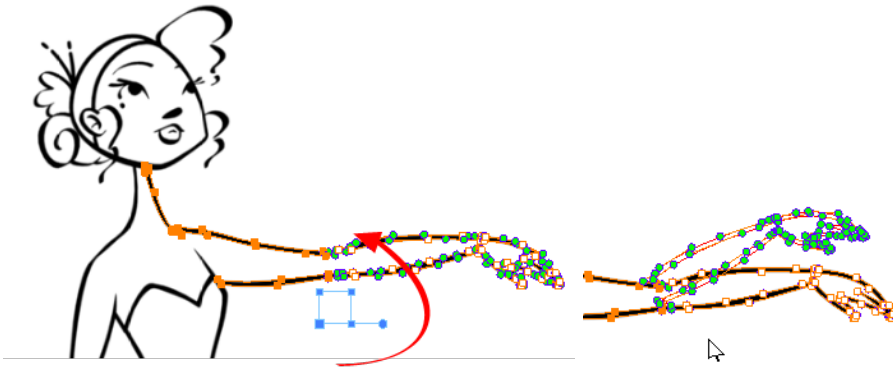

Use the **Show Contour Editor Controls**  option to show the contour editor controls. You can use these controls to scale, reposition and rotate the selected anchor points.

## Apply to Line and Colour Art

The **Apply to Line and Colour Art**  option uses the concept of Line Art and Colour Art layers. Use this option to apply an action such as selecting or resizing a drawing on both Line Art and Colour Art layers, as well as the Overlay and Underlay layers.



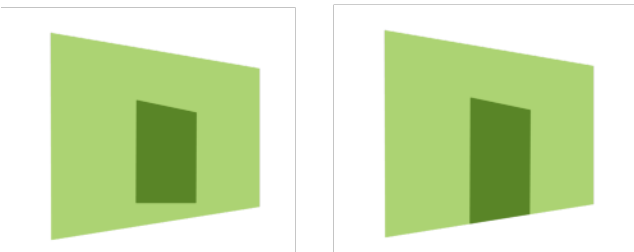

To access this option, you must be in the Advanced Art mode—see [Overlay, Line Art, Colour Art, Underlay and Preview Mode on page 116](#).

## Snap to Contour



The **Snap to Contour**  option will snap the selected anchor point to any line you position it on.

**To snap two shapes together:**

1. In the Tools toolbar, select the **Contour Editor**  tool or press [Alt] + [Q].
2. In the Tool Properties view, click the **Snap to Contour**  button.

3. In the Camera or Drawing view, click on an anchor point you want to snap to the other shape, drag it on top of the contour line area and release it.

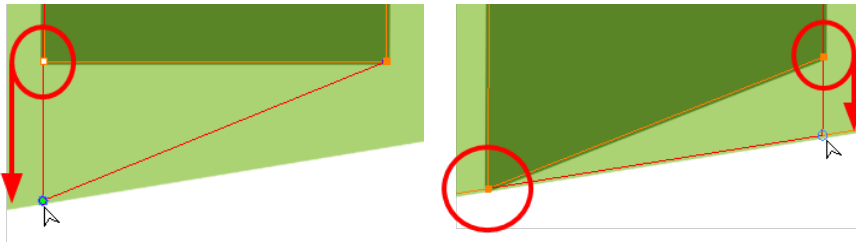

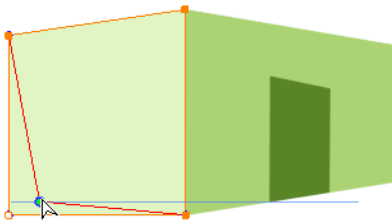

## Snap and Align



The **Snap and Align**  option lets you snap the selected anchor point to any existing line while displaying temporary rulers as a guide that you can also snap your anchor point to.

To snap and align:

1. In the Tools toolbar, select the **Contour Editor**  tool or press [Alt] + [Q].
2. In the Tool Properties view, click the **Snap and Align**  button.
3. In the Camera or Drawing view, click on an anchor point you want to snap, drag it until a ruler is displayed, position it on the ruler or on the contour line and release.

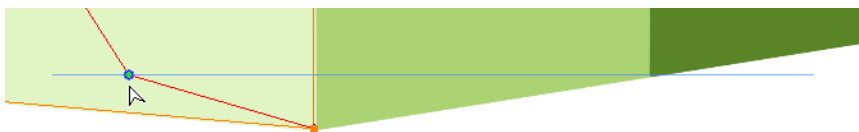

## Smooth Selection





The **Smooth**  operation lets you smooth out selected drawing strokes and remove extra points. You can also access this feature through the top menu, by selecting **Drawing > Optimize > Smooth** or press [Alt] + [Shift] + [S].

## Related Topics

- [Reshaping a Drawing Using the Contour Editor Tool](#) on page 181

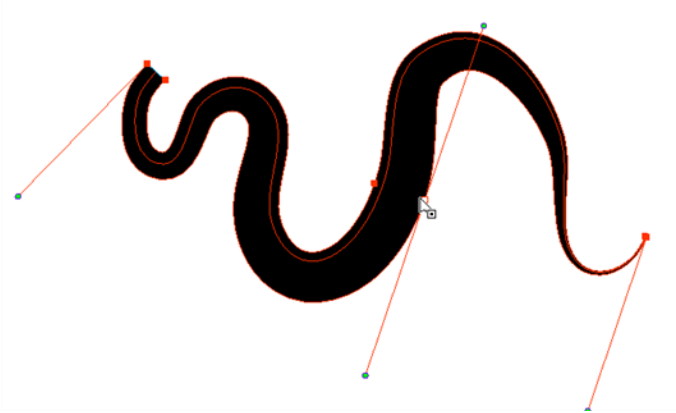
# Reshaping Pencil Lines with the Pencil Editor Tool



The **Pencil Editor**  tool is used to modify the thick and thin contour of a pencil line. A pencil line is a central vector shape. The shape control points are located all along the central spine allowing to adjust the stroke curve and position. When using the **Contour Editor** tool, you will be able to reposition the spine of the stroke. When using the **Pencil Editor** tool, you will be able to adjust the thick and thin areas of the line.

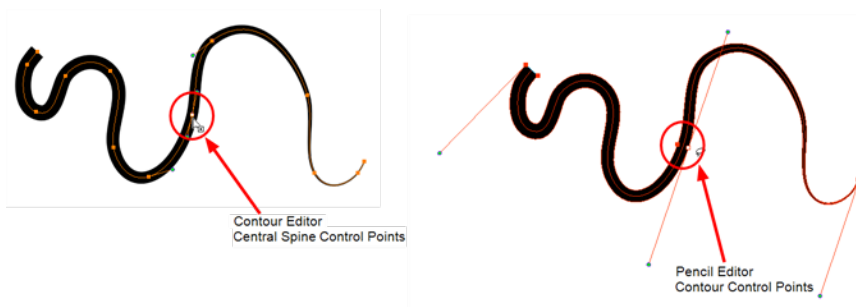

## To use the Pencil Editor tool:

1. In the Tools toolbar, select the **Pencil Editor**  tool located in the **Contour Editor** drop-down menu or press [Alt] + [W].
2. In the Camera or Drawing view, select a pencil line and click the line to reshape it.

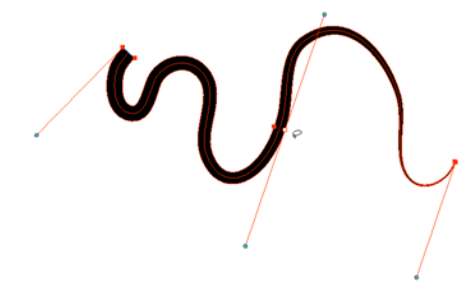

3. Select one or several points by clicking them or circling around.

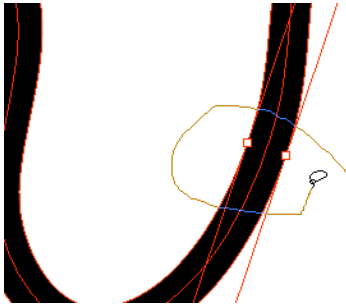

4. Press [Delete] to delete a selected point.
5. Press [Ctrl] (Windows) or [⌘] (Mac OS X) and click the central spine to add a set of points to adjust the contour.
6. To modify the shape, you can:
  - ▶ Move the selected points to a new area. If you select matching points on each side of the line, holding the Shift key will move them both. This way you can thicken or thin a line from both side at the same time.

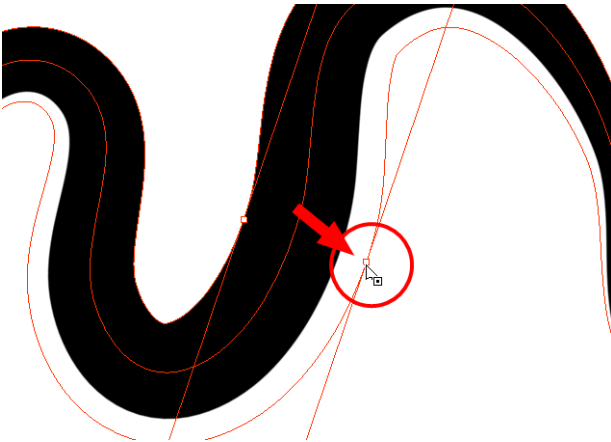

- ▶ Pull on the Bezier handle. Both points' handles will move as one.

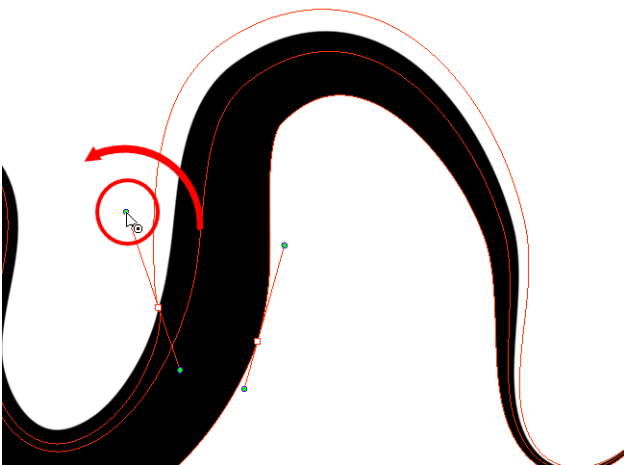

- ▶ Hold [Alt] down and pull on one of the Bezier handles. The point's handle will move independently from the other one.



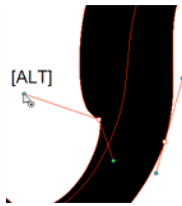

- ▶ Pull directly on the line in-between two points. No selection is necessary. Holding down the [Shift] key will limit the contour modification to the curve between the two first points.

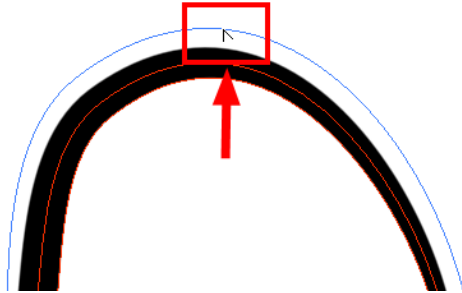

- ▶ If an anchor point has no visible Bezier, hold down the [Alt] key to get them.

## Related Topics

- [Pencil Editor Properties](#) below

# Pencil Editor Properties

When you select the **Pencil Editor** tool, its properties and options appear in the Tool Properties view.

These are the options available for the Pencil Editor tool:

- [Lasso and Marquee](#) below
- [Smooth](#) on the facing page
- [Pump Pencil Pressure](#) on the facing page
- [Deflate Pencil Pressure](#) on the facing page
- [Merge Pencil Lines](#) on page 191
- [Reverse Pencil Thickness](#) on page 191
- [Adjusting the Pencil Line Style](#) on page 191
- [Working with Thickness Stencils](#) on page 137
- [Adding Texture to a Pencil Line](#) on page 192

## Lasso and Marquee

Choose between the **Lasso**  and **Marquee**  options to change the selection style of the tool.

- Click and hold [Alt] to temporarily switch from the current mode to the other.

## Smooth



The **Smooth**  operation lets you smooth out selected drawing strokes and remove extra points. You can also access this feature through the top menu, by selecting **Drawing > Optimize > Smooth** or press [Alt] + [Shift] + [S].

## Pump Pencil Pressure

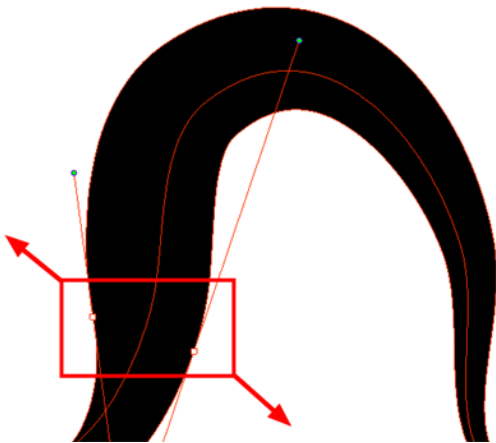

The **Pump Pencil Pressure**  option is used to increase the line thickness of a selected area on a pencil line.

## Deflate Pencil Pressure

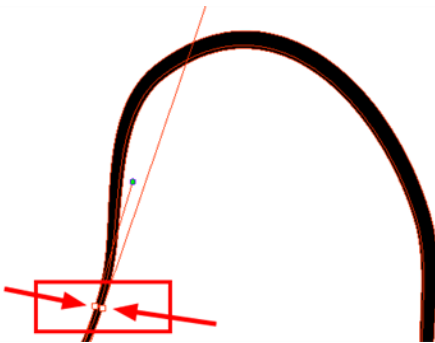

The **Deflate Pencil Pressure**  option is used to decrease the line thickness of a selected area on a pencil line.

## Merge Pencil Lines

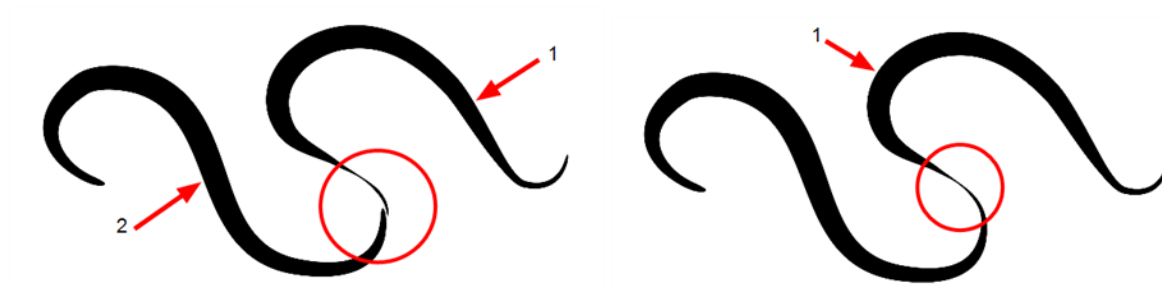

Pencil lines are central vector lines and it might be difficult to match pencil line's tips properly to align them and make it look like it is one single line. With the **Select** tool, you can select several pencil lines and merge them as one single object using the **Merge Pencil Lines**  option. It will take your lines and adjust the ends to form one single line.

## Reverse Pencil Thickness

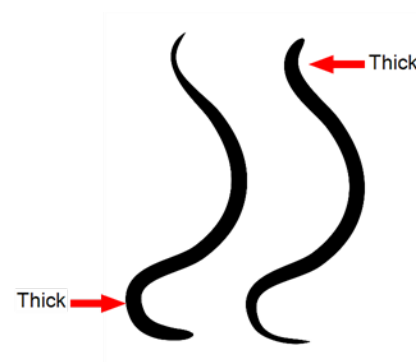

The **Reverse Pencil Thickness**  option will invert the thick and thin section on a selected pencil line. This option will take the thickest size on the line and apply it to the thinnest, and it will apply the thinnest to the thickest.

## Adjusting the Pencil Line Style

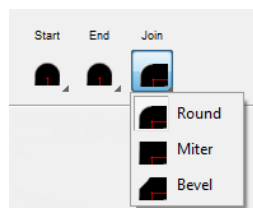

You can adjust the start, end, and joint style of a selected pencil line.

- **Start:** Lets you select the style of the start tip, which is the first tip you drew. You can choose between Round or Flat style.

- **End:** Lets you select the style of the end tip, which is the last tip you drew. You can choose between Round or Flat style.
- **Join:** Lets you select the joint style. The joints are where the line curves abruptly. You could also define the Join style as the corner style. You can choose between Round, Mitre and Bevel style.

## Thickness Stencils

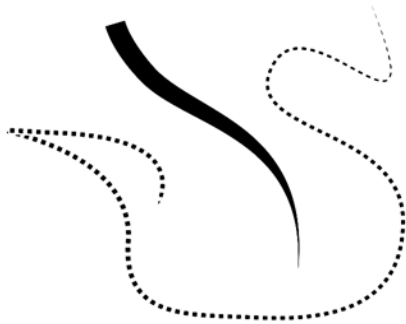

Toon Boom Animate gives you the flexibility to change the style and thickness of your lines even after they are drawn. You can apply preset thickness stencils or create your own.



Refer to [Working with Thickness Stencils on page 137](#), [Creating a Pencil Thickness Stencil with the Select Tool on page 139](#) and [Working with Thickness Stencils on page 137](#).

## Adding Texture to a Pencil Line

Pencil lines support texture. Once a pencil line is drawn, you can apply a preset texture or load your own. Textures are independent from Pencil thickness stencils.



Refer to [Pencil Line Texture on page 140](#), [Applying a Preset Texture to a Pencil Line on page 145](#) and [Creating a Pencil Texture Template with the Select Tool on page 143](#).

## Related Topics

- [Reshaping Pencil Lines with the Pencil Editor Tool on page 187](#)

# Drawing with Shapes





In Toon Boom Animate, you can use the shape tools to draw with circles, lines and squares. You can also easily reshape a square or circle into a much more complex drawing such as these butterfly wings.



Refer to [Reshaping a Drawing Using the Contour Editor Tool on page 181](#) and [Reshaping Pencil Lines with the Pencil Editor Tool on page 187](#) topics to learn more about the Contour Editor and Pencil Editor tools.

## To draw with a Shape tool:

1. In the Timeline or Xsheet view, select the cell where you want to draw.
2. In the Tools toolbar, select a shape  tool.
3. In the Tool Properties view, you can switch between the different shapes mode.. Select either the **Ellipse**  or **Rectangle**  tool.
4. In the Camera view, click and drag your mouse to draw the shape.

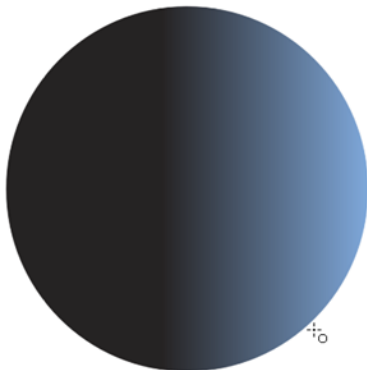

- ▶ Hold down [Shift] to lock the rectangle or the ellipse ratio to 1:1.
- ▶ Hold down [Alt] to draw the rectangle or ellipse from its centre.
- ▶ Hold down [Shift] to snap the line every 15 degrees.
- ▶ Hold down [Alt] to snap the starting or end point of the line to a close by stroke.

5. Use the **Contour Editor**  tool to deform your shape and create your drawing.

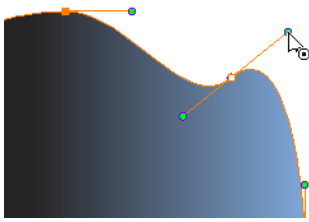

## Related Topics

- [Shape Tool Options](#) below

# Shape Tool Options

When you select a shape tool, its properties and options appear in the Tool Properties view.

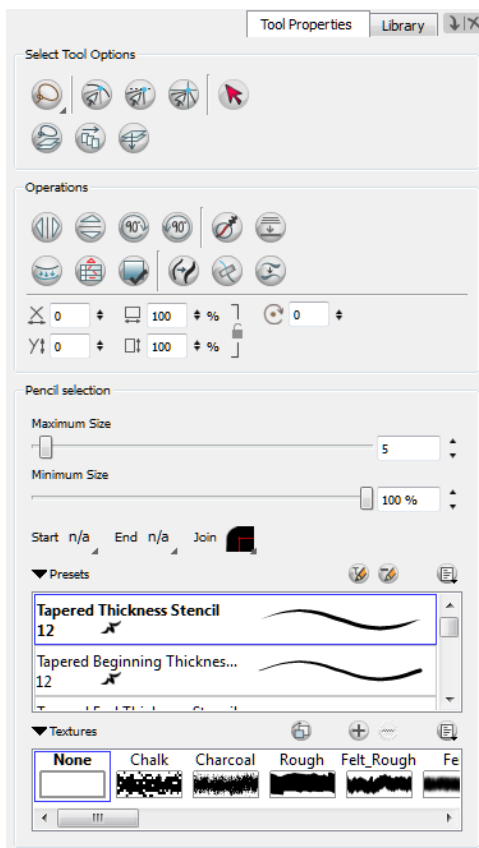



These are the options available for the shape tools:

- [Line, Rectangle and Ellipse](#) on the next page
- [Draw Behind](#) on the next page
- [Snap Options](#) on the next page
- [Line Building Mode](#) on page 196

- [Automatic Filling](#) on the facing page
- [Create Colour Art Automatically](#) on page 197
- [Auto-Flatten Mode](#) on page 197
- [Auto-Close Gap](#) on page 198
- [Use Stored Colour Gradient](#) on page 198
- [Keep Proportion](#) on page 198
- [Pencil Templates](#) on page 198
- [Thickness Adjustment](#) on page 199
- [Adjusting the Pencil Line Style](#) on page 199
- [Applying Texture to a Pencil Line](#) on page 199

## Line, Rectangle and Ellipse



Click on the    button corresponding to the shape you want. Click and drag your mouse to draw the selected shape. The shape tools create centre lines.

Using the **Ellipse** or **Rectangle** option, press [Shift] to create a perfect round or a perfect square and press [Alt] to create the shape from its centre.

Using the **Line** tool, press [Shift] to create a line which snaps-to every 15 degrees and then press [Alt] to connect the start or end point of that line to another nearby line. To create a curve in the line as you draw, hold down [Ctrl] (Windows) or [⌘] (Mac OS X) and drag to create a bend in the line.



## Draw Behind



When the **Draw Behind**  mode is enabled, the lines you draw will appear behind the art that already exists.

## Snap Options

When drawing a shape, you can enable different snap modes to help you create your shape.

- The **Snap to Contour**  option snaps your shape to any line you position it on.
- The **Snap and Align**  option snaps the selected anchor point to any existing line, while displaying temporary rulers as a guide that you can also snap your anchor point to.
- The **Snap to Grid**  snaps your shape to the currently enabled grid.



Refer to the topic to learn more about the Grid feature.

## Line Building Mode

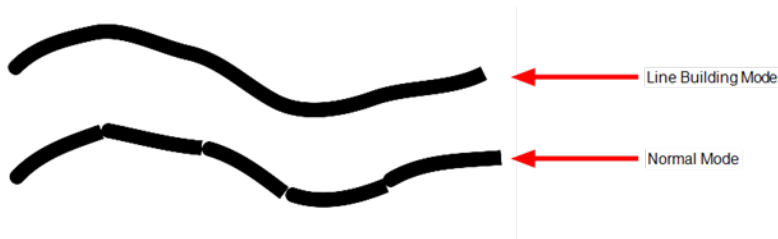

The **Line Building**  mode is very useful when drawing long lines and curves in small increments with pencil lines. As the pencil lines are central vector lines and it may be difficult to align the line tips perfectly to create a uniform stroke and close all gaps.

In this mode, you can draw lines in small increments and the tips merge into one single stroke.



This mode only works with pencil lines.

## Automatic Filling

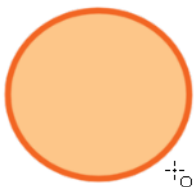

Use the **Automatic Filling**  option to automatically fill your shape with the selected colour as you draw. By default, the Shape tool creates the contour of an empty shape that you can later fill using the Paint tool.





Refer to [Selecting the Current Colour of a Tool](#) on page 288 to learn more about selecting a fill colour.

## Create Colour Art Automatically

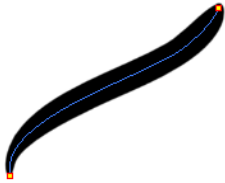

As you draw in the **Line Art** layer, the **Create Colour Art Automatically**  automatically creates the corresponding strokes in the **Colour Art** layer.



To access this option, you must be in the Advanced Art mode—see [Overlay, Line Art, Colour Art, Underlay and Preview Mode](#) on page 116.

## Auto-Flatten Mode

When enabled, the **Auto-Flatten** mode automatically flattens the new lines created with the existing artwork as you draw in the Drawing or Camera view. Brush strokes will flatten with brush strokes and pencil lines will flatten with pencil lines.

Using the **Select** tool, you can use the **middle** mouse button to select a segment of flattened pencil line. Use this technique to create a nice finish to lines and corners in your artwork.

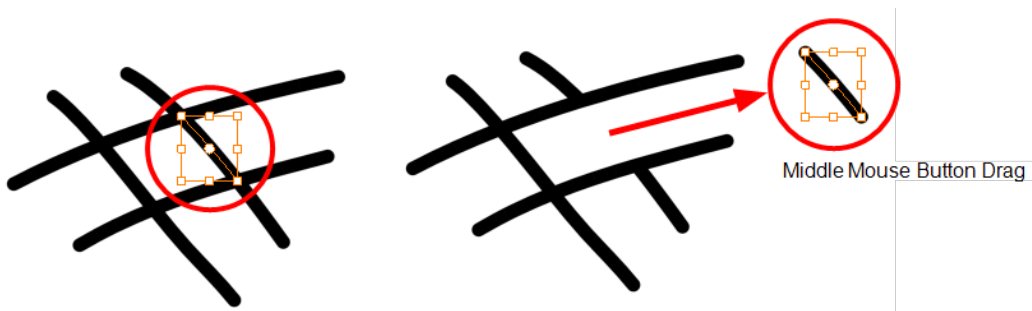

## Auto-Close Gap

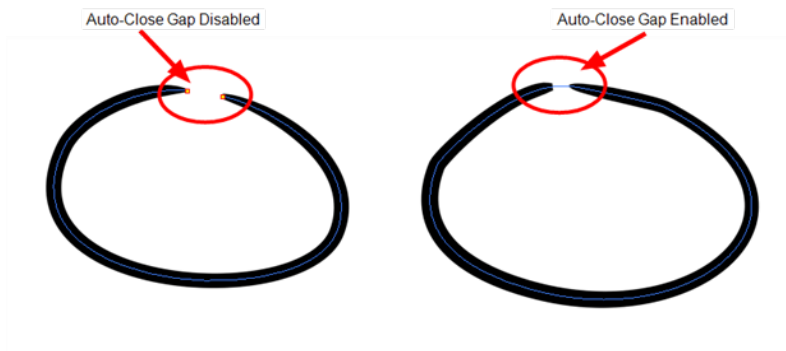

When enabled, the **Auto-Close Gap**  mode automatically connects, with an invisible stroke, the pencil lines you draw close to each other in the Camera or Drawing view.



It is recommended to leave this option **ENABLED** when drawing with the Pencil tool.

## Use Stored Colour Gradient

The **Use Stored Colour Gradient**  option makes your tool use the previously stored gradient position. This way, every new brush line or colour fill will use the stored gradient position.

## Keep Proportion

Draw Circle

Draw Square

When the **Ellipse** or **Rectangle** mode is enabled in the **Tool Properties** view, the **Draw Circle** or **Draw Square** option appears. When selecting these options, the shape produced will either be a circle or a square. Holding down the [Shift] key as you create your shape will maintain proportion.

## Pencil Templates

Toon Boom Animate provides a variety of pencil templates and also lets you create and save your own. It is a good idea to create and save pencils with precise sizes and parameters when you draw and design.

You also have the possibility to apply different textures to your lines by either using the preset ones or importing your own—see [Working with Thickness Stencils on page 137](#)

## Thickness Adjustment

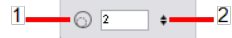

### Adjusting the Pencil Line Style

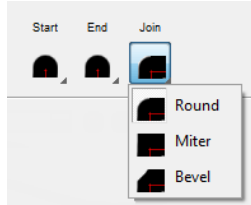

You can adjust the start, end, and joint style of a selected pencil line.

- **Start:** Lets you select the style of the start tip, which is the first tip you drew. You can choose between Round or Flat style.
- **End:** Lets you select the style of the end tip, which is the last tip you drew. You can choose between Round or Flat style.
- **Join:** Lets you select the joint style. The joints are where the line curves abruptly. You could also define the Join style as the corner style. You can choose between Round, Mitre and Bevel style.

## Applying Texture to a Pencil Line

Pencil lines support texture. Once a pencil line is drawn, you can apply a preset texture or load your own. Textures are independent from Pencil templates.



Refer to [Pencil Line Texture](#) on page 140, [Applying a Preset Texture to a Pencil Line](#) on page 145 and [Creating a Pencil Texture Template with the Select Tool](#) on page 143.

---

### Related Topics

- [Working with Thickness Stencils](#)

# Drawing with the Polyline Tool



The **Polyline** tool is used to draw shapes. It is a central vector type of line. To form a shape, you click to add a point and then, without releasing the mouse, pull the handle in the desired direction before adding the next point and repeat the operation. To edit the shape, you can use the Contour Editor tool.

## To draw with the Polyline tool:

1. In the Timeline view, select the cell where you want to draw.  
*In Harmony Paint, select a drawing in the **Drawing** panel.*
2. In the Tools toolbar, select the **Polyline**  tool or press [Alt] + [L].
3. In the Camera view, click and drag your mouse to create a point and a Bezier handle to shape your line.
  - Press [Alt] to pull only one handle, instead of two.
  - Press [Shift] to snap the handles to 45, 90, or 180 degrees.
4. Click again into a new area and drag the mouse to create a second point and Bezier handle.

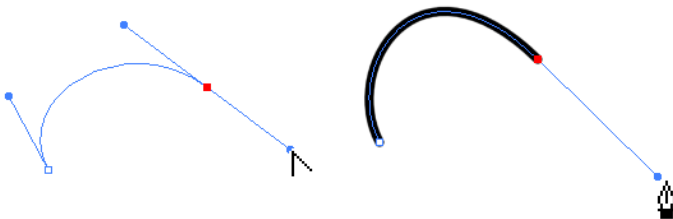

5. Repeat the previous step until your shape is completed.
6. Press [Ctrl] (Windows) or [⌘] (Mac OS X) and click to release the Polyline tool from the current path or shape that it is creating. Continue to use the tool to make multiple, independent paths or shapes.
7. If necessary, reshape the lines using the **Contour Editor**  tool.



Refer to [Reshaping a Drawing Using the Contour Editor Tool on page 181](#) to learn more about the **Contour Editor** tool.

## Related Topics

- [Polyline Tool Options](#) below

# Polyline Tool Options

When you select the **Polyline** tool, its properties and options appear in the Tool Properties view.

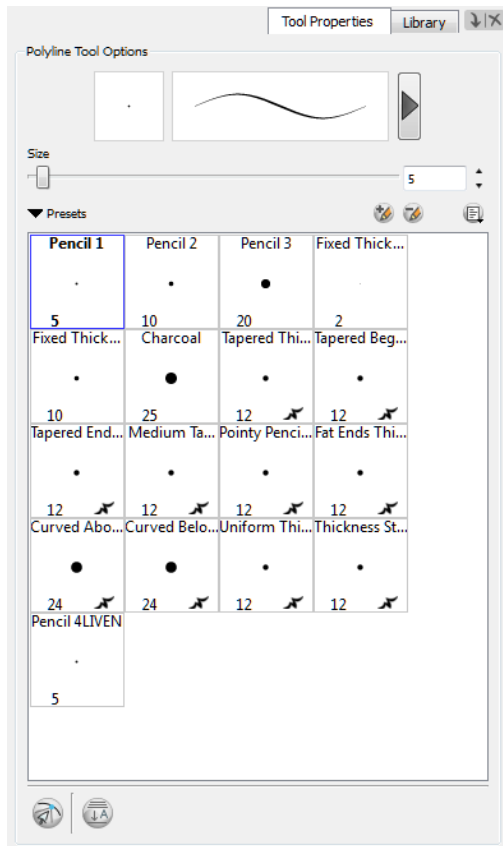

These are the options available for the Polyline tool:

- [Snap to Contour](#) on page 203
- [Create Colour Art Automatically](#) on page 203
- [Pencil Templates](#) on page 203

## Previewing the Stroke

The Preview area lets you see a preview of the stroke that will be produced after you customize the different parameters in the Tool Properties view.

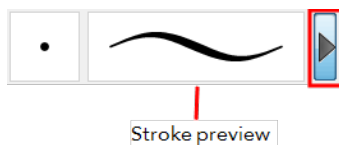

## Size

The Size parameter lets you set the size of the polyline that you will draw.

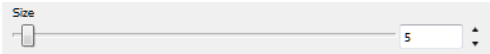

## Polyline Presets

Polyline presets are created by saving the properties of the current tool to a new preset, which you can reuse for repeated tasks. You can create as many presets as you need.

## Size and Smoothness

This is where you set the minimum and maximum sizes of your drawing tool which will produce the thick and thin effect on your stroke. This works with the pressure sensitivity of a pen tablet.

- ▶ **Maximum/Minimum Size:** Defines the minimum and maximum width of the stroke.
- ▶ **Smoothing:** Defines the number of control points added to the centre line.
- ▶ **Contour Smoothing:** Defines the number of control points added to the contour boundaries (around the line). Lower values mean that the line will appear as you draw it (with more control points added along the centre line). Higher values mean that the line will be smoothed out (removing control points from the centre line).

## Adjusting Polyline Style

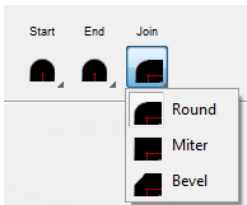

You can adjust the start, end, and joint style of a selected pencil line.

- **Start:** Lets you select the style of the start tip, which is the first tip you drew. You can choose between Round or Flat style.
- **End:** Lets you select the style of the end tip, which is the last tip you drew. You can choose between Round or Flat style.
- **Join:** Lets you select the joint style. The joints are where the line curves abruptly. You could also define the Join style as the corner style. You can choose between Round, Mitre and Bevel style.

## Working with Line Textures

Like pencil lines, polylines support texture. Before drawing, you can select or import a texture and apply it to your lines. You can also change it afterwards using the Select tool. Textures are independent from pencil templates—see [Pencil Line Texture on page 140](#).

## Snap to Contour

The **Snap to Contour**  option will snap your selection to any line you position it on.

## Create Colour Art Automatically

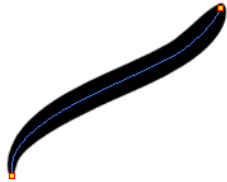

As you draw in the **Line Art** layer, the **Create Colour Art Automatically**  automatically creates the corresponding strokes in the **Colour Art** layer.



To access this option, you must be in the Advanced Art mode—see [Overlay, Line Art, Colour Art, Underlay and Preview Mode](#) on page 116.

---

## Pencil Templates



Toon Boom Animate gives you the flexibility to change the style and thickness of your pencil lines even after they are drawn. You can apply preset templates or create your own.



Refer to [Working with Thickness Stencils](#) on page 137, [Creating a Pencil Thickness Stencil with the Select Tool](#) on page 139 and [Working with Thickness Stencils](#) on page 137.

---

## Related Topics

- [Drawing with the Polyline Tool](#) on page 200

# Drawing Using Invisible Lines

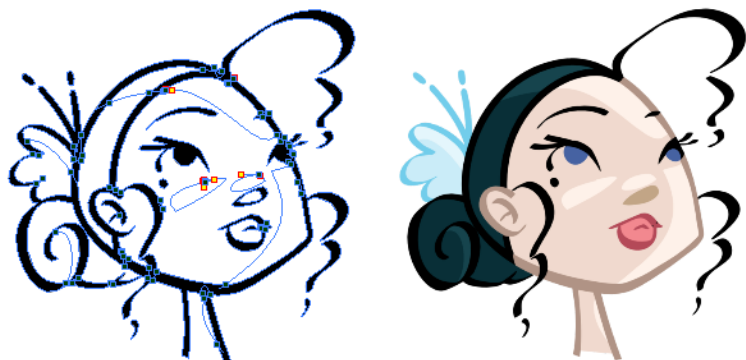



There are two different ways to draw invisible lines:

- [Pencil Tool](#) below
- [Stroke Tool](#) on the next page

## Pencil Tool

Using the **Pencil** tool, you can draw as strokes only, meaning that the line will be invisible. This can be useful to draw tones and highlights directly on the character.

To draw invisible lines with the **Pencil** tool:

1. In the Timeline or Xsheet view, select the cell where you want to draw.  
*In Harmony Paint, select a drawing in the **Drawing** panel.*
2. In the Tools toolbar, select the **Pencil**  tool or press [Alt] + [/].
3. In the top menu, select **View > Drawing > Show Strokes**  or press [K].  
*In Harmony Paint, select **View > Show Strokes**.*
4. In the Tool Properties view, set the Pen Style size to 0. You can also adjust the smoothness.
5. In the Camera or Drawing view, start drawing.

If you forgot to enable the **Show Strokes** option before drawing, as soon as you draw a first stroke, a Message dialog box opens.



Select the **Don't Show This Message Again** option if you do not want the dialog box to notify you about the Show Strokes option. Click OK.



6. You can modify the stroke shape with the **Contour Editor**  tool.



# Stroke Tool

The **Stroke**  tool draws invisible lines only. You cannot add thickness to the line.

## To draw invisible lines with the Stroke Pencil tool:

1. In the Timeline or Xsheet view, select the cell where you want to draw.  
*In Harmony Paint, select a drawing in the **Drawing** panel.*
2. In the Tools toolbar, select the **Stroke**  tool or press [Alt] + [V].
3. In the top menu, select **View > Show Drawing > Show Strokes**  or press [K].  
*In Harmony Paint, select a drawing in the **Drawing** panel.*
4. In the Tool Properties view, you can adjust the smoothness.
5. In the Camera or Drawing view, start drawing.

If you forgot to enable the **Show Strokes** option before drawing, as soon as you draw a first stroke, a Message dialog box opens.



Select the **Don't Show This Message Again** option if you do not want the dialog box to notify you about the Show Strokes option. Click OK.

6. You can modify the stroke shape with the **Contour Editor**  tool.

## Related Topics

- [Stroke Tool Options](#) below
- [Show Strokes as Washed-out Colours](#)

# Stroke Tool Options

When you select the **Stroke** tool, its properties and options appears in the Tool Properties view.

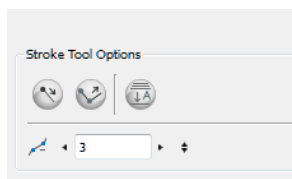

Here are the options available for the Stroke tool:

- [Draw Stroke as Straight Lines](#) on the facing page
- [Connect Line Ends](#) on the facing page
- [Auto-Flatten Mode](#) on the facing page

- [Central Line Smoothness](#) below

## Draw Stroke as Straight Lines

Enable the **Draw Stroke as Straight Lines**  option if you want the new strokes that you will draw to be a perfect straight line. Disable the option if you want the stroke to follow the mouse gesture.

## Connect Line Ends

Enable the **Connect Line Ends**  option if you want the start or end point of your new stroke to connect to your existing strokes to make sure no gaps are left in your drawing.

## Auto-Flatten Mode

When enabled, the **Auto-Flatten** mode automatically flattens the new lines created with the existing artwork as you draw in the Drawing or Camera view. Brush strokes will flatten with brush strokes and pencil lines will flatten with pencil lines.

## Central Line Smoothness

You can modify the **Central Line Smoothness**  of your line using this option. This parameter smoothes the initial movement of your line. Increasing the value will result in a smoother line with fewer control points.

### Related Topics

- [Drawing Using Invisible Lines on page 204](#)
- [Show Strokes as Washed-out Colours](#)

# Deforming a Drawing Using the Perspective Tool



The Perspective tool lets you deform a drawing selection and alter its perspective.

**To deform a drawing with the Perspective tool:**

1. In the Tools toolbar, select the **Perspective**  tool or press [Alt] + [0].

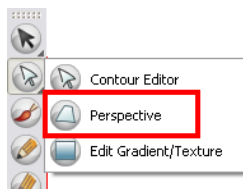

2. In the Camera or Drawing view, select the drawing you want to deform.
3. Click and drag the different anchor points to deform the shape.

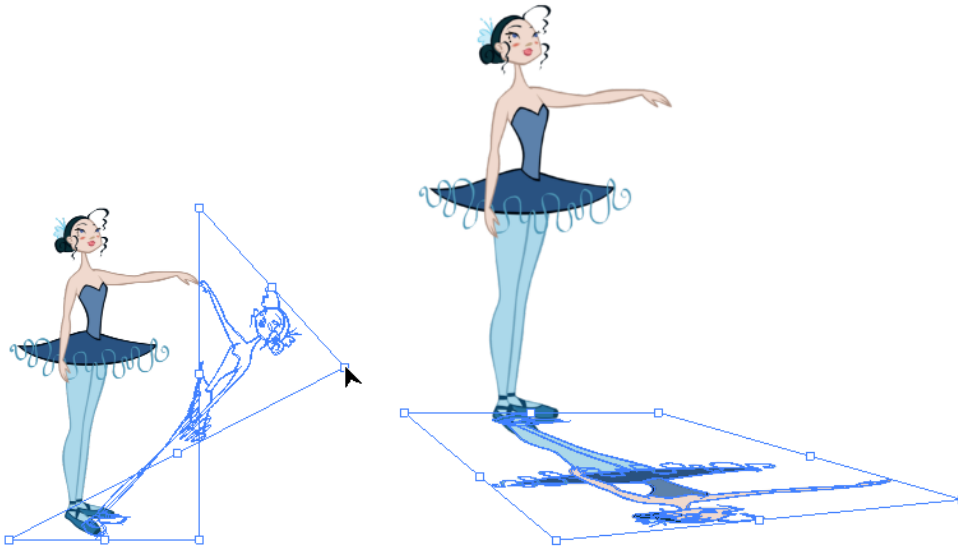

## Related Topics

- [Perspective Tool Properties](#) below

# Perspective Tool Properties

Selecting the Perspective tool displays its properties and options in the **Tool Properties** view.

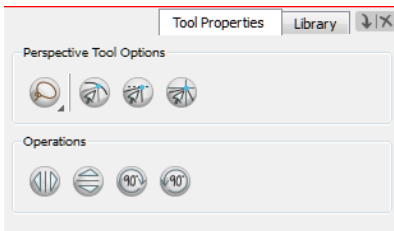

- [Lasso and Marquee](#) below
- [Apply to Line and Colour Art](#) on the next page
- [Flip Horizontal and Vertical](#) on the next page
- [Rotate 90 Degrees CW and CCW](#) on page 210

## Lasso and Marquee

Choose between the **Lasso**  and **Marquee**  options to change the selection style of the tool.

- Click and hold [Alt] to temporarily switch from the current mode to the other.

## Snap to Contour

The **Snap to Contour**  option will snap the selected anchor point to any line you position it on—see [Contour Editor Tool Properties](#) on page 183.

## Snap and Align

The **Snap and Align**  option lets you snap the selected anchor point to any existing line while displaying temporary rulers as a guide that you can also snap your anchor point to—see [Contour Editor Tool Properties](#) on page 183.

## Snap to Grid

The **Snap to Grid**  option snaps your selection according to the currently enabled grid.

## Apply to Line and Colour Art

The **Apply to Line and Colour Art**  option uses the concept of Line Art and Colour Art layers. Use this option to apply an action such as selecting or resizing a drawing on both Line Art and Colour Art layers, as well as the Overlay and Underlay layers.



To access this option, you must be in the Advanced Art mode—see [Overlay, Line Art, Colour Art, Underlay and Preview Mode](#) on page 116.

---

## Flip Horizontal and Vertical



The **Flip Horizontal**  and **Flip Vertical**  operations flip the current selection horizontally or vertically.

From the top menu, select **Drawing > Transform > Flip Horizontal** and **Flip Vertical**.

## Rotate 90 Degrees CW and CCW



The **Rotate 90 Degrees CW**  and **Rotate 90 Degrees CCW**  operations rotate the current selection 90 degrees clockwise or counter-clockwise.

From the top menu, select **Drawing > Transform > Rotate 90 Degrees CW** and **Rotate 90 Degrees CCW**.

Or press [Ctrl] + [7] and [Ctrl] + [9] (Windows) or [⌘] + [7] and [⌘] + [9] (Mac OS X).

### Related Topics

- [Deforming a Drawing Using the Perspective Tool](#) on page 207

# Cutting Drawing Parts



The Cutter tool is used to cut a drawing area to move, copy, cut or delete it.

**To cut with the Cutter tool:**

1. In the Tools toolbar, select the **Cutter**  tool or press [Alt] + [T].
2. In the Camera view, trace a selection around the part to cut away.

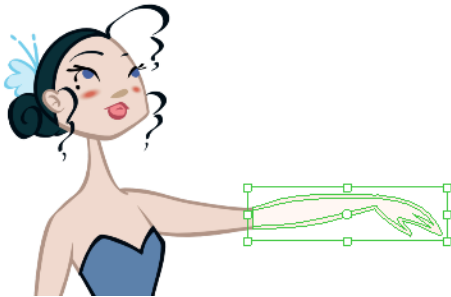

- ▶ To delete the selected zone, press[Delete].
- ▶ To move the selection, click the selection and drag it to a new area.
- ▶ Use the bounding box controls to scale, skew, or rotate the cut piece.

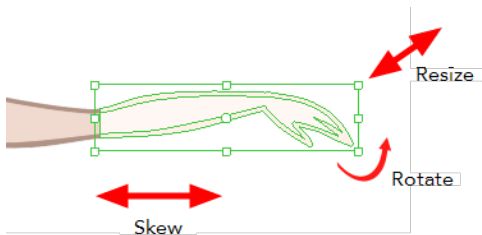

## Related Topics

- [Cutter Tool Options on the facing page](#)

# Cutter Tool Options

When you select the **Cutter**  tool, its properties and options appear in the **Tool Properties** view.

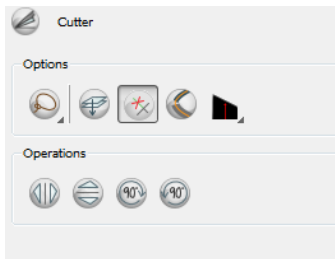

Here are the options available for the **Cutter** tool:

- [Lasso and Marquee below](#)
- [Apply to Line and Colour Art below](#)
- [Use Mouse Gesture below](#)
- [Use Mouse Gesture Breaker Mode on the next page](#)
- [Tip Style on the next page](#)
- [Flip Horizontal and Vertical on page 214](#)
- [Rotate 90 Degrees CW and CCW on page 214](#)

## Lasso and Marquee

Choose between the **Lasso**  and **Marquee**  options to change the selection style of the tool.

- Click and hold [Alt] to temporarily switch from the current mode to the other.



## Apply to Line and Colour Art

The **Apply to Line and Colour Art**  option uses the concept of Line Art and Colour Art layers. Use this option to apply an action such as selecting or resizing a drawing on both Line Art and Colour Art layers, as well as the Overlay and Underlay layers.



To access this option, you must be in the Advanced Art mode—see [Overlay, Line Art, Colour Art, Underlay and Preview Mode on page 116](#).

## Use Mouse Gesture

When using the **Lasso**  selection type, the **Use Mouse Gesture**  option lets you automatically delete any extra sections of line in your artwork by simply dragging your mouse over it.





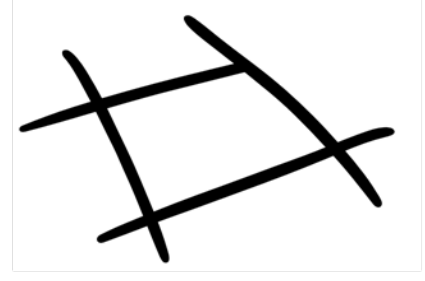
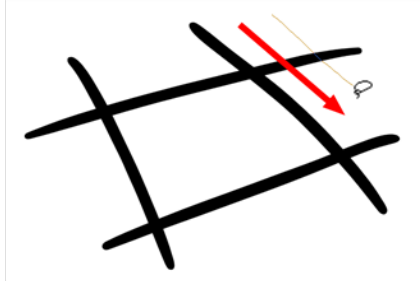
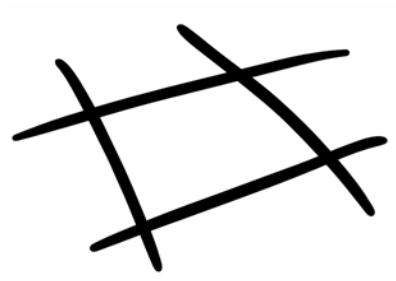

For this operation to work, you lines **CANNOT** be flattened.



## Use Mouse Gesture Breaker Mode

When using the **Lasso**  selection type, the **Use Mouse Gesture Breaker Mode**  option lets you draw an invisible stroke on a pencil line to cut it in two individual objects. Once a pencil line is cut with this option, you will be able to select the two portions independently with either the **Cutter** tool, **Pencil Editor** tool or **Select** tool.

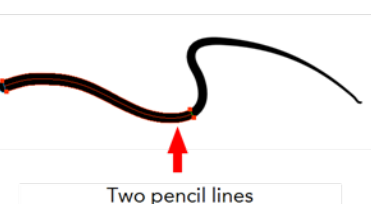
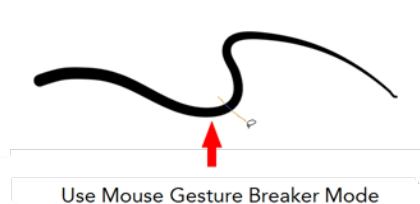
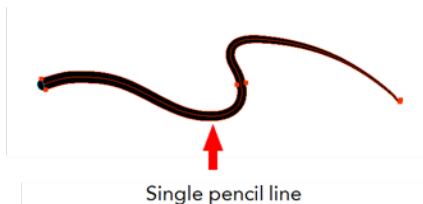

This option only works with pencil lines.

## Tip Style

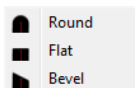

Use the **Tip Style** option to customize the tip of the pencil line you are cutting.

## Flip Horizontal and Vertical



The **Flip Horizontal**  and **Flip Vertical**  operations flip the current selection horizontally or vertically.

From the top menu, select **Drawing > Transform > Flip Horizontal** and **Flip Vertical**.

## Rotate 90 Degrees CW and CCW



The **Rotate 90 Degrees CW**  and **Rotate 90 Degrees CCW**  operations rotate the current selection 90 degrees clockwise or counter-clockwise.

From the top menu, select **Drawing > Transform > Rotate 90 Degrees CW** and **Rotate 90 Degrees CCW**.

Or press [Ctrl] + [7] and [Ctrl] + [9] (Windows) or [⌘] + [7] and [⌘] + [9] (Mac OS X).

### Related Topics

- [Cutting Drawing Parts on page 211](#)

# Smoothing Lines



When drawing in a digital application, it is not like drawing on a sheet of paper, sometimes the lines you draw may look as if they were drawn with an unsteady hand. When this occurs, you may need to correct the look of your lines.

Toon Boom Animate has a very powerful tool you can use to optimize contours and reduce the number of points on the lines, the Smooth Editor  tool.

## To optimize lines with the Smooth tool:

1. In the Tools toolbar, select the **Smooth Editor**  tool or select **Drawing > Tools > Smooth Editor**.

*In Harmony Paint, select **Tools > Smooth Editor**.*

2. In the Camera or Drawing view, place your pointer over the lines to smooth. You may need to pass over the same line several times to remove more points and make the line smoother.

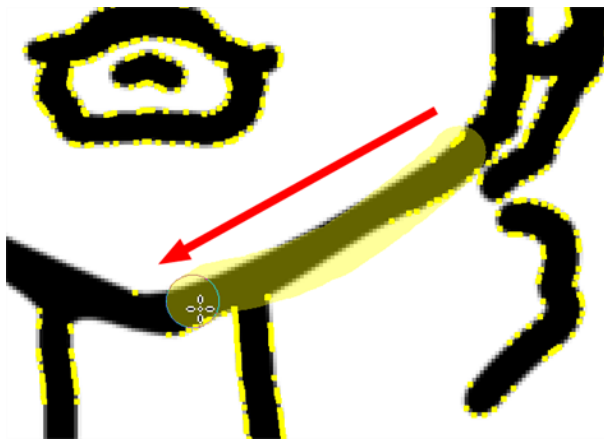

## Related Topics

- [Smooth Editor Tool Options](#) on the facing page

# Smooth Editor Tool Options

When you select the Smooth Editor tool, its properties and options appear in the Tool Properties view.

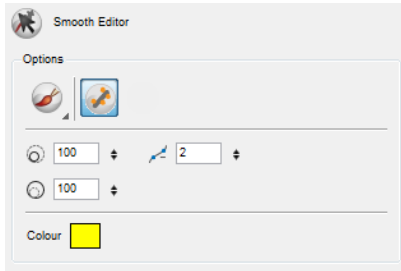

Here are the options available for the **Smooth Editor** tool:

- [Brush, Marquee and Lasso Smoothing Style](#) below
- [Show Control Points](#) below
- [Minimum Size and Maximum Size](#) below
- [Smoothness](#) on the next page
- [Colour](#) on the next page

## Brush, Marquee and Lasso Smoothing Style

The Smoothing Style options allows you to smooth a portion of your drawing either by tracing a smoothing stroke over the zone to optimize or by selecting an area of the drawing with the Marquee or the Lasso.

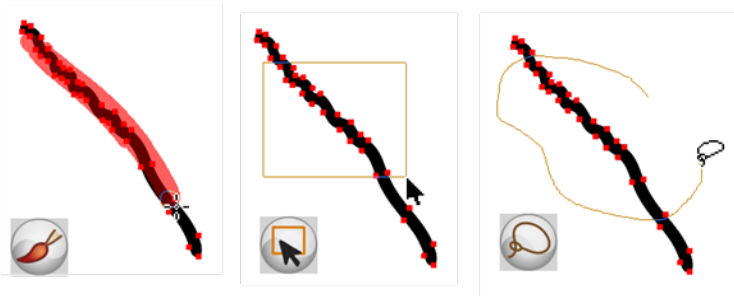

## Show Control Points

The **Show Control Points**  option allows you to show or hide the Bezier points around your lines. When the

Bezier points are displayed, you can see the result of your smoothing and the number of points left on your curve. When it is turned off, you will only see the original artwork.

## Minimum Size and Maximum Size

This is where you set the minimum and maximum sizes of your drawing tool which will produce the thick and thin effect on your stroke. This works with the pressure sensitivity of a pen tablet.



1. **Minimum Size** field: Type a value in this field to set the minimum width of the line.
2. **Maximum Size** field: Type a value in this field to set the maximum width of the line.
3. **Up/Down arrows**: Use the up and down arrows to set the minimum size value.
4. **Up/Down arrows**: Use the up and down arrows to set the maximum size value.

This options is available while using the **Brush Smoothing**  style.

## Smoothness

The **Smoothness**  impacts the strength of the smoothing result. The higher the value, the more points are removed and the smoother the curve is. The Smoothness range is from 0 to 100; the default value is 20.

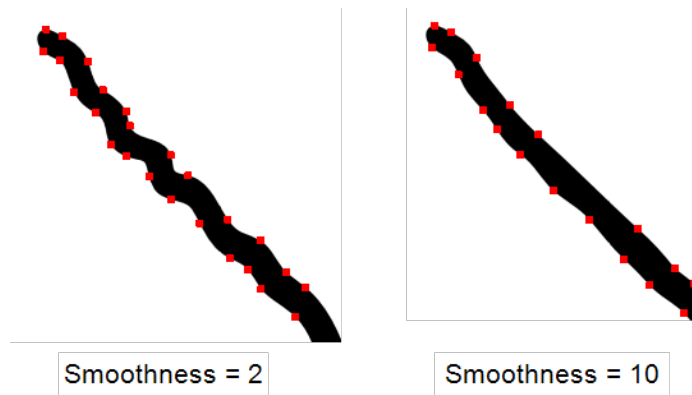

## Colour

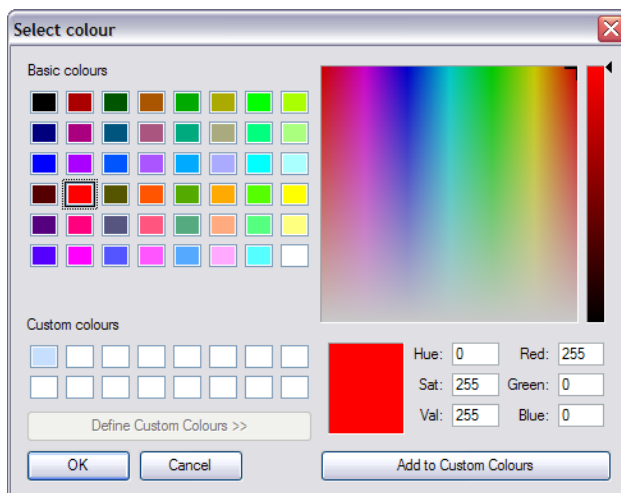

You can modify the colour of the control points displayed on the artwork while working with the **Smooth Editor** tool by double-clicking on the colour swatch.

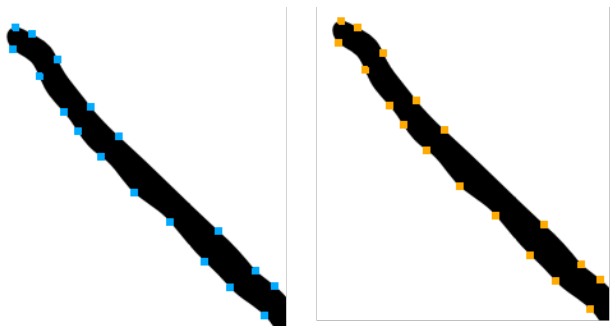

### Related Topics

- [Smoothing Lines](#) on page 215

# Working With Text

With the Text tool, you can type text in your project, using various fonts and text attributes. Text objects are part of a drawing, so you can manipulate them the same way.

## To add text to your drawings:

1. Do one of the following:
  - ▶ In the Tools toolbar, select the **Text**  tool.
  - ▶ Select **Drawing > Tools > Text**.
  - ▶ Press [Alt] + [9].  
*In Harmony Paint, select a **Tools > Text**.*
2. In the Timeline view, select the cell containing the drawing you want to add text to.
3. In the Drawing or Camera view, click on the location you want your text to begin.



4. You can use the **Tool Properties** view to select the font, font size and format the text you will type—see [Formatting the Text](#) below.
5. Type in the desired text.

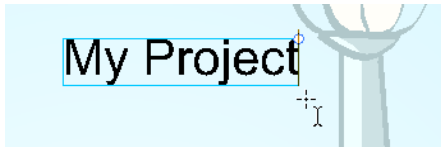

6. Click outside the text box to exit the typing mode.  
If you want to create another text object, click outside the currently active text box. You can always return to edit the text by selecting the **Text**  tool and clicking in the text.

## Related Topics

- [Formatting the Text](#) below

# Formatting the Text

Use the Text tool Tool Properties view to select the font type and other formatting options you want to apply to the text.

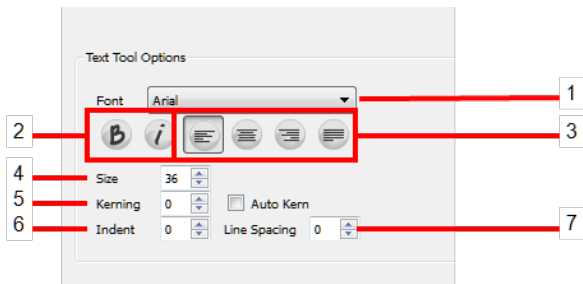

1. [Font Type](#) below
2. [Font Style](#) below
3. [Alignment](#) on the next page
4. [Font Size](#) on the next page
5. [Kerning](#) on the next page
6. [Indent](#) on page 222
7. [Line Spacing](#) on page 222

- [Resizing the Text Box](#) on page 222
- [Converting Text into Separate Objects](#) on page 223



If you already wrote your text, you must first use the Text tool and select the text portion you want to format.

## Font Type

Use this drop-down menu to select the desired font, from the list of fonts available in your system.

Vivaldi Font

Copperplate Gothic Light



## Font Style

Use these buttons to select a desired style for your text:

-  Bold





-  Italic



## My Project

### Alignment

Use these buttons to align the paragraph.

<p> Left</p> <p>LOREM IPSUM DOLOR SIT AMET, CONSECTETUR ADIPISCING ELIT. AENEAN VESTIBULUM, METUS AC FERMENTUM PORTTITOR, ODIO TURPIS PORTTITOR NIBH, ID CONSEQUAT MAGNA LIGULA ET ELIT. CURABITUR SOLLICITUDIN ELIT AC LOREM MOLLIS ACC UMSAN.</p>	<p> Centred</p> <p>LOREM IPSUM DOLOR SIT AMET, CONSECTETUR ADIPISCING ELIT. AENEAN VESTIBULUM, METUS AC FERMENTUM PORTTITOR, ODIO TURPIS PORTTITOR NIBH, ID CONSEQUAT MAGNA LIGULA ET ELIT. CURABITUR SOLLICITUDIN ELIT AC LOREM MOLLIS ACC UMSAN.</p>
<p> Right</p> <p>LOREM IPSUM DOLOR SIT AMET, CONSECTETUR ADIPISCING ELIT. AENEAN VESTIBULUM, METUS AC FERMENTUM PORTTITOR, ODIO TURPIS PORTTITOR NIBH, ID CONSEQUAT MAGNA LIGULA ET ELIT. CURABITUR SOLLICITUDIN ELIT AC LOREM MOLLIS ACC UMSAN.</p>	<p> Justified</p> <p>LOREM IPSUM DOLOR SIT AMET, CONSECTETUR ADIPISCING ELIT. AENEAN VESTIBULUM, METUS AC FERMENTUM PORTTITOR, ODIO TURPIS PORTTITOR NIBH, ID CONSEQUAT MAGNA LIGULA ET ELIT. CURABITUR SOLLICITUDIN ELIT AC LOREM MOLLIS ACC UMSAN.</p>

### Font Size

Type the desired size for the text in this field. You can also use the up and down arrow buttons to set the desired value.

small text **big text**

### Kerning

Use the kerning field to modify the spacing between letters and characters. You can select the **Auto Kern** option to set the kerning automatically, based on the font's predefined standard. A negative value decreases spacing between each character creating a letter overlap and a positive value increases it.

Lorem ipsum dolor sit amet, consectetur adipiscing elit. Aenean vestibulum, metus ac fermentum porttitor, odio turpis porttitor nibh, id consequat magna ligula et elit. Curabitur sollicitudin elit ac lorem mollis acc umsan.

Lorem ipsum dolor sit amet, consectetur adipiscing elit. Aenean vestibulum, metus ac fermentum porttitor, odio turpis porttitor nibh, id consequat magna ligula et elit. Curabitur sollicitudin elit ac lorem mollis acc umsan.

### Indent

Enter a value in the **Indent** field to increase or decrease the indentation on the first line of your text. A positive value sets the first line of your paragraph farther to the right and a negative value sets it farther to the left.

Lorem ipsum dolor sit amet, consectetur adipiscing elit. Aenean vestibulum, metus ac fermentum porttitor, odio turpis porttitor nibh, id consequat magna ligula et elit. Curabitur sollicitudin elit ac lorem mollis acc umsan.

Lorem ipsum dolor sit amet, consectetur adipiscing elit. Aenean vestibulum, metus ac fermentum porttitor, odio turpis porttitor nibh, id consequat magna ligula et elit. Curabitur sollicitudin elit ac lorem mollis acc umsan.

### Line Spacing

Enter a value in the **Line Spacing** field to decrease or increase the space between each line of text.

Lorem ipsum dolor sit amet, consectetur adipiscing elit. Aenean vestibulum, metus ac fermentum porttitor, odio turpis porttitor nibh, id consequat magna ligula et elit. Curabitur sollicitudin elit ac lorem mollis acc umsan.

Lorem ipsum dolor sit amet, consectetur adipiscing elit. Aenean vestibulum, metus ac fermentum porttitor, odio turpis porttitor nibh, id consequat magna ligula et elit. Curabitur sollicitudin elit ac lorem mollis acc umsan.

### Resizing the Text Box

You can resize the text box by selecting your text box with the **Text**  tool and moving the anchor point right or left.

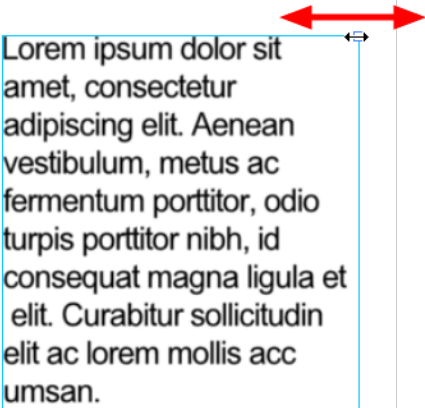

Using the **Select** tool will distort and scale your text itself rather than changing the width and height of your text box.

## Converting Text into Separate Objects

Text contained in a text field is treated as a single drawing object. You can easily separate the text so that each character becomes an individual drawing object that you can select and modify independently.

**To break a text object:**

1. In the **Tools** toolbar, click on the **Select**  tool or press [Alt] + [S].
2. In the **Drawing** or **Camera** view, select the text object you want to break.



3. Select **Drawing > Convert > Break Apart Text Layers**.  
*In Harmony Paint, select **Selected > Convert > Break Apart Text Layers**.*



Each character is now surrounded by its own bounding box that you can modify, they remain text objects that you can edit.

4. If you want to convert your independent letter to a complete vector object that you can deform, using the **Select** tool, select the letters to convert.
5. Select **Drawing > Convert > Break Apart Text Layers** to break the selection into a regular drawing object, with no more text attributes.  
*In Harmony Paint, select **Selected > Convert > Break Apart Text Layers**.*

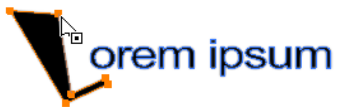

### Related Topics

- [Working With Text](#) on page 219

# Override Tool

The Override Tool lets you increase productivity by rapidly switching between tools used for short tasks and your previous tool. Most drawing tool shortcuts are accessed using the [Alt] key followed by another key, such as the Eraser tool which is accessed by pressing [Alt] + [E].

If you are drawing with the Brush tool and need to briefly switch to the Eraser before continuing, hold down the [E] key while you are erasing. Once done, release [E] to return to the previous tool, in this case, the Brush tool. You can do the same for most drawing tools that have a shortcut composed of [Alt] followed by another key.

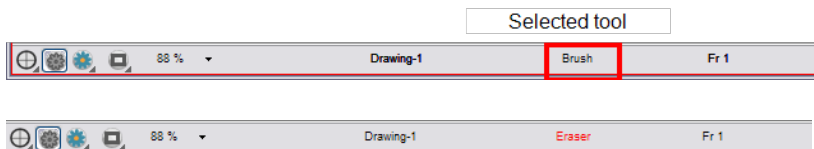

## Related Topics

- [Keyboard Shortcuts on page 57](#)
- [Tools Toolbar on page 71](#)

# More Drawing Tools





Animate offers a wide variety of useful tools to optimize your drawings and work more efficiently; tools such as Group, Arrange, and the animation disk to rotate your workspace.

## Related Topics

- [Arrange below](#)
- [Convert Brush Strokes to Pencil Lines](#) on the facing page
- [Pencil Lines to Brush Strokes](#) on the facing page
- [Strokes to Pencil Lines](#) on the facing page
- [Optimize](#) on page 227
- [Remove Extra Strokes](#) on page 227
- [Reduce Drawing Texture Resolution](#) on page 227
- [Crop Brush Textures](#) on page 228
- [Create Contour Stroke](#) on page 229
- [Remove Contour Stroke](#) on page 229
- [Grid](#) on page 229
- [Group/Ungroup](#) on page 230
- [Hand](#) on page 230
- [Rotate View](#) on page 230

## Arrange

Use the different **Arrange** options to reorder drawing objects inside a single layer in the **Drawing** or **Camera** view.

-  **Bring to Front** button or select **Drawing > Arrange > Bring to Front** or press [Ctrl] + [Shift] + [PgUp] (Windows) or [⌘] + [Shift] + [PgUp] (Mac OS X).  
The selected art is moved to the top.
-  **Bring Forward** button or select **Drawing > Arrange > Bring Forward** or press [Ctrl] + [PgUp] (Windows) or [⌘] + [PgUp] (Mac OS X).  
The selected art is moved one level higher.
-  **Send Backward** button or select **Drawing > Arrange > Send Backward** or press [Ctrl] + [PgDown] (Windows) or [⌘] + [PgDown] (Mac OS X).  
The selected art is moved one level lower.
-  **Send to Back** button or select **Drawing > Arrange > Send to Back** or press [Ctrl] + [Shift] + [PgDown] (Windows) or [⌘] + [Shift] + [PgDown] (Mac OS X).  
The selected art is moved to the bottom.

## Convert Brush Strokes to Pencil Lines



The **Brushes Strokes to Pencil Lines**  operation converts the selected contour strokes into centreline pencil strokes. This command is only available from the top menu.

Select **Drawing > Convert > Brush Strokes to Pencil Lines**.

*In Harmony Paint, this options is found in the **Selected** menu rather than the **Drawing** menu.*

The [^].

## Pencil Lines to Brush Strokes



The **Pencil Lines to Brush Strokes**  operation converts the selected centreline pencil strokes into contour strokes brush lines.

From the top menu, select **Drawing > Convert > Pencil Lines to Brush Strokes**.

*In Harmony Paint, this options is found in the **Selected** menu rather than the **Drawing** menu.*

The [&].

## Strokes to Pencil Lines

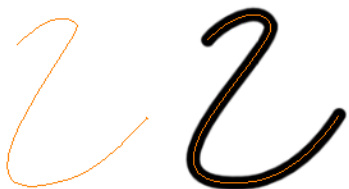

The **Strokes to Pencil Lines**  operation converts the selected invisible line to a pencil line.

Select **Drawing > Convert > Strokes to Pencil Lines**.

In *Harmony Paint*, this options is found in the **Selected** menu rather than the **Drawing** menu.

The [Shift] + [F12] (Windows only).

## Optimize

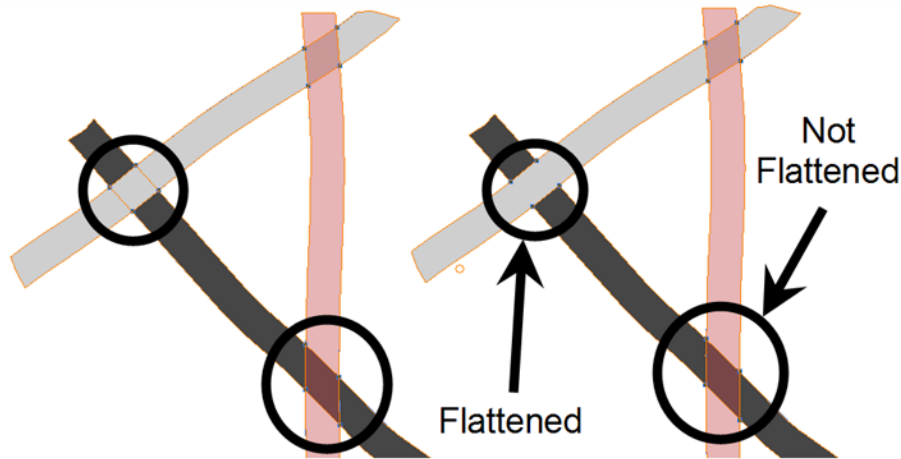

The **Optimize** command reduces the number of layers, such as overlapping brush strokes, in the selected drawing objects. Drawing objects will only be flattened and optimized if the selected objects will not change the appearance of the final image when they are merged.

For example, if you have selected a number of partially transparent objects, which you layered to create an additive colour effect, the selected transparent drawing objects will not be merged. This is because merging the transparent drawing objects will cause them to lose the effect of the layered transparent colours.

- Use the **Select** tool to select the drawing objects you want to optimize.
- Select **Drawing > Optimize > Optimize**.

*In Harmony Paint, this options is found in the **Selected** menu rather than the **Drawing** menu.*

## Remove Extra Strokes

The **Remove Extra Strokes** option is used to remove the invisible lines in your selection.

- Use the **Select** tool to select the drawing objects you want to remove invisible lines from.
- Select **Drawing > Optimize > Remove Extra Strokes**.

*In Harmony Paint, this options is found in the **Selected** menu rather than the **Drawing** menu.*

## Reduce Drawing Texture Resolution

If you import and vectorize as texture (colour) a high resolution image, the size of your drawing can be heavy. This option is used to reduce the size and resolution of the textures in your drawing. When you import and vectorize drawings using the grey or colour preset styles, you don't have control on the size of the bitmap texture. This tool allows you to reduce that bitmap texture.

### To reduce the drawing texture resolution:

- In the **Timeline** or **Xsheet** view, **Select** tool to select the drawing objects you want to reduce the texture resolution for. remove invisible lines from.
- Select **Drawing > Optimize > Reduce Drawing Texture Resolution**.  
*In Harmony Paint, this options is found in the **Selected** menu rather than the **Drawing** menu.*

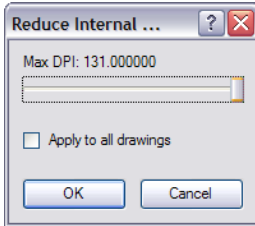

1. In the dialog box, drag the slider toward the left to reduce the texture resolution.
2. Enable the **Apply to All Drawings** option if you want the modification to be applied to all the drawings in your layer.
3. Click OK.

## Crop Brush Textures

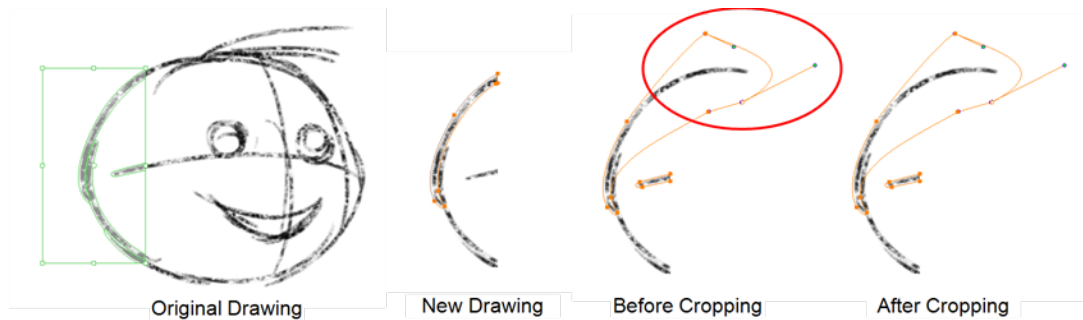

The **Crop Brush Textures** option is used to crop an unnecessarily large texture bitmap that lies, unseen, beneath the vector contour of a textured line. This often occurs when you cut and paste textured lines from one drawing into another. If you cut a portion from a textured line and paste it into a different drawing, Toon Boom Animate pastes the entire unseen texture bitmap from the source drawing into the new one, even if you only took a small portion of the source drawing. Using the **Crop Brush Texture** command will crop away extraneous texture that does not touch the vector area. If there are many textured lines in your scene, this will greatly reduce the file size.



In the example shown above, a textured line is cut from a drawing and pasted into a new drawing. At first glance, it appears as if only a cropped section of the underlying texture bitmap was cut and pasted as well. However, using the **Contour Editor** tool to expand the vector envelope of the textured line, it is revealed that more texture bitmap exists beyond the cropped boundary. If you use the **Crop Brush Texture** command the bitmap texture is cropped to the boundaries of the textured line's vector contour (as seen in the fourth image where the vector envelope has been pulled out to reveal empty space).

### To crop the brush texture:

1. In the **Timeline** or **Xsheet** view, select the drawing you want to crop the texture for.
2. Select **Drawing > Optimize > Crop Brush Textures**.  
*In Harmony Paint, this options is found in the **Selected** menu rather than the **Drawing** menu.*



## Create Contour Stroke

The **Create Contour Stroke**  option is used to add a permanent invisible line around a shape that was drawn directly in the application. This allows you to unpaint your lines with the **Paint**  tool but to maintain the shape of the lines should you need to repaint later.

This command is useful when inking and painting and using the **Apply to All Drawings in Layer**  option.

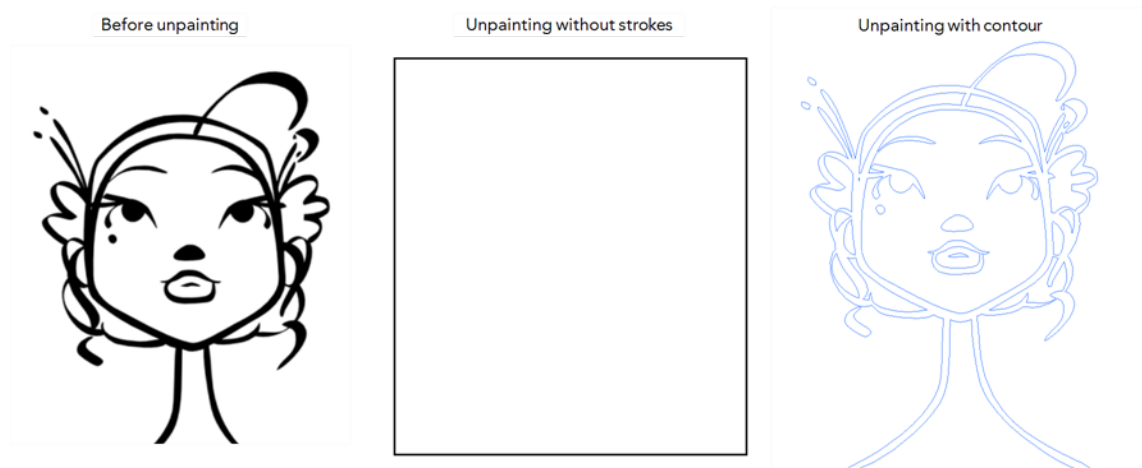

*In Harmony Paint, this options is found in the **Selected** menu rather than the **Drawing** menu.*

## Remove Contour Stroke





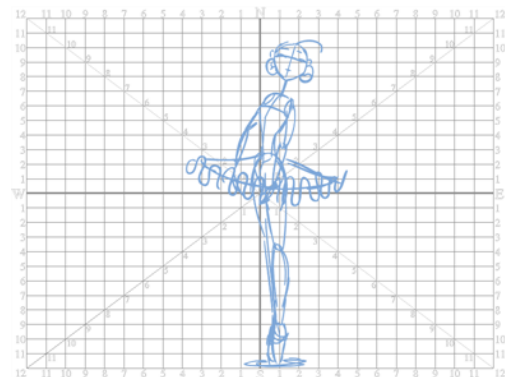

The **Remove Contour Stroke** option is used to remove any permanently invisible lines that were either created while scanning and vectorizing drawings or manually adding contour strokes. This is useful if you want to remove the intersection triangles created during vectorization.

*In Harmony Paint, this options is found in the **Selected** menu rather than the **Drawing** menu.*

## Grid



Use the **Show Grid** option to display a grid in the **Drawing** or **Camera** view.

-  Select **View > Grid > Show Grid**. The [Ctrl] + ['] (Windows) or [⌘] + ['] (Mac OS X).
-  Select **View > Grid > Square** to display a standard square grid.
-  Select **View > Grid > 12 Field Grid** to display a 12 field size grid.
-  Select **View > Grid > 16 Field Grid** to display a 16 field size grid.
-  Select **View > Grid > Underlay** to display the grid behind the drawing elements.
-  Select **View > Grid > Overlay** to display the grid over the drawing elements.

## Group/Ungroup

Use the **Group**  option to group the selected drawing objects. This can help in the selection, repositioning, re-scaling and other transformations to be applied to multiple objects of a drawing.

*In Harmony Paint, this options is found in the **Selected** menu rather than the **Edit** menu.*

- Select **Edit > Group > Group** or **Edit > Group > Ungroup**.
- Press [Ctrl] + [G] and [Ctrl] + [Shift] + [G] (Windows) or [⌘] + [G] and [⌘] + [Shift] + [G] (Mac OS X).

## Hand

Use the **Hand** tool to pan through the **Drawing** and **Camera** view.

- In the **Tools** toolbar, select the **Hand**  tool, click in the **Drawing** or **Camera** view and drag your cursor.
- You can also Hold down the keyboard shortcut [Spacebar], click in the **Drawing** or **Camera** view and move your mouse in the direction you want to pan the view.

## Rotate View

Use the **Rotate View**  tool to rotate the **Drawing** or **Camera** view, the same way as you would do with a real animation disc.

- Select **Drawing > Tools > Rotate View**.  
*In Harmony Paint, this options is found in the **Tools** menu rather than the **Drawing** menu.*
- Press [Ctrl] + [Alt] (Windows) or [⌘] + [Alt] (Mac OS X).

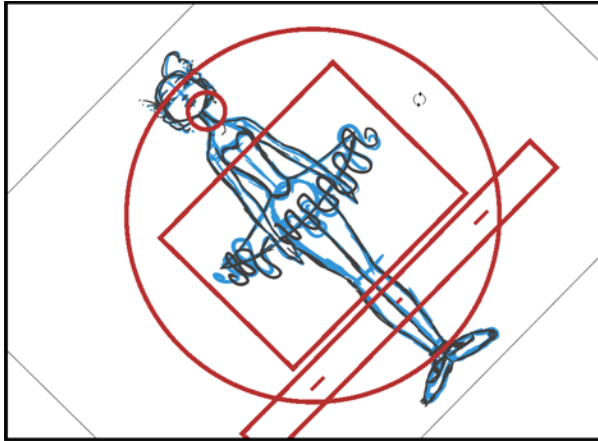

This tool can also be used in the **Perspective** view.

---

## Related Topics

- [How to Draw on page 113](#)

# Drawing Pivot Tool

The Drawing Pivot  tool lets you set the pivots on your character. You can set the drawing pivots on drawings and symbols.

- [Setting the Drawing Pivot for Symbols on All Frames](#) below
- [Snapping on the facing page](#)
- [Reset Pivot on the facing page](#)
- [Copying Pivot on Parent Symbol on the facing page](#)

## Setting the Drawing Pivot for Symbols on All Frames

The Set the Pivot for Symbol on All Frames  option is enabled by default. When you set a drawing pivot on a symbol, all of its cells use the same drawing pivot. This means you do not have to set a drawing pivot on all frames. Once you set it, it is done.

If you prefer to set a different drawing pivot for a series of cells, you can deselect the option and set your pivots on each cell or cell range.



If you have already set several different pivots on your symbol's cells and selected the Set the Pivot for Symbol on All Frames option, once you set a new pivot on the same symbol, all of its pivots will be reset and will use your new pivot.

## Snapping



When you drag the drawing pivot around, you can enable a snap option so that when the drawing pivot is released, it either snaps to the reference grid, drawing's contour, or aligns with an existing drawing stroke.



Refer to [Snap Options](#) on page 167.

## Reset Pivot

When you click the Reset Pivot  option, the drawing pivot of the selected drawing or symbol is reset to the centre of the Camera view (stage).

## Copying Pivot on Parent Symbol

When you import new extra drawings, such as hands and mouths, you can use the drawing pivot that was set on your drawings and report them to the symbol's cells. Use the Copy Pivot to Parent Symbol  command for this.



When you copy drawing pivots to the parent symbol, there is no link between the drawings' pivots and the symbol's pivots. If you modify the drawing pivot later, it will not link to the symbol. You would need to do the operation again. If you need to modify the symbol's pivots, you can do it directly on the symbol's cells.

## Related Topics

- [Setting the Pivots](#) on page 581
- [Setting Pivots on a Frame Range](#) on page 603

# Drawing Preferences

When drawing or animating traditionally in Toon Boom Animate, there are preferences you can set to help you work more efficiently.

To open the Preferences dialog box:

- ▶ Windows: Select **Edit > Preferences**.
- ▶ Mac OS X: Select **Animate > Preferences**.
- ▶ Press [Ctrl] + [U] (Windows) or [⌘] + [U] (Mac OS X).

## Related Topics

- [OpenGL Drawing Preferences](#) below
- [Drawing](#) on the facing page
- [Advanced Tab Preferences](#) on page 235

## OpenGL Drawing Preferences

Shortcuts General Camera Exposure Sheet Drawing Sound OpenGL Render Advanced

Settings

Alternate Gradient and Cutter  Conservative Texture Management

Use PBuffer for Picking  Smooth Textures

Support Triple Buffer Maximum Texture Size: 2048

Support Desktop Effects Texture Memory: 1622

Vector Drawing Maximum Texture Size : 1024

Full Scene Antialiasing

Enable

Number of samples (for Mac OS) 0

Performance Optimizations

Enable Tone and Highlight  Support Transparency in Pencil Lines

Enable Cutter  Enable Colour Override

Enable composite passthrough for all effects

## Full Scene Antialiasing

By default, the Full Scene Antialiasing preference is disabled. This option lets you see smooth lines as you draw as well as an antialiased drawing area. You can change the value of the Full Scene Antialiasing using the Preferences dialog box, to fit the current level used in the Camera or Drawing view.



Refer to the [Viewing the Final Lines as you Draw](#) on page 128.

## Support Transparency in Pencil Lines

When the option is enabled, the pencil lines are displayed normally. The lines will be opaque (unless there are transparencies). Disabling this option will reduce rendering times, but will display additive opacities for overlapping pencil lines and unevenly filled curved pencil lines.

## Drawing

These are the preferences you can find in the **Drawing** tab.

The screenshot shows the 'Drawing' tab in a software application's preferences window. The 'Light Table' section is highlighted with a red box. It contains the following settings:

- Onion Skin Render Style: **Enable Shade** (dropdown menu)
- Light Table: Enable Shade
- Light Table : Shade in Camera View
- Enable Onion Skin for Other Elements

On the right side of the 'Light Table' section, there are several numerical sliders:

- Onion Skin : Maximum Wash Value (0.0-1.0) : 0.8
- Onion Skin : Minimum Wash Value (0.0-1.0) : 0.4
- Onion Skin : Maximum Opacity (0.0-1.0) : 0.8
- Onion Skin : Minimum Opacity (0.0-1.0) : 0.2
- Light Table : Wash (0.0-1.0) : 0.2
- Light Table : Opacity (0.0-1.0) : 0.5

Below the 'Light Table' section is the 'Options' section, which includes:

- Grid on by Default
- Select Tool Is Lasso
- Brush Size Cursor
- Default Multiwheel Colour Picker
- Auto Save Pencil Styles
- Sticky Eye Dropper
- Thumbnail View location: **Right** (dropdown menu)
- Default Pencil Line Tip: **Bevel Tip** (dropdown menu)

The 'Zoom' section at the bottom is also highlighted with a red box and includes:

- Enable Paper Zoom
- Number of pixels per inch: 72 ppi
- Maximum Zoom Factor: 4 X
- Quick Close Up Zoom Factor: 4 X

## Light Table

- **Onion Skin Render Style:**
  - **Normal:** The onion skinned drawings is displayed in washed out colours.
  - **Enable Shade:** The previous onion skinned drawings are displayed in washed out red shades and the next onion skinned drawings are displayed in washed out green shades.
  - **Outlines Only:** The onion skinned drawings are displayed as outlines only.
- **Light Table: Enable Shade:** When enabled, the drawings appearing in the Light Table are displayed in washed out colours in the Drawing view. When this option is disabled, the drawings appearing in the Light Table are displayed using normal colours. This option is for the Drawing view only.
- **Light Table: Shade in Camera View:** When enabled, the drawings appearing on other layers are displayed in washed-out colours in the Camera view. When this option is disabled, the drawings appearing on other layers are displayed using normal colours. This option is for the Camera view only.

- **Enable Onion Skin for Other Elements:** When both Onion Skin and Light Table options are enabled, the drawings appearing in the Light Table also display their previous and next onion skinned drawings. This option is for the Drawing view only.
- **Onion Skin: Maximum Wash Value (0,0-1,0):** The maximum washed-out value for onion skinned drawings.
- **Onion Skin: Minimum Wash Value (0,0-1,0):** The minimum washed-out value for onion skinned drawings.
- **Onion Skin: Maximum Opacity (0,0-1,0):** The maximum opacity value for onion skinned drawings. (0 = transparent).
- **Onion Skin: Minimum Opacity (0,0-1,0):** The minimum opacity value for onion skinned drawings. (0 = transparent).
- **Light Table: Wash (0,0-1,0):** The washed-out value for the light table display.
- **Light Table: Opacity (0,0-1,0):** The opacity value for the light table display. (0 = transparent).

## Options

- **Grid On By Default:** When opening the **Drawing** view, the grid displays automatically.
- **Select Tool is Lasso:** When this option is enabled, the **Select** tool behaves as a lasso selector. When this option is disabled, the Select tool behaves as a rectangle selector.
- **Brush Size Cursor:** When this option is enabled, the brush tool displays the brush size as a circle around the cursor.
- **Auto Save Pen Styles:** When this option is enabled, new pens and pen styles are automatically saved.
- **Thumbnails View location:** When sending a series of drawings to the **Drawing** view, the drawing list appears in a **Side** panel. This preference changes the location of the **Side** panel in the **Drawing** view. By default, the panel is displayed on the right-hand side of the **Drawing** view. You must restart the application for this change to be applied.
- **Default Pencil Line Tip:** Sets the default pencil line tip to either **Round**, **Flat**, or **Bevel**.

## Zoom

- **Enable Paper Zoom:** Enabling this option allows you to set the 100% Zoom level onscreen, in order to physically match the measurements of your paper drawing.
  - **Number of Pixels per Inch:** Enter the PPI for your monitor. To obtain the PPI of your screen, divide the height or width of your monitor's resolution setting by the corresponding physical height or width of your monitor screen (resolution height divided by physical height, or resolution width divided by physical width) in inches.
  - **Maximum Zoom Factor:** Sets the maximum zoom level for the paper zoom.

## Advanced Tab Preferences

These are the related preferences you can find in the **Advanced** tab.

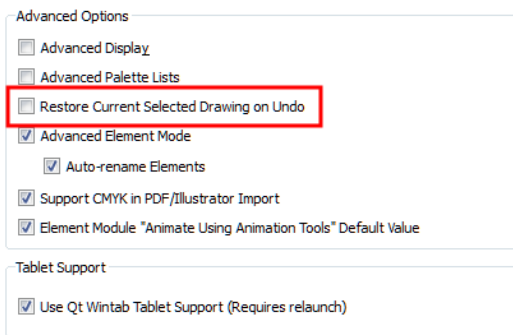

## Advanced Options

- **Restore Current Selected Drawing On Undo:** If a drawing other than the current one is being affected by an **Undo** command, the affected affected drawing is displayed.



# Chapter 5: Traditional Animation

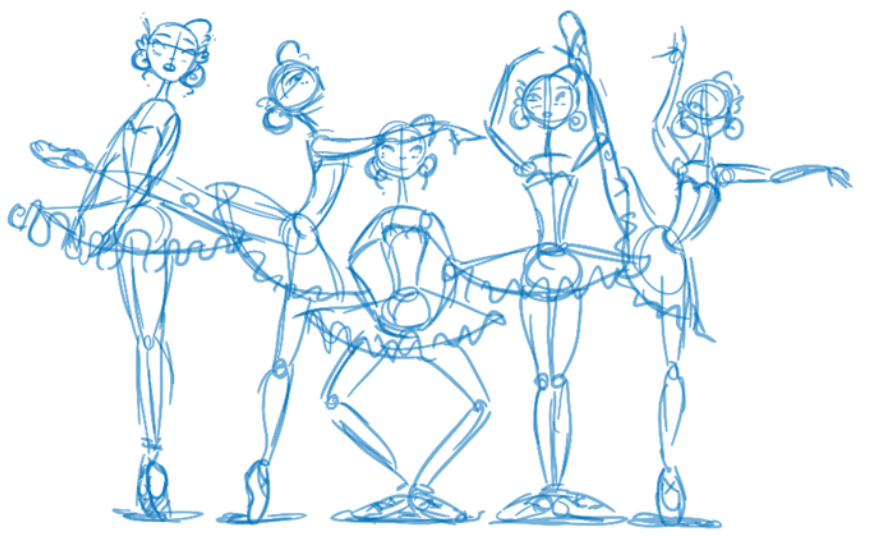

## Topics Covered

- [Traditional Animation Tools](#) on the facing page
- [Basic Traditional Animation](#) on page 247
- [Advanced Traditional Animation](#) on page 254
- [Cleaning Scanned Drawings](#) on page 1

# Traditional Animation Tools

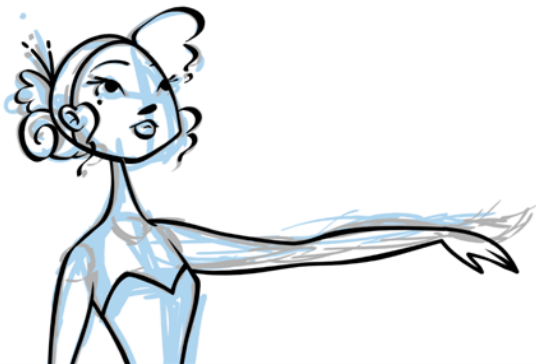

When you animate digitally using traditional techniques, there are certain tools you require in order to work efficiently, as you would do with an animation table, paper and pencils. These tools are described in this section:

- [Onion Skin](#) below
- [Light Table](#) on page 240
- [Drawing Identification](#) on page 241
- [Create Empty Drawing](#) on page 244
- [Reposition All Drawings](#) on page 244

## Onion Skin



The Onion Skin  tool is used to preview the previous and subsequent drawings. When designing or

animating, it is useful to be able to see your previous drawings. By default, the previous drawings will appear with a shade of red and the next drawings will be displayed with a shade of green but you can change the display options in the Preferences panel.



Refer to the [Drawing Preferences](#) on page 233 topic to learn about the Onion Skin preferences.

## To use the Onion Skin feature:

### 1. Enable the Onion Skin feature:

- ▶ In the Tools toolbar, click on the **Show Onion Skin**  button.
- ▶ In the Timeline view, click on the **Onion Skin**  icon. When enabled, the icon will turn red .

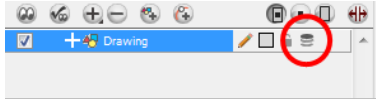









- ▶ From the top menu, select **View > Onion Skin > Show Onion Skin**.
- ▶ Or press [Alt] + [O].

### 2. You can select the number of previous and next drawings you want to show:

- ▶ In the Timeline view, click and drag the Onion Skin blue markers to choose how many previous and next drawings will be displayed.



- ▶  Select **View > Onion Skin > No Previous Drawing** or press [~].
- ▶  Select **View > Onion Skin > Previous Drawing** or press [!].
- ▶  Select **View > Onion Skin > Previous Two Drawings** or press [@].
- ▶  Select **View > Onion Skin > Previous Three Drawings** or press [#].
- ▶  Select **View > Onion Skin > No Next Drawing** or press [Ctrl] + [ ] (Windows) or [⌘] + [ ] (Mac OS X).
- ▶  Select **View > Onion Skin > Next Drawing** or press [Ctrl] + [1] (Windows) or [⌘] + [1] (Mac OS X).
- ▶  Select **View > Onion Skin > Next Two Drawings** or press [Ctrl] + [2] (Windows) or [⌘] + [2] (Mac OS X).
- ▶  Select **View > Onion Skin > Next Three Drawings** or press [Ctrl] + [3] (Windows) or [⌘] + [3] (Mac OS X).

### 3. The previous and next drawings will appear in both the Camera and Drawing view.



## Related Topics

- [Traditional Animation Tools](#) on page 238

# Light Table

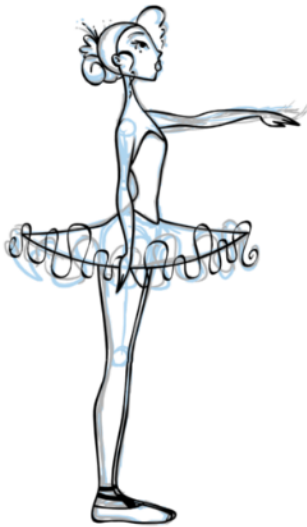

The Light Table  is used to preview the previous and subsequent active layers in washed-out colours. It is useful to be able to see the other layers when designing, animating or cleaning up your animation.

In the Camera view, when the Light Table is activated all layers apart from the currently selected one are shown washed-out. The display returns to the normal mode when the Select tool or a scene setup tool is selected.

Only the currently selected drawing is displayed by default in the Drawing view. When enabling the Light Table, the other layers appear as a washed-out display and are used as a reference. You can not select or manipulate them.

### To use the Light Table feature:

1. Enable the Light Table feature:
  - ▶ In the top menu, select **View > Light Table**.
  - ▶ In the Drawing View toolbar, click on the **Light Table**  button.
  - ▶ Or press [Shift] + [L].
2. The drawings for the other layers are displayed as washed-out colours in the Camera and Drawing view.

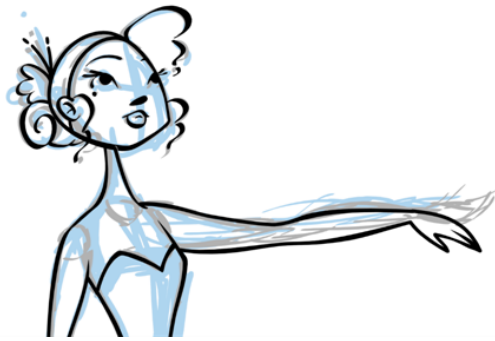

3. In the Timeline view, you can disable the layers you wish to hide from the Light Table.

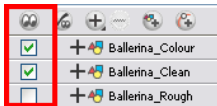

Refer to the [Drawing Preferences on page 233](#) topic to learn about the Light Table preferences.

## Related Topics

- [Traditional Animation Tools on page 238](#)

# Drawing Identification

In the Xsheet view, you can identify your drawings as Key, Breakdown or In-between. This helps to keep your Xsheet well organized while animating.



When working with several animators, directors, or even other studios, the necessity for retakes will often arise. Animate also gives you the possibility to mark your new drawings as either Retake Key, Retake Breakdown, or Retake Inbetweens.

If your production requires you to mark your drawing with a custom marker, you also have the option to create your own.

### To mark a drawing as Key, Breakdown or In-between:

1. In the top menu, select **Windows > Toolbars > Mark Drawing** to display the **Mark Drawing** toolbar.



2. In the Xsheet view, select the cell you want to identify. This option is not available in the Timeline view.
3. In the Mark Drawing toolbar, press on the Mark as Key Drawing , Mark as Breakdown Drawing  or

Mark as In-between Drawing  buttons. In the Xsheet View menu, you can also select **Drawing > Mark**

**Drawing As > Key Drawing, Breakdown Drawing, In-between Drawing, Retake Key, Retake BD and Retake IB.**

- If you select Mark as Key Drawing, a **K** icon appears in the cell.

- ▶ If you select Mark as Breakdown Drawing, a **B** icon appears in the cell.
- ▶ If you select Mark as In-Between Drawing, there is no icon displayed in the cell since it is used to remove a Key or Breakdown marker.

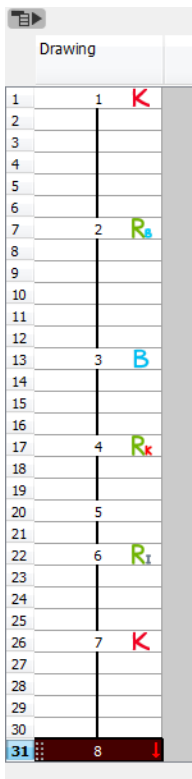

You can create your own custom shortcuts for the Drawing Identification options by going in the Preferences panel. Refer to [Customizing a Keyboard Shortcut on page 58](#) to learn how to customize keyboard shortcuts.

## Custom Marks in the Xsheet View

Make custom marks for the Xsheet by creating your own icons, then cutting, pasting and changing a bit of code. Not only is it possible to have your custom mark appear in the Xsheet and Mark Drawing toolbar, but also in the Onion Skin and Flip toolbars.

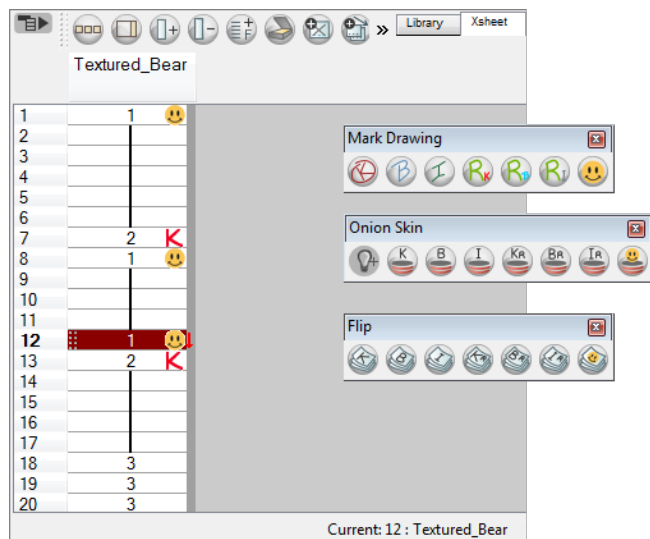

### To create your custom markers:

1. With a bitmap editing software, create the following icons in PNG format:
  - Mark Drawing Toolbar icon (24 x 24 pixel)
  - Onion Skin Toolbar icon (24 x 24 pixel)
  - Flip Toolbar icon (24 x 24 pixel)
  - Xsheet Column icon (16 x 16 pixel)
2. Close Animate.
3. Once your icons are ready, go to the Toon Boom Animate **resources/drawingTypes.d** directory:
  - **Stand-alone**
    - Mac OS X: **/Applications/Toon Boom Animate 3/resources/drawingTypes.d**
    - Windows: **C:/Program Files (x86)/Toon Boom Animation/Toon Boom Harmony 10.0/resources/drawingTypes.d**
4. Paste your icons in the **resources/drawingTypes.d** directory.
5. In that same directory, open the **drawingTypes.xml** file in a text editor.
6. For each custom icon you want to create, add the following line. Make sure it is placed before the closing **</DrawingTypes>** tag.
  - `<DrawingType text="NewButtonName" pixmapFile="XsheetIcon.png" commandIcon="MarkDrawingIcon.png" flipIcon="FlipIcon.png" onionIcon="OnionIcon.png" />`
7. In that line, replace the following information with your new icon information:
  - **NewButtonName**: Write the name of your new marker. This name will appear in the button tooltip.
  - **XsheetIcon.png**: Write the name of the icon that you created to appear in the Xsheet column. Include the file extension.
  - **MarkDrawingIcon.png**: Write the name of the icon that you created to appear in the Mark Drawing toolbar. Include the file extension.
  - **FlipIcon.png**: Write the name of the icon that you created to appear in the Flip toolbar. Include the file extension.
  - **OnionIcon.png**: Write the name of the icon that you created to appear in the Onion Skin toolbar. Include the file extension.
8. Save the file and close it.

9. Launch Animate.

## Related Topics

- [Traditional Animation Tools on page 238](#)

# Create Empty Drawing



The Create Empty Drawing  command automatically creates a drawing in the selected cell of the Timeline and Xsheet view, replacing any drawing that may already be exposed in that cell and the following ones until it meets another drawing.

### To create an Empty Drawing:

1. In the Timeline or Xsheet view, select the cell you want to create an empty drawing in.
2. In the Xsheet View toolbar, click on the **Create Empty Drawing**  button or select

**Animation > Create Empty Drawing** or press [Alt] + [Shift] + [R].

3. The new drawing will be created in the Xsheet and Timeline views.

1		1	
2		2	
3		3	
4		4	

## Related Topics

- [Traditional Animation Tools on page 238](#)

# Reposition All Drawings

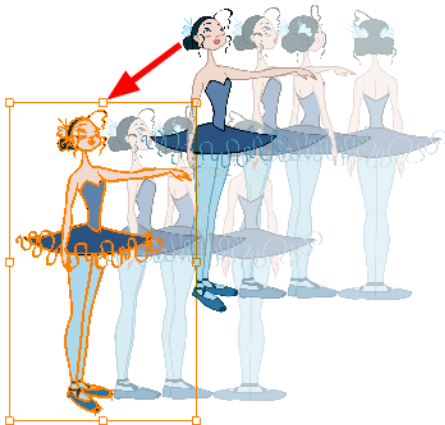

The Reposition All Drawings  option is used to reposition, scale, rotate or skew all drawing strokes on every drawing included in a layer.



## To reposition all drawings:

1. In the Tools toolbar, select the **Reposition All Drawings**  tool. This also automatically selects every stroke in your drawing in the Drawing and Camera view.

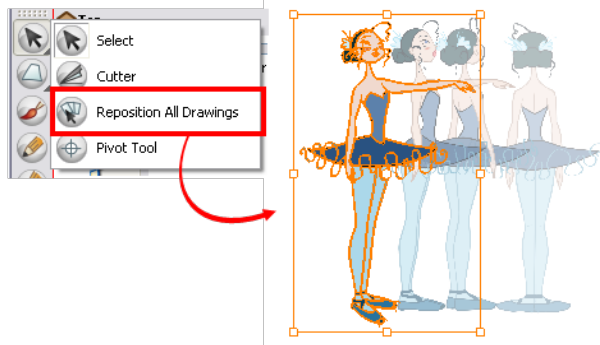

2. To deform or reposition a selection:
  - ▶ To reposition, click and drag your selection to a new area.

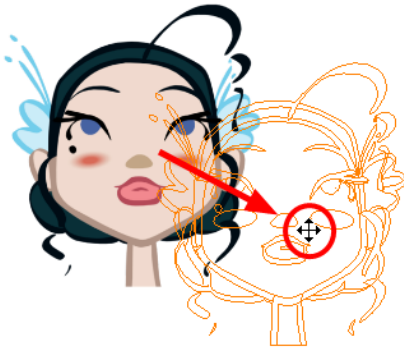

- ▶ To rotate, rotate the selection box handle.

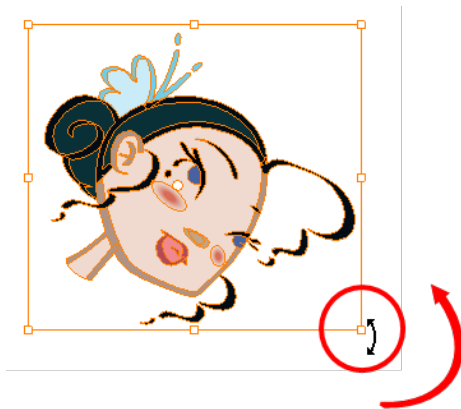

- ▶ To scale, pull or push either on the top, side, bottom or corner control points. Hold down [Shift] to lock the selection's ratio.

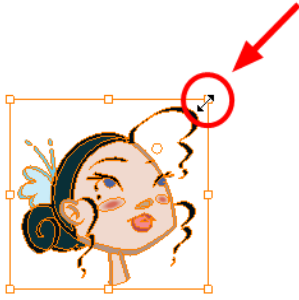

- ▶ To skew, drag the sides or top and bottom segments, between the control points.

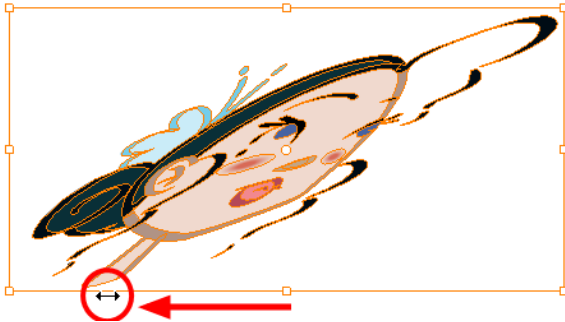

3. When you release your cursor, every drawing contained in the drawing layer you repositioned, scaled, rotated or skewed will follow the same transformation.

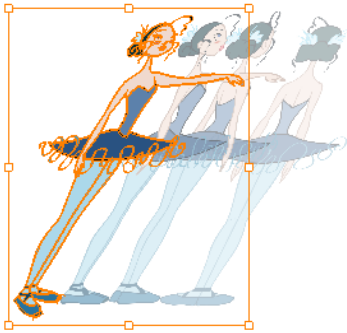

## Related Topics

- [Traditional Animation Tools on page 238](#)

# Basic Traditional Animation

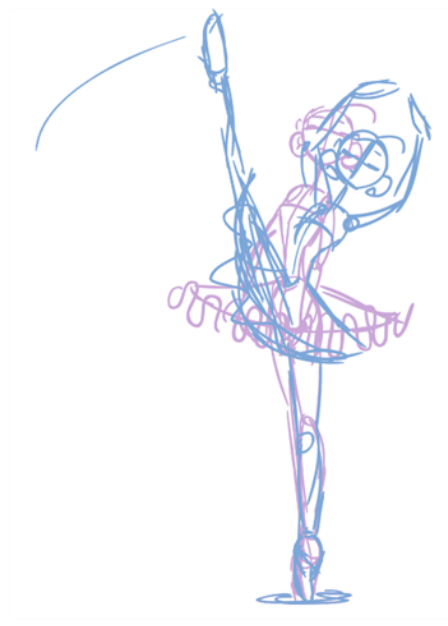

Toon Boom Animate lets you animate traditionally, but work entirely digitally. Many tools and features are supplied to help you achieve that traditional animation look easily and efficiently.

## Related Topics

- [Animating below](#)
- [Cleaning Up on page 251](#)
- [Setting the Timing on page 253](#)

## Animating



Now that you know about the existing tools, you can start your animation.

The first step to complete is the rough animation, which is the skeleton of your animation. You would usually start with the main action. For example, to animate a walk-cycle, you will start with the torso moves and the legs. Head, arms and clothes will be added later, during the secondary animation.

For a satisfactory animation, complete the main action before adding all of the details. If you start animating all of the details right away, you will lose a lot of time if you have to do corrections, and your animation will often look too rigid.

#### To animate:

1. In the Preferences panel, you can set your preferences to Use Current Frame as Drawing Name. Refer to [Exposure Sheet](#) on page 272 to learn more about this preference.
2. In the Tools toolbar, select the Brush  tool or press [Alt] + [B].
3. In the Colour view, select the colour you will use to draw. It is a good idea to choose a light colour for your rough animation to help for the following task, the clean up process.

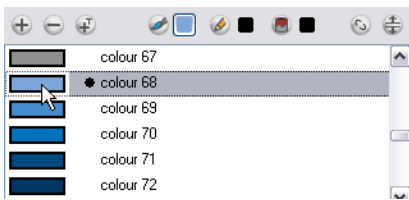

4. In the Timeline or Xsheet view, select the cell where the first drawing will appear.
5. In the Camera or Drawing view, draw the first key drawing.

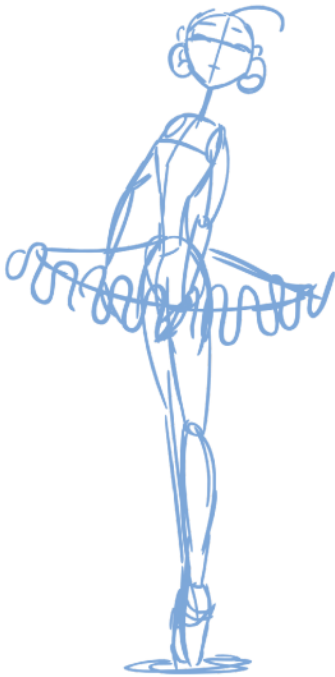

6. Make sure your first key drawing is still selected, and in the Mark Drawing toolbar, click on the **Mark Selected Drawings as Key** button.
  - In the Xsheet view, you can also select **Animation > Mark Drawing As > Key Drawing** to identify your drawing.

Drawing		
1	1	K
2		
3		
4		
5		

- In the Tools toolbar, click on the **Enable Onion Skin**  button.
- In the Timeline view, click and drag the onion skin blue markers to extend the number of previous and next visible drawings to fit your need.



- In the Timeline or Xsheet view, select the cell where your next key drawing will appear.

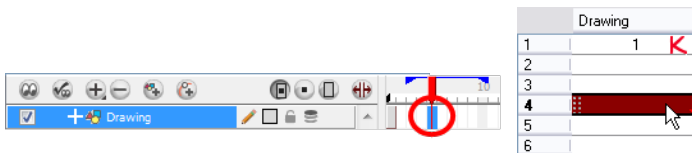

- In the Camera or Drawing view, draw your second key drawing.

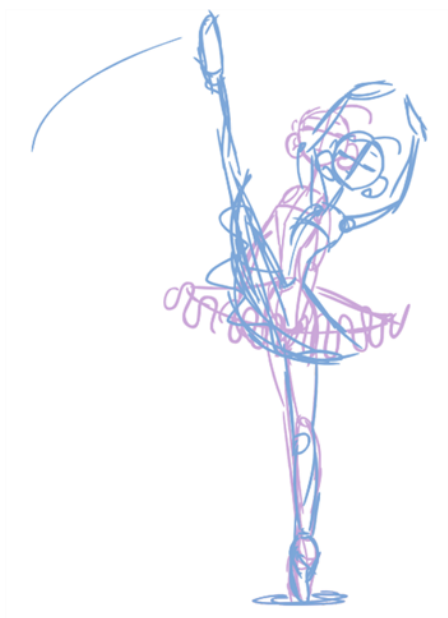

- In the Xsheet view, identify the drawing as a key drawing.

Drawing		
1	1	K
2		
3		
4	4	K
5		

- In the Xsheet view, select a cell between your two key drawings.



13. From the Timeline View toolbar, click  to create an empty drawing or press [Alt] + [Shift] + [R].

- In the Xsheet view, right-click and select **Drawings > Create Empty Drawing** or press [Alt] + [Shift] + [R].



14. Draw your new drawing.

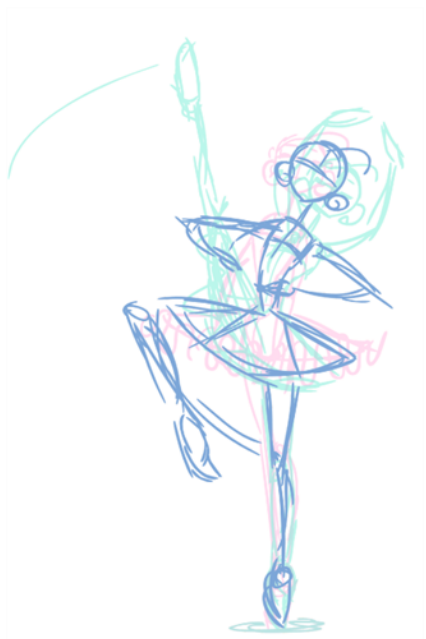

15. If necessary, in the Xsheet view, identify the new drawing as a Key, Breakdown or In-between drawing.

Drawing		
1	1	K
2	2	B
3		
4	4	K
5		

16. In the Timeline or Xsheet view, select a new cell and repeat step 9 to step 15 for each new drawing.

17. In the Timeline view, disable the layers you do not want to show during playback.

18. In the Playback toolbar, click on the **Loop**  button if you want the playback to loop.

19. In the Playback toolbar, click on the **Play**  button to start the animation.

## Related Topics

- [Cleaning Up on the next page](#)
- [Setting the Timing on page 253](#)

## Cleaning Up



When your rough animation is ready, it is time to clean it up and ink it. The clean-up is also called *tracing*. It consists of tracing solid and clean lines over the rough animation to get closed zones. This is the final paperless animation step before the ink and paint step.

You will need to add a new drawing layer to draw your clean. This is the equivalent of adding a sheet of paper and tracing the rough using the animation disk.



If you plan on tracing your animation in the Drawing view, you will need to enable the Light Table feature in order to display all the layers of your project.

### To trace your animation in a new layer:

1. In the Timeline View toolbar, click on the **Add Drawing Layer**  button.
2. In the Timeline view, click the lock icon of the layer containing your rough animation to prevent selecting the layer in the Camera view.

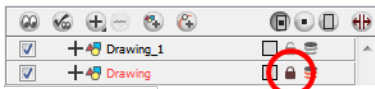

3. In the Timeline or Xsheet view, select the new layer's cell corresponding to the first key drawing of your rough animation.
4. In the Tools toolbar, select the drawing tool of your choice. We recommend the Pencil  tool.
5. In the Colour view, select the colour you will use to trace your animation. Pick a dark bold colour such as black to make sure it contrasts well with the light colour of your rough animation.
6. In the Camera or Drawing view, start tracing the first key drawing.

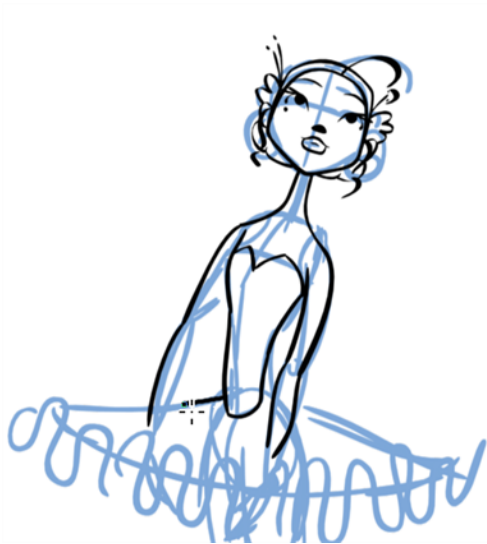

7. If you have some other layers in the way, you can disable them temporarily from the Timeline view so that only your rough animation and your clean up layer are displayed in the Camera view.
8. In the Tools toolbar, click on the **Enable Onion Skin**  button and extend the Onion Skin in the Timeline view.



9. In the Timeline or Xsheet view, select the next cell corresponding to a rough drawing.
10. In the Camera view, trace your next drawing.

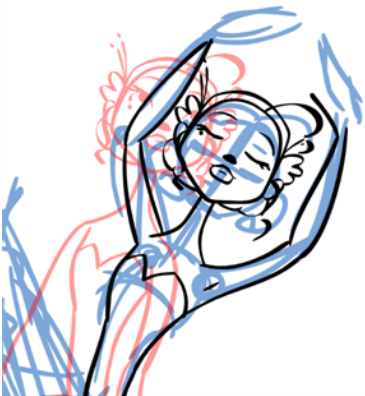

11. Repeat the previous steps for each drawing.



This method allows you to keep the roughs and the cleans intact. You only need to disable the rough layer to prevent it from appearing in the scene.



## Related Topics

- [Animating on page 247](#)
- [Setting the Timing below](#)

# Setting the Timing

---



Refer to the following topics in the [Timing on page 339](#) chapter to learn how to set the timing of your animation:

---

- [Filling Exposure on page 379](#)
- [Filling Exposure Mode on page 379](#)
- [Typing Exposure on page 380](#)
- [Extending a Single Exposure on page 382](#)
- [Extending an Exposure Sequence on page 382](#)
- [Dragging Cells on page 384](#)
- [Increasing and Decreasing Exposure on page 386](#)
- [Deleting Exposure on page 389](#)
- [Inserting Blank Cells on page 390](#)
- [Setting the Exposure on page 391](#)
- [Filling a Selection with a Single Exposure on page 392](#)
- [Filling a Selection with a Sequence on page 393](#)
- [Filling a Selection Randomly on page 395](#)
- [Creating Cycles on page 396](#)

## Related Topics

- [Animating on page 247](#)
- [Cleaning Up on page 251](#)

# Advanced Traditional Animation



Toon Boom Animate has many useful features such as the Flipping toolbar, enhanced Onion Skin, extra drawing layers, automated matte and more.

## Related Topics

- [Flip and Easy Flipping Toolbars](#) below
- [Onion Skin Toolbar](#) on page 256
- [Shift and Trace](#) on page 258
- [Drawing Layers](#) on page 268
- [Multiple Drawings in the Drawing View](#) on page 269

## Flip and Easy Flipping Toolbars

Toon Boom Animate provides a Flip feature which allows you to rapidly flip through the drawings as one would with paper drawings. You can flip through the Key, Breakdown or In-between drawings individually, or view a combination.





The Flipping features only work in the Drawing view.

### To flip through your drawings:

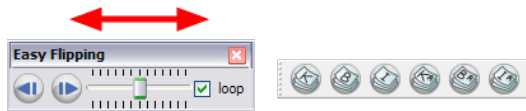
1. In the top menu, select **Window > Toolbars > Easy Flipping and Flip**.



2. In the Easy Flipping toolbar, click on the **Previous**  or **Next**  button to see the previous or next drawing of your animation.
3. Enable the **Loop** option to loop your animation during the flip. This way, when you reach the end of your animation, the first drawings will show up again.

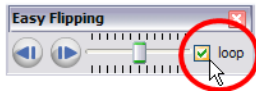

4. Move the slider to the right to flip forward and to the left to flip backward through your drawings.

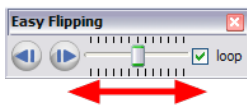

- The more that you move the slider to the left or the right, the faster the drawings will flip.
5. If you marked some of your drawings as Key, Breakdown or In-between, you can flip through the markers and avoid seeing all the in-betweens. Enable the Flip Key, Flip Breakdown or Flip In-between option in the Flip toolbar, to see only one type or a combination. [See Drawing Identification on page 241.](#)

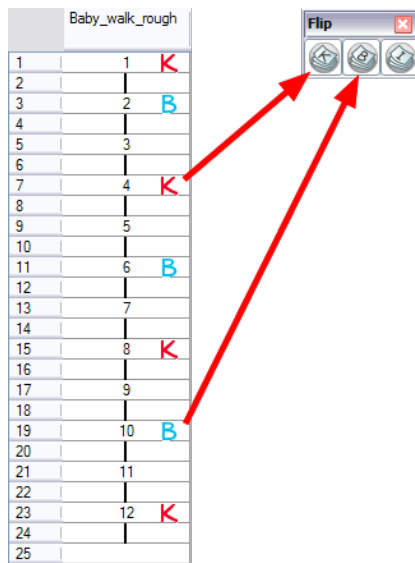

## Related Topics

- [Drawing Identification on page 241](#)
- [Advanced Traditional Animation on the previous page](#)

## Onion Skin Toolbar

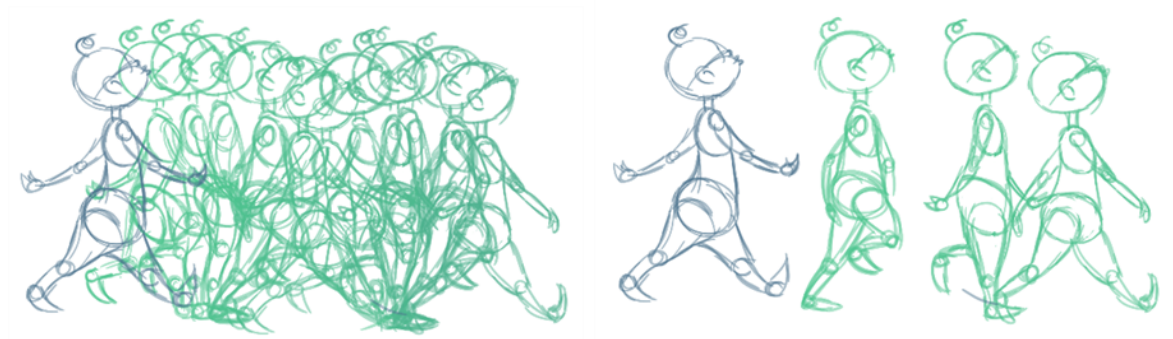

You can setup your onion skin to display only the marked drawings, in the same way that you flip through your drawings marked as Key, Breakdown or Inbetween drawings. [See \*Drawing Identification\* on page 241.](#)



This Onion Skin feature only operates in the Drawing view.

### To display the marked drawings in the onion skin:

1. In the top menu, select **Window > Toolbars > Onion Skin**.



2. In the Tools toolbar, enable the **Onion Skin**  feature.

3. In the Timeline view, pull on the blue arrows to extend the number of drawings displayed in the onion skin preview.



4. In the Onion Skin toolbar, enable the markers you want to see in your Onion Skin preview.

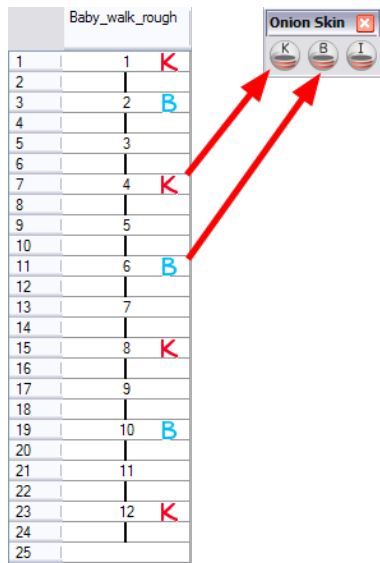

## Related Topics

- [Drawing Identification on page 241](#)
- [Enabling the Onion Skin in Other Layers below](#)
- [Advanced Traditional Animation on page 254](#)
- [Flip and Easy Flipping Toolbars on page 254](#)

## Enabling the Onion Skin in Other Layers

Sometime, you might need to refer to previous and next drawings in other layers than the current one. You can activate the Enable Onion Skin in Other Elements option to see the previous and next drawings of the layers visible in Light Table mode.



This Onion Skin feature only operates in the Drawing view.

### To enable the onion skin in other layers:

1. In the top menu, select **Window > Toolbars > Onion Skin**.



2. In the Tools toolbar, enable the **Onion Skin**  feature.

3. In the Drawing view, enable the **Light Table**  option. This option is not available in the Camera view.

4. In the Timeline view, pull on the blue arrows to extend the number of drawings displayed in the onion skin preview.

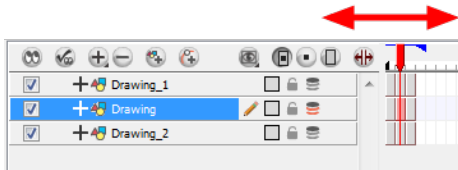

5. In the Onion Skin toolbar, enable the **Enable Onion Skin in Other Elements** option.

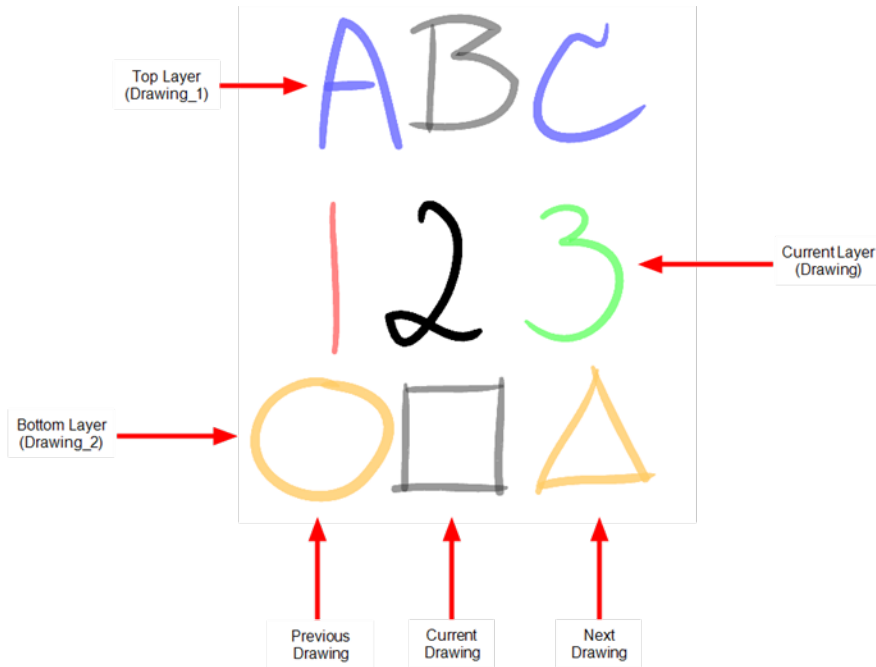

- By default, layers located on top (in the Timeline view) of the current layer will be displayed as shades of blue.
- By default, layers located below (in the Timeline view) of the current layer will be displayed as shades of yellow.
- By default, the current layer will be displayed in shades of green and red.



You can change the Onion Skin display default colours in the Preferences panel. [See \*General > Edit Colours\* on page 271.](#)

## Related Topics

- [Advanced Traditional Animation](#) on page 254
- [Flip and Easy Flipping Toolbars](#) on page 254
- [Onion Skin Toolbar](#) on page 256

## Shift and Trace

When animating traditionally, it is very important to stay on model. Losing the proportions or features of a character is easy to do. The Shift and Trace feature makes it possible to temporarily move a drawing so that you

can trace it on another one. This is similar to animators working on an animation light table and using cut-out pieces of a character to move it underneath the new drawing and trace it.

The Shift and Trace option will not modify your drawing, it will only allow it to be moved, rotated or scaled in the **Shift and Trace** mode. As soon as you disable the Shift and Trace option, the repositioned drawing returns to its normal state.



If you use the Shift and Trace feature a lot, you can assign custom shortcuts to the following operations:

- Shift and Trace Drawing Move Down
- Shift and Trace Drawing Move Up
- Shift and Trace Drawing Reset Position
- Shift and Trace Drawing Toggle Peg State
- Shift and Trace Drawing Toggle Visibility
- Shift and Trace Move Tool
- Shift and Trace Rotate Tool
- Shift and Trace Scale Tool
- Shift and Trace Toggle Manipulator
- Shift and Trace Toggle View

Refer to [Customizing a Keyboard Shortcut on page 58](#) to learn how to customize keyboard shortcuts.

### To shift and trace:

1. In the Tools toolbar, enable the **Onion Skin**  feature.
2. Open a Drawing view.
3. In the Xsheet view, select the range of drawings you need to shift and trace. This selection should include at least the layer containing the piece you need to trace and the new drawing in which you will trace.

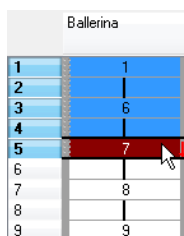

4. In the Xsheet view, right-click on your drawing selection and select **Drawings > Send to Drawing view**. The selected drawings are sent to the Thumbnail view which appears in the Drawing view.

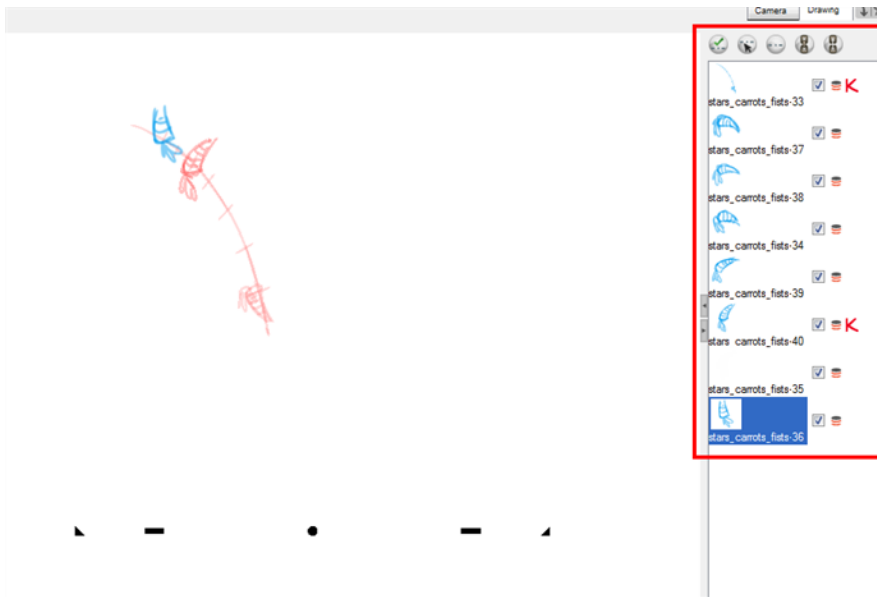

The Thumbnail view is situated by default on the right side of the Drawing view. You can change its positioning via the Preferences panel.

5. Press on the **Shift and Trace Enable**  button to enable the option.

Registration holes appears at the bottom of your drawings.

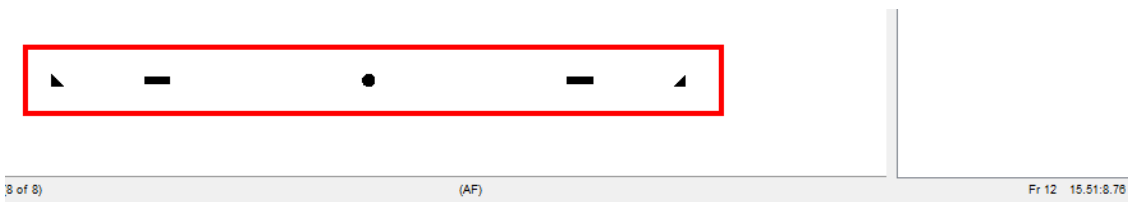

At the bottom of the Drawing view, a close up window appears to display the registration marks up close to be able to move and reposition them easier if you are zoomed out quite a bit while working on your drawings.

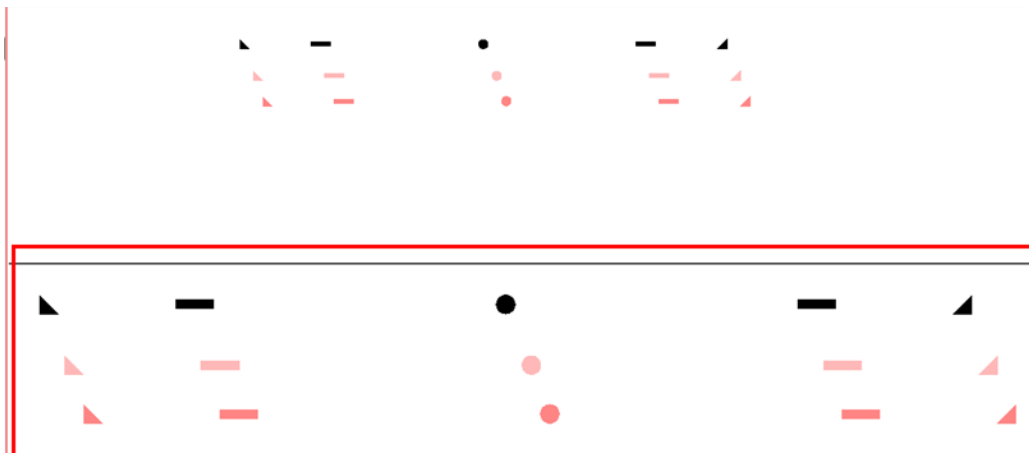



6. Select the **Shift and Trace**  tool.
7. Enable the **Onion Skin**. Select **View > Onion Skin > Show Onion Skin** or press [Alt] + [O].
8. If not done already, enable the check box corresponding to the drawing you want to allow to be transformed temporarily. All drawings are enabled for Shift and Trace operations by default.

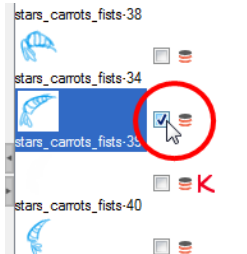

9. Select the drawing you want to move.

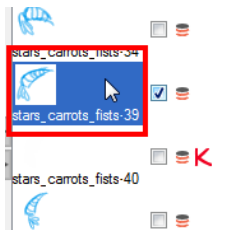

10. If you want to draw more than one drawing at once, you can link them together. In the Shift and Trace panel, select several drawings and click on the Link Drawings and Unlink Drawings buttons to lock their position together.

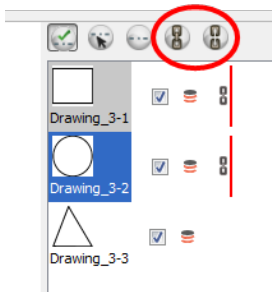

11. In the Drawing view, transform the drawing as needed, to position it between you two key poses:
  - To reposition, click and drag the drawing to a new area.



- To rotate from the centre peg, click on the flat peg hole and rotate.



- ▶ To scale, pull or push on the triangle control.



- ▶ Hold [Alt] to show the pivot point. The pivot point is situated in the middle of your current drawing view. To rotate from the pivot point. Hold [Alt] and rotate



- ▶ To scale from the pivot point, hold [Shift] and move your cursor.

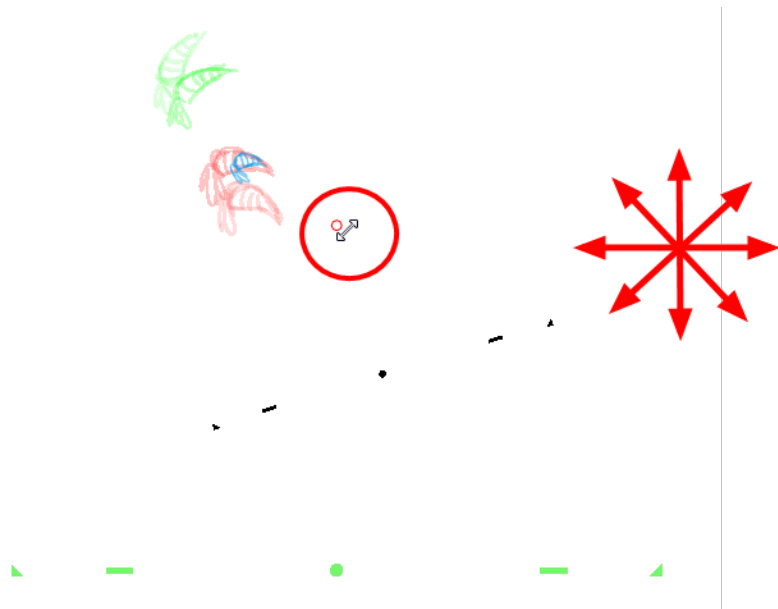

- ▶ Click and drag the pivot point to move it to a new position. Once the pivot point have been moved, you need to hold [Alt] and move your drawing in order to show it again.



12. Once your drawing is repositioned, select the drawing into which you want to trace.

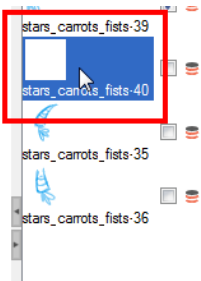

13. Select the drawing tool of your choice.

14. In the Drawing view, trace your drawing.



15. If you want to select another drawing and reposition it, you can hold down [Ctrl] (Windows) or [⌘] (Mac OS X) and click on the **Shift and Trace Registration** marks (Peg holes).

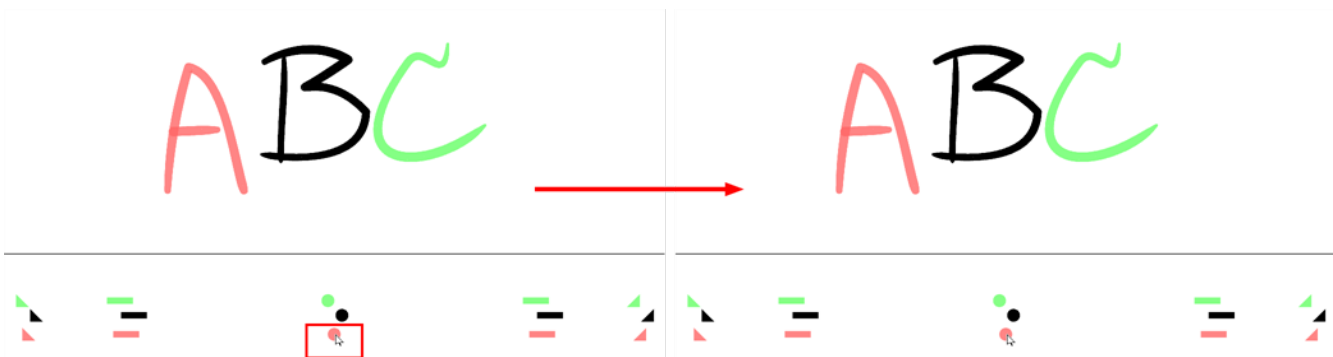

16. If necessary, click on the **Shift and Trace Reset**  button to reset the position of the modified drawing.

17. Right-click in the drawing list column and select Remove All Drawings to close the drawing list.

- ▶ To remove one, or several, drawings from your selection without clearing the entire list, select the drawings you want to remove using [Ctrl] (Windows) or [⌘] (Mac OS X), right-click in the drawing list column and select Remove Selected Drawing.

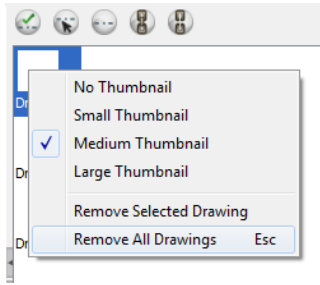

## Related Topics

- [Shift and Trace Linked Drawings](#) below
- [Enabling and Disabling Individual Drawing Shift and Trace Onion Skin](#) on page 267

## Shift and Trace Linked Drawings

When using the Shift and Trace feature, you can link different drawings from the Drawing List so that they move together when dragging or scaling. These drawings can be from different columns in the Xsheet view. Bars in differing colours will appear beside the chain link icon to easily identify different linked groups.

### To link your Shift and Trace Drawings:

1. In the Drawing view's Thumbnail area, display the drawings you want to use to perform your Shift and Trace operation.
2. In the Thumbnail area, hold down [Ctrl] (Windows) or [⌘] (Mac OS X) and select the drawings you want to link together.
3. In the Thumbnail area's toolbar, click on the Link Drawings button to link your selection.



A coloured bar and a link icon appear beside the linked drawings.

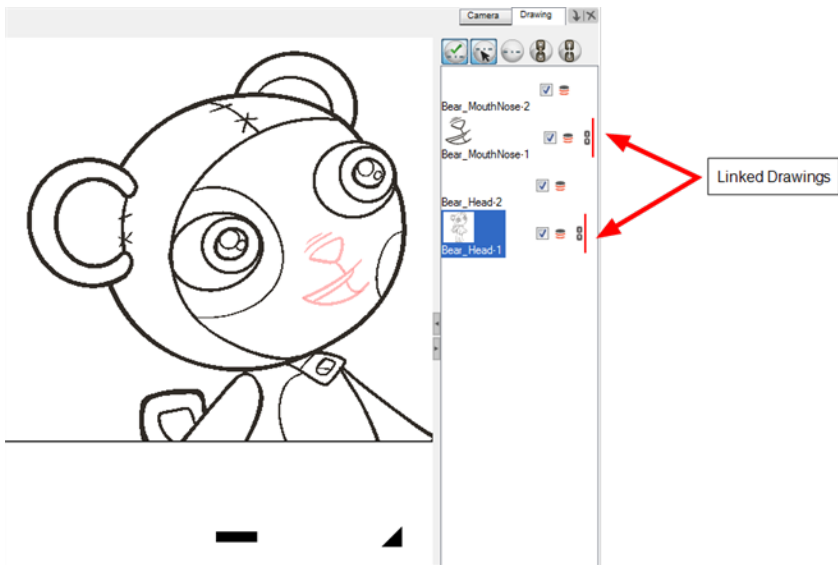

4. Enabling the **Shift and Trace** feature, move your linked drawings.

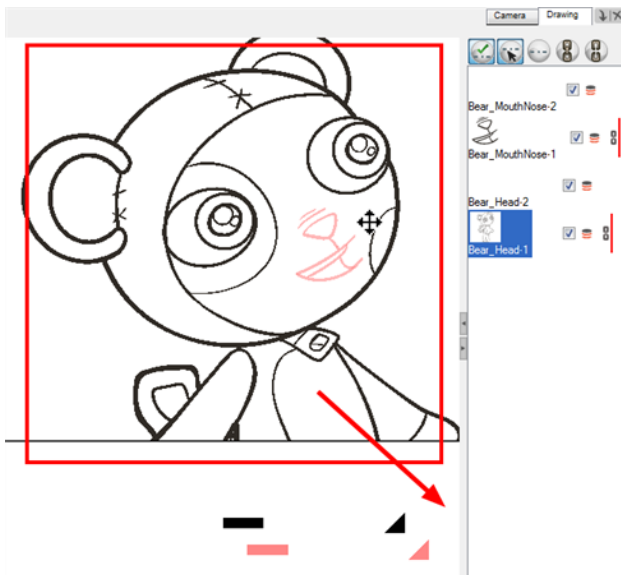

5. If you want to unlink your drawings, in the Thumbnails area, select one of the linked drawings and click on the **Unlink Drawing** button.



6. You can now move your drawings independently.

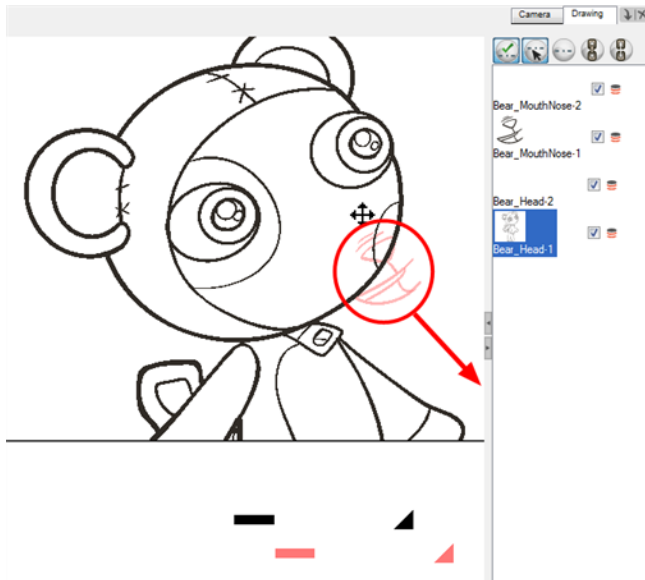

## Related Topics

- [Shift and Trace](#) on page 258

## Enabling and Disabling Individual Drawing Shift and Trace Onion Skin

It is possible that you would end up with a lot of drawings in your onion skin display while working with the Shift and Trace feature. You can disable individual drawings from the Onion Skin display without deactivating them.

**To enable and disable individual drawing shift and trace onion skin display:**

1. In the Tools toolbar, enable the **Onion Skin**  feature.
2. In the Drawing view's Shift and Trace panel, click on the drawing's onion skin icon to enable or disable it.





## Related Topics

- [Shift and Trace](#) on page 258

# Drawing Layers

Toon Boom Animate has two layers included in its drawings that is only available in the Advanced Art Mode:

-  [Line Art](#) below
-  [Colour Art](#) below

1. In the Camera or Drawing view bottom toolbar, click on either the **Line Art**  and **Colour Art**  buttons.
2. Click on the **Preview**  button to display all the layers together.

## Line Art

In traditional animation, you mainly use the Line Art layer to trace and clean up your animation. The outline is drawn in the Line Art layer and you paint in the Colour Art layer.



## Colour Art

In traditional animation, you use the Colour Art layer to paint your animation. The outline is drawn in the Line Art layer and you paint in the Colour Art layer. You need to generate invisible lines out of your Line Art to be able to do so.





## Multiple Drawings in the Drawing View

If you only want to work on a portion of an animation sequence or many drawings from different layers, you can. To do this, select the segment needed in one or more layers in the Xsheet or Timeline view and then, use the Send to Drawing View and Add Drawings to Drawing View options to send the selection to the Drawing view and allow you to work only on these drawings.

### To send several drawings to the Drawing View:

1. In the Xsheet or Timeline view, select a consecutive cell range from one or several layers. In the Xsheet view, using [Ctrl] (Windows) or [⌘] (Mac OS X), you can click on any cell to add it on the selection, even if it is not consecutive.

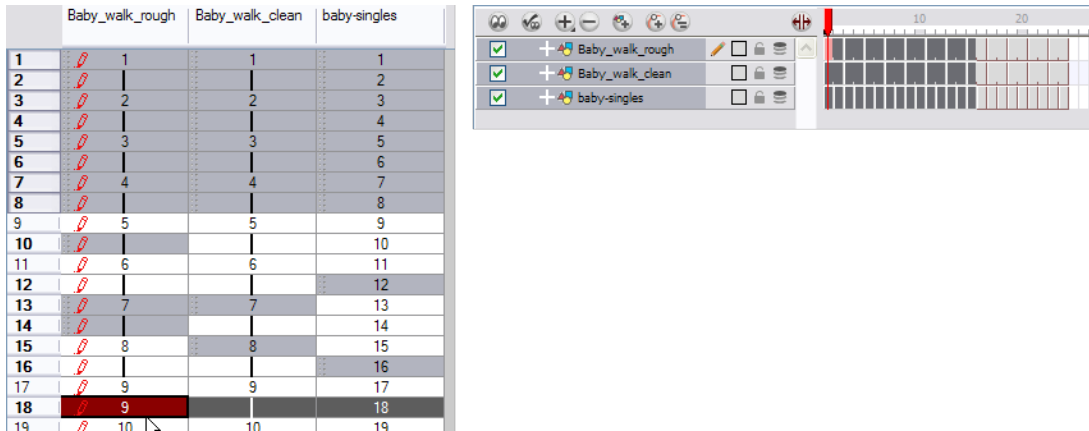

2. In the Timeline View or Xsheet View menu, select **Drawings > Send to Drawing View**. In the Xsheet view, you can also hold down the [Alt] key and click on the selection.

The drawings appear at the side of the Drawing view.

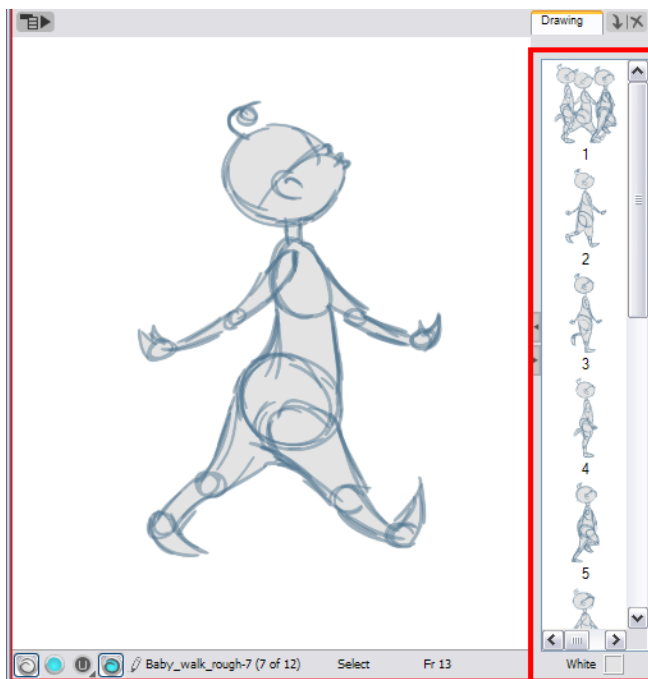

3. If the Drawing view side panel is hidden, click on the Arrow button, located to the right side of the view.

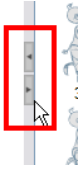

4. If you want to add some extra drawings to the Drawing view without having to start over, in the Xsheet view, select the desired drawings to be added.
5. In the Xsheet View menu, select **Drawings > Add Drawings to Drawing View** or press [Alt] + click.
6. If you want to send a new drawing selection to the Drawing view and remove the current one, select a new range of drawings in the Timeline or Xsheet view.
7. In the Timeline View or Xsheet View menu, select **Drawings > Send to Drawing View**.
8. To change the size of the thumbnails displayed in the side panel, right-click in the side panel and select **No Thumbnail**, **Small Thumbnail**, **Medium Thumbnail** or **Large Thumbnail**.
9. To empty the drawing list accumulated in the Drawing view, right-click in the side panel and select **Remove Selected Drawings** or **Remove All Drawings**.

## Related Topics

- [Advanced Traditional Animation](#) on page 254

# Traditional Animation Preferences

When animating traditionally in Toon Boom Animate, there are preferences you can set to help you work more efficiently.

To open the Preferences panel:

- Windows: Select **Edit > Preferences**.
- Mac OS X: Select **Animate > Preferences**.
- Or press [Ctrl] + [U] (Windows) or [⌘] + [U] (Mac OS X).

## Related Topics

- [General > Edit Colours](#) below
- [Exposure Sheet](#) on the facing page

## General > Edit Colours

You can change the colours for the Onion Skin for Other Elements option.

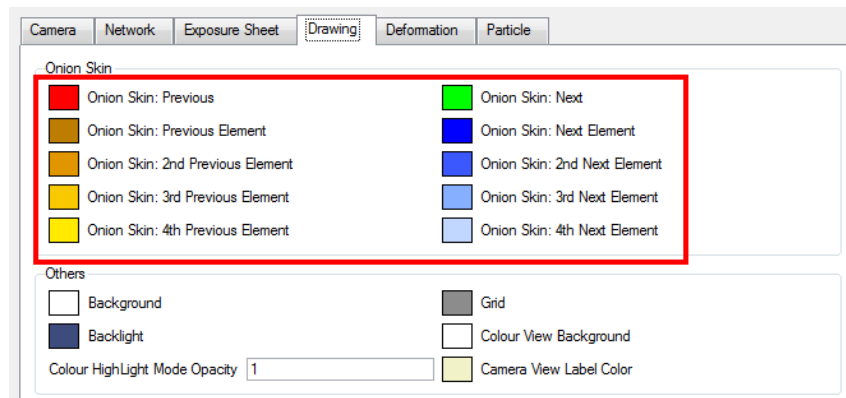

## Edit Colours for Onion Skin in Other Elements

To change the onion skin display colour:

1. In the Preferences panel, go to the **General** tab.
2. In the General tab, click on the **Edit Colours** button.
3. In the Edit Colours window, go to the Drawing tab.
4. In the Drawing tab, in the Onion Skin section, click on the colour swatch of the onion skin display you want to change.
5. In the Colour Picker window, select the colour.
6. Click OK to confirm the colour.
7. Click OK to confirm and close the **Edit Colours** window.
8. Click OK to confirm the changes and close the **Preferences** panel.



Refer to [Enabling the Onion Skin in Other Layers on page 257](#) to learn more about the Onion Skin for other Layers option.

## Related Topics

- [Exposure Sheet](#) below

# Exposure Sheet

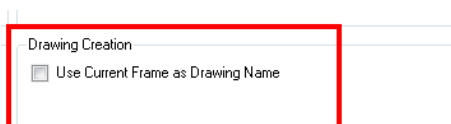

## Current Frame as Drawing Name

The Current Frame as Drawing Name option can be enabled in the Preferences panel, under the Exposure Sheet tab. Use this preference to automatically name the drawing corresponding to the frame position, this avoids numbering conflicts while animating.

	Drawing
1	1
2	9
3	4
4	6
5	3
6	8
7	5
8	7
9	10
10	2

For example, using the default preferences, you start with the first drawing on frame 1, this drawing is called 1. You then draw the extreme position drawing on frame 10, this drawing is called 2. Next, the in-between pose is drawn on frame 5, this drawing is called 3 and so on.

At the end, you have a sequence like this: 1-9-4-6-3-8-5-7-10-2.

	Drawing
1	1
2	2
3	3
4	4
5	5
6	6
7	7
8	8
9	9
10	10

Instead, using the Use Current Frame as Drawing Name preference, each drawing is automatically named by its frame number and the sequence looks like: 1-2-3-4-5-6-7-8-9-10.

## Related Topics

- [General > Edit Colours on the previous page](#)

# Chapter 6: Colour



With Toon Boom Animate, you can add colour to your projects and even create sets of colours for your characters. With Toon Boom Animate's colour palette concept, painting and colour styling has never been easier!

## Topics Covered

- [How to Paint on the facing page](#)
- [Colours on page 276](#)
- [Colour Display Modes on page 286](#)
- [Selecting the Current Colour of a Tool on page 288](#)
- [Painting Using the Paint Tool on page 290](#)
- [Painting Pencil Lines with the Ink Tool on page 298](#)
- [Selecting a Colour in a Drawing on page 302](#)
- [Editing Gradients and Textures on page 304](#)
- [Closing Gaps Manually on page 310](#)
- [Protecting Colours on page 313](#)
- [Line Art and Colour Art Layers on page 314](#)
- [Verifying Zones are Painted on page 318](#)
- [Palettes on page 319](#)
- [Colour Model on page 331](#)
- [Colour Preferences on page 336](#)

# How to Paint

Learn how to paint your drawings by following these instructions.

## To paint your drawings:

1. In the Tools toolbar, select the Paint  tool or press [Alt] + [I].
2. In the Colour view, select a colour from the palette.
  - ▶ Double-click on a colour swatch to open the Colour Picker window and modify the colour.

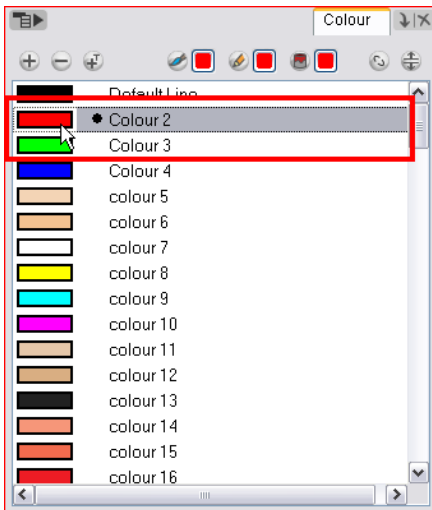

The colour palette will only appear in the Colour view once a drawing element has been selected.

3. In the Camera or Drawing view, start painting the colours on your drawing.



## Related Topics

- [Colours](#) on the facing page
- [Colour View](#) on page 83

# Colours

Toon Boom Animate has some very powerful colouring features when it comes to painting. To paint your drawings you will use different colour swatches, unlike some paint programs where you modify one swatch each time you want to paint with a different colour.



In the Colour view, you choose a different colour swatch for each colour you want to paint in your drawing. You can add as many swatches as you want. You can also rename them and modify existing ones.

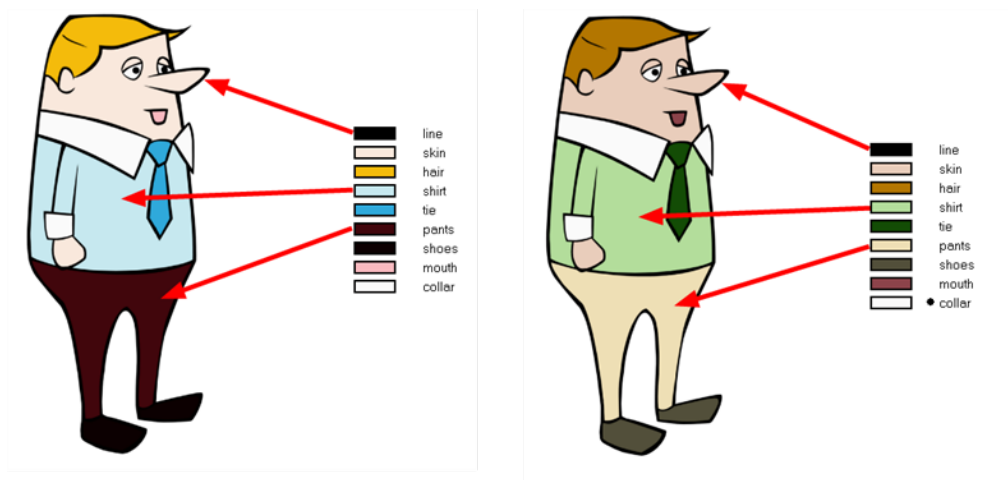

When you modify the colour of an existing swatch it automatically updates all the zones painted with this swatch throughout the entire project. The colour swatch has a unique ID number that associates it with the painted zones. This way, you can change the look of your character at anytime without having to repaint it!

## Related Topics

- [Adding a Colour Swatch](#) below
- [Deleting a Colour Swatch](#) on page 284

## Adding a Colour Swatch

You can use three different types of colour swatches, these are described in the following sections:

- [Solid Colour Swatch](#) on the next page



- [Default Colour Swatch](#) on page 279
- [Gradient Colour Swatch](#) on page 280
- [Bitmap Texture Swatch](#) on page 282

## Solid Colour Swatch



To add or modify a solid colour swatch:

1. In the Colour view, click on the **New Colour**  button.
2. In the Colour View menu, select **Colours > Edit**. You can also double-click on the colour pot. The Colour Picker window opens.

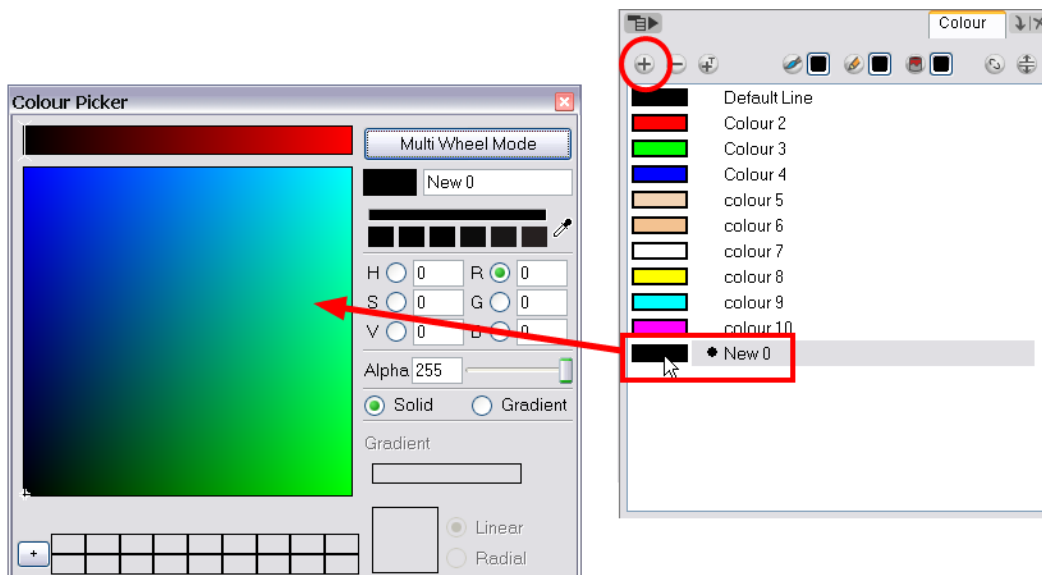

3. To set your colour:
  - In the colour wheel, select the desired colour.

OR

- ▶ Type in the HSV or RGB values in the corresponding fields. Click on the **R,G,B,H,S** or **V** radio buttons to change the look of the colour picking area.

H	<input type="radio"/> 207	R	<input checked="" type="radio"/> 0
S	<input type="radio"/> 100	G	<input type="radio"/> 107
V	<input type="radio"/> 76	B	<input type="radio"/> 194

OR

- ▶ Click on the **Dropper**  button to select any colour on your screen. It can be from the Toon Boom Animate's interface, your Operating System or any other open application.

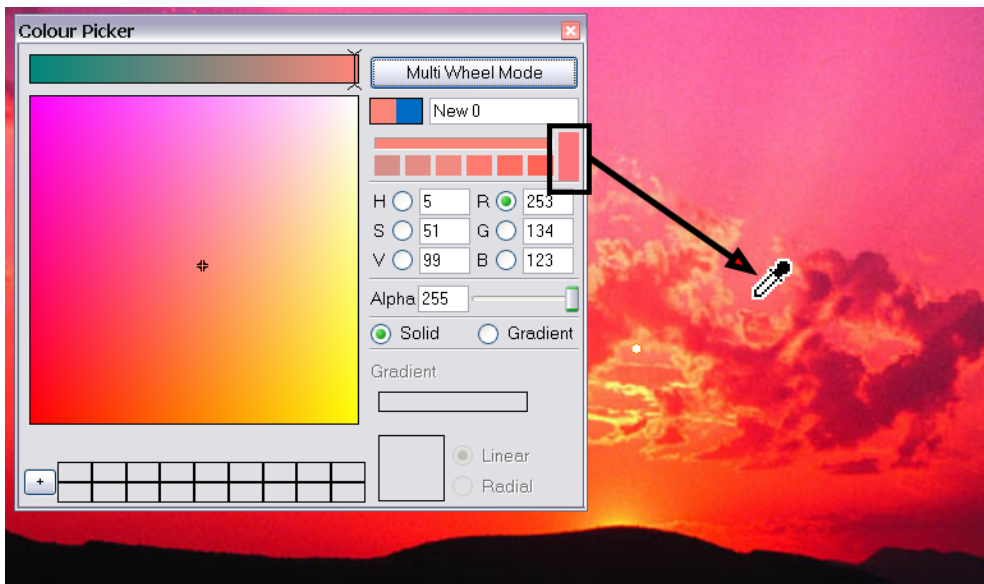

You can also click on the **Multi Wheel Mode** button to open the Multiwheel Colour dialog box. This displays all the picking area styles together and also contains a picking undo list. Click on the **Single Wheel Mode** button to go back to the regular Colour Picker window.

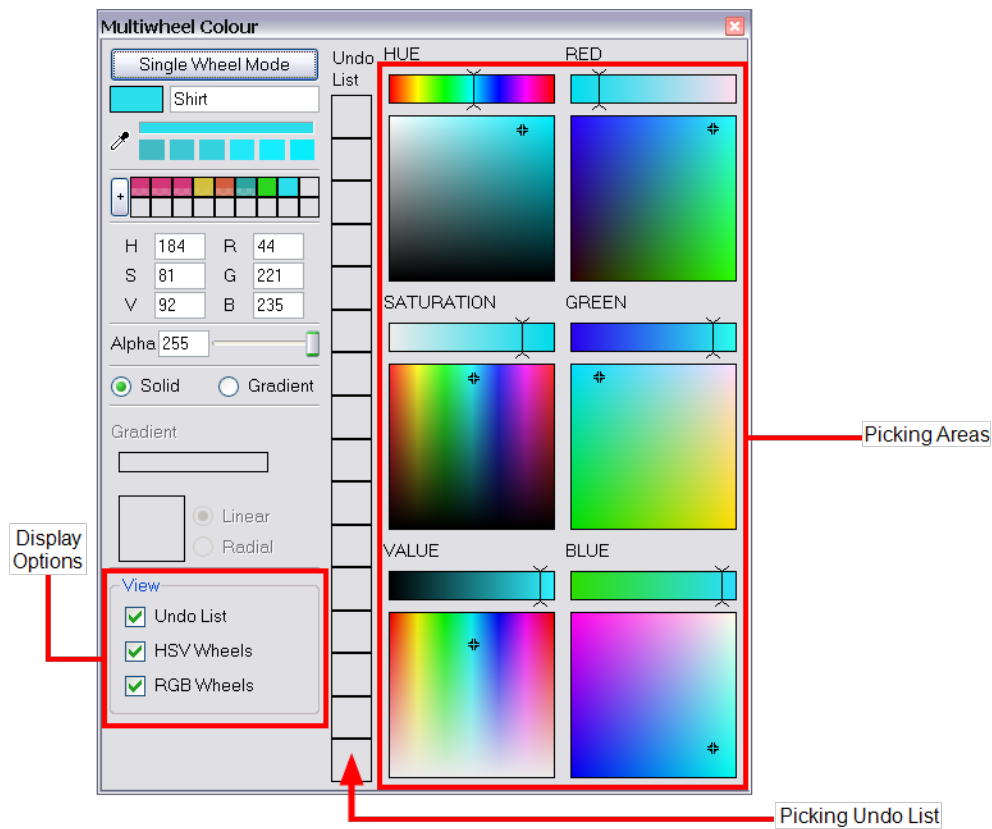

4. If needed, click on the **Shade Scale**'s swatches to modify the shade of the selected colour.



5. If necessary, adjust the desired level of transparency with the Alpha slider, or type the value directly in the Alpha field.

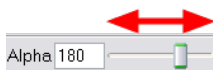

6. If necessary, click on the **Add** button to add the current selected colour to the Colour Storage Library, so you can quickly access it later.

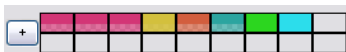

7. You can rename the colour swatch in the Colour Picker window or directly in the colour list by double-clicking on its name.

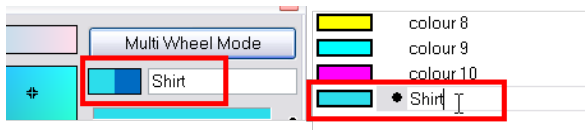

## Default Colour Swatch

In Toon Boom Animate, when you click on the **Add Colour**  button, a new colour swatch is created using the colour of the currently selected swatch from your palette. However, you can set a Default colour to be used

every time you create a new colour in your colour palette. This might be useful if you want to create different shades of the same basic colour.

### To change the default swatch colour for all your colour palettes:

1. In the top menu, go to **Edit > Preferences (Windows)** or **Animate > Preferences (Mac OS X)**.
2. In the Preferences panel, under the Drawing tab, enable the **Create New Colour Pot Using the Default Colour** option. In addition, You can click on the colour swatch, located just beside, to change the Default colour.

The default colour is also the colour used when you choose to vectorize images that you are scanning into your scene, however you add the Default colour swatch to your palette in a different way, so that it is unique. It has a unique ID number that makes it recognizable from all the other colours in your colour palettes. Being able to change this colour allows you to change the basic colour of all scanned drawings. This can be useful on more than just an aesthetic level as sometimes when you go to NTSC or PAL, pure colours, such as pure black, can create problems.

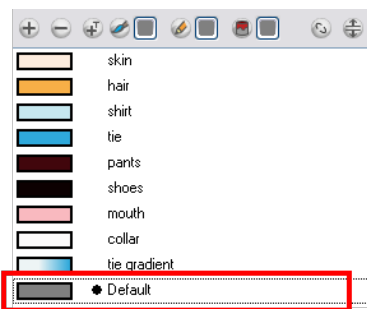

### To add a new colour swatch using the default colour:

1. In the Colour View menu, select **Colours > New**.

A new swatch will be added to your palette using the default colour pot colour. The new swatch created with the New command will be named **New 0**.



Refer to [Colour Preferences](#) on page 336 to learn more on the Create New Colour Pot Using The Default Colour preference and how to customize the default colour pot colour.

## Gradient Colour Swatch



**To create a gradient colour swatch:**

1. In the Colour view, select the colour to be modified.

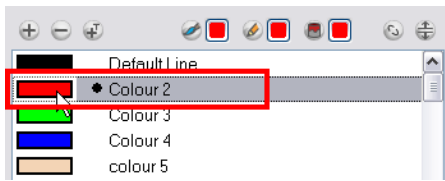

2. In the Colour View menu, select **Colours > Edit**. You can also double-click on the colour pot. The Colour Picker window opens.

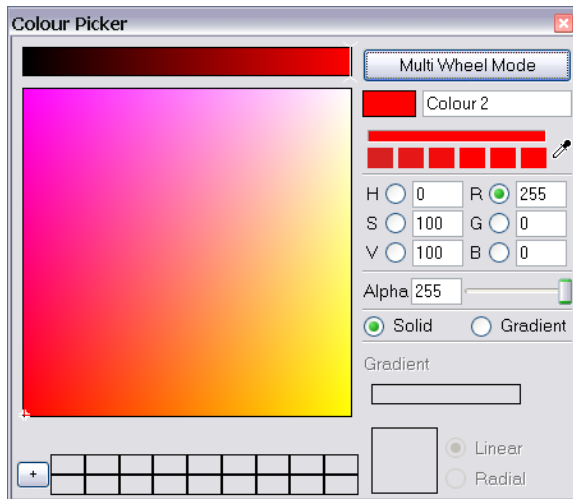

3. Enable the **Gradient** option.

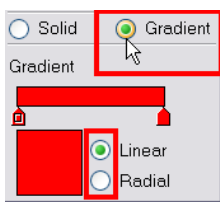

4. Select the **Linear** or **Radial** option.
5. Select the **Gradient** arrows to modify the colours.

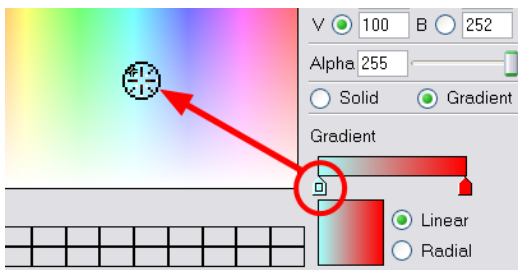

- ▶ Click between the arrows to add extra colours.

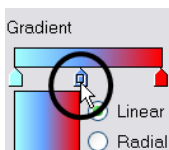

- ▶ Pull down the arrows to remove them.

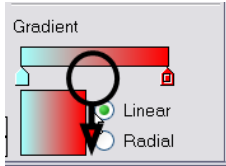

- ▶ Move the arrows left and right to modify the gradient distance.

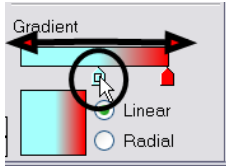

Refer to the [Editing Gradients and Textures on page 304](#) topic to learn how to reposition your gradient zones in your drawings.

## Bitmap Texture Swatch



To create a texture colour:

1. In the Colour View menu, select **Colours > New Texture** or click on the **New Texture**  button.

The Browser window opens.

2. Browse for a PSD or TGA bitmap file created in a third party software.

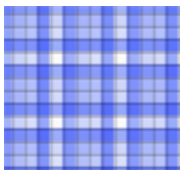

3. Click on the **Open** button to create the colour swatch.

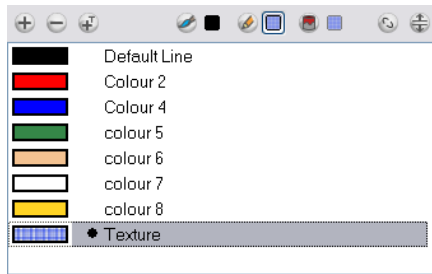

Refer to the [Editing Gradients and Textures on page 304](#) topic to learn how to reposition your textured zones in your drawings.

You can also replace a texture once it is painted. If you decide to make the character's shirt wool instead of plaid, just update the texture file in the swatch and the entire project updates. Any transformation previously applied to the texture's position in your drawings will be kept.

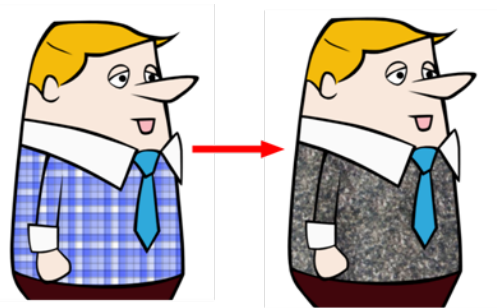

#### To replace a texture swatch:

1. In the Colour view, select the texture swatch you want to change the embedded bitmap texture file in.

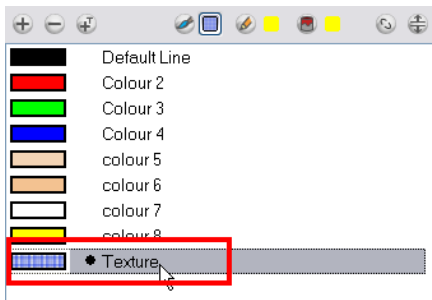

2. In the Colour View menu, select **Colours > Edit Texture**. You can also double-click on the swatch. The Browser window opens.
3. Browse for the new PSD or TGA bitmap file created in a third party software.



- Click on the **Open** button to update the colour swatch.

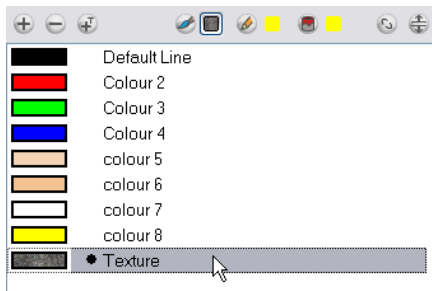

## Related Topics

- [How to Paint on page 274](#)
- [Deleting a Colour Swatch below](#)

## Deleting a Colour Swatch

To delete a colour swatch:

- In the Colour view, select the colour swatches to delete.

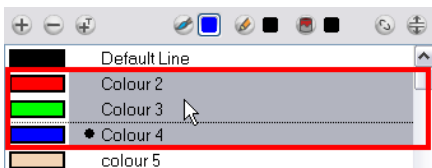

- In the Colour View menu, select **Colours > Delete**. You can also click on the **Delete Colour**  button.

The default keyboard shortcut is [Delete].

If the colour swatch is used in a drawing, the Delete Colour dialog box opens.

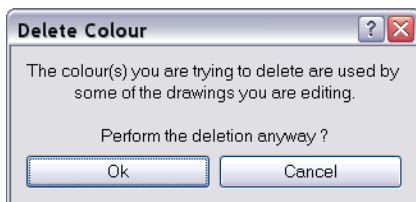

- Click **OK** to delete the colours or click **Cancel** to abort the operation.
  - ▶ If you delete colour swatches already in use, the zones painted with them turn red so you can easily identify them.





## Related Topics

- [Adding a Colour Swatch](#) on page 276

# Colour Display Modes

This section describes the colour modes.

- [Switching Between Thumbnails and List Display modes](#) below
- [Displaying Colour Values](#) below

## Switching Between Thumbnails and List Display modes

The Colour view has two display modes:

- List Mode
- Swatch Mode

To toggle between the display modes:

1. In the Colour View menu, select **Colours > Swatch Mode**.
  - Enable the option to display the swatches.
  - Disable the option to display the colour list.

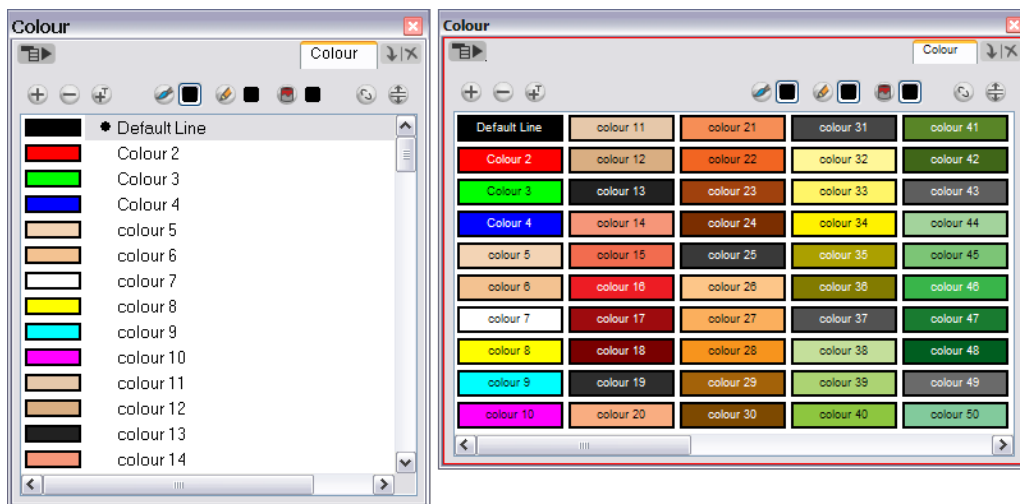

## Displaying Colour Values

When using Toon Boom Animate, you can display the RGB values and names of your solid colour swatches.



This option is not available when displaying the colours in Swatch mode.

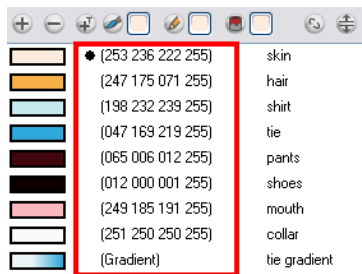

### To display the swatch colour values:

- ▶ In the Colour View menu, select **Palettes > Display Colour Values**.

The solid colour swatches' RGB values will be displayed between the colour swatch and its name. The gradient colour swatches will be identified as (gradient).

### Related Topics

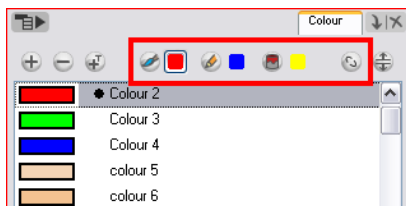

- [Colour View on page 83](#)

# Selecting the Current Colour of a Tool



While drawing and painting, you can let Animate retain the last colour you selected for each one of the following tools:

- Brush
- Paint
- Pencil, Ellipse, Line, Rectangle, Polyline

The Colour view has three swatches where you can set a colour for the Brush , Paint  and Pencil  tools.

**To unlink the storage swatches:**

1. In the Colour view, if the storage swatches are linked, click on the **Linking**  button to unlink them.



2. Click on the **Brush**  storage swatch.

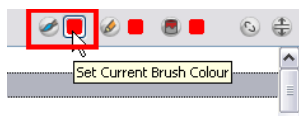

3. In the Colour list, select the desired colour.
4. Click on the **Pencil**  storage swatch.

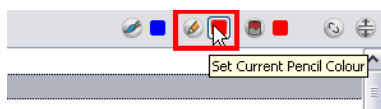

5. In the Colour list, select the desired colour.
6. Click on the **Paint**  storage swatch.

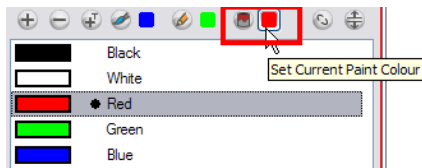



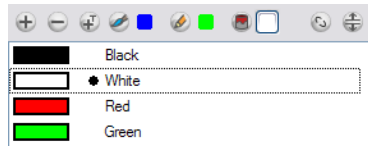



7. In the Colour list, select the desired colour.



If you prefer not to use this behaviour and have Toon Boom Animate use the same colour swatches regardless of the selected tool, you can link the three swatches together.

**To link the storage swatches:**

1. In the Tools toolbar, select one of the following tool:

- ▶  Brush tool
- ▶  Paint tool
- ▶ Pencil tools:
  -  Pencil tool
  -  Polyline tool
  -  Line tool
  -  Ellipse tool
  -  Rectangle tool

2. In the Colour view, if the storage swatches are linked, click on the **Linking**  button to link them.

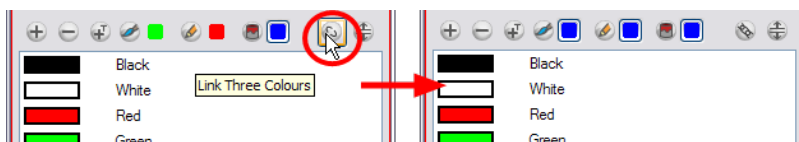



Each time you select a new colour for your current tool, all the storage swatches are updated.

**Related Topics**

- [How to Paint on page 274](#)

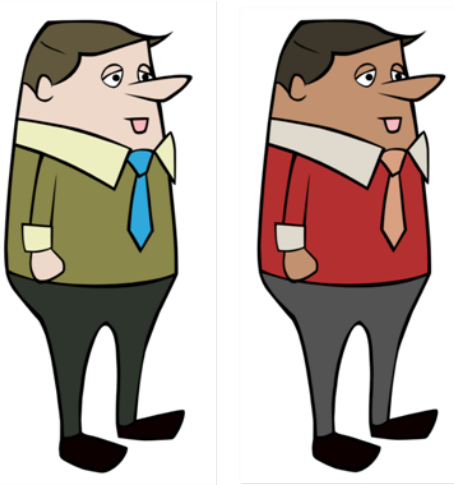
# Painting Using the Paint Tool





The main tool you will use to paint your drawings with is the Paint  tool. The Paint tool can be used in several different modes, these can be customized in the Tool Properties view.

The Paint tool paints closed zones, this includes brush strokes, as well as pencil lines. If you have gaps in the lines defining a zone, you will have to close them using either the Brush, Pencil, Close Gap tools or the Automatic Close Gap option.

## To paint with the Paint tool:

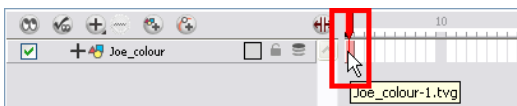
1. In the Timeline or Xsheet view, select the cell where you want to paint.



2. In the Tools toolbar, click on the **Paint**  tool or press [Alt] + [I]. You can also select the Paint tool in the top menu under **Drawing > Tools > Paint**.
3. In the Colour view, select a colour.

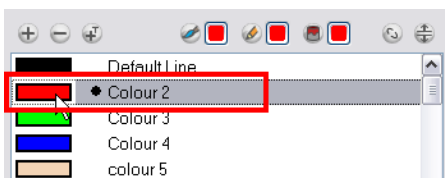

4. In the Camera view, start painting. You can click on a zone or pencil line to paint it, or you can trace a lasso or marquee selection to paint several zones or pencil lines at once.



The last colour you select while using the Paint tool will be remembered the next time you select the Paint tool.

## Related Topics

- [Paint Tool Properties](#) on the facing page

# Create Breaking Triangles to Paint Brush Strokes

The Brush tool is often the most intuitive and rapid tool for creating rough sketches and clean lines. A single colour, such as black, is often used when tracing a clean version of a rough sketch. However, when it comes time to soft trace the lines in different colours, the flattened or unflattened clean brush strokes can suddenly become time consuming to ink.

Toon Boom Animate provides a solution by creating triangular breaks at natural line intersections. These intersections are the probable locations of where colour line breaks may occur, such as where a sleeve meets a hand.

**To create breaking triangles on a drawing:**

1. In the Camera or Drawing view, use the Select tool to select part or all of the drawing to be broken.



2. In the top menu, select **Drawing > Create Breaking Triangles**. If your brush strokes are not flattened, they will be flattened automatically before the breaking occurs.



3. Use the Repaint tool  to paint the outline of different colour zones with different colours.

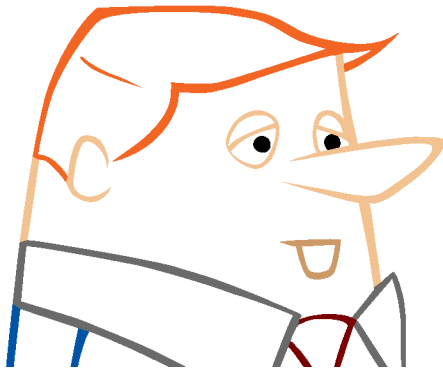

## Paint Tool Properties

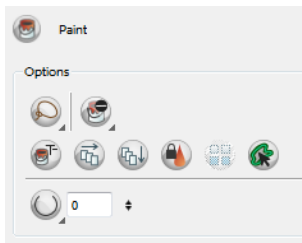

When you select the Paint tool, its properties and options appears in the Tools Properties view.



- [Lasso and Marquee](#) below
- [Painting Mode](#) on the next page
- [Automatic Close Gap](#) on page 294
- [Paint and Remove Texture](#) on page 295
- [Apply to Multiple Drawings](#) on page 295
- [Apply to All Visible Drawings](#) on page 296
- [Respect Protected Colour](#) on page 296
- [Use Stored Colour Gradient](#) on page 297
- [Select Newly Painted/Repainted/Unpainted Contours/Lines](#) on page 297

## Lasso and Marquee

The Lasso and Marquee options let you choose what type of selection the Paint tool will do when you will click and drag your cursor to paint your drawings. The default selection mode is Marquee.

- The Marquee  option makes a rectangle selection box. Everything inside the selection will be painted according to the painting mode you selected.
- The Lasso  option lets you draw a custom selection box around the zones to be painted. Everything inside the selection will be painted according to the painting mode you selected.

Hold down the [Alt] key to switch to the opposite mode of your selection.



## Painting Mode

The Paint tool has four different modes available:

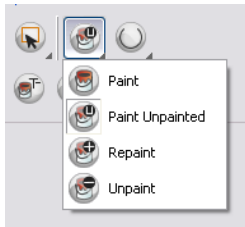

 Paint Mode

 Paint Unpainted Mode

 Repaint Mode

 Unpaint Mode

You can also find these tools directly in the Tools toolbar and in the Drawing Tools menu.

### Paint Mode



The Paint  mode paints everything it touches, including empty and filled zones.

### Paint Unpainted Mode

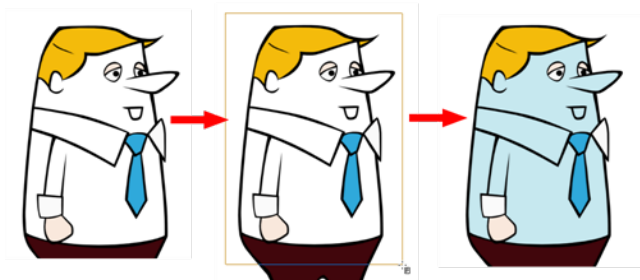

The Paint Unpainted  mode paints only empty zones. Any line or filled zone will remain unchanged.

## Repaint Mode

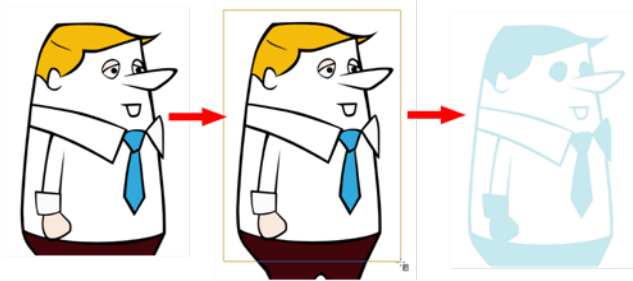

The Repaint  mode paints everything it touches except empty zones. Any zone that is not painted will remain intact.

## Unpaint Mode

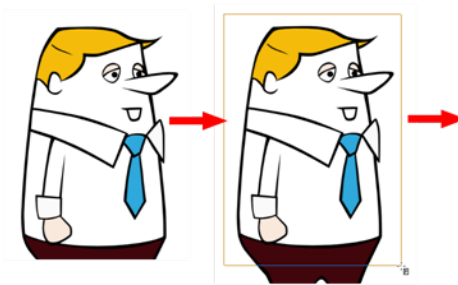

The Unpaint  mode unpaints everything it touches, including empty and filled zones.

## Automatic Close Gap

The Automatic Close Gap option has four modes available:

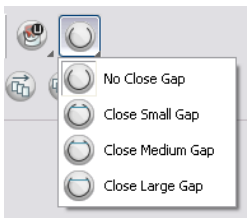

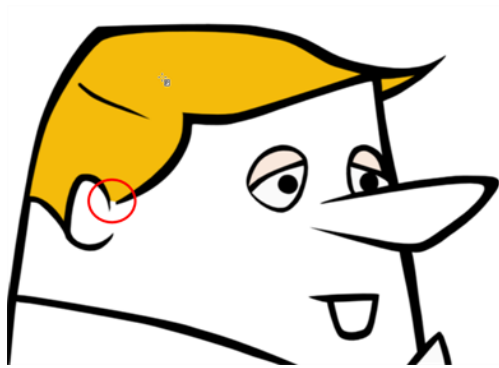

The Automatic Close Gap  option is used while painting drawings with small gaps. Instead of having to close them manually either with the Brush tool or Close Gap tool, Toon Boom Animate will analyze the drawing and close the gaps while you paint according to the selected mode.

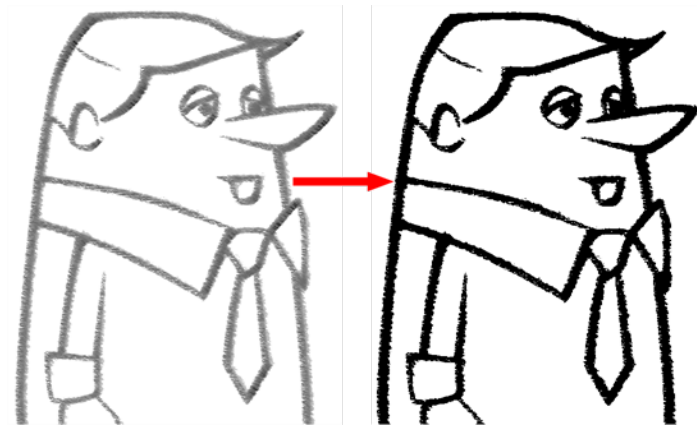

The automated gap closing should be done using the zoom function setting of your Camera or Drawing view. If your eye does not see the gap, Toon Boom Animate won't either.

## Paint and Remove Texture



The Paint and Remove Texture  option is used when you vectorized some images as greyscale texture style.

An image vectorized as texture is a mix of bitmap filling encapsulated in a vector based frame. Painting a textured zones with the Paint tool will change the tint of the textured lines. Painting the textured zones using the Paint and Remove Texture option transforms the bitmap filling into a 100% vector based zone and fills it with a solid colour.

## Apply to Multiple Drawings

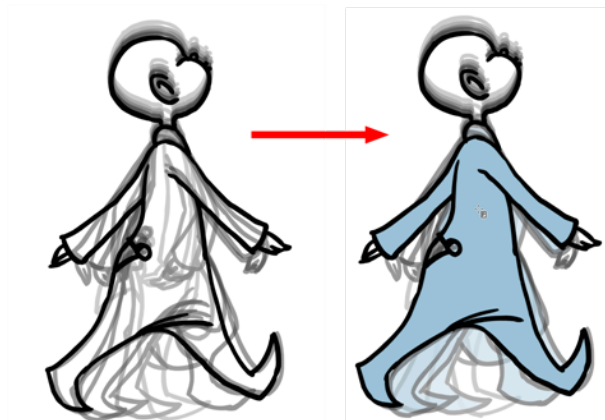

The Apply to Multiple Drawings  option is used for hand-drawn animation fast painting. When you want to paint several drawings in a same layer at once, such as a walk cycle, you can enable this option and make a selection in your Camera or Drawing view. All the closed zones located within your Paint tool selection are painted with the selected colour swatch.

You do not need to enable the Onion Skin preview to use this option. The option will stay enabled only for the next action. If you want to use it again, you must click on the Apply to Multiple Drawings button again, or press [Alt] + [A].

## Apply to All Visible Drawings

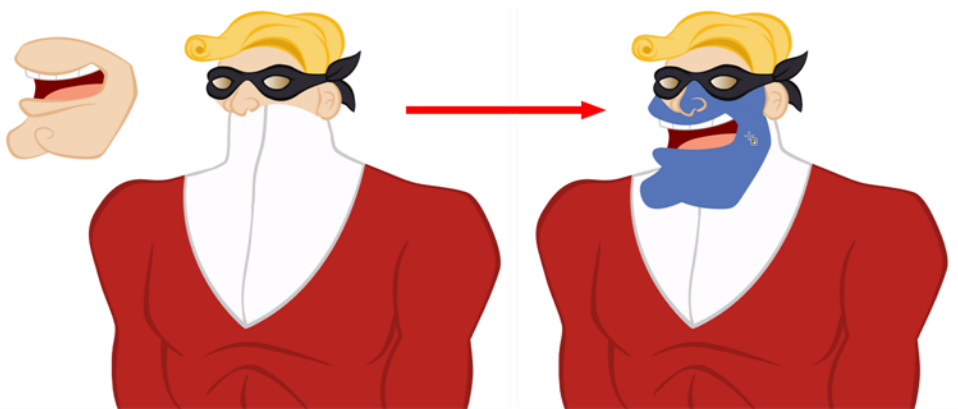

The Apply to All Visible Drawings  option is used to paint several drawings on separated layers on the current frames. If you have a character broken in several layers, you can enable this option to paint all your layers at once. The operation is only applied on the current frame.

The option will stay enabled only for the next action. If you want to use it again, you must click on the **Apply to All Visible Drawings** button again.

This option is only available in the Camera view and does not affect symbols.

## Respect Protected Colour

The Respect Protected Colour  option is enabled by default. In your Colour view, you can protect some colour swatches to avoid repainting or unpainting the zones linked to that swatch.

If you disable this option the Paint tool will not follow the protect colour rule and will repaint or unpaint the protected colours on your drawings until you enable the option again.



Refer to the [Protecting Colours on page 313](#) topic to learn how to lock your colours.

## Use Stored Colour Gradient



When you paint a zone with a gradient or textured colour swatch, the gradient or texture's position is set relative to the size of the zone you are painting. If you want the Paint tool to use a particular size and position, you must first store your desired position and size using the Select  tool and then enable the **Use Stored**

**Colour Gradient**  option in the Paint tool Tool Properties view.



Refer to the [Storing Your Favourite Gradient or Texture Settings](#) on page 308 topics to learn how to store your gradient or texture position.

---

## Select Newly Painted/Repainted/Unpainted Contours/Lines

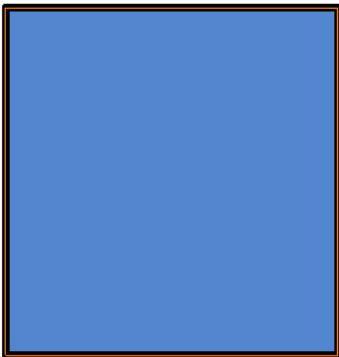

In the Paint  tool Tool Properties view, engaging this option will keep a selection highlighted around the latest painted zone after using either the Paint, Repaint, Unpaint, or Paint Unpainted tool.

### Related Topics

- [Painting Using the Paint Tool on page 290](#)

# Painting Pencil Lines with the Ink Tool

Although pencil lines can be painted in much the same way as closed zones, you can use the Paint, Repaint, Repaint Brush, and Ink tools to make painting segmented lines easier.

Normally when you have a drawing, such as the one below, and you use the Paint tool to paint one of the lines, the entire line is painted.

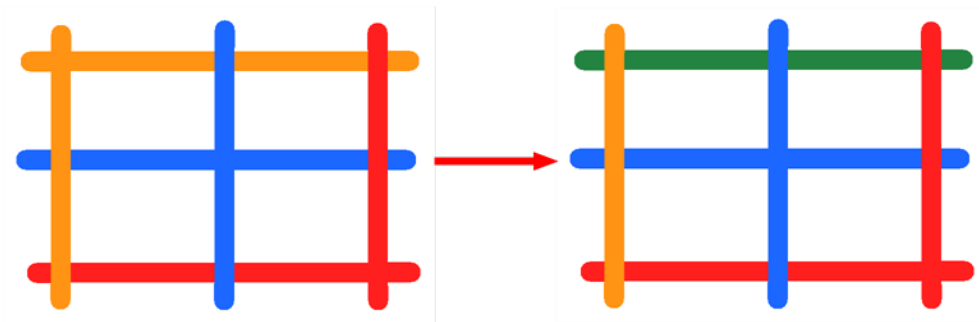

However, if you select the **Ink**  tool instead and click on the same pencil line, only the segment that you clicked on between two intersections will be painted.

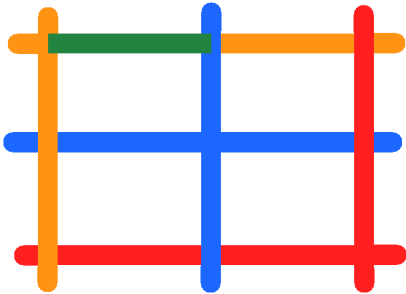

The newly inked segment will always be moved to the front of all other pencil strokes, even if it was behind all other pencil strokes before it was inked.

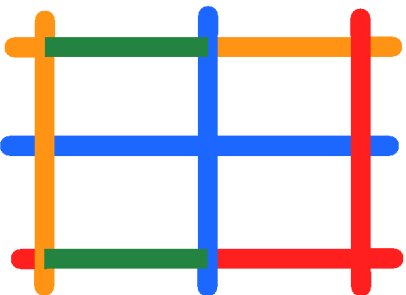

That is, unless you hold down [Alt] while clicking a segment. Then the opposite becomes true. The inked segment will be sent to the back, even if it was in front of all other segments to begin with.

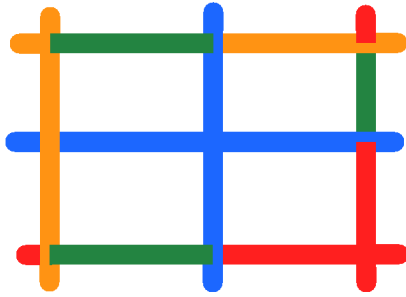

Painting and Inking can be used in combination depending on what it is that you need to paint. If you need to ink a character's outline in black, it might be easier to use the Paint tool. If you need to paint the outline of a character's neck with a tan colour and its shirt outline blue and both the neck and shirt belong to the same continuous outline, then the Ink tool might prove more useful.

## Related Topics

- [Ink Tool Properties](#) below

# Ink Tool Properties

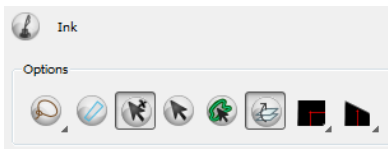

When you select the **Ink** tool, its properties and options appears in the **Tools Properties** view.



- [Lasso and Marquee](#) below
- [Show Inkable Lines](#) on the facing page
- [Be Smart on Connecting Lines](#) on the facing page
- [Select Mode](#) on the facing page
- [Arrange Ink Lines](#) on the facing page
- [Mitre](#) on the facing page
- [Tip Style](#) on the facing page

## Lasso and Marquee

The Lasso and Marquee options let you choose what type of selection the Paint tool will do when you will click and drag your cursor to paint your drawings. The default selection mode is Marquee.

- The Marquee  option makes a rectangle selection box. Everything inside the selection will be painted according to the painting mode you selected.
- The Lasso  option lets you draw a custom selection box around the zones to be painted. Everything inside the selection will be painted according to the painting mode you selected.

Hold down the [Alt] key to switch to the opposite mode of your selection.

## Show Inkable Lines

The **Show Inkable Lines**  option highlights all pencil lines (so no brush strokes) on the selected layer. Pencil line segments that are already inked with the selected swatch colour from the colour palette are also not highlighted.

## Be Smart on Connecting Lines

With this  option selected, as you hover and move the cursor across intersecting pencil lines, the path that you create will get highlighted. When you click on your mouse or stylus the highlighted segments will get inked.

With this option disabled, all the intersecting segments that your cursor comes near will get highlighted and become part of the selection, even if they were not situated in the direction of the chosen path.

This option only works if the **Ink** tool is in **Hover Mode** and not **Select Mode**.

## Select Mode

Use this  mode instead of the **Hover Mode**. In the **Hover Mode**, any potentially inkable pencil line will have its central vector line highlighted as the **Ink** tool's cursor hovers over it. Use [Ctrl] (Windows) or [⌘] (Mac OS X) to toggle between the two modes.

## Arrange Ink Lines

Use this  option to have every newly inked line be brought to the front. Disable this option to have every newly inked line be sent to the back. Use [Alt] to toggle between the two options.

## Mitre

As you hover over two perpendicular or nearly perpendicular segments a highlighted path with a corner is created. Clicking on these highlighted segments inks both segments and makes them appear as a single stroke with a corner or bend.

Click on the **Mitre**  button to reveal four options from its drop down menu. Select either **Round**, **Mitre**,

**Bevel** or **As Is** before creating corner selections to make a bend in the path either round, sharp, bevelled or gapped.

## Tip Style

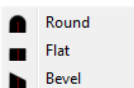

Use the **Tip Style** option to customize the edge of the **Ink** tool.



## Related Topics

- [Painting Pencil Lines with the Ink Tool](#) on page 298

# Selecting a Colour in a Drawing

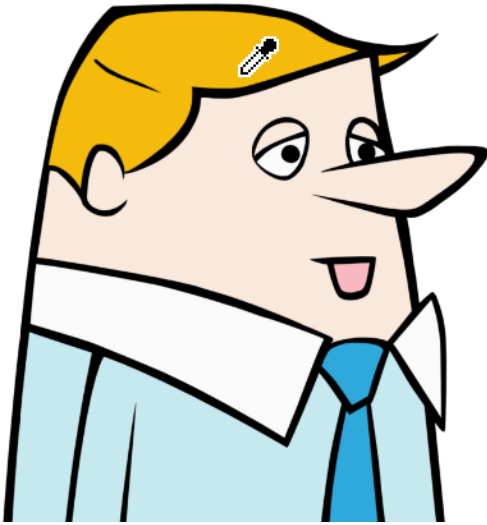

While working in your Camera or Drawing view, you can use the Dropper  tool to pick a colour from your drawing without going to the Colour view.

## To use the Dropper tool:

1. In the Tools toolbar, select the **Dropper**  tool or press [Alt] + [D]. You can also select the Dropper tool from **Drawing > Tools > Dropper** in the top menu.
2. In the Camera or Drawing view, click on the desired colour.
  - If you are using another drawing tool such as the Paint tool, you can temporarily hold down the [D] key and click in your drawing before releasing the key to pick your colour. Once you let go the hot key, Toon Boom Animate will go back to your previous tool.

You may also want to select the zones painted with the colour currently selected in the Colour view. This can be useful to remove rough lines from a clean drawing.



**To select the zones painted with the current colour:**

1. In the Colour view, select the colour you want to select the corresponding zones from.

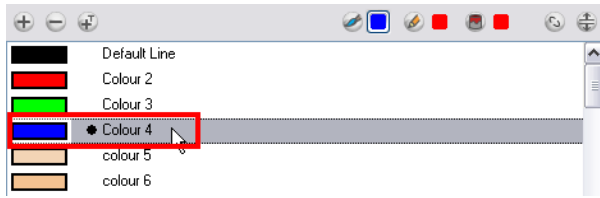

2. Select **Drawing > Select Strokes with Current Colour**.  
Or press [Ctrl] + [Shift] + [A] (Windows) or [⌘] + [Shift] + [A] (Mac OS X).

**Related Topics**

- [How to Paint on page 274](#)

# Editing Gradients and Textures



If you paint a zone or pencil line with a gradient or texture you can use the Edit Gradient/Texture  tool to modify its position in the zone. You can move, scale, rotate and skew. If you have to match the transformations performed on a gradient or texture from one zone or pencil line to many others, you can copy and paste the Edit Gradient/Texture position. When moving to the next drawing, you can select the next texture and paste the previous position to continue the modifications.

**To use Edit Gradient/Texture tool on a zone:**

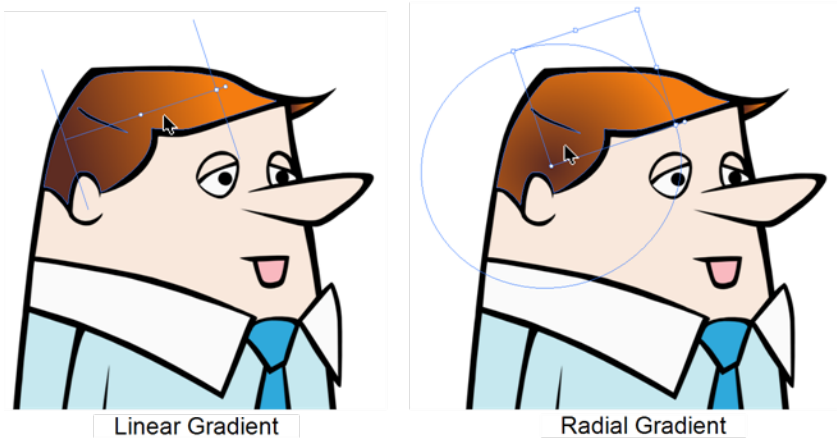

1. In the Tools toolbar, select the **Edit Gradient/Texture**  tool. You can also select this tool from the top menu under **Drawing > Tools > Edit Gradient/Texture** or press [Shift] + [F3].
2. Click on the Gradient or Texture zone to be modified.

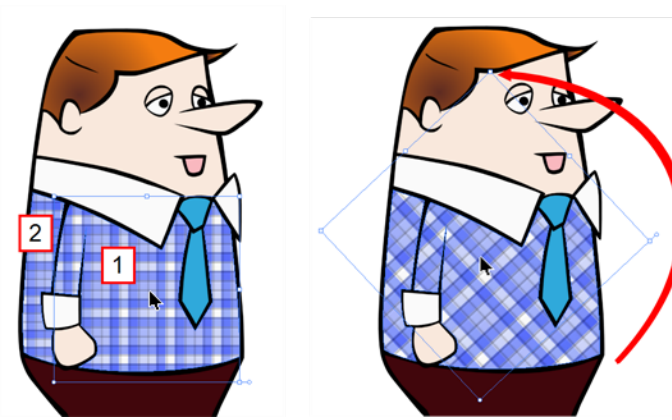

- ▶ If you want to modify several areas at once, hold down the [Shift] key and click on the zones to be modified.



3. Move the edit texture's anchor points to the desired result.
  - If the same modification needs to be applied to another gradient in another drawing or texture zone, you can select the modified zone and select **Edit > Copy**. Select the zone to be modified in the other drawing and select **Edit > Paste**.

A pencil line can have its gradient, texture or texture's gradient edited in two different ways, either with the Pencil Editor  or with the Edit Gradient/Texture  tool.

#### To use Pencil Editor tool to edit the texture or gradient on a pencil line:

1. In the Tools toolbar, select the Pencil Editor  tool. You can also select this tool from the top menu under **Drawing > Tools > Pencil Editor** or press [Alt] + [W].
2. Click on the pencil line to be modified to bring up its contour envelope.

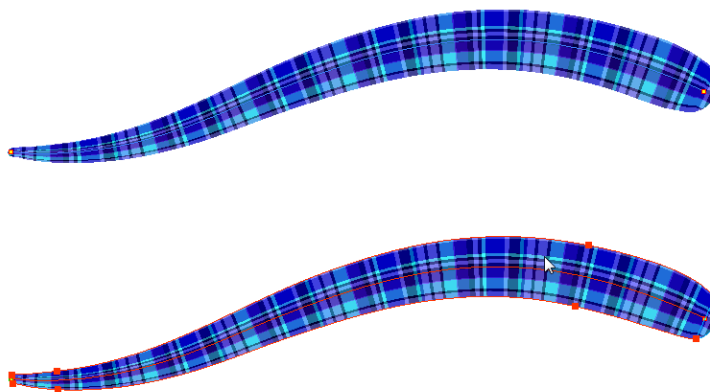

3. Select one of the contour points around the envelope and move its position to change the size of the tiled texture or gradient. You can also pull directly on the lines of the contour envelope or play with the bezier handles of any given point in order to continue to modify the envelope form.

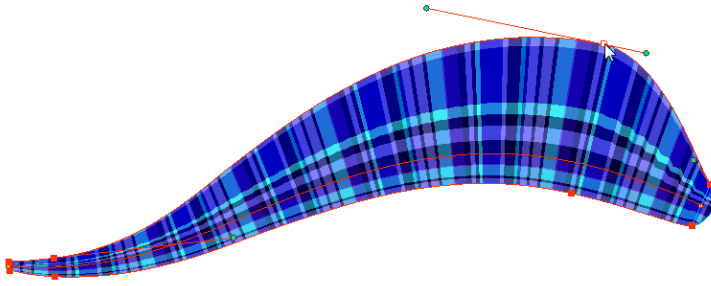

Expanding the width of the envelope parallel to the pencil line's central vector will cause the tiled texture to be stretched. Conversely, reducing the envelope's width will cause the tiled texture to look squashed. Reducing the contour's width perpendicular to the pencil line's central vector will reduce the number of tiles, while expanding it will increase the number of tiled images.

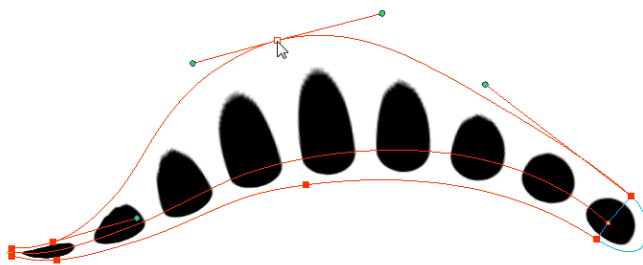

This editing technique does not just work on texture fills, but can also be applied to pencil lines drawn with a textured "brush".

#### To use Edit Gradient/Texture tool to edit the texture or gradient on a pencil line:

1. In the Tools toolbar, select the **Edit Gradient/Texture**  tool. You can also select this tool from the top menu under **Drawing > Tools > Edit Gradient/Texture** or press [Shift] + [F3].
2. Click on the pencil line to be modified to bring up the editor controls.

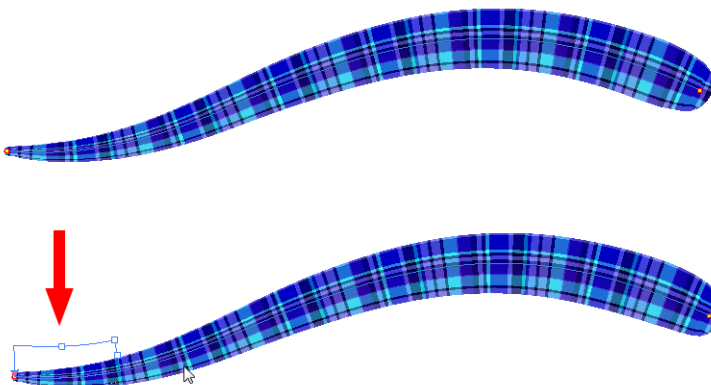

3. The editor controls delineate a single tile in the texture. For gradients, this is less applicable. Pull on the top of the editor controls to stretch the tiled texture throughout the length of the stroke.

As gradients are parallel to the stroke's central vector, this will stretch the way that the gradient is distributed in the pencil line's envelope. The envelope still acts as a boundary for the texture or gradient.

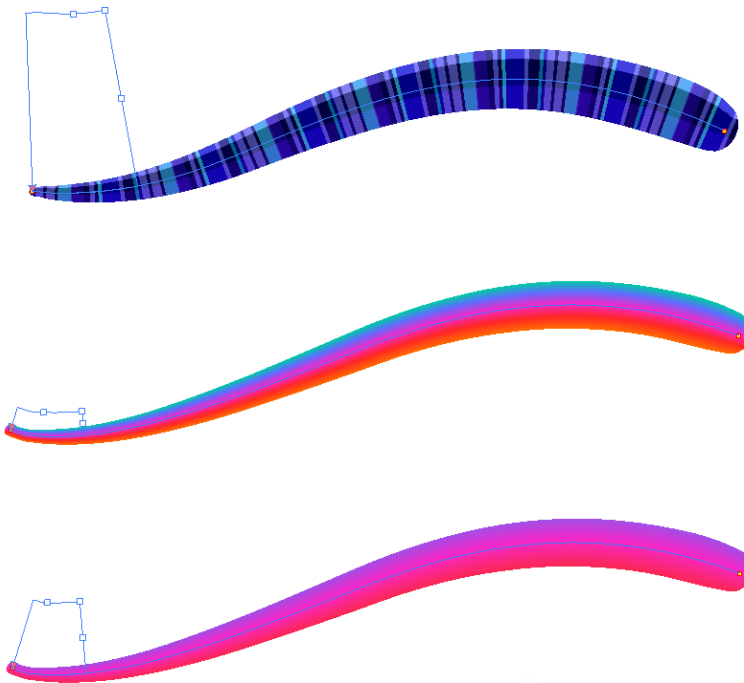

4. Drag the editor control perpendicular to the stroke. You will feel it glide along the stroke's central vector line. This is another way to resize the texture tile. Instead of stretching or shrinking it vertically, this motion stretches or shrinks it horizontally. As gradients are parallel to the pencil line's central vector, stretching them vertically gives no visual result.

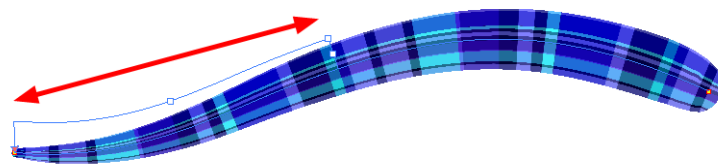

This way of editing a texture using the Edit Gradient/Texture tool also works with pencil lines drawn with textured "brushes". If you then paint your textured pencil line with a gradient, you can do so and then edit both elements independently at the same time.

#### To use Edit Gradient/Texture tool to edit both the texture and the gradient of a pencil line:

1. In the **Tools** toolbar, select the **Edit Gradient/Texture**  tool. You can also select this tool from the top menu under **Drawing > Tools > Edit Gradient/Texture** or press [Shift] + [F3].
2. Click on the pencil line to be modified to bring up the editor controls.

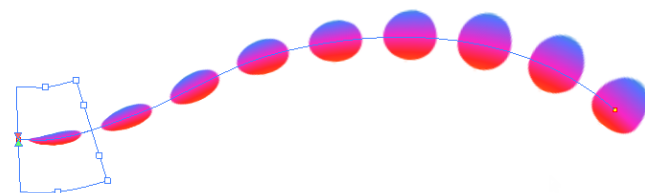

3. Use the top editor controls edit the gradient.

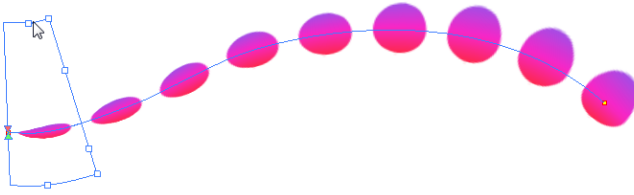

4. Use the bottom controls edit the "brush" texture.

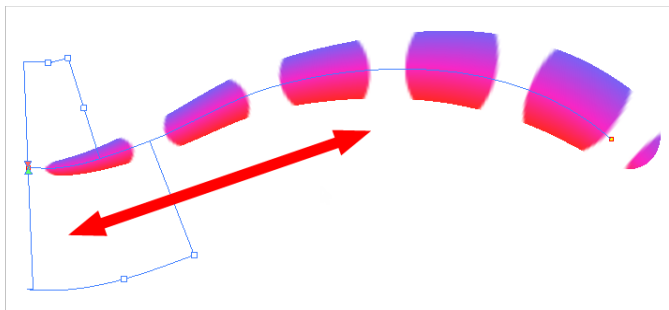
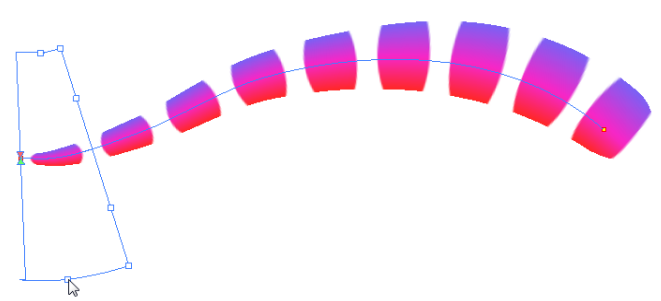

## Related Topics

- [Drawing Using the Pencil Tool](#) on page 130
- [Storing Your Favourite Gradient or Texture Settings](#) below

# Storing Your Favourite Gradient or Texture Settings

If you are painting a hand-drawn animation or if you want the Brush tool and Paint tool to use your gradient's position, angle and scale settings instead of the default ones, you can store your own settings and reuse them afterward.

**To store your gradient and texture settings:**



1. In the Tools toolbar, select the **Select**  tool or press [Alt] + [S].
2. In the Camera or Drawing view, select the gradient or texture zone to store.

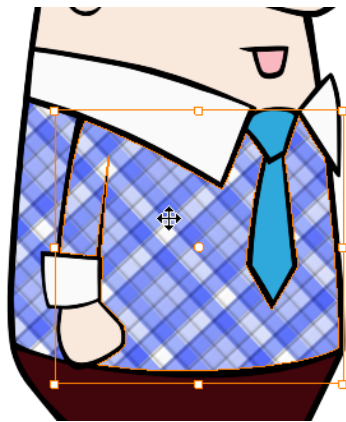



3. In the **Tool Properties** view, click on the **Store Colour Gradient**  button.

**To use the stored gradient and texture settings:**

1. In the **Tools** toolbar, select the **Brush**  or **Paint**  tool.
2. In the **Tool Properties** view enable the **Use Stored Colour Gradient**  button.
3. In the **Camera** or **Drawing** view, draw and paint.

**Related Topics**

- [Editing Gradients and Textures](#) on page 304

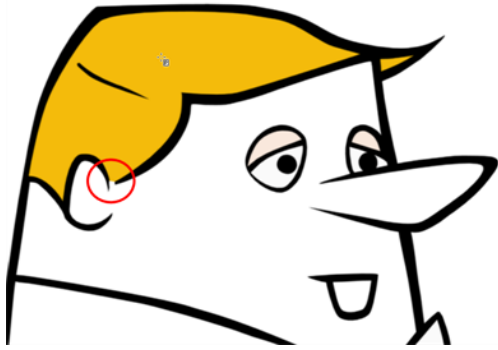

# Closing Gaps Manually



When painting, you will notice that some of your drawing areas are not closed. To close the zone you can either draw the missing line with the Brush or Pencil tool, but you can also close the gap with an invisible line. To do so, you will use the Close Gap  tool.

The Close Gap tool is used to close small gaps in a drawing. The Paint tool only paints closed areas. The Close Gap tool will create a small, invisible stroke between the two closest points to close the colour zone. You do not need to trace directly over the gap. You can draw it a few millimetres away and the Close Gap will automatically choose the two closest points and close the gap.

## To use the Close Gap tool:

1. In the **Tools** toolbar, select the **Close Gap**  tool. You can also select the **Close Gap** tool from the top menu under **Drawing > Tools > Close Gap** or press [Alt] + [C].
  - ▶ Enable the **Auto-Flatten**  option in the Tool Properties view if you want the stroke you will draw to be flattened in your drawing instead to be on top.
  - ▶ You can display the invisible lines with the Show Strokes option under **View > Show Strokes** or press [K].
  - ▶ If you do not display the strokes, a Message dialog box will appear.

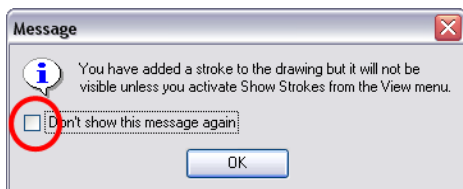

Enabling the Don't Show This Message Again option prevents this Message dialog box from appearing.

2. In the Camera or Drawing view, trace an invisible line near to the gap to be closed. The gap will automatically close.

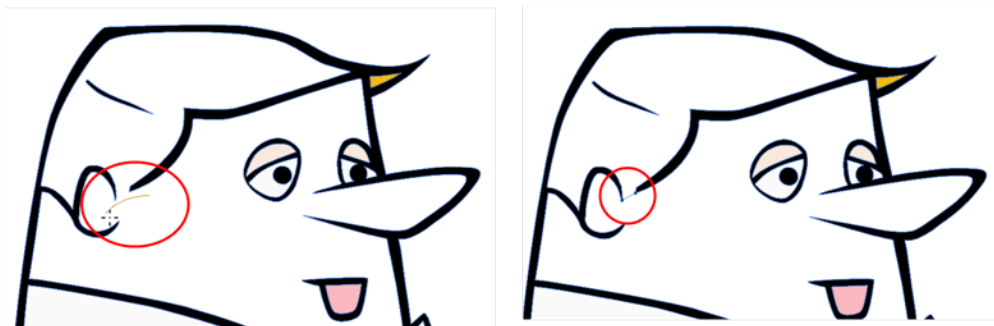

## Related Topics

- [Close Gaps](#) below
- [How to Paint](#) on page 274

## Close Gaps

When you have too many gaps in your drawings, you can use the Close Gaps feature in Toon Boom Animate

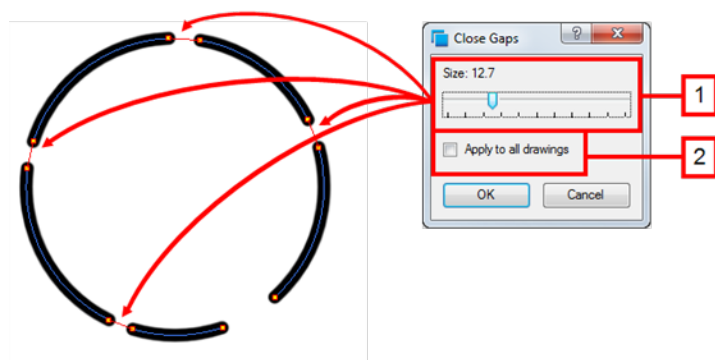

1. Close Gaps slider: Use this slider to determine the size of the gap you want to be closed. Move the slider to the left for smaller gaps and move it to the right for bigger gaps.
2. Apply to all drawings: Enable this option so that the **Close Gaps** feature is applied to all the drawings of the selected layer.

### To use the Close Gaps feature:

1. Select the **Show Strokes** option to see a preview of the result.
2. Select **View > Show Strokes** or press [K].
3. Select **Drawing > Clean Up > Close Gaps** or press [Shift] + [F10] (Windows only).

The Close Gaps dialog box opens.

4. Adjust the slider.

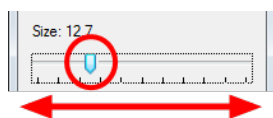

5. Select the **Apply to all drawings** option if needed.

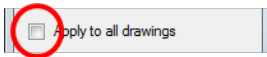

6. Click OK.



Refer to [Colour Preferences](#) on page 336 at the end of this chapter to learn more about the Close Gap options.

---

## Related Topics

- [Closing Gaps Manually](#) on page 310

# Protecting Colours

When you are finished painting some zones, you can protect the colour swatch they are associated with so the work cannot be accidentally painted over.

## To use Protect Colour:

1. In the Colour view, select the colour to be protected.

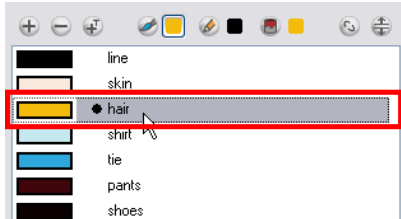

2. In the Colour view menu, select **Colours > Protect Colour**. You can also right-click on the selected colour and select **Protect Colour**.

A red bar will appear on the side of the colour, notifying you that it is locked.

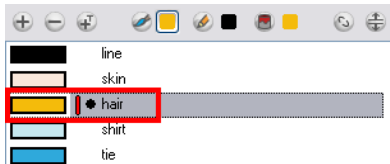

## Related Topics

- [Respect Protected Colour](#) on page 296

# Line Art and Colour Art Layers

Toon Boom Animate has an option allowing you to paint the lines and the colour fills separately.

In Toon Boom Animate, a drawing is composed of two embedded layers:

- Line Art Layer
- Colour Art Layer





The Line Art and Colour Art layers are only available in the Advanced Art Mode.

You can draw and paint in all layers, but if you prefer working in a single layer, you can do everything in Line Art.

The main advantage of using the Line Art and Colour Art option is so you can repaint the lines easily. If your colour fills are separated from the lines, it allows you to use the repaint tool and paint the lines without affecting the colour zones. Also, it allows you to paint tones and highlights in line art and then add some transparency to see the Colour Art through it.

**To toggle between Line Art and Colour Art and enable the Preview mode:**

1. In the Tools toolbar, select any drawing tool.
2. To toggle between Line Art and Colour Art:
  - In the Drawing view, right-click and select **Switch to Colour Art/Switch to Line Art** or s[L].
  - In the Drawing or Camera bottom toolbar, click on the **Colour Art**  button.
  - In the Drawing or Camera bottom toolbar, click on the **Line Art**  button.
3. To preview the Line Art and Colour Art at the same time:
  - In the Drawing view, right-click and select **Preview Line Art and Colour Art**. While using the Preview mode, you still edit one mode at a time or press [Shift] + [P].
  - In the Drawing or Camera bottom toolbar, click on the **Preview**  button. To be able to see only one of the layers at a time in the Camera view, you must enable the **Current Drawing on Top** option, available from the Camera bottom toolbar drop-down menu. If this option is not enabled, you will see the final composition of all four layers.

## Related Topics

- [Generating a Matte for Your Animation](#)
- [Creating Strokes to Paint Your Drawings on a Separated Layer](#) on the next page
- [Drawing Layers](#) on page 268

## Creating Strokes to Paint Your Drawings on a Separated Layer

You can use the outline you traced on one of the four embedded layers and create invisible strokes to paint your drawings on separate layers, this provides more inking and painting flexibility.

To do so, you must use the **Create Colour Art from Line Art** option. You can also configure the option to create the invisible strokes on any of the four embedded layers.



Make sure to enable the Advanced Art Mode in the Preferences panel in order to be able to use this feature.

**To create Colour Art zones out of the Line Art content:**

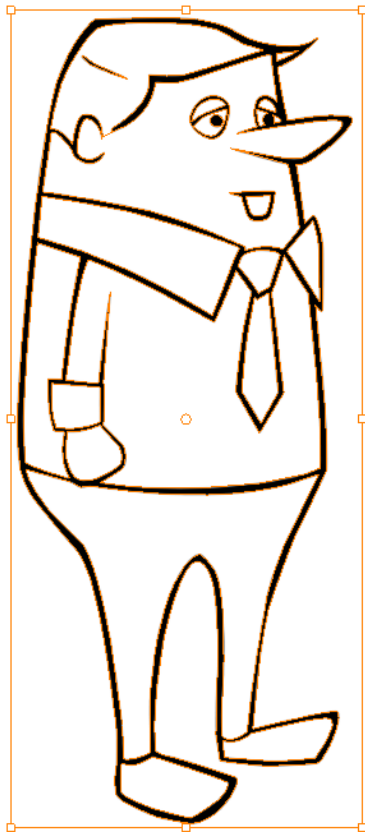

1. In the Tools toolbar, select the **Select**  tool or press [Alt] + [S].
2. In the Camera or Drawing view, select the artwork to transfer to the Colour Art.

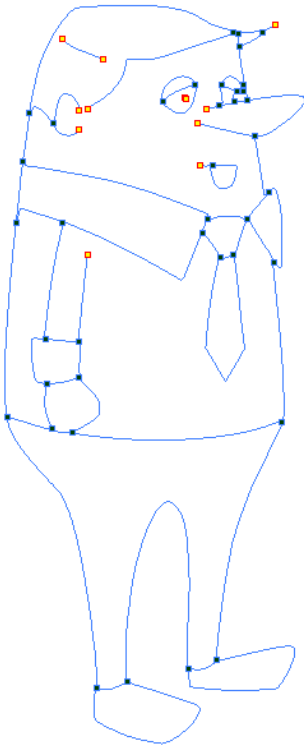

3. In the Drawing View toolbar, click on the **Create Colour Art from Line Art**  button or press [\*].



### To Configure the Line Art to Colour Art command settings:

1. In the Tools toolbar, select the **Select**  tool or press [Alt] + [S].
2. In the Tool Properties view, hold down the [Shift] key and click on the **Create Colour Art from Line Art**  button to open the Configure Line Art to Colour Art dialog box and modify the default settings of this command.

The Configure Line Art to Colour Art dialog box opens.

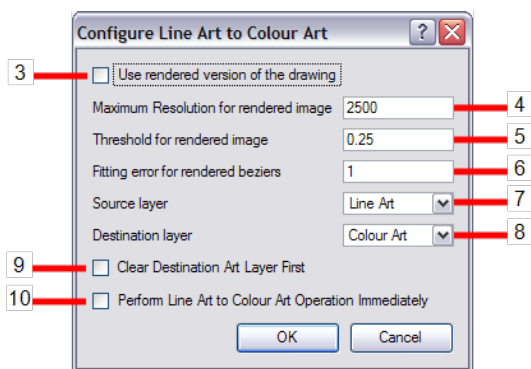

3. Use rendered version of the drawing: This option will render the drawing and vectorize it to calculate the position of the centreline that will produce the colour art stroke.
4. Maximum Resolution for rendered image: This is the size of the rendered image.
5. Threshold for rendered image: The value of grey processed to create the rendered vectorized arts.
6. Fitting error for generated Beziers: This value represents how precise the fitting of the colour art zone in relation of the line art will be.



7. **Source Layer:** In the Source Layer drop-down menu, select the layer (Line Art, Colour Art, Underlay or Overlay) you want the strokes to be created from.
8. **Destination Layer:** In the Destination Layer drop-down menu, select the layer (Line Art, Colour Art, Underlay or Overlay) you want the strokes to be created on.
9. **Clear Destination Art Layer First:** If you already have artwork on the destination layer and you want the content to be deleted before the strokes are added into it, enable this option.
10. **Perform Line Art to Colour Art Operation Immediately:** Enable this check box to perform the Create Colour Art from Line Art command when you click on the OK button of this window.

## Related Topics

- [Line Art and Colour Art Layers](#) on page 314

# Verifying Zones are Painted

When the painting process is completed, you should verify that each zone was painted correctly.

The Backlight feature produces a silhouette effect by changing the drawing's coloured areas into a single dark, solid colour use this to verify the completeness of the ink and paint process. Any unpainted zones can be seen as the light shows through the unpainted areas of the silhouetted drawing.

**To use the Backlight:**



This feature is only available in the Drawing view.

---

1. In the top menu, select **View > Backlight** or press [Alt] + [Shift] + [B]. You can also click on the **Backlight**  button available in the Drawing View toolbar.
2. Verify the drawings in the Drawing view.



## Related Topics

- [How to Paint on page 274](#)
- [Painting Using the Paint Tool on page 290](#)

# Palettes

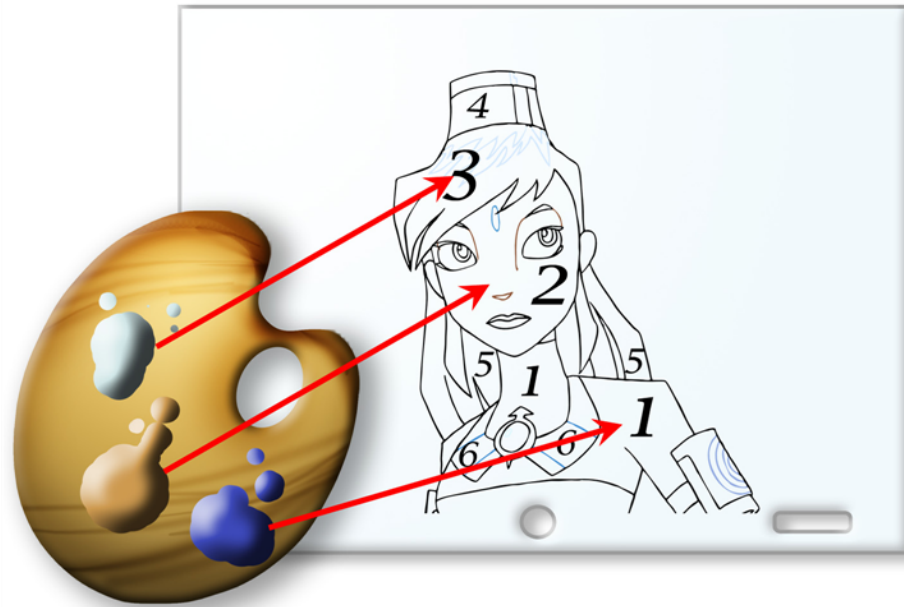

In colour animation, specific colours are used to paint each particular character. In order to maintain absolute consistency, a colour palette is created for each character, prop and effect throughout the production. These are referred to as master palettes.

Master palettes contain a colour swatch for each zone to colour with a precise RGBA colour value.

Using a master colour palette has many benefits, including:

- Each character consistently retains their dedicated colours.
- You cannot accidentally use a colour which is not in the master palette.
- Standardization and colour consistency throughout the production
- Multiple artists can use the same colour palette and produce the same results.

Toon Boom Animate uses palettes to hold all of the colours needed to paint your elements, allowing complete control and consistency in your painting process.

A palette is created by assigning a set of colours to each character, prop or effect. You will create a new palette and add a new colour, known as a colour swatch, for each zone of the character, such as the skin, hair, tongue, shirt, pants, etc.

This topic is divided as follows:

- [Displaying the Palette List on the facing page](#)
- [Creating a Colour Palette on page 321](#)
- [Copying and Pasting Colours on page 322](#)
- [Removing a Colour Palette on page 323](#)
- [Duplicating a Colour Palette on page 324](#)
- [Cloning a Colour Palette on page 325](#)

- [Mixing the Colours](#) on page 327
- [Importing a Colour Palette](#) on page 329
- [Ordering the Palette List](#) on page 330

## Displaying the Palette List

The Colour view has two modes: basic and advanced.

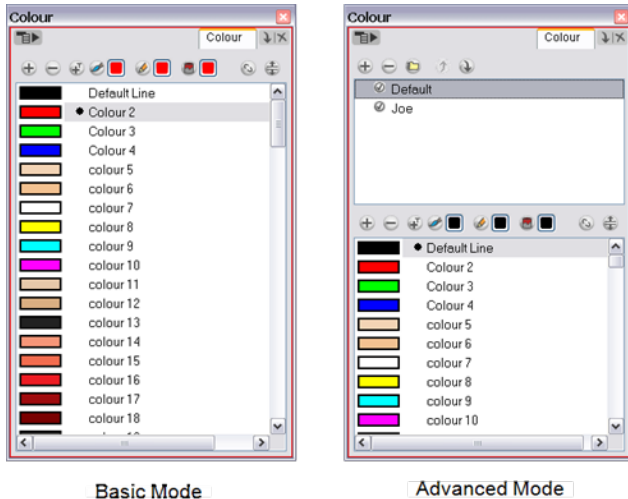

### Basic Mode

The Colour view's basic mode only shows the Colour list. When you open Toon Boom Animate, you only see the colours available in the default palette. This default palette contains six basic colour swatches and is automatically named the same as your scene. For simple projects, you can manage with the default palette, but for movies, series or shorts it is recommended that you create palettes for your characters. To create a palette, you have to switch to the advanced display of the Colour view and show the Palette list.

### Advanced Mode

To create palettes for your characters, you must display the Palette list. Once you display the Palette list area, a series of new buttons appear.

To show or hide the Palette List area:

1. In the Colour view, click on the **Show/Hide Palette List View**  button to expand or collapse the Palette List area.

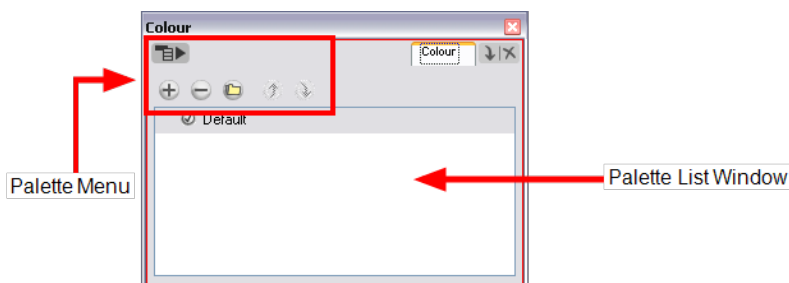

- Each palette you add in your scene will appear in the Palette list.
- You can add, delete, import and order palettes in your scene using the Palette menu buttons.

## Related Topics

- [Creating a Colour Palette](#) below

# Creating a Colour Palette

You can create a palette in either basic or advanced mode:

- [Basic Palette Lists Mode](#) below
- [Creating a Colour Palette](#) above
- [Renaming a Colour Palette](#) on the facing page

By default, Toon Boom Animate is set on basic mode. For simple productions, it is recommended to use the basic mode. For more advanced productions, it is a good idea to explore the possibilities of the advanced mode.



If you are using Animate Network, refer to [Managing Palettes](#).

---

## Basic Palette Lists Mode

To create a new palette (Basic Palette Lists mode):

1. In the Colour View menu, select **Palettes > New** or click on the **New Palette**  button.

The Create Palette window opens.

2. Enter the palette name according to the model.

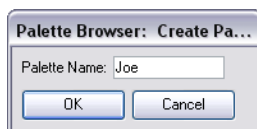

3. Click on **OK**.

The palette appears in the drawing element's palette list.



## Renaming a Colour Palette

To rename a palette:

1. In the Colour view, select the palette to rename.

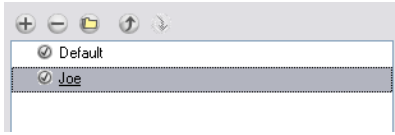

2. In the Colour View menu, select **Palettes > Rename**.
3. In the Rename dialog box, rename the palette.



4. Click **OK**.

### Related Topics

- [Copying and Pasting Colours](#) below
- [Removing a Colour Palette](#) on the next page
- [Duplicating a Colour Palette](#) on page 324
- [Cloning a Colour Palette](#) on page 325

## Copying and Pasting Colours

When you are creating palettes, you may want to copy colour swatches or their values and paste them in other palettes to save time.

To copy and paste colours

1. In the Colour view, select the colour to copy.

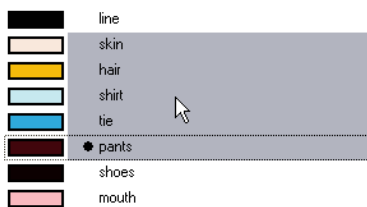

2. In the Colour View menu, select **Colours > Copy** or press [Ctrl] + [C] (Windows) or [⌘] + [C] (Mac OS X).
3. In the Palette list, select the palette in which you want to paste the colours.

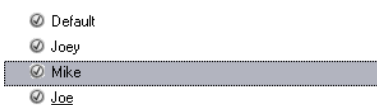

4. In the Colour View menu, select **Colours > Paste as New Colours** or press [Ctrl] + [V] (Windows) or [⌘] + [V] (Mac OS X).

- ▶ If you want to paste the colour values of the copied swatch over an existing colour swatch, select **Colours > Paste as Values**.

## Copying Colours from Another Palette

In Toon Boom Animate you can quickly copy a colour value from a palette in your scene to a selected colour swatch in a different palette.

### To use Copy Colour From:

1. In the Colour view, select the colour swatch you want to copy the colour into.
2. In the Colour View menu, select **Colour > Copy Colour From**, then select the palette where the colour you want to copy is listed and finally select the colour.

The selected colour swatch will immediately change to this new colour.

### Related Topics

- [Adding a Colour Swatch](#) on page 276

## Removing a Colour Palette

You can remove palettes from your Palette list if they are not needed in your scene. The actual palette file will not be deleted and you will be able to reimport it in your Palette list later on.

### To remove a palette:

1. In the Colour view, select the palette to remove.



2. In the Colour View menu, select **Palettes > Remove** or click on the **Remove Palette**  button.

- ▶ If the palette was in use in your scene, the zones painted with its colours will turn red.



### Related Topics

- [Creating a Colour Palette](#) on page 321
- [Duplicating a Colour Palette](#) on the facing page

- [Cloning a Colour Palette on the next page](#)

## Duplicating a Colour Palette

A duplicate palette uses the same names, colour values, but has a different ID and is independent from the original palette. This ensures that both palettes are completely independent.

This option is used when there are similar models and you want to avoid recreating and naming all of the colours. You can change the values and the names afterward. You can also keep some RGBA values, such as the eyes, teeth, tongue, inside mouth, etc.

### To duplicate a palette:

1. In the Colour view, select the palette to be duplicated.

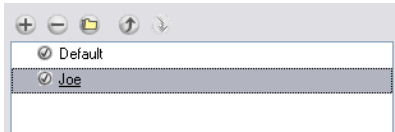

2. In the Colour View menu, select **Palettes > Duplicate**.

The Palette Browser: Duplicate Palette window opens.



3. Name the palette appropriately.
4. Click **OK** to create the palette.

The palette appears in the palette list.



### Related Topics

- [Cloning a Colour Palette on the next page](#)



## Cloning a Colour Palette

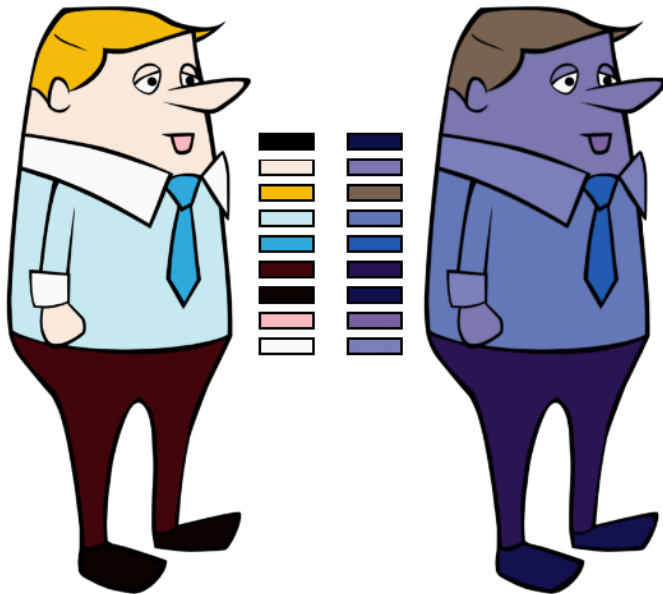

A character usually has only one master palette, although there are times when the characters are placed in different lighting conditions and require a different colour shading. The night palette is a popular choice when a scene or sequence changes from day to night. It can be difficult and time-consuming to repaint everything and creating two independent palettes can be quite complex. As an alternative, Toon Boom Animate provides clone palettes.

The clone palette is a copy of the master palette. The colours in each palette have the same properties. The colours have the same identification number pointing to the same colour zones, but they can have different names and RGBA values. Depending on the activated palette (night or day), the painted drawing will update. So there is no need to repaint the animation, but to create or import a clone palette (palette style).

### To clone a palette:

1. In the Colour view, select the palette to be cloned.



2. In the Colour View menu, select **Palettes > Clone**.

The Palette Browser: Clone Palette window opens.



3. Name the palette. (*It is recommended to keep the suffix "-clone" in the name.*)
4. Click **OK** to create the palette.

The clone appears in the palette list.



In the Colour view, you can also modify the colours individually by using the Colour Picker window or all at once using the Tint Panel window.



If there is more than one clone palette loaded, the system will use the one highest in the palette list.



When you want to see through painted drawings, but still see the outlines, you can create a clone palette where you set a lower alpha value on all of the filling colours. This trick can be handy when setting pivot points on cut-out puppets.

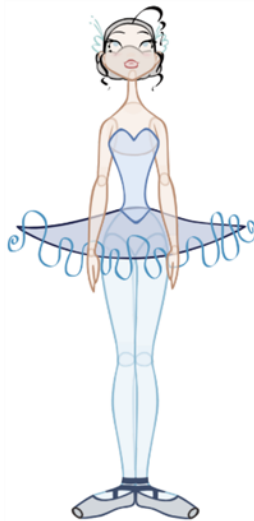

## Cloning a Colour Swatch

In Toon Boom Animate, you can copy a selected colour swatch and paste it as a clone.

### To clone a colour swatch:

1. In the Colour view, select the colour swatch you want to clone.
2. In the Colour View menu, select **Colours > Copy**. The [Ctrl] + [C] (Windows) or [⌘] + [C] (Mac OS X).
3. In the Colour view, select the colour palette you want to paste the clone into, or create a new palette.
4. In the Colour View menu, select **Colours > Paste as Clone**.

The cloned colour swatch appears in the palette.

Since it produces a clone colour swatch, it is impossible to use the Paste as Clone command in the same palette as you copied the original colour swatch from. If you try to do it, a Message dialog box will open as a reminder.

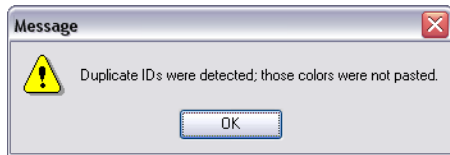

## Related Topics

- [Mixing the Colours](#) below
- [Duplicating a Colour Palette](#) on page 324

# Mixing the Colours

If you want to modify a series of colour at once to blend a tint in them or offset their RGBA values, you can use the Tint panel. The Tint panel is quite useful when creating palette styles such as night and day styles.

### To mix colours:

1. In the palette list, select the palette to offset or blend colours in it.



2. In the Colour View menu, select **Palettes > Tint Panel**.

The Blend/Offset Tint panel opens.

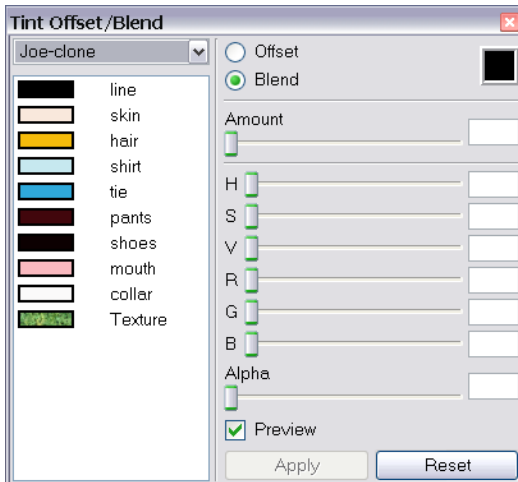

3. Select one or more colours to be modified in the colour list. To select all your colours, press [Ctrl] + [A] (Windows) or [⌘] + [A] (Mac OS X).

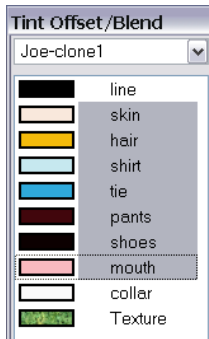

#### 4. Check **Preview**.

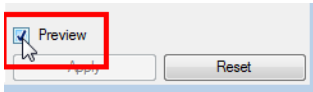

#### 5. **Offset, Blend** or **Mix** the selected colours.

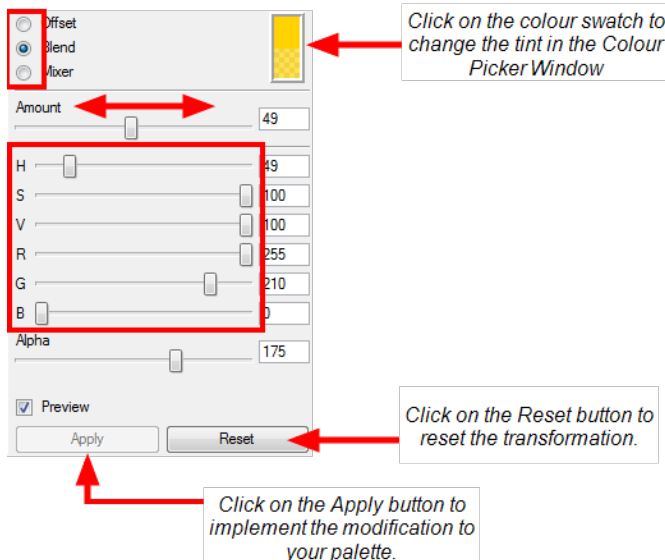

##### ▸ Offset

Use this option to simply offset the selected colours by the adjustments made using the HSB and RGB sliders. Use the Amount slider to adjust the degree of offset. Use the Alpha slider to adjust the opacity of the selected colour.

##### ▸ Blend

Use this option to blend the selected colours with the colour swatch in the top right corner. Use the Amount slider to adjust the degree of blend. A blend of 100% would turn the selected colours into the same colour as the swatch. Adjusting the HSB and RGB sliders affect the swatch colour, which in turn affects the selected colours on the left. Use the Alpha slider to adjust the opacity of the swatch.

##### ▸ Mixer

Select a Base and Tint colour to form a third colour swatch. Use the slider just beneath to mix the Base and Tint colours by different amounts. This will affect the mixed swatch whether it is selected or not. Select either the Tint or Base swatch and use the HSB and RGB sliders to adjust its colour. This will affect the mixed swatch colour, which in turn affects the selected colours on the left.



6. Click on the **Apply** button.
7. Close the Tint Offset/Blend Panel window.

## Related Topics

- [Cloning a Colour Palette](#) on page 325
- [Adding a Colour Swatch](#) on page 276

## Importing Palettes

- [Importing a Colour Palette](#) below
- [Importing Palettes](#) above
- [Importing Palettes](#) above
- [Importing Palettes](#) above

## Importing a Colour Palette

If you created a palette in another project and you would like to import it in your current project, you can browse for the palette file on your computer and add it to your project. When the palette is imported in your scene, the file is copied in the project's directory. It is not linked to the original file.

**To import a palette into your project:**

1. In the Colour View menu, select **Palettes > Import** or click on the Import Palette  button.

The Browser window opens.

2. Browse for a palette file located on your hard-drive. You will generally find the palettes in your projects' Palette-Library directory.
3. Click on the **Open** button.

The palette appears in the Palette list.

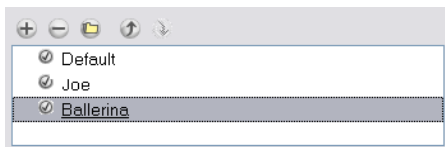

# Ordering the Palette List

When you are using several cloned palettes that are related to the same original palette, Toon Boom Animate uses the highest palette in the list to determine the colour of the painted zones.

To reorder palettes in the **Palette** list:

1. In the Colour View menu, select **Palettes > Move Up** or **Move Down**. You can also use the Up  and Down  icons.

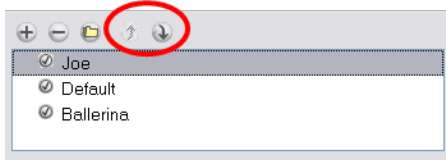

## Related Topics

- [Cloning a Colour Palette on page 325](#)

# Colour Model

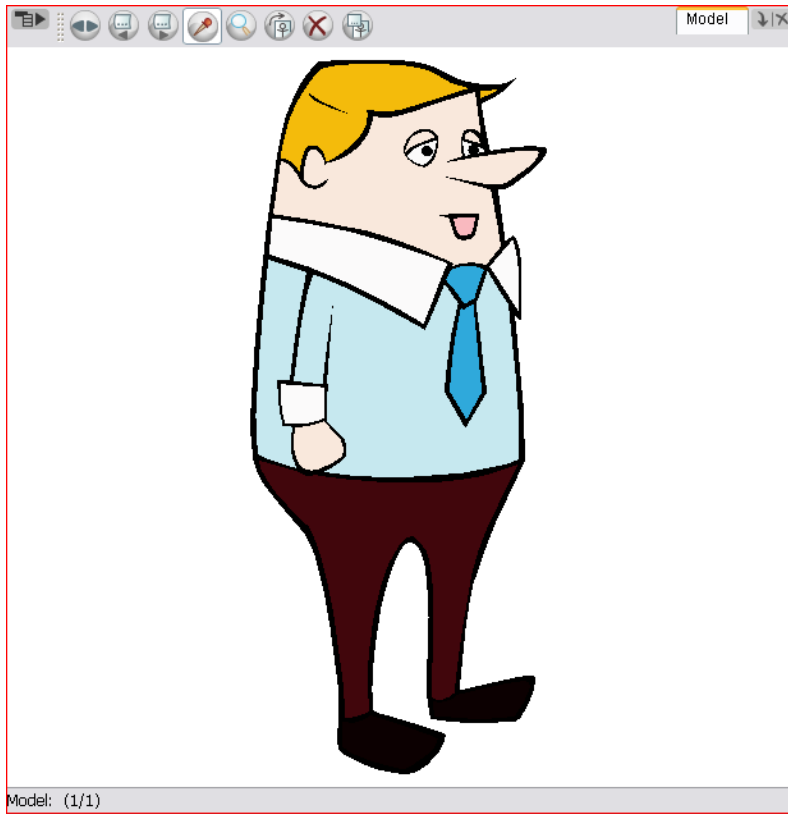

Once you have a fully painted drawing, you can use it as a colour model and load it in the Model view. That drawing can be used and loaded in any of your Animate scenes.

Once a drawing is loaded in the Model view, you can click on the **Dropper** , select a colour from the model and use it to paint in your Camera or Drawing view without having to pick the colour from the colour palette.

- [Loading a Colour Model below](#)
- [Cutting, Copying and Pasting from a Colour Model on page 334](#)

## Loading a Colour Model

To load a colour model from your Timeline or Xsheet view:

1. In the Timeline or Xsheet view, select the desired drawing (\*.tvg).

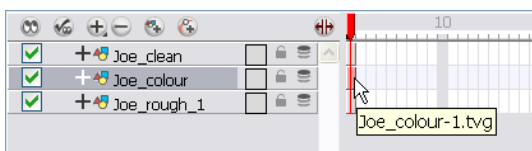

2. Bring the model into the Model view by doing one of the following:
  - In the Timeline view, click and drag the selected drawing and drop it directly in the Model view.
  - In the Model View menu, select **Use Current Drawing as Model**.

- ▶ Use **Current Drawing**  button in the Model View toolbar's extra buttons.

The model appears in the Model view.

#### To browse for a colour model drawing on your hard drive:

1. Do one of the following:
  - ▶ In the Model View menu, select **Import Model**.
  - ▶ Click the **Import Model**  button or from the Model View's toolbar.
  - ▶ Select **File > Import > Colour Model**.
2. In the Browser window, browse for any \*.tvg drawing file on your hard drive.
3. Click **Open**.

The model appears in the Model view.

#### To load the Default models:

1. In your scene's folder, create a new folder and name it models.
2. On your hard drive copy the \*.tvg drawing file you want to use as colour models in your scene.
3. In the Model View menu, select **Load Default Model**. You can also click on the **Load Default Model** 

button available in the Model View toolbar's extra buttons.

#### To load a single drawing from the Library view:

1. In the Library view, click the template containing the drawing to import in the Model view.
2. Right-click on the template and select **Open As Folder**.
3. In the Library view's left side, select the template's folder and continuing expanding its sub-folders until \*.tvg files appear on the right side.

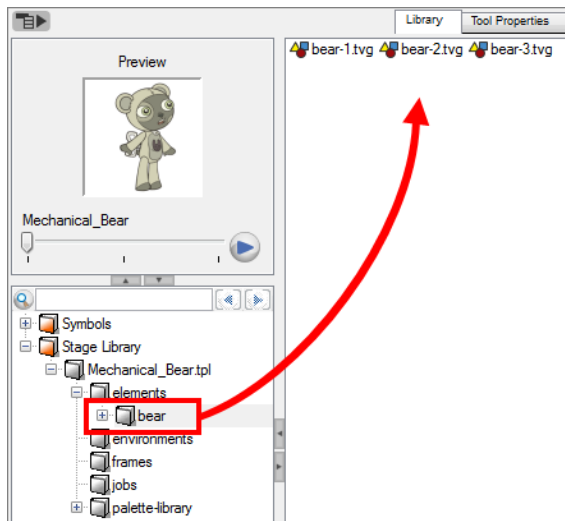



4. In the Library view's right side, select the TVG drawing to import and drag it into the Model view.

#### To load a template with multiple drawings from the Library view:

1. In the Library view, find the template you want to import in the Model view.
2. In the Library view's right side, click and drag the template (\*.tpl file) and drop it directly in the Model view.





- Use the **Scroll Backward**  and **Scroll Forward**  buttons, found in the Model view's toolbar, to view all the drawings contained in the template. This can often be the front, profile and 3/4 views of a character.

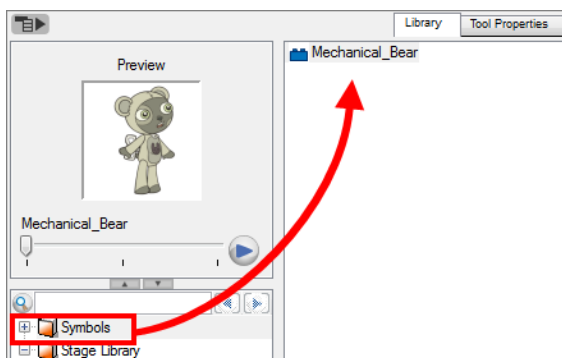

#### To load a symbol from the Library view:

- In the Library view's left side, click on the **Symbols** folder.
- In the Library view's right side, select the symbol that you would like to use as a model and drag and drop it directly into the Model view.



- Use the **Scroll Backward**  and **Scroll Forward**  buttons, found in the Model view's toolbar, to view all the drawings contained in the symbol. This can often be the front, profile and 3/4 views of a character.

#### To clear a colour model:

- In the Model View menu, select **Clear Model** or press [Delete].

# Cutting, Copying and Pasting from a Colour Model

You can do more than just copy colours from a colour model. Animate gives you the ability to copy parts of the character directly from its colour model and paste these elements into the Drawing or Camera views.

**To copy the entire model from the Model view:**

1. In the Model view's toolbar, select the **Select**  tool.
2. In the Model view, select your model.

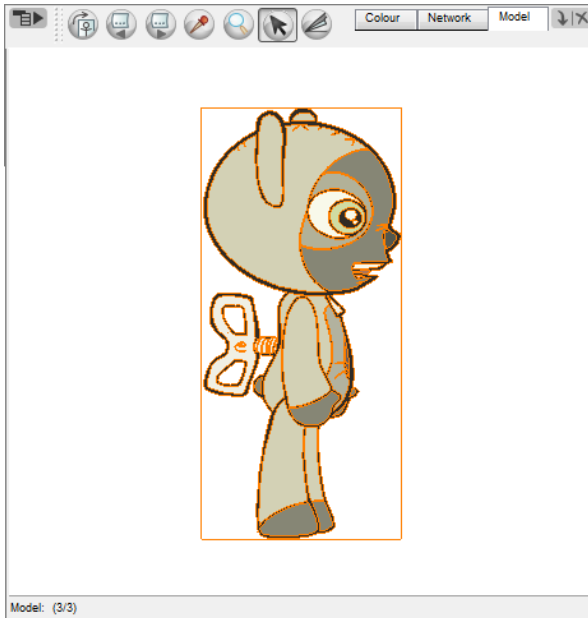

3. In the top menu, select **Edit > Copy Drawing Object** or press [Ctrl] + [C] (Windows) or [⌘] + [C] (Mac OS X).
4. In the Timeline view, make sure that you have the correct layer and frame selected.
5. Select either the Drawing or Camera views then go to the top menu and select **Edit > Paste Drawing Object**, or select the Timeline view and from the top menu select **Edit > Paste cells in the Timeline** or press [Ctrl] + [V] (Windows) or [⌘] + [V] (Mac OS X).

The model now appears in the selected view.

**To copy part of the model from the Model view:**

1. In the Model view's toolbar, select the **Cutter**  tool or press [Alt] + [T].
2. In the Model view, use the Cutter tool to create a selection around the part of your model that you would like to copy.

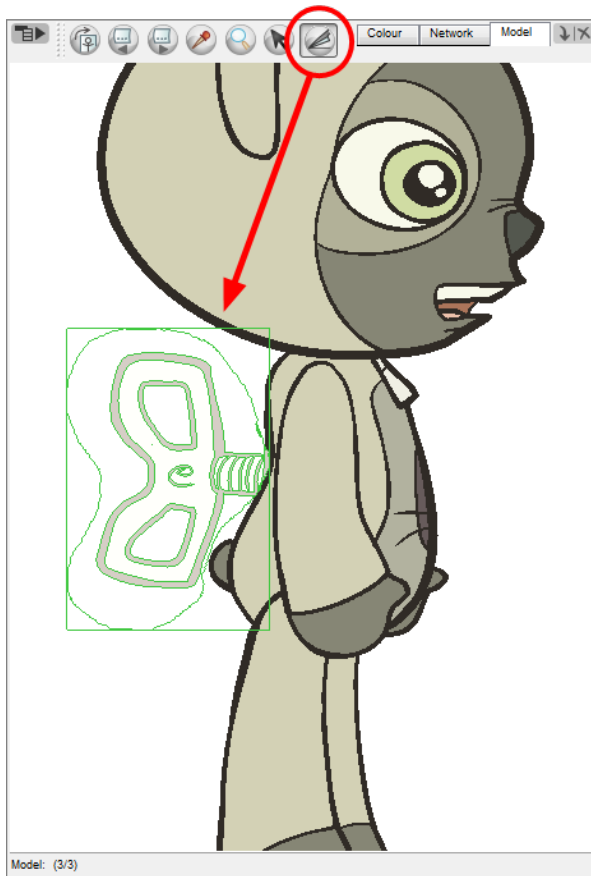

3. In the top menu, select **Edit > Copy Drawing Object** or press [Ctrl] + [C] (Windows) or [⌘] + [C] (Mac OS X).
4. In the Timeline view, make sure you have the correct layer and frame selected.
5. Do one of the following:
  - Select the Drawing or Camera view and select **Edit > Paste Drawing Object**.
  - Select the Timeline view and select **Edit > Paste cells in the Timeline** or press [Ctrl] + [V] (Windows) or [⌘] + [V] (Mac OS X).

The model appears in the selected view.

# Colour Preferences

Adjusting preferences to suit your techniques allows you to paint your drawings more efficiently.

To open the Preferences panel:

- ▶ Windows: Select **Edit > Preferences**.
- ▶ Mac OS X: Select **Animate > Preferences**.
- ▶ Or press [Ctrl] + [U] (Windows) or [⌘] + [U] (Mac OS X).

In the **Preferences** panel, you will find the following preferences that are related to adding colours to your project.

## Drawing Tab

The screenshot shows the Drawing Tab preferences panel with the following sections and options:

- Light Table**
  - Onion Skin Render Style: Enable Shade (dropdown)
  - Light Table: Enable Shade
  - Light Table: Shade in Camera View
  - Enable Onion Skin for Other Layers
  - Onion Skin : Maximum Wash Value (0.0-1.0) : 0.8
  - Onion Skin : Minimum Wash Value (0.0-1.0) : 0.4
  - Onion Skin : Maximum Opacity (0.0-1.0) : 0.8
  - Onion Skin : Minimum Opacity (0.0-1.0) : 0.2
  - Light Table : Wash (0.0-1.0) : 0.2
  - Light Table : Opacity (0.0-1.0) : 0.5
- Options**
  - Grid On By Default
  - Select Tool Is Lasso
  - Brush Size Cursor
  - Default Multiwheel Colour Picker
  - Auto Save Pencil Styles
  - Multi-Click Eye Dropper
  - Thumbnail View location: Right (dropdown)
  - Default Pencil Line Tip: Bevel Tip (dropdown)
- Settings**
  - Create New Colour Pots Using Default Colour (with a black color swatch)
  - Morphing Quality: 0.2
- Paint**
  - 0 (input field) Auto Gap Closing on Startup
  - Auto Gap Closing in Pixel Unit
- Zoom**
  - Enable Paper Zoom
  - Number of pixels per inch: 72 (input field) ppi
  - Maximum Zoom Factor: 4 (input field) X
  - Quick Close Up Zoom Factor: 4 (input field) X

## Default Multiwheel Colour Picker

Enable this option to display the Mutliwheel Colour Picker window instead of the regular Colour Picker.

## Sticky Eye Dropper

Enable this option to keep the Colour Picker's Dropper tool active until it is released by clicking on the Dropper icon again.

## Create New Colour Pots Using Default Colour

Set the default colour for creating a new colour swatch. Enable the option so that this default colour is used each time you add a new colour in your palettes. This option is useful for when you create new colour pots so that a more recognizable colour is created and not just a duplicate of the currently selected colour. Choosing a colour that is the opposite of your intended colour palette is recommended, such as grey if your palette will be filled with bright, primary colours.

## Auto Gap Closing on Startup

The values for automatic gap closing while painting drawings are:

- 0 = Disabled
- 1 = Small
- 2 = Medium
- 3 = Big

## Auto Gap Closing in Pixel Units

Disabling this option will cause your gap to be zoom dependant. Zoom dependent means that the more you zoom in, the smaller the gap you can close with the Close Gap tools. By enabling this option, you choose to make the gap display available in pixel units, which is not zoom dependant.

## General Tab

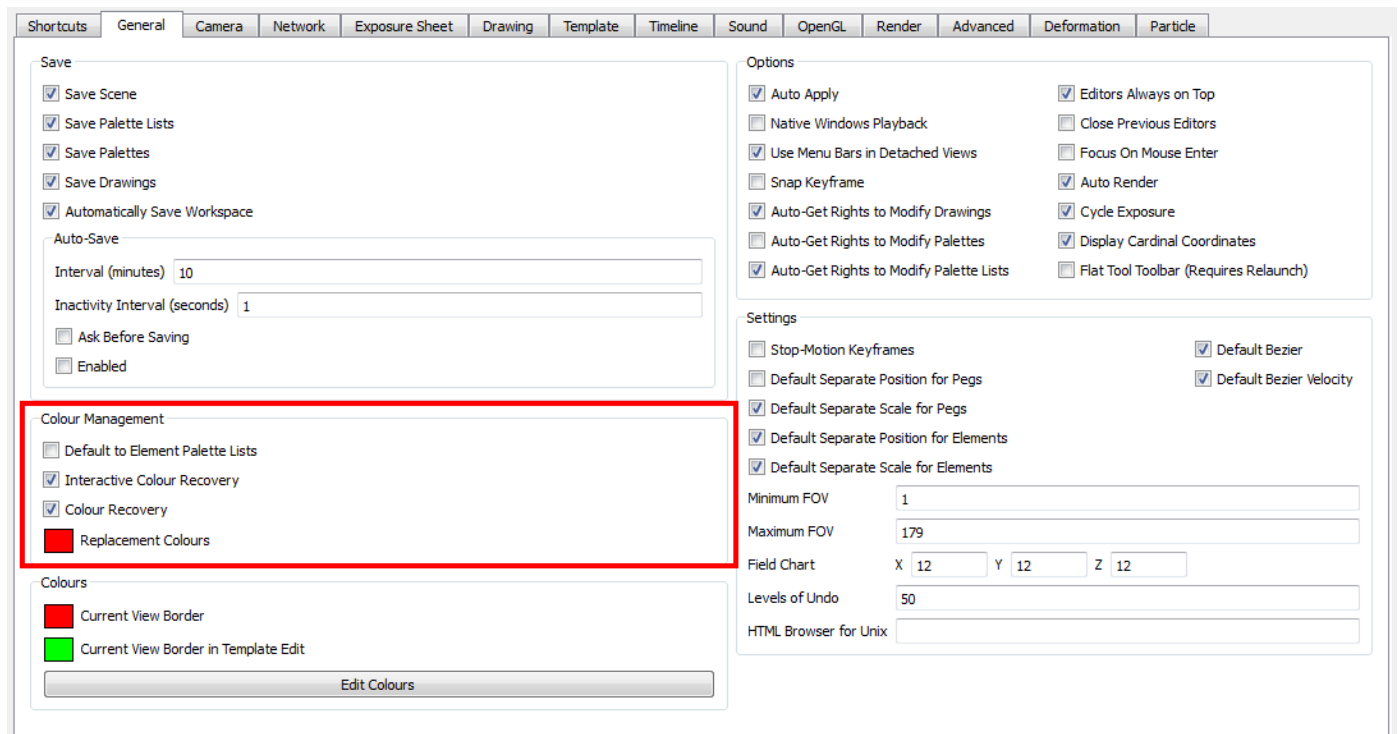

## Colour Management

In the General tab of the Preference panel, you will find the following options:

- **Default to Element Palette Lists:** When this option is enabled the new, cloned, duplicated, imported and linked palettes will be stored in the Element Palette list instead of the Scene Palette List.
- **Interactive Colour Recovery:** If a colour palette for your scene is deleted or cannot be found, you will be asked if you want to recover colours from the program's memory. If this option is unchecked, the program recovers missing colours without displaying a dialog box for your input.

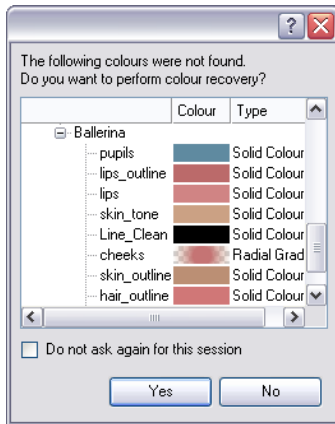

- **Colour Recovery:** If this option is unchecked, colour recovery will not occur.
- **Replacement Colours:** If colours are no longer available for your scene, these colours are automatically replaced with the ones indicated by the Replacement Colour swatch. The default colour is red, as it acts as a missing colour warning device.

## Shortcuts Tab

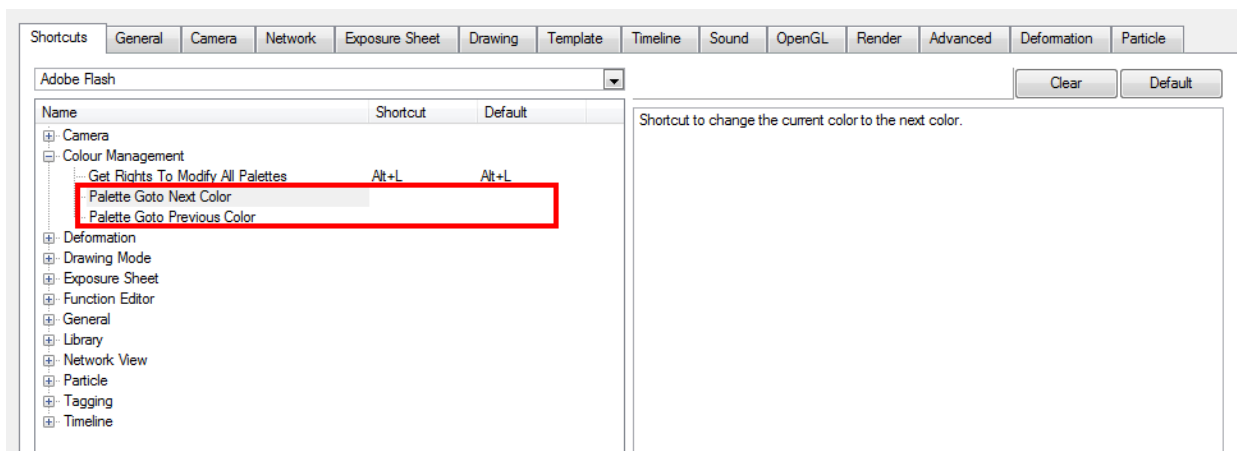

### Go to Next/Previous Colour in the Colour Palette

Under the Colour Management section, you can set two new possible shortcuts. You can set a shortcut to Go to the Next Colour in the Colour Palette or to Go to the Previous Colour.

# Chapter 7: Timing

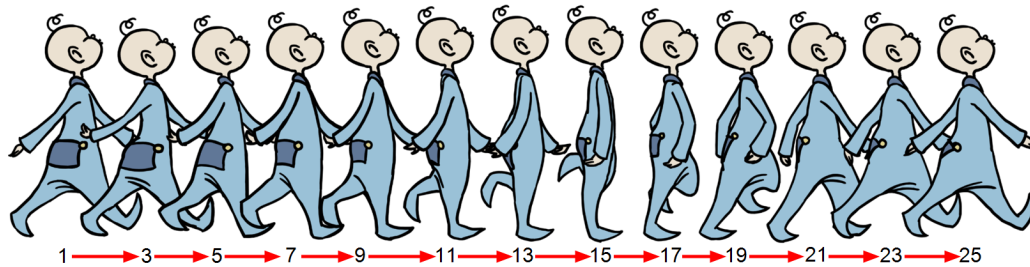

When you create hand-drawn animation, it is important to know how to set and modify the timing of your drawings. You can adjust the timing in both the Timeline and Xsheet views, depending on which technique you are used to working with. If you are a digital animator, you will probably use the Timeline view. If you are more of a traditional animator, you will probably work with the Xsheet view (exposure sheet). Animate offers you both.

In this topic, you will learn how to work on your drawing's exposure and length. The exposure and animation paths for symbols are covered in separate chapters.

## Topics Covered

- [Understanding the Timeline View on the facing page](#)
- [Xsheet View on page 342](#)
- [Frames on page 351](#)
- [Layers and Columns on page 355](#)
- [Filling Exposure on page 379](#)
- [Navigating between Frames and Columns on page 400](#)
- [Managing Drawings on page 402](#)
- [Tempo Markers on page 408](#)
- [Annotation Columns on page 410](#)
- [Printing the Xsheet on page 1](#)
- [Element Manager on page 1](#)
- [Timing Preferences on page 415](#)

# Understanding the Timeline View

To set your animation timing, you will mostly work with the Timeline and Xsheet views. This section will help you become familiar with these views, how they work and the differences between them.

- [Timeline View](#) below
- [Layer Section](#) below
- [Timing Selection](#) on the next page
- [Data View Section](#) on the next page

## Timeline View

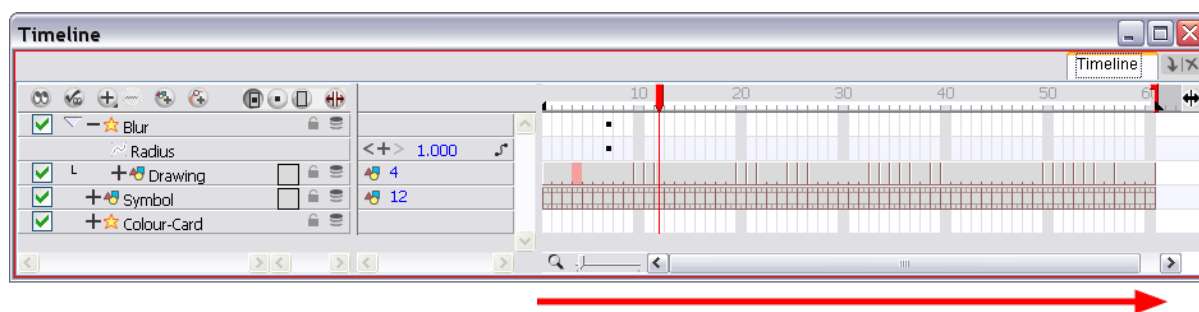

The Timeline view allows you to read your timing from left to right. It represents the scene's elements in their simplest form.

In the Timeline view you can see your layers and their names as well as the drawing's exposure. The drawing name is displayed when you place your cursor above the drawing's exposure.



You can also see the drawing name when you display the Data view. The name of the drawing folder to which the layer is linked is displayed in the Data view.



## Layer Section

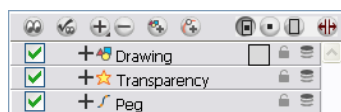

The Layer section is located to the left of the Timeline view. This is where you add, delete, rename, reorder, and parent layers. Any operation you do that affects the layer globally is done here.



## Timing Selection

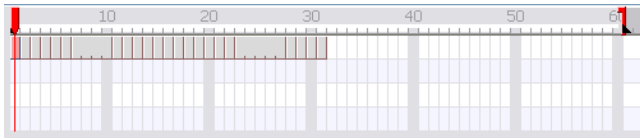

The Timing section is located on the right side of the Timeline view. This is where you can increase and decrease a drawing's exposure, duplicate drawings, add blank cells, etc. Any operation you do that affects a drawing or its timing is done in this section.

## Data View Section

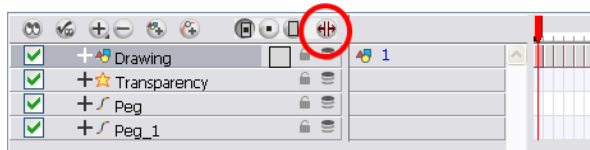

The Data view section is part of the Layer section. By default, the Data view is hidden.

The Data view allows you create new drawings by typing a new name in the Drawing Substitution field. You can also swap between existing drawings by sliding your cursor  to the left or right.

To display the Data view:

- ▶ Click the **Show Data View**  button.

### Related Topics

- [Swapping Images on page 763](#)

# Xsheet View

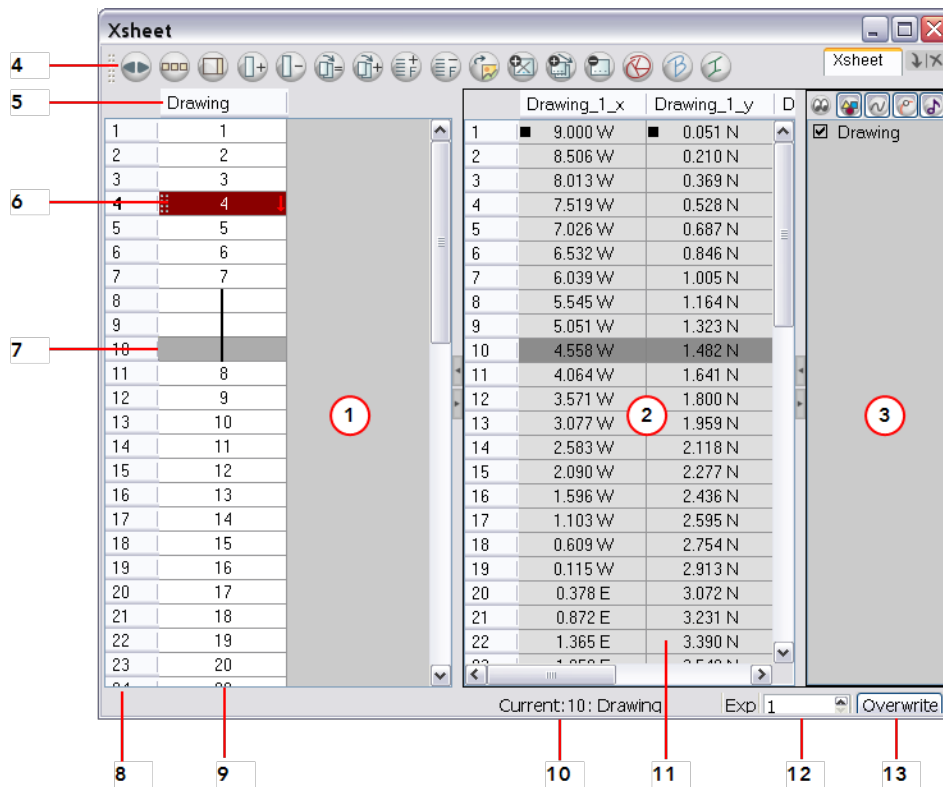

1. [Xsheet Main Section](#) on the next page
2. [Functions Section](#) on page 344
3. [Column List Section](#) on page 345
4. [Xsheet View Toolbar](#) on page 346
5. [Column Header](#) on page 346
6. [Current Drawing](#) on page 347
7. [Current Frame](#) on page 347
8. [Frame Numbers](#) on page 348
9. [Drawing Exposure](#) on page 349
10. [Current Frame Display](#) on page 349
11. [Function Column](#) on page 349
12. [Increase/Decrease Exposure](#) on page 350
13. [Overwrite/Insert Modes](#) on page 350

In Animate, you will also find the Xsheet View menu  button in the top-left corner. This button allows you to access commands related to the Xsheet view.

The Xsheet view lets you read your timing vertically, displays the drawing layers as columns and shows the drawing's name. You also see the functions and keyframes of the motion paths in the Xsheet's function columns.

The value of each keyframe is shown in the Xsheet view, these are black squares in the Timeline view. The Xsheet view contains details than the Timeline view, and is faster and easier to read.

## Related Topics

- [Adding and Deleting Keyframes on page 650](#)

## Xsheet Main Section

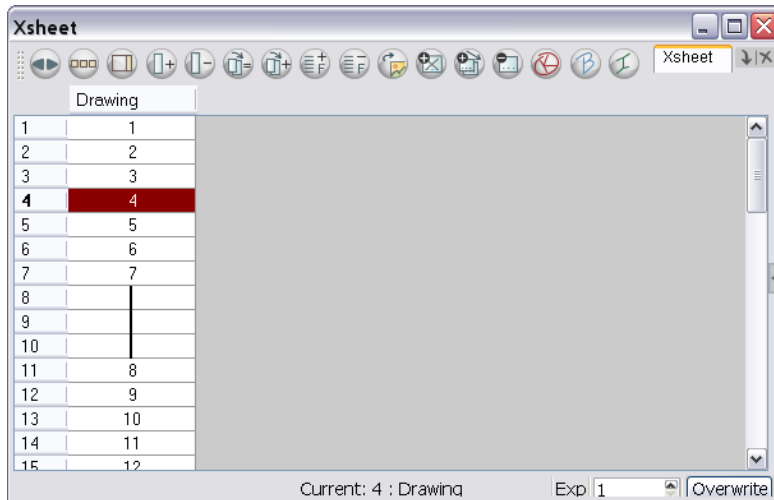

The Xsheet view has three sections. By default, only the main section is visible. It displays the drawing layers, also known as *drawing columns*.

When using advanced compositing and animation techniques, unconnected functions (motion paths) also appear in the main section. Unconnected functions mean that some motion paths are not attached to any particular layer.

	Drawing	Peg_x	Peg_y	Peg_z	Peg_velo
1	1	■ 0.000	■ 0.000	■ 0.000	■ 1.000
2	2				
3	3				
4	4				
5	5				
6	6				
7	7				
8					
9					
10					
11	8				
12	9				
13	10				
14	11				
15	12				



When you reconnect functions to a layer they are still visible in the main section.



Refer to [Sharing Functions](#) on page 685 to learn about the unconnected functions.

Refer to the topic [Showing and Hiding Columns](#) on page 368 to learn how to temporarily hide unconnected functions from the main section.

## Related Topics

- [Xsheet View](#) on page 342

## Functions Section

Drawing		Drawing_1_x	Drawing_1_y	Drawing_1_z	Drawing_1
1	1	9.000 W	0.051 N	0.000	0.0
2	2	8.506 W	0.210 N		0.0
3	3	8.013 W	0.369 N		0.0
4	4	7.519 W	0.528 N		0.0
5	5	7.026 W	0.687 N		0.0
6	6	6.532 W	0.846 N		0.0
7	7	6.039 W	1.005 N		0.0
8		5.545 W	1.164 N		0.0
9		5.051 W	1.323 N		0.0
10		4.558 W	1.482 N		0.0
11	8	4.064 W	1.641 N		0.0
12	9	3.571 W	1.800 N		0.0
13	10	3.077 W	1.959 N		0.0
14	11	2.583 W	2.118 N		0.0
15	12	2.090 W	2.277 N		0.0
16	13	1.596 W	2.436 N		0.0
17	14	1.103 W	2.595 N		0.0
18	15	0.609 W	2.754 N		0.0

The Functions section is used for more advanced techniques. This section displays the functions (paths) related to the selected layer in the Timeline view. By default, the Functions section is hidden.

To display the Functions section:

1. In the Xsheet view, click on the Expand button located on the right side of the main section. Click on the same button to collapse it. You can also use the Show Column List  button in the Xsheet View toolbar.

Drawing	
1	1
2	2
3	3
4	4
5	5
6	6
7	7
8	
9	
10	
11	8
12	9
13	10
14	11



If you select a drawing column in the main section of the Xsheet view, the function columns will not be displayed. You must select the layer from the Timeline view.

## Related Topics

- [Xsheet View on page 342](#)
- [Animation Paths on page 637](#)

## Column List Section

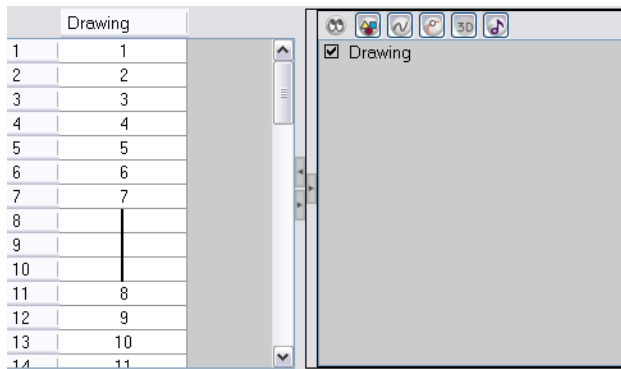

The Column List section allows you to show and hide columns from your Xsheet view. When you hide a layer using your Xsheet view, it is also disabled in the Timeline view.

You can use the Column List to hide individual columns or hide an entire column type (drawing or function) from your Xsheet view. By default, the Functions section is hidden.

### To display the Column List section:

1. In the Xsheet view, click the **Expand** button located on the right side of the main section to show the Functions section. Click on the same button to collapse it. You can also use the Show Column List  button in the Xsheet View toolbar.
  - In Animate, you can also go to the Xsheet View menu and select **View > Show Column List**.

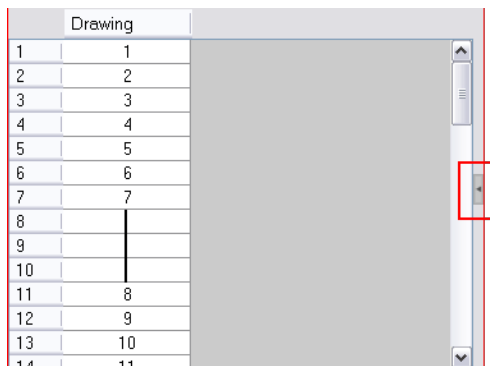

2. Click the **Expand** button on the right side of the Functions section to display the Column List section.

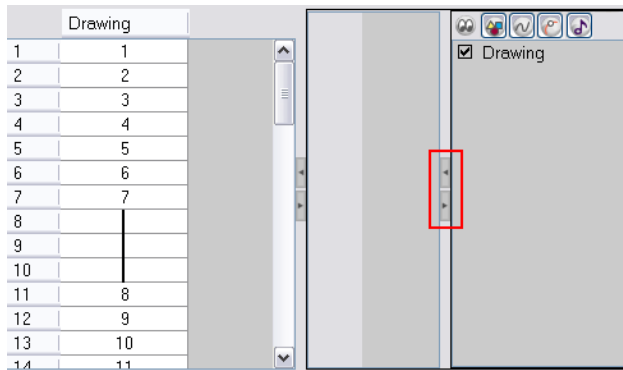

## Related Topics

- [Xsheet View on page 342](#)

## Xsheet View Toolbar



The Xsheet view has its own toolbar where you can find the most common features. This toolbar is displayed by default. If you do not see it, select **Windows > Toolbars > Xsheet View**.

The Xsheet view must be part of your workspace in order to display its toolbar.



Refer to [Toolbar Manager on page 96](#) to learn how to organize the buttons available in the Xsheet View toolbar.

## Related Topics

- [Xsheet View on page 342](#)

## Column Header

Drawing	
1	1
2	2
3	3

Each column available in the Xsheet view has a header displaying the column's name. The column's name is the same as the corresponding timeline layer. If you rename one or the other, they will both be renamed.

A quick access menu is available when you right-click. This menu contains the command affecting an entire column such as renaming, changing the default colour or deleting a column.

In Animate, the column header shows the layer's name and the name of the drawing folder to which it is linked. If the name of the layer is the same as the drawing folder, the drawing folder's name will not be displayed. For example; when you link a Timing column to a certain element (and thereby the Element's folder).

	Drawing	Character Drawing
1		
2		
3		
4		
5		

The tooltip that appears when you hover your cursor at the top of each Xsheet column shows the absolute folder path to the source drawings for that column.

## Related Topics

- [Xsheet View on page 342](#)

## Current Drawing

1
2
3
4
5

A drawing selected in dark red indicates that the drawing is currently displayed in the Drawing view. The current drawing selection is not linked to the drawing displayed in the Camera view since drawings from each visible layer are displayed at once.

## Related Topics

- [Xsheet View on page 342](#)

## Current Frame

	Drawing_3	Drawing_2	Drawing_1	Drawing
1				1
2				2
3				3
4				4
5				5
6				6

The darker frame appearing in the Xsheet view represents the current frame displayed in the Camera view. It does not necessarily correspond to the current drawing displayed in the Drawing view.



**Tip:** To show the real time updated of the selected frame, click the Xsheet menu and select **View > Enable Playback**right-click the Xsheet view and select View > Enable Playback.

There is a new option in the Xsheet to Enable Playback. This shows the real time update of what frame is selected. You can turn this off or on view the View menu in Animate Pro, and I think by right-clicking in Animate LB

## Related Topics

- [Xsheet View on page 342](#)

## Frame Numbers

1
2
3
4
5
6
7
8
9
10
11
12

On the left side of the Xsheet view, the frame numbers are shown indicating where you are. These read vertically instead of being displayed horizontally as they are in the Timeline view.

- To go to a particular frame, click the frame number.

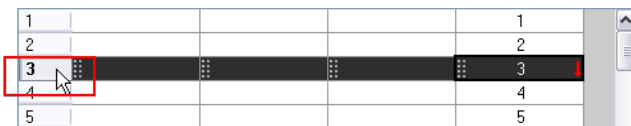

- To select an entire range of frames, click and drag a selection downwards.

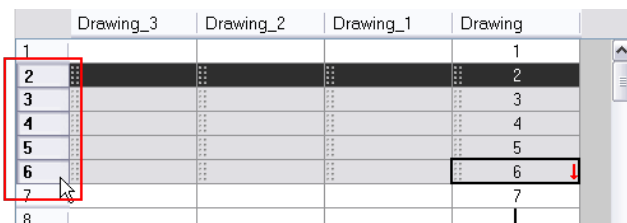

## Related Topics

- [Xsheet View on page 342](#)



# Drawing Exposure

	Drawing
1	1
2	
3	2
4	3
5	4
6	
7	
8	5
9	6
10	7
11	
12	

In the drawing columns, you can see the drawing names and their exposure. You can use any alphanumeric symbol to name your drawing. When a drawing is exposed over more than one cell, a vertical black line is displayed to indicate the continuity of the exposure. When there is no drawing in a cell, the cell will be blank.

## Related Topics

- [Xsheet View on page 342](#)

# Current Frame Display

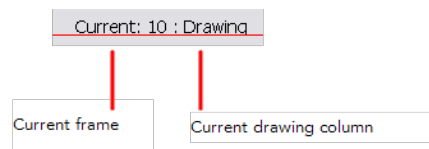

At the bottom of the Xsheet view, you can see the current frame number as well as the column containing the drawing currently displayed in the Drawing view

## Related Topics

- [Xsheet View on page 342](#)

# Function Column

	Transparency_
1	■ 50.000
2	62.500
3	75.000
4	87.500
5	■ 100.000
6	87.500
7	75.000
8	62.500
9	■ 50.000
10	
11	
12	
13	
14	
15	

The function columns are displayed in the Functions section of the Xsheet view. They represent the motion and rotation you applied to your drawing layer. Only the function columns related to the selected layer are displayed.

A function column can also be related to an effect. Selecting your effect layer shows you the corresponding function column in the Xsheet view.

The function columns display the position value or effect value on each cell. If there is a keyframe on a cell, a black square is displayed. Holding the same value for several frames displays a vertical black line.

Holding the same value for several frames displays a vertical black line.

## Related Topics

- [Xsheet View on page 342](#)

# Increase/Decrease Exposure

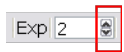

You can quickly increase or decrease the exposure of the selected cell by clicking on the up and down arrows in the Increase/Decrease Exposure field.



Refer to the [Increase/Decrease Exposure Field on page 388](#) topic to learn more about this feature.

## Related Topics

- [Xsheet View on page 342](#)

# Overwrite/Insert Modes

The Overwrite/Insert button allows you to decide the way the values are inserted into your Xsheet.

## Related Topics

- [Xsheet View on page 342](#)

# Frames

One of the first things to learn in Toon Boom Animate is how to add or delete frames in your scene.

## Related Topics

- [Adding Frames below](#)
- [Deleting Frames on page 353](#)

# Adding Frames

There are several ways to add frames to your scene using Toon Boom Animate.

## Related Topics

- [Setting the Scene Length below](#)
- [Extending the Timeline View below](#)
- [Adding Frames Before or After a Selection on the facing page](#)
- [Adding Frames to the Beginning or at the End of a Scene on the facing page](#)

# Setting the Scene Length

You can set the global scene length from the top menu.

To set the set scene length:

1. Select **Scene > Set Scene Length**.

The Set Scene Length dialog box opens.

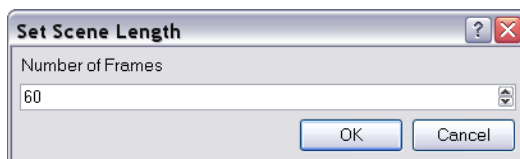

2. In the Number of Frames field, type how many frames are needed.

# Extending the Timeline View

You can quickly extend your scene length in the Timeline view.

To extend your scene in the Timeline view:

1. In the Timeline view, drag the scene length bracket to the right to add more frames to your scene.

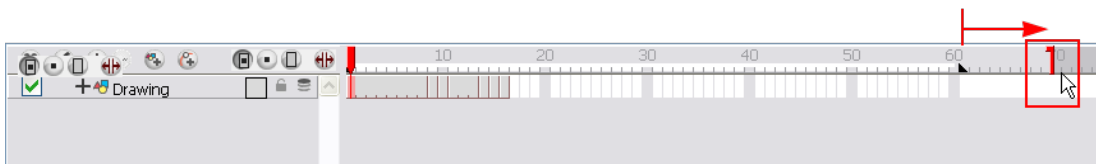

## Adding Frames Before or After a Selection

You can add frames anywhere in the middle of the scene. If you select a frame row in the Xsheet view, the system will add the new frames before or after the selection, depending on your choice.

**To add frames before or after selection:**

1. In the Xsheet view, select a frame row.

	Drawing_3	Drawing_2	Drawing_1	Drawing
1	13	15	1	1
2	14		2	
3	1		3	
4			4	
5		1	5	
6		2	6	
7		3		
8	2	4		

2. Do one of the following:
  - ▶ Select **Scene > Frame > Add Frames Before Selection** or **Add Frames After Selection**.
  - ▶ Press [Ctrl] + [G] and [Ctrl] + [H] (Windows) or [⌘] + [G] and [Ctrl] + [H] (Mac OS X).

*In Harmony Xsheet, select **Frame > Add Frames Before Selection** or **Add Frames After Selection**.*

The Add Frames dialog box opens.



3. In the Number of Frames to Add field, enter the amount of frames needed in the scene.



To add new frames after your selection, you can also use the **Add Frames**  button in the Xsheet

View toolbar.

## Adding Frames to the Beginning or at the End of a Scene

You can add some frames to the beginning or at the end of the scene.

**To add frames at start or at end:**

1. Select **Scene > Frame > Add Frames at Start** or **Add Frames at End**.

*In Harmony Xsheet, select **Frame > Add Frames at Start** or **Add Frames at End**.*

The Add Frames dialog box opens.



2. In the Number of Frames to Add field, enter the number of frames needed in the scene.



To add new frames at the end of your scene, you can also use the **Add Frames**  button found in the **Xsheet View** toolbar.

## Related Topics

- [Deleting Frames below](#)

## Deleting Frames

There are three ways to delete frames from your scene:

- [Reducing the Timeline Length below](#)
- [Removing Selected Frames below](#)
- [Deleting a Selected Frame Range on the facing page](#)



When you remove frames from the end of your scene, the exposed drawings and symbols are not deleted. If you extend your scene afterwards, these drawings and symbols are still available.

## Reducing the Timeline Length

You can quickly reduce your scene length in the Timeline view.

**To reduce your scene in the Timeline view:**

1. In the Timeline view, drag the scene length bracket to the left to remove frames from your scene.

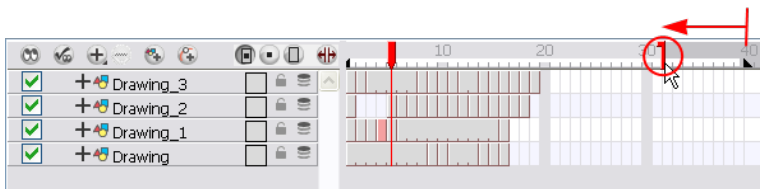

## Removing Selected Frames

You can remove any selected frame in your Xsheet view, such as the last frame of your scene.

**To remove a selected frame:**

1. In the Xsheet view, select a frame in a given column.
2. In the Xsheet View toolbar, click the **Remove Frames**  button. To remove several frames, click the button repeatedly.

You can also select **Scene > Frame > Remove Selected Frames** from the top menu.

*In Harmony Xsheet, select **Frame > Remove Selected Frames** from the top menu.*

## Deleting a Selected Frame Range

In the Xsheet view, you can remove any selected frame range.

To delete a frame range:

1. In the Xsheet view, select a frame range by clicking the first frame's number and then dragging the selection highlight down to the last frame to delete.

	Drawing_3	Drawing_2	Drawing_1	Drawing
1	13	15	1	1
2	14		2	
3	1		3	
4			4	
5		1	5	
6		2	6	
7		3		
8	2	4		
9	3	5		2
10	4	6		3
11	5	7		4
12	6	8		
13		9		
14	7	10		5
15	8	11		6
16	9	12	7	7
17	10	13		8
18	11	14		
19	12			
20				
21				

2. Do one of the following:
  - ▶ Press [Delete] to delete the selection.
  - ▶ From the top menu, select **Scene > Frame > Remove Selected Frames**.
  - ▶ Click **Remove Frames**  button.

*In Harmony Xsheet, go to **Frame > Remove Selected Frames**.*

The **Warning** dialog box opens.

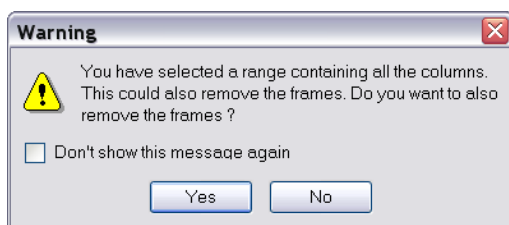

3. To complete the operation:
  - ▶ Click **Yes** to delete the selection.
  - ▶ Click **No** to only delete the exposure in the cell and not the frames.
  - ▶ Select the **Don't Show This Message Again** option to prevent the warning message from being displayed each time you delete a frame range.

## Related Topics

- [Adding Frames on page 351](#)

# Layers and Columns

In Toon Boom Animate there are two ways to see your layers:

- As horizontal layers in the Timeline view
- As vertical columns in the Xsheet view

In Animate, you can also see your layers displayed in the Network view as modules.

Whether you work in the Timeline or Xsheet view, they are the same and any modification you do to one or the other will be applied to both.

## Related Topics

- [Layer and Column Concepts](#) below
- [Adding New Drawing Layers](#) on page 360
- [Deleting Layers And Columns](#) on page 363
- [Modifying Layers](#) on page 365
- [Duplicating Layers and Columns](#) on page 372
- [Cloning Layers And Columns](#) on page 373
- [Xsheet Thumbnails](#) on page 374
- [Changing the Colour of a Layer or Column](#) on page 374
- [Expanding and Collapsing Layers and Columns](#) on page 377
- [Modifying the Look of the Column](#)



When working in Harmony Xsheet, only the Xsheet view and its functionalities are available.

---

## Layer and Column Concepts

In order to understand what happens when you duplicate a drawing, extend an exposure, create cycles or delete a drawing, it is important to know how a layer works.

Each layer is linked to a directory, this is the location where all of that layers' drawings are saved. This directory has the same name as the layer. When a value or drawing name is typed in a layer's cell, the system looks in the layer's directory for the corresponding drawing to display. If there is no corresponding drawing, a new one is created.

The layer's cells are not used for storage, but are linked to the drawings contained in the layer's directory. If you remove a drawing from the layer exposure, it is not deleted, but is simply not displayed.

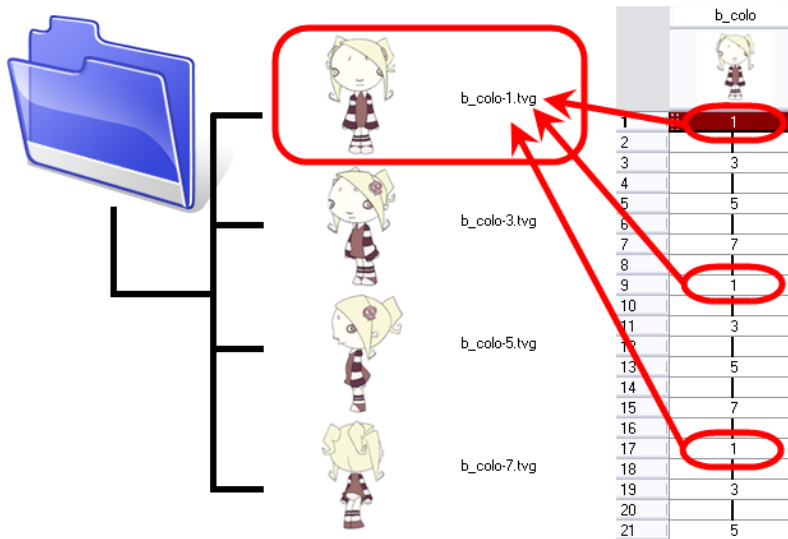

When you create a drawing cycle, all of the repeated drawings are linked to the same original files. This means that when you modify, repaint or correct a drawing named "1," all drawings named "1" are updated simultaneously. In order to modify a drawing independently from its other exposures, you must duplicate the drawing.

## Related Topics

- [Layers and Columns on the previous page](#)
- [Layer Types below](#)
- [Advanced Column Types on page 1](#)
- [Layer Content on page 359](#)
- [Adding New Drawing Layers on page 360](#)
- [Deleting Layers And Columns on page 363](#)
- [Modifying Layers on page 365](#)
- [Duplicating Layers and Columns on page 372](#)
- [Cloning Layers And Columns on page 373](#)
- [Xsheet Thumbnails on page 374](#)
- [Changing the Colour of a Layer or Column on page 374](#)
- [Expanding and Collapsing Layers and Columns on page 377](#)
- [Modifying the Look of the Column on page 1](#)
- [Duplicating a Drawing on page 405](#)

## Layer Types

There are several types of layers that you can add in the Timeline view. Some layers are not represented the same way in the Xsheet view.

- [Drawing Layer on the next page](#)



- [Bitmap Layer](#) below
- [Camera Layer](#) below
- [Effect Layer](#) on the facing page
- [Colour-Card Layer](#) on the facing page
- [Peg Layer](#) on the facing page
- [Quadmap Layer](#) on page 359
- [Sound Layer](#) on page 359

## Drawing Layer



The most common layer type is the Drawing layer. Any time you need to create a vector drawing or import a symbol, you can use a Drawing layer. In the Timeline view, the drawing layer is tagged with the Drawing  icon.



Bitmap images are contained in Bitmap layers.

---

## Bitmap Layer



If you import picture or bitmap images in your project, they are inserted in a Bitmap layer. If you choose to vectorize your image when you import, the Bitmap object will be placed on a Drawing layer. This way, you can have bitmap images mixed with vector drawings on a Drawing layer.

When importing a bitmap image, you have the option of encapsulating the image in a symbol. If you place a non-vectorized bitmap into a symbol, you still will not be able to mix vector drawings with it on the same layer. If you place a vectorized bitmap in a symbol, you must enter the symbol to be able to mix it with vector artwork.

In the Timeline view, the Bitmap layer is tagged with the Bitmap  icon.

## Camera Layer

You can only have one Camera layer at a time in your timeline. By default, there is no Camera layer when you create a scene. You need to add a Camera layer when you want to create a camera motion.

In the Timeline view, the camera layer is tagged with the Camera  icon.



The Camera layer is not visible in the Xsheet view.

---

## Effect Layer



To enhance the look of your scene, you can add effect layers and attach your drawings to them. In Toon Boom Animate, there is a series of effect modules in the Module Library view.

In the Timeline view, the Effect layer is tagged with the Effect  icon.

In the Xsheet view, you can see the Effect's parameter columns in the Functions section when you select the Effect layer in the Timeline view.

---



If you want to have several cameras with different settings, you can keep adding Camera layers in your Timeline view (however, only one will ever be visible at a time as you can only have one Camera at a time in your timeline). To switch between the camera available, select **Scene > Camera > select the desired camera**.

---

## Colour-Card Layer



The Colour-Card layer is used to add plain colour background to your scene. By default, your scene has no background colour and if you render it out as a QuickTime movie or image sequence it will have a black background.

In the Timeline view, the Colour-Card layer is tagged with the Effect  icon.

The Colour-Card layer is not visible in the Xsheet view.

## Peg Layer



A Peg layer can be described as a trajectory or motion path layer that does not contain drawings. This can be attached to any drawing layer, cut-out puppet or other peg layers, they will all follow the trajectory you set in the Peg layer.

In the Timeline view, the Peg layer is tagged with the Peg  icon.

In the Xsheet view, you can see the Peg's function columns in the Functions section when you select the Peg layer in the Timeline view.

## Quadmap Layer



A Quadmap layer can be described as a deformation transformation layer that does not contain drawings. This can be attached to any drawing layer, cut-out puppet or even other peg layers they will all follow the deformation you set in the Quadmap layer.

In the Timeline view, the Quadmap layer is tagged with the Quadmap  icon.

In the Xsheet view, you can see the Quadmap's function columns in the Functions section when you select the Quadmap layer in the Timeline view.

## Sound Layer



You can import sound files to add dialog and sound effects to your project. The sound layer will be added to your Timeline and Xsheet view when you import a sound file in your scene.

In the Timeline view, the Sound layer is tagged with the Sound  icon.

In the Xsheet view, the Sound layer is a dark grey colour.

## Related Topics

- [Layers and Columns on page 355](#)
- [Layer and Column Concepts on page 355](#)
- [Advanced Column Types on page 1](#)

## Layer Content

There are two types of elements that can be inserted in a drawing layer's cell:

- Vector drawings

- Symbols

A layer can contain the two different elements, but only in different cells. You cannot put two symbols or a drawing and a symbol into the same cell.

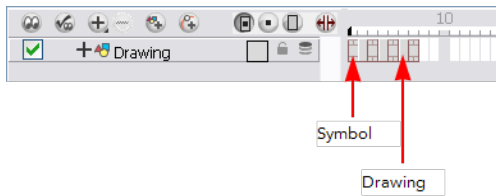

If you want to mix bitmap images in your Drawing layers, you must first import your bitmap image as a symbol or turn it into a symbol and insert it in your Drawing layer by dragging the symbol cell there through the Timeline.



Refer to [What is a Symbol?](#) to learn more about symbols.

## Related Topics

- [Layers and Columns on page 355](#)
- [Layer and Column Concepts on page 355](#)
- [Timing Columns on page 1](#)
- [Advanced Column Types on page 1](#)
- [Symbols on page 532](#)

# Adding New Drawing Layers

In this section, you will learn the different ways to add a drawing layer to your project. By default, when you create a new scene there is one Drawing layer included in your Timeline view.

This topic is divided as follows:

- [Adding Drawing Layers in the Timeline View below](#)
- [Adding a Drawing Layer from the Top Menu on the next page](#)
- [Adding Drawing Columns in the Xsheet View on page 362](#)

## Adding Drawing Layers in the Timeline View

You can add a new layer in the Timeline view in several different ways:

- Using the Layer toolbar
- Using the Add Layers dialog box
- Go to the Timeline view menu and select **Insert > Drawing**.

### To add a Drawing layer using the Timeline's Layer toolbar:

1. In the Timeline's Layer toolbar, click the **Add Layers**  button or press [Ctrl] + [R] (Windows) or [⌘] + [R] (Mac OS X).
2. In the drop-down menu, select the **Drawing** option.

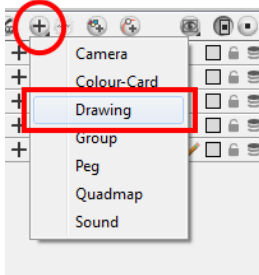

A new layer appears in the Timeline and Xsheet views.



You can also click on the Add Drawing Layer button in the Timeline's Layer toolbar or press [Ctrl] + [R] (Windows) or [⌘] + [R] (Mac OS X).

### To add drawing layers using the Add Layers dialog box:

1. In the Timeline view's layer section, right-click and select **Insert > Add Layer(s)**. The Add Layers dialog box opens.

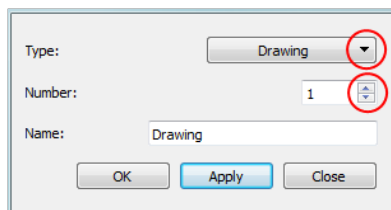

2. In the Type drop-down menu, select the **Drawing** option.
3. In the Number field, use the up and down arrows or type the number of layers you want to add at once.
4. In the Name field, type the name of the layer you want to add. If you are adding more than one layer at once, all of the layers use that name with a numerical suffix added.
5. To complete the operation:
  - Click **OK** to add your new layers and close the dialog box.
  - Click **Apply** to add your new layers and keep the dialog box open to add another layer.
  - Click **Close** to cancel the operation.

## Adding a Drawing Layer from the Top Menu

You can add a new layer from the top menu.

**To add a new layer from the top menu:**

1. In the top menu, select **Insert > Drawing**.  
A new layer appears in the Timeline and Xsheet views.

**Adding Drawing Columns in the Xsheet View****To add a drawing column:**

1. Do one of the following:
  - ▶ In the Xsheet view, right-click and select **Columns > Add Column**.
  - ▶ In the Xsheet View toolbar, click the **Add Columns**  button or press [Shift] + [C].
  - ▶ To quickly add a Drawing column, press [Ctrl] + [R] (Windows) or [⌘] + [R] (Mac OS X).

The Add Columns dialog box opens.

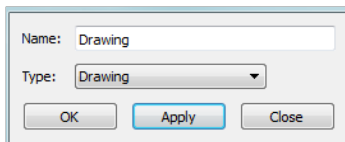

2. In the Column Name field, name your column accordingly.
3. In the Column Type field, select **Drawing**.



Refer to the topic [Layer Types](#) on page 356 to know more about the different column types available.

4. To complete the operation:
  - ▶ Click **OK** to add your new layers and close the dialog box.
  - ▶ Click **Apply** to add your new layers and keep the dialog box open to add column.
  - ▶ Click **Close** to cancel the operation.

In Animate, you can use the advanced Add Column dialog box, with more file format and field size options, to insert the column.

**Related Topics**

- [Layers and Columns](#) on page 355
- [Layer and Column Concepts](#) on page 355
- [Advanced Column Types](#) on page 1
- [Layer Content](#) on page 359
- [Adding New Drawing Layers](#) on page 360
- [Deleting Layers And Columns](#) on the next page
- [Modifying Layers](#) on page 365

- [Duplicating Layers and Columns on page 372](#)
- [Cloning Layers And Columns on page 373](#)
- [Xsheet Thumbnails on page 374](#)
- [Changing the Colour of a Layer or Column on page 374](#)
- [Expanding and Collapsing Layers and Columns on page 377](#)
- [Modifying the Look of the Column on page 1](#)

## Deleting Layers And Columns

You can delete layers from your projects in two different locations:

- Deleting a layer from the Timeline view
- Deleting a column from the Xsheet view

### Deleting a Layer from the Timeline View

There are two ways to delete a layer in the Timeline view, using the **Delete Layers**  button and via the quick access menu. This will also delete the associated modules from the Network view.

To delete layers in the Timeline view:

1. In the Timeline view, select the layers to be deleted.

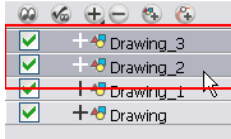

2. In the Timeline's Layer toolbar, click the **Delete Layers**  button.

You can also right-click on the selection and select **Delete**.

The Confirm Delete dialog box opens.

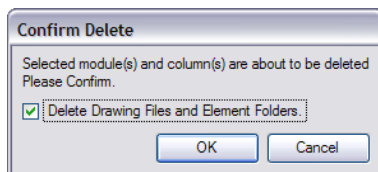

- Select the **Delete Drawing Files and Element Folders** option to delete all drawings and folder linked to this layer.
3. Select the **Delete Xsheet Columns** option if you also want to delete the existing column in the Xsheet view.

### Deleting a Column from the Xsheet View

There are two ways to delete a layer in the Xsheet view, using the **Delete Columns**  button and via the quick access menu.

### To delete layers in the Xsheet view:

1. In the Xsheet view, select the columns to be deleted by clicking on their header.

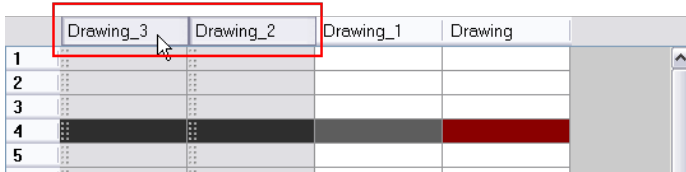

2. In the Xsheet View toolbar, click the **Delete Columns**  button. You can also right-click on the selection and select **Delete Columns** or press [Delete].

The Confirm Delete dialog box opens.

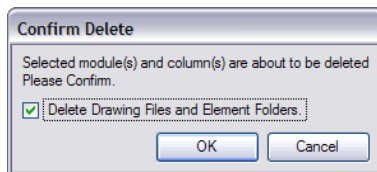

- ▶ Select the **Delete Drawing Files and Element Folder** option if you want to delete the drawings and folders linked to the selected column.

3. To complete the operation:

- ▶ Click **OK** to delete the selected layers.
- ▶ Click **Cancel** cancel the operation.

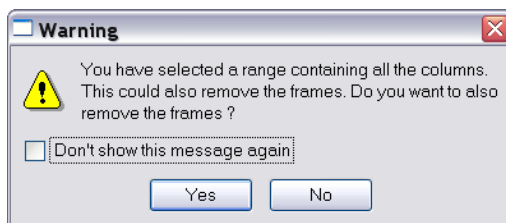

- ▶ Click **Yes** button delete all the frames from your scene.
- ▶ Click **No** button to keep the frames in your scene.
- ▶ Select the **Don't Show This Message Again** option if you do not want the dialog box to pop again in the future.

### Related Topics

- [Layers and Columns on page 355](#)
- [Layer and Column Concepts on page 355](#)
- [Advanced Column Types on page 1](#)
- [Layer Content on page 359](#)
- [Adding New Drawing Layers on page 360](#)
- [Deleting Layers And Columns on the previous page](#)
- [Modifying Layers on the next page](#)
- [Duplicating Layers and Columns on page 372](#)



- [Cloning Layers And Columns](#) on page 373
- [Xsheet Thumbnails](#) on page 374
- [Changing the Colour of a Layer or Column](#) on page 374
- [Expanding and Collapsing Layers and Columns](#) on page 377
- [Modifying the Look of the Column](#) on page 1

## Modifying Layers

Once you added layers to your project, you can modify their properties, name or ordering.

### Related Topics

- [Ordering Layers and Columns](#) below
- [Showing and Hiding Layers From the Timeline View](#) on the facing page
- [Showing and Hiding Columns](#) on page 368
- [Layer Properties](#) on page 370
- [Renaming Layers and Columns](#) on page 371

## Ordering Layers and Columns

You can change the order of your layers in the Timeline and Xsheet views. When you change the order of your layers in one of these views, the other one is updated.

### Reordering Layers in the Timeline View

To reorder layers in the Timeline view:

1. In the Timeline view, select the layers to move.
2. Drag the selection to the new location and drop it in between the existing layers. Dropping the selection on an existing layer would create a hierarchy. Layers located on top of the Timeline view are displayed in front of the other ones. Layers located at the bottom are displayed behind.

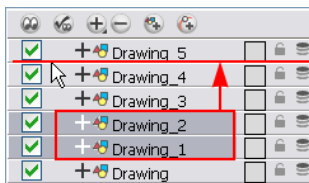

### Reordering Columns in the Xsheet View

You can reorder columns in the Xsheet view using the mouse's middle button.

To reorder columns in the Xsheet view:

- In the Xsheet view, click on the column's header with the middle mouse button and drag the column to its new position.

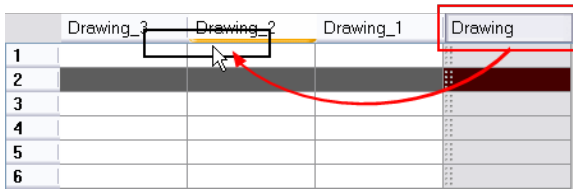



## Related Topics

- [Layers and Columns on page 355](#)
- [Modifying Layers on the previous page](#)
- [Showing and Hiding Layers From the Timeline View below](#)
- [Showing and Hiding Columns on page 368](#)
- [Layer Properties on page 370](#)
- [Renaming Layers and Columns on page 371](#)

## Showing and Hiding Layers From the Timeline View

As you work in the Drawing or Camera view, some layers may be in the way or are used as references. You can hide these layers to make your work area easier and less cluttered. You can show and hide layers in the Timeline view in several different ways.

### To show or hide all layers in the Timeline view:

- ▶ In the Timeline's Layer toolbar, click the **Enable/Disable All**  button to show or hide all layers. You can also click the **Enable All**  button located in the Timeline view toolbar's extra buttons.

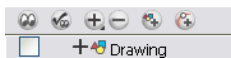

### To show or hide individual layers in the Timeline view:

- ▶ In the Timeline's Layer toolbar, deselect the layer's checkbox to disable a particular layer. Select the layer's checkbox to enable a particular layer. You can also click the **Enable/Disable**  button located in the Timeline View toolbar's extra buttons.



When you disable a layer in the Timeline view, the corresponding column is hidden in the Xsheet view.

### To disable all layers but the selected one:

- ▶ In the Timeline's Layer toolbar, click the **Show Selection and Hide All Others**  button to show only the currently selected layer and disable all the other layers. You can also click the **Disable All Others**  button located in the Timeline View toolbar's extra buttons.

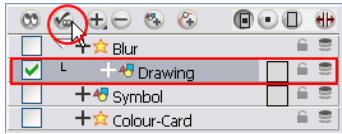

In the Timeline view, you can hide or show certain types of layers such as Group and Effect.

#### To show and hide layer types in the Timeline view:

1. In the Timeline View menu, select **View > Show > Show Manager**.
  - You can also select **View > Show > Show Sounds**, **Show Effects** or **Show Groups** to immediately show or hide the selected type. This option will remain only for the current session. Once the application is closed and reopened, the default settings will return.

The Show Manager dialog box opens.

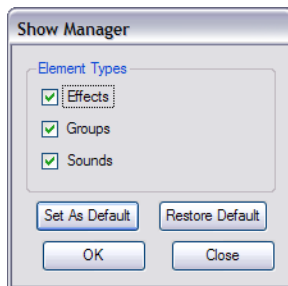

2. Select the types of layers you want to display and deselect the ones you want to turn off.
3. Click **Set As Default** to make these new settings the default ones that will be used each time to start the application. Click **Restore Default** to restore the settings used when installing the application.

In the Xsheet view, you have the choice of hiding or showing certain types of columns such as Annotation and Functions.

#### To show and hide layer types in the Timeline view:

1. In the Xsheet View menu, select **View > Column Types Manager**.

The Column Types dialog box opens.

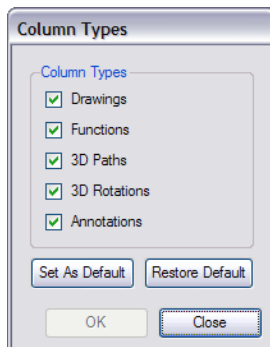

2. Select the types of columns you want to display and disable the ones you want to hide.
3. Click **Set As Default** to make these new settings the default ones that will be used each time to start the application. Click **Restore Default** to restore the settings used when installing the application.

## Related Topics

- [Layers and Columns](#) on page 355
- [Modifying Layers](#) on page 365
- [Showing and Hiding Columns](#) below
- [Layer Properties](#) on page 370
- [Renaming Layers and Columns](#) on page 371

## Showing and Hiding Columns



The Xsheet view has a Column List section that shows all the columns contained in the exposure sheet. It can be used to hide individual columns.

If you need to see a column after it has been hidden, you can display it directly from the Xsheet view without using the Column List section.

You can also hide an entire column type, such as Drawing or Sound.

When a column is hidden in the **Xsheet** view, the corresponding layer is disabled in the **Timeline** view.

### To show and hide columns in the Xsheet view:

1. In the Xsheet View toolbar, click the **Show Column List**  button.
2. Click the **Expand**  button located on the right side of the Functions section to display the Column List section.
3. In the Column List section, show or hide the columns by clicking in the column checkbox to add or remove the check mark. You can also click the **Hide Selected Column**  button located in the **Xsheet View** toolbar's extra buttons.

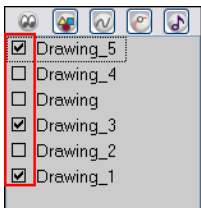

### To show a hidden column from the Xsheet view:

1. In the Xsheet view, click on the thick grey line that appeared in place of the hidden column. You can also right-click on the column header and select **Show Hidden Columns**.

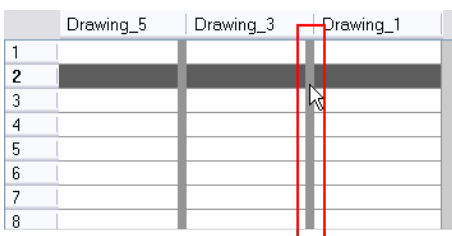

The Show Hidden Columns dialog box opens.

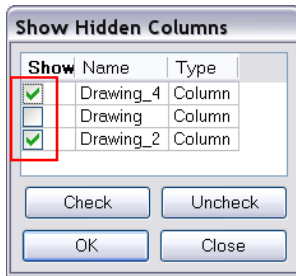







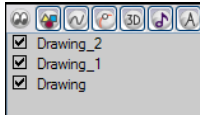

2. In the Show column, enable the hidden columns you want to display in the Xsheet view.
  - ▶ Click **Check** to check all the selected columns.
  - ▶ Click **Uncheck** to uncheck all the selected columns.

In Toon Boom Animate, in the Xsheet view menu, you can select **View > Unhide All Columns**.

### To hide and entire column type:

1. In the Column List section, click the **Column Type** button corresponding to the type you want to show or hide.



- ▶ The **Show/Hide All Columns**  button shows or hides every column available in the **Xsheet** view.
- ▶ The **Show Drawing Columns**  button shows the Drawing columns.
- ▶ The **Show Function Columns**  button shows the Bezier and Ease function columns.
- ▶ The **Show 3D Path Columns**  button shows the 3D Path function columns.
- ▶ The **Show Sound Columns**  button shows the Drawing columns.
- ▶ The **Show 3D Rotation Columns**  button shows the 3D Rotation columns.
- ▶ The **Show Annotation Columns**  button shows the Annotation columns.

### Related Topics

- [Layers and Columns on page 355](#)
- [Modifying Layers on page 365](#)
- [Showing and Hiding Layers From the Timeline View on page 366](#)
- [Layer Properties on the facing page](#)
- [Renaming Layers and Columns on page 371](#)

## Layer Properties

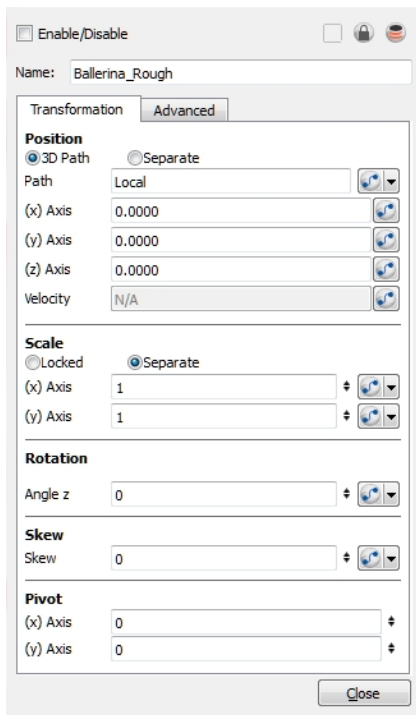

Each layer has its own set of properties that can be modified, including effect and peg layers.

Display the Layer Properties editor if you want to modify some of the layer's properties such as the name or the antialiasing quality. You can display the editor from the Timeline or Network view or open the Layer Properties as a view of its own.

The Xsheet column will not open the Layer Properties dialog box, it will show the Column Properties allowing you to modify settings related to the Xsheet column.

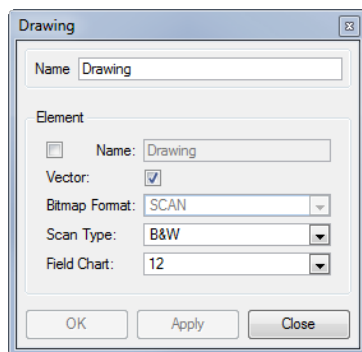

The Drawing Layer Properties editor allows you to:

- Rename the layer
- Enable or disable the layer
- Lock the layer
- Change the track colour
- Activate the onion skin preview

- Adjust the positioning and animation parameters
- Adjust many other advanced parameters

**To display the Layer Properties editor:**

1. Do one of the following:
  - In the Timeline view, double-click on a layer or press [Shift] + [E].
  - In the Network view, click on the module's yellow properties button.
  - In the top menu, select **Windows > Layer Properties**.
2. In the Timeline or Xsheet view, select the layer whose properties you want to view.

**To display the Column Properties Editor from the Xsheet view:**

1. In the Xsheet view, double-click on a column's header or press [Shift] + [E].

**Related Topics**

- [Layers and Columns on page 355](#)
- [Modifying Layers on page 365](#)
- [Showing and Hiding Layers From the Timeline View on page 366](#)
- [Showing and Hiding Columns on page 368](#)
- [Renaming Layers and Columns below](#)
- [Adding New Drawing Layers on page 360](#)

## Renaming Layers and Columns

You can rename a layer in two different ways; in the Layer Properties editor or directly on the Timeline's layer.

**To rename a layer in the Timeline view:**

1. In the Timeline view, double-click on the name of the layer to rename.
2. In the Name field, rename the layer and press [Enter/Return] to validate the modifications.

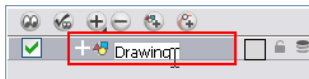
**To rename a layer in the Layer Properties editor:**

1. In the Timeline view, double-click on the layer to rename.  
The Layer Properties editor opens.
2. In the Name field, rename the layer.

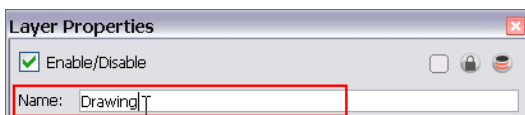

3. Click **Close**.

**To rename a column:**

1. In the Xsheet view, double-click on the column name to rename. Do not click on the drawing folder name that the column is linked to (this also appears in the column header just below the column name).

The Column Editor dialog box opens.

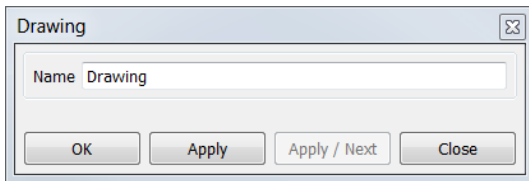

2. In the Name field, rename the column.
3. Click OK.
4. Click **Apply/Next** to apply the new name and open the editor for the following column.

**Related Topics**

- [Layers and Columns](#) on page 355
- [Modifying Layers](#) on page 365
- [Showing and Hiding Columns](#) on page 368

## Duplicating Layers and Columns

Duplicating a layer provides you with an independent copy of the drawings and their exposure. You can modify anything you want in the duplicated layer without affecting the original one. In the Network view, you can duplicate the selected modules in the same way.

**To duplicate a layer:**

1. In the Timeline or Xsheet view, click the layer you want to duplicate.

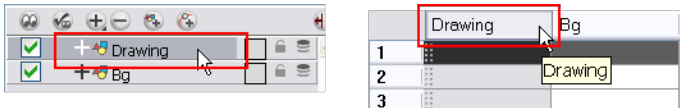

2. Select **Edit > Duplicate** or click the **Duplicate Layer**  button in the Xsheet View toolbar and

TimelineView toolbar.

*In Harmony Xsheet, select **Edit > Duplicate Selected Element**.*

The new duplicated layer or column appears.

**Related Topics**

- [Layers and Columns](#) on page 355
- [Layer and Column Concepts](#) on page 355
- [Advanced Column Types](#) on page 1
- [Layer Content](#) on page 359
- [Adding New Drawing Layers](#) on page 360



- [Deleting Layers And Columns on page 363](#)
- [Modifying Layers on page 365](#)
- [Cloning Layers And Columns below](#)
- [Xsheet Thumbnails on the facing page](#)
- [Changing the Colour of a Layer or Column on the facing page](#)
- [Expanding and Collapsing Layers and Columns on page 377](#)
- [Modifying the Look of the Column on page 1](#)

## Cloning Layers And Columns

Cloning a layer provides you with a copy of the selected layer that uses the same drawings as the original. If you modify a drawing in the cloned or original layer it is updated in both layers. You can modify the layers' timing independently one from the other, but the drawings remain linked. You can clone selected modules from the Network view in the same way.

This feature is useful when you want to reuse a hand-drawn animation but have different timings.

### To clone a layer:

1. In the Timeline or Xsheet view, click on the layer you want to clone.

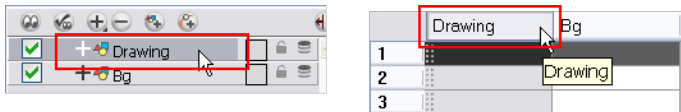

2. Select **Edit > Clone** or click the **Clone Layer**  button in the Xsheet View toolbar and Timeline View toolbar.

*In Harmony Xsheet, select **Edit > Clone Selected Columns**.*

The new cloned layer or column appears.

### Related Topics

- [Layers and Columns on page 355](#)
- [Layer and Column Concepts on page 355](#)
- [Advanced Column Types on page 1](#)
- [Layer Content on page 359](#)
- [Adding New Drawing Layers on page 360](#)
- [Deleting Layers And Columns on page 363](#)
- [Modifying Layers on page 365](#)
- [Duplicating Layers and Columns on the previous page](#)
- [Xsheet Thumbnails on the facing page](#)
- [Changing the Colour of a Layer or Column on the facing page](#)
- [Expanding and Collapsing Layers and Columns on page 377](#)

- [Modifying the Look of the Column](#) on page 1

## Xsheet Thumbnails

When there are a large number of columns in the exposure sheet, it is not always easy to quickly identify a particular column. Displaying the column thumbnails makes this easier. This option displays a small thumbnail picture of the current frame below the column header.

To display the thumbnails:

1. In the Xsheet view, click the **Show Thumbnails**  button.

The thumbnails appear.

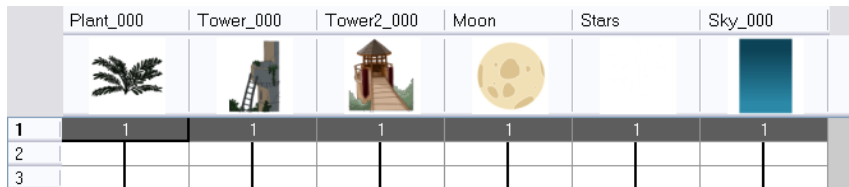

## Related Topics

- [Layers and Columns](#) on page 355
- [Layer and Column Concepts](#) on page 355
- [Advanced Column Types](#) on page 1
- [Layer Content](#) on page 359
- [Adding New Drawing Layers](#) on page 360
- [Deleting Layers And Columns](#) on page 363
- [Modifying Layers](#) on page 365
- [Duplicating Layers and Columns](#) on page 372
- [Cloning Layers And Columns](#) on the previous page
- [Changing the Colour of a Layer or Column](#) below
- [Expanding and Collapsing Layers and Columns](#) on page 377
- [Modifying the Look of the Column](#) on page 1

## Changing the Colour of a Layer or Column

To easily identify layers in your Timeline and Xsheet views, you can change their colour.

To change the layer's colour in the Timeline view:

1. Do one of the following:
  - In the Timeline view, click the colour swatch of the layer you want to modify.

- ▶ Select a layer and click the **Change Track Colour**  button in the **Timeline View** toolbar's extra buttons.

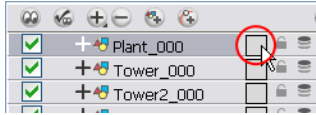

2. In the Colour Picker window, select a new colour for your layer and click OK.

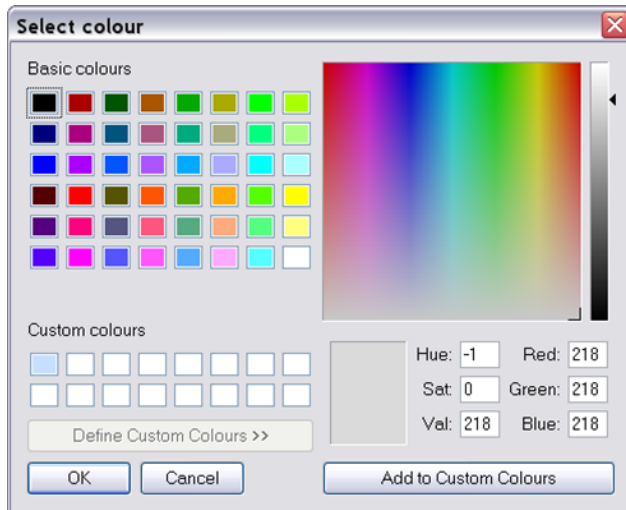

The layer's colour is updated.

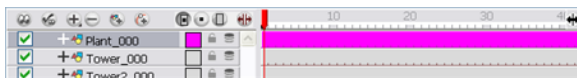

#### To reset a layer's colour in the Timeline view:

1. In the Timeline view, select the layers to reset and click the **Default Track Colour**  button in the **Timeline View** toolbar's extra buttons.

#### To change a column's colour in the Xsheet view:

1. In the Xsheet view, select one or more columns to modify.
2. Right-click on the column's header and select **Colour > Change Columns Colour**.
3. In the Colour Picker window, select a new colour for your columns and click OK.

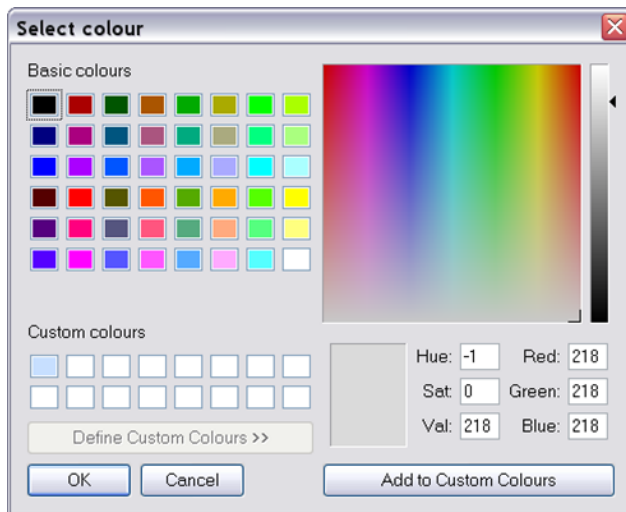

The column's colour is updated.



To reset the column's colour in the Xsheet view:

1. In the Xsheet view, select the columns to reset and right-click on the column's header and select **Colour > Default Columns Colour**.



## Related Topics

- [Layers and Columns on page 355](#)
- [Layer and Column Concepts on page 355](#)
- [Advanced Column Types on page 1](#)
- [Layer Content on page 359](#)
- [Adding New Drawing Layers on page 360](#)
- [Deleting Layers And Columns on page 363](#)
- [Modifying Layers on page 365](#)
- [Duplicating Layers and Columns on page 372](#)
- [Cloning Layers And Columns on page 373](#)
- [Xsheet Thumbnails on page 374](#)
- [Expanding and Collapsing Layers and Columns on the next page](#)
- [Modifying the Look of the Column on page 1](#)

## Expanding and Collapsing Layers and Columns

To simplify the look of your Timeline and Xsheet view, you can collapse and expand your layers. If some layers are parented to other ones, you can collapse the parent layer to hide all of its children. You can also collapse 3D Path columns in the Xsheet view.

### To collapse/expand a layer selection in the Timeline view:

1. In the Timeline view, select the layer(s) to collapse or expand.
2. Do one of the following:
  - ▶ Right-click on the selection and select **Collapse/Expand > Collapse/Expand**.
  - ▶ Click the **Expand Children Arrow**  button on the parent layer.
  - ▶ Press [Ctrl] + [I] (Windows) or [⌘] + [I] (Mac OS X).
  - ▶ Click the **Collapse/Expand**  button in the Timeline View toolbar's extra buttons.

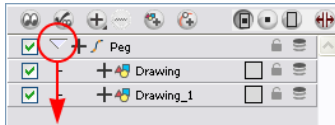



### To collapse or expand all layers in the Timeline view:

Do one of the following:

- ▶ Right-click on the layers and select **Collapse/Expand > Expand All** or **Collapse All**.
- ▶ Press [0] and [9].
- ▶ Click the **Collapse All**  or **Expand All**  buttons in the Timeline View toolbar's extra buttons.

### To collapse and expand 3D Path columns in the Xsheet view:

1. In the Xsheet view, display the Functions section by clicking the **Show Column List**  button.
2. In the Functions section, select the header of the **3D Path** column to collapse.
3. Do one of the following:
  - ▶ Right-click on the column's header and select **Expand/Collapse > Collapse Selection**.
  - ▶ To expand a collapsed column, select the column's header, right-click on the selection and select **Expand/Collapse > Expand Selection**.
  - ▶ Click the **Collapse Selection**  or **Expand Selection**  buttons in the Xsheet View toolbar's extra buttons.

### To collapse or expand all 3D Path columns in the Xsheet view:

Do one of the following:

- ▶ Right-click on any column's header and select **Collapse/Expand > Expand All** or **Collapse All**.
- ▶ The [0] and [9].
- ▶ Click the **Collapse All**  or **Expand All**  buttons in the Xsheet View toolbar's extra buttons.

## Related Topics

- [Layers and Columns](#) on page 355
- [Layer and Column Concepts](#) on page 355
- [Advanced Column Types](#) on page 1
- [Layer Content](#) on page 359
- [Adding New Drawing Layers](#) on page 360
- [Deleting Layers And Columns](#) on page 363
- [Modifying Layers](#) on page 365
- [Duplicating Layers and Columns](#) on page 372
- [Cloning Layers And Columns](#) on page 373
- [Xsheet Thumbnails](#) on page 374
- [Changing the Colour of a Layer or Column](#) on page 374
- [Modifying the Look of the Column](#) on page 1
-

# Filling Exposure

Toon Boom Animate provides different tools to fill-in exposures and values, create cycles, and set increments.

## Related Topics

- [Filling Exposure Mode](#) below
- [Typing Exposure](#) on the facing page
- [Holding Exposure](#) on page 1
- [Extending a Single Exposure](#) on page 382
- [Extending an Exposure Sequence](#) on page 382
- [Dragging Cells](#) on page 384
- [Increasing and Decreasing Exposure](#) on page 386
- [Inserting Blank Cells](#) on page 390
- [Setting the Exposure](#) on page 391
- [Filling a Selection with a Single Exposure](#) on page 392
- [Filling a Selection with a Sequence](#) on page 393
- [Filling a Selection Randomly](#) on page 395
- [Creating Cycles](#) on page 396

## Filling Exposure Mode

In the Xsheet view, you can fill columns using two different filling modes: Overwrite or Insert. These modes control the filling behaviour. The Timeline view only uses the Overwrite mode.

To toggle between Overwrite and Insert modes:

- ▶ In the Xsheet view's right bottom corner, click the **Overwrite/Insert** button or press [I].

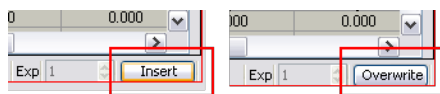

## Overwrite Mode

By default, the Xsheet view is set to Overwrite mode. Add a new value or a new value sequence overwrites existing ones. The existing timing sequence remains in the same place and is not pushed further down the column.

Drawing	
1	1
2	2
3	3
4	4
5	5
6	6
7	7
8	8
9	9
10	10
11	
12	
13	
14	
15	
16	
17	

Drawing	
1	1
2	2
3	3
4	100
5	
6	
7	
8	
9	9
10	10
11	
12	
13	
14	
15	
16	
17	

### Insert Mode

The Insert mode is the opposite of the Overwrite mode. When you add a new value or a new value sequence over existing ones, the new values are inserted between the old ones. The existing timing sequence is pushed down the column.

Drawing	
1	1
2	2
3	3
4	4
5	5
6	6
7	7
8	8
9	9
10	10
11	
12	
13	
14	
15	
16	
17	

Drawing	
1	1
2	2
3	3
4	100
5	4
6	5
7	6
8	7
9	8
10	9
11	10
12	
13	
14	
15	
16	
17	

### Related Topics

- [Filling Exposure on the previous page](#)
- [Filling Exposure Mode on the previous page](#)

## Typing Exposure

To fill in your exposure, you can directly type the values in the Xsheet and Timeline views.

- [Typing a Value in the Timeline View below](#)
- [Typing a Value in the Xsheet View on the next page](#)

### Typing a Value in the Timeline View

If you want to type an exact drawing name or value into the Timeline view, you must use the Data view section of the Timeline.





You can only use alphanumeric values. (0-9, a-z, underscore (\_) and dash (-)).

### To type a value in the Timeline view:

1. In the Timeline view, click the **Show Data View**  button.



2. In the Drawing Substitution field, type the name of the drawing you want to create, and press [Enter/Return].

## Typing a Value in the Xsheet View

To enter a value in a column's cell, double-click in the cell and type the numbers or letters.



You can only use alphanumeric values. (0-9, a-z, underscore (\_) and dash (-)).

- Press [Enter/Return] to move on to the next cell.
- Press [Esc] to exit the typing mode and return to normal mode.

### To type values in the Xsheet view:

1. In an Xsheet column, double-click on one cell.

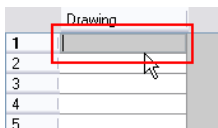

2. Type a value or drawing name in the cell.

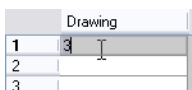

3. Press [Enter/Return] to move on to the next cell.

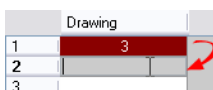

4. Press [Esc] to quit the typing mode.

Drawing	
1	3
2	
3	



## Related Topics

- [Filling Exposure on page 379](#)

## Extending a Single Exposure

The **Extend Exposure** feature allows you to select an Xsheet's cell containing a value and to pull it down to the desired frame.

To extend a cell exposure:

1. In the Xsheet view, select the red arrow  in the cell's right side. Make sure to see the drag down  cursor.

Drawing	
1	1
2	
3	

2. Pull down the selected cell to the desired frame.



The red selection box must be visible when releasing the mouse button. If it is not visible, the action is considered cancelled.

Drawing	
1	1
2	
3	
4	
5	
6	
7	
8	
9	
10	
11	
12	
13	

## Related Topics

- [Filling Exposure on page 379](#)

## Extending an Exposure Sequence

You can extend and create a sequence using almost the same procedure as you would when you extend a single exposure. The only differences being that the selected cell must only contain numbers and that you need to press the [Shift] key while pulling down on the selection.



The creation of the sequence only works with numbers in the selected cell, not letters.

### To create a sequence:

1. In the Xsheet view, select a cell containing a number.
2. In the selected cell, click on the red arrow on the cell's right side. Make sure to see the drag down cursor.

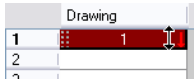

3. Hold down the [Shift] key. Make sure a plus (+) sign appears.
4. Pull down the selection box to the desired frame.

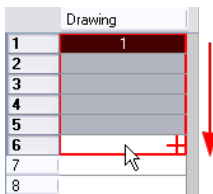

The red selection box must be visible when releasing the mouse button. If it is not visible, the action is considered as cancelled.

5. First release the [Shift] key, then release the mouse button.

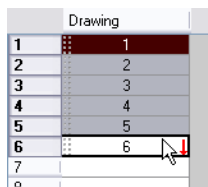

You can also select a cell and select **Animation > Cell > Extend Exposure** or press [F5]. In the dialog box, type the frame number you want to extend the cell to.

### Related Topics

- [Filling Exposure on page 379](#)

# Dragging Cells

To readjust your timing, you can drag one or several cells to a new location in both the Timeline and Xsheet views.

You can drag a cell to any other frame in the same column or into another column.

## To drag a cell to another location in the Timeline view:

1. In the Timeline view, select one or several cells to move.

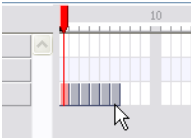

2. Click on the cells selection and drag it to the new location.

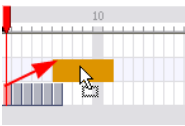

- If you drop the selection, it overwrites the existing cells.

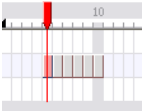

- If you hold [Ctrl] (Windows) or [⌘] (Mac OS X) while dropping the selection, the cells are copied and not moved.

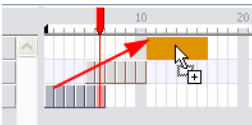

- If you press [Shift] while dropping, the selection is inserted between the existing frames.

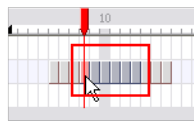
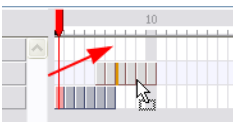

## To drag a cell to another location in the Xsheet view:

1. In the Xsheet view, select one or more cells.

	Drawing_2	Drawing_1	Drawing
1			1
2			2
3			3
4			4
5			5
6			6
7			
8			
9			

2. In the Xsheet view, select the small dotted area  on the left side of the selected cells.

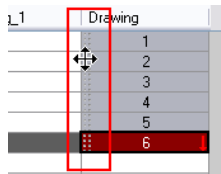

3. Drag the selection to any other cell in the same column or in another column.

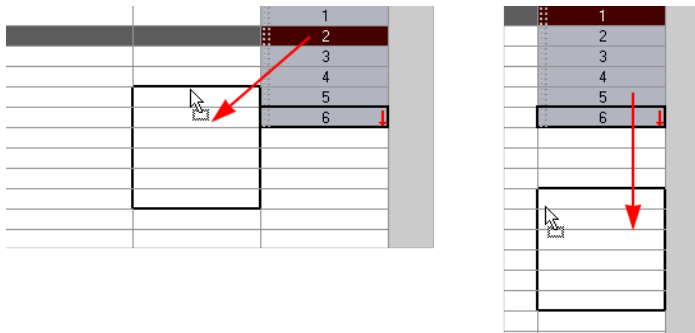

► If you drop the selection, it overwrites the existing cells.

	Drawing_2	Drawing_1	Drawing
1		1	
2		2	
3		3	
4		4	
5		1	
6		2	
7		3	
8		4	
9		5	
10		6	
11		11	
12		12	
13		13	
14			

► If you hold [Ctrl] (Windows) or [⌘] (Mac OS X) while dropping the selection, the cells are copied and not moved.

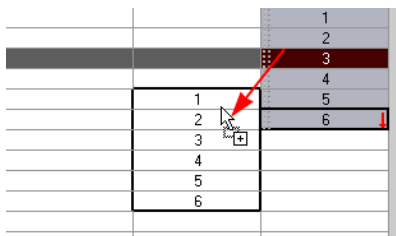

► If you press [Shift] while dropping, the selection is inserted between the existing frames.

	Drawing_2	Drawing_1	Drawing
1		1	
2		2	
3		3	
4		4	
5		5	
6		6	
7		7	
8		1	
9		2	
10		3	
11		4	
12		5	
13		6	
14		8	
15		9	
16		10	
17		11	
18		12	
19		13	

You can turn off the Gestural Drag Mode for the Xsheet view to prevent drawings from being dragged from one location to another. A Toggle Gestural Drag Mode button is available for this feature, accessible by customizing the Xsheet View toolbar. Otherwise, access it by right-clicking on a cell or the Xsheet's Edit menu.

#### To turn off the Gestural Drag mode:

- ▶ In the **Xsheet** view, right-click and deselect the **Gestural Drag Mode** option.
- ▶ You can also customize the Xsheet View toolbar and display the **Toggle Gestural Drag** mode button to enable and disable this option.

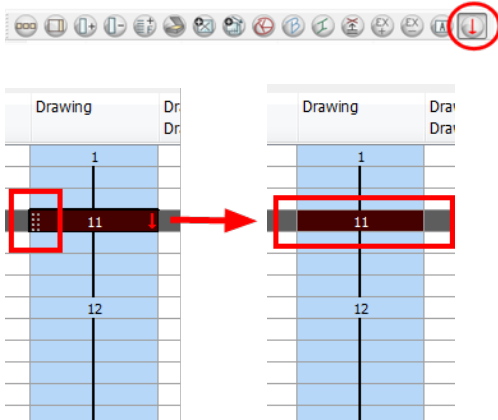

The dragging pad disappears when the Gestural Drag mode is off.



This feature does not apply for Annotation columns.

#### Related Topics

- [Filling Exposure on page 379](#)

## Increasing and Decreasing Exposure

Once a value is entered in the Timeline or Xsheet view, you can increase and decrease its exposure.

#### Related Topics

- [Increasing Exposure below](#)
- [Decreasing Exposure on the next page](#)
- [Increase/Decrease Exposure Field on page 388](#)
- [Clear Exposure and Pull on page 388](#)

### Increasing Exposure

Increasing the exposure adds one more exposure to a selected cell, repeating this action adds an extra cell every time. This is a quick way of extending a drawing exposure and is always set in the Insert mode. Increasing an

exposure always pushes the existing exposure down.

### To use Increase Exposure:

1. In the Timeline or Xsheet view, select a cell.

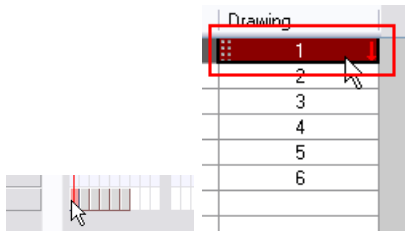

2. Do one of the following:
  - ▶ In the top menu, select **Animation > Cell > Increase Exposure**.
  - ▶ Right-click on the selected cell and select **Exposure > Increase Exposure**.
  - ▶ Press [+].
  - ▶ In Harmony Xsheet, select **Selected > Increase Exposure**.
  - ▶ Click the **Increase Exposure**  button in the Xsheet View and Timeline View toolbars' extra buttons.
3. Repeat this action to add more cells to your drawing's exposure.

### Related Topics

- [Decreasing Exposure below](#)
- [Increase/Decrease Exposure Field on the facing page](#)

## Decreasing Exposure

Decreasing the exposure removes one exposure from a selected cell. Repeating this action removes an extra cell every time. This is a rapid way to reduce a drawing exposure and remove the exposed drawing.

### To decrease exposure:

1. In the Timeline or Xsheet view, select a cell.

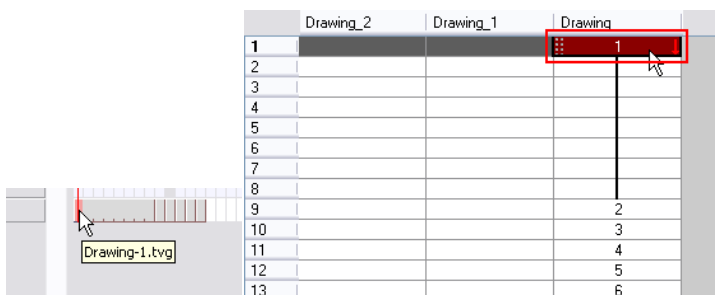

2. Do one of the following:
  - ▶ In the top menu, select **Animation > Cell > Decrease Exposure**.
  - ▶ Right-click on the selected cell and select **Exposure > Decrease Exposure**.
  - ▶ Press [-].

*In Harmony Xsheet, select **Selected > Decrease Exposure**.*

- Click the **Increase Exposure**  button in the Xsheet View and Timeline View toolbars' extra buttons.

3. Repeat this action to decrease more cells to your drawing's exposure.

## Related Topics

- [Increasing and Decreasing Exposure on page 386](#)
- [Clear Exposure and Pull below](#)

## Increase/Decrease Exposure Field

Another technique you can use to quickly increase or decrease the exposure of a selected drawing is by making use of the Increase/Decrease Exposure field available in the Xsheet view.

**To increase and decrease exposure using the Increase/Decrease Exposure field:**

- In the Xsheet view, select the cell to modify.

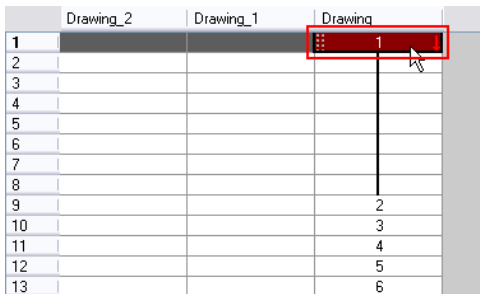

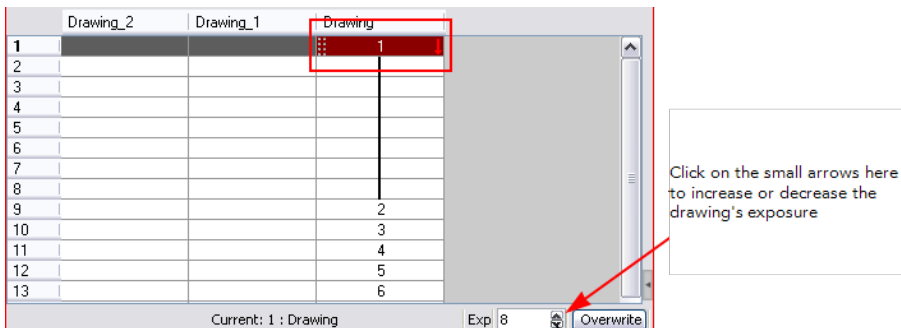

	Drawing_2	Drawing_1	Drawing
1			1
2			
3			
4			
5			
6			
7			
8			
9			2
10			3
11			4
12			5
13			6

- In the Xsheet's bottom-right corner, increase or decrease the drawing's exposure by clicking the up or down arrows. To increase the exposure, press [+]. To decrease the exposure, press [-].



	Drawing_2	Drawing_1	Drawing
1			1
2			
3			
4			
5			
6			
7			
8			
9			2
10			3
11			4
12			5
13			6

Current: 1 : Drawing Exp 8   Overwrite

Click on the small arrows here to increase or decrease the drawing's exposure

## Related Topics

- [Increasing and Decreasing Exposure on page 386](#)
- [Decreasing Exposure on the previous page](#)
- [Clear Exposure and Pull below](#)

## Clear Exposure and Pull

You can reduce a drawing's exposure using the Clear Exposure and Pull option.



**To use the Clear Exposure and Pull feature:**

1. In the Timeline or Xsheet view, select a cell.

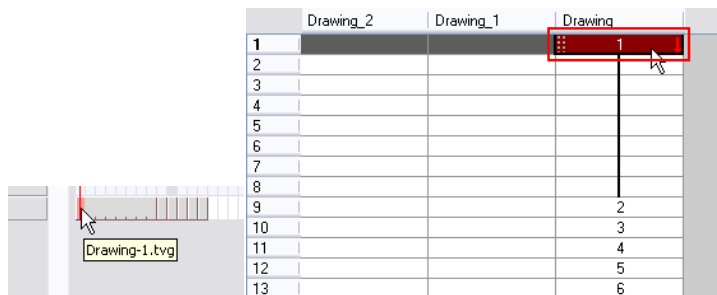

2. Do one of the following:
  - ▶ In the top menu, select **Animation > Cell > Clear Exposure and Pull**.
  - ▶ Right-click on the selected cell and select **Exposure > Clear Exposure and Pull**.
  - ▶ *In Harmony Xsheet, select **Selected > Clear Exposure and Pull**.*
  - ▶ Click the **Clear Exposure**  button in the Xsheet View and Timeline View toolbars' extra buttons.
  - ▶ Press [Z].

**Related Topics**

- [Increasing and Decreasing Exposure on page 386](#)

## Deleting Exposure

You can delete a drawing's exposure in several simple ways. Note that when you delete a drawing's exposure from the Timeline or Xsheet view, you are not deleting the actual drawing file. You can always bring it back by typing its name again in a cell.

You can delete the exposure contained in a selected cell range or delete the entire exposure of a drawing exposed over several cells. Note that you can also delete the exposure for drawings contained inside a collapsed group.

**To delete selected exposures:**

1. In the Timeline or Xsheet view, select the exposure you want to delete.
2. Right-click on the selection and select **Delete** or press [Delete].

**To completely clear the exposure of a drawing:**

1. In the Timeline or Xsheet view, select a cell of a drawing exposed over several cells.
2. Do one of the following:
  - ▶ In the top menu, select **Animation > Cell > Clear Exposure**.
  - ▶ In the Timeline view, right-click on the selection and select **Exposure > Clear Exposure**.
  - ▶ Click the **Clear Exposure**  button in the **Timeline View** toolbar's extra buttons.

## Related Topics

- [Filling Exposure on page 379](#)
- [Layer and Column Concepts on page 355](#)

## Inserting Blank Cells

Use the Insert Blank Cell option to place an empty cell between other cells. This is always done in Insert mode and pushes down existing exposure, even if you are set to Overwrite mode.

To insert blank cells:

1. In the Xsheet or Timeline view, select the cell where you want to insert a blank cell.

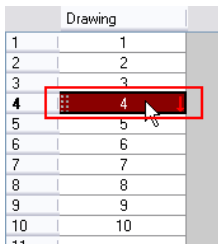
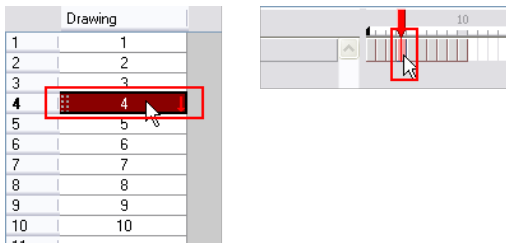

2. Do one of the following:

- ▶ In the top menu, select **Animation > Cell > Insert Blank Cell**.
- ▶ In *Harmony Xsheet*, select **Selected > Insert Blank Cell**.
- ▶ Right-click on the selected cell and select **Exposure > Insert Blank Cell**.
- ▶ Press [Shift] + [J].
- ▶ Click the **Insert Blank Cell**  button in the **Timeline View** and **Xsheet View** toolbars' extra buttons.

The blank cell is inserted.

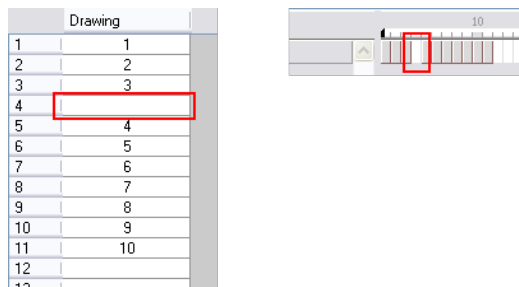

To clear a selected cell range without changing the exposure and timing:

1. In the Xsheet view, select the frame range to clear.

Drawing	
1	1
2	2
3	3
4	4
5	5
6	6
7	7
8	8
9	9
10	10
11	
12	
13	
14	
15	
16	

2. Right-click on the selected cells and select **Clear**.

Drawing	
1	1
2	2
3	
4	
5	
6	
7	
8	
9	3
10	4
11	5
12	6
13	7
14	8
15	9
16	10
17	

## Related Topics

- [Filling Exposure on page 379](#)

# Setting the Exposure

You can easily increase or decrease the exposure for a selected cell range by using the Set Exposure options.

To use the **Set Exposure** options:

1. In the Timeline or Xsheet view, select the cell range that you want to set the exposure for.

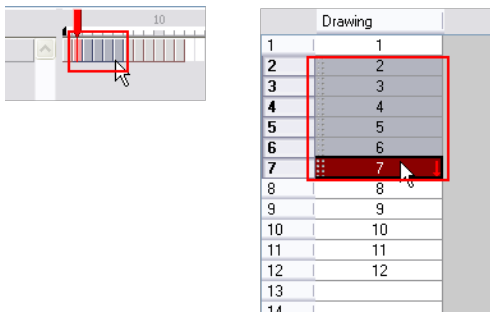

2. In the top menu, select one of the following:
  - **Animation > Cell > Set Exposure > Set Exposure to 1**
  - **Animation > Cell > Set Exposure > Set Exposure to 2**
  - **Animation > Cell > Set Exposure > Set Exposure to 3**
  - **Animation > Cell > Set Exposure**

You can also click the **Set Exposure**     buttons in the **Timeline View** toolbar's extra buttons.

3. In *Harmony Xsheet*, right-click and select **Exposure > Set Exposure** to and then select one of the following:

- **Set Exposure to 1**
- **Set Exposure to 2**
- **Set Exposure to 3**
- **Set Exposure**

If you choose the Set Exposure option, the Set Exposure dialog box opens.

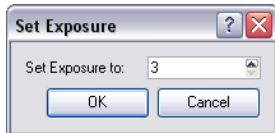

4. Type the amount of frames you want the drawings to be displayed and click OK.

The new timing is displayed in the Xsheet view.

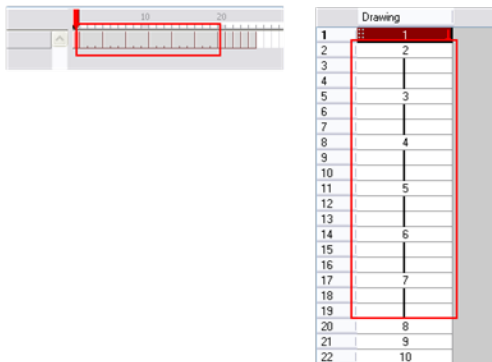

## Related Topics

- [Filling Exposure on page 379](#)

## Filling a Selection with a Single Exposure

The Fill Selection option is used to fill the same value all over a selection. The selection can be over one cell, a cell range in one column, a cell range over many columns, an entire column or many entire columns. You can use numbers, words, letters or any alphanumeric value.

### To use Fill Selection:

1. In the Xsheet or Timeline view, select a cell range.



2. Do one of the following:

- ▶ Select **Animation > Cell > Fill Selection**.
- ▶ Press [Ctrl] + [T] (Windows) or [⌘] + [T] (Mac OS X).
- ▶ In Harmony Xsheet, select **Selected > Fill Selection**.
- ▶ Click the **Fill Selection**  button in the **Xsheet View** and **Timeline View** toolbars' extra buttons.

The Fill Selection dialog box opens.



3. In the Value field, type the desired value and click OK.



## Related Topics

- [Filling Exposure on page 379](#)

# Filling a Selection with a Sequence

The Sequence Fill option is used to create a number sequence over a selection. The sequence can be forward, backward, single, double or higher increment, as a cycle, etc. The selection can be over one cell, a cell range in one or more columns, an entire column, or several entire columns.

**To fill a selection with a sequence:**

1. In the Xsheet or the Timeline view, select a cell range.

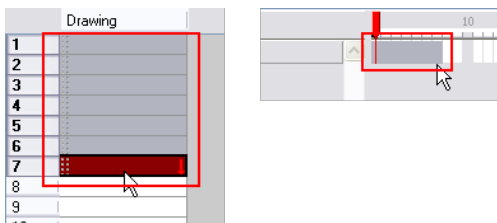

2. If you are working in the Xsheet view, select **Animation > Cell > Sequence Fill**. Click the **Sequence Fill**  button in the **Xsheet View** toolbar's extra buttons.

*In Harmony Xsheet, select **Selected > Sequence Fill**. You can also click on the **Sequence Fill**  button available in the **Xsheet View** toolbar's extra buttons.*

**OR**

If you are working in the **Timeline** view, right-click and select **Exposure > Sequence Fill**.

- ▶ Press [Ctrl] + [M] (Windows) or [⌘] + [M] (Mac OS X).

The Sequence Fill dialog box opens.

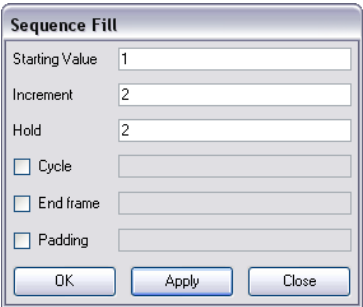

- 3. In the Starting Value field, type the starting number for the number sequence.
- 4. In the Increment field, type the increment to which the number will change from frame to frame. (1-2-3-4, 1-3-5-7, 10-9-8-7-6-5-4-3-2-1). The value can be positive or negative.
- 5. In the Hold field, choose an exposure holding value.
- 6. Select the **Cycle** option if you want a cycle; type the number of cells for this cycle's duration.



If you choose a two cell hold, a cycle of three drawings will last for six cells.

- 7. If you selected a larger range than the amount of frames needed, select the **End Frame** option and type the last frame needed.

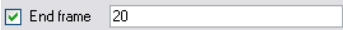

- 8. If you want to have more than one digit in your numbers such as "001" instead of "1", select the **Padding** option and add as many pound signs (#) as digits needed. Also, you can type a letter or word in the field for it to be added in front of the drawing number.



- 9. Click OK.

	Drawing
1	mouth1
2	
3	mouth3
4	
5	mouth5
6	
7	mouth1
8	
9	mouth3
10	
11	mouth5
12	
13	mouth1
14	
15	mouth3
16	
17	mouth5
18	
19	mouth1
20	
21	

## Related Topics

- [Filling Exposure on page 379](#)

# Filling a Selection Randomly

The Fill Cells Randomly option is used to fill in random values over a selection. You can give a maximum and a minimum value and create a range for the system to choose the random values from. The selection can be over one cell, a cell range in one column, a cell range over many columns or an entire column or several entire columns.

### To use Fill Cells Randomly:

1. In the Xsheet view, select a cell range.

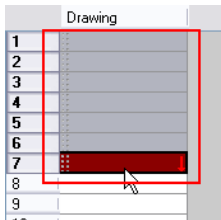

2. Select **Animation > Cell > Fill Cells Randomly**.

*In Harmony Xsheet, select **Selected > Cell > Fill Cells Randomly**.*

- ▶ You can also click on the **Fill Cells Randomly**  button available in the **Xsheet View** toolbar's extra buttons.

The **Fill Cells Randomly** dialog box opens.

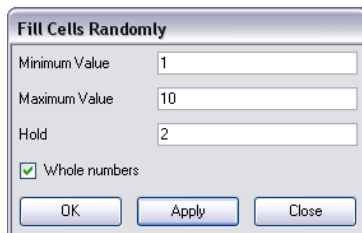

3. In the Minimum Value field, type a minimum value.
4. In the Maximum Value field, type a maximum value.
5. In the **Hold** field, choose an exposure holding value.
6. If you are applying this option to a drawing column, enable the **Whole Numbers** option to avoid decimal points.
7. Click OK.

	Drawing
1	5
2	
3	3
4	
5	9
6	
7	2
8	
9	
10	
11	

## Related Topics

- [Filling Exposure on page 379](#)

## Creating Cycles

Once you have entered a series of drawings and exposures, you can create cycles out of them in several ways.

You can loop your drawings using the following commands:

- Paste Cycle
- Paste Reverse
- Create Cycle

When you create a drawing cycle, all of the repeated drawings are linked to the same original files. This means that when you modify, repaint or correct a drawing named "1" all drawings named "1" are updated simultaneously. In order to modify a drawing independently from its other exposures, you must duplicate the drawing.

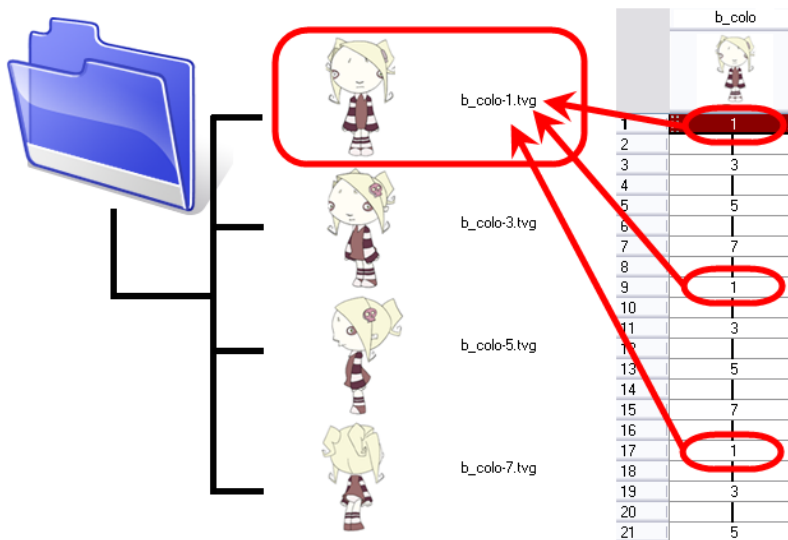

### To use the Paste Cycle command:

1. In the Xsheet or Timeline view, select the cell range to loop.

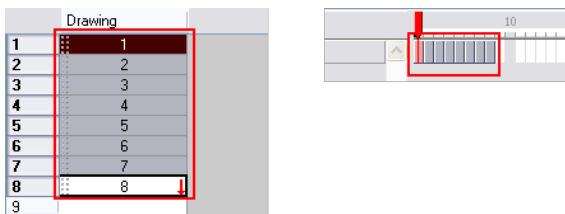

2. In the top menu, select **Edit > Copy**.
3. In the Xsheet or Timeline view, select the cell where you want your cycles to start.



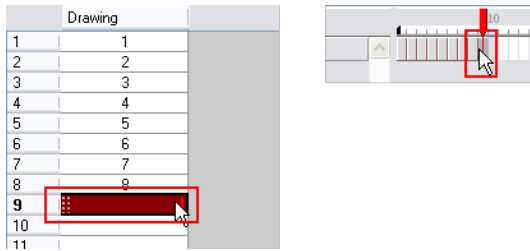

4. In the top menu, select **Edit > Paste Cycle**.

*In Harmony Xsheet, right-click and select **Paste Cycle**.*

- The [Ctrl] + [I] (Windows) or [⌘] + [I] (Mac OS X).

The Paste Cycle dialog box opens.

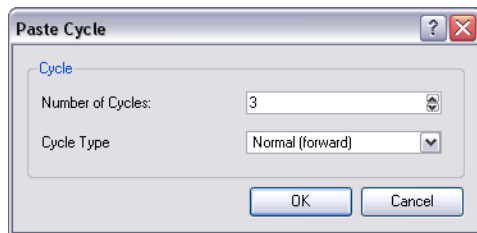

5. In the Number of Cycles field, use the up and down arrow to increase or decrease the amount of cycles you want to paste. You can also directly type the value.
6. In the Cycle Type drop-down menu, select the type of cycle you want to paste.

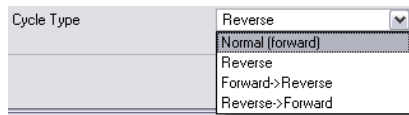

- **Normal (forward)**: Pastes your selection as it is, starting with the first cell and ending with the last one.
  - **Reverse**: Pastes your selection reversed, starting with the last cell and ending with the first one.
  - **Forward -> Reverse**: Pastes your selection as a yo-yo, starting with the first cell, going to the last one and ending with the first cell.
  - **Reverse -> Forward**: Pastes your selection as a reversed yo-yo, starting with the last cell, going to the first one and ending with the last cell.
7. Click OK.



You can do the same operation using the Paste Special dialog box. To open the Paste Special dialog box, select **Edit > Paste Special** or press [Ctrl] + [B] (Windows) or [⌘] + [B] (Mac OS X).

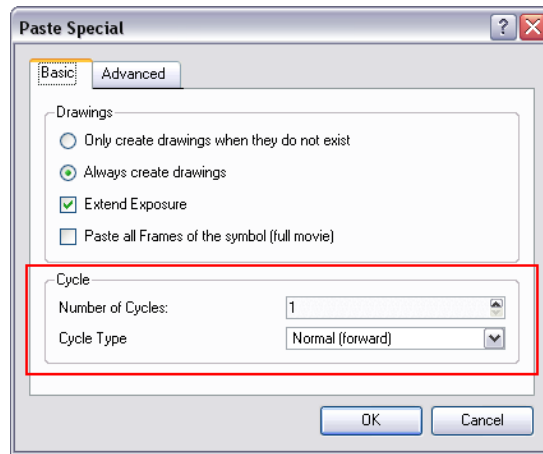

#### To use the Paste Reverse command:

1. In the Xsheet or Timeline view, select the cell range to paste inverted.

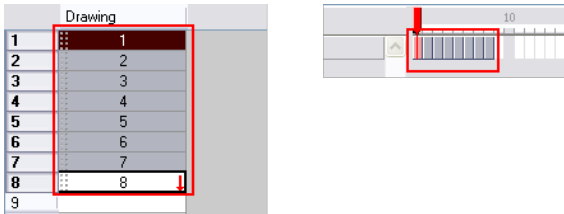

2. In the top menu, select **Edit > Copy**.
3. In the Xsheet or Timeline view, select the cell where you want your cycles to start.

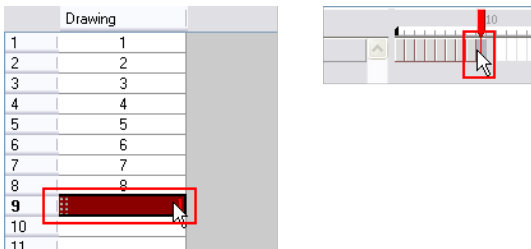

4. In the top menu, select **Edit > Paste Reverse**.  
*In Harmony Xsheet, right-click and select **Paste Reverse**.*
  - ▶ Press [Ctrl] + [.] (Windows) or [⌘] + [.] (Mac OS X).

Drawing	
1	1
2	2
3	3
4	4
5	5
6	6
7	7
8	8
9	8
10	7
11	6
12	5
13	4
14	3
15	2
16	1
17	

**To use the Create Cycle command:**

1. In the Timeline view, select the cell range to loop.

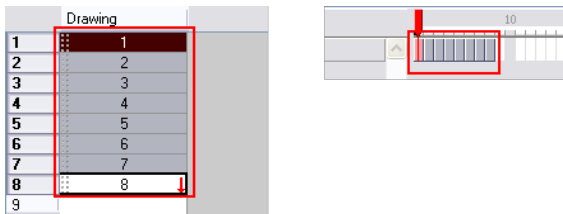

2. In the Timeline View toolbar, click on the **Create Cycle**  button located in the toolbar's extra buttons.

The Create Cycle dialog box opens.

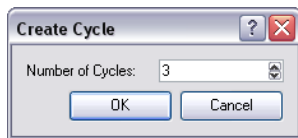

3. Enter the number of cycles you want, including the current selection.

**Related Topics**

- [Filling Exposure on page 379](#)

# Navigating between Frames and Columns

Once a cell is selected in the Timeline or Xsheet view, you can navigate between the layers, frames and drawings using keyboard shortcuts that are effective in the Camera, Drawing, Timeline and Xsheet view.

You can navigate through:

- Columns
- Drawings
- Frames

To navigate through the drawings, frames and columns:

1. In the Timeline or Xsheet view, select a cell.

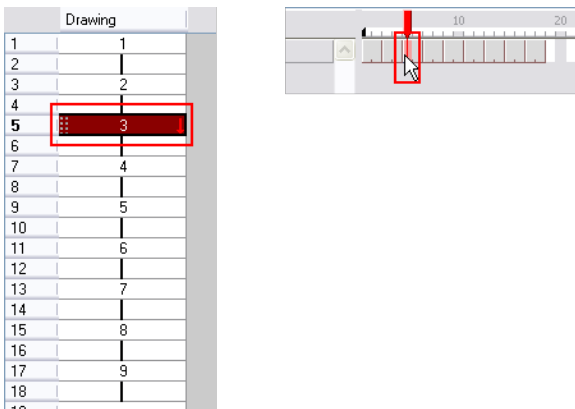

2. Once the cell is selected, you can navigate between:

- Previous and next layers from the top menu, you can select **Edit > Previous Layer** and **Next Layer**. You can also press [H] and [J].

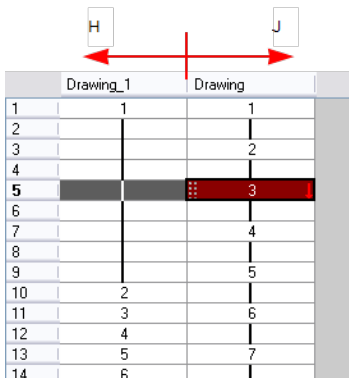

- Previous and next drawings, from the top menu, select **Edit > Previous Drawing** and **Next Drawing** or **Drawing > Previous Drawing** and **Next Drawing**. You can also press [F] and [G].

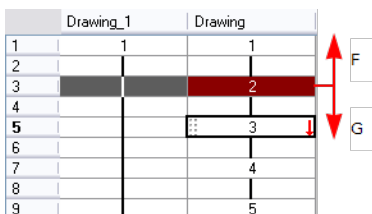

- ▶ Previous and next frames, from the top menu, select **Play > Previous Frame** and **Next Frame**. You can also press [,] and [.]

	Drawing_1	Drawing
1	1	1
2		
<b>3</b>		<b>2</b>
4		
5		3
6		
7		4
8		
9		5
10	2	

The diagram shows a timeline table with two columns: 'Drawing\_1' and 'Drawing'. The rows are numbered 1 through 10. Frame 3 is highlighted in red. To the right of the table, there are two red arrows pointing left and right, and two boxes containing the keys [,] and [.] respectively, indicating navigation controls.

# Managing Drawings

Drawings that are created in Toon Boom Animate are not encapsulated in their cells. They are actual files stored in the project's folder. If you want to rename a drawing or delete a drawing from your project, you need to edit the file and not the cells.



You also have the option of marking your drawing as Key, Breakdown and In-betweens—see [Drawing Identification](#) on page 241 to learn more about this feature.

## Related Topics

- [Renaming a Drawing](#) below
- [Renaming Drawings by Frame Position](#) on the next page
- [Deleting a Drawing](#) on page 404
- [Duplicating a Drawing](#) on page 405
- [Copying and Pasting Drawings](#) on page 406
- [Drawing Identification](#) on page 241



## Renaming a Drawing

To rename a drawing, you do not type the new name in the cell. You need to select the cell containing the drawing and use the Rename Drawing command.

### To rename a drawing:

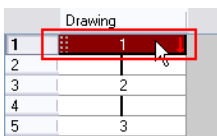
1. In the Timeline or Xsheet view, select the drawing to rename.



2. Do one of the following:
  - ▶ In Harmony Stage's top menu, select **Drawing > Rename Drawing** or press [Ctrl] + [D] (Windows) or [⌘] + [D] (Mac OS X).
  - ▶ Click the **Rename Drawing**  button in the **Timeline View** or **Xsheet View** toolbars' extra buttons.
  - ▶ *In Harmony Xsheet, use the **Rename Drawing**  button in the **Xsheet View** toolbars' extra buttons.*

The Rename Drawing dialog box opens.

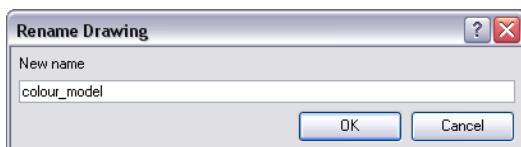

3. In the New Name field, type the new drawing name.

## Related Topics

- [Managing Drawings](#) on the previous page
- [Renaming Drawings with a Prefix](#) below
- [Renaming Drawings by Frame Position](#) below
- [Deleting a Drawing](#) on the facing page
- [Duplicating a Drawing](#) on page 405
- [Copying and Pasting Drawings](#) on page 406

## Renaming Drawings with a Prefix

You have a the possibility to rename a drawing sequence with a prefix. This option can be quite useful for cut-out puppet breakdown and deformation animation.

To rename a drawing sequence with a prefix:

1. In the Xsheet or Timeline view, select your drawing sequence. Note that you can only select a drawing range in one column or layer at the time.
2. Right-click and select **Drawings > Rename Drawing with Prefix**.

The Rename Drawing with Prefix dialog box opens.

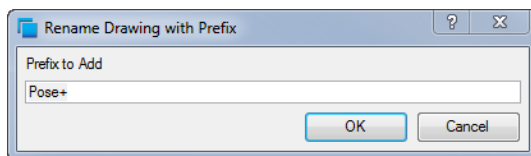

3. In the Prefix to Add field, type the prefix you want to add before your drawing name.

## Related Topics

- [Managing Drawings](#) on the previous page
- [Renaming a Drawing](#) on the previous page
- [Renaming Drawings by Frame Position](#) below
- [Deleting a Drawing](#) on the facing page
- [Duplicating a Drawing](#) on page 405
- [Copying and Pasting Drawings](#) on page 406
- [Deformation](#)
- [Character Building](#) on page 553

## Renaming Drawings by Frame Position

You can rename a series of drawings relative to their frame position. This is useful in hand-drawn animation.

**To rename drawings by their frame position:**

1. In the Xsheet or Timeline view, select the drawing sequence to be renamed.

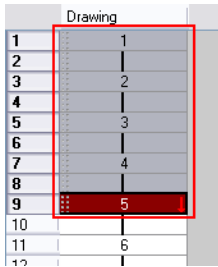

2. In the top menu, select **Drawing > Rename by Frame**.

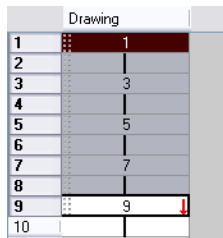
**Related Topics**

- [Managing Drawings on page 402](#)
- [Renaming a Drawing on page 402](#)
- [Renaming Drawings with a Prefix on the previous page](#)
- [Deleting a Drawing below](#)
- [Duplicating a Drawing on the next page](#)
- [Copying and Pasting Drawings on page 406](#)

## Deleting a Drawing

To permanently delete a drawing file, select the drawing you want to delete and use the **Delete Selected Drawings** command.



Deleting a drawing file is an operation that cannot be undone.

**To delete a drawing:**

1. In the Timeline or Xsheet view, select the drawings to delete.



Drawing	
1	1
2	1
3	2
4	1
5	3
6	1
7	4
8	1
9	5
10	1

- In the top menu, select **Drawing > Delete Selected Drawings**.

## Related Topics

- [Managing Drawings on page 402](#)
- [Renaming a Drawing on page 402](#)
- [Renaming Drawings with a Prefix on page 403](#)
- [Renaming Drawings by Frame Position on page 403](#)
- [Duplicating a Drawing below](#)
- [Copying and Pasting Drawings on the facing page](#)

## Duplicating a Drawing

If you want to modify a drawing that already exists, but keep the original drawing intact, you can duplicate the drawing and work on the copy. When duplicating a drawing, the selected cell is replaced with the new drawing. The exposure of the original drawing that was on the current cell is removed. The drawing is not deleted.

### To duplicate a drawing:

- In the Timeline or Xsheet view, select the drawing to duplicate.

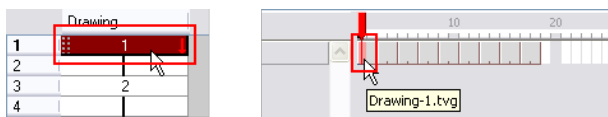

- In the Xsheet View toolbar, click the **Duplicate Drawing**  button.
- In Harmony Stage's top menu, select **Drawing > Duplicate Drawing** or press [Alt] + [Shift] + [D].

Drawing	
1	14
2	1
3	2
4	1

With Toon Boom Animate you can create a keyframe at the same time as you duplicate your drawing. This way you can modify and reposition your drawings without affecting the original drawing.

## Related Topics

- [Managing Drawings on page 402](#)
- [Renaming a Drawing on page 402](#)
- [Renaming Drawings by Frame Position on page 403](#)

- [Deleting a Drawing on page 404](#)
- [Duplicating a Drawing on the previous page](#)
- [Copying and Pasting Drawings below](#)

## Copying and Pasting Drawings

When you copy and paste a selection in the Timeline or Xsheet view, you are not copying and pasting the actual drawings, you are pasting the exposure.

If you want to copy and paste the selected drawings into a different layer or paste the selection in the same layer to duplicate the drawings, you must use the Paste Special feature.

There are two main ways to paste your selected drawings with the Paste Special dialog box:

- **Always Create Drawings**

This option pastes all of your drawings as they are. If a drawing has the same name as an existing one, it is renamed and duplicated.

- **Only Create Drawings When They Do Not Exist**

This option only pastes only the drawings that are named differently from existing drawings. If a drawing has the same name as an existing one, it is ignored and not pasted. This avoids duplicating drawings in your layers.

This option is useful when you are pasting cut-out character templates containing drawings you may already have in your scene and some new ones. Using this option, you only paste the new drawings and are not duplicating all of the other parts you already have.

**To paste drawings with the Paste Special command:**

1. In the Timeline or Xsheet view, select the drawings to copy.

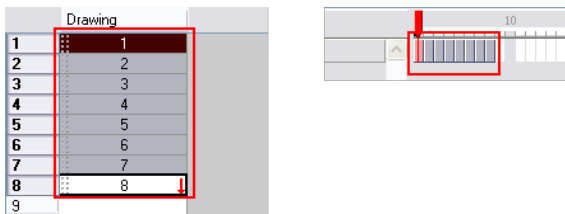

2. In the Timeline or Xsheet view, select the cell where you want your pasted selection to start.

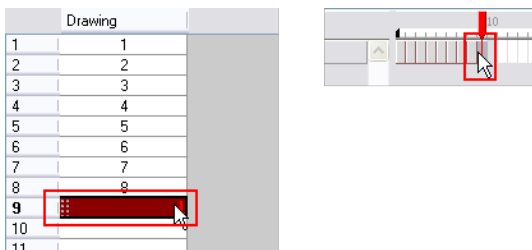

3. In the top menu, select **Edit > Paste Special** or press [Ctrl] + [B] (Windows) or [⌘] + [B] (Mac OS X). You can also click the **Paste Special**  button in the Timeline View and Xsheet View toolbars' extra buttons.

The Paste Special dialog box opens.

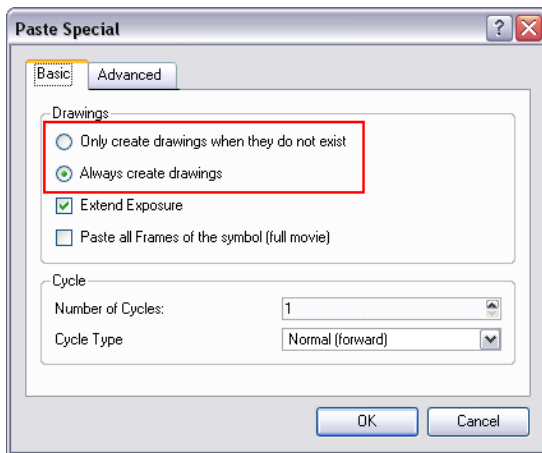

4. Select the **Basic** tab.
5. In the Drawings section, select the **Always Create Drawings** or the **Only Create Drawings When They Do Not Exist** option depending on what you need.



If you want to perform another paste special operation using the same settings you used previously, you can use the Paste Special Again command instead of the Paste Special command. This feature paste your selection using the same settings you used in your last paste special without opening the Paste Special dialog box.

To use the Paste Special Again command, select **Edit > Paste Special Again** or press [Ctrl] + [Shift] + [B] (Windows) or [⌘] + [Shift] + [B] (Mac OS X). You can also click the **Paste Special Again**  button

in the Timeline View and Xsheet View toolbars' extra buttons.

## Related Topics

- [Managing Drawings on page 402](#)
- [Renaming a Drawing on page 402](#)
- [Renaming Drawings with a Prefix on page 403](#)
- [Renaming Drawings by Frame Position on page 403](#)
- [Deleting a Drawing on page 404](#)
- [Duplicating a Drawing on page 405](#)

# Tempo Markers

Tempo markers are used to synchronize your animation with a musical score. Using this feature, you can reproduce the FPB (Frames Per Beat) and the tempo signature as Tempo markers. The Xsheet view allows you to pace your animation according to the tempo or beat of your soundtrack music or to any rhythmical sound, such as the ticking of a clock or water leaking from a spout.

	Drawing	Limpa_Colour	01_Next_Ext
1	1	1	
2		2	
3		3	
4		4	
5		5	
6		6	
7		7	
8		8	
9		9	
10		10	
11		11	
12		12	
13		13	
14		14	
15		15	
16		16	
17	2	17	
18	3	18	
19	4	19	
20	5	20	
21	6	21	
22	7	22	
23	8	23	
24	9	24	
25	10	25	
26	11	26	
27	12	27	
28	13		
29	14		
30	15		
31	16		
32	17		
33	18		

## To set the Tempo Markers:

1. In the Xsheet view, right-click and select **View > Set Tempo Marker**.

The Tempo Marker dialog box opens.

2. Reproduce the tempo and beat value of your music or sound for the Xsheet view marker display.
  - **Starting Frame:** Type the number of the frame where you want the tempo markers to begin.
  - **Frames/Beat:** Set the Frames Per Beat value. This will determine the frequency (in frames) a beat marker will appear. Keep in mind that, by default, 24 frames represent 1 second.
  - **Beat/Bar:** Set the Tempo of your music or sound. This will determine the frequency (in beats) a tempo marker will appear in the Xsheet view.
3. Click OK.

## Related Topics

- [Timing on page 339](#)

# Annotation Columns

The Annotation columns are a more than just a useful tool. They allow you to mark actions, corrections or any other information related to your animation that you would like to draw or write. This way, you can print your Xsheet, take it back to your animation table and work with the annotations.

## Related Topics

- [Adding an Annotation Column](#) below
- [Drawing and Typing in the Annotation Column](#) on the next page
- [Changing the Drawing Settings](#) on page 1
- [Importing an Annotation File](#) on page 1

## Adding an Annotation Column

To add an annotation column:

1. Do one of the following:
  - In the Xsheet View menu, select **Columns > Add Columns**.
  - In the Xsheet View toolbar, click the **Add Columns**  button.
  - Press [Shift] + [C].

The Add Columns dialog box opens.

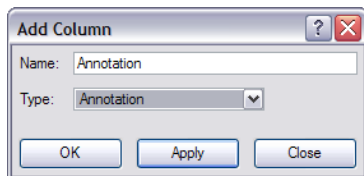

2. In the Column Name field, name your column accordingly.
3. In the Column Type field, select **Annotation**.
4. Click OK.

The new column appears.

## Related Topics

- [Annotation Columns](#) above
- [Drawing and Typing in the Annotation Column](#) on the next page
- [Changing the Drawing Settings](#) on page 1
- [Importing an Annotation File](#) on page 1

# Drawing and Typing in the Annotation Column

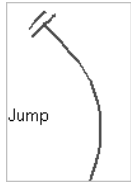

In the annotation column, you can not only type in your notes and relevant information, but also draw sketches and ideas which will be useful in producing your animation.

- [Drawing in the Annotation Column](#) below
- [Typing in the Annotation Column](#) on the facing page
- [Erasing Annotation Column Content](#) on the facing page

## Drawing in the Annotation Column



Before you can draw in the annotation column, you must first activate the Enable Drawing option. Once this is done, you can start drawing using the mouse or the pen tablet.



Pen tablet pressure sensitivity is not supported in the annotation column.

---

### To enable drawing in the annotation column:

1. In the Xsheet View menu, select **Annotation > Enable Drawing**. You can also click on the column's header icon to toggle the Drawing, Selection and Erasing modes.
  - ▶ The Select  icon indicates that the Select mode is enabled.
  - ▶ The Brush  icon indicates that the Drawing mode is enabled.
  - ▶ The Eraser  icon indicates that the Erasing mode is enabled.

### To draw in the annotation column:

- ▶ To draw in an annotation column, simply use your mouse or pen tablet.

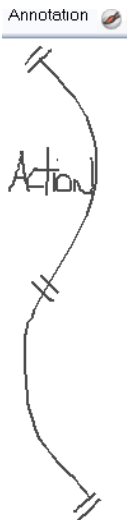

## Typing in the Annotation Column

Typing in an annotation column is independent from the Drawing mode. You can be in either mode and the typing will work.

**To type in an annotation column:**

1. In the annotation column, press [Ctrl] (Windows) or [⌘] (Mac OS X) on the cell where you want to write. By pressing [Ctrl] + [Shift] + click (Windows) or [⌘] + [Shift] + click (Mac OS X) in the annotation column, you will enter the editing mode in the cell at the current frame.

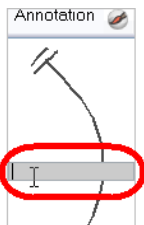

2. In the selected cell, type the desired text.

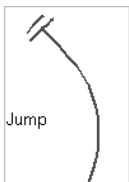

Refer to the topic [Typing Exposure on page 380](#) to get more information about typing values in the Xsheet view.

## Erasing Annotation Column Content

You can erase part or all of the annotation column's content.



**To erase the annotation content:**

1. In the Xsheet view, enable the **Erasing** mode by clicking on the mode icons.



2. In the Xsheet view, select the cell range you want to clear from text or images. Do not select any cells if you plan to clear everything.

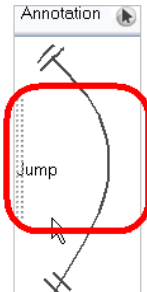

3. In the Xsheet view, right-click in the annotation column and select:
  - **Annotation > Erase All** to erase completely the content of the column.
  - **Annotation > Erase Selected Images** to erase the images contained in the selected cell range. Make sure to disable the Drawing mode to do so.
  - **Annotation > Erase Selected Texts** to erase the text contained in the selected cell range. Make sure to disable the Drawing mode to do so.



**Tip:** You can also use the Erasing mode to erase part of a drawn annotation.

**To erase part of a drawn annotation using Erasing mode:**

1. In the Annotation column's header, enable the **Erasing** mode.

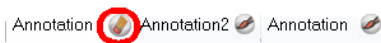

2. In the column, click and drag the cursor on top of the drawn annotation to erase parts of it.

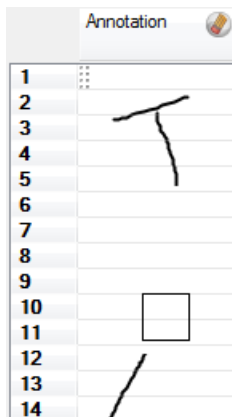



---

Annotations that you type in are not erased using this method.

---

# Timing Preferences

When adjusting your timing in the **Timeline** and **Xsheet** view, you may want to set some preferences.

This section covers the preferences related to timing, **Timeline** and **Xsheet** view.

---



The preferences related to Harmony Xsheet can be found under the **Exposure Sheet** tab only.

---

You will find the preferences listed under the following tabs:

- **Exposure Sheet**
- **Timeline**
- **Advanced**

To open the Preferences panel:

- Windows: Select **Edit > Preferences**.
- Mac OS X: Select **Animate > Preferences**.
- The [Ctrl] + [U] (Windows) or [⌘] + [U] (Mac OS X).

## Related Topics

- [Exposure Sheet Preferences](#) below
- [Timeline Preferences](#) on page 417
- [Advanced Preferences](#) on page 418

# Exposure Sheet Preferences

This is the Exposure Sheet preferences tab.

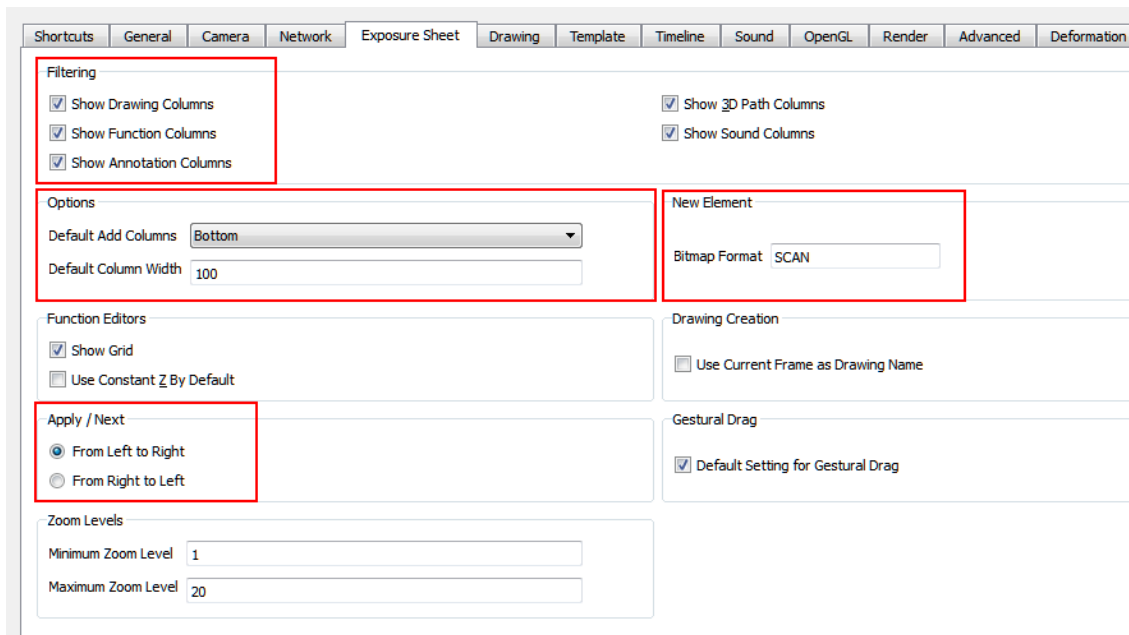

## Filtering

These preferences are used to display or hide certain layer types in the Xsheet view.

- **Show Drawing Columns:** Displays the Drawing layers in the Xsheet view.
- **Show Function Columns:** Displays the Function columns layers in the Xsheet view.
- **Show Annotation Columns:** Displays the Annotation columns layers in the Xsheet view.
- **Show 3D Path Columns:** Displays the 3D Path columns in the Xsheet view.
- **Show Sound Columns:** Displays the Sound columns in the Xsheet view.

## Options

- **Default Add Columns:** The default position where the new column will be added.
- **Default Column Width:** The default width value for the new column being created.

## New Element

- **Bitmap Format:** By default, when you create a new empty bitmap column, it will use the file format indicated in the field as the new column format. The default value is SCAN, which means that it is set for scanned-in drawings.
- **Scan Type:** By default, the Scan Type is set to 2 which equals vector import. This means that the imported bitmap images will be placed into a Drawing layer. Scan type 1 is bitmap import.

## Apply/Next

- **From Left to Right:** When clicking on the **Apply/Next** button in the Xsheet view **Column Properties**, the next column to be displayed in the **Column Properties** will be the one on the right.

- **From Right to Left:** When clicking on the **Apply/Next** button in the **Xsheet** view **Column Properties**, the next column to be displayed in the **Column Properties** will be the one on the left.

## Related Topics

- [Timing Preferences](#) on page 415
- [Timeline Preferences](#) below
- [Advanced Preferences](#) on the facing page

# Timeline Preferences

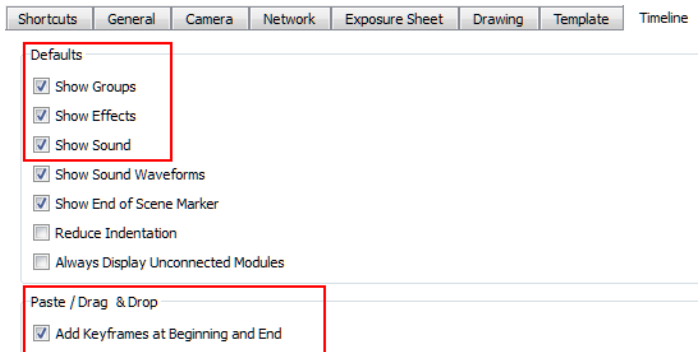

## Defaults

- **Show Groups:** Displays the Group layers in the Timeline.
- **Show Effects:** Displays the Effect layers in the Timeline.
- **Show Sound:** Displays the Sound layers in the Timeline.

## Paste/Drag & Drop

- **Add keyframes at beginning and end:** Select this option to copy and paste a set of frames that includes an interpolated sequence between two keyframes, but only extracts a partial section. Under normal circumstances, cutting and pasting a function without either the start or end keyframe would render the function null. This option caps the partial function with a new keyframe when you perform the paste.

## Related Topics

- [Timing Preferences](#) on page 415
- [Exposure Sheet Preferences](#) on page 415
- [Advanced Preferences](#) on the facing page

# Advanced Preferences

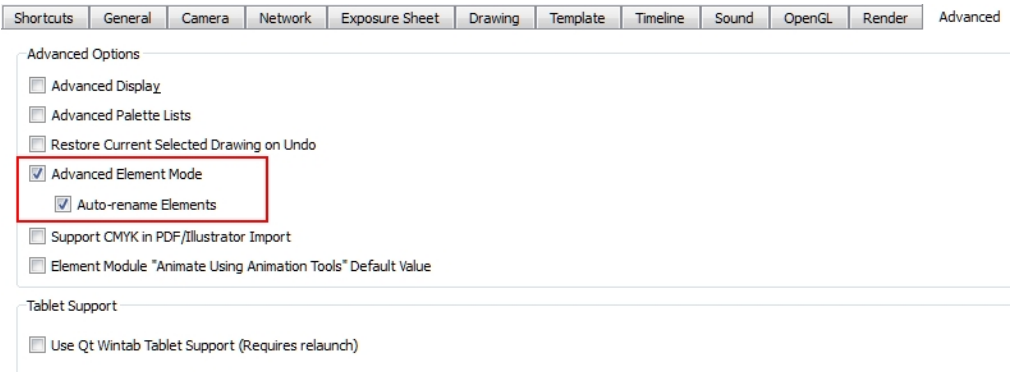

- **Advanced Element Mode:** Displays more options in the **Add Column** dialog box and the **Column Properties** dialog box.
  - **Auto-rename Elements:** Controls whether to rename the element whenever the corresponding module name in the Network view or layer name in the Timeline view is changed.

## Related Topics

- [Timing Preferences on page 415](#)
- [Exposure Sheet Preferences on page 415](#)
- [Timeline Preferences on the previous page](#)

# Chapter 8: Morphing



Hand-drawn animation requires you to spend a lot of time tracing in-between drawings. Animate speeds up the process using its helpful Morphing feature. This powerful and useful feature creates computer generated drawings and places them between vector drawings to save time and increase quality. Animation created with the Morphing feature can be reused in different projects. You can easily modify the timing and velocity (ease in and ease out).

One of the main uses of the Morphing feature is in effect animation. For example, animating smoke or water can be time-consuming because these types of effects are usually slow moving requiring a large number of closely placed in-betweens.

## Topics Covered

- [Understanding Morphing on the facing page](#)
- [Source and Destination Drawings on page 421](#)
- [Morphing Rules on page 422](#)
- [Creating a Basic Morphing Sequence on page 426](#)
- [Tool Properties View on page 429](#)
- [Adjusting the Velocity and Timing on page 433](#)
- [Morphing Tool and Hints on page 437](#)
- [Morphing Two Sequences in a Row on page 446](#)
- [Inserting a Morphing Key Drawing on page 447](#)
- [Converting Morphing In-betweens to Drawings on page 449](#)
- [Morphing Holes and Transparencies on page 450](#)
- [Adjusting the Morphing Quality on page 453](#)
- [Tips and Tricks on page 454](#)
- [Morphing Preferences on page 455](#)

# Understanding Morphing

The Morphing feature is used to animate similar and simple shapes such as hair or smoke. It helps you by saving time when you are working on tedious in-betweening and tracing tasks. This, in turn, provides you with more time to spend on complex animation tasks such as walk-cycles or acrobatic sequences.

## Ideas Behind Morphing

To learn how to morph drawings, it is better to start with basic shapes such as circles and rectangles. Once you are more familiar with the tool, you can increase your knowledge and expertise. In a very short time you will be producing some remarkable effects.

It is helpful to know the pros and cons of morphing before you start. Understanding what you can do and which drawing lines can give you a problem will enable you to design your key drawings so they morph efficiently.



The more complex the shape is, the longer it takes to morph. If it takes more time to morph a drawing than to hand draw it, then it is better to animate it instead of morphing. However, if you spot an occasion when you can morph your drawings, do it! It allows you to fix your timing and velocity in no time without having to create any extra drawings!

---

### Related Topics

- [Source and Destination Drawings on the next page](#)



# Source and Destination Drawings

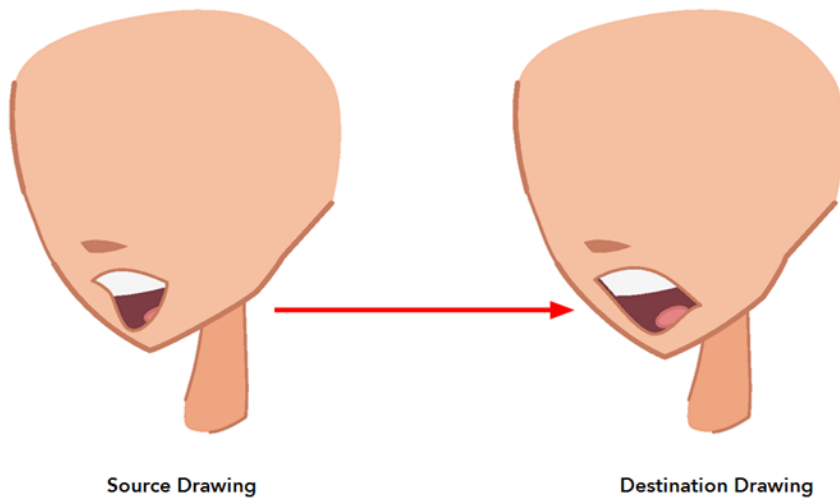

The Morphing feature matches similar shapes in two drawings. These are the source and destination drawings. Animate evaluates the source's shape properties and matches them to the most similar one in the destination drawing.

Morphing works between similar shapes, which are drawings that have the same palette, colours and number of shapes. You can even change a rabbit into an elephant, as long as source and destination keep the same colours and number of shapes.

## Related Topics

- [Creating a Basic Morphing Sequence on page 426](#)
- [Morphing Rules on the facing page](#)

# Morphing Rules

Animate follows a set of rules as it evaluates the shapes. Familiarize yourself with these basic morphing rules before you start morphing.

## Related Topics

- [Closest Similar Shape below](#)
- [Pencil Line to Pencil Line below](#)
- [Fill Shape to Fill Shape on the next page](#)
- [Colour Swatch to Same Colour Swatch on page 424](#)
- [Vanishing and Appearing on page 424](#)
- [Colour Art to Colour Art and Line Art to Line Art on page 425](#)

## Closest Similar Shape

A colour, line shape or zone will morph with the closest similar one in the destination drawing. This means it will morph with the zone nearest to it, as long as that zone uses the same palette's colour swatch (Colour ID) and has the same vector properties (Central or Contour).

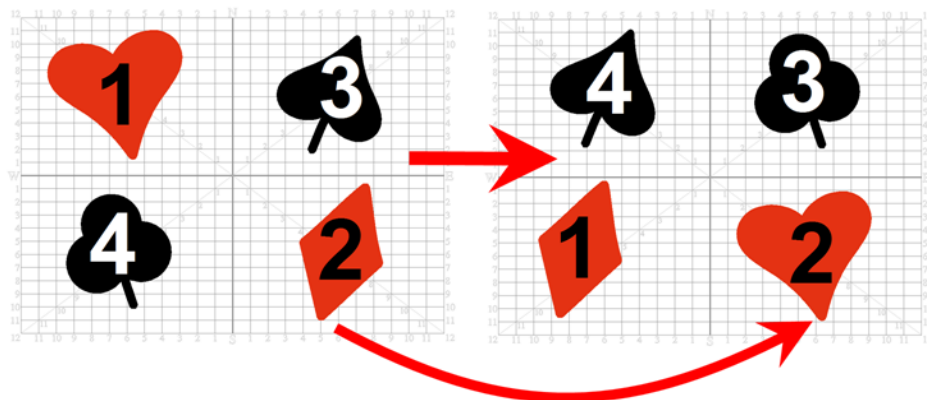

## Pencil Line to Pencil Line

If you trace a shape using a pencil line such as the Ellipse , Rectangle , Polyline , Line  or Pencil 

tool, you have to morph it with another pencil line. Make sure that both drawings are pencil shapes (central vector).

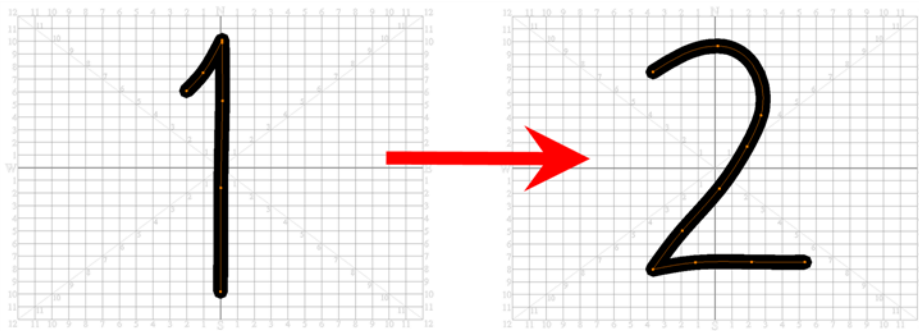

A pencil line will never morph with a brush stroke.

Pencil lines with thickness **ARE SUPPORTED** in morphing sequences. The thickness will morph according to the thickest and thinnest areas in the source and destination drawings.

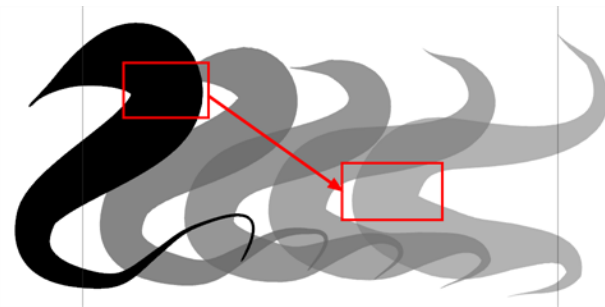

If you have pencil lines in your source drawing, the same number of pencil lines must be present in the destination drawings. A pencil line will appear if it is not found in the destination drawing. It will pop out on the first or last frame depending on which one it is drawn.

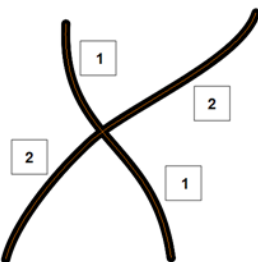

When two pencil lines cross one another, they are considered to be two lines and not four lines anymore (as it was in previous versions of the application). In this case, you must have two pencil lines in your destination drawing for your morphing to work correctly.

## Fill Shape to Fill Shape

If you have a brush line or a colour fill zone which are contour vectors, make sure that you morph it with another fill or brush line. Contour vectors will not morph with pencil lines (central vectors). A brush line can morph into a

colour fill zone and vice versa.

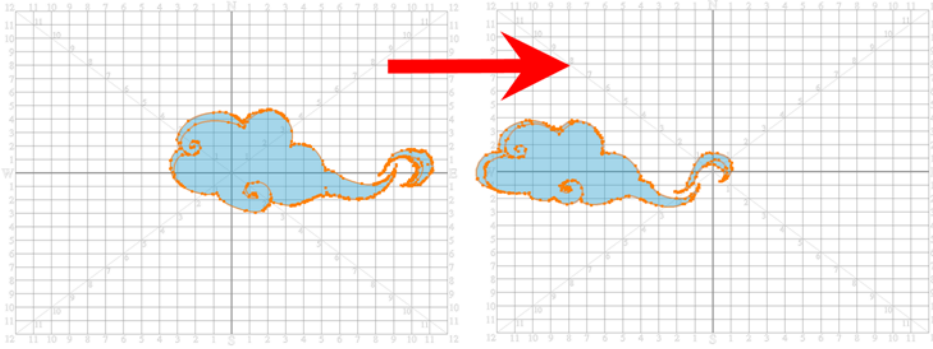

## Colour Swatch to Same Colour Swatch

Animate does not morph colours. If you want to perform a colour transition, you have to create the effect at the compositing level. A colour palette is composed of colour swatches. Each colour swatch has its own unique identification number, even if two colours pots are the same shade of red, they are identified independently. A colour zone or shape will morph with another one painted with the same colour swatch.

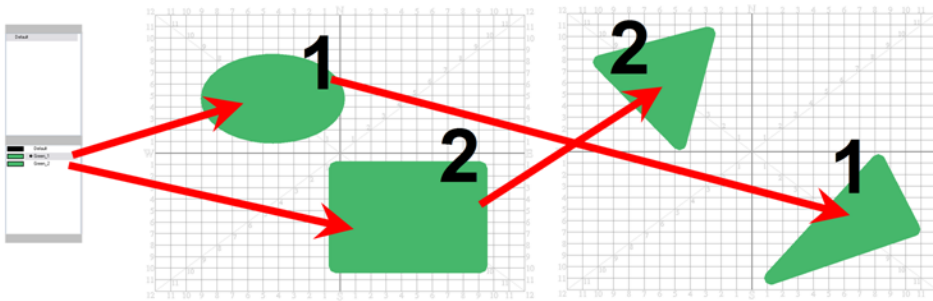

## Vanishing and Appearing

If a colour zone does not find a match in the first or the second drawing, it will progressively appear or disappear.

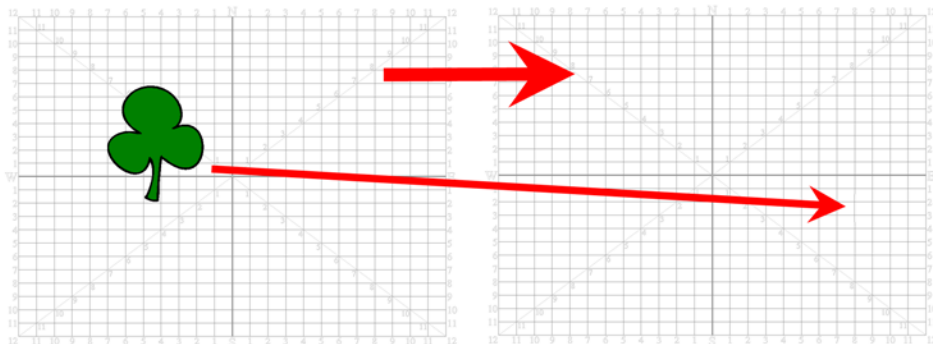

## Colour Art to Colour Art and Line Art to Line Art

In Animate, there is an advanced concept for painting your drawings called Line Art and Colour Art. Basically, an extra layer is added in your drawings so that you can fill the colour zones on a separate layer. The regular layer on which you are drawing is called Line Art and the extra layer under the Line Art is the Colour Art.

- A shape drawn in Colour Art can only be morphed with another shape existing in the Colour Art.
- A shape drawn in Line Art can only be morphed with another shape existing in the Line Art.
- A shape created in Colour Art can never morph with a shape created in Line Art.

### Related Topics

- [Drawing with the Brush or the Pencil on page 123](#)
- [Line Art and Colour Art Layers on page 314](#)

# Creating a Basic Morphing Sequence

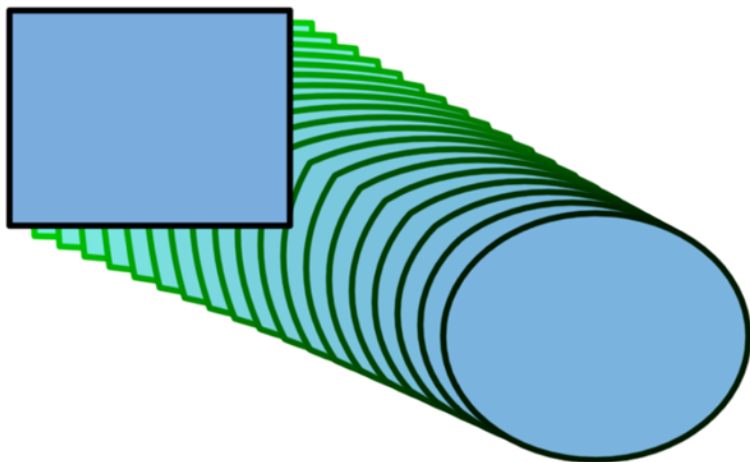



Once you are familiar with the basic rules, you can start creating morphing sequences. You need to practice and become at ease with the Morphing feature. To begin, start with simple elements, once you become confident with the morphing process you can move on to complex and advanced morphing techniques, such as head rotation or full characters.

## To create a basic morphing:

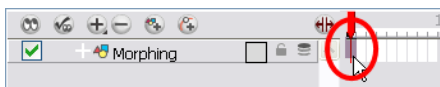
1. In the Timeline view, click on the Add Drawing Layer  button to add a new layer to your project.
2. Rename the new layer **Morphing**.
3. In the Timeline or Xsheet view, select the first cell in your layer.



4. In the Tools toolbar, select the Rectangle  tool or press [Alt] + [7].
5. In the Tool Properties view, enable the Auto Fill  option.
6. In the Colour view, click on the Set Paint Current Colour  button.
7. In the Colour list, select a colour to fill your rectangle with.

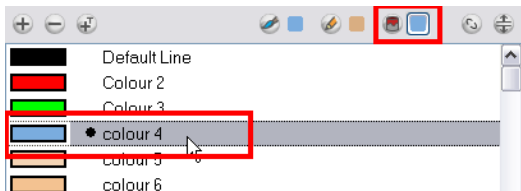

8. In the Colour view, click on the Set Pencil Current Colour  button.

9. In the Colour list, select a colour to trace your rectangle's outline with.

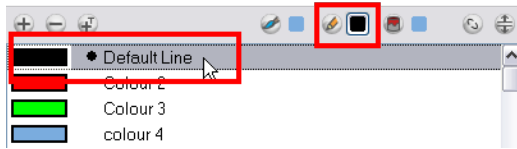

10. In the Camera or Drawing view, draw a rectangle.

- ▶ Hold down the [Shift] key if you want to draw a square.
- ▶ Hold down the [Alt] key if you want to draw the rectangle from its centre.



11. In the Xsheet or Timeline view, select the last cell.



12. Repeat Step 5 to Step 10 using the Ellipse  tool instead of the Rectangle tool or press [Alt] + [=].

- ▶ Draw an ellipse using the same outline colour as the rectangle ("Outline").
- ▶ Paint the ellipse with the same fill colour as the rectangle ("Fill").

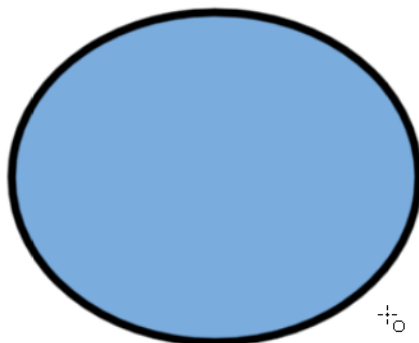

13. In the Xsheet or Timeline view, select your first drawing's cell, the rectangle drawing.



14. In the Xsheet or Timeline view, right-click on the selection and select **Morphing > Create Morphing** or press [Alt] + [M].

- ▶ In the top menu, you can also select **Animation > Morphing > Create Morphing**.

Arrows appear between the two key drawings to show they are computer generated.

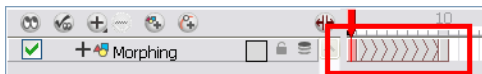

15. Use the Playback toolbar to play the morphing sequence. To flip through the in-betweens toggle between [,] and [.] or press [F4] to toggle between the two key drawings.

## Related Topics

- [Deleting a Morphing Sequence below](#)

## Deleting a Morphing Sequence

You may want to delete an entire morphing sequence in order to redo a sequence from scratch.

**To delete an entire Morphing sequence:**

1. In the Xsheet or Timeline view, right-click on a cell between two keyframes.
2. Select **Morphing > Delete Morphing** or from the top menu, select **Animation > Morphing > Delete Morphing**.

The entire sequence between the two keyframes is removed.

## Related Topics

- [Creating a Basic Morphing Sequence on page 426](#)



# Tool Properties View

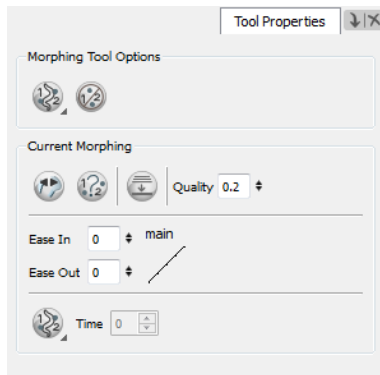

As you create and adjust your morphing sequences, you will often use the Tool Properties view. Using this view allows you do things such as toggling between your key drawings, adjusting the easing or selecting a hint type.

**To access the content of the Tool Properties view:**

- ▶ Select the Morphing  tool in the Tools toolbar or press [F3].

## Related Topics

- [Hint Type below](#)
- [Hide Hints on the facing page](#)
- [Show Morphing in Place on the facing page](#)
- [Suggest Hints on the facing page](#)
- [Switch Between Drawings on page 431](#)
- [Flatten on page 431](#)
- [Quality on page 431](#)
- [Easing on page 431](#)
- [Convert Hints on page 432](#)
- [Time on page 432](#)

## Hint Type

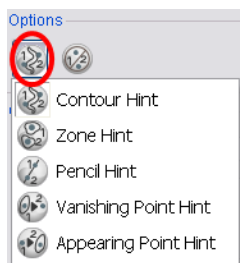

The Hint Type drop-down menu allows you to select the correct hint to remedy any problem areas in your drawing.



You can have more than one hint type in your drawings. You can mix all of the hint types in your morphing sequence.



Refer to:

- [Contour Hint on page 441](#)
- [Morphing Tool and Hints on page 437](#)

## Hide Hints

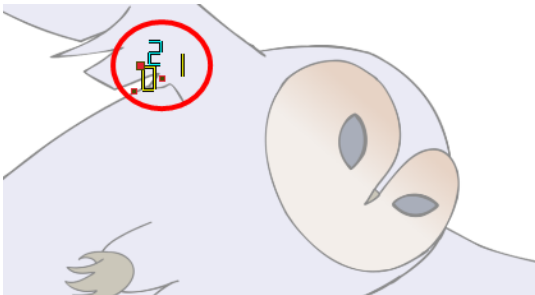

The Hide Hints  button temporarily hides the hint points from the key drawings. Use this option when you have a series of hint points hiding some lines you would like to see.

## Show Morphing in Place

The Show Morphing In Place  option is used with morphing layers. Enabling this option prevents the currently selected morphing layer from being shown on top of the others and maintains the correct layer ordering.



Refer to [Morphing Layers](#).

## Suggest Hints

The Suggest Hints  option is used to automatically set hint points on your key drawings as a help tool. If you are not sure where to set your hints, you can use this option. It will set the main hints which you can then fine

tune.

## Switch Between Drawings

The Switch Between Drawings  button is used to toggle between the two key drawings in your morphing sequence. This option is useful while setting hints or press [F4].

## Flatten

The Flatten  option is used when you have to morph a sequence with a semi-transparent or transparent colour in it.



Refer to [Morphing Holes and Transparencies](#) on page 450.

---

## Quality

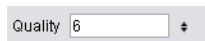

The Quality setting is used to make the lines of the morphed drawings smoother. Adjust this parameter when you are doing an extreme close up of your animation.



Refer to [Adjusting the Morphing Quality](#) on page 453

---

## Easing

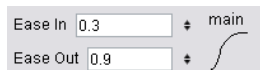

The Easing option is used to adjust the starting and ending velocity of your morphing sequence so that the motion is smooth and not mechanical.

You can adjust the Ease In and Ease Out value by dragging your cursor up and down or typing a new value. The values go from -1.0 to 1.0.



Refer to [Adjusting the Velocity and Timing](#) on page 433

---

# Convert Hints

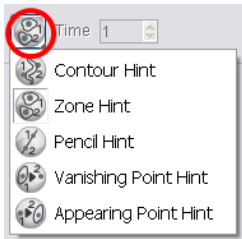

The Convert Hints  option is used to switch the type of the current selecting hint points. This option is useful when you position hints and then realize they are not the right type. You can select them and convert them to the correct type instead of deleting them and setting new ones.

Use the Morphing tool to select the hints and then convert them by going to the Tool Properties view and selecting the new hint type from the Convert Hints drop-down menu.

## Time

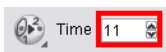

The Time parameter is used to set the timing on Appearing Point and Vanishing Point hints. These hints are used to set the trajectory of appearing and vanishing objects, they do not have to appear or disappear from the first frame to the last frame of the morphing sequence. With the Time parameter, select your Appearing Point or Vanishing Point hint and type the frame number on which the object will start its animation.



Refer to the [Appearing Point Hint](#) topic to learn more.

## Related Topics

- [Morphing Tool and Hints on page 437](#)

## Adjusting the Velocity and Timing

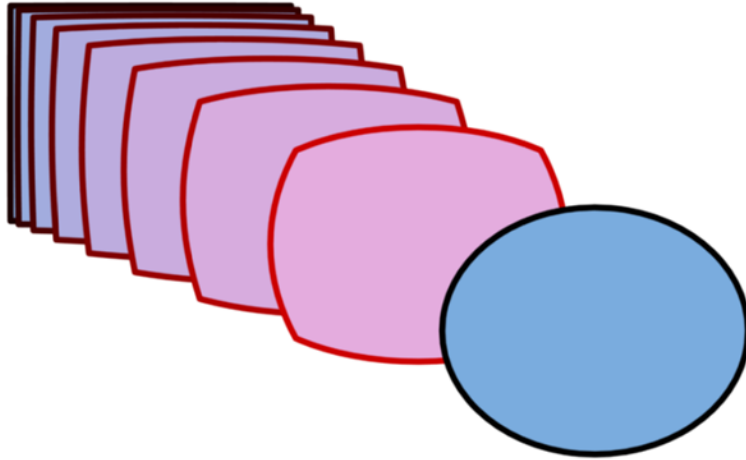

Once you have established a morphing sequence, you can control its timing and velocity. When you look at your animation you will notice that the morphing motion is constant. To produce a less mechanical motion, you will probably want to create some ease in or ease out.

If you did not place your source and destination drawings on the correct frames you may need to extend or shrink the sequence length.

- [Changing the Morphing Sequence Length below](#)
- [Adjusting the Velocity in the Layer Properties Editor below](#)

## Changing the Morphing Sequence Length

To extend or shrink a morphing sequence length:

1. In the Timeline view, select the source or destination drawing.
2. Click on your selection and drag the drawing to its new frame.

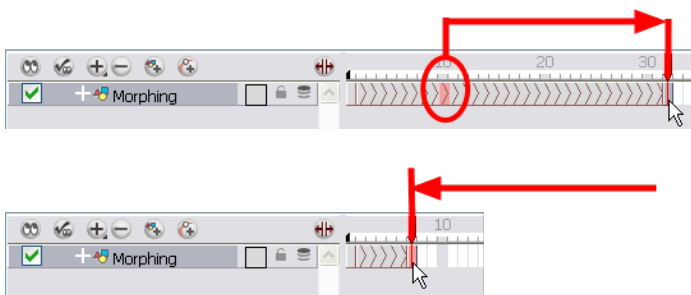

## Adjusting the Velocity in the Layer Properties Editor

If you have several morphing sequences on a single layer, you may find it easier to adjust their velocities on one function curve rather than several separate ones. Having all of your velocity parameters in one place is more efficient and easier to modify.

Adjusting the velocity in the Layer Properties editor also allows you to reverse a section of the morphing sequence. The sequence will always start with the source drawing and end at the destination. You can play the morphing sequence backwards or forwards during the animation.

You can have two levels of easing. It is possible to adjust the velocity of each sequence in your layer independently using the Tool Properties view and then adjust the morphing velocity function in the Layer Properties editor to control the entire layer's easing.

### To adjust the velocity in the layer editor:

1. In the Timeline view, double-click on the drawing element module to open the Layer Properties editor.

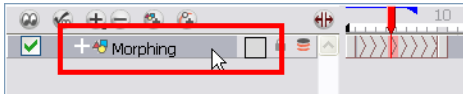

2. In the Layer Properties editor, go to the Drawing tab and click on the Function  button to create a function curve.

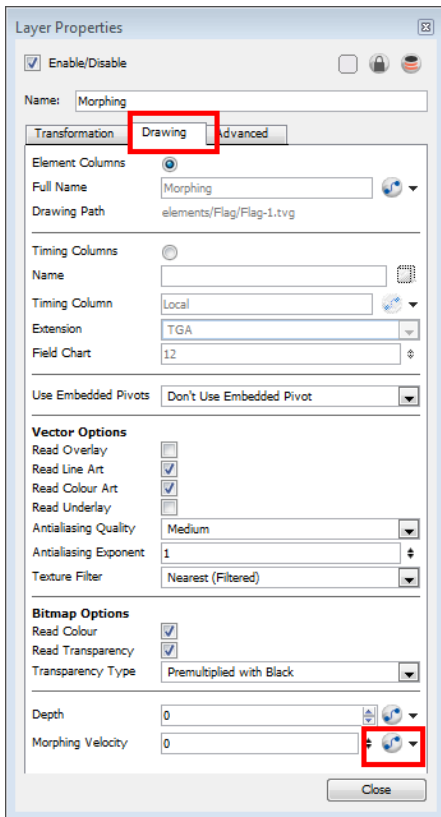

3. In the Layer Properties editor, click on the Function  button once more to open the velocity curve.

4. Add a keyframe at the first frame of the morphing (Source) and one at the end (Destination) by clicking on the Add/Remove Keyframe  button.

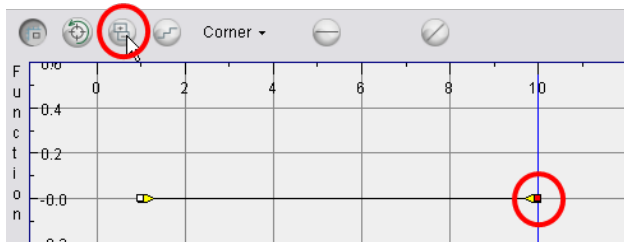
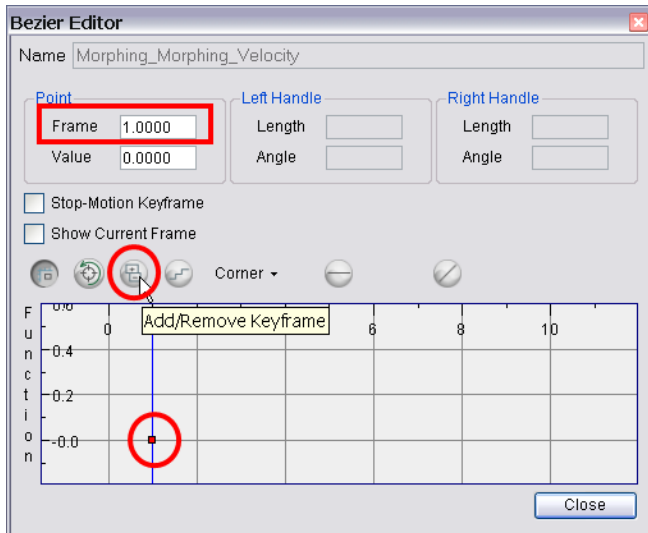

5. Move the end keyframe up.

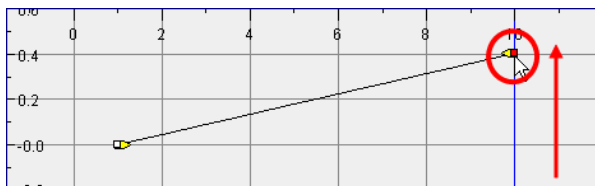

It is important that the last keyframe remains above the first one.

6. Make sure that the first keyframe is **NOT** a Stop-motion keyframe. To do this, uncheck the Stop-motion Keyframe option to disable it. To use the Toggle Stop-Motion Segment feature, press [S].

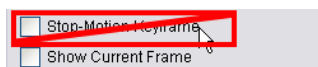

7. Click on the keyframes and pull the Bezier handles to create ease in and ease out. If you make the curve go downward instead of upward, the animation will play backward until the curve starts to go upward again.

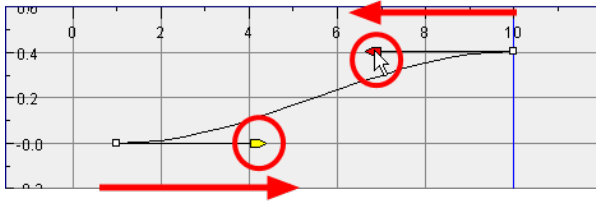

If you have more than one morphing sequence in the same layer, you need to add a keyframe on the velocity curve for each source and destination drawings.



If you want your morphing to play back on a double frame exposure rather than single frame, you can use the Hold Value editor and set the velocity to change every second frame, instead of every frame.

In the Morphing Function editor, click on the Hold Value Editor  button and set the parameters to hold the value for two frames.

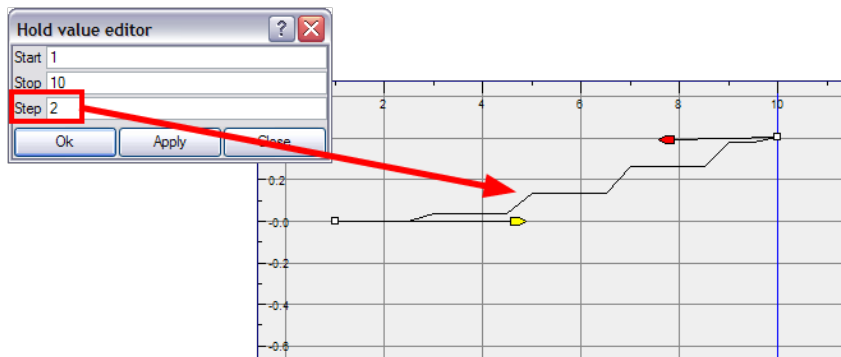



## Related Topics

- [Function Curves](#) on page 683
- [Adjusting the Ease](#) on page 701

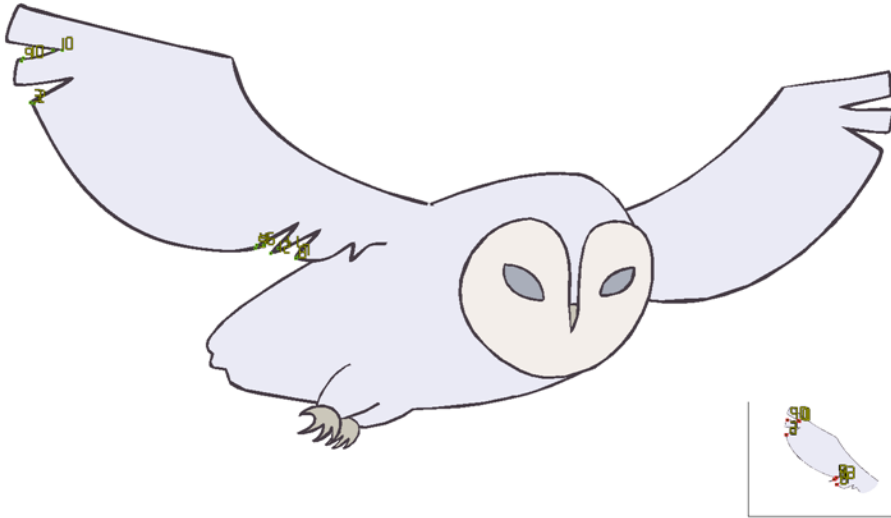

# Morphing Tool and Hints



Animate provides the Morphing  tool to control your morphing sequence, this works by placing different types of hints to help the system morph the animation the way that you want it.

Hints are points which are placed in both the source and destination drawings, they associate zones and lines between the two drawings. Hints are used to fix problem zones, such as a line that is not following the colour fill zone.

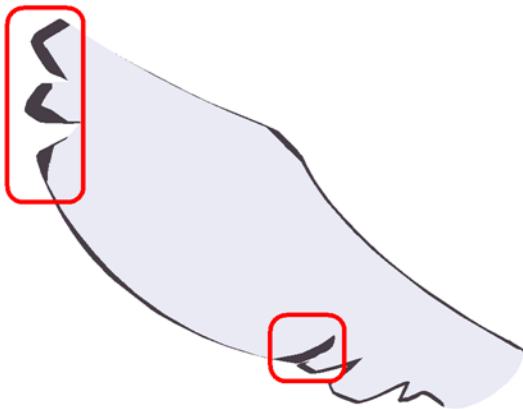

Corners and points generally give the most problems. The software does not necessarily understand the animation curves and may be unable to match corners. It will generally associate a corner with the nearest one, this is not always correct and it is why we use hint points to determine what goes with what.

## Related Topics

- [Using the Morphing Tool on the facing page](#)
- [Hints on page 440](#)
- [Copying Hint Points from One Drawing to Another on page 443](#)

# Using the Morphing Tool

Hints are identification points existing in both the source and destination drawings to create associations between the two of them.

To correct morphing distortions, Animate has different types of hints available for controlling different types of problems:

- [Contour Hint on page 441](#)
- [Zone Hint on page 441](#)
- [Pencil Hint on page 442](#)
- [Vanishing Point Hint on page 442](#)
- [Appearing Point Hint on page 443](#)

Each type of hint has a different purpose and they can all be used in the same drawing.

Use the Morphing tool to add hints to your morphing sequences. You can add different hints to your source and destination drawings and combine all types of hints in the same drawing.

A hint will automatically appear in both the source and destination drawings when it is added. A hint cannot exist in a single drawing. If you delete a hint from one drawing, it will be also deleted from the other.

The key to placing your hints is to put them where the biggest problem is. Fix the largest distortions first, this may also fix the smaller ones at the same time.

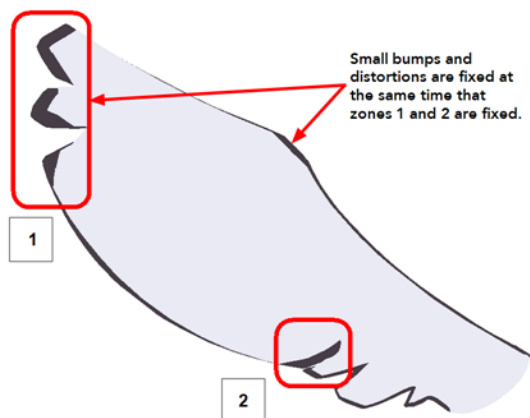

Do not add too many hints, this is a common mistake when morphing, it takes some practice to learn how to correctly use and place hints.

## To add and remove hints:

1. In the Timeline or Xsheet view, select the source or destination drawing of your morphing sequence.

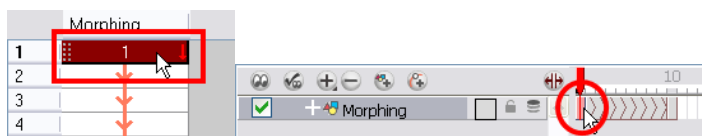

2. In the Tools toolbar, select the Morphing  tool or press [F3].

Use your other morphing key drawing, shown in the Drawing view's bottom right corner, as a reference.

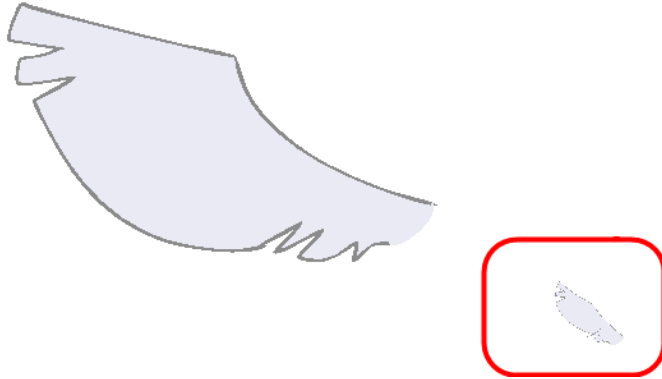

3. In the Tool Properties view, select the type of hint you want to use.

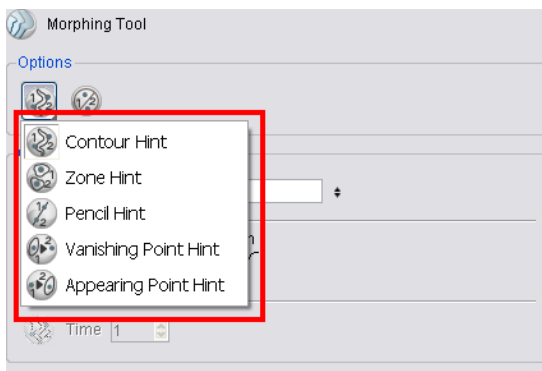

- ▶ Select Contour Hint to correct a brush line or colour zone's contour (Contour vector). Contour Hint points will behave similar to Pencil Hint points when used on a pencil line. Note that you obtain better results using the Pencil Hint point.
  - ▶ Select Pencil Hint to correct a pencil line (Central vector).
  - ▶ Select Zone Hint to correct a colour zone morphing match.
  - ▶ Select Vanishing Point Hint to correct a vanishing shape's trajectory.
  - ▶ Select Appearing Point Hint to correct an appearing shape's trajectory.
4. In the Camera or Drawing view, click on the drawing near the area to add a hint.

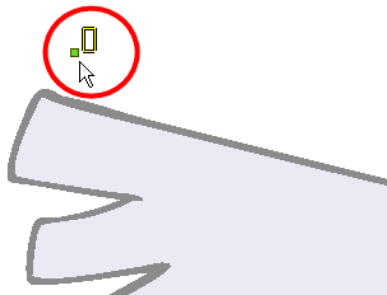

5. Select the hint's point and move it to its correct position.

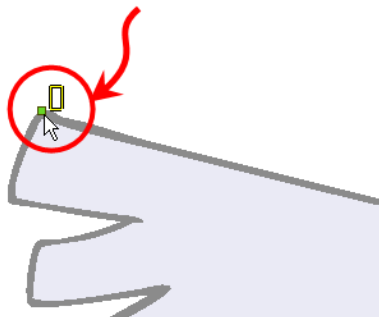

6. Select one or many hints and press [Delete] to remove extra or unused hints.
  - To delete all of the hint points at once, press [Shift] + [Delete].

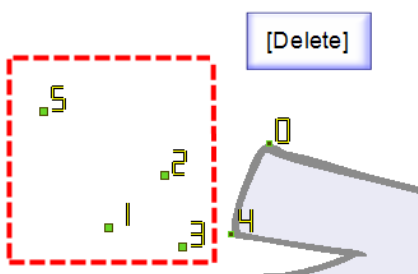

7. In the Playback toolbar, press the Play  button to see the result.

## Related Topics

- [Hints below](#)

## Hints

Here are the available hint points:

- [Contour Hint](#) on the next page
- [Zone Hint](#) on the next page
- [Pencil Hint](#) on page 442
- [Vanishing Point Hint](#) on page 442
- [Appearing Point Hint](#) on page 443

## Contour Hint

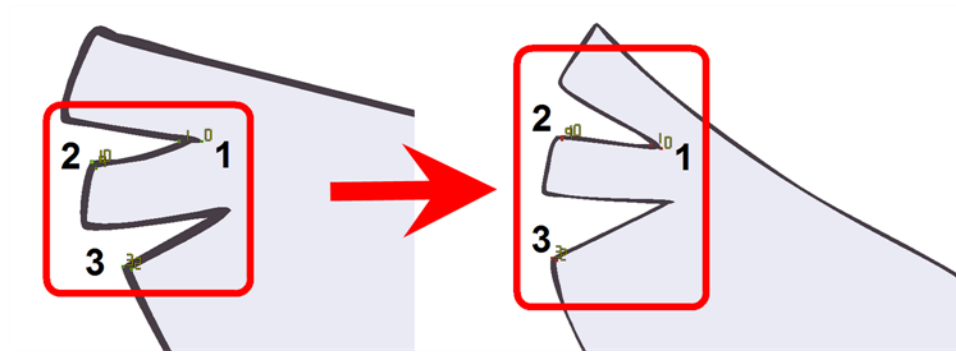

The Contour Hint  point is used on the colour fill zone and brush lines; in other words, on Contour vectors. It allows the control of line thickness and contour position. Also, if a contour is not animated the way that it should be you can use hints to correct the animation. For example, if a flag is not waving properly.

When adding a Contour Hint point, make sure that you place it far enough away from the contour so that you can see it snap to the contour.

The Contour Hint points are yellow.





Do not place the Contour Hint directly on the line as it may look like it has snapped to the contour, when in fact, it has not and the morphing will remain unchanged.

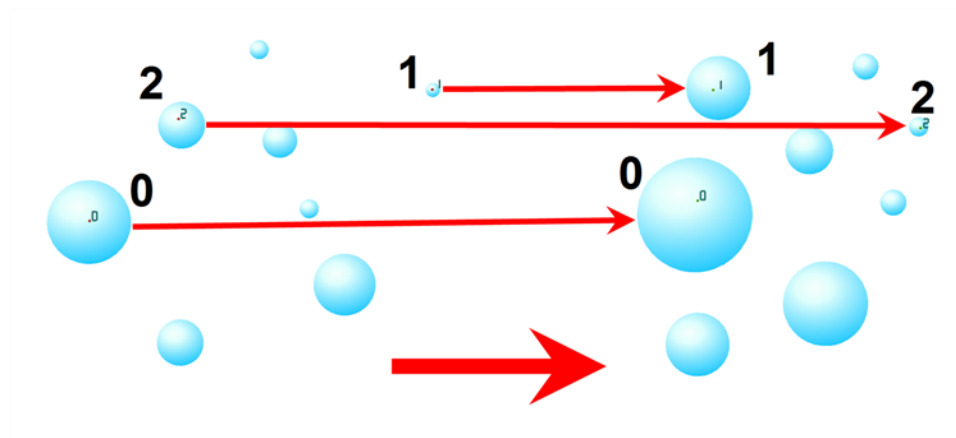

To correct a brush stroke, place a hint on both sides of the line to indicate its thickness variations over time.

## Zone Hint



The Zone Hint  point is used on a colour zone to control the proximity rule. The Zone Hint is placed in the centre of the colour zone. Sometimes a colour zone is not associated with the corresponding one by default. For example, in a splash animation there are many water droplets that are the same colour. The system automatically morphs the droplet to the nearest one. This is not always correct. A Zone Hint will force a colour zone to morph with another one.

Zone Hint points are cyan in colour so you can easily see them.

## Pencil Hint

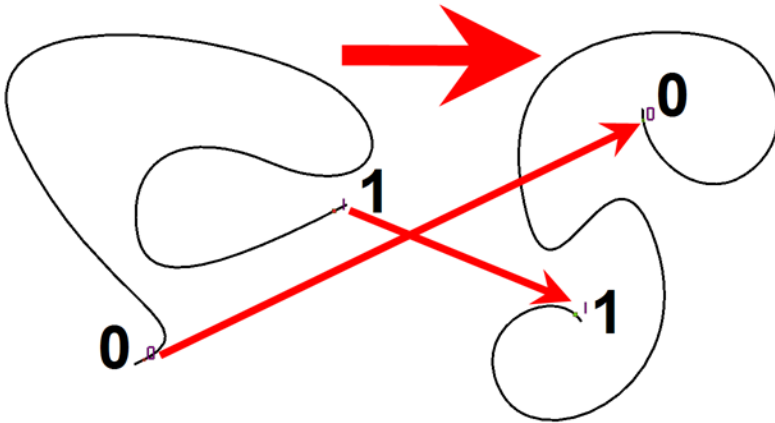

A Pencil Hint  point is used to control a pencil line, also known as central vector. It can be used on drawings that were done using the Pencil, Polyline, Ellipse, Line and Rectangle tools. Like the Contour Hint, the Pencil Hint snaps to the central vector. Make sure to place it far enough away from the line so you will see it snap when you move it.

Pencil Hint points are magenta in colour so you can easily see them.

## Vanishing Point Hint

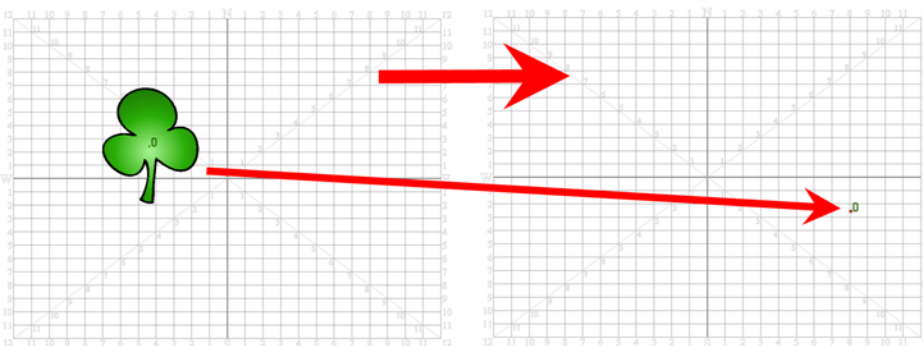

A Vanishing Point Hint  is used to control the trajectory of a vanishing shape. A shape will vanish from the source drawing when there is no corresponding shape in the destination drawing. If you do not place a Vanishing Hint to control the point of disappearance, the shape will vanish into its centre.

Vanishing Point Hint points are green in colour so you can easily see them.

## Appearing Point Hint

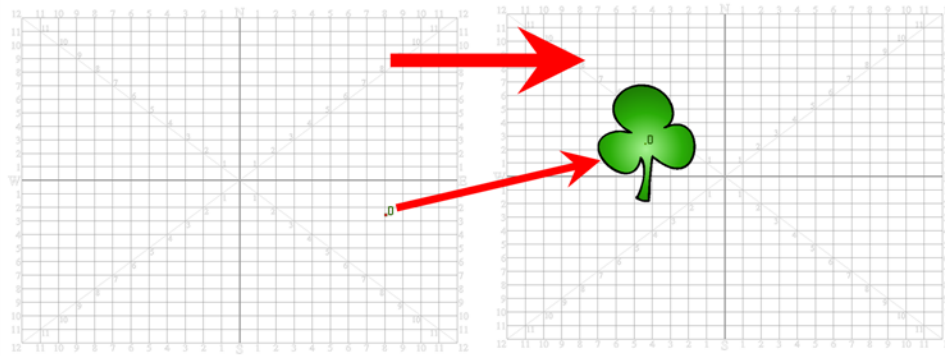

An Appearing Point Hint  is used to control the trajectory of an appearing shape. A shape will appear in the destination drawing when there is no corresponding shape in the source drawing. If you do not place an Appearing Point Hint to control the point of appearance, the shape will appear from its centre and expand outwards.

Appearing Point Hint points are violet in colour so you can easily see them.

### Related Topics

- [Morphing Tool and Hints on page 437](#)

## Copying Hint Points from One Drawing to Another

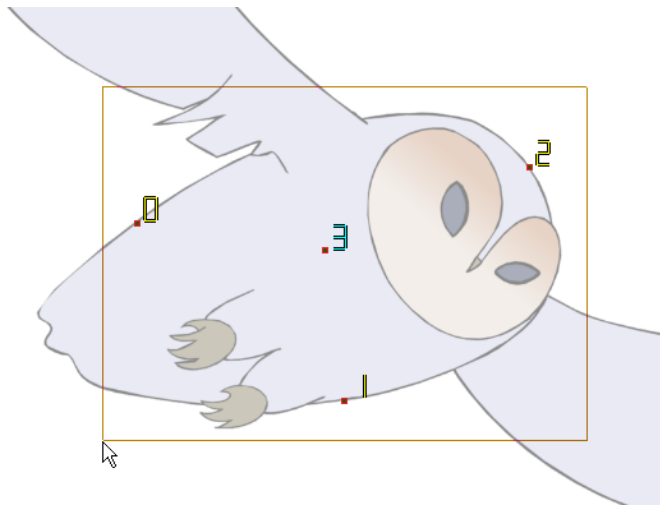

If you have two morphing sequences that use the same drawing and you would like to copy it and its hint points, you can do so in the Drawing view.

### To copy a drawing and its hints:

1. In the Tools toolbar, select the Select  tool or press [Alt] + [S].

- In the Drawing view, select the drawing you will reuse in your second morphing sequence. In the top menu, select **Edit > Copy** or press [Ctrl] + [C] (Windows) or [⌘] + [C] (Mac OS X).

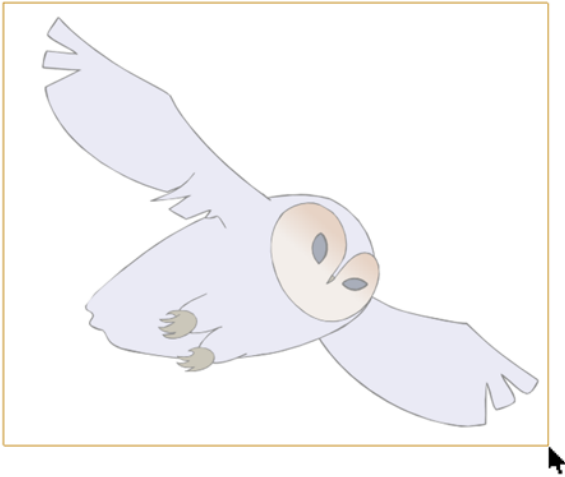

- In the Timeline view, select the cell where the new drawing will be.

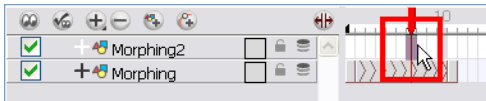

- In the Drawing view, paste your selection. In the top menu, select **Edit > Paste** or press [Ctrl] + [V] (Windows) or [⌘] + [V] (Mac OS X).
- In the Timeline view, select the cell where the second drawing will be.



- In the Drawing or Camera view, draw your second drawing.



- In the Timeline view, create the morphing sequence for the new drawings or press [Alt] + [M].

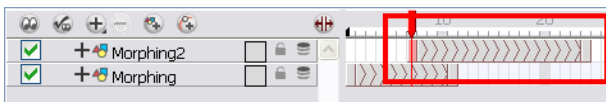

- In the Tools toolbar, select the Morphing  tool or press [F3].



9. In the Drawing or Camera view, position your hint points.

## Related Topics

- [Morphing Tool and Hints on page 437](#)

# Morphing Two Sequences in a Row

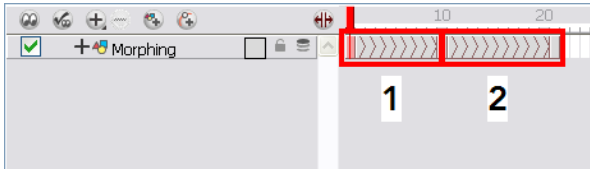

If you are morphing two sequences in a row, you will have to create a different set of hint points for each sequence.

Morphing two sequences in a row requires three drawings: 1, 2 and 3. Using these three drawings you create two morphing sequences; one sequence between drawings 1 and 2, and a second sequence between drawings 2 and 3.

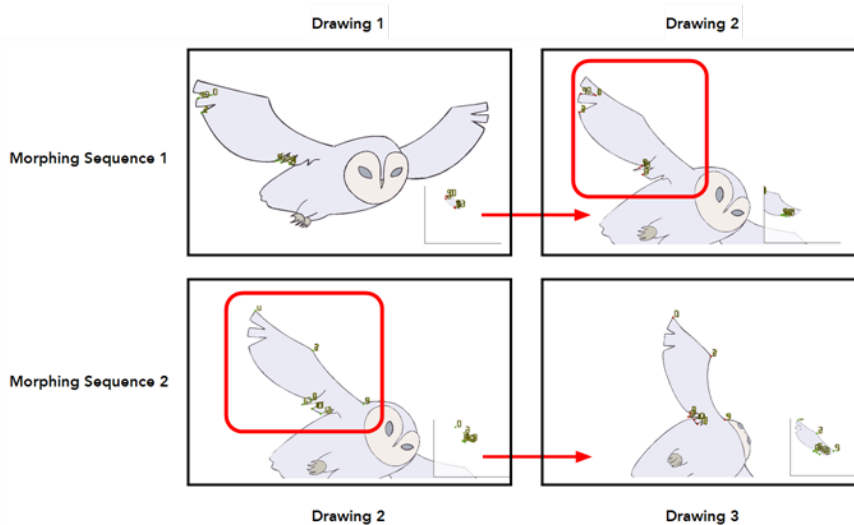

Each morphing sequence has its own set of parameters and hints. This means that Drawing 2 will have a set of hints for the first sequence and another set for the second sequence. The two sets of hints will not show at the same time. Each set of hints that appears always corresponds to the morphing sequence you are working on.

## Related Topics

- [Creating a Basic Morphing Sequence on page 426](#)

# Inserting a Morphing Key Drawing

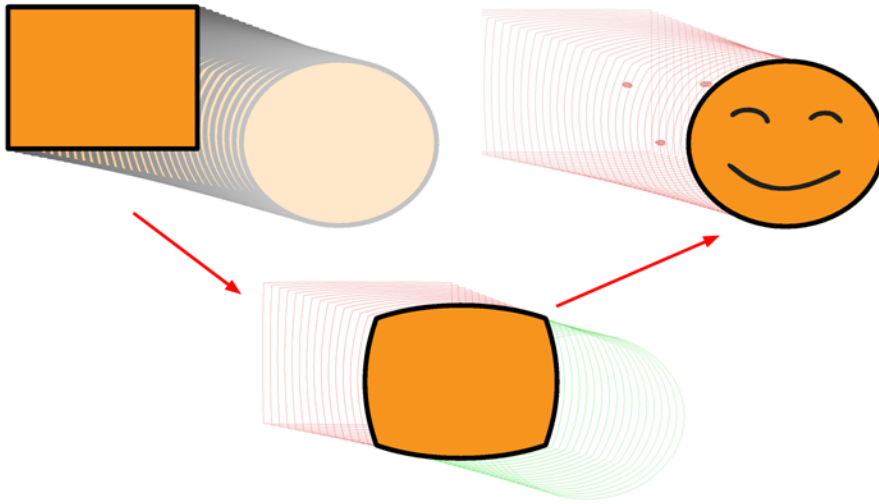

Once you have a morphing sequence, you can add a Morphing Key drawing.

A Morphing Key drawing allows you to insert extra details into a morphing sequence. For example, during a morphing sequence you may need to insert a detail such as teeth or a mouth, this is easy to do when you use a Morphing Key drawing. Instead of creating an entirely new drawing, convert a computer generated in-between to a Morphing Key drawing and add your extra details to it and the next key drawing.

A Morphing Key drawing converts a computer generated morphing frame into a real drawing that you can edit. It splits the morphing sequence into two sequences, retaining any previous modifications.

## To insert a Morphing Key drawing:

1. In the Timeline or Xsheet view, select the morphing frame you want to transform into a morphing keyframe.



2. Right-click on your selection and select **Morphing > Insert Morphing Key Drawing**.
  - In the top menu, you can also select **Animation > Morphing > Insert Morphing Key Drawing**.
 The new Morphing Key drawing appears.



3. In the Drawing or Camera view, draw your new details on the Morphing Key drawing.
4. In the Playback toolbar, press the **Play** button to see the result.

## Related Topics

- [Creating a Basic Morphing Sequence on page 426](#)

# Converting Morphing In-betweens to Drawings

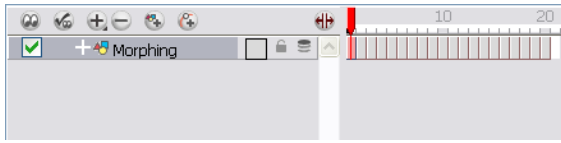

Animate lets you convert your morphing in-betweens to real drawings that you can edit.

This is useful when you manually edit your morphing sequence or if you prefer to have your animation timing in double frame instead of single frame.

## To convert morphing in-betweens to drawings

1. In the Timeline or Xsheet view, select a morphed drawing in the morphing sequence you want to convert to real drawing.



2. Right-click on your selection and select **Morphing > Convert Morphing to Drawings**.
  - In the top menu, you can also select **Animation > Morphing > Convert Morphing to Drawings**.
 The Converting Morph dialog box opens.

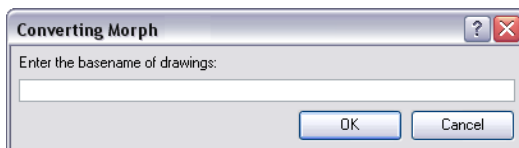

3. Type the drawing basename you want to give to your new drawings. In this case, you could type **circle**.
4. Click on the OK button.

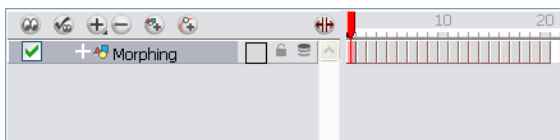

## Related Topics

- [Creating a Basic Morphing Sequence on page 426](#)

# Morphing Holes and Transparencies

To be able to morph shapes with holes or transparent colours, it is important to understand the process of analyzing and morphing a shape. Animate begins the process by reading the exterior outline of the entire shape. So if you are morphing a doughnut, it will first read the entire circular shape and ignore the central hole.

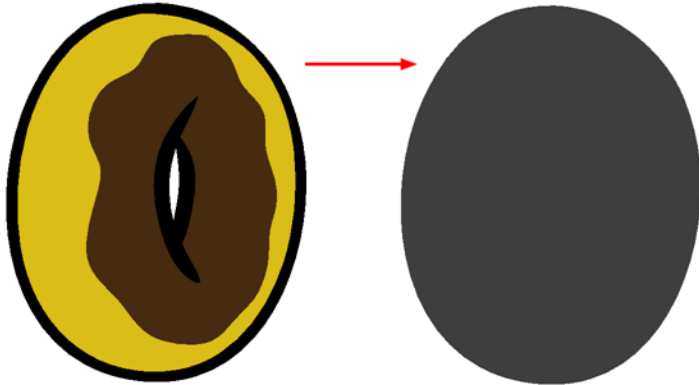

Once the general morphing shape is analyzed, the system will carry on analyzing the interior details such as colour zones and holes.

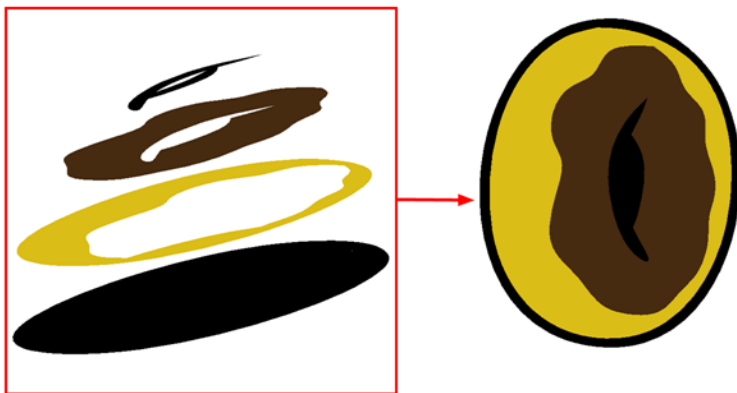

As you can see, because the hole was placed on top after the main shape was morphed, the centre is filled with an opaque brown colour. In order to avoid opaque holes, you have to paint the zone with a transparent colour so that you can control it and flatten the transparency to cut a hole through the main shape.

The same thing happens when you have holes painted with semi-transparent colours. To see through your shapes, you have to follow the same process as morphing shapes with holes.

**To morph a shape with a hole:**

1. In your Colour view, select an unused colour swatch and set its alpha (transparency) to 0.

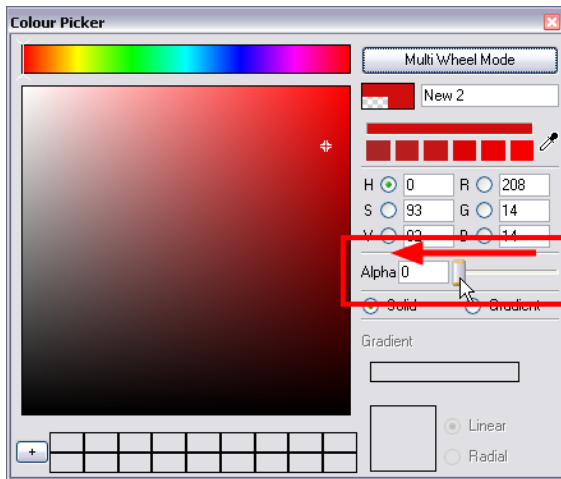

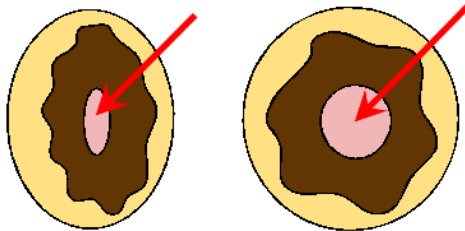

2. Paint both holes on the source and destination drawings.



3. In the Timeline or Xsheet view, click on a cell in your morphing sequence.



4. In the Tools toolbar, select the **Morphing**  tool or press [F3].
5. In the Tool Properties view, enable the **Flatten**  option.

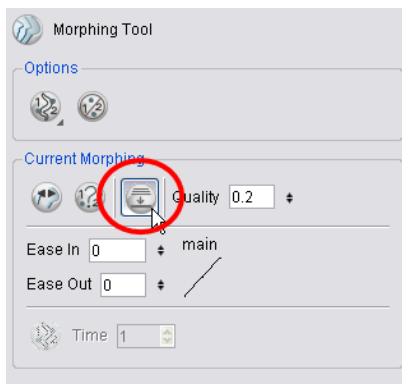

A hole appears in the shape.

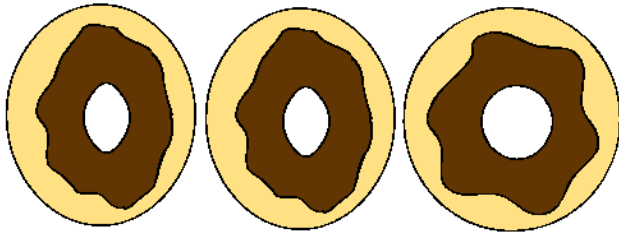

### Related Topics

- [Creating a Basic Morphing Sequence on page 426](#)



# Adjusting the Morphing Quality

To improve the morphing quality, zoom in close to a morphing animation when compositing.

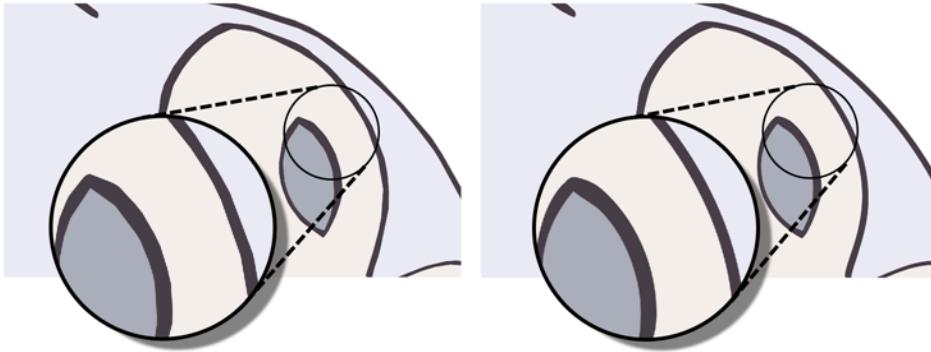

Increasing the quality improves the line shape between vector points. It also creates a larger file, so only increase quality when you are zooming in close.

**To set a morphing sequence's quality level:**

1. In the Timeline or Xsheet view, click on a cell in your morphing sequence.



2. In the Tools toolbar, select the **Morphing**  tool or press [F3].
3. In the Tool Properties view, increase or decrease the quality level by dragging your cursor up or down. You can also type a new value directly in the text field.

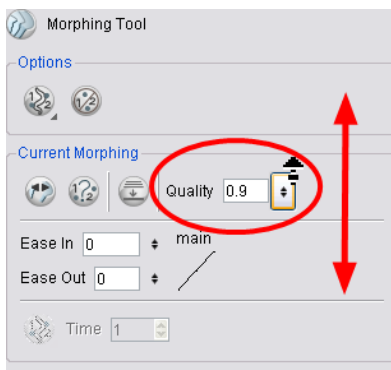

## Related Topics

- [Creating a Basic Morphing Sequence on page 426](#)

# Tips and Tricks

This section provides a list of easy tips and tricks to help you morph your drawings more efficiently.

## Morphing Similar Shapes

Similar shapes have the same number of colour zones. This only applies to the number of zones and lines and not the number of points on a curve.

## Avoiding Crossing Zones During Morphing

If a zone inside a larger zone on the source drawing ends up outside on the destination drawing, the morphing will fail.

A line cannot cross another line during a morphing sequence.

For example, if you are morphing a face so it turns from the front to the side, the nose is located in the middle of the face on the source drawing. However if after morphing, the nose ends up outside or merged with the face profile line on the destination drawing, this will give undesirable results. You can avoid this by using morphing layers and splitting the nose on a separate layer.

## Using the Brush Tool as a Beginner

When learning about morphing, it is recommended that you use the Brush tool. You can use the Pencil line for simple closed shapes.

## Flattening Drawings

Flatten your drawing before starting a morphing sequence.

## Cleaning-up your Drawings

If you leave a dot, even the smallest one, it is possible that your morphing will create odd shapes. If the source line is closer to the dot than the destination line, the source line will morph into the dot and the destination line will disappear.

## Using the Same Colour Swatch

Use the same colour swatch between two drawings. You cannot morph between two different colour swatches even if they have the same RGB values. This can be turned to your advantage for complex morphing.

### Related Topics

- [Creating a Basic Morphing Sequence on page 426](#)
- [Understanding Morphing on page 420](#)

# Morphing Preferences

To open the Preferences panel:

- ▶ Windows: Select **Edit > Preferences**.
- ▶ Mac OS X: Select **Animate > Preferences**.
- ▶ Or press [Ctrl] + [U] (Windows) or [⌘] + [U] (Mac OS X).

## Drawing Tab

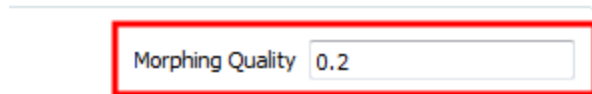

## Morphing Quality

The Morphing Quality preference is used to set the default quality value for the morphing sequences. If you change this value, it will not affect the morphing sequence which was created previously.

After a morphing sequence has been created using this default quality value, it's quality can be changed manually by using the Morphing Tool Properties.

### Related Topics

- [Adjusting the Morphing Quality on page 453](#)



# Chapter 9: Import



Toon Boom Animate allows you to import external content as well as being able to draw directly in the software. This means that characters, backgrounds and videos created in other drawing, painting and multi-media programs can be brought in and animated. You can import QuickTime videos, pictures, multi-layered PSD files, as well as AI, SWF and PDF files. You can also scan your images in with a scanner and either import them as bitmap or vectorize them.

## Topics Covered

- [Importing Bitmap Images](#) on the facing page
- [Importing PSD Files as Separate Layers](#) on page 467
- [Exporting and Re-Importing a PSD Layout](#) on page 1
- [Scanning Images](#) on page 470
- [Importing AI and PDF Files](#) on page 473
- [Scanning Images](#) on page 470
- [Importing from Adobe Flash](#) on page 476
- [Importing QuickTime Movies](#) on page 480
- on page 1
- [Import Preferences](#) on page 482



For sound import, refer to [Importing a Sound File](#) on page 608.

---

# Importing Bitmap Images



Images can come in many different file formats and are usually saved in a format that retains the original specifications set by the image creator. Some formats are able to preserve transparency or transparent layers, while others are not resolution dependent due to their vector nature. Toon Boom Animate supports the following formats: JPEG, BMP, PNG, TGA, PSD, TIFF, SGI, TVG, OMF, PAL, SCAN.

In this section, you will cover the following topics:

- [Importing a Bitmap Image without Vectorization](#) below
- [Importing and Vectorizing Images](#) on page 463
- [on page 1](#)

## Importing a Bitmap Image without Vectorization

A bitmap image is an image composed of pixels that is both size and resolution-dependant.

To import a bitmap image:

1. From the top menu select **File > Import > Images**. You can also click on the **Import Images**  button in the File toolbar.
  - In the Xsheet view, you can right-click anywhere in the frame area and select **Import > Drawings**. The Import Images dialog box opens.

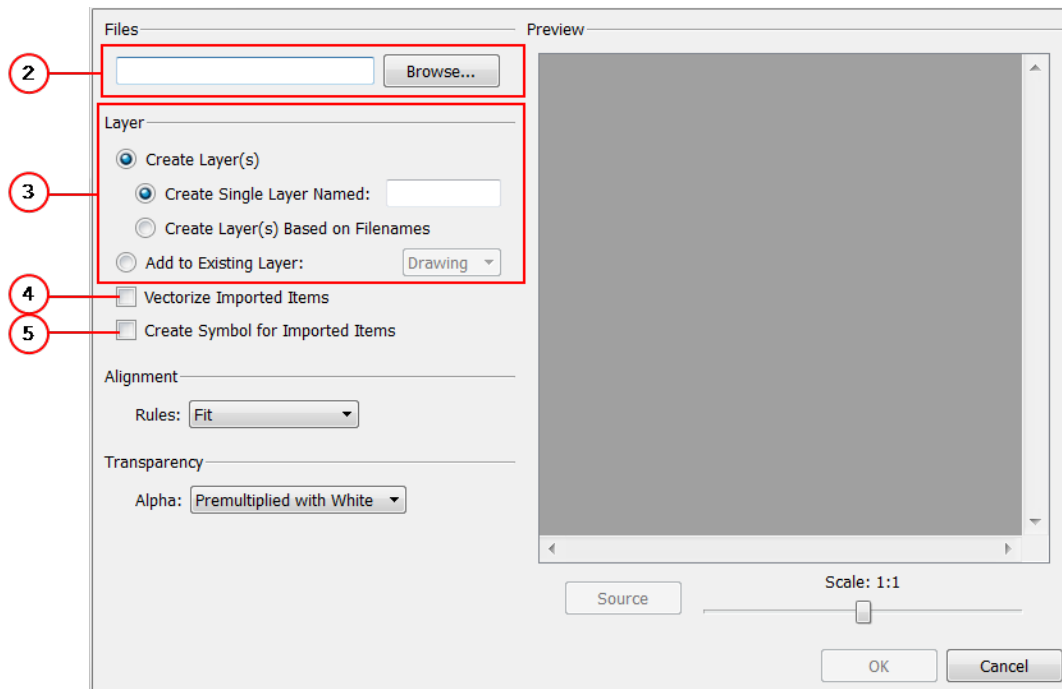

2. In the Files section, click Browse to find and select one or several images on your computer.
3. In the Layer section, you have the option of creating a whole new layer for your image or adding the image to an existing layer.
  - ▶ To create a new layer, select **Layer > Create Layer(s) > Create Single Layer Named** and name your layer accordingly.
 OR
  - ▶ To create a new layer using the file name, select **Layer > Create Layer(s) > Create Layer(s) Based on Filenames**.
 OR
  - ▶ To add the image to an existing layer, select **Layer > Add to Existing Layer** and select the layer already created in your Animate file from the drop-down menu. If only vector  layers are available in your scene (and therefore the drop-down menu), you will either have to Vectorize Imported Items, Create Symbols for imported Items or check both options to put your bitmap image on a vector layer.



Refer to [Adding Images to a Bitmap Layer](#) on page 462 for more information.



If you vectorize your image using the Vectorize as Colour option, you can import it on a vector layer, and use vector tools on it.

4. In this case, uncheck the **Vectorize Imported Items** option.

The vectorization options are hidden and the Transparency section appears.

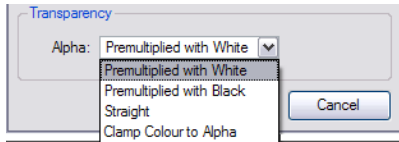

- In Toon Boom Animate, if you want your bitmap images to be encapsulated in a symbol, enable the **Create Symbol for Imported Items** option. If not, disable the option. If you chose to add your image to an existing vector layer then the Create Symbol for Imported Items will automatically be checked and greyed out.



To learn more about Symbols, refer to [Library on page 521](#).

- Next, in the Alignment section, you must decide on the size and placement of your image within the camera frame. Depending on the Scene Settings (the height and width in pixels that you chose for your project), an image that you import may get scaled to the point where all its individual pixels become visible.



Be sure that you are in the Camera view's Render Mode when judging an imported image, otherwise it may appear blurry.

The following three options are available

- Alignment > Rules > Fit
  - If your image orientation is portrait format, this selection will enlarge or shrink (but not distort) to your image height to match the full height of the camera frame.
  - If your image orientation is landscape format, this selection will enlarge or shrink (but not distort) your image width matches that of the camera frame.
- Alignment > Rules > Pan

This selection achieves the opposite result of the Fit command.

- If your image orientation is portrait, its width will be made to match the width of the camera frame. As a result, part of the image's height will extend beyond the height of the frame.
- This can be useful if you want to make your background move up and down, or from left to right to make it appear as if the camera is panning, or to actually perform a camera pan.
- Alignment > Rules > Project Resolution



This selection will scale the image in proportion to the scene's resolution. The system looks at the resolution of the bitmap image, for example 4000 x 2000, then compares it to the scene's resolution, for example 1920 x 1080, and adjusts the scale factor in proportion. So in this example the bitmap would appear at 208% (4000/1920). If you import a bitmap that is 960 x 540 it will be displayed at 50% (960/1920) of the size of the project resolution.

- The last step is to decide on the image's transparency from the Alpha drop-down menu. For this, there are four options available. These options deal with the way that the bitmap image will be antialiased, more specifically the way that the pixels along the edge are blended in the RGBA (red, green, blue, alpha (transparent)) channels.

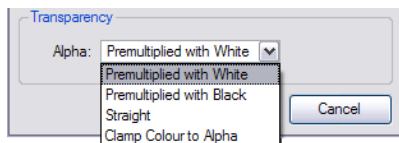

The options are:

- Premultiplied with White

Individual pixels at the edge of an image are blended with white.

- Premultiplied with Black

Pixels at the edge of an image are blended with black.

- Straight

Pixels at the edge of an image are blended with black, white and greys.

- Clamp Colour to Alpha

Select this option if you want to premultiply the colour value with the alpha value. When the colour is clamped to the alpha, the colour value cannot be higher than the alpha value. If you have a pixel of value R=247, G=188, B=29 and the alpha is 50% (the image is 50% transparent, then the actual RGB value output would be half of the amounts listed above).

- Click OK.

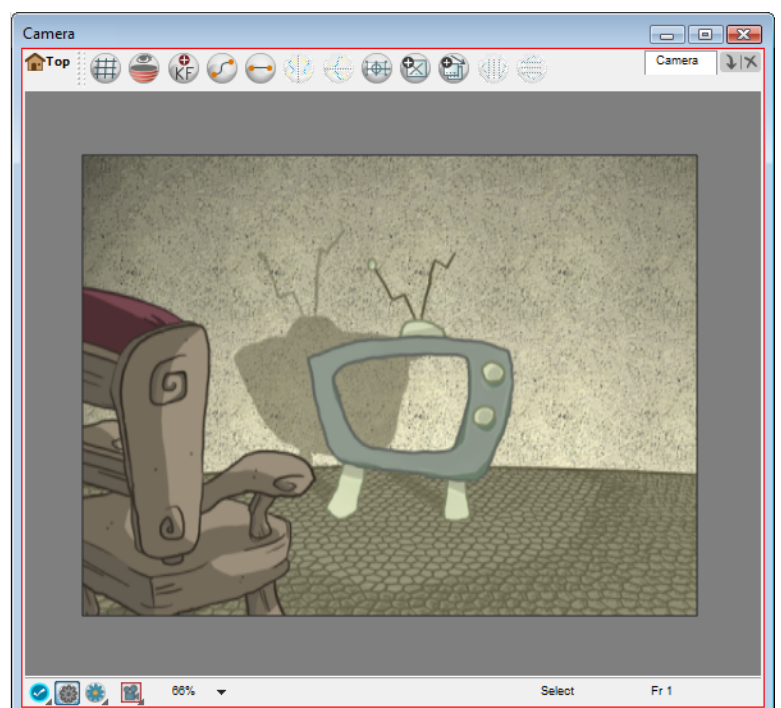
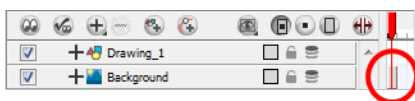

## Related Topics

- [Adding Images to a Bitmap Layer](#) below
- [Importing and Vectorizing Images](#) on the next page

## Adding Images to a Bitmap Layer

If you want to add more bitmap images to an existing bitmap layer:

1. In the Timeline view, if the bitmap image is contained in a Symbol, double-click on the bitmap symbol cell to edit the symbol. Otherwise, if the bitmap image is on a bitmap  layer, leave it as is.

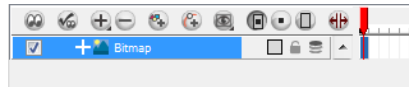
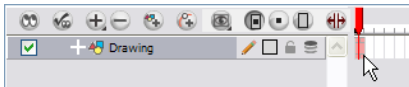

2. If necessary, in the Timeline view, pull on the red bracket to extend the exposure.
3. From the top menu, select **File > Import > Images**. You can also click on the Import Image  button.

The Import Images dialog box opens.

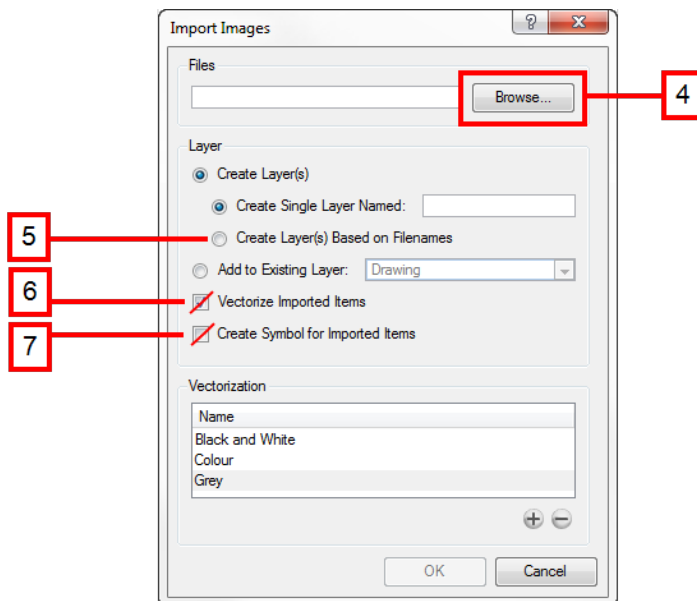

4. Click on the Browse button to find and select one or several images on your computer.
5. In the Layer section, choose **Layer > Add to Existing Layer** and select the bitmap layer already created in your Toon Boom Animate file from the drop-down menu.
6. Uncheck the Vectorize Imported Items option.

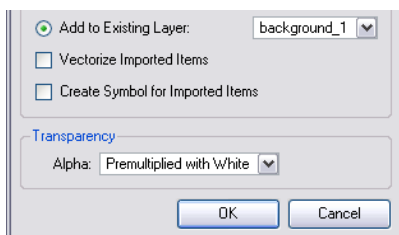

7. Disable the Create Symbol for Imported Items option.
8. Click on the OK button.

## Related Topics

- [Importing a Bitmap Image without Vectorization](#) on page 458
- [Bitmap Image Quality](#) below

## Bitmap Image Quality

If the bitmap images that you have imported look blurry or slightly pixelated, follow the steps below to clean-up the image. These steps will effect the quality of the preview in Camera view, but will have no effect on the final render.

1. In the Camera view, double-click on the bitmap image to enter its symbol if the image is encapsulated or simply select the bitmap image layer in the Timeline view if it isn't.
2. In the top menu, select **View > Bitmap Image Quality** or press [Ctrl] + [Q] (All Platforms).
3. The Bitmap Image Quality dialog box opens.

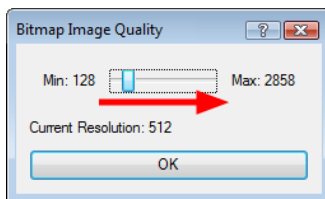

4. Click and drag the Bitmap Image Quality slider to the right to improve the quality.
5. Click on the OK button.
6. If you are inside a symbol, go to the top of the Camera view and click on Top to exit the symbol and return to your scene.

## Related Topics

- [Importing a Bitmap Image without Vectorization](#) on page 458

## Importing and Vectorizing Images

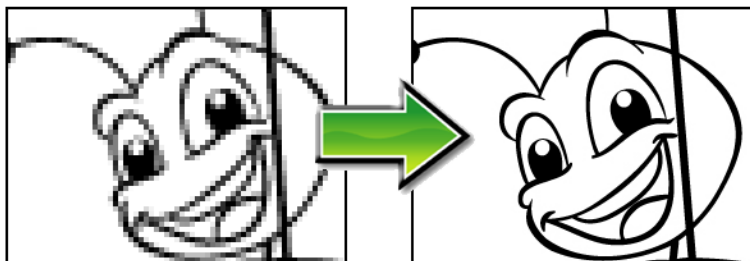

You can turn your images into 100% vector drawings, while still maintaining the sketchiness of a pencil line or into vector images with a bitmap fill. Both of these options can add "life" to an animation, which straight vectorization with smoothing does not.

### To import and vectorize a bitmap image:

1. In the top menu, select **File > Import > Images**. Or click on the **Import Image**  button in the File toolbar.

The Import Images dialog box opens.

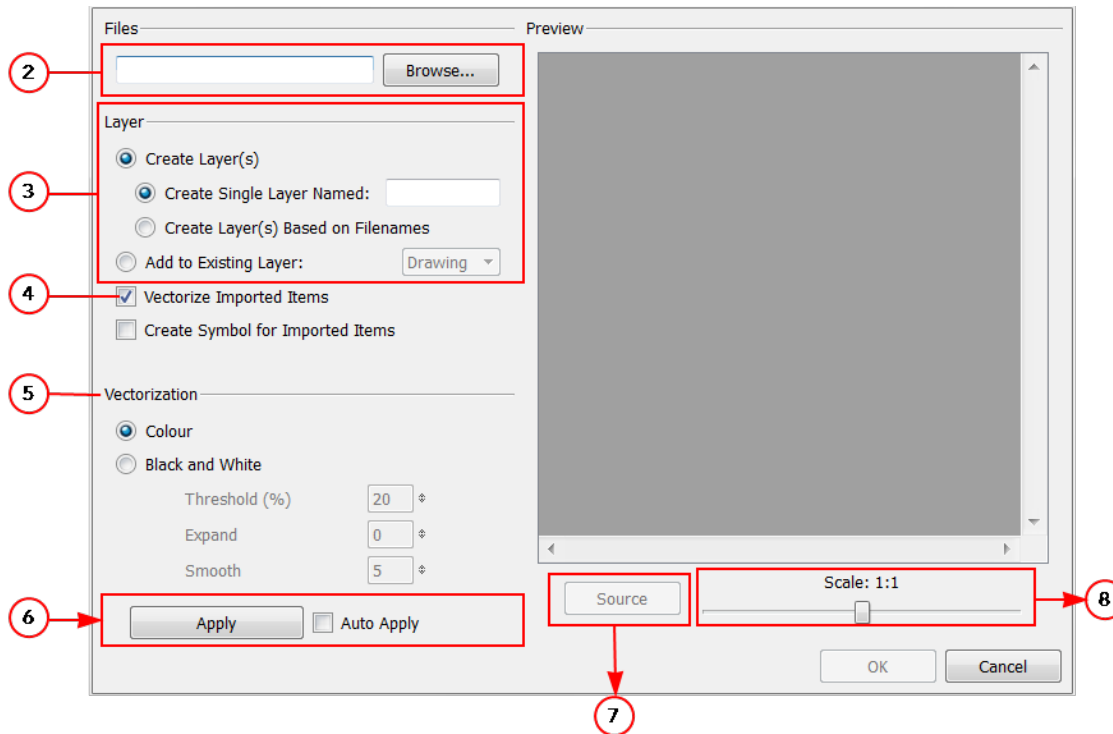

2. Click on the Browse button to find and select one or several images on your computer.
3. You now have the option of creating a whole new layer for your image or adding the image to an existing layer.
  - ▶ To create a new layer, select **Layer > Create Layer(s) > Create Single Layer Named** and name your layer accordingly.

OR

- ▶ To create a new layer using the file name, select **Layer > Create Layer(s) > Create Layer(s) Based on Filenames**.

OR

- ▶ To add the image to an existing layer, select **Layer > Add to Existing Layer** and select the layer already created in your Toon Boom Animate scene from the drop-down menu. If only vector  layers are available in your scene (and therefore the drop-down menu), you will either have to Vectorize Imported Items, Create Symbols for imported Items or check both options to put your bitmap image on a vector layer.



To mix bitmap images with vector drawings on the same layer, the bitmap image must be encapsulated in a symbol and vice versa. When you check the option Create Symbol for Imported Items, these symbols will also automatically be added to your Symbol Library.

4. In this case, enable the Vectorize Imported Items option.

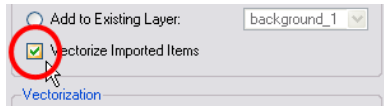

5. Under the Vectorization section, decide whether you would like to import your image in colour or black and white, or if you would like to add a new preset.
  - ▶ Colour: this style vectorizes your image as a colourful bitmap texture within a vector frame.
  - ▶ Black and White: this style vectorizes your drawings as a solid black line. This creates a 100% vector-based drawing. You can customize the different settings levels:
    - ▶ Threshold%: The Threshold value filters out noise in your images. Noise can be dirt or faint smudges on your scanned images. For example, if your value is set to 70%, all colour values below 70% are converted to white and ignored in the final image. If your value is set to 100%, only completely black lines will be kept.
    - ▶ Expand: Enter a value between 1 and 100 to thicken lines or the outer edges of the bitmap. Use this option if your line art is too fine or pale so that their visibility is increased in the software.
    - ▶ Smooth: Enter a value between 1 and 5 to set the smoothness level. Greater smoothness equals less jaggedness and imperfections, but at a greater loss to detail.
6. Press **Apply** to make the current settings visible on your image in the Preview section. You can also check the **Auto Apply** option to automatically apply the changes as you edit the vectorization parameters.
7. Click **Vectorized** to switch to the source version of the selected image in the Preview section and click **Source** to switch to the vectorized version of the image in the Preview section.
8. Use the **Scale** slider to zoom in or out of your preview images.



The vectorized images are painted with the Vectorize Line colour swatch from the colour palette.

---

9. Click **OK**.



You should now have a symbol or new layer that contains the vector drawing. If your image is contained into a symbol, in order to edit the image, you must double-click on the image's first cell in the Timeline view to enter the symbol.

### Related Topics

- [Importing a Bitmap Image without Vectorization](#) on page 458

# Importing PSD Files as Separate Layers

The Adobe Photoshop PSD file format is unique in that they are able to retain multiple layers. This format has the advantage of the image remaining fully editable, in terms of any colour correction, effects, masking, transparency or compositing that was made to the PSD file in Adobe Photoshop.

**To import the separated layers of a PSD file:**

1. Organize your Adobe Photoshop file so that all your layers are "grouped" into individual folders, or that all of the elements you want to import as a single layer in Toon Boom Animate are grouped together in their own folder. Any layer that is not in a folder group, by itself or otherwise, will not be imported.

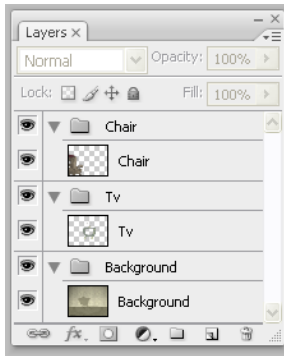

2. In Animate, go to the top menu and select **File > Import > Images**. You can also click on the Import Image  button.

The Import Images dialog box opens.

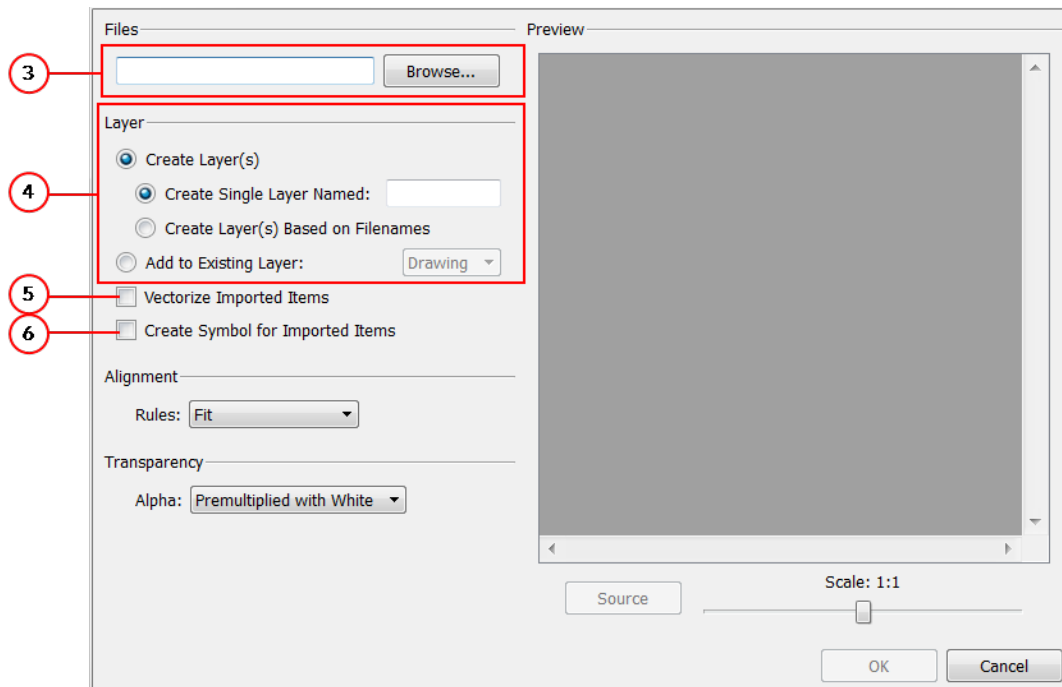

3. Click Browse to find and select the image on your computer.
4. Select **Layer > Create Layer(s) > Create Single Layer Named** or **Create Layer(s) Based on Filenames**.
5. Decide whether to check or uncheck the Vectorize Imported Items option.



If you decide to use the Vectorize Imported Items option, please refer to [Importing and Vectorizing Images](#) on page 463 to learn more about vectorization settings.



If you decide to disable the Vectorize Imported Items options the Transparency and Alignment settings will appear in place of the Vectorization settings. Please refer to [Importing a Bitmap Image without Vectorization](#) on page 458 to learn more about these settings.

6. Enable or disable the **Create Symbol for Imported Items** if you want your layers to be contained in symbols or not.
7. Click **OK**.

The Multilayer Image Import Settings dialog box opens.

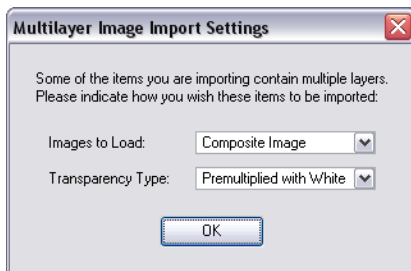

8. In the Image to Load field, select
  - **Composite Image** to flatten your layers.
  - **All Layers Image** to keep your layers separated.
9. Select the Transparency Type if applicable. Refer to the [Importing a Bitmap Image without Vectorization](#) on page 458 section to learn more the different Transparency Type options.
10. Click on the OK button.

Your image should appear as separate layers in the Timeline view, corresponding to the PSD layer group folders.



As a result of a multilayer PSD file import, artwork displayed in each of your layers is linked to the same source image. This means that if you use the command **Drawing > Delete Selected Drawings** to physically delete the drawing from the project folder, the exposed drawing will be deleted in all of the layers simultaneously. Once deleted from the project folder, the image can not be retrieved unless you re-import your psd file.

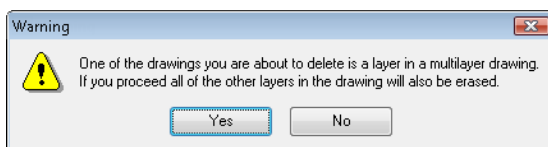



## Related Topics

- [Exporting and Re-Importing a PSD Layout](#)

# Scanning Images



Toon Boom Animate can receive images from any TWAIN device such as scanners and digital cameras. These images can either be loaded into your scene as bitmaps or converted into vector-based images that can be edited using Toon Boom Animate.

If your operating system does not automatically recognize your device after it has been connected, you must install the correct TWAIN drivers in order to access its contents. You can usually download the drivers from the device manufacturer's website.



TWAIN drivers are not always created for every model of scanner or digital camera. If TWAIN drivers do not exist for your device, you will not be able to use it with Toon Boom Animate.

---

You can scan in a single image or multiple images in the same session. Before you begin scanning, you need to select your scanning device.

## To scan drawings from a TWAIN device:

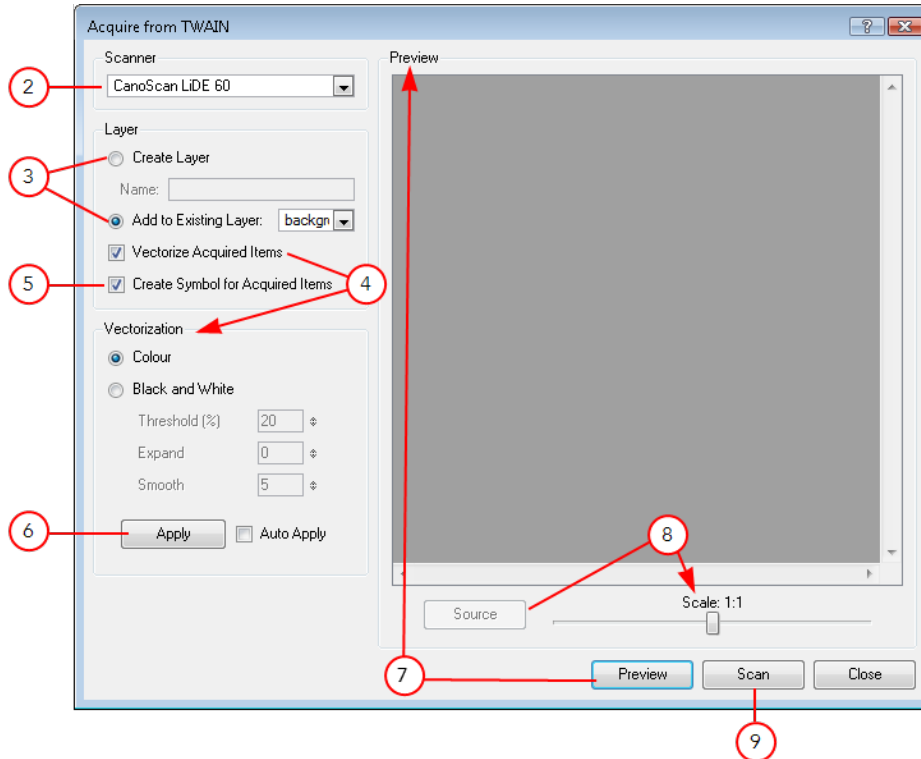

1. In the Top Menu, select **File > Acquire > From TWAIN** or press [Ctrl]+[Shift]+[A] (Windows) or +[Shift]+[A] (Mac OS X).

The Scan Drawings window opens.

2. Select your scanner or other supported TWAIN device from the drop-down menu. If none are available, check your device to ensure that it is properly connected to your computer. If your device still does not appear in the drop-down menu, you may have to shut down and relaunch the software.
3. You can import the images to scan into an existing layer or create a new one.



- ▶ To import the image into a new layer, enable the **Create Layer** option. In the Name field, type a name for the layer.
  - ▶ To import the image into an existing layer, select **Add to Existing Layer** and select the layer from the drop-down list.
4. Decide if you want to vectorize or not the scanned images. If you want to vectorize the scanned images, select the **Vectorize Acquired Items** option and choose the parameters from the Vectorization section:
    - ▶ **Colour**: this style vectorizes your image as a colourful bitmap texture within a vector frame.
    - ▶ **Black and White**: this style vectorizes your drawings as solid black lines and shapes. This creates a 100% vector-based drawing. Use the filters listed below to transform the bitmap into vector art. If you select this option customize the parameters below:
      - ▶ **Threshold percentage**: The Threshold value filters out noise in your images. Noise can be dirt or faint smudges on your scanned images. For example, if your value is set to 70%, all colour values below 70%

are converted to white and ignored in the final image. If your value is set to 100%, only completely black lines will be kept.

- **Expand:** Enter a value between 1 and 100 to thicken lines or the outer edges of the bitmap. Use this option if your line art is too fine or pale so that their visibility is increased in the software.
  - **Smooth:** Enter a value between 1 and 100 to set the smoothness level. Greater smoothness equals less jaggedness and imperfections, but at a greater loss to detail.
5. Decide if you would like to encapsulate the scanned drawings into individual Symbols. These Symbols will also appear in your Symbols Library. If not, uncheck the **Create Symbol for Acquired Items** option.
  6. Click **Apply**. Check the **Auto Apply** box to continually and automatically update your most current settings at the Preview level. The auto-apply is simply for preview purposes. If you do multiple scans, the vectorization parameters used on the first scan in the set are the ones that will be applied throughout, even if the preview does not show the image vectorized.
  7. Click **Preview**.  
 The scanning dialog box for your TWAIN device opens. To do a preview inside the Animate interface you will need to do an actual scan in the TWAIN device's interface. Previewing in just the TWAIN does not send any information to Animate. Use the settings in that box to launch a scan. When the scan is complete, if the device's window does not close automatically, close it. The image preview now appears in the preview area of the Acquire from TWAIN dialog box in Animate.
  8. If you chose the Vectorize option, the Source/Vectorize toggle now becomes active. Use this button to toggle between the image as it has been vectorized using the settings in the Parameters section and the original, source image. Use the slider to increase or decrease the preview size in order to check and compare the two images for accuracy.
  9. Click **Scan** to open the scanning dialog box for your TWAIN device.
  10. Use the settings from your scanner to scan your drawings. You can close the TWAIN device's scanning dialog box at any time and readjust your vectorization parameters in Animate's Acquire from TWAIN dialog box. You can also scan multiple images with your device before closing the Acquire from TWAIN dialog box.
  11. To automatically import the scanned images into your scene, exit the TWAIN device scanning interface.
  12. Click Close to close the Acquire from TWAIN dialog box.

The scanned image(s) appears in the centre of your camera frame and fitted with the height of the camera frame.

## Related Topics

- [Cleaning Scanned Drawings](#)

# Importing AI and PDF Files



You can import AI and PDF files into Toon Boom Animate, it will convert your files to the Toon Boom format (TVG) and create a colour palette based on the colour settings of the original file.



Only Legacy versions of Adobe Illustrator are supported. SWF's exported, including Actionscript 2 and Actionscript 3, cannot be imported.

---

## To import an AI or PDF file:

Go to the Library view and right-click on the Stage Library folder. Choose Right to Modify to unlock the library folder. Make sure the Lock icon disappears from the folder to unlock it, otherwise your library will remain locked and not editable.



The option to import will not be available until this step is completed successfully

---

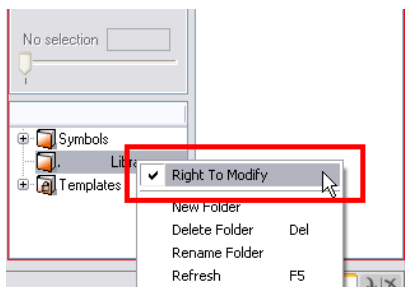



For more information about the Library, see the [Library on page 521](#) chapter.

1. In the top menu, select **File > Import > SWF, Illustrator Files to Library**. Orright-click on any unlocked folder and select **Import Fi les**.

The browser window opens.

2. Find and select your AI file in the Import Files dialog box and click on Open.

The Rename dialog box opens.

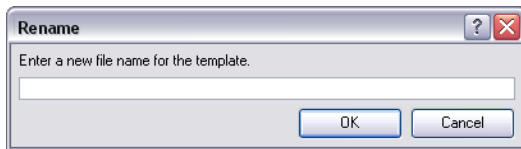

3. Enter a name for the new template or keep the name of the original AI or PDF file.
4. Click **OK**.
5. Click and drag the new template folder from the Library view to the left side of the Timeline view; wait until the copy cursor  appears before releasing the mouse button.

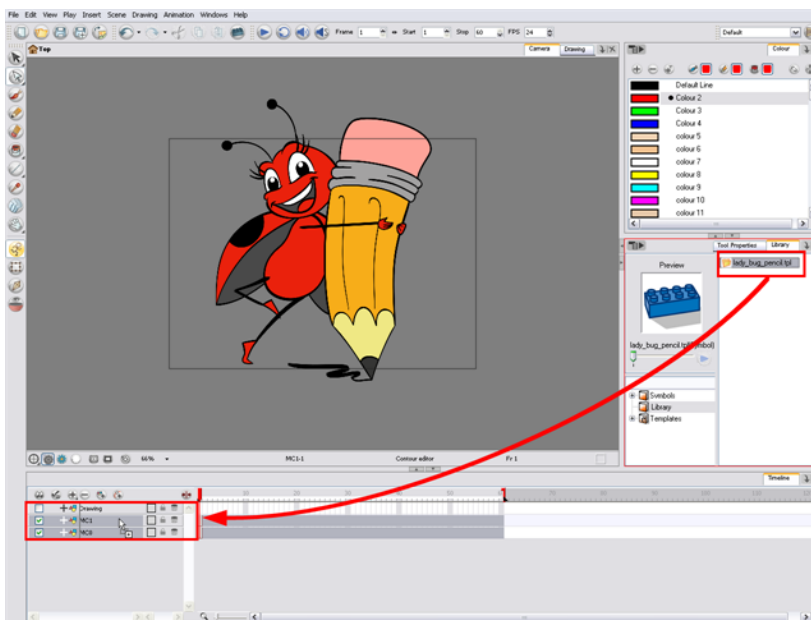

6. The colour recovery dialog box appears, requesting that a colour recovery should occur. Before clicking on the Yes button, you have the option to select the **Do Not Ask Again For This Session** option. This might be useful if you plan to import multiple AI drawings.

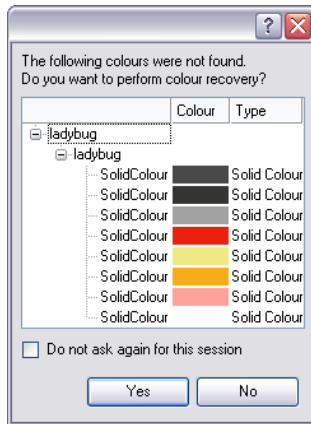

This process will import the colour palette used to create the Illustrator file and create a new palette in Toon Boom Animate under the imported file's name.



Refer to the [Import Preferences on page 482](#) section to learn about the Support CMYK in PDF/Illustrator Import preferences.



When importing an Illustrator or PDF file in Toon Boom Animate, by default the file will be imported as separate layers. The import will use the Illustrator file's top level groups as separate layer names. However, you can change this behaviour by disabling the PDF/Illustrator Import as Separate Layers, to import your file as a single layer. Refer to [Import Preferences on page 482](#) to learn more.

## Related Topics

- [Importing and Vectorizing Images on page 463](#)
- [Importing from Adobe Flash on the facing page](#)
- [Import Preferences on page 482](#)

# Importing from Adobe Flash



If a project was started in Adobe Flash and it needs a more professional boost, such as camera movements or multiplaning it can easily be imported into Toon Boom Animate. The actual \*.fla file is not supportable, so you have to export your project to an \*.swf movie.

## To import a Flash file:

1. Go to the Library view and right-click on the Stage Library folder. Choose **Right to Modify** to unlock the library folder. Make sure the Lock icon disappears from the folder to unlock it, otherwise your library is locked and not editable.



The option to import will not be available until this step is completed successfully.

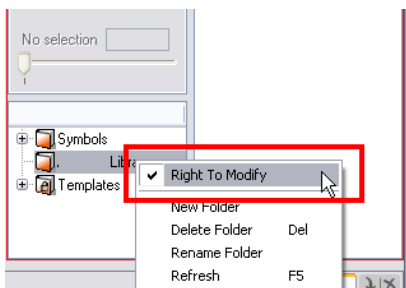

For more information about the Library, see the [Library on page 521](#) chapter.

2. In the top menu, select **File > Import > SWF, Illustrator Files to Library**. You can also right-click on any unlocked folder and select Import Files.



The browser window opens.

- Find and select your .swf file in the Import Files dialog box and click on Open.

The Rename dialog box opens.

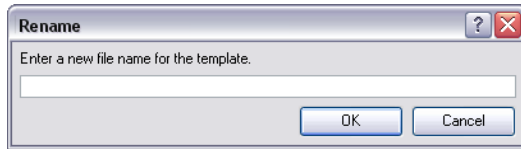

- Enter a name for the new template or keep the name of the original \*.swf file.
- Click on the OK button.
- Click and drag the new template folder from the Library view to the left side of the Timeline view; wait until the copy cursor  appears before releasing the mouse button.

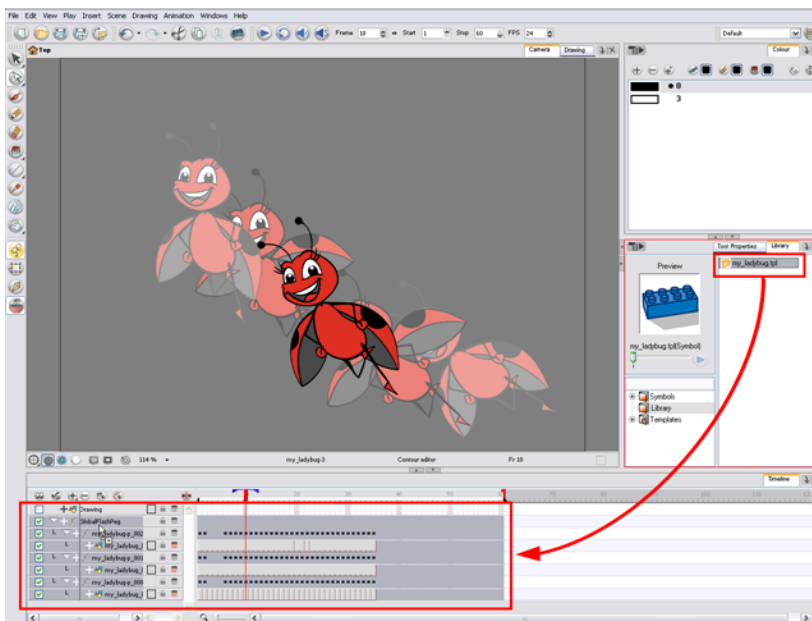

- The colour recovery dialog box appears, requesting that a colour recovery should occur. Before clicking on the Yes button, you have the option of selecting the Do Not Ask Again For This Session option. This might be useful if you plan to import multiple \*.swf movies.

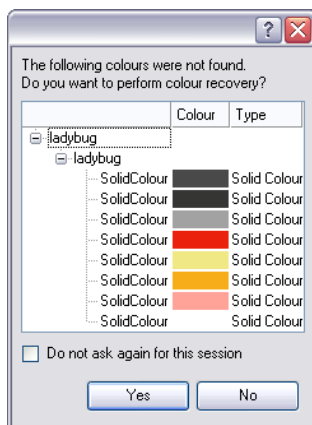

This process will import the colour palette used to create the Flash file and create a new palette in Toon Boom Animate under the imported file's name.



All the Flash layers are automatically attached to a parent peg called GlobalFlashPeg. **DO NOT DELETE THIS PEG.** To maintain the look of your movie, it is important that this peg is not deleted, nor its child layers detached.

The Adobe Flash file layers should now appear in the Timeline view. Symbols that were created in Flash become regular drawing layers, but can be reconverted into Symbols in Toon Boom Animate. Symbols within symbols or drawings within symbols collapse into their corresponding parent symbol.



Some of the layers contained in your SWF movie could end up being combined in a single layer as a result of optimization enhancement in your movie file. You can easily bring these elements back on separate layers. Refer to the [Distribute To Layers](#) below section to learn how.

In addition, all drawing elements that are dynamically linked to the Toon Boom Animate file are grouped together in one folder. This means that when you scroll through the Drawing Substitution preview in the Library view, the different hand, leg, tentacles, antennae, torso and facial positions are all organized together.



## Related Topics

- [Distribute To Layers](#) below
- [Importing AI and PDF Files](#) on page 473

# Distribute To Layers

In some instances, due to an optimization enhancement in the exported SWF file (CS4), some of the layers might be combined as a single layer. In that case, use the Distribute to Layers feature to quickly redistribute these elements onto individual layers again.

## To distribute to layer:

1. In the Tools toolbar, click on the Select  tool.
2. In the Camera view, select the drawing you want to redistribute the elements from. To select the all the elements of the selected drawing layer, press [Ctrl] + [A] (Windows) or [⌘] + [A] (Mac OS X).
3. From the top menu, select **Drawing > Distribute to Layers**. You can also click on the **Distribute to Layers**  button in the Select tool's Tool Properties view.

The number of drawing layers corresponding to the different grouped elements are created in the Timeline view.

- The selected elements in the original drawing layer will be removed.
  - Each element will be distributed into each new drawing layer.
4. Repeat the process for every drawing you need to distribute the element from.

## Related Topics

- [Importing from Adobe Flash](#) on page 476

- [Select Tool Properties](#) on page 165

# Importing QuickTime Movies

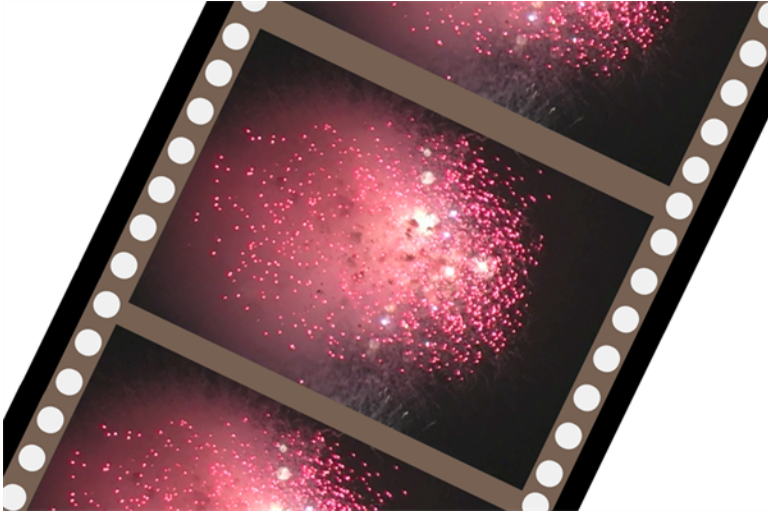

When creating an animation, it is not unusual to embed moving elements saved as videos within the animation. Toon Boom Animate allows you to import QuickTime movies into your project.

## To Import a QuickTime movie:

1. In the top menu, select **File > Import > Movie**.
2. Browse for the QuickTime movie to import and click **Open**.

A progress bar appears.

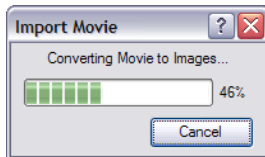

The Import Drawings dialog box opens.



Do not browse for the movie file again; leave the automatically generated field text as "many files selected".

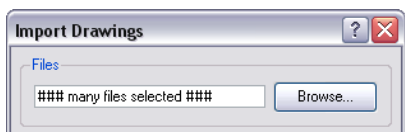

3. Make your decisions for the Layer, Alignment and Transparency.



Refer to the [Importing a Bitmap Image without Vectorization on page 458](#) section for further details about the **Import Drawings** dialog box.

---

4. Click **OK**.

The QuickTime video appears in the Timeline view as an image sequence. You should be able to scroll through the film frame-by-frame, just as you would scroll through your animation drawing-by-drawing.

## Related Topics

- [Importing a Bitmap Image without Vectorization on page 458](#)

# Import Preferences

In the **Preferences** panel, you will find the following preference that is related to importing PDF and Illustrator files in your project.

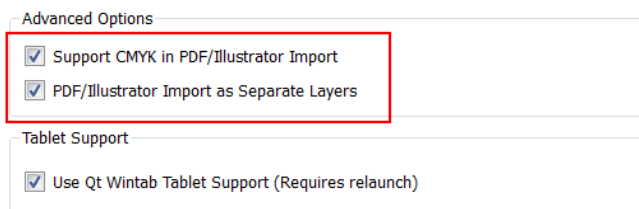

## Advanced Option

- **Support CMYK in PDF/Illustrator Import:** When this preference is enabled, you will be able to successfully import PDF and AI files that were created or exported in CMYK mode. The colours of the resulting imported image may still not look 100% faithful to its CMYK original due to the RGB conversion. It is recommended that you convert these files to RGB images before importing them into Toon Boom Animate. Disabling this function will cause all the colours of the imported image to be displayed as red to indicate that the file was not converted to RGB prior to import.
- **PDF/Illustrator Import as Separate Layers:** When this preference is enabled, the different groups/elements of the PDF or Illustrator file will be imported as separate layers. For Illustrator files, the import will use the top level group as separate layer names. Disable this preference to import your PDF or Illustrator file as a single layer.

# Chapter 10: Scene Setup



Setting up your scene can be compared to building a set for a television show. This is the point when you position each scene element such as the camera frame, the background elements and the characters.

## Topics Covered

- [Importing the Scene Components](#) on the facing page
- [Setting the Camera Frame](#) on page 485
- [Positioning the Scene Components](#) on page 490
- [Cloning and Duplicating Layers](#) on page 1
- [Setting Up the Network](#) on page 1
- [Display Concepts](#) on page 1
- [Creating a Multiplane](#) on page 509
- [Scene Setup Preferences](#) on page 516

# Importing the Scene Components

The first step in the scene setup task is gathering up the scene's different components and then importing them into your project.



Refer to the [Setting Up the Network](#) on page 1 and [Display Concepts](#) on page 1 sections to learn more about the Network view connections and display concepts.

---

## Backgrounds, Sounds and Movie

- [Importing Bitmap Images](#) on page 458
- [Importing QuickTime Movies](#) on page 480
- [Importing a Sound File](#) on page 608

## Templates and Symbols



Refer to [Importing Symbols and Templates](#) on page 543 to learn more.

---

### Related Topics

- [Setting the Camera Frame](#) on the next page



# Setting the Camera Frame

The scene action occurs inside the camera frame, so it's really important to set it up correctly.

- [Adding a Camera Layer](#) below
- [Setting the Camera Using the Translate and Rotate Tools](#) on the facing page
- [Setting the Camera using the Camera Layer Properties](#) on page 487
- [Resetting the Camera Position](#) on page 489
- [Camera List](#) on page 489



The Camera layer is static which means that if you need to animate it, you must add a peg.



Refer to the [Animation Paths](#) on page 637 chapter to learn how to animate layers using pegs.



Refer to [3D Camera Motion](#) to learn more about setting and moving the camera in the 3D space.

## Adding a Camera Layer

To set the camera frame, add a Camera layer into your scene so you can edit the default camera frame.

To add a Camera layer in the Timeline view:

1. In the Timeline view, click the Add Layer  button or select **Insert > Camera** from the top menu.
2. Select Camera from the drop-down menu.

A new camera layer is added to your scene and appears in the Timeline view.



You cannot add a camera inside a symbol. If you try to do so, a warning message will pop-up and inform you that this operation is not possible.



If you've added more than one camera to your scene, you can switch the active camera by going to **Scene > Camera** and selecting the camera you want to use.

## Setting the Camera Using the Translate and Rotate Tools

You can reposition your camera frame directly in the Camera view, using the Translate  and Rotate  tools.

To reposition the camera frame directly in the Camera view:

1. Select **Animation > Tools > Translate** or press [Alt] + [2].
2. In the Camera view, click on the camera frame to select it. You can also select the camera layer from the **Timeline** view.

The selected camera frame is highlighted in purple.

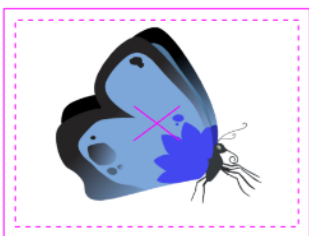

3. Drag the camera frame to a new position.

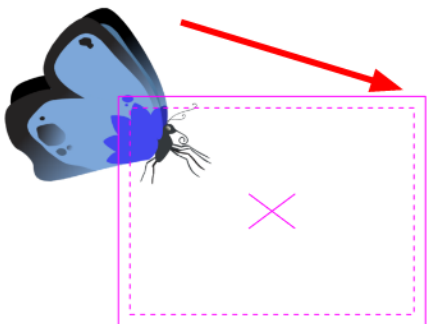

4. To tilt the camera frame, select **Animation > Tools > Rotate** or press [Alt] + [3].
5. In the Camera view, click on the camera frame to select it and rotate the camera frame until it reaches the desired rotation angle.

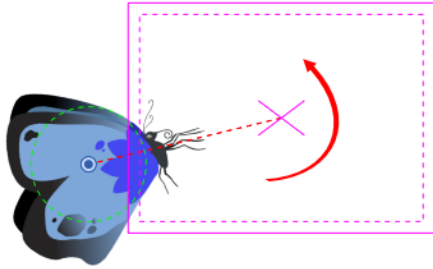

The Translate and Rotate tools can also be found in the Advanced Animation toolbar.

---



Refer to the [Managing the Toolbars on page 94](#) to learn how to display the **Advanced Animation** toolbar.

---

## Setting the Camera using the Camera Layer Properties

One way to set up your camera frame is to type the coordinates directly in the Camera Properties dialog box. Doing this positions the camera precisely where you want it.

---



Refer to [3D Camera Motion](#) on page 1 to learn more about setting the camera in the 3D space.



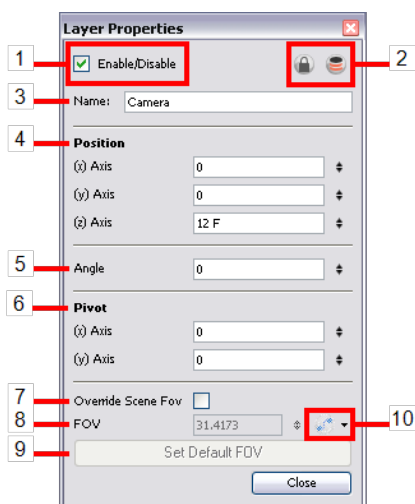

---

### To set up the camera frame using the camera Layer Properties:



- ▶ In the Timeline view, double-click on the **Camera** layer.  
The camera Layer Properties dialog box opens.



The legend below explains each of the Layer Properties:

1. Use the **Enable/Disable** check box to enable or disable the camera layer.
2. The **Lock**  and **Onion Skin**  buttons.
  - Once you are satisfied of the camera frame position, you can use the **Lock**  button to lock the camera layer and prevent changes on the camera frame position.
  - The **Onion Skin**  button is used to enable the **Onion Skin** feature in the **Camera** and **Drawing** view.
3. The **Name** field displays the current layer name and is used to rename it. Type in the new layer name.
4. The **Position** section displays the current position of the camera layer using X-axis (East, West), Y-axis (North, South) and Z-axis (Forward, Backward) coordinates. To reposition your camera frame, type in the new values corresponding to the desired position coordinates. You can also use the up and down arrows to set the value of each field.
5. The **Angle** field displays the current rotation value. To set a new rotation position, type in a new angle value. You can also use the up and down arrows to set the new angle value.
6. The **Pivot** field displays the current position of the rotation pivot of the camera layer. The camera will perform a rotation taking the position of the pivot as its angle centre. By default, the pivot is set at the centre of the camera frame. To reposition the pivot point, type in new X and Y coordinates values in the appropriate field. You can also use the up and down arrows to set the position values. In order to see the pivot's position you will need to have the Rotate tool selected.
7. Enable the **Override Scene FOV** check box to enable the **FOV** field in which you can type in a new field-of-view value.
8. The **FOV** field displays the current field-of-view default value. When enabled, you can type in a new zoom value for your camera frame. You can also use the up and down arrows to set the new zoom value.
9. Use the **Set Default FOV** to reset the custom zoom value to its default value.
10. The **Function** button is used when animating the camera zoom value—see the [Animation Paths](#) on page 637 chapter to learn more about creating functions.

## Resetting the Camera Position

Once you set up your camera frame, you can always easily reset it to its original position. Use the **Reset** command to reset the value of the selected element to the initial value of the active tool. For example, if the **Rotate**  tool is active, the transformation angle will be reset to 0 and if the **Transform**  tool is active, then the entire transformation values will be reset.

**To reset the camera position:**

1. In the **Tools** toolbar, select the **Transform**  tool or press [Shift] + [T].
2. In the Timeline or directly in the Camera view, select the camera layer.
3. Select **Animation > Reset** or press [Shift] + [R].

The camera automatically returns to its original position.

## Camera List

You can only see one camera at the time in the Timeline view. If you add several cameras to your scene and you want different settings on each, you can use the Camera List to display each of them. You can use this feature if you are still working on your scene composition and you have different camera setups to choose from.

**To select a camera from the Camera list:**

1. In the top menu, select **Scene > Camera > *the desired camera***.
  - If you only add one camera to your scene, you will only see **Default Camera** in your list.

### Related Topics

- [Positioning the Scene Components](#) on the facing page

# Positioning the Scene Components

Setting up the scene also involves positioning the different scene elements within the camera frame.

- [Animate Mode](#) below
- [Selecting a Layer](#) below
- [Positioning an Element using the Transform Tool](#) on page 498
- [Using Advanced Animation Tools to Position a Layer](#) on page 501
- [Flipping an Element](#) on page 504
- [Positioning an Element Using the Layer Properties](#)
- [Resetting a Transformation](#) on page 506

## Animate Mode

When positioning elements, make sure that the Animate Mode is disabled, or it will create a keyframe within the drawing layer.

**To disable Animate Mode:**

- ▶ In the Tools toolbar, click the **Animate Mode**  button.



### Related Topics

- [Selecting a Layer](#) below



## Selecting a Layer

There are different ways of selecting the layers you want to reposition in the Camera view.



The topic is divided as follows:

- [Selecting a Layer from the Camera View using the Transform Tool](#) on the next page
- [Bounding Box Selection Style](#) on the next page
- [Finding the Selected Layer in the Timeline View](#) on page 492
- [Selecting a Layer](#) above
- [Selecting an Element from the Timeline or Xsheet View](#) on page 492
- [Selecting a Layer](#) above



## Selecting a Layer from the Camera View using the Transform Tool

You can select your elements directly in the Camera view using the **Transform**  tool. When you select the **Transform**  tool, its properties and options appear in the Tool Properties view.



When using the **Transform**  tool to select element in the Camera view, always make sure that the **Peg Selection Mode**  option in the Transform tool Tool Properties view is disabled or else it will limit the selection to peg only.

**To select from the Camera view:**

1. In the Tools toolbar, select the **Transform**  tool or press [Shift] + [T].
2. In the **Transform** tool **Tool Properties** view, make sure the **Peg Selection Mode**  is deselected.
3. In the Camera view, select the element to be repositioned. You can select more than one element at a time.

The corresponding layers and columns will be highlighted in the **Timeline** and **Xsheet** views.

## Bounding Box Selection Style

You can change the display style of selected elements to Bounding Box. This will remove the normal selection coloured highlight and leave only the bounding box around your selected element.

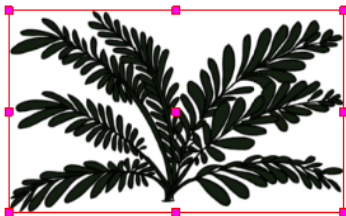

**To set the bounding box selection style:**

1. Select **View > Show > BBox Selection Style**.

## Finding the Selected Layer in the Timeline View

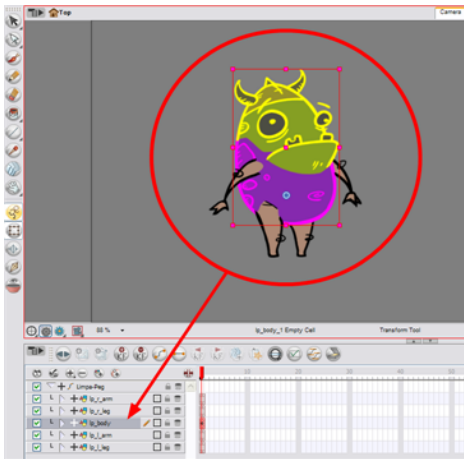

When you have several layers in your Timeline view, you may find it hard to locate which one is selected. Toon Boom Animate has an easy solution to this problem, you can use the **Centre on Selection** feature to display the selected layer in the Timeline view.

### To centre on the selected layer in the Timeline:

1. In the Camera view, select the desired layer.
2. Make the Timeline view the current active view.
3. From the Timeline menu, select **View > Centre on Selection** or press [O]. If your selected layer is in a group, or a child of one or more elements, continue to press [O] to expand the layers in the Timeline until your selected layer becomes visible.
4. You can also click the **Centre On on Selection**  button in the **Timeline View** toolbar.



Refer to the [Managing the Toolbars on page 94](#) to find out more about customizing the toolbars.

## Selecting an Element from the Timeline or Xsheet View

You can also select your elements from the Timeline or Xsheet view. This can be useful when there are too many objects in the scene or when an object is hard to grab.

### To select from the Timeline or Xsheet view:

- In the Timeline view, click the layer corresponding to the element you want to reposition.
- In the Xsheet view, click the column header corresponding to the element you want to reposition.

The selected element will be highlighted in the Camera view.

### Related Topics

- [Transform Tool Properties](#) on the next page



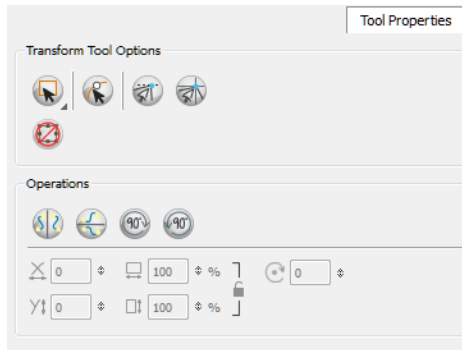

## Transform Tool Properties



- [Lasso and Marquee](#) below
- [Peg Selection Mode](#) below
- [Snap Option](#) on the facing page
- [Hide Manipulator Controls](#) on the facing page
- [Flip Horizontal and Flip Vertical](#) on the facing page
- [Width and Height](#) on the facing page
- [Offset X and Y](#) on page 495
- [Angle](#) on page 495

### Lasso and Marquee

Choose between the **Lasso**  and the **Marquee**  modes to change the selection style of the **Transform** tool.



- Click and hold [Alt] to temporarily switch from the current selected mode to the other.

#### To invert a selection:

- From the top menu, select **Edit > Invert Selection**, or press [Ctrl] + [Shift] + [I] (Windows) or [⌘] + [Shift] + [I] (Mac OS X).

You may also find the **Invert Selection** option from the **Camera View** or **Drawing View** menu by selecting **Edit > Invert Selection**.

### Peg Selection Mode

Click the **Peg Selection Mode**  button to limit the selection in the Camera view to pegs. When disabled, the Transform  tool selects the drawing layers.



This mode can be useful when you have created your character rig using peg layers for each drawing. That way, you don't accidentally select the drawing layer, when you want to animate on the peg.

## Snap Option

When transforming or repositioning your layer using the **Transform** tool, you can enable different snap options to help you.

- **Snap and Align:** Snaps the selected layer to any existing line, while automatically displaying temporary rulers that guide you and that you can also snap your object to.
- **Snap to Grid:** Snaps your selection according to the currently enabled grid.

## Hide Manipulator Controls

Enable the **Hide Manipulator Controls** option to hide the bounding box and manipulator controls from the **Camera** view when an element is selected.



Refer to following topics to learn more about the Snapping option utilities and the Grid feature:

- [Contour Editor Tool Properties on page 183](#) (Snap to Contour and Snap and Align)
- [More Drawing Tools on page 225](#) (Grid)

## Flip Horizontal and Flip Vertical

Use these buttons to flip the selected element horizontally or vertically.

- You can also select **Animation > Flip > Flip Horizontal** and **Flip Vertical** or press [4] and [5].

## Width and Height

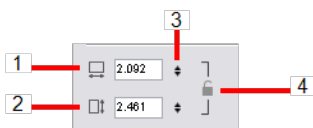

Use the **Width** and **Height** fields to enter specific values when you want to accurately resize the selected layer.



1. **Width:** type a width value in this field to resize the width of your selection.

2. **Height:** type a height value in this field to resize the height of your selection.
3. Use the up and down arrows to modify the value contained in either the **Width** or **Height** value field.
4. **Lock icon:** Click on the lock icon to either lock or unlock the ratio between the width and height values.

## Offset X and Y

Use the **Offset X**  and **Offset Y**  fields to enter specific values to reposition the selected layer accurately.

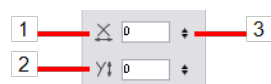

1. **X:** type an offset value in this field to reposition the selected layer along the X-axis.
2. **Y:** type an offset value in this field to reposition the selected layer along the Y-axis.
3. Use the up and down arrows to modify the value contained in either the **X** or **Y** value field.

## Angle

Use the **Angle**  field to enter specific values to rotate the selected layer accurately. A positive value will rotate the layer counter-clockwise and a negative value will rotate the layer clockwise.

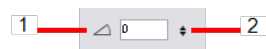

1. **Angle:** type a degree value in this field to rotate the selected layer.
2. Use the up and down arrows to modify the value contained in the **Angle** value field.

## Related Topics

- [Selecting a Layer](#) on page 490

## Locking Layers in the Timeline View

You can prevent correctly positioned layers from being selected by locking them in the Timeline view. This is useful for making a multiple selection inside the Camera view and leaving them visible. Once a layer has been locked, its locked state will be remembered next time you open your saved project.

You can perform five types of locking actions on your layers:

- [Lock on the facing page](#)
- [Unlock on the facing page](#)
- [Lock All](#) on page 497
- [Unlock All](#) on page 497
- [Lock All Others](#) on page 497

## Lock

The **Lock**  option let you lock one or a multiple selection of layers.

**To lock a layer or a selection of layers:**

1. In the **Timeline** view, select one or many layers.

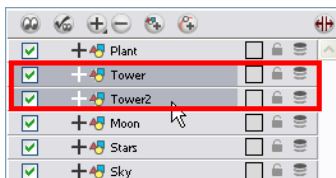

2. Do one of the following:

- ▶ From the top menu, select **Animation > Lock > Lock**.
- ▶ Click one of the selected layer's **Lock**  icon.
- ▶ Press [Ctrl] + [Alt] + [L] (Windows) or [⌘] + [Alt] + [L] (Mac OS X).

All selected layers are locked.

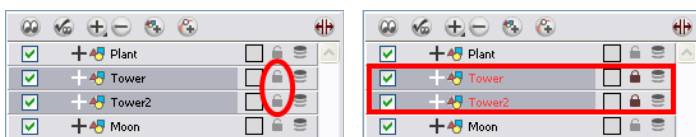

## Unlock

The **Unlock**  button lets you unlock one or a multiple selection of locked layers.

**To unlock a locked layer or a selection of locked layers:**

1. In the **Timeline** view, select one or many locked layers.

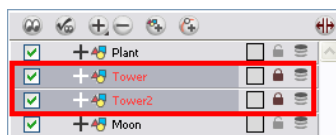

2. Do one of the following:

- ▶ Select **Animation > Lock > Unlock**.
- ▶ Click one of the selected layer's **Lock**  icon.
- ▶ Press [Ctrl] + [Shift] + [K] (Windows) or [⌘] + [Shift] + [K] (Mac OS X).

All selected layers are unlocked.

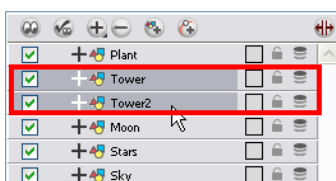

## Lock All

The Lock All option lets you lock all the layers in the Timeline view at once.

### To lock all layers:

- ▶ In the top menu, select **Animation > Lock > Lock All**.
- ▶ Click one of the selected layer's **Lock**  icon.
- ▶ Press [Ctrl] + [Shift] + [L] (Windows) or [⌘] + [Shift] + [L] (Mac OS X).

All layers are locked.



## Unlock All

The **Unlock All**  button lets you unlock all the layers in the **Timeline** view at once.

### To unlock all layers:

- ▶ In the top menu, select **Animation > Lock > Unlock All**.
- ▶ Press [Ctrl] + [Alt] + [Shift] + [L] (Windows) or [⌘] + [Alt] + [Shift] + [L] (Mac OS X).

All layers are unlocked.

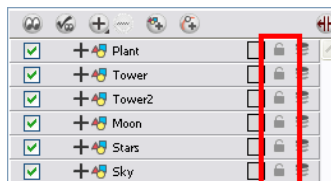

## Lock All Others

The **Lock All Others**  button lets you lock every layer except the selected ones.

### To lock all other layers:

1. In the Timeline view, select the layers that you do not want to lock.

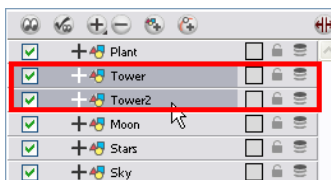

2. Do one of the following:

- In the top menu, select **Animation > Lock > Lock All Others**.
- Press [Ctrl] + [Alt] + [Shift] + [O] (Windows) or [⌘] + [Alt] + [Shift] + [O] (Mac OS X).

All layers are locked except the selected ones.



## Related Topics

- [Selecting a Layer](#) on page 490

# Positioning an Element using the Transform Tool

Using the Transform tool, you can easily reposition, scale, rotate and even skew the layers directly in the Camera view.



When positioning a drawing layer using the Transform tool, always make sure that the Peg Selection Mode is disabled in the Transform tool Tool Properties view, or it will limit the selection to pegs in the Camera view.



Refer to [Positioning Elements in 3D Space](#) to learn about the 3D Transform tool and how to position your elements in the 3D space.

- [Repositioning the Pivot Point Temporarily](#) below
- [Panning a Drawing Layer](#) on the next page
- [Rotating a Drawing Layer](#) on page 500
- [Scaling an Element](#) on page 500
- [Skewing an Element](#) on page 501

## Repositioning the Pivot Point Temporarily

Some transformations, such as rotation, scale, skew and flip, are made relative to the pivot point position. You can temporarily reposition this pivot point for each transformation using the Transform  tool.

**To temporarily reposition the pivot point:**

1. In the Tools toolbar, select the Transform  tool.

- In the Transform tool Tool Properties view, make sure that the Peg Selection Mode  is disabled.
- In the Camera view, click on your element to select it.  
The pivot point will appear in the **Camera** view.

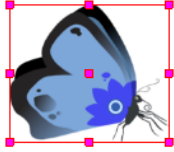

- Click on the pivot point and drag it to a new position.  
This will be the new position of the pivot point for the current transformation. It will remain in this new position as long as you do not deselect the drawing.

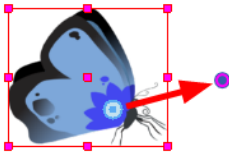

Using the Transform tool to reposition your pivot will temporarily override the existing pivot point position until you complete the current transformation, it then returns automatically to its original position.



When you translate the pivot using the Transform tool, the permanent pivot will appear as a ghost so you know where it is and also from where the animation will be interpolated when you create motion paths. The animation is always interpolated from the original pivot and not the temporary pivot.

## Panning a Drawing Layer

To pan a layer using the Transform tool:

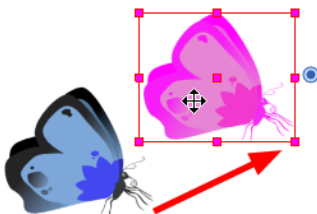



- In the Tools toolbar, select the Transform  tool.

2. In the Transform tool Tool Properties view, make sure that the Peg Selection Mode  is disabled.
3. In the Camera view, select a drawing layer and drag the selection to a new area.

## Rotating a Drawing Layer

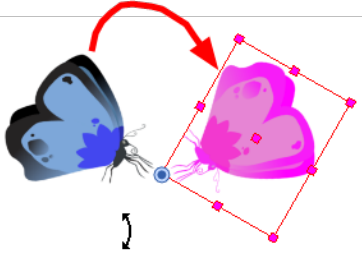
To rotate a layer using the Transform tool:



1. In the Tools toolbar, select the Transform  tool.
2. In the Transform tool Tool Properties view, make sure that the Peg Selection Mode  is disabled.
3. In the Camera view, select the drawing layer and rotate the transform bonding box handle.



A preference found in the Camera tab will add a rotation handle to your object's bounding box. This preference is off by default.

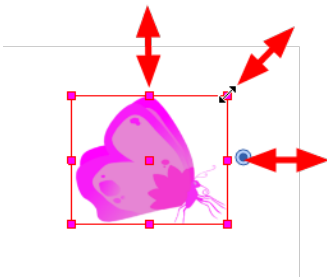

## Scaling an Element

To scale a layer using the Transform tool:



1. In the Tools toolbar, select the Transform  tool or press [Shift] + [T]
2. In the Transform tool Tool Properties view, make sure the Peg Selection Mode  is disabled.





3. In the Camera view, select the drawing layer and then pull or push either on the size, top or corner control point. Hold down [Shift] to lock the selection's ratio.

## Skewing an Element

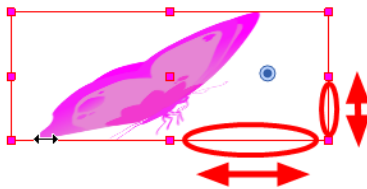
To skew a layer using the Transform tool:



1. In the Tools toolbar, select the Transform  tool.
2. In the Transform tool Tool Properties view, make sure that the Peg Selection Mode  is disabled.
3. In the Camera view, select the drawing layer and drag sideways or up and down the sides or top and bottom segments, between the control points.

### Related Topics

- [Using Advanced Animation Tools to Position a Layer](#) below

## Using Advanced Animation Tools to Position a Layer



You can also use the advanced animation tools to position your layers.

- [Permanently Repositioning the Pivot Point](#) below
- [Panning an Element using the Translate Tool](#) on the facing page
- [Rotating an Element using the Rotate Tool](#) on page 503
- [Scaling an Element using the Scale Tool](#) on page 503
- [Skewing an Element using the Skew Tool](#) on page 504

## Permanently Repositioning the Pivot Point

Some transformations, such as the rotation, scale, skew and flip, are made relative to the pivot point position. Reposition this pivot point anywhere using the current Advanced Animation tool.

To permanently reposition the pivot point:

1. In the Advanced Animation toolbar, select the Rotate , Scale  or Skew  tool.
2. In the Camera view, [Ctrl] + click (Windows) or [⌘] + click (Mac OS X) to select your element.  
The pivot point appears in the Camera view.

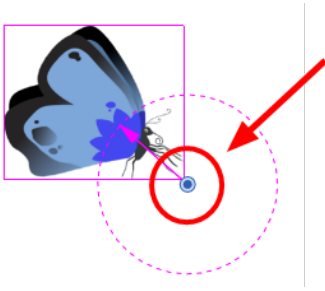

3. Click the pivot point and drag it to a new position.

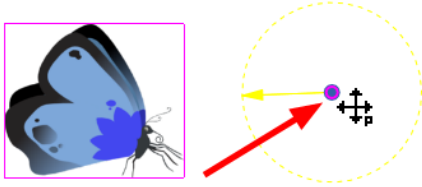

This is the new position of the pivot point for future transformations until you reposition it.



Using the Advanced Animation tools to reposition your pivot permanently overrides the existing pivot point position until you change its position again.

## Panning an Element using the Translate Tool

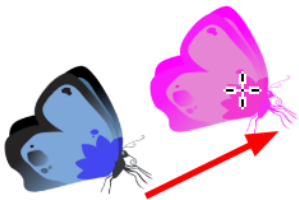

To pan a layer using the Translate tool:

1. Do one of the following:
  - ▶ In the top menu, select **Animation > Tools > Translate**.
  - ▶ In the **Advanced Animation** toolbar, click the **Translate**  tool.
  - ▶ Press [Alt] + [2].
2. In the **Camera** view, [Ctrl] + click (Windows) or [⌘] + click (Mac OS X) on the element to select it and drag the selection to a new area.

You can select multiple layers to reposition them at the same time. Press [Ctrl] + [Shift] + click (Windows) or [⌘] + [Shift] + click (Mac OS X) on each element to select them.

## Rotating an Element using the Rotate Tool

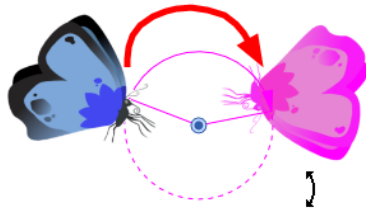

To rotate a layer using the Rotate tool:

1. Do one of the following:
  - ▶ Select **Animation > Tools > Rotate**.
  - ▶ In the Advanced Animation toolbar, click the **Rotate**  tool.
  - ▶ Press the [Alt] + [3].
2. In the **Camera** view, [Ctrl] + click (Windows) or [⌘] + click (Mac OS X) on the element to select it and rotate the layer.

You can select multiple layers to rotate them at the same time. Press [Ctrl] + [Shift] + click (Windows) or [⌘] + [Shift] + click (Mac OS X) on each element to select them.

## Scaling an Element using the Scale Tool

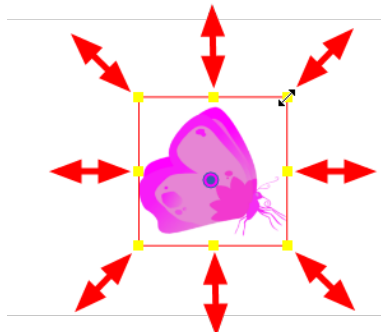

To scale a layer using the Scale tool:

1. Do one of the following:
  - ▶ Select **Animation > Tools > Scale**.
  - ▶ In the **Advanced Animation** toolbar, click the **Scale**  tool.
  - ▶ Press [Alt] + [4].
2. In the **Camera** view, [Ctrl] + click (Windows) or [⌘] + click (Mac OS X) on the element to select it and pull or push either on the side, top or corner control point. Hold down [Shift] to lock the selection's ratio when using the corner control points.

You can select multiple layers to scale them at the same time. Press [Ctrl] + [Shift] + click (Windows) or [⌘] + [Shift] + click (Mac OS X) on each element to select them.

## Skewing an Element using the Skew Tool

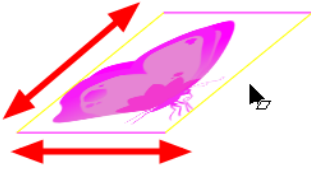

To scale a layer using the Skew tool:

- Do one of the following:
  - Select **Animation > Tools > Skew**.
  - In the **Advanced Animation** toolbar, click the **Skew**  tool.
  - Press [Alt] + [5].
- In the Camera view, [Ctrl] + click (Windows) or [⌘] + click (Mac OS X) on the element to select it and drag a side of the bounding box up, down or sideways.

You can select multiple layers to skew them at the same time. Press [Ctrl] + [Shift] + click (Windows) or [⌘] + [Shift] + click (Mac OS X) on each element to select them.



Refer to the [Interface on page 61](#) chapter to learn how to display the Advanced Animation toolbar.

### Related Topics

- [Positioning an Element using the Transform Tool on page 498](#)

## Flipping an Element

There are two different options you can use when you want to flip your element.



- [Flip Horizontal and Flip Vertical below](#)
- [Flip Scale X and Flip Scale Y on the next page](#)

### Flip Horizontal and Flip Vertical

The Flip Horizontal and Flip Vertical options flip your drawing layer along **Camera** view's horizontal and vertical axis.



### To flip a layer:



1. In the Tools toolbar, select the **Transform**  tool or press [Shift] + [T]
2. In Tool Properties view, make sure the **Peg Selection Mode**  is disabled.
3. In the Camera view, select the drawing layer you want to flip using the **Transform**  tool.
4. Select **Animation > Flip > Flip Horizontal** or **Flip Vertical** or press [4] and [5].

## Flip Scale X and Flip Scale Y

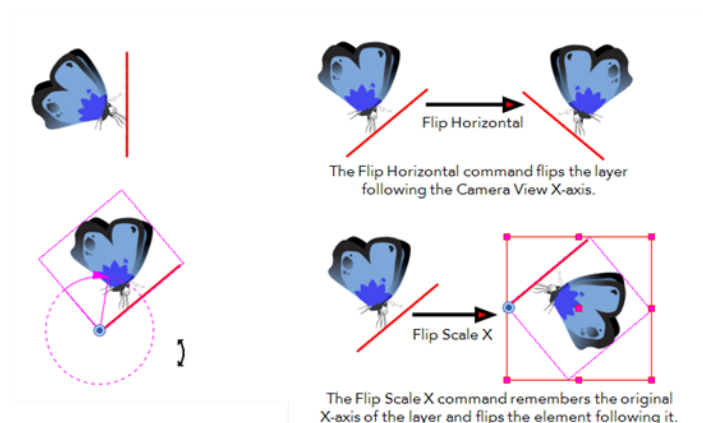
Once your drawing layer has been rotated, the original horizontal and vertical axes change. The **Flip Scale X** and **Flip Scale Y** will perform a flip on your drawing layer following its original axis.





### To flip an element following its original axis:

1. In the Transform tool Tool Properties view, make sure that the **Peg Selection Mode**  is disabled.
2. In the Camera view, using the **Transform**  tool, select your element that has already been transformed.
3. Select **Animation > Flip > Flip Scale X** or **Flip Scale Y**.



## Related Topics

- [Positioning an Element using the Transform Tool](#) on page 498

## Resetting a Transformation

Once your layers are positioned in the **Camera** view, you can easily reset them to their original position. Use the **Reset** command to reset the value of the selected element to the initial value of the active tool. For example, if the **Rotate**  tool is active, the transformation angle will be reset to 0 and if the **Transform**  tool is active, the entire transformation values will be reset.



When using the **Transform**  tool to select element in the **Camera** view, always make sure that the **Peg Selection Mode**  option in the **Tool Properties** view is disabled or else it will limit the selection to peg only.

### To reset the layers position:

1. In the Tools toolbar, select the **Transform**  tool or press [Shift] + [T].
2. In the Timeline or directly in the Camera view, select the drawing layers you wish to reset. You can select more than one layer at a time.
3. Select **Animation > Reset** or press [Shift] + [R].  
The selected layers will automatically return to their original position.

You may also choose to reset all values of your selected element, except for its position in Z space.

### To reset all except Z:

1. In the Tools toolbar, select the **Transform**  tool or press [Shift] + [T].
2. In the Timeline or directly in the Camera view, select the drawing layers you wish to reset. You can select more than one layer at a time.
3. Select **Animation > Reset All Except Z**.

All values, except for those set on the Z axis, will be reset.



In the **Timeline** view, you can also use the **Clear All Values** command to reset all transformation values on the selected layers. Right-click on the selected layers and select **Clear All Values**.

## Related Topics

- [Positioning the Scene Components](#) on page 490

# Clone Layer

A cloned layer is linked to the original element directory. If a drawing is modified in the original or cloned layer, both will be updated. However, clone layers can have different timings.

For example, if you make a walk-cycle for a soldier and want to use it for a whole army, you may want to have fifty layers with fifty different drawing exposures to produce a slight difference in the timing. You don't necessarily want the same drawing fifty times. If you copy your layers and their drawings fifty times over, it will create a very heavy scene. It is better to clone the fifty layers from the same initial layer to have them all linked to the same walk cycle drawings, producing fifty layers but one drawing directory. This will also allow you to correct the drawings in one layer and have all of the other ones updated simultaneously.



When you clone a layer that is already linked to a function, the cloned layers are automatically linked to the same function, so if you reposition the layers while in **Animate** mode, they are all

repositioned to the same place because a keyframe is added to this function. If you want the layers to move on a trajectory that is independent, make sure to unlink the function before cloning.



## To clone a layer:

1. In the Timeline view, select the layer to clone.
  - In the Network view, select the module you want to clone.

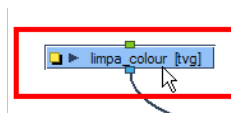

2. In the Timeline View menu, select **Layers > Clone Selected Layers**.
  - In the Network View menu, select **Modules > Clone Selected Modules**.

Note that the module will not appear in the Timeline view if it is not connected to the Composite module or if the Display mode is not set on **Display All**.

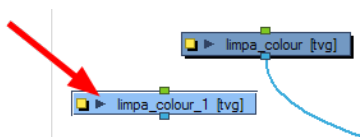
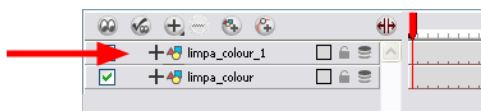

## Related Topics

- [Duplicate Layer](#)
- [Animation Paths on page 637](#)
- [Setting Up the Network on page 1](#)



# Creating a Multiplane



One of the most exciting features in Toon Boom Animate is the multiplane, or Z-depth. In the multiplane you can create backgrounds in several layers, spread them on the Z-axis, add depth, and then move the camera through this environment to create an impressive perspective illusion. You can create backgrounds, use a layered PSD file or use a project from the sample material package.

## Related Topics

- [Top View and Side View below](#)
- [Perspective View on the facing page](#)
- [Setting Up the Multiplane on page 512](#)
- [Distributing Elements on the Z-Axis on page 513](#)
- [Positioning Elements in 3D Space on page 1](#)
- [3D Camera Motion on page 1](#)

## Top View and Side View

The Top and Side views are used mainly for multiplane scenes and to position elements in 3D Space. They let the scene's stage to be seen from the top or the side. This lets the camera cone and the spacing between the elements to be seen.



Refer to the following sections of the [3D Space](#) chapter to learn more about positioning elements in 3D space and creating 3D Camera moves:

- [Positioning Elements in 3D Space](#)
  - [3D Camera Motion](#)
-

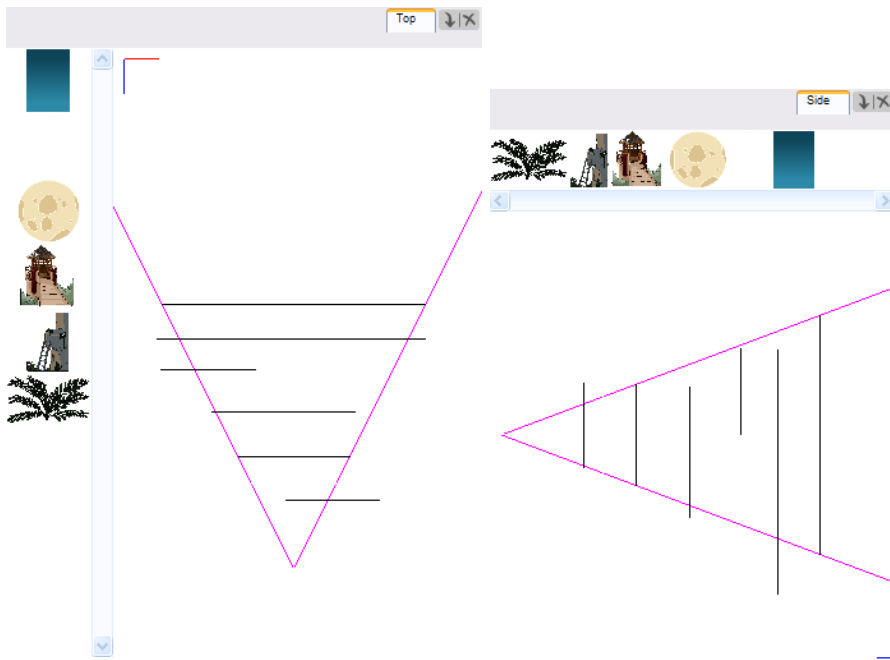

1. The camera cone represents the camera's field-of-view (FOV).
2. A thumbnail of each drawing layer in your scene. The order of the thumbnail images is based on each element's FB position in the scene space. You can see a representation of the FB position of each layer in the camera cone.



Refer to the [Animation Paths on page 637](#) chapter to learn about keyframes, control points and animation paths. Refer to the [Creating a Multiplane on the previous page](#) topic to learn how to position your elements in the Top and Side view.

## Related Topics

- [Perspective View below](#)
- [Creating a Multiplane on the previous page](#)

## Perspective View



The Perspective view is used during scene setup. Its main use is to allow you to see your multiplane scene's orientation. The Perspective view is similar to a 3D display, as it lets you rotate your scene through all possible angles to understand the spacing between the elements. You can also position and rotate your layers and the camera inside the 3D display to achieve some 3D setup and camera moves.

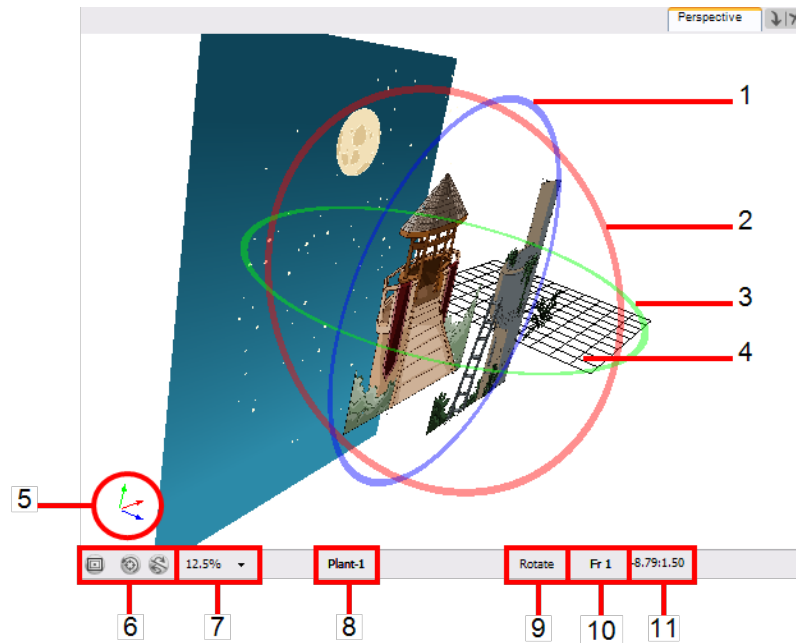

Refer to the following sections of the [3D Space](#) chapter to learn more about positioning elements in 3D space and creating 3D camera moves:

- [Positioning Elements in 3D Space](#)
- [3D Camera Motion](#)



1. The blue circle represents a rotation of the X and Y axis plane.
2. The red circle represents the rotation of the Y and Z axis plane.
3. The green circle represents the rotation of the X and Z axis plane.
4. This is a perspective grid reference.
5. The axis reference arrows let you maintain your orientation when navigating in the Perspective view.
6. There are three view option buttons displayed in the lower-left corner of the view.
  - ▶  **Show/Hide Camera:** Shows or hides camera frame in the Perspective view.
  - ▶  **Reset View:** Resets the Pan, Rotation and Zoom of the Perspective view.
  - ▶  **Reset Rotation:** Resets the rotation of the Perspective view.
7. This field displays the current zoom level in the Perspective view. You can use the Zoom level drop-down menu to select a specific zoom level from the list. Zoom levels from 2.5% to 6400% are available, you can also select Fit To View to automatically use a zoom level that lets you see all of your scene layers and information in the Perspective view at once.

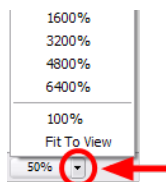

8. This field displays the currently selected layer and drawing name.
9. This field displays the currently selected tool.
10. This field displays the currently selected frame of your animation.
11. This field displays the current position of your cursor inside the Perspective view.

**To rotate a scene in the Perspective view:**

1. In the Tools toolbar, select the **Rotate View**  tool.



- ▶ Click in the view, and drag your cursor around to rotate the view.
- ▶ Press and hold [Alt] + [Shift] and click and drag to rotate the view one axis at a time.

**Related Topics**

- [Creating a Multiplane on page 509](#)
- [Top View and Side View on page 509](#)

## Setting Up the Multiplane

To construct a multiplane, you must imagine what a real environment is like. Take a look at your background picture and imagine a camera moving across the space. You will notice that objects in the picture would move at different speeds depending on where they are in relation to the camera lens.

Building a multiplane requires an understanding of the scene's background as well as the positioning of the elements on different layers.

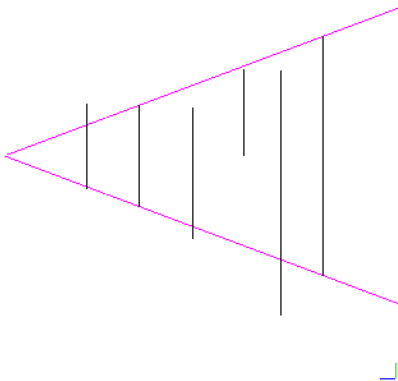
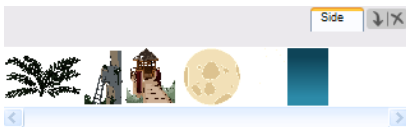

For example, in this background, the main objects to be separated are:

1. Fern
2. Front tower
3. Second tower
4. Moon
5. Stars

## 6. Sky



Although the bottom of the tower is hidden behind the plant and the ladder, each of your multiplane layers should be a complete drawing. This is because hidden portions may show up during a camera movement later on in the scene

### Related Topics

- [Distributing Elements on the Z-Axis below](#)

## Distributing Elements on the Z-Axis

Now is the time to distribute the layers composing your multiplane along the Z-axis, maintaining their distance. You can position your layers on the Z-axis in the Side and Top view.

Positioning your element toward the camera will make your element bigger. Using the Maintain Size  tool, you will be able to drag your element toward the camera while keeping the same size aspect in the Camera view. This tool is available in the Advanced Animation toolbar.



It is a good idea to keep a Camera view opened to see what your scene looks like while positioning your element in the Top or Side view.

## Positioning Elements in the Top and Side Views

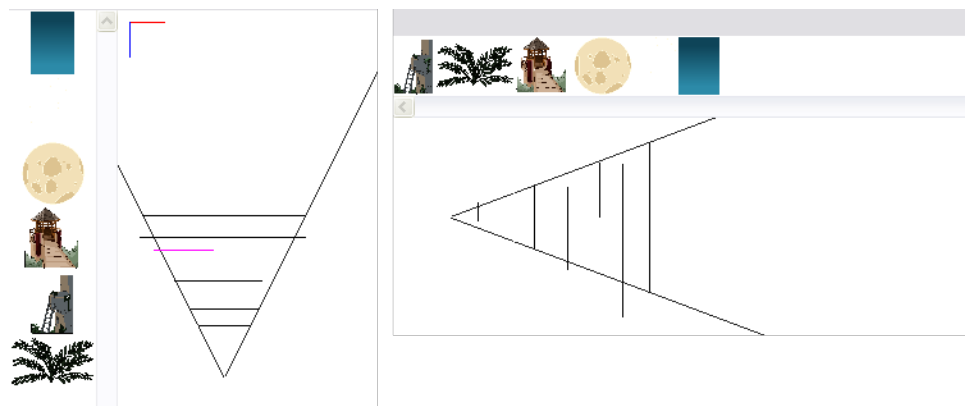

To be able to distribute the layers along the Z-axis using the Top and Side views, disable the No Z Dragging option by selecting **Animation > No Z Dragging**.

**To position your element in the Top and Side views:**

1. In the Advanced Animation toolbar, click the Maintain Size  tool or press [Alt] + [6].
2. In the Side view, select one of the layers in the thumbnails section of the Top or Side view. You can also select your layer from the Timeline view.

The selected layer will be highlighted in the camera cone.

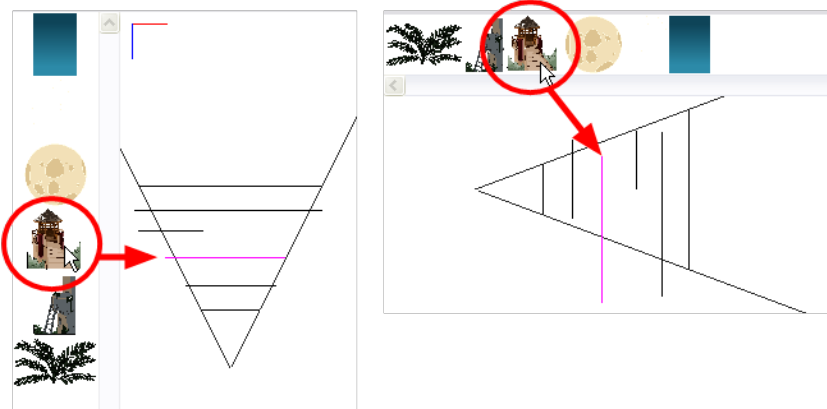

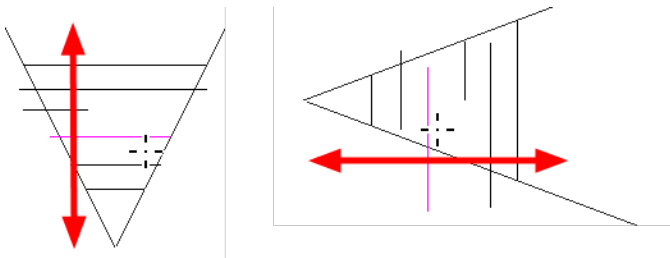

3. Click and drag the layer to the correct depth position in the camera cone. Your element aspect will remain the same in the Camera view.



4. In the Tools toolbar, click the Transform  tool, or select the Translate  tool in the Advanced

Animation toolbar and select a layer from the thumbnails section of the Top or Side view. You can also select your layer from the Timeline view.

- If you choose the Transform  tool, make sure that the Peg Selection Mode  option is disabled in the Transform tool's Tool Properties view.

The selected layer will be highlighted in the camera cone.

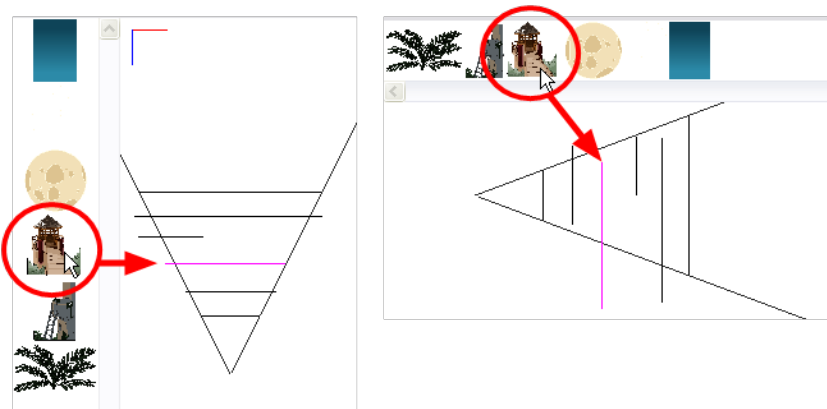

5. In the TOP view, drag the element sideways to position horizontally. You can press and hold [Shift] while dragging the element to make sure it only moves along the X-axis.
6. In the Side view, drag the selected element up or down to position it vertically. You can press and hold [Shift] while dragging the element to make sure it only moves along the Y-axis.

## Related Topics

- [Creating a Multiplane on page 509](#)
- [Top View and Side View on page 509](#)
- [Perspective View on page 510](#)
- [Setting Up the Multiplane on page 512](#)

# Scene Setup Preferences

When setting up your scene in Animate, some preferences can help you work more efficiently.

- [General Tab Preferences](#) below
- [Camera Tab Preferences](#) on the next page
- [Scene Setup Preferences](#) above
- [Scene Setup Preferences](#) above
- [OpenGL Tab Preferences](#) on page 519
- [Scene Setup Preferences](#) above

To open the Preferences dialog box:

- Windows: Select **Edit > Preferences**.
- Mac OS X: Select **Animate > Preferences**.
- Press [Ctrl] + [U] (Windows) or [⌘] + [U] (Mac OS X).

## General Tab Preferences

Shortcuts **General** Camera Exposure Sheet Drawing Sound OpenGL Render

Save

Automatically Save Workspace

Auto-Save

Interval (minutes)

Inactivity Interval (seconds)

Ask Before Saving

Enabled

Options

Auto Render

Focus On Mouse Enter

Snap Keyframe

Touch Interface

Support Gestures

Invert Scroll Direction

Touch Sensitivity

Shortcut Zooms on Mouse

Flat Toolbar (Requires Relaunch)

Colour Management

Interactive Colour Recovery

Colour Recovery

Replacement Colours

Colours

Current View Border

Current View Border in Template Edit

Edit Colours

Settings

Stop-Motion Keyframes

Default Separate Position

Default Separate Scale

Levels of Undo

Default Bezier

Default Bezier Velocity

Timeline

Add Keyframes at Beginning and End

Advanced

Use Advanced Art Mode (need to restart application)



# Camera Tab Preferences

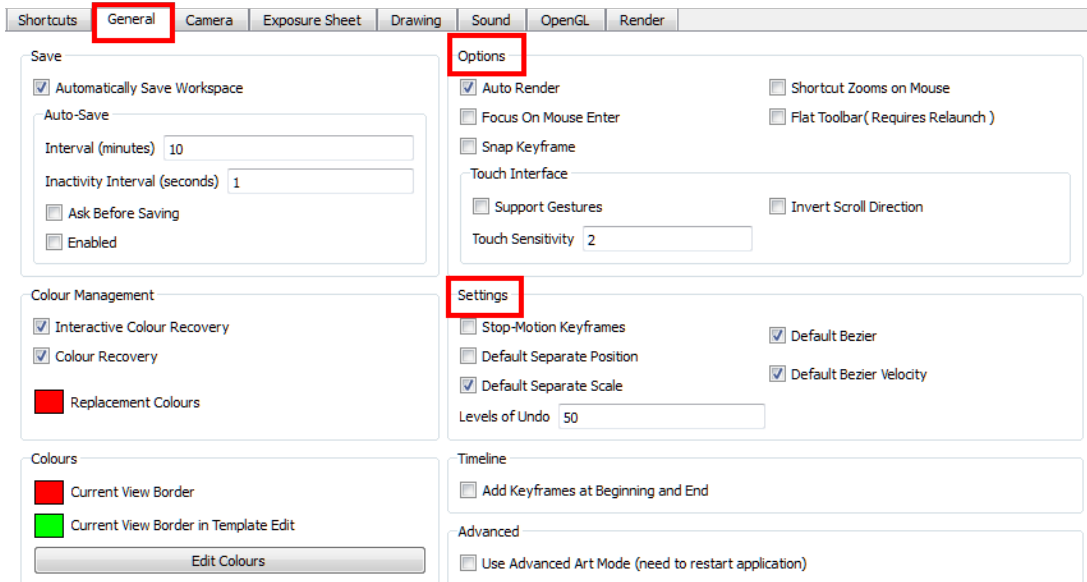

## Tools

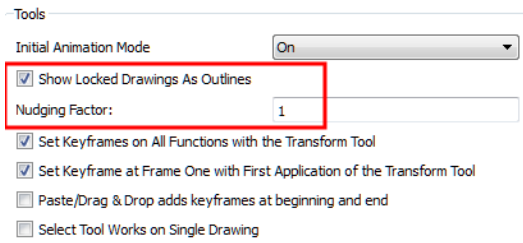

- **Show Locked Drawings As Outlines:** In the Camera view, locked elements are displayed as outlines only.
- **Bounding Box Selection Style:** In the Camera view, selected elements are not highlighted in colour but are displayed with the bounding box only.
- **Nudging Factor:** The nudging increment value.
- **Use Rotation Lever with transformation tools:** Enable this preference if you prefer to see the rotation lever when using the transformation tools. Without this preference enabled, hovering your cursor of the corner of an element's bounding box is sufficient to rotate it.

## Zoom Settings

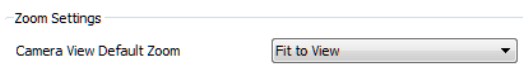

- **Camera View Default Zoom:** The default zoom value for the Camera view.

## Settings

Settings

Thumbnail Size  pixels

Small Bitmap Resolution  pixels

Override Small Bitmap Files

Safe Area  (ratio)

- **Thumbnail Size:** The thumbnail size, in pixels, that appears in the Top and Side views.
- **Small Bitmap Resolution:** The size, in pixels, of the smaller bitmap version of your image. When you import a bitmap image into a scene, a smaller version of it is created by the system in order to accelerate the compositing and playback processes.
- **Override Small Bitmap Files:** Enable this option if you want the system to generate new versions of the already existing smaller bitmap files, every time you modify the Small Bitmap Resolution value. When the option is disabled, the already existing smaller bitmap versions will not be regenerated and will keep the same resolution as when they were created.

## Wash Background

Wash Background

Enable in Camera

Enable in Camera Drawing Mode

Wash Background Percentage

- **Enable in Camera:** Dulls background bitmaps in Camera view. This allows you to see other elements clearly, such as the ones that have not yet been painted.
- **Enable in Camera Drawing Mode:** Dulls background bitmaps in Camera view while using drawing tools. This allows you to see other elements clearly, such as the ones that have not yet been painted.
- **Wash Background Percentage:** The Wash Percentage value.

# OpenGL Tab Preferences

## Settings

- **Conservative Texture Management:** Turns on and off conservative memory management for bitmap texture files. Performance will improve when this is enabled. If disabled, you will have a better on-screen rendering of bitmap files at the expense of slower performance.
- **Smooth Textures:** Smooths out the pixels of bitmap images when zooming in; this improves bitmap image quality.
- **Alternate Gradient and Cutter:** This is an alternative way to disable write in the OpenGL Backbuffer, required for some video cards (i.e. GeForce FX5200). Do not enable this option unless you are experiencing problems with gradients and cutters in OpenGL.
- **Use PBuffer for Picking:** This will use an off-screen buffer for picking, resulting in a quicker response. This option should not be enabled if using a small capacity video card (32MB).
- **Support Triple Buffer:** Enable this option for a better compatibility with Windows Vista if your video card driver does not allow to disable the triple buffering option. Not enabling this option may result in a dashing line when drawing a brush stroke.
- **Support Desktop Effects:** Enable this option for better compatibility with Windows 7, Windows Vista and Mac OS X desktop effects. This will prevent graphic compositing problems from happening when the full-scene anti-aliasing option is enabled.
- **Maximum Texture Size:** The size that the bitmap file will be reduced to when using the Conservative Texture Management
- **Texture Memory:** The amount of temporary memory used to store bitmap texture files.

- **Vector Drawing Maximum Texture Size:** This is the size that the .tvg file will be reduced to for better performance when in OpenGL render mode.

# Chapter 11: Library

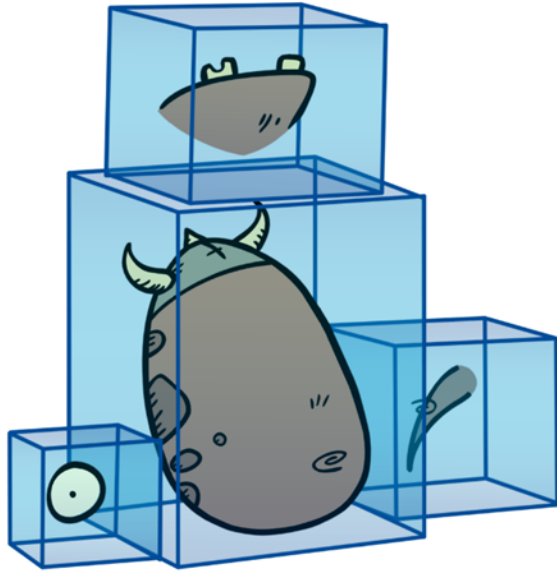

You can share and reuse any elements you create in Toon Boom Animate using symbols and Templates. Animate has a library where you can store several different elements such as puppets, backgrounds, animations and keyposes. In fact, anything you create in Animate can be stored in the library.

## Topics Covered

- [Understanding the Library Concept on the facing page](#)
- [Library View on page 524](#)
- [Structuring the Library on page 527](#)
- [Symbols on page 532](#)
- [Templates on page 540](#)
- [Importing Symbols and Templates on page 543](#)
- [Preferences on page 1](#)

# Understanding the Library Concept

Use the Library view to reuse your artwork and animation in other scenes or to build props and puppets.

- [What is a Library? below](#)
- [What is a Symbol? below](#)
- [What is a Template? on the next page](#)
- [Understanding the Library Concept above](#)

## What is a Library?

A library is a folder where you store your templates and symbols. You can access these folders from different projects. Using the library is easy, just drag the content into the library to store your artwork and then drag it into your Timeline or Camera view when you want to reuse it.

Organize your library using subfolders. You can keep several different library folders on your hard drive or network.

## What is a Symbol?



A symbol is a container or construction block used to build your props, puppets and looping clips. Use symbols to contain artwork and animation, to manipulate them as a single object, or as a case holder where you will put a series of different drawings for each body part of your puppets.

To create a symbol, drag your artwork to the Symbol library. When you drag a symbol from the Symbol library into your scene, it will be linked to the original one. If you drag a symbol into your scene several times in the Timeline view, they will all be linked to the original one. If you modify one, they will all be modified.

A symbol is local to the project and cannot be accessed directly from other scenes. To reuse a symbol's content into another scene, you must create a template out of it.

When a symbol is exposed in the Timeline view, the symbol's cells are represented as a movie strip.

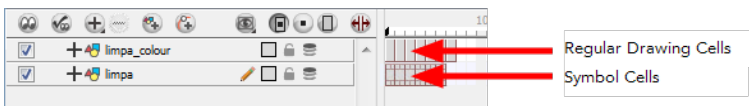

## What is a Template?

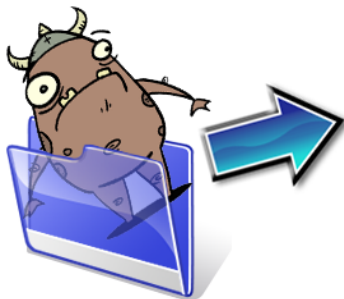

A template is an individual copy of the artwork stored in the library. This package can be reused in different scenes. Once a template is stored in the library it can be accessed from any project.

Dragging a template into your scene copies the content in your Timeline and does not link it to the original. This individual copy can be modified at will.

### Related Topics

- [Library View](#) on the facing page

# Library View

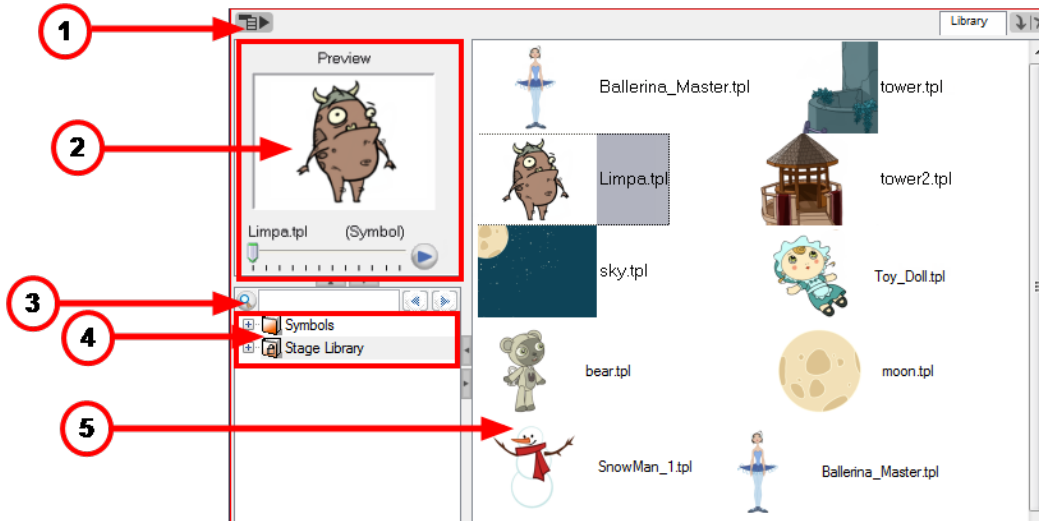

You use the Library view to create and manage your symbols and templates, display the folders and manage all of the content.

1. [Library View Menu](#) below
2. [Preview and Drawing Substitution](#) below
3. [Library Search Tool](#) on the next page
4. [Library List](#) on the next page
5. [Templates and Symbols List](#) on page 526

## Library View Menu

The Library View menu lets you access commands specific to the Library view such as opening a Library or getting the rights to modify a library folder.

## Preview and Drawing Substitution

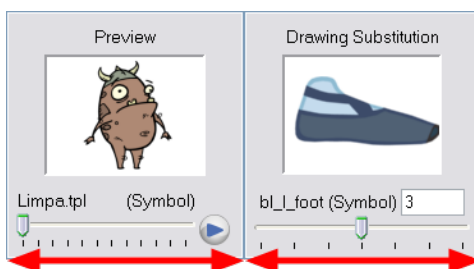

The Preview window, allows you to preview the content of a symbol or template and to swap between drawings and symbol cells in your Timeline view. This window is also used as the Drawing Substitution window.

**To preview a template or symbol's content:**

1. In the Library view's right side, click or double-click on the symbol or template to preview.



2. In the Preview window, click on the Play button or drag the slider to scrub through the frames.

## Library Search Tool

When working on a movie or series, you will most likely end up with a lot of templates and symbols in your library. You have access to a Search tool to help you find templates and symbols in your folders.

**To use the Library Search tool:**

1. In the Library view, in the left side, select the library you wish to search in.

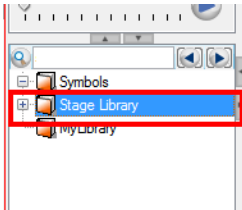

2. In the Search field, type the name or partial name of the symbol or template you are looking for.

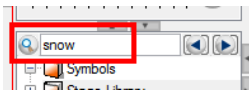

3. Click on the left and right arrows to see the previous and next results. The Search engine will look for result within the library master folder and its subfolders. It will not look in other libraries.

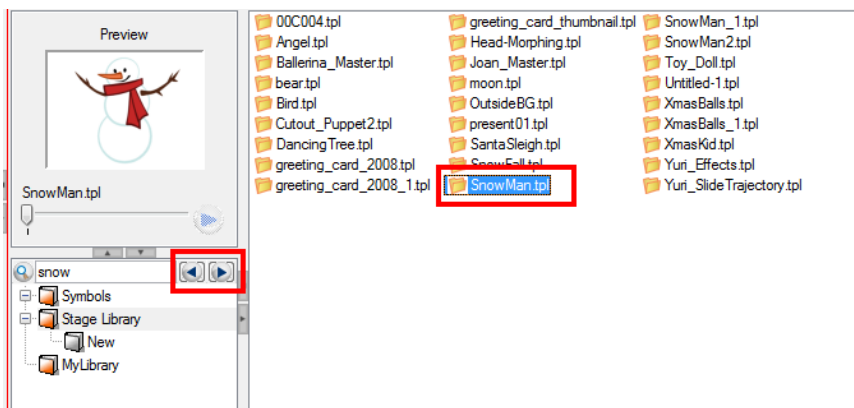

## Library List

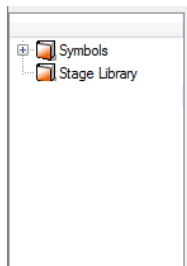

The Library List is used to navigate through the different libraries and subfolders. You can also open, close and create new libraries from here.

The Library has two default folders:

- **Symbols**

The only library folder containing symbols for your project. You can organize the symbols library folder using subfolders, but you cannot create a second Library for your symbols. This library is local to your project.

- **Animate Library**

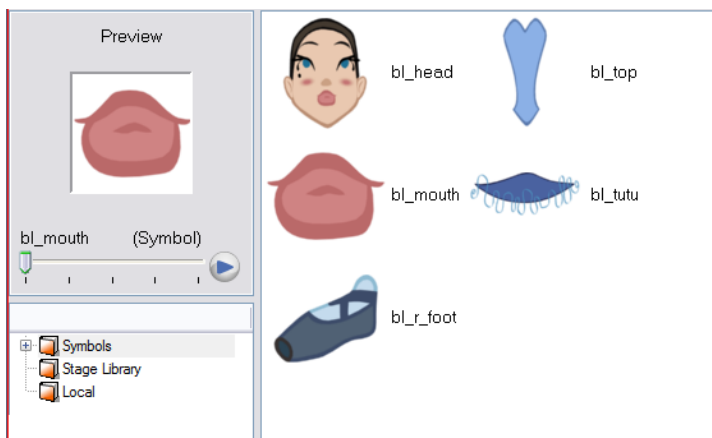

This folder contains templates and is stored on your hard drive. You can share the contents of this Library between different projects. You can organize the Animate library folder using subfolders. This folder does not contain symbols.

## Templates and Symbols List



The symbols and templates contained in the selected Library list can be displayed on the right side of the Library view as thumbnails, in a list or as details.

**To access the templates and symbols list display options:**

- ▶ In the Library view's right side, right-click and select **View > List, Thumbnails** or **Details**.
- ▶ In the Library View toolbar, you can click on the following buttons:
  -  Thumbnails
  -  List
  -  Details

### Related Topics

- [Understanding the Library Concept on page 522](#)

# Structuring the Library

As you will probably create a large number of symbols and templates you will soon realize that they need to be organized. You can create different libraries and subfolders so that you can gain easy access to your assets. For example, create a different library for each project and divide it into several categories, such as:

- Characters
- Props
- Backgrounds

Although you can only have one symbol library folder, you can organize it by creating subfolders.

- [Creating a Library below](#)
- [Opening a Library on the facing page](#)
- [Closing a Library on page 529](#)
- [Creating a Folder on page 529](#)
- [Deleting a Folder on page 530](#)
- [Renaming a Folder on page 530](#)
- [Refreshing the Library on page 530](#)
- [Generating Thumbnails on page 531](#)

## Creating a Library

There are two ways to create Library folders.

- Using Animate's interface.
- Directly through your operating system.

To create a library using your operating system, create a new folder with a relevant name in the location where you want the library to be stored. This can be opened in Animate when you require it. .

**To create a library from Animate:**

1. In the Library view click on the Menu  button and select **Folders > Open Library**.

The Browser window opens.

2. Browse for the location where you want to store your new library.
3. Click on the Make New Folder button.

The new folder appears.

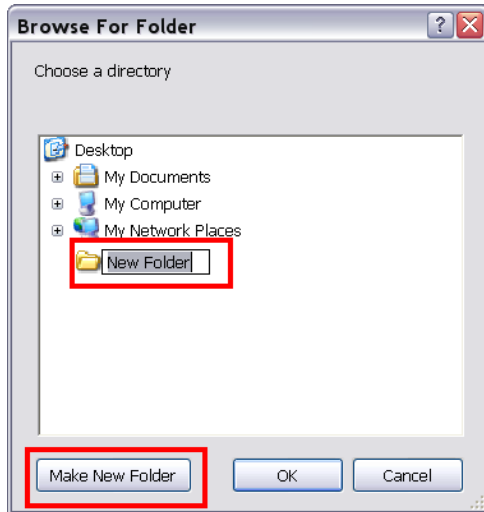

4. Name the new library with a relevant name.

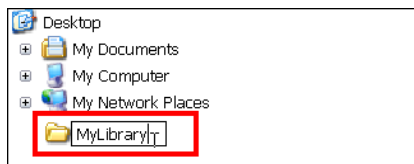

5. Click on the OK button.

The new library appears in the Library List section.

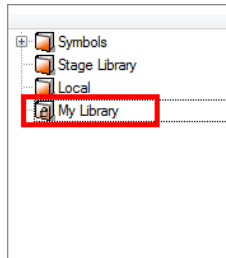

## Opening a Library

You can open any folder on your hard drive or network as a library. Opening a library means linking the folder to your Library view. You only need to open the library once. The library folder is available every time you open the application until you decide to close the library and unlink it.

### To open a library:

1. In the Library View menu, select **Folders > Open Library**.  
The Browser window opens.
2. Browse to the location of the library folder.
3. Select the folder.
4. Click on the OK button.

The new library appears in the Library Folders section.

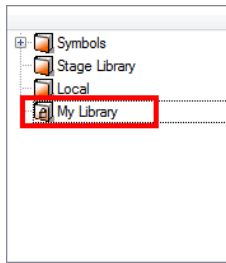

## Closing a Library

You may not always require all of the library folders in the Library List, if this is the case you can close the ones you do not need. Closing it does not delete the folder, it only unlinks it from the Library view. If you want to reopen in later, you only need to locate it on your hard drive or network and open it in the Library view.

### To close a library:

1. In the Library view's right side, select the library folder to close.
2. In the Library View menu, select **Folders > Close Library**.

The library closes.

## Creating a Folder

Symbols and Template libraries need to be well organized. You can create different subfolders on your hard drive or in the Library view so that you can gain easy access to your assets. By default, any new library you link to your Library view is locked, this prevents the accidental deletion or modification of templates and symbols. You must obtain the right to modify a locked folder before being able to create subfolders for it.

### To create a folder:

1. In the Library view's left side, select a library folder that you would like to make subfolders for.
2. In the Library View menu, select **Edit > Right to Modify** or right-click on the selected library and select **Right to Modify**.
3. In the Library View menu, select **Folders > New Folder**.

The new subfolder is added to the Library view (although not immediately visible as it is collapsed in its parent folder). Click on the root library folder containing the new folder and click on the "+" sign to expand it.

The new subfolder appears.

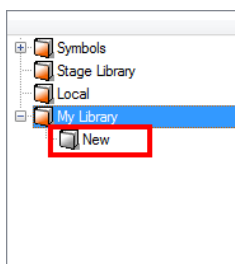

## Deleting a Folder

You can delete a folder from the library if its contents are no longer needed.



ALL THE TEMPLATES OR SYMBOLS CONTAINED IN THE FOLDER WILL BE DELETED FROM YOUR HARD DRIVE. ONCE DELETED THE DATA CAN NOT BE RETRIEVED.

### To delete a folder:

1. In the Library view's left side, select the folder to delete.
2. In the Library View menu, select **Edit > Right to Modify** or right-click on the selected library and select **Right to Modify**.
3. In the Library View menu, select **Folders > Delete Folder** or press [Delete].

## Renaming a Folder

Once you add a folder, you can rename it, this also renames the folder on your hard drive.

### To rename a folder:

1. In the Library view's left side, select the folder to rename.
2. In the Library View menu, select **Edit > Right to Modify** or right-click on the selected library and select **Right to Modify**.
3. In the Library View menu, select **Folders > Rename Folder**.
4. Rename the selected folder.

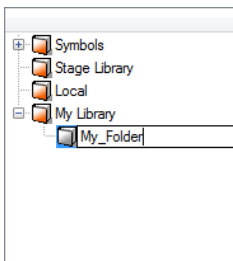

5. Press [Enter/Return] to validate the operation.

## Refreshing the Library

If you update the content of your libraries through your operating system, you will need to refresh your library folders in the Library view.

### To refresh a library:

1. In the Library view's left side, select the folder to refresh.
2. In the Library View menu, select **Folders > Refresh** or press [F5].

The library now displays the new content.

# Generating Thumbnails

When you display thumbnails in the Library view, the system generates a series of small images (thumbnails) for you. You can generate template thumbnails yourself, if they do not display or if the process has been stopped.

## To generate thumbnails:

1. In the Library view's right side, select the template you want to generate thumbnails for.

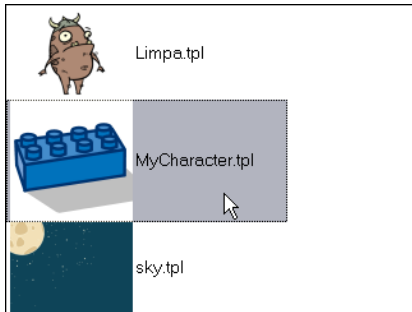

2. In the Library View menu, select **View > Generate Thumbnails**.

The progress bar appears.

You can also delete thumbnails if you want to send a template to another user or studio and keep your packages small.

## To delete thumbnails:

1. In the Library View menu, select **Edit > Delete Thumbnails**.  
All the thumbnails contained in the library are removed.

## Related Topics

- [Understanding the Library Concept on page 522](#)

# Symbols



A symbol combines animation, artwork or layers into a single object that you can control in one layer. You can also create symbols out of each body part in your cut-out puppets.



You do not need to create Symbols in order to create drawings or characters in Toon Boom Animate.

## Related Topics

- [Creating a Symbol](#) below
- [Deleting a Symbol](#) on page 535
- [Editing a Symbol](#) on page 536
- [Duplicating a Symbol](#) on page 538
- [Sharing a Symbol](#) on page 538



## Creating a Symbol

You can create symbols in several ways:

- [Creating a Symbol from a Drawing Selection](#) below
- [Creating a Symbol from the Timeline View](#) on page 534
- [Creating a Symbol](#) above
- [Creating an Empty Symbol](#) on page 535

## Creating a Symbol from a Drawing Selection

To create a symbol from a drawing selection:

1. In the Tools toolbar, select the Select  or Cutter  tool.



- In the Camera view, select the drawing objects which you want to create a symbol out of.

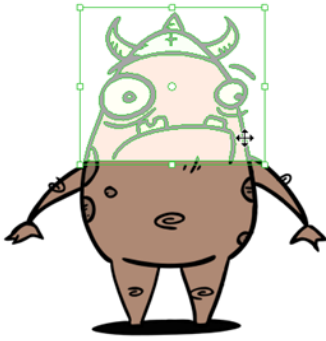

- In the top menu, select **Edit > Create Symbol** or press [F8]. You can also click on the **Create Symbol**  button in the Edit toolbar.

The Create Symbol from Drawing Selection dialog box opens

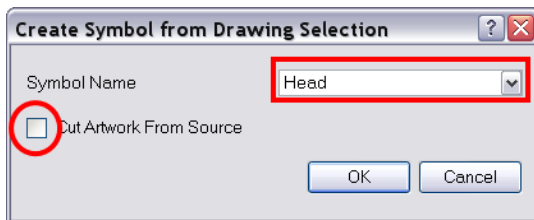

- In the Symbol Name field, type the name of the symbol.
  - You can also select an existing layer from the Symbol Name drop-down menu. It will add your symbol on the layer's current cell. If there is already an exposure on that cell a warning message will appear stating, "*Layer Head already has an exposure on current frame. Can't perform operation.*"

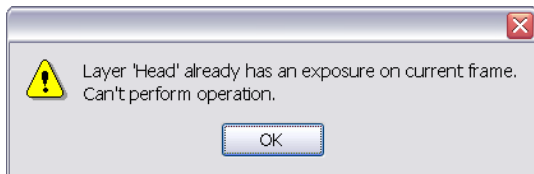

- If you want to rename a symbol, right-click on the symbol and select **Rename**.
- You can choose to leave the current selected artwork in the drawing or not:
    - To remove currently selected artwork from the drawing and leave it in the new symbol, enable (place a checkmark in the checkbox) the **Cut Artwork From Source Drawing** option.
    - To keep currently selected artwork in both the drawing and in the new symbol, disable (remove the checkmark from the checkbox) the **Cut Artwork From Source Drawing** option.
  - Click **OK**.

The new symbol appears in the Library view's symbol folder and in the Timeline view as a new layer.

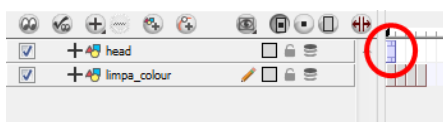

## Creating a Symbol from the Timeline View

To create a symbol from the Timeline view:

1. In the Timeline view, select the layer or the cells from which you want to create a symbol.
2. In the top menu, select **Edit > Create Symbol** or press [F8]. You can also click on the **Create Symbol**  button in the Edit toolbar.
  - ▶ Another way to create a symbol is to select the layer or cells from the Timeline view and to drag them on the Symbol folder in the Library view.

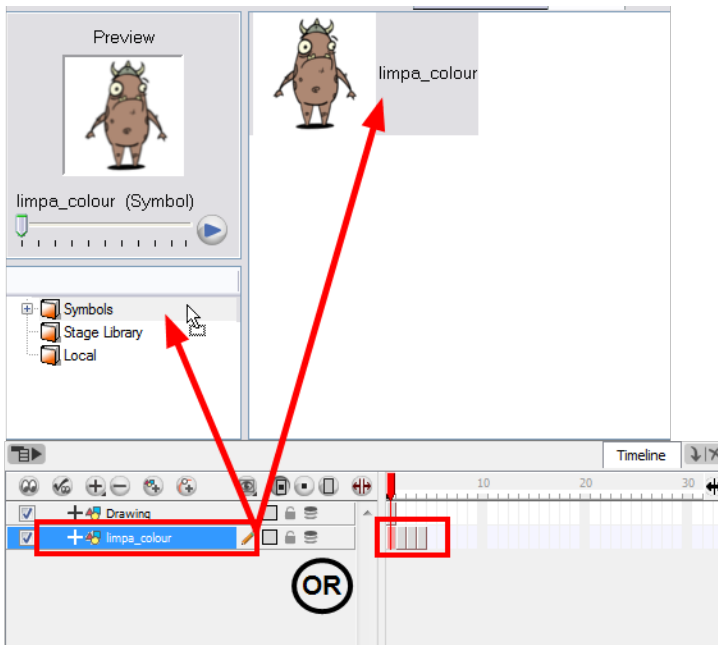

The Create Symbol dialog box opens

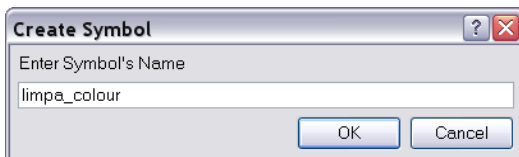

3. In the Enter Symbol's Name field, type the new symbol's name.
  - ▶ To rename a symbol once it is created, right-click on the symbol and select **Rename**.
4. Click **OK**.

The new symbol appears in the Library view's symbol folder.



The current selection is not replaced by the new symbol. The new symbol only appears in the library. You must drag it into your scene to use it.

## Creating an Empty Symbol

To create an empty symbol:

1. In the Library view, select the Symbol folder.
2. In the Library view's right side, right-click and select **New Symbol**. You can also select **Insert > Create Empty Symbol in Library** from the top menu.

The new empty symbol appears in the Library view.

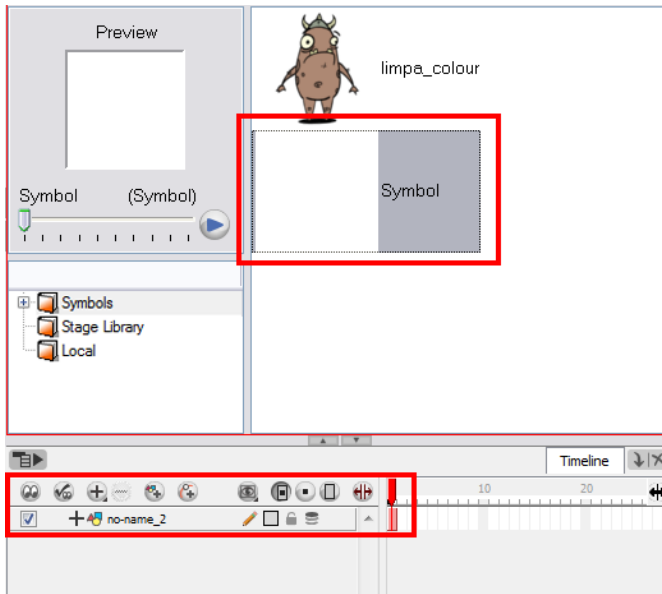

- ▶ The symbol is ready for you to edit (add content to). To go back to the root timeline, click on the **Top**  button in the Camera view.
- ▶ To rename a symbol once it is created, right-click on the symbol and select **Rename**.

### Related Topics

- [Importing Symbols and Templates on page 543](#)

## Deleting a Symbol

Deleting a symbol is easy.



WARNING: THE SYMBOL WILL BE DELETED FROM YOUR HARD DRIVE. USE UNDO TO RETRIEVE THE DATA. THE DATA CANNOT BE RETRIEVED ONCE YOU CLOSE THE APPLICATION.

To delete a symbol:

1. In the Library view, select the symbols to be deleted.
2. Right-click on the selection and select **Delete** or press [Delete].

- ▶ If the symbol is currently in use in the scene, a warning message will pop up and the symbol will not be deleted.

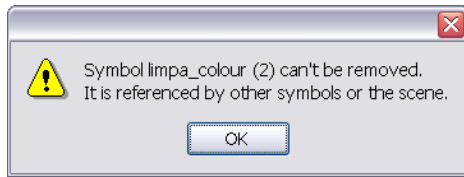

## Related Topics

- [Creating a Symbol on page 532](#)

# Editing a Symbol

When you import a symbol from the library to the Timeline view it is linked to the original symbol in the library. If you import a symbol into your scene several times in the Timeline view, they will all be linked to the original symbol. If you modify one, they will all be modified.

If you want to edit a symbol without modifying the other instances, you must duplicate the symbol first, [See \*Duplicating a Symbol\* on page 538.](#)

You can either edit a symbol from the Timeline view or from the Library view.

When you edit a symbol, the drawings contained in it are not placed at the centre of the stage, but are located in the position where they were created. The pivot is translated at the centre of the symbol.

### To edit a symbol from the Timeline view:

1. In the Timeline view, double-click on the symbol's cell to edit the symbol. You can also double-click on the symbol in the Camera View or press [Ctrl] + [E] (Windows) or [⌘] + [E] (Mac OS X). You can also click on the **Edit Selected Symbol**  button, available in the Camera View toolbar's extra buttons.

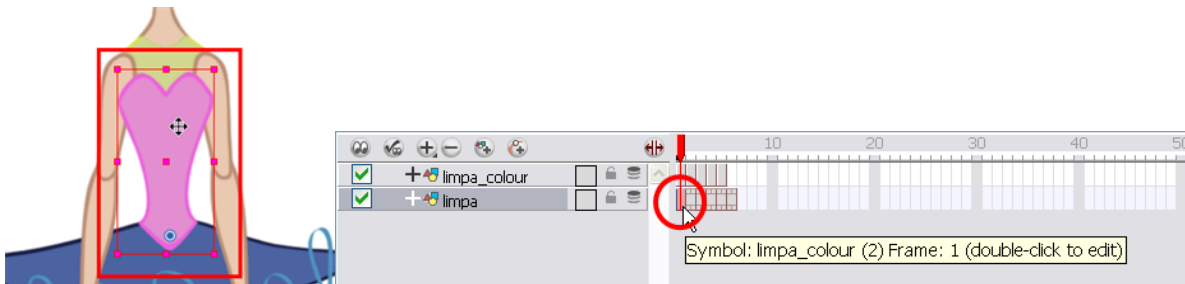

You are now inside the symbol and you are able to edit it.



2. Click on the **Top**  button in the Camera view's top left corner to return to the project's timeline or press [Ctrl] + [Shift] + [E] (Windows) or [⌘] + [Shift] + [E] (Mac OS X). In the Timeline view's right side, right-click and select **Symbols > Leave Current Symbol**.

#### To edit a symbol from the Library view:

1. In the Library view, select the symbol to edit.
2. Right-click and select **Edit > Edit Symbol**. You can also double-click on the symbol.  
You are now inside the symbol and you are able to edit it.



3. Click on the **Top**  button in the Camera view's top left corner to go back to the project's timeline or press [Ctrl] + [Shift] + [E] (Windows) or [⌘] + [Shift] + [E] (Mac OS X).

## Related Topics

- [Creating a Symbol on page 532](#)

## Symbol Hierarchy

When you enter a symbol to edit it, you are entering another scene where you have an independent timeline for your symbol. You can nest many symbols one inside the other. To help you follow the hierarchy of your nested symbol, take note of the Editing stack at the top of the Camera view which displays the path to your symbol's location. You can click on the symbols' name to move up the chain.

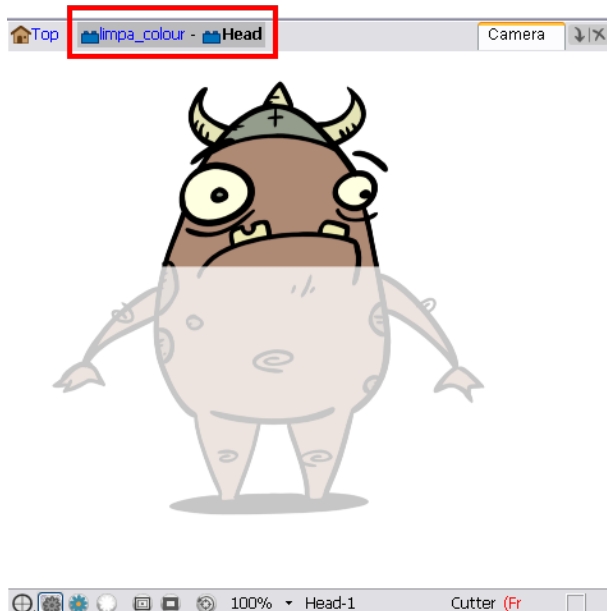

## Related Topics

- [Editing a Symbol on page 536](#)

# Duplicating a Symbol

You must duplicate a symbol if you want to modify a copy of it without altering the original symbol and the other copies.

### To duplicate a symbol:

1. In the Timeline view, go to the frame where you want to duplicate the symbol.
2. Select the symbol's cell.



3. In the top menu, select **Edit > Duplicate Selected Symbol**.

In the Library view, the symbol is duplicated and in the Timeline view, the current cell is replaced with the new symbol. You can now modify the symbol's content.



If other symbols are nested inside the new symbol, those ones are not duplicated. If you modify them, the original and other instances will also be modified.

## Related Topics

- [Creating a Symbol on page 532](#)

# Sharing a Symbol

You can share a symbol and use its contents (the drawing or drawings that it contains) in another scene. To do this, you must first convert your symbol into a template. This conversion breaks the drawing's link with both the original scene and symbol. It then becomes a separate entity that you can import into your other projects.

### To convert a symbol into a template:

1. From the Library view, select the symbol to convert into a template and drag it to the Camera or Timeline view.



If you drop your symbol into the Camera view instead of the Timeline view, it will not be placed in the centre of your camera frame, but rather wherever your cursor drops it within the camera frame.

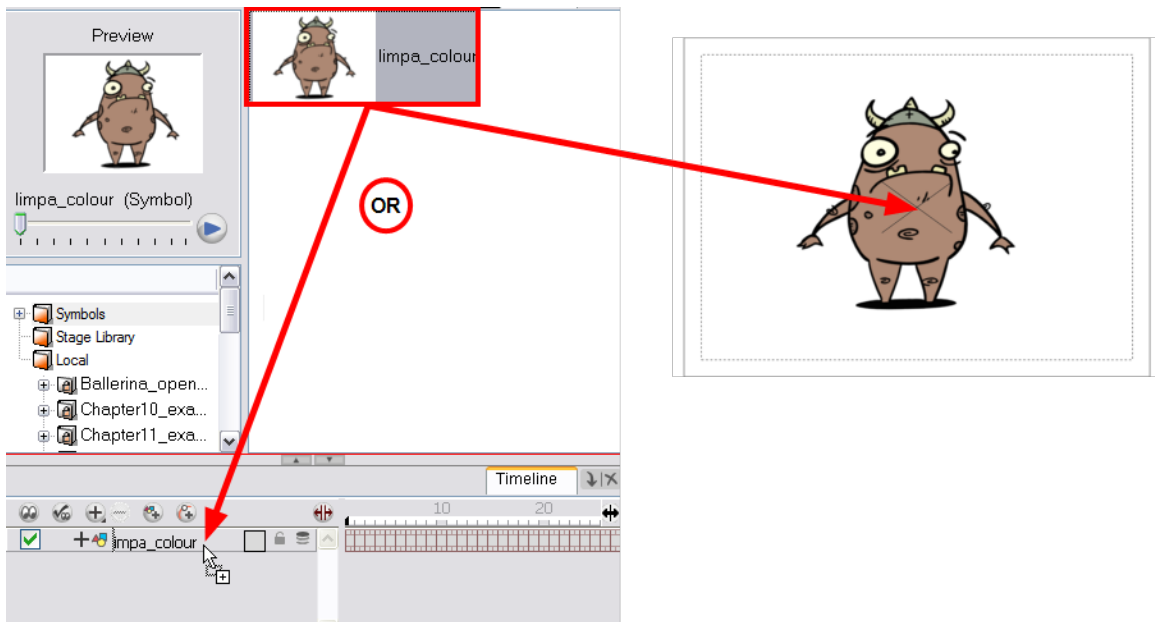

2. In the Timeline view, select the symbol's cells or layer and drag it to the Stage Library folder or to any other library folder. Make sure you have the right to modify the library folder.

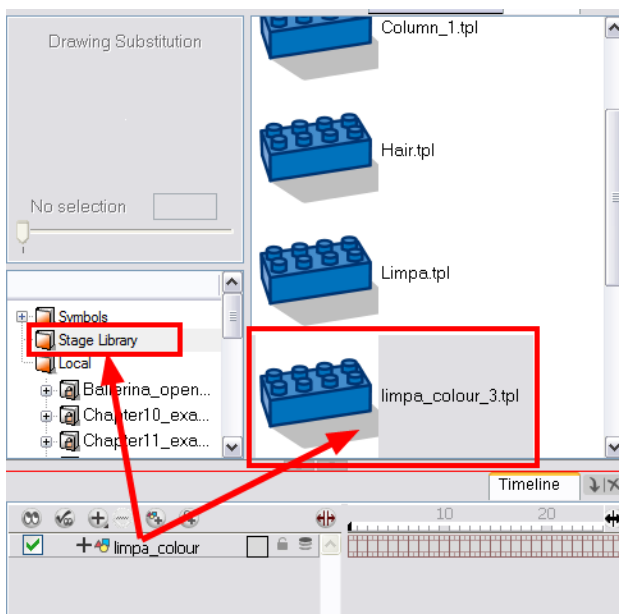

3. In the Rename dialog box, rename the new template.

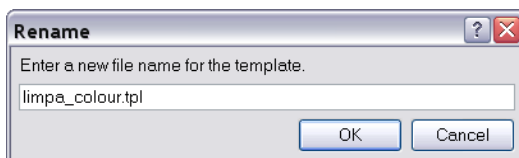

4. Click on the OK button.

## Related Topics

- [Creating a Symbol](#) on page 532

# Templates

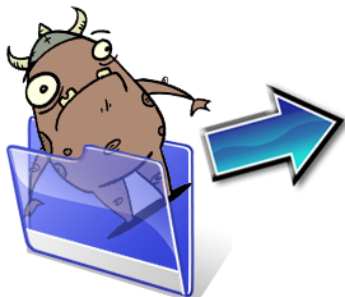

If you want to reuse artwork and animation from your project into other scenes, you need to create a template out of it. A template can be seen as a portable scene or package that you can drag inside your project.

## Related Topics

- [Creating a Template below](#)
- [Deleting a Template on the next page](#)
- [Editing a Template on page 542](#)

## Creating a Template

You can create a template from both the Timeline and the Network views:

- [Creating a Template](#)
- [Creating a Template from the Timeline View below](#)

## Creating a Template from the Timeline View

You can create a template out of a layer or cells. You can store anything available in the Timeline view as a template.



Creating a template selecting a layer will incorporate the layer and all the drawings that were created in it, even if they're not exposed in the Timeline view. Selecting cells will only save those specific drawings in the template.

### To create a template from the Timeline view:

1. In the Timeline view, select some cells or layers.
2. In the Library view, select the folder in which you want to store the template.
3. If the library folder is locked, right-click and select **Right to Modify**.
4. Drag the selection to the Animate Library folder or to any other library folder.



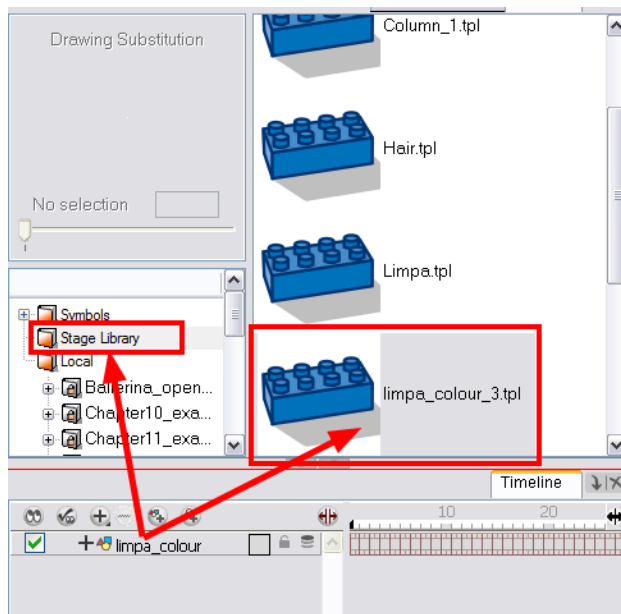

5. In the Rename dialog box, rename the new template.

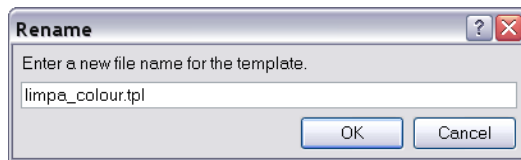

If you want to rename a template once it is created, right-click on it and select Rename.

6. Click OK.

## Related Topics

- [Importing Symbols and Templates on page 543](#)

## Deleting a Template

To delete templates from your library, use the Library view. Animate lets you undo the action if necessary.



Do not delete them using the operating system.

### To delete a template:

1. In the Library view, select the folder containing the template to delete.
  - If the library folder is locked, right-click on the folder and select **Right to Modify**.
2. Right-click on the selection and select **Delete** or press [Delete].

## Related Topics

- [Creating a Template on page 540](#)

# Editing a Template

A template is like a scene, you can open it and edit it as any regular project. If you want to do some modifications in your templates, you can edit them using the Edit Template command.

### To edit a template

1. In the Library view, select the folder containing the template to edit.
  - If the library folder is locked, right-click on the folder and select **Right to Modify**.
2. Right-click on the selection and select **Edit Template**.  
A new Animate application opens.
3. Edit the template.
4. In the top menu, select **File > Save**.
5. In the top menu, select **File > Quit** (Windows) or **Animate > Quit** (Mac OS X).

## Related Topics

- [Creating a Template on page 540](#)

# Importing Symbols and Templates

There are several ways you can import templates and symbols in your scene.

## Related Topics

- [Importing a Template below](#)
- [Importing a Symbol on the facing page](#)
- [Opening a Template as a Folder on page 545](#)
- [Using Paste Special on page 546](#)
- [Expanding a Symbol on page 551](#)
- [Animating Using Symbols](#)

## Importing a Template

To import a template in the Timeline view:

1. In the Library view, select the template you want to import.
2. Drag the selected template to the Camera view or Timeline view's left side.

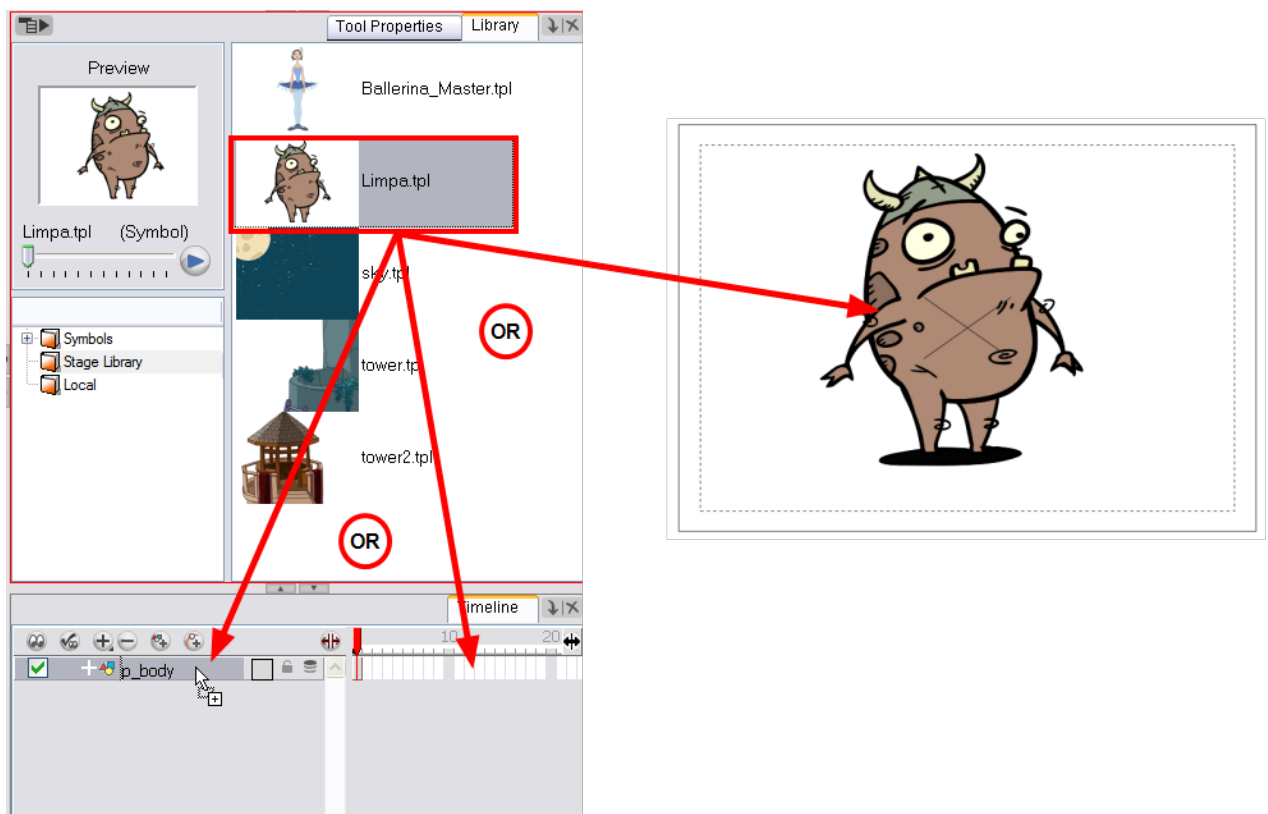

3. You can also drag a template to the Timeline view's right side into existing layers if the layer structure is the same as the existing one.

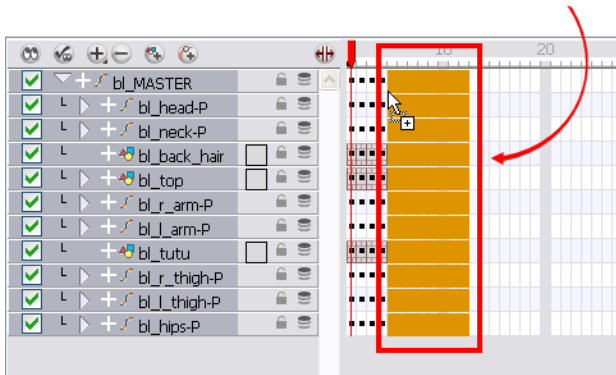

## Related Topics

- [Importing Symbols and Templates on the previous page](#)

## Importing a Symbol

To import a symbol in the Timeline view:

1. In the Library view, select the symbol you want to import.
2. Drag the selected symbol to:
  - The Timeline view's left side if you want to import it into the centre of the camera frame.
 OR
  - The Camera view if you want to place it where ever your mouse releases it.



This may be useful if you have saved a character's body parts as separate symbols. If you dropped them into the timeline then they would all appear in the centre, haphazardly one on top of the other. It would be more efficient to arrange them into their correct places as you bring them into the scene.

## Related Topics

- [Importing Symbols and Templates on the previous page](#)

## Importing a Template with Symbols

Sometimes a character's rig is not a straightforward matter. Rigs, which are usually saved as templates, can contain symbols, such as a leg that was made with a patch. However, a symbol does not work in the same way as an action template. In the Timeline view, you can add an Action template into another template of the same structure. When a symbol is dropped into the right side of the timeline layer into a symbol of the same structure, instead of adding itself onto the previous symbol, the new symbol becomes a copy.

To take more control of how the action template will behave when brought into the Timeline view, bring it in using a Paste Special.

### To import a template with symbols:

1. Select the action template containing symbols from the right side of the Library view.
2. As you drag it from the Library view to the right side of the Timeline view to drop it next to a template with the exact same rig, hold down [Alt] (Windows) or [⌘] (Mac OS X).

The Paste Special window appears.

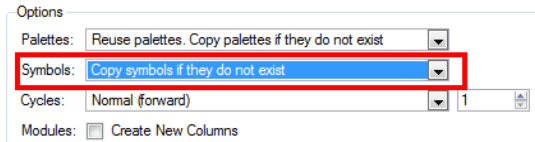

3. Click on the Advanced tab.
4. Select one of the following options from the Symbols drop-down menu:

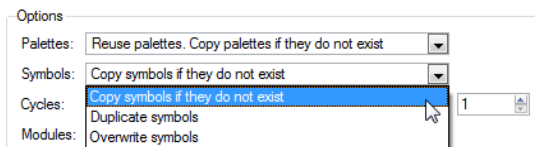

- ▶ **Copy symbols if they do not exist:** This is the default setting for this operation and will prevent symbols in an action template from being copied.
- ▶ **Duplicate symbols:** Select this option if you wish to make copies of the symbols in your template.
- ▶ **Overwrite symbols:** If for some reason, a modification was made to a symbol in the action template that does not exist in the basic rig template for a character, select this option to overwrite the previous symbol.

### Related Topics

- [Using Paste Special on the facing page](#)

## Opening a Template as a Folder

Since a template is like a scene, you can open the template's folder and select elements inside it such as drawings.

Instead of importing the entire contents of a template you may only want to import a few drawings or a palette. In this case, use the Open As Folder command to import the items you want.

If you want to import a palette, drag the palette file into the Palette List section of the Colour view.

### To open a template as a folder:

1. In the Library view, select the folder containing the template to open.
  - ▶ If the library folder is locked, right-click on the folder and select **Right to Modify**.
2. Right-click on the selection and select **Open As Folder**.

3. In the library list section, click on the template's folder to display its content.

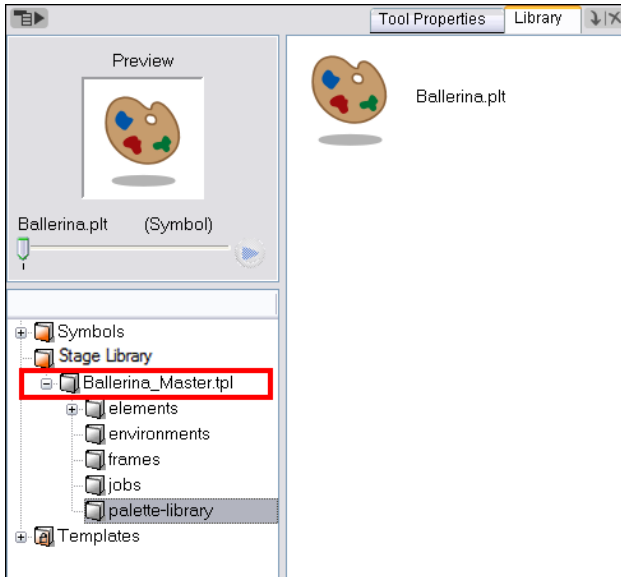

4. Drag the content to the Timeline or Colour view.

## Related Topics

- [Creating a Template on page 540](#)

# Using Paste Special

When you import a symbol in your scene, by default its full length is exposed. If you import your symbol in the Timeline view's left side all the frames will be exposed, but if you import it into an existing layer, you can use the Paste Special command to adjust the import behaviour to fit your requirements.

When you import a template in the Timeline view, all layers are created as well as drawings and keyframes. It is possible that you will want to import only the keyframes without the drawings or import only the drawings that are not already in your layers. You can adjust the behaviour using the Paste Special command.

Once you set the parameters, Animate will reuse them each time you import a symbol in the Timeline view's right side until you set new parameters.

### To open the Paste Special dialog box:

1. In the Library view, select the symbol or template to import.
2. While dragging the selection to the Timeline view, hold down [Alt] (Windows) or [⌘] (Mac OS X).



Drop the selection in the Timeline view BEFORE releasing the hot key.

The Paste Special window opens.

3. Set the parameters.
4. Click **OK**.

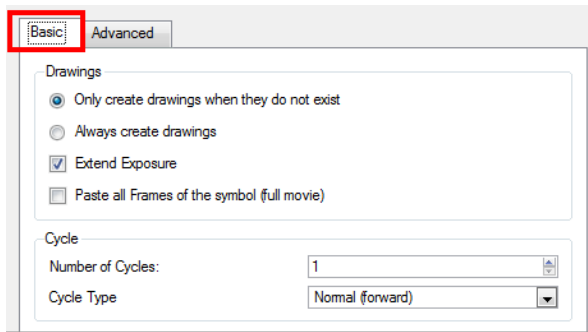

Basic Tab

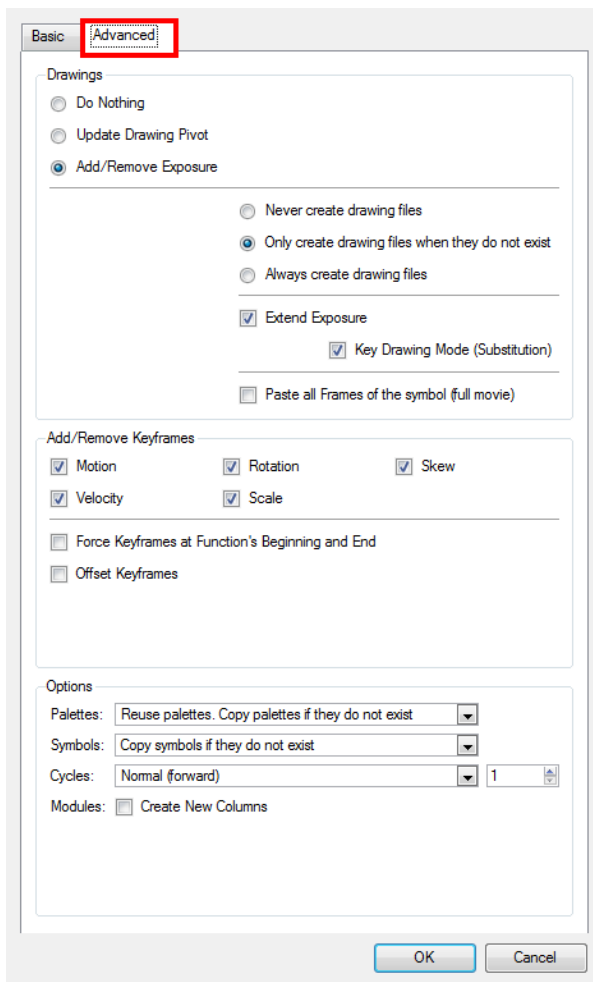

Advanced Tab

## Paste Special - Basic Tab

### Drawings

- **Only create drawing files when they do not exist:** When adding exposures to a drawing layer, new drawings will be created only when drawings with the same name do not already exist in the destination.

- **Always create drawing files:** When adding exposures to a drawing layer, new drawings will always be created. If drawing files with the same name already exist, Animate will create a new name for the drawing.
- **Extend Exposure:** Extends the exposure of drawings to fill the range of cells to the destination frame.
- **Paste all Frames of the Symbols (full movie):** When enabled, the Paste Special command will expose all the symbol's frames instead of the first one only.

## Cycle

- **Number of Cycles:** Use the up and down arrows to increase or decrease the number of cycles you want to paste. You can also type the value directly in the field.
- **Cycle Type**
  - **Normal (forward):** This pastes your selection as it is, starting with the first cell and ending with the last one.
  - **Reverse:** This pastes your selection in reverse, starting with the last cell and ending with the first one.
  - **Forward -> Reverse:** This pastes your selection as a yo-yo, starting with the first cell, going to the last one and ending with the first cell.
  - **Reverse -> Forward:** This pastes your selection as a reverse yo-yo, starting with the last cell, going to the first one and ending with the last cell.

## Paste Special - Advanced Tab

### Drawings

- **Do Nothing:** Does not create or overwrite drawings.
- **Update Drawing Pivot:** Revises the drawing pivot in the destination to use the same drawing pivot as the first drawing in the template. If you have a range of drawings selected in the destination, the pivot points of all selected drawings will be updated.
- **Add/Remove Exposure:** Creates/deletes exposure values in the selected layer.



You have the following choices as to how to treat drawings that will be created when adding an exposure:

- **Never create drawing files:** When adding exposures to a drawing layer, drawing files will not be created.
- **Only create drawing files when they do not exist:** When adding exposures to a drawing layer, new drawings will be created only when drawings with the same name do not already exist in the destination.
- **Always create drawing files:** When adding exposures to a drawing layer, new drawings will always be created. If drawing files with the same name already exist, Animate will create a new name for the drawing.
- **Extend Exposure:** Extends the exposure of drawings to fill the range of cells to the destination frame.
- **Key Drawing Mode (Substitution):** Pasting an exposure value replaces the cell value in the current frame and in all frames following in sequence with the original cell value.
- **Paste all Frames of the Symbols (full movie):** When enabled, the Paste Special command exposes all the symbol's frames instead of only the first one.

## Add/Remove Keyframes

- **Motion:** Copies the properties of the selected motion keyframe to the new frame.
- **Velocity:** Copies the properties of the selected velocity keyframe to the new frame.
- **Rotation:** Copies the properties of the selected rotation keyframe to the new frame.
- **Skew:** Copies the properties of the selected skew keyframe to the new frame.
- **Scale:** Copies the properties of the selected scale keyframe to the new frame.
- **Force Keyframes at Function's Beginning and End:** Adds a keyframe to the beginning and end of the pasted function, reproducing the source function.
- **Offset Keyframes:** When pasting functions, this option offsets the keyframes from the function's last value by the values in the pasted function. This will continue the progression of a function rather than repeat the values.

## Option

- **Palette Option**

- **Do nothing:** Does not create, overwrite, merge or link palettes.
- **Reuse palettes. Copy palettes if they do not exist:** Palettes in the destination drawings are left as they are.
- **Copy and overwrite existing palettes:** Overwrites destination palettes with the palettes from the source drawings.
- **Copy and create new palette files:** Creates new palette files, placing them at the same relative environment and scene level as the source. If the palettes in the templates were stored at the environment level of the source scene, the paste operation will place the palettes in the environment level of the destination scene.
- **Copy and create new palette files in element folder:** Creates new palette files in the element folders of the destination scene, rather than in the same relative job or environment.
- **Copy palette and merge colours. Add new colours only:** Adds new colours to the destination palettes and ignores colours that are the same in the two palettes.
- **Copy palette and update existing colours only:** Adds new colours to the destination palette and updates duplicate colours in the destination with colour values from the source.
- **Link to original palettes (colour model):** Links the colour palettes in the destination scene to the palettes in the source. Use this to link drawings to the palettes in a colour model.
- **Copy scene palettes and merge colours. Add new colours only:** Adds new colours to the destination scene palettes and ignores colours that are the same in the two palettes.
- **Copy scene palettes and update existing colours:** Adds new colours to the destination scene palette and updates duplicate colours in the destination with the colour values from the source.
- **Duplicate All Symbol Content:** Instead of linking the symbol instance to the original one, the symbol will be duplicated. A new symbol is created in the Library.
- **Symbols**
  - **Copy symbols if they do not exist:** This is the default setting for this operation and will prevent symbols in a Action template from being copied.
  - **Duplicate symbols:** Creates a duplicate of the symbol instead of linking the symbol instance to the original one. The new symbol is created in the Library.
  - **Overwrite symbols:** If a modification was made to a symbol that does not exist in the basic rig template for a character, select this option to overwrite the previous symbol.
- **Cycles:**
  - Cycle Types:
    - **Normal (forward):** This pastes your selection as it is, starting with the first cell and ending with the last one.
    - **Reverse:** This pastes your selection reversed, starting with the last cell and ending with the first one.
    - **Forward -> Reverse:** This pastes your selection as a yo-yo, starting with the first cell, going to the last one and ending with the first cell.
    - **Reverse -> Forward:** This pastes your selection as a reverse yo-yo, starting with the last cell, going to the first one and ending with the last cell.
  - **Number of Cycles:** Use the up and down arrows to increase or decrease the number of cycles you want to paste. You can also type the value directly in the field.
- **Modules: Create New Columns:** If you enable this option a new column will be created when you copy and paste modules from the Network view or Layer in the Timeline view. If the layers are linked to function curves, the function curves, the drawings and the timing will be duplicated.

## Related Topics

- [Importing Symbols and Templates on page 543](#)

# Expanding a Symbol

You can use the Expand Symbol command to extract a symbol's content and place it on the root timeline. The symbol will not be removed from the Timeline view. Its content will be copied and inserted into the root timeline. The symbol's layers will be parented to it in case you created motions and transformation on the drawing layer that is containing the symbol. Breaking the hierarchy could result in losing any scaling and animation you may have done.

You can also expand a symbol within a group to avoid crowding your Timeline with a series of layers. When you will expand the symbols, the layers will be contained in a Group module which you can expand to see the content.

### To expand a symbol:

1. In the Timeline view, select the symbol to expand.



2. In the top menu, select **Edit > Expand Symbol** or press [Shift] + [F8].

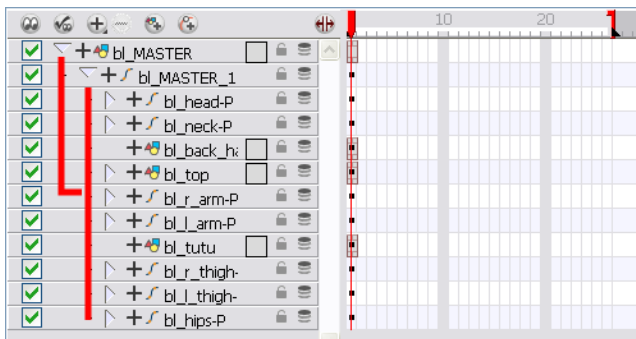

### To expand a symbol in a group:

1. In the Timeline or Network view, select the symbol module or symbol cell you want to expand.

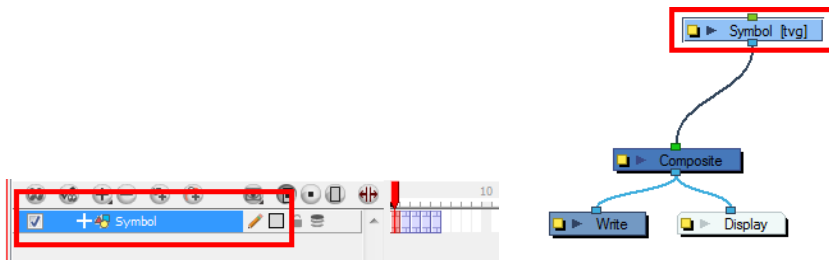

2. In the top menu, select **Edit > Expand Selected Symbol in a Group**.

3. In the Timeline view, click on the Plus sign to see the Group content. In the Network view, click on the **Expand Arrow** to enter the group.

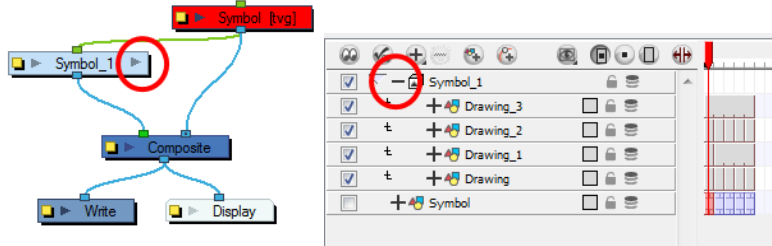

# Chapter 12: Character Building



Toon Boom Animate is a great tool for building your characters. You can make use of different techniques and features to break down your puppets.

## Topics Covered

- [Setting the Default Separate Position Preference on the facing page](#)
- [Breaking Down the Character on page 556](#)
- [Ordering the Layers on page 563](#)
- [Rigging on page 566](#)
- [Adding Extra Drawings on page 579](#)
- [Setting the Pivots on page 581](#)
- [Storing the Character in the Library on page 586](#)
- [Appendix on page 588](#)

# Setting the Default Separate Position Preference

Before you start adding layers to your puppets, you should enable the Default Separate Positions preference if it is not already done.

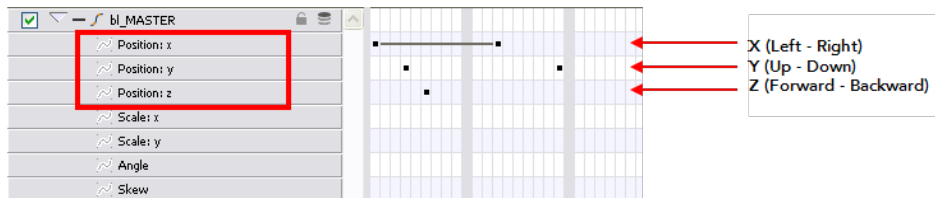

If you enable the Default Separate Positions preference, when you create new layers, their X, Y and Z axes will be independent one from the other.

By default, this preference is disabled, so when you animate your layers, the three directions are locked together to form long and smooth trajectories controlled by a single easing parameter. However, when you do cut-out animation, you will probably prefer to have three independent axes so that you can control them individually.

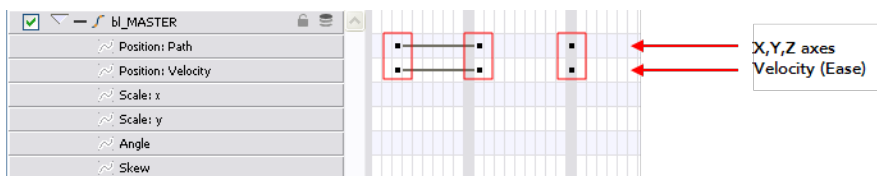

When you lock the three positions together, each time you add a keyframe, it is added on all three positions at once.

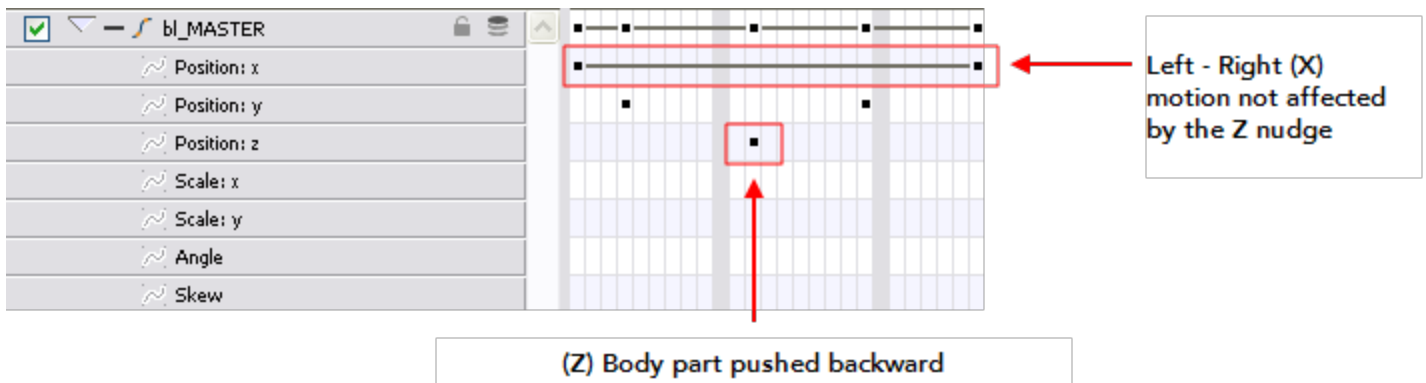

When you separate the three positions, when you add a keyframe on one axis, it is not added on the other two. This gives you more freedom when animating with motion keyframes and nudging parts forward and backward over time.

**To enable the Default Separate Positions preference:**

1. In the top menu, select **Edit > Preferences** (Windows) or **Animate > Preferences** (Mac OS X). The keyboard shortcut is [Ctrl] + [U] (Windows) or [⌘] + [U] (Mac OS X).
2. In the Preferences panel, go to the **General** tab.
3. In the Settings section, enable the **Default Separate Positions** option.

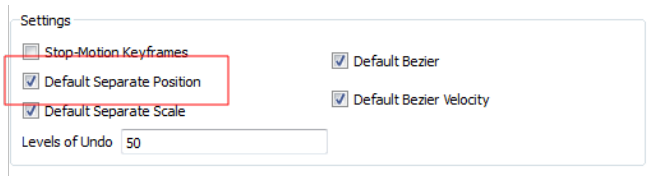

4. Click on the OK button.

## Related Topics

- [Breaking Down the Character](#) on the facing page

# Breaking Down the Character



There are many techniques you can use to break down a puppet. In this section, you will learn about one of the most common and simplest method. For your first character break down, follow these instructions to get an idea of the way Animate works. Once you are used to the software and understand its basic functions and commands, you will be able to create your own techniques to satisfy the needs of your production.



Refer to [Appendix on page 588](#) at the end of the chapter for alternate technique tips.

## Related Topics

- [Tracing the Model](#) below
- [Articulations](#) on page 560

## Tracing the Model

The main break down technique shown here is to trace your model, completing the hidden lines and filling the gaps. See the [Appendix on page 588](#) to learn about more techniques.

### To trace over your model:

1. In the Timeline view, add a new drawing layer for each body part to separate. You can press [Ctrl] + [R] (Windows) or [⌘] + [R] (Mac OS X).

<input checked="" type="checkbox"/>	hero_Neck
<input checked="" type="checkbox"/>	hero_Headband
<input checked="" type="checkbox"/>	hero_TopHair
<input checked="" type="checkbox"/>	hero_Ear_F
<input checked="" type="checkbox"/>	hero_Eyebrow_B
<input checked="" type="checkbox"/>	hero_Sideburn_F
<input checked="" type="checkbox"/>	hero_Eyebrow_F
<input checked="" type="checkbox"/>	hero_Mouth

2. In the Timeline view, select the layer's first cell in which you want to draw the part.



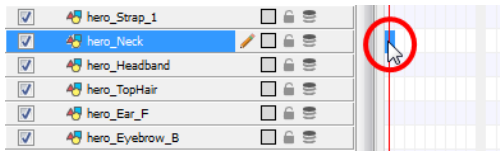

3. In the Tools toolbar, select the drawing tool needed.

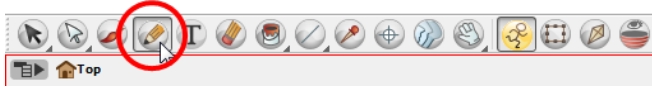

4. In the Colour view, select the desired colour swatch.

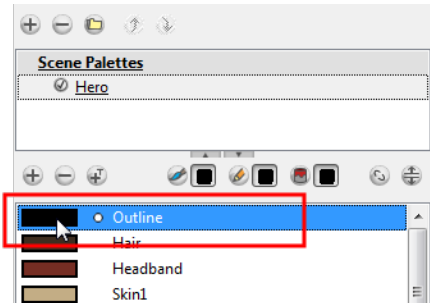

5. In the Camera or Drawing view, draw the new part.



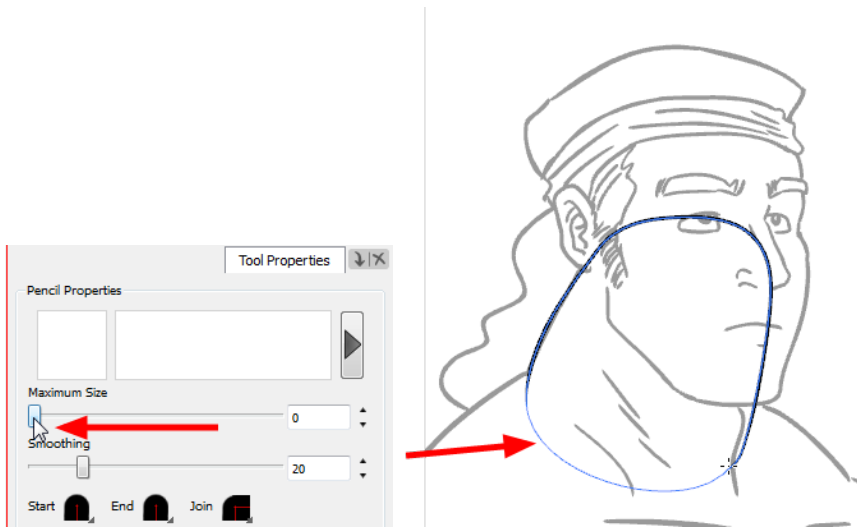

If you are working in the Drawing view, click on the Light Table button located in the Drawing View toolbar to display the other layers as washed out colours. You can also press [Shift] + [L].

6. In the Tool Properties view, you can set the Pencil tool width to 0 to create invisible hairline if you want to close a shape without drawing an actual stroke.

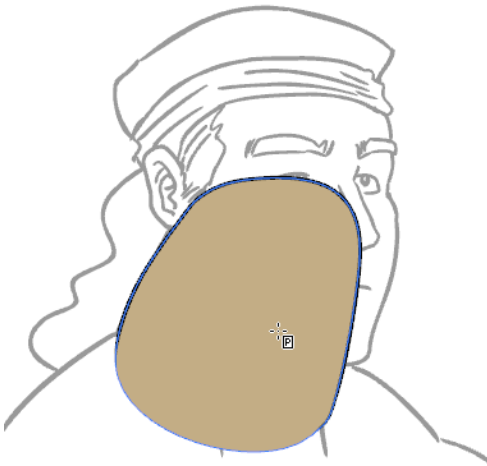

7. In the Tools toolbar, select the Paint or Paint Unpainted tool to colour your drawing.
8. In the Colour view, select the corresponding colour.
9. In the Camera or Drawing view, paint your drawing.



10. Using the Select tool, select your drawing and flatten your lines by clicking on the **Flatten**  button located in the Tool Properties view.
11. If your lines are composed of several pencil strokes, you might want to combine them into one single smooth pencil line using the Merge Pencil Lines option. Using the Select tool, select the pencil lines to be merged and in the Tool Properties view, click on the **Merge Pencil Lines**  button.

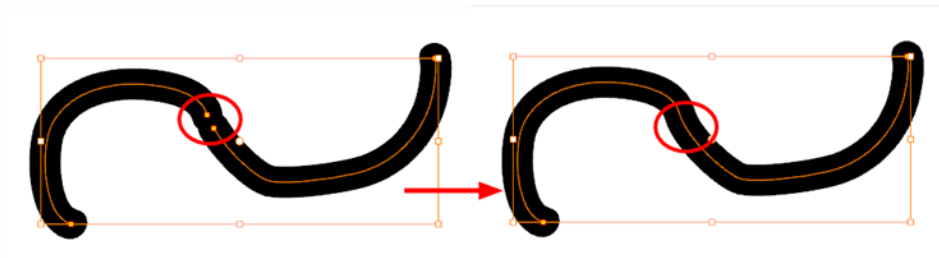

12.Repeat the entire process until the breakdown is completed.

<input checked="" type="checkbox"/>	hero_Body_1
<input checked="" type="checkbox"/>	hero_BodyDetails_F
<input checked="" type="checkbox"/>	hero_BodyDetails_B
<input checked="" type="checkbox"/>	hero_Body_Lines
<input checked="" type="checkbox"/>	hero_SideBuckleTop
<input checked="" type="checkbox"/>	hero_SideBuckleBottom
<input checked="" type="checkbox"/>	hero_Vest_1
<input checked="" type="checkbox"/>	hero_Strap
<input checked="" type="checkbox"/>	hero_UpperArm_F
<input checked="" type="checkbox"/>	hero_Tattoo
<input checked="" type="checkbox"/>	hero_Bracer_F
<input checked="" type="checkbox"/>	hero_Arm_F_1
<input checked="" type="checkbox"/>	hero_Trap_F
<input checked="" type="checkbox"/>	hero_Arm_F_2
<input checked="" type="checkbox"/>	hero_Hand_F
<input checked="" type="checkbox"/>	hero_Strap_1
<input checked="" type="checkbox"/>	hero_Neck
<input checked="" type="checkbox"/>	hero_Headband
<input checked="" type="checkbox"/>	hero_TopHair
<input checked="" type="checkbox"/>	hero_Ear_F
<input checked="" type="checkbox"/>	hero_Eyebrow_B
<input checked="" type="checkbox"/>	hero_Sideburn_F
<input checked="" type="checkbox"/>	hero_Eyebrow_F
<input checked="" type="checkbox"/>	hero_Mouth
<input checked="" type="checkbox"/>	hero_Eye_F_1
<input checked="" type="checkbox"/>	hero_Eye_F
<input checked="" type="checkbox"/>	hero_Iris_F
<input checked="" type="checkbox"/>	hero_Nose
<input checked="" type="checkbox"/>	hero_Eye_B
<input checked="" type="checkbox"/>	hero_Eye_B_1
<input checked="" type="checkbox"/>	hero_Iris_B
<input checked="" type="checkbox"/>	hero_Head
<input checked="" type="checkbox"/>	hero_Hair_1
<input checked="" type="checkbox"/>	hero_Trap_B
<input checked="" type="checkbox"/>	hero_UpperArm_B
<input checked="" type="checkbox"/>	hero_Bracer_B
<input checked="" type="checkbox"/>	hero_Arm_B_1
<input checked="" type="checkbox"/>	hero_Arm_B_2
<input checked="" type="checkbox"/>	hero_Hand_B
<input checked="" type="checkbox"/>	hero_UpperLeg_F
<input checked="" type="checkbox"/>	hero_Knee_F
<input checked="" type="checkbox"/>	hero_Leg_F_1
<input checked="" type="checkbox"/>	hero_Shoe_F
<input checked="" type="checkbox"/>	hero_Foot_F
<input checked="" type="checkbox"/>	hero_Ankle_F
<input checked="" type="checkbox"/>	hero_Shoe_F_1
<input checked="" type="checkbox"/>	hero_Strap_F
<input checked="" type="checkbox"/>	hero_AnkleBand_F

## Related Topics

- [Drawing Using the Pencil Tool on page 130](#)

# Articulations

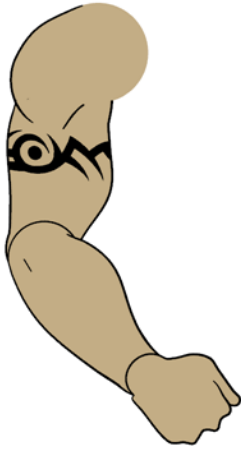

Once your pieces are traced, you can proceed to the completion of the articulations.

Articulations are an important aspect of any cut-out break down, without them a puppet cannot move properly and will not look good.

This topic is divided as follows:

- [Classical Articulation](#) below

## Classical Articulation

In this section, you will learn about classical articulation.

Classical articulation is the most popular technique for basic characters. It is quite simple and produces excellent results, but it is not the most efficient method. In many instances, it causes limitations and extra drawing corrections. For example, there may be a gap in the articulation if the part is bent too far. Joint design is usually designed as a circle; the overlapping part cannot be sent behind without showing the joint.

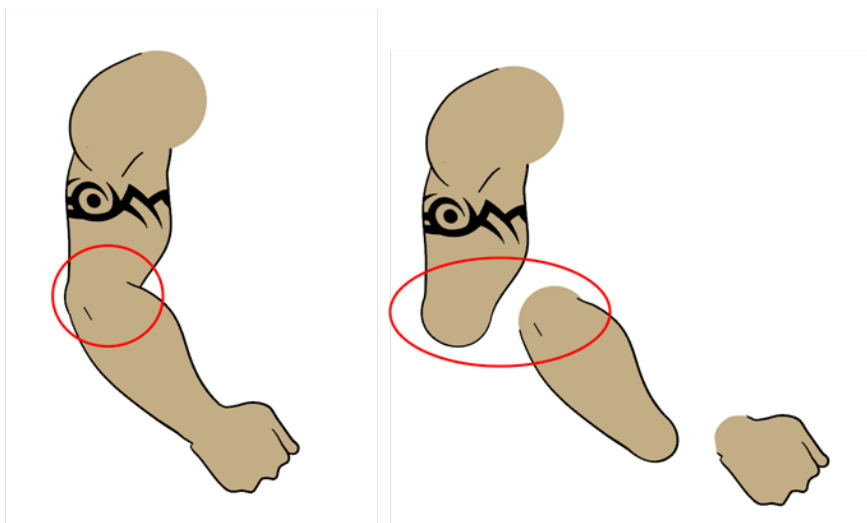

Classical articulation is done by erasing a part of the line from the overlay layer, leaving the colour overlapping the bottom one.

Repeat the following instructions for all the articulations on your puppet.

### To create a classical articulation:

1. In the Timeline view, select the cell containing the first part to modify, such as the upper arm.



2. In the Tools toolbar, select the **Pencil**, **Polyline**, **Ellipse**, or **Contour Editor** tool.
3. In the Colour view, select the outline colour.

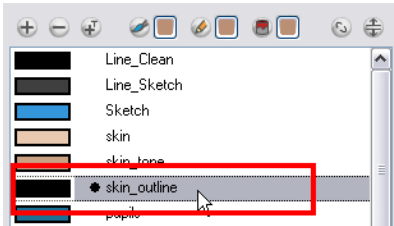

4. In the Drawing or Camera view, use your drawing tool to make sure that the joint is overlapping the other part in a half-circle shape.

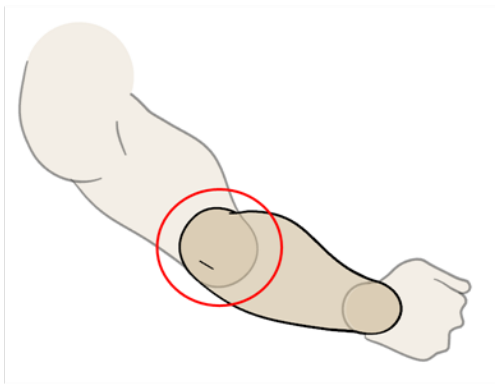

- If you are working in the Drawing view, click on the **Light Table**  button located in the Drawing View toolbar or press [Shift] + [L].
5. In the top menu, select **View > Show > Show Strokes** to display the invisible lines that could be present in your drawing. You can also press [K].
  6. In the Drawing or Camera view, select all the strokes in your drawing.
  7. In the Tools Properties view, click on the **Flatten** button.
  8. In the Drawing or Camera view, select all the strokes in your drawing.
  9. In the top menu, select **Drawing > Optimize > Remove Extra Strokes**. This operation will remove any unnecessary invisible lines in your drawing.
  10. Repeat Step 1 to Step 9 for the other part of the joint.
  11. In the Timeline view, select the cell of the part that will be on top of the joint.

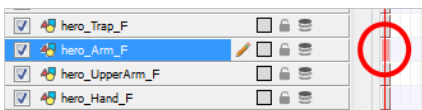

12. In the Tools toolbar, choose the **Select, Cutter** or **Eraser** tool.
13. In the Drawing or Camera view, remove a part of the overlapping outline in order to have only the filling colour overlapping the joint.

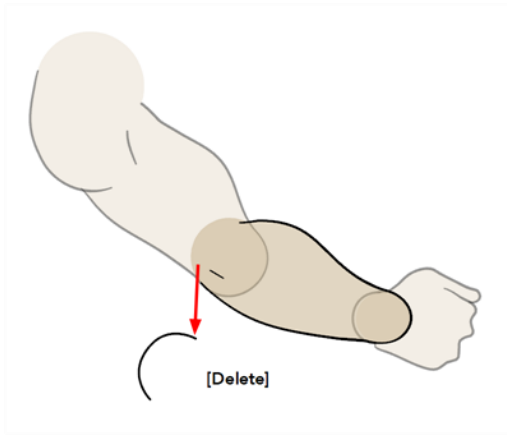

14. In the Tools toolbar, select the Contour Editor tool.
15. In the Drawing or Camera view, adjust the colour fill so that the pencil outline does not overlap it. Be careful not to leave a gap between the line and the fill.

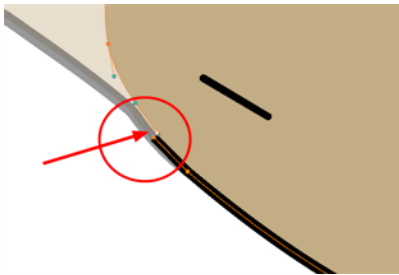

When placing rotation pivots later on, make sure they are positioned at the centre of the articulation.

# Ordering the Layers

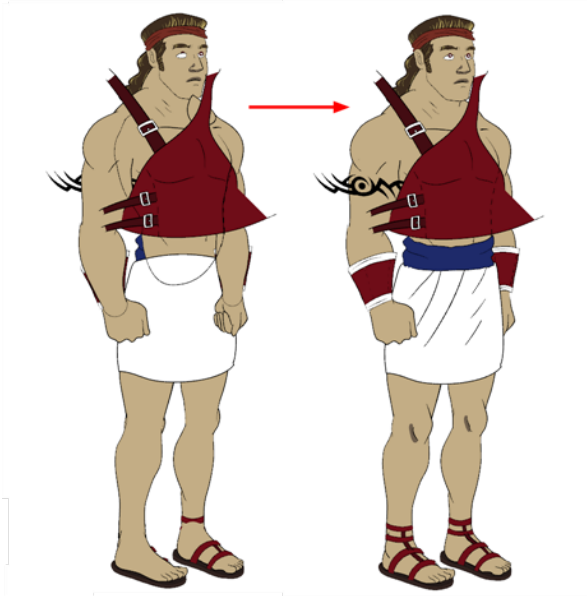

At this point, it is possible that your character's pieces may show up in the wrong order.

There are several ways to fix this. First, you can reorder your layers by dragging them to a higher or lower level in the Timeline view. The top layer is displayed in front of the others and the bottom one is displayed behind. Second, you can use the Z-axis nudging (forward and backward) if you have extra views included in the same layers (front, three-quarter, back, etc.).

This topic is divided as follows:

- [Ordering the Timeline Layers](#) below
- [Nudging Parts Backwards and Forwards](#) on the facing page

## Ordering the Timeline Layers

In the Timeline view, the layer positioned at the top will be displayed in front and the ones below will be displayed behind. If you have multiple views, you should order your layers based on the most common view, which is generally the three-quarter front.

**To order the layers:**

- In the Timeline view, drag a layer to reorder it and drop it between the other layers.

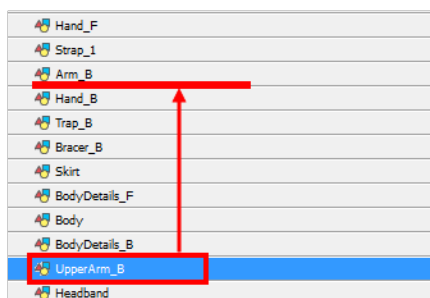



If you drop it on a layer, it will create a parent hierarchy, so make sure to drop it between layers.

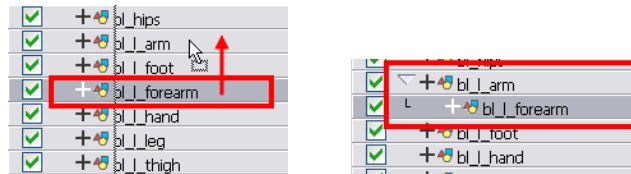

## Nudging Parts Backwards and Forwards

If you created a hierarchy on your arms, legs or other body parts, it is possible that you will want a part, such as the hand, to appear in front of its parent. Yet, if you move the hand layer above the arm layer, you will break the hierarchy. To reorder a layer rigged in a hierarchy, nudge it backwards or forwards on the z-axis.

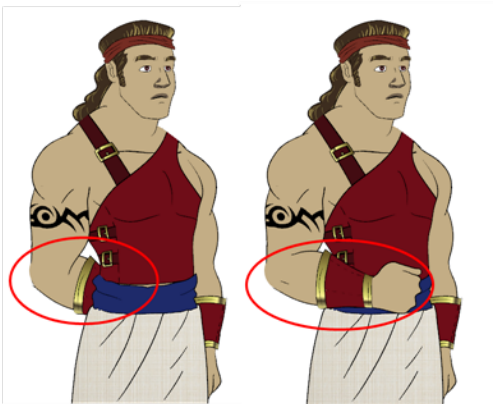

Animate allows you to move your elements in three dimensions:

- Up and Down (Y-axis)
- Left and Right (X-axis)
- Backwards and Forwards (Z-axis)

In the same way you create multiplane backgrounds (depth), you can do a micro nudge of the part to be reordered and see it in front of the other elements, even if its layer is actually behind the other ones in the Timeline view. The Forward-Backward position can also be animated over time.

Repeat the following instructions for all the views.

**To nudge your parts backward and forward:**

1. In the Tools toolbar, select the **Transform**  tool. Make sure to enable the **Animate**  mode.



2. In the Camera view, select the element that you want to reorder. Make sure that the focus (red outline) is around the Camera view before selecting the element.
3. To move the element forward, press [Alt] + [Down Arrow] and to move the element backward, press [Alt] + [Up Arrow].

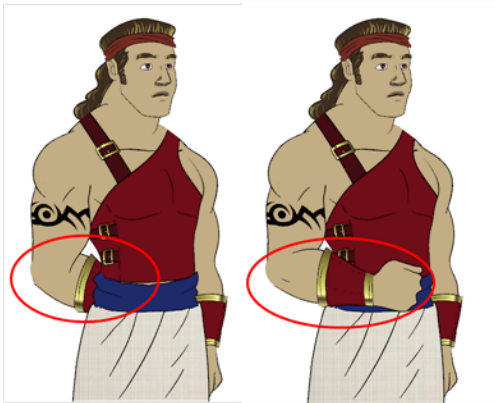

## Related Topics

- [Adding the Master Peg on page 575](#)
- [Creating a Hierarchy on page 572](#)

# Rigging



The rigging process is where building a puppet can take several different directions.

## Related Topics

- [About Rigging below](#)
- [Rigging the Head on page 570](#)
- [Rigging the Body on page 571](#)
- [Creating a Hierarchy on page 572](#)
- [Ordering the Layers on page 563](#)
- [Adding the Master Peg on page 575](#)
- [Creating the Keyframes on page 576](#)
- [Masking on page 577](#)

## About Rigging

There are few basic concepts to know about rigging and layer parenting:

- [Simple Rigging on the next page](#)
- [Parenting Layers on page 568](#)

- [Rigging Using Pegs on page 569](#)

## Simple Rigging

Simple rigging is very fast and easy to do. It is built as follows:

- All the body parts are independent
- All the timeline's layers are attached to a master peg layer (trajectory layer)

The advantage of using this technique is that you are free to move any part around without being influenced by any parent layer.

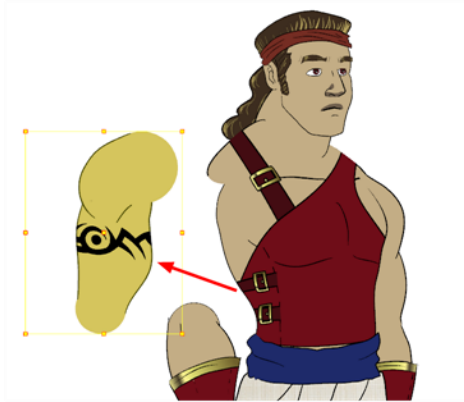

However, since the parts are not parented to each other, the parts will move from point A to point B along a straight trajectory. The hand will not follow the arm's rotation. You will have to set more keyframes for the hand to move along a curved path.

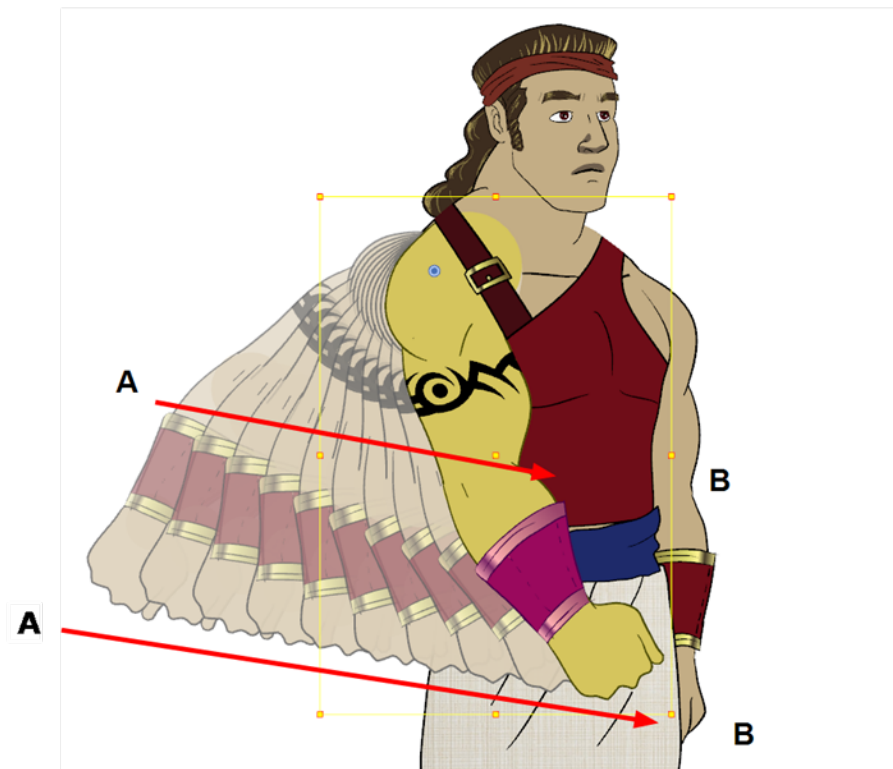

## Parenting Layers

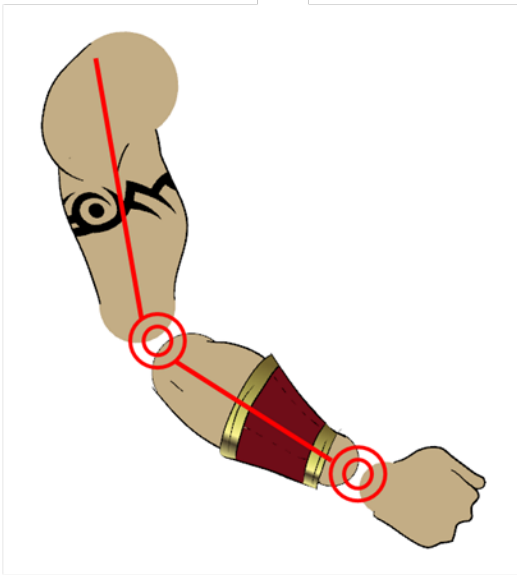

When you want a part to follow another one, such as the forearm following the arm, you can attach the layers one to the other. For example, you can attach the forearm layer to the arm layer without having to encapsulate the forearm into the arm layer. They will still be parented, but you will be able to access the forearm directly without having to enter the arm layer.

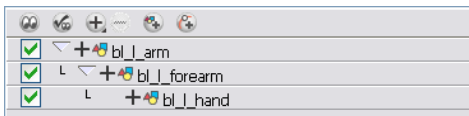

The advantage of parenting layers is that the child layers will follow the parent smoothly without having to select them or create a series of keyframes.

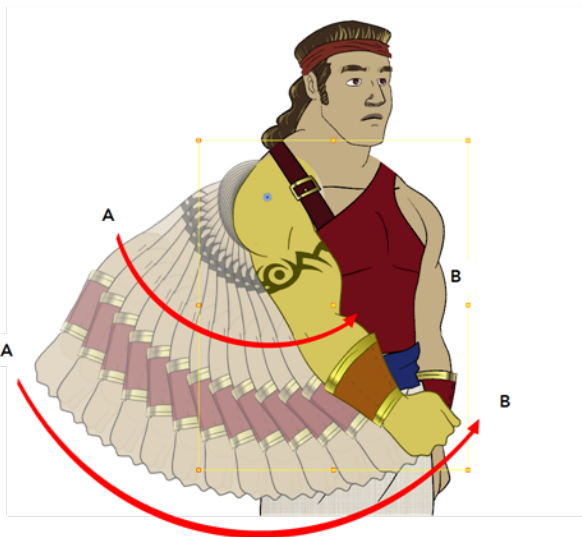

The disadvantage of parenting layers is that you are not able to move the parent independently of its children, since the child layers receive all the transformation information from their parent.

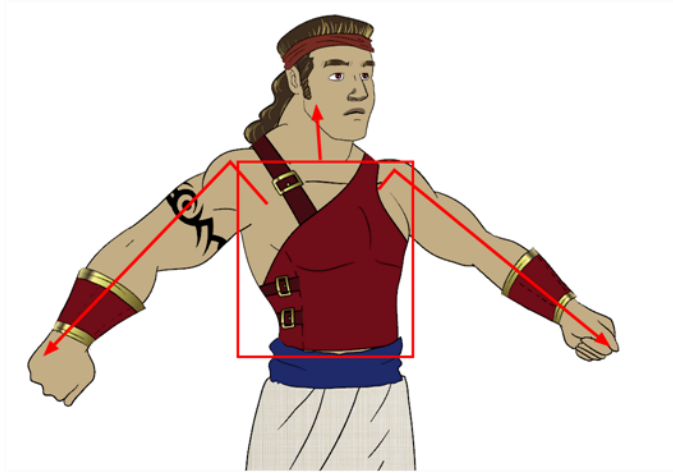

Parenting layers such as the arms and legs and letting the torso and hips independent from those is often a good solution.



To attach one layer to another, you have to drag the desired layer onto the other one in the Timeline view.

Animate offers powerful techniques to create hierarchies between your layers without having to encapsulate layers into each other. These techniques are a great improvement over the less efficient and time consuming method of creating parenting between your layers by inserting symbols into other symbols. Therefore, rigging with symbols inside symbols is **NOT** recommended.

This method is not recommended. For efficiency in your production, do not encapsulate symbols inside symbols.

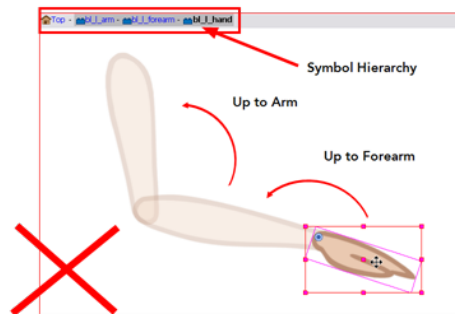

## Rigging Using Pegs

When you are doing more advanced puppet rigging, you can use peg layers. Peg layers are trajectory layers that do not contain drawings. They are motion paths that you can use to control your entire puppet or advanced hierarchies.

Parenting a drawing layer to a peg layer allows you to divide your motions on two separated levels. You can scale your body part directly on the drawing layer. This way, you do not affect any child layers that could be attached to that part. Then, you can perform your translation and rotation on the peg layer so that all the parts attached to that peg layer will follow the same trajectory.

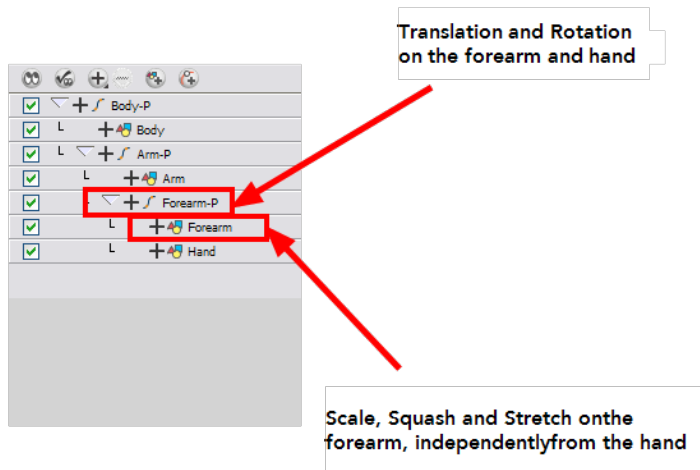

## Related Topics

- [Rigging the Head below](#)
- [Rigging the Body on the next page](#)
- [Creating a Hierarchy on page 572](#)

## Rigging the Head

You will start by attaching the facial features to the head.

The advantage of parenting the head and the facial features to the same peg is that you can easily animate each facial feature, and they will all follow the head motion.

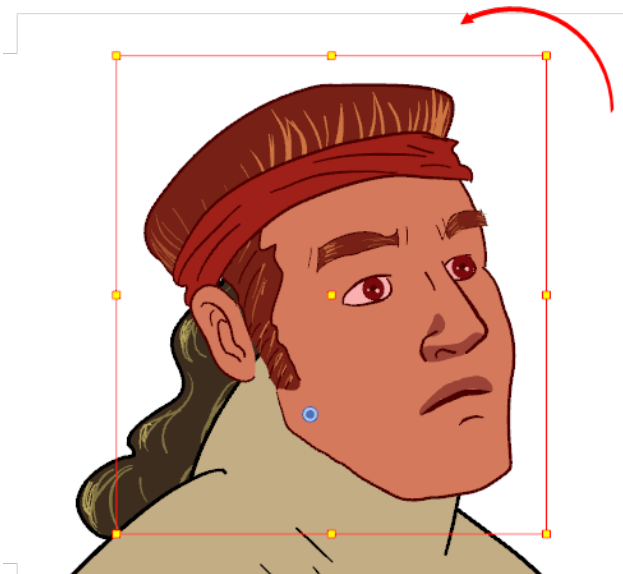

**To parent the facial features to the head:**

1. In the Timeline view, deselect any layer that could be selected.
2. Select the head layer.

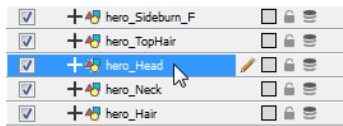

3. In the Timeline View Layer toolbar, click on the **Add Parent Peg**  button to add a new peg layer to your timeline. You can rename the peg to keep your work organized.

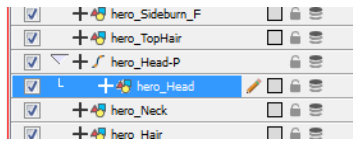

A new peg is added and parented to the head layer.

4. Select all the remaining head and facial features layer and drag them **ONTO** the peg layer or **BETWEEN** the head layer and the new head peg to parent them.

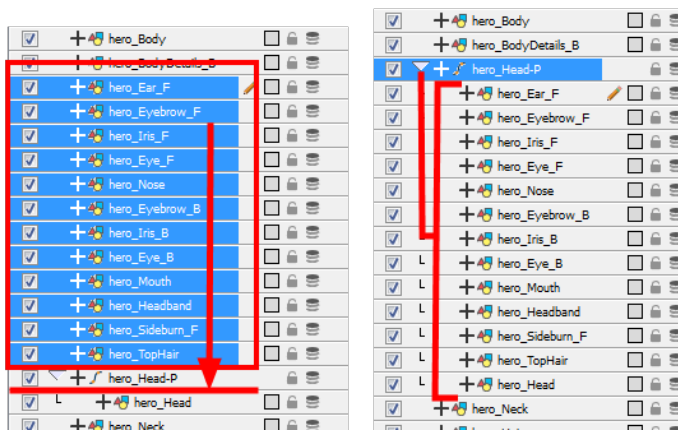

## Related Topics

- [Rigging the Body below](#)

## Rigging the Body

Now that the character's head is ready, you can move on to the body. You can do a simple rigging where all of the body parts are independent one from the other, or create some parenting between some of the layers. Refer to [Creating a Hierarchy on the facing page](#) to learn how to parent your layers.

Simple rigging consists of leaving the layers in the Timeline view without doing any kind of parenting. Later on, you will attach those layers to a master peg and organize them in the correct order.

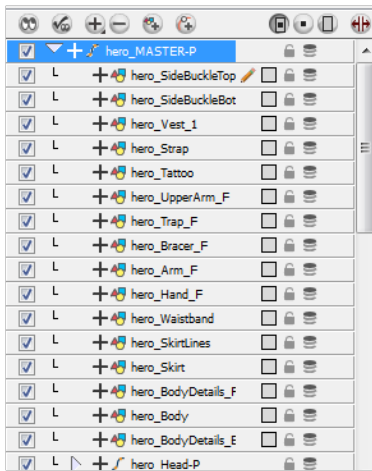

## Related Topics

- [Rigging the Head on page 570](#)
- [Creating a Hierarchy below](#)

## Creating a Hierarchy

Animate lets you extend your rigging techniques beyond normal boundaries and sets new standards. You can create hierarchies without encapsulating pieces inside each other by creating a linked structure between your layers.

You should create a hierarchy on your arms and legs and keep the arms and legs separated from the body. This gives you more animation freedom. This way, when you need to scale or skew the torso, it will not affect the entire body.



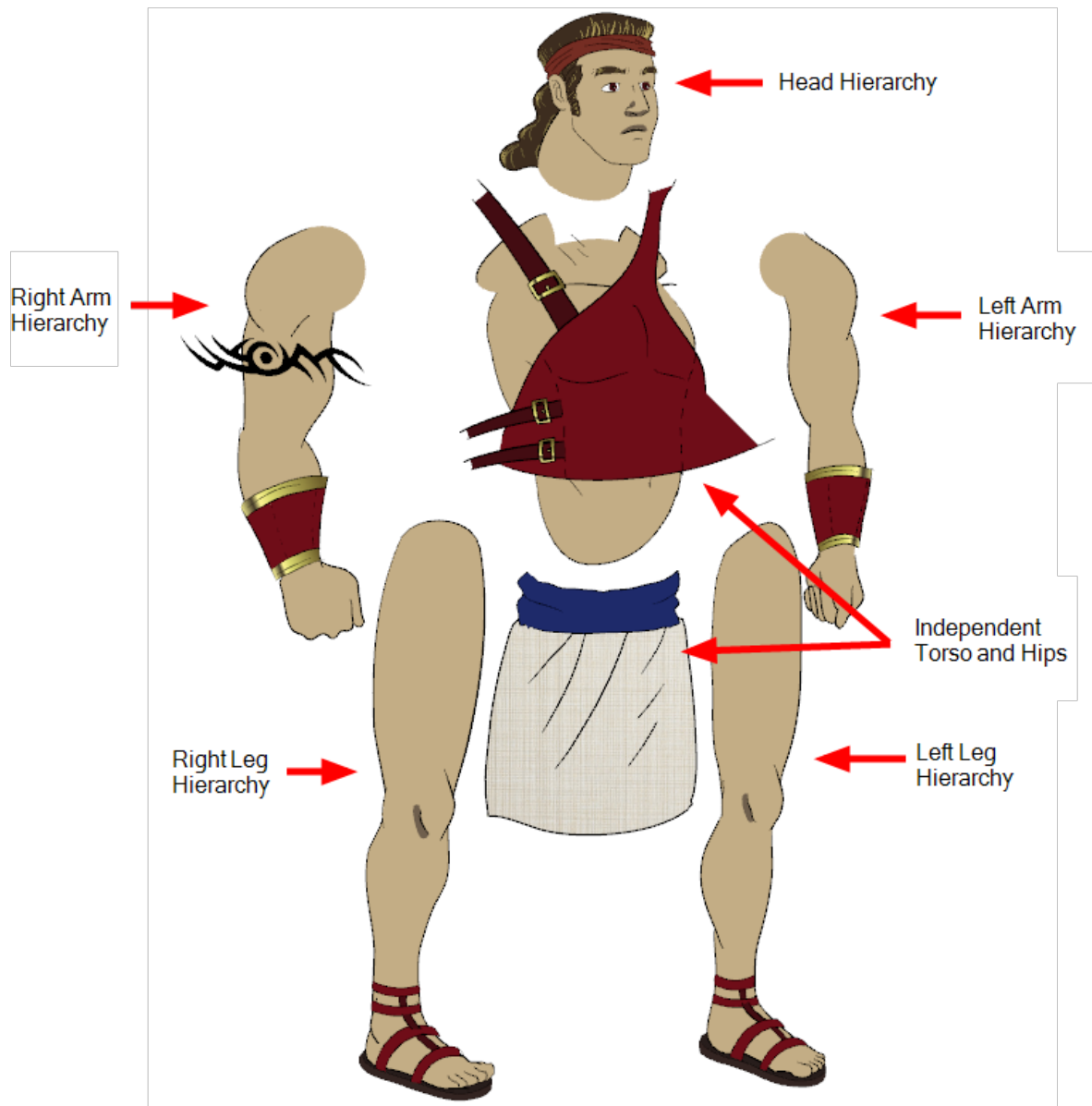

**To create a hierarchy in the Timeline view:**

- ▶ Drag the child piece (hand) and drop it **ON** the parent piece (forearm). Then, you can drag the parent (forearm) piece onto another parent piece (arm).
- ▶ See [Nudging Parts Backwards and Forwards](#) to reorder parts that should be in front of their parents.

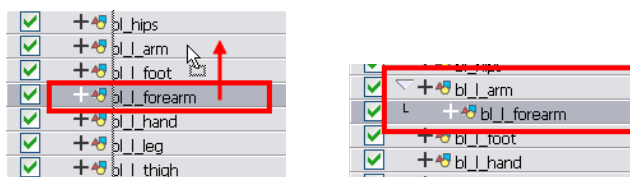

Here is an example of a rig with a simple hierarchy:

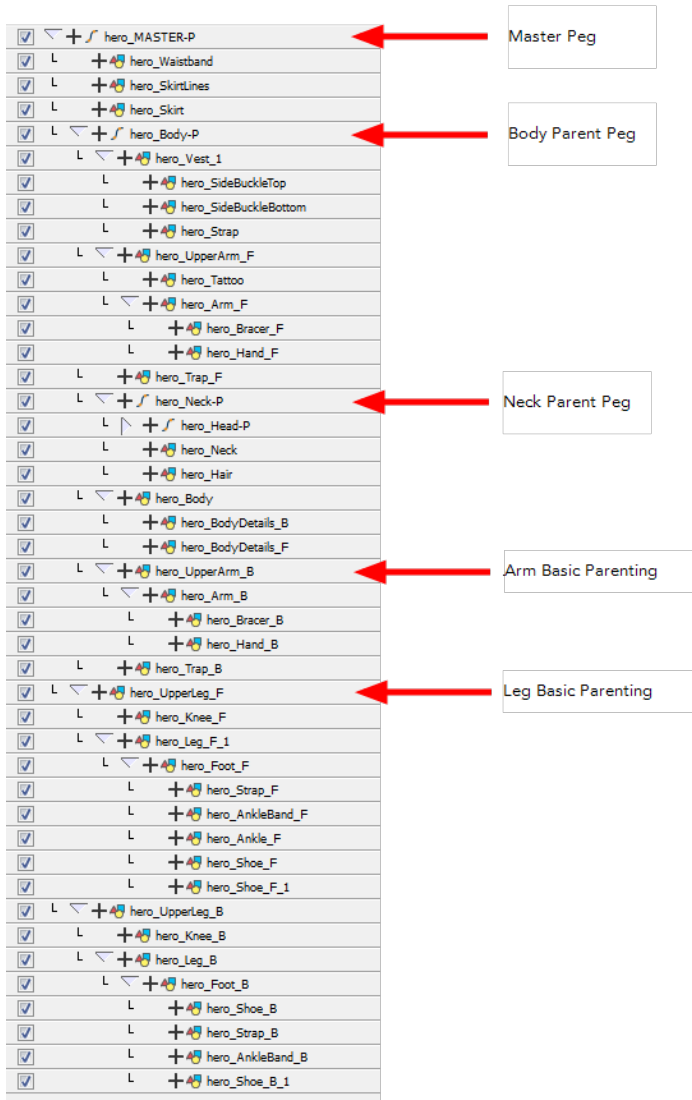

## Related Topics

- [Masking on page 577](#)
- [Adding the Master Peg on the next page](#)

# Adding the Master Peg

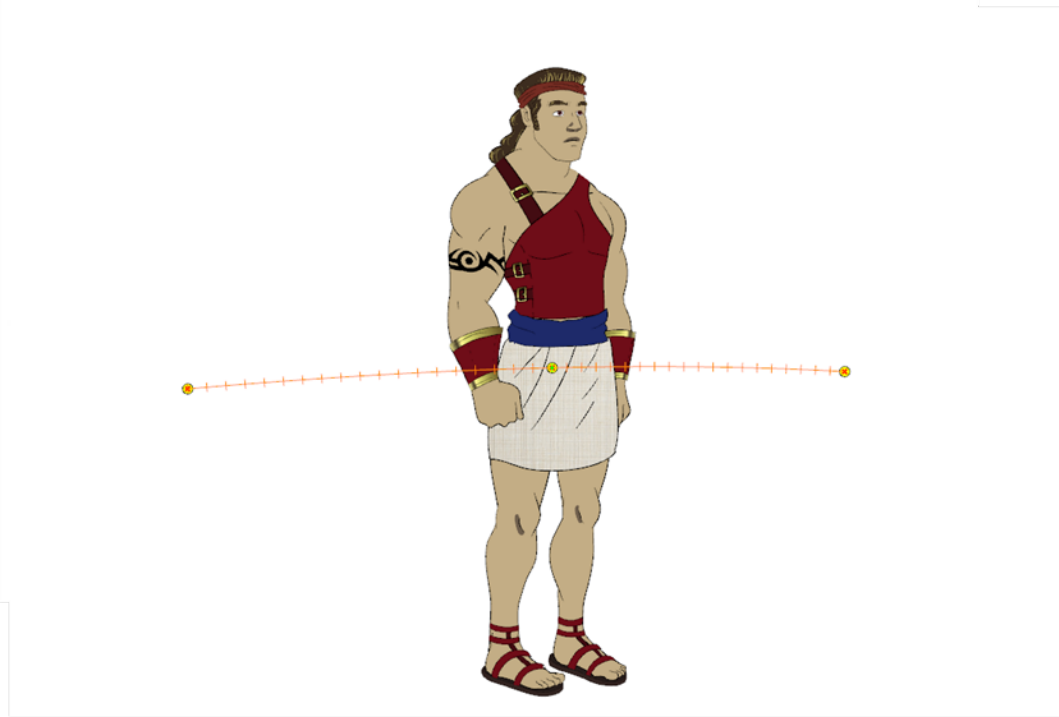

When you animate your character, you will probably need to resize and reposition it to fit your scene. When you need to scale down or move your character, it is a good idea to hook (attach) the whole puppet to a trajectory.

Attaching your puppet to a peg will allow you to scale it and reposition it without having to do this to your different parts and pieces. Only one layer will contain the position information, this makes your animation easier to modify and control.

## To add a Master peg:

1. In the Timeline view, deselect any selected layers and click on the Add Peg  button located in the Timeline Layers toolbar.
2. Name the new peg **Master** plus the character's name.
3. In the Timeline view, select all of the layers you want to attach to your new peg.

4. Drag your selection **ON** the peg layer to parent all your character's pieces to the peg.

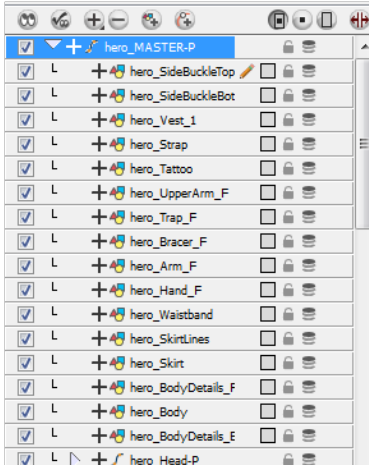

## Related Topics

- [Pegs on page 643](#)

## Creating the Keyframes

Once all of your drawings are ordered and your master peg is added, you need to insert keyframes on each cell to create all of the function curves and block your pose in place.

To create the keyframes:

1. In the Timeline view, collapse the master peg by clicking on the **Expand**  arrow.

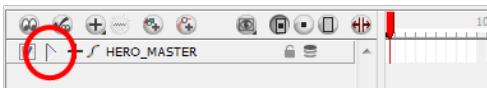

2. In the Timeline view, select the first cell.



3. In the top menu, select **Insert > Keyframe** or press [F6]. You can also click on the **Add Keyframe**  button located in the Timeline View toolbar.



Note: If you use [F6] when working the Flash flavour keyboard shortcuts, this not only creates a keyframe but also duplicates a drawing.

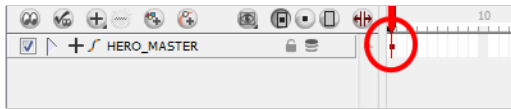

## Related Topics

- [Adding and Deleting Keyframes on page 650](#)

## Masking

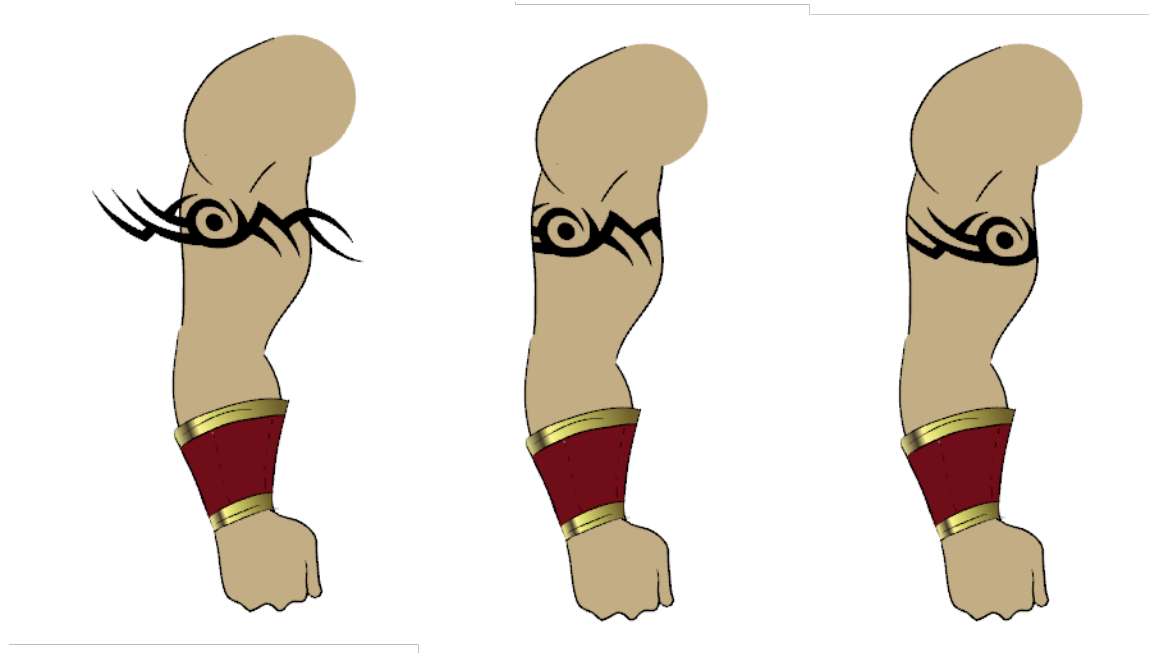

When rigging a character, there will be cases where you will want to be able to move some pieces to give the illusion of a rotation or move the pupil within the white of the eye without having the extra bit of the drawing sticking out of the character or eyeball. To do so, you can use masks to cut anything you do not want to be visible.

### To mask an object:

1. In the Timeline view, make sure the keyframe is added on the object that will be masking the piece to cut.

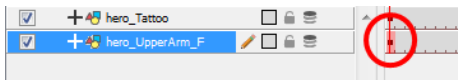

2. Select the layer that will be masking the piece you want to cut.
3. In the Timeline view, right-click on the layer and select **Clone Selected Layers**.

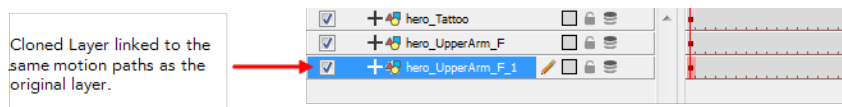

4. In the Timeline Layer toolbar, click on the Add Layer button and from the drop-down menu, click on **Mask**.

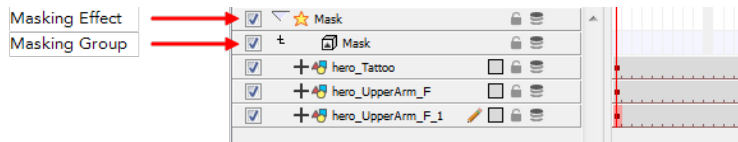

5. Drag the object to be masked **ONTO** the Mask effect layer to connect it to the effect and drag the cloned layer **ONTO** the masking group layer to cut the object.

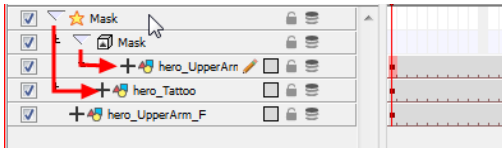

6. Your masking effect is most likely inverted and what you want to cut is probably showing. Double-click on the Mask layer to open the Layer Properties window. In the Layer Properties window, enable the **Inverted** option.

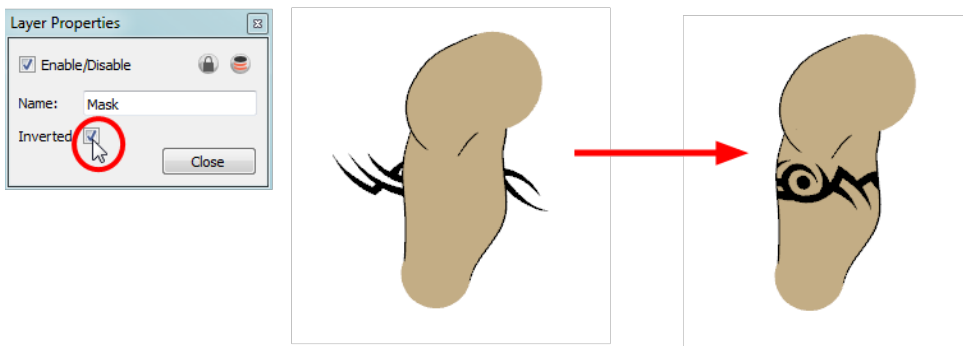

7. Using the Transform tool, you can now move the cut object within the masking zone.

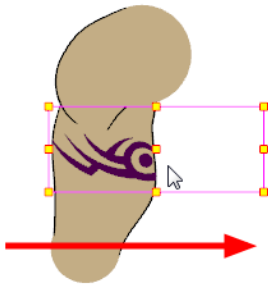

## Related Topics

- [Adding the Master Peg on page 575](#)

# Adding Extra Drawings

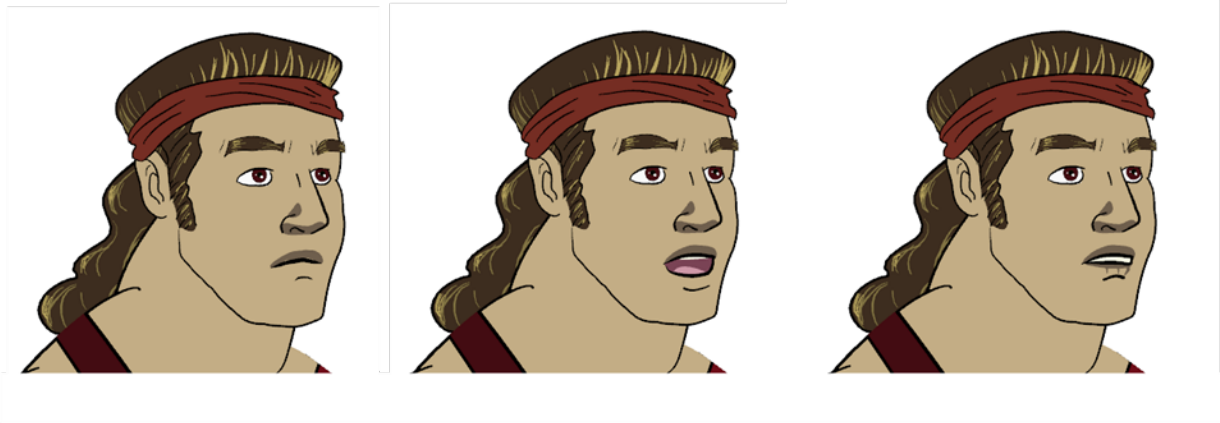

Your break down is now complete. You can move on to adding extra drawings your character needs, such as principal hand positions and mouth shapes. If ever you forget to add extra drawings in your main character's template, you will easily be able to add them later.



Add your extra drawings in the layer corresponding to the part which you are drawing. You should see the layers as containers for the different pieces. Each part of the body has its own container where you can add more drawings of the same part.

## To add extra drawings:

1. In the Timeline view, expand the master peg by clicking on the **Expand**  arrow.

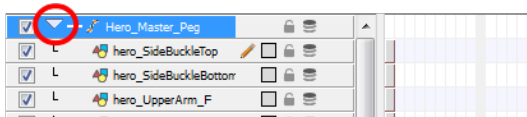



2. In the Timeline view, select the cell where you want to add your new drawing. If you want to duplicate the current drawing and work from it, you can select **Drawing > Duplicate Drawings** or press [Alt] + [Shift] + [D].

This creates a new drawing in the selected cell, automatically extended to the next one. This new drawing is a duplicate of the one that was selected so it contains a duplicate of the art. You can modify it to create your new drawing or delete its contents in the Camera or Drawing view and start from scratch.

3. In the Tools toolbar, select the drawing tool you need to draw your extra part.
4. In the Camera or Drawing view, draw your new drawing.



5. Using the Select  tool, select your drawing and flatten your lines by clicking on the **Flatten**  button located in the Tool Properties view.



# Setting the Pivots

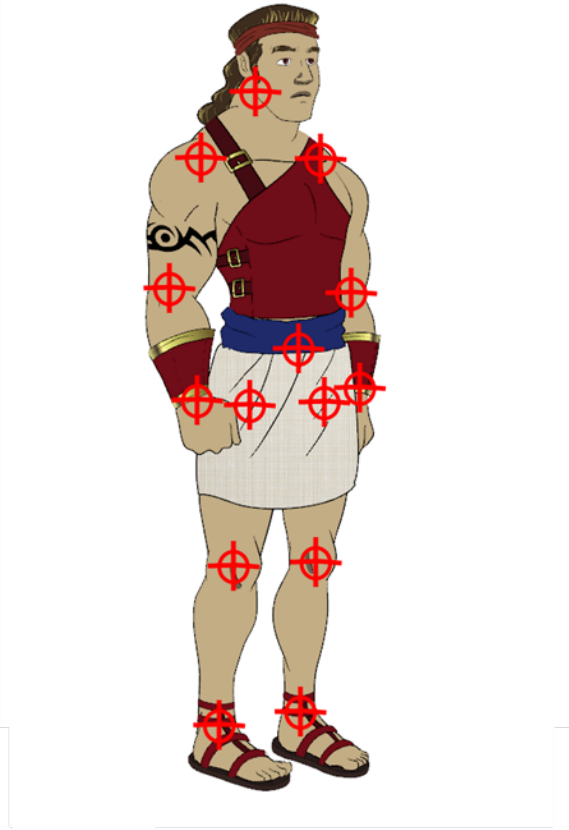

The last step before storing the character in the library is to set the pivots for the different parts.

Animate has three types of pivots:

- **Peg Pivot**  
The Peg pivot is a permanent pivot that is applied to the entire drawing layer. If you modify its position, it will be changed for the whole layer and will therefore modify the animation, scale and rotation interpolation. The Peg pivot is set using either the Rotate, Translate or Scale tool. The Transform tool will only move that pivot temporarily for positioning purpose, but the animation interpolation will be done from the original Peg pivot's position.
- **Drawing Pivot**  
The Drawing pivot is contained within each drawing. In one layer, each drawing can have its own pivot. If you have many different views of a character within one layer, the pivot can be different and the animation will adjust to the pivot. The Drawing pivot can also be referred to as embedded pivot. If you are not mixing different views within the same layers or are using pegs to animate your layers, it is recommended to use the Peg pivot. See [Drawing Pivot Tool on page 231](#).
- **Symbol Pivot**  
The Symbol pivot is similar to the Drawing pivot. Each symbol cell can have its own pivot and act the same as the Drawing pivot. The Symbol pivot can also be referred to as embedded pivot. Inside a symbol, each drawing can have its own pivot. If you are not mixing different views within the same layers or are using pegs to animate your layers, it is recommended to use the Peg pivot. See [Setting Different Pivots for a Puppet Using Symbols on page 601](#).

For a simple character rig, it is recommended to set the Peg pivot (even on drawing layers) using the Rotate tool.



You can set a different pivot for each one of your drawings. For example, if you have a series of drawings from different views, they are not likely to rotate from the same location. In that case, you can set a different pivot for these drawings by using the Drawing Pivot tool.

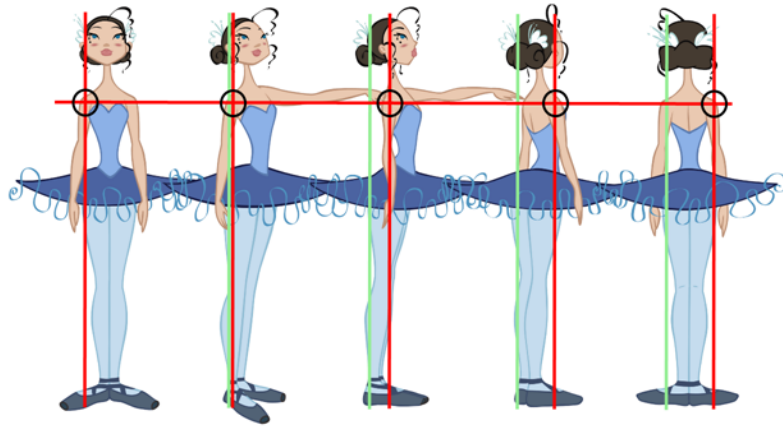

This topic is divided as follows:

- [Setting the Pivots Using the Rotate Tool](#) below
- [Setting the Master Peg Pivot](#) on page 584

## Setting the Pivots Using the Rotate Tool

If you want your puppet's pieces to rotate correctly, you need to set the pivot points right in the middle of an articulation such as an elbow or a knee.

Do the following steps for each layer in the Timeline view.

**To set the pivots:**

1. In the top menu, select **Windows > Toolbars > Advanced Animation** to display the Advanced Animation toolbar.
2. In the Advanced Animation toolbar, select the **Rotate**  tool.
3. In the Camera or Timeline view, select the layer you want to set the pivot for. In the Camera view, you can also hold down [Ctrl] (Windows) or [⌘] (Mac OS X) and click on the piece you want to set the pivot for.
4. In the Camera view, drag the blue pivot where you want to the pivot to be. You can also drag the pivot marker to the desired location.

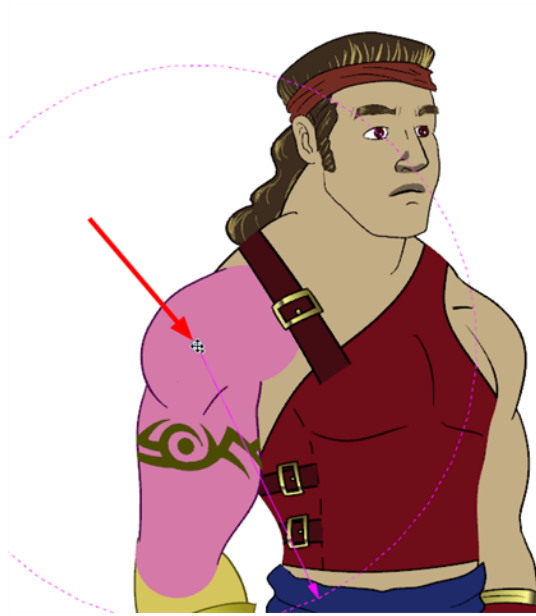



5. Repeat the previous steps for all the pieces, including the eyes, mouth and nose.

## Setting the Master Peg Pivot





By default, your master peg pivot is placed at the centre of the Camera view, which generally equates to your character's hips. A good way to set your peg's pivot is to move it between your character's feet.

To permanently move a peg pivot, use the Rotate  or Scale  tool. While animating, you are easily able to temporarily move this pivot to another location with the Transform tool.

The Transform tool is designed to move the pivot temporarily during the animation process. It also permits you to select multiple pegs and apply a common temporary pivot.

### To set the peg pivot:

1. In the Advanced Animation toolbar, select the **Rotate**  or **Scale**  tool.

2. In the Timeline view, select the master peg layer.



3. In the Camera view, click on the peg pivot and move it to its new location.

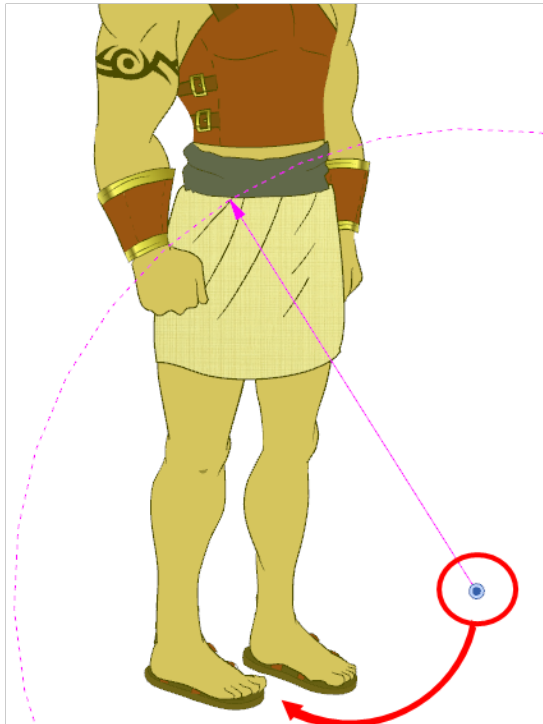

If you added other pegs to your rig, you must set their pivot following the same method.

---

# Storing the Character in the Library

To be able to reuse your character in different scenes, you have to store a template in the Library view. You can create different kinds of templates. You can create templates with all layers are included, a template for a body pose or even some containing only the head.

This topic is divided as follows:

- [Timeline Template](#) below
- [Key Pose Template](#) on the next page

## Timeline Template

To create a template from the Timeline view:

1. In the Library view, right-click on the desired library folder and select **Right To Modify**.
2. In the Timeline view, collapse the master peg layer.

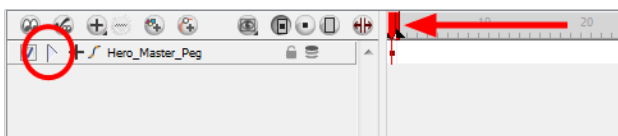

3. If your scene has a series of blank cells, they will also be included in the template if you drag the layer to the Library view. Reduce the scene length to have no empty cells before creating your template.
4. In the Timeline view, select your master peg and drag it to the Library view.

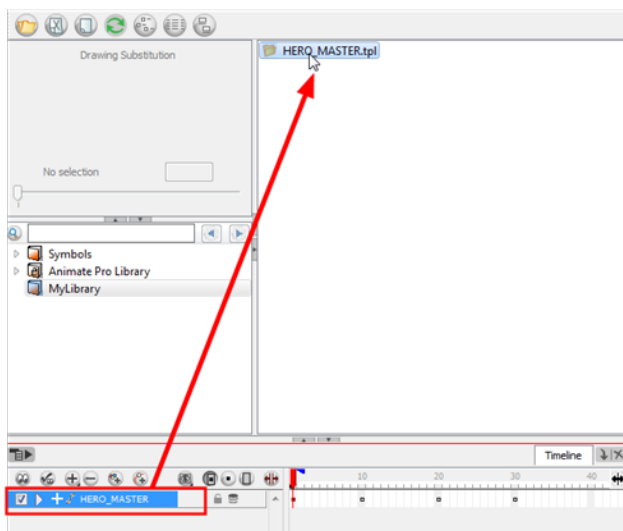

The Rename dialog box opens.

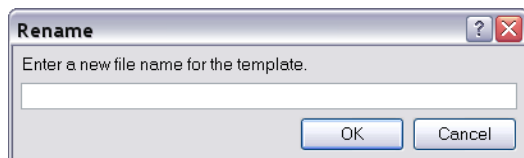

5. In the Name field, name the new template.
6. Click on the **OK** button.

# Key Pose Template

To create a key pose template:

1. In the Library view, right-click on the desired library folder and select **Right To Modify**.
2. In the Timeline view, collapse the master peg layer.

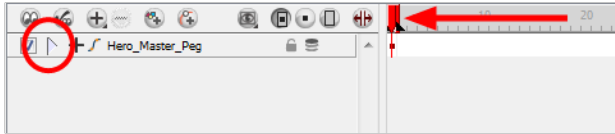

3. Select the cell containing the desired view and drag it into the desired library folder.

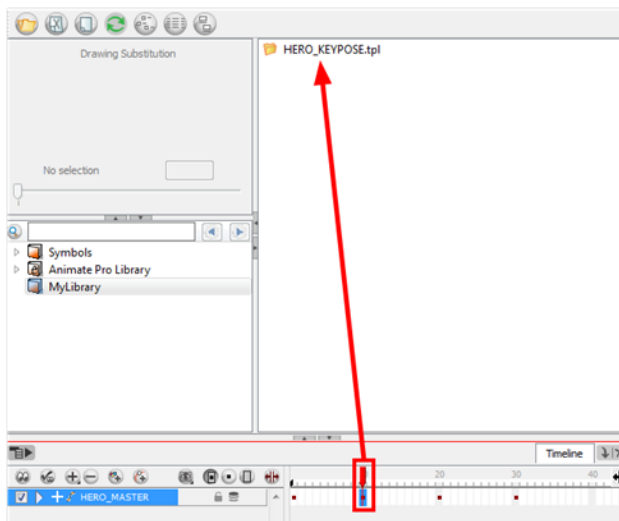

The Rename dialog box opens.

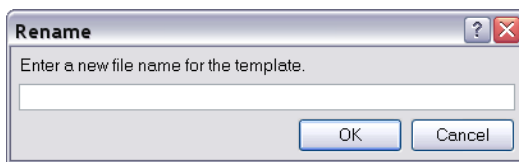

4. In the Name field, name the new template.
5. Click on the **OK** button.



When you create a template from the Timeline view, for everything to work properly when you re-import it into a scene, you must first import your master template. Once the master template is imported, you can import the key pose template's content into the right hand side of the Timeline view.

## Related Topics

- [Library on page 521](#)

# Appendix

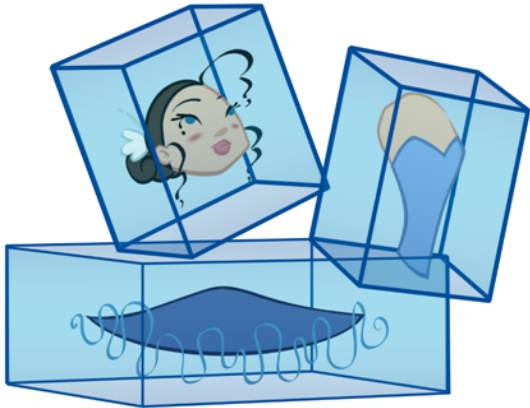

There are many options and animation techniques available when building a puppet, it is impossible to determine only one method to break down a character. Here are some advanced tips on breaking down puppets. As you become more familiar with the software, you will find more ways to improve the construction of your puppet.

## Related Topics

- [Break Down: Cutting the Character in Pieces on the next page](#)
- [Break Down: Distribute to Layers on page 600](#)
- [Setting Different Pivots for a Puppet Using Symbols on page 601](#)
- [Setting Pivots on a Frame Range on page 603](#)



## Break Down: Cutting the Character in Pieces

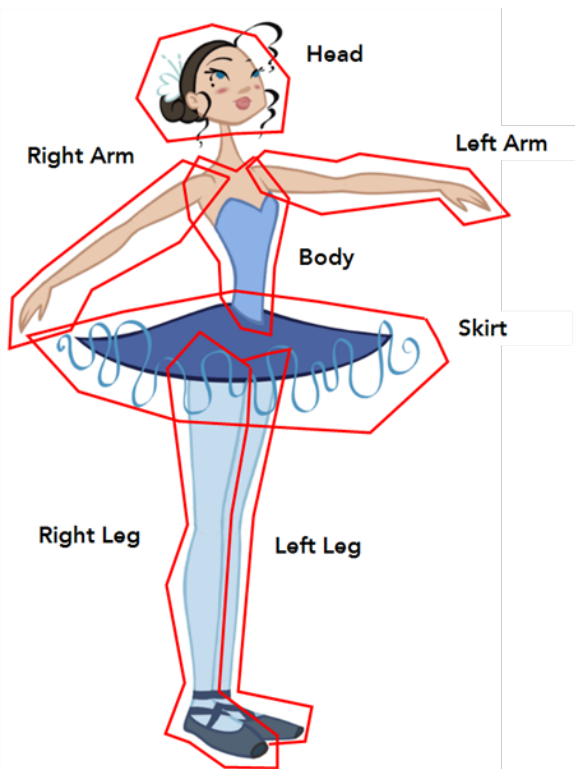

If you do not want to redraw all the artwork for your character, you can use the cut away technique where, with the Cutter tool, you select and send pieces of the model on a new layer.

The first step in breaking down your character is to do a rough cut down of the main parts such as the body, arms, legs and head. Use the Create Drawing from Drawing Selection feature to automatically create your layers and copy your selection in it.



This section is divided as follows:

- [Breaking Down the Main Parts](#) below
- [Breaking Down the Secondary Parts](#) on page 592
- [Selecting and Incorporating to an Existing Layer](#)
- [Breaking Down the Extra View Main Parts](#) on page 595
- [Breaking Down Secondary Parts in the Extra Views](#) on page 596

### Breaking Down the Main Parts

To break down the main body parts, you will use the Create Drawing From Drawing Selection feature. There is no need to create any layers prior to this process, you need to have your model well centred and sized in the Camera view.



You do not need to make clean cuts around your parts; a rough one is quite sufficient as long as it includes all of the artwork of the part you want to break down. You will clean the extra bits and pieces later.

You will use the Cutter  tool to roughly cut the main sections. You can also use the Select  tool to select precise lines and colour zones.

### To break down the main parts:

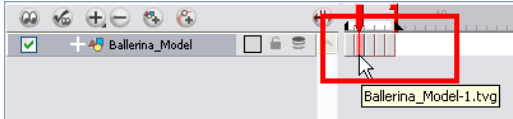
1. In the Timeline view, select the model's cell that corresponds to the first view to break down.



2. In the Tools toolbar, select the Cutter  tool.
  - ▶ If you prefer to use the Select tool, choose the **Select**  tool from the Tools toolbar or press [Alt] + [S].
  - ▶ In the Tool Properties view, you can switch to the **Lasso**  selection mode.
3. In the Camera view, create a selection around the first part to break down. If you click on a zone, the Cutter tool will select the zone. It will end the selection at the first point of intersection that it meets.

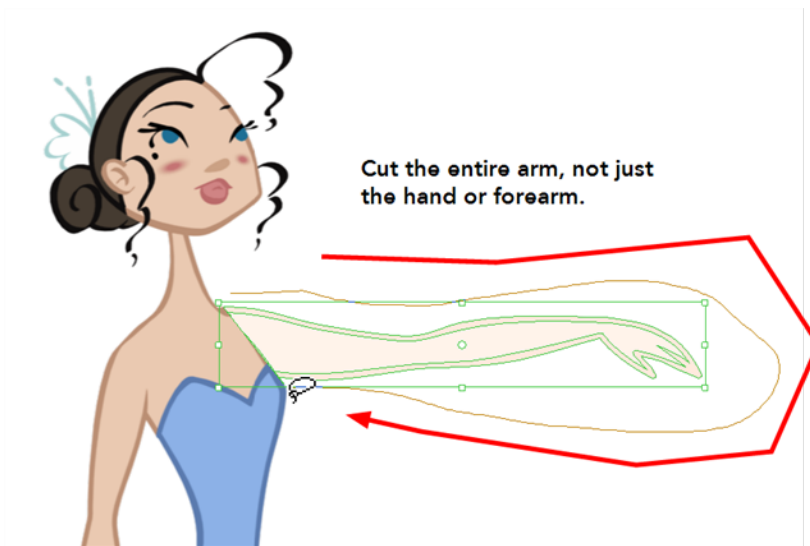

- ▶ If you hold down [Shift], you can create a new lasso selection around another zone and add it to your previous selection.

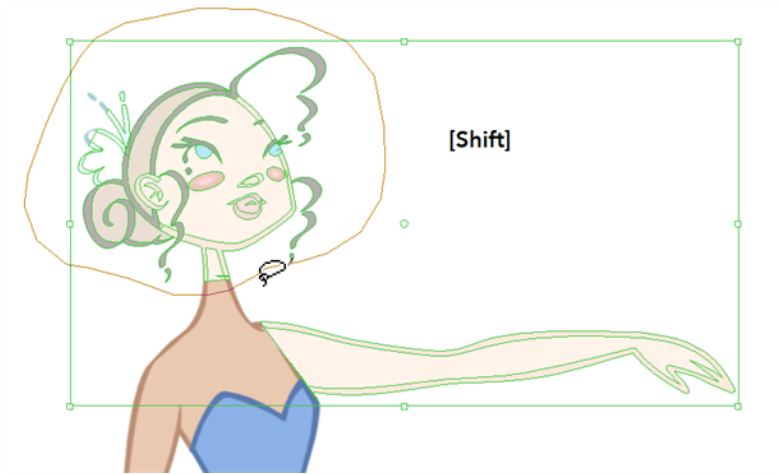

- In the top menu, select **Edit > Create Drawing From Drawing Selection** or press [F9].  
The Create Drawing From Drawing Selection dialog box opens.



- In the Layer Name field, type the name of the layer you want to create following the naming convention you established previously.
- Make sure to disable the **Cut Artwork From Source** option in order to keep the selected artwork on your original drawing. You do not want to cut the artwork from your colour model.
- Click on the **OK** button to complete the operation.

The new layer is created and your selection is copied in it. The drawing is created in the same frame number as the cell it was taken from.

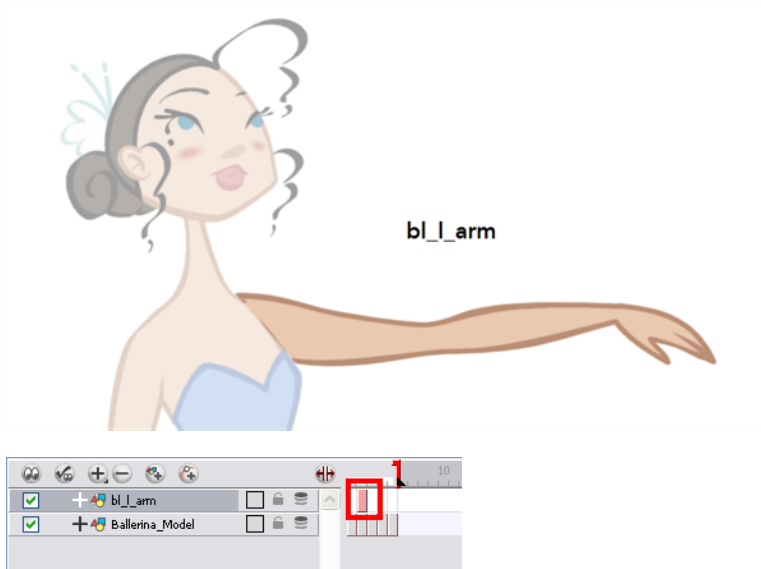

- Repeat Step 1 to Step 7 for each main body part.

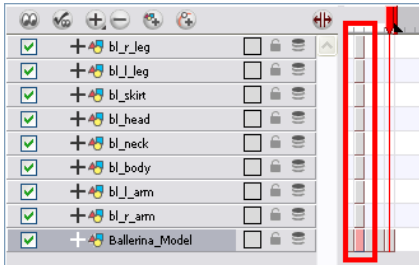

## Breaking Down the Secondary Parts

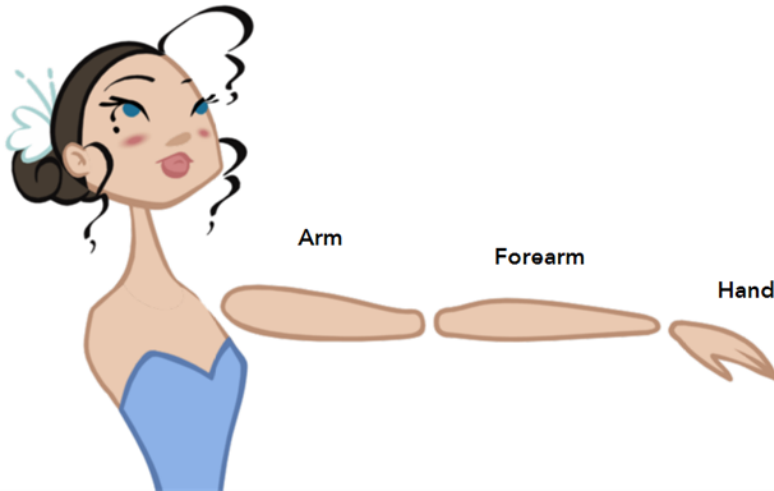

You should now have a layer for each main part of the character for the first view to break down. You are now ready to break down those main pieces into smaller ones.

Breaking down the secondary parts is similar to the main part break down process except that this time you will cut away the artwork from the layer it has been selected from.

**To break down the secondary parts:**

1. In the Timeline view, lock your model layer by clicking on its **Lock**  button.

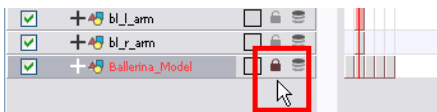

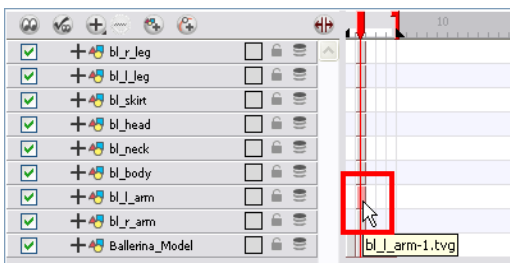

2. In the Timeline view, select the cell that corresponds to the main part you want to break down.

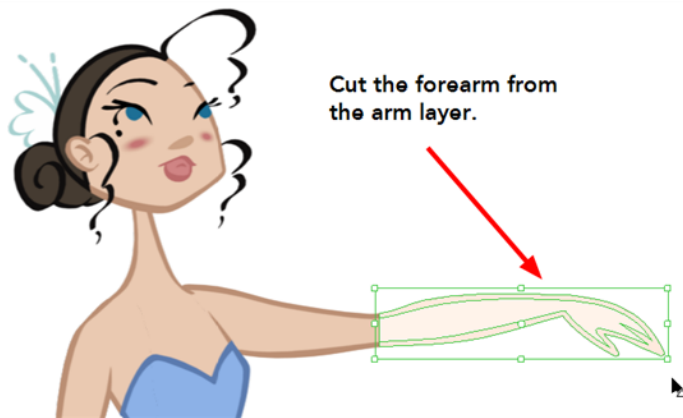

3. In the Tools toolbar, select the **Cutter**  tool.

- ▶ If you prefer to use the Select tool, choose the **Select**  tool from the **Tools** toolbar or press [Alt] + [S].
4. In the Camera view, create a selection around the part to break down.



- ▶ If you click on a zone, the Cutter  tool will select the zone. It will end the selection at the first point of intersection that it meets.

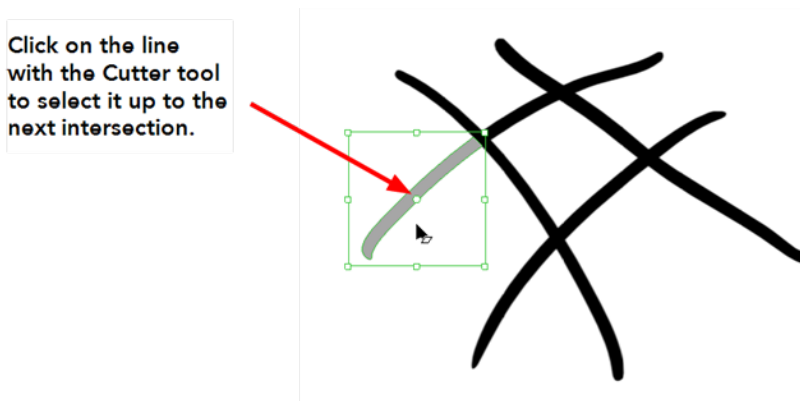

5. In the top menu, select **Edit > Create Drawing From Drawing Selection** or press [F9]. The Create Drawing From Drawing Selection dialog box opens.

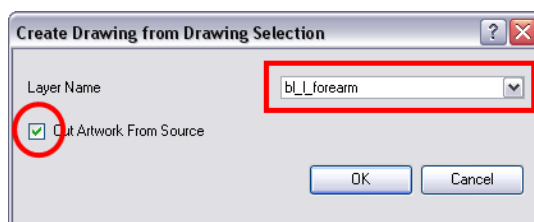

6. In the Layer Name field, enter the name of the layer you want to create, following the naming convention you established previously.
7. Enable the **Cut Artwork From Source** option in order to remove the selected artwork from your original drawing. In this case, you want to cut the artwork from your colour model.
8. Click on the **OK** button to complete the operation.

The new layer is created and your selection is copied in it. The drawing is created in the same frame number as the cell it was taken from.

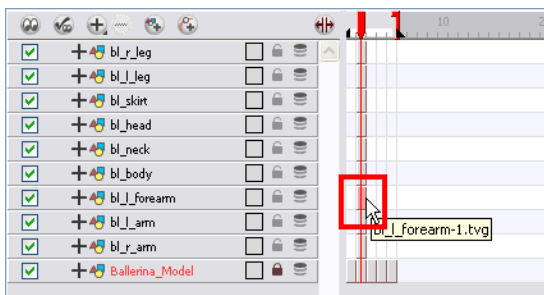

9. Repeat Step 2 to Step 8 for each body part.

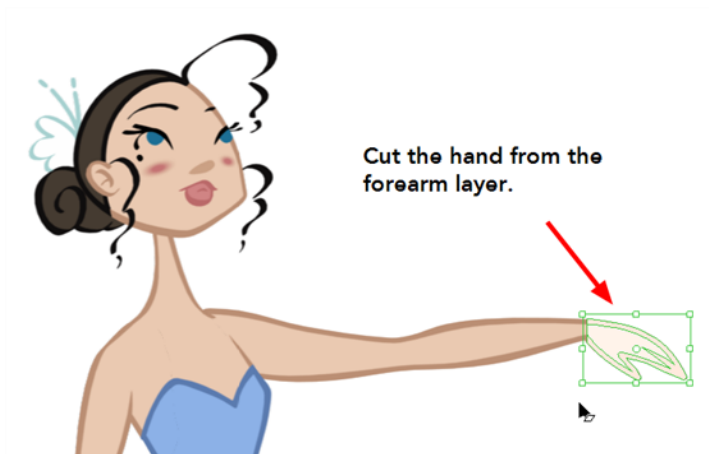



If you forgot to add some artwork to a layer you previously created, you can always add it later.

In the Camera view, select the artwork to send to the existing layer. Open the Create Drawing from Drawing Selection dialog box. The [F9]. In the dialog box, select an existing layer from the drop-down list instead of typing a new name. When you click on the OK button, the artwork will be added to the existing drawing in the layer you selected.

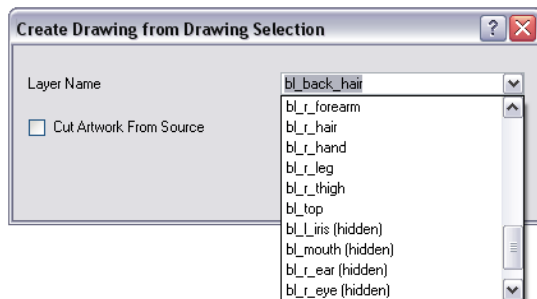

## Selecting and Incorporating to an Existing Layer

Your first view should now be completely broken down. If your articulations are still rough and bits and pieces are missing you will fix those in the next step.

If your character model has more than one view, now is the time to break them down.

The process is very similar to breaking down the first view. You have two choices:

- Breaking down the new view in a net set of layers
- Braking down the new views in the same existing layers  
If your layers are not in the correct order, you can reorder them later. Simply add the part that you are breaking down to the layer you previously created for the same body part.

Start by breaking down the main pieces, as you did before. The secondary parts will be broken down later on.

## Breaking Down the Extra View Main Parts

Repeat the following steps for each extra view you have to break down.

To break down the other views:

1. In the Timeline view, selected the model's cell corresponding to the view to break down.

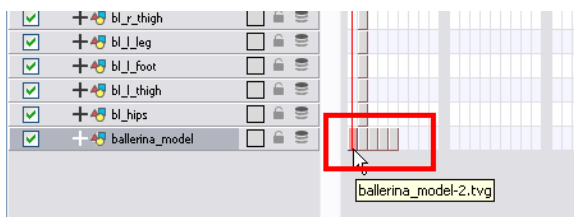

2. In the Tools toolbar, select the **Cutter**  tool.

- If you prefer to use the Select tool, in the Tools toolbar select the Select  tool or press [Alt] + [S].

- In the Camera view, create a selection around the first part to break down.

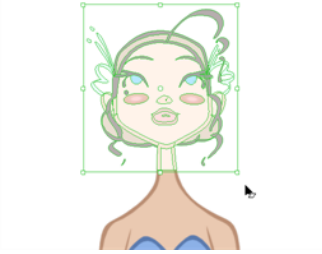

- In the top menu, select **Edit > Create Drawing From Drawing Selection** or press [F9].

The Create Drawing From Drawing Selection dialog box opens.

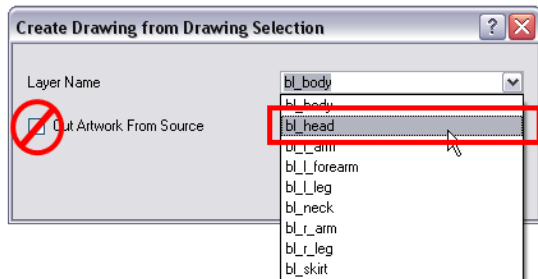

- In the Layer Name field, select the corresponding layer from the drop-down list if you want to use the same layers or type a new name if you want to create a new layer.
- Make sure to disable the **Cut Artwork From Source** option in order to keep the selected artwork on your original drawing. You do not want to cut the artwork from your colour model.
- Click on the **OK** button to complete the operation.

The artwork is inserted into the existing layer. The drawing is created in the same frame number as the cell it was taken from. It is not incorporated in the other view's drawings.

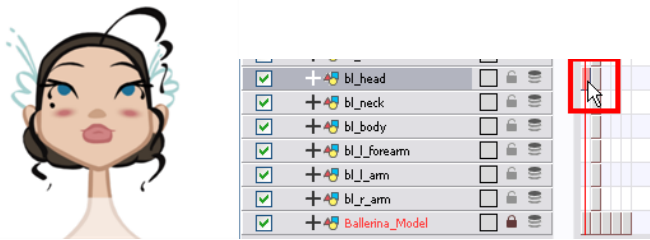

- Repeat Step 1 to Step 7 for each main body part.

## Breaking Down Secondary Parts in the Extra Views

To break down the secondary parts for your extra views you will follow the exact same process as you did for the first view you broke down, but you will incorporate the new parts in the already existing layers. See [Breaking Down the Secondary Parts on page 592](#).

This is an example of how your timeline should look at this stage:



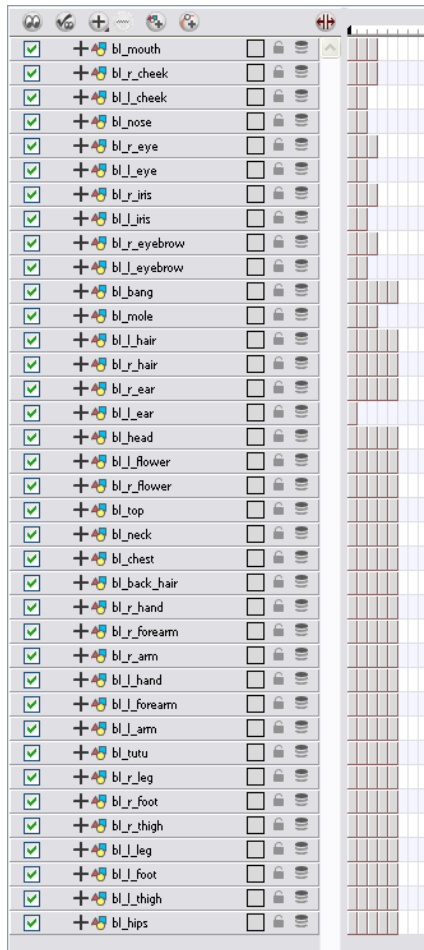







## Completing the Parts and Articulation



Now that all of your layers are created and your parts are basically broken down, it is time to clean up your parts and complete the articulation.

## Cleaning the Parts

You will need to use a series of drawing tools to clean the parts:

-  Brush Tool
-  Eraser Tool
-  Select Tool
-  Cutter Tool
-  Contour Editor Tool
-  Paint Tool
-  Close Gap Tool



To clean your drawings:

1. In the Tools toolbar, select the drawing tool you need to fix your drawings.





2. In the Timeline view, select the cell containing the drawing to fix.



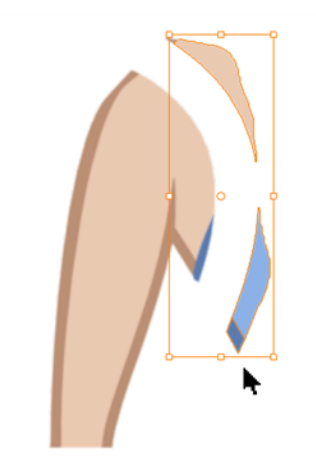

3. In the Camera view, delete the extra bits using the **Select**  or **Cutter**  tool. You can also use the **Eraser**  tool.

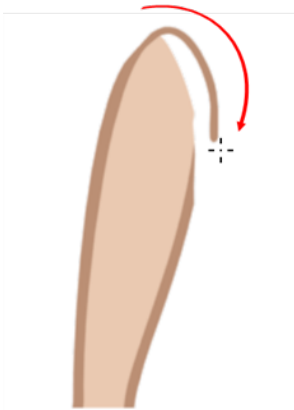

4. Draw the missing lines using the Brush  tool. If you use the Brush tool, it is recommended that you enable the **Auto-Flatten**  option in the Tool Properties view.



5. Using the Paint  tool, paint the gaps. You can close some gaps with invisible lines using the Close Gap  tool. The keyboard shortcut is [Alt] + [C].



6. Reshape your lines using the **Contour Editor**  tool. The keyboard shortcut is [Alt] + [Q].

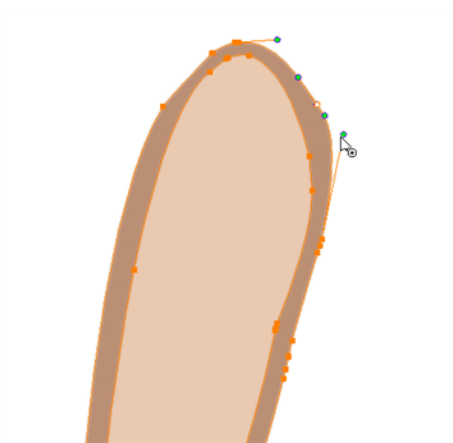

7. Using the Select tool, select your entire drawing and click on the **Flatten**  button in the Tool Properties view to flatten your drawings.

- In the top menu, select **View > Show > Show Strokes** to display the invisible lines that could be present in your drawing or press [K].

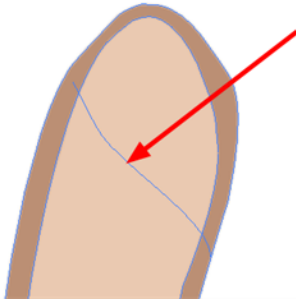

- In the top menu, select **Drawing > Optimize > Remove Extra Strokes**. This operation will remove any unnecessary invisible lines in your drawing.
- Repeat this entire process for each drawing to fix.

## Related Topics

- [Drawing Using the Pencil Tool](#) on page 130
- [Drawing with the Brush Tool](#) on page 146
- [Erasing Parts of a Drawing](#) on page 177
- [Drawing with Shapes](#) on page 193
- [Cutting Drawing Parts](#) on page 211
- [Reshaping a Drawing Using the Contour Editor Tool](#) on page 181
- [Painting Using the Paint Tool](#) on page 290

## Break Down: Distribute to Layers

When breaking down your character, you can use the Distribute to Layers option to distribute the selected art strokes to a new layer each.





This feature will automatically take each stroke from the drawing selection made in the Camera view and separate them into different layers. If one of your puppet's part is composed of several strokes, you must group them using **Edit > Group > Group** before using the Distribute to Layers option. This option cannot be done in the Drawing view. It must be done from the Camera view.

### To distribute to layers:

- In the Tools toolbar, click on the **Select**  tool.

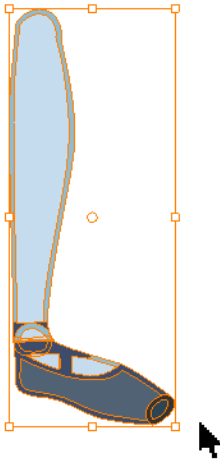
- In the Camera view, select the art strokes you want to distribute to different layers.



- Select **Drawing > Distribute to Layers**. You can also click on the **Distribute to Layers**  button in the Tool Properties view.

The number of drawing layers corresponding to different strokes or groups of strokes are created in the Timeline view.

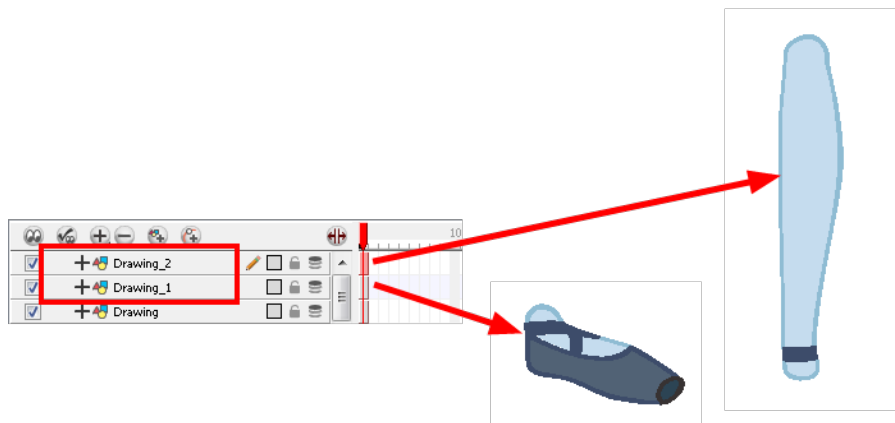

- ▶ The selected strokes in the original drawing layer will be removed.
- ▶ Each stroke or group of strokes will be distributed into each new Drawing layer.

## Related Topics

- [Breaking Down the Character on page 556](#)

# Setting Different Pivots for a Puppet Using Symbols

If you want your puppet's pieces to rotate correctly, you need to set the pivot points onto the articulations. You can either set the pivots using the Rotate tool and have it set for the whole layer or you can set the pivots directly on your symbol and have a different pivot for each symbol cell. By default, when you create your symbols, the symbol pivot is located at the centre of your drawing. You will need to move it onto the shoulder or elbow.

You will set the pivot on the symbol's cells, not directly on the drawings. To set your pivots, you have to be at the top level of your character building scene and not inside the symbols.

By default, when you set your pivot onto your symbol, all the cells use the same pivot. If you need different pivots for your different cells, refer to the following procedure.

Do the following steps for each layer in the Timeline view.

### To set the pivots for the body parts:

1. In the Tools toolbar, select the **Drawing Pivot**  tool. You can also select **Drawing > Tools > Drawing Pivot**.
2. In the Camera or Timeline view, select the symbol you want to set the pivot for.

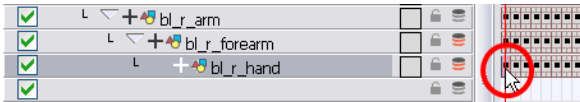

3. In the Tool Properties view, if you only want to set one pivot for your symbol, make sure that the **Set the Pivot for Symbol on All Frames**  option is enabled.

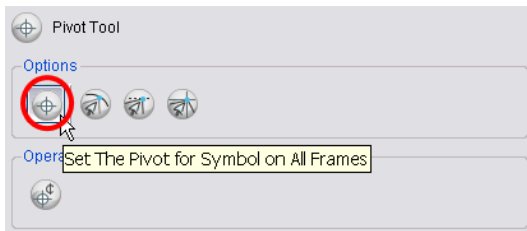

- Disable this option if you want to set a series of different pivots for your symbol's cells.
4. In the Camera view, click where you want the pivot to be. You can also drag the pivot marker to the desired location.



5. If you want to set a different pivot for another drawing or symbol cell, select the drawing or cell and in the Camera view, set the new pivot. Make sure that the Set the Pivot for Symbol on All Frames option is **DISABLED**.

## Related Topics

- [Setting Pivots on a Frame Range below](#)

## Setting Pivots on a Frame Range

If you are using the drawing pivots rather than the Rotate tool pivot and if some elements need the same drawing pivot, such as all of the three-quarter hands, you can select all of these hands cells and set the pivot all at once. If your pivot is already correctly set on your first drawing, copy and paste that pivot onto the other drawings in the Timeline or Xsheet view.



You must have the same drawing pivots on the extra parts from the same angle. If you substitute a drawing while the part is rotating, the animation risks popping out of place if the pivot is uneven.

### To set the pivot on a frame range:

1. In the Timeline view, select the cell where you want to set the same pivot. The cells have to be part of the same layer.



2. In the Camera view, click where you want the pivot to be. You can also drag the pivot marker to the desired location.



### To copy and paste drawing pivots:

1. In the Drawing or Camera view, set the first drawing pivot of the series. For example, set it on hand-1.
2. In the Timeline view, select the cell that contains the correct pivot.

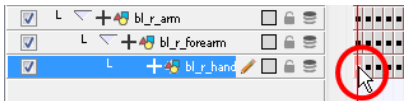

3. In the top menu, select **Edit > Copy**.
4. In the Timeline view, select the cell range that requires the same pivot.

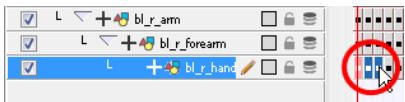

5. In the top menu, select **Edit > Paste Special** or press [Ctrl] + [B] (Windows) or [⌘] + [B] (Mac OS X).  
The Paste Special dialog box opens.

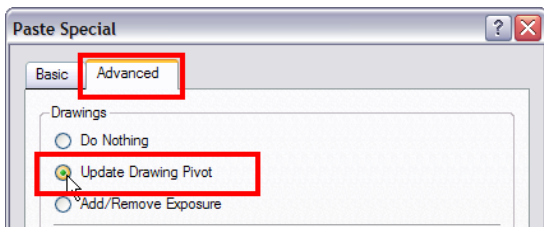

6. In the Paste Special dialog box, go to the **Advanced** tab.
7. In the Drawings section, enable the **Update Drawing Pivot** option.
8. Click on the **OK** button.





You can also copy and paste the pivot from one drawing to another using the keyboard shortcuts [Ctrl] + [C] and [Ctrl] + [V] (Windows) or [⌘] + [C] and [⌘] + [V] (Mac OS X) when the Drawing Pivot tool is active and the focus is around the Camera view.

---

## Related Topics

- [Setting the Pivots on page 581](#)



# Chapter 13: Sound

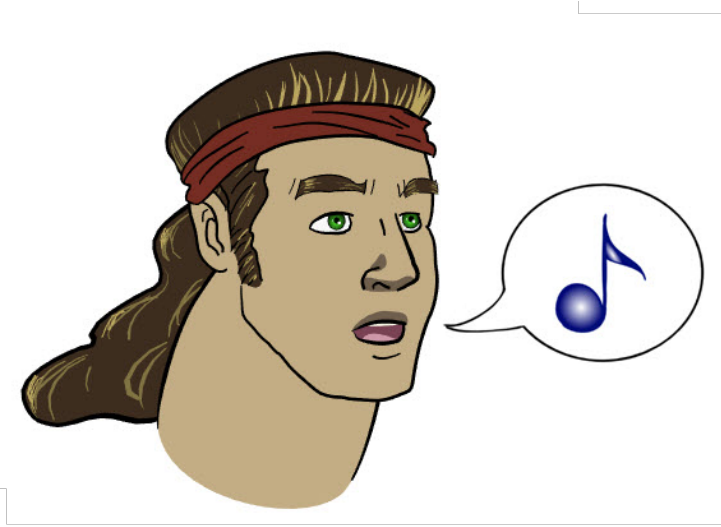

With Animate, you can import soundtracks and dialogue into your animation to make it more engaging and entertaining. There are several sound editing features that can be used to synchronize sounds to individual frames or moments in time. You can also use them to trim unwanted seconds from the beginning and end of your sound files, as well as to loop sounds that you want to continue throughout your animation.

Your ability to add dialogue to animation is greatly enhanced with the Animate lip-sync tools. Animate can analyze voice tracks to determine which of the eight animation phonemes (lip positions) would best apply to each frame of sound. With the mouth chart that the software generates, you can easily draw lip positions for your character. Furthermore, Animate can automatically apply drawings of lip positions to each frame of your animation based on the mouth chart.



You can also synchronize your animation to a music score, refer to [Tempo Markers on page 408](#) to learn more.

---

## Topics Covered

- [Importing a Sound File on the facing page](#)
- [Sound Layer Properties on page 610](#)
- [Sound Displays on page 612](#)
- [Sound Playback on page 613](#)
- [Sound Scrubbing on page 614](#)
- [Editing a Sound File on page 617](#)
- [Add Empty Sound Layer on page 626](#)
- [Lip-sync on page 628](#)
- [Sound Preferences on page 636](#)

# Importing a Sound File

If you decide to add sound to your movie, you must first prepare this sound outside of Animate. When this is done you must add a sound element in Animate to the organize sound files in your animation. Sound will play in the movie until it reaches the end of the file or a stop frame that you have created in the Sound Element Editor.



If you first create your project in Toon Boom Storyboard Pro, the sound will be cut up into the different scenes for you automatically.

You can import WAV, AIFF or MP3 sound files using any of the methods listed below.

## To import a sound file:

1. Select **File > Import > Sound**
  - Right-click anywhere in the frame zone of the Xsheet view.
  - From the Top menu
  - From the Xsheet View menu
  - From the Timeline View menu

The Select Sound File dialog box opens.

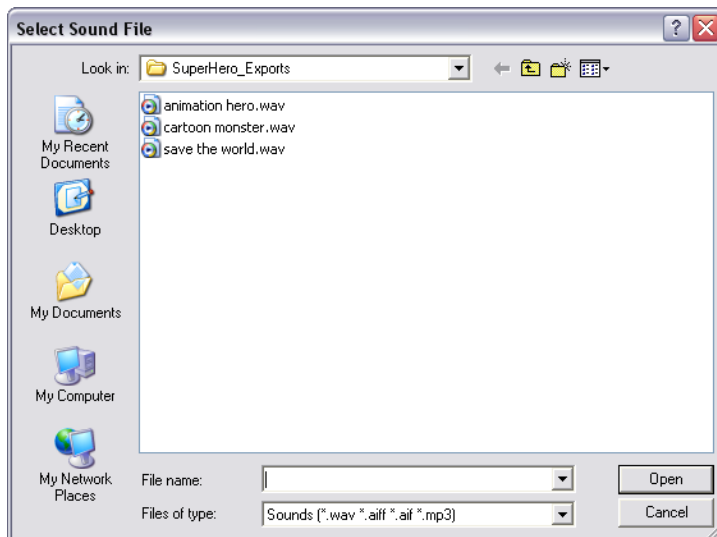

2. From the Select Sound File dialog box find and select your sound file from your computer.

Your sound file appears as a layer in both the Timeline and Xsheet view.

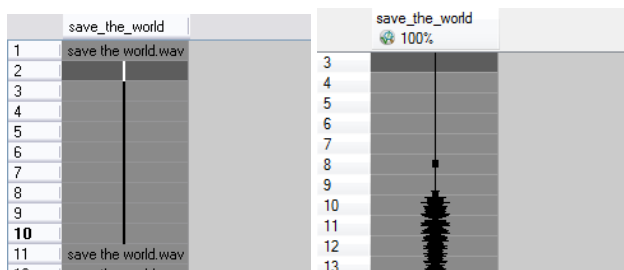



## Related Topics

- [Sound Layer Properties](#) on the facing page
- [Sound Displays](#) on page 612
- [Sound Playback](#) on page 613
- [Sound Scrubbing](#) on page 614
- [Editing a Sound File](#) on page 617
- [Add Empty Sound Layer](#) on page 626
- [Lip-sync](#) on page 628

# Sound Layer Properties

When you select a sound layer in the Timeline view, the options related to that layer appear in the Layer Properties view.

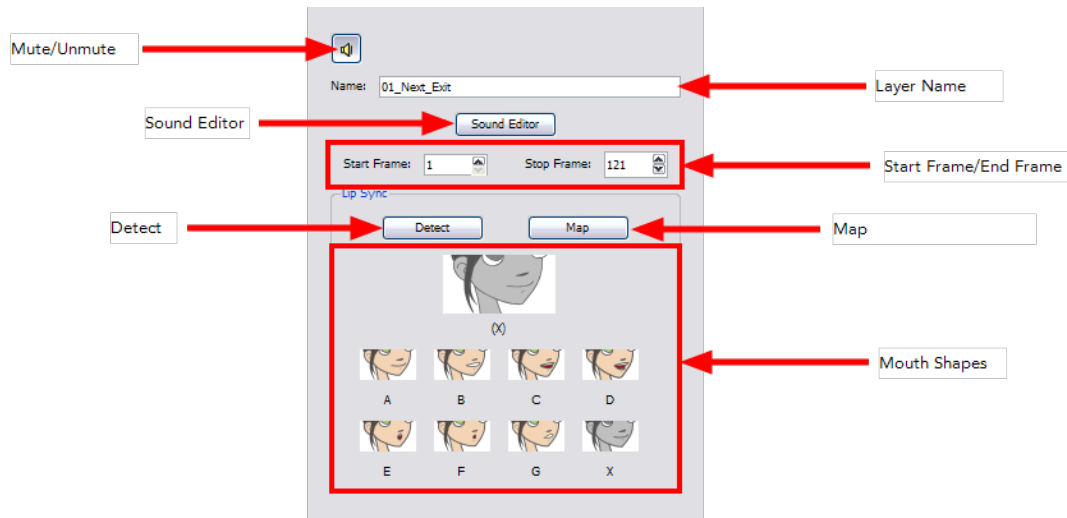

- **Mute/Unmute**  
This button mutes and unmutes the sound layer during the scene play back.
- **Layer Name**  
This field displays the layer's name.
- **Sound Editor**  
This button opens the Sound editor.
- **Start Frame/End Frame**  
These fields determine the start and end frame of the sound file.
- **Detect**  
This button launches the automated lip-sync detection.
- **Map**  
This button opens the Map Lip-sync dialog box.
- **Mouth Shapes**  
This section shows the automated lip-sync detection during the scene play back. Click on the thumbnail image of each mouth to change the phoneme assigned to the current frame.

## Related Topics



- [Importing a Sound File on page 608](#)
- [Sound Displays on page 612](#)
- [Sound Playback on page 613](#)
- [Sound Scrubbing on page 614](#)

- [Editing a Sound File](#) on page 617
- [Add Empty Sound Layer](#) on page 626
- [Lip-sync](#) on page 628

# Sound Displays

Within the **Xsheet** view, the sound file can be displayed in different ways, depending on your sound editing needs.

## To change the sound display:

1. Right-click in the sound column or on the sound column header, choose **Sound Display >** and one of the following:
  - ▶ **Sound Name:** Shows the name of the sound file, as well as the file format. The line running vertically through the column frames between the same file name indicates a continuity of the same sound file in these frames.
  - ▶ **Mouth Shapes:** Show the letter (or name depending on the way you named your character's different mouth positions) in the column's frames. There is only one mouth position allotted per frame and this position should correspond to the sound file after performing a lip-sync.
  - ▶ **Waveform:** Shows a vertical display of the sound file's actual waveform. In the column header, in the field under the column name, you can type in a percentage to zoom-in or zoom-out on the waveform, or pass the scroll cursor  over the Zoom Waveform  icon.

	Sound_Name	Mouth_Shapes	Waveform
16	13_STARS.MP3	X	200%
17		X	
18		X	
19		X	
20		X	
21		X	
22		X	
23		X	
24		X	
25		X	
26		X	
27		X	
28	13_STARS.MP3	X	



You can show/hide the waveform in the Timeline view by pressing the Waveform button in the Timeline View toolbar.

## Related Topics

- [Lip-sync on page 628](#)
- [Sound Preferences on page 636](#)



# Sound Playback



Before playing back any sound, click on the Enable Sound  button in the Playback toolbar or enable it

through the Play menu in the top menu. This will make sure that you can hear the sound layers in your scene, even the ones included within symbols.

## To play back your sound sample:

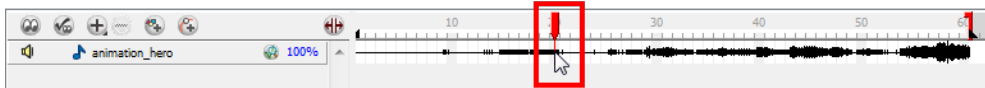
- To select a starting point:
  - In the Xsheet view, click on a cell in the sound column.
  - In the Timeline view, click on a cell in the sound layer. You can also slide the red playhead to the correct cell.



- Click on the Play  button in the Playback toolbar or in the top menu select **Play > Play Scene Forward** or click on the [Enter/Return] key.
- If you would like to hear your sound sample played back again and again, click the Loop  button in the Playback toolbar or the **Loop** option from the Play menu.

## Mute

If you have two or more sound layers and would like listen to them independently, you can disable the unwanted sound by clicking on the **Mute Sound**  icon located on the sound name layer in the Timeline view.

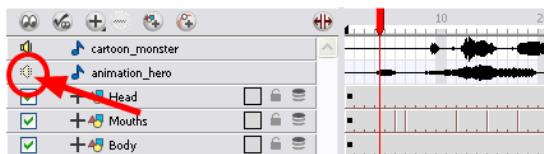

## Related Topics

- [Importing a Sound File](#) on page 608
- [Sound Layer Properties](#) on page 610
- [Sound Displays](#) on the previous page
- [Sound Scrubbing](#) on the facing page
- [Editing a Sound File](#) on page 617
- [Add Empty Sound Layer](#) on page 626
- [Lip-sync](#) on page 628

# Sound Scrubbing

Animate uses a process known as Sound Scrubbing to let you hear sound in real-time while you move the playback pointer forward or backward. This is very useful for finely-tuned lip-synching. You can scrub sounds from the Timeline view.

**To scrub a sound from the Timeline view:**

1. In the Playback toolbar, click on the **Sound Scrubbing**  button or from the top menu, select

**Play > Enable Sound Scrubbing.** You can also activate Sound Scrubbing by right-clicking in the Timeline view's frame bar.

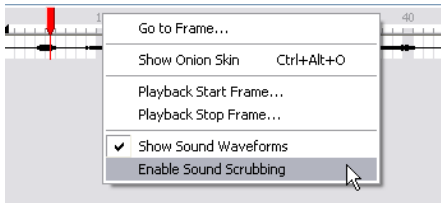

2. At the top of the Timeline view, drag the red frame marker along to hear the sound at each frame. The [Ctrl] + [Up Arrow] and [Ctrl] + [Down Arrow] (Windows) and [⌘] + [Up Arrow] and [⌘] + [Down Arrow] (Mac OS X).



## Related Topics

- [Analog Sound Scrubbing below](#)

## Analog Sound Scrubbing

Animate is set to the digital sound scrubbing mode by default. This means that all sounds are played in real time. It also means that as you scrub over a frame you will hear the section of your sound file that is allotted to that frame. As you are scrubbing, although it is accurate, the sound can sound clipped. It can also be difficult to hear nuances in pitch and tone.

Animate has an analog sound scrubbing option. When sound scrubbing in this mode, the sound is played back according to the speed that the playhead or jog is manually adjusted. Animate's interface offers shuttle and jog sliders to perform analog sound scrubbing, however, external hardware and their corresponding software can be used in conjunction with Animate for improved analog sound scrubbing results.



Please refer to the device's manual to configure its functionality with Animate.

## Performing an Analog Sound Scrub in Animate

Before you can perform an analog sound scrub in Animate, you have to learn about the Shuttle and Jog.

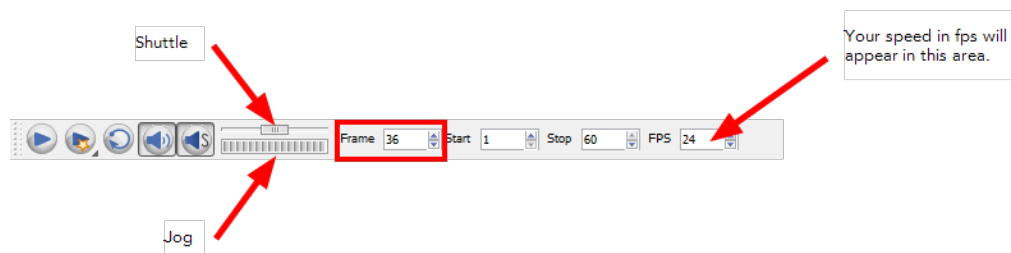

- **Shuttle:** Pull the Shuttle backward or forward to make the red playhead, in the Timeline view, jump by large increments in the direction you are moving the shuttle.
- **Jog:** Click and drag along the Jog to make the "dial" rotate. The Jog controls finer incremental movements along the soundwave. Use the Frame field to see the frame number which you are on. As you rotate the dial, your speed in fps appears directly after the FPS field.

**To perform an analog sound scrub:**

1. In the Playback toolbar, click on the **Sound Scrubbing**  button or from the top menu, select **Play >**

**Enable Sound Scrubbing.** You can also activate **Sound Scrubbing** by right-clicking in the Timeline view's frame bar.

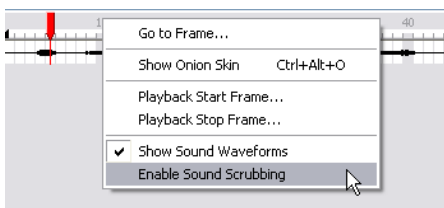

2. In the top menu, go to **Edit > Preferences** (Windows) or **Animate > Preferences** (Mac OS X).
3. In the Sound tab enable the **Analog Sound Scrubbing** option.
4. Click on the **OK** button.
5. In the Playback toolbar, use the Shuttle to find the general location of where you would like to start your sound scrub, or in the Timeline view, drag the red playhead to the desired location.
6. In the **Playback** toolbar, use the **Jog** to fine tune your scrub to just a few frames.

## Related Topics

- [Sound Scrubbing on page 614](#)

# Editing a Sound File

Now that you have successfully imported your sound file into Animate, it is time to familiarize yourself with the sound editing interface. The Sound Element editor makes it possible to edit sounds that were created outside of Animate and imported into your scene.

## To open the Sound Element editor:

1. Either double-click the sound layer name in the Timeline view or the sound column header in the Xsheet view.

The Sound Element Editor dialog box opens.

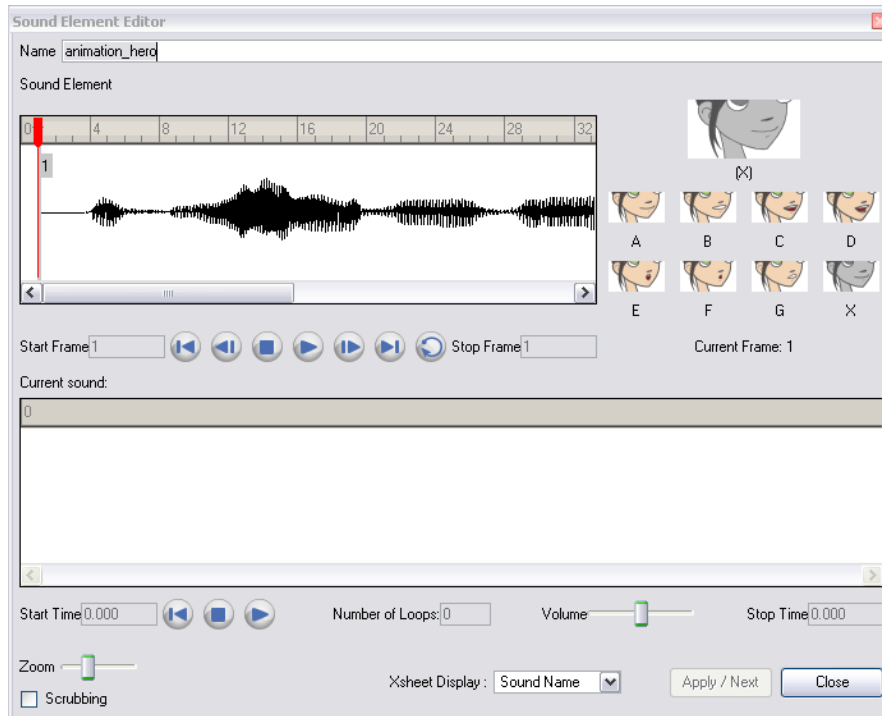

The Sound Element editor consists of three main parts.

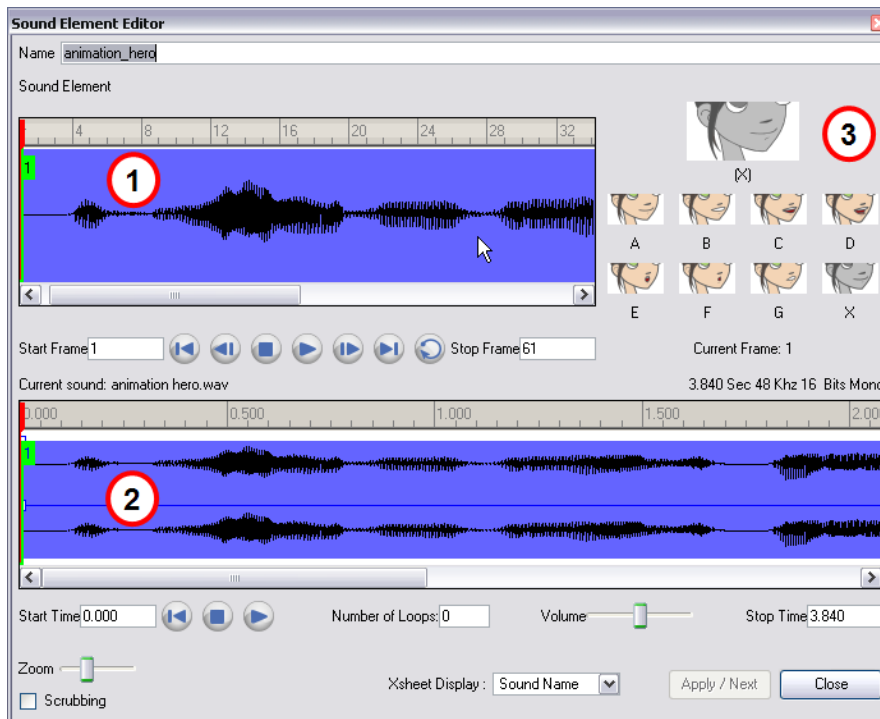

**1. Sound Element** - The wave form seen in the top Sound Element window is the actual sample that will be heard when the final movie is rendered. It may be shorter than the original sound sample due to length of the scene. If any edits are made to the sound sample, they can be heard here.

In the Sound Element panel you will see some coloured tabs, these tabs represent the frames. The frame number is shown inside the tab flag marker. Note that these tabs indicate the start and end frames of a sound segment.

**2. Current Sound** - The Current Sound window displays the original sound file in its entirety and is where you can edit its properties. This window remains empty until you click inside the Sound Element window.

**3. Lip-sync Preview** - Is used to preview the automated detection and to manually insert different mouth positions to correspond with the sound sample.

You can accomplish the following in the Sound Element editor:

- [Changing the Start or End Frame of a Sound on the next page](#)
- [Trimming the Start and End of a Sound File on page 621](#)
- [Looping a Sound on page 622](#)
- [Mixing the Sound Volume on page 623](#)
- [Customizing the Playback Range on page 624](#)
- [Recomputing the Mouth Chart on page 634](#)

## Related Topics

- [Lip-sync on page 628](#)

## Changing the Start or End Frame of a Sound

To synchronize the sound with specific images in your scene, you must set a start frame for your sound. To make sure the sound ends by a certain frame, you must set an end frame.



In the Sound Element panel you will see some coloured tabs, these tabs represent the frames. The frame number is shown inside the tab flag marker. These tabs indicate the start and end frames of a sound segment.

### To change start or end frame of a sound:

1. Either double-click the sound layer name in the Timeline view or the sound column header in the Xsheet view to open the Sound Element editor.
2. Select the sound sample you want from the Sound Element panel. To distinguish one sound section from another on the same sound layer, check the frame numbers that appear on tabs flanking the start and stop lines of each waveform section.

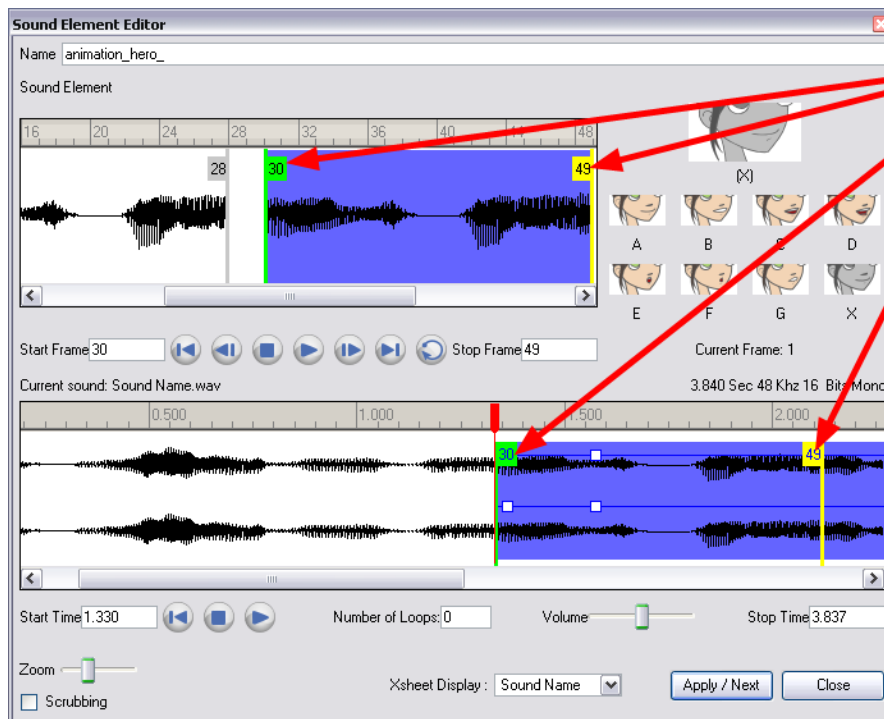

Click on the Play  button in the Current Sound panel (only the selected sound plays).

3. Within the Sound Element panel, click and drag the selected clip to the frame number where you want it to start playing.

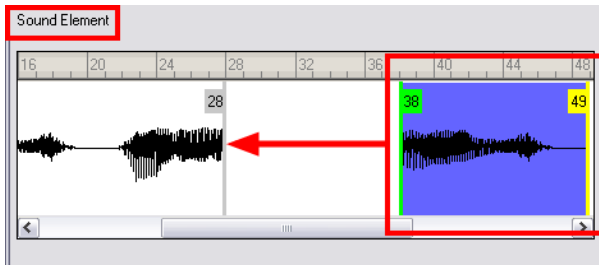

You can only move the clip to a section that does not already contain a clip; you cannot overlap two clips in the same element.

- To change the end frame, drag the yellow marker at the end of the waveform to the frame position.

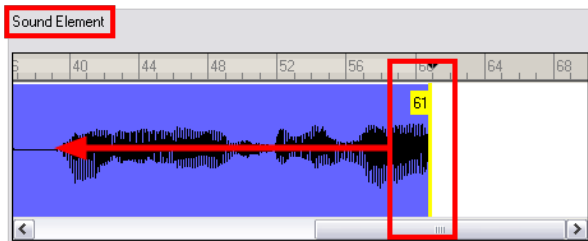

- To hear how all of the clips fit together in the element, click on the Play button in the Sound Element panel.

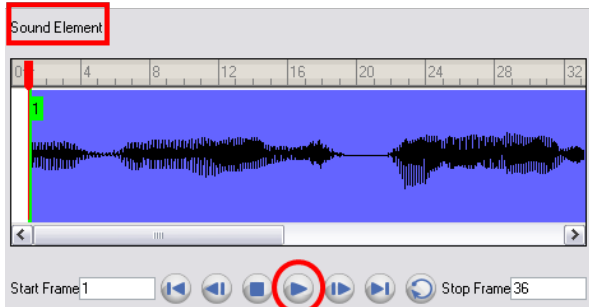

If you only want to hear the selected clip, click on the Play button in the Current Sound panel.

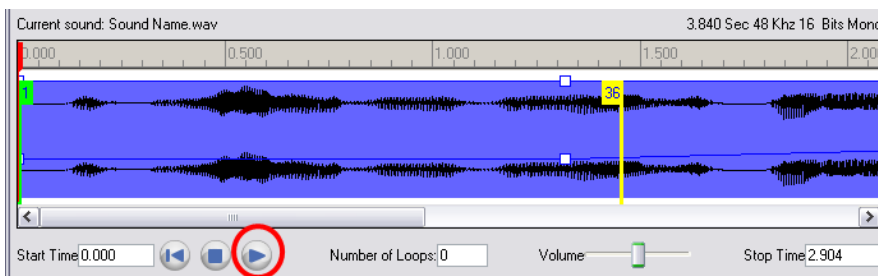

- Click Apply/Next when done.

The Xsheet and Timeline views display the sound clip at the start frame you selected.

## Related Topics

- [Trimming the Start and End of a Sound File on the next page](#)



- [Looping a Sound](#) on the facing page
- [Mixing the Sound Volume](#) on page 623
- [Customizing the Playback Range](#) on page 624

## Trimming the Start and End of a Sound File

To play only a section of a sound file, use the Sound Element Editor to select the exact part you want to use. For example, if there is a bit of noise at the start of the sound, use the Sound Element Editor to cut the noise.

The Sound Element Editor does not change the original sound file; it only plays a section of it, ignoring the rest. This means that the entire sound file is included on export. If you need to be mindful of file size, it is better to edit sound files completely in a sound editor before bringing them into Animate.

### To trim the start and end of a sound file:

1. Either double-click the sound layer name in the Timeline view or the sound column header in the Xsheet view to open the Sound Element editor.
2. Select the sound you want to work on from the Sound Element panel.
3. Select the sound sample you want from the Sound Element panel. To distinguish one sound section from another on the same sound layer, check the frame numbers that appear on tabs flanking the start and stop lines of each waveform section. Or select a soundwave and click on the Play  button in the

Current Sound panel (only the selected sound will play).

4. Using the Current Sound panel, you can decide which part of the file you want to play by dragging the left and right boundaries of the selection area.

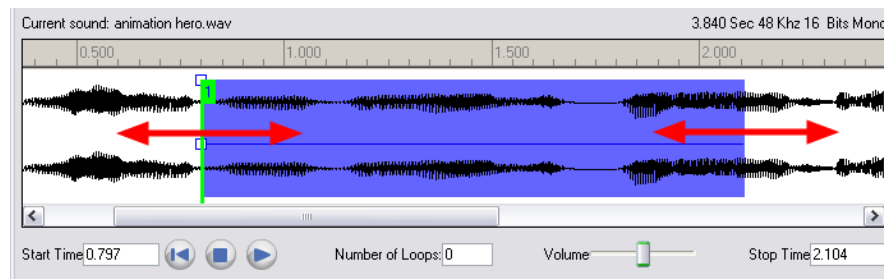

5. Click on the Play  button in the Current Sound panel to check that you have trimmed the desired sections. Use the Zoom slider at the bottom of the panel to zoom in on the wave form so that you can trim it more accurately.

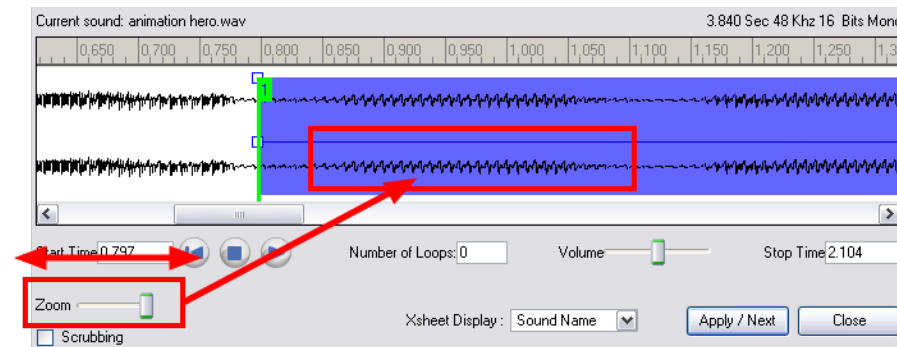

6. Click on the **Apply/Next** button.

The trimmed sound sample should now appear in both the Timeline and Xsheet views at the start and end positions that you selected.

## Related Topics

- [Changing the Start or End Frame of a Sound](#) on page 619
- [Looping a Sound](#) below
- [Mixing the Sound Volume](#) on the next page
- [Customizing the Playback Range](#) on page 624

## Looping a Sound

To repeat a sound, specify the number of times that you want it to loop in the Sound Element editor.

### To loop a sound sample:

1. Either double-click the sound layer name in the Timeline view or the sound column header in the Xsheet view to open the Sound Element editor.
2. From the Sound Element panel, select the sound section that you want to loop.
3. In the Current Sound panel, type the number of times you want the sound to play in the Number of Loops field.

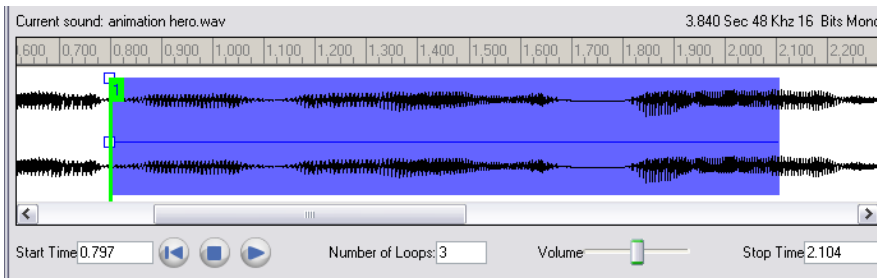

4. Press on the [Enter/Return] key. The looped sound appears after the current sound. They are indicated by their grey waveforms, as opposed to black.

When you loop a sound, the looped sections fill the cells in the sound element (column or layer) until the next sound sample starts or until the scene ends. This means that the looping could effectively get cut if the next sound sample starts too soon, or if the scene ends too quickly.

## Related Topics

- [Changing the Start or End Frame of a Sound](#) on page 619
- [Trimming the Start and End of a Sound File](#) on the previous page
- [Mixing the Sound Volume](#) on the next page
- [Customizing the Playback Range](#) on page 624

## Mixing the Sound Volume

You can adjust the volume of an entire sound clip or modify the volume in increments by adjusting the fade-in and fade-out times, otherwise known as sound envelopes. The fade edit only affects the play back; the original sound file is not affected.

### To adjust the overall volume of the entire sound clip:

1. Either double-click the sound layer name in the Timeline view or the sound column header in the Xsheet view to open the Sound Element editor.
2. In the Sound Element panel, select the sound that you want to work on. A more detailed version of the selected sound appears in the Current Sound panel.
3. In the Current Sound panel, use the Volume slider to adjust the volume.

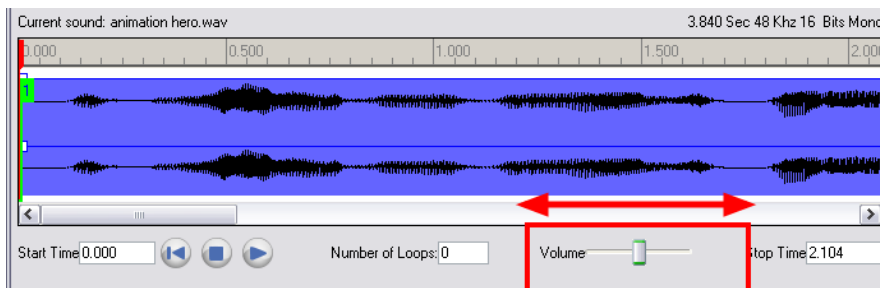

4. Click on the Play button in the Current Sound panel to verify the volume.

### To create the fade in/out effect on a sound clip:

1. Either double-click the sound layer name in the Timeline view or the sound column header in the Xsheet view to open the Sound Element editor.
2. In the Sound Element panel, select the sound you want to work on.
3. In the Current Sound panel, click on the thin blue line above waveform to add an envelope marker.

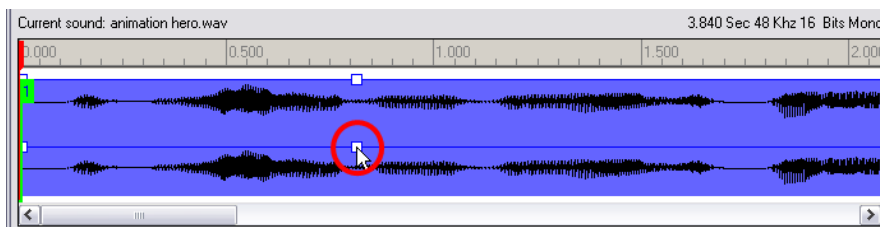

4. Drag the envelope markers to adjust the volume at that frame and to create the time of the transition. The line from the edge of the clip to the envelope marker identifies how the volume either increases (fades-in) or decreases (fades-out) over time.

Dragging the marker to the bottom of the channel will mute the volume, while dragging it upwards will increase the volume.



To create an even effect, be sure to adjust the envelope markers uniformly in both the left and right (bottom and top) channels.

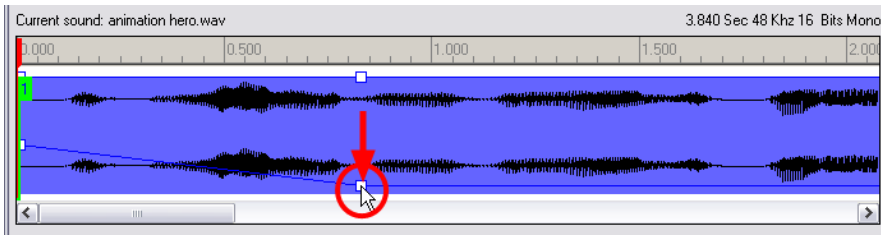

- Click on the Play button in the Current Sound panel to check the fade envelopes.

## Related Topics

- [Changing the Start or End Frame of a Sound](#) on page 619
- [Trimming the Start and End of a Sound File](#) on page 621
- [Looping a Sound](#) on page 622
- [Customizing the Playback Range](#) below

## Customizing the Playback Range

To hear a specific section of the sound element, adjust the playback range in the Sound Element Editor to start or stop at specific frames. This customized playback range does not affect the actual sound in the Sound element.

To change the playback range in the Sound Element Editor dialog box:

- Drag the start or end range markers in the Sound Element panel to the boundary frames you want.

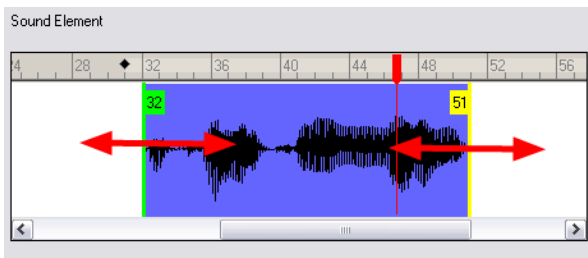

- When you click on the Play button to play back your sound in the Sound Element editor, it only plays the sound which exists between the two markers.

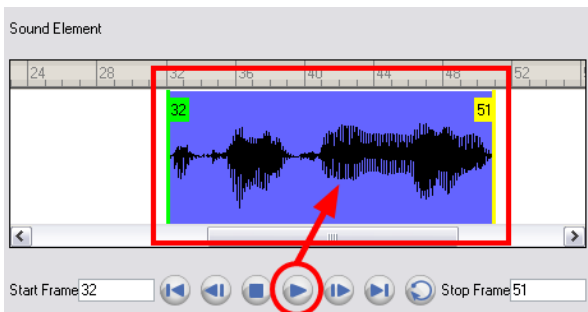

## Related Topics

- [Changing the Start or End Frame of a Sound](#) on page 619
- [Trimming the Start and End of a Sound File](#) on page 621
- [Looping a Sound](#) on page 622
- [Mixing the Sound Volume](#) on page 623

# Add Empty Sound Layer

When performing sound editing tasks, it can be useful to chop up a sound sample into different layers. For example, when performing a lip-sync, only a single view of the various mouth positions for a character can exist on one layer. Therefore, if you would like to have your character turn its head from a profile view to a three-quarter view and have mouth position changes to fit with the sound sample from these two different views, you would need to cut-up the sound samples needed for the profile view mouth positions on one layer and the sound samples needed for the three-quarter view on another.

For this task, you will need an empty sound layer.

To add an empty sound layer:

1. In the top menu, select **Windows > Toolbars > Timeline View**.

The Timeline view toolbar appears at the top of the Timeline view.



2. Right-click on the Timeline View toolbar and choose **Customize**.
3. Choose the **Add Sound**  button from the Available Tools column on the left and add it to the Toolbar column on the right. Click **Ok** to accept the change.

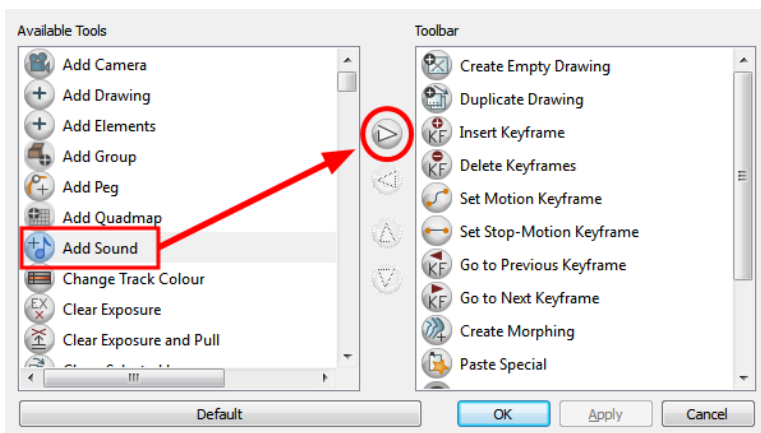

4. Click on the **Add Sound**  button.

An empty (silent) sound layer should appear in both your Timeline and Xsheetviews.

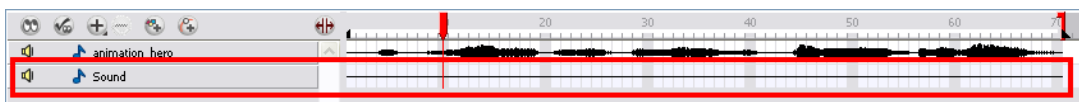

5. Rename your layers accordingly.
6. Click the cell where you wish to start the cut and **[Shift] +** click on the final cell of the cut. The sample to be cut becomes highlighted.

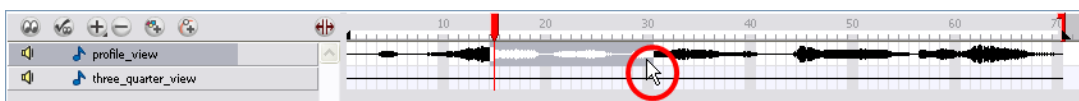

7. Drag the selection into the empty sound layer below.

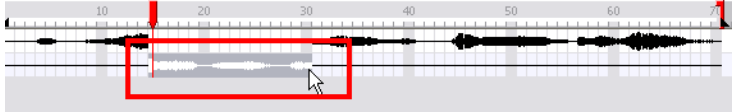

8. You can now continue to cut-up and distribute the sound sample between the two layers or carry on to the lip-synching process for each layer and its corresponding facial view.



If you need to duplicate your sound layer to keep an unedited copy for safety, you can click on the Duplicate Selected Layers button, located in the Timeline View toolbar.

---

## Related Topics

- [Importing a Sound File on page 608](#)
- [Sound Layer Properties on page 610](#)
- [Sound Displays on page 612](#)
- [Sound Playback on page 613](#)
- [Sound Scrubbing on page 614](#)
- [Editing a Sound File on page 617](#)
- [Lip-sync on the facing page](#)

# Lip-sync



Adding a lip-sync to a project can really enhance its quality and storytelling. However, it can be difficult to shape a character's mouth so that it matches the sound at the precise frame.

To solve this problem Animate provides a lip-sync feature which analyzes the contents of a sound element and generates a mouth chart (see below) based on the eight animation phonemes (A, B, C, D, E, F, G, and X, which is used to represent silence).

The mouth shapes used by Animate are based on the conventional mouth chart used in the animation industry.



The letters used to represent the shapes do **NOT** correspond to an actual sound.



If you are doing cut-out animation, refer to [Adding Extra Drawings on page 579](#) to learn how to add extra drawings to your character.



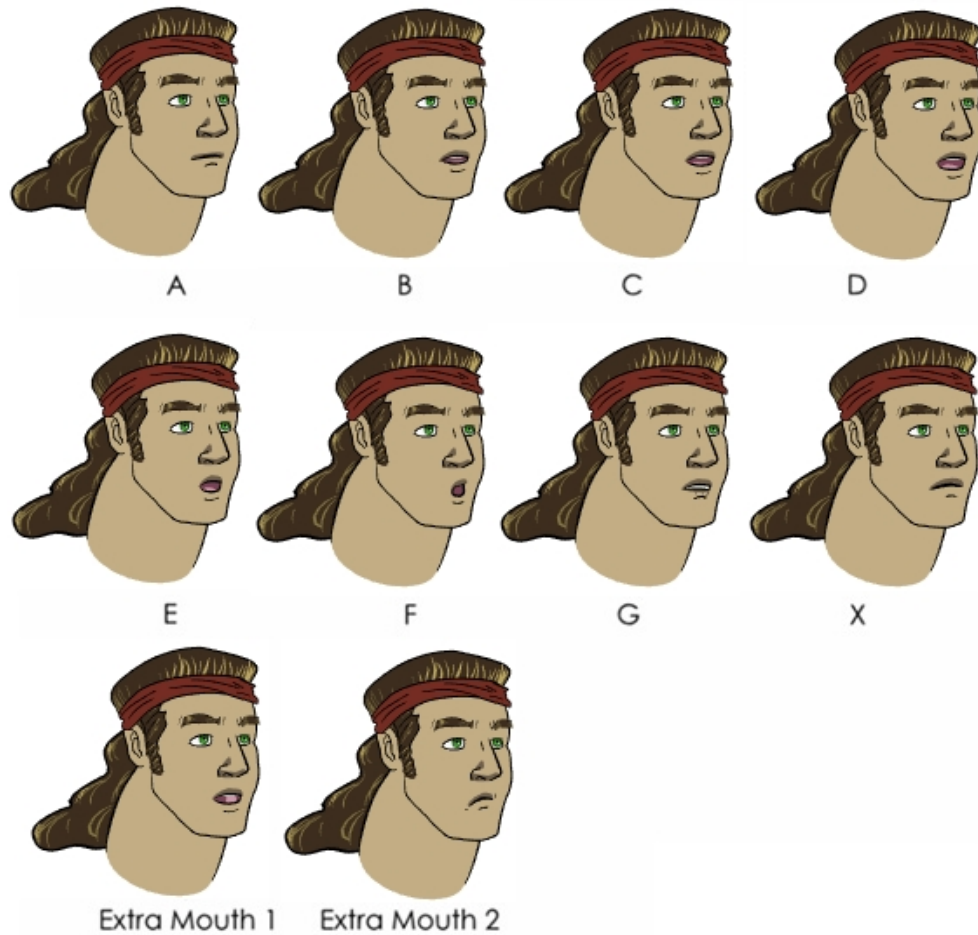

Here is an approximation of which sound each mouth shape can produce:

- **A:** m, b, p, h
- **B:** s, d, j, i, k, t
- **C:** e, a
- **D:** A, E
- **E:** o
- **F:** u, oo
- **G:** f, ph
- **X:** Silence, undetermined sound

You can lip-sync the traditional way or let the system automatically create the basic detection.

You can refer to the mouth chart positions as you draw the shape of your character's mouth.

## Related Topics

- [Generating a Lip-sync Detection on the facing page](#)
- [Mapping the Lip-Sync Detection on page 631](#)

- [Modifying the Lip-sync Detection](#) on page 633
- [Manual Lip-sync](#) on page 635

## Generating a Lip-sync Detection

There are three places where you can perform a lip-sync detection:

- [Timeline and Xsheet Views](#) below
- [Generating a Lip-sync Detection](#) above
- [Layer Properties View](#) on the next page

### Timeline and Xsheet Views

To generate a sound detection for your lip-sync using the Xsheet or Timeline view:

1. To show the mouth chart letters, if they are not already present in the Xsheet view, right-click on the sound column and select **Lip-Sync > Sound Display > Mouth Shapes** from the pop-up menu.
2. In the Xsheet view or Timeline view, right-click on the sound layer's cells and select **Lip-Sync > Auto Lip-Sync Detection** from the pop-up menu. You can also select **Animation > Lip-Sync > Auto Lip-Sync Detection** from the top menu.



Animate analyzes the selected sound clips and assigns a lip-sync letter to each frame. The X markers in the frame are replaced by these designated letters.

### Sound Element Editor

To generate a sound detection for your lip-sync using the Sound Element Editor:

1. Either double-click the sound layer name in the Timeline view or the sound column header in the Xsheet view to open the Sound Element editor.
2. In Sound Element panel, select the waveform you want to generate the mouth chart for.
3. Right-click on the sound file and select **Auto Lip-Sync Detection** from the pop-up menu.

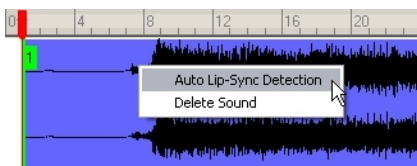

A progress bar appears while Animate analyzes the selected sound clips and assigns a lip-sync letter to each sound cell.

## Layer Properties View

To generate a sound detection for your lip-sync using the Layer Properties view:

1. In the Timeline or Xsheet view, select your sound layer.
2. In the Layer Properties, click on the Detect button.

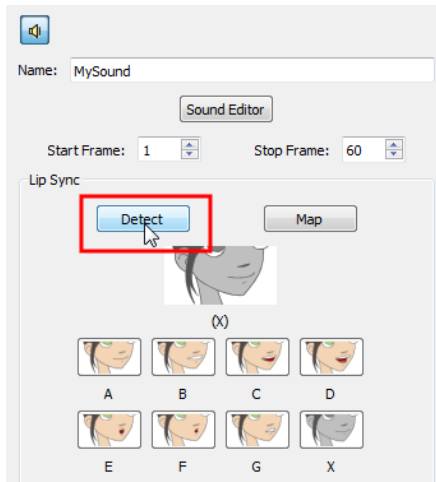

A progress bar appears while Animate analyzes the selected sound clips and assigns a lip-sync letter to each sound cell.

### Related Topics

- [Manual Lip-sync on page 635](#)
- [Mapping the Lip-Sync Detection below](#)
- [Modifying the Lip-sync Detection on page 633](#)

## Mapping the Lip-Sync Detection

Animate can automatically map drawings in an element to the mouth chart you have generated for a sound. This can save time when you are lip-synching a voice track.

In the Lip-Sync Mapping dialog box, you can identify each lip drawing of a character. Animate then automatically labels all of the cells in the character's element with the appropriate name.

To automatically map lip-sync drawings to a mouth layer:

1. To open the Lip-Sync Mapping dialog box:
  - In the Timeline view, right-click on any cell in the sound sample layer. From the pop-up menu, select **Lip-Sync > Map Lip-Sync**. You can also select **Animation > Lip-Sync > Map Lip-Sync** from the top menu.
  - OR
  - In the Timeline view, select your sound layer and in the Layer Properties view, click on the Map button.

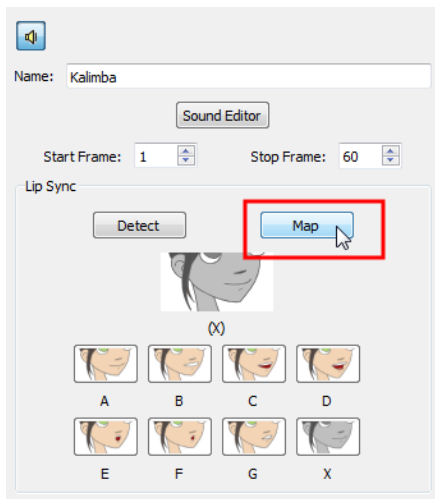

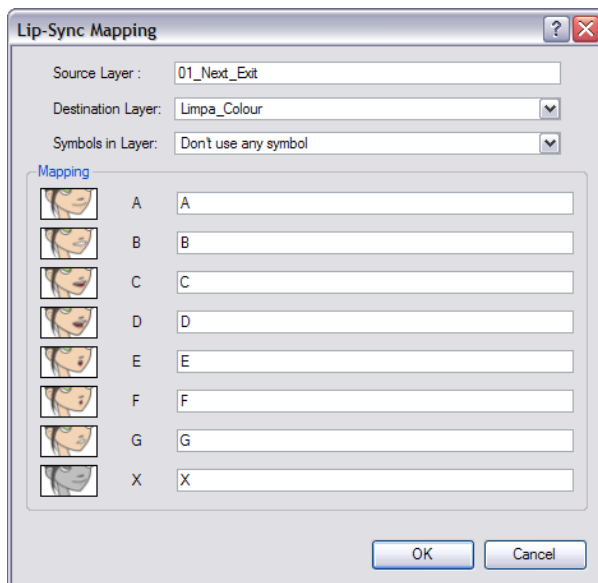

The Lip-Sync Mapping dialog box opens.

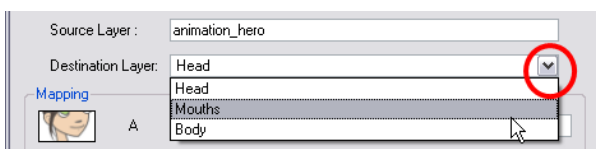

- From the **Destination Layer** drop-down list, select the layer that contains the mouth positions for the character's voice track.



- If the selected layer contains symbols, you can map the lip-sync using drawings located directly on the layer or use the symbol's frames. In the Symbol Layer field select **Don't Use Any Symbol** if you want to use the drawings or select the desired symbol from the drop-down menu.
- In the Mapping section, type the drawing name or Symbol frames in the field to the right of the phoneme it represents. If your drawings are already named with the phoneme letters, you do not have to do anything.
- Click on the OK button.

- Press the Play  button in the Playback toolbar to see and hear the results in the Camera view. To play back your scene with sound, enable the Sound  button in the Playback toolbar.

## Related Topics

- [Generating a Lip-sync Detection on page 630](#)
- [Manual Lip-sync on page 635](#)
- [Modifying the Lip-sync Detection below](#)

# Modifying the Lip-sync Detection

You can change the mouth position that has been assigned to a frame if you think that another position would be more appropriate.

For example, you may have a character who says nothing for ten frames, in between two speeches. Animate would normally assign an X image for the silence period. However, if you want your character's mouth to hang open in astonishment for these ten frames, you can change the lip assignment for these frames from an X to an F.

### To change the lip assignment of a sound in the Xsheet:

- Right-click in the cell that contains the mouth position that you want to change.
- From the pop-up menu, select **Lip-Sync > Change Mouth Shape to** and choose the letter that reflects the mouth position that you want to use for that sound. You can also select **Animation > Lip-Sync > Lip-Sync > the desired mouth shape** from the top menu.

The drawing will automatically be updated in the **Camera** view.

You can also change the mouth assignment of a sound in the Sound Element editor.

### To change the mouth position assignment of a sound from the Sound Element editor:

- Either double-click the sound layer name in the Timeline view or the sound column header in the Xsheet View to open the Sound Element editor.
- In the Sound Element panel, drag the frame slider to the frame you want to change the mouth position assignment on.

In the Lip-sync image area, the image on top represents the lip position assigned to the current frame.

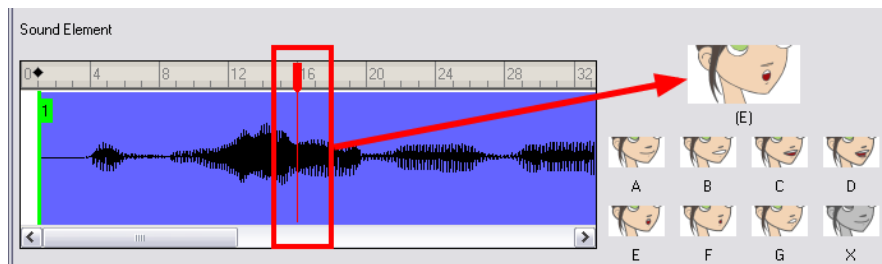

- To change the image assigned to the frame, click on the image of the mouth position you want from below the preview image. The preview image changes to the mouth position image you select. You can perform the same operation in the Layer Properties view.

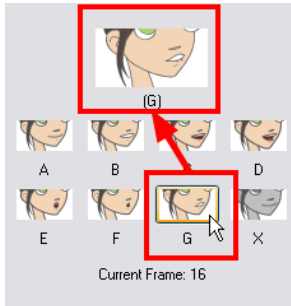

The position will also be updated in the Timeline and Xsheet views.



Note that if you modify the lip-sync detection you must remap the detection to your mouth layer. See [Mapping the Lip-Sync Detection](#)

## Related Topics

- [Recomputing the Mouth Chart below](#)

## Recomputing the Mouth Chart

When you generate the mouth chart for a sound in a sound element, you can either accept the mouth positions assigned by Animate or assign your own lip-sync images.

However, if you change the sound's start frame or reassign its mouth position, you must reanalyze the sound and regenerate the mouth chart for it. This erases any manual modifications you may have made to the mouth assignments in the mouth chart.

### To recompute the mouth chart for a selected sound from the Sound column:

- In a Sound column in the Xsheet or Timeline view, right-click on a cell that contains the sound file you want to recompute the lip-sync for. Select **Lip-Sync > Auto Lip-Sync Detection** from the pop-up menu. The mouth position assignment for each frame is recomputed, erasing any modifications you have made.

### To recompute the mouth chart for a selected sound from the Sound Element Editor:

- Either double-click the sound layer name in the Timeline view or the sound column header in the Xsheet view to open the Sound Element editor.
- Click on the waveform in the Sound Element section in the Sound Element editor.
- Right-click and select **Auto-Lip Sync Detection** from the pop-up menu.



## Related Topics

- [Generating a Lip-sync Detection on page 630](#)

# Manual Lip-sync

Animate allows for the manual swapping of mouth position drawings to match a voice track. For this process, both sound scrubbing (listening to a soundwave broken up frame-by-frame) and drawing substitutions from the Library View are used.

## To perform a manual lip-sync:

1. In the Playback toolbar, enable the **Sound Scrubbing**  button.
2. In the Timeline view, drag the red position indicator along the sound layer waveform.
3. When you reach a frame where a mouth position should go, for example, an open mouth with rounded lips for an "oh" sound, click on that frame on your mouth shapes layer.
4. In the Timeline view, click on the **Expand**  button to display the Data view.
5. Staying on your mouth shapes layer, place your cursor on top of the drawing name (often a letter) until it changes to the swapping  pointer.
6. Pull the cursor to see the list of mouth shape names and choose the one you want. The current drawing automatically changes to the new selection.

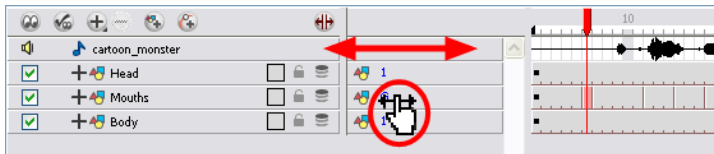

You can also use the Library view to swap drawings.

## To perform a manual lip-sync using the Library view:

1. In the Playback toolbar, enable the **Sound Scrubbing**  button.
2. In the Timeline view, drag the red playhead along the waveform of your sound layer.
3. When you reach a frame where a mouth position should go, for example, an open mouth with rounded lips for an "oh" sound, click on that frame on your mouth shapes layer.
4. In the Drawing Substitution window of the Library view, click and drag the slider to choose a mouth shape. The current drawing is swapped for the one in the preview window.

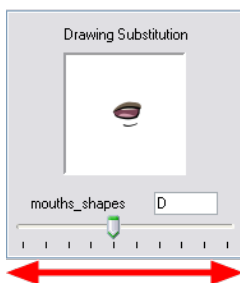

## Related Topics

- [Preview and Drawing Substitution on page 524](#)
- [Sound Scrubbing on page 614](#)

# Sound Preferences

When working with sound in Animate, you can set some preferences to help you work more efficiently.

## Timeline Tab

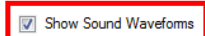

### Show Sound Waveform

Enable this option if you would like to see your imported sound's waveform in the Timeline view.



You can always toggle the visibility of the waveform in the Timeline view by adding the Show Sound Waveform button from the Toolbar Manager. This button will work whether you have the Show Sound Waveform option enabled or disabled in the Preferences panel.

## Sound Tab

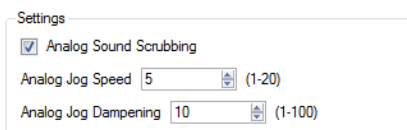

### Analog Sound Scrubbing

Enable this option to switch from digital to analog sound scrubbing.

### Analog Jog Speed

Choose a value between 1-20 for the Analog Jog Speed. The greater the jog speed value, the slower you can scrub to have the sound play at an average pace. This controls how sensitive you would like the jog slider or dial to be.

### Analog Jog Dampening

Choose a value between 1-100 for the Analog Jog Dampening. The greater the value, the less precise the software is at responding to the jog's changes in speed. However, the greater the value, the more smooth the play back is using the jog slider or dial.



# Chapter 14: Animation Paths

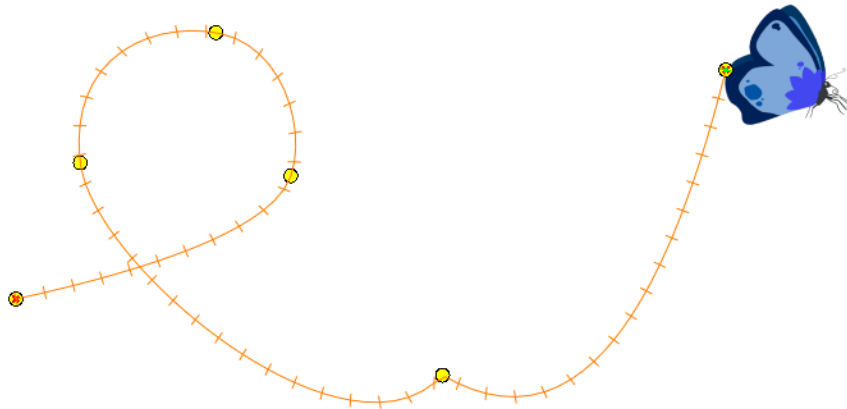

Movement is the essence of creating an animation; it is essentially what animation is: bringing drawings to life. Sometimes this movement comes from the characters or objects themselves, while other times, it is the camera moving through elements set-up on the camera "stage". Often these movements can be complex, such as a helicopter moving across the screen with its rotor blades rotating, as the helicopter disappears into the distance, it appears to get smaller in size as it recedes in space. Although this seems like a simple motion, you must coordinate three movements to produce the correct effect.

The sophisticated systems integrated in Toon Boom Animate have been specifically developed to accommodate the your complex motion needs.

## Topics Covered

- [Animating a Layer](#) on page 639
- [Differences between Pegs and Animated Layers](#) on page 642
- [Adding and Deleting Keyframes](#) on page 650
- [Stop-motion and Motion Keyframes](#) on page 653
- [Animating the Camera](#) on page 658
- [Modifying a Path in the Camera View](#) on page 662
- [Modifying a Path in the Timeline View](#) on page 672
- [Modifying a Path in the Function View](#) on page 676
- [Modifying a Path in the Xsheet View](#) on page 681
- [Function Curves](#) on page 683
- [Copying and Pasting a Motion](#) on page 692
- [Adjusting the Ease](#) on page 701
- [Expression Columns](#) on page 1

- [Animation Path Preferences](#) on page 708

# Animating a Layer

This section describes the basics of animating a layer. Animate's wide range of features let you produce accurate trajectories. However, before reaching this level you must learn how to create a simple motion and practice everything you learn in this chapter.

In this topic, you will find out about the two key elements in creating a motion:

- [Animate Mode](#) below
- [Animating a Layer](#) below
- [Enabling the Playback](#) on page 641

## Animate Mode

If you enable this mode when you animate layers, Animate will apply a transformation to the current frame. If you don't, it will apply a transformation on the entire layer instead of only the current frame.

To enable the Animate Mode:

- In the Tools toolbar, click the **Animate Mode**  button.

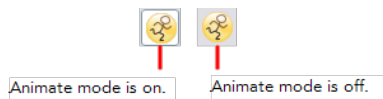

The Animate Mode button is highlighted.



## Animating a Layer

Follow these simple steps to perform a basic layer animation.

To animate a layer:

1. In the Tools toolbar, select the Transform  tool or press [Shift] + [T].
  - In the Tool Properties view, make sure the **Peg Selection Mode**  button is disabled so you can select your drawing layer directly and not the pegs. Refer to the section to learn more about this option.
2. In the Tools toolbar, enable the **Animate**  mode .
3. In the Timeline view, go to the first frame.

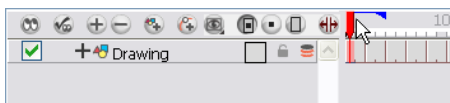

4. In the Camera view, select the element to animate and move it to its first position.

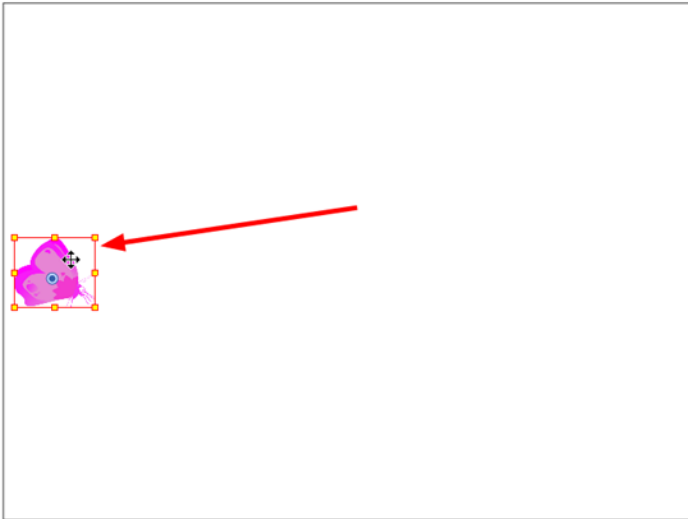

5. In the Timeline view, go to the frame where you would like to set the second position.

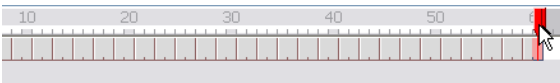

6. In the Camera view, move the selected element to its new position.

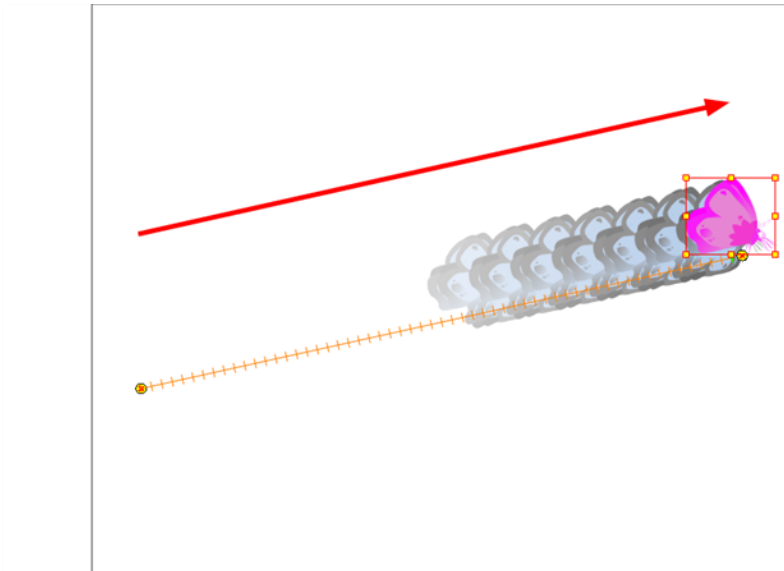

Refer to [Displaying a Path in the Camera View](#) on page 662 to learn how to display the trajectory.

7. In the Playback toolbar, click the Play  button to view your work.

# Enabling the Playback

To see your motion animations in the **Top**, **Side** or **Perspective** views while you play back, you must enable the Playback option.

To enable the Playback option:

1. In the top menu, select **Play > Enable Playback > Top View, Side View or Perspective View**.

## Related Topics

- [Stop-motion and Motion Keyframes on page 653](#)

# Differences between Pegs and Animated Layers

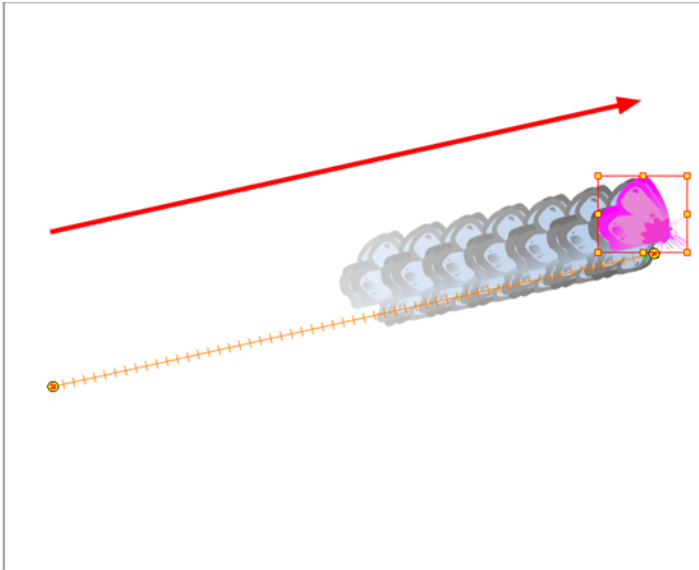

To animate the position of your drawings you need to create motion paths. Motion paths are trajectories on which you can hook your drawing objects to. You will use keyframes to record the key positions along this trajectory.

There are two ways in which to create motion paths:

- [Animated Layers below](#)
- [Pegs on the next page](#)

Animated drawing layers and pegs have different purposes which you will discover in the following topics.

## Animated Layers

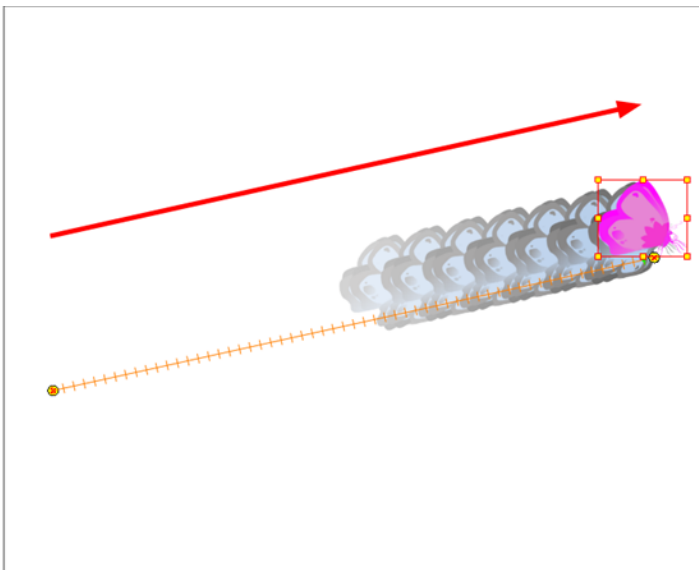

You can create a motion path directly on your layers.

Drawing layers can house drawings and symbols. Also, in that same layer you can create a motion path using keyframes and all the artwork contained in the layer will follow.

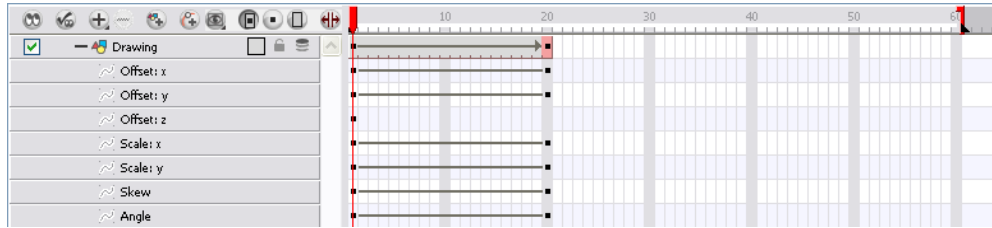

You can control and define your trajectory using several different parameters. These parameters are:

- X, Y and Z positions
- Angle (rotation)
- Skew
- X and Y scales

Each parameter has its own function curve where you can add keyframes and control the easing.

Do not worry about using graphs and function curves if you are not familiar with this concept. Animate has a series of easy-to-use tools for visually controlling your trajectories in the **Camera** view.

To animate a simple object such as an arrow in flight or a wheel spinning, you can use the integrated trajectory. Also, each part of a cut-out puppet will be animated directly on the drawing layer.

## Related Topics

- [Pegs below](#)
- [Layer Parameters on page 645](#)

# Pegs

A Peg layer is a trajectory that contains no drawings on which you can hook your drawings.

## Related Topics

- [Why Use a Peg Layer? below](#)
- [The Origins of the Peg on the facing page](#)
- [Adding a Peg to the Timeline View on page 645](#)
- [Pegs above](#)

## Why Use a Peg Layer?

A peg is composed of many customizable parameters including:

- X, Y and Z positions
- Angle (rotation)

- Skew
- X and Y scales
- 3D Rotation (when the 3D option is enabled)

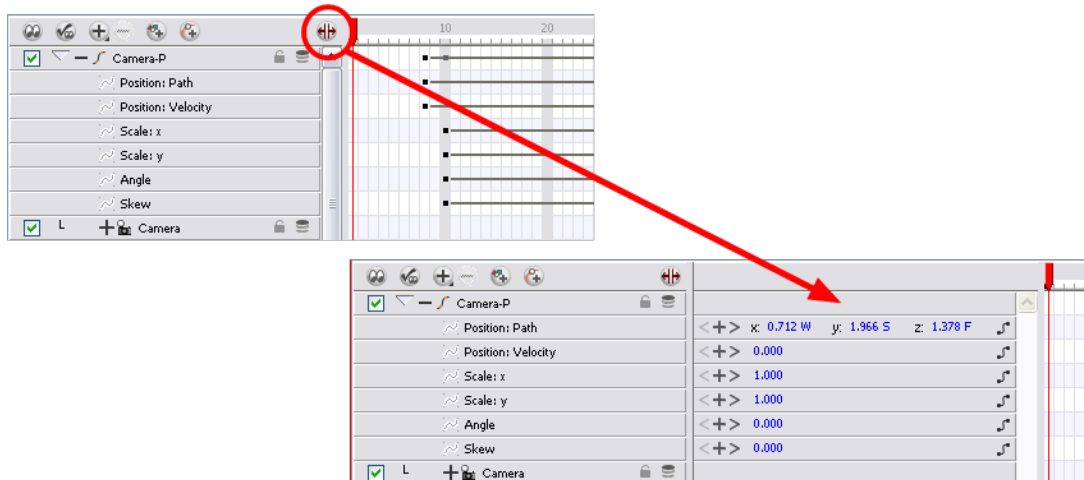

You can control a peg's trajectory the same way as the animated drawing layer.

Peg layers are mainly used to control a series of drawing layers together. If you have several drawing layers such as clouds or a character split into many parts, you can hook those to a peg layer and have them follow a trajectory as one unit. When building a puppet, most of the time you will add a master peg to control your puppet as one object.

## The Origins of the Peg



Pegs have been used for a long time in the traditional animation process, mainly for registration purposes. Peg holes at the bottom (or top) of animation paper are used to keep all of the sheets even and at the same registration.

There are three peg holes in regular animation paper. The centre peg hole is circular while the left and right ones are rectangular. These rectangular peg holes are situated, one on each side and four inches away from the centre peg hole.

To keep the drawings together, the animator uses a peg bar. This peg bar has three pins corresponding to the shape and location of the peg holes. Peg bars are normally found at the bottom and top of animation discs.



Before digital compositing, the peg bars were also used to move levels under the camera stand. They were the equivalent of digital trajectories. Animate makes use of these concepts to create animation and camera moves.

## Adding a Peg to the Timeline View

To add a peg:

1. Select the layer on which you want to attach to the peg.

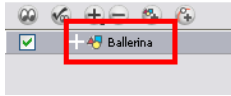

2. Add the peg by doing one of the following:

- ▶ From the Timeline View layers' toolbar, click the **Add Peg**  button.
- ▶ From the top menu, select **Insert > Peg**.
- ▶ Right-click on the layer and select **Add > Peg**.

The layer that was originally selected becomes a child of the new parent peg layer.

The new peg layer automatically takes the name of its child layer, with the addition of the suffix **-P**.

The indentation of the layer, along with the L-shaped line indicates hierarchy and that the layer is attached to the Peg layer. Their relationship is known as *parent-child*.

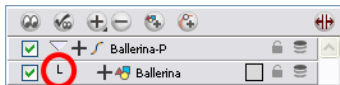

If you intend adding multiple pegs, or if the layer name that was added to the peg does not accurately represent the content of the peg layer, you can rename it. You can do this by clicking on the layer name and typing in the editable field, or double-clicking on the layer and entering the new name into the dialog box.



If you did not create your peg layer directly above the layer you intended on parenting it to, then click and drag the layer you want to attach to the peg and drop it directly below the peg layer. The indentation of the layer below the Peg layer will be an indication of whether it was correctly attached or not.



### Related Topics

- [Layer Parameters below](#)

## Layer Parameters

A layer is composed of many customizable parameters, such as the X, Y and Z positions, angle (rotation), skew and scales. Each parameter has its own function. A function is a mathematical formula expressing a relation between position values. You can view each function on a graph as a simple curve such as this one.

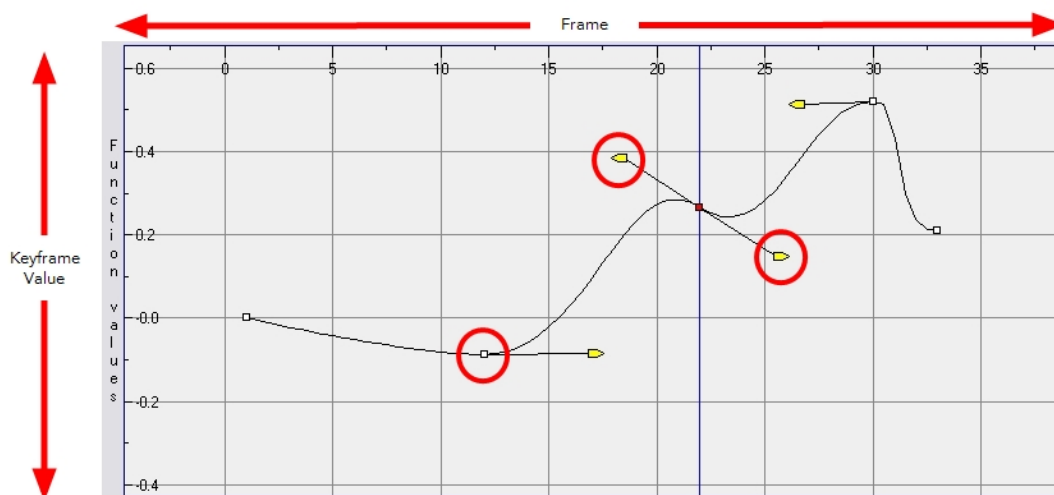

Learn more:

- [3D Path](#) on the next page
- [Separate Positions](#) on page 648
- [Locked Scales and Separated Scales](#) on page 648
- [Setting the Parameters](#) on page 648

To display the Layer parameters in the Timeline View:

- In the **Timeline**'s left-hand side, click on the **Expand Function**  $\oplus$  button or press [Alt] + [F].

OR

- Select the layer whose functions you want to display, go to the **Timeline View** menu and select **View > Show Functions**.

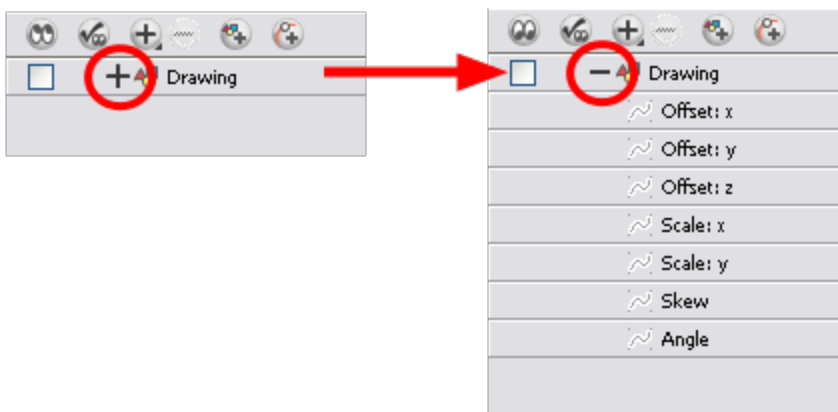

There are six options available for setting up the function parameters:

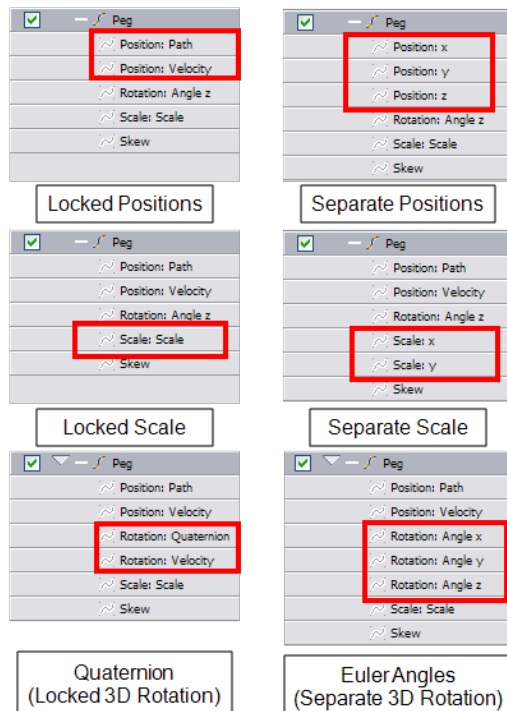

- Locked Positions (3D Path)
- Separate Positions
- Locked Scales
- Separate Scales
- Quaternion (3D Rotation)
- Euler Angles (3D Rotation)



You can set the preferences to suit your way of working. In your general preferences, enable **Default Separate Positions** to get separate X, Y and Z positions, or disable it to get a 3D path. The 3D path is set by default.

Enable the **Default Separate Scale** to get separate X and Y scales. It is highly recommended that you use default separate scales.



You must lock or unlock your functions before starting the animation. When you lock or unlock parameters, this does not convert the functions from one to the other, but creates new ones.

## 3D Path

In a 3D Path, the X, Y and Z curves are locked together and controlled by a single velocity function. When you add a keyframe, it is added on all three trajectories at once, as is the velocity. This is very useful for long, smooth trajectories.

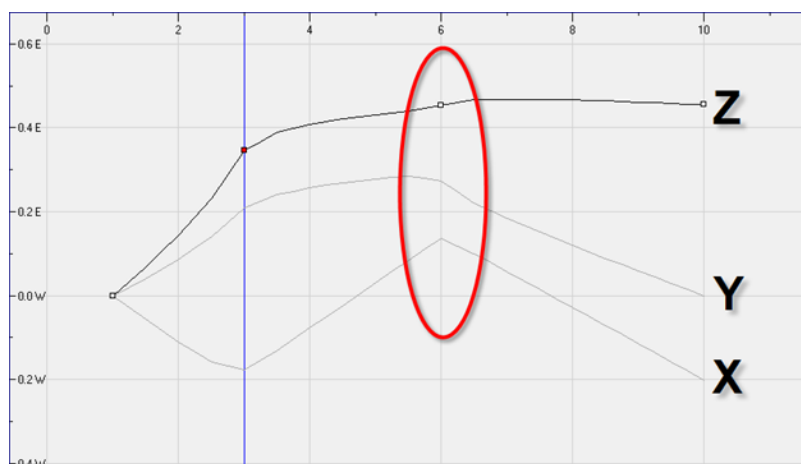

## Separate Positions

When the **Separate Positions** option is used, the X, Y and Z curves are independent and have velocity controls directly on their function curve. This is useful when you want to set keyframes on one of the curves without affecting the others.

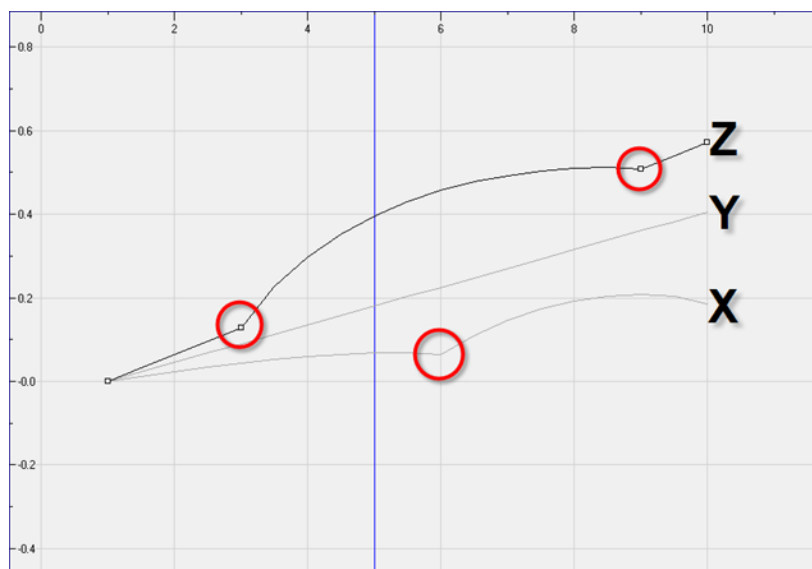

## Locked Scales and Separated Scales

When using the scale function, you can have a single function curve controlling both the vertical and horizontal scale, or have the two scales separate. This means that when using the single function, the values will be the same for the X (horizontal) and the Y (vertical) axes, enabling a uniform size change without distortion. However, if you separate the scale functions, you will be able to squash, stretch and skew your elements.

## Setting the Parameters

This topic will cover the 2D motion parameters.

## To set the parameters:

1. In the Timeline view, double-click the layer on which you want to set the parameter.  
The Layer Properties editor opens.

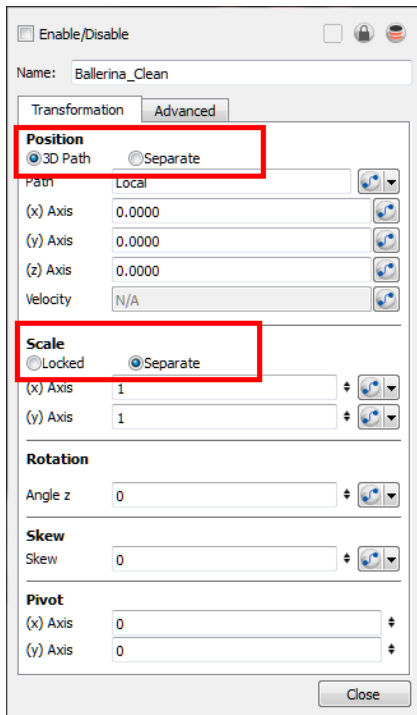

2. Select the **Transformation** tab.
3. In the Position section, select the **3D Path** or **Separate** option.
4. In the Scale section, select the **Locked** or **Separate** option.
5. Click **Close**.

## Related Topics

- [3D Parameters](#)
- [3D Space](#)

# Adding and Deleting Keyframes

You can create a keyframe in several different ways. You can add a coordinate keyframe, position keyframe or a keyframe along with your drawing duplication.

## Related Topics

- [Coordinate Keyframe](#) below
- [Add Keyframe and Duplicate Drawing](#) below
- [Position Keyframe](#) on the next page
- [Delete Keyframe](#) on the next page

## Coordinate Keyframe

To create keyframes:

1. In the Timeline view, select the cell where you want to add a keyframe.



2. Do one of the following:
  - ▶ In the top menu, select **Insert > Keyframe**.
  - ▶ Right-click on the selection and select **Add Keyframe**.
  - ▶ Click the **Add Keyframe**  button in the Timeline View toolbar.
  - ▶ In the Camera view, if the **Animate** mode is enabled, as soon as you move the selected element, a keyframe will be automatically created on the current frame.

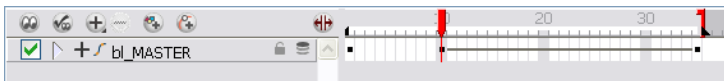

## Add Keyframe and Duplicate Drawing

The method described previously only creates a keyframe without a drawing. It adds a new coordinate points but the drawing in the layer stays the same. You may want to duplicate your drawing at the same time if you need to modify it and do not want to modify the original one. In this case, you can use the Add Keyframe and Duplicate Drawing function.

To create a keyframe and duplicate your drawing at once:

1. In the **Timeline** view, select the cell containing the drawing where you want to add a keyframe and duplicate.

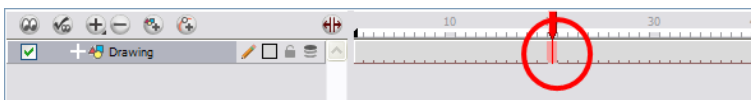

2. Here are the different ways to add a keyframe and duplicate:

- ▶ In the top menu, select **Insert > Keyframe and Duplicate Drawing**.
- ▶ Right-click on the selection and select **Insert Keyframe and Duplicate Drawing**.

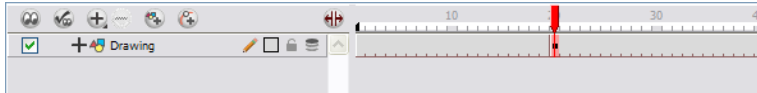

## Position Keyframe

You can also add a Position keyframe instead of a regular keyframe. When you add a Position keyframe, keyframes will only be added on the X, Y and Z parameters of the selected layer. Keyframes are not added on the **Angle**, **Scale** and **Skew** parameters.

**To add a Position keyframe:**

1. In the Timeline view, select the cell where you want to add a position keyframe.



2. In the top menu, select **Insert > Position Keyframe**.
  - ▶ If you select a keyframe in the Timeline view and press the [Delete] key, you will also delete the drawing exposure. To only delete the keyframe, you must use the **Delete Keyframe** command.

## Delete Keyframe

**To delete a keyframe:**

- ▶ With the **Transform**  tool selected, choose the keyframe to be deleted from the trajectory in the **Camera** view and press the [Delete] key.

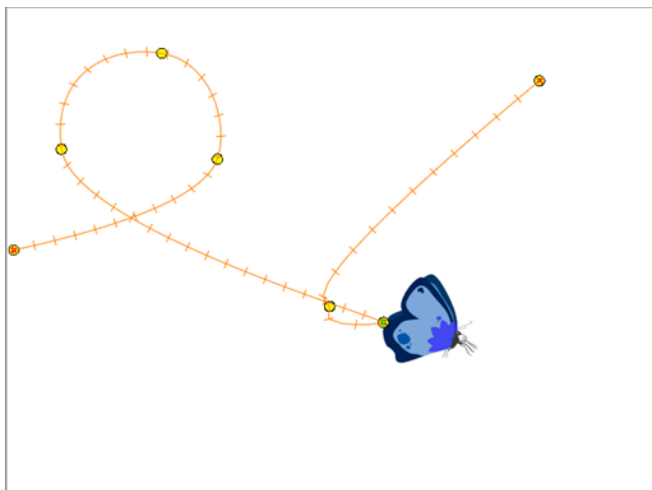

OR

- ▶ In the Timeline view, click on the keyframe to be deleted, right-click and select **Delete Keyframes** or press [F7]. You can also select **Animation > Delete Keyframe** from the top menu.

## Related Topics

- [Modifying a Path in the Camera View on page 662](#)
- [Modifying a Path in the Timeline View on page 672](#)
- [Modifying a Path in the Function View on page 676](#)



# Stop-motion and Motion Keyframes

Interpolation is the computer-generated motion between two keyframes. Some animators and composers create their own in-betweens, others have the computer do it. Animate gives you stop-motion and motion keyframes.

- [Stop-motion Keyframes](#) below
- [Motion Keyframes](#) below

## Stop-motion Keyframes

A stop-motion keyframe means that there is no computer-generated motion between two keyframes. The segment is constant or flat.

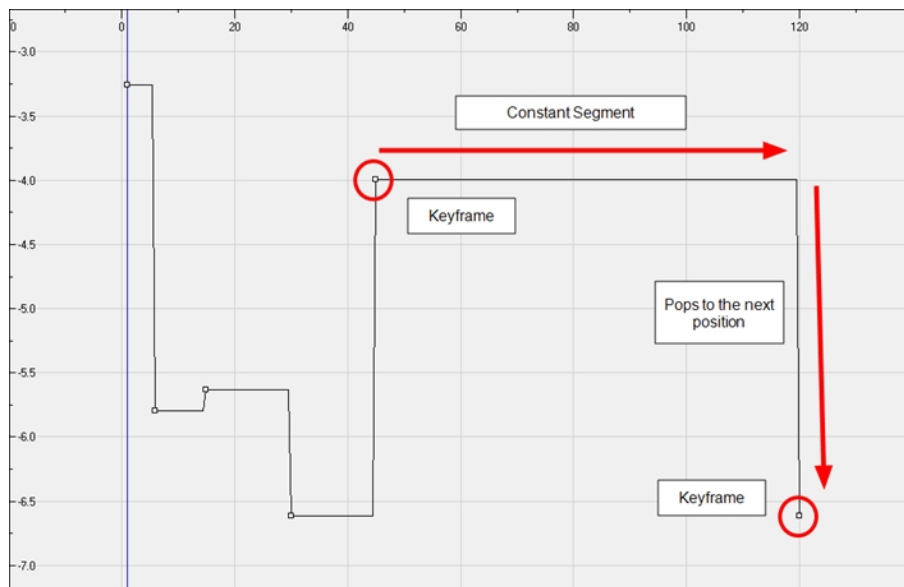

## Motion Keyframes

A motion keyframe means that there is computer-generated motion between two keyframes. The segment has a variation over time.

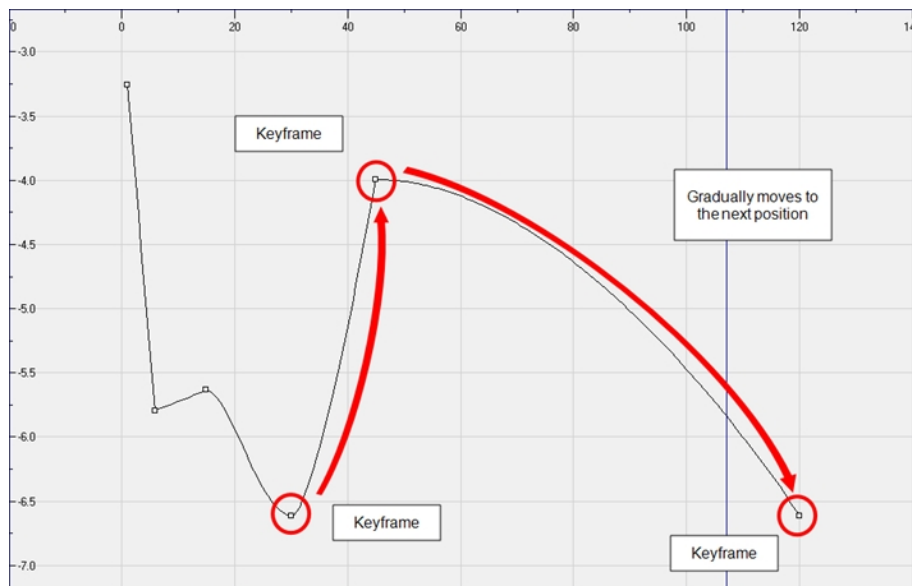

## Related Topics

- [Toggling between Motion and Stop-motion Keyframes below](#)
- [Constant Z on page 657](#)



# Toggling between Motion and Stop-motion Keyframes

You can switch a keyframe between stop-motion and motion at any time in the Timeline view and Function Editor.

To toggle between motion and stop-motion in Timeline view:

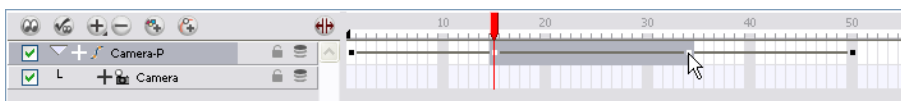
1. On the right side of the Timeline view, select one or more keyframes to be modified.



2. To toggle between motion and stop-motion:
  - ▶ Right-click on the selected keyframes and select **Set Motion Keyframes** or **Set Stop-Motion Keyframes**.
  - ▶ Press [Ctrl] + [L] and [Ctrl] + [K] (Windows) or [⌘] + [L] and [⌘] + [K] (Mac OS X).
  - ▶ In the Timeline View toolbar, click the **Motion Keyframe**  and **Stop-Motion Keyframe**  buttons.
  - ▶ In the Camera view, select the keyframe to convert. In the Coordinates and Control Point view, select/deselect the **Stop-Motion Keyframe** option.

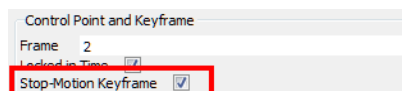

## To toggle between motion and stop-motion keyframes in the Function Editor:

### 1. Open the **Function Editor**:

- In the Timeline view, double-click on the layer that contains the keyframes you want to convert.

The Layer Properties dialog box opens.

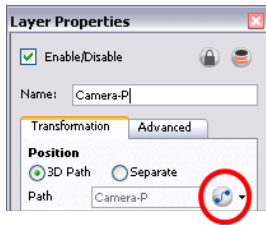

In the Transformation tab, click the **Function Editor**  button to display the **Editor** window.

OR

- In the Timeline view, click the **Expand Function**  button and double-click on the function to edit.

You can also press [Alt] + [F].

### 2. Select one or more keyframes to be modified on the function curve.

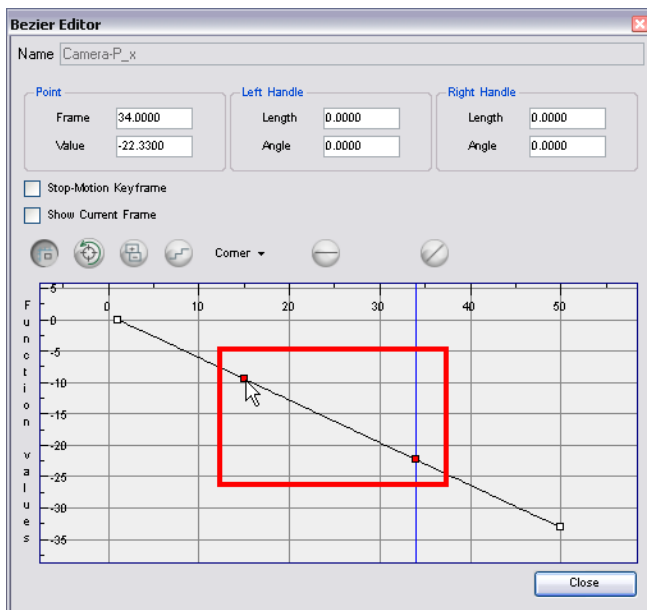

### 3. Select/deselect the **Stop-Motion Keyframe** option to set a stop-motion or motion keyframe.

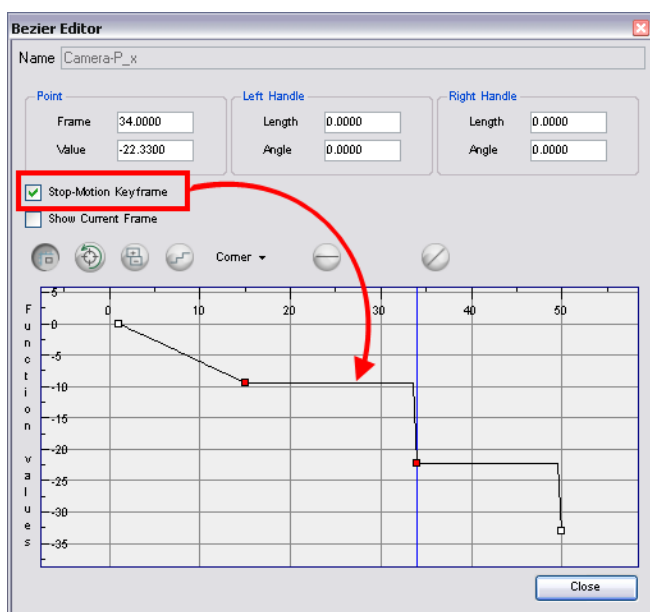

## Setting a Different Colour for Stop-motion and Motion Keyframes

In the **Preferences** dialog box, you can set a different colour for your stop-motion keyframes in order to create a greater visual difference in the Timeline view.

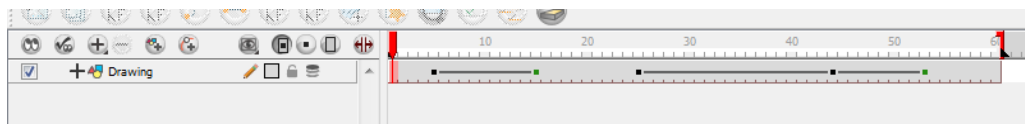

To set the stop-motion keyframe colour:

1. Open the Preferences dialog box by pressing [Ctrl] + [U] (Windows) or [⌘] + [U] (Mac OS X).
2. In the General tab, in the **Colours** section, click on the **Edit Colours** section.
3. In the Colours window, select the **Exposure Sheet** tab.
4. In the Others section, click the **Stop Motion Keyframe** swatch.
5. In the Select Colour window, select a new colour.
6. Click **OK** to close the **Select Colour** window.
7. Click **OK** to close the **Colours** window.
8. Click **OK** to close the **Preferences** dialog box.

### Related Topics

- [Stop-motion and Motion Keyframes on page 653](#)
- [Constant Z on the next page](#)

# Constant Z

The Constant Z is used when creating motion keyframes. The Z function will use stop-motion keyframes and will not be interpolated, this can be very useful for cut-out animation. The Constant Z feature only works with 3Dpaths.

You can also enable the Constant Z option directly in the Function Editor or Function view for specific functions.

## To enable the Constant Z option:

1. In the Timeline view, expand the function of the layer you want to set to **Constant Z**. Note that the 3D Path option must be enabled for that particular layer.
2. Double-click on the **Position** function to open the **Function Editor**.
3. In the Function Editor window, select the **Constant Z** option.

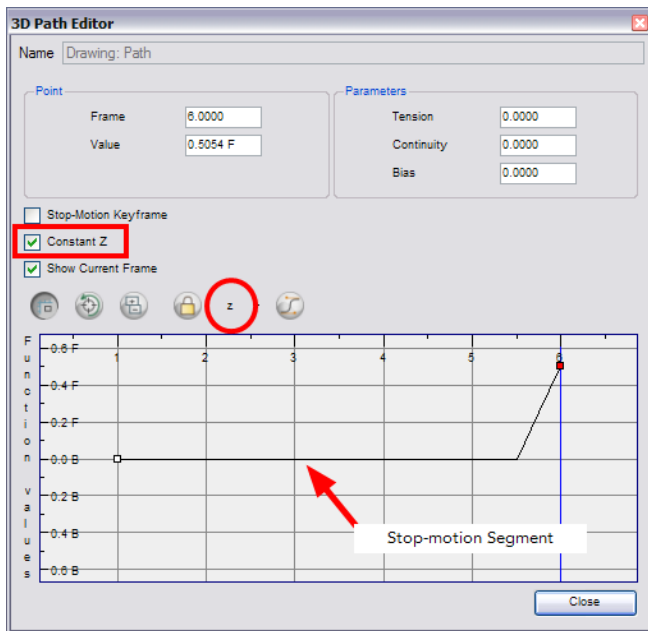

## Related Topics

- [Toggling between Motion and Stop-motion Keyframes on page 654](#)
- [Stop-motion and Motion Keyframes on page 653](#)

# Animating the Camera

Just as in a live-action film, scenes are not only composed of characters moving around in a static camera field, but also of camera movements. Although it is not always something that we think about, often it is the exact opposite—the character is static while the camera moves through elements on the stage. Camera pans, jumps, cuts and zooms are as important to storytelling as the story itself.

Animate has a camera that can move along the X, Y, and Z axes. Having the camera move on the Z-axis offers the possibility to create truck in and truck out, as well as multiplane camera moves. The default camera position is centred and backed up to 12 fields.

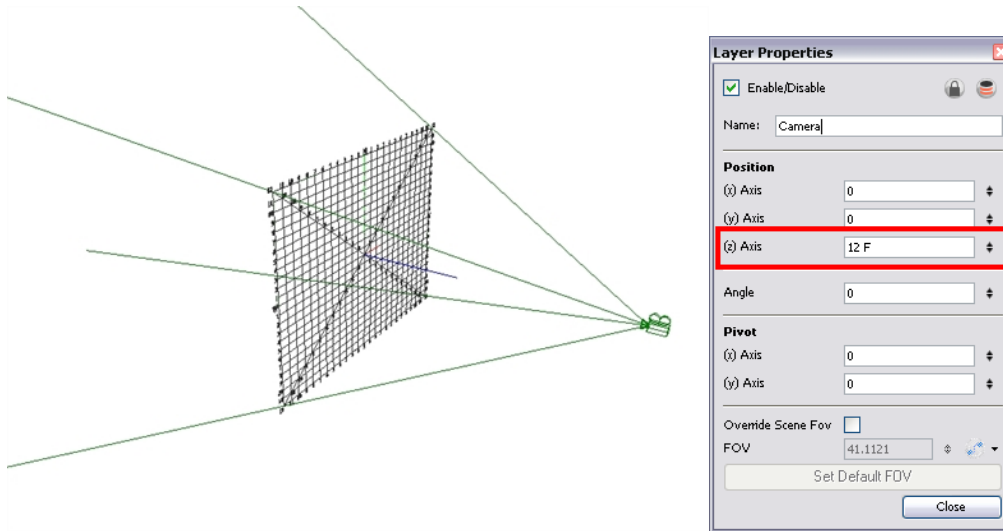

## Related Topics

- [Basic Camera Move below](#)

## Basic Camera Move

The camera is treated the same way as any other element. The same tools and selection modes are used to offset or animate it. To animate the camera, you need to connect it to a peg element.

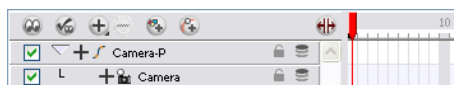

This means that you can animate the camera visually, with the function curve, or by typing values in the Xsheet column.

### To add a camera with a peg to your scene:

1. If you do not already have a camera layer, add one in one of two ways:
  - ▶ From the top menu, select **Insert > Camera**
  - ▶ From the Timeline View Layers toolbar, click the Add Layers  button and select Camera.
  - ▶ From the Library view, select a Camera module and drag it to the Network view.

A new camera layer is added to your scene and appears in the Timeline view.

- From the Timeline View Layer toolbar, click the Add Peg  button.

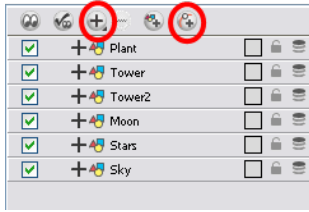

A peg layer appears directly above the camera layer so that the camera layer is automatically attached to it. The peg layer automatically takes on the name of the camera and adds the suffix **-P** to indicate that it is a peg layer, for example **Camera-P**.

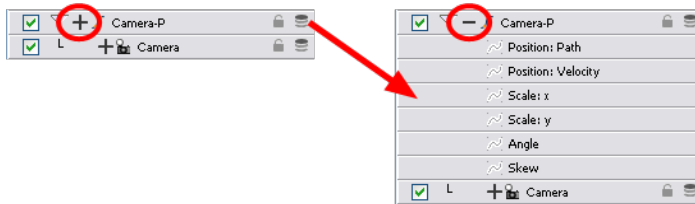

If the new peg layer did not appear directly above the camera, you may have clicked elsewhere in the scene, deactivating the layer on which you want to add the peg layer.

- ▶ Select the camera layer and drag and drop in under the new peg layer.

OR

- ▶ Delete the misplaced peg layer, select the camera layer and click the Add Peg  button again.



You are now ready to animate your camera.

It is recommended to use both the Top and Camera views while making camera moves. You can open this view is one of two ways:

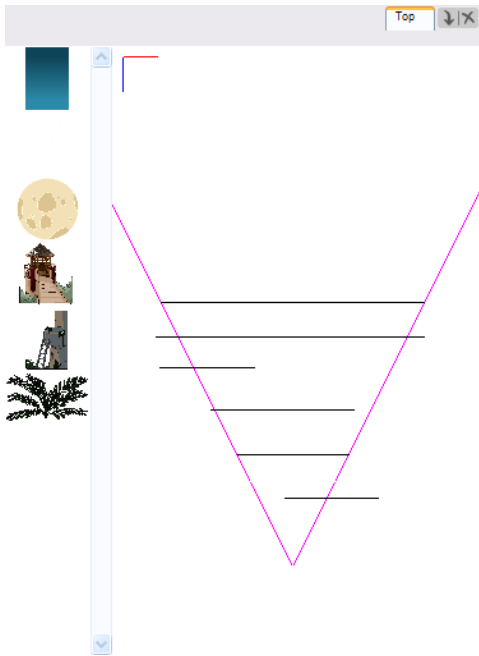
- From the top menu, select **Windows > Top**.
- From any existing window already open in your project, click the arrow  button in the top-right corner and select **Top**.



### To animate your camera:

1. Make sure that the Animate  button and Transform  tool are activated.
2. In the Top, Side or Camera view, select the camera and move it to the desired position.
  - ▶ In the Top and Side view, the camera is the large V cone. You need to click directly on one of the edge.
  - ▶ In the Camera view, the camera is represented by a thin frame. You need to click directly on one of the edge.

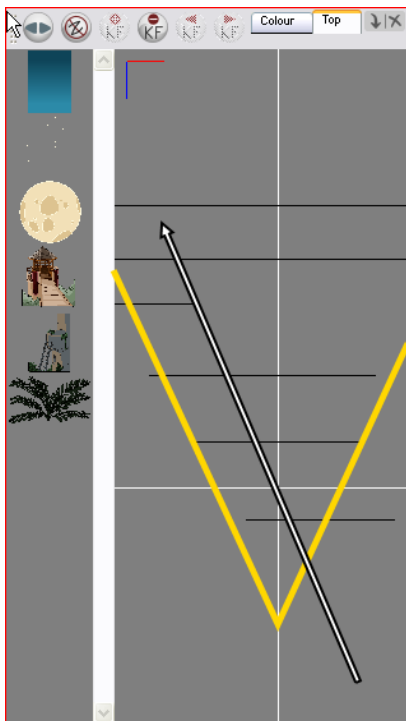

3. In the Timeline view, click on a cell in the Camera Peg layer where you want the camera move to begin.
4. Right-click and select Insert Keyframe.





A keyframe appears in that cell. Any frames preceding this keyframe cell will hold the same camera position as in this keyframe.

5. Click on another cell, further down your scene's Timeline, where you want the camera move to end.
6. Select the camera in the Top view and move it to the desired position.

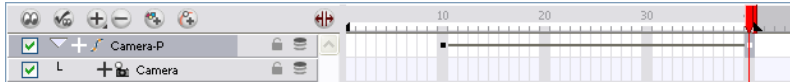

A second keyframe appears and a line is created between the two frames to indicate that the subsequent motion between the frames will be calculated and rendered by the program.

7. Play back  the camera move in the Camera view to watch the results.

## Related Topics

- [Camera Truck-ins and Line Thickness](#)

# Modifying a Path in the Camera View

Although the example cited in the [Animating the Camera on page 658](#) section seems simple enough, camera moves and motion paths can become complex, especially with moves through 3D space. That is why Toon Boom has developed a way to view your camera's path and make adjustments to it from both a 2D and 3D perspective.

## Related Topics

- [Displaying a Path in the Camera View below](#)
- [Shaping a Path on page 664](#)
- [Offsetting a Trajectory on page 670](#)

## Displaying a Path in the Camera View

You can display the trajectory for your motion path when you select an object in the Timeline or Camera view.

If you want to see the trajectory, enable the **Show Control Points on Selected Layers** preference.

To enable the **Show Control Points on Selected Layers** preference:

1. In the top menu, select **Edit > Preferences** (Windows) or **Animate > Preferences** (Mac OS X). The [Ctrl] + [U] (Windows) or [⌘] + [U] (Mac OS X).  
The Preferences dialog box opens.
2. Select the **Camera** tab.
3. In the **Control Points** section, enable the **Show Control Points on Selected Layers** preference.

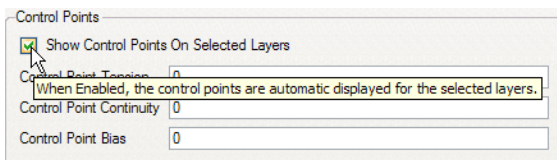

4. Click **OK**.

If the trajectory is hidden when you select an element, you may want to display it using the Control command.

To view your layer's trajectory using the **Control** command:

1. Verify that the **Camera** view (click on its tab) is selected and that the layer that you wish to display the trajectory of is selected in the Timeline view.

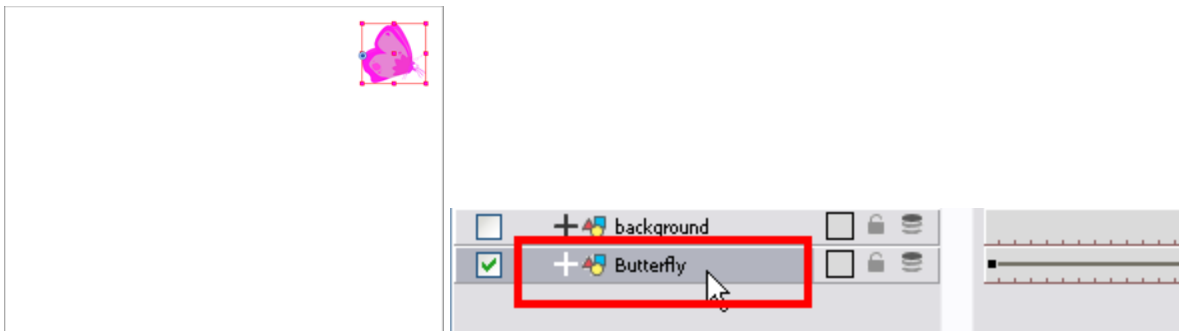

- ▶ From the top menu, select **View > Show > Control**.
- ▶ Press [Shift] + [F11].

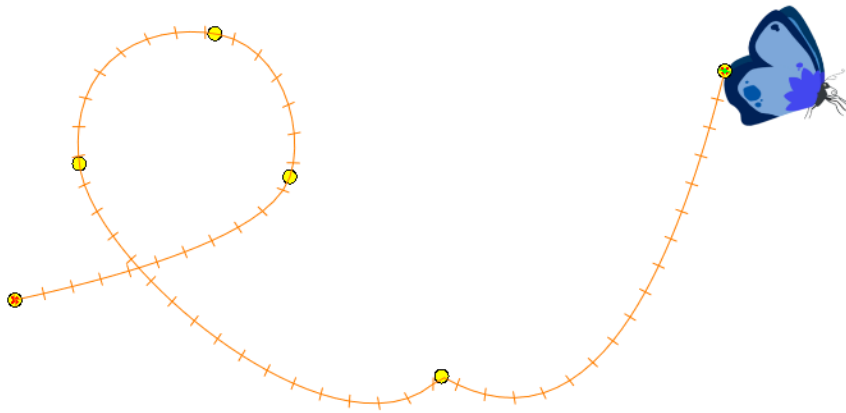

If nothing appears in the **Camera** view, you may not have animated or selected the layer.

### To hide your layer's trajectory:

1. Verify that the **Camera** view (click on its tab) is selected and that the layer that you want to hide the trajectory of is selected in the **Timeline** or **Camera** view.

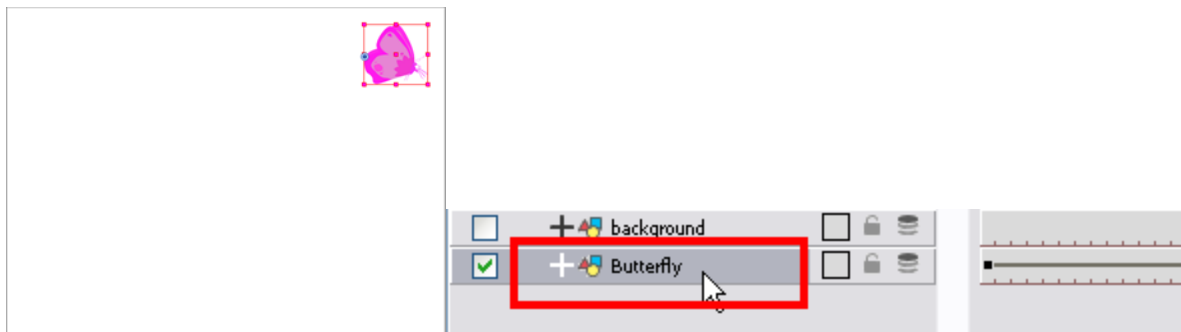

- ▶ From the top menu, select **View > Show > Control**.
- ▶ Press [Shift] + [F11].
- ▶ If you want to hide all of your trajectories at once without selecting any layer, select **View > Hide All Controls** or press [Shift] + [C].

### Related Topics

- [Shaping a Path](#) on the facing page

## Shaping a Path

A motion path is as easy to manipulate as shaping the vector points of a drawing layer in the **Camera** view. One important concept to understand is that a trajectory contains both keyframes and control points. Both can be used to shape a path, each have their own significance and behaviours, however only keyframes appear in the Timeline view. Their descriptions, in terms of their use along a path, are listed below:

- **Keyframe:** A marker that signifies a change (size, position, direction, etc.) along the normal of a path or function and has a precise position and frame.
- **Control Point:** Has a position but no fixed frame or timing. It is mainly used to deform a trajectory. There are no velocity handles available on a control point. The velocity segments are set between keyframes only, making curves and trajectories much smoother. Control points can only be added on 3D Path.



To resize an entire animation path so it fits into your scene's composition better, convert the animation into a Symbol, then resize the Symbol itself. Refer to the [Library on page 521](#) chapter to learn how to create and import Symbols.

You can edit keyframes and control point parameters, such as the position, continuity, bias, tension and lock-in-time using the Coordinates and Control Point view.

## Coordinates and Control Points View

Each time a keyframe or a control point is selected in the Camera, Timeline or Xsheet view, its parameters appear in the Coordinates and Control Points view. You can also see the same information in the Coordinate and Control Point toolbars.

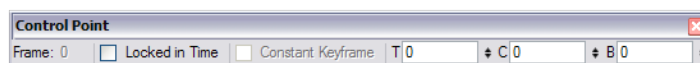
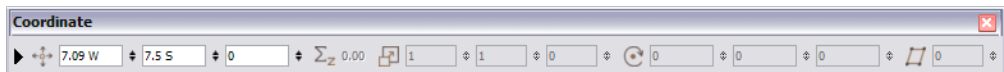
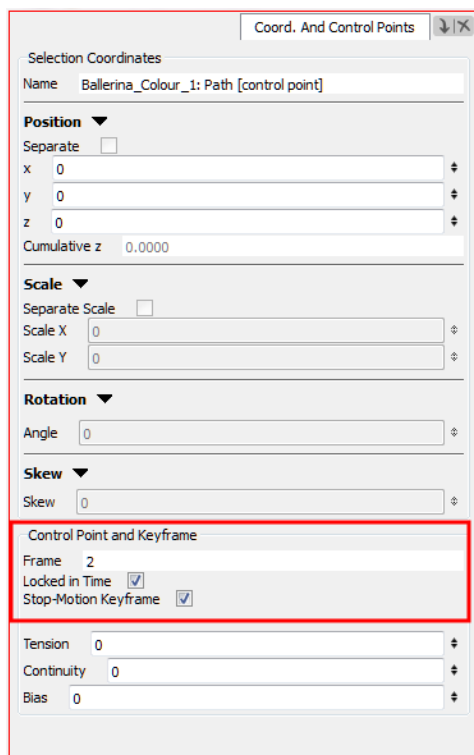

## Adding Control Points

A control point has a position but no fixed frame or timing. It is mainly used to deform a trajectory. There are no velocity handles available on a control point. The velocity segments are set between keyframes only, making curves and trajectories much smoother.

A control point will not show in the **Timeline** view because it has no precise frame to be displayed on. It will appear on the function curve and in the **Camera** view. There are different ways to add control points:

- Displaying the trajectory in the **Camera** view, the [P].
- Add a keyframe on the function curve and disabling the **Lock in Time** option.

The control point is displayed as a circle.

You can display your trajectories in the **Camera**, **Top** and **Side** views to better understand the way that your elements move in your scene. This also makes it easier to modify them. You can display a peg or layer's control to be able to see where your elements are going, modify the curve and add keyframes and control points.

### To add a Control Point on a trajectory:

1. In the **Timeline** or **Camera** view, select the peg or layer you want to add the control point on.
2. If the selected element's trajectory is not displayed, select **View > Show > Control** in the top menu. The [Shift] + [F11].

The trajectory appears in the **Camera**, **Top**, **Side** and **Perspective** views.

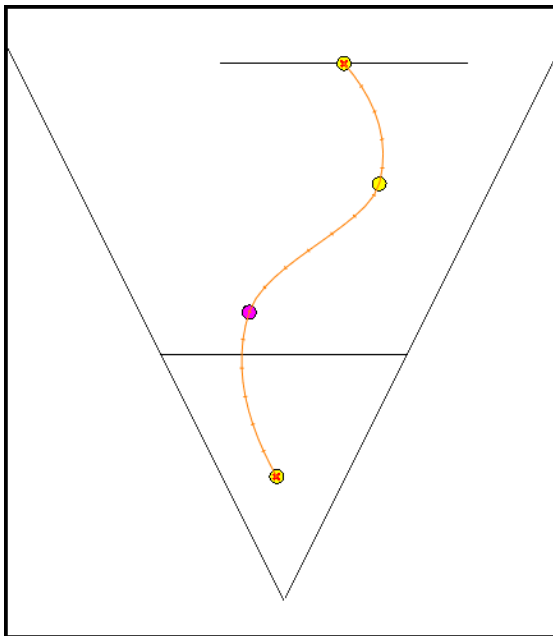

3. You can add control points on a 3D path trajectory by placing your mouse where you want to add the point. The [P].

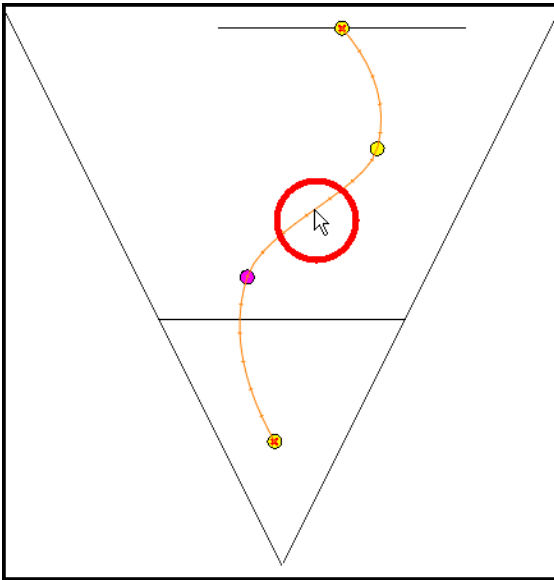

## Toggling Between Keyframe and Control Points

To toggle between Keyframe and Control Points:

1. In the **Camera** view, using the **Transform** tool select the point you want to convert.
2. To convert the point:
  - In the **Coordinates and Control Point** view, enable or disable the **Locked in Time** option.

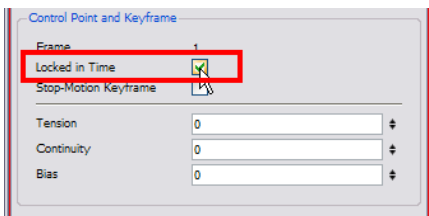

- In the top menu, select **Animation > Lock in Time**. The [Alt] + [L].
- In the **Function** view or **Function** editor, select the keyframe to convert and click on the **Lock in Time** button.

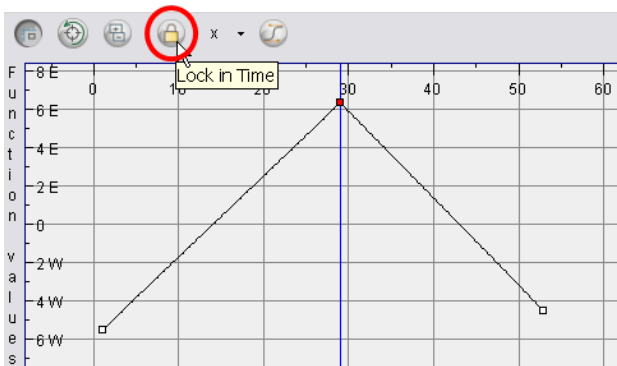

## Related Topics

- [Adjusting the Tension, Bias and Continuity below](#)
- [Modifying a Path in the Camera View on page 662](#)

## Adjusting the Tension, Bias and Continuity

You can edit keyframes and control point parameters, such as the position, continuity, bias, tension and lock in time using the **Coordinates and Control Point** view.

Each time a keyframe or a control point is selected in the **Camera**, **Timeline** or **Xsheet** view, its parameters appear in the **Coordinates and Control Point** view. You can also see the same information in the **Coordinate and Control Point** toolbars.

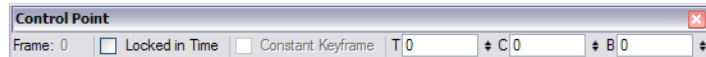
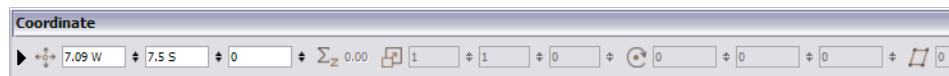
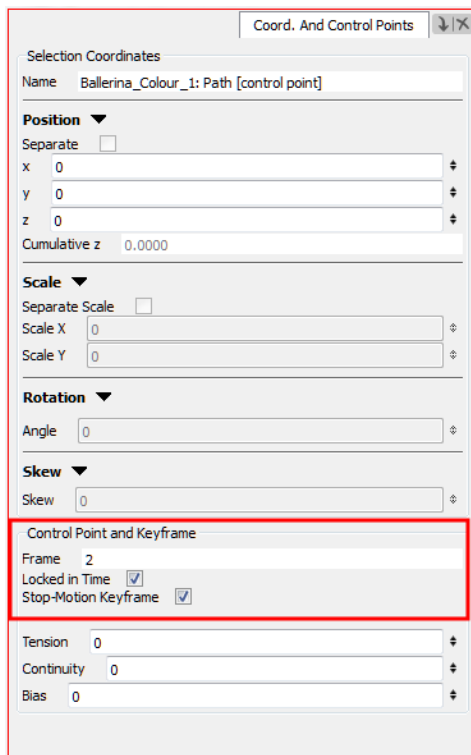

You can adjust the **Tension**, **Bias** and **Continuity** parameters on existing control points and keyframes by selecting the point in the Camera view with the **Transform**  tool.

- **Continuity** controls the smoothness of a transition between the segments joined by a point.

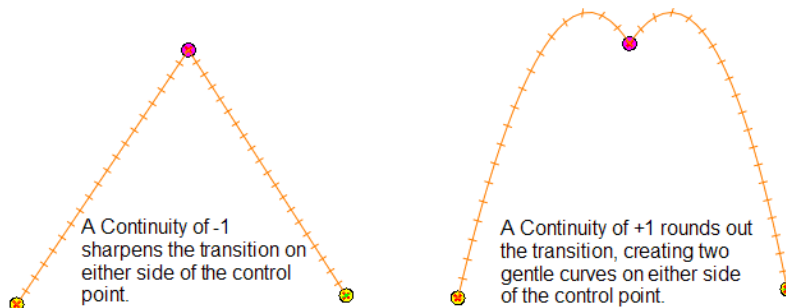

- **Tension** controls how sharply the path bends as it passes through a control point or keyframe.

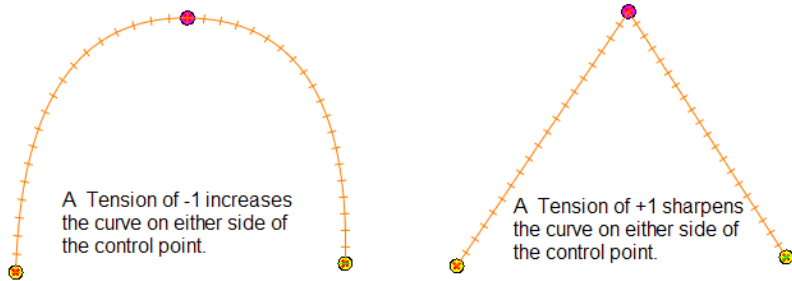

- **Bias** controls the slope of the path so that it flows towards one side of the motion point or the other.

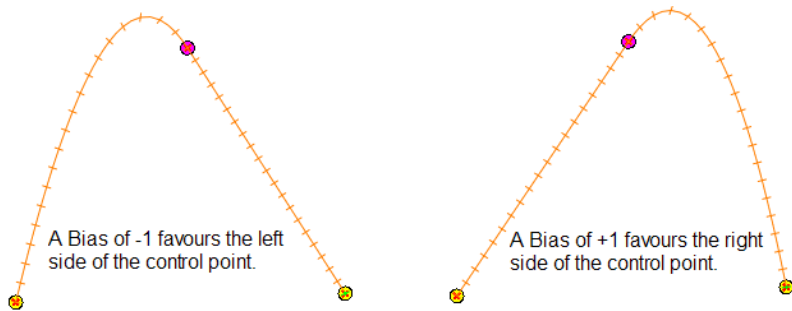

#### To adjust the Continuity, Tension and Bias parameters:

1. In the Tools toolbar, select the **Transform**  tool.
2. In the Timeline view, select the layer that you want to adjust the parameters for.



3. In the top menu, select **View > Show > Control** or press [Shift] + [F11] to display the trajectory.
4. In the Camera view, select the control point or keyframe you want to adjust.

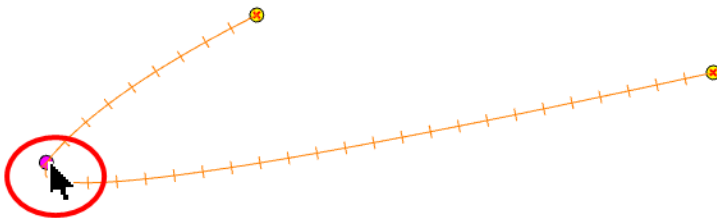

5. In the Coordinates and Control Points view, adjust the **Continuity**, **Tension** and **Bias** parameters.



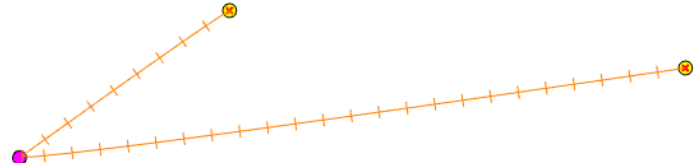
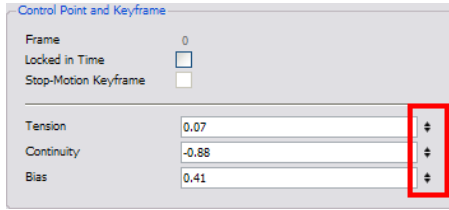

If you find that you are using the same Continuity, Tension and Bias settings, you can set a preference to remember your settings.

### To adjust the Point Setting Preferences:

1. From the top menu, select **Edit > Preferences (Windows)** or **Animate > Preferences (Mac OS X)**. The Preferences dialog box opens.
2. Select the **Camera** tab and look at the entire right section.



## Toggleing between a Linear or Curved Motion

When you select a control point on a path, you can toggle between a rounded or square corner by using the **Linear/Curve** command.

### To toggle between a linear or curved corner:

1. In the Tools toolbar, select the **Transform**  tool.
2. In the Camera view, select the point to convert.
3. In the top menu, select **Animation > Linear/Curve**.

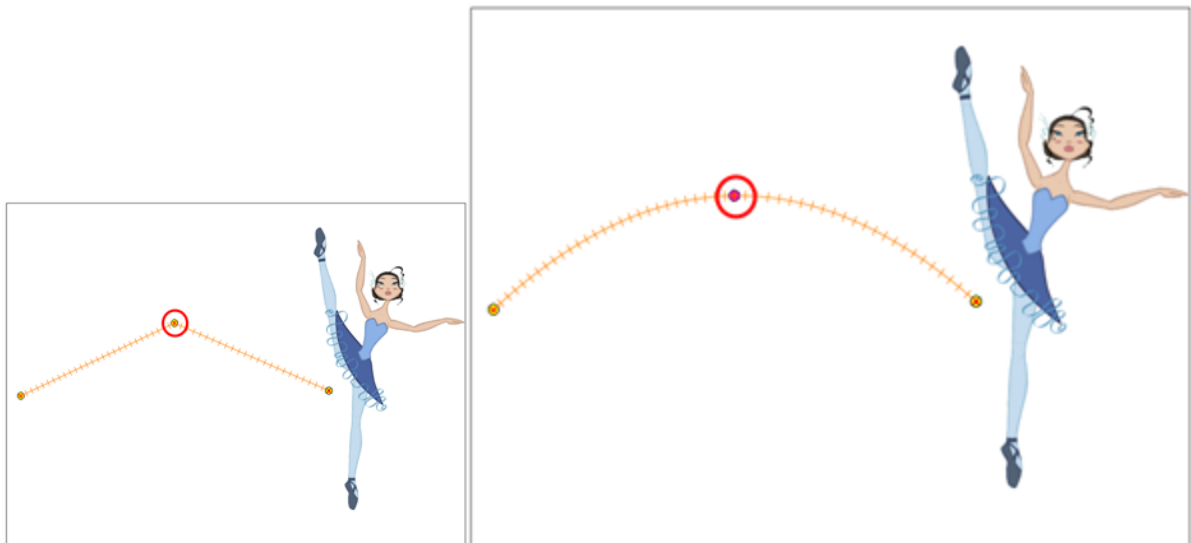

## Related Topics

- [Shaping a Path on page 664](#)

## Cumulative Z Value

You can see the cumulative Z Value information in the **Coordinates and Control Points** view. When you select a drawing cell including a keyframe, it will display the **Cumulative Z** value.

When a layer is parented to other layers that are moved forward or backward on the Z-axis, the currently selected layer's position Z value may not be accurate since its parent will also have an offset on the Z-axis. The **Cumulative Z** value is a compilation of all the Z-axis offsets to give the real Z-axis offset value related to the (0,0) centre.

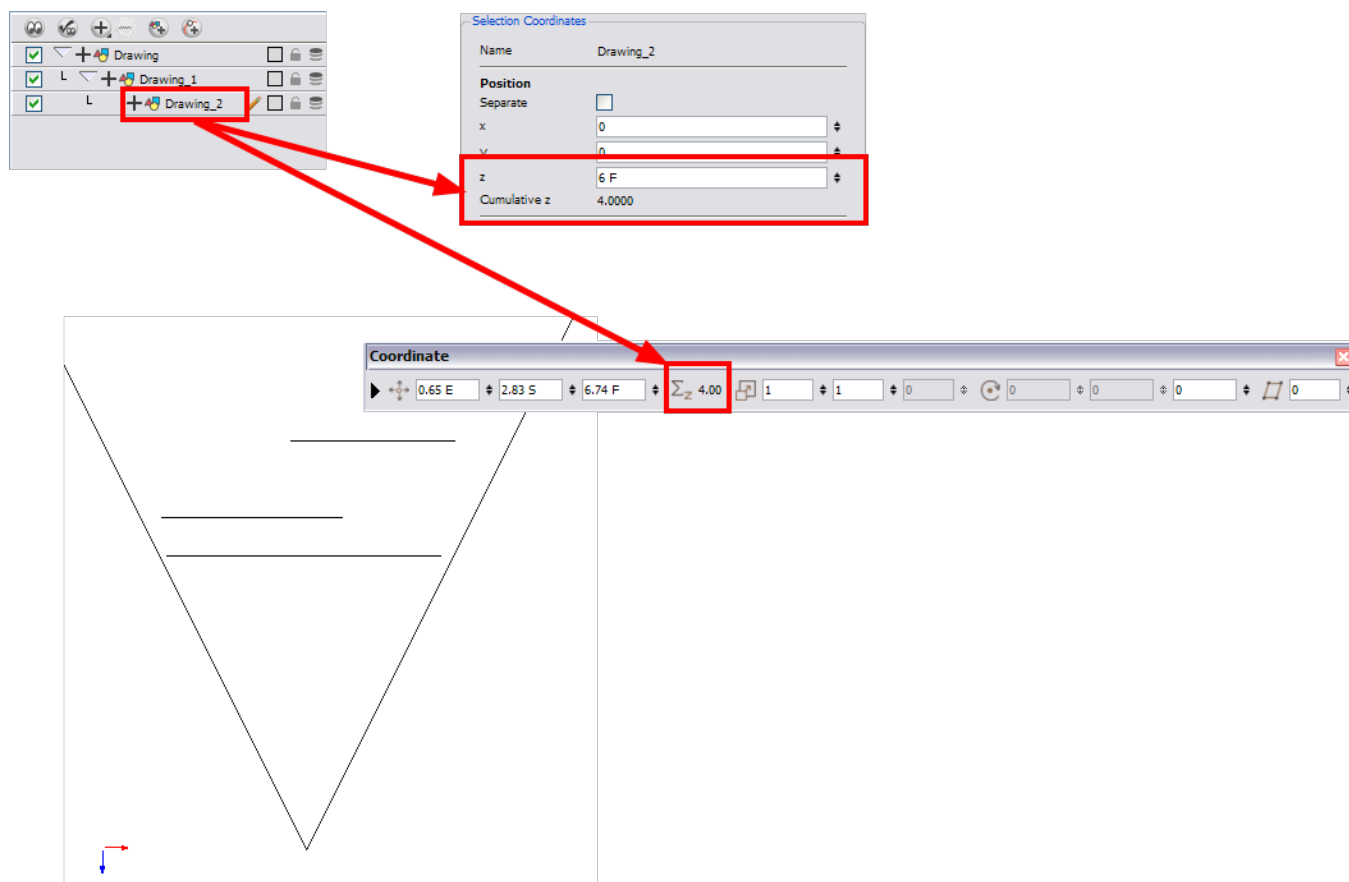

## Related Topics

- [Shaping a Path on page 664](#)

## Offsetting a Trajectory

To reposition the visual trajectory to a more convenient location, you can use the **Spline Offset** tool.

Offsetting your trajectory will not offset or modify your animation. It will facilitate your work.

**To offset a spline/trajectory:**

1. In the Animation Tools toolbar, select the **Spline Offset**  tool or press [Alt] + [9].
2. In the Camera or Timeline view, select the layer to be offset.
3. In the top menu, select **View > Show > Control** to display the trajectory. If you do not display the trajectory, the transformation done using the **Spline Offset** tool will be ignored.

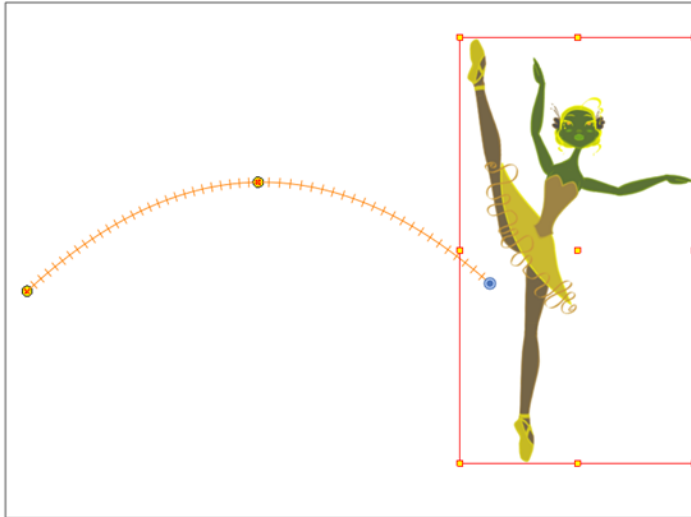

4. In the Camera view, move the trajectory to the proper position. You can move it on the X and Y axes, but also on the Z-axis using the **Top** and **Side** views.

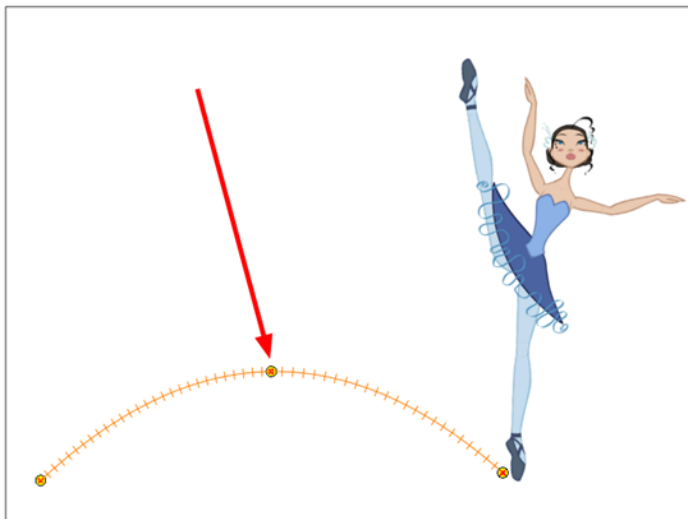
**Related Topics**

- [Modifying a Path in the Camera View](#) on page 662

# Modifying a Path in the Timeline View

When you select a peg or drawing layer in the Camera view and move it around, Animate will automatically create the corresponding function curves.

If you would then like to modify these functions, you can always do it through the peg's or layer's parameters in the Timeline view.

- [Creating a Function below](#)
- [Adding and Deleting Keyframes in the Timeline View on the next page](#)
- [Changing Keyframe Values on the next page](#)
- [Flipping Between Keyframes on page 675](#)

## Creating a Function

To create the function curve in the Timeline view:

1. Double-click on a Drawing or Peg layer.  
The Layer Properties panel opens.

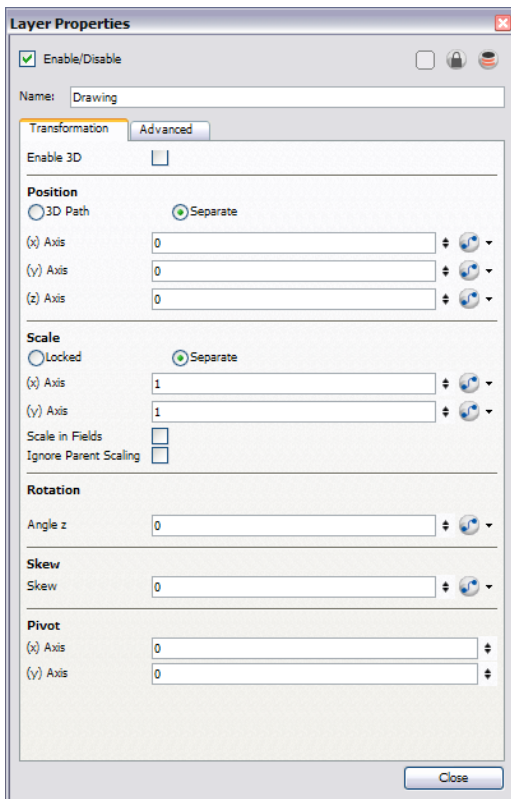

2. Identify the section of the type of function that you want to create.
3. Click the **Function Arrow** button at the end of the corresponding row.

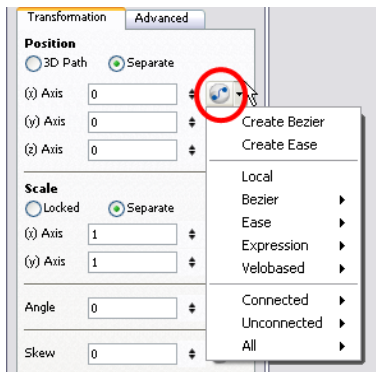

4. Select **Create Bezier** or **Create Ease**.

## Adding and Deleting Keyframes in the Timeline View

To insert a Keyframe:

1. On the right side of the **Timeline** view, select a cell on the layer's function that you want to animate.

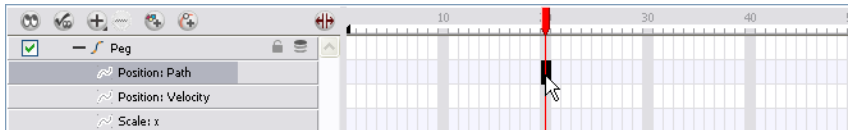

2. Right-click the selected cell and select **Insert Keyframe** or press [F6].

To delete a keyframe:

1. On the right-hand side of the **Timeline** view, select a cell with the keyframe that you want to delete.
2. Right-click on the selected keyframe and select **Delete Keyframes** from the menu that appears.

You can [Shift] + click on several keyframes to select a group before selected the **Delete Keyframes** option.





If you select a keyframe or group of keyframes and press [Delete], it will also delete the corresponding drawings on that cell.

## Changing Keyframe Values

To change the keyframe values in the Timeline:

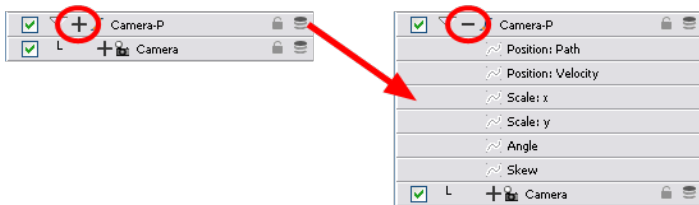
1. Open the layer's parameters by clicking the **Expand Function** **+** button next the layer's name or press [Alt] + [F].



2. Click the **Show/Hide Data View**  button at the top of the **Timeline** view, between the layer names and the timeline fields.

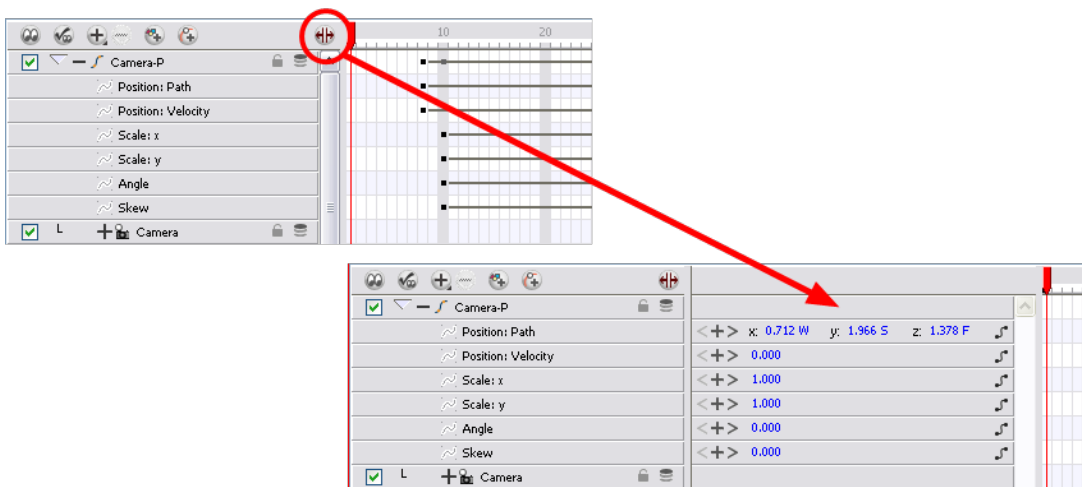

3. Select the parameter that you wish to create a function curve for: **Path**, **Velocity**, **Scale: x** or **y**, **Angle** or **Skew**. For this example we will use **Velocity**.
4. Pass the cursor over the blue number value of the parameter layer that you wish to modify.
  - ▶ Wait until the cursor becomes a white hand with a two-way arrow  and then click and drag the hand slightly to the left or right to decrease or increase the value.



OR

- ▶ Click directly on the blue number and enter a value into the white field that appears.
- ▶ If you selected the keyframe in the **Camera** view, you can modify the values in the **Coordinate and Control Points** view.

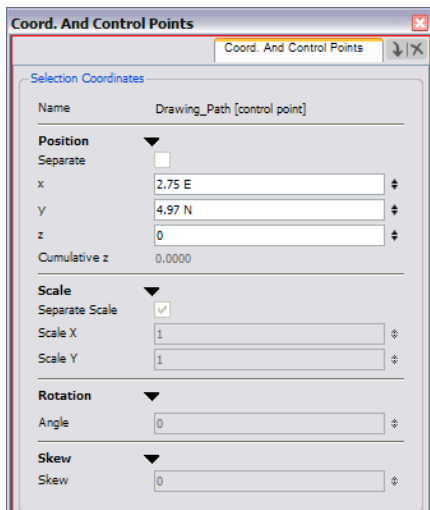

A function is automatically created as soon as the values are no longer zero.

5. Press [Enter/Return] or click on the **Play**  button to view the changes you have made in the **Camera** view.

## Flipping Between Keyframes

Animate lets you flip between the selected layer's keyframes.

To flip through your poses:

1. In the **Camera** or **Timeline** view, select the layer you want to see the keyframes for.

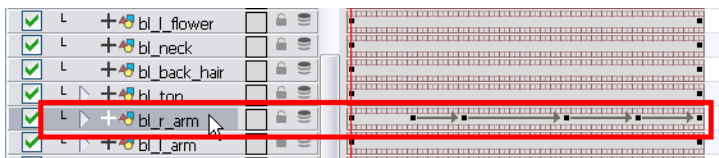

2. In the top menu, select **Animation > Go to Previous Keyframe** or **Go to Next Keyframe**. The [;] and ['].]

## Related Topics

- [Function Types](#) on page 689

# Modifying a Path in the Function View

If you are used to graphs and function curves, you can use the Function view to define your trajectories.

## Related Topics

- [Function View](#) below
- [Editing a Function in the Function View](#) on page 678
- [Adding and Deleting Keyframes in the Function View](#) on page 678
- [Changing a Keyframe's Values](#) on page 680

## Function View

While editing the X function of this 3D motion path, you can see the graphs for the Y, Z and velocity.

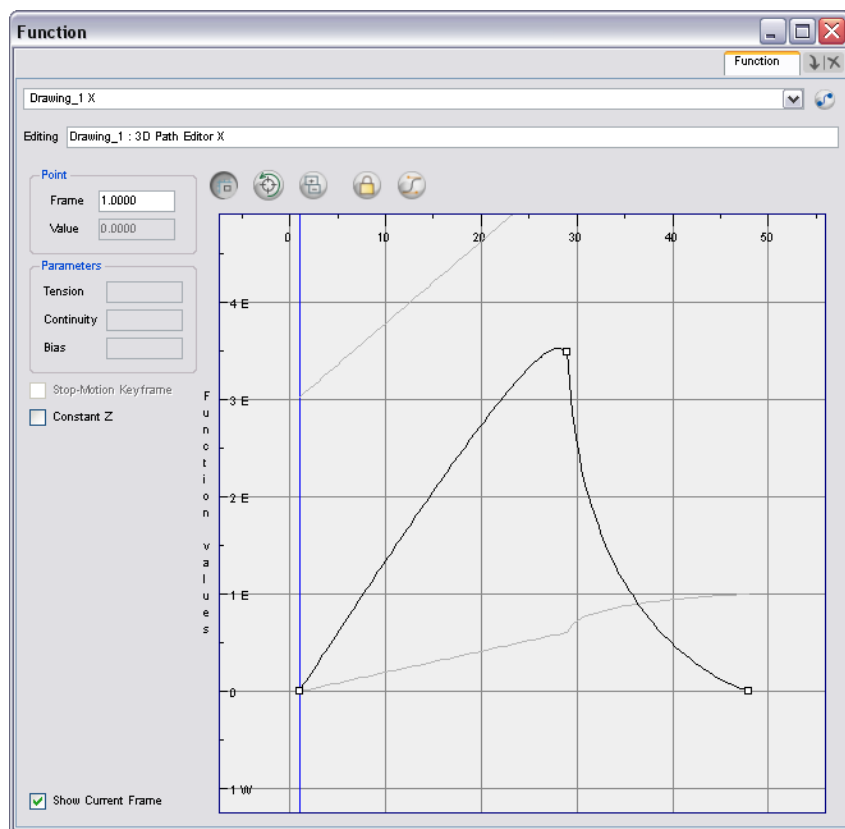

The **Function** view allows you to display multiple functions in the background as a reference. While you are editing one function, you can see other selected functions, this helps you synchronize changes in one function with other functions.

You can set the orientation of the Function view to be vertical (portrait) or horizontal (landscape).

- ▶ In the **Function View** menu, select **View > Set Vertical Layout/Set Horizontal Layout**.



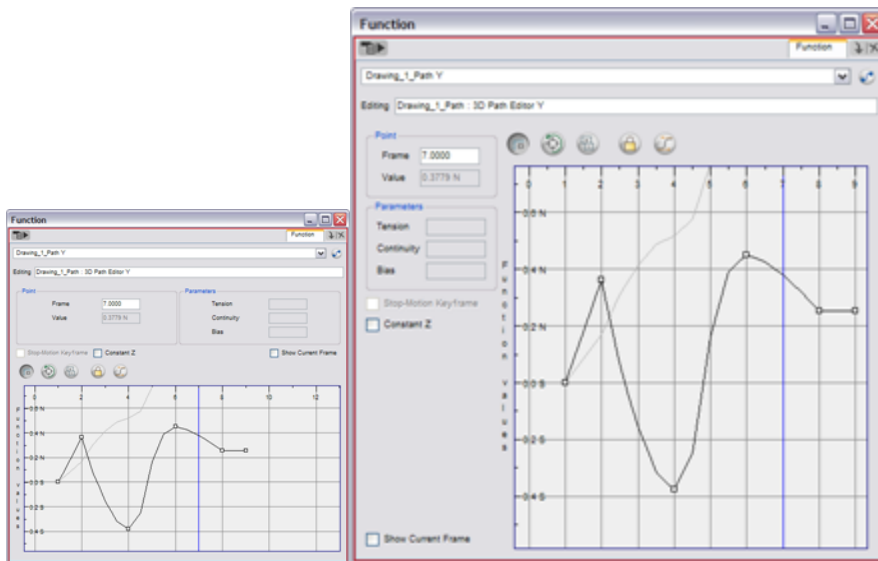

To display a function in the Function view, click its name in the Timeline view. You can also display several functions in the Function View.

**To display functions in the Function view:**

1. Open the **Function** view.  
The **Function** view is blank until you select the functions you want to display.
2. Click on the **Function**  button and scroll down the list of available functions. Click the checkbox next to the function name to display it in the view.

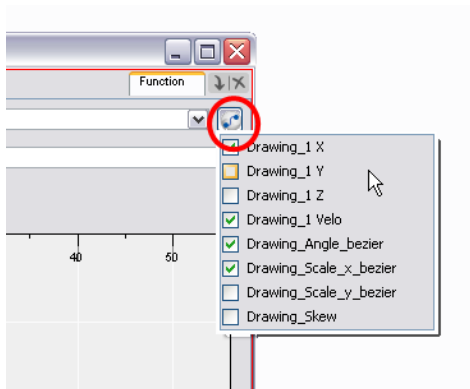

▶ To display a function in the **Function** view, click its name in the **Timeline** view.

3. To select the function you want to edit, select its name from the function drop-down menu.

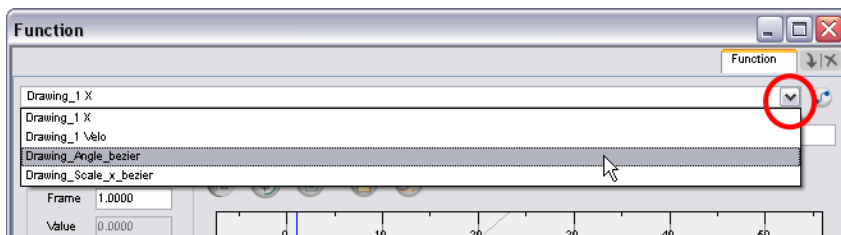

## Related Topics

- [Editing a Function in the Function View below](#)

# Editing a Function in the Function View

The graph displays the motion over the first and last keyframes set in the scene, as well as any keyframes created between. If the scene is 60 frames, but the character's motion ends at frame 40, then the editor will only display up to frame 40.

To edit a function in the Function view:

1. In the graph of the **Function** editor, select one of the white keyframes. If selected properly, the keyframe turns red and displays a pointed yellow handle.
2. Click and drag the point either up or down or click and pull one of the handles to adjust the curve of the graph.

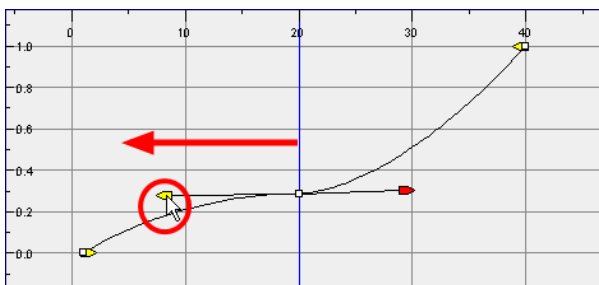

In this case, changing the velocity from a straight line (constant velocity) to a curved one, changes the ease-in (where the curve shoots up and then flattens-out) and ease-out (where the curve flattens-out and then shoots up) values.

The centre keyframe can not be dragged up or down because the velocity is set. Theoretically dragging it downwards towards zero would put it back to a place of non-movement.

3. Press the [Enter/Return] key with the **Parameter** window still open to watch the result of your curve adjustment in the **Camera** view.

## Related Topics

- [Adding and Deleting Keyframes in the Function View below](#)

# Adding and Deleting Keyframes in the Function View

If you want to change a parameter between two motion keyframes in the **Timeline** view, such as the scale, you can do so by adding keyframes in the **Scale** editor.

To add or remove keyframes in the parameter editor:

1. Open the layer parameters by clicking the **Expand Function** **+** button next the layer's name.

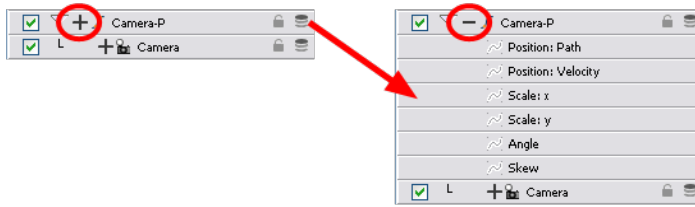

2. Select the parameter that you wish to create a function curve for: **Path**, **Velocity**, **Scale: x or y**, **Angle** or **Skew**. For this example we will use **Scale: x**.
3. Double-click on the parameter layer name to open the **Function** editor window or click once on the parameter layer to display it in the **Function** view.

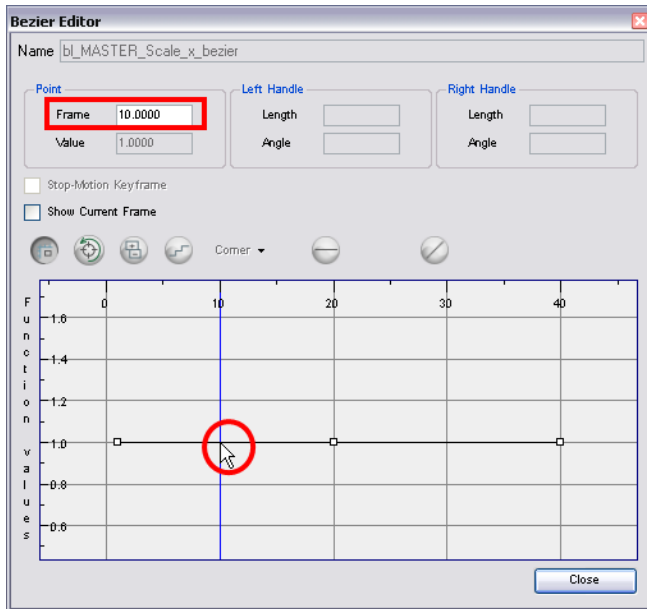

4. In the graph section, click on the frame number where you would like to make changes or in the **Point** section, enter the frame number directly into the **Frame** field.  
In the graph section, a vertical blue line will indicate the frame number selected.
5. Click the **Add/Remove Keyframes**  button.



6. Click on the newly created keyframe and drag it up (to decrease the width of the object) or down (to increase the width of the object) or pull on the handles to create a smooth fluctuation of the drawing object's width.
7. If you do not like the changes made, you can delete the new keyframe by selecting the keyframe, if it is not already selected, and press the [Delete] key, or by clicking on the **Add/Remove Keyframes**  button.

You can delete an already existing keyframe by using the same process.

## Related Topics

- [Modifying a Path in the Function View on page 676](#)

## Changing a Keyframe's Values

In the example cited above, once a keyframe is created, it can be moved and its handles manipulated to change the shape of the curve. Once a keyframe is manipulated its value changes. This value is displayed in the **Value** field of the **Point** section in the **Function** editor.

However, it is possible to work the other way around; it is possible to enter values into the Value field and watch the keyframe change position and the curve along with it.

To change a keyframe's value:

1. Open the peg element's parameters by clicking on the **Plus**  sign next the peg layer's name.

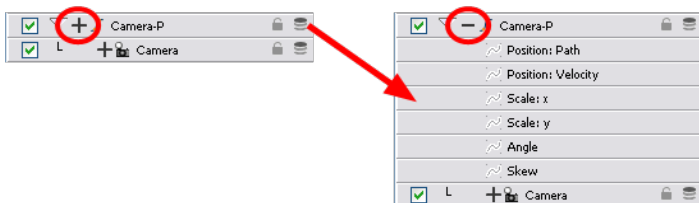

2. Select the parameter that you wish to create a function curve for: **Path**, **Velocity**, **Scale: x or y**, **Angle** or **Skew**. For this example we will use **Scale: y**.
3. Double-click on the parameter layer name to open the **Editor** window or click once on the parameter layer to display it in the **Function** view.

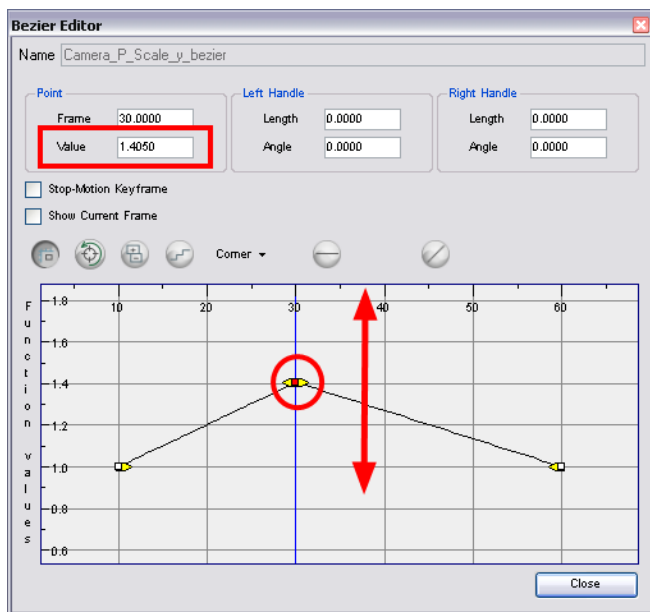

4. In the **Point** section, enter a value in the **Value** field or drag up or down the keyframe you want to modify.
5. Press [Enter/Return] or click the **Play**  button to view the changes made in the **Camera** view.
6. Keep adjusting your values accordingly, until you are satisfied with what you see.
7. Click **Close**.

### Related Topics

- [Adding and Deleting Keyframes in the Function View on page 678](#)

# Modifying a Path in the Xsheet View

If you are used to working with the Exposure Sheet, you can also create keyframes and type values in the Xsheet view.

You cannot create function curves directly in the Xsheet view. You must do this in either the Layer Properties editor or the Timeline view.

To edit a function column in the Xsheet view, you must first display the Functions section of the Xsheet view and then select the layer you want to modify.

**To display the function columns in the Xsheet view:**

1. In the **Xsheet** view, click on the **Expand Function Section** button.
2. In the **Timeline** view, select the layer containing the parameters to modify.

The columns appear in the **Xsheet** view.

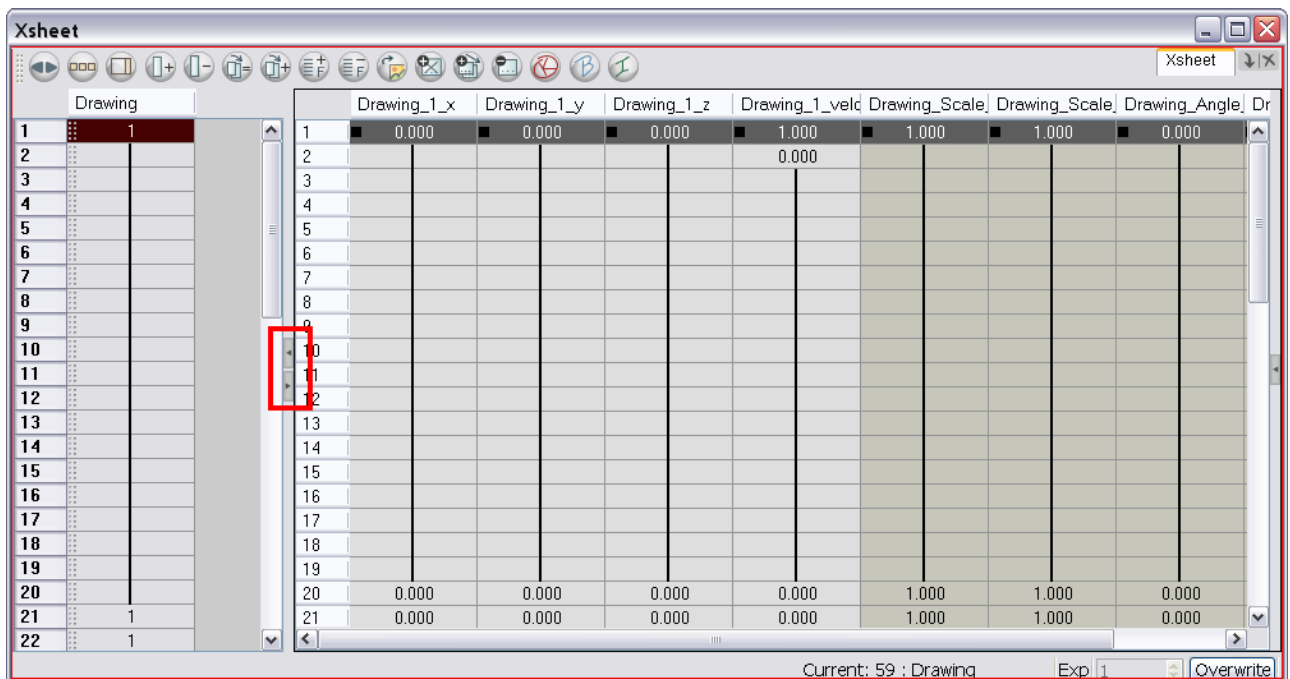

**To add a keyframe in the Xsheet view:**

1. In the **Xsheet** view, go to the function column where you want to add a keyframe.

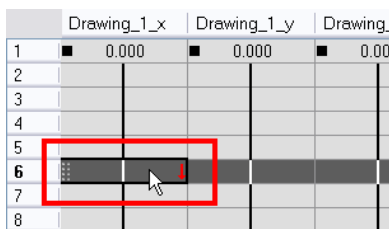

2. Double-click on the cell where you want to add a keyframe and type a numeric value.

	Drawing_1_x	Drawing_1_y	Drawing_1_z
1	0.000	0.000	0.000
2			
3			
4			
5			
6	5.000 E		
7			
8			

- Click on [Enter/Return] to continue to the next cell.
- Click on [Esc] to exit the typing mode.

	Drawing_1_x	Drawing_1_y	Drawing_1_z
1	0.000	0.000	0.000
2	1.000 E		
3	2.000 E		
4	3.000 E		
5	4.000 E		
6	5.000 E	0.000	0.000
7			
8			

### To convert a cell into a keyframe:

- In the **Xsheet** view, go to the function column where you want to add a keyframe.
- Select the cell to convert.

	Drawing_1_x	Drawing_1_y	Drawing_1_z	Drawing_1
1	0.000	0.000	0.000	
2	1.000 E			
3	2.000 E			
4	3.000 E			
5	4.000 E			
6	5.000 E	0.000	0.000	
7				

- Right-click on the cell and select **Set Selection As Keyframe** or press [F6].

	Drawing_1_x	Drawing_1_y	Drawing_1_z	Drawing_1
1	0.000	0.000	0.000	0.000
2	1.000 E			0.200
3	2.000 E	0.000	0.000	0.400
4	3.000 E			0.600
5	4.000 E			0.800
6	5.000 E	0.000	0.000	1.000
7				0.000

- If you want to remove a keyframe, select the keyframe, right-click on the cell and select **Clear Keyframe in Selection** or press [F7].

If you double-click on a function column's header, you will display the corresponding function curve in the **Function** editor.

### Related Topics

- [Modifying a Path in the Timeline View on page 672](#)

# Function Curves

By default, when a drawing or peg is added to the scene, no function curve is created. You will generally create the ones needed to avoid having an overload of useless functions.

When you select an element in the **Camera** view and move it around, it will automatically create the corresponding function curves.

If you need to create certain functions manually, you can always do it through the **Layer Properties** view or editor.

You can also link a layer's parameter to an existing function curve.

## Related Topics

- [Creating Function Curves below](#)
- [Sharing Functions on page 685](#)
- [Function Drop-down Menu on page 688](#)
- [Function Types on page 689](#)

## Creating Function Curves

You can manually create a function in the **Layer Properties** view or the **Layer Properties** editor. You can either share it with other layer's parameters or to set your keyframes directly on the function curve instead of the **Timeline** or **Camera** view.

To create the function curves for your project:

1. To open the Layer Properties editor, in the **Timeline** view, double-click on the layer or click once to display it in the **Layer Properties** view.



The **Layer Properties** editor opens.



2. Select the **Transformation** tab.
3. Click the **Function Arrow**  button beside the local function information.
4. Create a **3D Path**, **Bezier**, **Ease** or **Velobased** curve.
  - You can also create an **Expression** column. Refer to the [Expression Columns](#) on page 1 section to learn more.

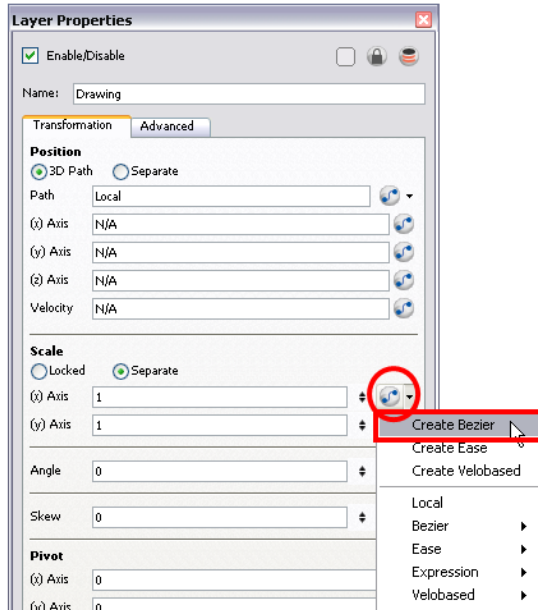

You can click on the **Function**  button to open the **Function** editor.

5. Click OK.

## Related Topics

- [Function Types](#) on page 689



# Sharing Functions



You can hook several parameters to the same function curve. For example, if you have an aircraft performing loops between clouds, you may want the camera to follow the aircraft's motion path. If you attach the camera to the aircraft's layer, the camera will also loop, but this may produce undesirable results and even induce a feeling of motion sickness as you watch the final animation. Instead, what you can do is to share the X, Y and Z aircraft's position with the camera's peg layer, but ignore the angle, scale and skew.

By default all the function curves you create are private. This means that the function curves can only be used and modified using their original parameter. If you want another layer or parameter to use the same function curve, you must make the function public.

There are two ways to share a function:

- Share Functions command
- Layer Properties Editor

**To share a function using the Share Functions command:**

1. In the Timeline view, select the function layer to share.



2. Right-click on the selection and select **Share Functions**.

The function now becomes public to the other layers and parameters and can be shared.

Public functions are visible in the main section of the Xsheet view.

	Drawing	Drawing_1_x	Drawing_1_y	Drawing_1_z	Drawing_1_velc
1	1	0.000	0.000	0.000	0.000
2		1.000 E			0.200
3		2.000 E	0.000	0.000	0.400
4		3.000 E			0.600
5		4.000 E			0.800
6		5.000 E	0.000	0.000	1.000
7					0.000
8					
9					
10					
11					
12					
13					
14					
15					
16					
17					
18					
19					
20					
21	1	5.000 E	0.000	0.000	0.000
22	1	5.000 E	0.000	0.000	0.000

- In the **Timeline** view, open the **Layer Properties** editor of the layer you want to link its parameter to the public function.
- To open the **Layer Properties** editor, in the **Timeline** view, double-click on the layer containing the function to share or click once to display it in the **Layer Properties** view.

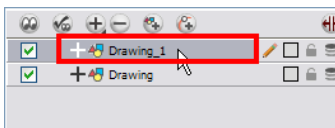

The **Layer Properties Editor** opens.

- Go to the **Transformation** tab.
- Click on the **Function Arrow** button beside the function you want to link to the function column.
- In the drop-down menu, select the function you just turned public from either, the **3D Path**, **Bezier**, **Ease**, **Velobased**, **Expression**, **3D Path**, **Connected**, **Unconnected**, **All** menu, and hook it to your parameter.

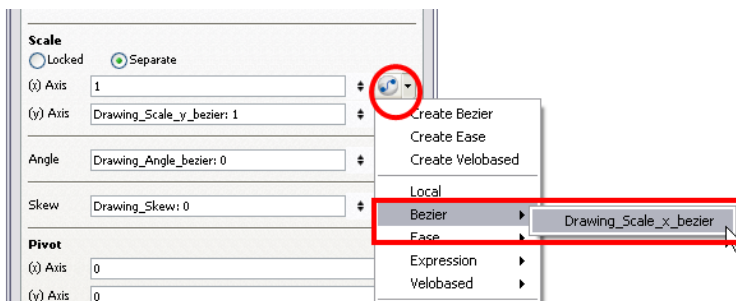



The two parameters are now both linked to the same function curve and should follow the same path. If you modify the curve, both parameters will update.

#### To share function curves:

- To open the **Layer Properties** editor, in the **Timeline** View, double-click on the layer containing the function to share or click once to display it in the **Layer Properties** view.



The **Layer Properties Editor** opens.

2. Go to the Transformation tab.
3. Click on the Function Arrow  button beside the function to share.
4. In the drop-down menu, select the Local option.
5. Click on the Function Arrow  button beside the Function field and choose an existing function from the drop-down list.

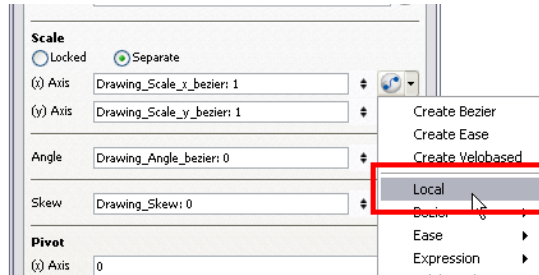

The function now becomes public to the other layers and parameters and can be shared.

Public functions are visible in the main section of the Xsheet view.

Xsheet					
	Drawing	Drawing_1_x	Drawing_1_y	Drawing_1_z	Drawing_1_velc
1	1	0.000	0.000	0.000	0.000
2		1.000 E			0.200
3		2.000 E	0.000	0.000	0.400
4		3.000 E			0.600
5		4.000 E			0.800
6		5.000 E	0.000	0.000	1.000
7					0.000
8					
9					
10					
11					
12					
13					
14					
15					
16					
17					
18					
19					
20					
21	1	5.000 E	0.000	0.000	0.000
22	1	5.000 E	0.000	0.000	0.000

6. In the same drop-down menu, where you choose the Local option, select the function you just turned public from either the 3D Path, Bezier, Ease, Velobased, Expression, 3D Path, Connected, Unconnected, All menu and hook it to your parameter.

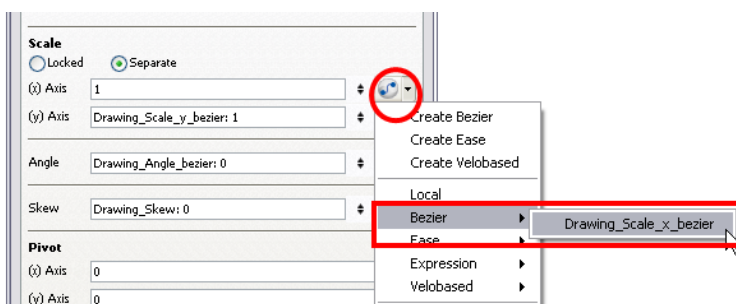

7. In the **Timeline** view, open the **Layer Properties** editor of the other layer you want to link its parameter to the public function.
8. In the **Layer Properties** editor or view, hook the parameter to the public function the same way you did for the first layer.

The two parameters are now both linked to the same function curve and should follow the same path. If you modify the curve, both parameters will update.

## Related Topics

- [Function Drop-down Menu](#) below

## Function Drop-down Menu

When you create a function curve in the **Layer Properties** view or editor, you have several choices available:

- **Create 3D Path:**  
Creates a new 3D Path Column set.
- **Create Bezier**  
Creates a new Bezier curve.
- **Create Ease**  
Creates a new Ease curve.
- **Local**  
Disconnects the parameter from any function and turns it public.
- **3D Path**  
Displays the list of every public 3D Path function available.
- **Bezier**  
Displays the list of every public Bezier curve available.
- **Ease**  
Displays the list of every public Ease curve available.
- **Velobased**  
Displays the list of every public velocity based curve available.
- **Expression**

Displays the list of every public Expression function available.

- **3D Rotation**

Displays the list of every public 3D Rotation function available.

- **Connected**

Displays the list of every public connected function curve.

- **Unconnected**

Displays the list of every public unconnected function curve.

- **All**

Displays the list of every public function curve.

The user has the choice of creating a new function curve or linking it to an already existing public one. This way, he can have two or more parameters following the same function.

## Related Topics

- [Function Types below](#)

# Function Types

Depending of your favourite working method, you can create different types of function curves to suit your need.

You have several choices available:

- [Ease and Bezier Functions below](#)
- [Velobased Functions on the facing page](#)
- [Converting Ease and Bezier Functions on the facing page](#)

## Ease and Bezier Functions

When you create a function to control a parameter over time (Scale, X, Y, Z, Rotate), you have the choice of an Ease or Bezier function.

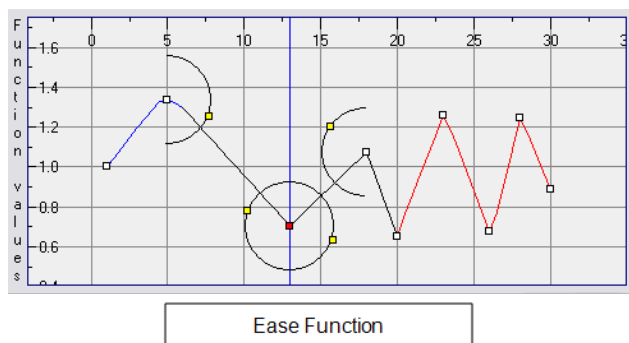

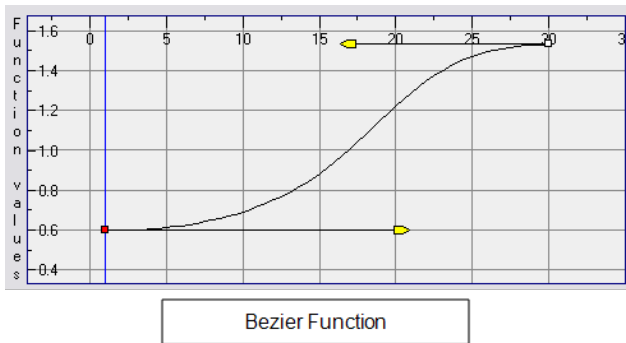

These function editors present different ways of editing the values over time. The shape of the created graph indicates the velocity of the function, regardless of the chosen editor. The type of function that you choose is largely based on your own working preference.

With the **Ease** editor, you can edit the shape of the function curves using the ease-in and ease-out controls. You may choose to use this type of function if you are used to working with ease-in and ease-out values.

## Velobased Functions

You can also create Velobased functions for certain effects, like changes in rotation or size over time. In these cases, the Velobased functions are linked to the velocity of a 3D path. You cannot change the shape of a Velobased function to control its velocity.

With Velobased functions, you can link changes in rotation or scaling to the velocity of a 3D path. This makes it possible for changes in rotation or scaling to progress at the same speed as changes to the position of an element.

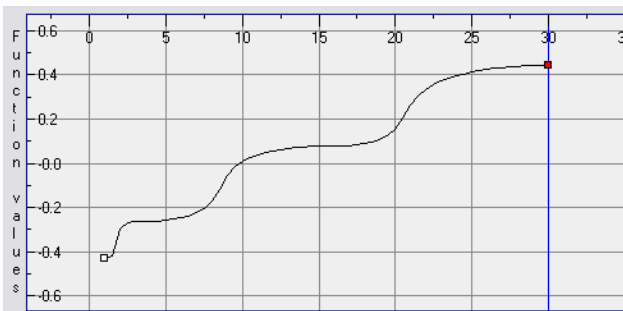

## Converting Ease and Bezier Functions

To convert Ease and Bezier functions so that you can edit them using the controls offered by that editor.

**To convert Ease and Bezier functions:**

1. In the **Xsheet** view, if not done yet, show the function columns.
2. In the **Xsheet** view, click on the Expand button located on the right side of the main section to show the Functions section. Click on the same button to collapse it. You can also use the **Show Column List** 

button in the **Xsheet View** toolbar.

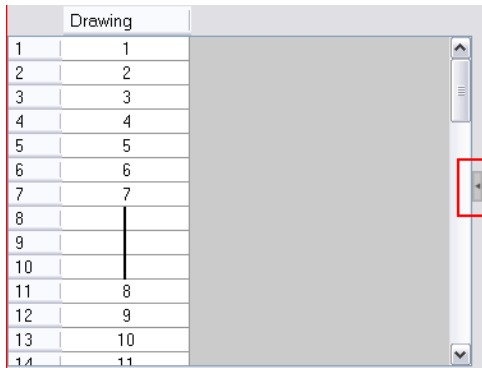

3. Click the **Expand** button on the right side of the **Functions** section to display the **Column List** section.

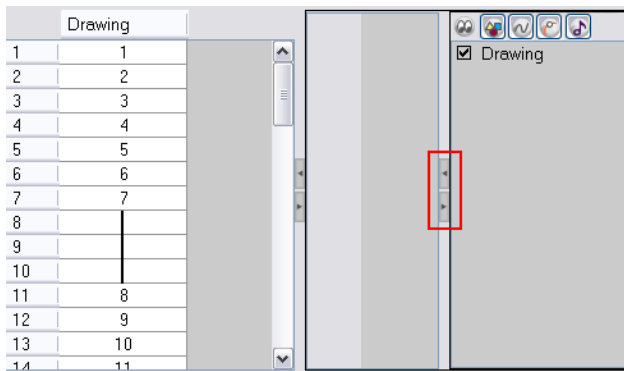

4. In the **Timeline** view, click the layer you want to display the function columns from.



5. In the Xsheet view, right-click the column's header and select one of the following from the **Convert** menu:

- ▶ **Convert the column:** The values of multiple effects may be linked to the original column. When you use the Convert the Column command, all links to the original column will transfer to the new converted column.
- ▶ **Create a new column and update links:** Creates a new function from the original. All links to the original column will transfer to the new column. The original function column will remain in the exposure sheet in case you decide you want to switch back to it.
- ▶ **Create a new unused column:** Creates a new column based on the values in the original column and leaves all links pointing to the original column. You can use this command to experiment with various functions and then link effect values to the new function curve column.

## Related Topics

- [Function Curves](#) on page 683

# Copying and Pasting a Motion

In the Timeline view, you can easily drag keyframes to change the animation timing, delete them, cycle them and even copy them.

When you have position keyframes set in your drawing layer and you want to move them around with moving your drawing's timing, you can use the Paste Special feature to only move the keyframes selected.

You can also use the Paste Cycle and Paste Reverse feature to cycle your selection including keyframes and drawings.

- [Paste Special below](#)
- [Paste Special Dialog Box on the next page](#)
- [Pasting Cycles on page 698](#)

## Paste Special

To copy and paste a motion:

1. In the Timeline view, select the keyframes, to copy and paste. If you want to move the keyframes, move on to step 3.

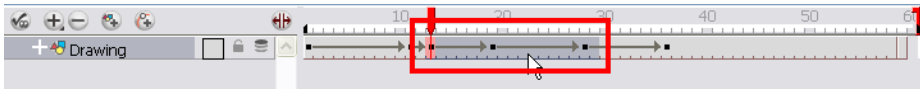

2. In the top menu, select **Edit > Copy**.
3. To edit your selection:
  - ▶ To paste the selection, in the **Timeline** view, select the first cell where you want to paste your keyframes and in the top menu, select **Edit > Paste Special**.
  - ▶ To move the selection, in the **Timeline** view, drag the selection and hold down [Alt] (Windows) or [⌘] (Mac OS X). Drop the selection where you need it before releasing the hot key.

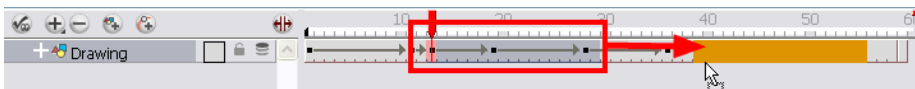

The Paste Special window opens.

4. Set the **Drawing, Pegs and Functions, and Cycles** parameters. and

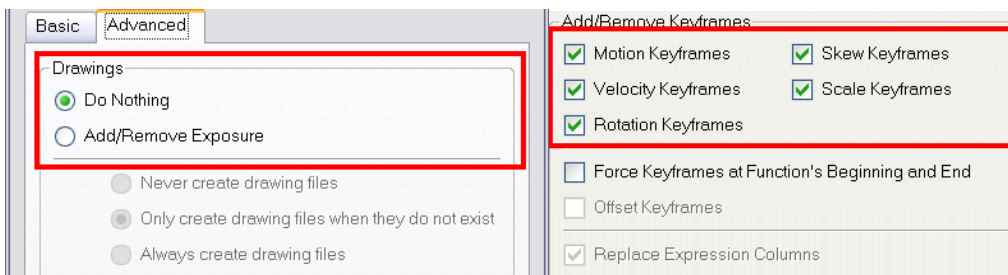

5. Click OK.

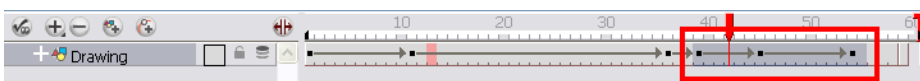



## Paste Special Dialog Box

To open the Paste Special dialog box:

1. In the Library view, select the symbol or template to import.
2. While dragging the selection to the **Timeline** view, hold down the [Alt] (Windows) or [⌘] (Mac OS X).



Drop the selection in the **Timeline** view before releasing the hot key.

The Paste Special window opens.

3. Set the parameters.

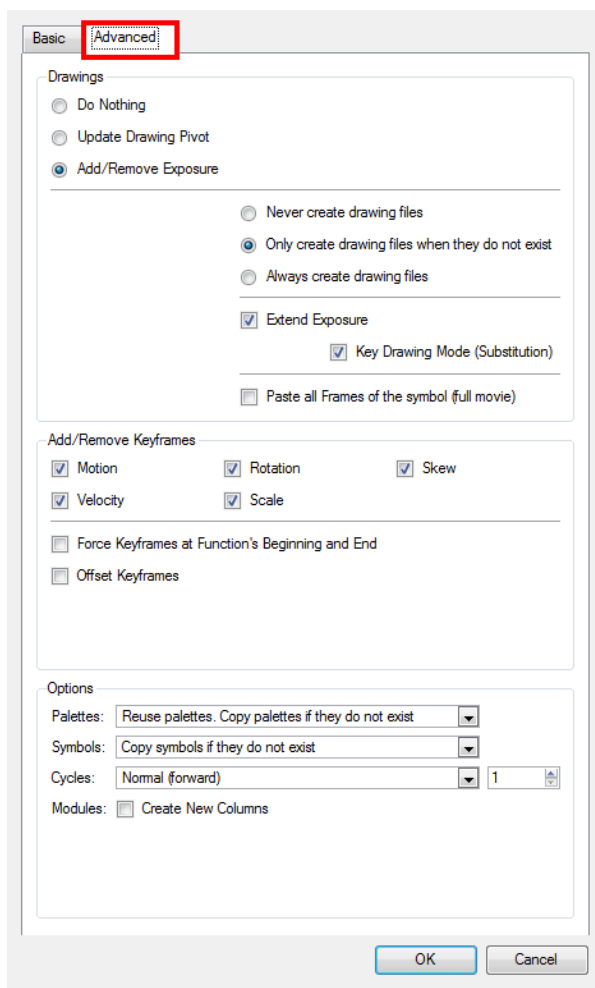

Advanced Tab

## Paste Special - Basic Tab

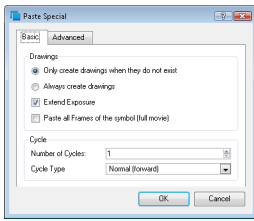

### Drawings

- **Only create drawing files when they do not exist:** When adding exposures to a drawing layer, new drawings will be created only when drawings with the same name do not already exist in the destination.
- **Always create drawing files:** When adding exposures to a drawing layer, new drawings will always be created. If drawing files with the same name already exist, Animate will create a new name for the drawing.
- **Extend Exposure:** Extends the exposure of drawings to fill the range of cells to the destination frame.
- **Paste all Frames of the Symbols (full movie):** When enabled, the Paste Special command will expose all the Symbol's frames instead of the first one only.

### Cycle

- **Number of Cycles:** Use the up and down arrows to increase or decrease the number of cycles you want to paste. You can also type the value directly in the field.
- **Cycle Type**

- **Normal (forward):** This pastes your selection as it is, starting with the first cell and ending with the last one.
- **Reverse:** This pastes your selection in reverse, starting with the last cell and ending with the first one.
- **Forward -> Reverse:** This pastes your selection as a yo-yo, starting with the first cell, going to the last one and ending with the first cell.
- **Reverse -> Forward:** This pastes your selection as a reverse yo-yo, starting with the last cell, going to the first one and ending with the last cell.

## Paste Special - Advanced Tab

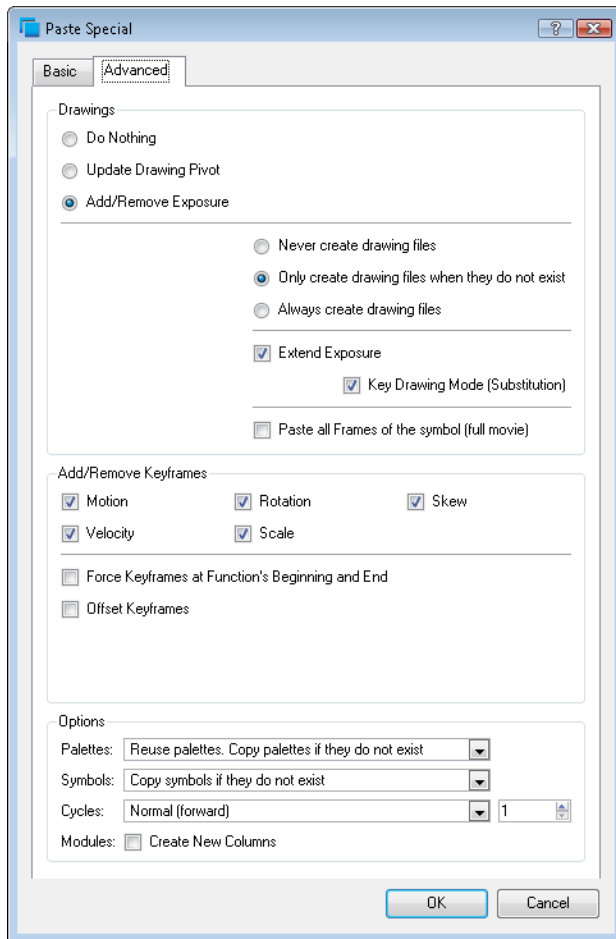

### Drawings

- **Do Nothing:** Does not create or overwrite drawings.
- **Update Drawing Pivot:** Revises the drawing pivot in the destination to use the same drawing pivot as the first drawing in the template. If you have a range of drawings selected in the destination, the pivot points of all selected drawings will be updated.
- **Add/Remove Exposure:** Creates/deletes exposure values in the selected layer.

You have the following choices as to how to treat drawings that will be created when adding an exposure:

- **Never create drawing files:** When adding exposures to a drawing layer, drawing files will not be created.
- **Only create drawing files when they do not exist:** When adding exposures to a drawing layer, new drawings will be created only when drawings with the same name do not already exist in the destination.
- **Always create drawing files:** When adding exposures to a drawing layer, new drawings will always be created. If drawing files with the same name already exist, Animate will create a new name for the drawing.
- **Extend Exposure:** Extends the exposure of drawings to fill the range of cells to the destination frame.
- **Key Drawing Mode (Substitution):** Pasting an exposure value replaces the cell value in the current frame and in all frames following in sequence with the original cell value.
- **Paste all Frames of the Symbols (full movie):** When enabled, the **Paste Special** command exposes all the Symbol's frames instead of only the first one.

### Add/Remove Keyframes

- **Motion:** Copies the properties of the selected motion keyframe to the new frame.
- **Velocity:** Copies the properties of the selected velocity keyframe to the new frame.
- **Rotation:** Copies the properties of the selected rotation keyframe to the new frame.
- **Skew:** Copies the properties of the selected skew keyframe to the new frame.
- **Scale:** Copies the properties of the selected scale keyframe to the new frame.
- **Force Keyframes at Function's Beginning and End:** Adds a keyframe to the beginning and end of the pasted function, reproducing the source function.
- **Offset Keyframes:** When pasting functions, this option offsets the keyframes from the function's last value by the values in the pasted function. This will continue the progression of a function rather than repeat the values.

### Option

- **Palette Option**

- **Do nothing:** Does not create, overwrite, merge or link palettes.
- **Reuse palettes. Copy palettes if they do not exist:** Palettes in the destination drawings are left as they are.
- **Copy and overwrite existing palettes:** Overwrites destination palettes with the palettes from the source drawings.
- **Copy and create new palette files:** Creates new palette files, placing them at the same relative environment and scene level as the source. If the palettes in the templates were stored at the environment level of the source scene, the paste operation will place the palettes in the environment level of the destination scene.
- **Copy and create new palette files in element folder:** Creates new palette files in the element folders of the destination scene, rather than in the same relative job or environment.
- **Copy palette and merge colours. Add new colours only:** Adds new colours to the destination palettes and ignores colours that are the same in the two palettes.
- **Copy palette and update existing colours only:** Adds new colours to the destination palette and updates duplicate colours in the destination with colour values from the source.
- **Link to original palettes (colour model):** Links the colour palettes in the destination scene to the palettes in the source. Use this to link drawings to the palettes in a colour model.
- **Copy scene palettes and merge colours. Add new colours only:** Adds new colours to the destination scene palettes and ignores colours that are the same in the two palettes.
- **Copy scene palettes and update existing colours:** Adds new colours to the destination scene palette and updates duplicate colours in the destination with the colour values from the source.
- **Duplicate All Symbol Content:** Instead of linking the Symbol instance to the original one, the Symbol will be duplicated. A new Symbol is created in the Library.
- **Symbols**
  - **Copy symbols if they do not exist:** This is the default setting for this operation and will prevent Symbols in a Action template from being copied.
  - **Duplicate symbols:** Creates a duplicate of the Symbol instead of linking the Symbol instance to the original one. The new Symbol is created in the Library.
  - **Overwrite symbols:** If a modification was made to a Symbol that does not exist in the basic rig template for a character, select this option to overwrite the previous Symbol.
- **Cycles:**
  - Cycle Types:
    - **Normal (forward):** This pastes your selection as it is, starting with the first cell and ending with the last one.
    - **Reverse:** This pastes your selection reversed, starting with the last cell and ending with the first one.
    - **Forward -> Reverse:** This pastes your selection as a yo-yo, starting with the first cell, going to the last one and ending with the first cell.
    - **Reverse -> Forward:** This pastes your selection as a reverse yo-yo, starting with the last cell, going to the first one and ending with the last cell.
    - **Number of Cycles:** Use the up and down arrows to increase or decrease the number of cycles you want to paste. You can also type the value directly in the field.
- **Modules: Create New Columns:** If you enable this option a new column will be created when you copy and paste modules from the Network view or Layer in the Timeline view. If the layers are linked to function curves, the function curves, the drawings and the timing will be duplicated.

## Related Topics

- [Pasting Cycles below](#)

# Paste Special

To copy and paste a motion:

1. In the Timeline view, select the keyframes, to copy and paste. If you want to move the keyframes, move on to step 3.

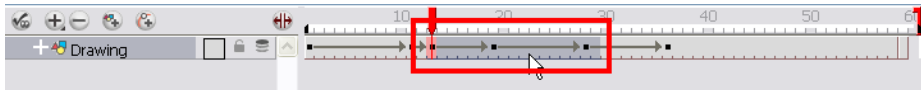

2. In the top menu, select **Edit > Copy**.
3. To edit your selection:
  - ▶ To paste the selection, in the **Timeline** view, select the first cell where you want to paste your keyframes and in the top menu, select **Edit > Paste Special**.
  - ▶ To move the selection, in the **Timeline** view, drag the selection and hold down [Alt] (Windows) or [⌘] (Mac OS X). Drop the selection where you need it before releasing the hot key.

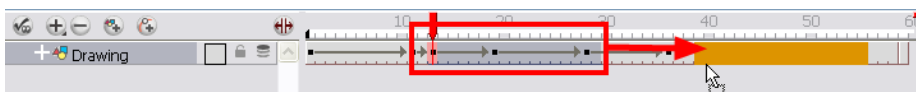

The Paste Special window opens.

4. Set the **Drawing, Pegs and Functions, and Cycles** parameters.

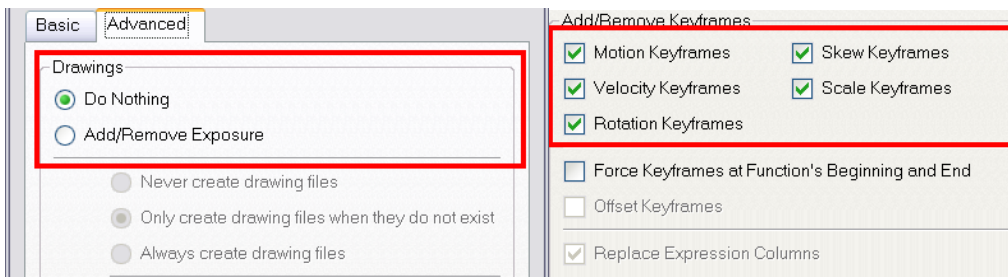

5. Click OK.

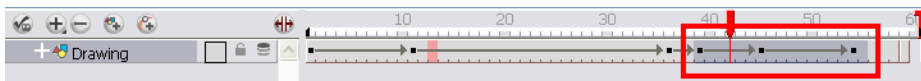

## Related Topics

- [Pasting Cycles below](#)

# Pasting Cycles

If you want to cycle a portion of your animation, you can use the Paste Cycle command. You can also use the Paste Reverse command to completely reverse the flow of your animation.

To use the Paste Cycle command:

1. In the Xsheet or Timeline view, select the cell range and keyframes to loop.

- In the top menu, select **Edit > Copy**.
- In the Xsheet or Timeline view, select the cell where you want your cycles to start.

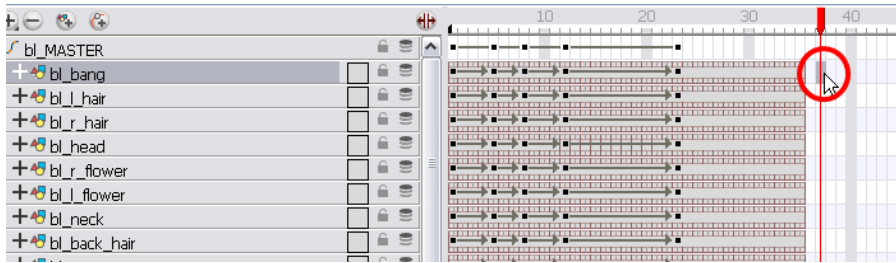

- In the top menu, select **Edit > Paste Cycle** or press [Ctrl] + [/] (Windows) or [⌘] + [/] (Mac OS X). The Paste Cycle dialog box opens.

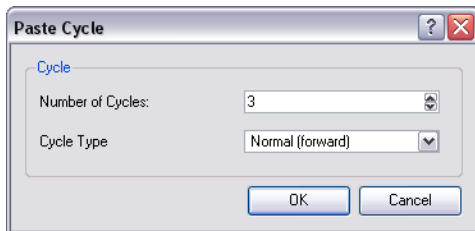

- In the **Number of Cycles** field, use the up and down arrow to increase or decrease the amount of cycles you want to paste. You can also directly type the value.
- In the **Cycle Type** drop-down menu, select the type of cycle you want to paste.

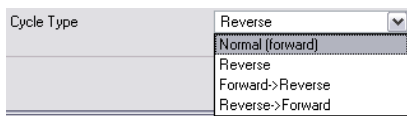

- ▶ **Normal (forward)**: Pastes your selection as it is, starting with the first cell and ending with the last one.
  - ▶ **Reverse**: Pastes your selection reversed, starting with the last cell and ending with the first one.
  - ▶ **Forward -> Reverse**: pastes your selection as a yo-yo, starting with the first cell, going to the last one and ending with the first cell.
  - ▶ **Reverse -> Forward**: pastes your selection as a reversed yo-yo, starting with the last cell, going to the first one and ending with the last cell.
- Click OK.

#### To use the Paste Reverse command:

- In the Xsheet or Timeline view, select the cell range and keyframes to paste inverted.

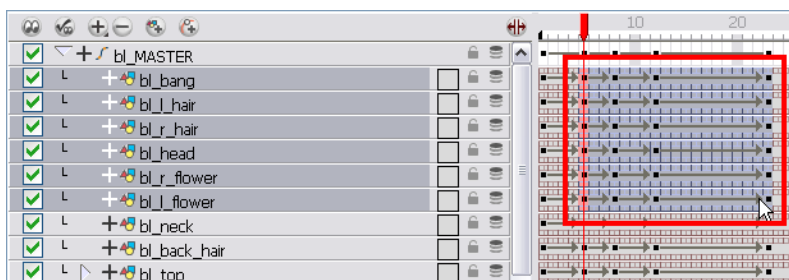

- In the top menu, select **Edit > Copy** or press [Ctrl] + [C] (Windows) or [⌘] + [C] (Mac OS X).
- In the **Xsheet** or **Timeline** view, select the cell where you want your cycles to start.

4. In the top menu, select **Edit > Paste Reverse** or press [Ctrl] + [.] (Windows) or [⌘] + [.] (Mac OS X).

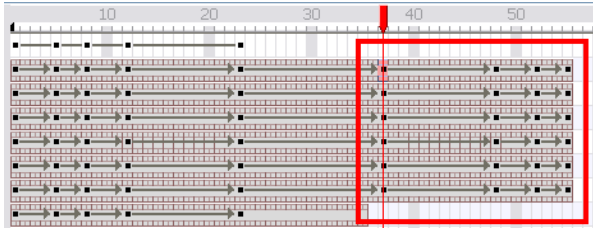

## Related Topics

- [Copying and Pasting a Motion on page 692](#)



# Adjusting the Ease

To add ease in and ease out on your motion paths, you can display the function curve and modify the Bezier or Ease curve. To apply an ease to multiple functions and keyframes, you can use the **Set Ease For Multiple Parameters** script and set the amount desired.

The Velocity, or ease, is used on motion keyframes. The velocity has to be adjusted directly on the function curve in either the Function view or the **Function** editor. When a keyframe is selected, easing values appear in the right handle and left handle fields, as well as Bezier handle or Ease wheel controls on each selected keyframe. Pull on them to adjust the ease in and ease out, or type values in the fields.

## Related Topics

- [Displaying the Velocity Curve below](#)
- [Reshaping a Velocity Function using Bezier Controls](#) on the facing page
- [Reshaping a Velocity Function using Ease Controls](#) on page 703
- [Creating a Stepped Velocity](#) on page 704
- [Adjusting the Velocity of Several Layers at the Same Time](#) on page 705

## Displaying the Velocity Curve

To display the velocity curve:

1. In the Timeline view, click on the **Expand Function**  button to display the layer's functions.

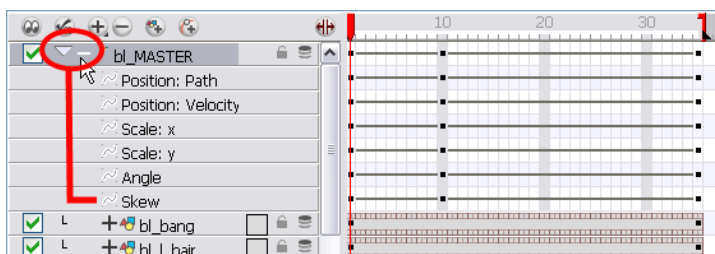

2. Double-click on the desired function.

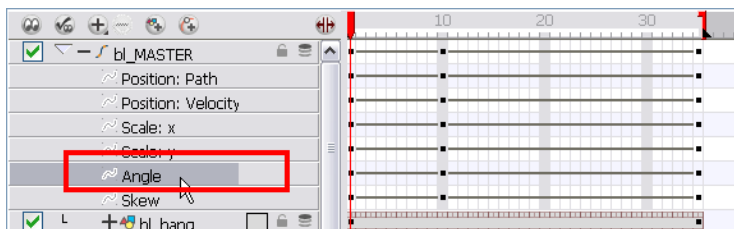

The Function Editor opens.

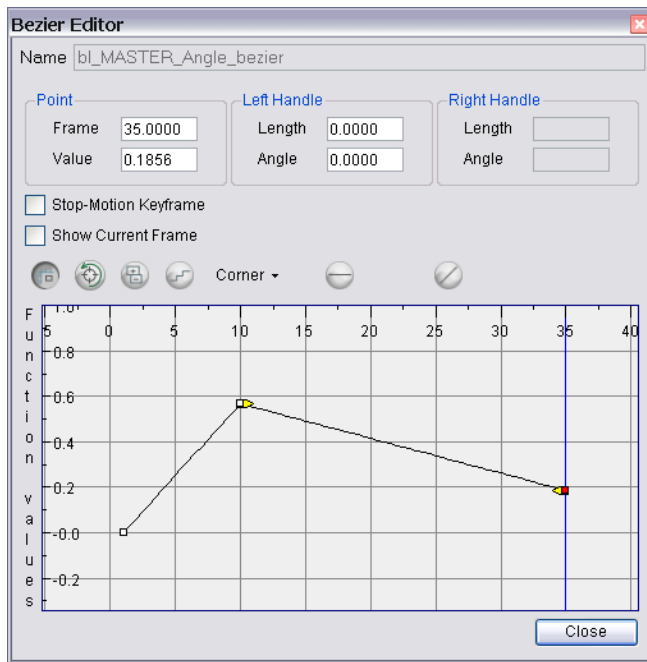

The editor will not be displayed if the function does not already exist.

## Related Topics

- [Reshaping a Velocity Function using Bezier Controls below](#)
- [Reshaping a Velocity Function using Ease Controls on the next page](#)
- [Creating a Stepped Velocity on page 704](#)
- [Adjusting the Velocity of Several Layers at the Same Time on page 705](#)

# Reshaping a Velocity Function using Bezier Controls

You can reshape the velocity function using Bezier controls.

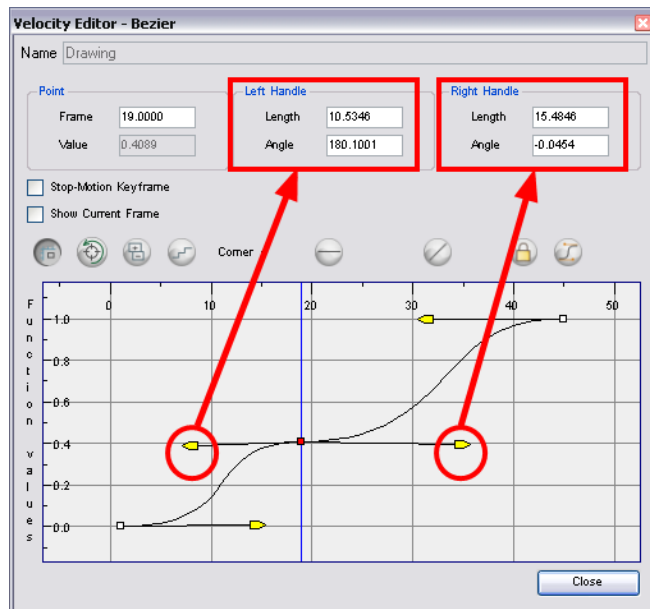

You can reshape the function using either the Bezier or Ease controls.

#### To reshape a function using Bezier controls:

1. Click on the keyframe to select it.
2. Drag the handles to modify the shape of the curve.

The Continuity options, Corner, Straight and Smooth, influence how you can move the handles.

- **Straight:** allows you to move the handles together, maintaining the same angle to the point.
- **Corner:** allows you to move the handles independently.
- **Smooth:** allows you to move the handles together, maintaining the same distance and angle to the point.

#### Related Topics

- [Displaying the Velocity Curve on page 701](#)
- [Reshaping a Velocity Function using Ease Controls below](#)
- [Creating a Stepped Velocity on the facing page](#)
- [Adjusting the Velocity of Several Layers at the Same Time on page 705](#)

## Reshaping a Velocity Function using Ease Controls

You can reshape the velocity function using Ease controls.

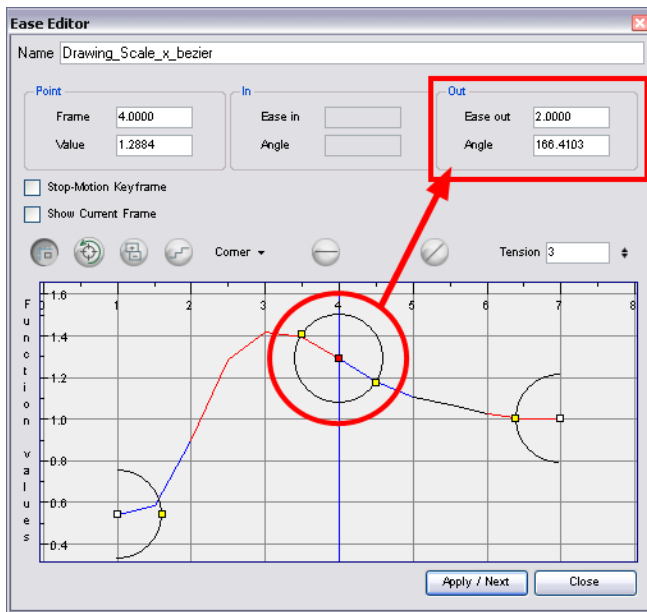

### To reshape the function using Ease controls:

1. Click on the keyframe to select it.
2. To set the number of frames in the ease-in, press [Alt], click to the right of the keyframe and drag the green line. The ease in slope is indicated in blue.

As you change the values visually, the value in the Ease In field is updated. This value represents the number of frames in the ease-in.

3. To set the number of frames in the ease-out, press [Alt], click to the left of the keyframe and drag the green line. The ease out slope is indicated in red.

As you change the values visually, the value in the **Ease Out** field is updated. This value represents the number of frames in the ease-out.

4. To adjust the ease-in or ease-out, drag the handles around the keyframe.

The **Continuity** options, **Corner** and **Straight**, influence how you can move the handles:

- **Straight:** allows you to move the handles together, maintaining the same angle to the point.
- **Corner:** allows you to move the handles independently.

### Related Topics

- [Reshaping a Velocity Function using Bezier Controls on page 702](#)
- [Creating a Stepped Velocity below](#)
- [Adjusting the Velocity of Several Layers at the Same Time on the next page](#)

## Creating a Stepped Velocity

You can create a stepped curve to hold the same value over a selected number of frames. This works well when you are animating drawings on 2's, for example, and you want to hold the same value for a function over those two frames.

**To hold the same value over several frames:**

1. Click the **Hold Value Editor**  button.

The Hold Value editor opens.

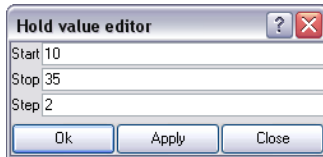

2. In the Hold Value editor, enter the following values:
  - ▶ In the **Start** field, enter the starting frame for the effect.
  - ▶ In the **Stop** field, enter the last frame for the effect.
  - ▶ In the **Step** field, enter the number of frames that you want to hold the value for.
3. Click **Apply**.
4. Click **OK**.

The function curve is updated based on the values you entered.

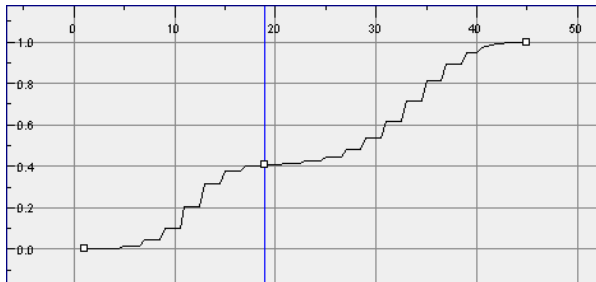

You can reshape the curve to create a linear velocity so that the values are interpolated (tweened) consistently between keyframes (that is, there is no acceleration in the effect).

**To create a linear velocity between two keyframes:**

- ▶ Click the keyframe to select it and then click the **Linear Velocity**  button. This command resets the handles on the Ease or Bezier function so that the velocity is linear.

**Related Topics**

- [Adjusting the Ease on page 701](#)

## Adjusting the Velocity of Several Layers at the Same Time

If you have several functions you would like to adjust the velocity for at the same time, you can use the Set Ease for Multiple Parameters dialog box. It allows you to apply the same velocity parameters to all the selected keyframes in a same frame.

**To set eases on multiple parameters:**

1. In the **Timeline** view, select a keyframe on one or many layers.

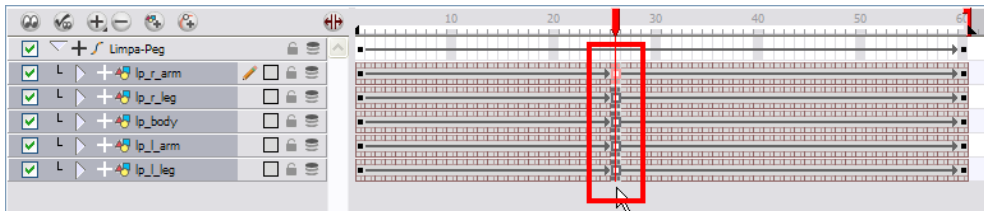

Only the first selected keyframe will be considered when using the **Set Ease For Multiple Parameter** function. If many keyframes are selected on a same layer, the ease values will be applied only to the first one and the rest will be ignored.

- In the Timeline view, right-click and select **Set Ease For Multiple Parameters**. In the **Timeline View** toolbar, you can click on the **Set Ease For Multiple Parameters**  button. This button is available in the

**Timeline View** toolbar's extra buttons. Refer to the chapter on [Toolbar Manager](#) on page 96 to learn how to customize your toolbars.

The **Set Ease For Multiple Parameters** dialog box opens.

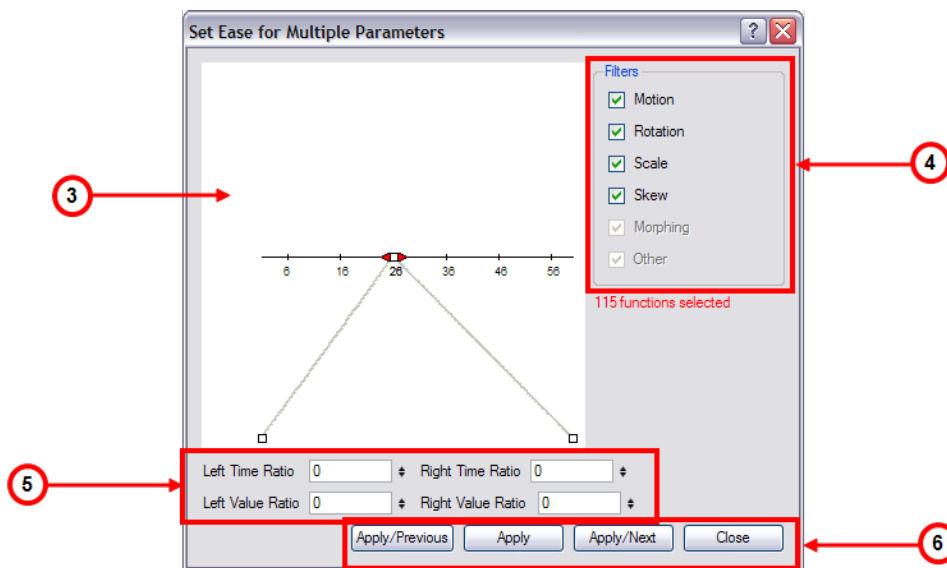

- In the graph interface, pull on the Bezier handle to adjust the velocity for all the selected functions.



- To apply these easing parameters to a specific type of function only, such as Rotation or Scale, go to the **Filters** section and disable the function types you do not want to affect.

- **Motion:** If this option is enabled, the easing parameters will be applied to the selected **Position X**, **Position Y**, **Position Z** and **3D Path** functions
  - **Rotation:** If this option is enabled, the easing parameters will be applied to the selected **Angle** functions.
  - **Scale:** If this option is enabled, the easing parameters will be applied to the selected **Scale** functions.
  - **Skew:** If this option is enabled, the easing parameters will be applied to the selected **Skew** functions.
  - **Morphing:** If this option is enabled, the easing parameters will be applied to the selected **Morphing Velocity** functions. Note that it applies to the Morphing velocity function found in the **Layer Properties** dialog and not to the basic morphing ease in the **Tool Properties** view.
  - **Other:** If this option is enabled, the easing parameters will be applied to all the other the selected functions such as all functions created to animate effect parameters.
5. You can also adjust the easing by typing values in the **Time Ratio** and **Value Ratio** fields. The values are calculated in percentage.
- In the **Left Time Ratio** and **Right Time Ratio** fields, type the percentage value corresponding to the length of time you want the easing to last for. It is recommended to remain between 0% and 100%. If you go beyond 100%, your motion will overshoot.
  - In the **Left Value Ratio** and **Right Value Ratio** fields, type the percentage value of how strong you want the easing out to be. It is recommended to remain between 0% and 100%. If you go beyond 100%, your motion will overshoot.
  - If your **Time Ratio** and **Value Ratio** values are equal, you will have a linear motion.
6. Once done, click on one of the following button:
- **Apply:** This will apply the easing parameters to the selected keyframes.
  - **Apply/Previous:** This will apply the easing parameters to the selected keyframes and then selects the previous keyframe in the timeline.
  - **Apply/Next:** This will apply the easing parameters to the selected keyframes and then selects the next keyframe in the timeline.
  - **Close:** This closes the dialog box. If you did not apply the modifications, they will be cancelled.

## Related Topics

- [Adjusting the Ease on page 701](#)

# Animation Path Preferences

While creating motion paths and setting up your scenes, there are preferences you can set to make your work more efficient.

To open the Preferences panel:

- ▶ Windows: Select **Edit > Preferences**.
- ▶ Mac OS X: Select **Animate > Preferences**.
- ▶ Press [Ctrl] + [U] (Windows) or [⌘] + [U] (Mac OS X).

## Related Topics

- [General Preferences](#) below
- [Camera Preferences](#) on the next page
- [Exposure Sheet Preferences](#) on page 710
- [Timeline](#) on page 1

## General Preferences

The screenshot shows the 'General' preferences tab. The 'Options' section has 'Snap Keyframe' checked and highlighted with a red box. The 'Settings' section is also highlighted with a red box and contains the following options:

- Stop-Motion Keyframes
- Default Separate Position
- Default Separate Scale
- Default Bezier
- Default Bezier Velocity

Other visible options include 'Auto Render', 'Focus On Mouse Enter', 'Shortcut Zooms on Mouse', 'Flat Toolbar (Requires Relaunch)', 'Support Gestures', 'Invert Scroll Direction', 'Levels of Undo: 50', 'Add Keyframes at Beginning and End', and 'Use Advanced Art Mode (need to restart application)'.

## Options

- **Snap Keyframe:** If two keyframes have the same value, they will both update to the same new position when the first of the two keyframes is modified. The previous keyframe has to be a Stop-Motion keyframe.

## Settings

- **Stop-Motion Keyframes:** New keyframes are created as stop-motion keyframes.



- **Default Separate Positions:** New pegs are created with separate position functions.
- **Default Separate Scale:** New pegs are created with separate scale functions.
- **Default Bezier:** New functions curves are created as Bezier Curves.
- **Default Bezier Velocity:** New velocity curves are created as Bezier Curves.

## Related Topics

- [Camera Preferences](#) below
- [Exposure Sheet Preferences](#) on the facing page
- [Timeline](#) on page 1

# Camera Preferences

Shortcuts General Camera Exposure Sheet Drawing Sound OpenGL Render

Tools

Initial Animation Mode

Show Locked Drawings As Outlines

Nudging Factor:

Set Keyframes on All Functions with the Transform Tool

Set Keyframe at Frame One with First Application of the Transform Tool

Paste/Drag & Drop adds keyframes at beginning and end

Select Tool Works on Single Drawing

Settings

Thumbnail Size  pixels

Small Bitmap Resolution  pixels

Override Small Bitmap Files

Safe Area  (ratio)

Zoom Settings

Camera View Default Zoom

Wash Background

Enable in Camera

Enable in Camera Drawing Mode

Wash Background Percentage

Control Points

Show Control Points On Selected Layers

Control Point Tension

Control Point Continuity

Control Point Bias

## Tools

- **Initial Animation Mode:** Determines which animation mode are enabled when the scene is opened.
- **Set Keyframes on All Functions With the Transform tool:** A keyframe is added by default on all the functions of the selected layer when you perform a transformation with the transform tool. Disable this option if you want the Transform tool to add a keyframe only on the transformation you are doing, such as a rotation or scale.
- **Set Keyframe At Frame One With First Application On the Transform Tool:** When this preference is enabled, wherever you set a keyframe on your layer, there will be a keyframe added on your frame 1. If the preference is disabled, there will be only a keyframe added to the current frame. If later on, you add a keyframe on your frame one, it may modify the first keyframe you added.

## Control Points

- **Show Control Points On Selected Layer:** By default, when you select an element with the Transform tool, the motion path related to the object is displayed.
- **Control Point Tension:** The default Tension value for new keyframes and Control Points.
- **Control Point Continuity:** The default Continuity value for new keyframes and Control Points.
- **Control Point Bias:** The default Bias value for new keyframes and Control Points.

## Related Topics

- [General Preferences on page 708](#)
- [Exposure Sheet Preferences below](#)
- [Timeline on page 1](#)

## Exposure Sheet Preferences

Shortcuts General Camera Exposure Sheet Drawing Sound OpenGL Render

Filtering

- Show Drawing Columns
- Show Function Columns
- Show Annotation Columns
- Show 3D Path Columns
- Show Sound Columns

Options

Default Add Columns: Bottom

Default Column Width: 100

Function Editors

- Show Grid
- Use Constant Z By Default

Zoom Levels

Minimum Zoom Level: 1

Maximum Zoom Level: 20

Drawing Creation

- Use Current Frame as Drawing Name

Gestural Drag

- Default Setting for Gestural Drag

## Function Editors

- **Show Grid:** When selected, the grid is displayed by default when opening the Function Editor.
- **Use Constant Z By Default:** When selected, the Constant Z option will be enabled by default in the Function Editor.

Constant Z means that even when creating Motion keyframes, the Z function will use Stop-Motion keyframes and will not be interpolated, this can be very useful for cut-out animation. The Constant Z feature only works with 3Dpaths.

You can also enable the Constant Z option directly in the Function Editor or Function view for specific functions.

## Related Topics

- [General Preferences on page 708](#)

- [Camera Preferences](#) on page 709
- [Timeline](#) on page 1



# Chapter 15: Cut-out Animation



Animate provides you with some great tools to animate your puppets. You can create simple animation using the Transform tool and you can make advanced animation using both forward and inverse kinematics. Animate has advanced onion skinning and image swapping features to help you animate efficiently and quickly. To give you animation freedom you are able to mix several different techniques of animation such as simple rigging, hierarchy and symbol animation.

## Topics Covered

- [Getting the Character](#) on page 715
- [Keyframes and Drawing Blocks](#) on page 716
- [Creating a Simple Cut-out Animation](#) on page 718
- [Selecting Layers to Animate or Position](#) on page 721
- [Navigating the Hierarchy](#) on page 725
- [Animating using the Transform Tool](#) on page 727
- [Animating using Inverse Kinematics](#) on page 730
- [Animating in Stop-motion](#) on page 748
- [Animating using Computer Generated Interpolation](#) on page 750
- [Flipping Through Poses](#) on page 756
- [Using the Onion Skin in Cut-out Animation](#) on page 758
- [Flipping Parts](#) on page 761
- [Reusing Extra Drawings, Poses and Facial Expressions](#) on page 1
- [Swapping Images](#) on page 763
- [Adding a New Drawing](#) on page 766
- [Ordering Layers Over Time](#) on page 767
- [Resetting a Transformation](#) on page 769
- [Creating Cycles](#) on page 771

- [Adding Pegs on page 776](#)
- [Offsetting Part of an Animation on page 1](#)
- [Preferences on page 1](#)

# Getting the Character

The first step in animating your character is to import a master template from the library.

- [Importing a Character from the Library below](#)

## Importing a Character from the Library

To import your character from the library:

1. Create your new Animate project.
2. In the Library view, select the character's master template you want to animate.

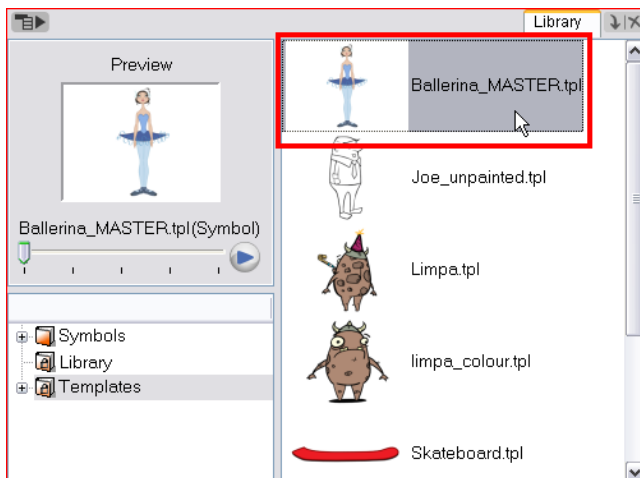

3. Drag the selected template to the Camera or Timeline view's left side.

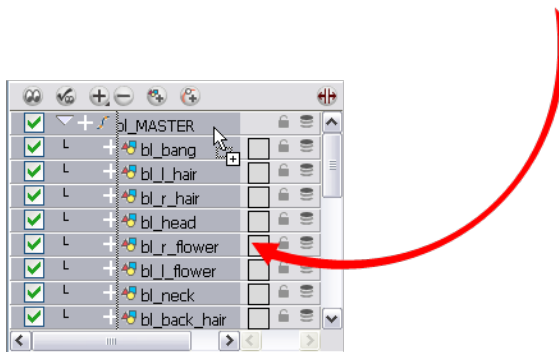

4. In the Timeline view, drag the scene length bracket to extend or shorten your scene length.



### Related Topics

- [Selecting the Pose](#) on page 1
- [Extending the Exposure](#) on page 1

# Keyframes and Drawing Blocks

When you extend the exposure of a drawing it is represented by a grey block in the Timeline view. When you expose a second drawing, a second grey block is displayed.

You can consider these blocks as drawing blocks.

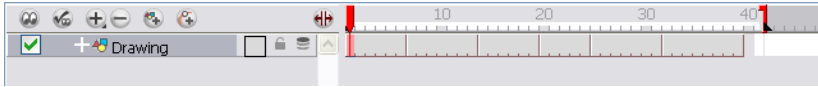

To animate the position of a block over time, you do not need to create a second block, you simply need to add a position keyframe. The position keyframes are coordinates indicating the position of your drawing on a particular frame. These appear as black squares in the Timeline view. If you refer to the example below, you can see that the keyframes are positioned on frames independently from the beginning and end of each drawing block.

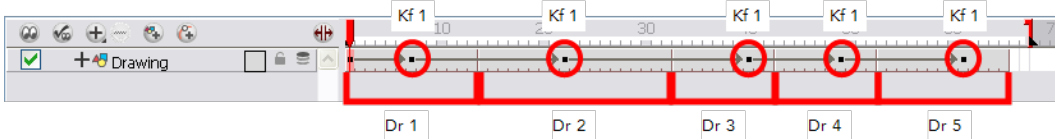

You can keyframe three different positions for your drawing in the same drawing block and create a motion path between them.

## Timeline Behaviour

In the Timeline view, you can see how the Timeline behaves differently depending on whether you either create a new drawing, a new keyframe, or both at the same time.

- [Creating a Drawing in the Timeline View below](#)
- [Creating a Keyframe in the Timeline View on the next page](#)
- [Creating a Drawing and a Keyframe in the Timeline View at the Same Time on the next page](#)

## Creating a Drawing in the Timeline View

You can use the Create Empty Drawing command to add a new drawing in the Timeline view. This will automatically insert a new drawing block.

- ▶ Select **Drawing > Create Empty Drawing**. You can also use the **Create Empty Drawing**  button from the Timeline View toolbar.

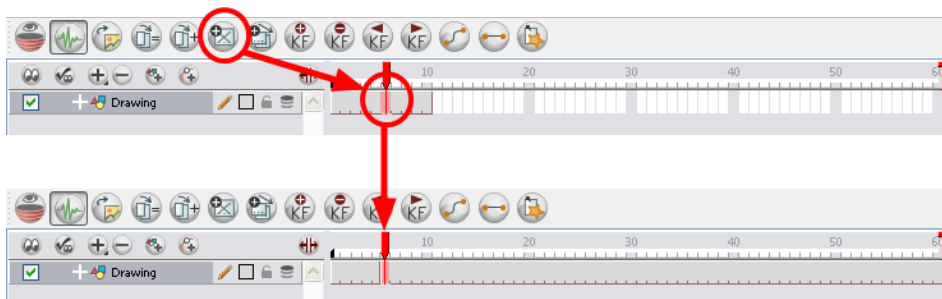



## Creating a Keyframe in the Timeline View

You can use the Add Keyframe command to add a new keyframe in the Timeline view. This will automatically create a keyframe in your layer.

- ▶ Select **Insert > Keyframe** . You can also press [F6].
- ▶ You can also use the **Add Keyframe**  button from the Timeline View toolbar.

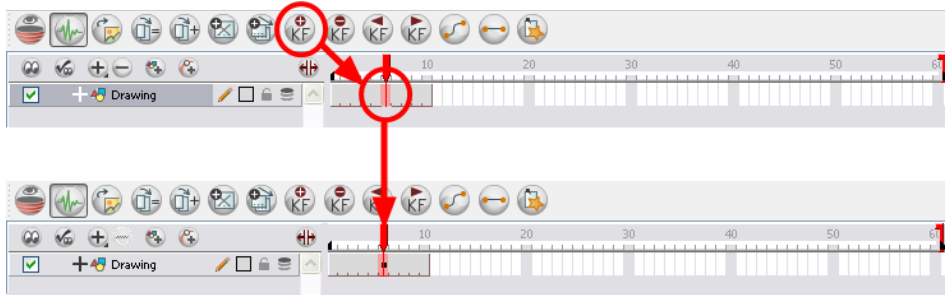

## Creating a Drawing and a Keyframe in the Timeline View at the Same Time

You can use the Insert Keyframe and Duplicate Drawing command to add a keyframe and a drawing at the same time. This will create a drawing block containing copies of the selected drawing and a keyframe.

- ▶ Select **Insert > Keyframe and Duplicate Drawing**.

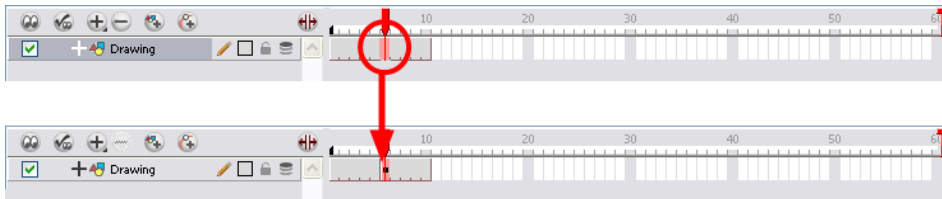



# Creating a Simple Cut-out Animation



To create a simple cut-out animation, follow these steps so you can try out the animation tools you will learn in the next topics.

## To create a simple cut-out animation:

1. In the Tools toolbar, select the Transform  tool. You can also press [Shift] + [T].
2. In the Tool Properties view, make sure that the Peg Selection Mode  option is disabled.
3. In the Tools toolbar, enable the Animate  mode so that everything you move will be keyframed automatically.
4. In the top menu, select **Animation > Stop-Motion Keyframe** so that the interpolation is not created automatically between your keyframes.
5. In the Timeline view, collapse your character.

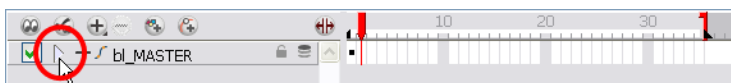

6. In the Timeline view, go to the frame where you want to set your first pose.

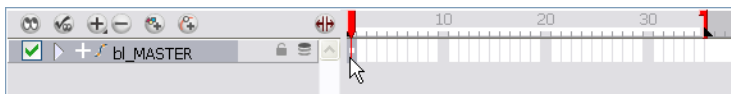

- In the Camera view, select the parts to animate.

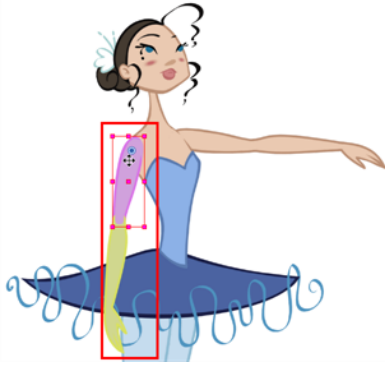

- Using the Transform  tool, rotate, skew, scale or translate the selection to its new position.

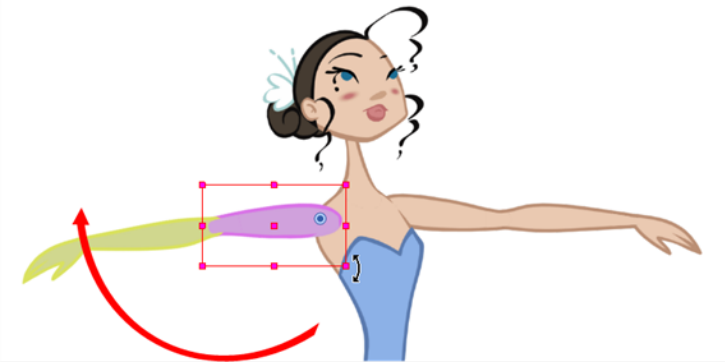

A new keyframe appears in the Timeline view.

- If you want to make sure that nothing will move on your new pose, in the Timeline view, select the frame corresponding to the pose, right-click and select Add Keyframe. You can also press [F6].

- In the Tools toolbar, enable the Onion Skin  feature.

- In the Timeline view, go to the frame where you want to set your second keyframe.



- In the Camera view, animate your character.

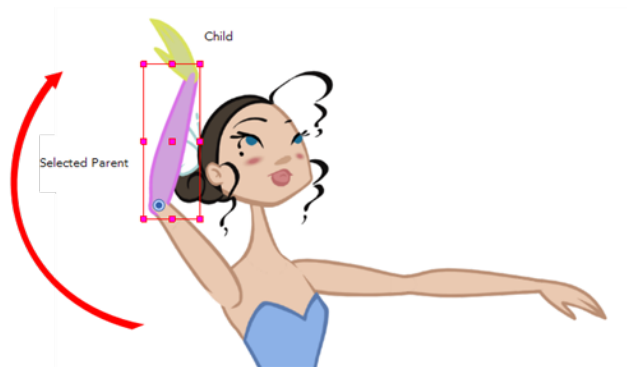

- Repeat this process until all your poses are done.

## Related Topics

- [Selecting Layers to Animate or Position](#) on the next page
- [Animating using the Transform Tool](#) on page 727
- [Animating using Computer Generated Interpolation](#) on page 750
- [Using the Onion Skin in Cut-out Animation](#) on page 758

# Selecting Layers to Animate or Position

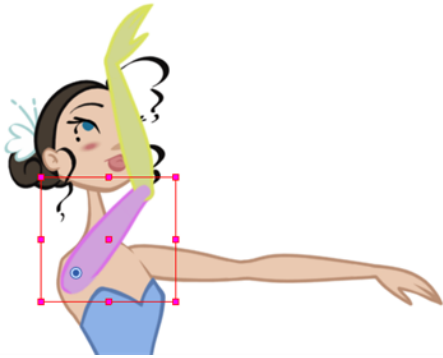

When you are animating characters, it is important to understand how the Animate mode allows you to create keyframes on the current frame or to reposition the entire layer.

This topic is divided as follows:

- [Animate Mode below](#)
- [Selecting Drawing Layers using the Transform Tool on the facing page](#)

## Animate Mode

The Animate  button, in the Tools toolbar, toggles the keyframing option on or off.

When you enable the Animate mode, as soon as you move an element in your Camera view, a keyframe is positioned on the current frame in the Timeline view to indicate the new position.

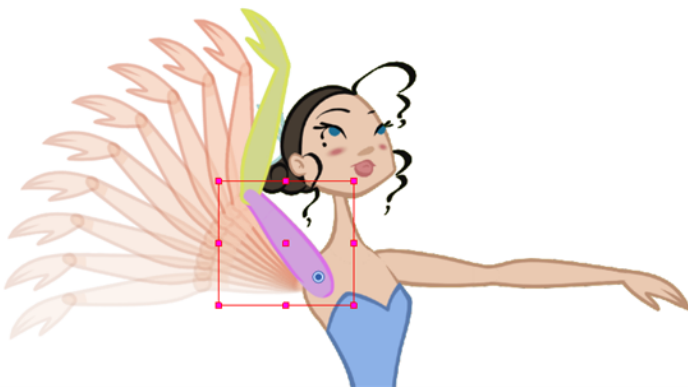

When you disable the Animate mode, and you select and move an element, the entire animation in the layer will be offset at once.

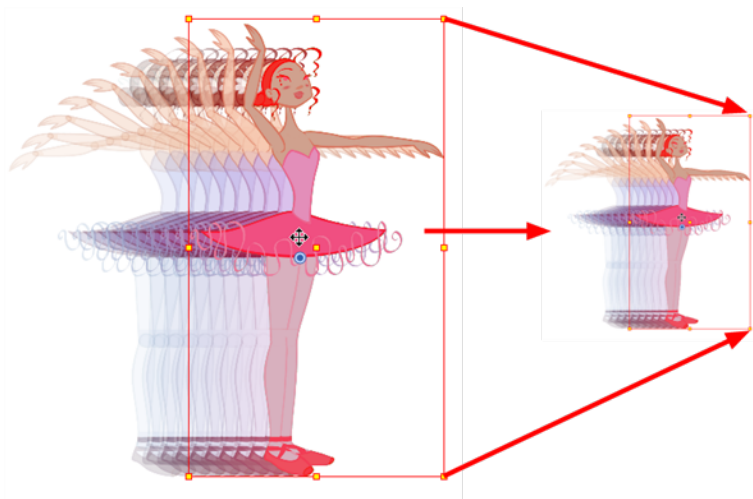

This means that when you are animating your character, you must enable the Animate mode.

If you are scaling down your puppet to fit the scene composition and want to resize the entire animation, you must disable the Animate mode.

**To enable and disable the Animate mode:**

- ▶ In the Tools toolbar, click on the **Animate**  button. You can also enable and disable the Animate mode in the top menu under **Animation > Animate**.

## Selecting Drawing Layers using the Transform Tool

To manipulate your drawing layers in order to animate them, you must use the Transform  tool. The Select tool is used to modify the drawing strokes and not the actual drawing layer.





When selecting your drawing layers with the Transform tool, make sure that the Peg Selection Mode option is disabled in the Transform Tool Properties view. If this option is enabled it will limit the selection in the Camera view to pegs only.

This section is divided as follows:

- [Selecting an element in the Camera View using the Transform Tool](#) on the next page
- [Selecting a Layer in the Timeline View](#) on the next page
- [Selecting in the Network View](#) on page 724

**To select using the Transform tool:**

1. In the Tools toolbar, click on the **Transform**  tool or press [Shift] + [T]. You can also select the Transform tool in the top menu under **Animation > Tools > Transform**.
2. In the Tool Properties view, make sure that the **Peg Selection Mode**  is disabled.
3. In the Camera view, select the element to animate.

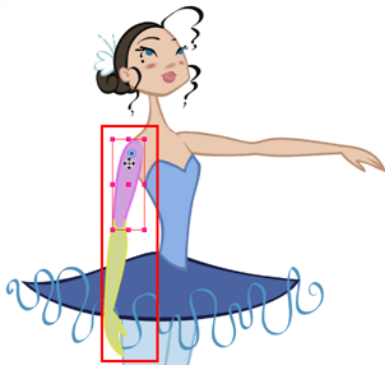

## Selecting an element in the Camera View using the Transform Tool

When you select an element in the Camera view using the Transform tool, make sure that the Peg Selection Mode  is disabled in the Transform Tool Properties view, the element selected is the actual drawing layer

corresponding to the selected element. If you have a peg parented to that layer, you must either use the keyboard shortcuts to go up the hierarchy chain, select it in the Timeline view, or enable the Peg Selection Mode  option in the Transform Tool Properties view, this will limit the selection in the Camera view to pegs only.



If the layer has child layers, they will also be highlighted.

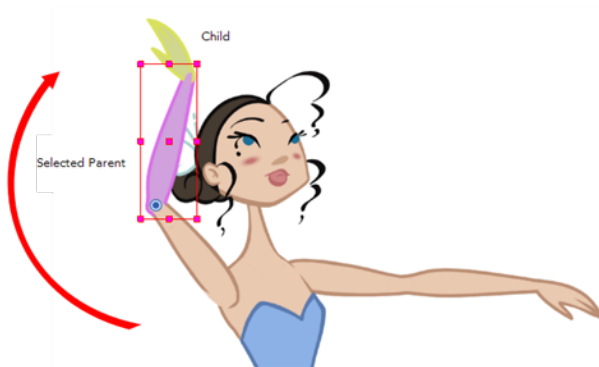

## Selecting a Layer in the Timeline View

When you select a layer in the Timeline view, the corresponding element will be highlighted in the Camera view. If the selected layer has child layers, they will also be highlighted.

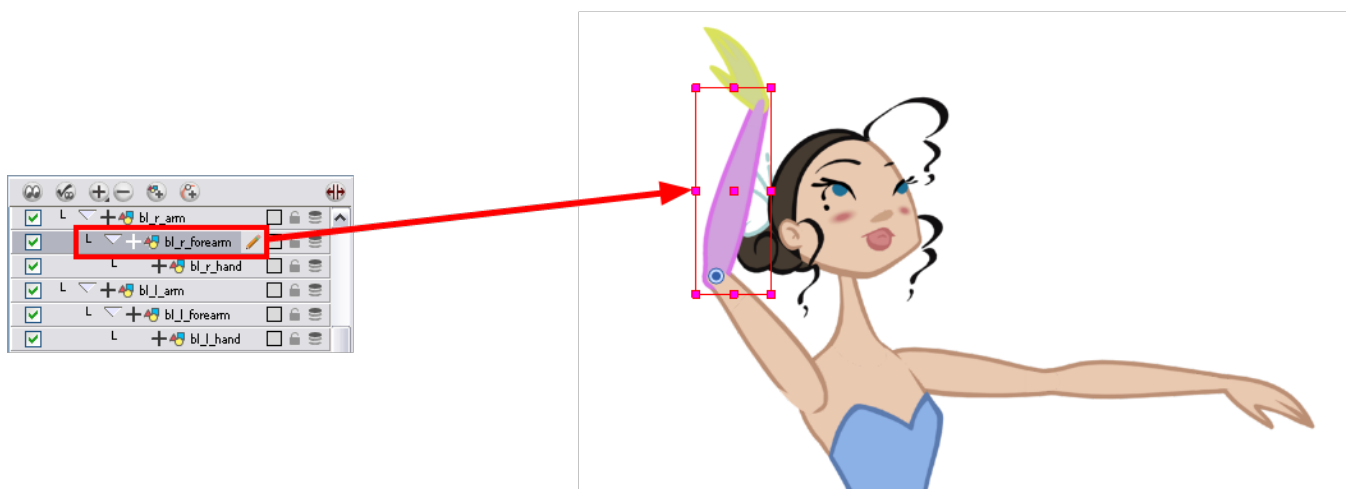

## Selecting in the Network View

As with the **Timeline** view, when you select a module in the **Network** view, the corresponding element will be highlighted in the **Camera** view. If the selected module has child layers, they will also be highlighted.

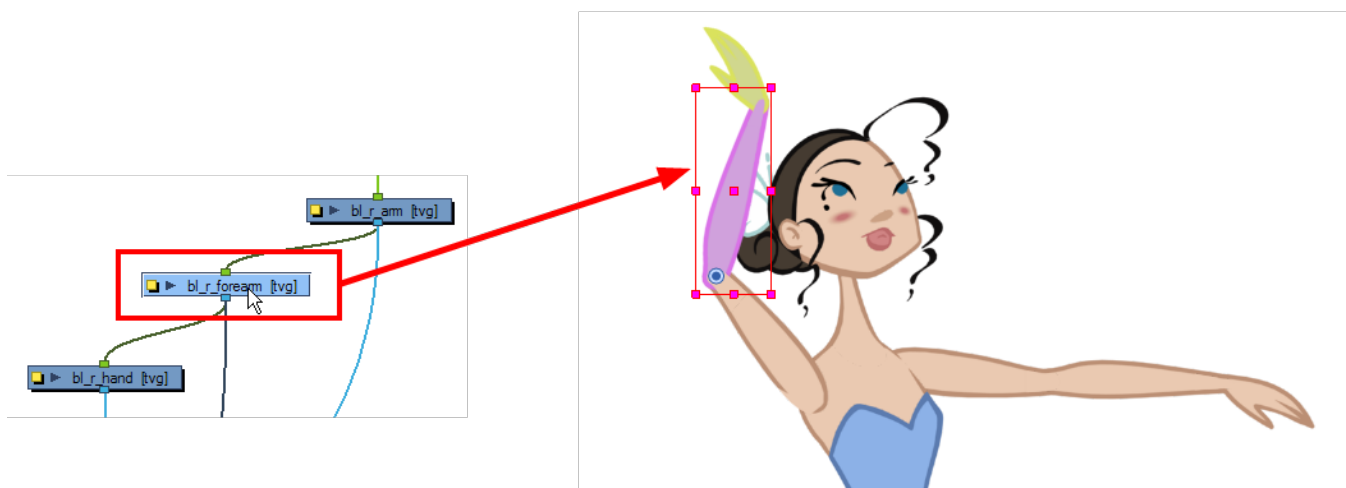

## Related Topics



- [Navigating the Hierarchy on the next page](#)



# Navigating the Hierarchy

If you created a layer hierarchy when you built your puppet, you can use the keyboard shortcuts to travel up and down the parent-child chain. You can also travel between the children in a layer.

## To select the parent or child layer:

1. In the Tools toolbar, select the **Transform**  tool.
2. In the Tool Properties view, make sure that the **Peg Selection Mode**  is disabled.
3. In the Camera or Timeline view, select a layer attached to a hierarchy.

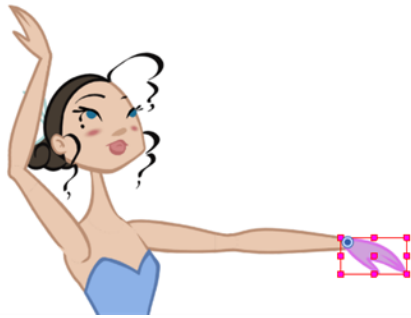

4. Select **Animation > Select Parent Skipping Effects** to select the parent layer and select **Animation > Select Child Skipping Effects** to select the child layer. The keyboard shortcuts are [B] and [Shift] + [B].



That these keyboard shortcuts will ignore any effect module encountered in the Network or Timeline view. Only drawing and peg modules will be considered. If you would like to navigate the hierarchy including the effect modules, you create a custom keyboard shortcut in the Preferences panel for the Select Parent Skipping Effects and Select Child Skipping Effects commands under the General category. Refer to [Customizing a Keyboard Shortcut on page 58](#) to learn how to create custom keyboard shortcuts.

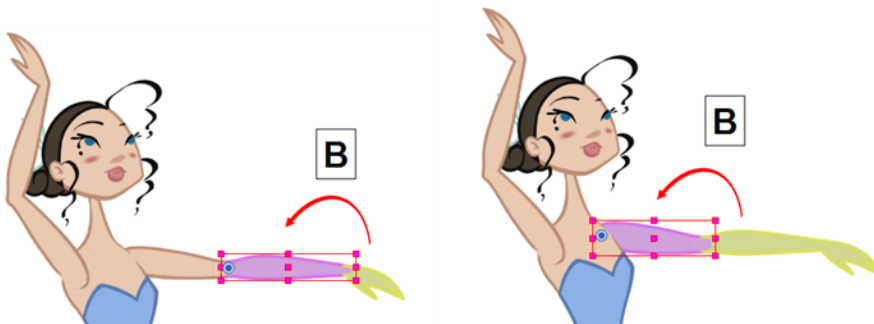

## To select the children layers:

1. In the Tools toolbar, select the **Transform**  tool.

- In the Camera or Timeline view, select a layer attached to a parent layer with several children or not parented at all.

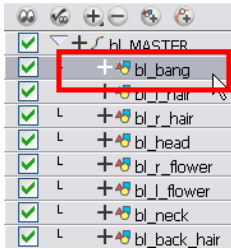

- Select **Animation > Select Previous Brother** to select the previous child layer and select **Animation > Select Next Brother** to select the next child layer. You can also select **Animation > Select Children** to select all child layers at once. The keyboard shortcuts are [/] and [?].

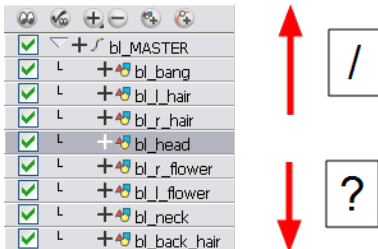

## Related Topics

- [Creating a Simple Cut-out Animation on page 718](#)
- [Selecting Layers to Animate or Position on page 721](#)
- [Animating using the Transform Tool on the next page](#)
- [Animating using Inverse Kinematics on page 730](#)
- [Flipping Through Poses on page 756](#)
- [Flipping Parts on page 761](#)
- [Ordering Layers Over Time on page 767](#)
- [Resetting a Transformation on page 769](#)
- [Adding Pegs on page 776](#)
- [Offsetting Part of an Animation on page 1](#)

# Animating using the Transform Tool

The Transform tool is the main tool you use when working with a cut-out character. The Transform tool has many useful functions:

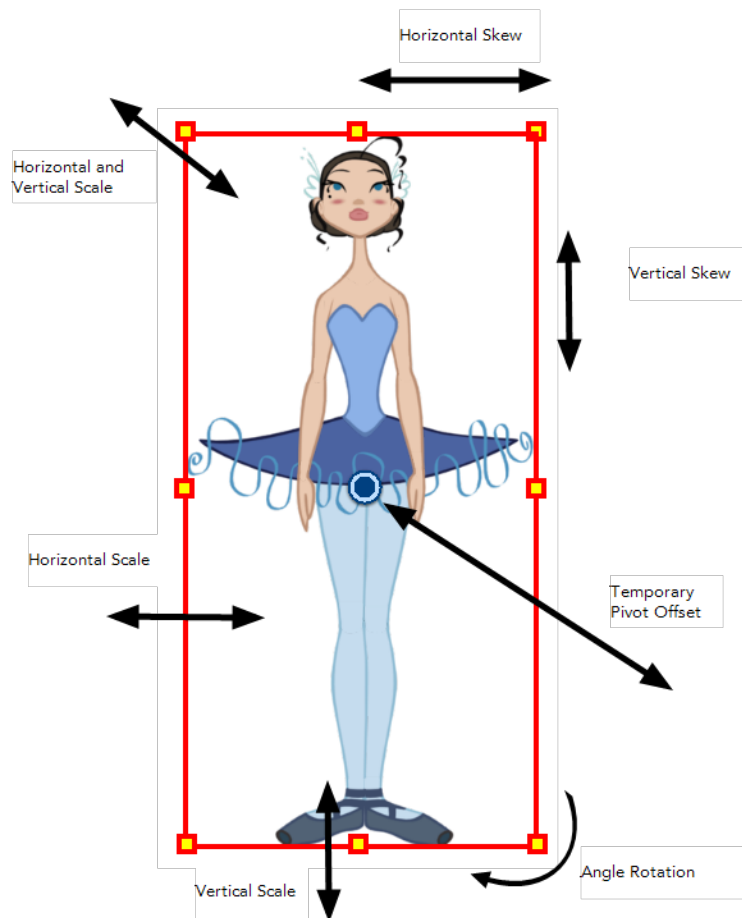

Using the individual Rotate, Translate, Scale and Skew tools is not recommended, as they move each piece from their own pivot point. They are compositing tools. The Transform tool will create a global selection, so when many parts are selected, the Transform tool will move it as one. The Transform tool is highly recommended for cut-out animation.



When animating with the Transform tool, make sure to select the right selection mode. In this example, make sure that the Peg Selection Mode  is disabled in the Tool Properties view or it will

limit the selection in the Camera view to pegs only.

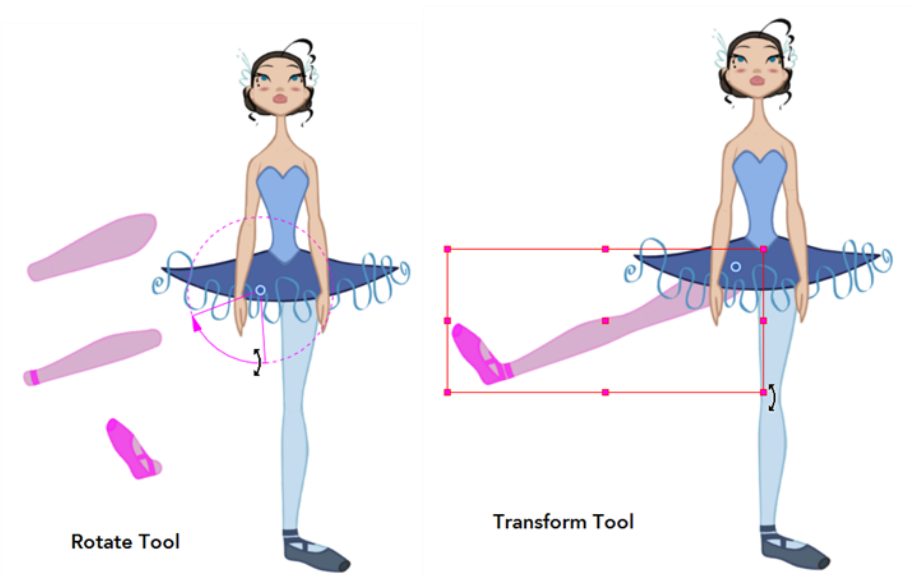

If you have hierarchy connections in your cut-out character, the Transform tool will also be used as the Forward Kinematics equivalent.



The Transform tool can be used on any kind of rigging.

When many parts are selected with the Transform tool, the first selected part's pivot will be used as the global selection's pivot. This pivot can be moved temporarily for the animation. When you offset the pivot, the permanent pivot is displayed as a ghost.



The interpolation of your animation poses is always calculated from the permanent pivot.

### To use the Transform tool:

1. In the Tools toolbar, click on the **Transform**  tool or press [Shift] + [T].
2. In the Tool Properties view, make sure that the **Peg Selection Mode**  is disabled.
3. In the Camera view, select the element to animate and move it.

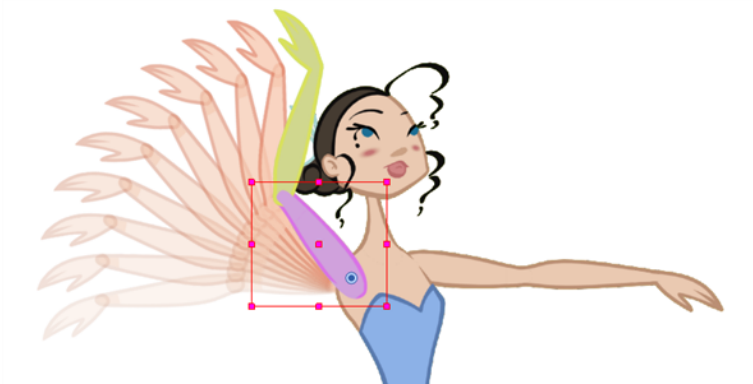

4. In the Timeline view, go to the frame where you want to set your next position.



5. In the Camera view, animate the character.

## Related Topics

- [Positioning an Element using the Transform Tool](#) on page 498

# Animating using Inverse Kinematics



The Inverse Kinematics tool (IK) allows you to pull on your character's extremities, such as the hands and feet, and have the rest of the body follow.

The Inverse Kinematics tool will animate from an extremity and make the rest of the hierarchy follow (called the IK chain). It can be used on any piece connected in a hierarchy. However, you do not have to use IK every time that you have a hierarchy rig. This tool is useful when you want to bend a character's knees, make him sit and move the rest of the body, etc.

Inverse Kinematics helps a new animator to understand how a puppet should move. It will also help any animator easily create difficult moves.

Inverse Kinematics will not work on basic rigs without hierarchy because there is no hierarchy chain present, IK only works on hierarchy parenting when the pivots are properly set.

When animating a hierarchy puppet, an animator will use the Transform and Inverse Kinematics tools.

## Topics Covered

- [IK Hierarchy Chains](#) on the next page
- [Where to Start with Inverse Kinematics?](#) on page 732
- [Inverse Kinematics Tool Properties](#) on page 734
- [Setting up the Character to use IK](#) on page 738
- [Nails](#) on page 742
- [Minimum and Maximum Angle](#) on page 1
- [IK Keyframes](#) on page 743
- [When to use the Inverse Kinematics Tool](#) on page 745

# IK Hierarchy Chains

Before we go any further, a word about IK chains. There are three types of chains:

- [Single Chains](#) below
- [Direct Chains](#) below
- [All Chains](#)

## Single Chains

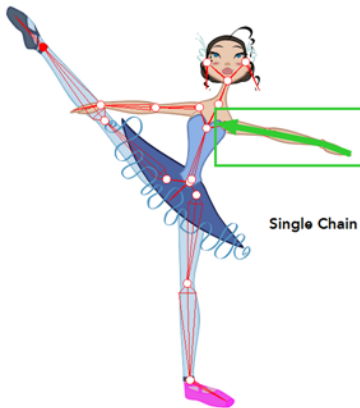

These are the most basic of chains. A single chain is a straight line with no secondary chain attached.

## Direct Chains

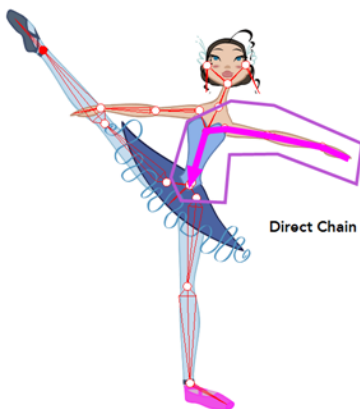

These link directly to the core of the character rigging. A direct chain is a single chain which goes directly to the core.

## All Chains



All chains are attached and move simultaneously when one part is moved.

### Related Topics

- [Where to Start with Inverse Kinematics? below](#)
- [Inverse Kinematics Tool Properties on page 734](#)
- [Setting up the Character to use IK on page 738](#)
- [Nails on page 742](#)
- [Minimum and Maximum Angle on page 1](#)
- [IK Keyframes on page 743](#)
- [When to use the Inverse Kinematics Tool on page 745](#)

## Where to Start with Inverse Kinematics?

This section explains the basics of the Inverse Kinematics tool. IK works best when you lock a part of the character to the spot, such as a foot on the floor, then select the entire body or another extremity and move it.

To lock a part in place, you use the IK Nail option.

**To use the Inverse Kinematics tool:**

1. In the Tools toolbar, select the **Inverse Kinematics**  tool or press [Alt] + [8].
2. In the Camera view, [Ctrl] + click (Windows) or [⌘] + click (Mac OS X) on a part of the body.



The entire IK skeleton appears.



3. Click on a part of the body and pull on it to move the character.



4. Hold down the [Shift] key and click on the pivot belonging to the part you want to lock in place.

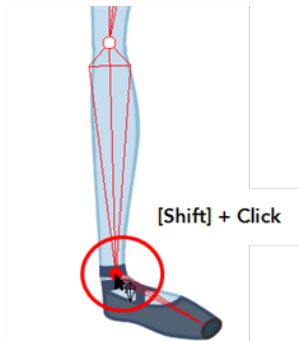

5. Click on another part of the character and pull on it. You can [Shift] + click on a bone to lock the orientation of the bone.

## Related Topics

- [IK Hierarchy Chains](#) on page 731
- [Inverse Kinematics Tool Properties](#) on the facing page
- [Setting up the Character to use IK](#) on page 738
- [Nails](#) on page 742
- [Minimum and Maximum Angle](#) on page 1

- [IK Keyframes](#) on page 743
- [When to use the Inverse Kinematics Tool](#) on page 745



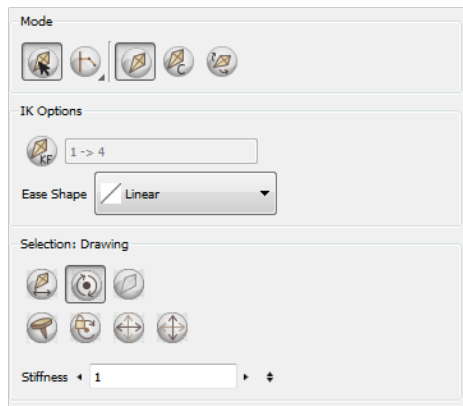

## Inverse Kinematics Tool Properties



- [IK Modes](#) below
- [IK Tool Options](#) on the next page
- [Selection](#) on page 736

## IK Modes

The IK tool has six different modes that can be found in the Tool Properties view:

-  [Bone Selection Mode](#) below
-  [Chain Menu](#) on the next page
-  [IK Manipulation Mode](#) on the next page
-  [Apply IK Constraints Mode](#) on the next page
-  [Bone Editing Mode](#) on the next page

## Bone Selection Mode

The Bone Selection mode is enabled by default. This option allows you to click on any bone in your character and move it without having to select the actual layer.

Once you disable this option, you can not move any bone except the selected one. This allows you to grab and rotate the selected part from many angles and location. You can click completely outside the character and move the pieces.

## Chain Menu

The Chain drop-down menu allows you to choose from three types of chain:

- **Simple Chain Mode:** this is the default mode and will only allow for the movement of parts attached to a single chain up to the point of intersection. A single chain is a straight line with no secondary chain attached
- **Direct Chain Mode:** this mode will allow the movement of parts up a simple secondary chain to a principle chain as long as translation movement is possible (the principle chain is attached to its own peg), but will ignore all secondary chains. A direct chain is a single chain which goes directly to the core.
- **All Chain Mode:** this mode allows for the movement of all parts attached to all chains in the IK skeleton. All chains are attached and move simultaneously when one part is moved.

## IK Manipulation Mode

The IK Manipulation mode is the main working mode for the Inverse Kinematics tool. Enable this mode when you want to animate and position your puppet.

[Ctrl] + click (Windows) or [⌘] + click (Mac OS X) on a body part to select it. You do not need to select a part to be able to move it.

## Apply IK Constraints Mode

The Apply IK Constraints mode is used to correct a part's position on a series of frames. For example, if the character's foot seems to be sinking into the floor, you can correct its position and angle over a series of frames using the IK Constrains mode.

## Bone Editing Mode

The Bone Editing mode is used to fix the bone orientation on extremities such as hands and feet.

## IK Tool Options

The IK tool has two special options that can be found in the Tool Properties view:

- [IK Keyframe below](#)
- [Ease Shape on the facing page](#)

## IK Keyframe

The IK keyframe option is used in combination with the IK Constraints mode. It determines the starting frame of the constraint you will apply.

## Ease Shape

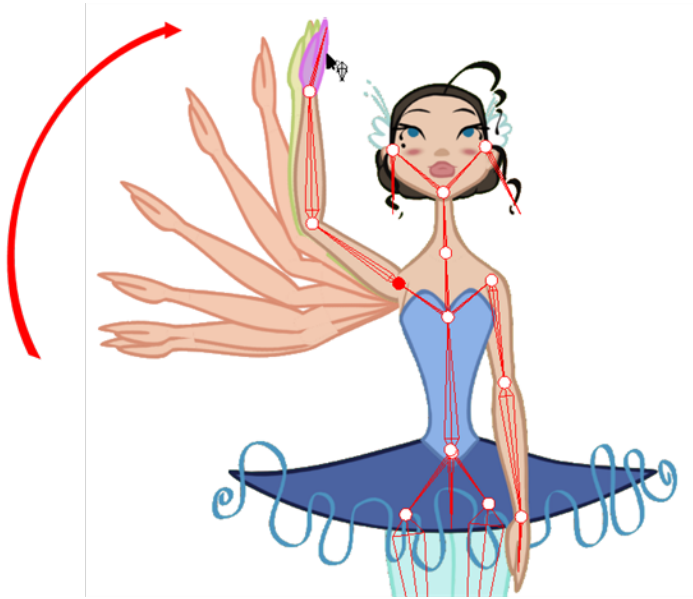

While you animate with the IK tool, prior to doing a movement you can set an easing preset so that your motion is not so mechanical.

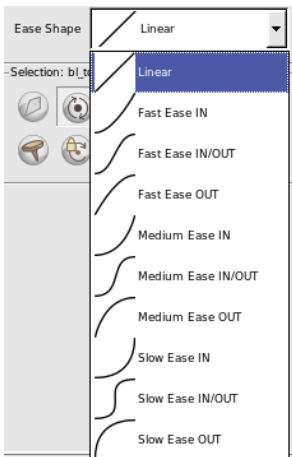

Before moving your part, select a preset from the list in the drop-down menu.





If you select a new preset in the list and move the part again on the same keyframe, the easing will be automatically updated.

## Selection

With the IK tool, you are able to do the following that can be found in the Tool Properties view:

-  [Enable Translation If Top of Hierarchy on the next page](#)
-  [Enable Rotation on the next page](#)

-  [Exclude From IK below](#)
-  [IK Nails on the facing page](#)
- [Stiffness on the facing page](#)

## Enable Translation If Top of Hierarchy

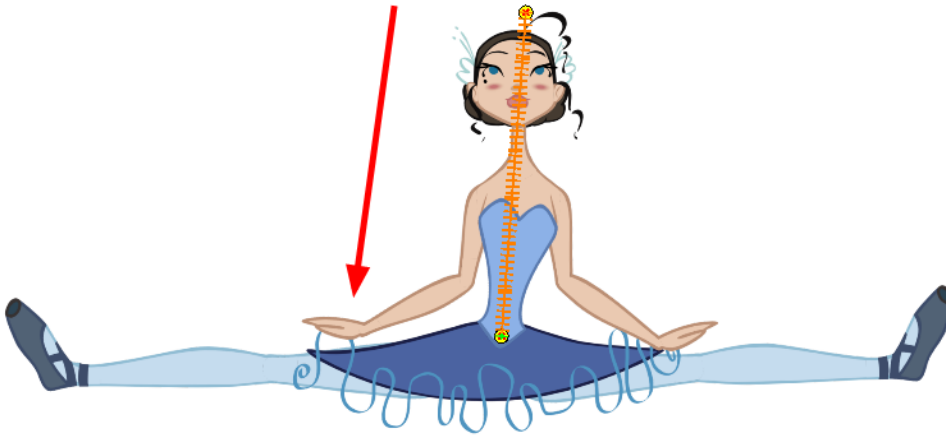

This option is mainly used on master pegs. You will need to use the Enable Translation If Top of Hierarchy option when you have a situation such as this; if you want your character to do a perfect split (sitting down with the legs at right angles to the body or at the sides with the trunk facing forwards), then the hip will need to translate and not just rotate on the spot. And since IK is all about rotation, you would select the hip layer and enable the translation option.

## Enable Rotation

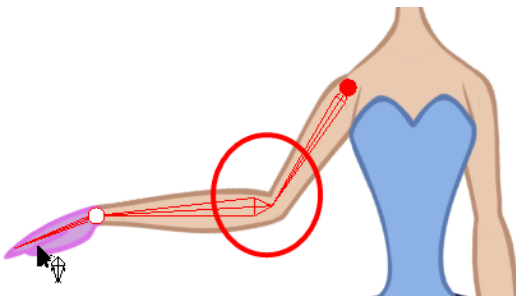

The Enable Rotation option is enabled by default. If you disable this option, the selected part will not be able to rotate anymore and will remain in the same position all the time. You can use this option to simulate an arm in a plaster cast.

When you enable this option, the pivot will disappear but you will still see the bone.

## Exclude From IK

You can use the Exclude From IK option when you want certain parts of your puppet such as the eyes and mouth to be excluded from the IK influence.

## IK Nails



IK nails are used to temporarily fix a part of a character to a spot either in translation or rotation, or to enable maximum and minimum angle usage.

## Stiffness

When a certain part is selected, you can apply a stiffness value to it. A different stiffness value can be set to each body part individually. The greater the Stiffness value applied, the more difficult it is to make that part rotate, thereby rendering it stiff while the other parts continue to move freely on their joints.

## Related Topics

- [Nails on page 742](#)
- [IK Hierarchy Chains on page 731](#)
- [Minimum and Maximum Angle on page 1](#)

## Setting up the Character to use IK

The first time you display the character's skeleton, you will notice a series of bones on the extremities which are out of place, and there may also be some elements that you would like to exclude from the Inverse Kinematics chain.

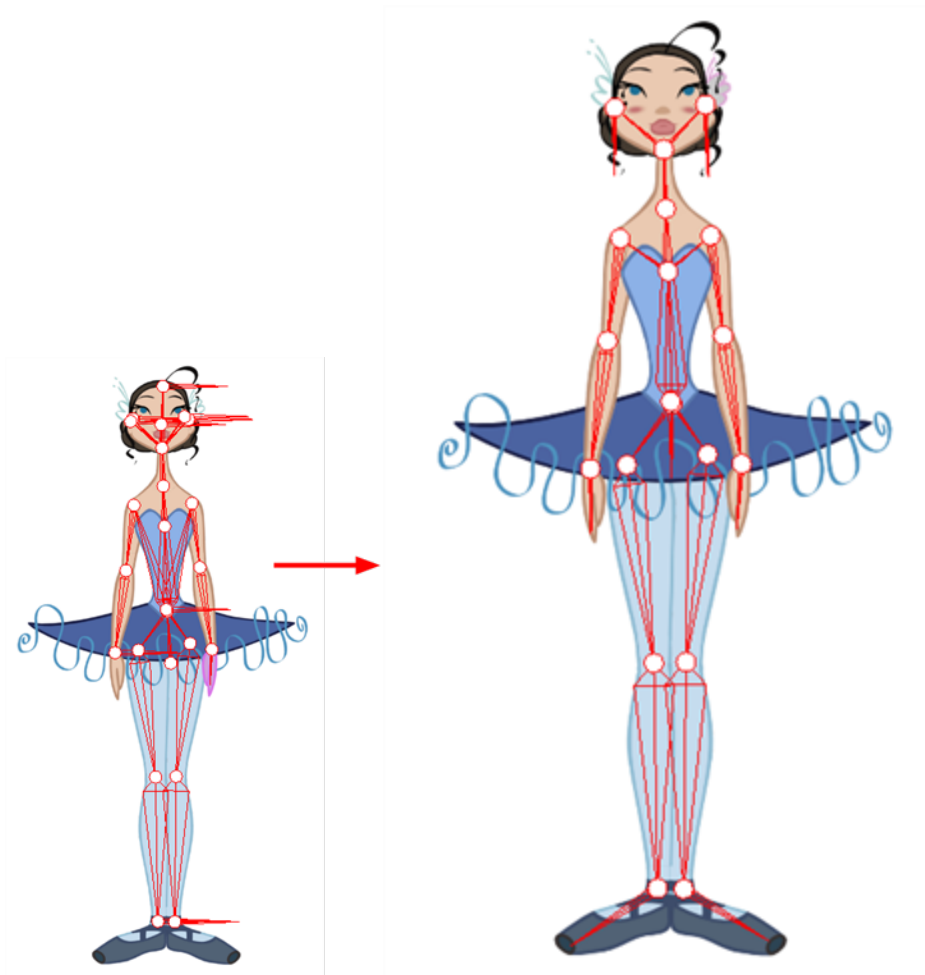

You should setup the skeleton before starting your animation. There are three things to do to setup the character:

- [Connecting any Hierarchy Chain below](#)
- [Excluding Extra Elements from IK on the facing page](#)
- [Setting Up the Bones for the Extremities on the facing page](#)

## Connecting any Hierarchy Chain

Before fixing any bones, or excluding layers from the IK, it is important that you make sure all the elements you want to be parented in a chain are setup.



You do not need to have a chain all over the body. It can be on the legs and arms. If the body is not completely rigged in hierarchy, the skeleton will look a bit more messy, but the IK tool will still work without any problem.

## Excluding Extra Elements from IK



When working with the IK tool, you will probably want to move the main parts around, but not necessarily the small ones such as the nose or ears. In this case, you can select some elements on your character and exclude them from the skeleton.

**To exclude elements from the skeleton:**

1. In the Tools toolbar, select the **Inverse Kinematics**  tool or press [Alt] + [8].
2. In the Tool Properties view, make sure the **IK Manipulation Mode**  is enabled.
3. In the Camera view, [Ctrl] + click (Windows) or [⌘] + click (Mac OS X) on the part to exclude from the IK.

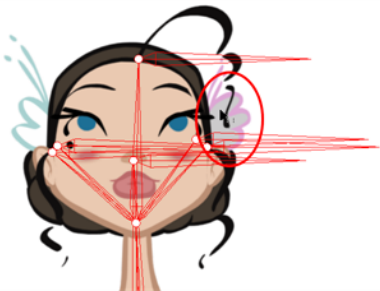

4. In the Tool Properties view, click on the **Exclude from IK**  button.

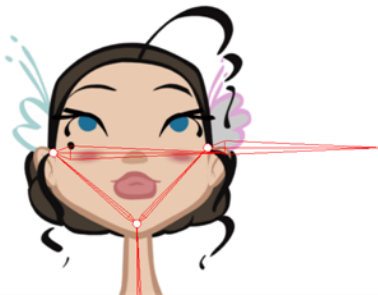

5. Repeat the process for every part to be excluded from the IK.



## Setting Up the Bones for the Extremities

Once you remove the extra elements from your skeleton, you will want to set the bone orientation for the extremity parts. By default they are oriented horizontally towards the right. This orientation often works for the



feet but not necessarily for the hair or hands,

#### To set the bone orientation:

1. In the Tools toolbar, select the **Inverse Kinematics**  tool or press [Alt] + [8].
2. In the Tool Properties view, enable the **Bone Editing**  mode.
3. In the Camera view, click on the pivot belonging to the part you whose bone you want to reposition, then pull the pivot in the direction you want the bone to be.

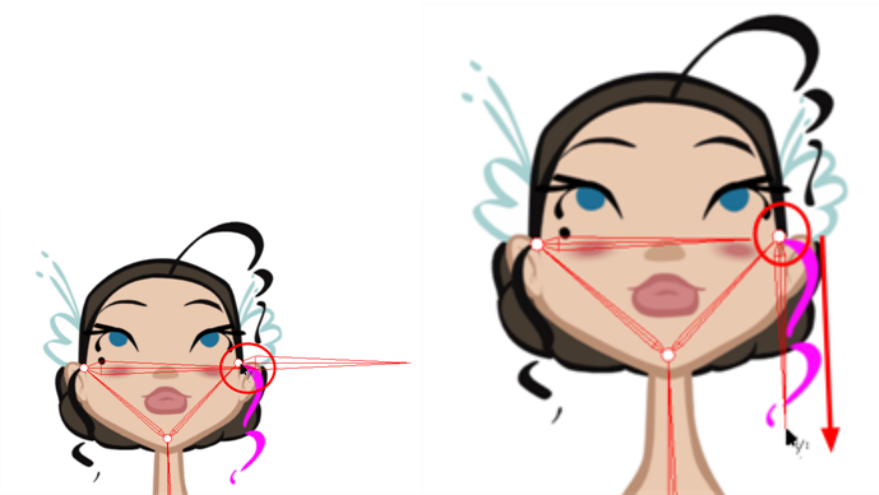

4. Repeat this process for each bone you want to position.



This command will only work on the extremities.

---

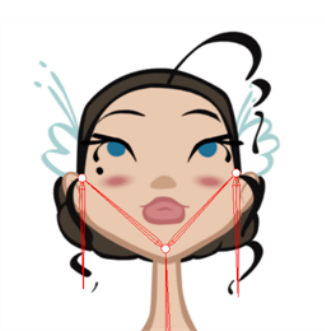

#### Related Topics

- [Animating using Inverse Kinematics on page 730](#)

# Nails

Using the Inverse Kinematics tool, if you pull a hand the system will animate all of the character's parts included in the hierarchy chain; the torso, the hips and the legs, depending on your rig. Often, you will only want to animate part of a character, such as the arm and not the whole body. To do so, you need to make use of IK constraints such as IK nails that are used to temporarily cut or constrain the chain. IK nails can be used to cut an IK chain or to block a part on the spot. For example, you can fix a character's feet to the ground when he walks.

There are different types of constraints that can be placed on the chain:

-  IK Nail

Blocks the X, Y and Z positions.

-  Hold Orientation

Blocks the angle



-  Hold X

Blocks only the X position

-  Hold Y

Blocks only the Y position

**To set an IK nail:**

1. In the Tools toolbar, select the **Inverse Kinematics**  tool or press [Alt] + [8].
2. In the Tool Properties view, make sure the **IK Manipulation Mode**  is enabled.
3. In the Camera view, [Ctrl] + click (Windows) or [⌘] + click (Mac OS X) on the part to set a nail on.
4. In the Tool Properties view, click on the type of nail you will use.



- You can also hold down the [Shift] key and click on any part's pivot to set a regular nail on it without having to select it.
- You can hold down the [Shift] key and click on the bone to set a Hold Orientation nail.
- You can select the nail type in the top menu by selecting **Animation > IK Constraints > the desired nail**.

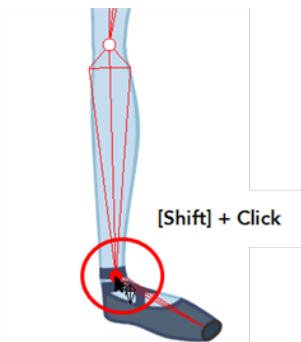

- You can remove the nail at anytime using the same technique you did to place the nail. It will not affect the animation.
5. To remove every nail except the Enable Min/Max Angle ones, in the top menu select **Animation > IK Constraints > Remove All Constraints**.

## Related Topics

- [Animating using Inverse Kinematics on page 730](#)

# IK Keyframes



When you animate a walking character and lock the feet down, the locked position will be perfect on the key poses. However, when you use the Motion keyframes to auto in-between the animation, you will notice a movement of feet. This motion is caused by the in-betweening of the rotations.

The nail holds in place the body part on the keyframe, but it will not hold it for the whole duration between keyframes.

If you place a nail on the shoulder to move just the arm, you do not necessarily want to keep the shoulder in the same place until the next key pose. You will probably want the shoulder, or any other part that is nailed, to have a slight, natural motion following the main body action. Of course, this is not the case when you fix a hand or a foot on the spot. If you have a fixed hand or foot, you will probably want it to stay exactly where you placed it. That is why you can apply an IK constraint on a frame range and on selected body parts.

To fix the part on the same spot requires an angle (rotation) correction on the parts that are moving too much. For example, to fix a foot that is moving too much, you will correct the angles on the foot, leg and thigh. To fix a hand, you will correct the angles on the hand, forearm and upper arm.

### To apply IK constraints on a frame range:

1. In the Tools toolbar, select the **Inverse Kinematics**  tool or press [Alt] + [8].
2. In the Camera view, click on the part you want to apply the constraint to.
3. In the Timeline view, set the cursor to the first frame where you want to start applying the constraint.



4. In the Tool Properties view, enable the **Apply IK Constraints Mode** .

- In the Tool Properties view, click on the **IK Keyframe**  button to enter the first frame number.

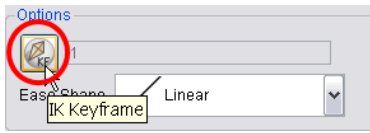

- In the Timeline view, move the playhead to the last frame where you want to apply the constraint.



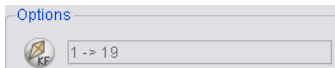

The IK Keyframe field should now look like this:



- In the Camera view, set a nail at the top of the limb you are correcting. In the case of a foot, set the nail on the thigh by holding down the [Shift] key and clicking in its pivot.



- In the Tool Properties view, select the type of constraint you want to apply to your piece. The most common case is a combination of the regular **Nail**  and **Hold Orientation**  options.

- In the Camera view, click on the bone of the part you want to apply a constraint to.

A warning message appears and requesting you to confirm that you want to add your constraint on that particular piece and for that frame duration.

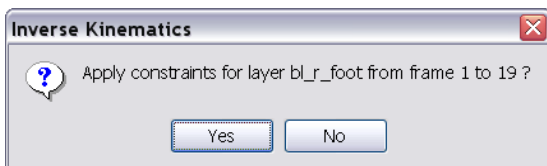

- Click on the OK button.

Your constraint are now be applied.

## Related Topics

- [Animating using Inverse Kinematics on page 730](#)

# When to use the Inverse Kinematics Tool

This summarizes what you have read so far.

Animate provides different tools with which to animate cut-out characters and trajectories. The two main tools used to animate characters are the Transform and the Inverse Kinematics tools.

Here, we will compare the usage of these tools and explain the Inverse Kinematics philosophy.

- **The Transform Tool**

The Transform tool is also known as Forward Kinematics. This is the main tool to use for cut-out animation. The Transform tool rotates, scales, moves and skews all the elements selected as one global element.

Forward Kinematics means that the element will be animated from the parent element down to the last child as a single piece. In other words, if the shoulder is animated, the arm, forearm and hand will follow as a complete arm drawing.

- **The Inverse Kinematics Tool**

The Inverse Kinematics tool (IK) is an assistance tool. This tool will help you to achieve complex motions such as sitting down or knee bending. The Inverse Kinematics tool will move and rotate every selected element as a chain.

Inverse Kinematics means that the element will be animated from the child element up to the parent element. In other words, if the hand is animated, the forearm, arm and shoulder will follow the hand in a fairly natural way in terms of the movement, rotation and bending.

## Inverse Kinematics in Toon Boom Animate

In most 3D animation software, Inverse Kinematics is implemented as a skeleton system. Animate uses the rigging hierarchy already created in the Timeline view, so there is no need to place bones in the character. Inverse Kinematics in Animate uses the connection between each of the parts' pivots.

## IK Tool and Rigging

The IK tool can not be used on every type of cut-out character. It depends on the way the pieces and parts are attached to one another. In other words, it depends on the rigging type.

There are several ways to rig a puppet. These are the three main rigging techniques:

- The Basic Rig technique is the simplest.
  - There are no connections between the parts.
  - They are free to move, rotate and scale independently one from the other.
  - The Inverse Kinematics tool CANNOT be used on this type of rigging.
- The Hierarchy Rig technique is the most complex.

- All the parts are connected one to the other.
- As they move, rotate and scale, they will influence all the other parts.
- The Inverse Kinematics tool can be used on this type of rigging.
- The Mix Rig technique is the best of the Basic and Hierarchy rig.
  - Some parts are independent such as the torso.
  - Some parts are setup into a hierarchy such as the arms and legs
  - The Inverse Kinematics tool can be used on this type of rigging.

## Animating with the Tools

Puppets are animated by using a combination of Transform and Inverse Kinematics tools.

You will mainly use the Transform tool (Forward Kinematics) as it has all the main motions; rotate, scale, skew, move and select. You can also control the exact position of the parts while using the Transform tool. As well, the Transform tool creates a temporary global pivot on the selection that can be moved around for the animation purpose.

To complete complex motions, such as bending the knees while keeping the feet on the ground, you will use Inverse Kinematics tool as an assistance tool. By adding IK Constraints (Nails), it is possible to lock the feet or any other parts on the spot and move the rest of the body, which will react to the constraints.

## Inverse Kinematics Philosophy

It is important to keep in mind that the Inverse Kinematics tool is an assistance tool. You won't use it to animate all the time.

Also, the Inverse Kinematics tool can be used to do the character's posing faster. Posing is a crucial part in the animation process. The IK tool can be used to pose the character more naturally, depending on your own preferences.

An IK Nail can be added anywhere on the character to animate only a small part of the hierarchy chain, such as an arm or a portion of the arm.

## Tips and Tricks for Inverse Kinematics

Here are some tips and tricks to help you to use the Inverse Kinematics tool.

- **IK on Mix Rigging**

The Inverse Kinematics tool can be used on a full puppet's body even if it is connected as a mix rigging, meaning some parts are rigged in a hierarchy and others not. For example, you can add IK Nails on the puppet's feet, select the full body master peg and move the character as if it was connected in a full hierarchy rig. This technique works on most of the mix rigging.

- **IK Constraints**

It is important to remember that you can add and remove IK Constraints (Nails, Hold Orientation, etc.) at anytime during the animation. They hold a certain part on the spot while you animate the rest of the body. Because they are not constricting one part to another object, you can add or remove them without affecting any of the animation you have already done.

- **Useful Shortcuts**

- While using the IK tool, you can [Ctrl] + click (Windows) or [⌘] + click (Mac OS X) to select any part.
- You can hold down the [Alt] key to rotate the selected part without affecting the IK chain.
- You can press the [Shift] key and click in a part's pivot to add or remove an IK Nail.
- You can press the [Shift] key and click on a bone to add or remove and Hold Orientation constraint.

## Related Topics

- [Where to Start with Inverse Kinematics? on page 732](#)

# Animating in Stop-motion

To start animating your character, start by doing your key poses. In fact, most of your time will be spent doing your key poses. It is better to work with Stop-motion keyframes as Animate will not automatically create the interpolation between your keyframes.

When using Stop-motion keyframes, also known as *step* keyframes, the segment between two keyframes is constant. There is no animation generated by the computer between the poses. The drawing will remain in position until the next keyframe, then pops to its new position.

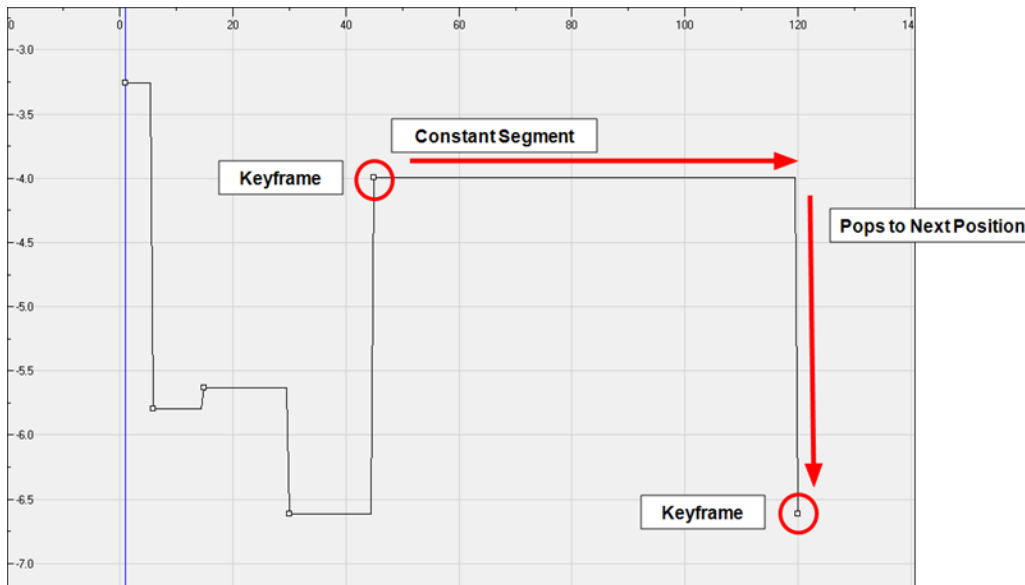

## Creating a Stop-motion Keyframe

You can create a stop-motion keyframe in several different ways. You can have Animate create it automatically, transform a motion keyframe into a stop-motion keyframe, or even switch your preferences to get Animate to always create stop-motion keyframes by default.

To automatically create stop-motion keyframes:

1. In the top menu, make sure that the **Animation > Stop-Motion Keyframe** option is enabled.
2. In the Timeline view, select the cell where you want to add a keyframe.



3. Right-click on the selection and select **Add Keyframe** or press [F6]. You can also click on the **Add Keyframe**  button available in the Timeline View toolbar.
  - In the Camera view, if the Animate mode is enabled, as soon as you move the selected element, a keyframe is automatically created on the current frame.





**To convert a Motion keyframe into a Stop-Motion keyframe:**

1. In the Timeline view, select the motion keyframes to convert into stop-motion keyframes or press [S].

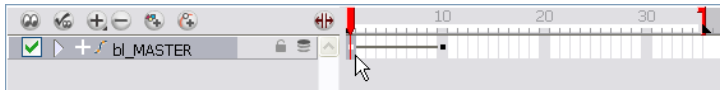

2. Right-click on the selection and select **Set Stop-Motion Keyframes** or press [Ctrl] + [L] (Windows) or [⌘] + [L] (Mac OS X). You can also click on the **Stop-motion Keyframe**  button available in the Timeline

View toolbar.

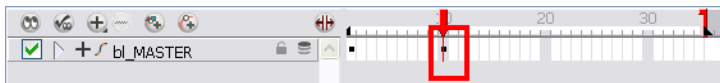
**Related Topics**

- [Animating using Computer Generated Interpolation](#) on the facing page

# Animating using Computer Generated Interpolation

After you have created the key poses you can animate the in-between poses yourself or let Animate do it using motion keyframes. When you use motion keyframes, your drawings will gradually move to the next position instead of staying on the spot until the next keyframe.

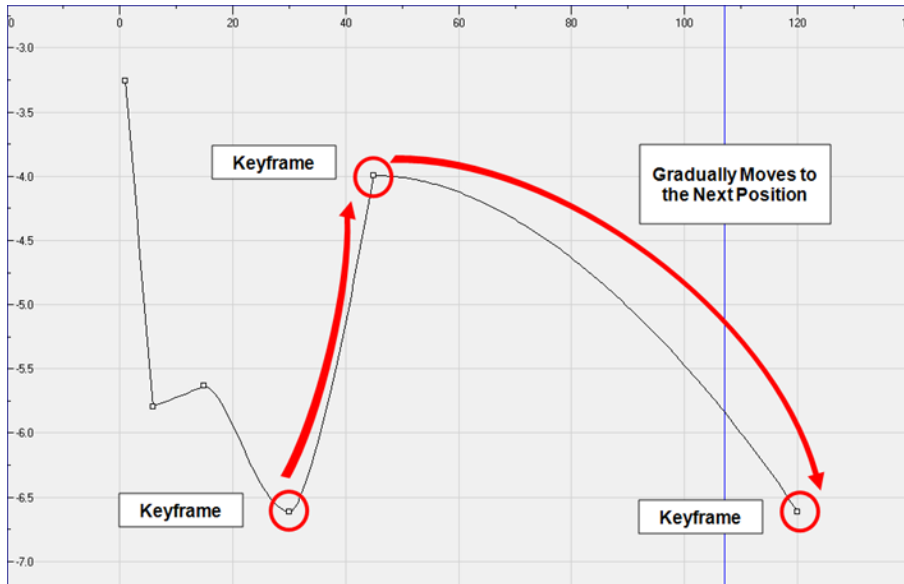

## Creating a Motion Keyframe

You can create a motion keyframe in several different ways. You can have Animate create it automatically, transform a stop-motion keyframe into a motion keyframe and even switch your preferences to get Animate to always create Motion keyframes by default.

**To automatically create motion keyframes:**

1. In the top menu, select **Animation > Motion Keyframe**. Make sure the option is disabled.
2. In the Timeline view, select the cell where you want to add a keyframe.



3. Right-click on the selection and select **Add Keyframe** or press [F6]. You can also click on the **Add Keyframe**  button available in the Timeline View toolbar.
  - In the Camera view, if the Animate mode is enabled, as soon as you move the selected element, a keyframe will be automatically created on the current frame.

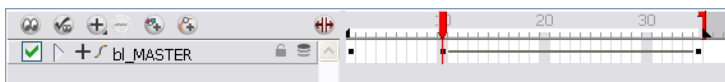

**To convert a stop-motion keyframe into a motion keyframe:**

1. In the Timeline view, select the stop-motion keyframes to convert into motion keyframes.

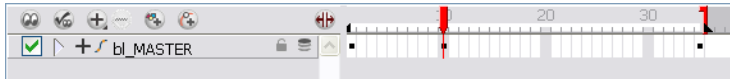

2. Right-click on the selection and select **Set Motion Keyframes** or press [Ctrl] + [K] (Windows) or [⌘] + [K] (Mac OS X). You can also click on the **Motion Keyframe**  button available in the Timeline View toolbar



## Related Topics

- [Animating in Stop-motion on page 748](#)

## Adjusting the Ease



To add ease in and ease out on your motion paths, you can display the function curve and modify the Bezier or Ease curve. To apply an ease to multiple functions and keyframes, you can use the Set Ease for Multiple Parameters feature and set the amount which you want.

The Velocity, or ease, is used on motion keyframes. The Velocity has to be adjusted directly on the function curve in either the Function view or the Function editor. When a keyframe is selected, easing values appear in the right handle and left handle fields, as well as Bezier handle or Ease wheel controls on each selected keyframe. Pull on them to adjust the ease in and ease out, or type values in the fields.

- [Adjusting the Velocity in the Function View on the facing page](#)
- [Adjusting the Velocity on Multiple Elements Concurrently on page 753](#)

## Adjusting the Velocity in the Function View

To adjust the velocity in the Function view:

1. In the Timeline view, click on the **Expand Function**  $\oplus$  button to display all of the layer's functions.

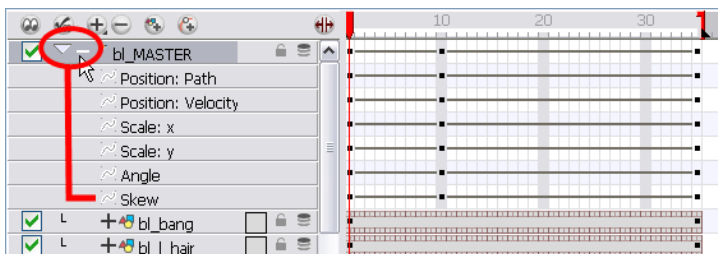

2. Double-click on the desired function.

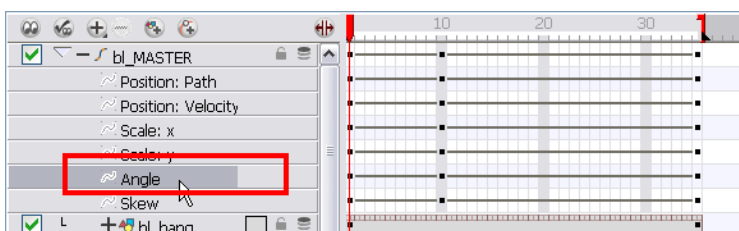

The Function Editor opens.

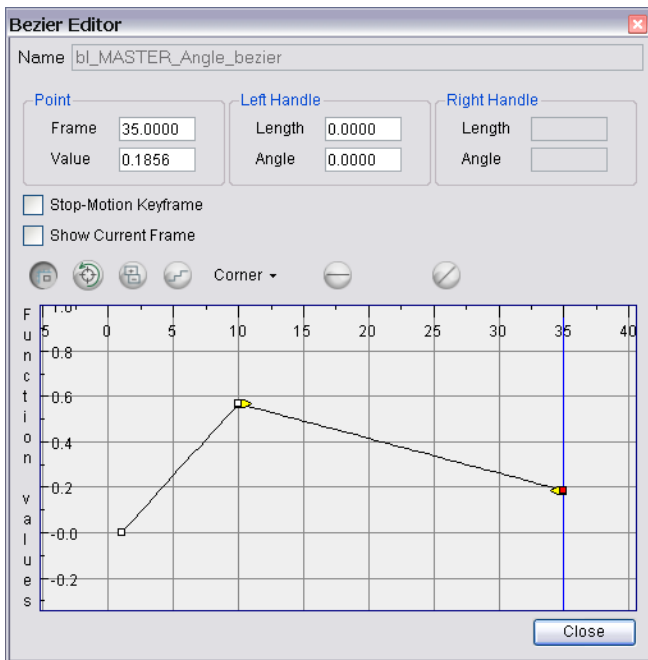

Note that the Function Editor will not be displayed if the function does not already exist.

3. Select a keyframe and pull on its Bezier handles or Ease wheel to adjust the velocity.

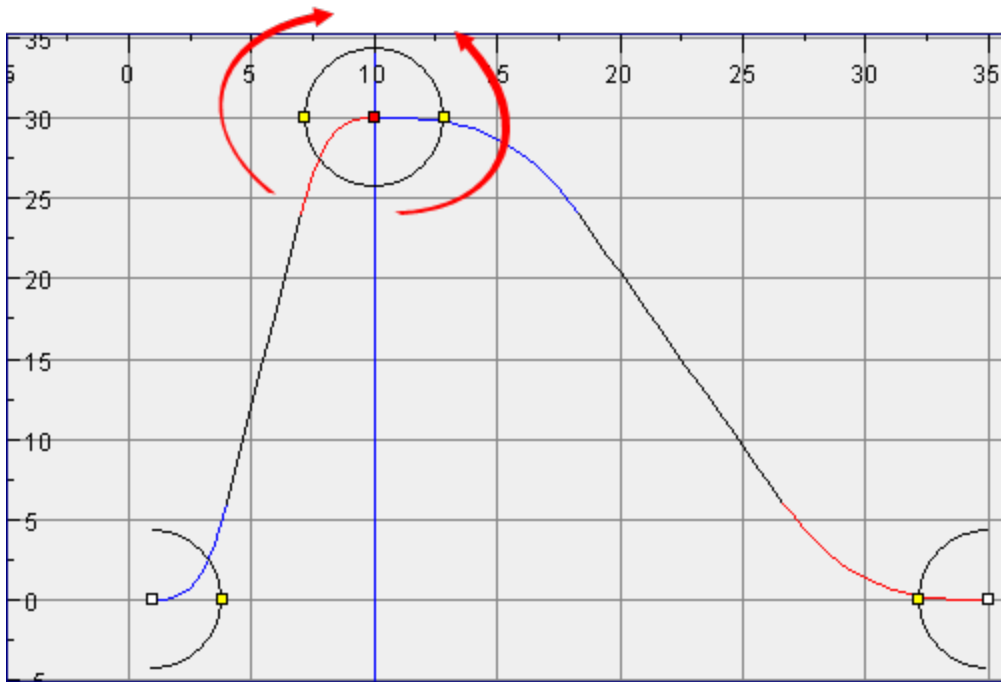
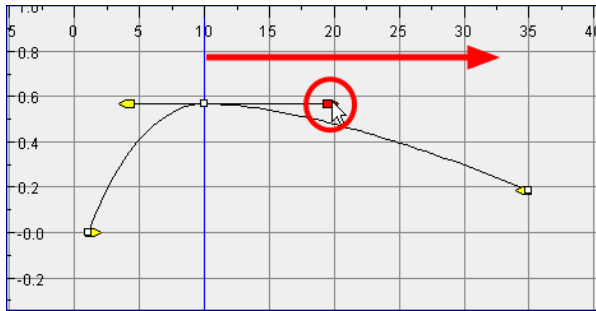

## Adjusting the Velocity on Multiple Elements Concurrently

If you have several functions you would like to adjust the velocity for at the same time, such as the hand, forearm and arm of a cut-out character, you can use the Set Ease for Multiple Parameters dialog box. It allows you to apply the same velocity parameters to all the selected keyframes in one frame.

**To set an ease for multiple parameters:**

1. In the Timeline view, select a keyframe from one or many layers.

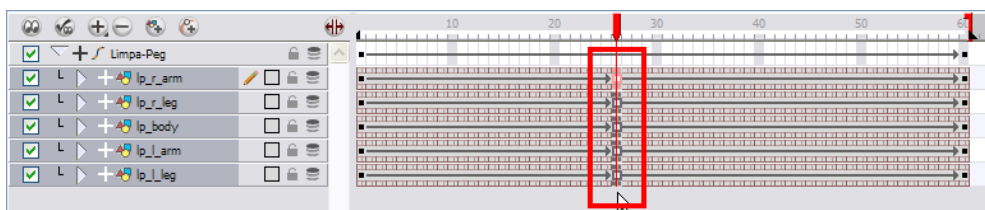



Only the first keyframe selected on a given layer will be considered when using the Set Ease For Multiple Parameter function. If many keyframes are selected on the same layer, the ease values will only be applied to the first one, the rest will be ignored.

- In the Timeline view, right-click and select **Set Ease For Multiple Parameters**. In the Timeline View toolbar, you can click on the **Set Ease For Multiple Parameters**  button. If the button is not in the Timeline View menu by default, you can add it through the Toolbar Manager (Customize). The Set Ease For Multiple Parameters dialog box opens.

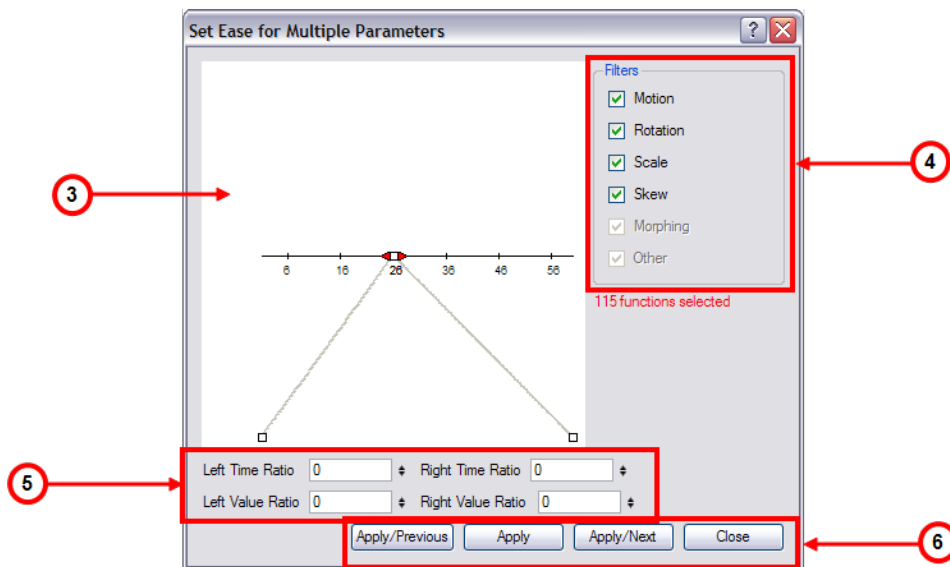

- In the graph interface, pull on the Bezier handle to adjust the velocity for all the selected functions.



- If you want to apply these easing parameters to a certain type of function only, such as Rotation or Scale, in the Filters section, disable the function types you do not want to affect.
  - ▶ **Motion:** If this option is enabled, the easing parameters will be applied to the selected Position X, Position Y, Position Z and 3D Path functions
  - ▶ **Rotation:** If this option is enabled, the easing parameters will be applied to the selected Angle functions.
  - ▶ **Scale:** If this option is enabled, the easing parameters will be applied to the selected Scale functions.
  - ▶ **Skew:** If this option is enabled, the easing parameters will be applied to the selected Skew functions.
  - ▶ **Morphing:** If this option is enabled, the easing parameters will be applied to the selected Morphing Velocity functions. Note that it applied to the Morphing velocity function found in the Layer Properties dialog and not to the basic morphing ease in the Tool Properties view.

- **Other:** If this option is enabled, the easing parameters will be applied to all the other selected functions such as all functions created to animate effect parameters.
5. You can also adjust the easing by typing values in the Time Ratio and Value Ratio fields. The values are calculated in percentage.
- In the Left Time Ratio and Right Time Ratio fields, type the percentage value corresponding to the length of time you want the easing to last for. The value must be between 0% and 100%.
  - In the Left Value Ratio and Right Value Ratio fields, type the percentage value of how strong you want the easing out to be. The value must be between 0% and 100%.
  - If your Time Ratio and Value Ratio values are equal, you will have a linear motion.
6. Once done, click on one of the following button:
- **Apply:** This will apply the easing parameters to the selected keyframes.
  - **Apply/Previous:** This will apply the easing parameters to the selected keyframes and then selects the previous keyframe in the timeline.
  - **Apply/Next:** This will apply the easing parameters to the selected keyframes and then selects the next keyframe in the timeline.
  - **Close:** This closes the dialog box. If you did not apply the modifications, they will be cancelled.

## Related Topics

- [Animating using Computer Generated Interpolation on page 750](#)

# Flipping Through Poses



When animating, it is useful to flip through your poses to see the flow of your animation without going through each frame in your Timeline. Animate lets you flip between the selected element's keyframes.

**To flip through your poses:**

1. In the Camera or Timeline view, select the layer you want to see the poses for.

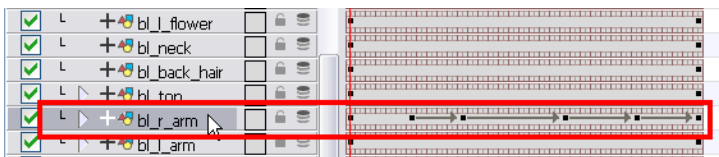
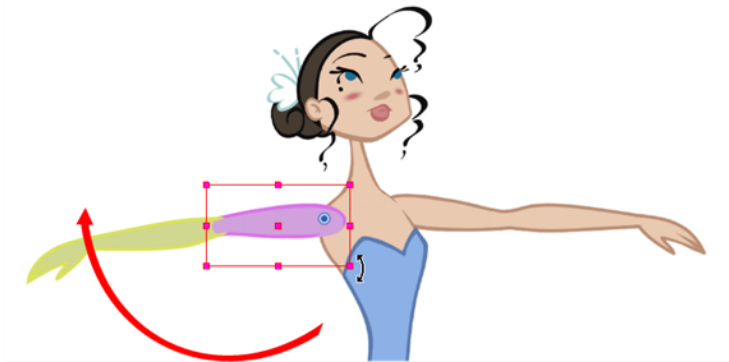

2. In the top menu, select **Animation > Go to Previous Keyframe** or **Go to Next Keyframe**. The keyboard shortcuts are [;] and ['].

## Related Topics

- [Keyframes and Drawing Blocks on page 716](#)
- [Creating a Simple Cut-out Animation on page 718](#)



- [Selecting Layers to Animate or Position](#) on page 721
- [Navigating the Hierarchy](#) on page 725
- [Animating using the Transform Tool](#) on page 727
- [Animating using Inverse Kinematics](#) on page 730
- [Animating in Stop-motion](#) on page 748
- [Animating using Computer Generated Interpolation](#) on page 750
- [Using the Onion Skin in Cut-out Animation](#) on the facing page
- [Animating Using Symbols](#) on page 1
- [Reusing Extra Drawings, Poses and Facial Expressions](#) on page 1
- [Swapping Images](#) on page 763
- [Adding a New Drawing](#) on page 766
- [Ordering Layers Over Time](#) on page 767
- [Resetting a Transformation](#) on page 769
- [Offsetting Part of an Animation](#) on page 1

# Using the Onion Skin in Cut-out Animation

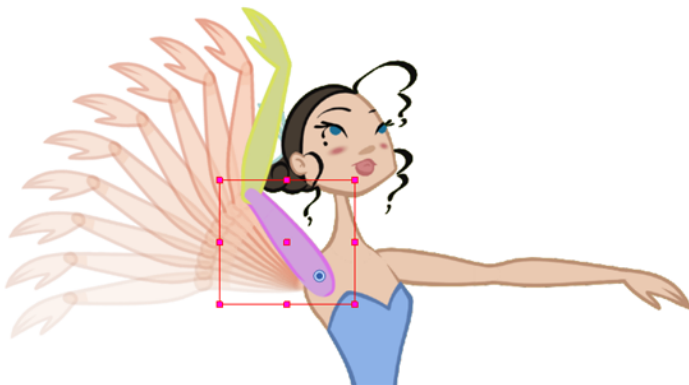



When animating cut-out characters, it is useful to see the previous and next frames on the animation. However, it can sometimes be confusing to see the onion skin for every part of the character. You will often only want to see the onion skin on a single part or a few parts, such as the arm, that are currently being animated. Animate offers that possibility.

While animating in the Camera view, there are four different onion skin options:

- [Add to Onion Skin on the next page](#)
- [Remove from Onion Skin on the next page](#)
- [Remove Unselected from Onion Skin on the next page](#)
- [Add All to Onion Skin on page 760](#)
- [Remove All from Onion Skin on page 760](#)

You can enable these options in the menu or manually in the Timeline view using the layer's Show Onion Skin  button. Unless you change the onion skin options when you display the onion skin, only the selected layers will be displayed in the onion skin preview.

## To use the onion skin options:

1. In the Tools toolbar, enable the **Onion Skin**  option or press [Alt] + [O].
2. In the Tools toolbar, click on the **Transform**  tool or press [Shift] + [T].
3. In the Camera view, select one or many elements.
4. In the top menu, select **View > Onion Skin > Add to Onion Skin, Remove From Onion Skin, Remove Unselected from Onion Skin, Add All to Onion Skin** or **Remove All from Onion Skin**.

## Add to Onion Skin

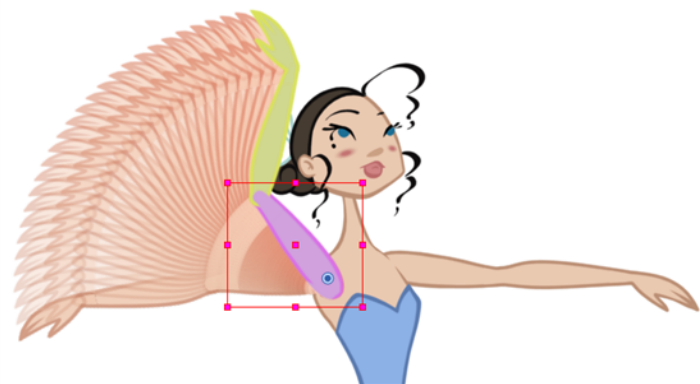

The Add to Onion Skin command is used to add a series of selected elements to the onion skin preview. The keyboard shortcut is [Shift] + [S].

## Remove from Onion Skin



The Remove From Onion Skin command is used to remove a series of selected elements from the onion skin preview.

## Remove Unselected from Onion Skin



The Remove Unselected from Onion Skin command is used to remove all elements except the ones selected from the onion skin preview.

## Add All to Onion Skin



The Add All to Onion Skin command is used to add all of the scene's elements to the onion skin preview. The keyboard shortcut is [Alt] + [Shift] + [O].

## Remove All from Onion Skin



The Remove All Onion Skin command is used to remove all of the scene's elements from the onion skin preview. The keyboard shortcut is [Ctrl] + [Shift] + [O] (Windows) or [⌘] + [Shift] + [O] (Mac OS X).

### Related Topics

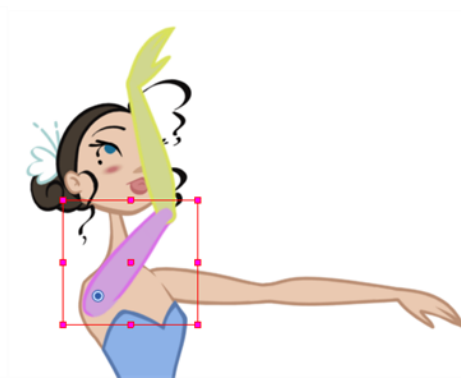

- [Flipping Through Poses on page 756](#)

# Flipping Parts



If you want to flip a part, a limb or a whole puppet, use the Transform tool and the Flip Horizontal and Flip Vertical options.

## To flip a selection

1. In the Animation Tools toolbar, select the **Transform**  tool or press [Shift] + [T].
2. In the Tool Properties view, make sure that the **Peg Selection Mode**  is disabled.
3. In the Camera view, select the parts to be flipped.

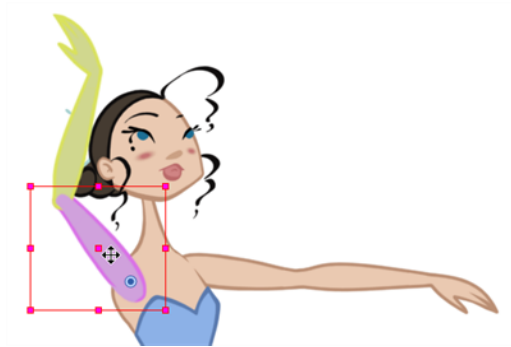

4. In the Tool Properties view, click on the **Flip Horizontal**  or **Flip Vertical**  option. The keyboard shortcuts are [4] and [5] respectively.

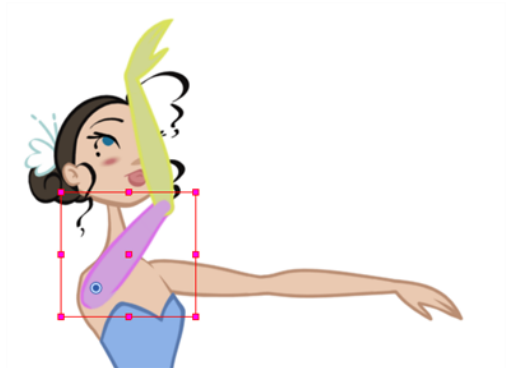



If the scaling parameter is not set to Separate Scale, the flip is not applied to the selection.

---

## Related Topics

- [Keyframes and Drawing Blocks on page 716](#)
- [Creating a Simple Cut-out Animation on page 718](#)
- [Selecting Layers to Animate or Position on page 721](#)
- [Navigating the Hierarchy on page 725](#)
- [Animating using the Transform Tool on page 727](#)
- [Animating using Inverse Kinematics on page 730](#)
- [Animating in Stop-motion on page 748](#)
- [Animating using Computer Generated Interpolation on page 750](#)
- [Flipping Through Poses on page 756](#)
- [Using the Onion Skin in Cut-out Animation on page 758](#)
- [Animating Using Symbols on page 1](#)
- [Reusing Extra Drawings, Poses and Facial Expressions on page 1](#)
- [Swapping Images on the next page](#)
- [Ordering Layers Over Time on page 767](#)
- [Resetting a Transformation on page 769](#)

# Swapping Images



Cut-out animation is not only about moving parts around, it's also about swapping drawings to give the animation a more traditional animation look.



You can add as many new drawings as you want in your character parts symbols and use them in your current animation. You can also add new drawings directly in your scene or import them from the library.

You do not need to remember the frame on which you drew or imported the drawings as you will be able to see them in the Drawing Substitution's interface.

You cannot swap a symbol for another one, only the symbol's frames or layer's drawings.

You can swap images in the **Timeline** or **Library** view. When you use the Drawing Substitution window in the **Library** view, you are not selecting drawings from the **Library** but from drawings contained in your scene's layers.

## To swap images in the Library view:

1. In the Camera view, with the **Transform**  tool.
2. In the Tool Properties view, make sure that the **Peg Selection Mode**  option is disabled.
3. In the Camera view, select the part you want to swap using the **Transform**  tool.



4. In the Library view, go to the **Drawing Substitution** panel.

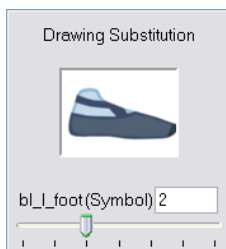

5. Move the substitution slider to the right or left to scroll through the symbol's frames or drawings. The keyboard shortcuts are `[[] + [ ]]` to perform the scroll, or from the top menu select **Animation > Substitute Drawing Previous** or **Substitute Drawing Next**.

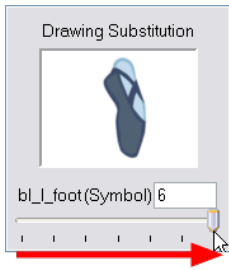

The drawing or symbol's cell on the current frame is replaced by the selected one.



To swap images in the Timeline view:

1. In the Timeline view, click on the **Show Data View**  button to expand the Data view.
2. In the Timeline view's right side, select the cell containing the drawing or symbol's cell to swap.

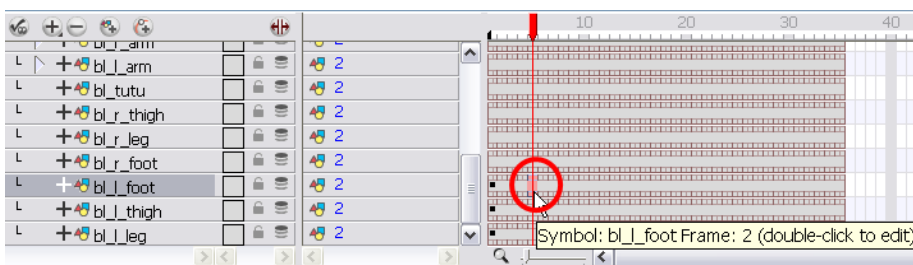

3. In the Data view, drag the pointer left or right to change the cell or drawing exposed for another one. You can also directly type the drawing name or symbol's cell number if you know it.

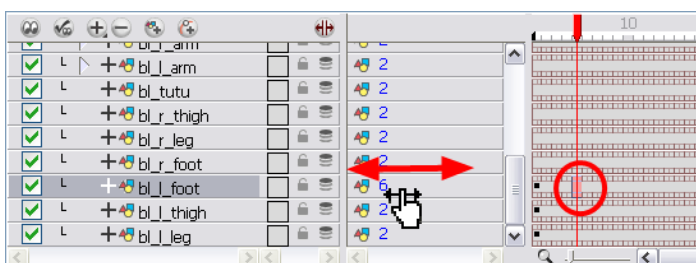



## Related Topics

- [Keyframes and Drawing Blocks](#) on page 716
- [Creating a Simple Cut-out Animation](#) on page 718
- [Selecting Layers to Animate or Position](#) on page 721
- [Navigating the Hierarchy](#) on page 725
- [Animating using the Transform Tool](#) on page 727
- [Animating using Inverse Kinematics](#) on page 730
- [Animating in Stop-motion](#) on page 748
- [Animating using Computer Generated Interpolation](#) on page 750
- [Flipping Through Poses](#) on page 756
- [Using the Onion Skin in Cut-out Animation](#) on page 758
- [Flipping Parts](#) on page 761
- [Animating Using Symbols](#) on page 1
- [Reusing Extra Drawings, Poses and Facial Expressions](#) on page 1
- [Adding a New Drawing](#) on the facing page
- [Ordering Layers Over Time](#) on page 767
- [Resetting a Transformation](#) on page 769

# Adding a New Drawing

If you need to add a new drawing in your scene, you can either do it inside the body part's symbol or, if you do not use symbols, directly on the part's layer by duplicating the existing drawing on the current frame.

## Duplicating a Drawing

If your character does not use symbols, you need to duplicate the drawing on the cell where you need to use a new drawing. You could also create a new blank drawing, but duplicating the existing drawing allows you to keep the pivot you previously set and you can also reuse a portion of the existing artwork. When you create a new drawing, you get a blank cell with a pivot set at the centre of the Camera view.

**To duplicate a drawing:**

1. In the Timeline or Camera view, select the drawing to duplicate.

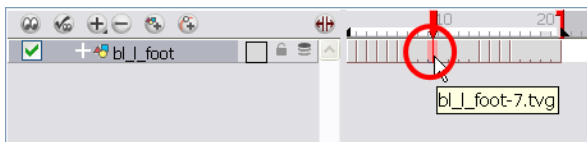

2. In the top menu, select **Drawing > Duplicate Drawing** or press [Alt] + [Shift] + [D].

The new drawing appears in the currently selected cell.

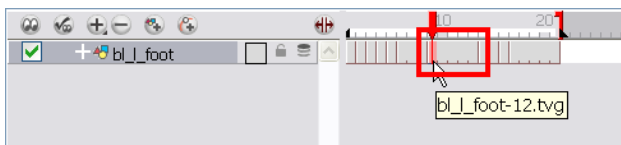

3. In the Camera view, draw the new piece.

## Related Topics

- [Keyframes and Drawing Blocks](#) on page 716
- [Creating a Simple Cut-out Animation](#) on page 718
- [Flipping Through Poses](#) on page 756
- [Using the Onion Skin in Cut-out Animation](#) on page 758
- [Flipping Parts](#) on page 761
- [Reusing Extra Drawings, Poses and Facial Expressions](#) on page 1
- [Swapping Images](#) on page 763

# Ordering Layers Over Time



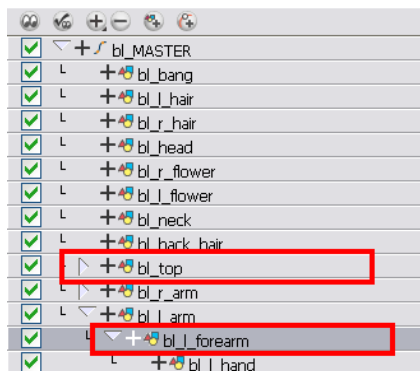

The layer ordering system in Animate saves time and simplifies your work. There is no need to create a new layer or to copy and paste artwork into other layers to change the order. The Z-axis (forward - backward) allows the user to create a multiplane and move elements closer to or further away from the camera. This allows the puppet's pieces to be moved in front or behind the other ones without physically changing the layer position.



Animate provides you with a shortcut to move the piece with a micro nudge on the Z-axis. The program creates a keyframe where different Z values can be entered. This allows for the piece to move forward and backwards in space without having to change the drawing's original position or break the layer hierarchy.

This also means that the layer ordering is maintained throughout the whole scene. You can combine animation assets so that the system can interpolate them.

## To nudge elements on the Z-axis:

1. In the Tools toolbar, select the **Transform**  tool or press [Shift] + [T].
2. In the Tools toolbar, enable the **Animate**  mode.

3. In the Camera view, click on the part to be repositioned and hold down the [Alt] key. Using the [Up] or [Down] arrow keys, nudge the part until it moves to the desired position. Make sure that the Camera view has a red outline around it.

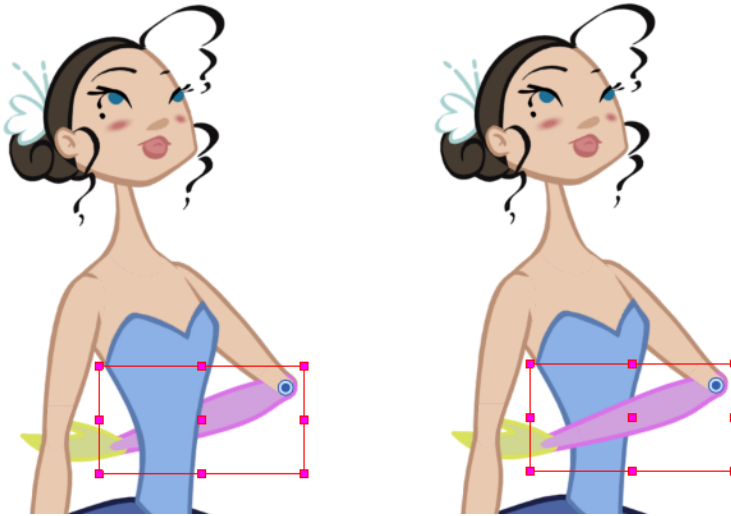

## Related Topics

- [Keyframes and Drawing Blocks](#) on page 716
- [Creating a Simple Cut-out Animation](#) on page 718
- [Animating in Stop-motion](#) on page 748
- [Animating using Computer Generated Interpolation](#) on page 750
- [Flipping Through Poses](#) on page 756
- [Using the Onion Skin in Cut-out Animation](#) on page 758
- [Flipping Parts](#) on page 761
- [Swapping Images](#) on page 763
- [Adding a New Drawing](#) on page 766
- [Resetting a Transformation](#) on the next page
- [Offsetting Part of an Animation](#) on page 1

# Resetting a Transformation

You may want to reset your character's position if you have made too many transformations and it is not going where you want it to go, or simply because you want to reset a pose you are reusing from another animation.

Once your layers are positioned in the Camera view, you can easily reinstate them to their original position.



When using the Transform tool to select element in the Camera view, always make sure that the Peg Selection Mode option in the Tool Properties view is disabled or else it will limit the selection to peg only.





In the Timeline view, you can also use the Clear All Values command to reset all transformation values on the selected layers. Right-click on the selected layers and select **Layers > Clear All Values**.



There are three different ways to reinstate a transformation:

- [Reset below](#)
- [Reset All below](#)
- [Reset All Except Z on the facing page](#)

## Reset

Use the Reset command to reset the value of the selected element to the initial value of the active tool. For example, if the Rotate  tool is active, the transformation angle will be reset to 0 and if the Transform  tool is active, the entire transformation values will be reset.

**To reset the transformation on the current frame:**



1. In the Tools toolbar, select the **Transform**  tool or any **Advanced Animation**  tools.
2. In the Timeline or directly in the Camera view, select the drawing layers you wish to reset. You can select more than one layer at a time.
3. Select **Animation > Reset** or press [Shift] + [R].

The selected layers will automatically return to their original position.

## Reset All

The Reset All option will reset all transformations on the current frame in a selected layer. Your keyframe will remain, but all the values will be reinstated to the default position. It will reset all the transformation regardless of the tool you are using.

**To reset all transformations on the current frame:**



1. In the Tools toolbar, select the **Transform**  tool or any **Advanced Animation**  tools.
2. In the Timeline or directly in the Camera view, select the drawing layers you wish to reset. You can select more than one layer at a time.
3. Select **Animation > Reset All**.

The selected layers will automatically return to their original position.

## Reset All Except Z

The Reset All Except Z option will reset all the transformations on the current frame except the Z position. This is useful when doing cut-out animation. Cut-out puppets often have a particular Z ordering for the different views of a character. You might want to reset the transformation, but not necessarily the Z position. To do so, you need to use the Reset All Except Z option.

**To reset all transformations except the Z position on the current frame:**

1. In the Tools toolbar, select the **Transform**  tool or any **Advanced Animation**  tools.
2. In the Timeline or directly in the Camera view, select the drawing layers you wish to reset. You can select more than one layer at a time.
3. Select **Animation > Reset All Except Z**.

The selected layers will automatically return to their original position, except for the Z values.

### Related Topics

- [Creating a Simple Cut-out Animation on page 718](#)

# Creating Cycles

If you want to cycle a portion of your animation, you can use the Paste Cycle command. You can also use the Paste Reverse command to completely reverse the flow of your animation.

## To use the Paste Cycle command:

1. In the Xsheet or Timeline view, select the cell range (or symbol cells) and keyframes to loop.

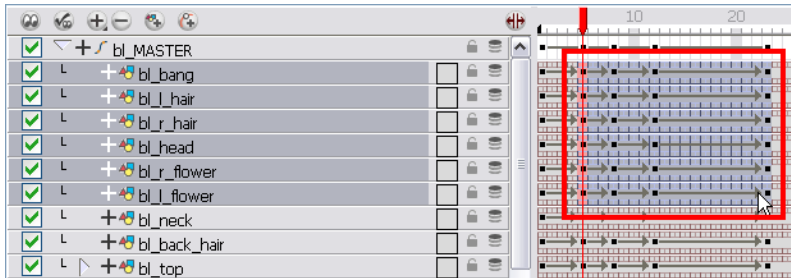

2. In the top menu, select **Edit > Copy**.
3. In the Xsheet or Timeline view, select the cell where you want your cycles to start.

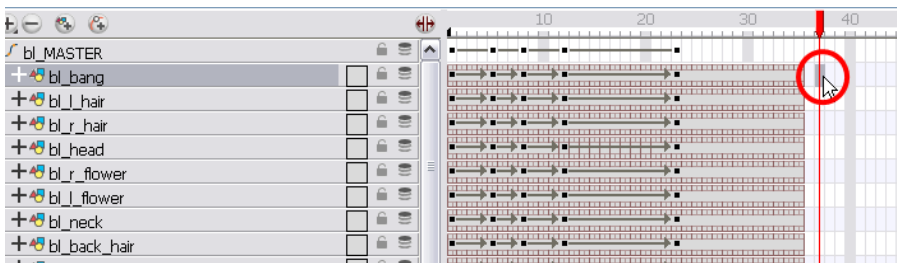

4. In the top menu, select **Edit > Paste Cycle** or press [Ctrl] + [/] (Windows) or [⌘] + [/] (Mac OS X).

The Paste Cycle dialog box opens.

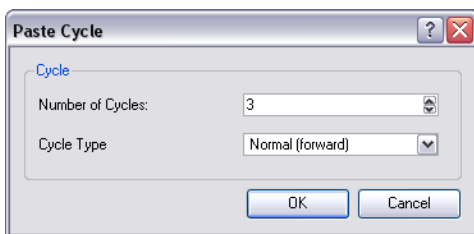

5. In the Number of Cycles field, use the up or down arrows to increase or decrease the number of cycles you want to paste. You can also type the value directly.
6. In the Cycle Type drop-down menu, select the type of cycle you want to paste.

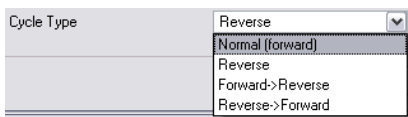

- ▶ **Normal (forward):** Pastes your selection as it is, starting with the first cell and ending with the last one.
- ▶ **Reverse:** Pastes your selection reversed, beginning with the last cell and ending with the first one.
- ▶ **Forward -> Reverse:** Pastes your selection as a yo-yo, starting with the first cell, going to the last one and ending with the first cell.

- **Reverse -> Forward:** Pastes your selection as a reversed yo-yo, starting with the last cell, going to the first one and ending with the last cell.

7. Click on the **OK** button to paste your cycles.

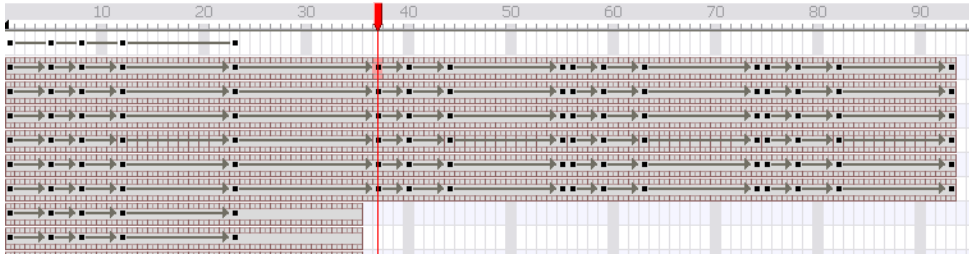

You can do the same operation using the Paste Special dialog box. To open the Paste Special dialog box, select

**Edit > Paste Special** or press [Ctrl] + [B] (Windows) or [⌘] + [B] (Mac OS X).

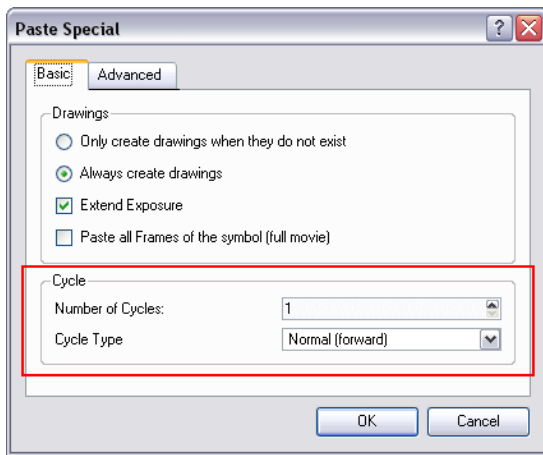

To use the **Paste Reverse** command:

1. In the Xsheet or Timeline view, select the cell range and keyframes to paste inverted.

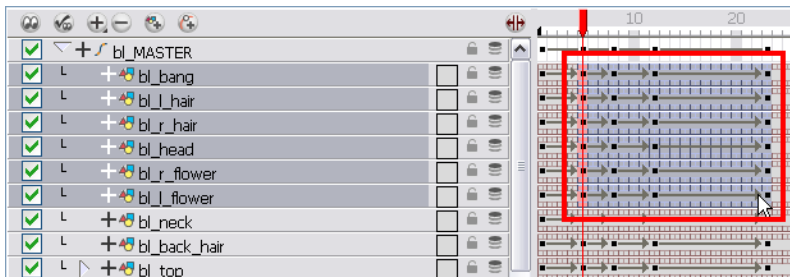

2. In the top menu, select **Edit > Copy**.
3. In the Xsheet or Timeline view, select the cell where you want your cycles to start.



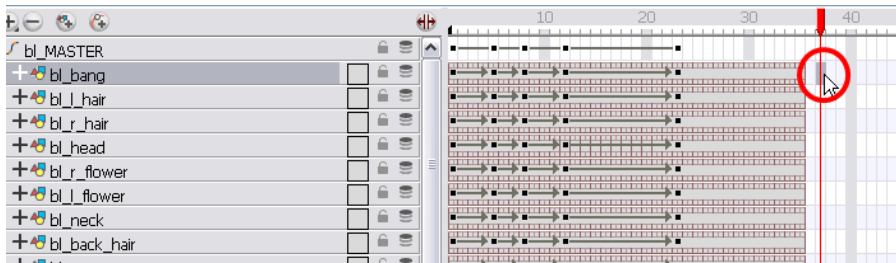

4. In the top menu, select **Edit > Paste Reverse** or press [Ctrl] + [.] (Windows) or [⌘] + [.] (Mac OS X).

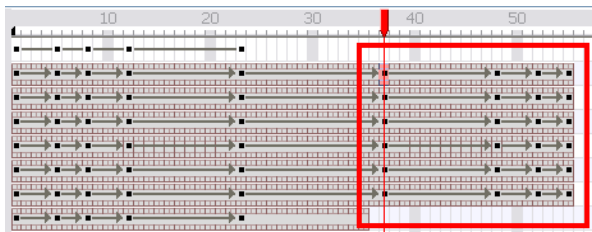



## Related Topics

- [Keyframes and Drawing Blocks](#) on page 716
- [Creating a Simple Cut-out Animation](#) on page 718
- [Navigating the Hierarchy](#) on page 725
- [Flipping Through Poses](#) on page 756
- [Using the Onion Skin in Cut-out Animation](#) on page 758
- [Creating Cycles](#) on page 771
- [Preferences](#) on page 1

# Copying and Pasting Animation

As you animate you will find that you may reuse a lot of positions, drawings and keys. However, you may only want to paste the drawings, or just the keys or maybe everything. There are different paste options available in the Timeline view which will give you the maximum flexibility when reusing and pasting.



There are three different modes for pasting your selection:

-  Paste Mode: All Drawing Attributes  
Pastes the drawing exposure and keyframes.
-  Paste Mode: Keyframes Only  
Pastes only the keyframes.
-  Paste Mode: Exposures Only  
Pastes only the drawing exposure.

To paste a selection using different modes

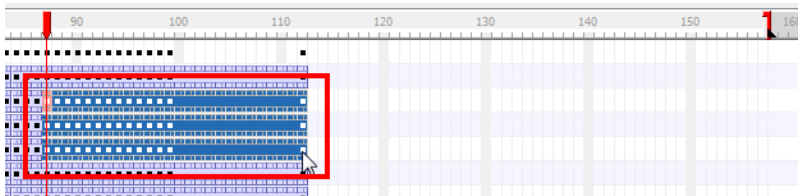
1. In the Timeline view, select the cells (or symbol cells) you want to copy and paste.



2. Select **Edit > Copy cells from the Timeline**.
3. In the Timeline view's left side, enable the desired **Paste**    mode.
4. In the Timeline view's right side, select the cell where you want to paste your selection.

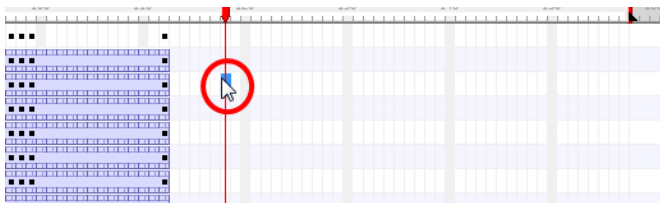

5. Select **Edit > Paste Cells in the Timeline**.



Note these modes also apply when you use drag instead of copy/ paste.

**Paste Mode:** All Drawing Attributes

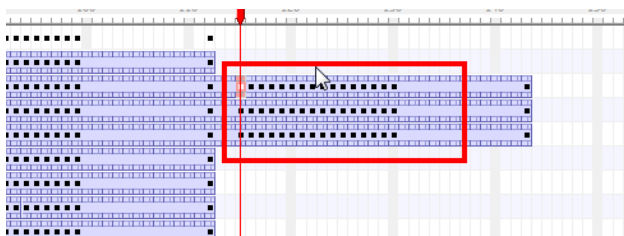

**Paste Mode: Keyframes Only**

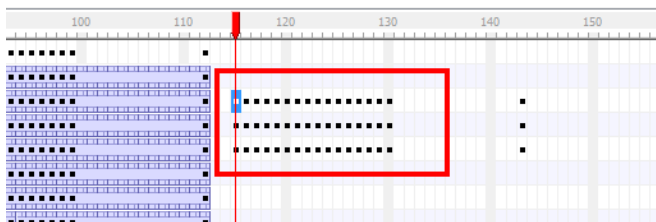

**Paste Mode: Exposures Only**

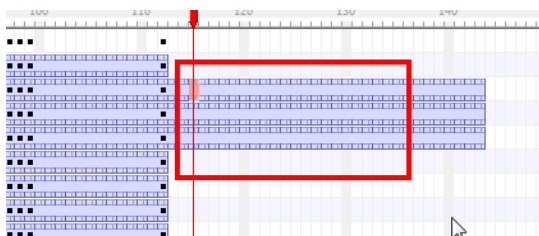

## Related Topics

- [Keyframes and Drawing Blocks](#) on page 716
- [Creating a Simple Cut-out Animation](#) on page 718
- [Animating using the Transform Tool](#) on page 727
- [Swapping Images](#) on page 763

# Adding Pegs

Now that you have your puppet on your stage, you probably need to resize and reposition it to fit your scene. When you need to scale down or move your character it's a good idea to hook (attach) the whole puppet to a trajectory.

In Animate, there is a type of layer you can add to your timeline allowing you to create a motion path or reposition drawings. This trajectory layer is called a Peg. Any drawing or layer you hook to a peg will follow the defined motion path, rotation, scaling and skewing information.

Attaching your puppet to a peg will allow you to scale it and reposition it without having to do it on all of your different parts and pieces. Only one layer will contain the position information, this makes your animation easier to modify and control.

## To add a repositioning peg:

1. In the Timeline view, click on the **Add Peg**  button.

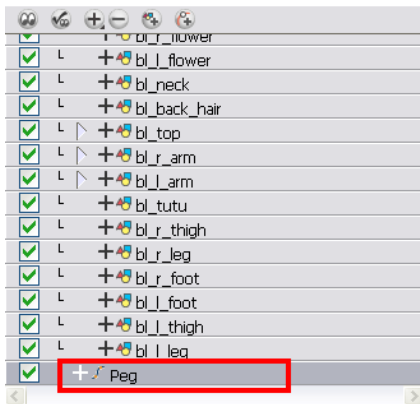

2. In the Timeline view, select all of the layers you want to attach to your new peg.
3. Drag your selection right on the peg layer to parent all your character's pieces to the peg.

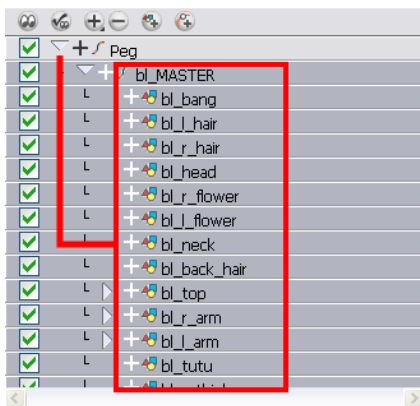

Next, you need to position your character on the stage by moving it and scaling it to the correct size. You will not scale each layer individually. You either want to do it on the top symbol or top peg layer.

## To reposition the character:

1. In the Timeline view, select the top peg layer (master peg).
2. In the Tools toolbar, select the **Transform**  tool and disable the **Animate**  mode.

3. In the Camera view, position the character.

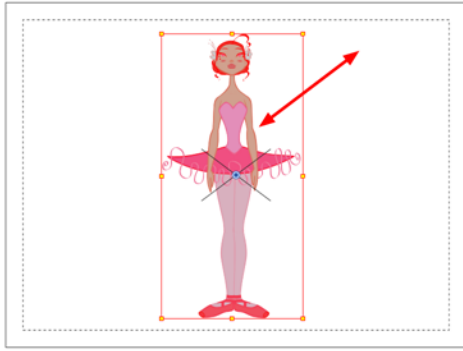

## Related Topics

- [Creating a Simple Cut-out Animation](#) on page 718
- [Selecting Layers to Animate or Position](#) on page 721
- [Navigating the Hierarchy](#) on page 725



# Chapter 16: Effects

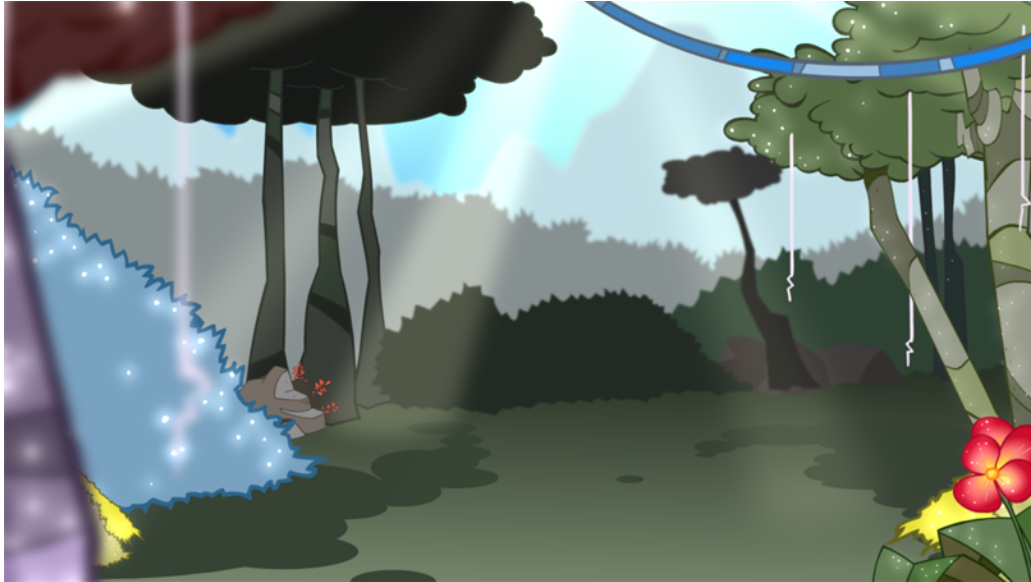

Once your animation is completed, you can add effects such as blurs and glows to make your project look even better! Animate provides you with a series of essential effects that you can add to your layers.

## Topics Covered

- [Adding Effects](#) on the facing page
- [Animating an Effect Over Time](#) on page 784
- [How Does an Effect Work?](#) on page 786
- [Using Effects](#) on page 788
- [Extra Commands](#) on page 1
- [Effects Preferences](#) on page 828

# Adding Effects

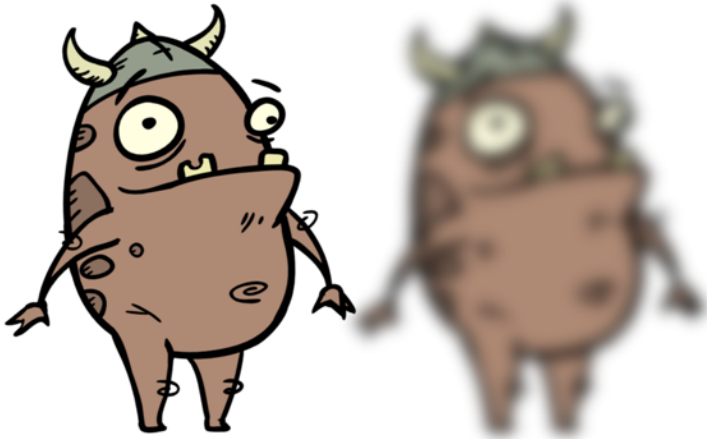

In Animate, to add an effect to your Timeline view, add an effect layer, connect the desired layer to it and adjust the parameters until you get the look you want.

- [Adding Effects Through the Timeline View](#) below

## Adding Effects Through the Timeline View

To add effect in the Timeline view:

1. In the Timeline view, click on the **Add Layers** button and from the Layers drop-down menu, select **Effects** > **the desired effect**. You can also select **Insert** > **Effects** > **the desired effect** from the top menu.

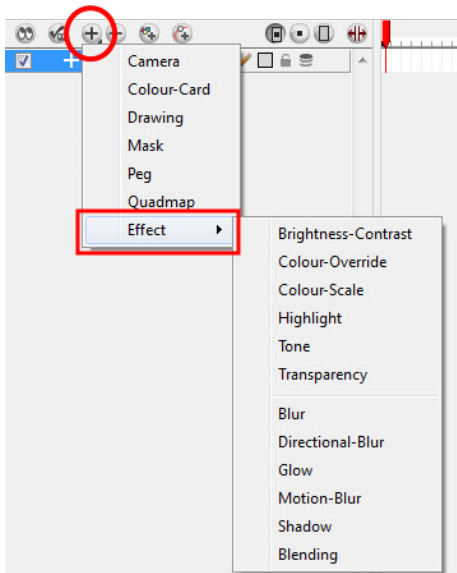



2. The effect appears in the Timeline view.
3. Drag the drawing layer on the new effect layer to parent them.



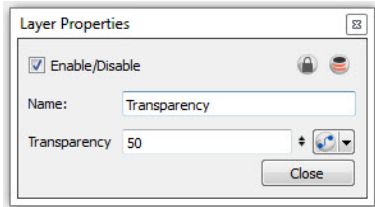

4. In the Camera view, click on the Render View Mode  button to see the result of rendering the scene's current frame and the effect .
5. In the Timeline view, double-click on the effect layer to open the Layer Properties view. The Layer Properties view opens, displaying the parameters available for the selected effect.



6. In the Layer Properties view, adjust the effect's parameters.
7. In the Camera view, click on the **Update Preview**  button to update the rendered preview.
8. To play back your scene with the final effects, in the Playback toolbar, click on the **Render and Play**  button.



Once you have set the parameters for your effect, you can store it in the Library view as a template so you can quickly reuse it later on without having to set the parameters again. Refer to [Creating a Template on page 540](#) to learn more about creating templates.

---

# Previewing Effects

Most effects need to be rendered in order to be previewed properly. Some effects can be displayed in the OpenGL view, but most of them have to be rendered and previewed in the Render Mode of the Camera view.

## To preview your effects:

1. In the Camera view, click on the Render Mode  button.

In the Camera view bottom left corner, the Preview Update  button indicates the status of the rendering. Depending on the size of the frame to render, it might take several seconds.

When the rendering is in progress, you will see the progress wheel icon, and once the progress is completed, you will see the Up-to-date Preview icon.



Once you preview your effect, you might want to adjust it. By default, as soon as you modify a parameter, Animate will recalculate the preview image. If your scene is rather heavy and you do not want the system to perform the render preview automatically, you can disable the Auto-Render option and request the preview update yourself.

## To disable the Auto-Render option:

1. In the Camera view bottom left corner, click on the **Preview Update**  button to open the quick access menu.
2. Disable the **Auto-Render** option.

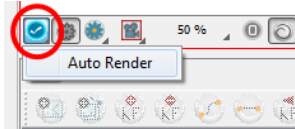

- ▶ In the Rendering toolbar,

Once the Auto-Render option is disabled, you will need to request the preview update. You can do so by either clicking on the Preview Update  button, or by using the Rendering toolbar.

## To update the rendering preview:

1. In the Camera view's bottom left corner, click on the Preview Update  button to open the quick access menu.
2. Click on the Auto-Render option.





Note that you cannot playback your animation in Render mode. You need to actually perform a render, or preview render, to see your animation with the final effects. See [Previewing and Playing Back Effects](#) on page 826.

---

## Related Topics

- [Previewing and Playing Back Effects](#) on page 826

# Animating an Effect Over Time

In Animate, to animate an effect over time, create a function curve by adding keyframes to the parameters you want to animate. To do this, you will use the Layer Properties view and the Timeline view. You can fine tune your animation using the Function view.

**To animate an effect over time:**

1. In the Timeline view, add the effect and connect the layers to it. See [Adding Effects Through the Timeline View](#) on page 780.

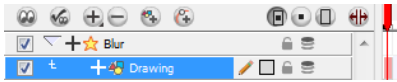

2. Select the Effect layer.

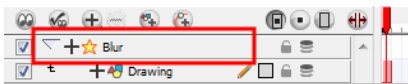

3. To create the function curve:

- In the Layer Properties view, click on the **Function**  button you want to animate to create a function curve.

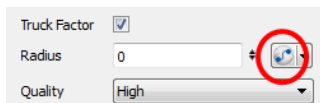

OR

- You can also expand the effect layer's parameters in the Timeline view by clicking on the Expand  Function button and add a keyframe using the [F6] key to the parameter you want to animate.

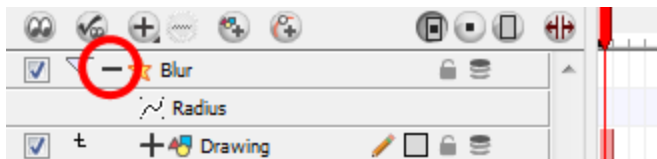

4. In the Timeline view, click on the **Show Data View**  button.
5. In the Timeline view, go to the frame where you want to start animating the effect.



6. In the Data view, click on the **Add Keyframe**  button.



7. In the Value field scroll to the keyframe value or type the value in the field.



- ▶ If your keyframes are stop-motion keyframes, in the Timeline view, select the new keyframes. Right-click on the selection and select **Set Motion Keyframe**.

8. Repeat this process for each keyframe to be added.



Refer to the [Previewing and Playing Back Effects](#) on page 826 to learn how to preview animated effects.

---

# How Does an Effect Work?

An effect always needs a drawing connection and sometime a matte or shape connection. A matte provides drawing information that will be used to determine the area where the effect will be applied on the drawing. The details and colours within the matte drawing do not matter, as the system will only use the shape and transparencies in it. A matte is also known as mask.

The matte principle can be demonstrated on the Tone effect.

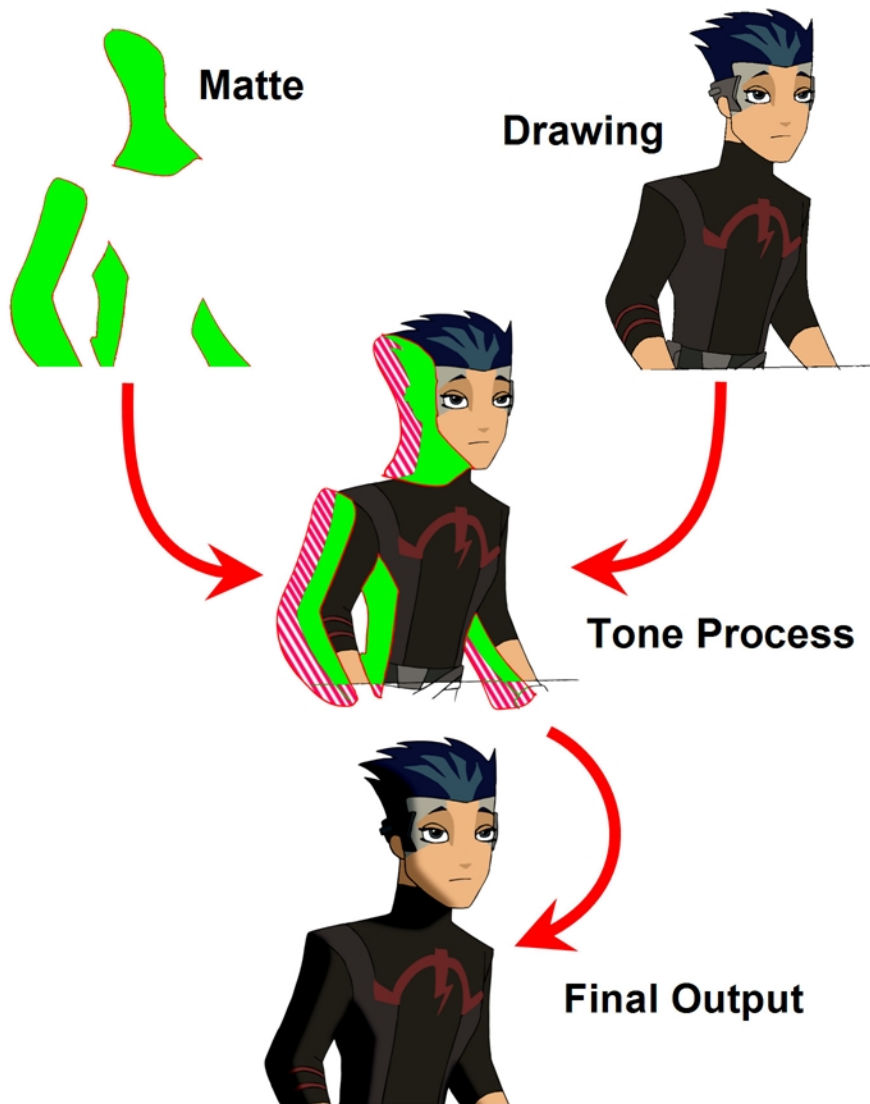

The drawing layer is connected in the right port of the effect and the matte (mask) in the left port. The Tone effect then applies darker colours where the matte overlaps the image, blurs the tone edge, and finally clips out the extra tone zone outside of the drawing before outputting a final drawing with a tone.

The tone's parameters can be adjusted in the Layer Properties view and any of them can be linked to a function column to be animated over time. This means that all of the effects can be customized.

## Related Topics

- [Using Effects](#) on the facing page

# Using Effects

Here is the list of the main effects available in Animate. Each effect and how to use it is described in the corresponding section.

- 
- [Blending](#) on the next page
  - [on page 792](#)
  - [Blur](#) on page 793
  - [Brightness and Contrast](#) on page 794
  - [Colour-Card](#) on page 795
  - [Colour-Override](#) on page 796
  - [Colour-Scale](#) on page 813
  - [Mask](#) on page 814
  - [Glow](#) on page 815
  - [Highlight](#) on page 817
  - [Motion Blur](#)
  - [Quadmap](#) on page 819
  - [Shadow](#) on page 820
  - [Tone](#) on page 822
  - [Transparency](#) on page 824
- 

## Related Topics

- [How Does an Effect Work?](#) on page 786



# Blending



Effects modules, like the Tone module and Highlight module, can control the colour and alpha composite operations for you. These modules were created with pre-set colour and alpha composite operations to fit the most frequently used, composite operations.

You might, however, still want to control the colour and alpha composite operation between two images using the Blending module, to create a multiplicity of lighting, shadow, filter or ambient effects. The Blending module combines two images into one output image, following the parameters you choose for your movie and images sequence or SWF movie exports.

The drawing module connected to the Blending effect will act as the blending image and will be applied to all the drawing layers situated under them in the Timeline view order.

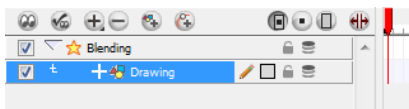

Use the Blending editor to control the settings of the Blending effect.

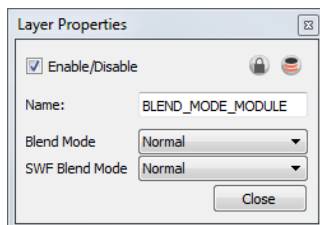

- **Name:** Use this field to rename the module.

- **Blend Mode:** Choose the blending effect mode you wish to apply to your layer. The Blend Mode type will only be visible when the Camera view is set to Render  mode and will only export to a bitmap movie file or sequence of images.
- **SWF Blend Mode:** Choose the blending effect mode you wish to apply to your layer. The SWF Blend Mode result will only be visible when exported to a SWF movie.

## Blend Mode and SWF Blend Mode

Both the Blending module and Composite-Generic module have regular blending modes and legacy blending modes. The regular blending modes will take the source images and unmultiply them before blending the two inputs together. The images will be remultiplied when being output from the module. The legacy blending modes use the pre-multiplied source images as is in order to apply the effect. Unmultiplying the images before processing them will give a final result closer to what can be found in software such as Adobe Photoshop.

Here is a list of the available Blending modes:

- **Normal:** The layer attached to the effect acts as a normal layer and will not create any blending mode effect.
- **Multiply:** This operation multiplies the blending element colour with the output image. This will darken the colour of the overlapping area.
- **Screen:** This operation multiplies the inverted colour of the blending element with the image. This will lighten the colour of the overlapping area.
- **Lighten (Lighten Legacy):** This operation lightens the area of the output image which, is darker than the blending element's colours. The lighter colours will remain unchanged.
- **Darken:** This operation darkens the area of the output image, which is lighter than the blending element's colours. The darker colours will remain unchanged.
- **Difference (Difference Legacy):** This operation subtracts the blending elements colour from the output image colours or vice-versa, depending on which of them has more bright colours. The final result will be colours that are more vibrant.
- **Add (Add Legacy):** This operation lightens the output image using the blending element.
- **Subtract (Subtract Legacy):** This operation darkens the output image using the blending element.
- **Invert:** This operation inverts the output image colours on the area overlapping the blending layer colours.
- **Overlay (Overlay Legacy):** This operation multiplies or screens the colours from the blending image, with those of the output image, depending on the base colour. Colours from the blending element overlay the colours of the drawing elements, while preserving the highlights and shadows of the base colour. The base colour is not replaced, but mixed with the blend colour to reflect the lightness, or darkness, of the original colour.
- **Hardlight (Hardlight Legacy):** This operation multiplies, or screens, the colours of the blending layer with those of the output image, depending on the blend colour. If the blend colour is lighter than 50% grey, the image is lightened, as if it were screened. This is useful for adding highlights to an image. If the blend colour is darker than 50% grey, the image is darkened, as if it were multiplied. This is useful for adding shadows to an image. Painting with pure black or white results in pure black or white. Play with the Opacity value to create a subtler look.

- **Alpha:** This operation will blend the alpha value of the blending layer with the output image. This effect is not available for SWF Blend Mode.
- **Erase:** This operation produces a cutter effect using the blending element. This effect is not available for SWF Blend Mode.
- **Divide (Divide Legacy):** This operation divides the output image colour values by the blending layer colour values. The blending image colour values are inverted, creating a negative image. The negative image's colour values are then multiplied by the right image colour values. This effect is not available for SWF Blend Mode.
- **Replace:** This operation replaces the output image by the blending layer. This effect is not available for SWF Blend Mode.
- **Softlight:** This operation darkens or lightens the colours in a soft and diffuse way, depending on the blend colour (image in left port). If the blend colour is lighter than 50% grey, the image is lightened. If the blend colour is darker than 50% grey, the image is darkened. Painting with pure black or white produces a distinctly darker or lighter area, but does not result in pure black or white.
- **Linear Light:** This operation burns or dodges the colours by decreasing or increasing the brightness depending on the colour of the underlying colour. If the blend colour is lighter than 50% grey, the colour is lightened because the brightness is increased. If the blend colour is darker than 50% grey, the colour is darkened because the brightness is decreased.
- **Pin Light:** This operation will replace the colours, depending on the underlying colour . If the blend colour is lighter than 50% grey, pixels darker than the underlying colour are replaced, and pixels lighter than the underlying colour do not change. If the blend colour is darker than 50% grey, pixels lighter than the underlying colour are replaced, and pixels darker than the underlying colour do not change.
- **Vivid Light:** This operation burns or dodges the colours by decreasing or increasing the brightness depending on the colour of the underlying colour. If the colour is lighter than 50% grey, the blend colour is lightened because the contrast is decreased. If the colour is darker than 50% grey, the blend colour is darkened because the contrast is increased.
- **Exclusion:** This operation produces a similar result to the Difference mode, but with a lower contrast.
- **Dodge:** This operation will lighten the colour.
- **Burn:** This operation will darken the colour.
- **Hue:** This operation will result in a colour that will take the luminosity and saturation of the underlying colour, and the hue of the source colour.
- **Saturation:** This operation will result in a colour that will have the same luminosity and hue of the underlying colour, and the saturation of the source colour.
- **Colour:** This operation will result in a colour that will have the luminosity of the underlying colour, and the hue and saturation of the source colour.
- **Luminosity:** This operation will result in a colour which has the hue and saturation of the underlying colour, and the luminosity of the source colour. This mode is opposite to the Colour mode.



It is possible to select two different blending modes in the same Blending effect layer, in the event that you want to export your project to both a Bitmap and an SWF movie file with different results.

---

## Related Topics

- [Using Effects](#) on page 788



The Directional-Blur effect creates the effect of a motion blur that pulls and smears the image from one contour edge to a different direction or angle. This effect is useful in creating the impression of speed, such as the streaks of colour that follow a car travelling at high speed.

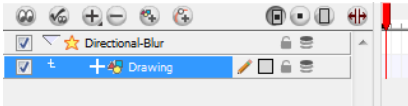

Use the Directional-Blur editor to control the settings of the Directional-Blur effect.

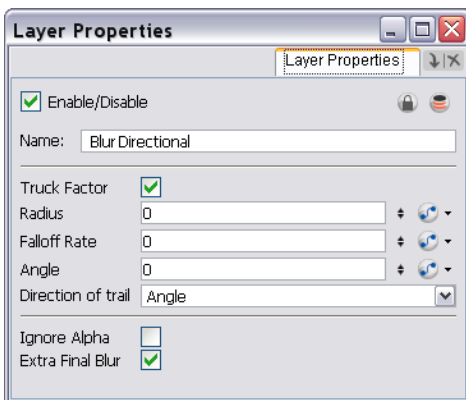

- **Truck Factor:** Activated by default, this option readjusts the blur when the elements undergo a change of depth or scale. When this option is disabled, the effect's values will remain unchanged regardless of any depth or scale changes. We recommended that this option be disabled when multiple drawings are composited and attached to this effect. You can attach these values to function curves  to change them over time.
- **Radius:** Enter a value for the size of the blur. The larger the value, the greater the blur effect. The blur radius is affected by the drawing scale and camera position.

- **Fall-off Rate:** The distance where the blur fades from the edge of the image. Select a value between 0 and 1.
  - A fall-off rate of 0 causes the blur to fade out slowly, distributing the blur evenly from the edge of the character to the farthest edge of the blur.
  - A fall-off rate of 1 causes the blur to fade out quickly so that the blur is heaviest closer to the edge of the image.
- **Angle:** The direction of the blur. Enter a value from 0 to 360.
  - **0:** blurs the image to the west.
  - **90:** blurs the image to the south.
  - **180:** blurs the image to the east.
  - **270:** blurs the image to the north.
- **Direction of trail:** If you do not set an Angle for the direction of the blur, you can select a direction (north, south, east, or west) from this menu. The calculations for this feature are faster than the calculations for the Angle setting.
- **Ignore Alpha:** This option controls the leading edge of the blur. Deselect this option for a solid or hard leading edge on the blur.
- **Extra Final Blur:** This option causes the software to apply a second blur after the Directional-Blur is created. If you have a Directional-Blur that begins at 0 and gradually gets stronger, disable this option to ensure a smooth progression.

## Related Topics

- [Using Effects](#) on page 788

## Blur

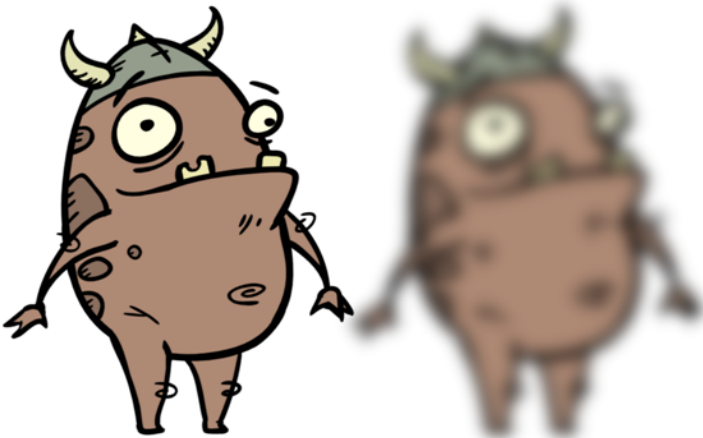

The Blur effect creates an effect that softens, fogs or obscures the image evenly in all directions. This effect is useful when you want to make cloudy images not realistically seen in detail, such as a drawing object that is farther back or in the background of your scene, usually blurry due to the laws of atmospheric perspective. Other uses include the general softening of objects such as snow, stars and shadows that do not naturally have a hard outline.

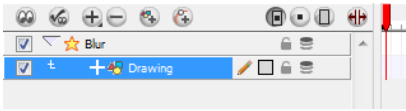

Use the Blur editor to change the values of the Blur effect.

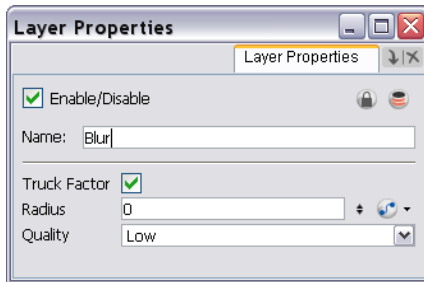

- **Truck Factor:** Activated by default, this option reads only the blur when the elements undergo a change of depth or scale. When this option is disabled, the layer's values will remain unchanged regardless of any depth or scale changes. It is recommended that this option be disabled when multiple drawings are composited and attached to this effect.
- **Radius:** Enter a value for the size of the blur. The larger the value, the greater the blur effect. The blur radius is affected by the drawing scale and camera position.
- **Quality:** Select High for a slow and accurate operation or Low for a faster operation with a more raw look.

## Related Topics

- [Using Effects](#) on page 788

## Brightness and Contrast

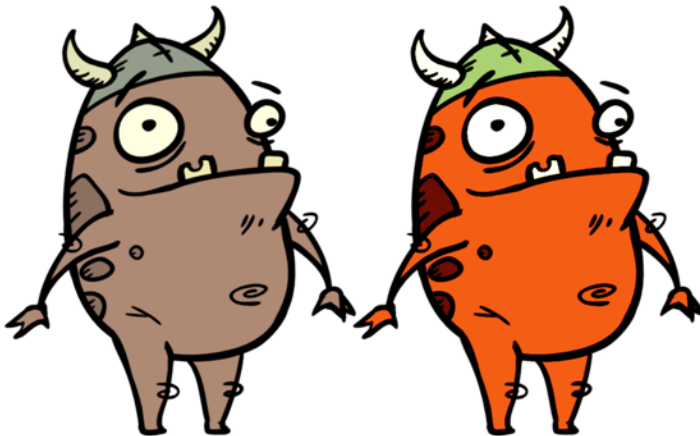

The Brightness and Contrast effect is used to modify the brilliance or dullness of an image or to create a greater difference between the lights and darks of an image by increasing their respective intensities. This effect can be used when an image appears too flat. Increasing the brightness or contrast can give a drawing a more attractive and 3D quality. This can be useful if you want to push your background to the rear by making it look dull and flat and pulling your foreground elements to the front by giving them a higher contrast.

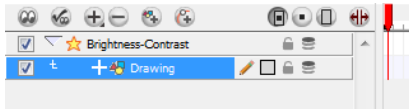

Use the Brightness and Contrast editor to change the values of the Brightness and Contrast effect.

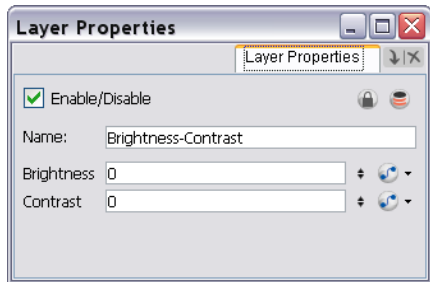

- **Brightness:** A value that is less than 0 will darken the image; a value greater than 0 will brighten it. Attach a Bezier or Ease function to change the brightness over time.
- **Contrast:** A value that is less than 0 will reduce contrast; a value greater than 0 will increase contrast. Attach a Bezier or Ease function to change the contrast over time.

## Related Topics

- [Using Effects](#) on page 788

## Colour-Card



The Colour Card is a solid background the same size as the camera. The Colour Card can be used to fill the scene's background with a solid colour when there is no background image. If no background or colour card is added to the scene, the resulting export will appear with a black background.

By default, the Colour Card has a Z ordering value of **12 Backward**. This will cause the Colour card to be behind all elements that have a value lower than **12 Backward**. Most of the time, the Colour card will appear automatically behind all of your scenes elements as they are all set to **0 Backward**, except is you started playing with the Z ordering of your scene components. At that point, the Colour Card will be in front of the elements that are pushed back to more than 12 fields backward.

Use the Colour Card editor to change the colour values.

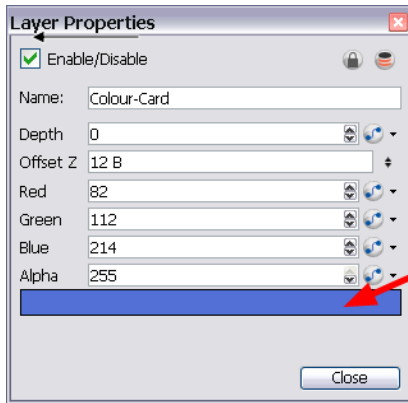

This bar indicates the card colour. Click on the bar to change colour.

- **Depth:** Animate uses the Depth value to determine composition order when the Z value of two elements is the same.
- **Offset Z:** Enter the front-back position of the Colour Card layer in 3D space. This value can be verified in the Top view.
- **Red/Green/Blue/Alpha:** In these fields you can enter a static value for a colour and transparency of the Colour Card or you can attach these parameters to function columns to change their values over time. Click on the Colour rectangle to open the Colour Picker window and select a colour.

## Related Topics

- [Using Effects](#) on page 788

## Colour-Override

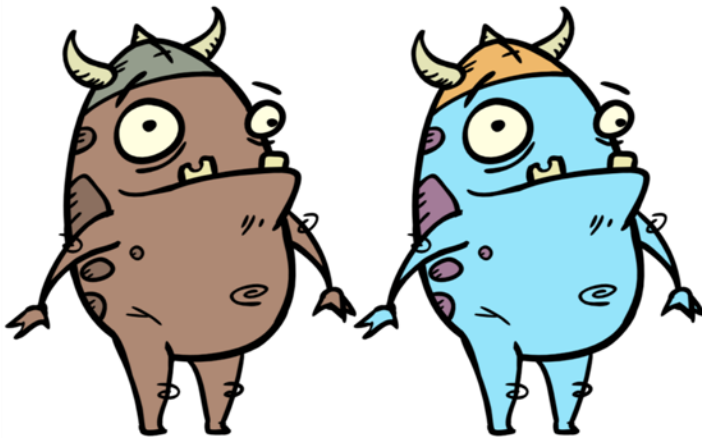

The Colour-Override processes the colours in a drawing layer. The drawings in this layer must be TVG files.

Using this effect you can change colours from the palette without affecting the actual palette, swap clone palettes, replace a specific colour zone with a bitmap texture or hide and display selected colours.

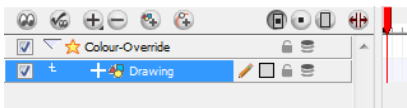

Use the Colour-Override effect to:



- Change colour values in drawings during the compositing process.
- Use colour values from a specific colour palette in the palette list.
- Establish the priority of override palettes in the palette list. For example, you may have different clones of the same palette, for example a daytime and nighttime version.
- Isolate specific areas of a drawing by selecting certain colours. For example, using specific colours to generate a matte for a glow effect.
- Hide certain colours.

Use the Colour-Override editor to set the colour override operations for TVG elements and their drawings.

## Colour-Override Editor Interface

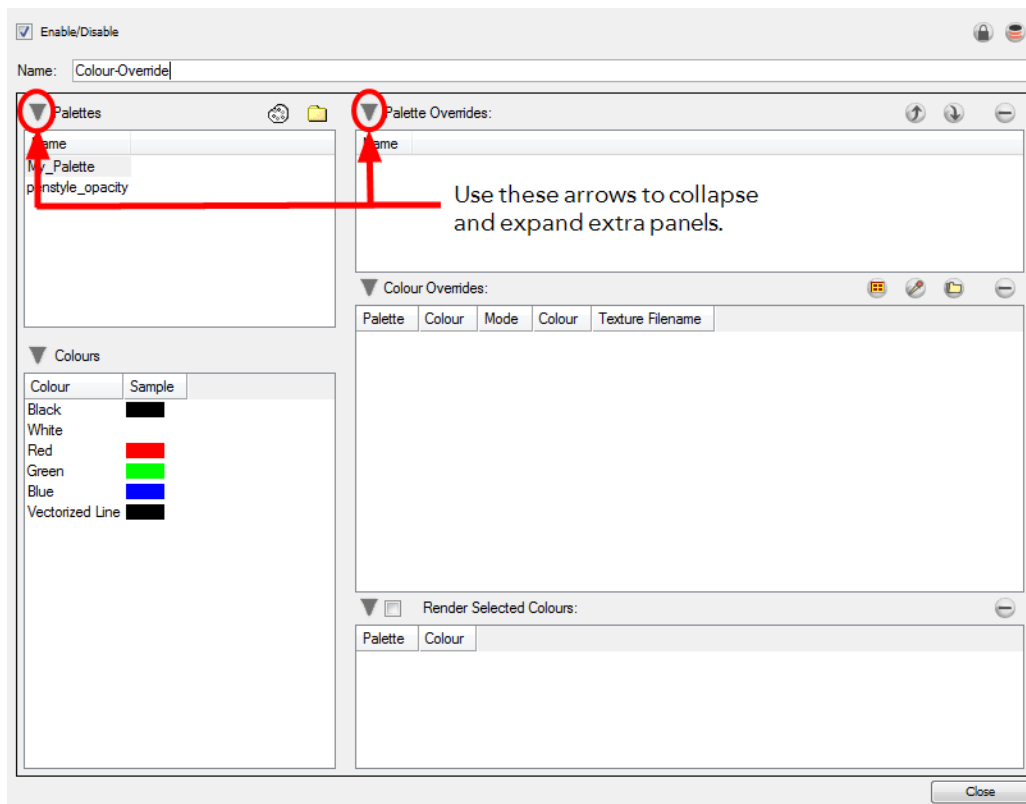

The Colour-Override editor interface is comprised of four sections:

- [Palettes](#) below
- [Colours](#) on the facing page
- [Palette Overrides](#) on the facing page
- [Colour Overrides](#) on page 799

## Palettes

This section displays the palettes in the palette list of the selected layer. Drag these palettes into the Palette Overrides section to re-order them. You can load additional palettes in the palette list from either your project,

by clicking on The Palette 🎨 button, or your computer by clicking on the Browse 📁 button.

- The Palette 🎨 button allows you to load a palette contained within the project hierarchy (Environment, Job, Scene and Elements).
- The Browse 📁 button allows you to load a palette located outside the project hierarchy, anywhere on your system or server.

## Colours

This section displays the colours swatches of the selected palette. Drag a swatch into the Colour-Overrides section to change its value or drag it into the Selected Colours section to render only that colour.

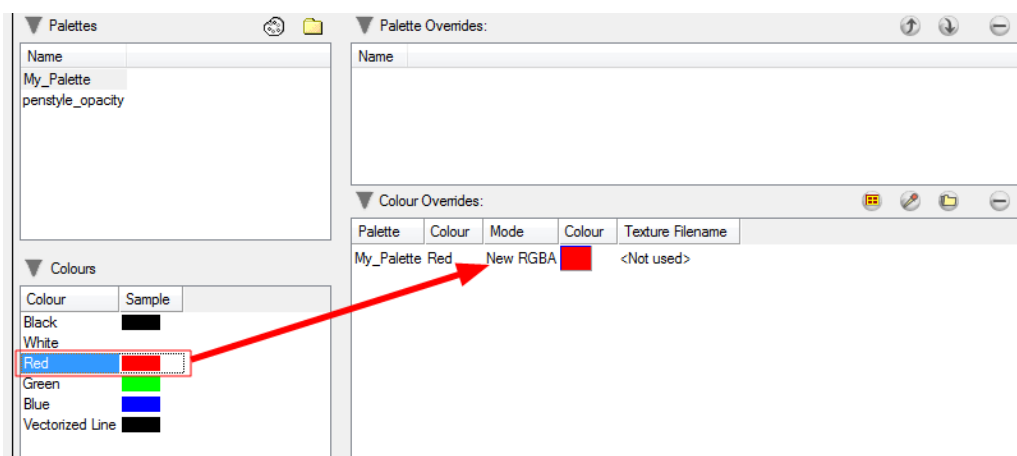

## Palette Overrides

This section forces the use of a particular palette or palette list order, during the composition process. You must drag palettes from the Palettes section to change their order. Animate searches the palettes in the order that they appear in the palette list to find the colour values associated with the colour IDs of each image. To apply a different version of a colour palette, for example to switch from a day to a night palette, use the override section to change the order of colour palettes (you must be working with cloned palettes).

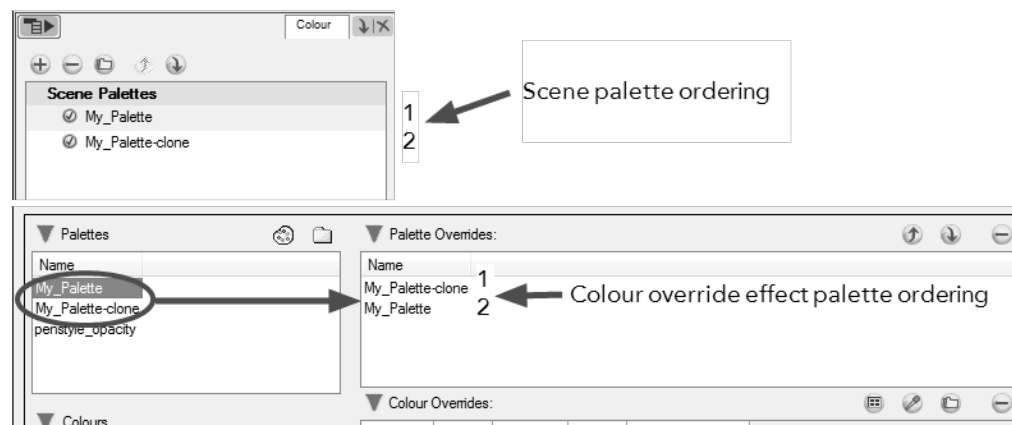

## Colour Overrides

Drag a swatch from the Colours section to this section to override its value. You can also override a colour with a texture.

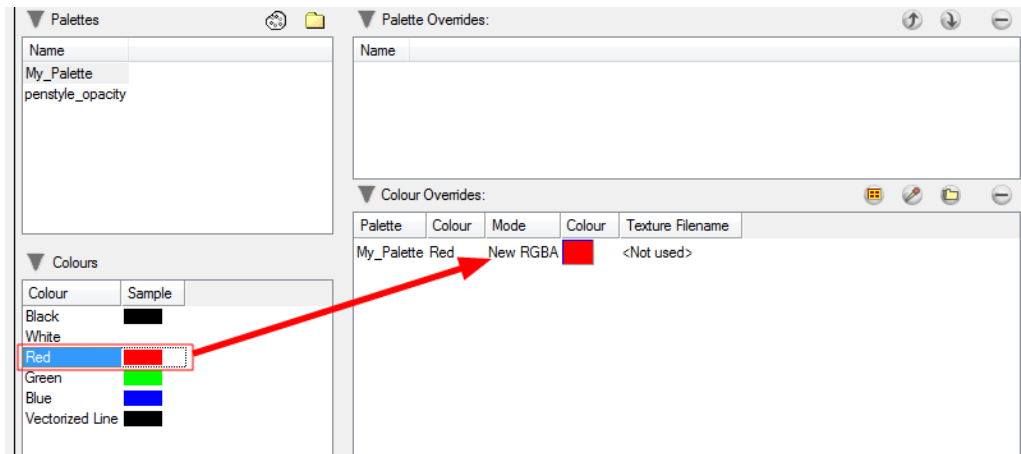

## Related Topics

- [Overriding a Colour](#) below
- [Overriding a Colour With a Texture](#) on the facing page
- [Rendering Selected Colours Only](#) on page 804
- [Modifying a Texture Fill's Transformation](#) on page 804
- [Overriding a Colour with a Bitmap Image Sequence](#) on page 806
- [Overriding a Texture on a Pencil Line](#) on page 808

## Overriding a Colour

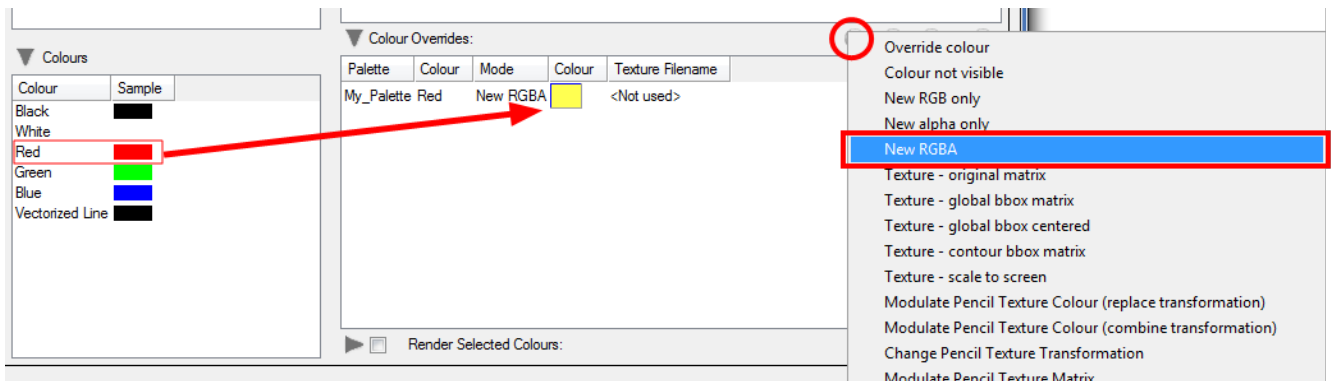

With the Colour-Override module, you can change the colour of some swatches. To do so, from the Colours section, you must drag the colour swatch to modify to the Colour-Overrides section.

Several options are available to modify your colours.



Once the swatch appears in the Colour-Overrides section, click on the Select Override Mode button to right-click on the Override Colour word and select one of the following option in the drop-down menu:



- **Colour not visible:** Renders the selected colour invisible in the Camera view.
- **New RGB only:** Overrides the colour swatch while maintaining its original alpha value. You can select a new colour by pressing the eye dropper  button or clicking directly on the colour swatch and choosing a new colour from the Colour Picker window.
- **New alpha only:** Overrides the swatch's alpha channel while maintaining its original RGB values. You can select a new alpha value by pressing the eye dropper  button or clicking directly on the colour swatch and choosing an alpha value from the Colour Picker window.
- **New RGBA:** Overrides the swatch's colour and alpha values. You can select a new colour by pressing the eye dropper  button or clicking directly on the colour swatch and choosing an alpha value from the Colour Picker window.

## Related Topics

- [Overriding a Colour With a Texture below](#)

## Overriding a Colour With a Texture

With the Colour Override module, can apply a texture over a selected colour. Any zone painted with the selected colour swatch will be overridden by the selected texture.

To apply a texture over a colour:

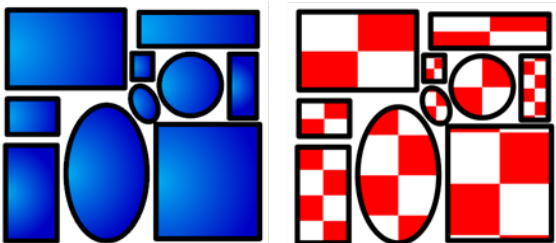

From the Colours section, select the colour swatch to override and drag it to the Colour Override section.

1. Once the swatch appears in the Colour Override section, select it and then click on the Select Override Mode button to right-click on the Override Colour word and select one of the following option in the drop-down menu:



- Texture - original matrix
- Texture - global bbox matrix
- Texture - global bbox centered
- Texture - contour bbox matrix
- Texture - scale to screen
- Override With This Texture Centered on Overridden Objects Centre
- Texture - Use Input Peg

- In the Colour-Override section, under the Texture Filename section, click on "Click to select texture file".

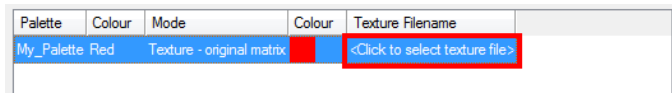

- Browse for your texture file.

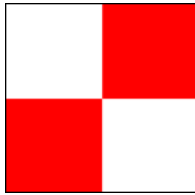

- Click on the Open button.

There are different ways to apply the texture over your colour:

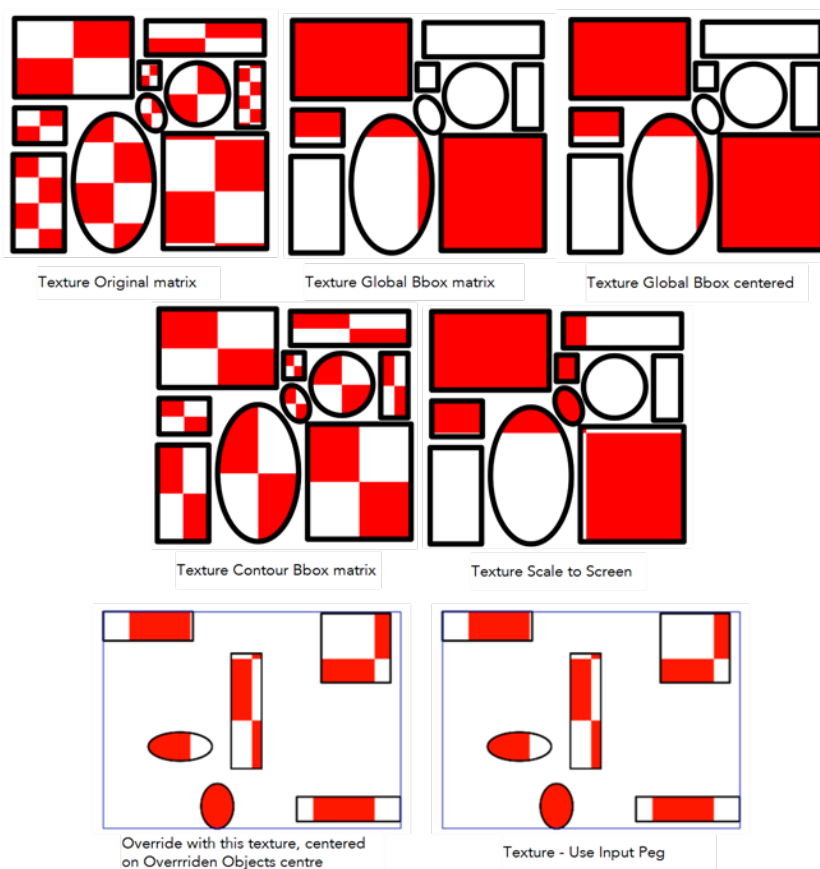

The result will only be visible in the Camera view while in Render mode. In OpenGL mode, you will see your original colour.

The matrix position can be modified using the Edit Gradient and Texture  tool. To do so, your drawing zone must be painted with a gradient swatch or texture swatch.

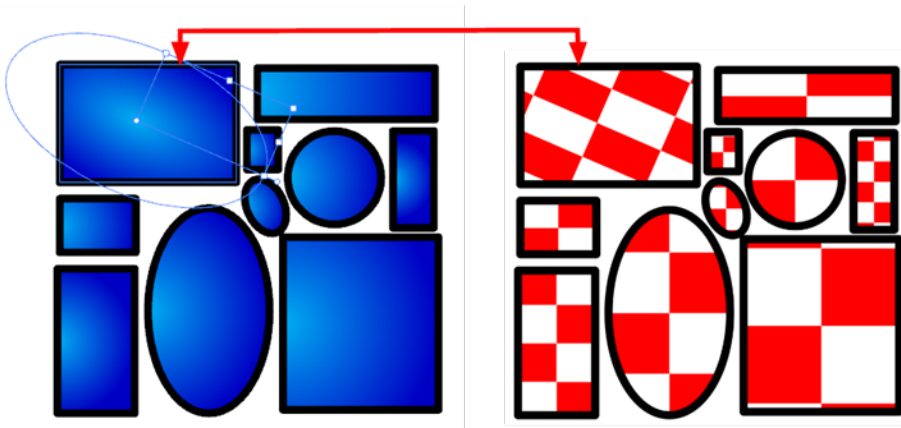

### Texture - Original matrix

Overrides the swatch's colour with a pattern or texture. You must right-click under the Texture header to bring up the Browser window to search for your texture. The texture's default matrix (fixed proportion and orientation) is mapped the full size of the bounding box of each colour area to be overridden.

### Texture - Global bbox matrix

Overrides the colour with a texture that is scaled non-proportionally to the size of the bounding box encompassing the colour areas to be overridden. With multiple objects, it will look as though their fills were all traced and cut from the same piece of stretched or squashed fabric.

### Texture - Global bbox centered

Overrides the colour with a texture that is scaled proportionally to the size of the bounding box encompassing all colour areas to be overridden. With multiple objects, it will look as though their fills were all traced and cut from the same piece of fabric.

### Texture - Contour bbox matrix

Overrides the colour with a disproportionately scaled texture for each individual colour area. In other words, each fill area will not only have the texture scaled to its individual proportions, but also stretched or squashed to fit within its contours.

### Texture - scale to screen

Disproportionately scales the texture to the output resolution before applying it as an override.

### Override with this Texture Centered on Overridden Objects Centre

Overrides the colour with a texture that is centered in the bounding box encompassing all colour areas to be overridden. With multiple objects, it will look as though their fills were all traced and cut from the same piece of fabric. The texture will not be stretched or distorted. It will be tiled in proportion. The centre of the texture zone will be centered in the middle of the bounding box's centre.

With this option, you can connect a Peg in the middle port to apply a transformation on the texture's position. Refer to [Animating a Texture Override with a Peg below](#) to learn how.

## Texture - Use Input Peg

Overrides the colour with a texture that is scaled non-proportionally to the size of the bounding box encompassing the colour areas to be overridden. With multiple objects, it will look as though their fills were all traced and cut from the same piece of stretched or squashed fabric.

With this option, you can connect a Peg in the middle port to apply a transformation on the texture's position. Refer to [Animating a Texture Override with a Peg below](#) to learn how.

## Related Topics





- [Colour-Override Editor Interface on page 797](#)
- [Overriding a Colour on page 799](#)

## Animating a Texture Override with a Peg

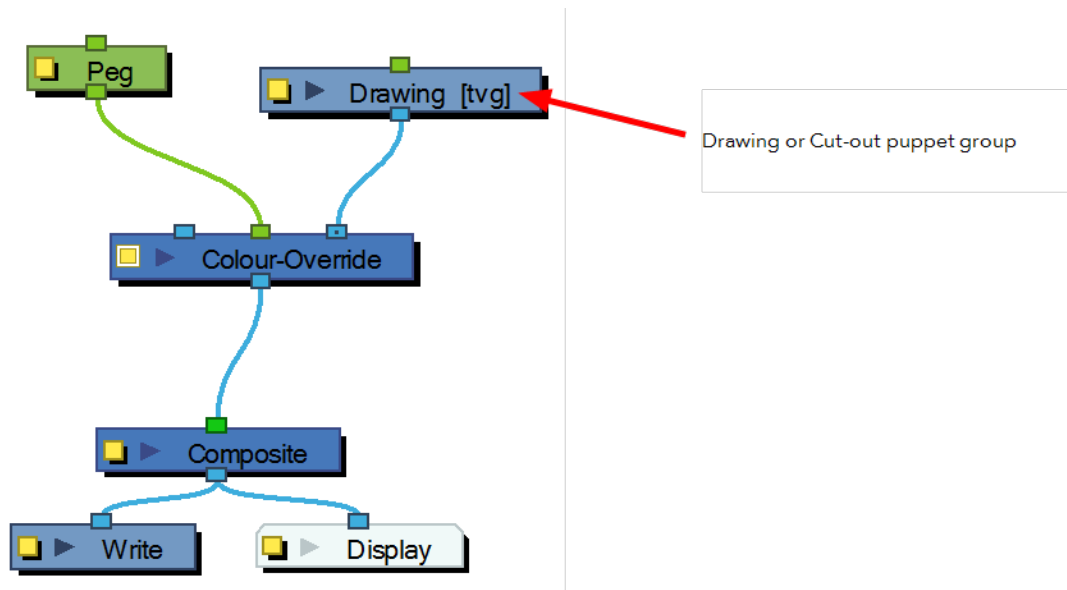
The advantage of being able to animate the texture is that it can be adjusted, scaled, rotated and translated to follow the general motion of a character if you want the texture to follow instead of having the character moving across the fixed texture.

1. From the Module Library view, drag a Peg module and drop it in the Network view.



2. Connect the Peg module in the Colour Override's middle port. The green port will take the transformation of the Peg to modify the pencil texture's position.
3. In the Network view, select the Peg module.
4. In the Advanced Animation toolbar, select either the Translate , Rotate  or Scale  tool.
5. In the Camera view bottom toolbar, enable the Render  mode.

- In the Camera view, move the Peg's position. As you move it, you will see the texture getting modified. You can animate the position by adding position keyframes in the Timeline view. You can use the Random Fill function to quickly create a random shake. [See Pegs on page 643.](#)

## Rendering Selected Colours Only

With the Colour-Override module, you can isolate some colours in your drawing and render those ones only.

To render selected colours:

- From the Colours section, drag the colour swatches to render and drop them into the Render Selected Colours section.



You have to enable the Render Selected Colours option for the module to proceed with the operation.

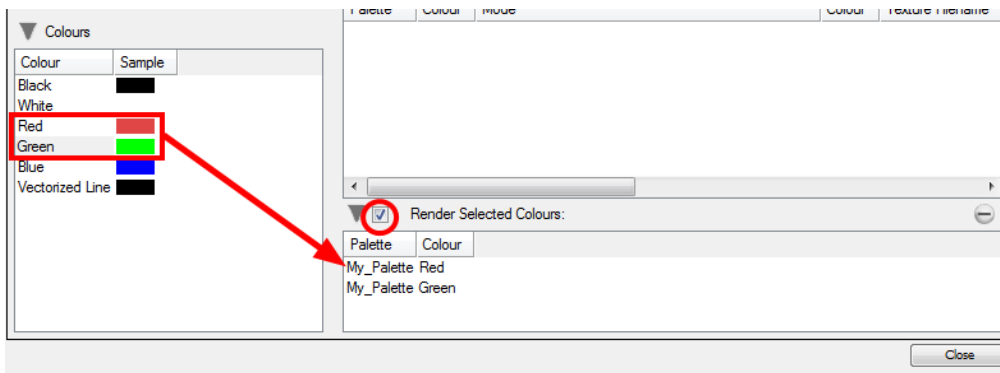

### Related Topics

- [Colour-Override Editor Interface on page 797](#)
- [Overriding a Colour on page 799](#)

## Modifying a Texture Fill's Transformation

When you paint a zone with a bitmap texture swatch, you might want to modify the size or position of the texture's matrix at the compositing level. Maybe for an effect purpose you need to animate the position of the texture in a zone. With the Colour-Override module and a Peg, you can animate the texture.

To modify a texture fill's transformation:

- From the Module Library view, drag a Colour-Override module and drop it in the Network view.
- From the Module Library view, drag a Peg module and drop it in the Network view.



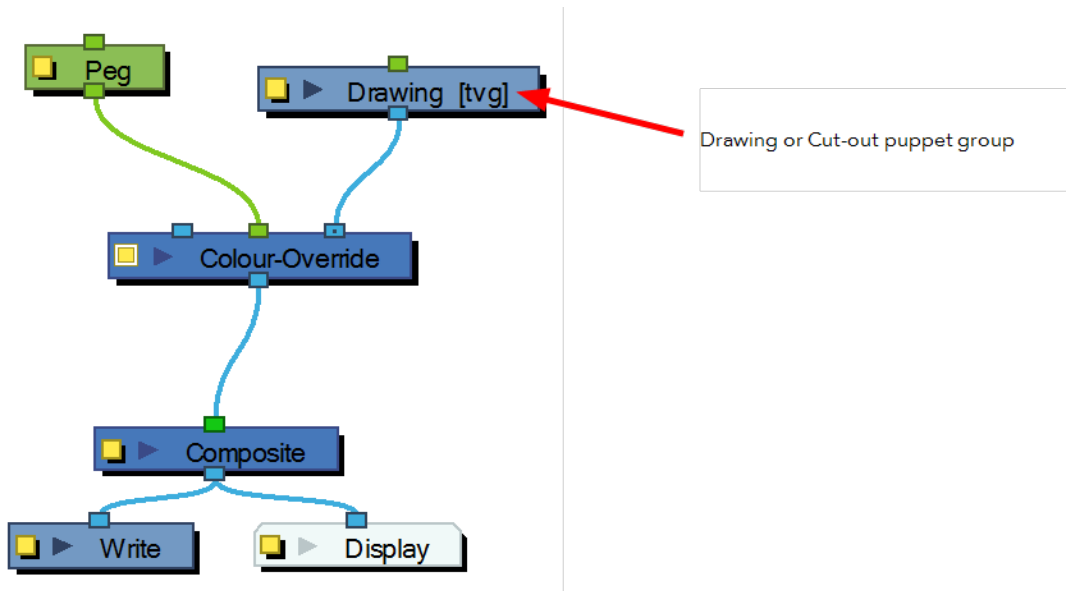



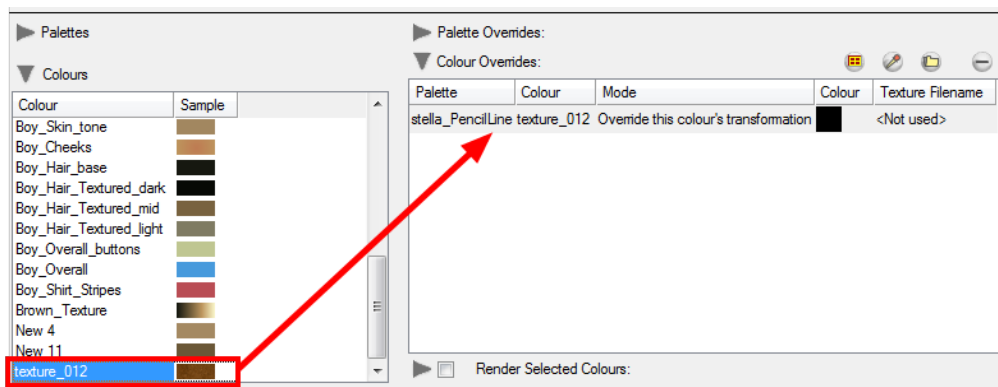



3. In the Network view, connect the Colour-Override module under the drawing module you want to animate the line for. Note that for a cut-out puppet, you would connect the Colour-Override under the final Composite, set as Pass-Through.
4. Connect the Peg module in the Colour-Override's middle port. The green port will take the transformation of the Peg to modify the pencil texture's position.
5. Click on the Colour-Override's yellow button to open the editor.
6. In the Colour-Override window, in the Palettes section, select the palette containing the bitmap texture swatch.
7. In the Colours section, select the texture swatch you used to paint the drawing and drag it to the Colour-Override section.



8. Once the swatch appears in the Colour-Override section, select it and then click on the Select Override Mode button to right-click on the New RGBA word and select one of the following option in the drop-down menu:



- **Override the colour's transformation:** This option will override the initial texture's transformation (matrix) established when you painted the zones or modified with the Edit Gradient and Texture  tool. This transformation override will be done by modifying the Peg's position.

- ▶ **Combine the colour's transformation:** This option will combine the initial texture's transformation (matrix) established when you painted the zones or modified with the Edit Gradient and Texture  tool with the new position transformation you will create when modifying the Peg's position.
9. In the Network view, select the Peg module.
  10. In the Advanced Animation toolbar, select either the Translate , Rotate  or Scale  tool.
  11. In the Camera view bottom toolbar, enable the Render  mode.
  12. In the Camera view, move the Peg's position. As you move it, you will see the texture fills getting modified. You can animate the position by adding position keyframes in the Timeline view.

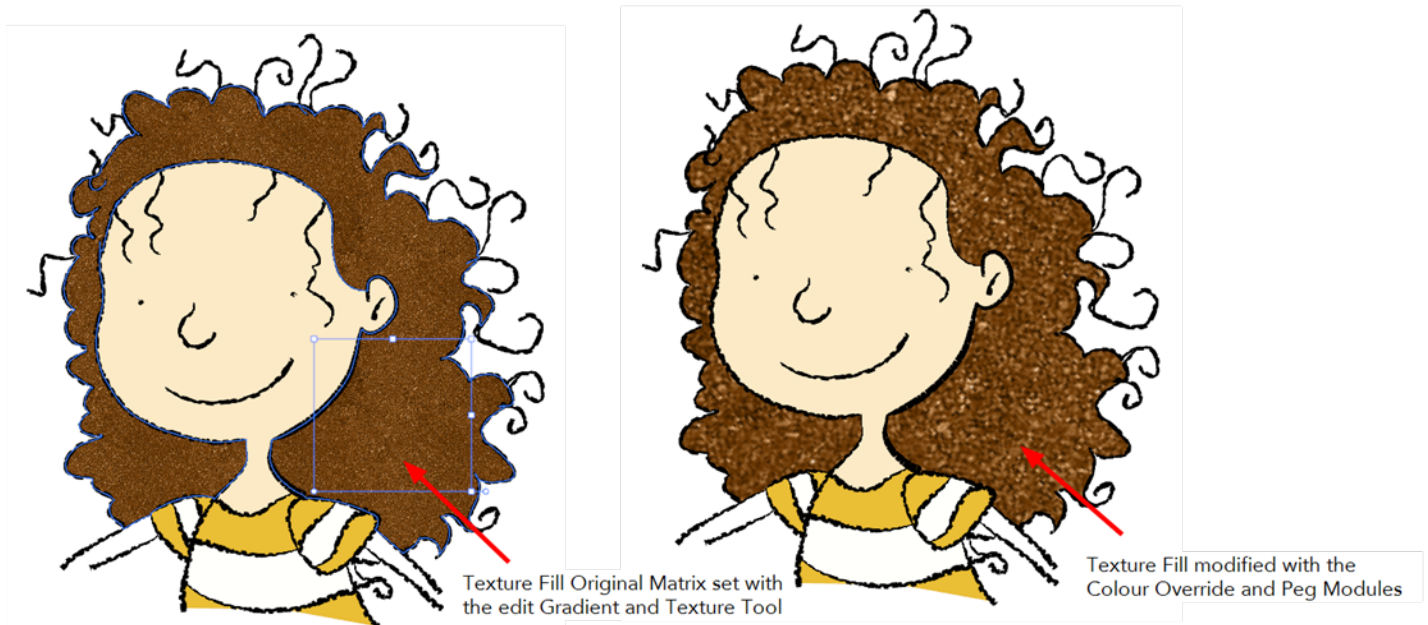

## Related Topics

- [Overriding a Colour With a Texture on page 800](#)
- [Rendering Selected Colours Only on page 804](#)
- [Overriding a Colour with a Bitmap Image Sequence below](#)
- [Overriding a Texture on a Pencil Line on page 808](#)

## Overriding a Colour with a Bitmap Image Sequence

In production, it will happen that you need to map a live action sequence or bitmap image sequence into a zone or over several zone. For example, you could have a mirror shattered in several pieces and you want to map in it the video or someone talking. You can paint the mirror pieces with a specific colour swatch and use the Colour-Override module to map the image sequence into the pieces. It can also be a single image without having to be an image sequence.

## To override a colour with a bitmap image sequence:

1. From the Module Library view, drag a Colour-Override module and drop it in the Network view.

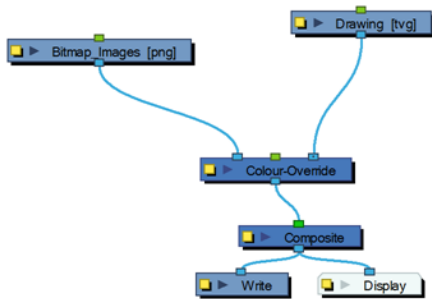

2. In the Network view, connect the Colour-Override module under the drawing module you want to animate the line for.
3. Connect the Live Action or Bitmap Image Sequence module in the Colour-Override's left port. The left blue port will input the images into the colour zones.
4. Click on the Colour-Override's yellow button to open the editor.
5. In the Colour-Override window, in the Palettes section, select the palette containing the colour to override.
6. In the Colours section, select the pencil texture you used to draw your lines and drag it to the Colour-Override section.

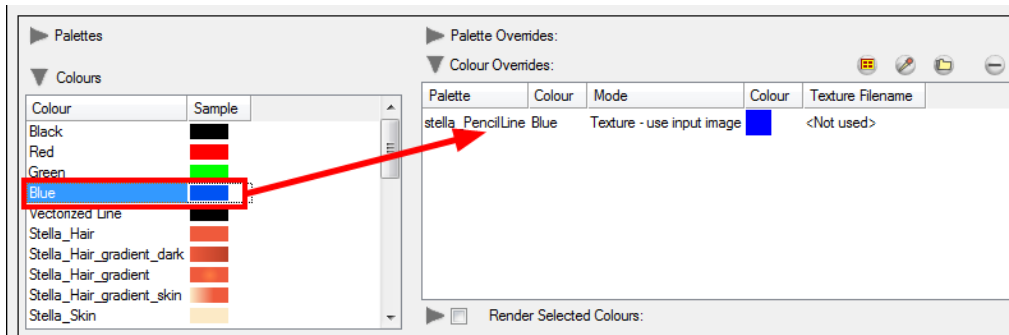

7. Once the swatch appears in the Colour-Override section, select it and then click on the Select Override Mode button to right-click on the New RGBA word and select Texture - Use Image Input.



8. In the Network view, select the bitmap image module.
9. In the Advanced Animation toolbar, select either the Translate , Rotate or Scale tool.
10. In the Camera view bottom toolbar, enable the Render mode.
11. In the Camera view, move the Bitmap Image position. As you move it, you will see the texture fills getting modified. You can animate the position by adding position keyframes in the Timeline view.

## Related Topics

- [Overriding a Colour With a Texture on page 800](#)
- [Modifying a Texture Fill's Transformation on page 804](#)

- [Overriding a Texture on a Pencil Line below](#)

## Overriding a Texture on a Pencil Line

A pencil line can be drawn with a texture but also painted with a texture swatch. With the Colour-Override module, you can either override either the pencil line's texture or texture fill and replace it by another one or you can also animate the texture's position.

With the Edit Gradient and Texture  tool, you can modify the size and position for both types of texture on a pencil line; the drawing texture and the filling texture. By doing that, you are actually modifying the texture's matrix.

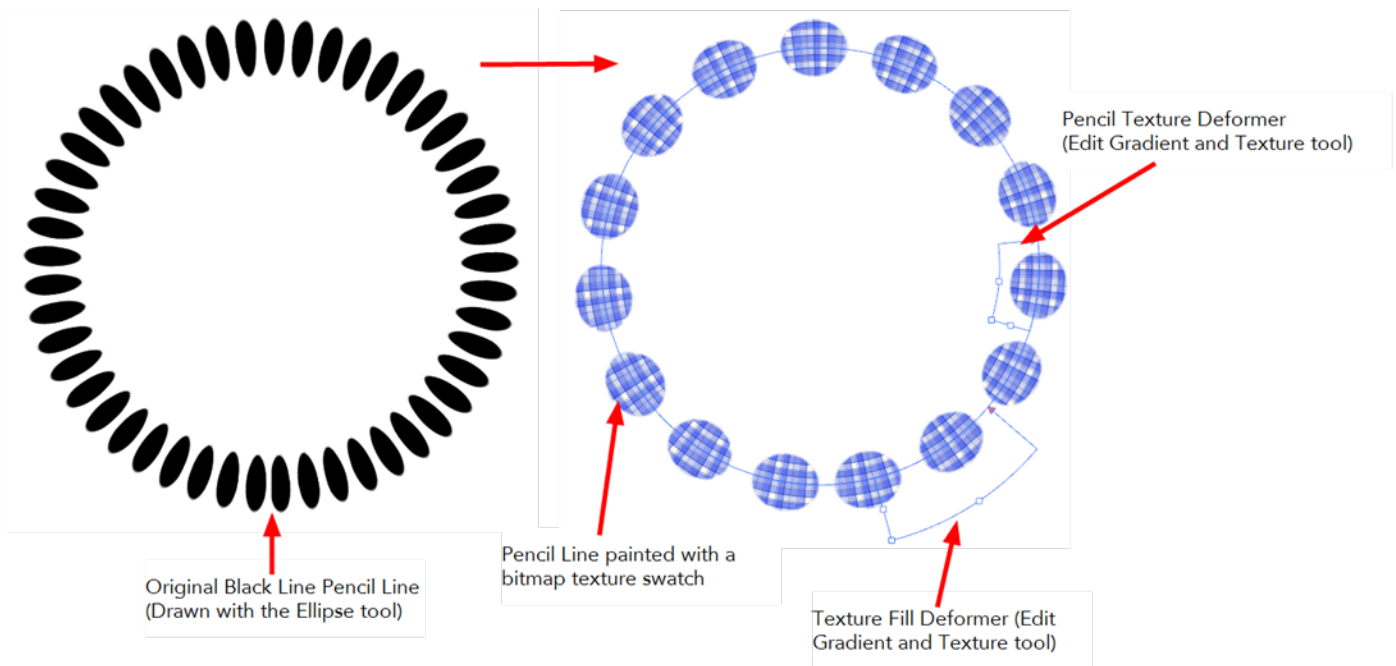

### Related Topics

- [Modifying a Texture Fill on a Pencil Line below](#)
- [Modifying a Pencil Texture on page 811](#)

### Modifying a Texture Fill on a Pencil Line

When you paint a pencil line with a bitmap colour swatch, you can override the position of the texture fill using the Colour-Override module and a Peg.

**To modify the pencil line texture:**

1. From the Module Library view, drag a Colour-Override module and drop it in the Network view.
2. From the Module Library view, drag a Peg module and drop it in the Network view.

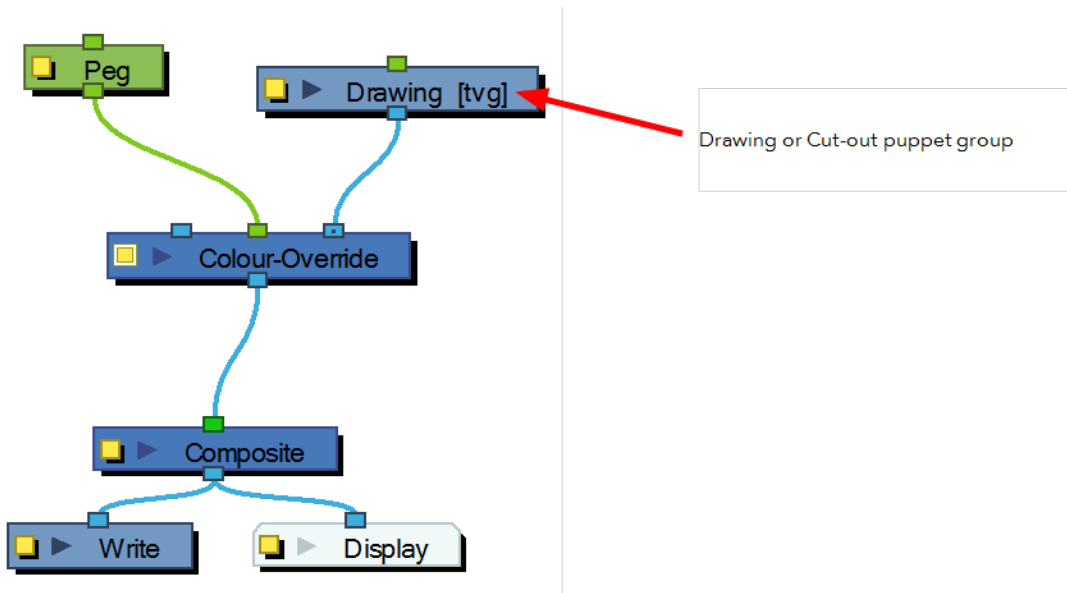

3. In the Network view, connect the Colour-Override module under the Drawing module you want to animate the line for. Note that for a cut-out puppet, you would connect the Colour-Override under the final Composite, set as Pass-Through.
4. Connect the Peg module in the Colour-Override's middle port. The green port will take the transformation of the Peg to modify the pencil texture's position.
5. Click on the Colour-Override's yellow button to open the editor.
6. In the Colour-Override window, in the Palettes section, select the palette containing the colour to override.
7. In the Colours section, select the bitmap texture swatch you used to paint your lines and drag it to the Colour-Override section.

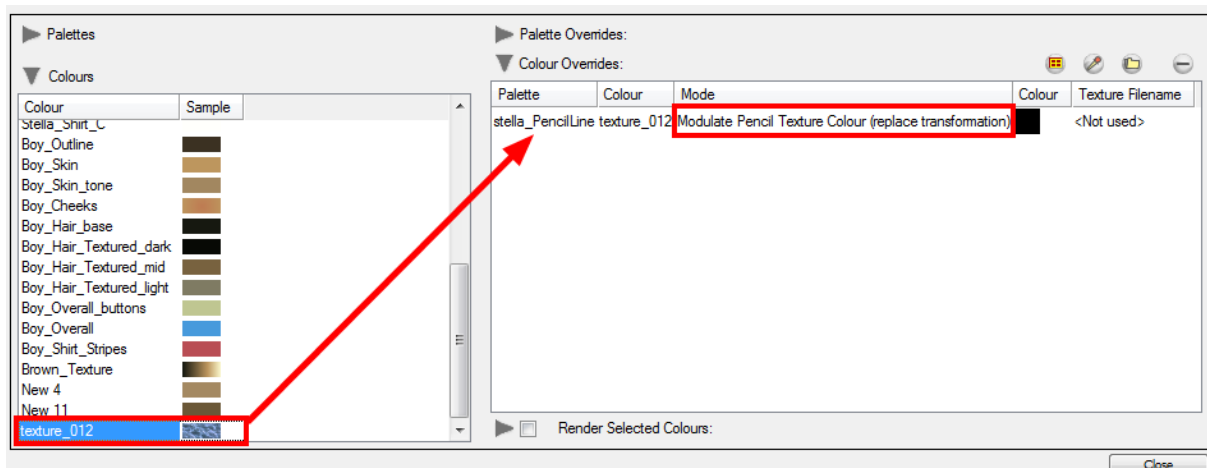

8. Once the swatch appears in the Colour-Override section, select it on Mac OS Xd then click on the Select Override Mode button to right-click on the New RGBA word and select one of the following option in the drop-down menu:



- ▶ **Modulate Pencil Texture Colour (replace transformation):** This option will override the initial texture fill's transformation (matrix) established when you painted the line or modified it with the Edit

Gradient and Texture  tool. This transformation override will be done by modifying the Peg's position.

- **Modulate Pencil Texture Colour (combine transformation):** This option will combine the initial texture fill's transformation (matrix) established when you drew the line or modified it with the Edit Gradient and Texture  tool with the new position transformation you will create when modifying the Peg's position.

9. In the Network view, select the Peg module.

10. In the Advanced Animation toolbar, select either the Translate , Rotate  or Scale  tool.

11. In the Camera view bottom toolbar, enable the Render  mode.

12. In the Camera view, move the Peg's position. As you move it, you will see the texture fill getting modified. You can animate the position by adding position keyframes in the Timeline view.

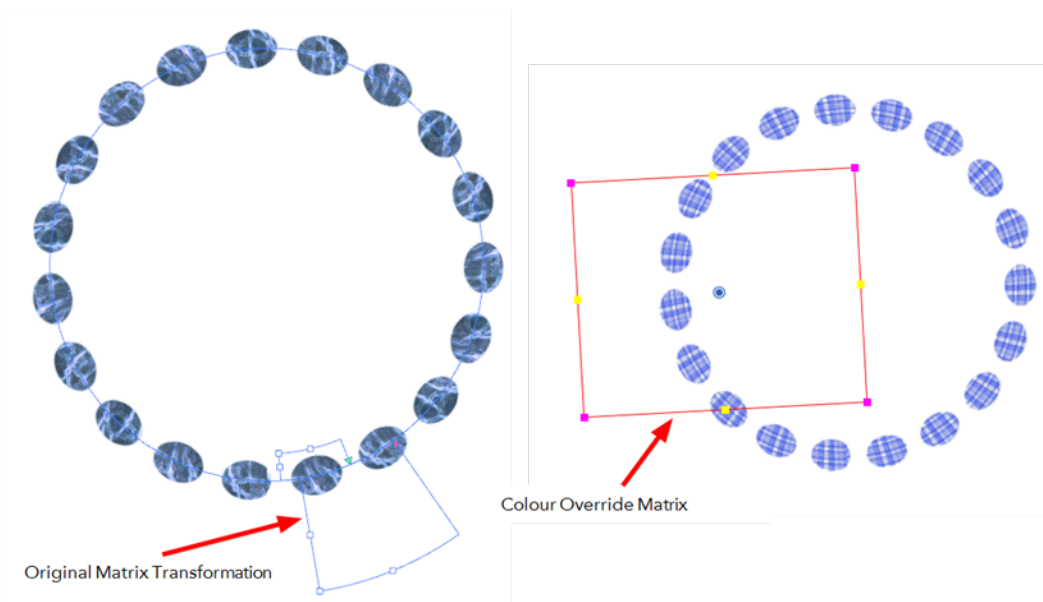

## Related Topics

- [Modifying a Pencil Texture on the next page](#)

## Modifying a Pencil Texture



You can modify and animate a pencil texture's position using the Colour-Override module and a Peg module. This lets you create a shaky line style which is a very popular design style. The main issue with this style is that it works well in traditional and tradigital animation, when the artist draws the line differently on each drawing, but it does not work in cut-out animation where the same drawing is used for the entire animation. The same issue happens when the same drawing is held for more than a few frames. The line moves during the animation, but stops moving during the drawing hold, which looks bad.

With the Colour-Override module, you can animate the position of the pencil line texture independently from the drawing exposure. Even if a drawing's exposure is held over several frames, the line will move.

### To modify the pencil line texture:

1. From the Module Library view, drag a Colour-Override module and drop it in the Network view.
2. From the Module Library view, drag a Peg module and drop it in the Network view.

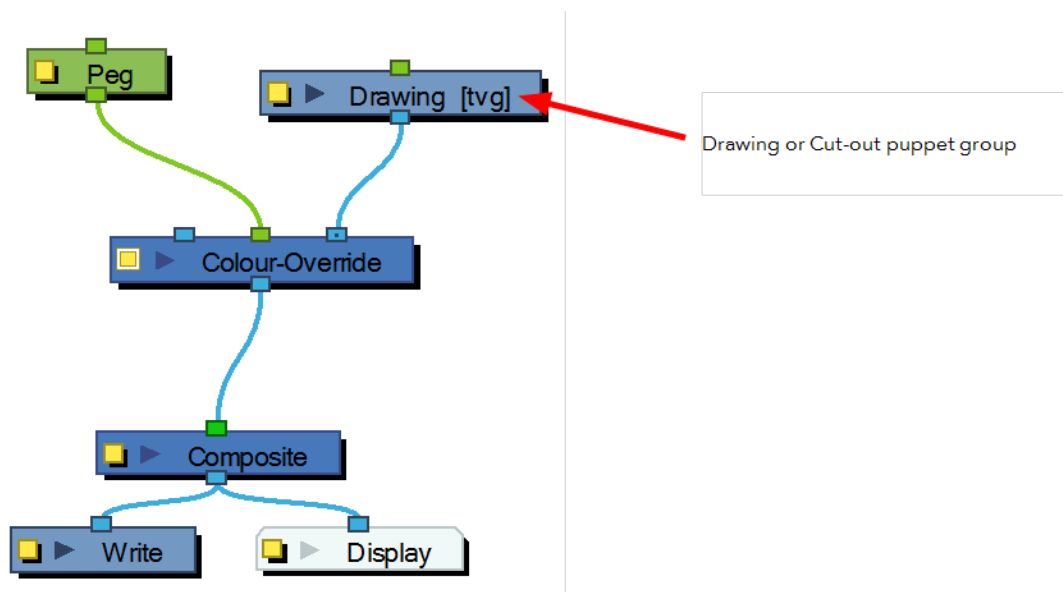

3. In the Network view, connect the Colour-Override module under the drawing module you want to animate the line for. Note that for a cut-out puppet, you should connect the Colour-Override under the final Composite, set as Pass-Through.
4. Connect the Peg module in the Colour-Override's middle port. The green port will take the transformation of the Peg to modify the pencil texture's position.

5. Click the Colour-Override's yellow button to open the editor.
6. In the Colour-Override window, in the Palettes section, select the **penstyle\_opacity** palette.

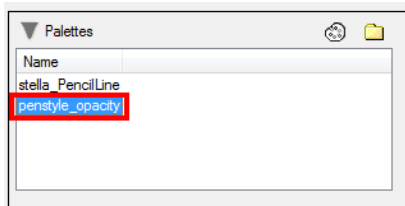



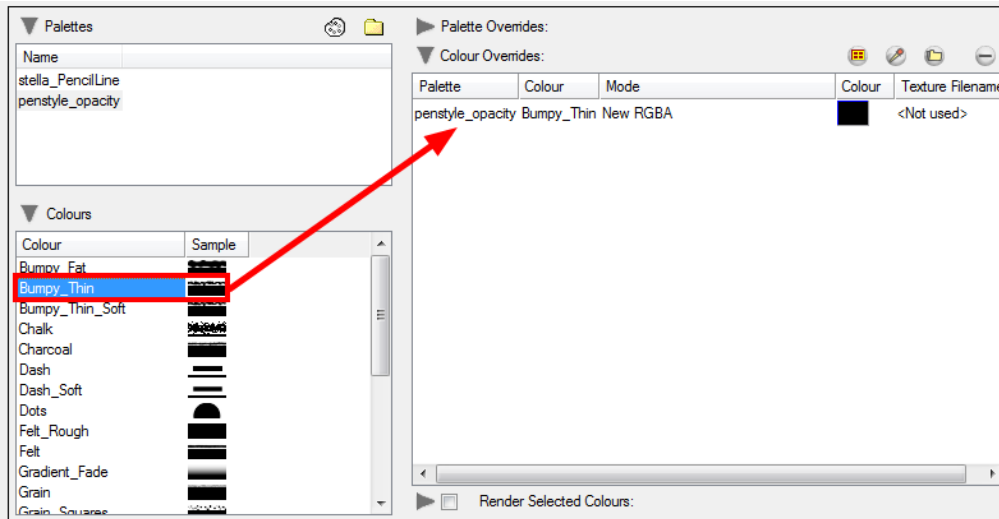



7. In the Colours section, select the pencil texture you used to draw your lines and drag it to the Colour Overrides section.



8. Once the swatch appears in the Colour-Override section, select it and click the **Select Override Mode** button to right-click on the New RGBA word and select one of the following:



- ▶ **Change Pencil Texture Transformation:** Overrides the initial pencil texture's transformation (matrix) established when you drew the line or modified with the Edit Gradient and Texture  tool. This transformation override will be done by modifying the Peg's position.
- ▶ **Modulate Pencil Texture Matrix:** Combines the initial pencil texture's transformation (matrix) that was established when you drew the line or modified with the Edit Gradient and Texture  tool with the new position transformation you will create when modifying the Peg's position.

9. In the Network view, select the Peg module.
10. In the Advanced Animation toolbar, select the **Translate** , **Rotate**  or **Scale**  tool.
11. In the Camera view bottom toolbar, select the **Render**  mode.
12. In the Camera view, move the Peg's position. As you move it, you will see the pencil texture getting modified. You can animate the position by adding position keyframes in the Timeline view. You can use the Random Fill function to quickly create a random shake.



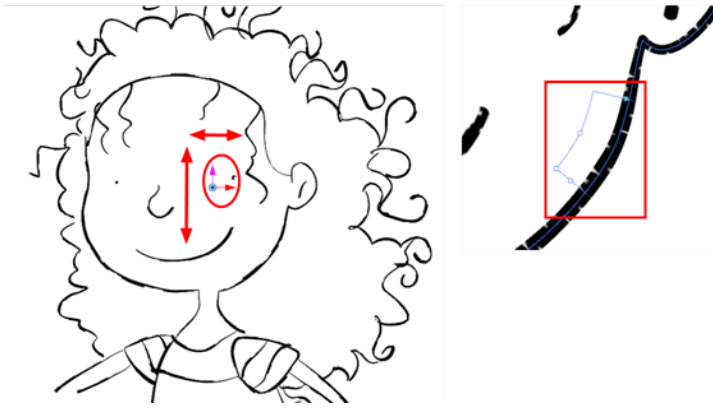

## Related Topics

- [Modifying a Texture Fill on a Pencil Line on page 808](#)

## Colour-Scale

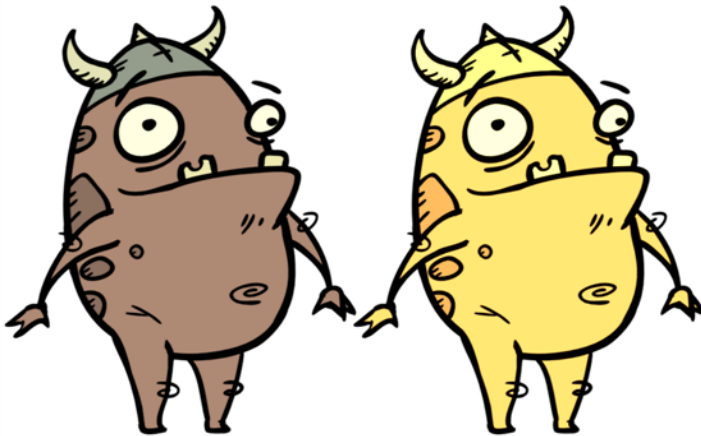

The Colour-Scale effect offsets an image's colours. This effect is useful in creating ambient transitions, such as from daytime to nighttime.

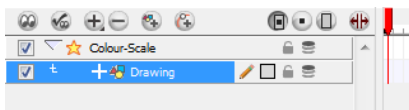

Use the Colour-Scale editor to set the colour scale effect by entering a value in the scale fields.

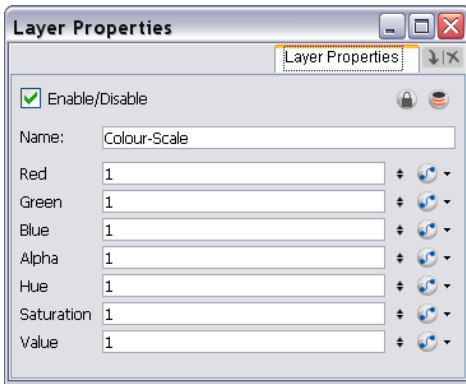

The actual colour values of the image are not changed; instead, the channels are multiplied by a selected amount. For example:

- If you enter a value of 1, the colour values do not change.
- If you enter a value greater than 1, you increase the colour channel value closer to 255 (or white).
- If you enter a value less than 1, you decrease the colour channel value closer to zero (0 or black).

You can set the colour scale value by entering a value in the field. You can also change the values of the colour scale effect over time by attaching it to a Bezier or Ease function curve  and adding keyframes.

## Related Topics

- [Using Effects](#) on page 788

## Mask



The Mask cuts out a portion of an image using a matte drawing. You can use the Mask to allow a character to disappear behind a background element or to cut a virtual hole into the layer itself. The Mask requires a matte input.

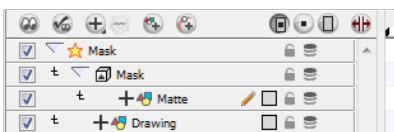

Use the Mask editor to invert the effect of the matte on an image. Instead of the object being hidden by the mask, it will only be visible where it intersects with the matte shape area.

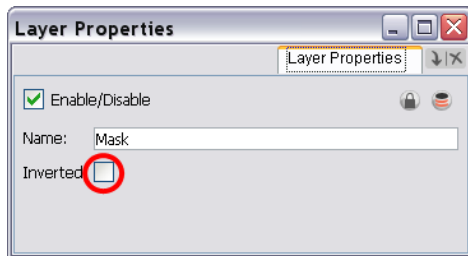

## Related Topics

- [Using Effects](#) on page 788

## Glow



The Glow effect adds a bright soft-edged light or diffuse light region around an image. The Glow effect is useful in creating a shining rim around objects such as the sun or stars.

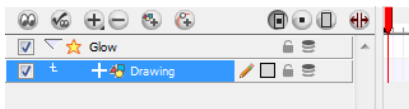

Use the Glow editor to control the direction of the blur that creates the glow, as well as its colour.

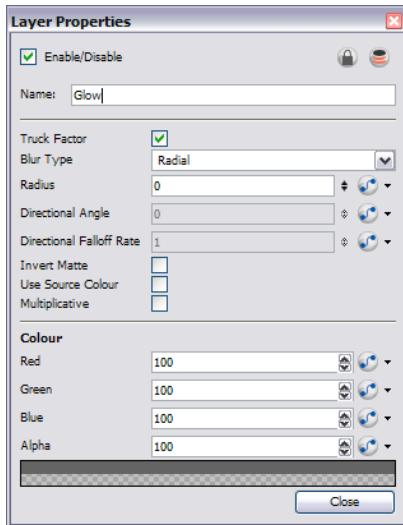

- **Truck Factor:** Activated by default, this option readjusts the blur when the elements undergo a change of depth or scale. When this option is disabled, the effect values remain unchanged regardless of any depth or scale changes. It is recommended that this option be disabled when multiple drawings are composited and attached to this effect.
- **Blur Type (Directional or Radial):**
  - If Directional is selected, the software will blur the matte in the direction you select. For example, if a character is walking east, the blur may fall to the west.
  - If Radial is selected, the software will blur the edges of the matte evenly around points that make up its edge.
- **Radius:** Enter a value for the size of the blur. The larger the value, the greater the blur effect. The blur radius is affected by the drawing scale and camera position.
- **Directional Angle:** If you select a Blur Directional Type, you can select the direction of the blur by entering a value from 0 to 360 in this field.
  - **0:** blurs the image to the west.
  - **90:** blurs the image to the south.
  - **180:** blurs the image to the east.
  - **270:** blurs the image to the north.
- **Directional Fall-off Rate:** The distance where the blur fades from the edge of the image. Select a value between 0 and 1.
  - A fall-off rate of zero causes the blur to fade out slowly, distributing the blur evenly from the edge of the character to the farthest edge of the blur.
  - A fall-off rate of 1 causes the blur to fade out quickly so that the blur is heaviest closer to the edge of the image.
- **Invert Matte:** Activate this option to invert the matte used to create the glow. Your matte will become a black silhouette while the glow will fill the background space.
- **Use Source Colour:** Select this option to use the colours painted in the matte for the glow effect. If you deselect this option, select a colour and alpha values in the Colour section.
- **Multiplicative:** Select this option to create a more diffused glow.
- **Colour:** Where you can choose the colour and alpha values for the glow effect.



If this effect is connected below a Composite module set to Pass-Through, the effect will be applied to each element connected in the Composite individually. If some of these elements are overlapping, the effect will also overlap.

## Related Topics

- [Using Effects](#) on page 788

## Highlight



Use the Highlight effect to turn a drawing's area lighter to simulate a light source. To produce the highlight effect, you must draw a shape to control where the highlight will appear on the original drawing.

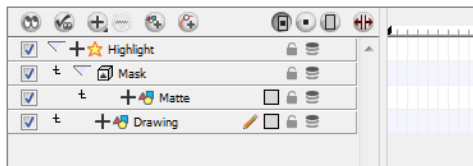

The Highlight effect uses a matte to determine the shape and position of the highlight on another element and can blur the edges to create a softer effect. Use the Highlight editor to control the type and amount of blur, as well as the colour of the highlight effect.

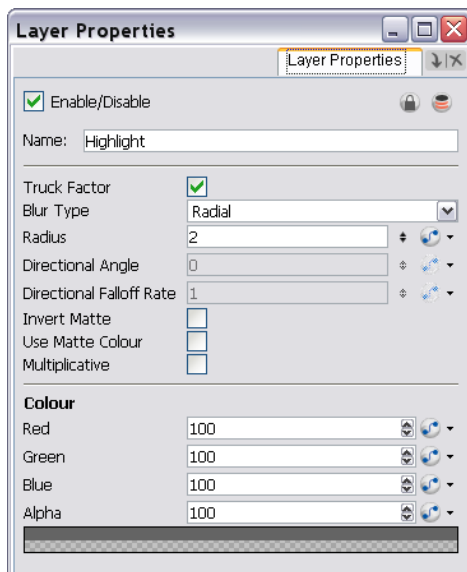

- **Truck Factor:** Activated by default, this option readjusts the blur when the element undergoes a change of depth or scale. When this option is disabled, the effect's values remain unchanged regardless of depth or scale changes. It is recommended that this option be disabled when multiple drawings are composited and attached this effect.
- **Blur Type (Directional or Radial):**
  - If Directional is selected, Animate will blur the matte in the direction you select.
  - If Radial is selected, Animate will blur the edges of the matte evenly around points that make up the edge of it.
- **Radius:** Enter a value for the size of the blur. The larger the value, the greater the blur effect. The blur radius is affected by the drawing scale and camera position.
- **Directional Angle:** If you select a Blur Directional Type, you can select the direction of the blur by entering a value from 0 to 360 in this field.
  - **0:** blurs the image to the west.
  - **90:** blurs the image to the south.
  - **180:** blurs the image to the east.
  - **270:** blurs the image to the north.
- **Directional Fall-off Rate:** The distance where the directional blur fades from the edge of the image. Select a value between 0 and 1.
  - A fall-off rate of 0 causes the blur to fade out slowly, distributing the blur evenly from the edge of the character to the farthest edge of the blur.
  - A fall-off rate of 1 causes the blur to fade out quickly so that the blur is heaviest closer to the edge of the image.
- **Invert Matte:** Activate this option to invert the matte used to create the highlight.
- **Use Matte Colour:** Select this option to use the colours in the matte for the highlight effect. If you deselect it, use the Colour section to select colour and alpha values.
- **Multiplicative:** Select this option to create a more diffused highlight.
- **Red/Green/Blue/Alpha:** In the RGBA fields, enter the value that you want added to or subtracted from the colour channels in the drawings. Alternatively, you can attach these values to function columns to animate them over time.

## Related Topics

- [Using Effects on page 788](#)

# Quadmap



Use the Quadmap transformation layer to deform the shape of an element. For example, you can use it to create a drop-shadow effect on an element.

You can edit the Quadmap visually in the Camera view.

## To edit the Quadmap the Camera view:

1. In the Timeline view, click on the Add Layer  button and select Quadmap from the drop-down menu.
2. Connect the Quadmap layer to the drawing layer that you want to deform, or in the Network view, drag in the Quadmap module from the Module Library and connect it above the drawing element module that you want the effect to act on.

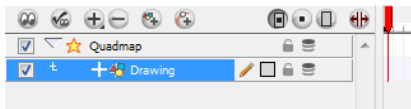

3. In the Tools toolbar, disable the Animate mode to change the value for the Quadmap over the entire duration of the element.
4. In the Timeline view, click on the Quadmap layer to select it.
5. Select **View > Show > Control** or press [Shift] + [F11].

The quadmap handles appear around the element in the window. There is also a pivot point at the centre of the quadmap frame that can be repositioned.

6. In the Camera View window, use the Transform tool to move the points on the quadmap. [Shift] + click to select multiple points.

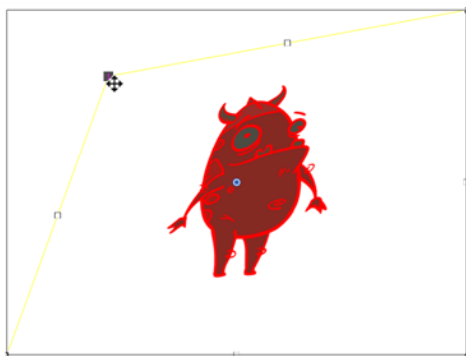

The value of each point on the quadmap can be changed gradually. To do this, use the Quadmap module Layer Properties to attach the points to function curves.

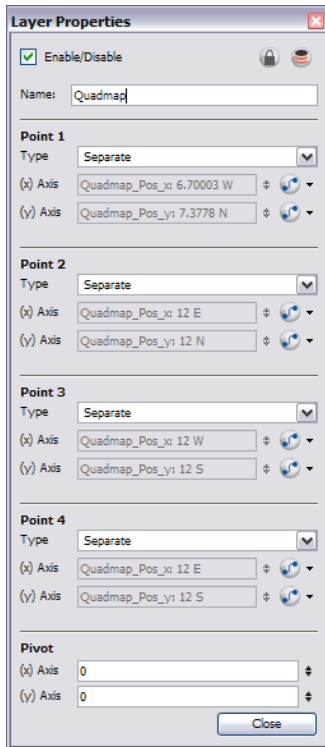

Only the X and Y values of each point in the quadmap can be changed.

- **2D Path:** change the X and Y values simultaneously and control the velocity of the change.
- **Separate:** change the X and Y values separately. Each of these can be attached to separate function curves.

## Related Topics

- [Using Effects](#) on page 788

## Shadow



With the Shadow effect, you can turn a drawing into a shadow. It does not matter if your drawing layer is a fully coloured character, the Shadow effect will render it into a grey, semi-transparent, slightly blurry silhouette.



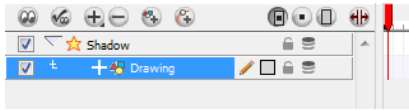

To add a shadow stretched out on the ground, simply add a Quadmap module to flip, stretch and skew the matte. Attach the entire effect to the same trajectory as your drawing layer and watch the shadow move along with your character.



Do not forget that you need to connect your character in both the final Composite module and the Shadow effect if you want to see your character and its shadow.

Use the Shadow editor to modify the way the Shadow effect is created.

The Shadow effect uses the shape of the drawing connected to create the shadow behind another element and can blur the edges to create a softer effect. You can control the type and amount of blur, as well as the colour of the shadow, in this dialog box.

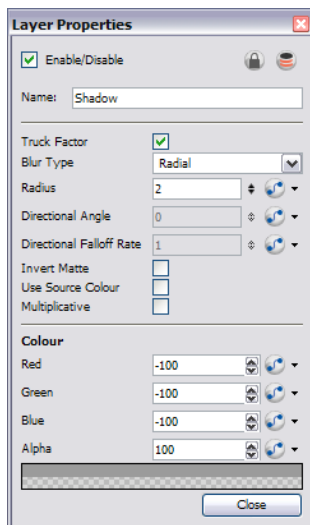

- **Truck Factor:** Activated by default, this option readjusts the blur when the elements undergo a change of depth or scale. When this option is disabled, the effect's values remain unchanged regardless of any depth or scale changes. It is recommended that this option be disabled when multiple drawings are composited and attached to this effect.
- **Blur Type (Directional or Radial):**
  - If Directional is selected, Animate will blur the matte in the direction you select.
  - If Radial is selected, Animate will blur the edges of the matte evenly around points that make up the edge of it.
- **Radius:** Enter a value for the size of the blur. The larger the value, the greater the blur effect. The blur radius is affected by the drawing scale and camera position.
- **Directional Angle:** If you select a Directional Blur Type, you can select the direction of the blur by entering a value from 0 to 360 in this field.

- **0**: blurs the image to the west.
- **90**: blurs the image to the south.
- **180**: blurs the image to the east.
- **270**: blurs the image to the north.
- **Directional Fall-off Rate**: The distance where the blur fades from the edge of the image. Select a value between 0 and 1.
  - A fall-off rate of 0 causes the blur to fade out slowly, distributing the blur evenly from the edge of the character to the farthest edge of the blur.
  - A fall-off rate of 1 causes the blur to fade out quickly so that the blur is heaviest closer to the edge of the image.
- **Invert Matte**: Activate this option to invert the matte used to create the shadow. In the render mode, the background will appear grey, while a the matte shape will act as a cut-out window, allowing you to see the original background colours beneath.
- **Use Source Colour**: Create the shadow using the matte shape's colour. Be sure that you are in render mode  to see this effect and that your background is **NOT** white and that you do **NOT** have a white colour card module attached to the composite. As the shadow matte only gives colour information, but no alpha, the matte is automatically multiplied with the background colours. If there is no colour card attached and the background appears black, you will see the matte colour at full opacity. If it is multiplied with a white background, the colours disappear into the full 255.
- **Multiplicative**: Multiplies the shadow colours with the background.
- **Red/Green/Blue/Alpha**: In the RGBA fields, you can enter the value to add or subtract from the colour channels in the drawings or you can attach these values to function curves.



If this effect is connected below a Composite module set to Pass-Through, the effect will be applied to each element connected in the Composite module individually. If some of these elements are overlapping, the effect will also overlap.

## Related Topics

- [Using Effects](#) on page 788

## Tone



Use a Tone effect to add a dark-coloured region to your drawing and simulate the shaded area away from a light source. To produce the tone effect, create a drawing to control where the tone will appear. The Tone effect uses a matte to determine the shape and position of the tone on your drawing and can be blurred at the edges to create a softer effect.

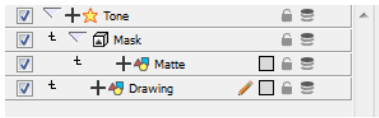

Use the Tone editor to control the type and amount of blur, as well as the colour of the tone.

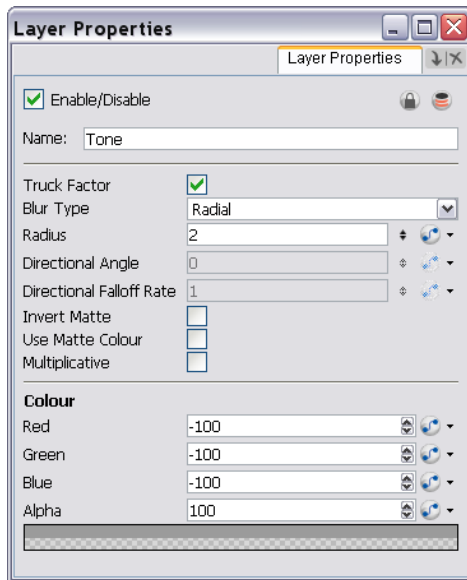

- **Truck Factor:** Activated by default, this option readjusts the blur when the elements undergo a change of depth or scale. When this option is disabled, the effect's values will remain unchanged regardless of depth or scale changes. It is recommended that this option be disabled when multiple drawings are composited and attached this effect.
- **Blur Type (Directional or Radial):**
  - If Directional is selected, Animate will blur the matte in the direction you select.
  - If Radial is selected, Animate will blur the edges of the matte evenly around points that make up the edge of the matte.
- **Radius:** Enter a value for the size of the blur. The larger the value, the greater the blur effect. The blur radius is affected by the drawing scale and camera position.
- **Directional Angle:** If you select a Directional Blur Type, you can select the direction of the blur by entering a value from 0 to 360 in this field.
  - **0:** Blurs the image to the west.
  - **90:** Blurs the image to the south.
  - **180:** Blurs the image to the east.
  - **270:** Blurs the image to the north.
- **Directional Fall-off Rate:** The distance where the blur fades from the edge of the image. Select a value between 0 and 1.

- A fall-off rate of 0 causes the blur to fade out slowly, distributing the blur evenly from the edge of the character to the farthest edge of the blur.
- A fall-off rate of 1 causes the blur to fade out quickly so that the blur is heaviest closer to the edge of the image.
- **Invert Matte:** Activate this option to invert the matte used to create the tone.
- **Use Matte Colour:** Uses the matte shape colour to create the tone.
- **Multiplicative:** Multiplies the tone colours with the background.
- **Red/Green/Blue/Alpha:** In the RGBA fields, you can enter the value you want added to or subtracted from the colour channels in the drawings or you can attach these values to function curves.

## Related Topics

- [Using Effects](#) on page 788

# Transparency

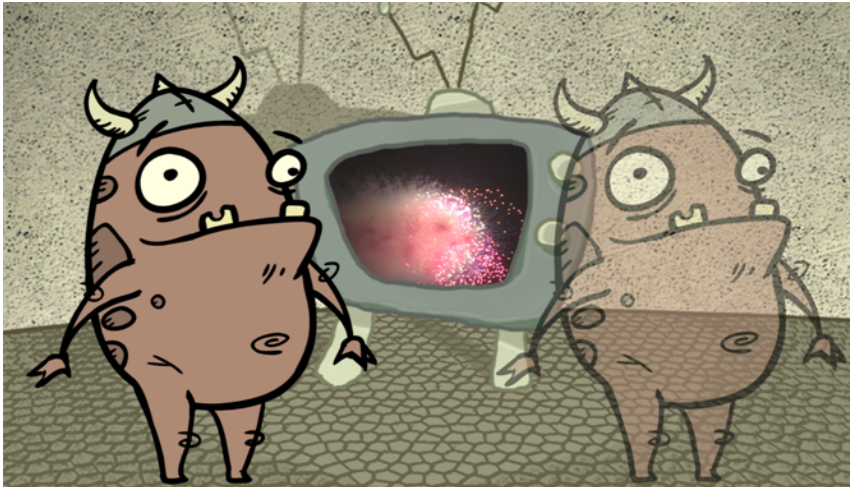

The Transparency effect is used to make an image partially transparent. The Transparency effect is useful when fading images in and out, such as a phantom or to make something partially see-through, such as a window.

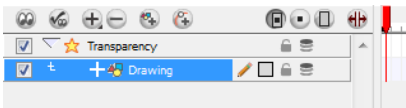

Use the **Transparency** editor to control how translucent the element should be.

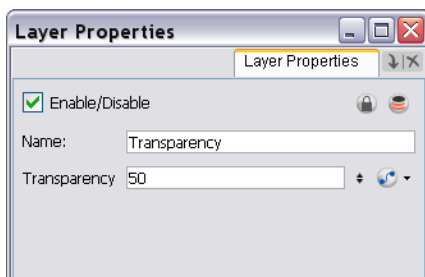

You can enter a value in the Transparency field or change the transparency value over time by linking it to a function curve. Entering a value of one hundred into the Transparency field will make the element 100% transparent, in other words, invisible. Entering a value of 0 will render the element completely opaque.



It is also possible to adjust a layer/module's transparency directly in the Layer Properties window without using the Transparency module. In the layer's properties, go to the Drawing tab and adjust the Opacity parameter. This parameter is visible in OpenGL mode.

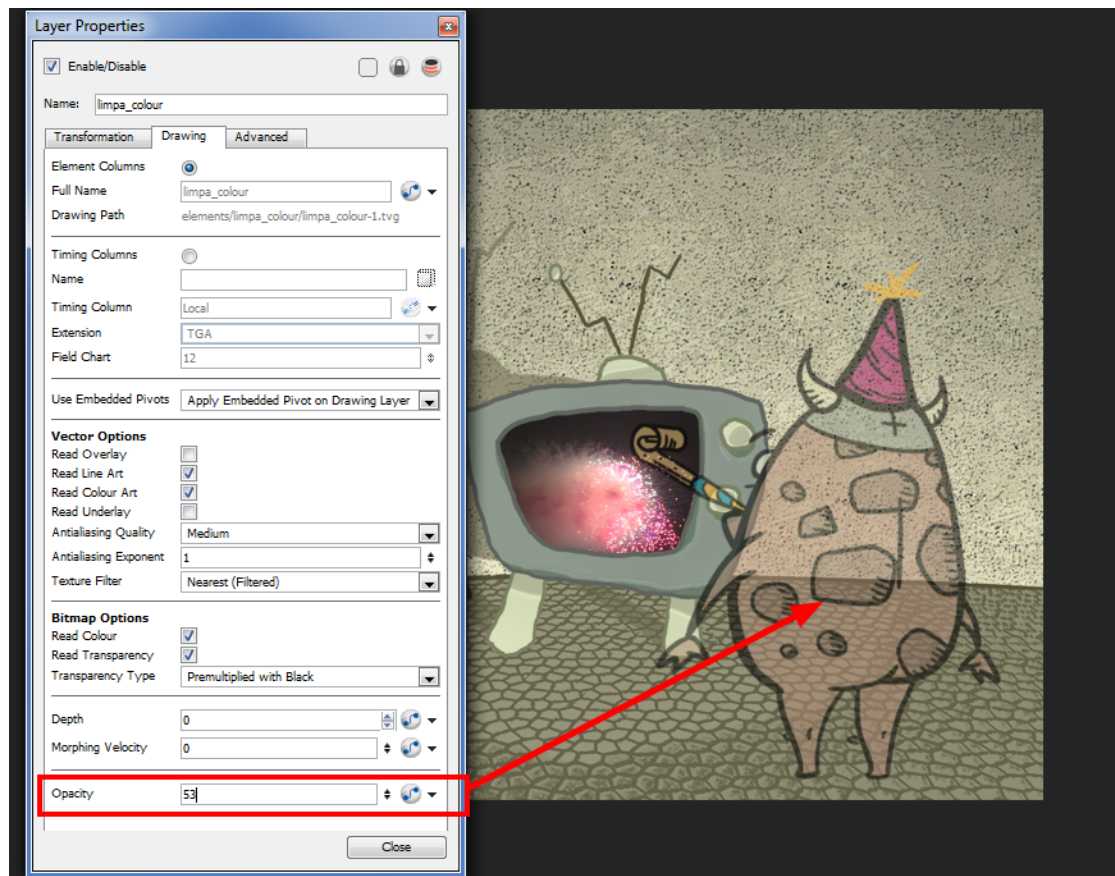

## Related Topics

- [Using Effects](#) on page 788

# Previewing and Playing Back Effects

To preview your effects, you will have to perform a quick render. Effects must be calculated before they can be viewed in real time.

**To preview your effects:**

1. In the Playback toolbar, press the **Render and Play**  button.

The Play module opens and loads the frames.

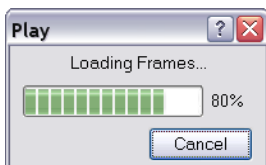

2. Once the frames are loaded, press the **Play**  button in the Play window.

## Preview Resolution

To make your previews calculate faster, you may want to render them out at a smaller resolution. You can use the Preview Resolution command so you will not have to modify the resolution of your scene every time you make a check preview.

The Preview Resolution command allows you to quickly ask for a preview at either a quarter, half or three-quarter of the scene resolution. You can even customize the preview resolution size.

**To use the Preview Resolution command:**

1. In the top menu, select **View > Preview Resolution**.
2. From the drop-down menu, select either **Same as Scene Resolution**, **3/4 of Scene Resolution**, **1/2 of Scene Resolution**, **1/3 of Scene Resolution**, **1/4 of Scene Resolution** or **Custom**.

If you selected the Custom option, the Custom Preview Resolution dialog box opens.

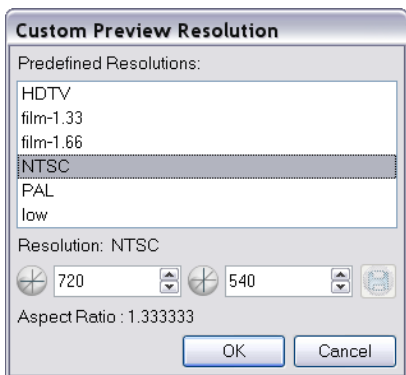

3. In the dialog box, select a resolution from the presets or type a new X-Y value.
4. Click on the **OK** button.
5. Preview your effects animation.

## Related Topics

- [Previewing Effects](#) on page 782

# Effects Preferences

Animate has a series of preferences you can adjust to make you work more efficient.

- [General](#) below
- [OpenGL](#) on the next page

To open the Preferences panel:

- Windows: Select **Edit > Preferences**.
- Mac OS X: Select **Animate > Preferences**.
- Press [Ctrl] + [U] (Windows) or [⌘] + [U] (Mac OS X).

## General

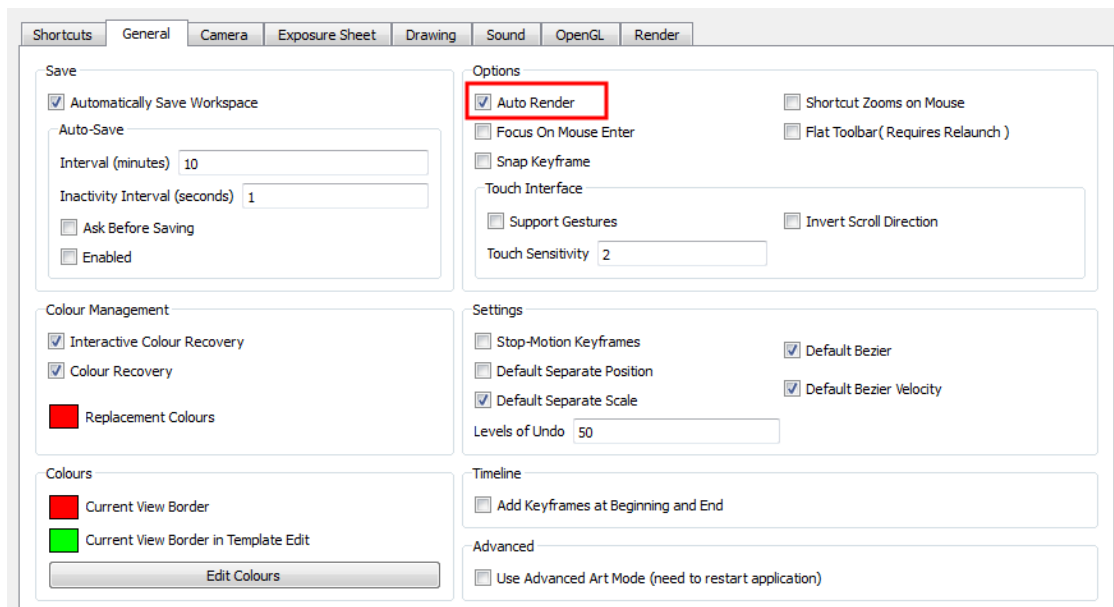

## Options

- **Auto-Render:** Automatically enables the Auto-Render option.



# OpenGL

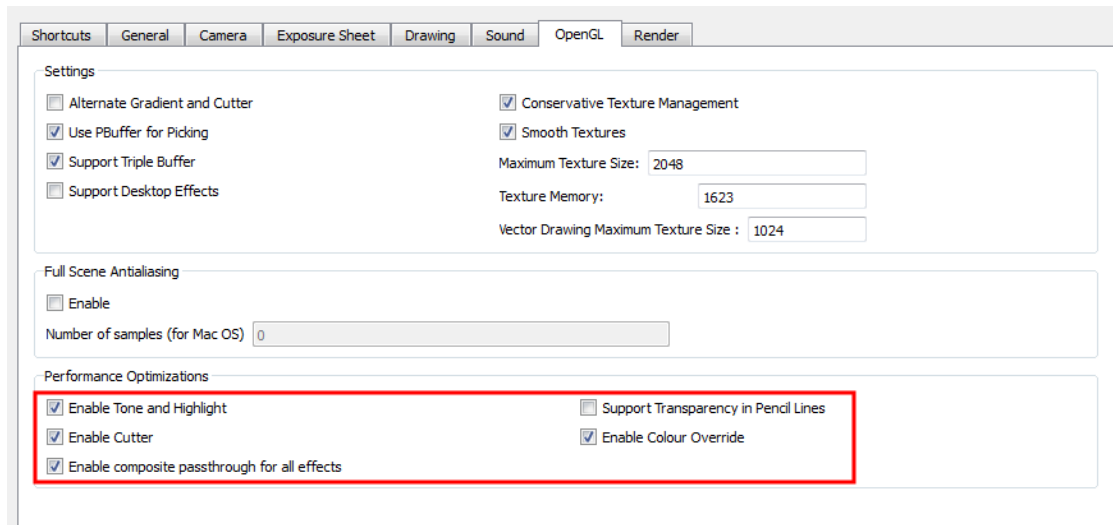

## Performance Optimizations

- **Enable Tone and Highlight:** Turns the Tone and Highlight effects on and off in the Camera, Top and Side views.
- **Enable Cutter:** Turns the rendering of Cutter effects on and off in the Camera, Top and Side views.
- **Enable Colour-Override:** Turns the rendering of the Colour-Override effects on and off in the Camera, Top and Side views.



# Chapter 17: Export

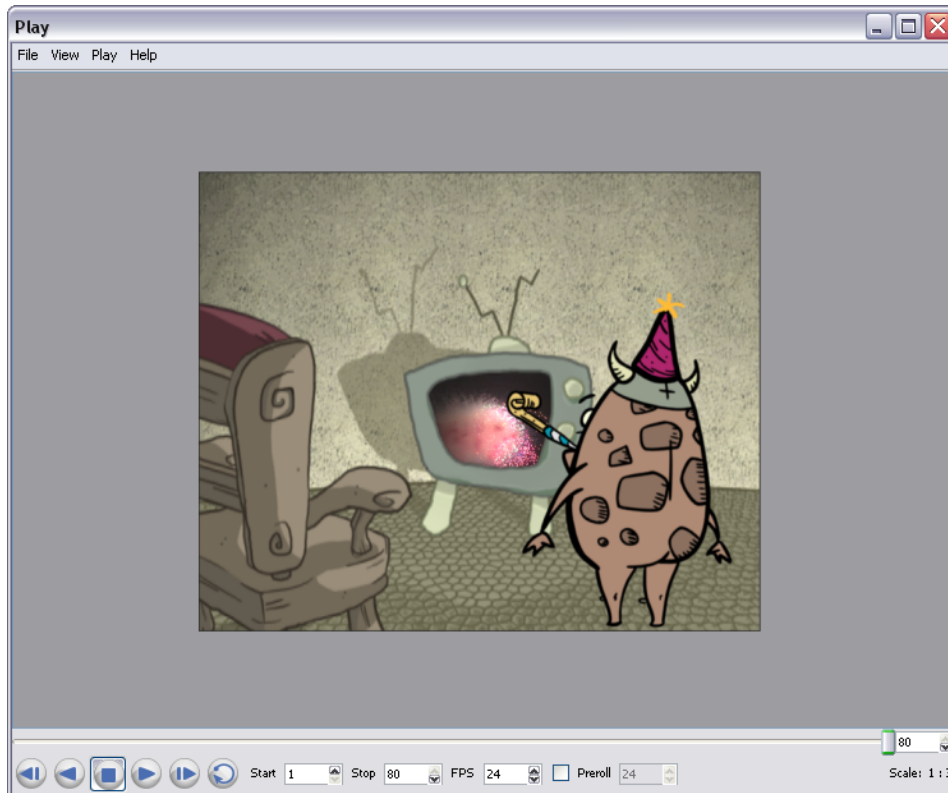

Now that you have finished your animation, it is time to render your movie. Depending on whether you plan to further edit your movie in a third party software, composite the movie in a larger body of work or put it up directly on the web, Toon Boom Animate supports several formats for all your rendering needs.

## Topics Covered

- [Exporting a QuickTime Movie on the facing page](#)
- [Exporting an SWF Movie \(Flash\) on page 837](#)
- [on page 1](#)
- [on page 1](#)
- [Export Preferences on page 841](#)

# Exporting a QuickTime Movie

To export a QuickTime Movie:

1. From the top menu, select **File > Export > Movie**.

The Export to QuickTime Movie dialog box opens.

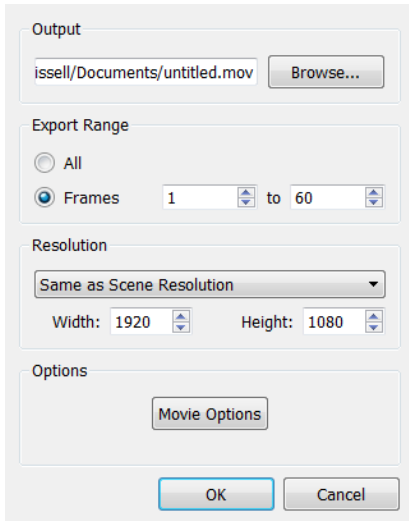

2. From the dialog box, click **Browse** to choose a destination path to where your movie will be saved and an appropriate filename for the export.
3. Click **Save** when you are finished.
4. From the Export Range section, decide whether you would like to export the entire scene (**All**) or just a selected frame range. If you decide on the latter, be sure to enter in the frame range in the fields provided.



5. In the Resolution section, choose a preferred resolution ratio from the drop-down menu or select Custom to enable the custom Width and Height fields and type a specific size.

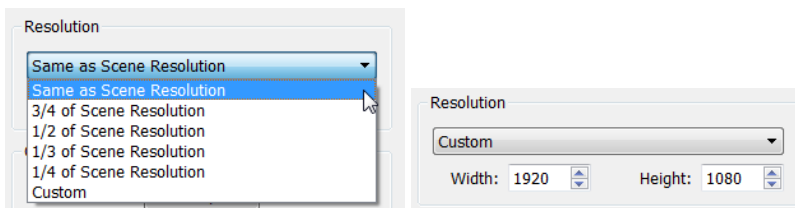

6. In the Options section, click on the Movie Options button.

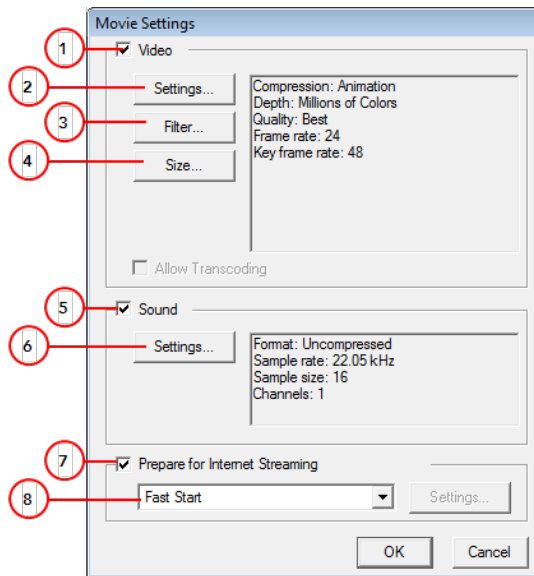

- **1. Video:** Check this box to enable the customization of the video settings, filters and size.
    - **2. Settings:** Opens the Standard Video Compression Settings dialog box (see below).
    - **3. Filter:** Opens the Choose Video Filter dialog box, where you can select from a range of filters to apply to your video export.
    - **4. Size:** Opens the Export Size Settings dialog box. The size settings are overridden by the Animate's scene settings.
  - **5. Sound:** Check this box to enable the customization of the sound settings.
    - **6. Settings:** Opens the Sound Settings dialog box (see below).
  - **7. Prepare for Internet Streaming:** Check this box to enable the customization of the internet streaming options.
    - **8. Internet Streaming drop-down:** Select from the drop-down menu options for the type of streaming best suited for your needs.
7. In the **Video** section, click on the Settings button.

The Standard Video Compression Settings dialog box opens.

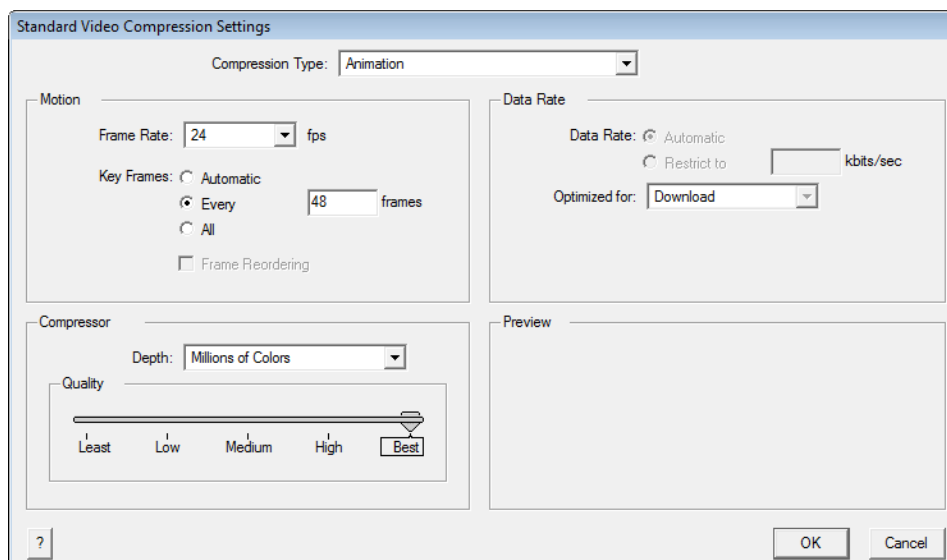

- From the Compression Type drop-down menu, select a codec.



The availability of certain Compression Settings depends on the Compression Type selected. For example, Animation is the default compression type and as a result the Data Rate option is greyed out.

- In the Motion section, choose your Frames per second from the drop-down menu.

By default, it will be set to match the frames-per-second (fps) of your Animate project. If you choose a lower frame rate, your export play back will be faster than your actual project. The reverse is also true for a higher frame rate.

- From the same section decide whether you would like key frames inserted by checking the **Key frame every** box, and if so, the number per frame.

This is the option is recommended by QuickTime. A further description of this topic is cited below.

*Many compressors use "frame differencing" to compress moving images.*

*Frame differencing is the process of determining what information has changed from a starting frame (called a "key frame") to subsequent frames. The key frame contains all of the information for an image. Subsequent frames contain only the information that has changed.*

*Depending on the compressor you use, you can specify how often you want key frames to occur. If you don't have enough key frames, the quality of your movie might be lower because most frames are generated from others. However, more key frames result in a larger movie with a higher data rate. With some compressors, an additional key frame is inserted automatically if too much of the image has changed from one frame to the next.*

*A good rule of thumb for general use is to have one key frame every 5 seconds (multiply the frames per second by 5). If you are creating a file for RTSP streaming and have concerns about the reliability of the delivery network (as with the public Internet), you may want to increase key frame frequency to one key frame every 1 or 2 seconds.*

- From the Compressor section, choose a Depth based on your movie's needs, for example, Millions of Colours+ houses an alpha channel.
- In the Quality section, use the slider to choose a quality setting. Remember that the better the quality of the export, the larger the file.

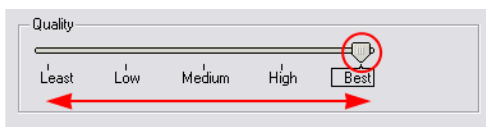

- From the Data **Rate** section, either choose to allow the program to automatically select the most optimal bit rate, or enter in a Restricted rate to save space and allow for faster downloading at a cost to the quality of your export.
- In the same section, from the Optimized for drop-down list, select the intended viewing method for your export.
- Click the OK button when you are finished.
- From the Movie Settings dialog box, click-on the **Sound Settings** button.

The Sound Settings dialog box opens.

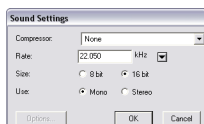

- From the Compressor drop-down menu, choose a compression type.

The default setting is None. This will preserve your original sound file, without the loss of information. However, an uncompressed sound file will inevitably add “weight” to the overall size of your video export.

18. Select a **Rate** by pressing the down arrow button next to kHz.

It is best to check and match the original properties of your sound file. For example, if your file has an audio sample rate of 48 kHz and you choose a conversion rate of 22.05 kHz, the sound will play at the same speed, but with higher frequencies missing.

For a standard film sound quality, choose **44.1 kHz**, or **48 kHz** for DVD quality. Anything less will make the sound “dull” or less bright. For things like recorded voice this doesn't matter so much, but for music it can make an audible difference.

If file size is a consideration, such as with videos for the internet, then a lower rate might be more practical.

19. Next, choose the **Size** and the **Use**, which are related. Once again, it is advisable to check your original sound file properties. If the file was recorded in one channel (mono), there is little point in choosing the two channel (stereo) option.

Although Mono can support a 16-bit channel, the extra information is unnecessary. Mono is generally paired with 8-bit and Stereo with 16-bit.

20. Click **OK** when you are done.

21. In the Export to QuickTime Movie dialog box, click **OK**.

A progress bar appears.

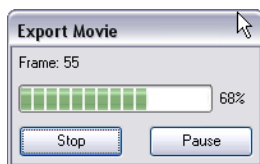

22. Browse to the location on your computer where you saved your QuickTime video and double-click on it to view your export.



If you feel that your exported video is either too small or too large, change your project size from the top menu under **Scene > Scene Settings**. This will change the size of the video output.

---

## Related Topics

- [Exporting a QuickTime Movie with Transparency below](#)
- [Export on page 831](#)

# Exporting a QuickTime Movie with Transparency

To render out a QuickTime movie with transparency, you need to set the Depth to Millions of Colours +.

### To set the depth to Millions of Colours:

- ▶ In the Standard Video Compression Settings dialog box, select **Millions of Colours** from the Depth drop-down menu.

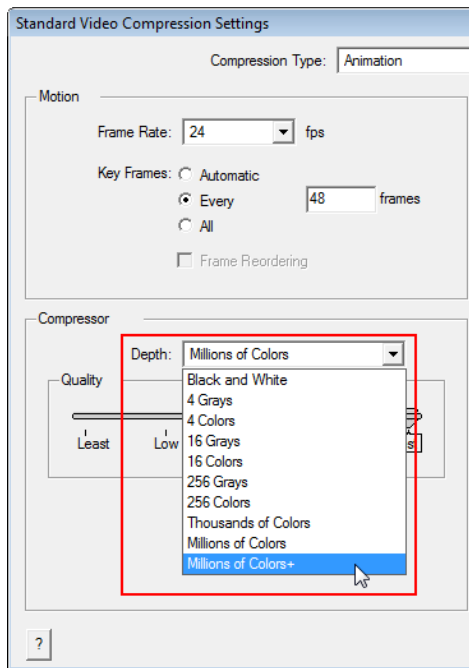



Refer to [Exporting a QuickTime Movie on page 832](#) to learn how to access the Standard Video Compression Settings dialog box.

## Related Topics

- [Exporting a QuickTime Movie on page 832](#)
- [Export on page 831](#)



# Exporting an SWF Movie (Flash)

The SWF export now supports both bitmap effects (which can be previewed in Render View  mode) and SWF Blend Modes (vector effects which can be previewed in OpenGL View  mode). If you have not already done so, you should preview the SWF by using the SWF preview  button to see what the two types of effects look like when blended together. Once you are satisfied with the results, continue to the Export to SWF Movie procedure.

## To export an SWF movie:

1. From the top menu, select **File > Export > SWF**.

The Export to Flash Movie (SWF) dialog box opens.

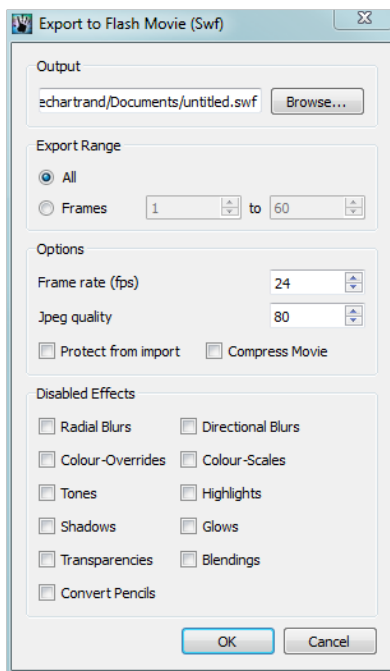

2. To choose an appropriate filename and a destination path where your movie will be saved to, from the dialog box, click **Browse**.
3. From the Export Range section, decide whether you would like to export all the frames of your movie or just a selected frame range. If you decide on the latter, be sure to enter in the frame range in the fields provided.



4. In the Options section, enter your Frames rate (fps) into the field provided. By default, it will be set to match the fps of your Animate project. If you choose a lower frame rate, your export play back will be faster than your actual project. The reverse is also true for a higher frame rate.
5. In the same section, select the **JPEG quality**.

- 100 = full quality
  - 50 = average quality at about 1/5th of the size.
  - 25 = medium quality where loss of high image resolution starts to occur.
  - 10 = low quality where “macro-blocking” or large pixelation become obvious.
  - 1 = lowest quality where there is extreme loss of colour and detail and where the image becomes nearly unrecognizable.
6. If you want to protect your movie to be imported in another application, enable the **Protect from Import** option.
  7. Enable the **Compress Movie** option if you want to get a lighter format. The movie may lose some quality, but in turn create a lighter file.
  8. In the Disabled Effects section, check the boxes of the vector-based effects that you would NOT like to see in the SWF render.  
  
Note that certain Animate effects will not be listed in this section as they are not vector-based and therefore not available for SWF export. These effects will not appear in the SWF render.
  9. In the Disabled Effects section, enable the **Convert Pencils** option to avoid transforming your pencil lines to fills. If this option is enabled, the pencil lines will remain pencil lines.
  10. Press **OK** when you are finished.
  11. Browse to the location on your computer where you saved your Flash Movie and double-click on it to view your export.

## Related Topics

- [Export on page 831](#)

## Exporting an Image Sequence

In Toon Boom Animate you can export your scene as a bitmap image sequence. If you have sound in your scene, the sound will not be exported with the images.

### To render an Image Sequence:

1. Select **File > Export > Images** or press [Ctrl] + [Shift] + [Y] (Windows) or [⌘] + [Shift] + [Y] (Mac OS X). The Export Images dialog box opens.

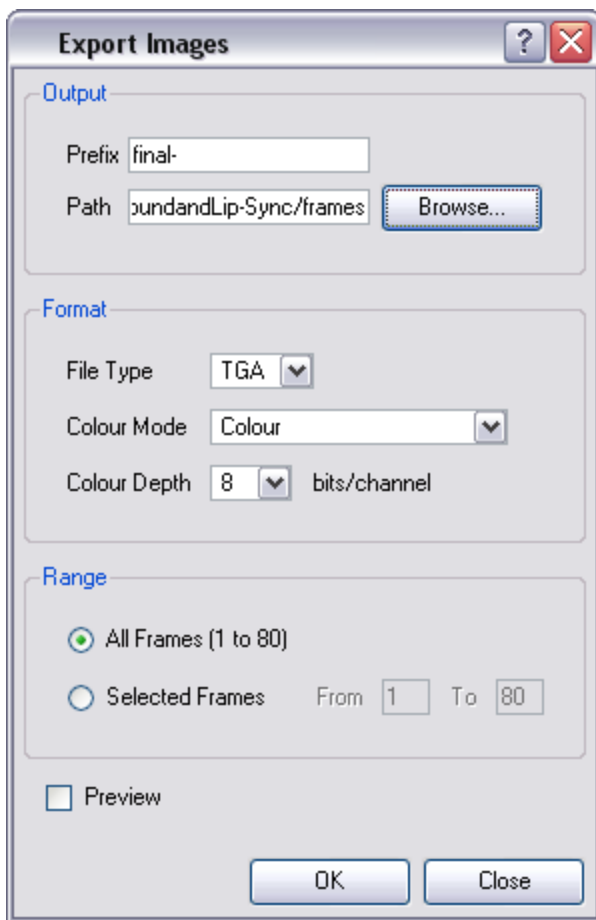

2. In the Output section, choose a prefix. The prefix is the file name. Each image in the sequence will have this name, plus a sequence number, plus the file format extension, for example final-0001.jpg.
3. From the same section, click **Browse** to choose a destination path to where your movie will be saved. The default location is in the file directory's frames folder.

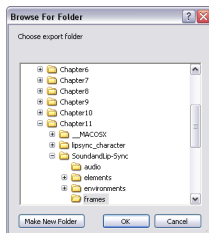

4. In the Format section, choose the File Type, Colour Mode and Colour Depth from their respective drop-down menus.
5. In the Range section, select the Frame Range to render.
  - **All Frames:** Select this option to export the entire scene.
  - **Selected Frames:** Type the first and last frame of the frame range you want to export.
6. Check the Preview box if you wish to see the images being rendered.
7. Click **OK**.

If you checked off the preview box, a generic player opens so you can watch the image sequence strung together as a video. The image sequence is now available in the scene's frames directory. You should be able to preview each frame as an individual image.

## Exporting an Image Sequence with Transparency

If you would like to export images with transparency you need to select the file type that supports this option, such as TGA, PSD or PNG. The Colour Mode menu adjusts according to the File Type selected. For example, selecting TIF will result in only having "Colour" as a Colour Mode option, whereas PNG will have "Colour" and "Colour with Transparency."

**To render out an Image Sequence with transparency:**

1. Bring up the Export Images dialog box and select **Format > Colour Mode > Colour with Transparency** from the drop-down menu.

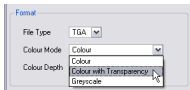

# Export Preferences

In Animate, you will find preferences related to the rendering under the **Render** tab.

To open the Preferences panel:

- ▶ Windows: Select **Edit > Preferences**.
- ▶ Mac OS X: Select **Animate > Preferences**.
- ▶ The [Ctrl] + [U] (Windows) or [⌘] + [U] (Mac OS X).



## Preview Options

- **Enable Blur:** Renders blur effects derived from the Blur-Directional Module, Blur-Radial Module, and the Blur-Variable Module in the Render View window.
- **Enable Line Texture:** Renders line texture in the Render View.

### Related Topics

- [Export on page 831](#)



# Chapter 18: Scripting

Qt Script provides access to many of the functions supported in the interface. With Qt Script, you can automate a number of Animate functions to speed the completion of various repetitive tasks.

To use scripts prepared by other users or for other scenes, you must first export the scripts from the originating scene and then import the scripts into a target scene.

You can add buttons to the Scripting Tools toolbar so that you can access them easily. They will appear to the right of the default Scripting Toolbar buttons.



To find more information about methods and functions for writing your own script, refer to the scripting help included in the software:

- Windows: C:\Program Files (x86)\Toon Boom Animation\Toon Boom Animate 3\help\en\script\index.html
  - Mac OS X: /Applications/Toon Boom Animate 3/Documentation.localized/script/index.html
- 

## Topics Covered

- [Creating a Qt Script on page 1](#)
- [Importing Scripts on page 1](#)
- [Linking a Script to a Toolbar Button on page 1](#)

# Creating a Qt Script

Use the Script Editor to create Qt scripts for Animate.

To create a script:

1. Open the Script Editor window by going to the top menu and selecting **Windows > Script Editor**.

The Script Editor view opens.

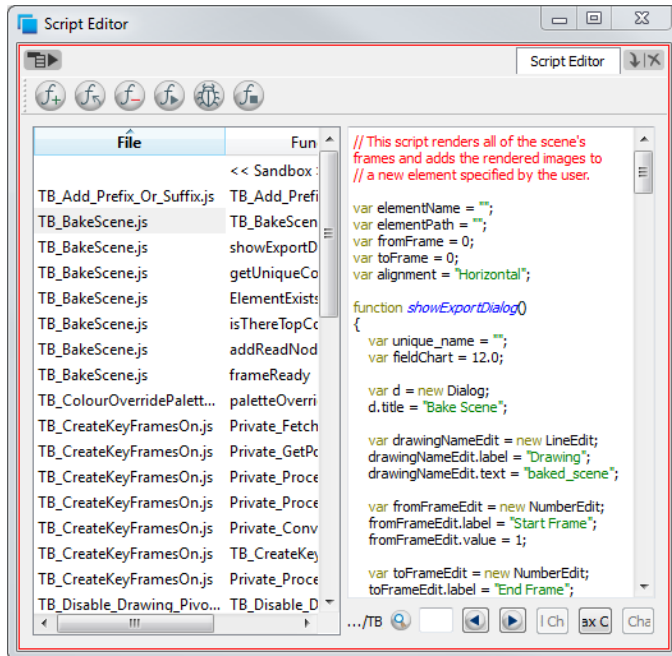

2. From the Script Editor toolbar, click on the **New Script**  button. (If you do not see the Script Editor toolbar, go to the top menu and select **Windows > Toolbars > Script Editor**).

The New Script dialog box appears.

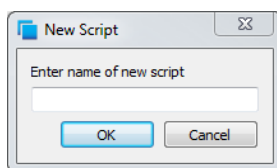

3. Enter a name in the Enter name of new script field, along with the file extension \*.js and click on **OK**.

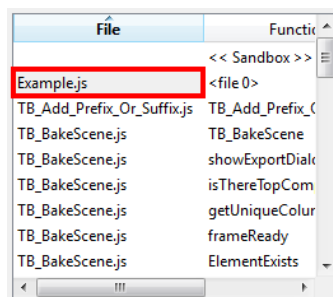

The name of your script appears in the File column of the Script Editor view.



4. Click in the right side of the Script Editor and start writing your script. Try the following script:



```
function add3dPathCol ()
{
column.add ("ColumnName", "3DPATH" );
}
```

5. To test your script, select the function you would like to run from the File column, then, from the Script Editor toolbar, click on the **Run**  button, or from the **View** menu  select **Play/Debug > Run**.
  - ▶ You may receive the message: **Only functions that have been saved or are explicitly called will be executed.** This usually occurs if you did not select the function you wished to run from the File column before running the script. In this case, click on the **Save Changes** button, then try running your script again.
  - ▶ You may also see this message on the right side of the Script Editor:

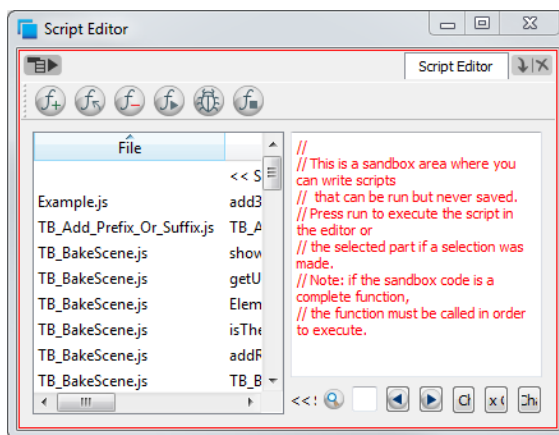

This is because the software jumped to the <<Sandbox>> item in the Function column. The <<Sandbox>> is provided to test scripts without saving them. Simply click on your newly created script and then try running it again.

A new 3Dpath column (or 3 separate x, y and z path columns and a velocity column) will appear in your Xsheet view with the name ColumnName.

#### To delete a script:

1. In the Script Editor, in the File column, select the script that you would like to delete.
2. From the Script Editor toolbar, click on the **Delete Script**  button.

#### To troubleshoot errors in your script:

- **Debug:** Select the function first, then from the Script Editor toolbar, click on the **Debug**  button.

The Qt Script Debugger opens.

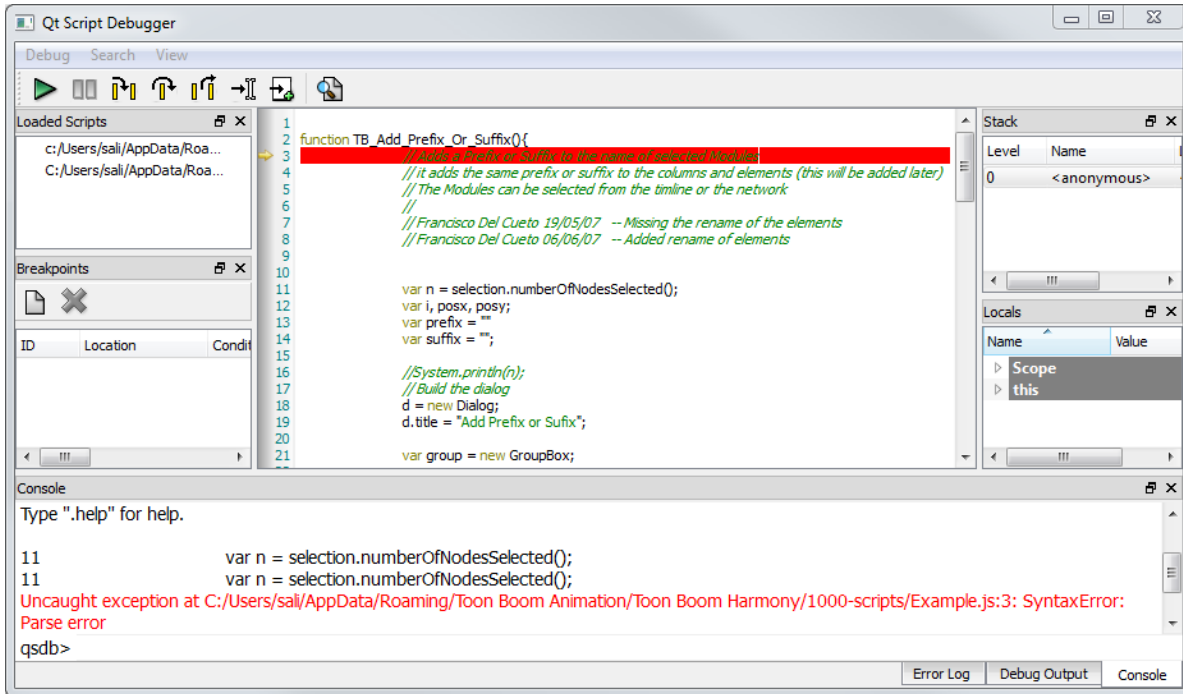

- Syntax Check: Click on the **Syntax Check** button.

A window will pop-up with syntax information.

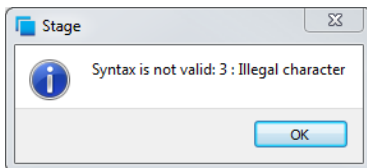

# Importing Scripts

To use scripts prepared by other users, transfer the \*.js files from the computer where the scripts were created to the one that you intend to use. Then use the Script Editor to import the \*.js files from where they are saved on your computer.

Scripts that you have created for one scene or project will be available for all other projects created on the same computer, with no need for any kind of transfer or import.

## To import a script:

1. On the computer that contains the \*.js files, open My Computer (Windows) or Finder (Mac OS X), then follow this path:
  - ▶ Windows: **C:\Program Files (x86)\Toon Boom Animation\Toon Boom Animate 3\resources\scripts**
  - ▶ Mac OS X: **Home > Library > Preferences > Toon Boom Animation > Toon Boom Animate 3 > 1000-scripts**
2. Copy the \*.js files that you would like to transfer to another computer onto a USB key, or use another transfer method of your choice.
3. Transfer and save the \*.js files onto the computer that you intend to use. Be sure that you save them in a logical location. You can save them directly in the locations indicated in Step 1, in which case they will automatically appear in the Script Editor. If for some reason you do not wish to mix them up with the default scripts, save them to a different location and continue following the steps below.
4. Open a new, or existing, scene in Animate.
5. In the Script Editor, click on the **Import Scripts**  button.

A browser window will open and allow you to browse to the location on the server where the \*.js files are saved.

6. Select the \*.js file and click on the **Open** button.

The script is imported and appears in the File list of the Script Editor.

# Linking a Script to a Toolbar Button

You can add buttons to the Scripting Tools toolbar so that you can access them easily. They will appear to the right of the default Scripting Toolbar buttons.

## To link a script to a toolbar button:

1. In the Scripting Tools toolbar, click on the **Manage Scripts**  button.

A dialog box containing all of the available scripts opens.

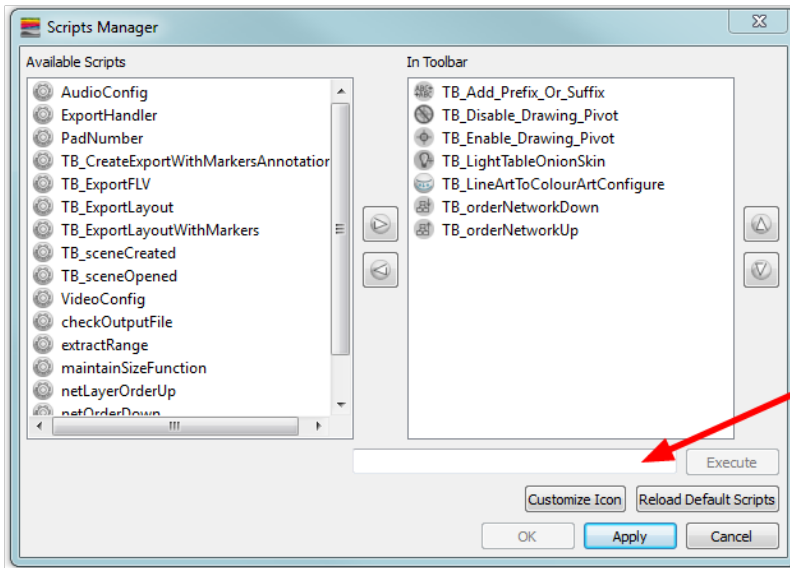

You can select a script from this dialog box and run it immediately by clicking on the Execute button. The field displays the name of the currently selected script.

2. In the Available Scripts list, select the script you want to link to a toolbar button.
3. Click on the **Right Arrow**  button to add the script to the In Toolbar list.
4. Click on **OK** to add the button and close the dialog box.

# Chapter 19: Keyboard Shortcuts for Animate

This document lists default keyboard shortcuts for Animate.



The Animate keyboard shortcuts set is used throughout the Animate documentation.

To use a shortcut, press the key and the character simultaneously. The sign + sign is not part of the sequence. If there is no shortcut allocated to a command it is left blank.

General					
COMMAND	FLASH		Animate		CUSTOM
	Win/Linux	Mac OS X	Win/Linux	Mac OS X	
Add Frame After Selection	Ctrl+H	^+H	Ctrl+H	^+H	
Add Frame At End					
Add Frame At Start					
Add Frame Before Selection	Ctrl+G	⌘+G	Ctrl+G	⌘+G	
Auto Render	Ctrl+Alt+R	⌘+Alt+R	Ctrl+Alt+R	⌘+Alt+R	
Copy	Ctrl+C	⌘+C	Ctrl+C	⌘+C	
Create Empty Drawing	Alt+Shift+R	Alt+Shift+R	Alt+Shift+R	Alt+Shift+R	
Cut	Ctrl+X	⌘+X	Ctrl+X	⌘+X	
Delete	Del	Del	Del	Del	
Delete (secondary key)	Back-space	Back-space	Back-space	Backspace	
Deselect All	Esc	Esc	Esc	Esc	
Duplicate Drawings	Alt+Shift+D	Alt+Shift+D	Alt+Shift+D	Alt+Shift+D	

<b>General</b>					
<b>COMMAND</b>	<b>FLASH</b>		<b>Animate</b>		<b>CUSTOM</b>
	<b>Win/Linux</b>	<b>Mac OS X</b>	<b>Win/Linux</b>	<b>Mac OS X</b>	
Export Layout					
First Frame	Home	Home	<	<	
Free Pan And Zoom	Space	Space	Space	Space	
Go to Next Column	J	J	J	J	
Go to Next Drawing	G	G	G	G	
Go to Previous Column	H	H	H	H	
Go to Previous Drawing	F	F	F	F	
Go to the Eighth Drawing in Drawing View					
Go to the Fifth Drawing in Drawing View					
Go to the First Drawing in Drawing View					
Go to the Fourth Drawing in Drawing View					
Go to the Second Drawing in Drawing View					
Go to the Seventh Drawing in Drawing View					
Go to the Sixth Drawing in Drawing View					
Go to the Tenth Drawing in Drawing View					

General					
COMMAND	FLASH		Animate		CUSTOM
	Win/Linux	Mac OS X	Win/Linux	Mac OS X	
Help	F1	F1	F1	F1	
Import Movie					
Invert Selection	Ctrl+Shift+I	⌘+Shift+I	⌘+Shift+I		
Jog Backward					
Jog Forward					
Last Frame	End	End	>	>	
Look at Selected					
Move Backward					
Move Forward					
New	Ctrl+N	⌘+N	Ctrl+N	⌘+N	
Next Frame	.	.	.	.	
Open	Ctrl+O	⌘+O	Ctrl+O	⌘+O	
Paste	Ctrl+V	⌘+V	Ctrl+V	⌘+V	
Paste Special	Ctrl+Shift+B	⌘+Shift+B	Ctrl+B	⌘+B	
Paste Special Again	Ctrl+Alt+B	⌘+Alt+B	Ctrl+Shift+B	⌘+Shift+B	
Preferences	Ctrl+U	⌘+U	Ctrl+U	⌘+U	
Previous Frame	,	,	,	,	
Quick Close-up	Shift+Z	Shift+Z	Shift+Z	Shift+Z	
Recentre	F12	⌘+F12	N	N	
Redo	Ctrl+Y	⌘+Y	Ctrl+Shift+Z	⌘+Shift+Z	
Rename Drawings	Ctrl+Shift+D	⌘+Shift+D	Ctrl+D	⌘+D	
Rename Drawings with Prefix					

General					
COMMAND	FLASH		Animate		CUSTOM
	Win/Linux	Mac OS X	Win/Linux	Mac OS X	
Render and Play					
Reset Pan	Shift+N	Shift+N	Shift+N	Shift+N	
Reset Rotation	Shift+X	Shift+X	Shift+X	Shift+X	
Reset View	Shift+M	Shift+M	Shift+M	Shift+M	
Reset Zoom					
Rotate View CCW					
Rotate View CW					
Save	Ctrl+S	⌘ +S	Ctrl+S	⌘ +S	
Select All	Ctrl+A	⌘ +A	Ctrl+A	⌘ +A	
Select Child					
Select Next Brother	?	?	?	?	
Select Parent					
Select Previous Brother	/	/	/	/	
Shuttle Backward					
Shuttle Forward					
Shuttle Reset					
Test SWF Movie					
Toggle Editor	Shift+E	Shift+E	Shift+E	Shift+E	
Toggle Full Screen	Ctrl+F	⌘ +F	Ctrl+F	⌘ +F	
Toggle Playback	Return	Return	Shift+Re- turn	Shift+Re- turn	
Toggle Velocity Editor	Shift+V	Shift+V	Shift+V	Shift+V	
Undo	Ctrl+Z	⌘ +Z	Ctrl+Z	⌘ +Z	
Unload Model	Del	Del	Del	Del	
Zoom In	Ctrl+=	⌘ +=	2	2	
Zoom Out	Ctrl+-	⌘ +-	1	1	



<b>Camera</b>					
<b>COMMAND</b>	<b>FLASH</b>		<b>HARMONY</b>		<b>CUSTOM</b>
	<b>Win/Linux</b>	<b>Mac OS X</b>	<b>Win/Linux</b>	<b>Mac OS X</b>	
Add all to Onion Skin	Alt+Shift+O	Alt+Shift+O	Alt+Shift+O	Alt+Shift+O	
Add to Onion Skin	Shift+S	Shift+S	Shift+S	Shift+S	
<b>Animate</b>					
Bitmap Image Quality	Ctrl+Q	^+Q	Ctrl+Q	^+Q	
Camera Show hidden	Alt+Shift+H	Alt+Shift+H	Alt+Shift+H	Alt+Shift+H	
Centre On Selection	Shift+O	Shift+O	Shift+O	Shift+O	
Create Drawing from Drawing Selection	F9	⌘ +F9	F9	⌘ +F9	
Create Symbol	F8	F8	F8	F8	
Distribute to Layers					
Duplicate Symbol					
Enable/Disable Playback	Alt+P	Alt+P	Alt+P	Alt+P	
Enter Selected Symbol	Ctrl+E	⌘ +E	Ctrl+E	⌘ +E	
Expand Symbol	Ctrl+B	⌘ +B	Shift+F8	Shift+F8	
Export Images			Ctrl + Shift + Y	⌘ +Y	

Camera					
COMMAND	FLASH		HARMONY		CUSTOM
	Win/Linux	Mac OS X	Win/Linux	Mac OS X	
Flip Horizontal	4	4	4	4	
Flip Scale X					
Flip Scale Y					
Flip Vertical	5	5	5	5	
Hide All Control Parameters	Shift+C	Shift+C	Shift+C	Shift+C	
Insert Control Point	P	P	P	P	
Insert Keyframe	Ctrl+F6	⌘ +F6	F6	F6	
Insert Keyframe and Duplicate Drawings	F6	F6			
Insert Position Keyframe					
Inverse Kinematics Tool	Alt+8	Alt+8	Shift+I	Shift+I	
Lock All	Ctrl+Shift+L	⌘ +Shift+L	Ctrl+Shift+L	⌘ +Shift+L	
Lock All Others	Ctrl+Alt+Shift+O	⌘ +Alt+Shift+O	Ctrl+Alt+Shift+O	⌘ +Alt+Shift+O	
Lock Selection	Ctrl+Alt+L	⌘ +Alt+L	Ctrl+Alt+L	⌘ +Alt+L	
Maintain Size Tool	Alt+6	Alt+6	Alt+6	Alt+6	
Remove all	Ctrl+Shift+	⌘ +Shift+	Ctrl+Shift+	⌘ +Shift+	

Camera					
COMMAND	FLASH		HARMONY		CUSTOM
	Win/Linux	Mac OS X	Win/Linux	Mac OS X	
Onion Skin	O	O	O	O	
Remove Selection from Onion Skin					
Remove Unselected from Onion Skin					
Reset All Transformations	Ctrl+Alt+Z	⌘+Alt+Z	Shift+R	Shift+R	
Reset Transformation	Ctrl+Shift+Z	⌘+Shift+Z	R	R	
Return To Parent Symbol	Ctrl+Shift+E	⌘+Shift+E	Ctrl+Shift+E	⌘+Shift+E	
Rotate Tool	Alt+3	Alt+3	Alt+3	Alt+3	
Scale Tool	Alt+4	Alt+4	Alt+4	Alt+4	
Select Control Point	T	T	T	T	
Select Next Control Point	'	'	'	'	
Select Previous Control Point	;	;	;	;	
Show/Hide Control Parameters	Shift+F11	⌘+F11	Shift+F11	⌘+F11	
Show/Hide					

Camera					
COMMAND	FLASH		HARMONY		CUSTOM
	Win/Linux	Mac OS X	Win/Linux	Mac OS X	
Transform Tool Controls					
Skew Tool	Alt+5	Alt+5	Alt+5	Alt+5	
Spline Offset Tool	Alt+9	Alt+9	Alt+8	Alt+8	
Substitute Drawing Next	]	]	]	]	
Substitute Drawing Prev	[	[	[	[	
Toggle Between Line and Curve					
Toggle Lock In Time	Alt+L	Alt+L	Alt+L	Alt+L	
Transform Tool	Alt+Q	Alt+Q	Shift+T	Shift+T	
Translate Tool	Alt+2	Alt+2	Alt+2	Alt+2	
Unlock All	Ctrl+Alt+Shift+L	⌘+Alt+Shift+L	Ctrl+Alt+Shift+L	⌘+Alt+Shift+L	
Unlock Selection	Ctrl+Shift+K	⌘+Shift+K	Ctrl+Shift+K	⌘+Shift+K	
Timeline					
COMMAND	FLASH		HARMONY		CUSTOM
	Win/Linux	Mac OS X	Win/Linux	Mac OS X	
Centre On	○	○	○	○	

Timeline					
COMMAND	FLASH		HARMONY		CUSTOM
	Win/Linux	Mac OS X	Win/Linux	Mac OS X	
Selection					
Clear Exposure					
Clear Exposure and Pull	Z	Z	Z	Z	
Collapse All Layers	0	0	0	0	
Collapse or Expand an Layer	Ctrl+I	⌘+I	Ctrl+I	⌘+I	
Convert Morphing to Drawings					
Create Morphing	Alt+M	Alt+M	Alt+M	Alt+M	
Decrease Exposure					
Delete Keyframe	Shift+F6	Shift+F6	F7	F7	
Delete Morphing					
Disable All Other Layers					
Disable Layers	D	D	D	D	
Enable All Elements					
Enable Layers	A	A	A	A	
Expand All Layers	9	9	9	9	

Timeline					
COMMAND	FLASH		HARMONY		CUSTOM
	Win/Linux	Mac OS X	Win/Linux	Mac OS X	
Extend Exposure	F5	F5	F5	F5	
Flip Horizontal					
Flip Vertical					
Go to Next Global Frame	Alt+.	Alt+.	Ctrl+Shift+C	⌘ +Shift+C	
Go to Next Keyframe	'	'	'	'	
Go to Previous Global Frame	Alt+,	Alt+,	Ctrl+Shift+X	⌘ +Shift+X	
Go to Previous Keyframe	;	;	;	;	
Insert Blank Frame	X	X	Shift+J	Shift+J	
Insert Camera					
Insert Drawing	Ctrl+R	⌘ +R	Ctrl+R	⌘ +R	
Insert Group	Alt+G	Alt+G	Alt+G	Alt+G	
Insert Keyframe	Ctrl+F6	⌘ +F6	F6	F6	
Insert Keyframe and Duplicate Drawings	F6	F6			
Insert Peg	Ctrl+P	⌘ +P	Ctrl+P	⌘ +P	
Insert					

Timeline					
COMMAND	FLASH		HARMONY		CUSTOM
	Win/Linux	Mac OS X	Win/Linux	Mac OS X	
Quadmap					
Insert Sound					
Lock All			Ctrl+Shift+L	⌘ +Shift+L	
Lock All Others			Ctrl+Alt+Shift+O	⌘ +Alt+Shift+O	
Lock Selection			Ctrl+Alt+L	⌘ +Alt+L	
Paste Cycle	Ctrl+/,	⌘ +/,	Ctrl+/,	⌘ +/,	
Paste mode: Cycle through presets					
Paste mode: Set all					
Paste mode: Set exposures only					
Paste mode: Set key frames only					
Paste Reverse	Ctrl+.	⌘ +.	Ctrl+.	⌘ +.	
Select Children					
Set Exposure					
Set Exposure to 1					

Timeline					
COMMAND	FLASH		HARMONY		CUSTOM
	Win/Linux	Mac OS X	Win/Linux	Mac OS X	
Set Exposure to 2					
Set Exposure to 3					
Set Motion Keyframe	Ctrl+K	⌘+K	Ctrl+K	⌘+K	
Set Stop-Motion Keyframe	Ctrl+L	⌘+L	Ctrl+L	⌘+L	
Show/Hide Functions	Alt+F	Alt+F	Alt+F	Alt+F	
Substitute Drawing Next	]	]	]	]	
Substitute Drawing Previous	[	[	[	[	
Unlock All			Ctrl+Alt+Shift+L	⌘+Alt+Shift+L	
Unlock Selection			Ctrl+Shift+K	⌘+Shift+K	

Xsheet					
COMMAND	FLASH		HARMONY		CUSTOM
	Win/Linux	Mac OS X	Win/Linux	Mac OS X	
Add Columns	Shift+C	Shift+C	Shift+C	Shift+C	
Add Drawing Column	Ctrl+R	⌘+R	Ctrl+R	⌘+R	



<b>Xsheet</b>					
<b>COMMAND</b>	<b>FLASH</b>		<b>HARMONY</b>		<b>CUSTOM</b>
	<b>Win/Linux</b>	<b>Mac OS X</b>	<b>Win/Linux</b>	<b>Mac OS X</b>	
Clear Exposure and Pull	Z	Z	Z	Z	
Clear Selected Cells					
Clone Selected Columns					
Collapse					
Collapse All	0	0	0	0	
Decrease Exposure	-	-	-	-	
Delete Selected Columns					
Delete Selected Drawings					
Duplicate Selected Columns	Ctrl+D	⌘ +D			
Enable/Disable Playback					
Expand					
Expand All	9	9	9	9	
Fill Randomly					
Fill Selection	Ctrl+T	⌘ +T	Ctrl+T	⌘ +T	
Gestural Drag Mode					
Hide Selected Column	Alt+H	Alt+H	Alt+H	Alt+H	
Increase Exposure	+	+	+	+	
Insert Blank Cell	X	X	Shift+J	Shift+J	
Insert Keyframe	Ctrl+F6	⌘ +F6	F6	F6	

**Xsheet**

COMMAND	FLASH		HARMONY		CUSTOM
	Win/Linux	Mac OS X	Win/Linux	Mac OS X	
Insert/Overwrite Mode	I	I	I	I	
Mark As Breakdown					
Mark As In-between					
Mark As Key					
Paste Cycle	Ctrl+/,	⌘ +/,	Ctrl+/,	⌘ +/,	
Paste Reverse	Ctrl+.	⌘ +.	Ctrl+.	⌘ +.	
Remove Frames					
Sequence Fill	Ctrl+M	⌘ +M	Ctrl+M	⌘ +M	
Set Custom Hold Cell					
Set Custom Hold 1 Cell	Ctrl+1	⌘ +1	Ctrl+1	⌘ +1	
Set Custom Hold 2 Cells	Ctrl+2	⌘ +2	Ctrl+2	⌘ +2	
Set Custom Hold 3 Cells	Ctrl+3	⌘ +3	Ctrl+3	⌘ +3	
Set Custom Hold 4 Cells	Ctrl+4	⌘ +4	Ctrl+4	⌘ +4	
Show Column Types					
Show Hidden Columns	Alt+Shift+H	Alt+Shift+H	Alt+Shift+H	Alt+Shift+H	
Thumbnails					
Zoom Extents					

Drawing Mode					
COMMAND	FLASH		HARMONY		CUSTOM
	Win/Linux	Mac OS X	Win/Linux	Mac OS X	
Activate Magnifier					
Apply Tool to All Drawings	Ctrl+Alt+A	⌘+Alt+A	Alt+A		Alt+A
Auto-Create Colour Art from Brush	Shift+F2	Shift+F2	Shift+F2		Shift+F2
Apply Tool to Line and Colour Art			Shift + Q		⌘ + Q
Auto-Matte					
Automatically Fill Inside Regions	Ctrl+Shift+R	⌘+Shift+R	Ctrl+Shift+R		⌘+Shift+R
Bring Forward	Ctrl+Up	⌘+Up	Ctrl+PgUp		⌘+PgUp
Bring To Front	Ctrl+Shift+Up	⌘+Shift+Up	Ctrl+Shift+PgUp		⌘+Shift+PgUp
Brush Tool			Alt+B		Alt+B
Brush Tool (General)	Alt+B	Alt+B			
Close Gap Tool	Alt+C	Alt+C	Alt+C		Alt+C
Contour Editor Tool	Alt+A	Alt+A	Alt+Q		Alt+Q
Convert Brush Strokes to Pencil Lines	^	^	^		^
Convert Pencil Lines	&	&	&		&

Drawing Mode					
COMMAND	FLASH		HARMONY		CUSTOM
	Win/Linux	Mac OS X	Win/Linux	Mac OS X	
to Brush Strokes					
Convert Strokes to Pencil Lines	Shift+F12		Shift+F12		
Create Breaking Triangles					
Create Colour Art from Line Art	*	*	*	*	
Crop Brush Textures					
Cutter Tool			Alt+T	Alt+T	
Decrement Brush Size			Shift+ P	⌘ +P	
Delete All Morphing Hints	Shift+Del	Shift+Del	Shift+Del	Shift+Del	
Drawing Pivot Tool			Shift + P		
Dropper Tool	Alt+I	Alt+I	Alt+D	Alt+D	
Edit Texture/Gradient Tool	Shift+F3	Shift+F3	Shift+F3	Shift+F3	
Ellipse Tool	Alt+O	Alt+O	Alt+=	Alt+=	
Enable Morphing Pencil Hint Mode					
Eraser Tool	Alt+E	Alt+E	Alt+E	Alt+E	
First Frame					

Drawing Mode					
COMMAND	FLASH		HARMONY		CUSTOM
	Win/Linux	Mac OS X	Win/Linux	Mac OS X	
Flatten	Alt+Shift+F	Alt+Shift+F	Alt+Shift+F	Alt+Shift+F	
Flatten and Remove Extra Strokes	Ctrl+Shift+F	⌘+Shift+F	Ctrl+Shift+F	⌘+Shift+F	
Flatten Latest	F2	F2	F2	F2	
Flip Horizontal					
Flip Vertical					
Go to Next Morphing Frame					
Go to Previous Morphing Frame					
Group	Ctrl+G	⌘+G	Ctrl+G	⌘+G	
Hand Tool					
Increment Brush Size					
Ink Tool					
Join Pencil Lines			Alt + Shift + J	Alt + Shift + J	
Light Table	Shift+L	Shift+L	Shift+L	Shift+L	
Line Tool	Alt+N	Alt+N	Alt+\	Alt+\	
Merge Pencil Lines					
Morphing Tool	F3	F3	F3	F3	
Onion Skin: 1 Next	Ctrl+1	⌘+1	Ctrl+1	⌘+1	

---

**Drawing Mode**

---

COMMAND	FLASH		HARMONY		CUSTOM
	Win/Linux	Mac OS X	Win/Linux	Mac OS X	
Onion Skin: 1 Previous	!	!	!	!	
Onion Skin: 2 Next	Ctrl+2	⌘ +2	Ctrl+2	⌘ +2	
Onion Skin: 2 Previous	@	@	@	@	
Onion Skin: 3 Next	Ctrl+3	⌘ +3	Ctrl+3	⌘ +3	
Onion Skin: 3 Previous	#	#	#	#	
Onion Skin: Add 1 next					
Onion Skin: Add 1 Previous					
Onion Skin: No Next	Ctrl+`	⌘ +`	Ctrl+`	⌘ +`	
Onion Skin: No Previous	~	~	~	~	
Onion Skin: Reduce 1 Next					
Onion Skin: Reduce 1 Previous					
Optimize	Ctrl+Alt+S hift+C	⌘ +Alt+S hift+C	Ctrl+Alt+Shif t+C	⌘ +Alt+Shif t+C	
Paint and Remove Texture	Ctrl+Shift+ F6	⌘ +Shift+ F6	Shift+F6	Shift+F6	
Paint Tool			Alt+l	Alt+l	
Paint Tool (General)	Alt+K	Alt+K			

---

Drawing Mode					
COMMAND	FLASH		HARMONY		CUSTOM
	Win/Linux	Mac OS X	Win/Linux	Mac OS X	
Paint Unpainted Tool			Alt+Y	Alt+Y	
Pencil Editor Tool			Alt+W	Alt+W	
Pencil Tool	Alt+Y	Alt+Y	Alt+/ Alt+Y	Alt+/ Alt+Y	
Permanent Selection	Ctrl+Shift+P	⌘+Shift+P	Ctrl+Shift+P	⌘+Shift+P	
Perspective Tool	Alt+0	Alt+0	Alt+0	Alt+0	
Polyline Tool	Alt+P	Alt+P	Alt+_	Alt+_	
Preview Line and Colour Arts	Shift+P	Shift+P	P	P	
Real-Time Antialiasing	Ctrl+Alt+S Shift+A	⌘+Alt+S Shift+A	Ctrl+Alt+A	⌘+Alt+A	
Rectangle Tool	Alt+R	Alt+R	Alt+7	Alt+7	
Reduce Drawing Texture Resolution					
Remove Selected Drawing					
Repaint Brush Tool			Alt+X	Alt+X	
Repaint Tool			Alt+R	Alt+R	
Resize Pencil Style Tool	○	○	○	○	
Rotate 180					

Drawing Mode					
COMMAND	FLASH		HARMONY		CUSTOM
	Win/Linux	Mac OS X	Win/Linux	Mac OS X	
Rotate 90 CCW	Ctrl+7	⌘ +7	Ctrl+7	⌘ +7	
Rotate 90 CW	Ctrl+9	⌘ +9	Ctrl+9	⌘ +9	
Rotate View Tool					
Select Delete Morphing Hint Mode	Del	Del	Del	Del	
Select Morphing Appearing Point Mode					
Select Morphing Contour Hint Mode	Ctrl+Shift+ H	⌘ +Shift+ H	F7	F7	
Select Morphing Vanishing Point Mode	F10		F10		
Select Morphing Zone Hint Mode					
Select Strokes With Current Colour	Ctrl+Shift+ A	⌘ +Shift+ A	Ctrl+Shift+A	⌘ +Shift+A	
Select Tool	Alt+V	Alt+V	Alt+S	Alt+S	
Send Backward	Ctrl+Down	⌘ +Down	Ctrl+PgDow n	⌘ +PgDow n	
Send To	Ctrl+Shift+ P	⌘ +Shift+ P	Ctrl+Shift+P	⌘ +Shift+P	



Drawing Mode					
COMMAND	FLASH		HARMONY		CUSTOM
	Win/Linux	Mac OS X	Win/Linux	Mac OS X	
Back	Down	Down	gDown	gDown	
Shift Trace Drawing Move Down					
Shift Trace Drawing Move Up					
Shift Trace Drawing Reset Position					
Shift Trace Drawing Toggle Peg State					
Shift Trace Drawing Toggle Visibility					
Shift Trace Move Tool					
Shift Trace Rotate Tool					
Shift Trace Scale Tool					
Shift Trace Toggle Manipulato r					
Shift Trace Toggle View					
Show Grid	Ctrl+'	⌘ +'	Ctrl+'	⌘ +'	
Show Grid	Ctrl+Alt+	⌘ +Alt+G			

Drawing Mode					
COMMAND	FLASH		HARMONY		CUSTOM
	Win/Linux	Mac OS X	Win/Linux	Mac OS X	
Outline Only	G				
Show Other Morphing Key Drawing	=	=	Ctrl+Shift+M	⌘ +Shift+M	
Show Strokes	D	D	K	K	
Show Symbol Pivot					
Show/Hide Contour Editor Controls	Alt+F5	Alt+F5	Alt+F5	Alt+F5	
Show/Hide Onion Skin	Ctrl+Alt+O	⌘ +Alt+O	Alt+O	Alt+O	
Smooth Editor Tool	Alt+Shift+S	Alt+Shift+S	Alt+Shift+S	Alt+Shift+S	
Snap and Align	Ctrl+Alt+,	⌘ +Alt+,	Ctrl+Alt+,	⌘ +Alt+,	
Snap to Contour	Ctrl+Alt+;	⌘ +Alt+;	Ctrl+Alt+;	⌘ +Alt+;	
Snap to Grid	Ctrl+Alt+'	⌘ +Alt+'	Ctrl+Alt+'	⌘ +Alt+'	
Split Pencil Line			Alt + Shift + K	Alt + Shift + K	
Stroke Tool	Alt+V	Alt+V	Alt+V	Alt+V	
Suggest Morphing Hints					

**Drawing Mode**

COMMAND	FLASH		HARMONY		CUSTOM
	Win/Linux	Mac OS X	Win/Linux	Mac OS X	
Switch to Line Art/Colour Art	L	L	L	L	
Text Tool	Alt+T	Alt+T	Alt+9	Alt+9	
Toggle Backlight	Ctrl+Shift+C	⌘+Shift+C	Alt+Shift+B	Alt+Shift+B	
Toggle Line Building Mode					
Toggle Morphing Key Drawings	F4	F4	F4	F4	
Toggle Protect Colours	Shift+S	Shift+S	Shift+S	Shift+S	
Ungroup	Ctrl+Shift+G	⌘+Shift+G	Ctrl+Shift+G	⌘+Shift+G	
Unpaint Tool			Alt+U	Alt+U	
Zoom Tool	Alt+Z	Alt+Z	Alt+Z	Alt+Z	

**Function Editor**

COMMAND	FLASH		HARMONY		CUSTOM
	Win/Linux	Mac OS X	Win/Linux	Mac OS X	
Edit Next Function	PgDown	PgDown	PgDown	PgDown	
Edit Previous Function	PgUp	PgUp	PgUp	PgUp	
Insert Point					

**Function Editor**

COMMAND	FLASH		HARMONY		CUSTOM
	Win/Linux	Mac OS X	Win/Linux	Mac OS X	
Lock/Unlock Point					
Select Left Handle	[	[	[	[	
Select Right Handle	]	]	]	]	
Toggle Grid	G	G	G	G	
Toggle Stop-Motion Segment	S	S	S	S	
Zoom In X	4	4	4	4	
Zoom In Y	6	6	6	6	
Zoom Out X	3	3	3	3	
Zoom Out Y	5	5	5	5	

**Library**

COMMAND	FLASH		HARMONY		CUSTOM
	Win/Linux	Mac OS X	Win/Linux	Mac OS X	
Details					
List					
Refresh	F5	F5	F5	F5	
Rename					
Thumbnails					

---

### Tagging

---

COMMAND	FLASH		HARMONY		CUSTOM
	Win/Linux	Mac OS X	Win/Linux	Mac OS X	

---

Tag Selection

---

Untag All

---

Untag All Others

---

Untag Selection

---



---

### Deformation

---

COMMAND	FLASH		HARMONY		CUSTOM
	Win/Linux	Mac OS X	Win/Linux	Mac OS X	

---

Add Articulation  
Module

---

Add Bone  
Module

---

Add Curve  
Module

---

Add  
Deformation  
Composite  
Module

---

Add Offset  
Module

---

Add Root  
Module

---

Convert Elliptic  
ROI to Shape

---

Show Current  
Deformers

---

---

**Particle**

---

**COMMAND****FLASH****HARMONY****CUSTOM**

---

Win/Linux

Mac OS X

Win/Linux

Mac OS X

---

Show Particles as  
Dots

---

---

# Index

---

## About

scripting 843

## Add

Create Drawing From Drawing Selection 589

## Adding

Add Colour 84

Add Drawing Layer 75

Add Layers 74

Add Peg 75

Adding a New View 90

Hierarchy 572, 577

Keyframe 576

Peg 571

Pivot 582

Pivot on Frame Range 603

## adjusting

Pencil Line Thickness 175

## Animation

Advanced Animation Toolbar 62

## Axis

Default Separate Position 554

Z axis 563

## Breakdown

Adding to Existing Layer 595

## Brush

Auto-flatten 599

Flatten 599

Set Current Brush Colour 85

## brush styles

renaming 152

## Camera

Camera View 64

Camera View Options Menu 67

Drawing Name 70

- Editing Stack Menu 70
- Frame Number 70
- Matte View Mode 67
- OpenGL View Mode 66
- Render View Mode 66
- Toggle Quick Close-Up 69
- Tool Name 70
- Update Preview 65
- Zoom Drop-down Menu 69
- Camera View Toolbar 63
- Symbol Hierarchy 569
- Camera View 64
- Character
  - Breakdown 556, 592
    - Extra View 595
  - Building a Character 553
  - Classic Joint 560
  - Fixing Joint 560
  - Joint 597
- Clean Up
  - Cut-out Puppet 598
  - Remove Extra Strokes 561, 600
- Close
  - Closing a View 91
- Colour
  - Colour View 83
    - Add Colour 84
    - Add Texture 85
    - Colour Swatch 86
    - Colour Swatch Name 86
    - Colour View Menu 87
    - Link/Unlink Three Colours 85
    - Remove Colour 84
    - Set Current Brush Colour 85
    - Set Current Paint Colour 85
    - set Current Pencil Colour 85



---

Show/Hide Palette List View 86

Current View Border 107

Current View Border in Template Edit 107

#### Colours

Camera 108

Drawing 108

Edit Colours Button 107

Exposure Sheet 108

Network 108

#### Contour

Show Stroke 561, 600

#### Control Point

Control Point Toolbar 62

#### convert

pencil to brush 171

#### Coordinate

Coordinate Toolbar 62

#### Copying

Copying Pivot on Parent Symbol 232

Duplicate Drawing 580

#### creating

Qt scripts 844

#### Cut-out

Breakdown 589, 592

Building a Character 553

Classic Joint 560

Fixing Joint 560

Master Template 586

Separate Position Path 554

#### Cutting

Breakdown 589

Create Drawing From Drawing Selection 593, 596

Cut-out Piece Clean Up 598

Cut Artwork From Source 591, 596

Cutter Tool 590, 592, 595

Intersection 593

## Delete

Colour View 84

Delete Layers 74

Remove Extra Strokes 561

## Deleting

Deleting a Workspace 101

## Disable

Enable/Disable All 73

## Display

Display Toolbar 62

Distribute to Layer 173

## Drawing

Adding to Existing Layer 595

Brush Styles

renaming 152

Create Drawing From Drawing Selection 589, 593, 596

Cut Artwork From Source 596

Drawing Exposure 80

Drawing Substitution 79

Drawing View 62

Drawing View Toolbar 63

Duplicate Drawing 580

Extra Drawing 579

Pivot 581, 603

preview

brush line 137, 148, 179, 201

Drawing View 115

## Editing

Edit Colours Button 107

Edit Toolbar 62

Editing Stack Menu 70

## Enable

Enable/Disable All 73

## export

scripts 847

Exporting and Importing Scripts 847

---

---

  
File

FileToolbar 62

## Flatten 580

Auto-flatten 599

Brush Tool 599

Remove Extra Strokes 600

## Flip

Flip Toolbar 62

## Focus

Focus on Mouse Enter 106

## Frame

Current Frame 76

Pivot on Frame Range 603

Set the Pivot for Symbol on All Frames 231, 602

## Function

Function View 62

Show/Hide Functions 76

## Hide

Show Selection and Hide All Others 74

Show/Hide Children 76

Show/Hide Functions 76

Show/Hide Palette List View 86

Showing and Hiding a Workspace 101

Showing or Hiding Toolbars 94

## Hierarchy 567, 572, 577

Advanced 569

Parent Layer 567-568

## import

scripts 847

## Interface 61

Advanced Animation Toolbar 62

Camera View Toolbar 63

Colour View 83

Control Point Toolbar 62

Coordinate Toolbar 62

Creating a New Workspace 99

- Deleting a Workspace 101
- Display Toolbar 62
- Drawing Name 70
- Drawing View 62
- Drawing View Toolbar 63
- Easy Flipping Toolbar 62
- Edit Toolbar 62
- File Toolbar 62
- Flat Tool Toolbar Preference 95
- Flip Toolbar 62
- Function View 62
- Integrated Help 62
- Interface Navigation 103
- Keyboard Shortcuts 57
- Layer Properties View 62
- Library View 62, 87
- Managing the Toolbars 94
  - Moving Toolbars 95
  - Showing or Hiding Toolbars 94
- Managing the Views 90
  - Adding a New View 90
  - Closing a View 91
  - Resizing a View 92
  - Swapping Views 91
- Managing the Workspace 98
  - Loading the Workspace 98
- Menu 81
- Message Log 62
- Model View 62
- Model View Toolbar 63
- Module Library View 62
- Network View 62
- New Mark Drawing Toolbar 63
- Onion Skin Toolbar 62
- Perspective View 62
- Playback Toolbar 62, 88

- 
- Preferences 55
  - Reordering the Workspace List 102
  - Restoring the Default Workspaces 102
  - Saving a Workspace 100
  - Scripting Toolbar 62
  - Showing and Hiding a Workspace 101
  - Side View 62
  - Side View Toolbar 63
  - Timeline View 62, 72
  - Timeline View Toolbar 63
  - Tool Properties View 62, 71
  - Toolbar 62
  - Toolbar Manager 96
  - Tools Toolbar 62, 71
  - User Interface Preferences - General Tab 105
  - View 62
  - Workspace Toolbar 62
  - Xsheet View 62
- Intersection
- Cutter Tool 593
- Joint 597
- Classic 560
  - Fixing 560
  - Light Table 561
- Keyboard Shortcut
- Reset Pan 103
  - Reset Rotation 103
  - Reset View 103
  - Reset Zoom 103
  - Rotate 90 CW 103
  - To Recentre the View 103
  - Toggle Full Screen 103
  - Zoom In 103
  - Zoom Out 103
- Keyboard Shortcuts
- Selecting a Keyboard Shortcut Set 58

## Keyframe

Default Separate Position 554

Keyframe Value 79

Motion Keyframe 554

Rigging 576

Timeline View 80

Z-nudging 564

## Layer

Add Drawing layer 75

Add Layers 74

Adding to Existing Layer 595

Create Drawing From Drawing Selection 593, 596

Cut Artwork From Source 591, 596

Delete Layer 74

Distribute to Layer 600

Layer Properties View 62

Lock 592

Lock/Unlock Layer 77

Ordering 563

Parent Layer 567-568

Z-nudging 564

## Library

Library View 62, 87

Library Folder List 88

Library View Menu 88

Preview Playback 88

Template/Symbol List 88

Library View Menu 88

Preview Menu 88

Master Template 586

Puppet 586

## Light Table

Classic Joint 561

## line texture parameters

Hardness 156

Maximum Opacity 156

- 
- Minimum Opacity 156
  - Texture File 156
  - Texture Scale 157
  - Link
    - Link/Unlink Three Colours 85
  - Linking a Script to a Toolbar Button 847
  - Loading
    - Loading a Workspace 98
  - Lock
    - Lock/Unlock Layer 77
  - Locking 592
  - Matte
    - Matte View Mode 67
  - Menu 81
    - Editing Stack Menu 70
    - Library View Menu 88
    - Play Menu 89
    - Quick Access Menu 82
    - Top Menu 81
  - Mode
    - Lasso Selection Mode 590
  - Model
    - Cut-out Model 589
    - Model View 62
    - Model View Toolbar 63
    - Tracing the Cut-out Model 556
  - Module
    - Module Library View 62
  - Motion
    - Keyframe 554
  - Naming
    - Colour Swatch Name 86
  - Navigation
    - Interface Navigation 103
  - Network
    - Network View 62

Onion Skin 78

    Onion Skin Toolbar 62

Open

    Workspace Manager 98

OpenGL

    Full Scene Antialiasing Preference in the OpenGL tab 109

    OpenGL View Mode 66

Ordering

    Layer 563

    Z-nudging 564

Overlay

    Classic Joint 560

Paint

    Set Current Paint Colour 85

Palette

    Show/Hide Palette List View 86

Parameter

    Set Current Paint Colour 85

    Set Current Pencil Colour 85

Parameters

    Set Current Brush Colour 85

Path

    Separate Position 554

Peg

    Adding 571

    Master Peg 567, 571, 575

    Master Peg Pivot 584

    Rigging 569

Pencil

    Set Current Pencil Colour 85

Pencil to Brush

    convert 171

Pencil Tool options

    smoothness 136

Perspective

    Perspective View 62



---

## Pivot

- Copying Pivot on Parent Symbol 232
- Drawing Pivot 581, 603
- Frame Range 603
- Master Peg 584
- Pivot Tool 231
- Rigging 581-582
- Rotate Tool 584
- Scale Tool 584
- Set the Pivot for Symbol on All Frames 231, 602
- Snapping 232
- Symbol 601
- Symbol Pivot 581
- Temporary 584

## Playback

- Playback toolbar 62
- Playback Toolbar 88
  - Play Menu 89
- Preview Playback 88

## Preference

- Advanced 56
- Camera 56
- Deformation 56
- Drawing 56
- Exposure Sheet 56
- Full Scene Antialiasing Preference in the OpenGL tab 109
- General 56
- Interface 55
- Network 56
- OpenGL 56
- Particle 56
- Preference Highlights 56
  - Accessing the Preferences Panel 56
  - Automatically Save Workspace 105
  - Flat Tool Toolbar 106
  - Focus on Mouse Enter 106

Levels of Undo 107

User Interface Preferences - General Tab 105

Render 56

Shortcuts 56

Sound 56

Template 56

Timeline 56

User Interface Preferences - General Tab 109

Zoom Settings 109

## Preferences

Separate Position 554

## Preview

Preview Playback 88

Preview Window 88

Update Preview 65

## Properties

Lasso 590

Tool Properties View 71

## Puppet

Breakdown 556, 589, 592

Extra View 595

Building a Character 553

Classic Joint 560

Extra Drawing 579

Fixing Joint 560

Joint 597

Layer Ordering 563

Library 586

Master Peg 575

Rigging 556

Z-nudging 564

## Qt scripts

creating 844

## renaming

brush styles 152

---

## Renaming

Renaming a Workspace 100

## Rigging 556, 566

Advanced 569

Basics 567

Body 571

Breakdown 589, 592, 596

Extra View 595

Building a Character 553

Clean Up 598

Cutting 592

Distribute to Layer 600

Extra Drawing 579

Head 570

Hierarchy 572, 577

Keyframe 576

Master Peg 567, 571, 575

Master Peg Pivot 584

Master Template 586

Peg 569

Pivot 581-582

Pivot on Frame Range 603

Tracing the Cut-out Model 556

## Rotate 90 CCW 103

## Rotation

Arm Rotation 567

Pivot 581-582

Rotate Tool 584

Set the Pivot for Symbol on All Frames 602

## Scaling

Scale Tool 584

## script

link to toolbar button 847

## scripting

about 843

## Scripting

Scripting Toolbar 62

## Selecting

Create Drawing From Drawing Selection 589, 593, 596

Distribute to Layer 600

Flatten 599

Lasso Selection Mode 590

Select Tool 590

Selecting a Keyboard Shortcut Set 58

Show Selection and Hide All Others 74

## Show

Show Selection and Hide All Others 74

Show Stroke 600

Show Strokes 561

Show/Hide Children 76

Show/Hide Functions 76

Show/Hide Palette List View 86

Showing and Hiding a Workspace 101

Showing or Hiding Toolbars 94

## Smoothness

Pencil tool option 136

## Snapping

Pivot 232

## Stage

Stage Library 88

## Stroke

Remove Extra Strokes 561, 600

Show Stroke 600

Show Strokes 561

## Swatch

Colour Swatch 86

Colour Swatch Name 86

## Symbol 88

Copying Pivot on Parent Symbol 232

Pivot 581, 601

Set the Pivot for Symbol on All Frames 231, 602

---

Symbol Exposure 80

Template/Symbol List 88

## Symbols

Hierarchy 569

## Template

Current View Border in Template Edit 107

Master Template 586

Template/Symbol List 88

## Texture

Add Texture 85

## Timeline

Collapse 576

Ordering 563

Timeline View 62, 72

Add Drawing layer 75

Add Layers 74

Add Peg 75

Change track Colour 77

Current Drawing Displayed in the Drawing View 75

Current Frame 76

Delete Layers 74

Drawing Exposure 80

Drawing Substitution 79

Enable/Disable All 73

Keyframe Value 79-80

Lock/Unlock Layer 77

Onion Skin 78

Show Selection and Hide All Others 74

Show/Hide Children 76

Show/Hide Data View 75

Show/Hide Functions 76

Split 76

Symbol Exposure 80

Zoom 80

Timeline View Toolbar 63

## Tool

Cutter Tool 590, 592, 595, 598

Flat Tool Toolbar 106

Flat Tool Toolbar Preference 95

Pivot Tool 231

Rotate Tool 584

Scale Tool 584

Select Tool 590

Tool Properties View 62, 71

Toolbar 62

Tools Toolbar 62, 71

## Toolbar 62

Advanced Animation Toolbar 62

Camera View Toolbar 63

Control Point Toolbar 62

Coordinate Toolbar 62

Display Toolbar 62

Drawing View Toolbar 63

Easy Flipping Toolbar 62

Edit toolbar 62

File Toolbar 62

Flat Tool Toolbar 106

Flat Tool Toolbar Preference 95

Flip Toolbar 62

Managing the Toolbars 94

Model View Toolbar 63

Moving Toolbars 95

New Mark Drawing Toolbar 63

Onion Skin Toolbar 62

Playback Toolbar 62, 88

Play Menu 89

Scripting Toolbar 62

Showing or Hiding Toolbars 94

Side View Toolbar 63

Timeline View Toolbar 63

Toolbar Manager 96

Tools Toolbar 62, 71

Workspace Toolbar 62

## Tracing

Cut-out Model 556

## Unlink

Link/Unlink Three Colours 85

## Unlock

Lock/Unlock Layer 77

## Velocity

Default Separate Position 554

## View

Resizing a View 92

Swapping Views 91

## Windows

Preview Window 88

## Workspace Manager

Creating a New Workspace 99

Renaming a Workspace 100

Saving a Workspace 100

## Xsheet

Xsheet View 62

## Z

Z-nudging 554, 563-564

## Zoom

Timeline View

Zoom Tool 80

Zoom Settings 109

ZoomDrop-down Menu 69

