



**Toon Boom Harmony 11.1
Paint Guide**

Legal Notices

Toon Boom Animation Inc.
4200 Saint-Laurent, Suite 1020
Montreal, Quebec, Canada
H2W 2R2

Tel: +1 514 278 8666
Fax: +1 514 278 2666

toonboom.com

Disclaimer

The content of this guide is covered by a specific limited warranty and exclusions and limit of liability under the applicable License Agreement as supplemented by the special terms and conditions for Adobe® Flash® File Format (SWF). For details, refer to the License Agreement and to those special terms and conditions.

The content of this guide is the property of Toon Boom Animation Inc. and is copyrighted.

Any reproduction in whole or in part is strictly prohibited.

Trademarks

Toon Boom® is a registered trademark and Harmony™ is a trademark of Toon Boom Animation Inc.

Credits

Art Development: Shabana Ali, Marie-Eve Chartrand, Tania Gray, Annie Rodrigue, Anouk Whissell

Technical Editor: Peter Cawthorne, Pamela Grimaud, Liven Tam

Technical Reviewer: Joel Baril, Marc-André Bouvier-Pelletier, Lindsay Brown, Steve Masson, John Payne, Elke Starck, Lilly Vogelesang

Technical Writer: Shabana Ali, Marc-André Bouvier-Pelletier, Marie-Eve Chartrand, Christopher Diaz, Annie Rodrigue, Liven Tam, Phoebe Wang Chao, Anouk Whissell

Publication Date

2014-11-28

Copyright © 2014 Toon Boom Animation Inc. All rights reserved.

Contents

Toon Boom Harmony 11.1 Paint Guide	1
Legal Notices	2
Contents	3
Chapter 1: Introduction	8
Chapter 2: Toon Boom Harmony - About this Help System	9
Help Structure	10
Tutorials and Other Help Tools	12
System Requirements	13
Harmony Network	13
Harmony	13
Chapter 3: About Toon Boom Harmony	15
Top Features	15
Toon Boom Pipeline	15
Modules	15
Chapter 4: Starting Toon Boom Harmony	21
Network Connection and Centralized Database	22
What is the Network Connection?	22
Working with Harmony Stage Via Harmony Network	22
Starting Paint	23
Loading Drawings and Elements	24
Saving a Scene	29
Verifying the Project Integrity	32
Check Files	32
Check Colours	32
Basic Commands	34
Preferences	38
Chapter 5: Interface	39
Menus	40
Managing the Views	42
Managing the Toolbars	44
View References	48
Colour View	48
Drawing View	54

Message Log View	56
Model View	57
Tool Properties View	58
Toolbar References	59
Top Toolbars	59
View Toolbars	59
Interface Navigation	60
Zoom Tool	61
Chapter 6: Character, Prop and Location Design	63
Preparation	64
Getting References	64
Using the Workspace	64
Sketching the Model	65
Drawing with the Brush or Pencil Tool	65
Override Tool	66
Relative Size	67
Palettes and Colours	70
Sketching the Character	74
Cleaning and Inking the Model	77
Drawing Tasks	79
Drawing with the Pencil Tool	79
Working with Pencil Presets	82
Pencil Line Texture	85
Drawing with the Brush Tool	88
Drawing with Textured Brushes	94
Drawing with Bitmap Brushes	100
Viewing the Final Lines as You Draw	105
Real-time Antialiasing	106
Selecting the Current Colour of a Tool	107
Using Independent Colours when Working with Bitmap Layers	109
Selecting Drawing Objects	109
Erasing Parts of a Drawing	112
Reshaping a Drawing Using the Contour Editor Tool	114
Reshaping Pencil Lines with the Pencil Editor Tool	116

Drawing with Shapes	118
Drawing with the Polyline Tool	119
Drawing with Invisible Lines	120
Deforming a Drawing with the Perspective Tool	122
Warping a Drawing with the Envelope Tool	123
Cutting Drawing Parts	125
Smoothing Lines	126
Working With Text	127
More Drawing Tools	127
Arrange	128
Convert Brush Strokes to Pencil Lines	129
Pencil Lines to Brush Strokes	129
Strokes to Pencil Lines	130
Optimize	130
Remove Extra Strokes	130
Create Contour Stroke	131
Remove Contour Stroke	131
Grid	132
Group/Ungroup	132
Hand	132
Rotate View	133
Drawing Tool References	134
Pencil Tool Options	134
Brush Tool Options	139
Select Tool Options	141
Reverse Pencil Thickness	148
Eraser Tool Options	150
Contour Editor Options	151
Pencil Editor Options	154
Shape Tool Options	157
Polyline Tool Options	162
Stroke Tool Options	163
Perspective Tool Options	164
Envelope Tool Options	165

Cutter Tool Options	168
Smooth Editor Tool Options	170
Text Tool Options	172
Drawing Pivot Tool	175
Chapter 7: Colour Styling and Colour Models	177
Preparation	178
Colour Model Storage	178
Scene Creation	178
Colour Model Scene Structure	179
Setting Up the Workspace	179
Working with Palettes	181
Palette Lists	182
Palette File Storage	185
Element Level	186
Scene Level	186
Where to Save the Palette File	187
What happens when you export a palette file?	187
Palette Backup	188
Creating a Colour Palette	188
Duplicating a Colour Palette	192
Cloning a Colour Palette	194
Palette Operations	196
Importing and Linking Palettes	200
Colours	205
Adding a Colour Swatch	206
Colour Display Modes	212
Copying and Pasting Colours	213
Mixing Colours	214
Painting the Model	216
Chapter 8: Ink and Paint	219
Preparation	221
Dirt Clean Up	223
Art Layers	226
Creating Strokes	229

Painting	231
Painting Using the Paint Tool	232
Advanced Painting Features	232
Selecting a Colour in a Drawing	236
Importing Models	238
Editing Gradients and Textures	240
Closing Gaps	245
Protecting Colours	247
Respecting Protected Colours	247
Highlighting the Selected Colour	247
Inverting a Colour Selection	248
Inking the Lines	249
Verifying the Zones are Painted	253
Ink and Paint Tool Properties	254
Ink Tool Properties	254
Paint Tool Properties	255
Lasso and Marquee	256
Painting Modes	256
Paint Mode	257
Paint Unpainted Mode	257
Repaint Mode	257
Unpaint Mode	258
Paint and Remove Texture	258
Apply to Multiple Drawings	258
Apply to All Visible Drawings	259
Respect Protected Colour	259
Use Stored Colour Gradient	260
Select Newly Painted/Repainted/Unpainted Contours/Lines	260
Automatic Close Gap	260
Glossary	262
Index	273

Chapter 1: Introduction

The Harmony Paint module is mainly used in large productions where there is an Ink and Paint or Colour Stylist team. The Harmony Paint module includes the Drawing and Colour views as well as drawing tools. By using this module the Ink and Paint team does not need to learn the entire application, but can focus on the Ink and Paint process.

The Harmony Paint module can only be used with a connection to the Harmony database, unlike other Harmony modules which can be used as a standalone application. To start the ink and paint process, you need to first fill in your scene's exposure sheets and import the drawings that need to be coloured.

Refer to the Harmony Xsheet and Harmony Scan Guides to learn more about the previous steps of the production.

This guide is divided as follows:

- [Toon Boom Harmony - About this Help System on page 9](#)
- [About Toon Boom Harmony on page 15](#)
- [Starting Toon Boom Harmony on page 21](#)
- [Interface on page 39](#)
- [Character, Prop and Location Design on page 63](#)
- [Colour Styling and Colour Models on page 177](#)
- [Ink and Paint on page 219](#)

Chapter 2: Toon Boom Harmony - About this Help System

Toon Boom Harmony is an animation and digital content creation tool that offers you a wide array of features and options. Harmony is packaged in several different modules and allows you to create animation using the technique of your choice—see [About Toon Boom Harmony on page 15](#).

This help system is built to guide you through the different workflows possible and explains which tool and module to use in a production context.

- [Help Structure on the next page](#)
- [Tutorials and Other Help Tools on page 12](#)

Help Structure

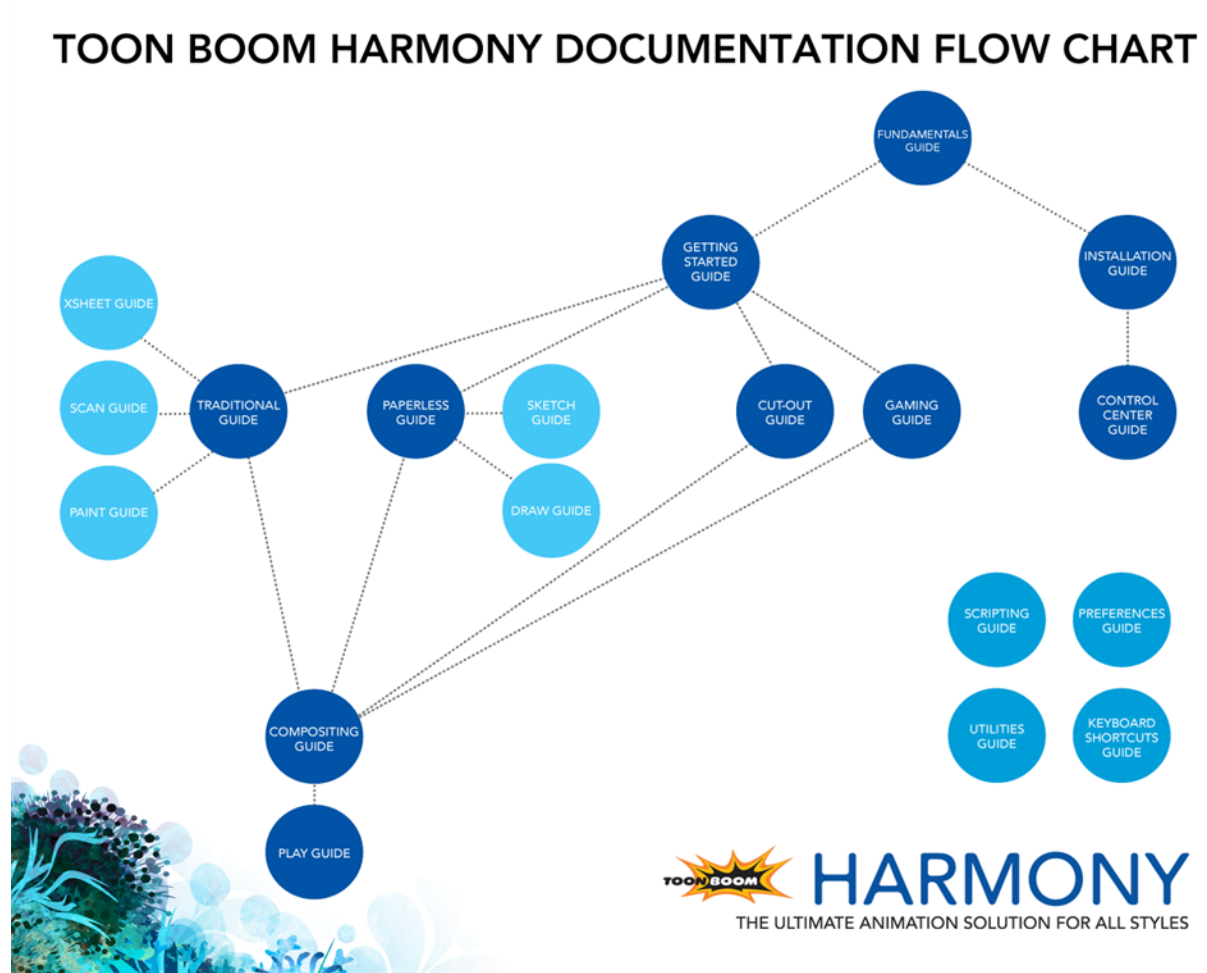

The fundamental concepts of animation and Harmony are explained in this guide. It covers the essentials of various animation workflows, basic animation principles, as well as Harmony's interface. Depending on what you want to do, you can either start with this Fundamentals Guide to get immersed into the world of Harmony and animation or go right to the Getting Started Guide, which covers the main functions and tasks. All conceptual and reference topics are omitted to get you up and running in a very short amount of time.

If your work revolves more around system administration or coordination tasks, you will probably want to move over to the Installation Guide followed by the Control Center and Server Guide to learn how to install and configure Harmony.

The core of this help system revolves around the main animation techniques you can use in Harmony to create animation:

- Traditional Animation
- Paperless Animation
- Cut-out Animation

If you use one of the animation technique listed above to produce games, you can complete your learning process using the Gaming Guide.

All workflows join in the compositing step of the process. All the information on compositing in Harmony can be found in the Compositing Guide. Finally, you can watch the rendered animations in the Play module. To learn how to use the Play module, refer to the Play guide.

If you are focusing on a single part of the workflow such as ink and paint or digital Xsheet creation, you can simply read the Fundamentals Guide and one of the corresponding module guides:

- Paint Guide
- Xsheet Guide
- Scan Guide
- Draw Guide
- Sketch Guide

Other satellite guides are also available to learn about additional information such as the preferences and keyboard shortcuts.

- Keyboard Shortcuts Guide
- Preferences Guide
- Scripting Guide
- Utilities Guide

If you are already a Harmony user and want to know more about the new features that were added to this latest version, refer to:

- Release Notes

Tutorials and Other Help Tools

Aside from the main product documentation, you can find supplementary material to learn more about Harmony. The [Toon Boom website's online resources](#) section offers a variety of videos and samples that can further your knowledge of Harmony.

- Video Tutorials: toonboom.com/resources/video-tutorials/harmony-network
- Templates and Sample Scenes: toonboom.com/resources/templates/harmony-network
- Tips and Tricks: toonboom.com/resources/tips-and-tricks/harmony-network
- White Papers: toonboom.com/solutions/white-papers

System Requirements

Here are the technical specifications for Toon Boom Harmony 11.1.

Harmony Network

Toon Boom Harmony Network is a server-client configuration. The server stores all the assets, and holds the database. The client machines simply run the software and allow the members of your team to work on Harmony and access the assets directly from the database.

Note that an Internet connection is required to activate the animation software.

Before installing Harmony, refer to the *Harmony and Your IT Department* white paper to learn about the network prerequisites for a Toon Boom Harmony installation. This document should be taken as a guide to help you understand the preliminary steps before performing a typical Harmony installation.

There are multiple ways of installing Harmony, as well as numerous types of hardware that can work with Harmony. To perform a custom installation which fits the studio's requirements, a proper analysis of the studio is required, such as: the type of project, the productivity expected, and the delivery date, etc. If you are not yet familiar with Harmony, you should get in touch with your sales contact at Toon Boom to organize a needs analysis of your studio and production in order to make the best of Harmony and optimize your production pipeline.

The person who performs the installation should have the knowledge and expertise required for setting up and configuring networks, computers, and operating systems. If you do not have an IT department or someone who knows the network technology thoroughly, contact your sales representative at Toon Boom to organize an installation with our consulting department.

- [White Paper: Harmony and Your IT Department](#)

Harmony

Here are the specifications to install Harmony on client machines. Note that this does not encompass the network and server specifications for Harmony Network.

Requirements	Windows	Mac OS X
Operating System	Windows 7 64-bit Windows 8 64-bit	Mac OS X 10.7.5 Mac OS X 10.8.5 Mac OS X 10.9.3 or later
Processor	Intel Core i7, 3.4 GHz Intel Core i5, 3 GHz Intel Core 2 Duo	
Monitor	Optimized for 1920 x 1080 or higher Minimum requirement is 1280 x 800	
Memory	16 GB 8 GB	

	4 GB	
Video Card	<p>Fast</p> <ul style="list-style-type: none"> ▶ NVIDIA Geforce GTX 780 <p>Medium</p> <ul style="list-style-type: none"> ▶ NVIDIA Geforce GTX 560 ▶ NVIDIA GeForce GTX 650 <p>Slow</p> <ul style="list-style-type: none"> ▶ Intel HD Graphics 4000, 5000 ▶ Intel Iris Graphics NVIDIA GeForce GT 520, 620, 720 	<p>Fast</p> <ul style="list-style-type: none"> ▶ NVIDIA GeForce GTX 775M <p>Medium</p> <ul style="list-style-type: none"> ▶ AMD Radeon HD 6770 ▶ NVIDIA GeForce 750M <p>Slow</p> <ul style="list-style-type: none"> ▶ Intel HD Graphics 4000, 5000 ▶ Intel Iris Graphics ▶ NVIDIA GeForce 320M ▶ Radeon HD 4670
Drawing Tablet	<p>Best</p> <ul style="list-style-type: none"> ▶ Wacom Intuos Pro ▶ Wacom Cintiq <p>Basic</p> <ul style="list-style-type: none"> ▶ Wacom Bamboo ▶ Wacom Intuos 	
Media Player	Apple QuickTime Player (free)	

Chapter 3: About Toon Boom Harmony

Toon Boom Harmony is the most advanced professional animation software on the market. Bringing together an impressive 2D drawing toolset with the ability to work in a real 3D space, and import 3D models,

Harmony Network combines the animation toolset of Harmony with an impressive database for collaborative workflow. Share assets, batch vectorize and render, and increase production efficiency.

Top Features

- **Advanced Drawing Tools:** Texture brushes, and thick and thin pencil lines
- **Smart Colour Palettes:** Colour you can adjust on the fly
- **Character Rigging:** Hierarchy, deform, and effects for creating sophisticated rigs
- **Special Effects:** An array of effects including highlights and shadows, glows, blurs, and a full particle effects engine
- **Real 3D Camera:** A camera you can reposition in a full 3D space
- **3D Integration:** Allowing you to import 3D models, position and animate them in 3D space
- **Batch Vectorizing and Rendering:** Quickly process images for import and export through a single workstation or a render farm
- **Database File Sharing:** Share libraries, colour palettes, animation, and more across the whole team
- **Production Pipeline Integration:** Seamlessly integrate content from pre-production via Toon Boom Storyboard Pro

Toon Boom Pipeline

Toon Boom Harmony has been recognized for its excellence by winning many awards, including a Primetime Emmy® Engineering Award and the prestigious Ub Iwerks Annie Award for the integrated pipeline with Toon Boom Storyboard Pro.

Harmony works perfectly with Toon Boom Storyboard Pro for all pre-production phases. Therefore, animatics created in Toon Boom Storyboard Pro can be imported seamlessly in Harmony for animation and scene setup guidance.

Modules



Harmony Network is composed of the following modules:

- [Control Center below](#)
- [Stage on the facing page](#)
- [Draw on the facing page](#)
- [Sketch on page 18](#)
- [Scan on page 18](#)
- [Xsheet on page 19](#)
- [Paint on page 19](#)
- [Play on page 19](#)
- [Cloud on page 20](#)

These modules are all accessible from:

- Windows: **Start > Programs > Toon Boom Harmony 11.1**
- Mac OS X: **Applications > Toon Boom Harmony 11.1**
- Linux: `/usr/local/ToonBoomAnimation/harmony_11.1/lnx86_64/bin`
 - `Controlcenter`
 - `Stage`
 - `Draw`
 - `Sketch`
 - `Scan`
 - `Stage -xsheet`
 - `Stage -paint`
 - `Play`
 - `ServerActivation`
 - `ClientActivation`
 - `LicenseWizard`

Control Center



The Control Center module controls the database and organizes the production. The Control Center module is used to create the environments, jobs and scenes, as well as importing and exporting scene packages. The technical director or system administrator also uses the Control Center to create the login information for users to access the database.

Control Center is also available in a cloud form where users can access scenes via the Internet.

To learn more about Control Center, refer to the following guides:

- Fundamentals Guide
- Installation Guide
- Control Center and Server Guide

Stage



The Stage module is the core of Harmony. It comprises all the major drawing, animation and compositing features. It is used to work in the scene: design, character breakdown, cut-out animation, traditional animation, ink and paint, exposure sheet, timeline, effects, compositing, camera moves, colour styling, and so on.

You cannot create scenes in Stage Harmony Network, you require Control Center. You create them directly in Stage with Harmony Stand Alone.

To learn more about Stage, refer to the following guides:

- Fundamentals Guide
- Getting Started Guide
- Traditional Animation Guide
- Paperless Animation Guide
- Cut-out Animation Guide
- Gaming Guide
- Compositing Guide
- Play Guide
- Preferences Guide
- Keyboard Shortcuts Guide
- Scripting Guide
- Utilities Guide

Draw



The Draw module is a component of the Stage module. It contains all the tools necessary to create a paperless frame-by-frame animation project. There is no node system in this module, only the basic essential effects. Contrary to the Stage module, instead of creating effects in the Network view, you simply create them in the Timeline view. The Draw module also includes all the scene setup and camera features for you to do the compositing for your project.

- Fundamentals Guide
- Draw Guide
- Preferences Guide

Sketch



The Sketch module is a component of the Stage module. It contains the essential tools to animate frame-by-frame drawings and paint them. It allows you to add layers and animation, and paint and adjust the timing. There are no effects, camera or other compositing tools included in this module. The Sketch module allows you to focus on the paperless animation tasks at hand without being distracted by other features that are not necessary to your work.

To learn more about the Sketch module, refer to the following guides:

- Fundamentals Guide
- Sketch Guide
- Preferences Guide

Scan



The Scan module is used to scan drawings in batch. It creates a drawing list from the timing and exposure previously created in the exposure sheet (via Stage or Xsheet module).

It is possible to scan the drawings from a TWAIN device directly in the Stage module.

To learn more about the Scan module, refer to the following guides:

- Fundamentals Guide
- Scan Guide

Xsheet



The Xsheet module is a component of the Stage module. It contains the tools used to create digital exposure sheets, columns and timing. It is mainly used in large traditional animation studios to maintain a structure and avoid users having to learn the full product application. This way, the Xsheet team can concentrate on their task without having to deal with the compositing and drawing tools.

To learn more about the Xsheet module, refer to the following guides:

- Fundamentals Guide
- Xsheet Guide
- Preferences Guide

Paint



Paint module is a component of the Stage module. It contains the drawing, painting and colour styling tools. It is mainly used in large traditional animation studios to maintain a structure and avoid users having to learn the full product application. This way, the colour styling or ink and paint team can concentrate on their task without having to deal with the compositing and timing tools.

To learn more about the Paint module, refer to the following guides:

- Fundamentals Guide
- Paint Guide
- Preferences Guide

Play



The Play module is used to play back the rendered image sequences enabling the user to view the final scenes and compositing results.

To learn more about the Play module, refer to the following guides:

- Fundamentals Guide
- Play Guide

Cloud



Access your Database via the Cloud. When you're running a studio, you will most likely have a database set up. This enables all the artists working on your production to share the same scenes and assets.

What the Toon Boom Cloud enables you to do is to host this database on the Internet. When you do so, you can have freelancers log in from anywhere with an internet connection. Then they can download a scene from the database, work on it, and upload it again.

No more need to spend time copying files to an FTP. No need to have an admin exporting and importing files from the database. Do it all directly through the Cloud.

To learn more about the Cloud module, refer to the following guides:

- [Installation Guide](#)
- [Control Center and Server Guide](#)

Chapter 4: Starting Toon Boom Harmony

Once Harmony is installed, you are ready to start the application and animate! In this chapter, you will learn about starting the application, setting the resolution and opening the scenes.

- [Network Connection and Centralized Database on the next page](#)
- [Starting Paint on page 23](#)
- [Saving a Scene on page 29](#)
- [Verifying the Project Integrity on page 32](#)
- [Basic Commands on page 34](#)
- [Preferences on page 38](#)

Network Connection and Centralized Database



The Harmony solution is a revolutionary team-based infrastructure for animation production and 2D games. Its array of features increases productivity and encourages creativity. Developed in conjunction with leading studios worldwide, Harmony is specifically designed for long-term episodic and feature length projects, providing a true animation pipeline. Several animators can work simultaneously on the same project while the asset library provides users with easy access to up-to-date media assets. Harmony is truly scalable; more than 100 staging clients can share animation just as easily as a few can.

Note that Harmony can be used in Database mode via the Network connection or as a standalone application.

What is the Network Connection?

Harmony Network is the link between the client machines and the server. It lets you work on the different projects stored in the central Harmony database.

At the heart of the Harmony solution is the server, which centralizes all the production assets in a repository. Loaded with production proven tools to manage administration tasks, the server is completely flexible and will fit in your existing infrastructure, whether you are on Windows, Linux or Mac OS X. To learn more, refer to the Control Center Guide.

Working with Harmony Stage Via Harmony Network

When you start Harmony Stage, you can opt to either work offline in the application as a standalone software, or connect to the database to work on projects via Harmony Network.

When working with Harmony Network, the scenes and their data are stored directly on the server. No data is saved or stored on the client machine. The client machines access the database and load the scenes and drawings directly from the server. Each time the user saves his scene, the data is updated directly on the server. There are no upload or download operations (check-in, check-out) done between the server and the clients.

If you have a standalone license, you will not have access to the database. You will automatically start the application in standalone mode.

Starting Paint

You can run the Harmony on the Linux, Mac OS X or Windows operating systems.

How to start Harmony Paint

1. Do one of the following:
 - Mac OS X: Double-click on the Harmony **Paint** icon or select **Applications > Toon Boom Harmony 11.1 > Paint**.
 - Windows: Double-click on the Harmony **Paint** icon or select **Start > Programs/All Programs > Toon Boom Harmony 11.1 > Paint**
 - Linux: Select **Applications > Toon Boom Harmony 11.1 > Paint**

Toon Boom Harmony opens.

2. In the User Name field, enter your username. It is generally provided by the supervisor, system administrator or team lead.
3. Click OK.

Loading Drawings and Elements

Once you launch Harmony Paint, you need to load a scene's drawings from the Database Selector, in order to start the ink and paint process. The drawings must have previously gone through the Xsheet and Scanning processes.

There are two ways of loading drawings:

- **Open Drawings**
This option will let you load drawings from one element at a time, for quick ink and paint on a single layer animation.
- **Open Elements**
This option will let you load drawings from several elements at once. This can be useful when an animation is separated in many layers, to insure that they are well aligned and that the painted shapes and lines fit together. A good example of this would be a dialogue with the chin and mouth separated from the rest of the head.

How to open drawings in Harmony Paint

1. Once Harmony Paint is launched and you are logged in, select **File > Open Drawings**. Press Ctrl + O (Windows/Linux) or ⌘ + O (Mac OS X).

The Database Selector opens, displaying the Environments available from the Harmony database.

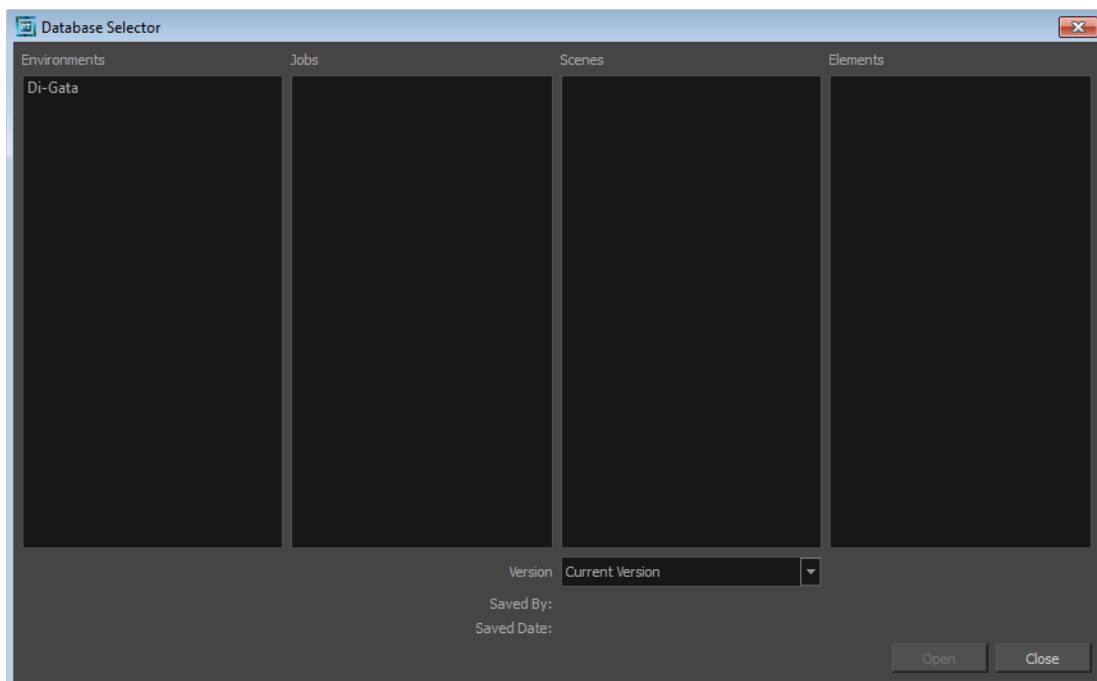

2. Select the Environment, Job, Scene and Element where the drawings you need to paint are located.

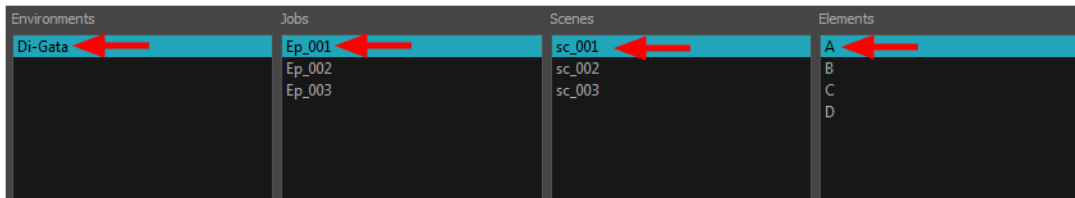

- Choose the version you want to open from the Version drop-down menu.

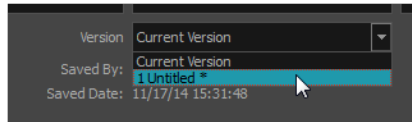

- ▶ The Saved By and Saved Date fields display the user who was the last to save the selected scene and the date of the last save.

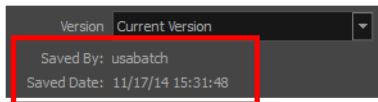

- Click on the Open button.
The Drawings Selector dialog box opens.

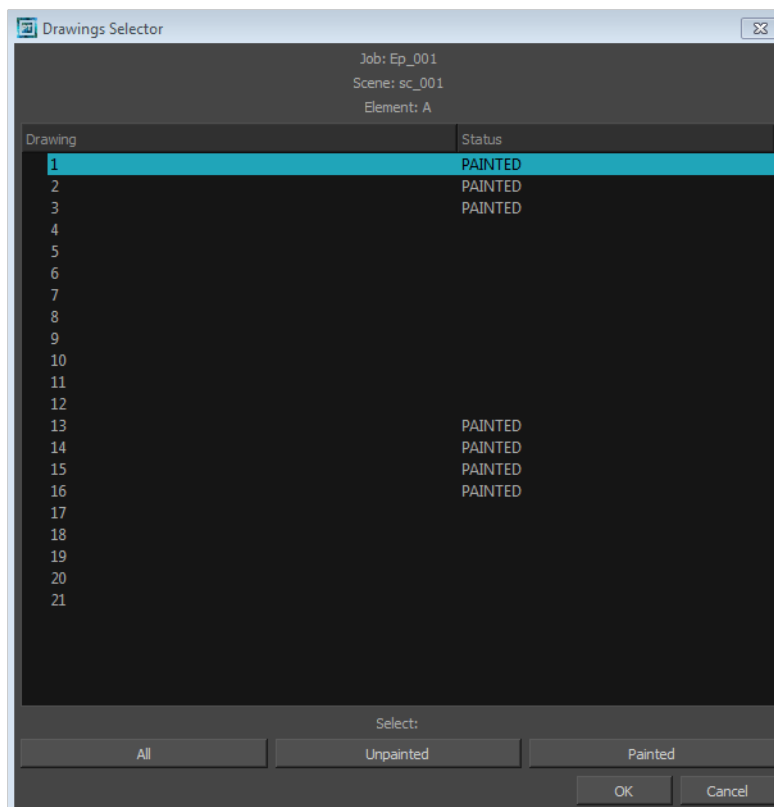

- Select the desired drawings from the drawings list:
 - ▶ Click on a single drawing to select it.
 - ▶ You can create a continuous multiple selection by holding the Shift key.

- ▶ You can create a multiple selection by holding the Ctrl (Windows/Linux) or ⌘ (Mac OS X) key.
 - ▶ Click on the All button to select all the drawings that are listed in the Drawings Selector.
 - ▶ Click on the Unpainted button to select all the drawings whose status appears as UNPAINTED.
 - ▶ Click on the Painted button to select all the drawings whose status appears as PAINTED.
6. Click OK.
- The selected drawings appear in the Drawing Thumbnails view
7. Use the Control panel to navigate between the previous and next drawings. Press F and G.



You are now ready to ink and paint!

How to open elements in Paint

1. Once Harmony Paint is launched and you are logged in, select **File > Open Elements**. Press Ctrl + E (Windows/Linux) or ⌘ + E (Mac OS X).
- The Database Selector opens, displaying the Environments available from the Harmony database.

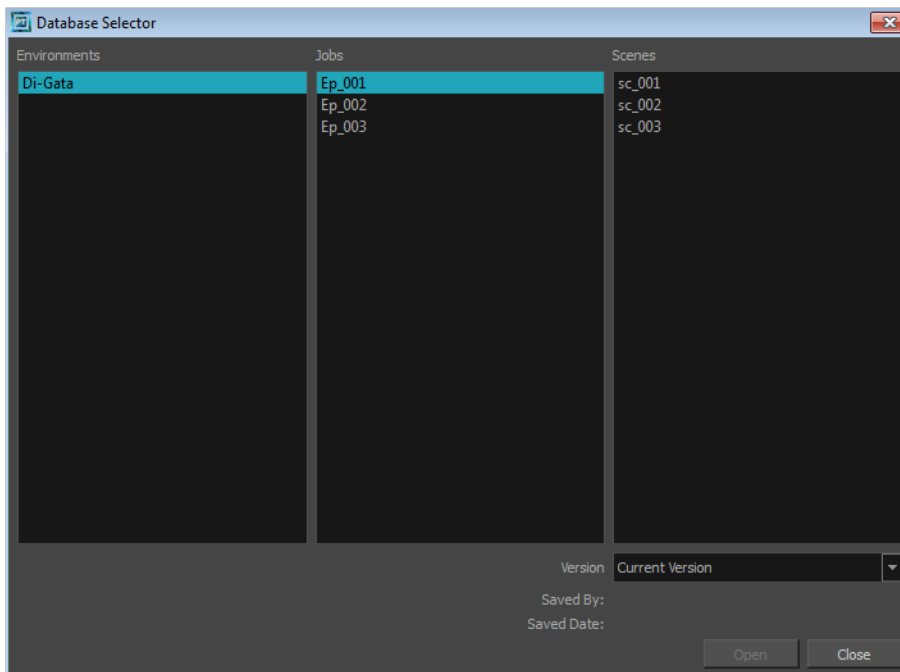

2. Select the Environment, Job and Scene where the elements containing the drawings you need to paint are located.

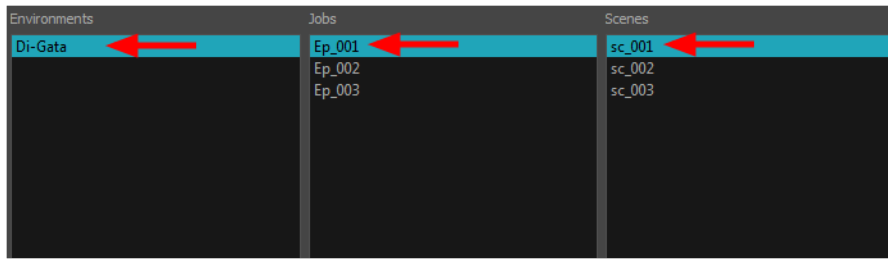

- Choose the version you want to open from the Version drop-down menu.

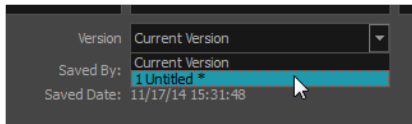

- ▶ The Saved By and Saved Date fields display the user who was the last to save the selected scene and the date of the last save.

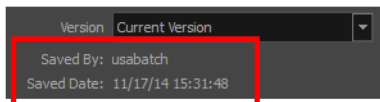

- Click on the **Open** button.

The Open Elements dialog box opens.

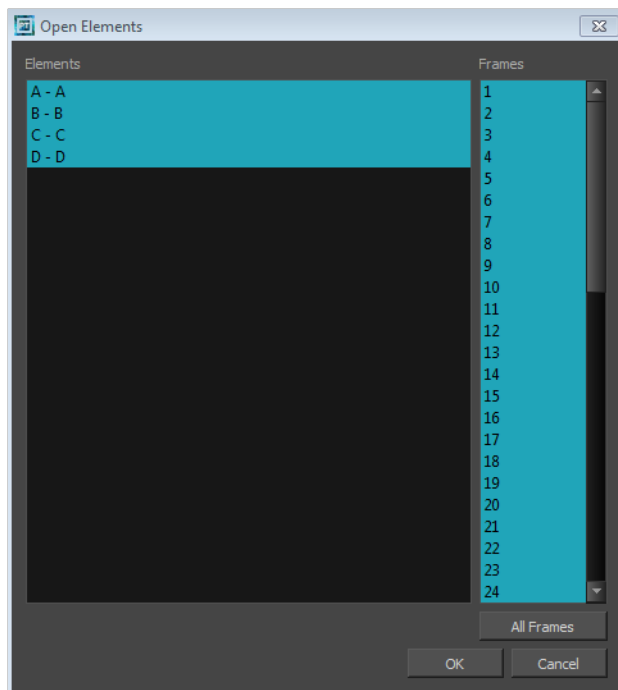

- Select the elements you need to paint from the Elements list:

- ▶ You can create a continuous multiple selection by holding the Shift key.
- ▶ You can create a multiple selection by holding the Ctrl (Windows/Linux) or ⌘ (Mac OS X) key.

6. Select the frames you wish to load from the Frames list:
 - ▶ You can create a continuous multiple selection by holding the Shift key.
 - ▶ You can create a multiple selection by holding the Ctrl (Windows/Linux) or ⌘ (Mac OS X) key.
 - ▶ Click on the All Frames button to load all the frames of the scene.
7. Click OK.

The Drawing Thumbnails view is hidden and your selected elements are loaded in Harmony Paint.
8. Enable the Light Table  option from the Drawing view toolbar to display all the drawing layers.

The selected layer are displayed in original colours and the other layers are displayed as washed out colours.

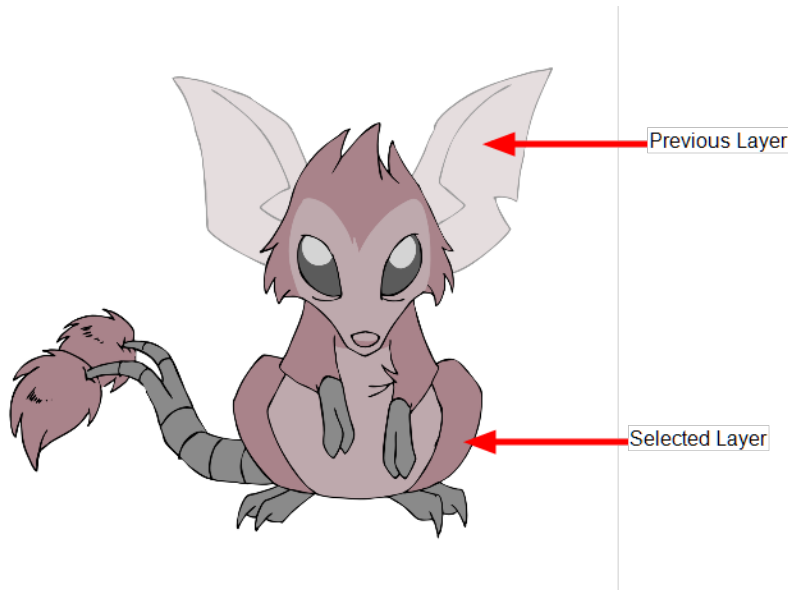

9. Use the Control Panel to navigate between previous and next layers. Press H and J.

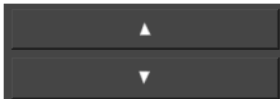

10. Use the Control panel to navigate between previous and next drawings. Press F and G.



You are now ready to ink and paint!

Saving a Scene

It is important to regularly save your scene. As you make changes to a scene, an asterisk (*) appears in the title bar beside the scene name to indicate that the scene contains unsaved changes.

When you use Harmony Network and work in a scene on the database, there are many choices and options available when you save your work.

- Save the scene as the current version.
- Choose specific assets that you want to save, such as drawings or palettes.

You might want to save some specific aspects of your scene or save a new version. The Advance Save feature allows you to do this. Once you have chosen the components to save, you will conclude the procedure by following the instructions in the section. All the specific components that are selected throughout the different tabs of the Advanced Save dialog box will be saved.

How to save a scene

- From the top menu, select **File > Save**.
- Press Ctrl + S (Windows/Linux) or ⌘ + S (Mac OS X).

About the Advanced Save dialog box

1. Make sure that you have the necessary rights to save the current scene version.
2. From the top menu, select **File > Save....**

The Advanced Save dialog box opens.

Drawings

The Drawings tab lists the modified drawings.

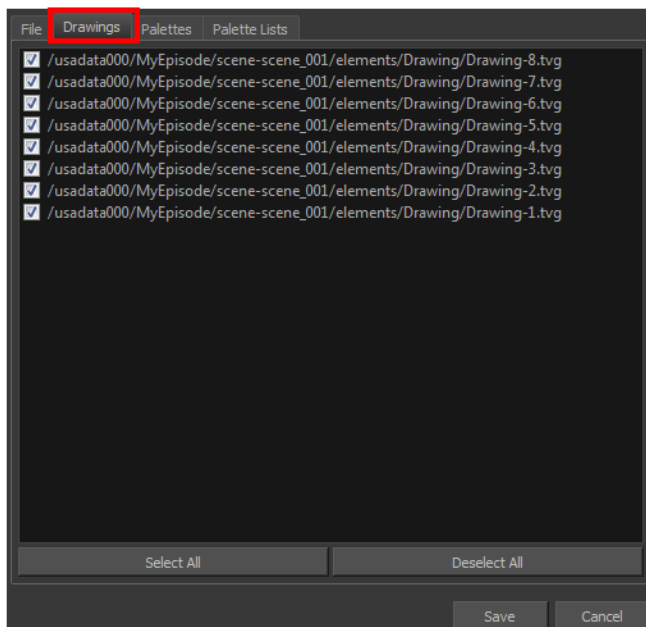

Parameter	Description
Drawing list	Lets you select the modified drawings to save, and deselect the ones you do not want to save.
Select All	Selects all modified drawings in list.
Deselect All	Deselects all modified drawings in the list.

Palettes

The Palette tab lists the modified colour palettes.

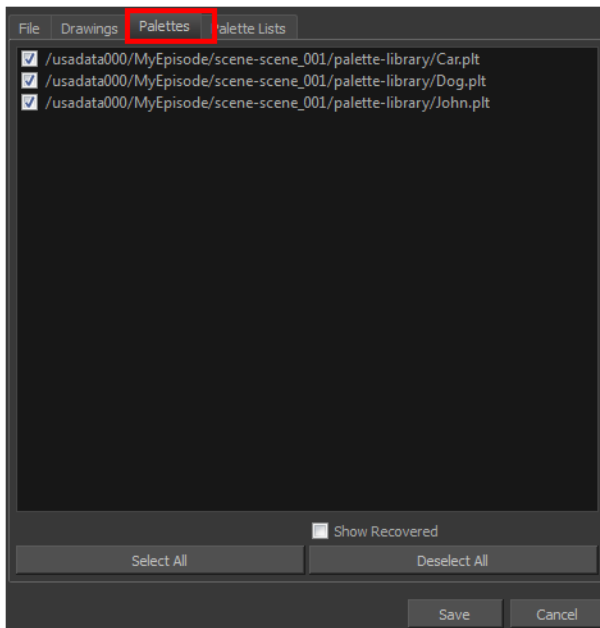

Parameter	Description
Colour Palette list	Lets you select the colour palette to save, and deselect the ones you do not want to save.
Show Recovered	Displays the recovered palettes in the list of modified palettes.
Select All	Selects all modified colour palettes in the palette list.
Deselect All	Deselects all modified colour palettes in the palette list.

Palette Lists

The Palette Lists tab lists all the modified colour palette lists.

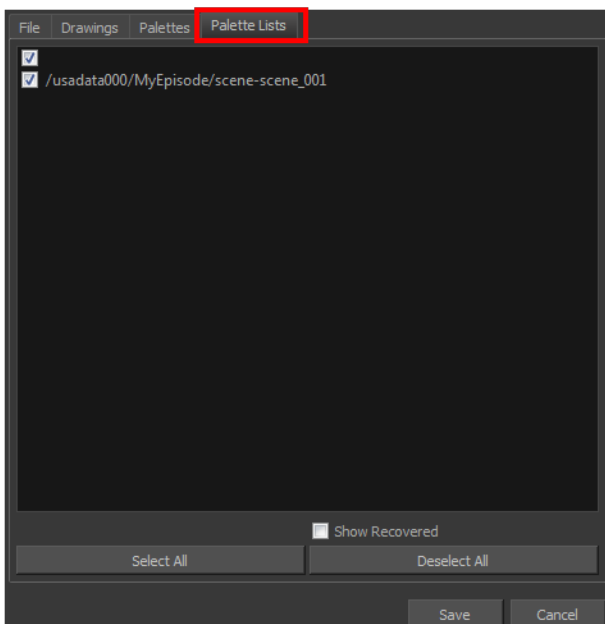

Parameter	Description
Palette Lists	Lets you select the modified palette list to save, and deselect the ones you do not want to save.
Show Recovered	Displays the recovered palettes in the list of modified palettes.
Select All	Selects all modified palette lists in the list.
Deselect All	Deselects all modified palette lists in the list.

How to save with advanced settings

1. After selecting the components to save, click **Save**.
All the specific components that were selected throughout the different tabs of the **Advanced Save** dialog box are saved.

Verifying the Project Integrity

The Check Files command verifies the integrity of the drawing and palette files in your project.

How to open the Check Files dialog box

- ▶ From the top menu, select **File > Check Files**.

Check Files

Use the Check Files dialog box to verify that the data is consistent, correct, and accessible.

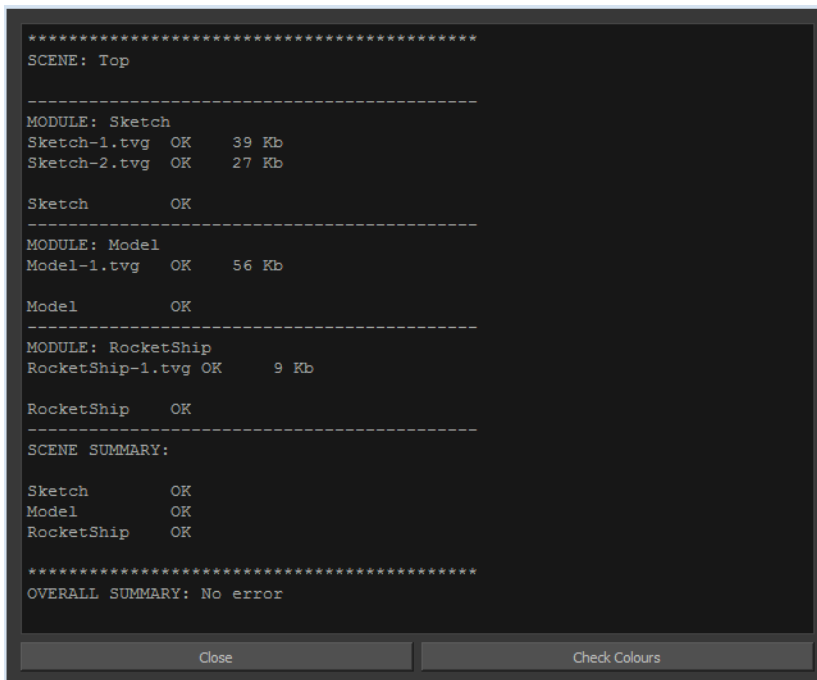

- Click **Check Colours** to open the Check Colours dialog box.

Check Colours

The Check Colours dialog box checks the palette integrity and displays the colour recovery data.

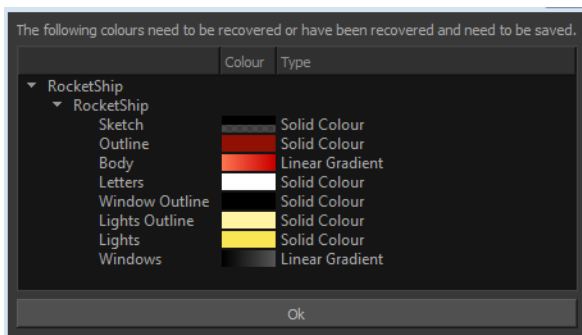

Related Tasks

Saving a Scene.....	29
---------------------	----

Basic Commands

This table lists the most common commands used in Harmony.

Command	Action	Access Methods
Close	Closes the currently opened scene, but does not close the Harmony application.	File > Close
Save	Saves all changes made to the opened scene, drawings, palettes, and palette lists.	File > Save Press Ctrl + S (Windows/Linux) or ⌘ + S (Mac OS X).
Quit	Closes HarmonyHarmony Stage.	Windows/Linux: File > Quit Mac OS X: Stage > Quit
Cut	Removes selected objects. You can then paste the object or its properties to another object.	Edit > Cut Press Ctrl + X (Windows/Linux) or ⌘ + X (Mac OS X).
Copy	Copies selected objects and properties.	Edit > Copy Press Ctrl + C (Windows/Linux) or ⌘ + C (Mac OS X).
Paste	Places an object you cut or copied into the location you select in the Camera, Drawing and Timeline views.	Edit > Paste Press Ctrl + V (Windows/Linux) or ⌘ + V (Mac OS X).
Delete	Removes selected objects.	Edit > Delete Delete
Select All	Selects all drawing objects in the current drawing window in the Drawing, Timeline and Camera views. This helps you manage multiple objects as one when moving them.	Edit > Select All Press Ctrl + A (Windows/Linux) or ⌘ + A (Mac OS X).

Command	Action	Access Methods
Deselect All	Deselects all selected objects in the Drawing and Camera views.	Edit > Deselect All Esc
Undo	Removes remove the last change made to your project. Harmony supports multiple undo, so you can undo changes you made in the order you made them.	Edit > Undo Press Ctrl + Z (Windows/Linux) or ⌘ + Z (Mac OS X).
Redo	Redoes and operation you have undone that you later decide to keep. This command is active only after you use the Undo command.	Edit > Redo Press Ctrl + Shift + Z (Windows/Linux) or ⌘ + Shift + Z (Mac OS X).
Help	Launches the Toon Boom Harmony Online Help system, complete with instructions on how to use the system. This requires an internet connection.	Help > Help
Toon Boom Harmony on the Web	Launches the Toon Boom Harmony website, which features a Support and Community > Forum section.	Help > Toon Boom Harmony on the Web
About	Use the About command to access general information about the software.	Windows/Linux: Help > About Mac OS X: Stage > About

This table lists the most common commands used in Harmony Paint.

Command	Action	Shortcut
File > Add/Revert	Use the Add/Revert command to load new drawings to the already existing selection or to reload drawings to revert the modifications to the	

Command	Action	Shortcut
	last save. This option does not work when several elements are loaded.	
Windows > Colour	Use the Colour command to display the Colour view.	
Windows > Colour Editor	Use the Colour Editor command to display the Colour Editor view.	
Windows > Model	Use the Model command to display the Model view.	
Windows > Tool Properties	Use the Tool Properties command to display the Tool Properties view.	
File > Load Background File	Use the Load Background File command to import a background image in Paint to compare your drawing's colours with it.	
File > Move Background	Use the Move Background command to move the background image in the stage.	
File > Open Drawings	Use the Open Drawings command to open the Database Selector dialog box to select a set of drawings.	The Ctrl + O (Windows/Linux) or ⌘ + O (Mac OS X).
File > Open Elements	Use the Open Elements command to open the Open Elements window and select a series of drawing elements and a frame range to work on.	The Ctrl + E (Windows/Linux) or ⌘ + E (Mac OS X).
Options > Play by Frame	Use the Play by Frame command to flip between the frames instead of the drawings. If a drawing is exposed on two frames,	

Command	Action	Shortcut
	you will have to flip twice before moving on to the next drawing.	
File > Reset Background Position	Use the Reset Background Position command to restore the background image original size and position.	
File > Scale Background Down	Use the Scale Background Down command to scale down the size of the background image.	
File > Scale Background Up	Use the Scale Background Up command to scale up the size of the background image.	
File > Unload Background	Use the Unload Background File command to remove the background image from Paint.	

Preferences

An important feature of Toon Boom Harmony is the Preferences dialog box. From here you can customize your interface, tool behaviour and shortcuts. Throughout this guide, you are often required to go to the Preferences dialog box to set parameters and options.

To learn about the different preferences available, refer to the Preferences Guide.

How to open the Preferences dialog box

1. Do one of the following:
 - ▶ Windows/Linux: From the top menu, select **Edit > Preferences**.
 - ▶ Mac OS X: Select **Stage > Preferences**.
 - ▶ Press **Ctrl + U** (Windows/Linux) or **⌘ + U** (Mac OS X).

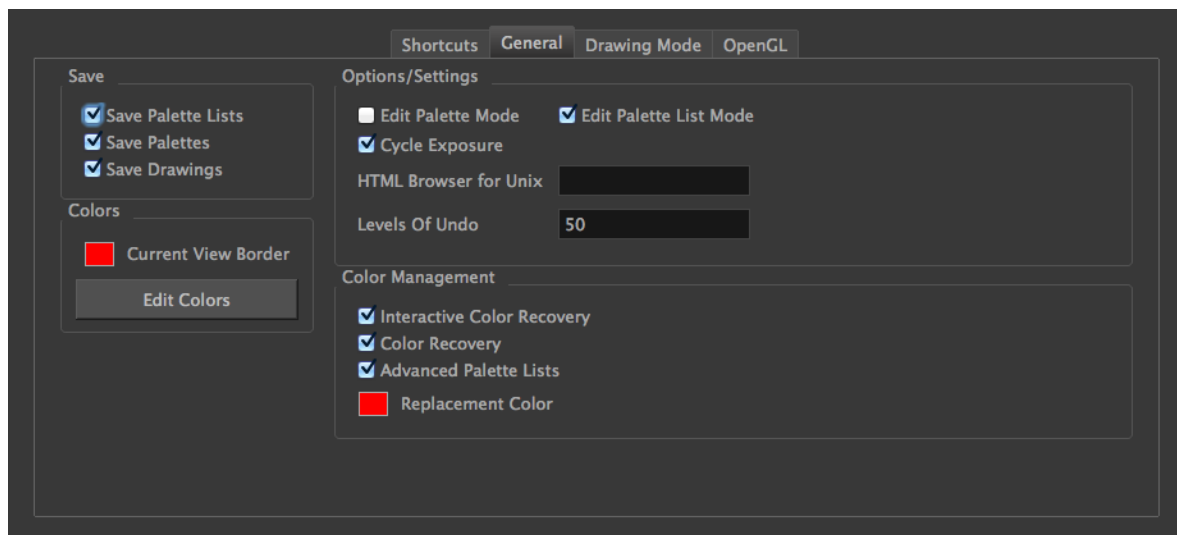

Chapter 5: Interface

Knowing how to manage the Toon Boom Harmony interface helps you to work efficiently and organize your workspace conveniently. There are a series of views and toolbars you can use as you perform different operations. Usually, each person has a specific way of working in the interface and prefer particular views and toolbars. In this chapter, you will learn about the main elements of the interface and how to manage them.

Throughout this chapter you might notice slight differences between your interface and the images used to demonstrate the procedure. This is because the images are taken from Harmony Stage. Paint is a subset of Harmony Stage.

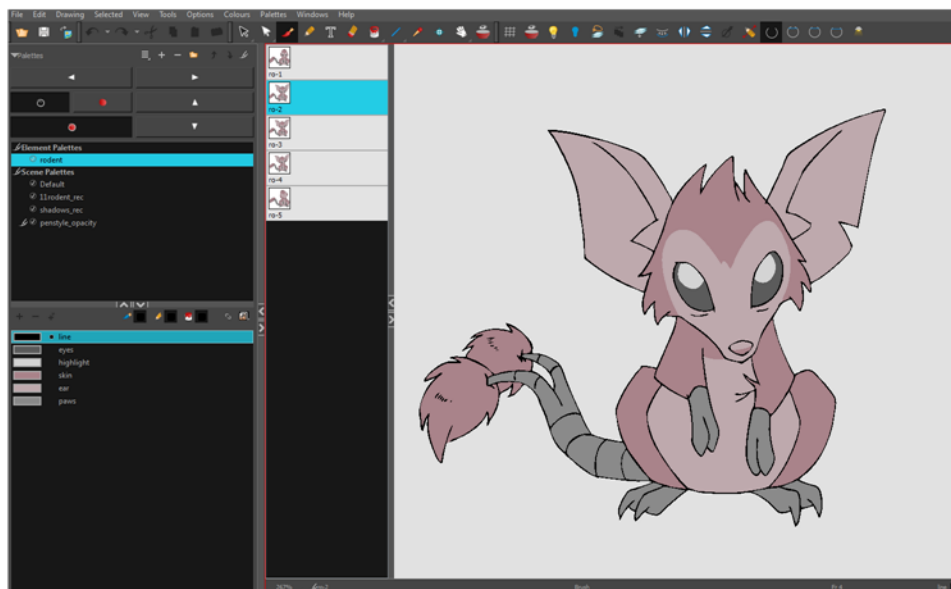

This chapter is divided as follows:

- [Menus on the next page](#)
- [Managing the Views on page 42](#)
- [Managing the Toolbars on page 44](#)
- [View References on page 48](#)
- [Toolbar References on page 59](#)
- [Interface Navigation on page 60](#)

Menus

Harmony has a large number of functions and options that you can access from the following menus:

Top Menu

The top menu contains most of the commands. Depending on the view you are working in and the element, some commands are available and others not. The top menu is always located at the very top of the interface.

The top menu contains the following categories:

- File
- Edit
- View
- Drawing
- Selected
- Tools
- Options
- Colours
- Palettes
- Windows
- Help

On Mac OS X, there is a Stage category containing the following commands:

- Preferences
- About
- Quit

View Menu

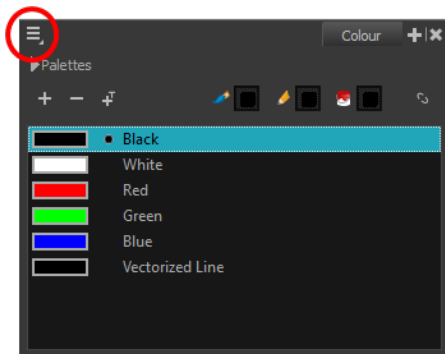

Some views have their own menu. These menus contain commands specifically related to that view.

How to access the view menu

1. In the view's top-left corner, click the Menu  button.
A list of commands is displayed.

Quick Access Menu

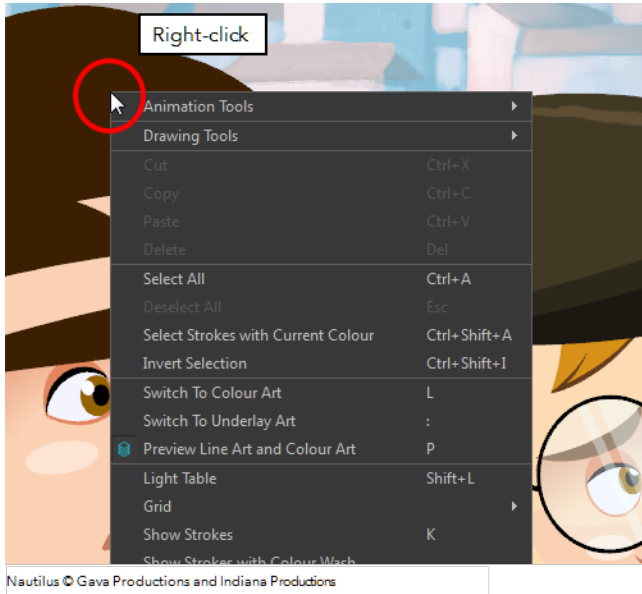

Each view has a quick access menu containing commands you will use most often. This menu is accessed by right-clicking anywhere in the view.

Managing the Views

The Harmony user interface is composed of different views, each one designed for a specific purpose. You can modify the location and accessibility of the views by adding a new view as a tab or as a window. You can also swap the view locations around.

Throughout this chapter you might notice slight differences between your interface and the images used to demonstrate the procedure. This is because the images are taken from Harmony Stage. Paint is a subset of Harmony Stage.

It is important to know about the active view. When a view is active, a red rectangle appears around the view. Keyboard shortcuts and top menu options are linked to the active view. If a menu option is greyed out, it either means it does not apply to your layer, drawing or other type of selection or the option does not apply to the active view.

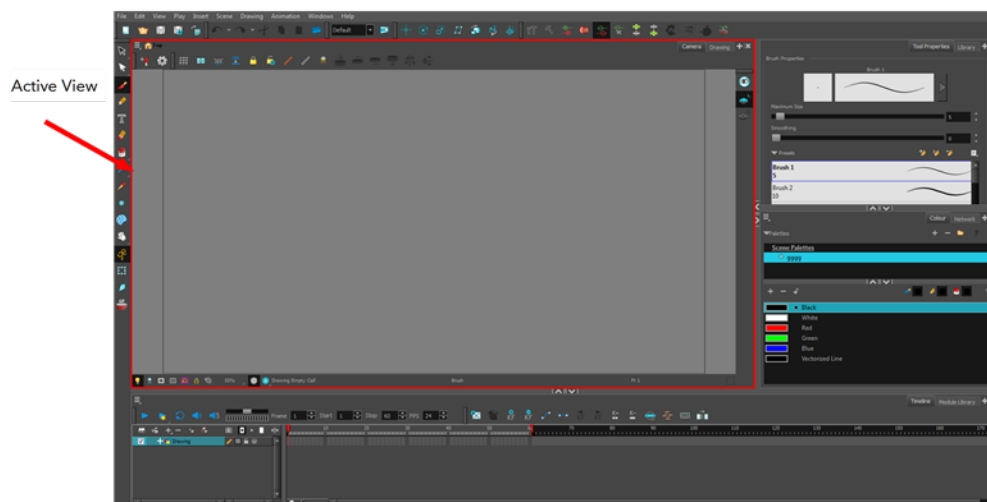

Workspace modifications are automatically saved when you exit the application unless you deselected the Automatically Save Workspace option in the Preferences dialog box.

How to add a view

1. Select the view you want to add from **Windows > the desired view**.

How to close a view

1. Click the Close View button.

How to resize a view

1. Position your cursor on the edge of the view you want to resize.
2. When you see the Resizing \leftrightarrow cursor, click and drag the side of the window to the desired width or height.

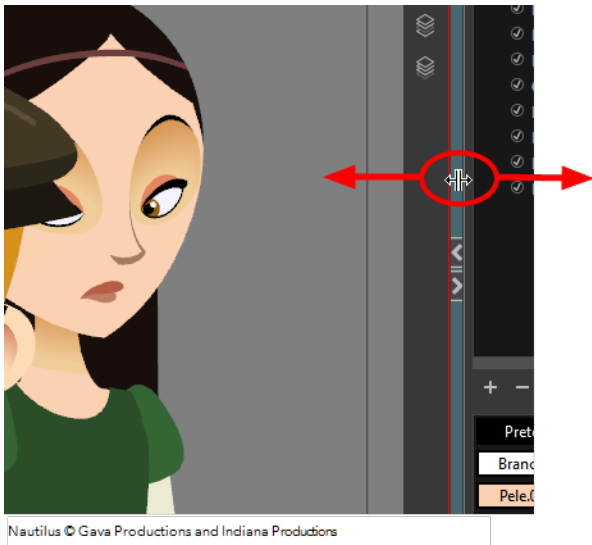

You can also temporarily hide a view to get more working space.

How to temporarily hide a view

1. On the edge of the window you want to hide, click the **Collapse/Expand** button.
The view is compressed and only the Collapse/Expand button is visible.
2. Click the **Collapse/Expand** button again to redisplay the view.

Managing the Toolbars

Harmony contains toolbars which, by default, are located at the top of the interface. Some of the workspace's views also have their own toolbars which you can move around. You can reposition the toolbars to suit your work style or hide unused ones.

Throughout this chapter you might notice slight differences between your interface and the images used to demonstrate the procedure. This is because the images are taken from Harmony Stage. Paint is a subset of Harmony Stage.

You can display or hide toolbars using the menus. The Toolbar menu only contains the View toolbars of the views that are displayed in the workspace. As you show or hide views in your workspace, the Toolbar menu updates.

The top toolbars can also be displayed directly in a view. Only one instance of each toolbar can be displayed. If a toolbar is already displayed in the top area and you decide to display it in a view, the selected toolbar will move from the top area to the view.

The View toolbars can be customized to contain your favourite tools and options. Using the Toolbar Manager window, you can organize different toolbars to suit your working style.

If the default toolbar does not contain the tools you require, you can customize the toolbar.

How to show and hide a toolbar

1. From the top menu, select **Windows > Toolbars > the desired toolbar**.
 - You can right-click anywhere in the toolbar area to access Harmony toolbars. View toolbars, however, are not available by right-clicking the toolbar area. You can access the toolbar of any open and active view by right-clicking in the view's top area or the Windows menu.

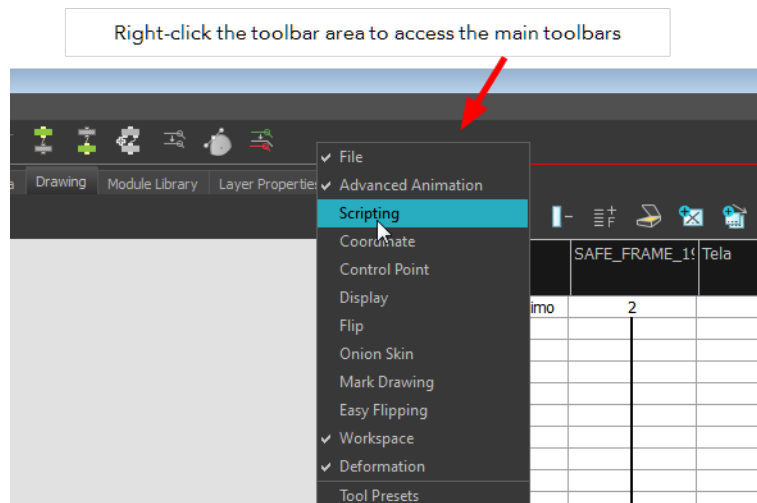

Right-click the top area of the view to access the selected view's toolbar, as well as the top toolbars that can be displayed within that view.

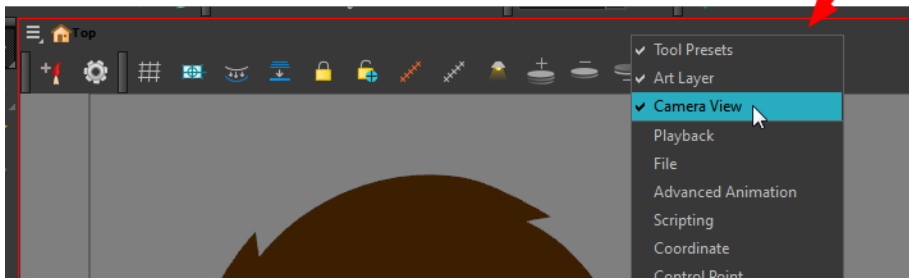

How to resize a toolbar

1. Hide a portion of a toolbar by dragging another open toolbar over its tail-end.
2. Click on the arrows appearing at the end of the collapsed toolbar to expand it.

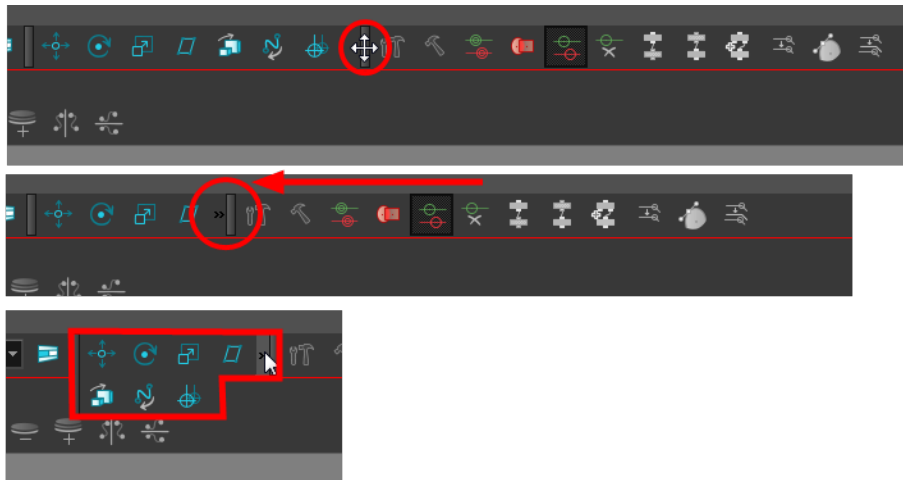

How to move a toolbar

1. Select the toolbar you want to move by clicking its anchor point and dragging it into a view toolbar area or another position in the top or side interface toolbar area.

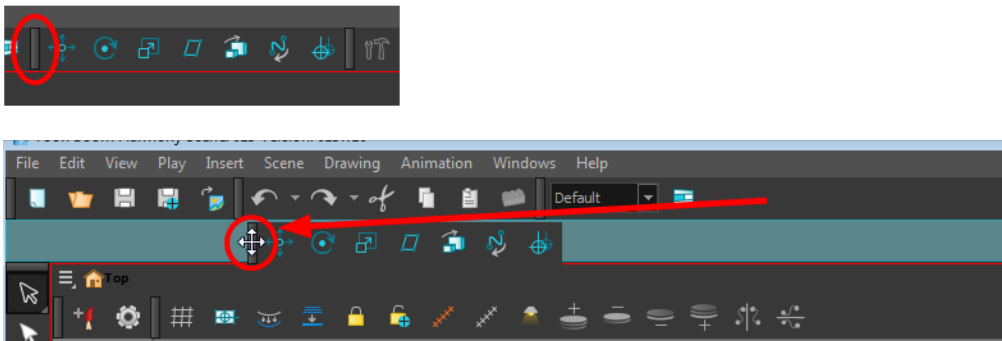

2. When a highlighted zone appears showing an available location for the toolbar, release the mouse button and drop the toolbar into position.

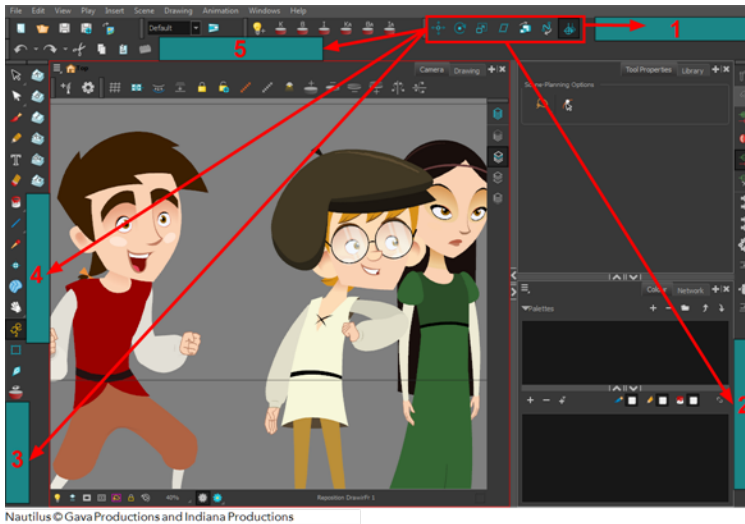

- ▶ 1. Dock to the top toolbar area.
- ▶ 2. Move a toolbar down a row.
- ▶ 3. Dock to the left toolbar area.

How to customize a view toolbar

1. In the chosen view, right-click on any button in the toolbar where you want to add or subtract a new button. You can also reorder the buttons. Make sure the button you right-click on is active.
2. From the menu, select **Customize**.

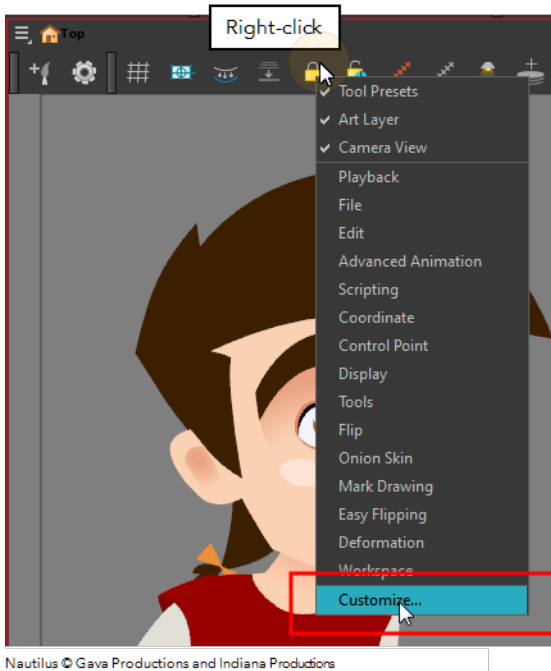

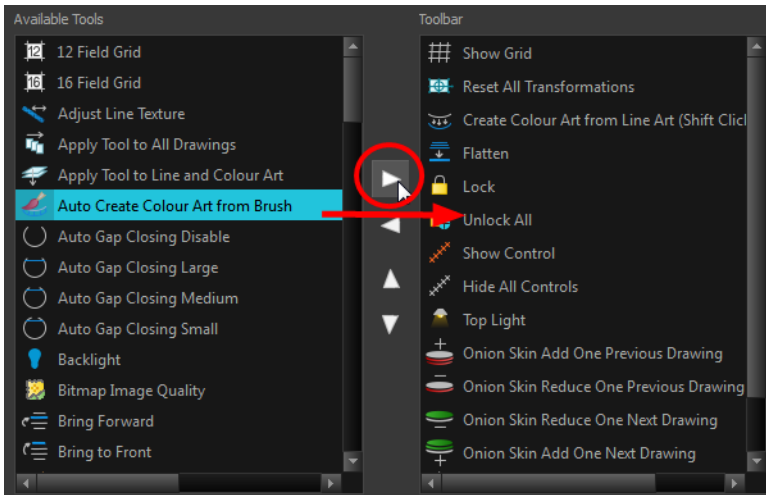

The Toolbar Manager window opens.

3. To add a new icon to your toolbar, select the tool or command from the Available Tools list and click the Right Arrow ► button to switch it to the Toolbar list.

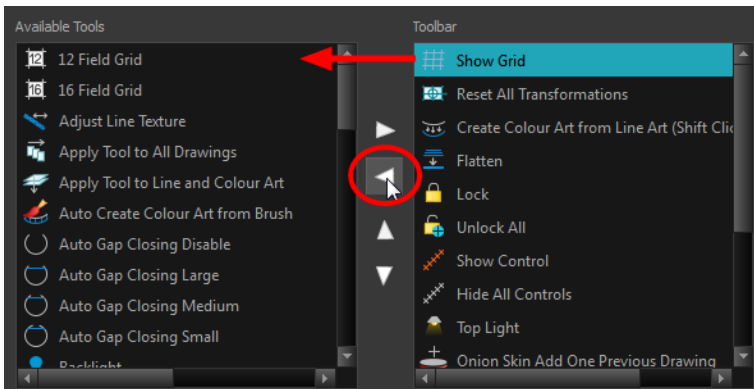

- To remove an icon from your toolbar, select the tool or command in the Toolbar list and click the Left Arrow  button to switch to the Available Tools list.



- To reorder the icons in your toolbar, select the command to be moved from the Toolbar list and click the Up  or Down  buttons to move it to the correct location.

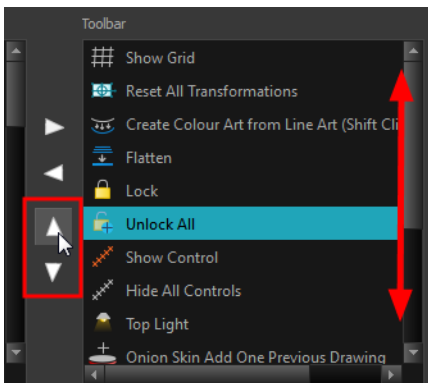

- Click **OK** when you are finished.

View References

Harmony contains a series of views that are each focused on a specific set of tasks. Here are the views available:

- Colour view
- Colour Editor view
- Drawing view
- Message Log view
- Model view
- Tool Properties view

Colour View

The Colour view is where you create colours and palettes and import existing palettes into your project. The Colour view is also necessary for drawing, painting and creating colour styling.

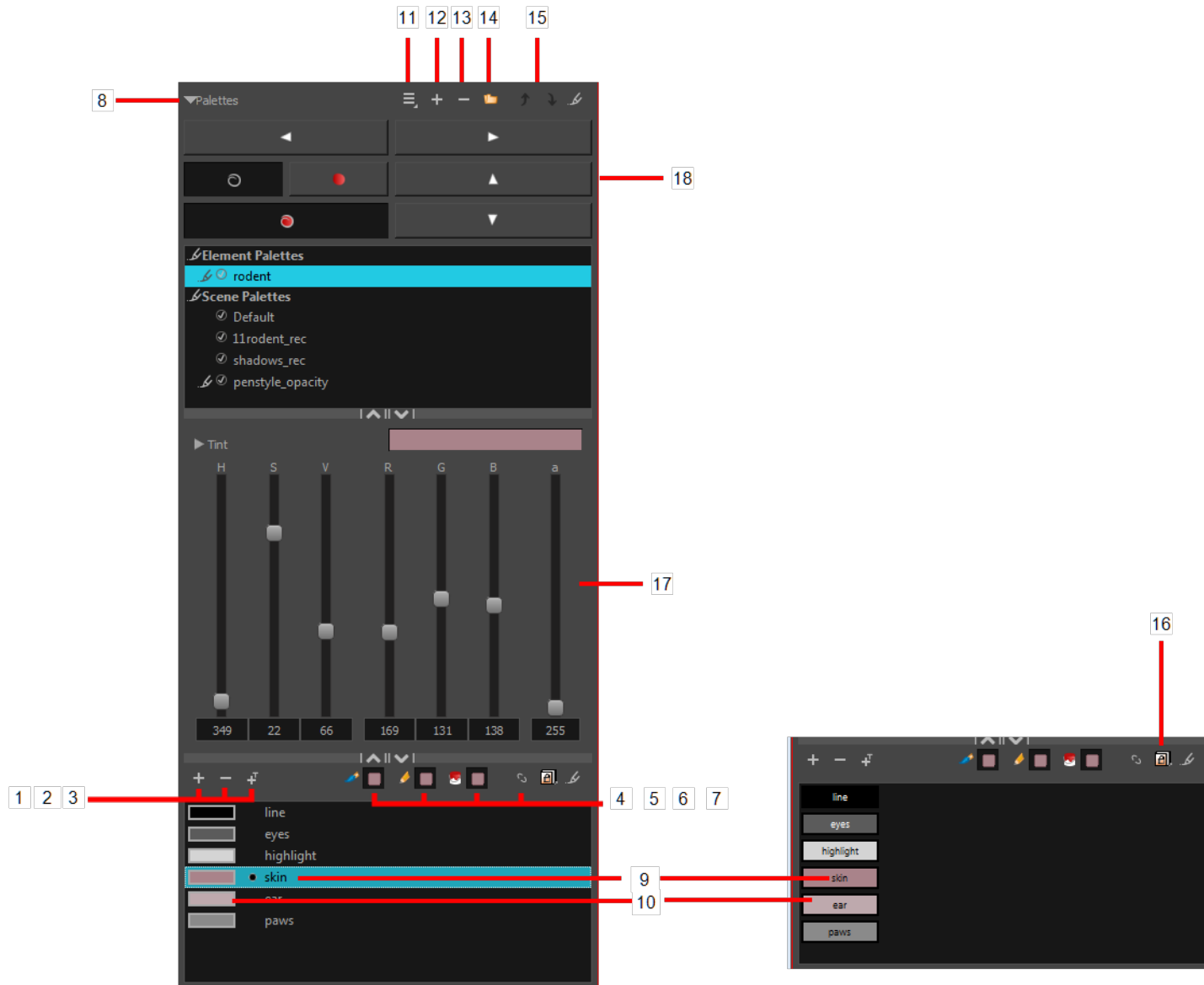

The Colour view has two display modes:

- List mode
- Swatch mode

How to switch between the display modes

1. From the Colour View menu, select **Colours > Swatch Mode** and do one of the following:
 - Select the option to display the swatches.
 - Deselect the option to display the colour list.

When you are painting on bitmap layers, the Colour view will look like the following. It contains a subset of the tools available when working with vector layers.

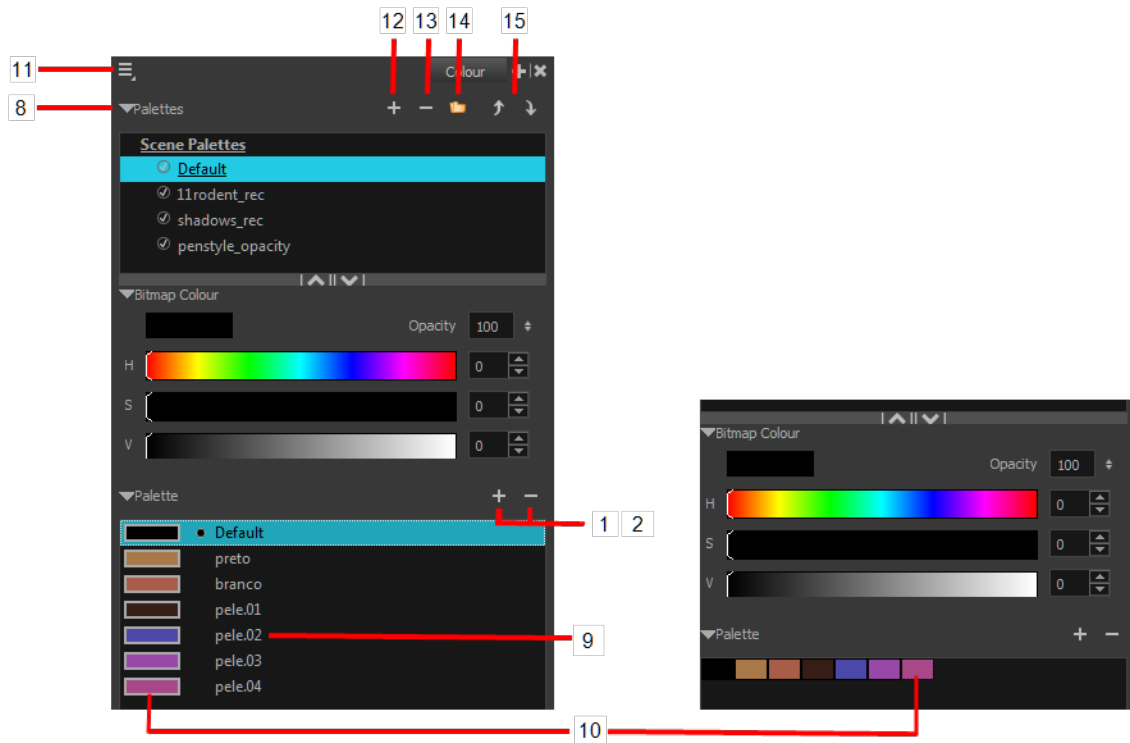

1. Add Colour

The Add Colour **+** button lets you add a new colour swatch to the bottom of your colour list.

2. Remove Colour

The Remove Colour **-** button lets you delete the currently selected colour swatches. If the colour swatch is used in your project, the Delete Colour dialog box will appear asking you to confirm the operation.

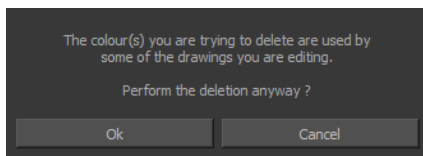

- ▶ Click **OK** to confirm the operation or **Cancel** to cancel it.

Zones painted with colour swatches which have been deleted will turn red, easily identifying them so you can repaint them with another colour swatch.





3. Add Texture









The Add Texture  button lets you add a bitmap colour swatch to your palette. You can load photos and textures and paint your drawings with it. The bitmap image must be a TGA or PSD file format.



4. Set Current Brush Colour

The Set Current Brush Colour  button let you set the currently selected colour swatch as the colour used by the Brush  tool. If you select a new colour in the Colour view while using the Brush tool, the Set Current Brush Colour swatch will be updated.

5. Set Current Pencil Colour

The Set Current Pencil Colour  button lets you set the currently selected colour swatch as the colour used by the Pencil , Polyline , Ellipse , Rectangle  and Line  tools. If you select a new colour in the Colour view while using any of these tools, the Set Current Pencil Colour swatch will be updated.

6. Set Current Paint Colour

The Set Current Paint Colour  button lets you set the currently selected colour swatch as the colour used by the Brush  tool. If you select a new colour in the Colour view while using the Paint tool, the Set Current Paint Colour swatch will be updated.

7. Link/Unlink Three Colours

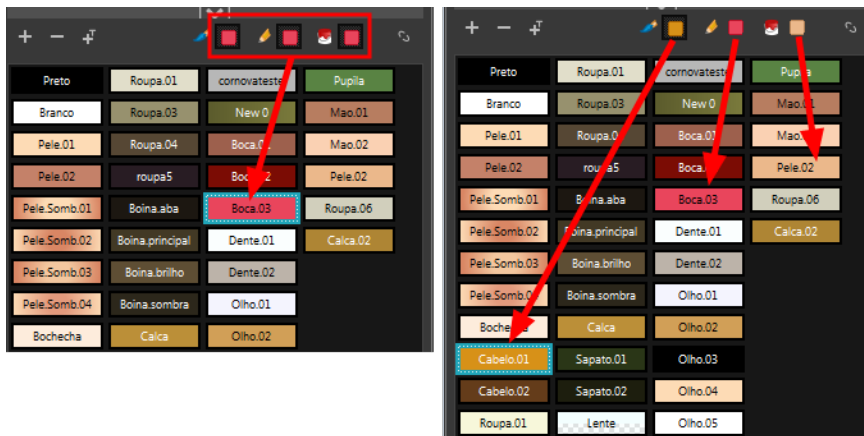

The Link/Unlink Three Colours  button lets you link the Set Current Brush Colour, Set Current Pencil Colour and Set Current Paint Colour switches to the currently selected colour swatches in the Colour view.

8. Show/Hide Palette List View

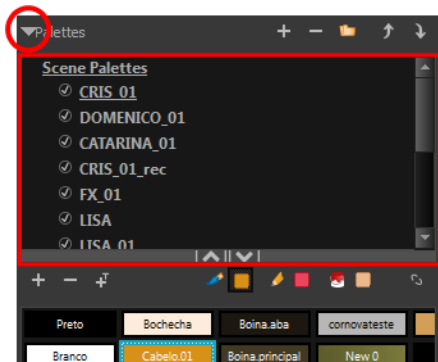

The Show/Hide Palette List View button lets you display the Palette List view in the Colour view. This option is for the advanced user who wants to create colour palettes for their props and characters.

9. Colour Swatch Name

	Skin
	Teeth
	Horns
	Helmet

Each colour swatch available in the Colour view can have its own name, making it easy to identify which colour is used to paint what part of your character or background.

Two colours can have the same name.

10. Colour Swatch



A colour swatch is a specific colour used to paint a certain zone of a character or background. Colour palettes are composed of colour swatches. They can also be called *colour pots*. When you paint a zone with a colour swatch, the zone is linked to the swatch. So if you update the swatch's tint, the zone will be updated along with it. This allows you to modify your animation colours even after it is completely painted.

11. Colour View Menu

The Colour view  menu lets you access commands related to the Colour view such as creating new palettes, adding new colour swatches, and displaying the Tint panel.

12. Add Palette

The Add Palette  button lets you add a new palette to the bottom of your palette list.

13. Remove Palette

The Remove Palette  button lets you delete the currently selected palette. If the colour swatch is used in your project, zones painted with colour swatches which have been deleted will turn red, easily identifying them so you can repaint them with another colour swatch.



Nautilus © Gava Productions and Indiana Productions

14. Link Palette

The Link Palette button lets you access other palettes created in the project and link them to your scene.

15. Order Palette List

The Up and Down arrows let you reorder the selected palette. When using clone palettes (colour styles), the highest palette in the list will override its clone located lower in the list.

16. Edit Palette Mode

In Network mode, the Edit Palette Mode  button lets you get the rights to modify the palette. The palette files can be locked to avoid accidentally modifying the palette.

17. Colour Editor

The Colour Editor panel allows you to modify the HSV and RGBA values of the selected colour without using the Colour Picker window.

18. Drawing Navigation and Art Layers

These controls are used to quickly have access to common commands.



- **Previous and Next Drawing**

These buttons let you switch to the previous or next drawings. The shortcuts are F and G.



- **Previous and Next Layer**

These buttons are used to switch to the previous or next layer when you have different layers loaded. The shortcuts are H and J.

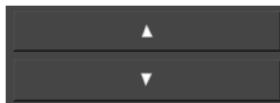

- **Line Art, Colour Art, Preview Mode**

Use these buttons to toggle between the Line Art to Colour Art layers. The shortcut is L. You can also enable or disable the Preview mode. The shortcuts are Shift + P.



Drawing View

Only the selected drawing is displayed by default in the Drawing view. You can use features, such as the light table to display the current drawing of all the enabled layers of your scene in washed-out colours, or the Onion Skin to display the previous and next drawings of the currently selected drawing layer.

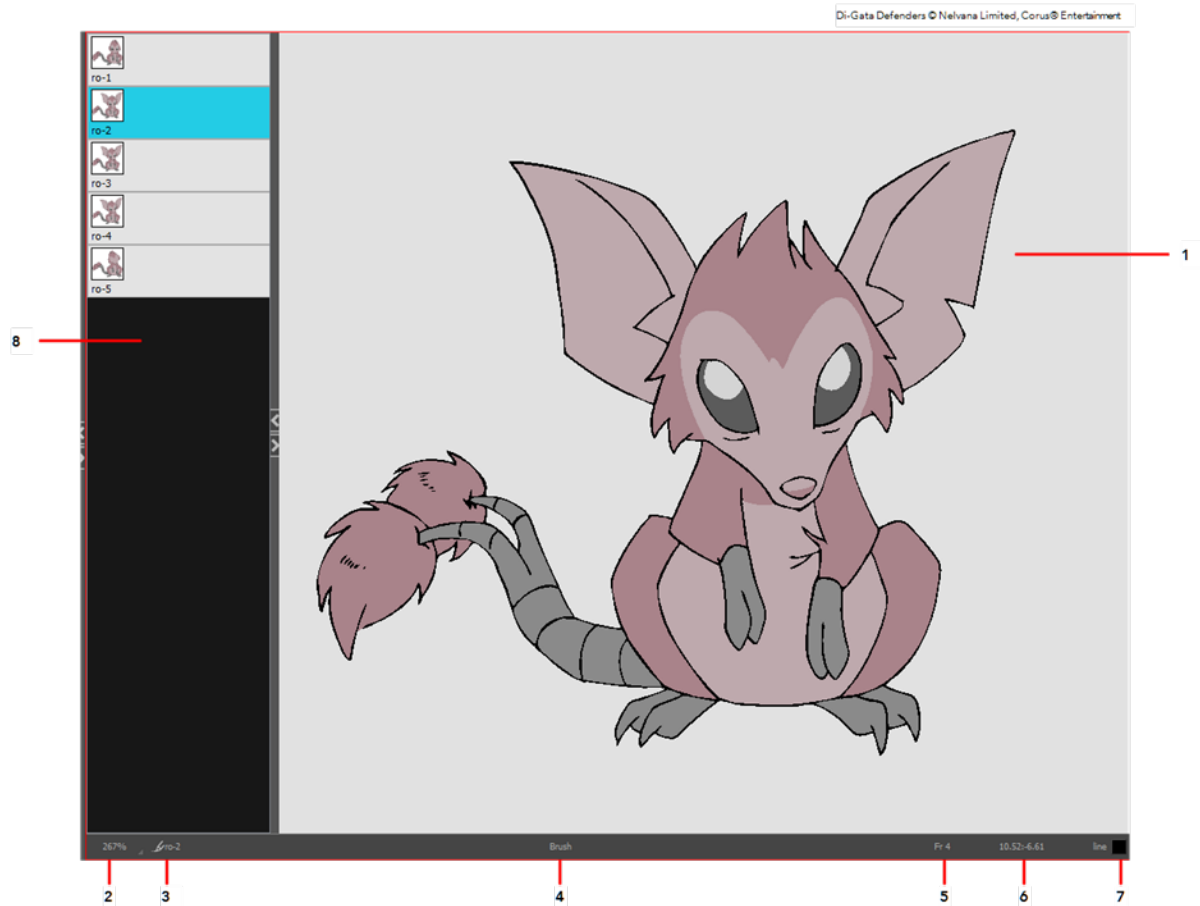

1. Drawing Area

This is the main space in the Drawing view. It is where you draw and where the drawings are displayed.

2. Zoom Menu

The Zoom menu lets you enlarge or reduce the Camera or Drawing view display.

To make the camera frame size always match the size of your view, select the **Fit to View** option. Click the drop-down arrow and select a zoom level or press 1 and 2.

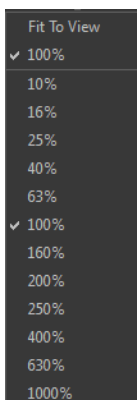

3. Drawing Name

The Drawing Name field displays the name of the selected drawing, as well as the layer containing it. If the cell does not contain any drawing, an **Empty Cell** text is shown in the field.

4. Tool Name

The Tool Name field displays the name of the selected tool. If you temporarily override a drawing tool using a keyboard shortcut, the tool's name will be highlighted in red. You can temporarily override a tool by holding its keyboard shortcut without the [Alt] key. For example, the Select tool shortcut is Alt + S. If you hold down [S], you will switch to the Select tool. As soon as you release the key, you will return to the tool you were using.

5. Current Frame

This field displays the current frame of the animation you are working on.

6. Cursor Coordinates

This indicates the position of the mouse cursor in the drawing area.

7. Colour Picker

The Colour Picker allows you to select a colour for drawing.

8. Drawing Thumbnails Panel

The Drawing Thumbnails panel displays a list with thumbnails of the loaded drawings. The highlighted drawing is the one displayed in the drawing area. You can select the drawing you want to paint directly from this list.

Message Log View

The Message log view displays information gathered during a render task, such as which frames and at what time they were each rendered. The view also contains a list of the colour recovery operations.

```

Message Log + X
T 17:04:39.202 Color recovery disabled - 1 colors not found in palette list [C:/Toon Boom
Projects/Harmony/HAR11/TB_magazine/Guru_Nautilus/Ale/_LINEUP/_elements/fundilhos]
T 17:04:39.206 Color recovery disabled - 1 colors not found in palette list [C:/Toon Boom
Projects/Harmony/HAR11/TB_magazine/Guru_Nautilus/Ale/_LINEUP/_elements/piru]
T 17:04:39.212 Missing palette [C:/Toon Boom Projects/Harmony/HAR11/TB_magazine/Guru_Nautilus/Ale/_LINEUP/_jobs/Digital/palette-
library/STILPEN_JOV_01.plt]
T 17:04:39.214 Color recovery disabled - 2 colors not found in palette list [C:/Toon Boom
Projects/Harmony/HAR11/TB_magazine/Guru_Nautilus/Ale/_LINEUP/_elements/fivela.632]
T 17:04:48.323 Color recovery for palette list [C:/Toon Boom Projects/Harmony/HAR11/TB_magazine/Guru_Nautilus/Ale/_LINEUP_]
T 17:04:48.323 14 colors recovered and 0 palettes loaded
T 17:04:48.323 Colors: [Pele.01] [New 12] [New 15] [Arma.02] [New 14] [Pele.01b] [New 0] [Braceleta] [Cinto.02] ...

T: 17:16:52.626 Missing palette [C:/Toon Boom Projects/Harmony/HAR11/TB_magazine/Guru_Nautilus/Ale/_LINEUP/_jobs/Digital/palette-
library/STILPEN_JOV_01.plt]
T: 17:16:52.789 Missing palette [C:/Toon Boom Projects/Harmony/HAR11/TB_magazine/Guru_Nautilus/Ale/_LINEUP/_jobs/Digital/palette-
library/PUOCK_01.plt]
T: 17:16:53.153 Missing palette [C:/Toon Boom Projects/Harmony/HAR11/TB_magazine/Guru_Nautilus/Ale/_LINEUP/_jobs/Digital/palette-
library/CRIS_01.plt]
T: 17:16:53.299 Missing palette [C:/Toon Boom Projects/Harmony/HAR11/TB_magazine/Guru_Nautilus/Ale/_LINEUP/_jobs/Digital/palette-
library/CRIS_01.plt]
T: 17:16:53.378 Missing palette [C:/Toon Boom Projects/Harmony/HAR11/TB_magazine/Guru_Nautilus/Ale/_LINEUP/_jobs/Digital/palette-
library/CRIS_01.plt]
T: 17:16:53.383 Missing palette [C:/Toon Boom Projects/Harmony/HAR11/TB_magazine/Guru_Nautilus/Ale/_LINEUP/_jobs/Digital/palette-
library/CRIS_01.plt]
T: 17:16:53.602 Missing palette [C:/Toon Boom Projects/Harmony/HAR11/TB_magazine/Guru_Nautilus/Ale/_LINEUP/_jobs/Digital/palette-
library/STILPEN_JOV_01.plt]
T: 17:17:25.094 Color recovery disabled - 1 colors not found in palette list [C:/Toon Boom
Projects/Harmony/HAR11/TB_magazine/Guru_Nautilus/Ale/_LINEUP/_elements/Lingua.409]
T: 17:17:25.095 Color recovery disabled - 1 colors not found in palette list [C:/Toon Boom
Projects/Harmony/HAR11/TB_magazine/Guru_Nautilus/Ale/_LINEUP/_elements/Coxa.475]
T: 17:17:25.095 Color recovery disabled - 1 colors not found in palette list [C:/Toon Boom
Projects/Harmony/HAR11/TB_magazine/Guru_Nautilus/Ale/_LINEUP/_elements/Nariz.01]
T: 17:17:25.119 Color recovery for palette list [C:/Toon Boom Projects/Harmony/HAR11/TB_magazine/Guru_Nautilus/Ale/_LINEUP_]
T: 17:17:25.119 3 colors recovered and 0 palettes loaded
T: 17:17:25.120 Colors: [Boca.01] [Calca.01a] [Pele.01b]
T: 17:17:25.120 Rendering frame 1
T: 17:17:27.194 Rendering frame 2
T: 17:17:27.207 Rendering frame 3
T: 17:17:27.350 Rendering frame 4
T: 17:17:28.518 Color recovery for palette list [C:/Toon Boom
Projects/Harmony/HAR11/TB_magazine/Guru_Nautilus/Ale/_LINEUP/_elements/Orelha.357]
T: 17:17:28.519 1 colors recovered and 0 palettes loaded
T: 17:17:28.519 Colors: [Pele.03]

```

Model View

Once you have a fully painted drawing, you can use it as a colour model and load it in the Model view. This drawing can be used and loaded in any of your Harmony scenes.

Once a drawing is loaded in the Model view, you can use the Dropper  tool to select a colour from the model and use it to paint in the Camera or Drawing view without having to pick the colour from the colour palette.

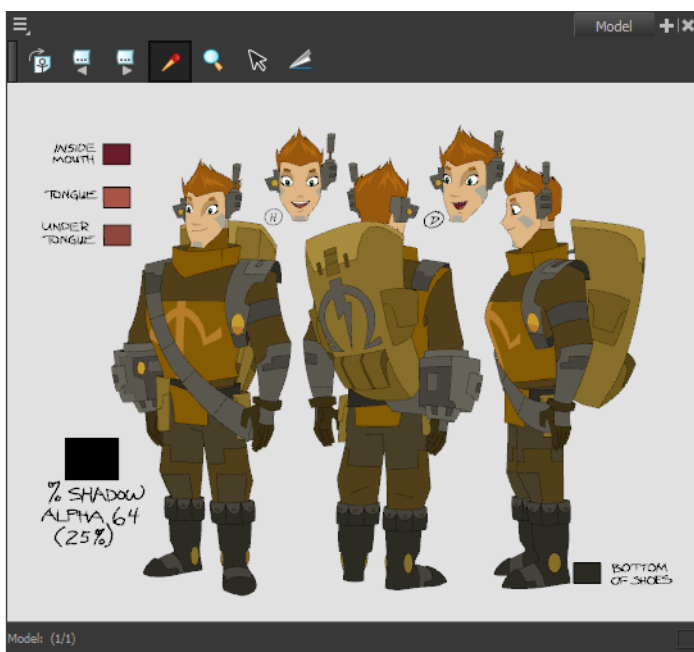

Erik, Di-Gata Defenders © Nelvana Limited, Corus® Entertainment Inc.

Tool Properties View

The contextual Tool Properties view contains the most common options and operations related to the currently selected tool. As soon as you select a tool from the Tools toolbar, the Tool Properties view updates.

For example, if you choose the Select tool in the Tools toolbar, the Tool Properties view will display the options and operations related to the Select tool, such as Snap to Contour, Apply to All Drawings, Flip Horizontal, and Flatten.

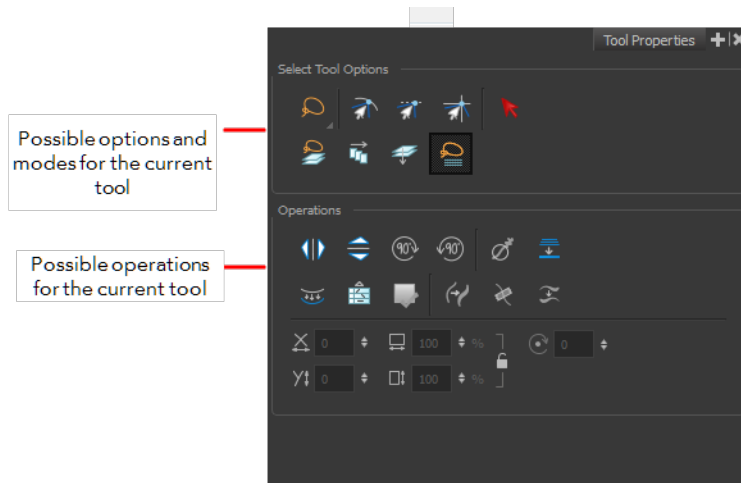

Options

Options are different modes you can apply to a selected tool to modify its behaviour to fit the current task's needs.

Operations

Operations are actions you can perform while using the selected tool.

Toolbar References

Harmony has several toolbars. The Top toolbars are available at the top of the interface and the View toolbars are in individual windows. View toolbars are only shown if the particular view is displayed in the workspace. This is a complete list of the toolbars available in Toon Boom Harmony.

Top Toolbars

Edit Toolbar

The Edit toolbar contains common operations such as Copy, Paste, Cut, Undo and Redo. These options can also be found in the Edit menu.



File Toolbar

The File toolbar contains the common file operations such as New, Save and Open. These options can also be found in the File menu.



Tools Toolbar



The Tools toolbar contains all of the main tools you will use while working in Harmony. In the default workspace, you will find this toolbar on the left-most side of the interface.

View Toolbars

Here is a list of the view toolbars available in Harmony:

- Model View Toolbar

Interface Navigation

Toon Boom Harmony supports zoom in, zoom out, rotate, pan and reset view for easy interface navigation for the views.

Command	Action	Access Methods
Zoom In	Zooms into the view.	View > Zoom In Press 2 or roll the mouse wheel up. In the Timeline view, press Ctrl (Windows/Linux) or ⌘ (Mac OS X) and roll the mouse wheel up.
Zoom Out	Zooms out of the view.	View > Zoom Out Press 1 or roll the mouse wheel down. In the Timeline view, press Ctrl (Windows/Linux) or ⌘ (Mac OS X) and roll the mouse wheel down.
Zoom In or Out	Zooms in or out of the view.	Roll the middle mouse button up or down.
Pan	Moving parallel to the view.	Hold down the Spacebar and drag the mouse in the direction in which you want to pan the view.
Recenter view	Recenters the view on your mouse cursor.	Press N
Reset Pan	Resets the view's pan to its default position.	View > Reset Pan Press Shift + N
Reset View	Resets the view to its default position.	View > Reset View Press Shift + M
Reset Rotation	Resets the view's rotation to its default position.	View > Reset Rotation Press Shift + X
Reset Zoom	Resets the view's zoom to its default position.	View > Reset Zoom
Rotate 90 CW	Rotates the Camera view 90 degrees	View > Rotate View CW

	clockwise, like an animation table.	
Rotate 90 CCW	Rotates the Camera view 90 degrees counter-clockwise, like an animation table.	View > Rotate View CCW
Toggle Quick Close-up	<p>Use the Magnifier tool to quickly center on the mouse position and zoom in to a pre-defined value such as 4X. Then you can zoom out again. Hold the shift key and press Z to zoom in and back out again. Replacing the Reset Zoom by pressing Shift +.</p> <p>The area where you zoom in or out is dependent on the cursor location in the Camera view. If you zoom in and then move the cursor to a different location when you zoom out the mouse will be centered on that location.</p>	



Zoom Tool

From the Tools toolbar, use the Zoom  tool to zoom in and zoom out in the Camera or Drawing view.

- The keyboard shortcuts are 1 and 2.
- When the Zoom In mode is selected, hold Alt as you click to zoom out.

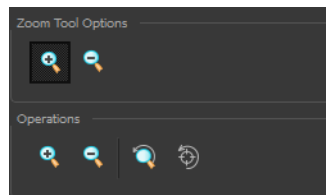
When you select the Zoom tool, its properties are displayed in the Tool Properties view.



Zoom Tool Options	Button	Description
Zoom In		Zooms in
Zoom Out		Zooms out
Operations	Button	Description
Perform Zoom In		Zoom in the Camera or Drawing view. The keyboard shortcut is 2.

Perform Zoom Out		Zoom out the Camera or Drawing view. The keyboard shortcut is 1.
Reset Zoom		Restores the current zoom level to 100%.
Reset View		Restores the original display by resetting any pan, rotation or zoom actions.

Chapter 6: Character, Prop and Location Design

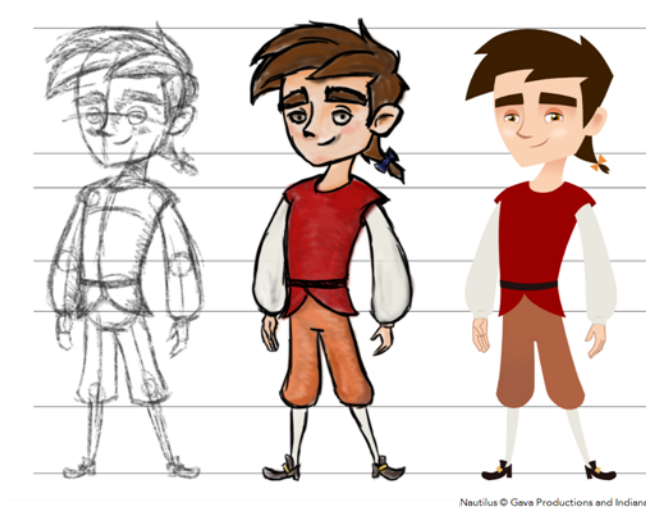

Another important step in the project creation is the character, prop and location design. This determines the style and models to follow for the entire project.

The design can be created on paper and scanned in or it can be created digitally. You can draw and even create the colours entirely on paper, while others like to design on paper and scan the drawings to create the colour model in a software program. The most popular method is to design directly in Harmony.

To save paper and time and avoid having to recreate colour palettes, Harmony gives you the ability to design all elements directly in the application. This keeps all your work within the same software, avoids using a lot of paper and losing time scanning in elements and importing them.

The character and prop design process is divided in three steps:

- [Preparation on the next page](#)
- [Sketching the Model on page 65](#)
- [Cleaning and Inking the Model on page 77](#)

Harmony has an extensive set of drawing tools that can be used to design your characters. You can learn more about this in the following topic:

- [Drawing Tasks on page 79](#)

Each drawing tool has a series of options to customize its behaviour and drawing style. You can learn more about them in the following section:

- [Drawing Tool References on page 134](#)

Preparation

To prepare for the design task, you will need to go through a few steps:

- [Getting References below](#)
- [Using the Workspace below](#)

Getting References

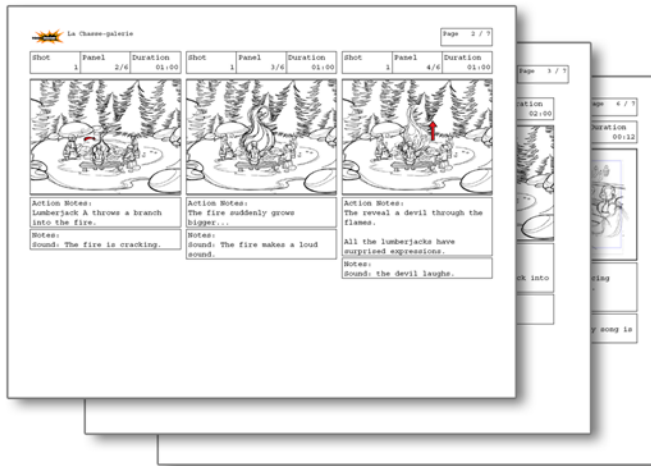

Creating models requires two main reference sources, the script and the storyboard. Once you have the script in hand, you can learn about the characters and their personalities, the props, the ambiances, and so on. This will be your main reference, so it is very important to read it carefully.

The storyboard is the second reference source and it can be quite useful as well. Although it will not yet be the final version of the storyboard, it will show you what the character is doing and what props need to be designed.

Using the Workspace

Once your scene is created, you can open it and set your workspace.

To sketch the characters, props or locations directly in Harmony, you will mostly use the Drawing view along with the Colour, and Tool Properties views.

Sketching the Model





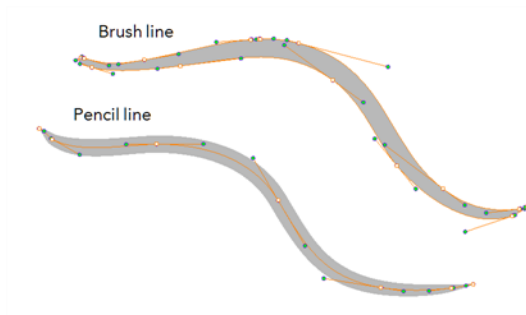

Now that your references and scene are created, you can start designing. To draw your characters, props and key locations, you will need to learn the following:

- [Drawing with the Brush or Pencil Tool below](#)
- [Override Tool on the next page](#)
- [Relative Size on page 67](#)
- [Palettes and Colours on page 70](#)
- [Sketching the Character on page 74](#)

Drawing with the Brush or Pencil Tool



The Brush  and Pencil  tools are used for drawing and sketching. Both tools support pressure sensitivity, allowing you to create lines with variable thickness. The Brush tool produces contour vector lines. The Pencil and shape tools produce central vector lines. This means that a pencil line's control points (used to deform its shape) are located along the length of the central spine, while the Brush line's control points are located along the contour.

- If you draw with the Brush tool and want to modify the thickness, use the Contour Editor  tool.
- If you draw with the Pencil tool and want to modify the thickness variation, use the Pencil Editor  tool.
- You can also convert a brush zone into a pencil line with the Brush Stroke to Pencil Line  option.

If you sketch a drawing using a semitransparent colour to get a paper-like feel, you should use the Brush tool as it produces a more realistic and natural feel. The pencil line is very useful for tracing clean or final drawings.

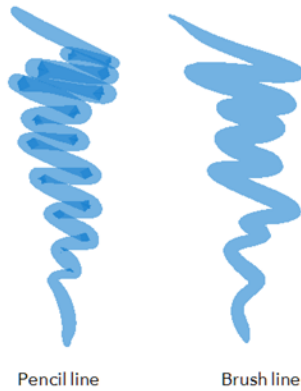

Also, it is recommended to use brush lines when designing cut-out puppet articulations which use patches.

Override Tool

The Override tool lets you increase productivity by rapidly switching between tools used for short tasks and your previous tool. Most drawing tool shortcuts are accessed using the Alt key followed by another key, such as the Eraser tool which is accessed by pressing Alt + E.

If you are drawing with the Brush tool and need to briefly switch to the Eraser before continuing, hold down the E key while you are erasing. Once you are done, release the E key to return to the previous tool; in this case, the Brush tool. You can do the same for most drawing tools that have a shortcut composed of Alt followed by another key.

Relative Size



The size relation between the props, characters and backgrounds is very important in maintaining consistency and structure throughout the project.

A production can contain many characters and props. It is not unusual for these to be created by different people. If there is no size control implemented, the characters and elements created by different artists can vary greatly. When this occurs, the characters that are placed together in a scene will be out of proportion. The animator or person doing the scene setup will then have to scale them to the correct size.

When a character or prop is scaled down, the outline will become increasingly thinner. By the time the element is scaled to its proper size, the outline may be so thin that a difference between one character's outline and the one beside it will not look very good.

Here are a few tips you can use to create a suitable size relation.

Line Up



A line up consists of copying and pasting all your character designs into the same drawing and then scaling them to the correct proportion in relation to the other characters. This line up is very important and should be handed to any animator, layout and posing artist or scene setup person working on the project.

For the prop design, it is recommended that you paste one of the main character's hands or even the full body beside the prop. This enables the animator to know what size to draw the prop.

In your character design scene, it is a good idea to create a column for the character line up. The line up is usually done during the character design step. When the character builder imports the model to the breakdown scene, the size relation should be correct.







Field Chart



Harmony includes a field chart in its Drawing view. This tool is very useful in setting the characters' and props' heights.

It is recommended that you keep the character design and breakdown inside the 12 field size. This ensures that it fits the default camera size and the template thumbnails. If some parts were drawn too big or too far apart, you can use the Reposition All Drawings tool and reposition, scale or rotate multiple drawings from different layers all at once.

Use the Show Grid option to display a grid in the Drawing view.

Name	Button	Description	Keyboard Shortcut
Show Grid		Displays the grid	From the top menu, select View > Grid > Show Grid Press Ctrl + ' (Windows/Linux) or ⌘ + ' (Mac OS X).
Square		Displays a standard square grid	From the top menu, select View > Grid > Square .
12 Field Grid		Displays a 12-field size grid	From the top menu, select View > Grid > 12 Field Grid .
16 Field Grid		Displays a 16-field size grid	From the top menu, select View > Grid > 16 Field Grid .
Underlay		Displays the grid under the drawing elements	From the top menu, select View > Grid > Underlay
Overlay		Displays the grid over the drawing elements	From the top menu, select View > Grid > Overlay

How to use the Reposition All Drawings

1. In the Tools toolbar from the Select drop-down menu, select the Reposition All Drawings  tool. This also automatically selects every stroke in your drawing in the Drawing view.
2. To deform or reposition a selection:
 - To reposition, click and drag your selection to a new area.

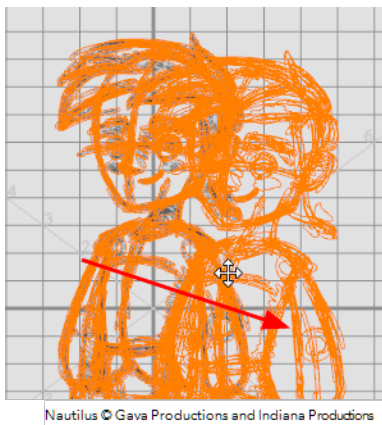

- To scale, pull or push on the top, side, bottom or corner control points. Hold down Shift to lock the selection's ratio.

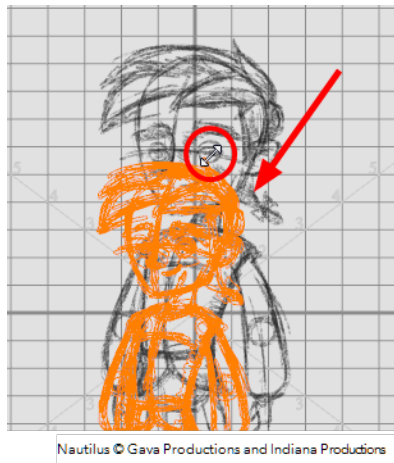

3. When you release your cursor, every drawing contained in the drawing layer you repositioned, scaled, rotated or skewed will follow the same transformation.

Brush Size

Harmony provides a variety of pens and brushes and also allows you to create and save your own through creating a tool preset.

It is a good idea to create and save pens with precise sizes and parameters to trace and design your models and breakdowns.

Palettes and Colours

Harmony has an integrated palette system. Each character, prop or background can have its own set of colours and each colour in the palette can be associated to colour fill zones on a drawing. You can create as many palettes and colours as you need.

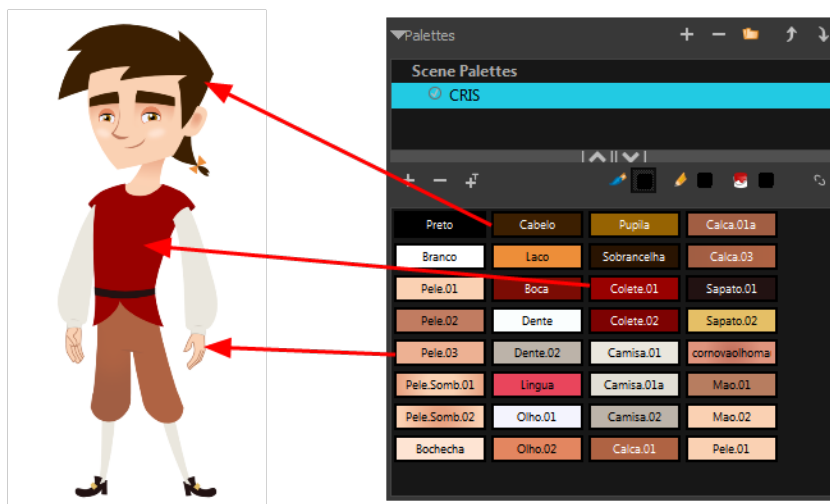

Each scene created in Harmony includes a default colour palette which contains a standard set of colours for sketching and painting.



You can sketch and design using the default palette without any problem. However, it is not recommended that you use the default palette for the colour models. A different colour palette should be created for each colour model.

To sketch and design with a different colour swatch or create a palette for each character, prop or key location, you will need to learn how to manage the Harmony palettes.

How to create a new palette (Basic Palette Lists mode)

- From the Colour View menu, select **Palettes > New** or click the New Palette **+** button.
 - Make sure that you have the necessary rights to modify the palette list. If you do not, select **Edit > Edit Palette List Mode**.

The Create Palette window opens.

- Enter the palette name according to the model.

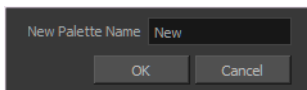

- Click **OK**.

The palette appears in the drawing element's palette list.

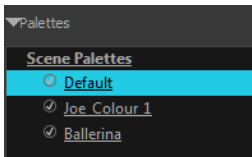

How to lock or unlock the palette list

- In the Colour view, click the Edit Palette Mode  button.

A grey pencil icon appears in the top-right corner of the Palette list.

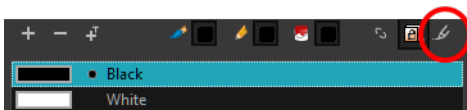

How to add or modify a solid colour swatch

- In the Colour view, click the New Colour **+** button.
- From the Colour View menu, select **Colours > Edit** or double-click on the colour swatch.

The Colour Picker window opens.

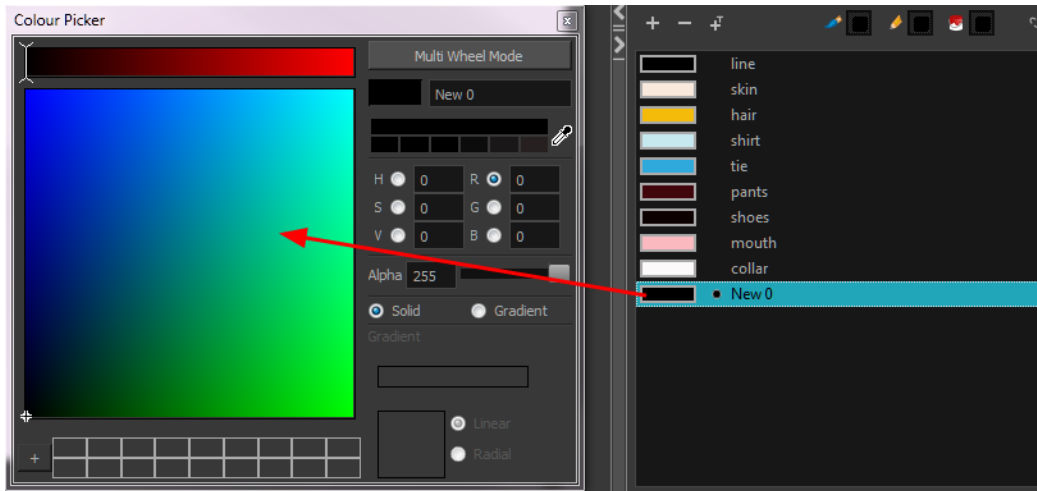

3. To set your colour, do one of the following:

- ▶ In the colour wheel, select a colour.
- ▶ Enter the HSV or RGB values in the corresponding fields. Select the **R,G,B,H,S** or **V** options to change the look of the colour picking area.

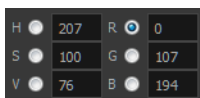

- ▶ Click the Dropper  button to select any colour on your screen. It can be from the Toon Boom Harmony interface, your operating system or any other open application.

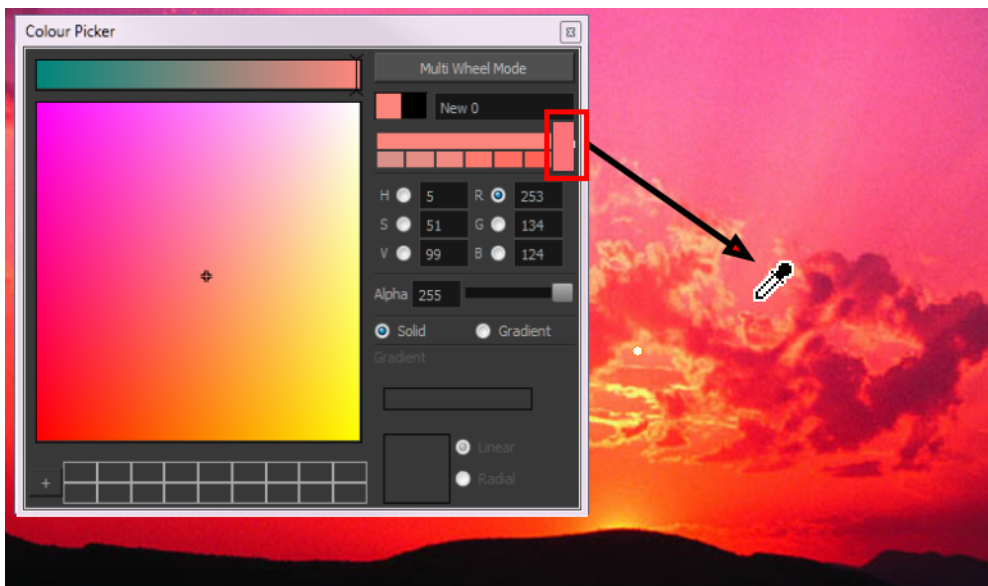

You can also click **Multi Wheel Mode** to open the Multiwheel Colour dialog box. This displays all the picking area styles together and also contains a picking undo list. To return to the regular Colour Picker window, click **Single Wheel Mode**.

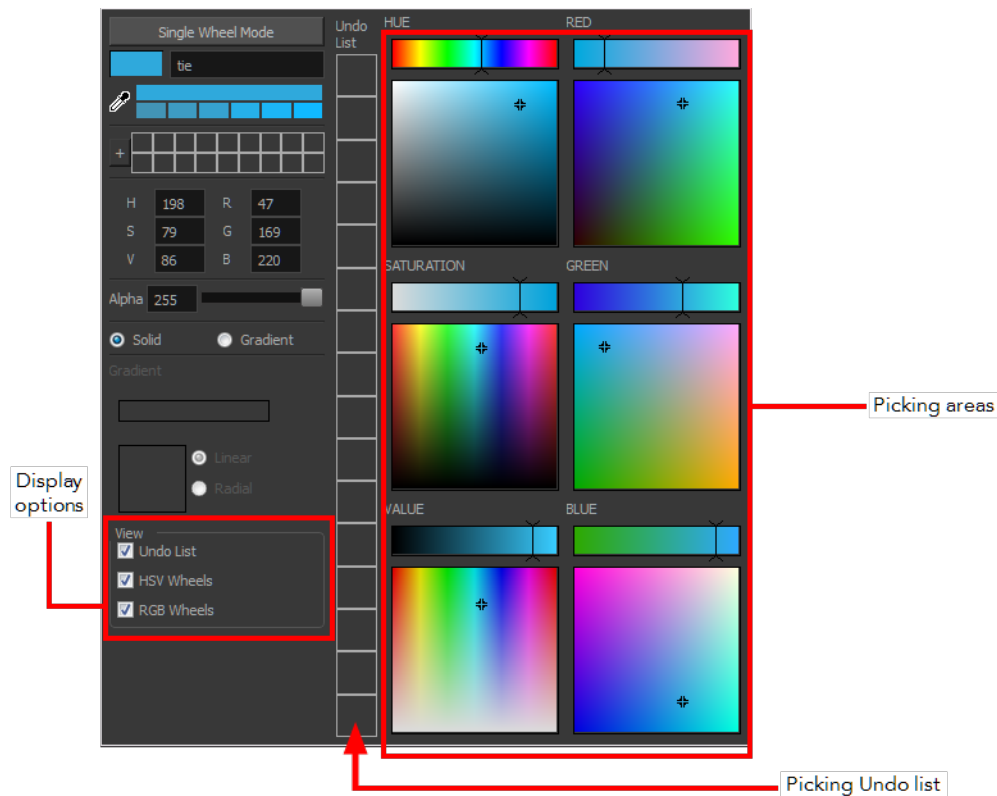

- Click on the Shade Scale swatches to modify the shade of the selected colour.



- Adjust the desired level of transparency with the Alpha slider, or type the value directly in the Alpha field.



- Click the **Add** button to add the current selected colour to the Colour Storage Library, so you can quickly access it later.



- You can rename the colour swatch in the Colour Picker window or directly in the colour list by double-clicking on its name.

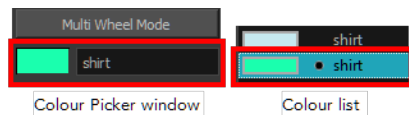

Sketching the Character



You are now ready to sketch your models. There are two tasks to perform in order to draw your characters:

- Add a drawing layer
- Sketch the model

You have the choice to sketch your model as a bitmap or vector drawing. If you like the feel of drawing with bitmap lines, you can set your layer as bitmap. If you like drawing with vectors, you can set your layer as vector. If you use vector, you will be able to enlarge your drawing and zoom into it without losing quality or resolution. You can also use the Contour Editor and Select tools to resize and modify lines. If you draw with bitmap, you will not be able to scale the drawing beyond 100% of its resolution without encountering pixelization issues.

If you would like to separate your lines and colours on separated art layers, see [Art Layers on page 226](#)

How to sketch a model

1. In the Tools toolbar, select the Brush  tool or press Alt + B.
2. In the Tool Properties view, select a brush preset and adjust its parameters.

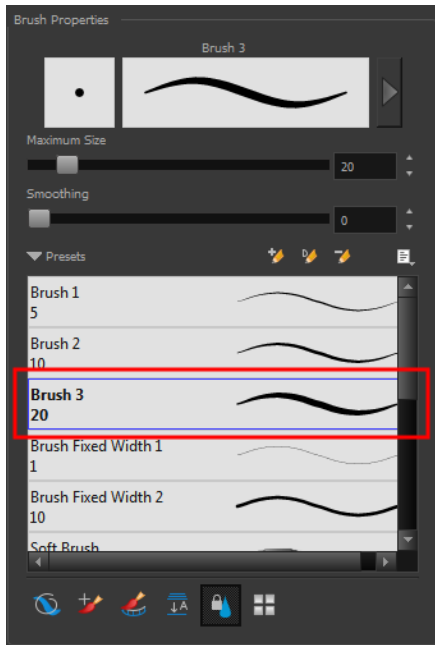

3. In the Drawing Thumbnails panel, select a drawing.
4. In the Drawing view, enable the Grid (Field Chart). You can press Ctrl + ' (Windows/Linux) or ⌘ + ' (Mac OS X).
 - Make sure the Drawing view is the active view while using the keyboard shortcut.
5. In the Drawing view, start drawing.



6. To select a different colour, in the Colour view, select a different colour swatch. Double-click on the colour swatch to open the Colour Picker window and modify the colour. Remember that anything already painted with that colour swatch will update to the new colour.

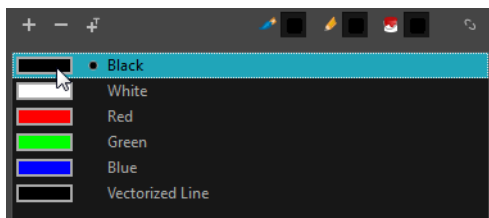

7. In the Drawing view, use the Rotary Table  to rotate your workspace. You can press Ctrl+Alt (Windows/Linux) or Ctrl+⌘ (Mac OS X).

- ▶ The default keyboard shortcut to reset the workspace rotation is Shift + X.

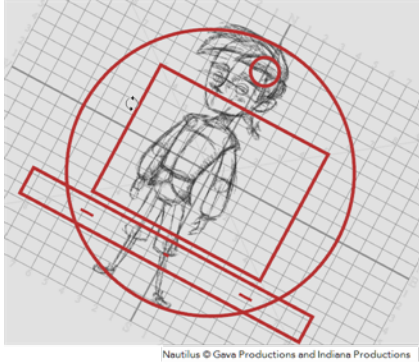

8. If you decide to draw in the next cell and need to see your previous drawing, enable the Onion Skin by pressing Alt + O.

Cleaning and Inking the Model



When your rough models are ready, it is time to clean and ink them. You can still use the default palette and colours to do so, especially if you are not the one doing the colour styling. If you have already created a palette for your model, you can add new colours for tracing.



If you want to keep your roughs and sketches, add a new drawing layer and trace in it using the Light Table. This is the equivalent of adding a sheet of paper and tracing over the rough using the animation disk light table. You only need to disable the rough layer to prevent it from appearing in the final scene render.

If you would like to separate your lines and colours on separated art layers, see [Art Layers on page 226](#)

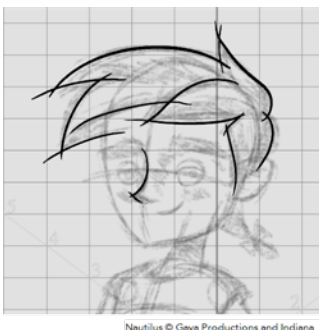

How to trace your character

1. In the Drawing Thumbnails panel, select the drawing to trace in.
2. If you work in the Drawing view, enable the Light Table  or press Shift + L.
3. Do one of the following:
 - In the Tools toolbar, select a drawing tool.
 - From the top menu, select **Tools > desired tool**.
4. Trace the model.

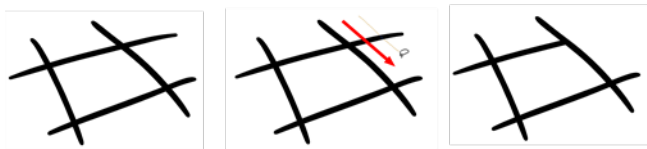
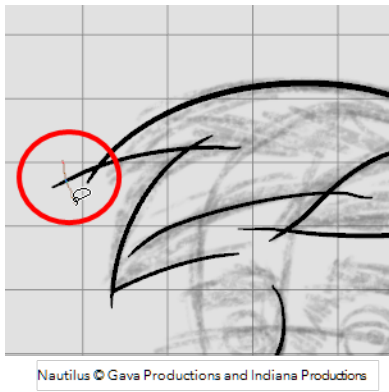

5. To make perfect points and corners, you can intersect the two strokes to create a point. Using the Cutter  tool, you can automatically trim the excess portion. In the Tool Properties view, enable the Lasso  selection type. Make sure the Use Mouse Gesture  button is enabled. In this mode, you can automatically delete any extra sections of line in your artwork by simply clicking, holding and dragging your mouse over it.



6. If you are using the Pencil tool to clean your drawing, you will need to merge your pencil lines together after cropping the points.
 - ▶ In the Tools toolbar, select the Select  tool.
 - ▶ In the Drawing view, select the two strokes to be merged.
 - ▶ In the Tool Properties view, click the Merge Pencil Lines  button.

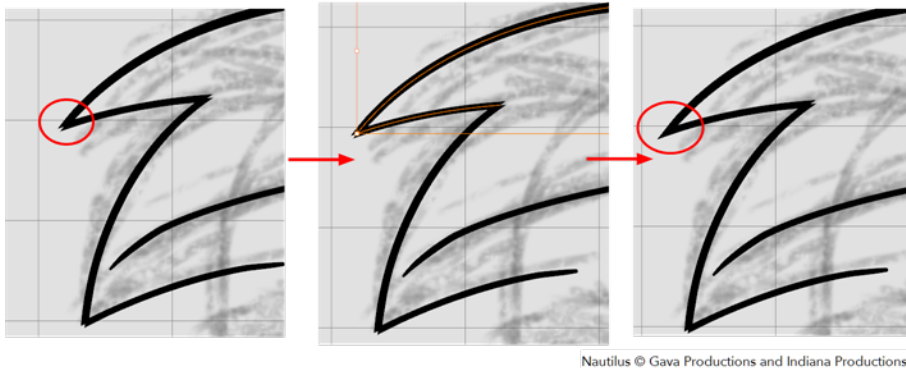

- ▶ You can also set the Join option to **Mitre**.

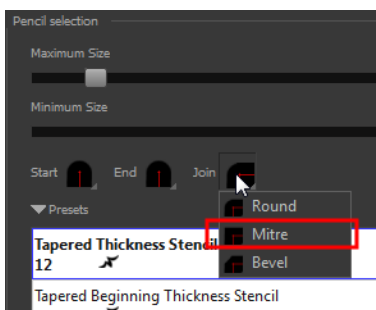

Drawing Tasks

Harmony has a wide variety of drawing tools for all kinds of drawing tasks. This section covers how to use these tools. For the complete details on their options in the Tool Properties view, see [Drawing Tool References](#) on page 134.

In this topic, you will learn about:

- [Drawing with the Pencil Tool](#) below
- [Drawing with the Brush Tool](#) on page 88
- [Drawing with Textured Brushes](#) on page 94
- [Viewing the Final Lines as You Draw](#) on page 105
- [Selecting the Current Colour of a Tool](#) on page 107See "Selecting the Current Colour of a Tool " on page 107
- [Selecting Drawing Objects](#) on page 109
- [Erasing Parts of a Drawing](#) on page 112
- [Reshaping a Drawing Using the Contour Editor Tool](#) on page 114
- [Reshaping Pencil Lines with the Pencil Editor Tool](#) on page 116
- [Drawing with Shapes](#) on page 118
- [Drawing with the Polyline Tool](#) on page 119
- [Drawing with Invisible Lines](#) on page 120
- [Deforming a Drawing with the Perspective Tool](#) on page 122
- [Warping a Drawing with the Envelope Tool](#) on page 123
- [Cutting Drawing Parts](#) on page 125
- [Smoothing Lines](#) on page 126
- [Working With Text](#) on page 127
- [More Drawing Tools](#) on page 127

Drawing with the Pencil Tool

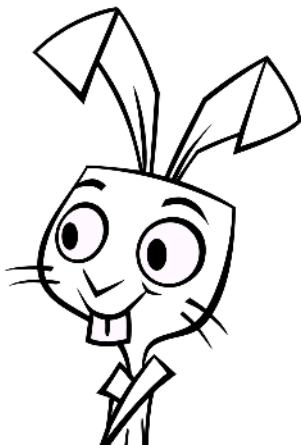

The Pencil tool is for drawing the final images, such as character modules, cut-out puppet and clean animation. The pencil creates a central vector shape. Pencil lines support pressure sensitivity and texture.

How to draw with the Pencil tool

1. Select a drawing from the Drawing Thumbnails panel.
2. In the Tools toolbar, select the Pencil  tool or press Alt + /.
3. In the Colour view, click a colour swatch to select a colour.

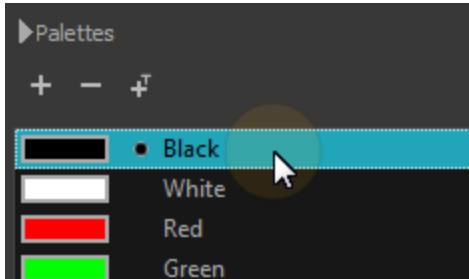

4. In the Drawing view, start drawing.
 - When you get close to an existing pencil line, hold Alt to draw and connect your stroke to the existing one. Pencil lines are central vector lines and you might think your line is connected, but in fact, only the contour is touching the other one. Also, make sure the central vector crosses the other one. To connect the start or end of your stroke, hold Alt when you start or finish drawing a line.
 - To draw a straight line, press Shift + Alt as you draw.

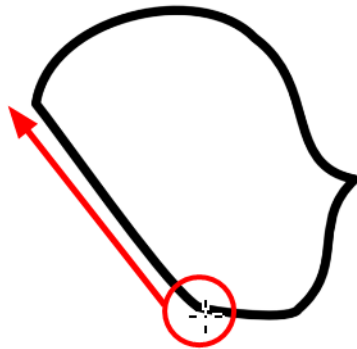

How to modify the pencil settings

1. In the Tools toolbar, select the Pencil  tool or press Alt + /.
2. In the Tool Properties view, the preview area displays the stroke that will be produced after you customize the different parameters in the Tool Properties view. Click the arrow button.

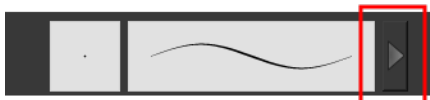

The Pencil Properties window opens.



This is where you set the minimum and maximum sizes of your drawing tool which will produce the thick and thin effect on your stroke. This works with the pressure sensitivity of a pen tablet.

Parameter	Description
Maximum Size	Sets the maximum width of the line.
Minimum Size	Sets the minimum width of the line in relation to the maximum size.
Smoothness	Lets you modify the central line smoothness of the line. This parameter smooths the initial movement of your line. Increasing the value will result in a smoother line with fewer control points.
Contour Smoothness	Optimizes the contour line smoothness of the line. This parameter will smooth the contour of the line once it has been traced; the higher the value, the fewer control points will compose your line.
Shape	

	<p>You can adjust the start, end, and joint style of a selected pencil line.</p> <ul style="list-style-type: none"> • Start: Lets you select the style of the start tip, which is the first tip you drew. You can choose between Round or Flat style. • End: Lets you select the style of the end tip, which is the last tip you drew. You can choose between Round or Flat style. • Join: Lets you select the joint style. The joints are where the line curves abruptly. You could also define the Join style as the corner style. You can choose between Round, Mitre and Bevel style.
Texture	See Pencil Line Texture on page 85.

Working with Pencil Presets



A preset is a pencil with specific properties. You can work with regular pencil presets and thickness stencils.

Regular pencil presets allow you to set the size and smoothing of the line or shape. As you draw, the thickness of the line varies according to the amount of pressure you apply with a pen and tablet.

Thickness stencils that are indicated with this  icon are also set with specific properties, but disregards the pressure you use with your pen and tablet. The line thickness varies. You can access thickness stencils from the list of presets on the Tool Properties view or create your own.

How to select a pencil preset



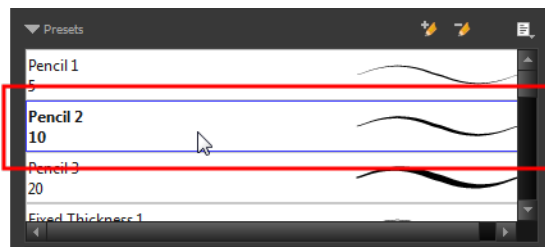

1. In the Tools toolbar, select the Pencil , Line , Ellipse , or Rectangle  tool.
2. In the Tool Properties view, use the Presets menu to select a pencil preset.



3. In the Drawing view, draw your pencil line or shape.



How to select a pencil thickness stencil



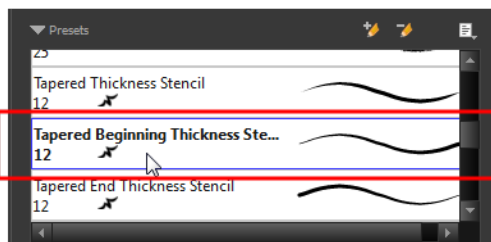

1. In the Tools toolbar, select the Pencil , Line , Ellipse , or Rectangle  tool.
2. In the Tool Properties view, use the Presets menu to select a thickness stencil. They are marked with this  icon.

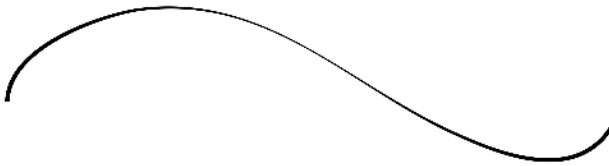

3. In the Drawing view, draw your pencil line or shape.



How to create a pencil preset

1. In the Tools toolbar, select the Pencil , Line , Ellipse , or Rectangle  tool.
2. In the Tool Properties view, adjust your pencil settings—see [How to modify the pencil settings on page 80](#).
3. In the Tool Properties view, click the New Brush  button.

The New Preset dialog box opens.

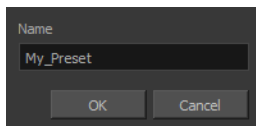

4. Type in a name for your new pencil thickness stencil and click **OK**.
5. Start drawing in the Drawing view.

How to create a pencil thickness stencil

1. In the Tools toolbar, select the Select  tool.
2. In the Camera view, select the pencil line or shape from which you want to take the style.

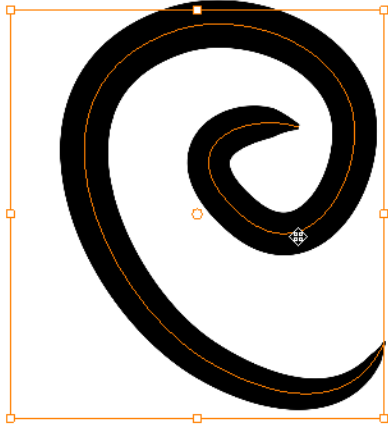

3. In the Tool Properties view, click the New Thickness Stencil  button.
A new thickness stencil is added to the end of the list in the Presets menu.
4. In the Presets menu, select a new thickness stencil and click on a line or shape in the Drawing view to apply the thickness stencil you created.

How to apply a thickness stencil to a pencil line or shape

1. In the Tools toolbar, select the Select  tool.
2. In the Drawing view, select the pencil line or shape on which you want to apply a style.

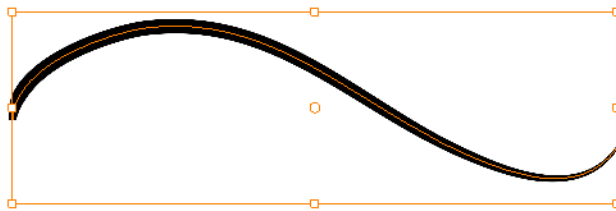



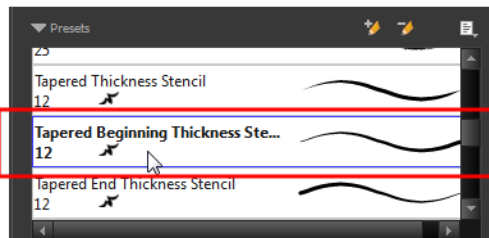

3. In the Tool Properties view, select the style you want to apply from the Presets list.



The style you selected is applied to your selection.



How to rename a thickness stencil or pencil preset

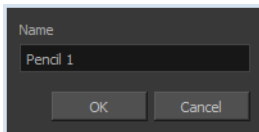

1. In the Tools toolbar, select the Pencil , Line , Ellipse , or Rectangle  tool.
2. In the Presets menu, select the thickness stencil or preset you want to rename.
3. From the Brush menu, select **Rename Brush**.

The Rename Preset dialog box opens.



4. In the Name field, type in the new name.

How to delete a thickness stencil or pencil preset

1. In the Tools toolbar, select the Pencil  tool.
2. In the Presets menu, select the thickness stencil or preset to delete.
3. Click the Delete Preset  button.

Pencil Line Texture

You can apply a texture to a pencil line.

Pencil lines support texture. Before drawing, you can select or import a texture and apply it to your lines. You can also change it afterwards using the Select tool. Textures are independent from pencil templates.

When you import a texture in your pencil styles, it is saved in your scene. If you want to add that texture to a bank that you will reuse in different scenes, you can add that texture to your preferences.

How to apply a preset texture to a pencil line

1. In the Tools toolbar, select the Pencil  tool.
2. In the Tool Properties view, the preview area displays the stroke that will be produced after you customize the different parameters in the Tool Properties view. Click the arrow button.

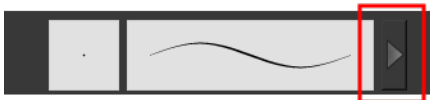

In the Pencil Properties display.

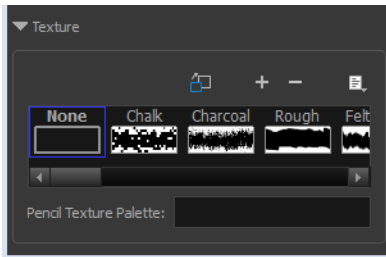



3. In the Texture section, select a texture for the pencil.
4. In the Drawing view, draw a pencil line.

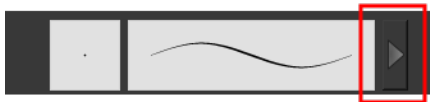

How to create a pencil texture template with the Pencil tool

1. In the Tools toolbar, select the Pencil  tool.
2. In the Tool Properties view, click the arrow button beside the stroke preview area.



3. In the Pencil Properties editor, click the New Texture  button or select **New Texture** from the Texture menu.
 - To delete a preset style, click the Delete Texture  button.
4. Browse for your bitmap texture file.

The file must be a TGA or PSD. Your texture **MUST HAVE** an alpha channel.

5. Click **Open**.
The imported texture is saved in your scene texture list.

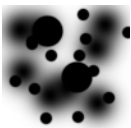

6. In the Pencil Properties editor, select your new texture.

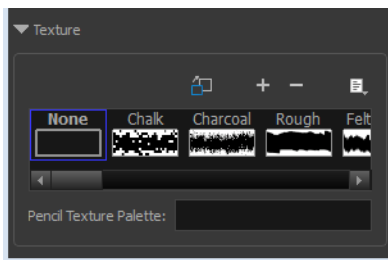

- In the Tool Properties view, click the Texture menu and select **Rename Texture**. The Rename Opacity Texture dialog box opens.

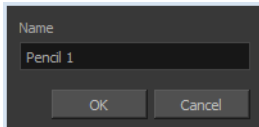



- In the Name field, type the template name and click **OK**.
- In the Drawing view, draw your pencil lines.

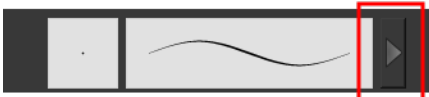

How to add a texture to your preferences

- In the Tools toolbar, select the Pencil  tool.
- In the Tool Properties view, click the arrow button beside the stroke preview area.



- In the Pencil Properties property editor, select a texture from the Textures area to add to your preferences.
- Click the Copy to Preference  button.

How to apply a preset texture to a pencil line

- In the Tools toolbar, select the Select  tool.
- In the Drawing view, select a pencil line.

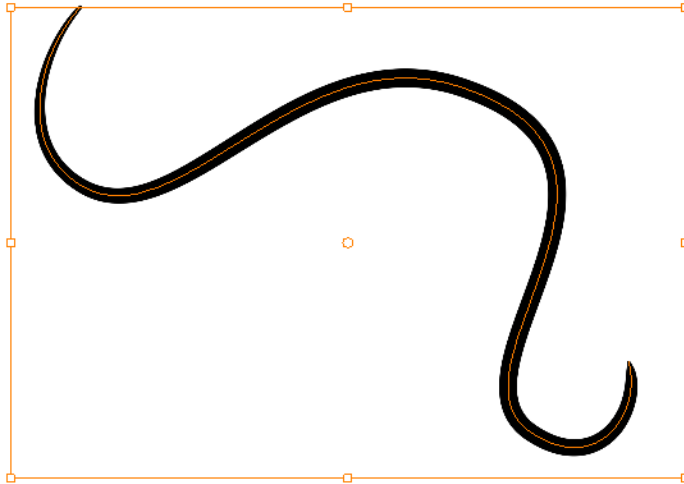

3. In the Tool Properties view, select a texture from the Textures area to apply to the selected stroke.



Drawing with the Brush Tool



The Brush tool is pressure sensitive and can create a contour shape which gives a thick and thin line effect, as if the drawing was made with a paint brush.

With the Brush tool, you can draw as vector or bitmap, depending on your preference. When you add your drawing layer, you can simply select the vector or bitmap option. If you use vector, you will be able to enlarge your drawing and zoom into it without losing quality or resolution. You can also use

the Contour Editor and Select tools to resize and modify lines. If you draw with bitmap, you will not be able to scale your drawing beyond 100% of its resolution without encountering pixelization issues.

You can create your own brush styles. A variety of brush styles are provided allowing you to create and save your own. This way you can create brushes with precise sizes and parameters and save them so you can draw and design. Renaming a brush can make it easier to identify and access the brushes you use most frequently.

A dynamic brush can be created for drawing using patterns created from your artwork. Create a new dynamic brush to copy a pattern you have drawn to reproduce it quickly. You can create dynamic brushes using a single or multiple patterns that will automatically switch through the patterns as you draw.

To draw with the Brush tool

1. In the Timeline or Xsheet view, select the cell on which you want to draw.
1. Select a drawing from the Drawing Thumbnails panel.
2. In the Tools toolbar, select the Brush  tool or press Alt + B.
3. In the Colour view, click a colour swatch to select a colour.

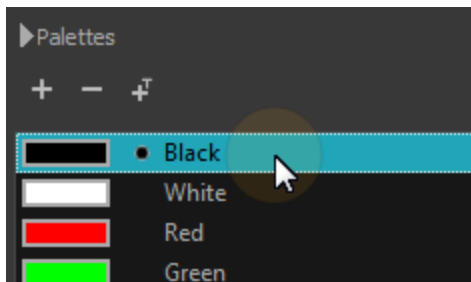

4. In the Drawing view, start drawing.
 - Hold Ctrl (Windows/Linux) or ⌘ (Mac OS X) to force a line to join the start and end of the shape while drawing.

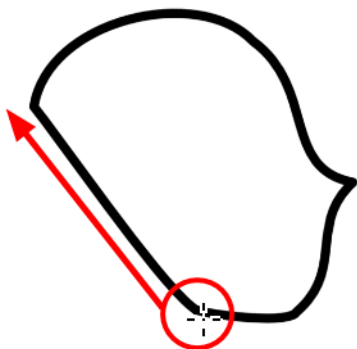

The last colour you select while using the Brush tool is recalled the next time you select the Brush tool.

How to select a brush style

1. In the Tools toolbar, select the Brush  tool or press Alt + B.
2. In the Tool Properties, select a brush style from the Brush Presets section.

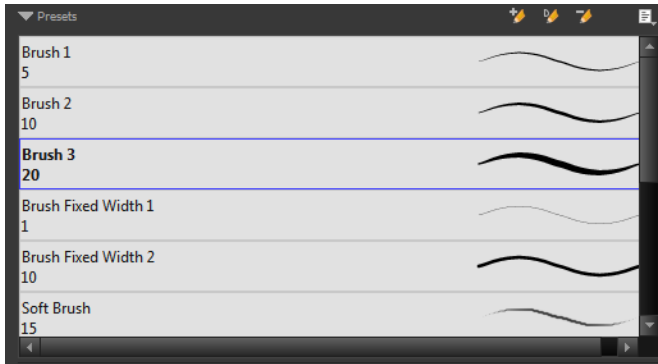

How to modify the brush settings

1. In the Tools toolbar, select the Brush  tool or press Alt + B.
2. In the Tool Properties view, the preview area displays the stroke that will be produced after you customize the different parameters in the Tool Properties view. Click the arrow button.

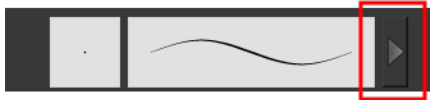

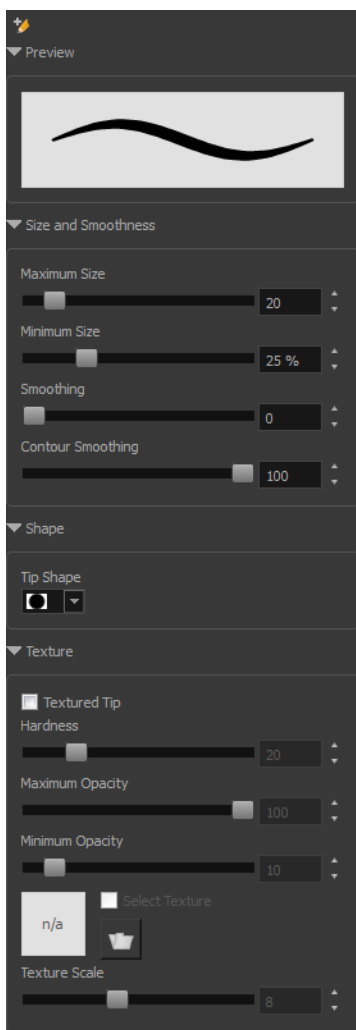

The Brush Properties window opens.

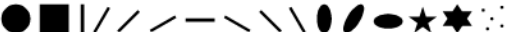

This is where you set the minimum and maximum sizes of your drawing tool which will produce the thick and thin effect on your stroke. This works with the pressure sensitivity of a pen tablet.

Parameter	Description
Maximum Size	Sets the maximum width of the line.
Minimum Size	Sets the minimum width of the line in relation to the maximum size.
Smoothness	Lets you modify the central line smoothness of the line. This parameter smooths the initial movement of your line. Increasing the value will result in a smoother line with fewer control points.
Contour Smoothness	Optimizes the contour line smoothness of the line. This parameter will smooth the contour of the line once it has been traced; the higher the value, the fewer control points will compose your line.
Tip Shape	Lets you select a tip shape from round and square ones to star shaped. 
Texture	See How to draw with textured lines on page 95

How to create a brush preset



1. Make sure your current brush has the settings you want in the preset you are will create.
2. Do one of the following:
 - ▶ In the Brush view, click the New Brush  button.
 - ▶ From the Brush  menu, select **New Brush Preset**.
 - ▶ In the Properties window of the tool you are using, click the  button in the upper-left corner.
3. In the New Preset window, type a name for your new brush preset.
The new brush is added to the end of the list of brush preset.

Brush presets cannot be updated. However you can select a preset, which applies those properties to the current brush. Then you can modify the properties, and create a new preset with the new properties. If desired, you can delete the old preset.

How to rename a brush

1. In the Tool Properties view, select a brush to rename.
2. From the Brush  menu, select **Rename Brush**.
3. Type in a new name for the brush.

How to delete a brush preset

1. Select the brush preset you want to delete.
2. Do one of the following:
 - ▶ In the Brush Preset view, click the Delete Brush  button.
 - ▶ From the Brush Preset  menu , select **Delete Brush**.



How to create a new dynamic brush

1. In the Tools toolbar, select a drawing tool.
2. In the Camera view, draw the pattern you want to use as your dynamic brush stamp.

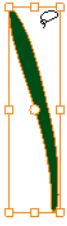

3. In the Tools toolbar, click the Select  tool and select the parts of the drawing you want to repeat.



4. In the Tools toolbar, select the Brush  tool or press Alt + B.
5. In the Tool Properties view, click the Add Dynamic Brush  button to add your selection as a new dynamic brush preset.
6. From the Brush  menu, select **Rename Brush**.
The Rename Preset dialog box opens.
7. Type in a name for the new dynamic brush and click **OK**.
8. In the Drawing view, start drawing with your dynamic brush to quickly repeat a pattern.

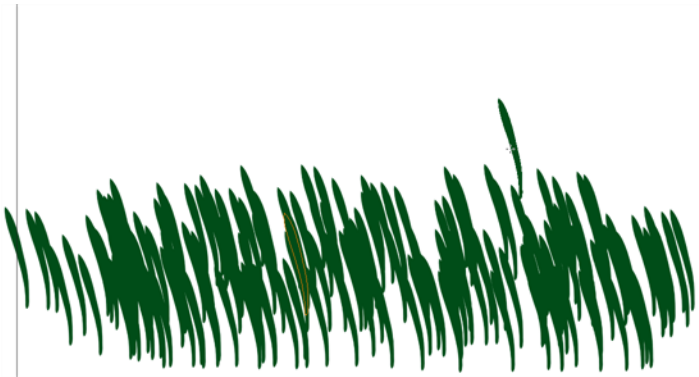



9. To adjust the scale of your pattern to make it bigger or smaller as you stamp it, adjust the Maximum Size value in the Tool Properties view.

How to create a dynamic brush with multiple drawings

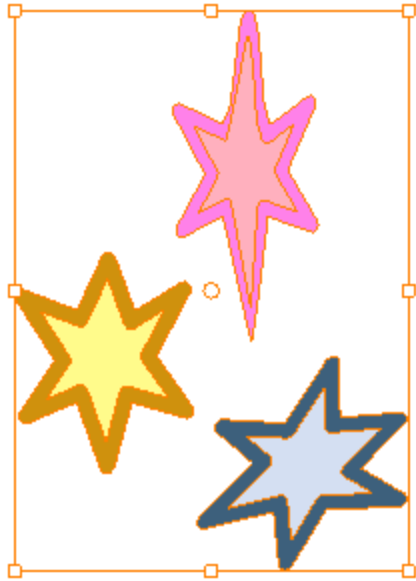
10. In the Drawing view, draw your pattern.
11. In the Tools toolbar, select the Select  tool.
12. In the Camera view, select all the drawings you want to add to your new dynamic brush.



13. In the Tools toolbar, select the Brush  tool or press Alt + B.
14. Click the Add Dynamic Brush  button to add your selection as a new Dynamic Brush preset.
15. From the Brush menu, select **Rename Brush**.
The Rename Preset dialog box opens.
16. Type in a name for the new dynamic brush and click **OK**.
17. In the Drawing view, start drawing with your dynamic brush to quickly repeat a pattern. When you use this brush, you will cycle through the drawings.



Drawing with Textured Brushes



In Harmony, you can use the Brush  tool to draw with bitmap textured lines.

In the Brush Tool Properties view, you will find a series of default textured brushes, but you can also create your own collection by importing PSD or TGA files in the Preset list.

To create your own texture brush, you must prepare your texture file in a third-party software, such as Adobe Photoshop. If your image has transparency in it, it will be supported. The texture file must be either a PSD or TGA file. It is recommended that you maintain your texture resolution between 100 x 100 pixels and 400 x 400 pixels.

When you use the Eraser tool to erase a portion of a textured line, the vector frame is cut straight and you lose the feather created while drawing with the Brush tool. In Harmony, a special option in the Eraser tool lets you create a soft edge on your textured lines. You can also cut or keep the vector frame as is.

Sometimes you need to hide the line texture to see the complete vector frame around your lines. This is useful to help you see any dirt floating around your drawing.

At some point, you may want to modify the look of a textured drawing. Maybe you find that your line is too smooth or too faint. You can adjust those parameters by using the Adjust Line Texture Opacity command.

To draw with textured lines, use the Brush tool and the correct pen in the list. You can also draw with pencil line texture—see [Pencil Line Texture on page 85](#)

How to draw with textured lines

1. In the Tools toolbar, select the Brush  tool or press Alt + B.
2. In the Tool Properties view, select a brush and click the Arrow button to open the Brush Properties view.



3. In the Texture section, select the **Select Texture** option.

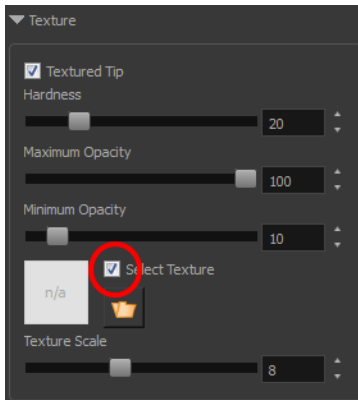

4. Set the following parameters:

- ▶ **Hardness:** The hardness value corresponds to the smoothness of the line edge. The lower the value, the more blurry and smooth the line edge will be. The higher the value, the sharper the line edge will be.



- ▶ **Minimum Opacity:** This value corresponds to the transparency of the brush when the pressure is very light. Values closer to 0 produce a more transparent line.



- ▶ **Maximum Opacity:** This value corresponds to the transparency of the brush when the pressure is heavy. Values closer to 1 produce a more opaque line.
- ▶ **Select Texture:** Lets you use and select a texture for your brush. The thumbnail displays the current texture. You can also browse for a texture file to import. Browsing for a texture file in a brush already using texture will replace the file currently in use, although it will not replace the texture in the lines already drawn. If your image has transparency in it, it will be supported. The texture file must be either a PSD or TGA file. It is recommended that you maintain your texture resolution between 100 x 100 pixels and 400 x 400 pixels.



- ▶ **Texture Scale:** Changes the size of the texture in the lines you draw. If you are using a plaid texture, the squares will be larger if you increase the value and smaller if you decrease it.

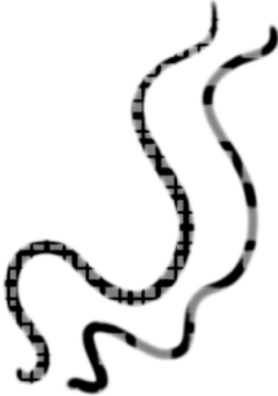

5. In the Drawing view, start drawing.



How to erase textured lines

1. In the Tools toolbar, select the Eraser  tool, press Alt + E.
2. In the Tool Properties view, click the arrow button.



The Brush Properties window opens.

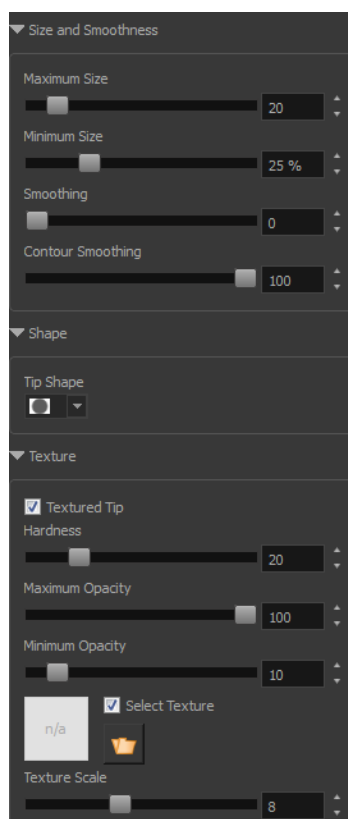

3. Adjust the following:

- ▶ **Maximum/Minimum Size:** Defines the minimum and maximum width of the stroke.
- ▶ **Smoothing:** Defines the number of control points added to the centre line.
- ▶ **Contour Smoothing:** Defines the number of control points added to the contour boundaries (around the line). Lower values mean that the line will appear as you draw it (with more control points added along the centre line). Higher values mean that the line will be smoothed out (removing control points from the centre line).
- ▶ **Tip Shape:** Lets you select a shape for the tip of the eraser. There are a variety of tips to choose from: round, square, oval, star-shaped, and more. This option is only available when the textured tip is not in use.

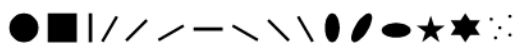

- ▶ **Soft Tip:** Gives the tip of your stroke a soft edge.
- ▶ **Keep Vectors:** Keeps your vector frames and does not cut them.
- ▶ **Hardness:** The smoothness of the line edge. The lower the value, the more blurry and smooth the line edge will be. The higher the value, the sharper the line edge will be.
- ▶ **Saturation:** The intensity of line colour.
- ▶ **Maximum Opacity:** The transparency of the brush when the pressure is heavy. Values closer to 1 produce a more opaque line.
- ▶ **Minimum Opacity:** The transparency of the brush when the pressure is very light. Values closer to 0 produce a more transparent line.

4. In the Drawing view, erase your textures lines.

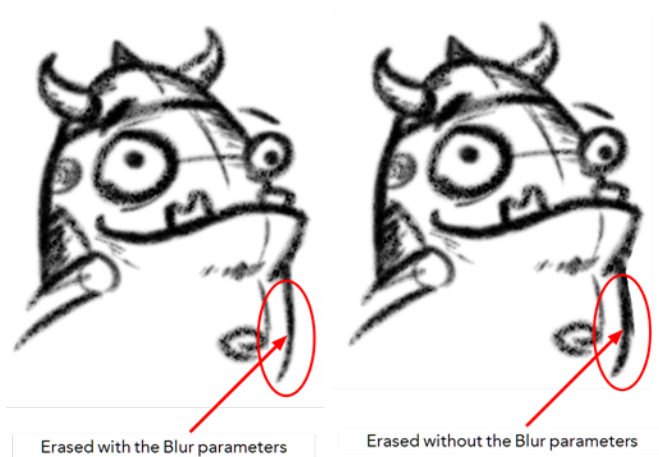

How to adjust the line texture opacity

1. Select a drawing from the Drawing Thumbnails panel.
2. In the Drawing view menu, select **Drawing > Adjust Line Texture Opacity**.

The Adjust Line Texture Opacity dialog box opens.

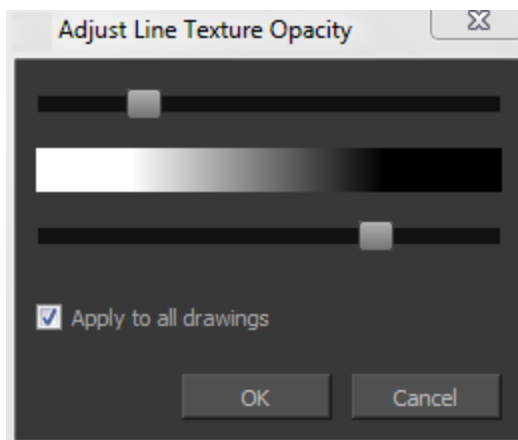

3. Drag the sliders toward the middle to increase the contrast and opacity of the textured lines.
4. If you want to apply the changes to all drawings exposed on the layer, select the **Apply to All Drawings** option and click **OK**.



Drawing with Bitmap Brushes



With Harmony, you have the choice to draw with vector or bitmap brushes. When adding a new drawing layer in Harmony Stage, Harmony Sketch or Harmony Draw, you can set your art layers (Line, Art, Colour Art) to vector or bitmap. This way, you can draw in bitmap and paint in vector, draw everything in bitmap, or whatever other combination suits you.

Not all drawing tools are available when working on a bitmap layer. You can use the following tools:

- Brush
- Cutter
- Dropper
- Ellipse
- Eraser
- Line
- Paint
- Paint Unpainted
- Pivot
- Rectangle
- Repaint
- Reposition All Drawings
- Select
- Text
- Unpaint

In Harmony Stage, Harmony Sketch or Harmony Draw, when adding a new drawing layer to the Timeline view, you can select the art mode for each art layer. You can set the Line Art layer to vector while setting the Colour Art as bitmap. You also have the opportunity to adjust them later by converting them from one to the other. If you are using the Overlay and Underlay layers, you can also set them to either bitmap or vector.

If you selected the incorrect art mode for your layers, you can open the Layer Properties view and modify them there directly. If you switch the art mode for a layer that already has strokes on it, the artwork will NOT be converted. You will be able to add new strokes. A drawing with bitmap strokes will be converted to a vector layer but the bitmap artwork will remain as bitmap. You will be able to use vector drawing tools to continue drawing on it. A drawing with vector lines switched to a bitmap layer will allow you to draw new bitmap strokes and move the vector strokes with the Select tool, but you will not be able to edit the vector art further. You need to convert the drawings in order to pass the artwork from one mode to the other.

To always reuse the same art mode settings, you can adjust them in the Preferences dialog box.

Before you start drawing in bitmap, it is important to understand that your artwork will now be resolution dependent. If you zoom in your scene, your artwork will be enlarged. It is important to plan ahead and decide how high of a resolution you need your artwork to be. If you plan to zoom in your scene, the smallest section of the image that the camera will frame must be 100% the size of your scene resolution. For example, if your scene resolution is set to 1920 x 1080 and you zoom in at 300%, then the resolution of the bitmap also has to be set to 300%. It is important to change the bitmap layer resolution before you start drawing.

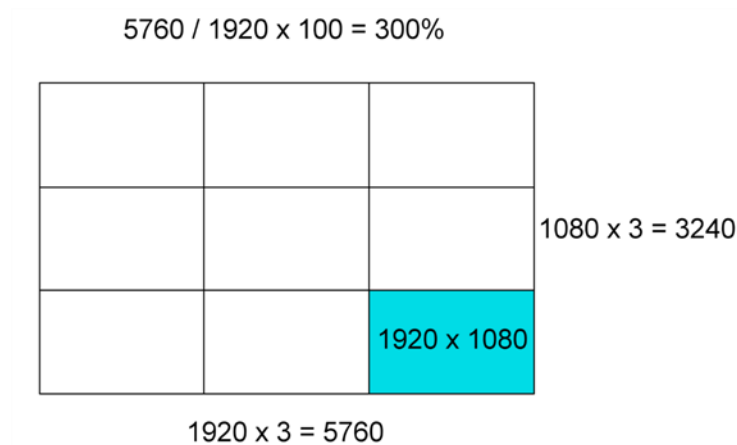

The bitmap resolution can be set at the scene level or drawing level. The setting at the scene level affects newly created bitmap art layers.

Note that even if your drawing resolution is set to be very large, it doesn't mean that your file will be very heavy. It depends on the amount of artwork your draw in it.

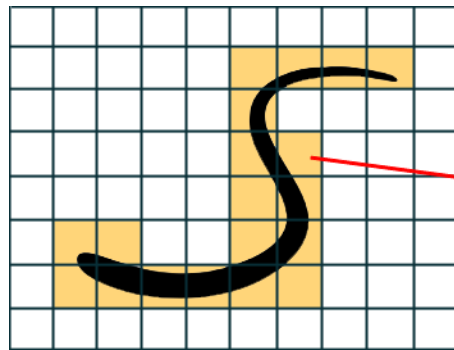

The yellow tiles are the spaces containing artwork. The white tiles are empty spaces, making the bitmap image much lighter.

The bitmap resolution (width and height) is the resolution of the tiles in relation to the project resolution. It is not the size of the bitmap created.

There is a function to change the resolution of bitmap art for individual drawings. You can reduce the resolution of your bitmap file as well as increase it. Be careful because enlarging the bitmap resolution on an existing drawing will result in a loss of quality. Harmony will perform a pixel smoothing pass (resampling) and create additional pixels to avoid losing too much quality, but only to a certain extent. For example, you used the default scene's resolution for bitmap art but then discover you are zooming quite close into the lines. If you do not want to see the pixels appear too much when you are zoomed in, you can set the bitmap resolution to 200% and the bitmap art will have a higher resolution with smaller pixels, but will NOT retain 100% of its quality. You can use this function on multiple drawings using the Apply to All Drawings option. Changing this option will affect existing and selected bitmap art layers.

If you drew an outline drawing on a bitmap layer, you can vectorize your artwork. Using a vector drawing layer, you can simply select your bitmap drawing and the vector cell on which you want your new vector layer to be, and use the Vectorize Line Art in Selected Drawing function.

You should avoid scaling up your bitmap strokes using the Select tool. If you do, keep in mind that when you continue drawing, your image will be resampled and your new strokes will be at the original resolution and not the scaled up size.

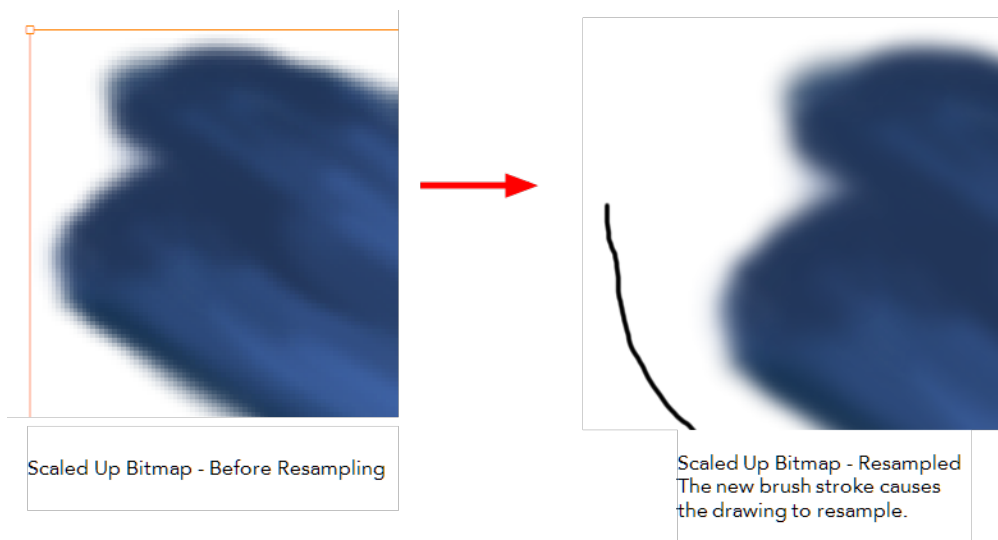

Your drawing should be scaled up using the Transform  tool instead of the Select tool to avoid creating very large bitmap layers.

How to change the bitmap resolution at the drawing level

1. In the Drawing Thumbnails panel, select a bitmap drawing.

Note that the drawing can be enlarged slightly and retain its original look, but you may lose quality if you enlarge it too much. Pixels are created and a smoothing pass is applied. You should set your resolution before drawing. If you need to change the resolution of a drawing to be larger than the one set in the Scene Settings dialog box, create an empty drawing first and then follow this procedure.

2. From the top menu, select **Drawing > Change Bitmap Drawing Resolution**.

The Change Bitmap Drawing Resolution window opens.



Parameter	Description
-----------	-------------

Scene Resolution	This is the scene resolution preset name and size in pixel.
Width	This is the width of the resolution for the bitmap that will be created. This is not the actual size of the bitmap. TVG drawings (Toon Boom drawing native format) have an infinite size. Bitmap TVGs are composed of small tiles. Therefore it does not mean that because you have artwork at the four corners of your camera frame or even quite far outside of your drawing that your bitmap image will be very large and heavy. By default, it is set to the same width as the scene resolution.
Height	This is the height of the resolution for the bitmap that will be created. By default, it is set to the same height as the scene resolution.
Resolution Factor	This is the size of the bitmap resolution in relation to the scene resolution. If you increase the percentage, the width and height fields will increase accordingly. If you plan to animate the camera and zoom into your background, you will need to set a higher resolution so that the smaller area in which you will zoom will be 100% of the scene resolution.
Resample Bitmap	When this option is selected, the existing bitmap image is modified to match the new resolution. If the width and height are increased, more pixels will be created to enlarge the image. Visually, the existing artwork will look the same, maybe a little bit smoothed out, but the size will look the same. When this option is deselected, the artwork is not modified. Only the reference grid is resized. If the scene resolution is 1920 x 1080 and you reduce the bitmap resolution to 960 x 540, the image will be scaled up to twice the size of the scene.
Apply to All Drawings	The modified settings are applied to all drawings in the drawing layer for a given art layer. If the Apply to Line Art and Colour Art option is enabled, it will then be applied to all bitmap art layers.

3. Change the bitmap resolution.
4. Click **OK**.

How to draw with bitmap brushes

1. In the Drawing Thumbnails panel, select a bitmap drawing.
2. In the Tools toolbar, select the Brush  tool or press Alt + B.
3. In the Colour view, select a colour.

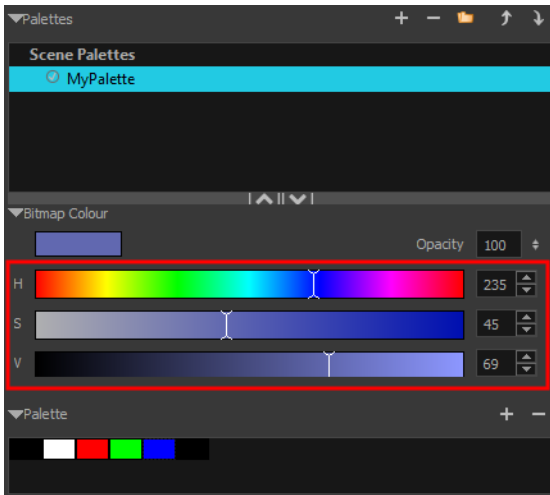

- ▶ To switch the bitmap colour picker from HSV to RGB, in the Colour view menu, select **Colour > Bitmap Colour Sliders > HSV Sliders** or **RGB Sliders**. You can also right-click on the colour sliders and select **RGB Sliders** or **HSV Sliders**.

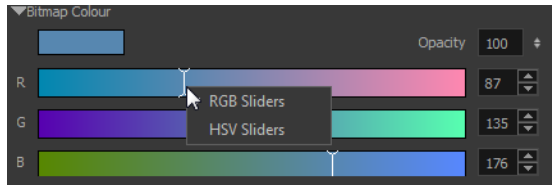

When using bitmap colours, there is no longer a link between the painted zones and selected colour. You can modify the colour picker as much as you want. Your drawing will not be affected. You can still select colours from your vector colour palette to use the same tint, but you will not create links between your drawing and the swatches.

4. In the Drawing view, start drawing.



Viewing the Final Lines as You Draw



Everything you draw in Harmony is vector-based, unless you purposely elected to draw as bitmap. Although, when you draw in the Drawing or Camera view, notice that your lines may appear jagged. This is caused by the fast real-time display called OpenGL. If you prefer to see smooth lines as you draw, you can enable the antialiasing preference.

Real-time Antialiasing

It is highly recommended that you use Full Scene Antialiasing. The Real-time Antialiasing method is NOT RECOMMENDED as it is heavier to run than the Full Scene Antialiasing.

Real-time Antialiasing is generated by . This means that when you draw your lines, the preview becomes antialiased as you go. If you zoom in more than 100% in the Camera view, pixels will start to appear. Your elements are still fully vector based. Only the preview becomes pixelated. Your drawings are antialiased to the scene's resolution.

Antialiasing is a preference you can turn on and off; by default, it is disabled.

This option lets you see the final result of your scene as you draw. You can change the value of the antialiasing, through the Preferences dialog box, to fit to the current zoom level used in the Camera or Drawing view or disable it.

Real-time Antialiasing parameters are only valid while you work in your scene. The scene will be rendered to 100% of its resolution regardless of your preference settings.

To customize the antialiasing parameters:

1. Select **Edit > Preferences** (Windows/Linux) or **Stage > Preferences** (Mac OS X).
The Ctrl + U (Windows/Linux) or ⌘ + U (Mac OS X).
The Preferences dialog box opens.
2. In the OpenGL tab, go to the Real-Time Antialiasing section.

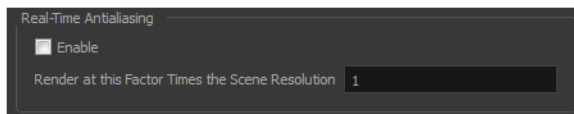

- ▶ **Enable:** Click on the **Enable** check box to enable or disable the Real-Time Antialiasing. Press Ctrl + Alt + A (Windows/Linux) or ⌘ + Alt + A (Mac OS X).
- ▶ **Render at this Factor Times the Scene Resolution:** The default value is 1. This value corresponds to how many times larger than the scene's resolution you want your drawings to be antialiased. If you zoom into your drawings to 200% you should set the value to 2.
- ▶ **Tile Size:** When the drawing is antialiased, the whole is broken into small tiles to make the process faster. Only the tiles with artwork on are rendered out. When you modify a zone on your drawing, only the modified tiles are updated.

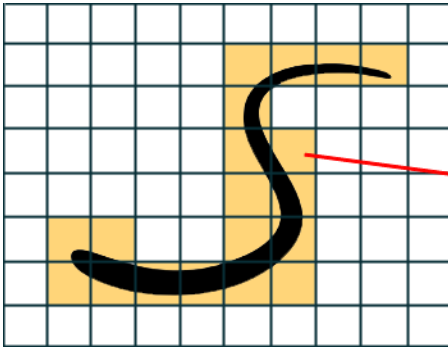

The yellow tiles are the spaces containing artwork. The white tiles are empty spaces, making the bitmap image much lighter.

The bitmap resolution (width and height) is the resolution of the tiles in relation to the project resolution. It is not the size of the bitmap created.

- Making the tiles too small results in sending more tiles to be rendered out, which makes the process longer.
- Making the tiles too large results in sending bigger tiles out to be rendered out which is more of a strain on the video card. Since the tiles are larger, they get updated more often because the artwork you modify may be one of these tiles.

Selecting the Current Colour of a Tool

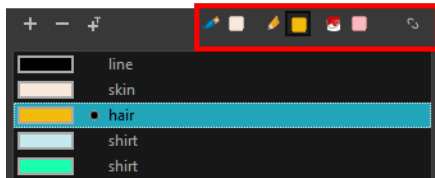

While drawing and painting, you can let Harmony retain the last colour you selected for each one of the following tools:

- Brush
- Paint
- Pencil, Ellipse, Line, Rectangle, Polyline

The Colour view has three swatches where you can set a colour for the Brush, Paint, and Pencil tools.

How to unlink the storage swatches

1. In the Colour view, if the storage swatches are linked, click the Link  button to unlink them.

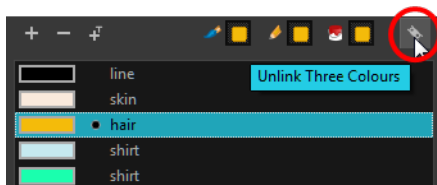

2. Click on the Brush  storage swatch.

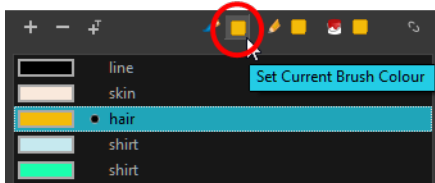

3. In the Colour list, select the desired colour.
4. Click the Pencil  storage swatch.

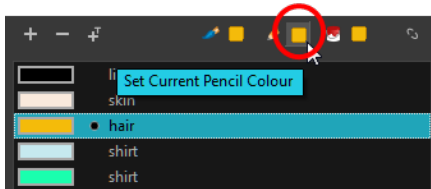

5. In the Colour list, select a colour.
6. Click the Paint  storage swatch.

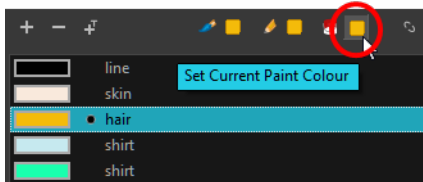



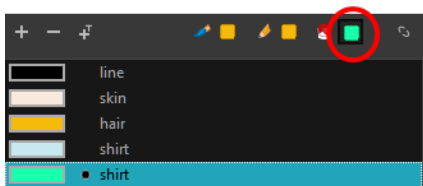





7. In the Colour list, select a colour.



If you prefer to have Toon Boom Harmony use the same colour swatches regardless of the selected tool, you can link the three swatches together.

How to link the storage swatches

1. In the Tools toolbar, select one of the following tools:
 -  Brush
 -  Paint
 -  Pencil
 -  Polyline
 -  Line
 -  Ellipse

-  Rectangle
2. In the Colour view, if the storage swatches are unlinked, click the Link  button to link them.

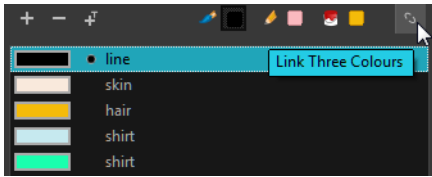

Each time you select a new colour for your current tool, all the storage swatches are updated.

Using Independent Colours when Working with Bitmap Layers

When working in the Colour view, by default the current colour is active for both vector and bitmap layers. You can however, use different reference colours for each layer.

When using bitmap colours, there is no longer a link between the painted zones and selected colour. You can modify the colour picker as much as you want. Your drawing will not be affected. You can still select colours from your vector colour palette to use the same tint, but you will not create links between your drawing and the swatches.

How to use independent colours

- From the Colour view menu, select **Colours > Independent Bitmap Colour**.
- Whichever colour you choose as the reference color is retained for that layer type.

Selecting Drawing Objects

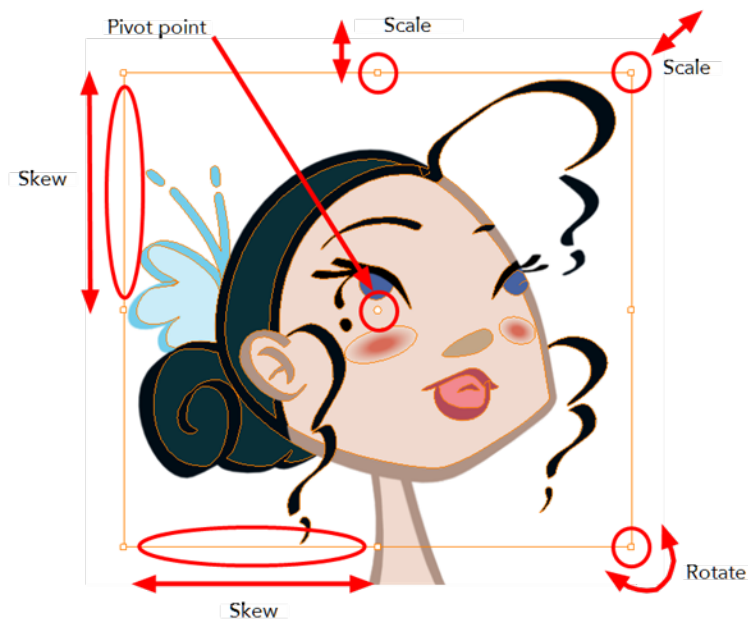

The Select tool is used to select strokes in both the Drawing view, and apply basic transformations, such as repositioning, rotating, scaling or skewing using the different handles of the bounding box.

Sometimes, when you want to select multiple objects while leaving one unselected, it can be handy to select only the stroke or line that you do not want included in your selection. Then, you can invert the selection so that everything else becomes selected. This can be quite a time saver.

Some of the transformations, such as rotation, scale, skew, and flip are done relative to the position of the pivot point. You can temporarily reposition this pivot point for a transformation using the Select tool.

How to select with the Select tool

1. Select a drawing from the Drawing Thumbnails panel.
2. In the Tools toolbar, select the Select  tool or press Alt + S.
3. In the Camera or Drawing view, select the drawing objects.
 - You can select all the drawing objects in a drawing by using **Edit > Select All** or by pressing Ctrl + A (Windows/Linux) or ⌘ + A (Mac OS X).
4. To deform or reposition a selection:
 - To reposition, click the selected drawing object and drag the selection to a new area.

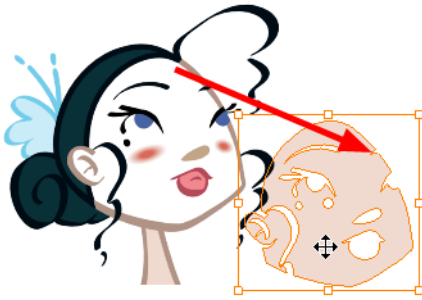

- To rotate, grab the selection box handle and rotate it.

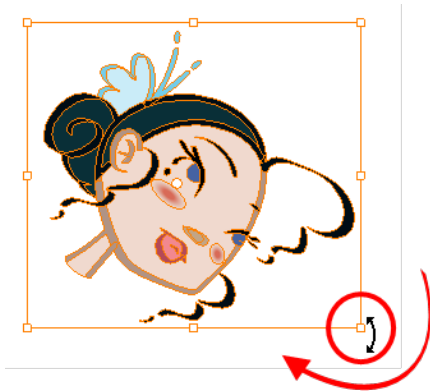

- To scale, pull or push on the top, side, bottom or corner control point. Hold down Shift to lock the selection's ratio.

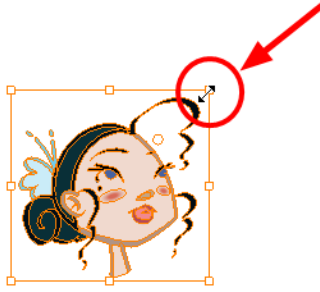

- ▶ To skew, drag sideways or up and down the sides or top and bottom segments, between the control points.

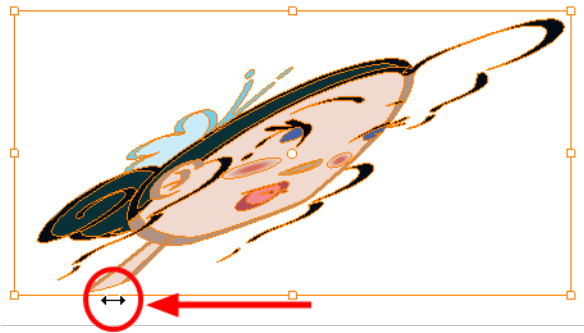

How to invert a selection

1. From the top menu, select **Edit > Invert Selection** or press **Ctrl + Shift + I** (Windows/Linux) or **⌘ + Shift + I** (Mac OS X).

How to temporarily reposition the pivot point

1. In the Drawing view, select the drawing object you want to transform. The pivot point appears in the middle of your selection.



2. Click the pivot point and drag it to a new position.

This becomes the new position of the pivot point for the current transformation and will remain there until you make a new selection.

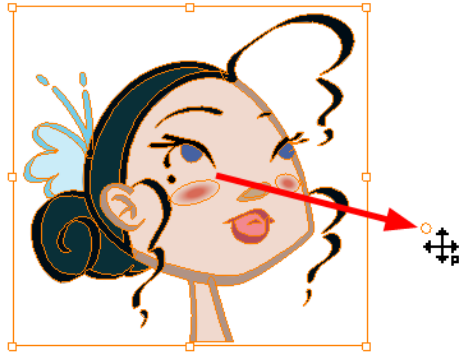

Erasing Parts of a Drawing

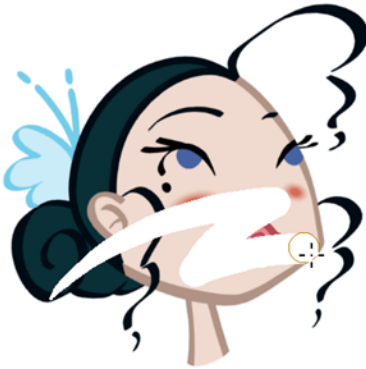

The Eraser tool is pressure sensitive, like the Brush tool, giving you more precision when erasing parts of a drawing. You can also use the Select tool to select drawing objects and delete them instead of erasing.

How to erase with the Eraser tool

1. Select a drawing from the Drawing Thumbnails panel.
2. In the Tools toolbar, select the Eraser  tool or press Alt + E.
3. In the Drawing view, start erasing.

How to modify the eraser settings

1. In the Tools toolbar, select the Eraser  tool .
2. In the Tool Properties view, the preview area displays the stroke that will be produced after you customize the different parameters in the Tool Properties view. Click the arrow button.

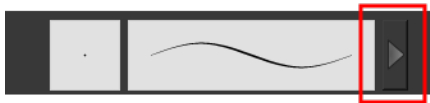

The Brush Properties window opens.

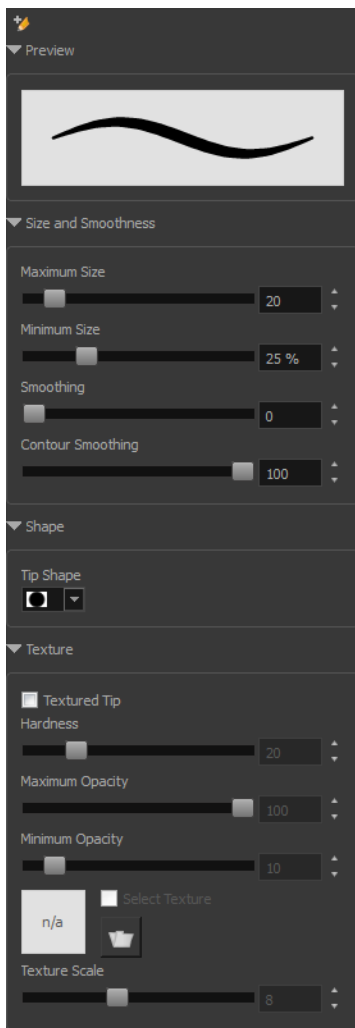

This is where you set the minimum and maximum sizes of your drawing tool which will produce the thick and thin effect on your stroke. This works with the pressure sensitivity of a pen tablet.

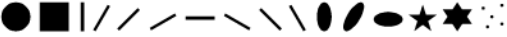
Parameter	Description
Maximum Size	Sets the maximum width of the line.
Minimum Size	Sets the minimum width of the line in relation to the maximum size.
Smoothness	Lets you modify the central line smoothness of the line. This parameter smooths the initial movement of your line. Increasing the value will result in a smoother line with fewer control points.
Contour Smoothness	Optimizes the contour line smoothness of the line. This parameter will smooth the contour of the line once it has been traced; the higher the value, the fewer control points will compose your line.
Tip Shape	Lets you select a tip shape from round and square ones to star shaped. 
Texture	See How to draw with textured lines on page 95





Reshaping a Drawing Using the Contour Editor Tool





The Contour Editor tool is a powerful tool that allows you to add, remove or modify points on a vector line and control them with Bezier handles. It is used to correct line shapes and modify a single part of a colour zone. If a line is too thin or has a gap in it, you can modify and correct it with the Contour Editor tool. You can also use this tool to create elaborate shapes.

The Contour Editor displays vector points around a shape and the central vector points in a pencil line. Pulling or pushing on these points adjusts the brush's line thickness. Points can be selected and deleted. Each point has two Bezier handles for correcting the curves between two points. Shapes can be modified by pulling and pushing directly on the segment between the points. You can use it to perfect a central shape pencil line, a contour shape brush line, or even create an elaborate shape from a basic ellipse or square.

How to reshape with the Contour Editor tool

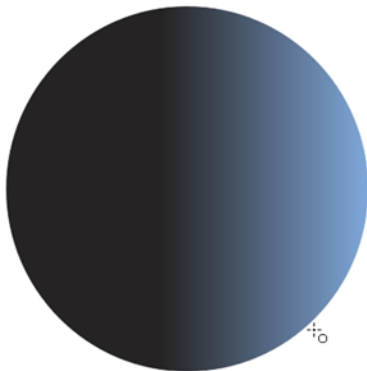
1. Select a drawing from the Drawing Thumbnails panel.
2. In the Tools toolbar, select a shape tool:   .
3. In the Tool Properties view, click the Ellipse  button, click the Auto Fill  button and set the pencil size to 0.
4. In the Drawing view, draw a circle.



5. In the Tools toolbar, select the Contour Editor  tool.
6. In the Drawing view, click the line to reshape it.

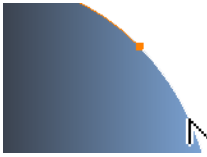

7. Select one or several points by clicking on them or circling around.

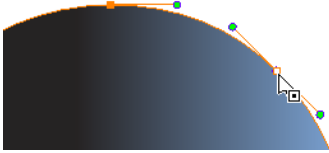

8. Press Delete to delete a selected point.

Press Ctrl (Windows/Linux) or ⌘ (Mac OS X) and click on the contour to add a new point to adjust the contour.

9. To modify the shape, you can:

- ▶ Pull on the Bezier handle. Both point's handles will move as one.

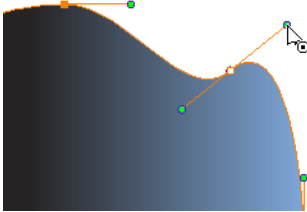

- ▶ Hold down Alt and pull on one of the Bezier handles. The point's handle will move independently from the other one.

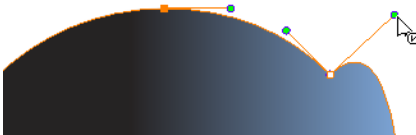

- ▶ Move the selected points to a new area.

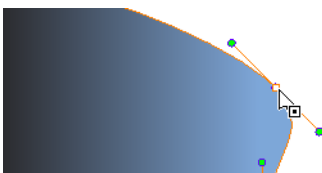

- ▶ Pull directly on the line between two points. No selection is necessary. Holding down Shift will limit the contour modification to the curve between the two first points.

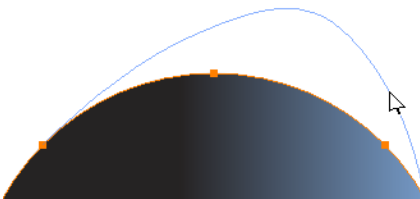

- ▶ If an anchor point has no visible Bezier handles, hold down the Alt key to display them.
- ▶ To add control points, press Ctrl (Windows/Linux) or ⌘ (Mac OS X) and click the line.

- ▶ To remove control points, select the control point and press Delete.

Reshaping Pencil Lines with the Pencil Editor Tool

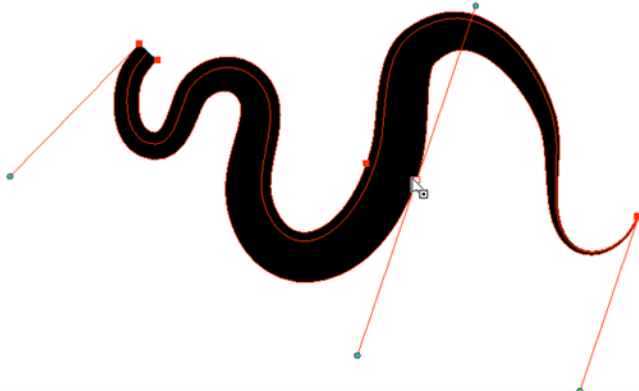

The Pencil Editor tool is used to modify the thick and thin contour of a pencil line. A pencil line is a central vector shape. The shape control points are located all along the central spine allowing you to adjust the stroke curve and position. When using the Contour Editor tool, you can reposition the spine of the stroke. When using the Pencil Editor tool, you can adjust the thick and thin areas of lines.

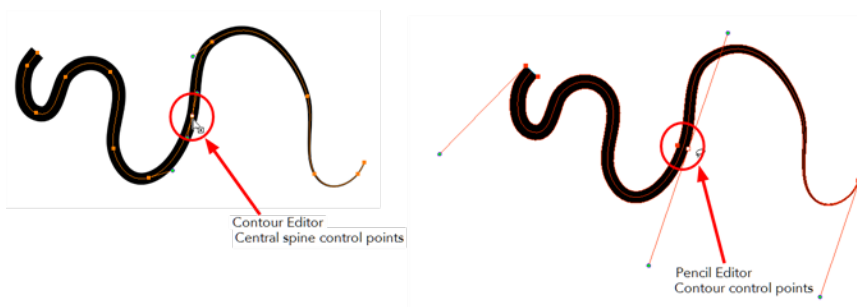

How to use the Pencil Editor tool

1. In the Tools toolbar, select the Pencil Editor  tool or press Alt + W.
2. In the Drawing view, select a pencil line and click the line to reshape it.

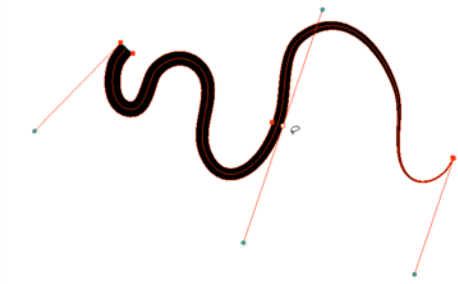

3. Select one or several points by clicking them or circling around.

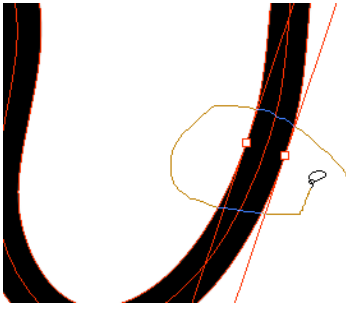

4. Press Delete to delete a selected point.
5. Press Ctrl (Windows/Linux) or ⌘ (Mac OS X) and click the central spine to add a set of points to adjust the contour.
6. To modify the shape, you can:
 - ▶ Move the selected points to a new area. If you select matching points on each side of the line, holding the Shift key will move them both. This way you can thicken or thin a line from both sides at the same time.

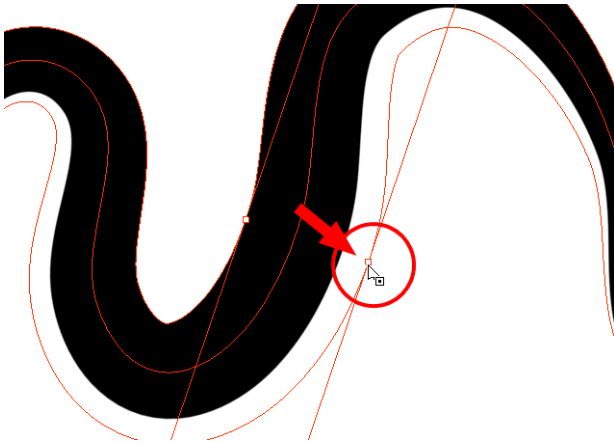

- ▶ Pull on the Bezier handle to move both points' handles as one.

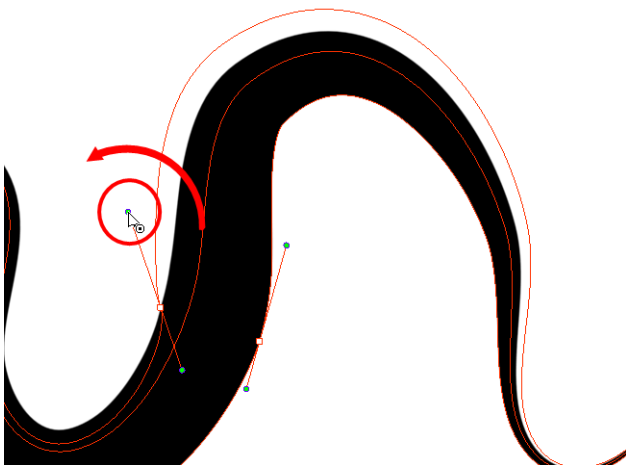

- ▶ Hold down Alt and pull on one of the Bezier handles. It moves the handle independently from the other one.



- ▶ Pull directly on the line between two points. No selection is necessary. Holding down the Shift key will limit the contour modification to the curve between the two first points.

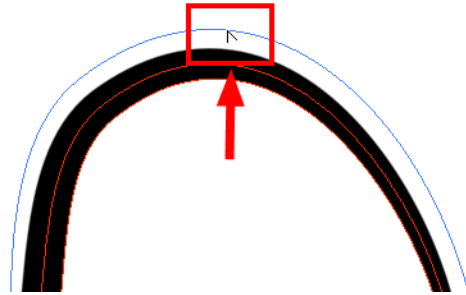



- ▶ If an anchor point has no visible Bezier handle, hold down Alt to display them.

Drawing with Shapes



In Harmony, you can use the shape tools to draw circles, lines and squares. You can also easily reshape a square or circle into a much more complex drawing such as these butterfly wings—see [Reshaping a Drawing Using the Contour Editor Tool on page 114](#) and [Reshaping Pencil Lines with the Pencil Editor Tool on page 116](#).

How to draw with a Shape tool

1. Select a drawing from the Drawing Thumbnails panel.
2. In the Tools toolbar, select a shape tool: .
3. To automatically fill the shape, in the Tool Properties view, select the Auto Fill  option.
4. In the DrawingCamera view, click and drag to draw the shape.

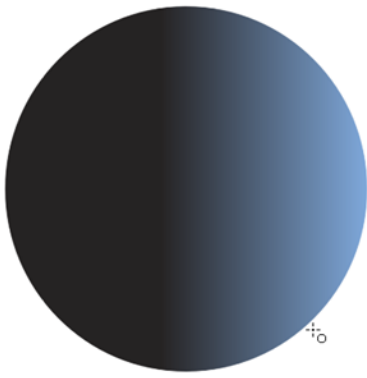

- Hold down Shift to lock the rectangle or the ellipse ratio to 1:1.
 - Hold down Alt to draw the rectangle or ellipse from its centre.
 - Hold down Shift to snap the line every 15 degrees.
 - Hold down Alt to snap the start or end of the line to a nearby stroke.
5. Use the Contour Editor  tool to deform the shape and create your drawing.

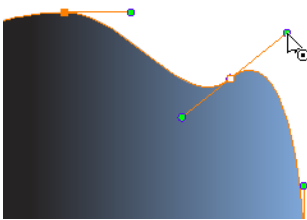

Drawing with the Polyline Tool





The Polyline tool is used to draw shapes with a central vector type of line. To form a shape, you click to add a point and then, without releasing the mouse, pull the handle in the desired direction before adding the next point and repeat the operation. To edit the shape, you can use the Contour Editor tool.

How to draw with the Polyline tool

1. Select a drawing from the Drawing Thumbnails panel.
2. In the Tools toolbar, select the Polyline  tool or press Alt + _.

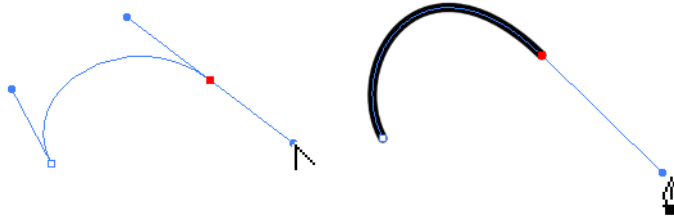
3. In the Drawing view, click and drag to create a point and a Bezier handle to shape your line.
 - Press Alt to pull only one handle, instead of two.
 - Press Shift to snap the handles to 45, 90, or 180 degrees.
4. Click a new area and drag to create a second point and Bezier handle.



5. Repeat the previous step until your shape is completed.
6. Press Ctrl (Windows/Linux) or ⌘ (Mac OS X) and click to release the Polyline tool from the current path or shape that it is creating. Continue to use the tool to make multiple, independent paths or shapes.
7. If necessary, reshape the lines using the Contour Editor  tool—see [Reshaping a Drawing Using the Contour Editor Tool on page 114](#).

Drawing with Invisible Lines

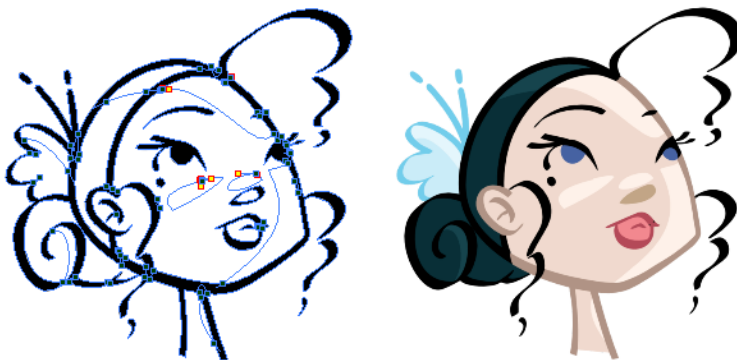

There are two different ways to draw invisible lines.



Using the Pencil tool, you can draw as strokes only, meaning that the line will be invisible. This can be useful for drawing tones and highlights directly on the character.

The Stroke tool draws invisible lines only. You cannot add thickness to the line, unlike the Close Gap tool that creates a short, straight line between two points. The stroke line will stay exactly where you draw it. This tool can be useful for closing a zone in a particular way or creating some hard shadows or highlight areas.



Sometimes, it may be difficult to see your strokes, especially if your colours are similar to the blue stroke colour. In Harmony, you can display the strokes and washed-out the colours of your drawings so that the invisible lines stand out.

How to draw invisible lines with the Pencil tool

1. Select a drawing from the Drawing Thumbnails panel.
2. In the Tools toolbar, select the Pencil  tool or press Alt + /.
3. From the top menu, select **View > Show Strokes**  or press K.
4. In the Tool Properties view, set the Pen Style size to 0. You can also adjust the smoothness.
5. In the Drawing view, start drawing.

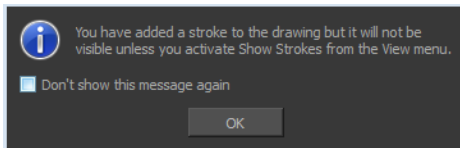

If you forgot to enable the Show Strokes option before drawing, as soon as you draw a first stroke, a Message dialog box opens.



Select the **Don't Show This Message Again** option if you do not want the dialog box to notify you about the Show Strokes option.

6. Click **OK**.
7. You can modify the stroke shape with the Contour Editor  tool.

How to draw invisible lines with the Stroke tool

1. Select a drawing from the Drawing Thumbnails panel.
2. In the Tools toolbar from the Paint drop-down menu, select the Stroke  tool or press Alt + V.
3. From the top menu, select **View > Show Strokes**  or press K.
4. In the Tool Properties view, you can adjust the smoothness.
5. In the Drawing view, start drawing.

If you forgot to enable the Show Strokes option before drawing, as soon as you draw a first stroke, a Message dialog box opens.

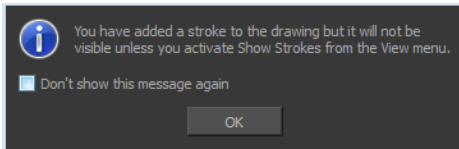

Select the **Don't Show This Message Again** option if you do not want the dialog box to notify you about the Show Strokes option.

6. Click **OK**.
7. You can modify the stroke shape with the Contour Editor  tool.

How to show the strokes with washed-out colours

- ▶ From the top menu, select **View > Show Stroke With Colour Wash**.

Deforming a Drawing with the Perspective Tool



The Perspective tool lets you deform a drawing selection and alter its perspective.

How to deform a drawing with the Perspective tool

1. In the Tools toolbar, select the Perspective  tool from the Contour Editor drop-down menu or press **Alt + 0**.
2. In the Drawing view, select a drawing to deform.
3. Click and drag the different anchor points to deform the shape.

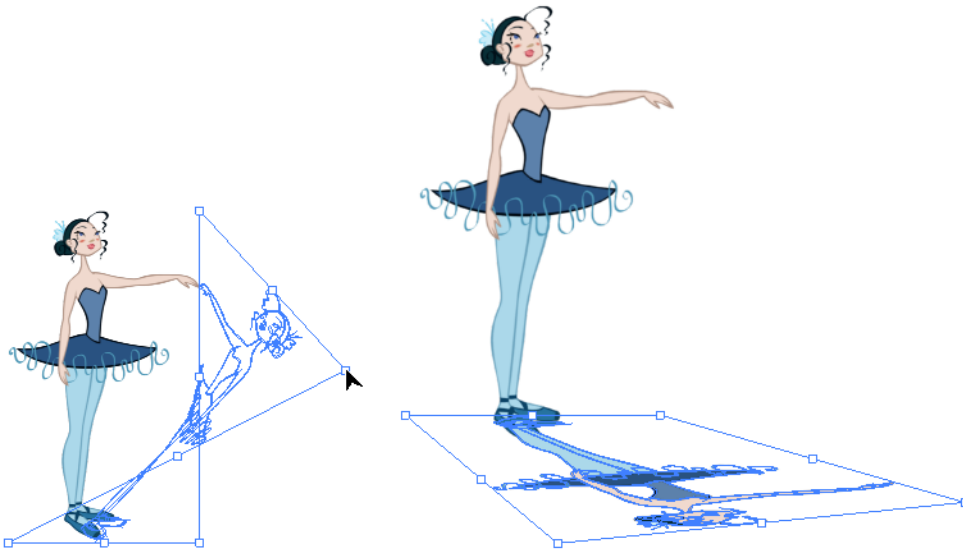

Warping a Drawing with the Envelope Tool

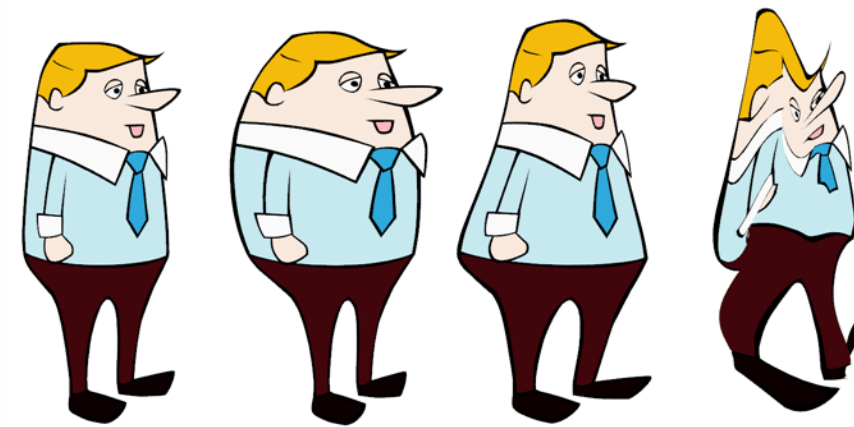

The Envelope tool lets you deform and warp part of a drawing using a grid envelope and Bezier handles.

How to warp a drawing with the Envelope tool

1. In the Tools toolbar, select the Envelope  tool from the Contour Editor drop-down menu.
2. Select a drawing from the Drawing Thumbnails panel.
3. In the Drawing view, select the region you want to deform



4. Click and drag the different anchor points and handles to deform the image.

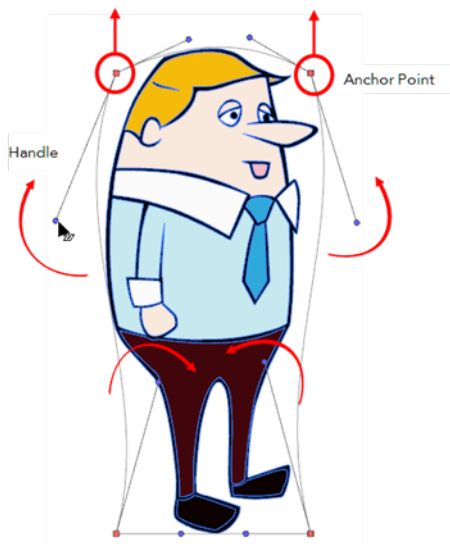

5. To display more controls, in the Tool Properties view, click the Show Advanced Controls button. 

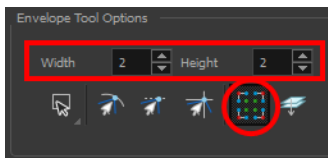

6. Increase the height and width of the grid to get more control points to deform your image.

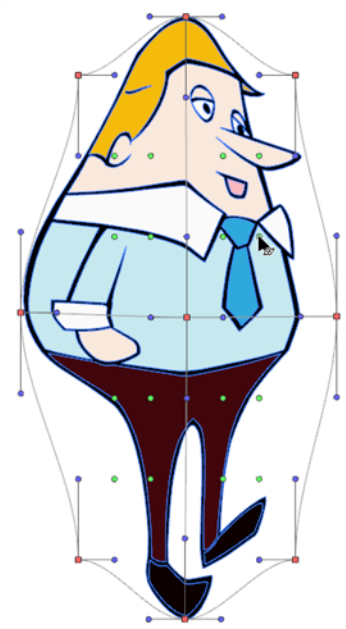

Cutting Drawing Parts



The Cutter tool lets you cut a drawing area to move, copy, cut or delete it.

How to cut with the Cutter tool

1. In the Tools toolbar, select the Cutter  tool or press Alt + T.
2. In the Drawing view, make a selection around an area to cut away.

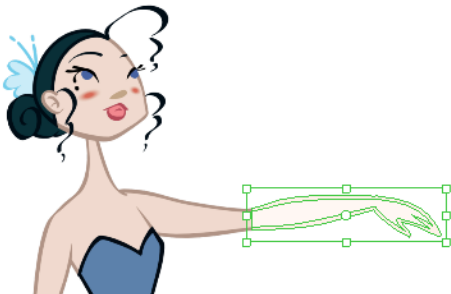

- ▶ To delete the selected zone, press Delete.
- ▶ To move the selection, click the selection and drag it to a new area.
- ▶ Use the bounding box controls to scale, skew, or rotate the cut piece.

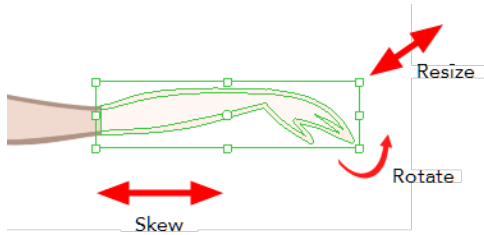

Smoothing Lines

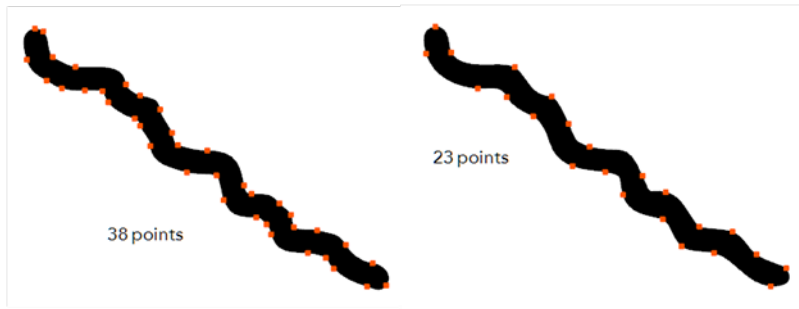

When drawing in a digital application, it is not like drawing on a sheet of paper. Sometimes the lines you draw may look as if they were drawn with an unsteady hand. When this occurs, you may need to correct the look of your lines.

Harmony has a very powerful tool you can use to optimize contours and reduce the number of points on the lines, the Smooth Editor tool.

How to optimize lines with the Smooth Editor tool

1. In the Tools toolbar, select the Smooth Editor  tool or select **Tools > Smooth Editor**.
2. In the Drawing view, place your pointer over the lines to smooth. You may need to pass over the same line several times to remove more points and make the line smoother. Note that by default, the Smooth Editor tool colour is yellow, it was changed to orange for screen grab clarity—see [Smooth Editor Tool Options on page 170](#) to learn about the various settings available.

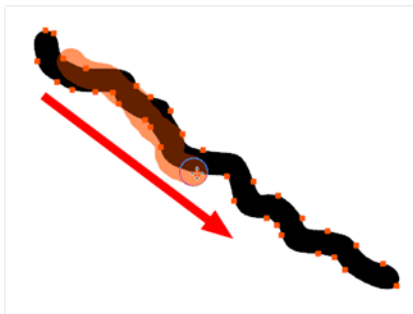

Working With Text

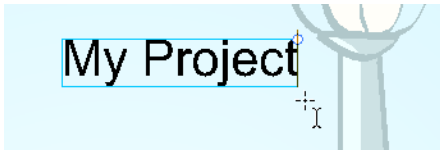

With the Text tool, you can type text in your project using various fonts and text attributes. Text objects are part of a drawing, so you can manipulate them in the same way. OTF fonts are also supported.

How to add text to drawings

1. Do one of the following:
 - ▶ In the Tools toolbar, select the Text **T** tool.
 - ▶ From the top menu, select **Tools > Text**.
 - ▶ Press **Alt + 9**.
2. In the Timeline view, select the cell containing the drawing on which you want to add text.
3. In the Drawing view, click on the location you want the text to begin.

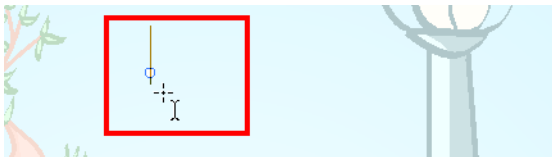

4. You can use the Tool Properties view to select the font, font size and format of the text you will type—see [Text Tool Options on page 172](#).
5. Type in the desired text.

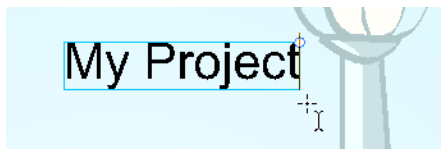

6. Click outside the text box to exit the typing mode.
If you want to create another text object, click outside the currently active text box. You can always return to edit the text by selecting the Text **T** tool and clicking in the text.



More Drawing Tools

Harmony offers a wide variety of useful tools to optimize your drawings and work more efficiently; tools such as Group, Arrange, and the animation disk to rotate your workspace.

- Arrange below
- Convert Brush Strokes to Pencil Lines on the facing page
- Pencil Lines to Brush Strokes on the facing page
- Strokes to Pencil Lines on page 130
- Optimize on page 130
- Remove Extra Strokes on page 130
- Create Contour Stroke on page 131
- Remove Contour Stroke on page 131
- Grid on page 132
- Group/Ungroup on page 132
- Hand on page 132
- Rotate View on page 133

Arrange

The different Arrange options let you reorder drawing objects inside a single layer in the Drawing or Camera view.

Name	Button	Description	Access Method
Bring to Front		Moves the selected art to the front (on top)	From the top menu, select Selected > Arrange > Bring to Front . Press Ctrl + Shift + PgUp (Windows/Linux) or ⌘ + Shift + PgUp (Mac OS X).
Bring Forward		Moves the selected art one level forward (closer to the front)	From the top menu, select Selected > Arrange > Bring Forward . Press Ctrl + PgUp (Windows/Linux) or ⌘ + PgUp (Mac OS X).
Send Backward		Moves the selected art one level lower (behind)	From the top menu, select Selected > Arrange > Send Backward . Press Ctrl + PgDown (Windows/Linux) or ⌘ + PgDown (Mac OS X).

Send to Back		Moves the selected art behind everything (bottom / back)	<p>From the top menu, select Selected > Arrange > Send to Back.</p> <p>Press Ctrl + Shift + PgDown (Windows/Linux) or ⌘ + Shift + PgDown (Mac OS X).</p>
--------------	---	--	---

Convert Brush Strokes to Pencil Lines



The Brushes Strokes to Pencil Lines operation converts selected contour strokes into centreline pencil strokes. This command is only available from the top menu.

How to convert brush strokes to pencil lines

- ▶ From the top menu, select **Selected > Convert > Brush Strokes to Pencil Lines** or press **^**.
- ▶ Right-click on the selection, select **Convert > Brush Strokes to Pencil Lines** or press **^**

Pencil Lines to Brush Strokes



The Pencil Lines to Brush Strokes operation converts the selected centreline pencil strokes into contour strokes brush lines.

How to convert pencil lines to brush strokes

- ▶ From the top menu, select **Selected > Convert > Pencil Lines to Brush Strokes** or press **&**.
- ▶ Right-click on the selection, select **Convert > Pencil Lines to Brush Strokes** or press **&**

Strokes to Pencil Lines



The Strokes to Pencil Lines operation converts the selected invisible line to a pencil line.

How to convert strokes to pencil lines

- ▶ From the top menu, select **Selected > Convert > Strokes to Pencil Lines** or press Shift + F12 (Windows/Linux only).
- ▶ Right-click on the selection, select **Convert > Strokes to Pencil Lines** or press Shift + F12 (Windows/Linux only)

Optimize

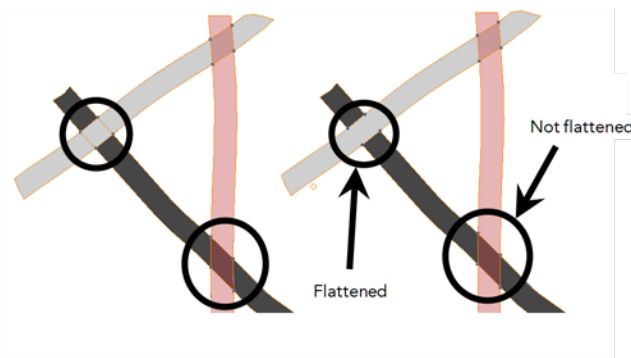

The Optimize command reduces the number of layers, such as overlapping brush strokes, in the selected drawing objects. Drawing objects will only be flattened and optimized if the selected objects do not change the appearance of the final image when they are merged.

For example, if you have selected a number of partially transparent objects, which you layered to create an additive colour effect, the selected transparent drawing objects will not be merged. This is because merging the transparent drawing objects will cause them to lose the effect of the layered transparent colours.

How to optimize

- ▶ Use the Select tool to select the drawing objects you want to optimize.
- ▶ From the top menu, select **Selected > Optimize**.

Remove Extra Strokes



The Remove Extra Strokes option let you remove the invisible lines in your selection.

How to remove extra strokes

1. In the Tools toolbar, select the Select tool.
2. In the Drawing view, use the Select tool to select the drawing objects you want to remove invisible lines from.
3. From the top menu, select **Selected > Flatten and Remove Extra Strokes**.

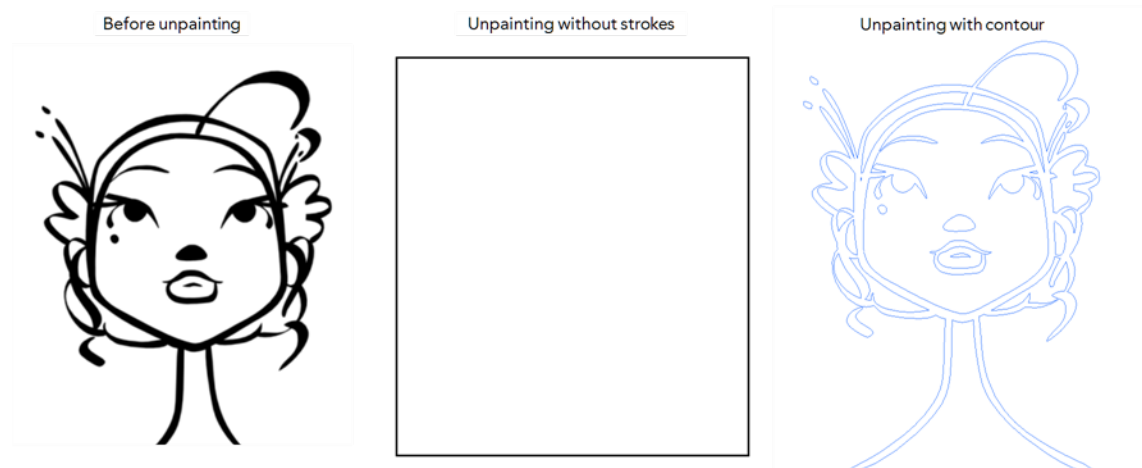
Create Contour Stroke



The Create Contour Stroke  option is used to add a permanent invisible line around a shape that was drawn directly in Harmony. This allows you to unpaint your lines with the Paint  tool but maintain the shape of the lines, should you need to repaint later.

This command is useful when inking and painting and using the Apply to All Drawings in Layer  option.

How to create contour strokes

1. In the Tools toolbar, select the Select tool.
2. In the Drawing view, use the Select tool to select the drawing objects you want to create contour strokes for.
3. From the top menu, select **Selected > Create Contour Strokes**.

Remove Contour Stroke

The Remove Contour Stroke option is used to remove any permanently invisible lines that were created while scanning and vectorizing drawings or manually adding contour strokes. This is useful if you want to remove the intersection triangles created during vectorization.

How to remove contour strokes

1. In the Tools toolbar, select the Select tool.
2. In the Drawing view, use the Select tool to select the drawing objects you want to remove contour strokes for.
3. From the top menu, select **Selected > Remove Contour Strokes**.

Grid

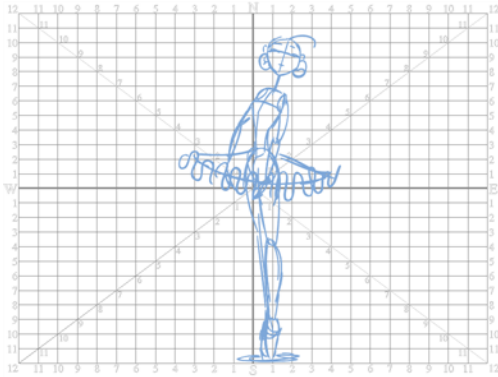

Use the Show Grid option to display a grid in the Drawing view.

Name	Button	Description	Keyboard Shortcut
Show Grid		Displays the grid	From the top menu, select View > Grid > Show Grid Press Ctrl + ' (Windows/Linux) or ⌘ + ' (Mac OS X).
Square		Displays a standard square grid	From the top menu, select View > Grid > Square .
12 Field Grid		Displays a 12-field size grid	From the top menu, select View > Grid > 12 Field Grid .
16 Field Grid		Displays a 16-field size grid	From the top menu, select View > Grid > 16 Field Grid .
Underlay		Displays the grid under the drawing elements	From the top menu, select View > Grid > Underlay
Overlay		Displays the grid over the drawing elements	From the top menu, select View > Grid > Overlay

Group/Ungroup

Use the Group option to group selected drawing objects. This can help in the selection, repositioning, re-scaling and other transformations to be applied to multiple objects of a drawing.

- From the top menu, select **Selected > Group > Group** or **Selected > Group > Ungroup**.
- Press Ctrl + G and Ctrl + Shift + G (Windows/Linux) or ⌘ + G and ⌘ + Shift + G (Mac OS X).

Hand

Use the Hand tool to pan through the Drawing view.

- In the Tools toolbar, select the Hand  tool, click in the Drawing view and drag.
- You can also Hold down the Spacebar, click in the Drawing view and move your mouse in the direction you want to pan the view.

Rotate View

The Rotate View  tool lets you rotate the Drawing view, the same way as you would do with a real animation disc. This tool can also be used in the Perspective view.

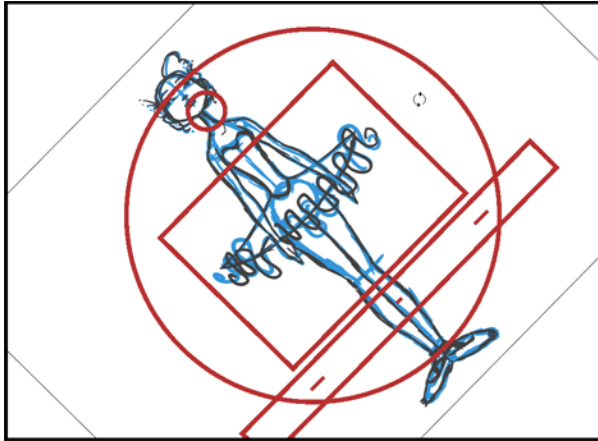

How to use the Rotate View tool

1. Do one of the following:
 - ▶ From the top menu, select **Tools > Rotate View**.
 - ▶ Press Ctrl + Alt (Windows/Linux) or ⌘ + Alt (Mac OS X).
 - ▶ In the Tools toolbar, select the Rotate View  tool.
 - ▶ In the Drawing view, right-click and select **Drawing Tools > Rotate View**.
2. In the Drawing view, click and drag to rotate the space.

Drawing Tool References

Harmony has a wide variety of drawing tools and each one of them has a series of options and modes available. This section covers these options. For details on how to use these tools, see [Drawing Tasks on page 79](#).

- [Pencil Tool Options below](#)
- [Brush Tool Options on page 139](#)
- [Select Tool Options on page 141](#)
- [Eraser Tool Options on page 150](#)
- [Contour Editor Options on page 151](#)
- [Pencil Editor Options on page 154](#)
- [Shape Tool Options on page 157](#)
- [Polyline Tool Options on page 162](#)
- [Stroke Tool Options on page 163](#)
- [Perspective Tool Options on page 164](#)
- [Envelope Tool Options on page 165](#)
- [Cutter Tool Options on page 168](#)
- [Smooth Editor Tool Options on page 170](#)
- [Text Tool Options on page 172](#)
- [Drawing Pivot Tool on page 175](#)

Pencil Tool Options

When you select the Pencil  tool, its properties and options appears in the Tool Properties view.

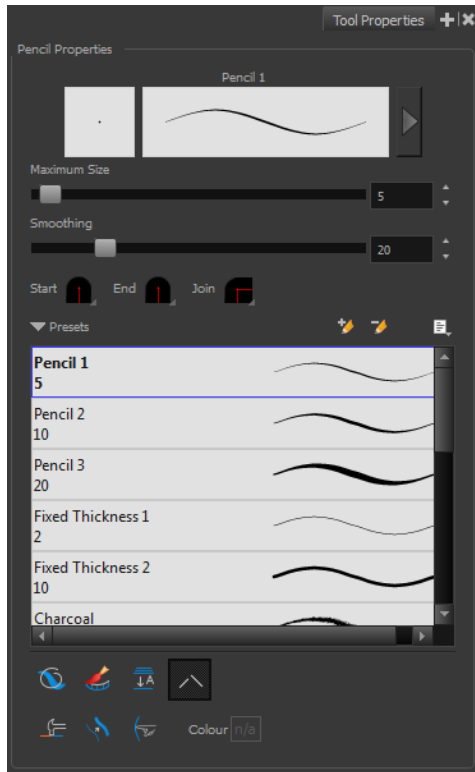

Previewing the Stroke

The Preview area lets you see a preview of the stroke that will be produced after you customize the different parameters in the Tool Properties view. Click on the Show Extended Properties arrow to display advanced customization parameters,

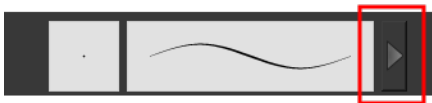

Maximum Size and Smoothing

This is where you set the minimum and maximum sizes of your drawing tool which will produce the thick and thin effect on your stroke. This works with the pressure sensitivity of a pen tablet.

- **Maximum and Minimum Size:** Defines the maximum and minimum width of the stroke.
- **Smoothing:** Defines the number of control points added to the centre line.

Adjusting the Pencil Line Style



You can adjust the start, end, and joint style of a selected pencil line.

- **Start:** Lets you select the style of the start tip, which is the first tip you drew. You can choose between Round or Flat style.
- **End:** Lets you select the style of the end tip, which is the last tip you drew. You can choose between Round or Flat style.
- **Join:** Lets you select the joint style. The joints are where the line curves abruptly. You could also define the Join style as the corner style. You can choose between Round, Mitre and Bevel style.

Thickness Stencils

Harmony provides a variety of thickness stencils and also lets you create and save your own. It is a good idea to create and save pencils with precise sizes and parameters when you draw and design.

A thickness stencil saves a preset of how the thickness information looks across the length of the line. When drawing with a thickness stencil, the pressure sensitivity of the tablet is discarded in order to apply the thickness stencil.

A thickness stencil can be used while drawing, or applied afterwards.

You also have the possibility to apply different textures to your lines by either using the preset ones or importing your own—see [Working with Pencil Presets on page 82](#) and [Pencil Line Texture on page 85](#).

Pencil Line Texture

You can apply a bitmap texture on your pencil line and adjust it as needed—see [Pencil Line Texture on page 85](#)

Draw Behind



Create Colour Art Automatically

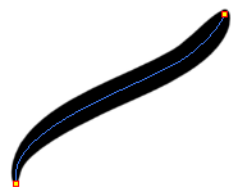

As you draw in the Line Art layer, the Create Colour Art Automatically  option automatically creates the corresponding strokes in the Colour Art layer. To access this option, you must be in the Advanced Art mode.

Auto-Flatten Mode

When drawing on vector layers, lines do not usually become one object. The Auto-Flatten  mode automatically merges lines created with the existing ones into one single object as you draw.

When drawing on a bitmap layer, you are laying down the bare pixels, so they are always flattened. You can no longer access the individual stroke after you draw it.

Using the Select tool, you can use the middle mouse button to select a segment of a flattened pencil line to create a nice finish on the lines and corners of your artwork.

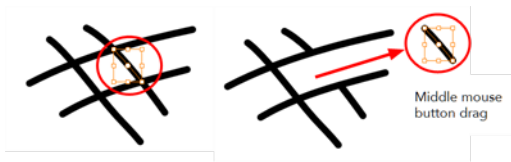

Auto-Close Gap

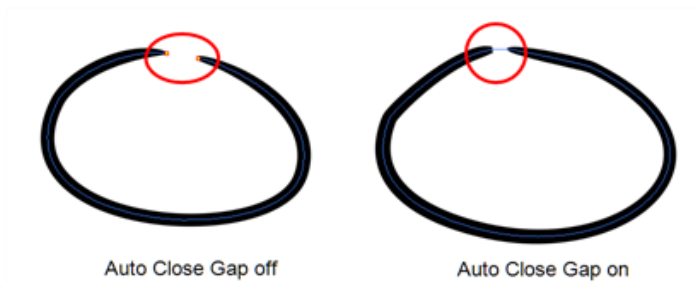

When using the pencil tool, you can automatically close strokes with an invisible stroke.

It is recommended to keep this option enabled when drawing with the Pencil tool.

Line Building Mode





The Line Building  mode is very useful when drawing long lines and curves in small increments with pencil lines. As the pencil lines are central vector lines and it may be difficult to align the line tips perfectly to create a uniform stroke and close all gaps.

In this mode, you can draw lines in small increments and the tips are merge into one single stroke.

This mode only works with pencil lines.

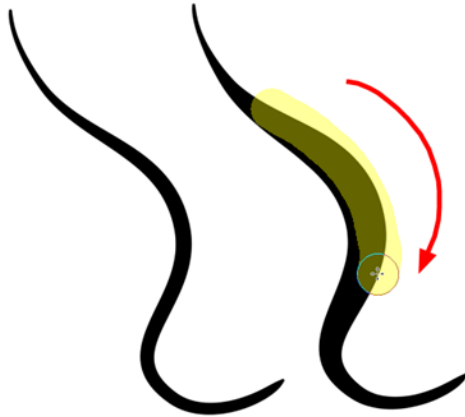

Auto Adjust Thickness



The Auto Adjust Thickness  tool is useful when you want to render a portion of a line thicker. When tracing a drawing on paper, you will often go back to a section of a curve to make it thicker to add dynamism to the line. Using the Auto Adjust Thickness tool, you can draw highlight strokes over the section to make thicker. Once you release the pen or mouse, the line becomes thicker following the shape and curve of the original stroke. This way is much faster and smoother than using the Pencil Editor tool. You do not have to add extra points and adjust the position and Bezier handles.

The default overlay colour is light yellow. If this colour is difficult to see because of the background or drawing colour, you can adjust the colour.

How to change the Auto Adjust Thickness Colour

1. In the Tools toolbar, select the Pencil  tool.
2. In the Tool Properties view, click the Auto Adjust Thickness  button.
3. Click the colour swatch.

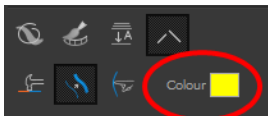

The Colour Picker window opens.

4. In the Colour Picker window, select a new colour.

Line Pushing Mode

The Line Pushing Mode  option lets you draw highlight strokes over existing pencil lines. You can reshape the curves. Depending how you draw the pushing stroke over your line, the highlighted section will be reshaped in one direction or the other.

The default overlay colour is light yellow. If this colour is difficult to see because of the background or drawing colour, you can adjust the colour.

To change the Line Pushing Mode colour

1. In the Tools toolbar, select the Pencil 

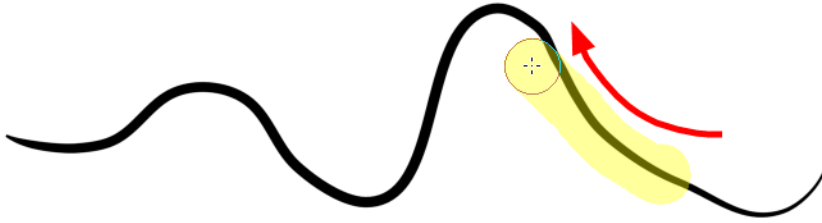

tool.

2. In the Tool Properties view, select the Line Pushing Mode  button.
3. Click the colour swatch.

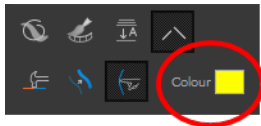

The Colour Picker window opens.

4. In the Colour Picker window, select a new colour.

Brush Tool Options

When you select the Brush  tool, its properties and options appear in the Tool Properties view.

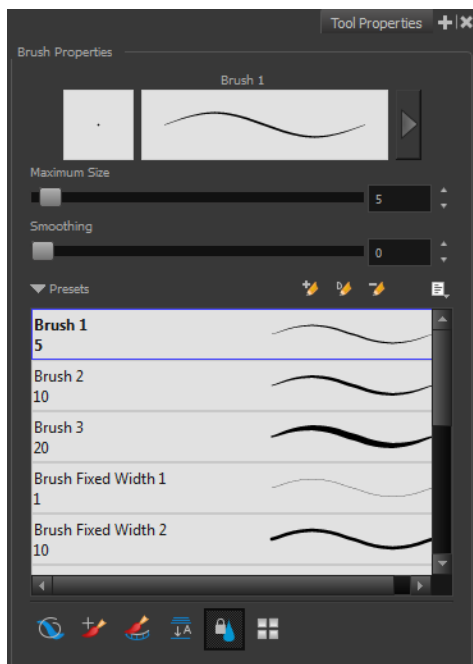

Previewing the Stroke

The Preview area lets you see a preview of the stroke that will be produced after you customize the different parameters in the Tool Properties view. Click on the Show Extended Properties arrow to display advanced customization parameters,



Maximum Size and Smoothing

This is where you set the minimum and maximum sizes of your drawing tool which will produce the thick and thin effect on your stroke. This works with the pressure sensitivity of a pen tablet.

- **Maximum and Minimum Size:** Defines the maximum and minimum width of the stroke.
- **Smoothing:** Defines the number of control points added to the centre line.

Brush Presets

Brush presets are created by saving the properties of the current brush to a new preset, which you can reuse for repeated tasks. You can create as many brush presets as you need—see [Drawing with the Brush Tool on page 88](#).

Draw Behind



When the Draw Behind  mode is enabled, the lines you draw will appear behind the art that already exists.

Repaint Brush Mode



The Repaint Brush  is used to repaint zones that have already been painted, it will not affect empty zones or pencil lines. It also automatically flattens each of its brush lines so it does not add

new brush lines on top of existing ones. You can use this mode to paint tones or highlights onto your character.

Create Colour Art Automatically

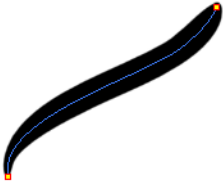

As you draw in the Line Art layer, the Create Colour Art Automatically  option automatically creates the corresponding strokes in the Colour Art layer. To access this option, you must be in the Advanced Art mode.

Auto-Flatten Mode

When enabled, the Auto-Flatten mode automatically flattens the new lines created with the existing artwork as you draw in the Drawingview. Brush strokes will flatten with brush strokes and pencil lines will flatten with pencil lines.

Respect Protected Colour

The Respect Protected Colour  option prevent the colours you marked as protected in the Colour view to be repainted using the Repaint Brush mode or any of the painting tools.

Use Stored Colour Gradient

The Use Stored Colour Gradient  option makes your tool use the previously stored gradient position. This way, every new brush line or colour fill will use the stored gradient position.

Select Tool Options

When you choose the Select  tool, its properties and options appear in the Tool Properties view.

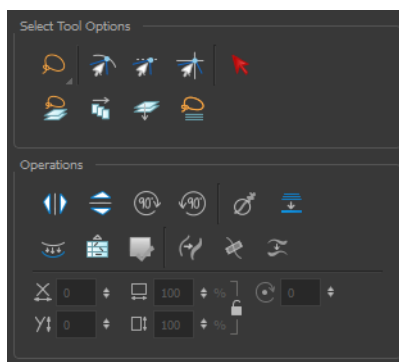



Lasso and Marquee

Choose between the Lasso  and Marquee  options to change the selection style of the tool.

- Click and hold Alt to temporarily switch from the current mode to the other.



Snap Options

You can enable different snapping modes to help you when repositioning drawings using the Select tool.

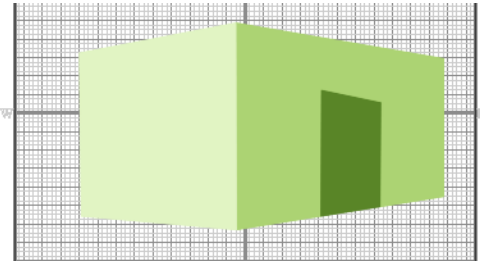
-  **Snap to Contour:** Snaps your selection or point to any line you position it on. As soon as you move it close enough to another line, your point or selection will snap to it.
-  **Snap and Align:** Snaps the selected anchor point to any existing line while displaying temporary rulers as a guide that you can also snap your anchor point to.
-  **Snap to Grid:** Snaps your selection following the currently enabled grid.



How to snap to grid

1. Do one of the following:
 - Select **View > Grid > Show Grid** to display the grid in the Camera or Drawing view or press **Ctrl + '** (Windows/Linux) or **⌘ + '** (Mac OS X).
 - Select **View > Grid > Square Grid, 12 Field Grid** or **16 Field Grid** for your current needs.
2. In the Tools toolbar, select the Contour Editor  tool or press **Alt + Q**.
3. In the Contour Editor Tool Properties view, click the Snap to Grid  button.
4. In the Camera or Drawing view, click on the anchor point you want to snap following the grid, drag it to the desired position and release.

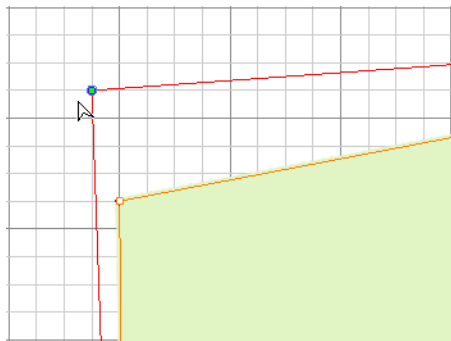

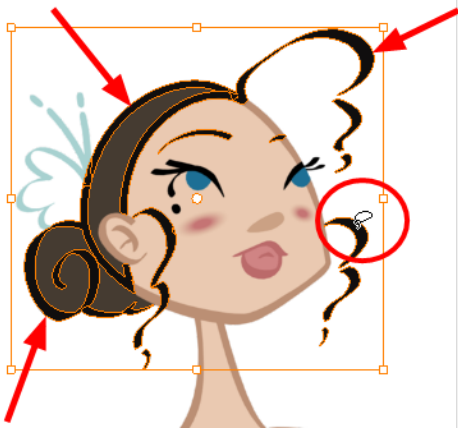

Select by Colour



The Select by Colour mode lets you select all the zones in your drawing painted with the same colour.

Only the zones painted with the **SAME** colour swatch will be selected. If another zone is coloured with the exact same RGB value (same colour), but not painted with the same colour swatch, it will not be selected.

How to select areas by colour

1. In the Tools toolbar, select the **Select**  tool or press Alt + S.
2. In the Tool Properties view, click the Select by Colour  button.
3. In the Drawing view, click on any zone in your drawing.
All zones of the same colour are selected.
4. Click the Select tool again to return to the regular Select mode.

Permanent Selection

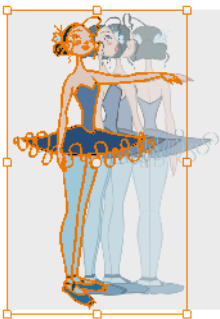

The Permanent Selection  option lets you maintain a selection over multiple drawings. Once this option is enabled, the selection zone made using the Select tool will remain as you navigate through drawings from a layer and drawings from other drawing layers. This option can be used to

simultaneously delete artwork inside or outside of the selection on several drawings when combined with the Apply to Multiple Drawings option.

Apply to All Drawings in Layer

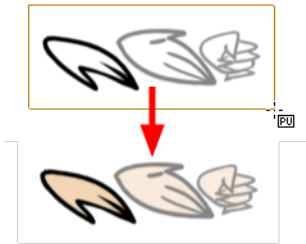



The Apply to All Drawings in Layer  option is used to perform an action on all the drawings contained in a layer. For example, you could enable the option to paint a section on all the drawings simultaneously. The Apply Tool to All Drawings option must be activated before performing the action and will stay enabled only for the next action.

Apply to Line and Colour Art

The Apply to Line and Colour Art  option uses the concept of Line Art and Colour Art layers. Use this option to apply an action such as selecting or resizing a drawing on both Line Art and Colour Art layers, as well as the Overlay and Underlay layers.

Flip Horizontal and Vertical





The Flip Horizontal  and Flip Vertical  operations flip the current selection horizontally or vertically.

- ▶ From the top menu, select **Selected > Transform > Flip Horizontal** and **Flip Vertical**.

Rotate 90 Degrees CW and CCW



The Rotate 90 Degrees CW  and Rotate 90 Degrees CCW  operations rotate the current selection 90 degrees clockwise or counter-clockwise.

- ▶ From the top menu, select **Selected > Transform > Rotate 90 Degrees CW** and **Rotate 90 Degrees CCW**.
- ▶ Press Ctrl + 7 and Ctrl + 9 (Windows/Linux) or ⌘ + 7 and ⌘ + 9 (Mac OS X).

Smooth

The Smooth  operation lets you smooth out selected drawing strokes and remove extra points.

- ▶ From the top menu, select **Selected > Smooth** or press Alt + Shift + S.

Flatten

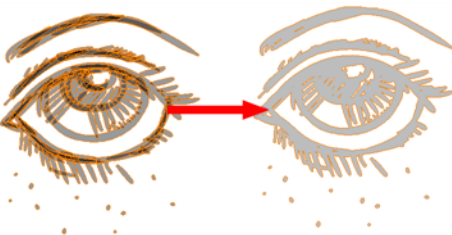

The Flatten  operation is used to merge drawing objects and brush strokes into a single layer. If you draw new lines to fix a drawing or line with many brush strokes, it can be useful to flatten them all into a single shape. By default, lines are drawn one on top of each other. If you intend to repaint the lines or modify their shape, it will be easier if they are flattened.

- ▶ From the top menu, select **Selected > Flatten** or press Alt + Shift + F.

Create Colour Art from Line Art

You can use the outline you traced on one of the four embedded layers and create invisible strokes to paint your drawings on separate layers. This provides more inking and painting flexibility.

You can also configure the option to create the invisible strokes on any of the four embedded layers.

How to create Colour Art zones out of the Line Art content

1. In the Tools toolbar, select the Select  tool or press Alt + S.
2. In the Drawing view, select the artwork to transfer to the Colour Art.
3. In the Drawing View toolbar, click the Create Colour Art from Line Art button or press *.

How to configure the Create Colour Art from Line Art option

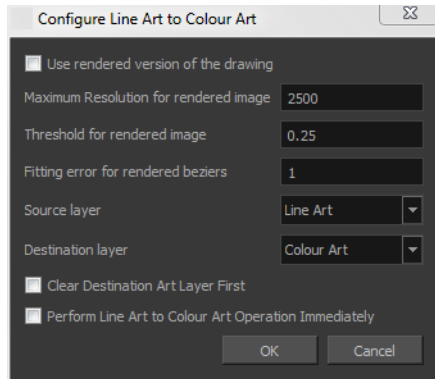

1. In the Tools toolbar, select the Select  tool or press Alt + S.
2. In the Tool Properties view, Shift + click the Create Colour Art from Line Art  button.

The Configure Line Art to Colour Art dialog box opens.





Parameter	Description
Use rendered version of the drawing	Renders the drawing and vectorize it to calculate the position of the centreline that will produce the colour art stroke.
Maximum Resolution for rendered image	The size of the rendered image.
Threshold for rendered image	The value of grey processed to create the rendered vectorized arts.
Fitting error for rendered Beziers	This value represents how precise the fitting of the colour art zone in relation to the line art will be.
Source layer	Lets you select the layer (Line Art, Colour Art, Underlay or Overlay) you want the colour art to be created from.
Destination layer	Lets you select the layer (Line Art, Colour Art, Underlay or Overlay) you want the colour art to be created on.
Clear Destination Art Layer First	Deletes the content before the colour art is added. This is useful when you already have artwork on the destination layer.
Perform Line Art to Colour Art Operation Immediately	Performs the Create Colour Art from Line Art command when you click OK.

Store Colour Gradient

Use the Store Colour Gradient  operation to record the selected gradient's position. This reuses the stored position of the gradient when drawing new brush lines or painting colour zones. Enable the Use Stored Colour Gradient  option in the Paint or Brush Tool Properties view to do this.

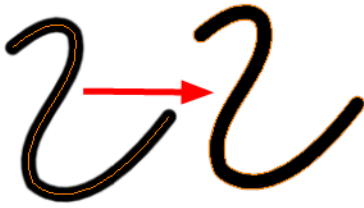
Pencil to Brush



The Pencil to Brush  operation converts the selected centre line pencil strokes into contour strokes brush lines.

From the top menu, select **Selected > Convert > Pencil Lines to Brush** or press &.

Merge Pencil Lines

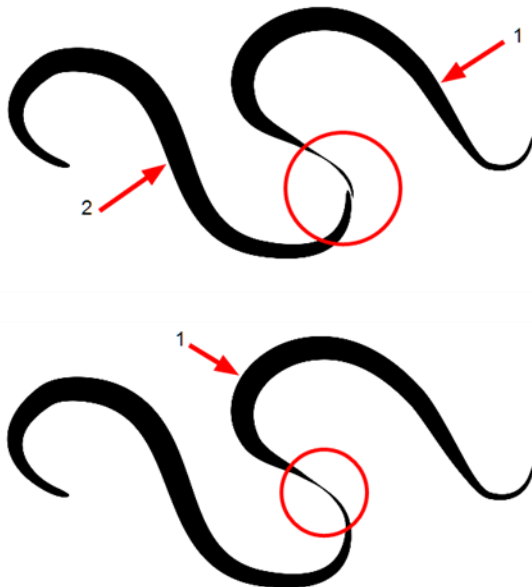

Pencil lines are central vector lines and it might be difficult to match pencil line's tips properly to align them and make it look like it is one single line. With the Select tool, you can select several pencil lines and merge them as one single object using the Merge Pencil Lines  option. The ends of your lines are adjusted to form one single line.

Points must be close enough to be merged. If there is a large gap between the lines, they will not be merged.

Reverse Pencil Thickness

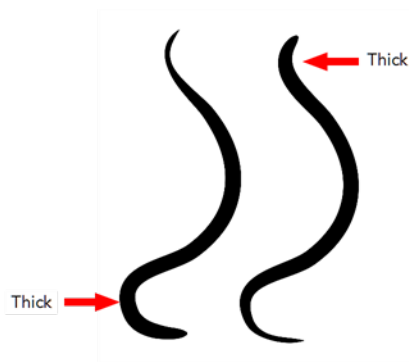

The Reverse Pencil Thickness  option inverts the thick and thin section on a selected pencil line. This option will take the thickest size on the line and apply it to the thinnest, and it will apply the thinnest to the thickest.

Width and Height

Use the Width and Height operation fields to enter specific values to resize the selected shape with precision.

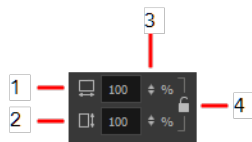

1. **Width:** Type a value in this field to resize the width of your selection.
2. **Height:** Type a value in this field to resize the height of your selection.
3. **Up/Down arrows:** Use the up and down arrows to modify the value in the Width or Height fields.
4. **Lock icon:** Click the lock icon to lock or unlock the ratio between the Width and Height values.

Offset X and Y

Use the Offset X and Offset Y operation fields to enter specific values and precisely reposition the selected shape.

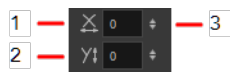

1. **X:** Type a value in this field to reposition your selection along the X-axis.
2. **Y:** Type a value in this field to reposition your selection along the Y-axis.
3. **Up/Down arrows:** Use the up and down arrows to modify the value in the X or Y value field.

Angle

The Angle operation lets you to enter specific values and accurately rotate the selected shape.



1. **Angle:** Type a degree value in this field to rotate your selection.
2. **Up/Down arrows:** Use the up and down arrows to modify the value in the Angle value field.

Adjusting the Pencil Line Thickness

Use the Adjusting the Pencil Line Thickness operation field to resize the selected centreline strokes. This operation is not permitted on contour line shapes, such as brush strokes or shape fills.

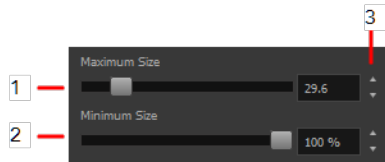

1. **Minimum Size:** Type a value in this field to set the minimum thickness of the selected centreline stroke.
2. **Maximum Size:** Type a value in this field to set the maximum thickness of the selected centreline stroke.
3. **Up/Down arrows:** Use the up and down arrows to modify the value contained in the Thickness value field.

Adjusting the Pencil Line Style



You can adjust the start, end, and joint style of a selected pencil line.

- **Start:** Lets you select the style of the start tip, which is the first tip you drew. You can choose between Round or Flat style.
- **End:** Lets you select the style of the end tip, which is the last tip you drew. You can choose between Round or Flat style.
- **Join:** Lets you select the joint style. The joints are where the line curves abruptly. You could also define the Join style as the corner style. You can choose between Round, Mitre and Bevel style.

Pencil Stencils



Toon Boom Harmony gives you the flexibility to change the style and thickness of your pencil lines even after they are drawn. You can apply preset pencil stencils or create your own—see [Working with Pencil Presets on page 82](#).

Adding Texture to a Pencil Line

Pencil lines support texture. Once a pencil line is drawn, you can apply a preset texture or load your own. Textures are independent from pencil stencils—see [Pencil Line Texture on page 85](#).

Adjusting the Text Selection

When you select text with the Select tool, the tool properties will display the Text tool options on the bottom of the view. You can also press **Alt + 9** to display only the Text properties in the Tool Properties view—see [Text Tool Options on page 172](#).

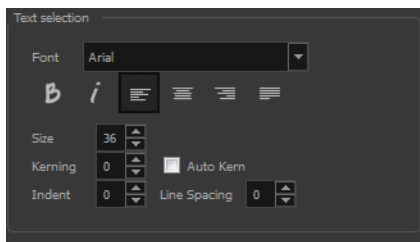

Eraser Tool Options

When you select the Eraser  tool, its properties and options appear in the Tool Properties view.

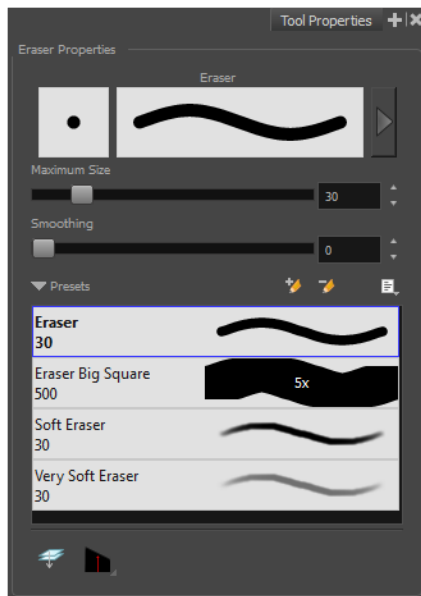

Previewing the Stroke

The Preview area lets you see a preview of the stroke that will be produced after you customize the different parameters in the Tool Properties view. Click on the Show Extended Properties arrow to display advanced customization parameters,



Maximum Size and Smoothing

This is where you set the minimum and maximum sizes of your drawing tool which will produce the thick and thin effect on your stroke. This works with the pressure sensitivity of a pen tablet.

- ▶ **Maximum and Minimum Size:** Defines the maximum and minimum width of the stroke.
- ▶ **Smoothing:** Defines the number of control points added to the centre line.

Eraser Presets

Eraser presets are created by saving the properties of the current eraser to a new preset, which you can reuse for repeated tasks. You can create as many eraser presets as you need—see [Erasing Parts of a Drawing on page 112](#).

The Eraser tool uses its own preset list, separated from the Brush tool. Toon Boom Harmony provides a variety of eraser styles and allows you to create and save your own. It is a good idea to create and save eraser with precise sizes and parameters to draw and design.

Eraser Blur Parameters

Since Harmony lets you draw with textured lines and create feathered edges on them, you may also want to erase with smooth edges instead of the solid vector based eraser. The Eraser Blur Parameters allow you to adjust the smoothness of your eraser for the textured lines—see [How to erase textured lines on page 97](#)

Apply to Line and Colour Art

The Apply to Line and Colour Art  option uses the concept of Line Art and Colour Art layers. Use this option to apply an action such as selecting or resizing a drawing on both Line Art and Colour Art layers, as well as the Overlay and Underlay layers.

Tip Style

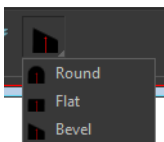

Use the Tip Style option to customize the tip of the pencil line you are cutting.

Contour Editor Options

When you select the Contour Editor  tool, its properties and options appear in the Tool Properties view.

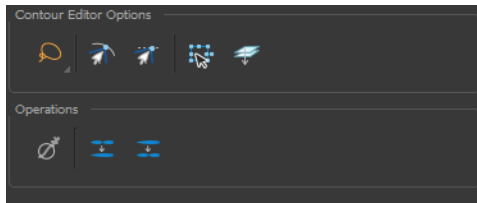



Lasso and Marquee

Choose between the Lasso  and Marquee  options to change the selection style of the tool.

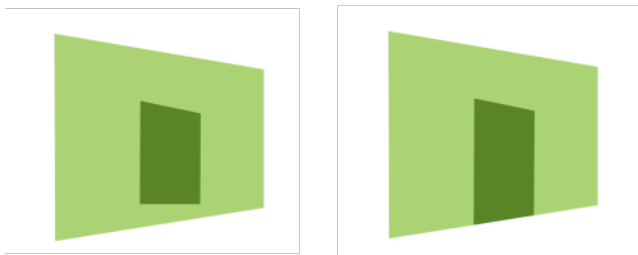

- Click and hold Alt to temporarily switch from the current mode to the other.

Snap to Contour



The Snap to Contour  option will snap the selected anchor point to any line you position it on.

How to snap two shapes together

1. In the Tools toolbar, select the Contour Editor  tool or press Alt + Q.
2. In the Tool Properties view, click the Snap to Contour  button.
3. In the Drawing view, click on an anchor point you want to snap to the other shape, drag it on top of the contour line area and release it.

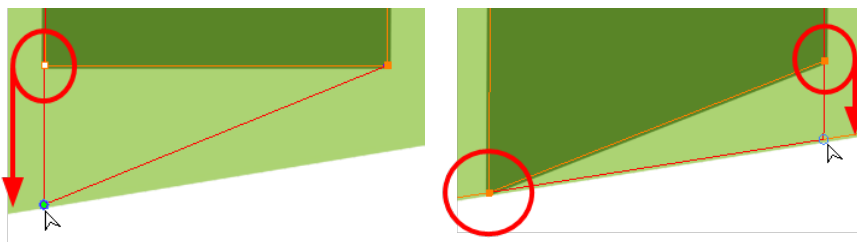

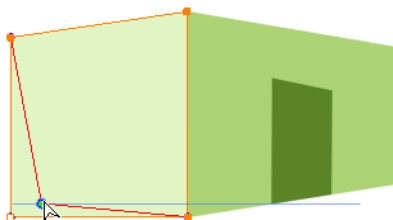

Snap and Align



The Snap and Align  option lets you snap the selected anchor point to any existing line while displaying temporary rulers as a guide that you can also snap your anchor point to.

How to snap and align

1. In the Tools toolbar, select the Contour Editor  tool or press Alt + Q.
2. In the Tool Properties view, click the Snap and Align  button.
3. In the Drawing view, click on an anchor point you want to snap, drag it until a ruler is displayed, position it on the ruler or on the contour line and release.



Show Contour Editor Controls

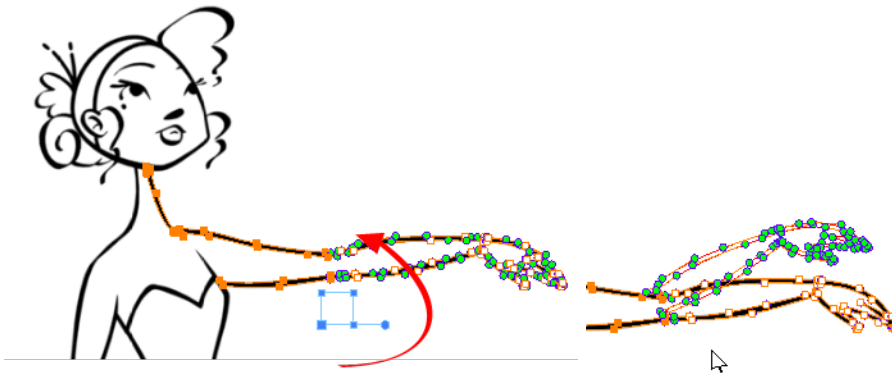

Use the Show Contour Editor Controls  option to show the contour editor controls. You can use these controls to scale, reposition and rotate the selected anchor points.

Apply to Line and Colour Art

The Apply to Line and Colour Art  option uses the concept of Line Art and Colour Art layers. Use this option to apply an action such as selecting or resizing a drawing on both Line Art and Colour Art layers, as well as the Overlay and Underlay layers.

Smooth Selection

The Smooth  operation lets you smooth out selected drawing strokes and remove extra points.

- ▶ From the top menu, select **Selected > Smooth** or press Alt + Shift + S.

Split Pencil Line and Join Pencil Lines

When drawing with the Polyline tool, your drawing has an even line thickness. You can use the Pencil Editor to adjust the thickness point by point, but if you want to adjust it quicker, you can use the Split Pencil Line and Point Pencil Lines options to create segments and apply a pencil stencil to your

drawing. Note that if you did not join the pencil lines on your polyline stroke, the segments between the points will act as separated segments.

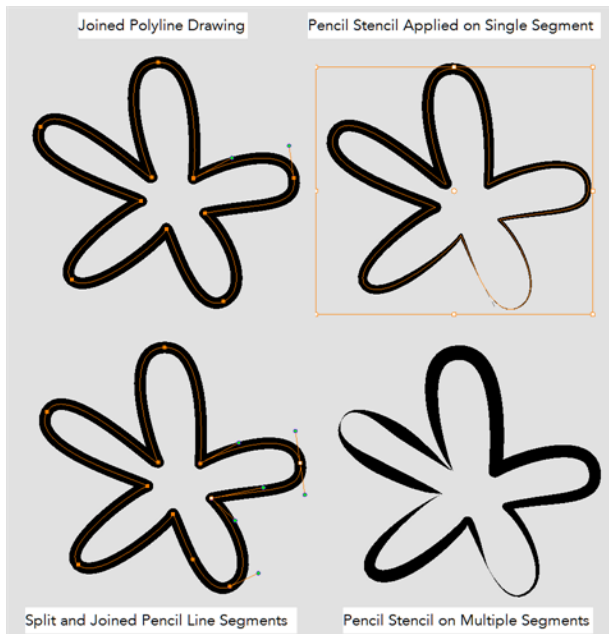

How to split and join pencil lines

1. In the Tools toolbar, select the Contour Editor tool.
2. In the Drawing, select the contour points you want to split or join.
3. In the Tool Properties view, click on the Join Pencil Lines or Separate Pencil Line buttons.

Pencil Editor Options

When you select the Pencil Editor tool, its properties and options appear in the Tool Properties view.



Lasso and Marquee

Choose between the Lasso  and Marquee  options to change the selection style of the tool.

- Click and hold Alt to temporarily switch from the current mode to the other.

Maximum Size and Smoothing

This is where you set the minimum and maximum sizes of your drawing tool which will produce the thick and thin effect on your stroke. This works with the pressure sensitivity of a pen tablet.

- **Maximum and Minimum Size:** Defines the maximum and minimum width of the stroke.
- **Smoothing:** Defines the number of control points added to the centre line.

Adjusting the Pencil Line Style

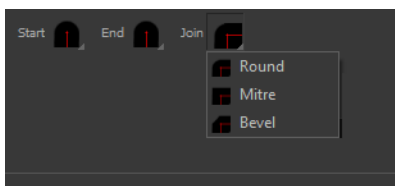

You can adjust the start, end, and joint style of a selected pencil line.

- **Start:** Lets you select the style of the start tip, which is the first tip you drew. You can choose between Round or Flat style.
- **End:** Lets you select the style of the end tip, which is the last tip you drew. You can choose between Round or Flat style.
- **Join:** Lets you select the joint style. The joints are where the line curves abruptly. You could also define the Join style as the corner style. You can choose between Round, Mitre and Bevel style.

Preset

To work with Pencil line presets, see [Working with Pencil Presets on page 82](#).

Textures

To work with Pencil Line Texture, see [Pencil Line Texture on page 85](#)

Smooth

The Smooth  operation lets you smooth out selected drawing strokes and remove extra points.

- ▶ From the top menu, select **Selected > Smooth** or press Alt + Shift + S.

Pump Pencil Pressure

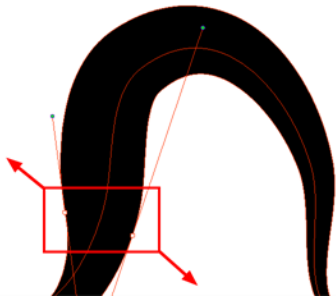

The Pump Pencil Pressure  option is used to increase the line thickness of a selected area on a pencil line.

Deflate Pencil Pressure

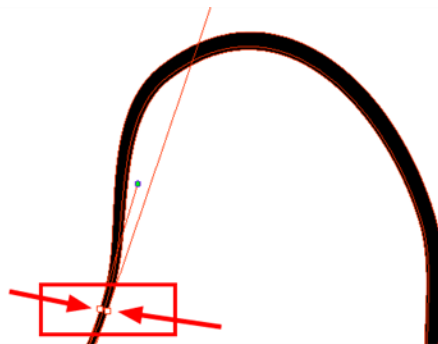

The Deflate Pencil Pressure  option is used to decrease the line thickness of a selected area on a pencil line.

Merge Pencil Lines

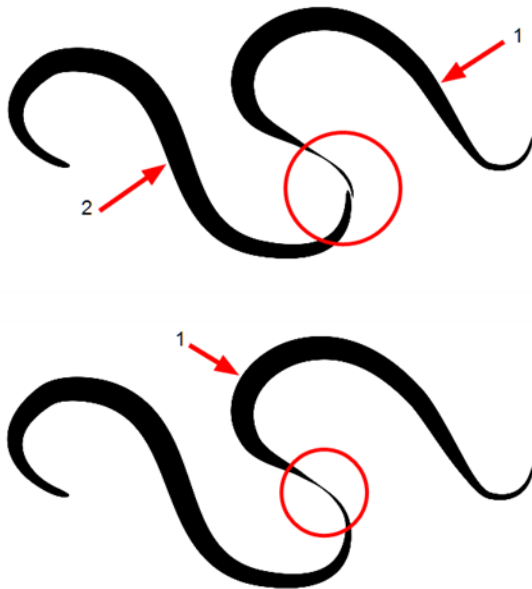

Pencil lines are central vector lines and it might be difficult to match pencil line's tips properly to align them and make it look like it is one single line. With the Select tool, you can select several pencil lines and merge them as one single object using the Merge Pencil Lines  option. The ends of your lines are adjusted to form one single line.

Reverse Pencil Thickness

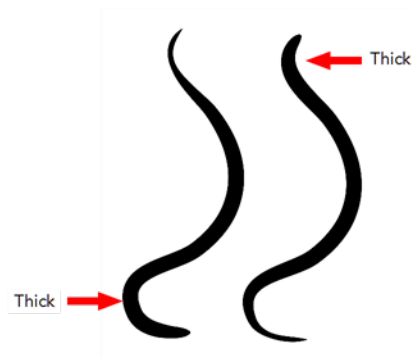

The Reverse Pencil Thickness  option inverts the thick and thin section on a selected pencil line. This option will take the thickest size on the line and apply it to the thinnest, and it will apply the thinnest to the thickest.

Shape Tool Options

When you select a shape tool (Rectangle, Ellipse, Line), its properties and options appear in the Tool Properties view.

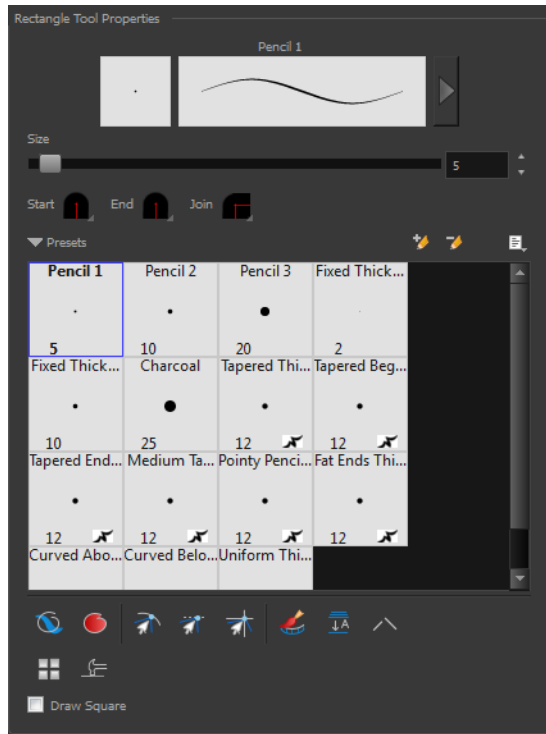

Previewing the Stroke

The Preview area lets you see a preview of the stroke that will be produced after you customize the different parameters in the Tool Properties view. Click on the Show Extended Properties arrow to display advanced customization parameters,

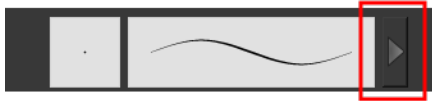

Size

Move the Size slider left to reduce the line thickness and to the right to increase its width.

Adjusting the Pencil Line Style



You can adjust the start, end, and joint style of a selected pencil line.

- **Start:** Lets you select the style of the start tip, which is the first tip you drew. You can choose between Round or Flat style.
- **End:** Lets you select the style of the end tip, which is the last tip you drew. You can choose between Round or Flat style.
- **Join:** Lets you select the joint style. The joints are where the line curves abruptly. You could also define the Join style as the corner style. You can choose between Round, Mitre and Bevel style.

Thickness Stencils

Toon Boom Harmony provides a variety of thickness stencils and also lets you create and save your own. It is a good idea to create and save pencils with precise sizes and parameters when you draw and design.

A thickness stencil saves a preset of how the thickness information looks across the length of the line. When drawing with a thickness stencil, the pressure sensitivity of the tablet is discarded in order to apply the thickness stencil.

A thickness stencil can be used while drawing, or applied afterwards.

You also have the possibility to apply different textures to your lines by either using the preset ones or importing your own—see [Working with Pencil Presets on page 82](#)



Draw Behind



When the Draw Behind  mode is enabled, the lines you draw will appear behind the art that already exists.

Snap Options

When drawing a shape, you can enable different snap modes to help you create your shape.

- The Snap to Contour  option snaps your shape to any line you position it on.
- The Snap and Align  option snaps the selected anchor point to any existing line, while displaying temporary rulers as a guide that you can also snap your anchor point to.
- The Snap to Grid  snaps your shape to the currently enabled grid.

Automatic Filling

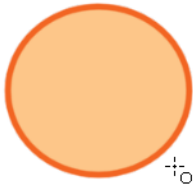

Use the Automatic Filling  option to automatically fill your shape with the selected colour as you draw. By default, the Shape tool creates the contour of an empty shape that you can later fill using the Paint tool.

Create Colour Art Automatically

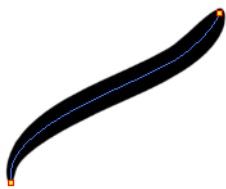

As you draw in the Line Art layer, the Create Colour Art Automatically  option automatically creates the corresponding strokes in the Colour Art layer. To access this option, you must be in the Advanced Art mode.

Auto-Flatten Mode

When enabled, the Auto-Flatten mode automatically flattens the new lines created with the existing artwork as you draw in the Drawingview. Brush strokes will flatten with brush strokes and pencil lines will flatten with pencil lines.

Using the Select tool, you can use the middle mouse button to select a segment of flattened pencil line. This creates a nice finish on the lines and corners of your artwork.

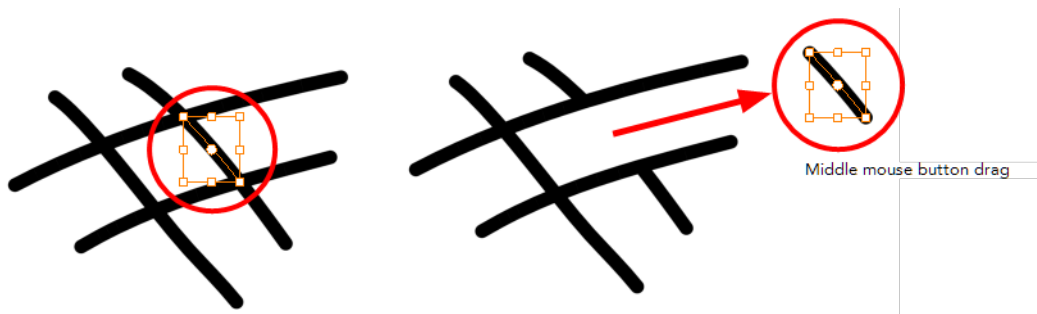

Auto-Close Gap

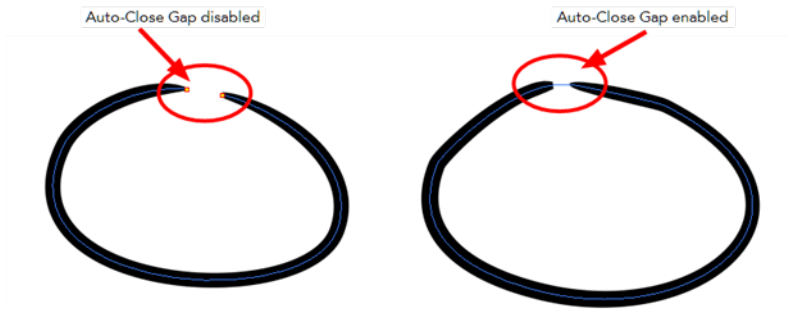

When enabled, the Auto-Close Gap  mode automatically connects, with an invisible stroke, the pencil lines you draw close to each other in the Drawing view.

It is recommended to leave this option enabled when drawing with the Pencil tool.

Use Stored Colour Gradient

The Use Stored Colour Gradient  option makes your tool use the previously stored gradient position. This way, every new brush line or colour fill will use the stored gradient position.

Line Building Mode



The Line Building  mode is very useful when drawing long lines and curves in small increments with pencil lines. As the pencil lines are central vector lines and it may be difficult to align the line tips perfectly to create a uniform stroke and close all gaps.

In this mode, you can draw lines in small increments and the tips are merge into one single stroke.

This mode only works with pencil lines.

Keep Proportion

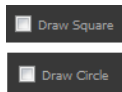

When the Ellipse or Rectangle mode is enabled in the Tool Properties view, the Draw Circle or Draw Square option appears. When selecting these options, the shape produced will be a circle or square. Holding down the Shift key as you create your shape will maintain proportion.

Polyline Tool Options

When you select the Polyline tool, its properties and options appear in the Tool Properties view.

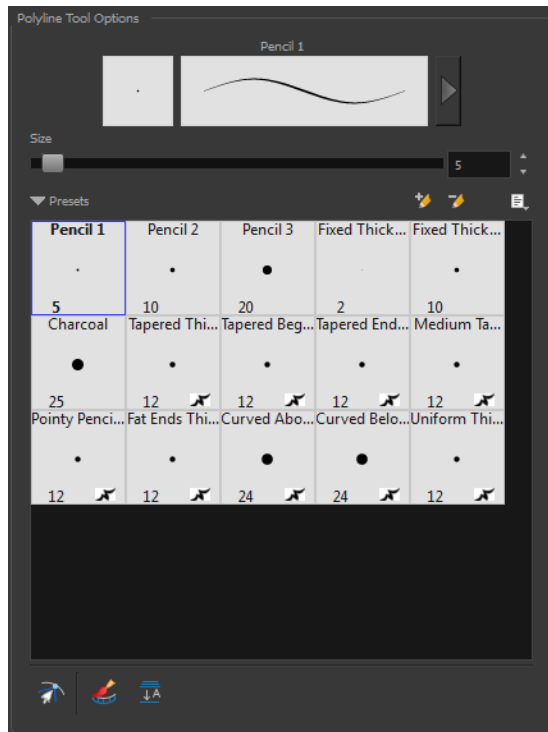

Previewing the Stroke

The Preview area lets you see a preview of the stroke that will be produced after you customize the different parameters in the Tool Properties view. Click on the Show Extended Properties arrow to display advanced customization parameters,

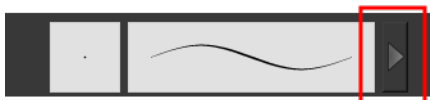

Size

The Size parameter lets you set the size of the polyline that you will draw.



Thickness Stencils

Harmony provides a variety of thickness stencils and also lets you create and save your own. It is a good idea to create and save pencils with precise sizes and parameters when you draw and design.

A thickness stencil saves a preset of how the thickness information looks across the length of the line. When drawing with a thickness stencil, the pressure sensitivity of the tablet is discarded in order to apply the thickness stencil.

A thickness stencil can be used while drawing, or applied afterwards.

You also have the possibility to apply different textures to your lines by either using the preset ones or importing your own—see [Working with Pencil Presets on page 82](#)

Snap to Contour

The Snap to Contour  option will snap your selection to any line you position it on.

Create Colour Art Automatically

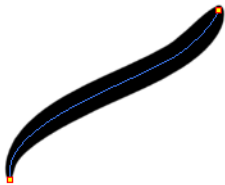

As you draw in the Line Art layer, the Create Colour Art Automatically  option automatically creates the corresponding strokes in the Colour Art layer. To access this option, you must be in the Advanced Art mode.

Auto-Flatten Mode

When enabled, the Auto-Flatten mode automatically flattens the new lines created with the existing artwork as you draw in the Drawingview. Brush strokes will flatten with brush strokes and pencil lines will flatten with pencil lines.

Stroke Tool Options

When you select the Stroke tool, its properties and options appears in the Tool Properties view.

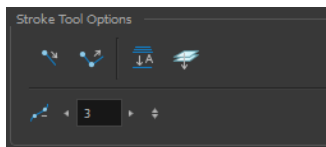

Draw Stroke as Straight Lines

Enable the Draw Stroke as Straight Lines  option if you want the new strokes you draw to be a

perfect straight line. Disable the option if you want the stroke to follow the mouse gesture.

Connect Line Ends

Enable the Connect Line Ends  option if you want the start or end point of your new stroke to connect to your existing strokes to make sure no gaps are left in your drawing.

Auto-Flatten Mode

When enabled, the Auto-Flatten mode automatically flattens the new lines created with the existing artwork as you draw in the Drawingview. Brush strokes will flatten with brush strokes and pencil lines will flatten with pencil lines.

Smoothness

You can modify the central line smoothness of your line using this option. This parameter smooths the initial movement of your line. Increasing the value will result in a smoother line with fewer control points. Use the left and right arrows to increment the value by one full unit. Use the Up - Down slider to quickly increment the value.

Perspective Tool Options

Selecting the Perspective tool displays its properties and options in the Tool Properties view.

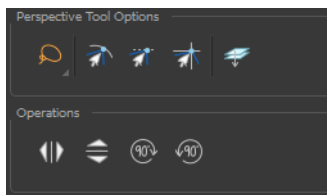



Lasso and Marquee

Choose between the Lasso  and Marquee  options to change the selection style of the tool.

- Click and hold Alt to temporarily switch from the current mode to the other.

Snap Options



- The Snap to Contour  option will snap the selected anchor point to any line you position it on—see [Contour Editor Options on page 151](#).
- The Snap and Align  option lets you snap the selected anchor point to any existing line while displaying temporary rulers as a guide that you can also snap your anchor point to—see [Contour Editor Options on page 151](#).
- The Snap to Grid  option snaps your selection according to the currently enabled grid.

Apply to Line and Colour Art

The Apply to Line and Colour Art  option uses the concept of Line Art and Colour Art layers. Use this option to apply an action such as selecting or resizing a drawing on both Line Art and Colour Art layers, as well as the Overlay and Underlay layers.

Flip Horizontal and Vertical





The Flip Horizontal  and Flip Vertical  operations flip the current selection horizontally or vertically.

- ▶ From the top menu, select **Selected > Transform > Flip Horizontal** and **Flip Vertical**.

Rotate 90 Degrees CW and CCW



The Rotate 90 Degrees CW  and Rotate 90 Degrees CCW  operations rotate the current selection 90 degrees clockwise or counter-clockwise.

- ▶ From the top menu, select **Selected > Transform > Rotate 90 Degrees CW** and **Rotate 90 Degrees CCW**.
- ▶ Press Ctrl + 7 and Ctrl + 9 (Windows/Linux) or ⌘ + 7 and ⌘ + 9 (Mac OS X).

Envelope Tool Options

Selecting the Envelope tool displays its properties and options in the Tool Properties view.

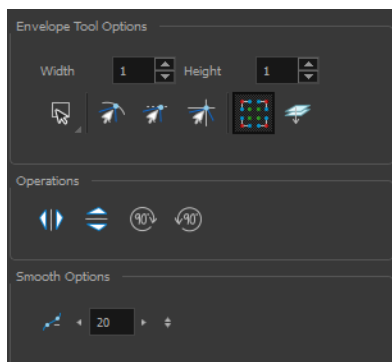

Width and Height

Increase the width and height values to add more columns and rows to the deformation grids.

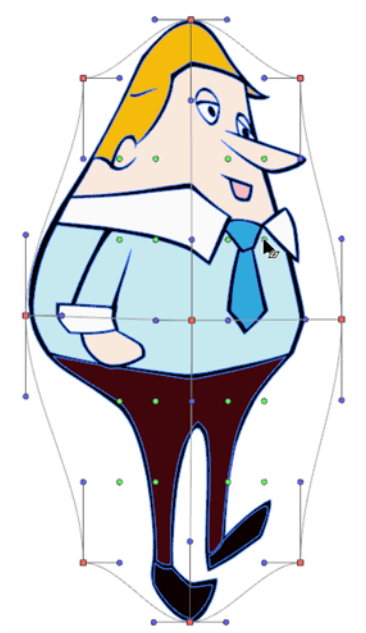



Lasso and Marquee

Choose between the Lasso  and Marquee  options to change the selection style of the tool.

- Click and hold Alt to temporarily switch from the current mode to the other.

Snap Options

- The Snap to Contour  option will snap the selected anchor point to any line you position it on—see [Contour Editor Options on page 151](#).
- The Snap and Align  option lets you snap the selected anchor point to any existing line while displaying temporary rulers as a guide that you can also snap your anchor point to—see [Contour Editor Options on page 151](#).
- The Snap to Grid  option snaps your selection according to the currently enabled grid.

Show Advanced Controls

To display more controls, you can click on the Show Advanced Controls  button.

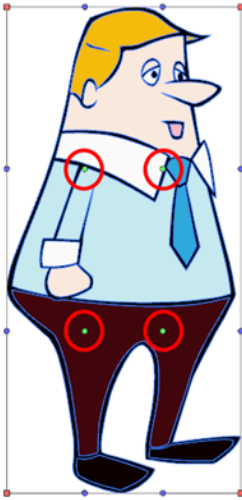



Apply to Line and Colour Art

The Apply to Line and Colour Art  option uses the concept of Line Art and Colour Art layers. Use this option to apply an action such as selecting or resizing a drawing on both Line Art and Colour Art layers, as well as the Overlay and Underlay layers.

Flip Horizontal and Vertical





The Flip Horizontal  and Flip Vertical  operations flip the current selection horizontally or vertically.

- ▶ From the top menu, select **Selected > Transform > Flip Horizontal** and **Flip Vertical**.

Rotate 90 Degrees CW and CCW



The Rotate 90 Degrees CW  and Rotate 90 Degrees CCW  operations rotate the current selection 90 degrees clockwise or counter-clockwise.

- ▶ From the top menu, select **Selected > Transform > Rotate 90 Degrees CW** and **Rotate 90 Degrees CCW**.
- ▶ Press Ctrl + 7 and Ctrl + 9 (Windows/Linux) or ⌘ + 7 and ⌘ + 9 (Mac OS X).

Smoothness

You can modify the central line smoothness of your line using this option. This parameter smooths the deformed lines. Increasing the value will result in a smoother line with fewer control points. The more you increase the value, the less details and curves you will get. Use the left and right arrows to increment the value by one full unit. Use the Up - Down slider to quickly increment the value.

Cutter Tool Options

When you select the Cutter  tool, its properties and options appear in the Tool Properties view.

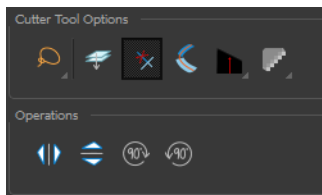

Lasso and Marquee



Choose between the Lasso  and Marquee  options to change the selection style of the tool.

- Click and hold Alt to temporarily switch from the current mode to the other.

Apply to Line and Colour Art

The Apply to Line and Colour Art  option uses the concept of Line Art and Colour Art layers. Use this option to apply an action such as selecting or resizing a drawing on both Line Art and Colour Art layers, as well as the Overlay and Underlay layers.



Use Mouse Gesture

When using the Lasso  selection type, the Use Mouse Gesture  option lets you automatically delete any extra sections of line in your artwork by simply dragging your mouse over it.

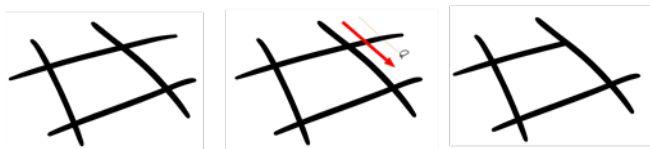
For this operation to work, you lines **CANNOT** be flattened.



Use Mouse Gesture Breaker Mode

When using the Lasso  selection type, the Use Mouse Gesture Breaker Mode  option lets you draw an invisible stroke on a pencil line to cut it in two individual objects. Once a pencil line is cut with this option, you will be able to select the two portions independently with either the Cutter tool, Pencil Editor tool or Select tool.

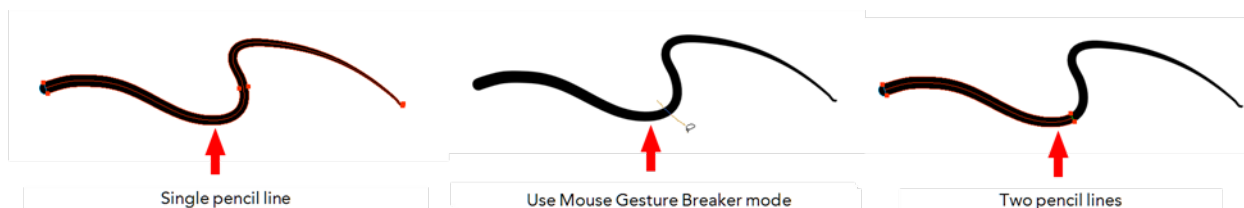

This option only works with pencil lines.

Tip Style

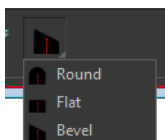

Use the Tip Style option to customize the tip of the pencil line you are cutting.

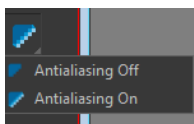

Antialiasing



When drawing on a bitmap layer, lines are no longer clean vector shapes. For the edges to be smooth, a slight amount of antialiasing is used. When using the Cutter tool, you can cut a portion of your drawing with or without antialiasing. By default, the option is enabled. If you want to cut your drawing using a hard edge, you can select the Antialiasing Off option.

Flip Horizontal and Vertical





The Flip Horizontal  and Flip Vertical  operations flip the current selection horizontally or vertically.

- ▶ From the top menu, select **Selected > Transform > Flip Horizontal** and **Flip Vertical**.

Rotate 90 Degrees CW and CCW



The Rotate 90 Degrees CW  and Rotate 90 Degrees CCW  operations rotate the current selection 90 degrees clockwise or counter-clockwise.

- ▶ From the top menu, select **Selected > Transform > Rotate 90 Degrees CW** and **Rotate 90 Degrees CCW**.
- ▶ Press Ctrl + 7 and Ctrl + 9 (Windows/Linux) or ⌘ + 7 and ⌘ + 9 (Mac OS X).

Smooth Editor Tool Options

When you select the Smooth Editor tool, its properties and options appear in the Tool Properties view.

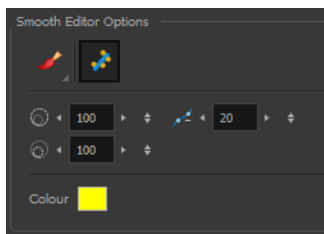

Brush, Marquee and Lasso Smoothing Style

The Smoothing Style options allow you to smooth a portion of your drawing by tracing a smoothing

stroke over the zone to optimize or by selecting an area of the drawing with the Marquee or Lasso.

Note that by default, the Smooth Editor tool colour is yellow, it was changed to orange for screen grab clarity.

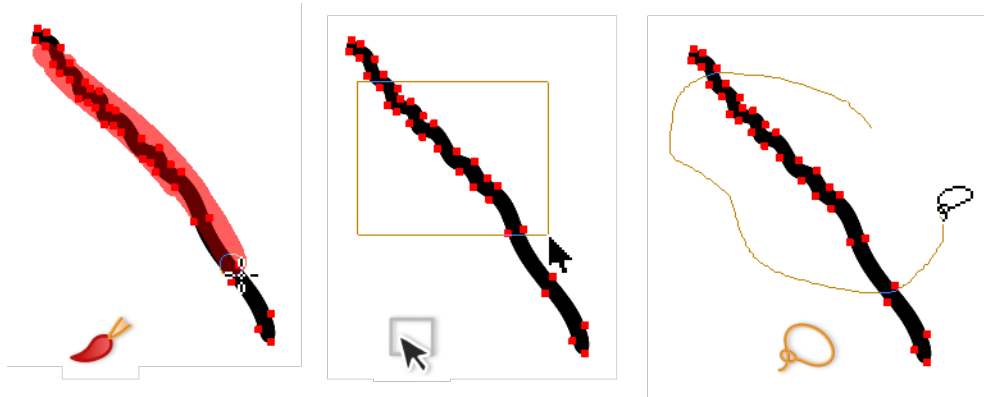

Show Control Points

The Show Control Points  option allows you to show or hide the Bezier points around lines. When the Bezier points are displayed, you can see the result of your smoothing and the number of points left on the curve. When it is turned off, only the original artwork is displayed.

Minimum Size and Maximum Size

This is where you set the minimum and maximum sizes of your drawing tool which will produce the thick and thin effect on your stroke. This works with the pressure sensitivity of a pen tablet.

This options is available while using the Brush Smoothing  style.

- **Maximum and Minimum Size:** Defines the maximum and minimum width of the stroke.
- **Up/Down arrows:** Use the up and down arrows to set the minimum and maximum size value.

Smoothness

The Smoothness  impacts the strength of the smoothing result. The higher the value, the more points are removed and the smoother the curve. The Smoothness range is from 0 to 100; the default value is 20.

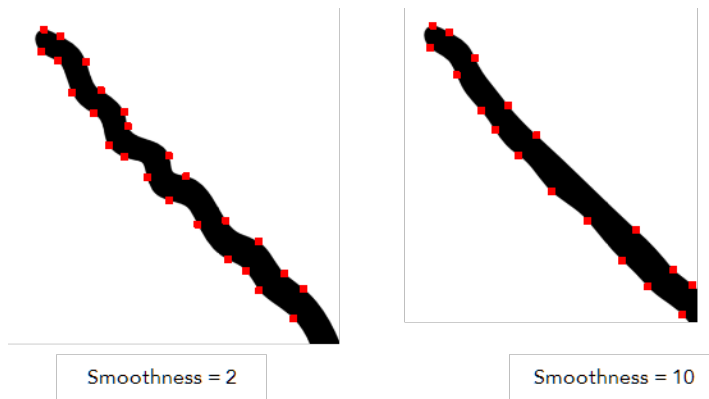

Colour

You can modify the colour of the control points displayed on the artwork while working with the Smooth Editor tool by double-clicking on the colour swatch.

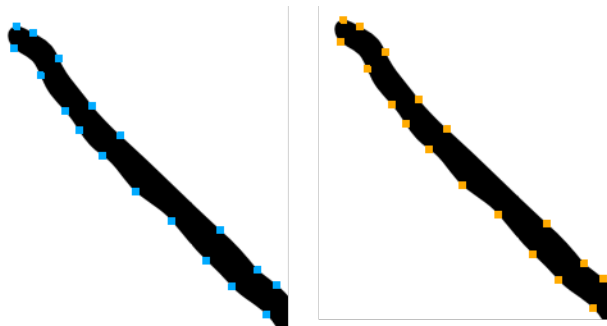

Text Tool Options

Use the Text tool's properties to select the font type and other formatting options you want to apply to the text.

If you already wrote your text, you must first use the Text tool and select the text portion you want to format.

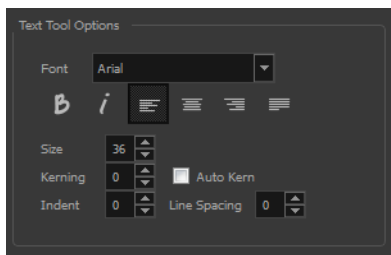

Font Type

Use the Font drop-down menu to select a font. OTF fonts are supported.

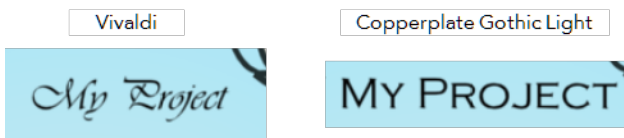

Font Style

Use these buttons to select a style for your text:

- **B** Bold





- *i* Italic



Alignment

Use these buttons to align the paragraph.

<p> Left</p> <p>LOREM IPSUM DOLOR SIT AMET, CONSECTETUR ADIPISCING ELIT. AENEAN VESTIBULUM, METUS AC FERMENTUM PORTTITOR, ODIO TURPIS PORTTITOR NIBH, ID CONSEQUAT MAGNA LIGULA ET ELIT. CURABITUR SOLLICITUDIN ELIT AC LOREM MOLLIS ACC UMSAN.</p>	<p> Centered</p> <p>LOREM IPSUM DOLOR SIT AMET, CONSECTETUR ADIPISCING ELIT. AENEAN VESTIBULUM, METUS AC FERMENTUM PORTTITOR, ODIO TURPIS PORTTITOR NIBH, ID CONSEQUAT MAGNA LIGULA ET ELIT. CURABITUR SOLLICITUDIN ELIT AC LOREM MOLLIS ACC UMSAN.</p>
<p> Right</p> <p>LOREM IPSUM DOLOR SIT AMET, CONSECTETUR ADIPISCING ELIT. AENEAN VESTIBULUM, METUS AC FERMENTUM PORTTITOR, ODIO TURPIS PORTTITOR NIBH, ID CONSEQUAT MAGNA LIGULA ET ELIT. CURABITUR SOLLICITUDIN ELIT AC LOREM MOLLIS ACC UMSAN.</p>	<p> Justified</p> <p>LOREM IPSUM DOLOR SIT AMET, CONSECTETUR ADIPISCING ELIT. AENEAN VESTIBULUM, METUS AC FERMENTUM PORTTITOR, ODIO TURPIS PORTTITOR NIBH, ID CONSEQUAT MAGNA LIGULA ET ELIT. CURABITUR SOLLICITUDIN ELIT AC LOREM MOLLIS ACC UMSAN.</p>

Font Size

Enter a size for the text.

small text **big text**

Kerning

Use the kerning field to modify the spacing between letters and characters. You can select the Auto Kern option to set the kerning automatically based on the font's predefined standard. A negative value decreases spacing between each character, creating a letter overlap and a positive value increases it.

Lorem ipsum dolor sit amet, consectetur adipiscing elit. Aenean vestibulum, metus ac fermentum porttitor, odio turpis porttitor nibh, id consequat magna ligula et elit. Curabitur sollicitudin elit ac lorem mollis accumsan.

Lorem ipsum dolor sit amet, consectetur adipiscing elit. Aenean vestibulum, metus ac fermentum porttitor, odio turpis porttitor nibh, id consequat magna ligula et elit. Curabitur sollicitudin elit ac lorem mollis accumsan.

Indent

Enter a value in the Indent field to increase or decrease the indentation on the first line of your text. A positive value sets the first line of your paragraph farther to the right and a negative value sets it farther to the left.

Lorem ipsum dolor sit amet, consectetur adipiscing elit. Aenean vestibulum, metus ac fermentum porttitor, odio turpis porttitor nibh, id consequat magna ligula et elit. Curabitur sollicitudin elit ac lorem mollis accumsan.

Lorem ipsum dolor sit amet, consectetur adipiscing elit. Aenean vestibulum, metus ac fermentum porttitor, odio turpis porttitor nibh, id consequat magna ligula et elit. Curabitur sollicitudin elit ac lorem mollis accumsan.

Line Spacing

Enter a value in the Line Spacing field to decrease or increase the space between each line of text.

Lorem ipsum dolor sit amet, consectetur adipiscing elit. Aenean vestibulum, metus ac fermentum porttitor, odio turpis porttitor nibh, id consequat magna ligula et elit. Curabitur sollicitudin elit ac lorem mollis accumsan.

Lorem ipsum dolor sit amet, consectetur adipiscing elit. Aenean vestibulum, metus ac fermentum porttitor, odio turpis porttitor nibh, id consequat magna ligula et elit. Curabitur sollicitudin elit ac lorem mollis accumsan.

Resizing the Text Box

You can resize the text box by selecting your text box with the Text **T** tool and moving the anchor point right or left. Using the Select tool will distort and scale your text itself rather than changing the width and height of your text box.

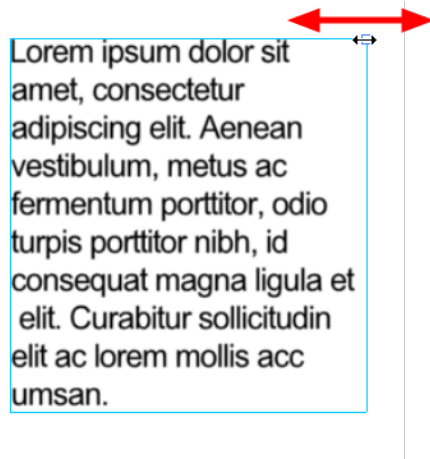

Converting Text into Separate Objects

Text contained in a text field is treated as a single drawing object. You can easily separate the text so each character becomes an individual drawing object that you can select and modify independently.

How to break a text object

1. In the Tools toolbar, click the Select  tool or press Alt + S.
2. In the Drawing view, select the text object you want to break.



3. From the top menu, select **Drawing > Convert > Break Apart Text Layers**.



Each character is surrounded by a bounding box that you can modify; they remain text objects that you can edit.

4. If you want to convert your independent letter to a complete vector object that you can deform, use the Select tool to select the letters to convert.
5. From the top menu, select **Selected > Convert > Break Apart Text Layers** to break the selection into a regular drawing object, with no more text attributes.

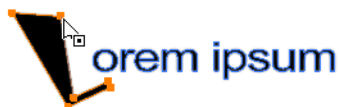

Drawing Pivot Tool

The Drawing Pivot  tool lets you set the pivots on your character. You can set the drawing pivots on drawings and symbols.

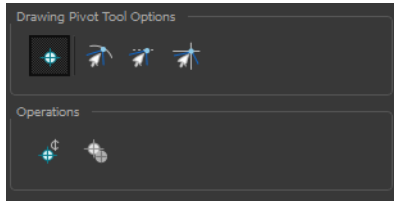

Snapping



When you drag the drawing pivot around, you can enable a snap option so that when the drawing pivot is released, it either snaps to the reference grid, drawing's contour, or aligns with an existing drawing stroke.

Reset Pivot

When you click the Reset Pivot  option, the drawing pivot of the selected drawing or symbol is reset to the centre of the Camera view.

Chapter 7: Colour Styling and Colour Models

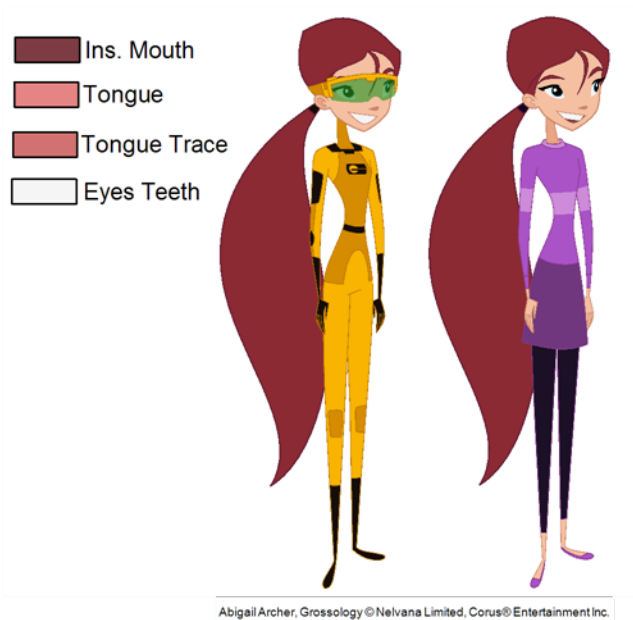

Once the characters, props and locations are designed, it is time for the colour styling and colour models creation. This is when the colours and moods are determined. The line models created during the design step are painted and organized as colour models for the colourists.

Harmony has a great concept of colour palettes. Each character can have its own set of colours that is carried through the entire project called the *master palette*. If the master is modified, the colours in the entire project are updated simultaneously.

By doing the colour styling in Harmony, your master palette will be created at the same time, so you do not need to use third party software. Also you will not have to recreate the colour palette again in Harmony. It is possible to create this step in an external software, but it is a great time saver to do it directly in Harmony.

Throughout this chapter you might notice slight differences between your interface and the images used to demonstrate the procedure. This is because the images are taken from Harmony Stage. Paint is a subset of Harmony Stage.

To create the colour style and colour models, follow these steps:

- [Preparation on the next page](#)
- [Working with Palettes on page 181](#)
- [Colours on page 205](#)
- [Painting the Model on page 216](#)

Preparation

Before painting, you need to organize the colour model scenes and bring in your references. The colour styling preparation is done in five steps:

- [Colour Model Storage below](#)
- [Scene Creation below](#)
- [Setting Up the Workspace on the facing page](#)
- [Preparation above](#)

Colour Model Storage

First, you will need to create a storage location for all your models and palettes. The best way to do this is to create a colour model scene. There are different possibilities available to structure your designs and colour model scenes. We strongly recommend that you put all of your colour models in the same scenes. It is important to maintain a structure for your models so they do not end up scattered throughout the project.

There are four main model categories:

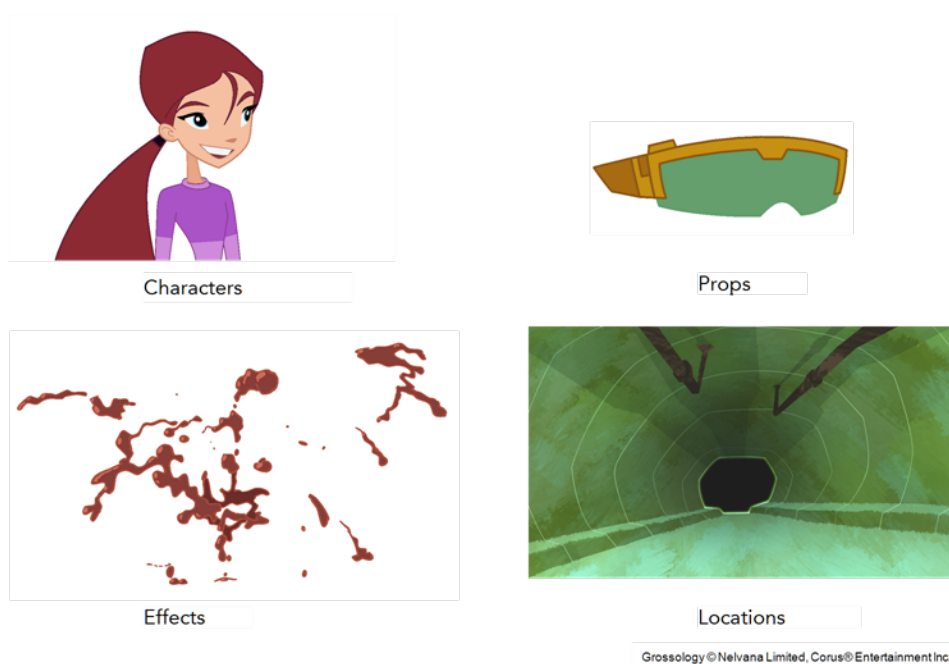

If you have a small project, such as a short or an advertising contract, you can always place all the characters, props, effects, and locations in the same scene. For large projects such as feature-length productions or series, you should create four separate model scenes following these categories.

Scene Creation

In order to create colour models, you need to create your scenes.

When working on a paperless or cut-out animation project, if you have designed your characters, props, effects and locations directly in Harmony, you can paint your models directly in your design scene. You can also create a new colour model scene and import your designs in that one. Refer to the Fundamentals Guide to learn more about creating a scene.

If you have not already done so, refer to the Fundamentals Guide to learn about production structure, file organization, and how to create a Project root directory. We recommend storing your colour model scenes in the root directory or in a colour models subdirectory for even better organization.

A useful way to name your colour model scene is to include the project name, then the colour model type such as characters, props, effects, or locations, and finally `colourmodel`. For example, a character colour model scene for the Adventure project would be named `adventure_characters_colourmodel`. This ensures that you always know what scene corresponds to what.

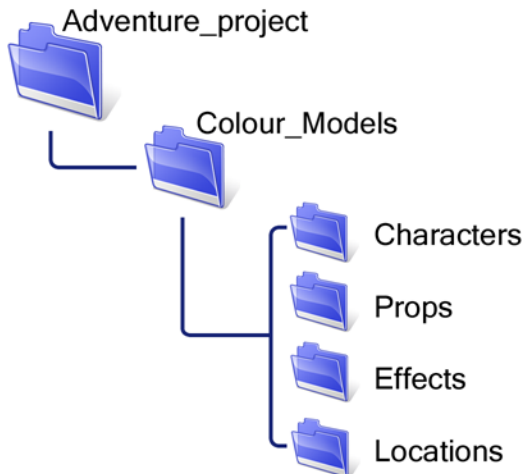

To learn how to create environment, job, and scene for your colour models, refer to the Control Center and Server Guide.

Colour Model Scene Structure

To store your colour models in a scene, it is recommended that you create one drawing layer for each character, prop, effect, or location. You should name these according to the model.

You can also load other colour references in the scene to balance your overall colours. For example, if you work in a character colour model scene, it is a good idea to import some of the key locations to compare and adjust the colours so they match well.

Setting Up the Workspace

Now that your scenes are created and structured, you can open the corresponding colour model scene. For the optimal workspace for inking and painting, set up your workspace with these views:

- Drawing
- Colour
- Model

How to rename a drawing

1. Do one of the following:
 - Press `Ctrl + D` (Windows/Linux) or `⌘ + D` (Mac OS X).
 The Rename Drawing dialog box opens.

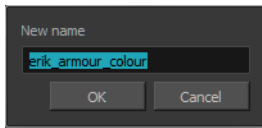

2. Type in a new name and click **OK**.

Working with Palettes

In animation, specific colours are used to paint each particular character. In order to maintain absolute consistency, a colour palette is created for each character, prop and effect throughout the production. These are referred to as **master palette**¹s.

Master palettes contain a colour swatch for each zone to colour with a precise RGBA colour value.

Using a master colour palette has many benefits, including:

- Each character consistently retains their dedicated colours.
- You cannot accidentally use a colour which is not in the master palette.
- Standardization and colour consistency throughout the production
- Multiple artists can use the same colour palette and produce the same results.

Toon Boom Harmony uses palettes to hold all the colours needed to paint your elements, allowing complete control and consistency in your painting process.

A **palette**² is created by assigning a set of colours to each character, prop or effect. You will create a new palette and add a new colour, known as a *colour swatch*, for each zone of the character, such as the skin, hair, tongue, shirt, pants, and so on.

In Harmony, palettes are individual files that you can copy, transfer, and store. Palettes have a ***.plt** file name extension—see [Palette File Storage](#) on page 185.

When a zone on the character is painted with the colour contained in a colour swatch, a link is automatically created between that colour swatch and the zone. This means that if the tint of the colour in the colour swatch is changed, any zone linked to it will update to the new tint. This is one way that colour palettes can save time and money in your production.

Another advantage of this system is that you can create complete palettes for different lighting situations. For instance, in addition to the regular palette for a character, you could have one for that character in the rain using colours that are duller and less vibrant than the dry daytime colours, or yet another for using in a night scene. Using palettes linked to your character in this way allows you to instantly change its colouring to suit the mood and atmosphere of the scene without tediously repainting each element.

¹A master palette is a group of colours attributed to a character or a prop. The palette is used throughout the entire production to maintain consistency in the look and to ensure that the same colours are used throughout the production. Also known as palette.

²A palette or master palette is a group of colours attributed to a character or a prop. The palette is used throughout the entire Toon Boom Studio project to maintain a consistency in the look and avoid the colour changing during the animation. Also referred to as a master palette.

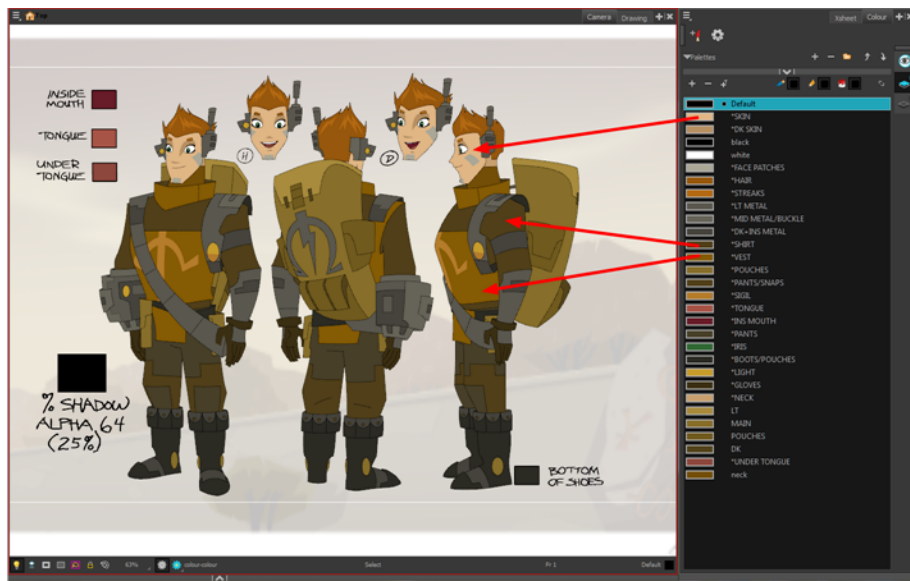

Erik, Di-Gata Defenders © Neivana Limited, Corus® Entertainment Inc.

This section is divided as follows:

- [Palette Lists below](#)
- [Palette File Storage on page 185](#)
- [Creating a Colour Palette on page 188](#)
- [Duplicating a Colour Palette on page 192](#)
- [Cloning a Colour Palette on page 194](#)
- [Palette Operations on page 196](#)
- [Importing and Linking Palettes on page 200](#)

Palette Lists

The Colour view has two modes: basic and advanced.

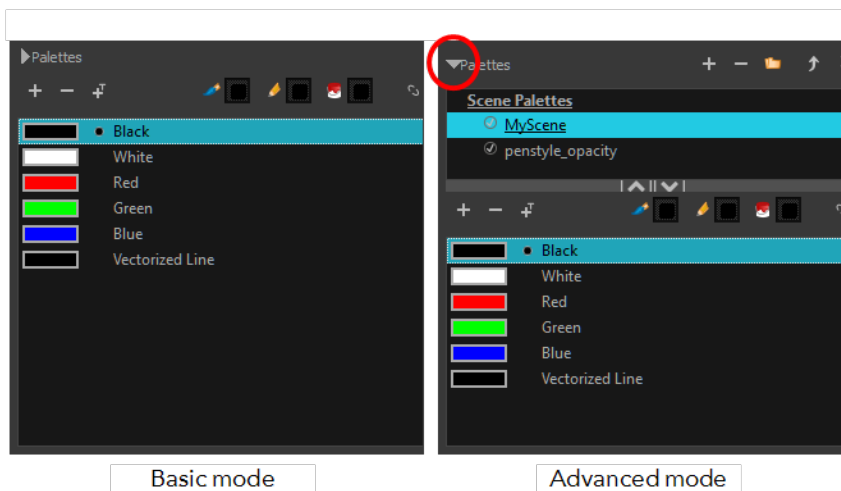

Basic mode

Advanced mode

- **Basic Mode**

The Colour view's basic mode only shows the Colour list. When you open Toon Boom Harmony, you only see the colours available in the Default palette which contains six basic colour swatches and is automatically named the same as your scene. For simple projects, you can manage with the default palette, but for movies, series, or shorts it is recommended that you create palettes for your characters. To create a palette, you have to switch to the Advanced mode of the Colour view and show the Palette list.

- **Advanced Mode**

The Advanced mode displays the list of all palettes that are linked to the scene. To create palettes for your characters, you must display the Palette list.

A palette list is a file containing all of the links to the original palette files. Every drawing layer has a palette list. The scene also has a palette list. For example, a drawing layer can use three different palettes stored in three different locations, while another drawing layer can use two of these palettes plus another one coming from another scene. The palette list keep track of the locations of the palettes.

There are two types of palette lists:

- **Scene Palette List**

The Scene Palette list is mainly used with cut-out animation, but is also very useful for paperless and traditional animations. A cut-out character will often be divided into 20 to 30 different drawing elements that use the character's master palette.

The palette list is stored at the scene level instead of the Element directory. This way, all palettes linked to this list will appear in every drawing element created in the scene. There is no need to manually load the palette in each element.

The Scene Palette list is the simplest one to use. By default, Toon Boom Harmony is set to use only Scene Palette lists.

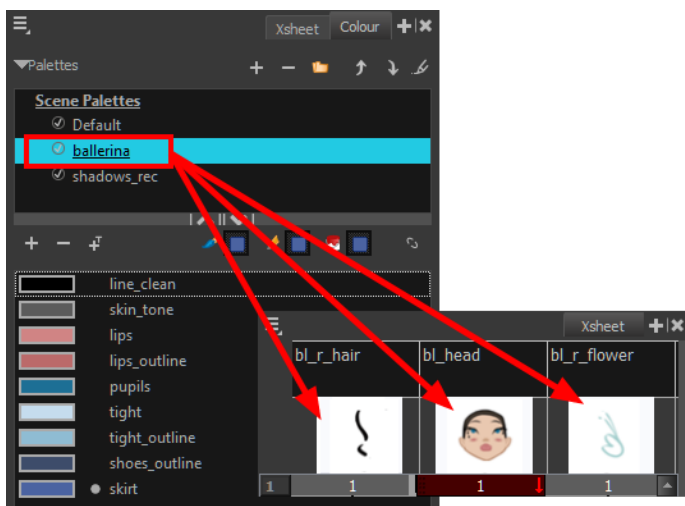

- **Element Palette List**

In Toon Boom Harmony, you can switch to Advanced Palette List mode and choose to save your palette at an element's level. The Element Palette list is mainly used with traditional and paperless animation. Unlike cut-out animation, all columns (drawing elements) contain different characters,

props, backgrounds, and effects. The Element Palette list is used when you do not necessarily want all of the palettes for all of your elements linked in every column.

The palette list is stored in the drawing element's directory instead of directly in the Scene level. This ensures that the links to the palettes appear only in the appropriate element. If you prefer to access a global palette list, link your palettes to the Scene Palette list.

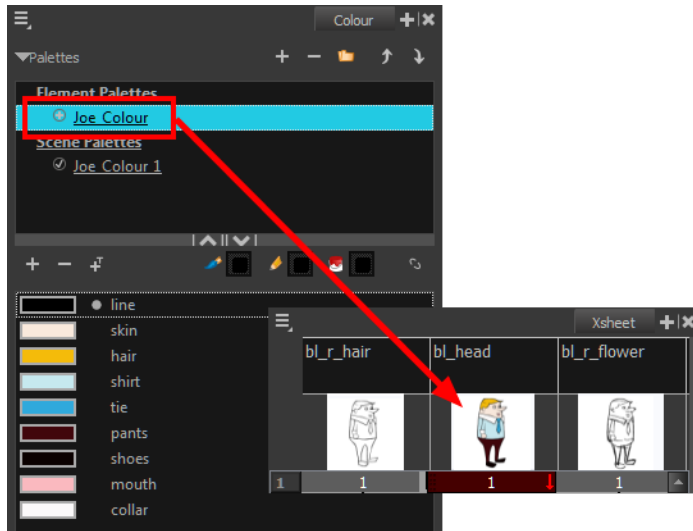

To prevent users from accidentally removing a link to a palette, the palette lists are locked. To link or create a new palette, the palette list must first be unlocked.

When you are using several cloned palettes that are related to the same original palette, Toon Boom Harmony uses the highest palette in the list to determine the colour of the painted zones—see [Cloning a Colour Palette on page 194](#).

How to show or hide the Palette list

- ▶ In the Colour view, click the Show/Hide Palette List View  button to expand or collapse the Palette List area.

The Palette List window opens and displays all your palettes.

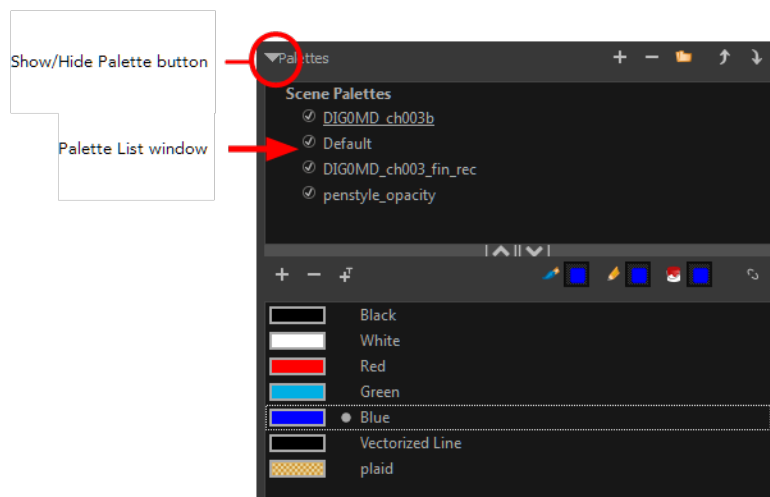

How to lock and unlock to the palette list

- ▶ From the top menu, select **Edit > Edit Palette List Mode**.

A grey pencil appears on the top-right corner of the Palette list to indicate that it can be modified.

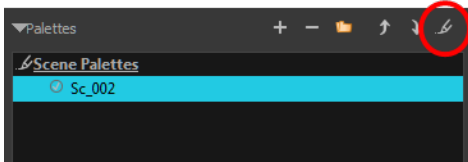



How to set the Advanced Palette Lists mode

1. Do one of the following:
 - ▶ From the top menu, select **Edit > Preferences** (Windows/Linux) or **Stage > Preferences** (Mac OS X).
 - ▶ Press **Ctrl + U** (Windows/Linux) or **⌘ + U** (Mac OS X).
2. Select the **General** tab.
3. Select the **Advanced Palette Lists** option.
4. Click **OK**.

How to reorder palettes in the Palette list

Do one of the following:

- ▶ From the Colour View menu, select **Palettes > Move Up** or **Move Down**.
- ▶ In the Palette list, click the Up  and Down  buttons.

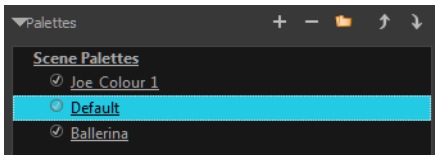

Palette File Storage

In Harmony, palettes are individual ***.plt** files that can be copied, transferred and stored. When a palette is created from Harmony, it needs to be stored somewhere. By default, the palette file is stored in the scene directory in a palette-library folder unless you specify a different location. There are four locations where you can find palette-library folders:

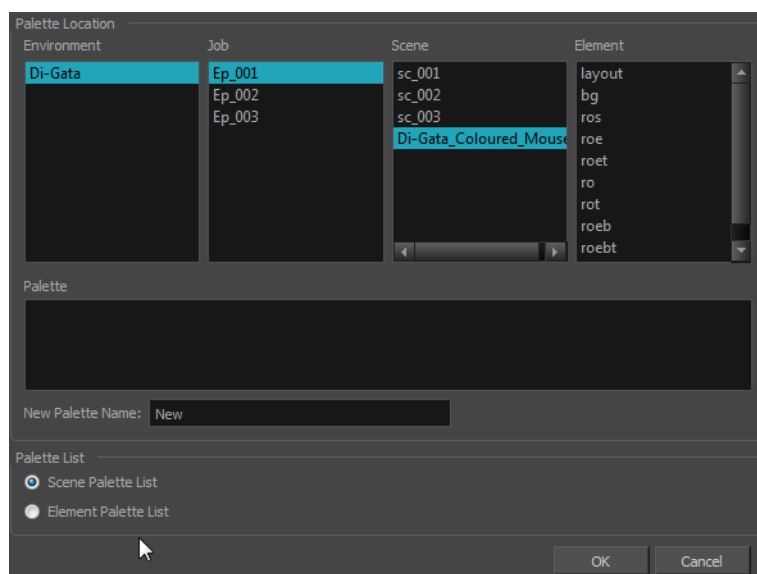

- **Element**

The Palette Library folder is stored directly in the drawing Element folder.

- **Scene**

The Palette Library folder is stored directly in the Scene folder.

- **Job**

The Palette Library folder is stored in a Job folder contained in the Scene folder.

- **Environment**

The Palette Library folder is stored in an Environment folder contained in the Scene folder.

By default, the palette is stored at the scene level. For simple projects and standalone projects, it is recommended to keep it as is. If you work with a larger studio, it is recommended to verify with them on the file structure.

This existing structure is compatible with Toon Boom Harmony Server. Toon Boom Harmony's database has a leveled structure starting from the Environment down to the Element. Its client-server configuration allows all data, such as palettes and scenes, to be shared between a series of client machines.

Element Level

Working with Harmony as a stand alone, the Element level is very useful when there are a lot of different palettes. When a colour model drawing is created, it is stored in its element folder. By storing the corresponding palette file with the colour model, the colourist can load them both from the same location. This also creates a more organized structure.

Scene Level

Working with Toon Boom Harmony as a stand alone, a palette file can also be saved at the scene level, so that all of the palettes from the scene are stored together. The palette naming must be structured so the colourist or character builders can find the correct one. Saving the palettes at the scene level makes it very easy to back up the palettes and retrieve their location.

The scene level can also be useful for cut-out animation. Instead of creating a colour model scene that includes all of the characters, props, effects, and location, the colour palette or model will often be directly imported to, or created in, the character building scene. Just as with a cut-out character building scene, each element uses the same palette so it would not be efficient to save the palette inside one element. Instead, it is saved at the scene level. This prevents a palette overload because all of the models are in different scenes. It also allows each scene to have its own set of palettes corresponding to its model.

When working on a cut-out animation production, it is highly recommended that you work with the Scene level.

Where to Save the Palette File

The palette storage location depends on the type of production and the backup plan being used. Some studios like to store their palettes at the Element level and others at the Environment level as this will not create a problem so long as the scene is in the Harmony structure. In fact, as long as the Harmony structure is maintained it can be stored at any level. However, difficulties may occur when the scene is backed up or transferred to another studio or database and removed from the structure.

What happens when you export a palette file?

It is important to understand what is happening to a palette file when the scene is exported.

Because of the Harmony client-server configuration, all of the data can be shared through all of the scenes in the database. This also includes the palette files, even if they are stored at the Element, Scene, Job, Drawing or Environment level. The palette files can be accessed from any scene of any project.

When you export scenes from Harmony to either archive or send them to other users or studios, the palettes stored in external scenes, jobs or environment will **NOT** be exported.

An exported scene will carry palettes stored in its own Element's Palette Library, scene's palette library, the Job and the Environment where it is stored. Any other palette from other Environments, Jobs, Elements or Scenes (even from the same job) will **NOT** follow. Instead a recovery palette will be created when the scene is reopened in another Harmony system. A recovery palette is a local palette created by the system when palettes and colours are missing. This palette is no longer shared with the rest of the project.

For example, in the following chart, if you export Scene 2 from Job 1, the package will carry the palettes from Scene 2, Job 1 and Environment. It **WILL NOT** carry the palettes from Element 3 in Scene 1, Scene 1 and Job 2. If Scene 2 was linked to any of these, the system will create a recovery palette the next time Scene 2 is opened in another Harmony system.

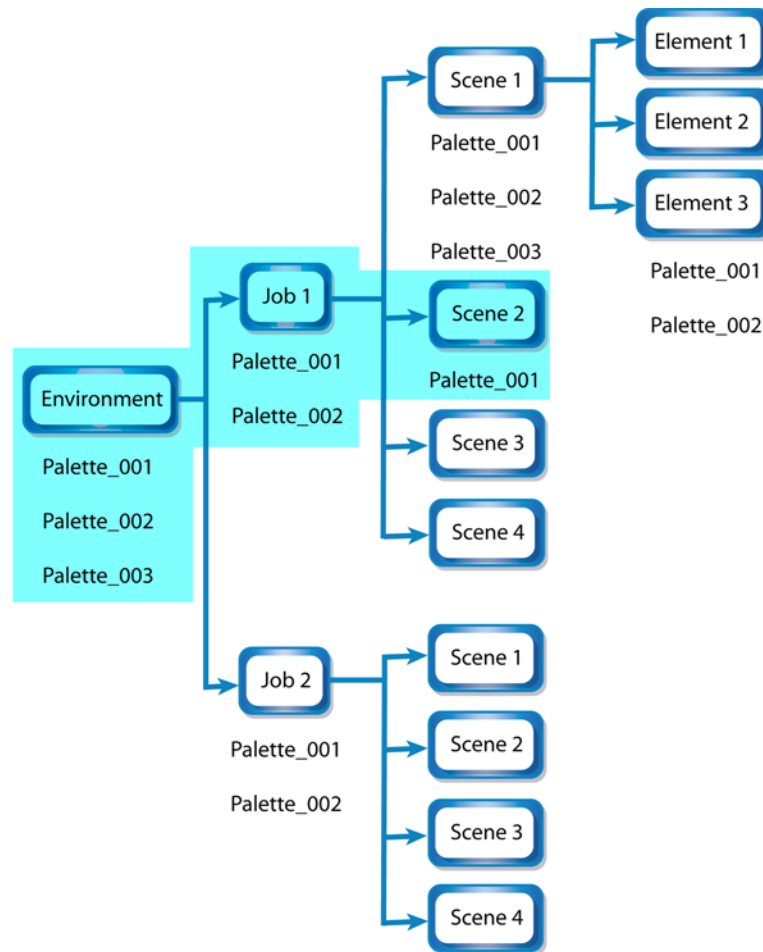

The best place to store your palette is:

- Environment level for a movie or series
- Job level for a publicity or small project
- Scene level for a student exercise

To store your palette with their colour models, you can use the Element level, however, it will require more structure when exporting the scenes. The scene will have to be exported along with its colour model scene. The other studio you are working with must recreate an identical structure to yours, then import the received scenes into the same location as you have them in order to maintain the links.

Palette Backup

When sharing palettes between scenes, some users may accidentally modify the colours, even though the palettes are locked by default. That is why it is a good idea to copy and back up your palette libraries and master palette directories.

When a palette file is copied, it automatically becomes a clone palette, so there will not be any trouble replacing an altered file. Harmony automatically updates all of the files and drawings linked to it.

Creating a Colour Palette

You can create a palette in either Basic or Advanced mode.

By default, Toon Boom Harmony is set to the Basic mode. For simple productions, it is recommended to use the Basic mode. This setting stores the palettes automatically for you and saves them at the Scene level. When you use the Advanced Palette Lists mode, you can decide at which level you want to store your palettes: Environment, Job, Scene, or Element.

If you are using Harmony Network, see [Palette File Storage on page 185](#).

Before you can create a palette in the Advanced Palette Lists mode, you must first set your preferences to Advanced Palette Lists mode in the Preferences dialog box. You also need to have the rights to modify the palette list. If you do not, select **Edit > Edit Palette List Mode** from the top menu.

You can remove palettes from your Palette list if they are not needed in your scene. The actual palette file will not be deleted and you can reimport it in your Palette list later on.

How to set the Advanced Palette Lists mode

- Do one of the following:
 - From the top menu, select **Edit > Preferences** (Windows/Linux) or **Stage > Preferences** (Mac OS X).
 - Press **Ctrl + U** (Windows/Linux) or **⌘ + U** (Mac OS X).
- Select the **General** tab.
- Select the **Advanced Palette Lists** option.
- Click **OK**.

How to create a new palette (Basic Palette Lists mode)

- From the Colour View menu, select **Palettes > New** or click the New Palette **+** button.
 - Make sure that you have the necessary rights to modify the palette list. If you do not, select **Edit > Edit Palette List Mode**.

The Create Palette window opens.

- Enter the palette name according to the model.

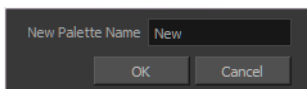

- Click **OK**.

The palette appears in the drawing element's palette list.

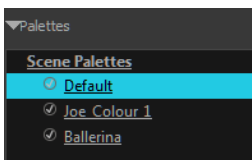

How to create a palette from the Advanced Palette Lists mode

- In the Timeline or Xsheet view, select the drawing that requires a palette.
- Make sure that you have the necessary rights to modify the palette list. If you do not, select **Edit > Edit Palette List Mode**.
- In the Colour view, click the **Show Palette List View** button to display the palette list.

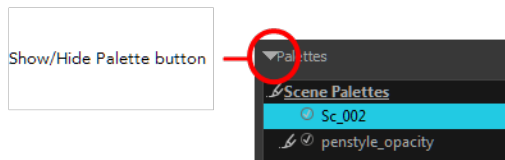

4. Do one of the following:

- ▶ From the Colour view menu, select **Palettes > New**.
- ▶ Click the Create Palette **+** button.

The Palette Browser: Create Palette dialog box opens.

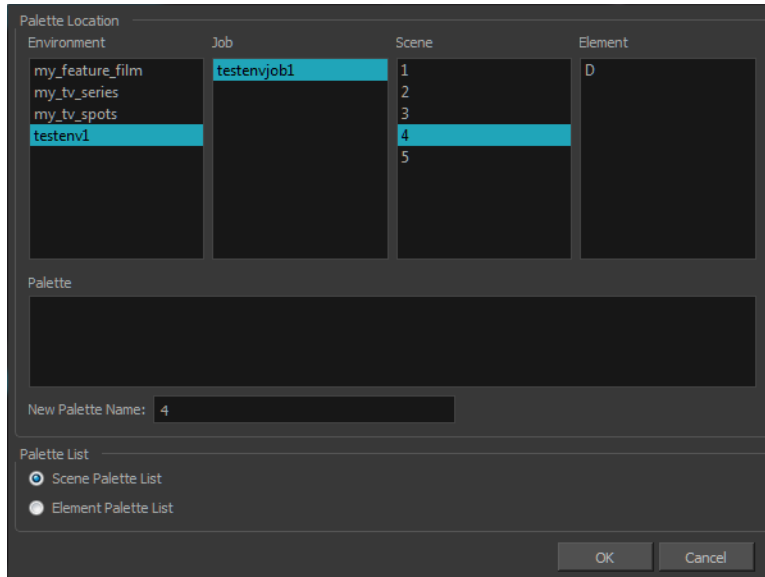

5. Select the level to store the palette file.

- ▶ **Environment:** The palette-library folder is stored in the scene's parent environment folder.
- ▶ **Job:** The palette-library folder is stored in the scene's parent job folder.
- ▶ **Scene:** The palette-library folder is stored directly in the scene folder.
- ▶ **Element:** The palette-library folder is stored directly in the drawing element folder.

When you select a level that has a palette stored in it, the palette names are displayed in the Palette field.

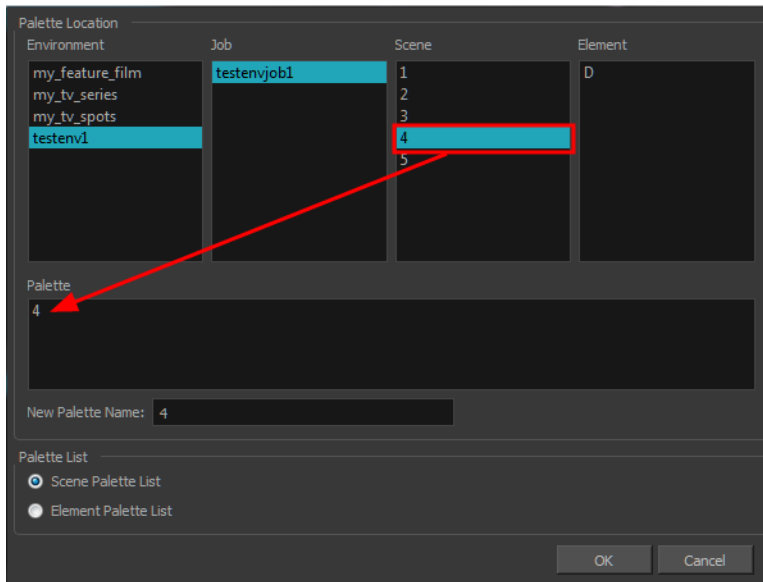

6. Name the palette. There is no need to add the suffix "palette" to the name as it is always recognized as a palette file.

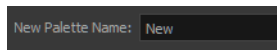

7. Select a Palette List option.

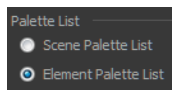

- ▶ The Scene Palette List is mainly used with cut-out animation. A cut-out character will often be divided in twenty to thirty different drawing elements that use the character's master palette.
The palette list is stored at the scene level instead of the Element directory. This way, all palettes linked to this list will appear in every drawing element created in the scene. There is no need to manually load the palette in each element.
- ▶ The Element Palette List is mainly used with traditional and paperless animation. Unlike cut-out animation, all columns (drawing elements) contain different characters, props, backgrounds and effects. The Element Palette List is used because you do not necessarily want all of the palettes for all of your elements linked in every column.
The palette list is stored in the drawing element's directory instead of directly in the Scene level. This ensures that the links to the palettes appear only in the appropriate element. If you prefer to access a global palette list, link your palettes to the Scene Palette List.

8. Click **OK**.

The new palette appears in the palette list.

How to rename a palette

1. In the Colour view, select the palette to rename.

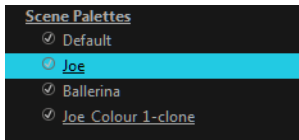

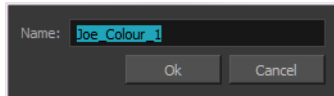

2. Do one of the following:
 - Right-click and select **Rename**.
 - From the Colour View menu, select **Palettes > Rename**.
3. In the Rename dialog box, give the palette a new name and click **OK**.

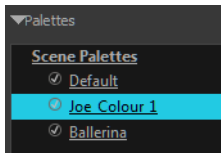

How to remove a palette

1. In the Colour view, select the palette to remove.



2. Do one of the following:
 - From the Colour View menu, select **Palettes > Remove**.
 - Right-click on the selected palette and select **Remove**.
 - Click the Remove Palette  button located above the Palette list.

If the palette was used in your scene, the zones painted with its colours turn red.



Duplicating a Colour Palette

A duplicated palette is a simple copy of the original palette. It uses the same names, colour values, but has a different ID and is independent from the original palette. This ensures that both palettes are completely independent.

This option is used when there are similar models and you want to avoid recreating and naming all of the colours. You can change the values and the names afterward without affecting the original palette. You can also keep some RGBA values, such as the eyes, teeth, tongue, inside mouth, etc.

How to duplicate a palette

1. In the Colour view, select the palette to be duplicated.

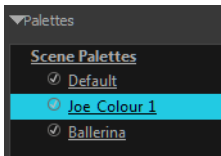

2. Do one of the following:
 - From the Colour View menu, select **Palettes > Duplicate**.
 - Right-click on the selected palette and select **Duplicate**.

The Palette Browser: Duplicate Palette window opens.

3. If you are in Advanced Palette List mode, select the palette storage level—see [Palette File Storage on page 185](#).

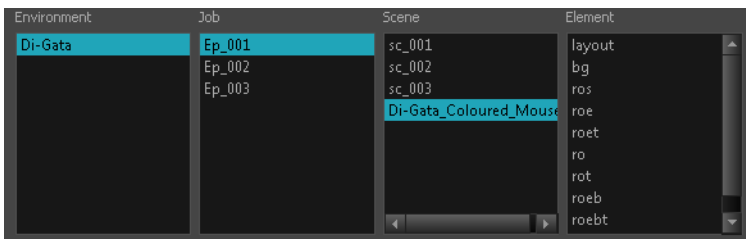

4. In the New Palette Name field, name the palette.

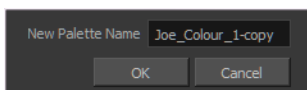

5. In the New Palette Name field, name the palette.
6. Click **OK**.

The palette appears in the palette list.

Cloning a Colour Palette

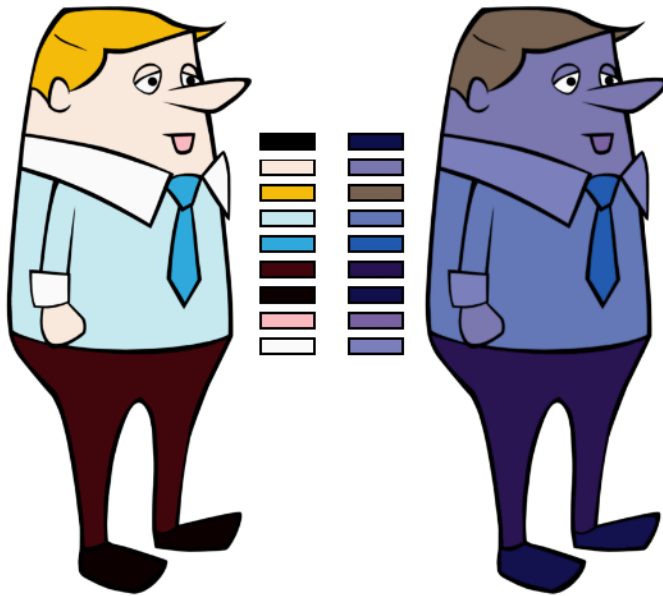

A character usually has only one master palette, although there are times when the characters are placed in different lighting conditions and require a different colour shading. The night palette is a popular choice when a scene or sequence changes from day to night. It can be difficult and time-consuming to repaint everything and creating two independent palettes can be quite complex. As an alternative, Toon Boom Harmony provides clone palettes.

The clone palette is a copy of the master palette. The colours in each palette have the same properties. The colours have the same identification number pointing to the same colour zones, but they can have different names and RGBA values. Depending on the activated palette (night or day), the painted drawing will update. So there is no need to repaint the animation, but to create or import a clone palette (palette style).

How to clone a palette

1. In the Colour view, select a palette to clone.

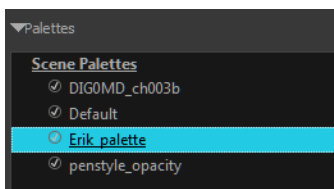

2. From the Colour View menu, select **Palettes > Clone** or right-click and select **Clone**.

The Palette Browser: Clone Palette dialog box opens.

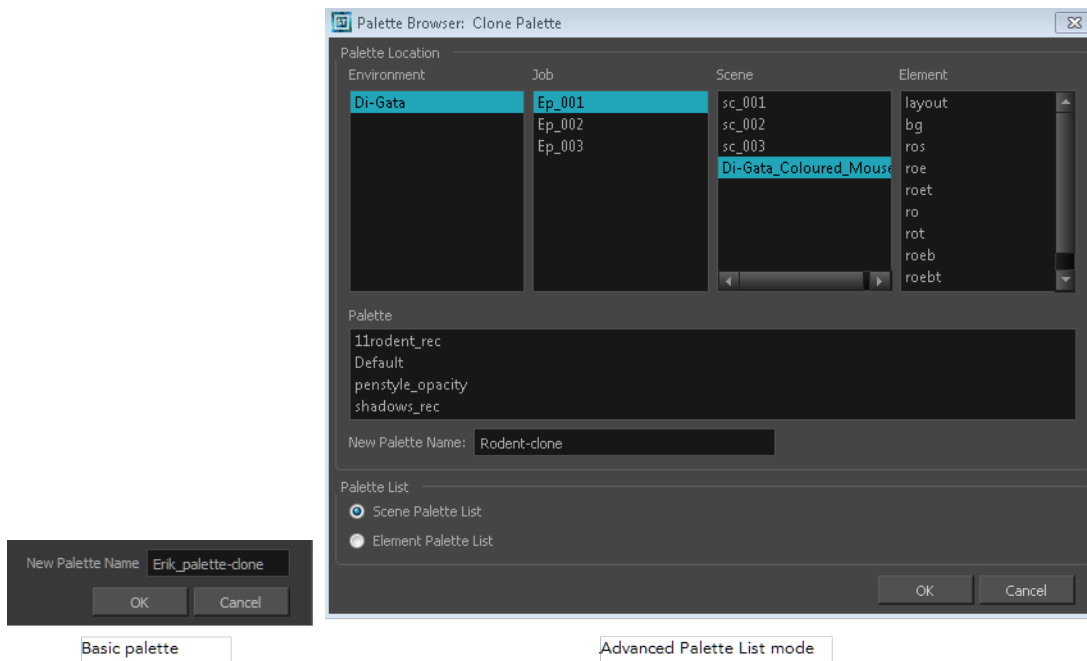

3. If you are in Advanced Palette List mode, select the palette storage level—see [Palette File Storage on page 185](#).

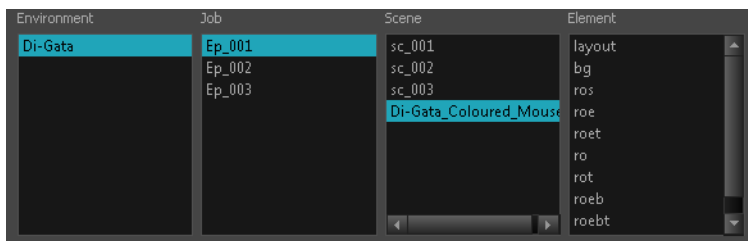

4. In the New Palette Name field, name the palette. It is recommended that you keep the "-clone" in the name.
5. Click OK.

The cloned palette appears in the palette list.

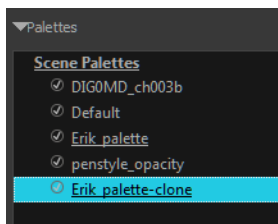

6. In the Palette list, select the clone palette you created to offset or blend colours—see [Mixing Colours on page 214](#).
7. From the Colour View menu, select **Palettes > Tint Panel** or right-click and select **Tint Panel**. The Blend/Offset Tint panel opens.

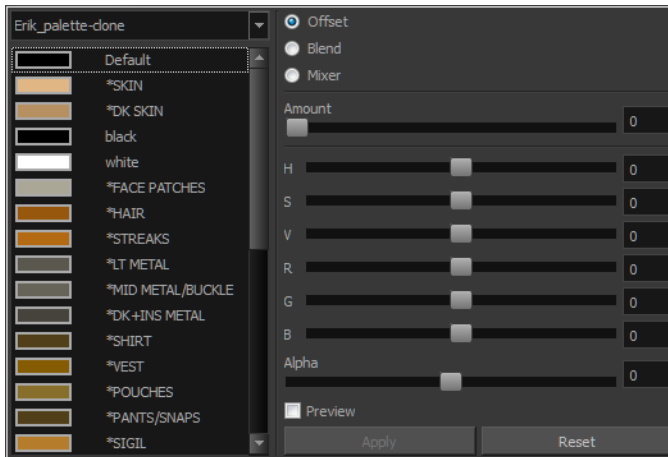

8. Select one or more colours to modify. You can select all your colours by pressing Ctrl + A (Windows/Linux) or ⌘ + A (Mac OS X).
9. Offset, blend, or mix the colours using the sliders and increasing the Amount value.

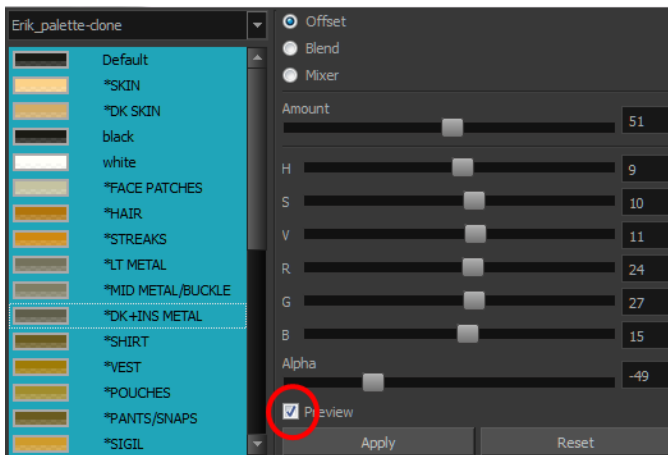

10. Select the **Preview** option to see a preview of the colours while you adjust them.

You can also modify the colours individually with the Colour Picker window.

Palette Operations

When you start Toon Boom Harmony connected to the database, you can access the Palette Operations dialog box which lets you clone, rename, or delete palettes.

How to open the Palette Operations dialog box

1. Start Harmony Paint and log in.
2. Close the Database Selector dialog box.
3. From the top menu, select **Tools > Palette Operations**.

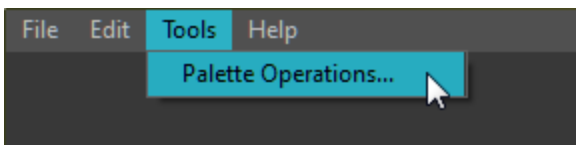

The Palette Operations dialog box opens.

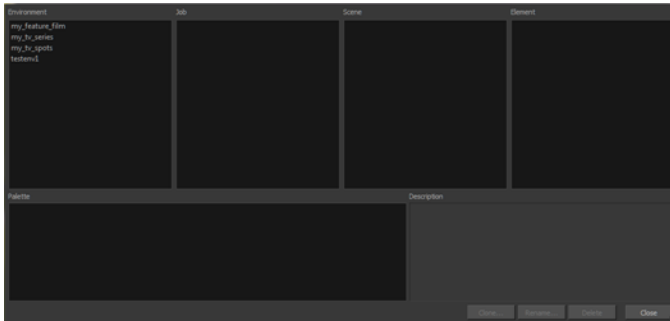

How to clone a palette in the Palette Operations dialog box

1. Select the palette you want to clone at the location and level in which it was stored.

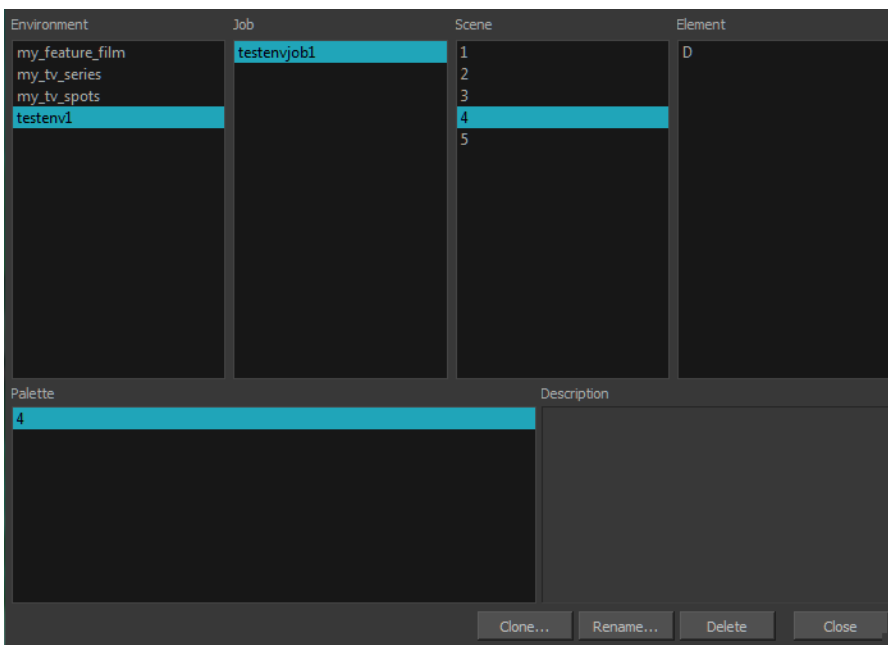

2. Click **Clone**.

A Warning dialog box opens.

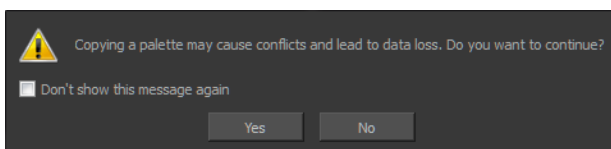

3. Select the **Don't show this message again** option if you do not want to see this message every time you perform this operation.
4. Click **Yes**.

The Palette Browser dialog box opens.

5. Select the level to store the palette file.

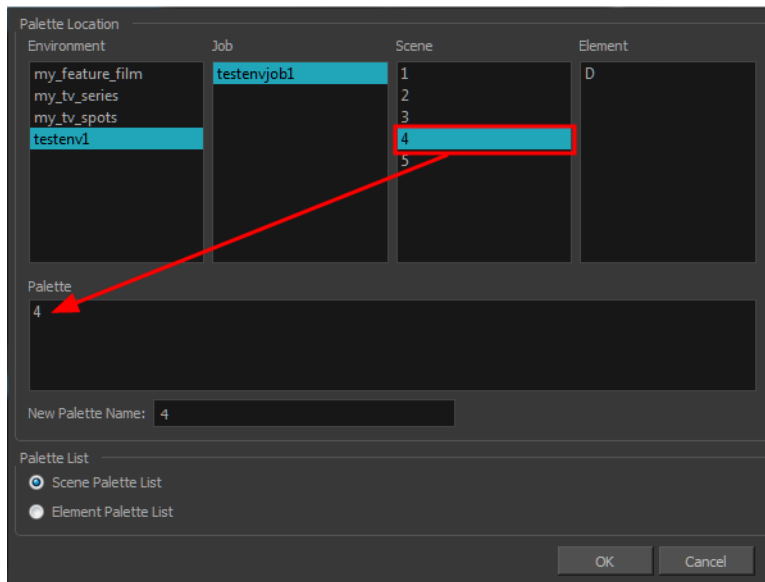

6. Name the palette. There is no need to add the suffix "palette" to the name as it is always recognized as a palette file.

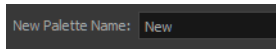

7. Select a Palette List option.

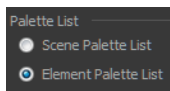

- ▶ The Scene Palette List is mainly used with cut-out animation. A cut-out character will often be divided in twenty to thirty different drawing elements that use the character's master palette.

The palette list is stored at the scene level instead of the Element directory. This way, all palettes linked to this list will appear in every drawing element created in the scene. There is no need to manually load the palette in each element.

- ▶ The Element Palette List is mainly used with traditional and paperless animation. Unlike cut-out animation, all columns (drawing elements) contain different characters, props, backgrounds and effects. The Element Palette List is used because you do not necessarily want all of the palettes for all of your elements linked in every column.

The palette list is stored in the drawing element's directory instead of directly in the Scene level. This ensures that the links to the palettes appear only in the appropriate element. If you prefer to access a global palette list, link your palettes to the Scene Palette List.

8. Click OK.

How to rename a palette in the Palette Operation dialog box

1. Select the palette you want to rename at the location and level in which it was stored.

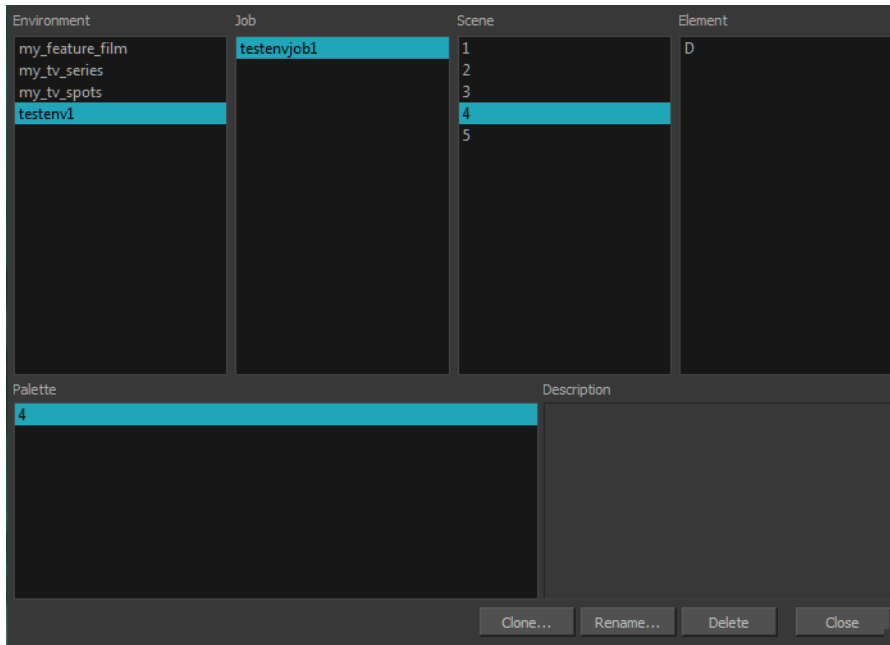

2. Click **Rename**.

A Warning dialog box opens.

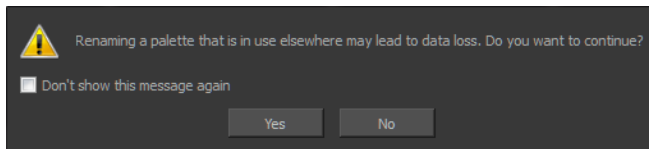

3. Select the **Don't show this message again** option if you do not want to see this message every time you perform this operation.
4. Click **Yes**.

The Rename Palette dialog box opens.

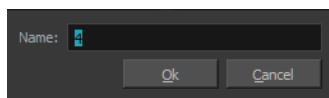

5. Type in a name for the palette.
6. Click **OK**.

How to delete a palette in the Palette Operation dialog box

1. Select the palette you want to delete at the location and level in which it was stored.

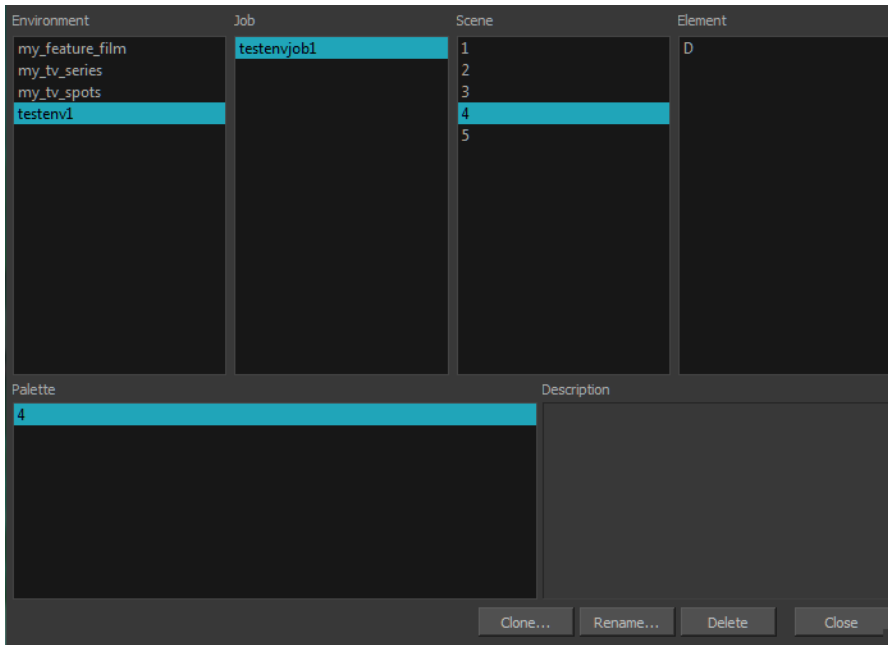

2. Click **Delete**.

A Warning dialog box opens.

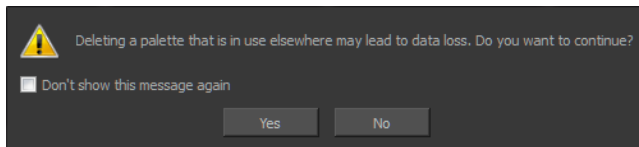

3. Select the **Don't show this message again** option if you do not want to see this message every time you perform this operation.

It is not recommended to disable the warning message as deleting a palette cannot be undone.

4. Click **Yes**.

Importing and Linking Palettes



Before starting colouring work such as Ink and Paint or even creating new colour models, you may want to load existing colour palettes to your scene. You can do so by linking colour palettes to your palette lists.

You may encounter a case where only a colour palette is visible when a layer is selected. If you need that palette in a second layer, you can link the palette to the second layer's palette list. A good example would be a scene where there is a character on one layer and its arm is on another. In order for both layers to access the palette, you must link both Element Palette lists to that palette. If you palette is linked to the Scene Palette list, it will be accessible by all layers.

If you created a palette in another project and you want to import it in your current project, you can browse for the palette file on your computer and add it to your scene. When the palette is imported in your scene, the file is copied in the project's directory. It is not linked to the original file.

Harmony lets you link an external palette to your scene without copying it in your project. This method is not recommended. It is always safer to have the palettes contained within the database to avoid data loss if the source palette were to be deleted or the project exported without including the external palettes.

You will notice that when you create or link a palette, a small icon appears on its left. These icons represent the palette linkage status.

Icon	Description
	<p>Indicates that the palette is safe.</p> <p>There won't be any trouble once the scene will be exported. For example, the palette file is stored in the scene folder and is linked to the Scene Palette List.</p>
	<p>Indicates that the palette file is stored in a directory external to the scene's structure.</p> <p>The palette file is probably stored in a Master Palette directory on a hard drive external to the palette-libraries planned for the palette storage. The warning in this case is that if you move your Master Palette directory to another location, you may lose the palette in your scene.</p>
	<p>Indicates that a palette file stored in a level such as Element, Scene, Job or Environment is linked to a Palette list that is not on the same level.</p> <p>For example, a palette file is stored into the Environment folder and is linked to the Element Palette list. The palette is shared.</p>

How to link a colour palette

- Do one of the following:
 - From the Colour View menu, select **Palettes > Link**.
 - Right-click and select **Link**.
 - Click the Import  button.

The Palette Browser: Link Palette dialog box opens.

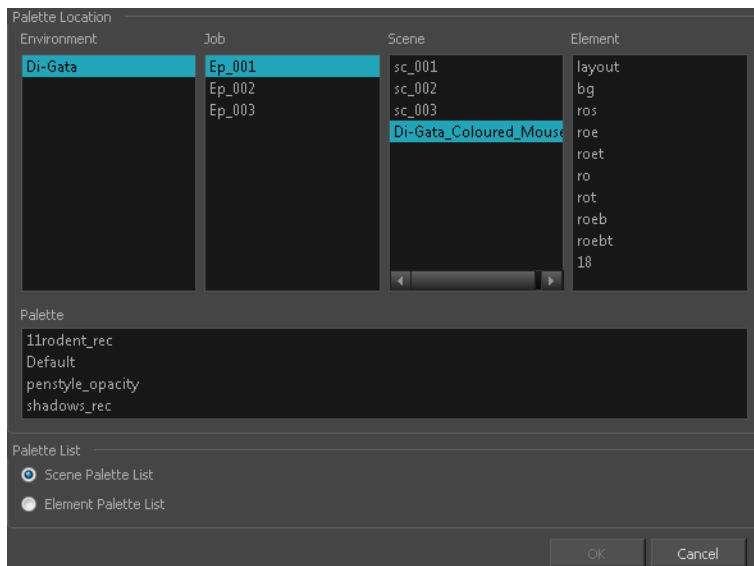

2. Select the level where the palette file is stored—see [Palette File Storage](#) on page 185.
3. Select the palette list linking level by enabling either **Scene Palette List** or **Element Palette List**—see [Palette Lists](#) on page 182.

The palette appears in the Colour view.

How to import a palette into your project

4. Do one of the following:
 - From the Colour View menu, select **Palettes > Import**.
 - Right-click and select **Import**.

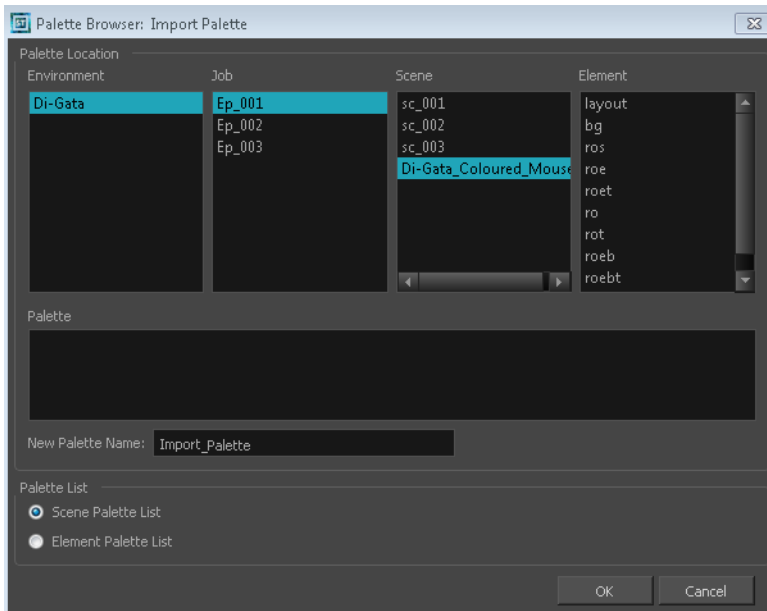

The Browser window opens.
5. Browse for a palette file located (***.plt**) on your hard drive. You will generally find the palettes in your project's palette-library directory.
6. Click **Open**.

The Palette Browser opens.



7. If you are in Advanced Palette mode, select the level where the palette file is stored—see [Palette File Storage on page 185](#).
8. If you are in Advanced Palette mode, select the palette list linking level by enabling either **Scene Palette List** or **Element Palette List**—see [Palette Lists on page 182](#).
9. In the New Palette Name, name the imported palette.
The palette appears in the Colour view and the file is copied in your project.

How to link to an external palette

1. In the Colour view, click on the **Create Palette**  button to create your palette to be used as external.
2. Save your scene by selecting **File > Save** from the top menu or by clicking the Save  button or press Ctrl + S (Windows/Linux) or ⌘ + S (Mac OS X).
3. On your computer or server, create a master directory. Ideally, this should be created in your Root folder to keep it within the project directory. You could also place it inside your Colour Model's subdirectory. Refer to the Fundamentals Guide to learn more about project organization.

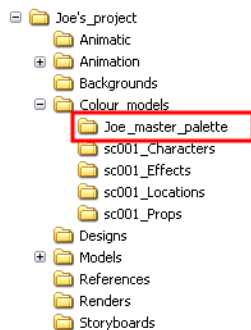

4. Name the folder appropriately, for example: **Joe_master_palette**.
5. From your operating system, browse to your Toon Boom Harmony scene and open the palette-library folder.

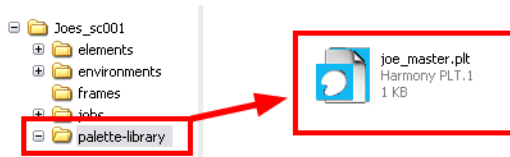

6. Select and copy your palette *.plt file to copy it to the master palette directory.

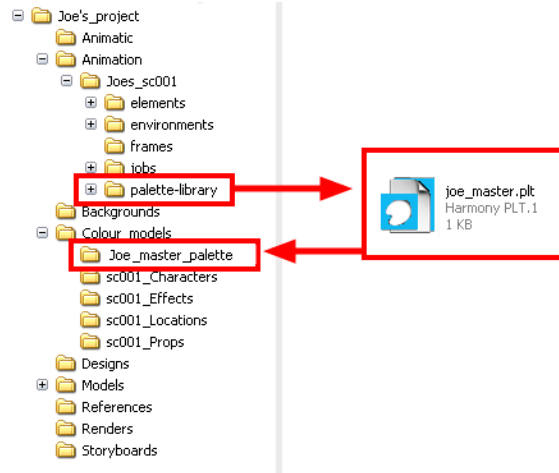

7. Create a new Toon Boom Harmony scene or open the scene where you will link this palette.
8. From the Colour View menu, select **Palettes > Link to External**.

The Link to External Palette dialog box opens.

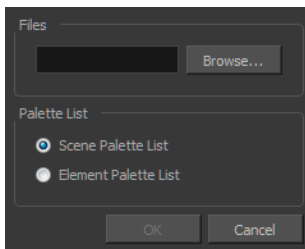

9. Click **Browse** to search for your master palettes folder and select the palette *.plt file you want to link.
10. In the Palette list section, select how you want to load the palette; at the scene or element level.
11. Click **OK**.

The linked palette appears in the Colour view.

If a palette is outside the scene, the External  icon appears beside the palette name.

To link an element (such as a colour model) to the palette that is stored in the external palette directory, you must remove the original palette from the element's palette list. You will then load the duplicated palette into the palette list using the Link to External command, like you did for the other elements.

Colours

Toon Boom Harmony has some very powerful colouring features when it comes to painting. To paint your drawings, you will use different colour swatches, unlike some other painting programs where you modify the main swatch each time you want to paint with a different colour.



In the Colour view, you choose a different colour swatch for each colour you want to paint in your drawing. You can add as many swatches as you want. You can also rename them and modify existing ones.

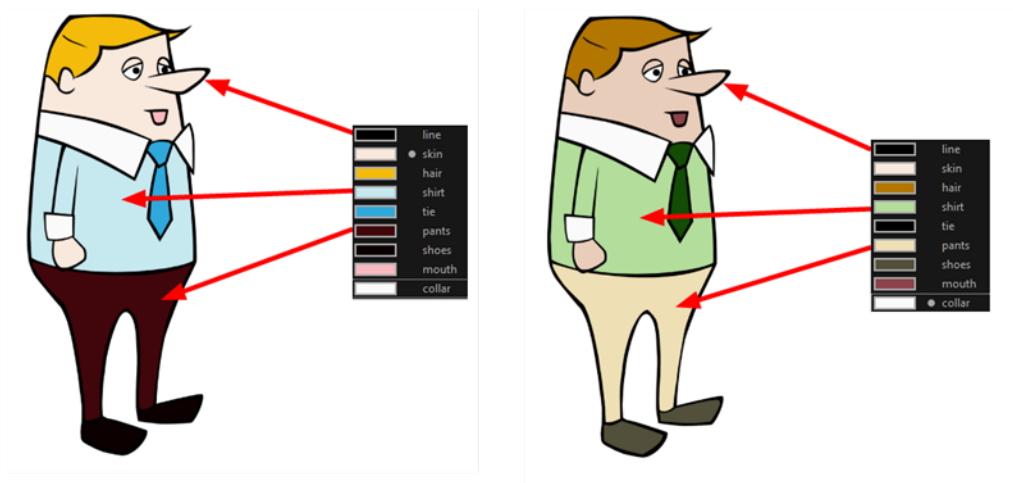

When you modify the colour of an existing swatch, it automatically updates all the zones painted with this swatch throughout the entire project. The colour swatch has a unique ID number that associates it with the painted zones. This way, you can change the look of your character at any time without having to repaint it!

This section is divided as follows:

- [Adding a Colour Swatch below](#)
- [Colour Display Modes on page 212](#)
- [Copying and Pasting Colours on page 213](#)
- [Mixing Colours on page 214](#)

Adding a Colour Swatch

You can use several different types of colour swatches.

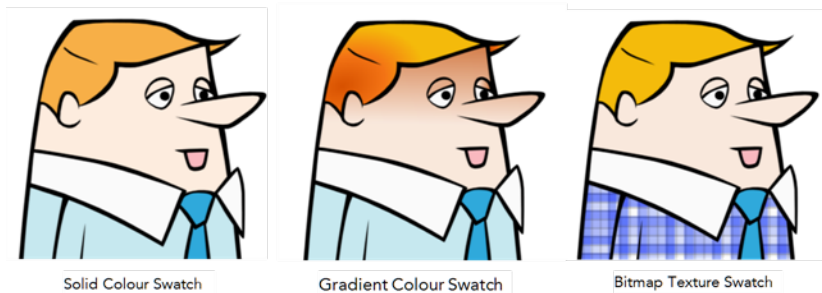

A colour palette is an actual file that is on the hard drive. These palette files can be stored in a different location on the server. They can be stored in the Environment, Job, Scene, or Element folder and linked to any palette list. This means that if the original palette file is modified, it will update in every drawing element the palette is linked to.

To avoid accidentally modifying the palette, the palette files can be locked. If a palette must be modified, you must get the rights to modify them before doing so.

How to lock or unlock the palette list

- In the Colour view, click the Edit Palette Mode  button.
- A grey pencil icon appears in the top-right corner of the Palette list.

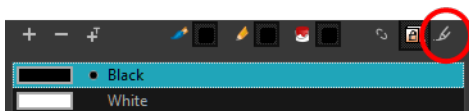

How to add or modify a solid colour swatch

1. In the Colour view, click the New Colour  button.
 2. From the Colour View menu, select **Colours** > **Edit** or double-click on the colour swatch.
- The Colour Picker window opens.

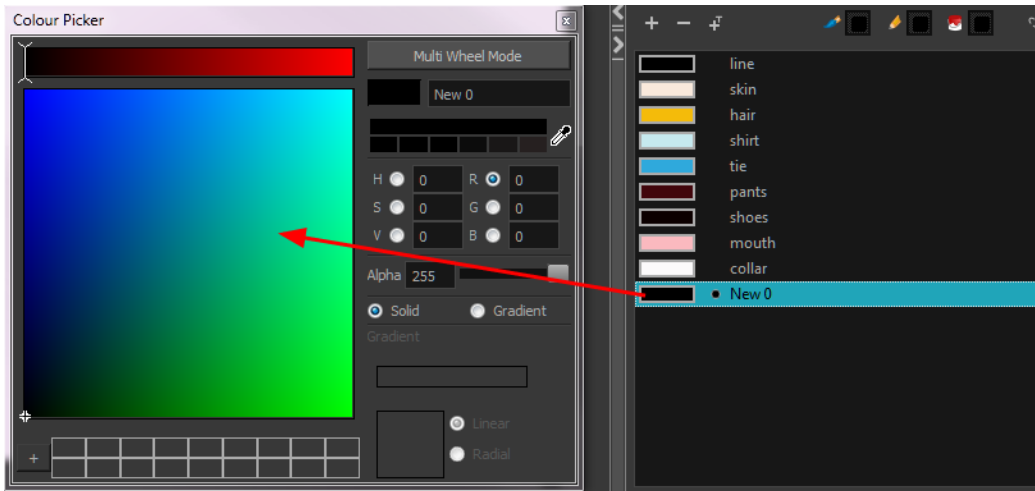

3. To set your colour, do one of the following:

- ▶ In the colour wheel, select a colour.
- ▶ Enter the HSV or RGB values in the corresponding fields. Select the **R,G,B,H,S** or **V** options to change the look of the colour picking area.

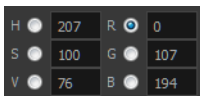

- ▶ Click the Dropper  button to select any colour on your screen. It can be from the Toon Boom Harmony interface, your operating system or any other open application.

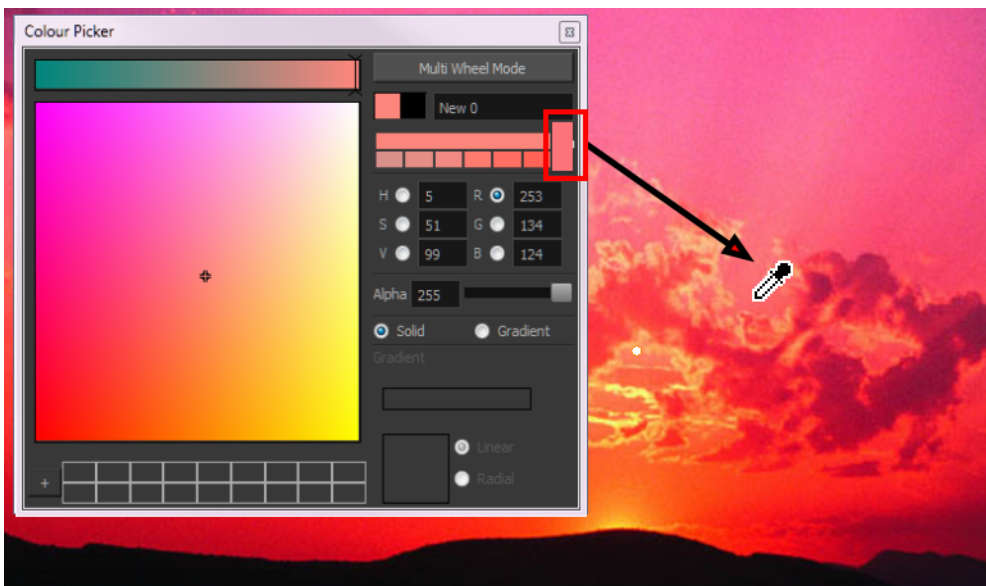

You can also click **Multi Wheel Mode** to open the Multiwheel Colour dialog box. This displays all the picking area styles together and also contains a picking undo list. To return to the regular Colour Picker window, click **Single Wheel Mode**.

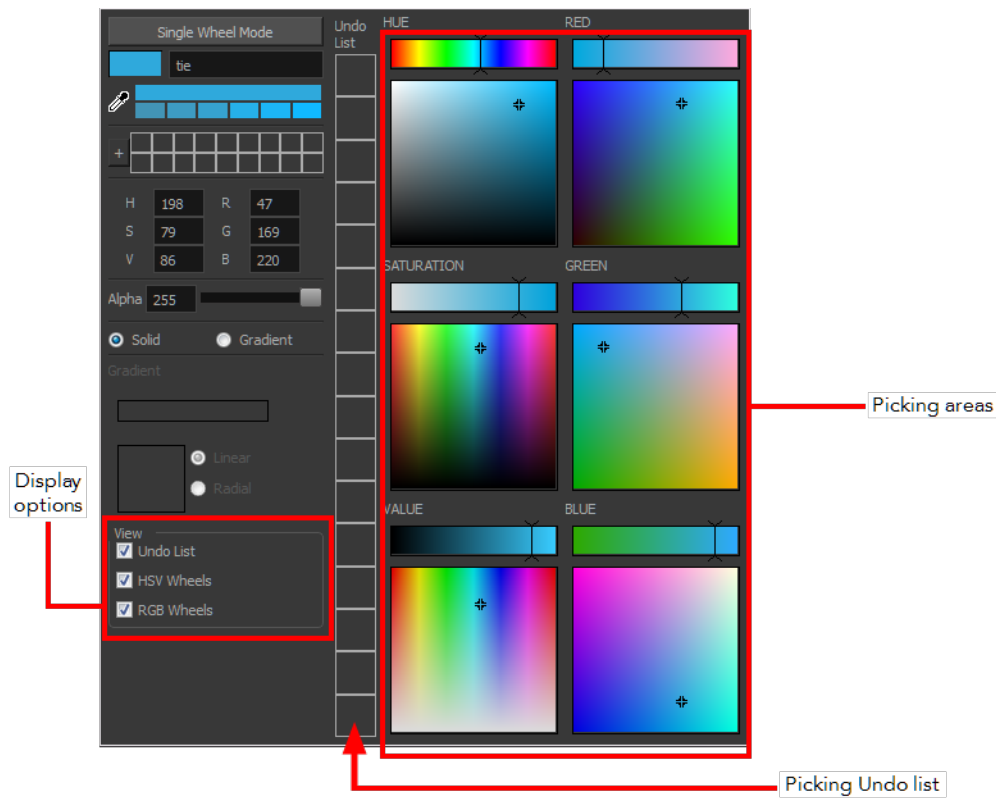

4. Click on the Shade Scale swatches to modify the shade of the selected colour.



5. Adjust the desired level of transparency with the Alpha slider, or type the value directly in the Alpha field.



6. Click the **Add** button to add the current selected colour to the Colour Storage Library, so you can quickly access it later.



7. You can rename the colour swatch in the Colour Picker window or directly in the colour list by double-clicking on its name.

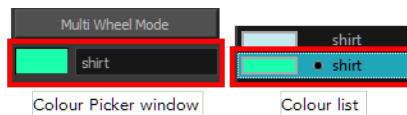

How to create a gradient colour swatch

1. In the Colour view, select a colour to modify .
2. Do one of the following:
 - Click the new colour and from the Colour View menu, select **Colours > New**.

- ▶ Double-click on the colour swatch.

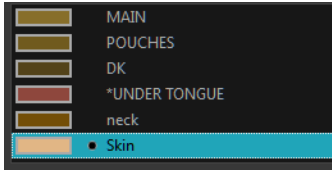

The Colour Picker window opens.

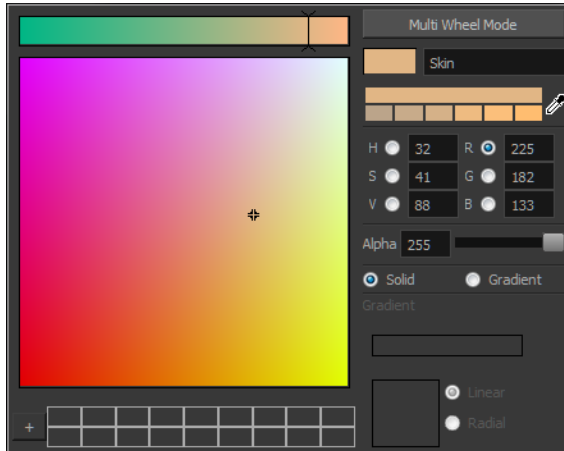

3. Select the **Gradient** option.
4. Select the **Linear** or **Radial** option.
5. Adjust the Gradient arrows to modify the colours.

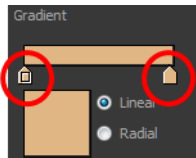

- ▶ Add extra colours by clicking between the arrows below the gradient bar. Then click on the Colour Preview to select a colour.
- ▶ Pull down the arrows to remove them.

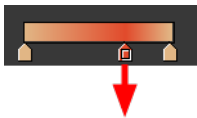

- ▶ Move the arrows left and right to modify the gradient distance.



Refer to the [Editing Gradients and Textures](#) on page 240 topic to learn how to reposition the gradient zones in your drawings.

How to create a texture colour

1. From the Colour View menu, select **Colours > New Texture** or click the New Texture  button. The Browser window opens.
2. Browse for a PSD or TGA bitmap file created with a third party software and click **Open**. The texture is added to the colour list.

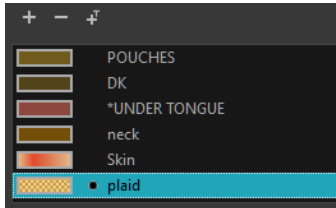

Refer to the [Editing Gradients and Textures on page 240](#) topic to learn how to reposition your textured zones in your drawings.

You can also replace a texture once it is painted. If you decide to make the character's shirt wool instead of plaid, just update the texture file in the swatch and the entire project updates. Any transformation previously applied to the texture's position in your drawings will be kept.

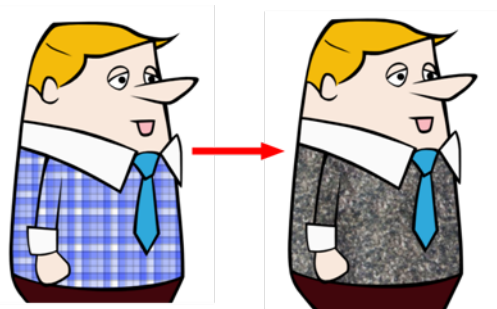

How to replace a texture swatch

1. In the Colour view, select the texture swatch that contains the bitmap texture you want to replace.

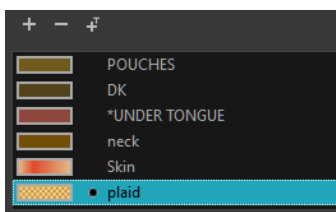

2. From the Colour View menu, select **Colours > Edit Texture** or double-click on the swatch. The Browser window opens.
3. Browse for the new PSD or TGA bitmap file created in a third party software.



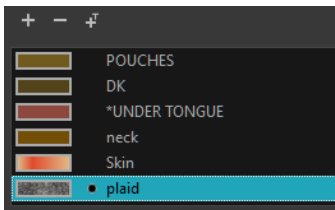

- Click **Open** to update the colour swatch.

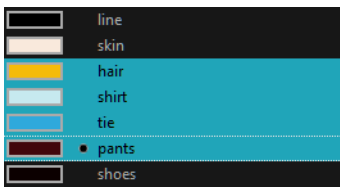

How to delete a colour swatch

- In the Colour view, select the colour swatches to delete.



- Do one of the following:
 - From the Colour View menu, select **Colours > Delete**.
 - Click the Delete Colour  button.
 - Right-click and select **Delete**.
 - Press Delete.

If the colour swatch is used in a drawing, the Delete Colour dialog box opens.

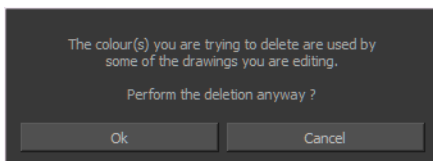

- Click **OK** to delete the colours or click **Cancel** to abort the operation.
 - If you delete colour swatches already in use, the zones painted with them turn red so you can easily identify them.



Colour Display Modes

The Colour view has two display modes:

- List
- Swatch

You can also display the RGB values and names of your solid colour swatches instead of only the name. This option is not available when displaying the colours in Swatch mode.

	• (000 000 000 255)	line
	(249 233 220 255)	skin
	(244 187 010 255)	hair
	(198 233 239 255)	shirt
	(047 169 220 255)	tie
	(065 006 012 255)	pants
	(012 000 000 255)	shoes
	(250 185 191 255)	mouth
	(251 249 250 255)	collar

How to switch between the display modes

1. From the Colour View menu, and do one of the following:
 - Select **Colours > Swatch Mode** to display the swatches.
 - Deselect **Colours > Swatch Mode** to display the colour list.



How to display the swatch colour values

- From the Colour View menu, select **Palettes > Display Colour Values**.

The solid colour swatches' RGB values will be displayed between the colour swatch and its name. The gradient colour swatches will be identified as (gradient).

Copying and Pasting Colours

When you are creating palettes, you may want to copy colour swatches or their values and paste them in other palettes to save time. You can also quickly copy a colour value from a palette in your scene to a selected colour swatch in a different palette.

You can copy a selected colour swatch and paste it as a clone. Since it produces a clone colour swatch, it is impossible to use the Paste as Clone command in the same palette as you copied the original colour swatch from.

If you would like to keep a reference file of some colour IDs or use them with custom plug-ins, you can copy the colour swatch IDs. Here is an example of colour ID: **075cf5b552401130**.

```
ToonBoomAnimationInc PaletteFile 2
Solid Black 0x075cf5b15fe006a1 0 0 0 255
Solid White 0x075cf5b15fe006a3 255 255 255 255
Solid Red 0x075cf5b15fe006a5 255 0 0 255
Solid Green 0x075cf5b15fe006a7 0 255 0 255
Solid Blue 0x075cf5b15fe006a9 0 0 255 255
Solid Custom 0x075cf5b15fe006a8 0 0 150 255
Solid "Vectorized Line" 0x0000000000000000 0 0 0 255
```

How to copy and paste colours

- In the Colour view, select one or more colours to copy.
 - In the Colour view, click the Edit Palette Mode  button to be able to edit the colour list.

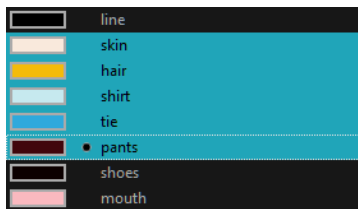

- In the Colour View menu, select **Colours > Copy** or press Ctrl + C (Windows/Linux) or ⌘ + C (Mac OS X).
- In the Palette list, select the palette in which you want to paste the colours.

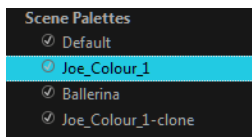

- From the Colour View menu, select **Colours > Paste as New Colours** or press Ctrl + V (Windows/Linux) or ⌘ + V (Mac OS X).
 - To paste the colour values of the copied swatch over an existing colour swatch, select **Colours > Paste Colour Values**.

How to clone a colour swatch

- In the Colour view, select the colour swatch you want to clone.
 - In the Colour view, click the Edit Palette Mode  button to be able to edit the colour list.
- From the Colour View menu, select **Colours > Copy** or press Ctrl + C (Windows/Linux) or ⌘ + C (Mac OS X).

- In the Colour view, select the colour palette you want to paste the clone into or create a new palette.
- From the Colour View menu, select **Colours > Paste as Clone**.
The cloned colour swatch appears in the palette.

How to copy a colour ID

- In the Colour view, select the colour swatch you want to get the ID from.
 - In the Colour view, click the Edit Palette Mode  button to be able to edit the colour list.
- From the Colour View menu, select **Colours > Copy Colour ID** or press Ctrl + C (Windows/Linux) or ⌘ + C (Mac OS X).
- Paste the copied value as plain text in the desired document.

Mixing Colours

If you want to modify a series of colours at once to blend a tint in them or offset their RGBA values, you can use the Tint panel. This panel is quite useful when creating palette styles such as night and day styles.

How to mix colours

- In the Colour view, select the palette that contains the colours you want to offset or blend.

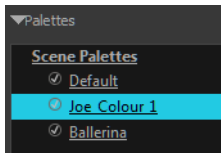

- Do one of the following:
 - From the Colour View menu, select **Palettes > Tint Panel**.
 - Right-click and select **Tint Panel**.

The Blend/Offset Tint panel opens.

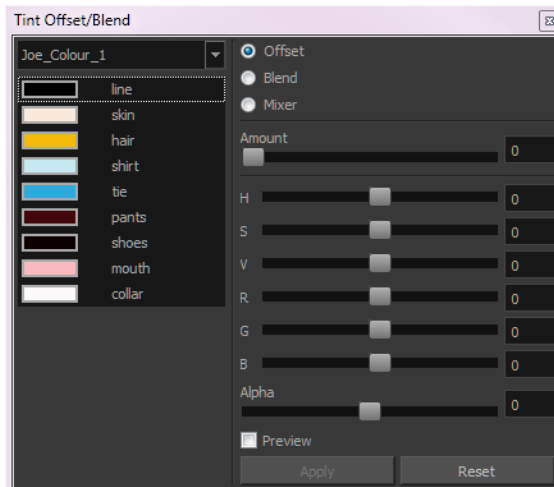

- Select one or more colours to modify in the colour list. To select all the colours, press Ctrl + A (Windows/Linux) or ⌘ + A (Mac OS X).

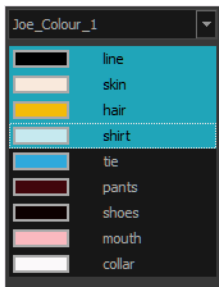

4. Select **Preview** option.
5. Select the **Offset, Blend, or Mix** option.

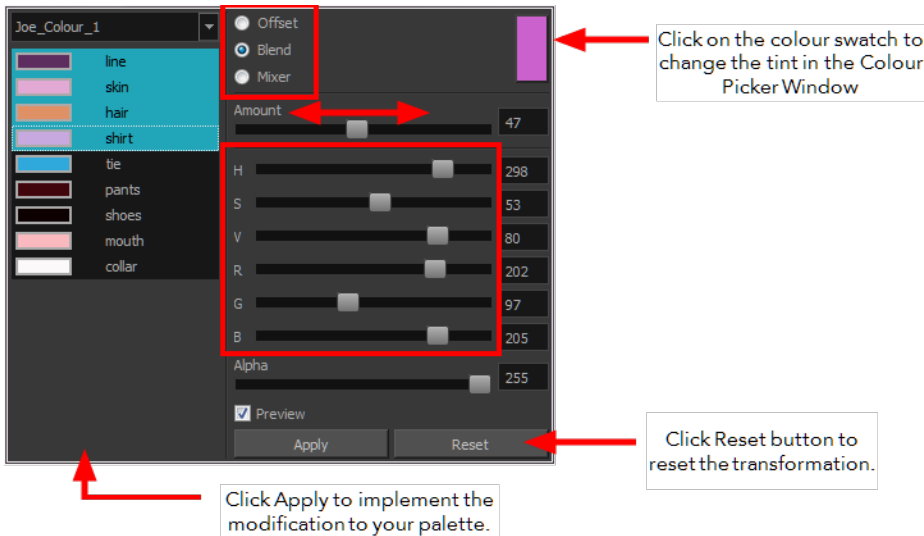

Parameter	Description
Offset	Offsets the selected colours by the adjustments made using the HSB and RGB sliders. Use the Amount slider to adjust the degree of offset. Use the Alpha slider to adjust the opacity of the selected colour.
Blend	Blends the selected colours with the colour swatch in the top-right corner. Use the Amount slider to adjust the degree of blend. A blend of 100% turns the selected colours into the same colour as the swatch. Adjusting the HSB and RGB sliders affect the swatch colour, which in turn affects the selected colours on the left. Use the Alpha slider to adjust the opacity of the swatch.
Mixer	Select a Base and Tint colour to form a third colour swatch. Use the slider just beneath to mix the Base and Tint colours by different amounts. This will affect the mixed swatch whether it is selected or not. Select either the Tint or Base swatch and use the HSB and RGB sliders to adjust its colour. This will affect the mixed swatch colour, which in turn affects the selected colours on the left.

6. Click **Apply**.

Painting the Model

Now that you have created the colours and the palette, you are ready to paint your model.

The colour model needs to be painted in order to adjust the colours with the other elements in the production. You can paint your model regardless of the colour RGBA and adjust them later when all the elements are together.

Once your palette is created and your model is painted, you can import a key background and other characters using the Import Drawings option or the Library to compare and adjust the palettes—see [Basic Commands on page 34](#) to learn how to import your background file.



Abigail Archer, Grossology © Nelvana Limited, Corus® Entertainment Inc.

For paperless and cut-out animation, it is a good idea to provide a line-up template with the colour model to show the scale ratio between the characters, props and backgrounds.







Nautilus © Gava Productions and Indiana Productions

Once your colour model is completed, create a line-up template by pasting one of the production's main characters, or even just a hand, beside the colour model to show the relative size. This allows the animator, layout artist, or scene setup artist to retain the correct scaling throughout the entire project when setting the elements in the scene. You can store your template in the Library.

How to paint a colour model

1. From the Drawing View menu, select **View > Switch to Colour Art/Switch to Line Art** or press L.
2. Create your master colour palette—see [Creating a Colour Palette on page 188](#)

3. Add new colours to the palette—see [Adding a Colour Swatch](#) on page 206.
4. Select your Paint Bucket    tool. We recommend the Paint Unpainted  tool.
5. In the Colour view, select the colour you need to paint your drawing.

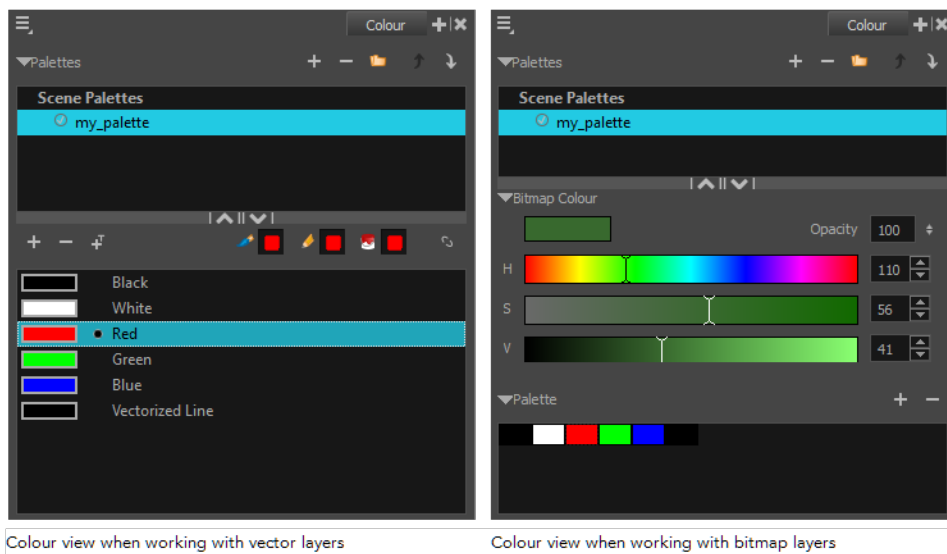

6. Paint the model by selecting colour swatches in the palette and clicking on your drawing. Note that only closed zones will be painted. If there is a gap in your artwork, you will need to close it in order to paint it.

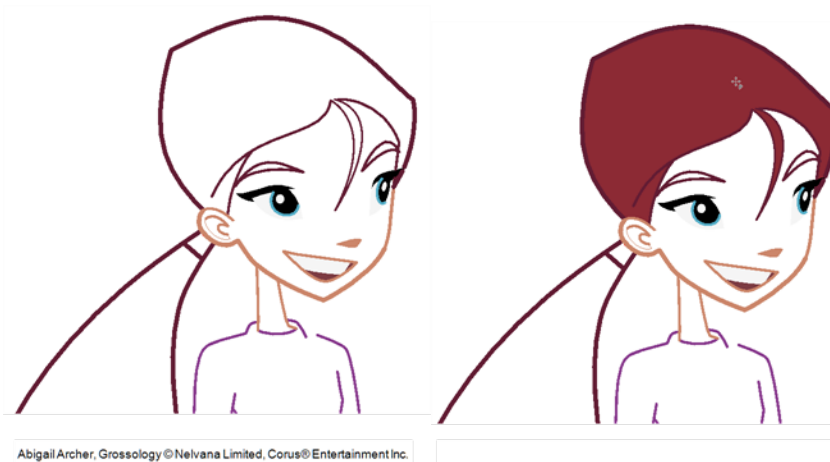

7. If you would like to separate your lines and fill zones on separated art layers, see [Art Layers](#) on page 226.
8. Adjust the colours—see [Mixing Colours](#) on page 214.

Chapter 8: Ink and Paint



When traditional animation is traced, cleaned up, scanned in and properly exposed, it is time for the ink and paint process. This consists of cleaning all dirt and hair (for example, dust that was in the scanner, dots that do not belong in the drawing, extra floating artwork around the drawing that must be removed), painting the lines and filling the colours in the empty zones on an entire animation sequence.

For paperless animation, the drawings are cleaned up directly in Harmony, so there is generally no dirt to clean, only painting and inking.

For cut-out animation, once the character builder paints the pieces, there is no more ink and paint process because the same parts are always reused and moved around. The ink and paint process applies only to traditional and paperless animation workflows.

Harmony is optimized to ink and paint drawings efficiently. Since most of the drawings are vector-based, the colour zones are completely filled and there are no scattered spots left blank. Also, there are some actions that can be applied on an entire animation sequence at once, like dirt removal, some colour filling, line repainting, and so on.

Harmony uses palettes to hold all the colours you need to paint your elements. A palette is created by assigning a set of colours to each character, prop or effect. The colour styling artist will create a new palette and add a new colour for each zone of the character, such as the skin, hair, tongue, shirt, pants, and so on. Each colour is known as a *colour swatch*—see [Working with Palettes](#) on page 181.

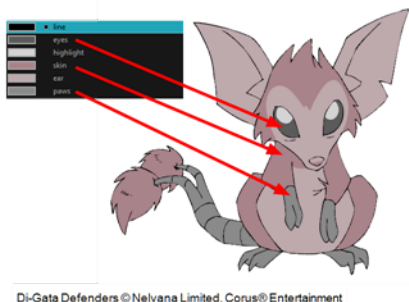

When a zone on the character is painted with the colour contained in a colour swatch, a link is automatically created between that colour swatch and the zone. This means that if the tint of the colour in the colour swatch is changed, any zone linked to it will update to the new tint. This is one way that colour palettes can save time and money in your production.

Another advantage of this system is that you can create complete palettes for different lighting situations. For instance, in addition to the regular palette for a character, you could have one for that character in the rain using colours that are duller and less vibrant than the dry daytime colours, or yet another for using in a night scene. Using palettes linked to your character in this way allows you to instantly change its colouring to suit the mood and atmosphere of the scene without tediously repainting each element.

The ink and paint process is divided into the following steps:

- [Preparation on the facing page](#)
- [Dirt Clean Up on page 223](#)
- [Art Layers on page 226](#)
- [Creating Strokes on page 229](#)
- [Painting on page 231](#)
- [Inking the Lines on page 249](#)
- [Verifying the Zones are Painted on page 253](#)
- [Ink and Paint Tool Properties on page 254](#)

Preparation

The optimal workspace for creating colour models and inking/painting in traditional animation includes the following views:

- Drawing
- Colour
- Model

As there is no default workspace for these tasks you will need to create a custom workspace for yourself—refer to the Fundamentals Guide.

You may have a character or element palette that has colours that are very similar to the Drawing and Camera view's background colour. For example, a white eyeball colour on a white background which makes it difficult to know if the zone was painted. You can change the background colour of the Camera or Drawing view in the Preferences dialog box.

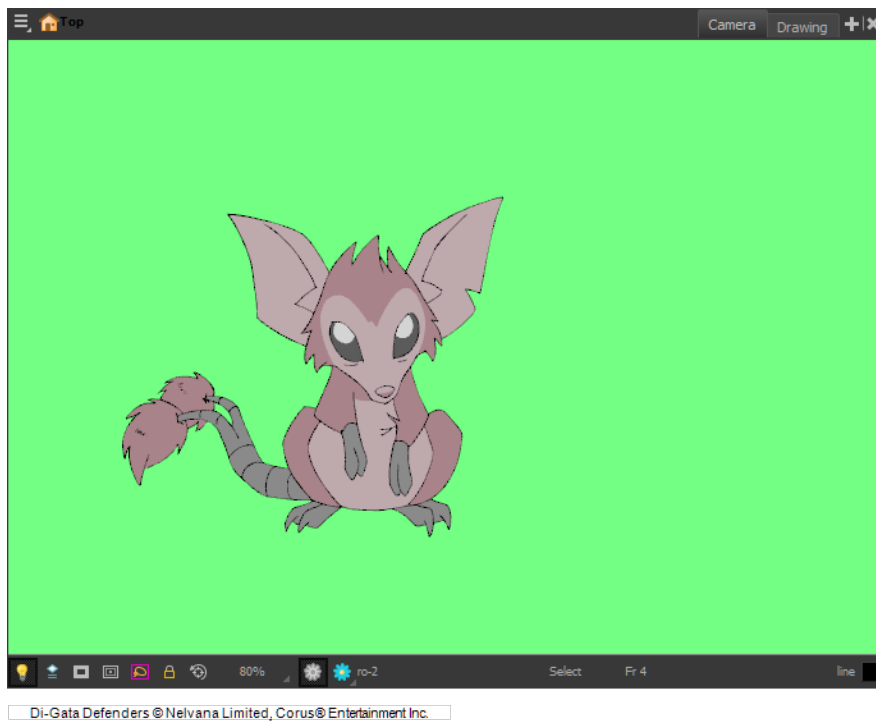

How to change a view's background colour

1. Do one of the following:
 - From the top menu, select **Edit > Preferences**.
 - Mac OS X: Select **Stage > Preferences**.
 - Press **Ctrl + U** (Windows/Linux) or **⌘ + U** (Mac OS X).

The Preferences dialog box opens.

2. Select the **General** tab.
3. In the Colours section, click **Edit Colours**.

The Colours dialog box opens.

4. Change the background colour of:

- ▶ Click the **Background** colour swatch.

The Select Colour dialog box opens.

5. Select a colour by clicking a colour swatch, clicking a colour in the colour gradient, or entering a HSV/RGB Value.

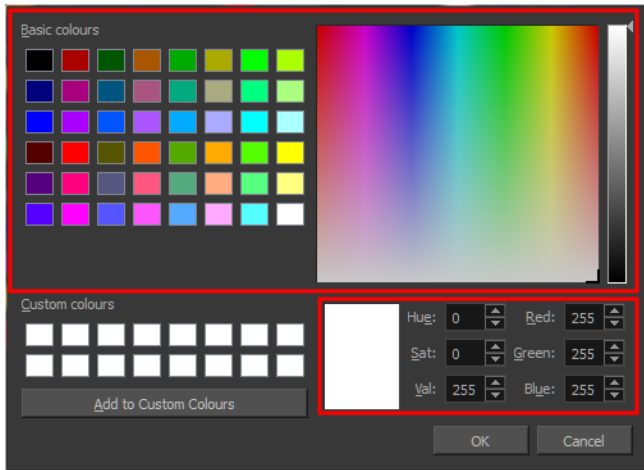

6. Click **OK** in the three opened dialog boxes to apply your changes.

When you need to paint drawings with similar colours throughout the palette, you can create a clone of that palette and change all the colours to very bright tints to facilitate the paint process—see .

Dirt Clean Up

When paper drawings are passed through a scanner, there can be some hair and dirt scattered across them. These lines and dots need to be cleaned. Harmony provides different tools to help get rid of them quickly.

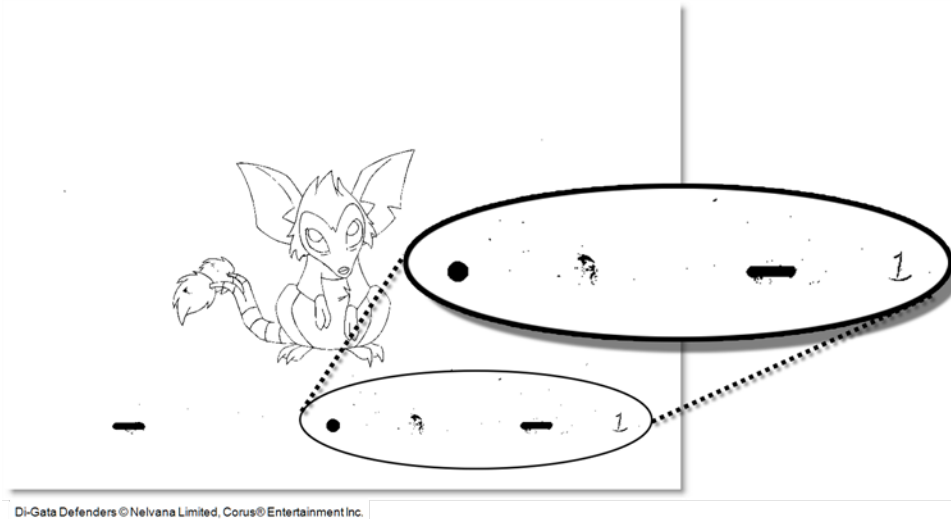

Di-Gata Defenders © Nelvana Limited, Corus® Entertainment Inc.

The Remove Dirt tool selects small dots and hairs on the drawing. Raising the Remove Dirt level will select bigger dots. When selecting larger dots, be careful not to lose small details like pupils and nostrils. Once you have chosen the level, you can apply it to the current drawing or the entire animation sequence. This is a quick way to get rid of most dirt and dust.

During this process, the dirt that will be removed is highlighted in red.

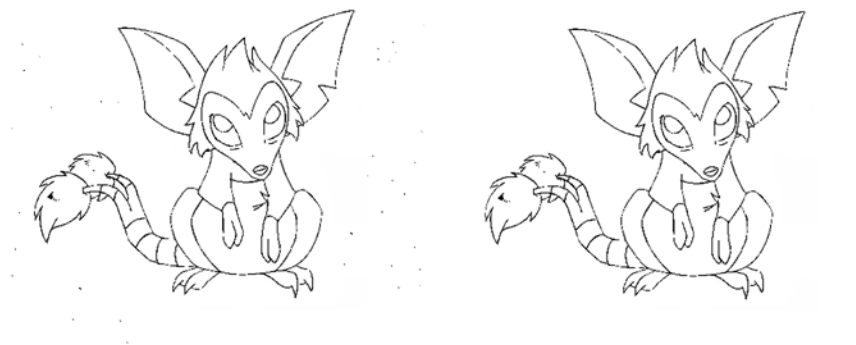

Di-Gata Defenders © Nelvana Limited, Corus® Entertainment Inc.

The Remove Art Outside Selection option lets you remove any art existing outside a selection. It is recommended that you clean your Colour Art level as well. If you have a stroke accumulation in your Colour Art, it can result in large output files, especially if you work in high-definition resolutions.



If there are some marks that cannot be removed with the automated tools, you can erase them with the Eraser tool or select them with the Select tool and then delete them. It is always safer to select and delete them than to erase them, so you do not overlook anything.

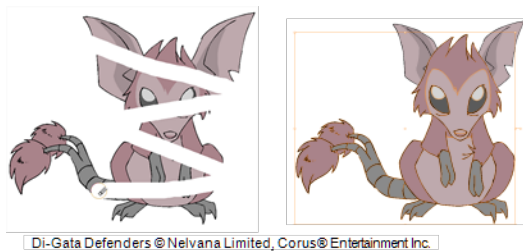

How to use the Remove Dirt tool

1. Do one of the following:
 - ▶ From the top menu, select **Selected > Clean Up > Remove Dirt**.
 - ▶ Press Shift + D.

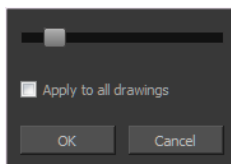

2. Increase the Remove Dirt value by moving the slider to the right.
3. Enable the Apply to All Drawings if you want to operation to be apply to all drawings in the layer.

How to clean dirt with Remove Art Outside Selection

1. In the Tools toolbar, select the Select  tool.
2. In the Tool Properties view, enable the **Permanent Selection** option.
3. Draw a selection around the animation making sure to include the entire animation sequence.

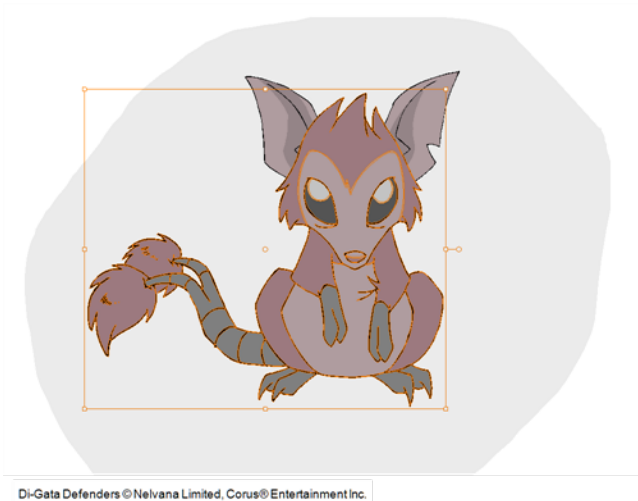

4. Select **Selected > Clean Up** and one of the following options:

- ▶ **Remove Art Outside Selection** to delete artwork outside your selection on a single drawing.
- ▶ **Remove Art Outside Selection on All Drawings** to delete artwork outside your selection on all the drawings.

The art outside the selection is removed.

How to access the Eraser tool

- ▶ From the Tools toolbar, click the Eraser  button.
- ▶ From the top menu, select **Tools > Eraser**.
- ▶ Press Alt + E.

How to access the Select tool

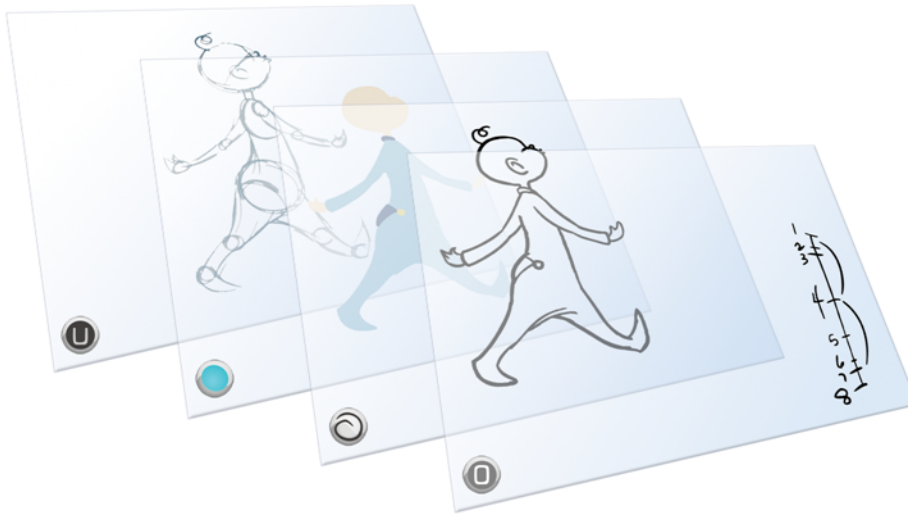

- ▶ From the Tools toolbar, click the Select  button.
- ▶ From the top menu, select **Tools > Select**.
- ▶ Press Alt + S.

Art Layers



Art layers give you the possibility to divide the artwork in your drawing on different layers. For example, you can separate the outline and colour fill on two art layers, similar to 1950s traditional cell animation. These art layers are contained within a single drawing as opposed to the timeline layers or Xsheet columns where individual drawings with individual timing are stacked one on top of the other—see [Creating Strokes](#) on page 229.

Toon Boom Harmony drawings include two art layers.

-  Line Art below
-  Colour Art on the facing page

Each layer can be used for separate hand-drawn animation tasks, letting you organize your work and facilitate creation and revision.

Line Art



In hand-drawn animation, the Line Art layer is mainly used to trace and clean up animation. The outline is drawn in the Line Art layer and colour is painted in the Colour Art layer.

Colour Art



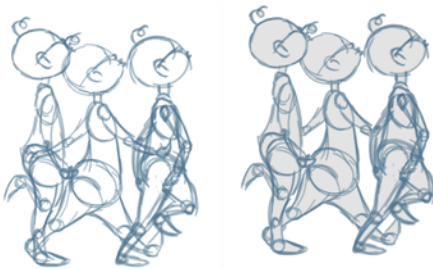

In hand-drawn animation, you use the Colour Art layer to paint your animation. The outline is drawn in the Line Art layer and colour is painted in the Colour Art layer. Strokes (invisible lines) are generated from Line Art to contain the painted area.



When you are doing rough animation, you may want to send a clip to somebody for feedback or approval before carrying on with your work. If you have several characters in your project that are overlapping, it may be difficult to understand what is going on as you can see through the characters. Toon Boom Harmony can generate a matte automatically in the Colour Art layer, and fill all the zones inside your characters making them opaque. This process is fast and easy and allows you to send easy-to-understand movies.

How to switch between Line Art and Colour Art layers and enable the Preview mode

1. Do one of the following:
 - ▶ In the Drawing view, right-click and select **Switch to Colour Art/Switch to Line Art** or press L.
 - ▶ In the Colour view, click the Colour Art  button.
 - ▶ In the Colour view, click the Line Art  button.
2. To preview the Line Art and Colour Art at the same time:
 - ▶ In the Drawing view, right-click and select **Preview Line Art and Colour Art** or press Shift + P. While using the Preview mode, you still edit one mode at a time.
 - ▶ In the Colour view, click the Preview  button.

To edit both Line Art and Colour Art at the same time, you must enable the Apply to Line Art and Colour Art button in the Tool Properties of the tools supporting the

operation.

Creating Strokes

A drawing is composed of Line and Colour filling layers. Lines and colours can be separated or kept together, depending on which animation process you use. The following diagram presents Line Art and Colour Art recommendations based on the selected animation workflow.

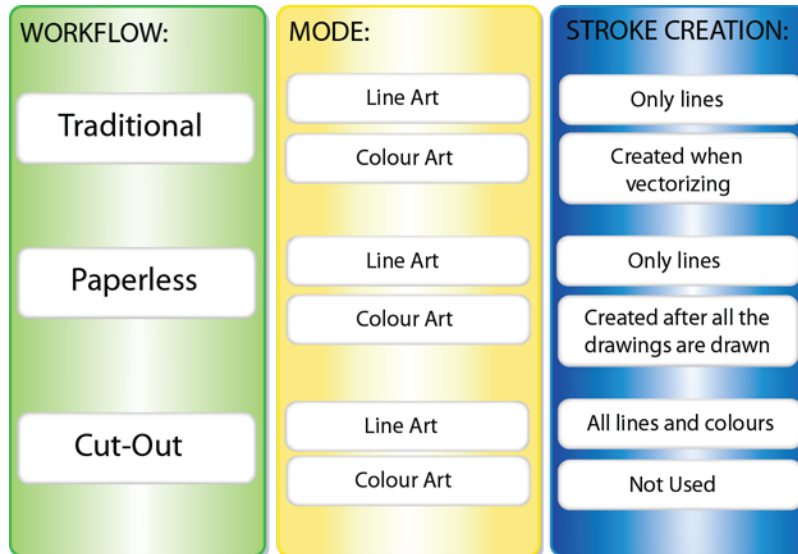

When a traditional drawing is scanned, strokes are automatically created in the Colour Art from the Line Art when drawings are vectorized unless you specified otherwise.

When working with Cut-out animation, we recommend that you do all of the work in the Line Art.

Once the drawing sequence is completed for paperless drawings, you can proceed with creating Colour Art strokes if you plan to paint the animation in the Colour Art. Use the Create Colour Art from Line Art option to create strokes from your lines.

You can create strokes in the Colour Art during the following stages:

- After the full drawing is completed in Line Art
- While drawing in Line Art

You may have some traditional drawings that need to be fixed; for example, needing extra lines to patch gaps. Use the Auto-Create Colour Art from Brush option to create the strokes at the same time as the lines are drawn. This creates strokes from the lines and brush strokes created in the Line Art while you draw and is useful for fixing drawings. However, if you are drawing a new sketch, it is better to create the strokes afterward using the Create Colour Art from Line Art option.

Make sure to select the Advanced Art Mode in the Preferences dialog box to use this feature.

How to create Colour Art zones out of the Line Art content

1. In the Tools toolbar, select the Select  tool or press Alt + S.

2. In the Tool Properties view, enable the Permanent Selection  option if you want to apply the operation on all drawings in the layer.
3. In the Drawing view, select the artwork to transfer to the Colour Art. Create a selection around the entire animation sequence if you want to apply the operation to all your drawings.

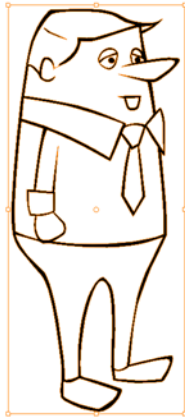

4. In the Drawing View toolbar, click the Create Colour Art from Line Art  button or press *.

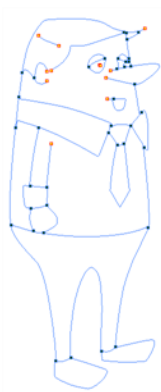

How to create strokes with the Auto-Create Colour Art From Brush option

5. Draw the required lines.
6. Once you are done, deselect the **Auto-Create Colour Art from Brush** option. You are now ready to paint your model.

Painting

You can choose to paint your animation in the Line Art or Colour Art level. You can paint in Line Art, but for traditional and paperless animation, you should fill your colour zones in Colour Art. You can access the art layers through the Art Layer toolbar—see [Art Layers on page 226](#).

There are many advantages to separating the lines and colour zones, but the main one concerns the painting process. To paint very quickly, it is useful to not worry about painting over the lines. If the lines are separated, you can fill the zones very quickly and you will never accidentally paint the lines. Conversely, if you are inking the lines, you will not repaint the colour zones either.

If you have transparent lines, bitmap lines or textured lines with transparency, it is better to have your colour zones bleeding under your lines to avoid seeing the backgrounds and other elements through the lines.

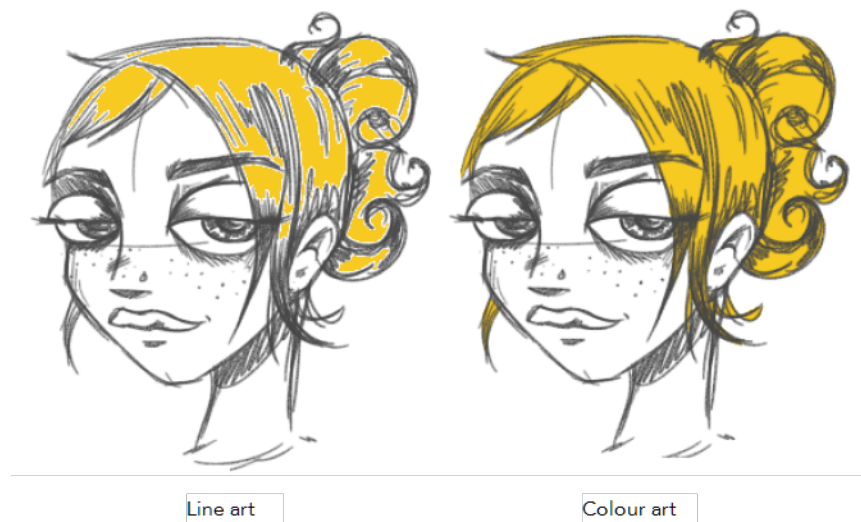

To avoid painting in Line Art by mistake, turn off the Preview mode and paint in the Drawing view rather than the Camera view. Press P to turn the mode on or off.

This section is divided as follows:

- [Painting Using the Paint Tool on the next page](#)
- [Advanced Painting Features on the next page](#)
- [Selecting a Colour in a Drawing on page 236](#)
- [Importing Models on page 238](#)
- [Editing Gradients and Textures on page 240](#)
- [Closing Gaps on page 245](#)
- [Protecting Colours on page 247](#)
- [Highlighting the Selected Colour on page 247](#)
- [Inverting a Colour Selection on page 248](#)

Painting Using the Paint Tool

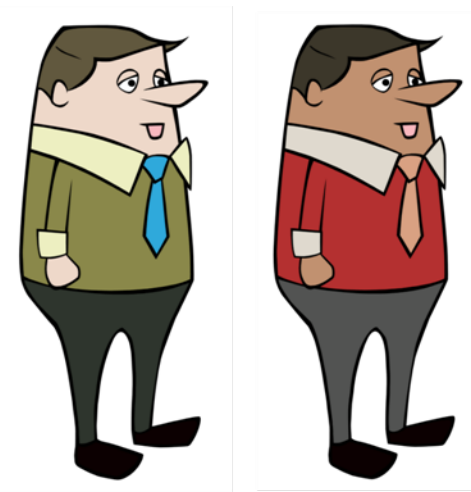

The main tool you will use to paint your drawings with is the Paint tool. The Paint tool can be used in several different modes, which can be customized in the Tool Properties view.

The Paint tool paints closed zones, including brush strokes and pencil lines. If there are gaps in the lines defining a zone, you must close them using the Brush, Pencil, or Close Gap tools or the Automatic Close Gap option.

How to paint with the Paint tool

1. Do one of the following:
 - In the Tools toolbar, click the Paint  tool.
 - From the top menu, select **Drawing > Drawing Tools > Paint**.
 - Press Alt + I.
2. In the Colour view, select a colour.

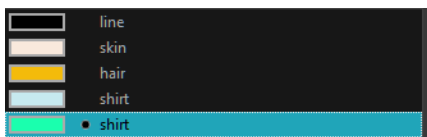

3. In the Drawing view, start painting. You can click on a zone or pencil line to paint it, or you can trace a lasso or marquee selection to paint several zones or pencil lines at once.

The last colour you select while using the Paint tool will be remembered the next time you select the Paint tool if you are using the unlocked painting tools in the Colour view.

Advanced Painting Features

The following advanced painting features are available in Toon Boom Harmony and are described in this section:

- Repaint Selection
- Repaint Selection On All Drawings
- Repaint Outside Selection
- Repaint Outside Selection On All Drawings
- Unpaint Selection
- Unpaint Selection On All Drawings
- Unpaint Outside Selection
- Unpaint Outside Selection On All Drawings

The Repaint Selection command is used to repaint any art inside a selection. You must first draw a selection using the Select tool in order for this command to be available.

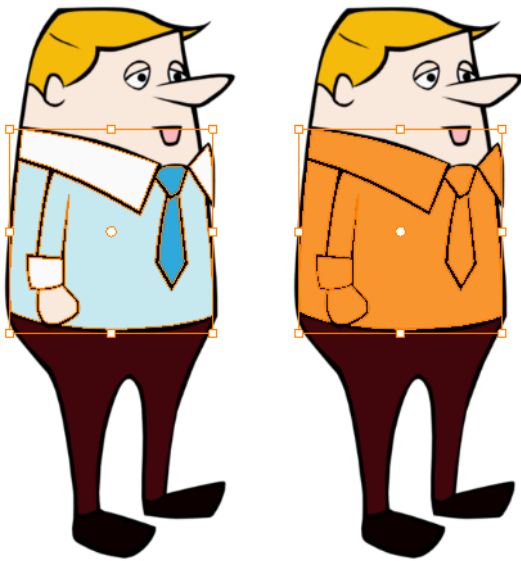

The Repaint Selection On All Drawings command is used to repaint any art inside a selection on all the drawings contained within the same layer. You must enable the Permanent Selection  option in the Select tool Tool Properties view and then select an area of your drawing using the Select tool in order for this command to be available. The Permanent Selection option lets you maintain the same selection throughout the drawings of a same layer.

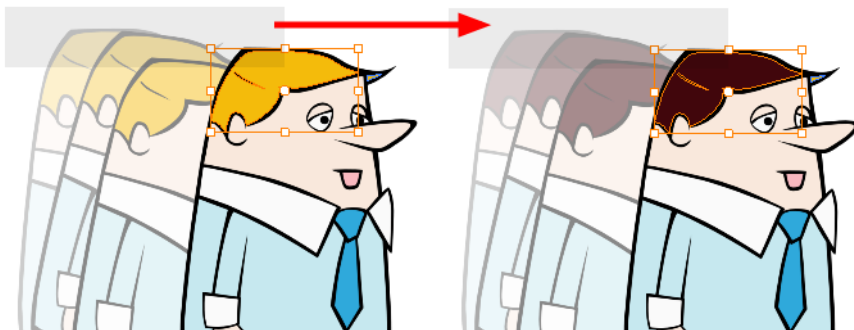

The Repaint Outside Selection command is used to repaint any art outside a selection. If no selection has been drawn using the Select tool, the entire drawing will be repainted.

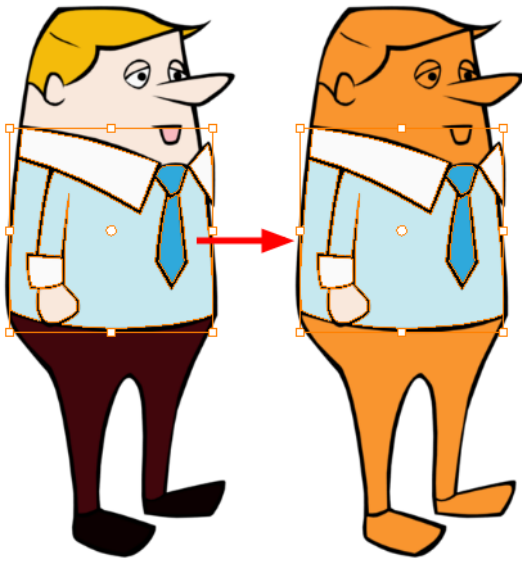

The Repaint Outside Selection On All Drawings command is used to repaint any art outside a selection on all the drawings contained within the same layer. You must enable the Permanent Selection  option in the Select tool Tool Properties view and then select an area of your drawing using the Select tool in order for this command to be available. The Permanent Selection option lets you maintain the same selection throughout the drawings of a same layer.

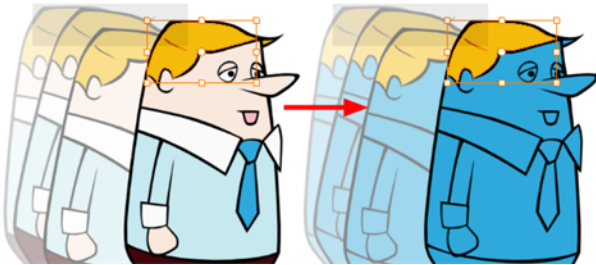

The Unpaint Selection command is used to unpaint any art existing inside a selection. You must first draw a selection using the Select tool in order for this command to be available.

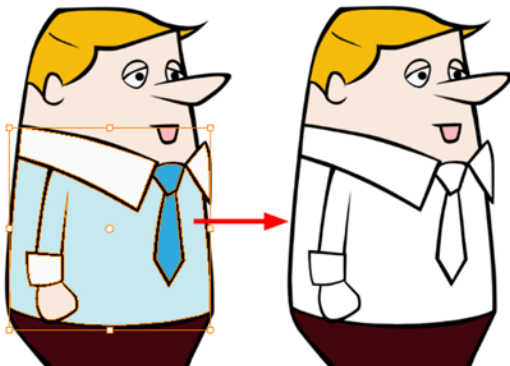

The Unpaint Selection on All Drawings command is used to unpaint all art contained inside a selection on all the drawings within the same layer.

You must enable the Permanent Selection  option in the Select tool Tool Properties view and then select an area of your drawing using the Select tool in order for this command to be available. The

Permanent Selection option lets you maintain the same selection throughout the drawings of a same layer.

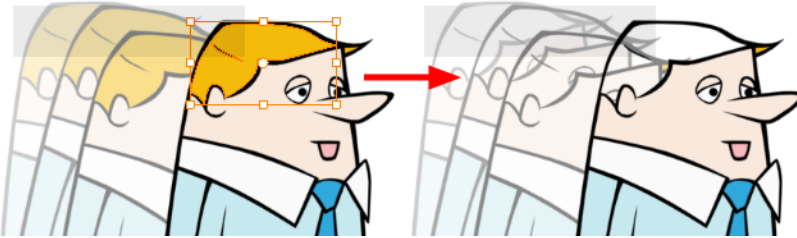

The Unpaint Outside Selection command is used to unpaint any art existing outside a selection. If no selection have been drawn using the Select tool, the entire drawing will be unpainted.

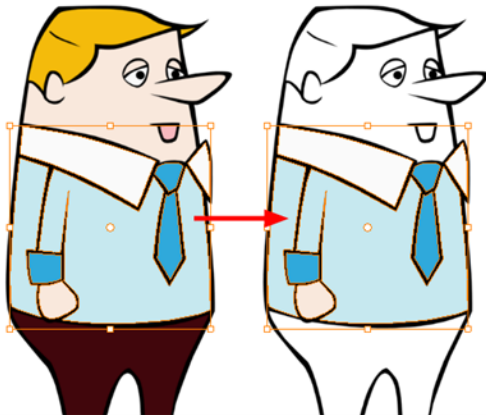

The Unpaint Outside Selection on All Drawings command is used to unpaint all art outside a selection on all the drawings within the same layer. You must enable the Permanent Selection  option in the Select tool Tool Properties view and then select an area of your drawing using the Select tool in order for this command to be available. The Permanent Selection option lets you maintain the same selection throughout the drawings of a same layer.

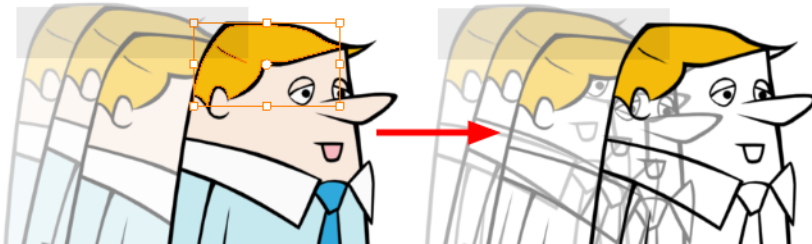

How to access the Repaint Selection command

- From the top menu, select **Drawing > Paint > Repaint Selection**.
- From the Camera or Drawing view menu, select **Drawing > Paint > Repaint Selection**.

How to access the Repaint Selection On All Drawings command

- From the top menu, select **Drawing > Paint > Repaint Selection On All Drawings**.
- From the Camera or Drawing view menu, select **Drawing > Paint > Repaint Selection On All Drawings**.

How to access the Repaint Outside Selection command

- ▶ From the top menu, select **Drawing > Paint > Repaint Outside Selection**.
- ▶ From the Camera or Drawing view menu, select **Drawing > Paint > Repaint Outside Selection**.

How to access the Repaint Outside Selection on All Drawings command

- ▶ From the top menu, select **Drawing > Paint > Repaint Outside Selection on All Drawings**.
- ▶ From the Camera or Drawing view menu, select **Drawing > Paint > Repaint Outside Selection on All Drawings**.

How to access the Unpaint Selection command:

- ▶ From the top menu, select **Drawing > Paint > Unpaint Selection**.
- ▶ From the Camera or Drawing view menu, select **Drawing > Paint > Unpaint Selection**.

How to access the Unpaint Selection On All Drawings command:

- ▶ From the top menu, select **Drawing > Paint > Unpaint Selection On All Drawings**.
- ▶ From the Camera or Drawing view menu, select **Drawing > Paint > Unpaint Selection On All Drawings**.

How to access the Unpaint Selection command

- ▶ From the top menu, select **Drawing > Paint > Unpaint Outside Selection**.
- ▶ From the Camera or Drawing view menu, select **Drawing > Paint > Unpaint Outside Selection**.

How to use the Unpaint Outside Selection On All Drawings command

- ▶ From the top menu, select **Drawing > Paint > Unpaint Outside Selection On All Drawings**.
- ▶ From the Camera or Drawing view menu, select **Drawing > Paint > Unpaint Outside Selection On All Drawings**.

Selecting a Colour in a Drawing

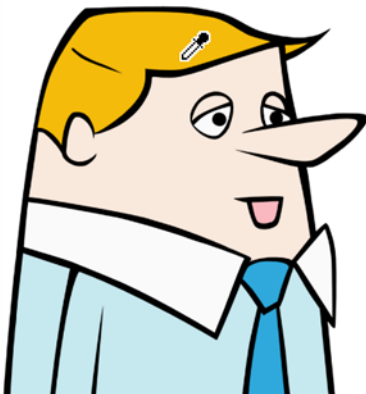

While working in your Drawing view, you can use the Dropper tool to pick a colour from your drawing without going to the Colour view.

How to use the Dropper tool

1. Do one of the following:
 - ▶ In the Tools toolbar, select the Dropper  tool.
 - ▶ Press Alt + D.
2. In the Drawing view, click on the desired colour.
 - ▶ If you are using another drawing tool such as the Paint tool, you can temporarily hold down the D key and click in your drawing before releasing the key to pick your colour. When you release the key, Toon Boom Harmony will return to your previous tool. You may also want to select the zones painted with the colour currently selected in the Colour view. This can be useful for removing rough lines from a clean drawing.

How to select the zones painted with the current colour

1. In the Colour view, select the colour you want to select the corresponding zones from.

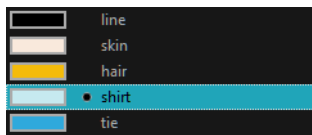

2. Do one of the following:
 - ▶ Press Ctrl + Shift + A (Windows/Linux) or  + Shift + A (Mac OS X).

Importing Models

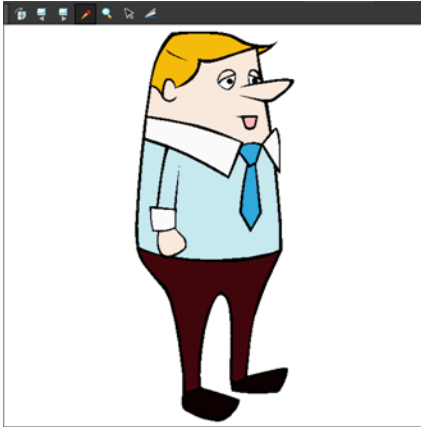

Once you have a fully painted drawing, you can use it as a colour model and load it in the Model view. That drawing can be used and loaded in any of your Harmony scenes.

Once a drawing is loaded in the Model view, you can use the Dropper  to select a colour from the model and use it to paint in your Camera or Drawing view without having to pick the colour from the colour palette.

You can do more than just copy colours from a colour model. Harmony gives you the ability to copy parts of the character directly from its colour model and paste these elements into the Drawing or Camera views.

How to browse for a colour model drawing on your hard drive

1. Do one of the following:
 - ▶ From the Model View menu, select **Import Model**.
 - ▶ Click the Import Model  button or from the Model View's toolbar.
 - ▶ Select **File > Import > Colour Model**.
2. In the Browser window, browse for any *.tvg drawing file on your hard drive or in the database.
3. Click **Open**.

The model appears in the Model view.

How to load the default models

1. In your scene's folder, create a new folder and name it models.
2. On your hard drive copy the *.tvg drawing file you want to use as colour models in your scene.
3. Do one of the following:
 - ▶ From the Model View menu, select **Load Default Model**.
 - ▶ In the Model View toolbar's extra buttons, click the Load Default Model  button .

How to clear a colour model

- ▶ In the Model View menu, select **Clear Model** or press Delete.

How to copy the entire model from the Model view

1. In the Model view's toolbar, select the Select  tool.
2. In the Model view, select your model.



3. From the top menu, select **Edit > Copy Drawing Object** or press Ctrl + C (Windows/Linux) or ⌘ + C (Mac OS X).
4. Select either the Drawing view then go to the top menu and select **Edit > Paste Drawing Object** or press Ctrl + V (Windows/Linux) or ⌘ + V (Mac OS X).

The model now appears in the selected view.

How to copy part of the model from the Model view

1. In the Model view's toolbar, select the Cutter  tool or press Alt + T.
2. In the Model view, use the Cutter tool to create a selection around the part of your model that you want to copy.

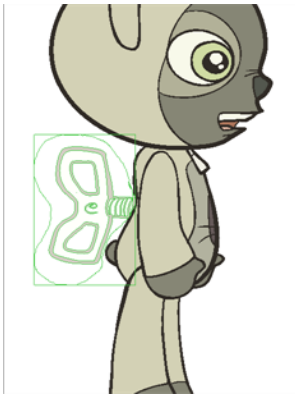

3. From the top menu, select **Edit > Copy Drawing Object** or press Ctrl + C (Windows/Linux) or ⌘ + C (Mac OS X).
4. Do one of the following:
 - ▶ Select the Drawing view and select **Edit > Paste Drawing Object**.
 - ▶ Select the Timeline view and select **Edit > Paste cells in the Timeline** or press Ctrl + V (Windows/Linux) or ⌘ + V (Mac OS X).

The model appears in the selected view.

Editing Gradients and Textures



If you paint a zone with a gradient or texture colour, you can use the Edit Gradient/Texture tool to modify its position in the zone. You can move, scale, rotate and skew. If you want to match the colour to the animation, set the first texture position and copy the Edit Gradient/Texture position. When moving to the next drawing, you can select the next texture and paste the previous position to continue the modifications.

If you are painting a hand-drawn animation or if you want the Brush tool and Paint tool to use your gradient's position, angle and scale settings instead of the default ones, you can store your own settings and reuse them afterward.

This way of editing a texture using the Edit Gradient/Texture tool also works with pencil lines drawn with textured "brushes". If you then paint your textured pencil line with a gradient, you can do so and then edit both elements independently at the same time.

How to use Edit Gradient/Texture tool

1. Do one of the following:
 - ▶ In the Tools toolbar, click the Edit Texture  tool.
 - ▶ From the Drawing View menu, select **Drawing Tools > Edit Gradient/Texture**
 - ▶ Press Shift + F3.
2. Click the gradient or texture colour to modify.



Erik, Di-Gata Defenders © Nelvana Limited, Corus Entertainment

A blue selection frame surrounds the selected gradient or texture.

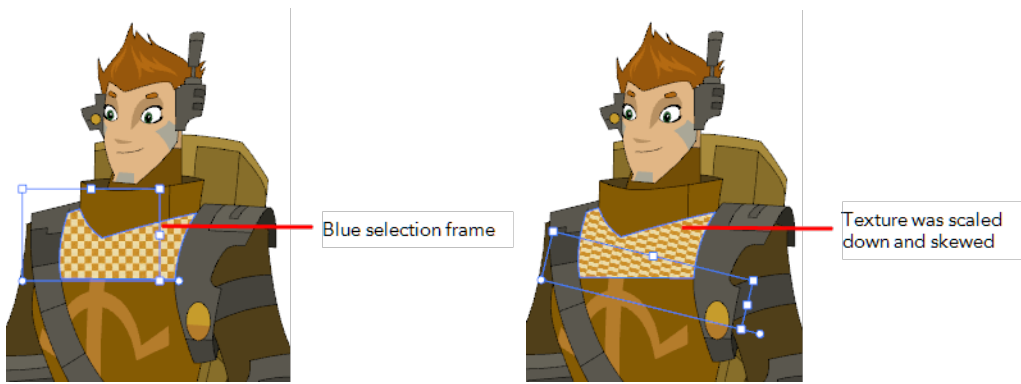

3. Edit the gradient or texture by adjusting the control handles around the selection frame.

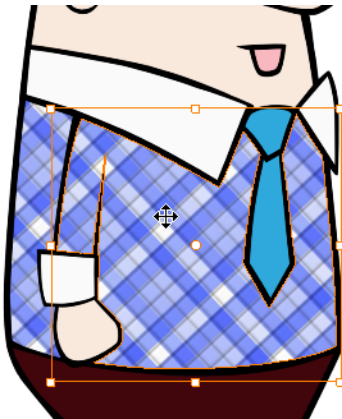

How to store your gradient and texture settings

1. In the Tools toolbar, select the Select  tool or press Alt + S.
2. In the Drawing view, select the gradient or texture zone to store.



3. In the Tool Properties view, click the Store Colour Gradient  button.

How to use the stored gradient and texture settings

1. In the Tools toolbar, select the Brush  or Paint  tool.
2. In the Tool Properties view, click the Use Stored Colour Gradient  button.
3. In the Drawing view, draw and paint.

How to use Pencil Editor tool to edit the texture or gradient on a pencil line

1. Do one of the following:
 - In the Tools toolbar, select the Pencil Editor  tool.
 - Press Alt + W.
2. Click on the pencil line to be modified to bring up its contour envelope.

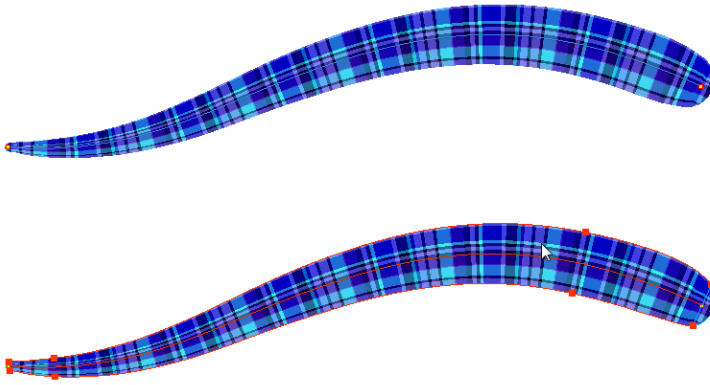

3. Select one of the contour points around the envelope and move its position to change the size of the tiled texture or gradient. You can also pull directly on the lines of the contour envelope or play with the Bezier handles of any given point in order to continue to modify the envelope form.

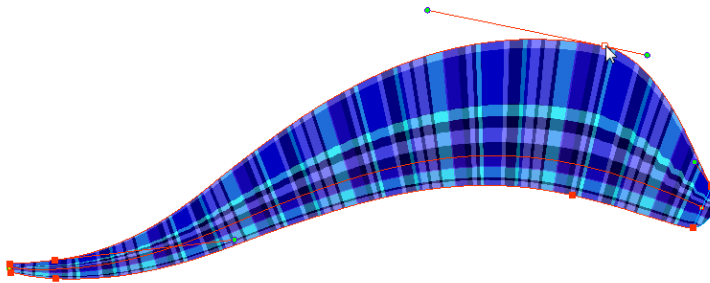

Expanding the width of the envelope parallel to the pencil line's central vector will cause the tiled texture to be stretched. Conversely, reducing the envelope's width will cause the tiled texture to look squashed.

Reducing the contour's width perpendicular to the pencil line's central vector will reduce the number of tiles, while expanding it will increase the number of tiled images.

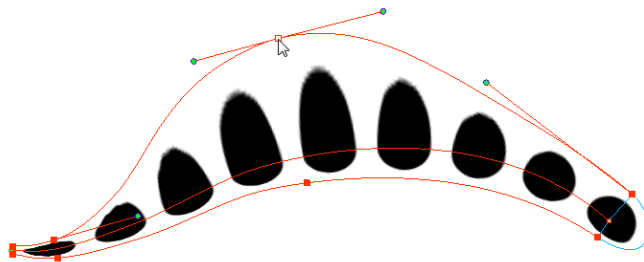

This editing technique does not just work on texture fills, but can also be applied to pencil lines drawn with a textured "brush".

How to use Edit Gradient/Texture tool to edit the texture or gradient on a pencil line

1. In the Tools toolbar, select the **Edit Gradient/Texture**  tool. You can also press Shift + F3.
2. Click on the pencil line to be modified to bring up the editor controls.

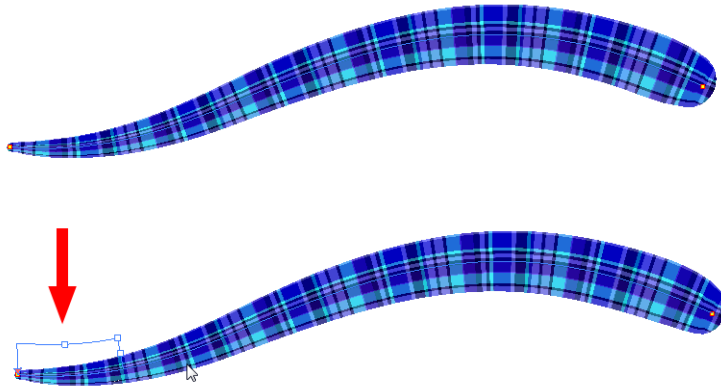

3. The editor controls delineate a single tile in the texture. For gradients, this is less applicable. Pull on the top of the editor controls to stretch the tiled texture throughout the length of the stroke.

As gradients are parallel to the stroke's central vector, this will stretch the way that the gradient is distributed in the pencil line's envelope. The envelope still acts as a boundary for the texture or gradient.

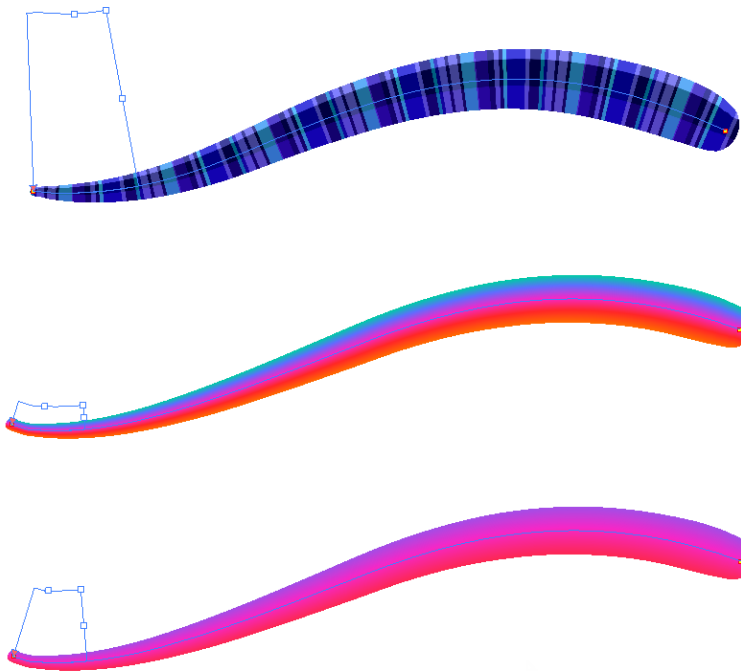

4. Drag the editor control perpendicular to the stroke. You will feel it glide along the stroke's central vector line. This is another way to resize the texture tile. Instead of stretching or shrinking it vertically, this motion stretches or shrinks it vertically. As gradients are parallel to the pencil line's central vector, stretching them vertically gives no visual result.

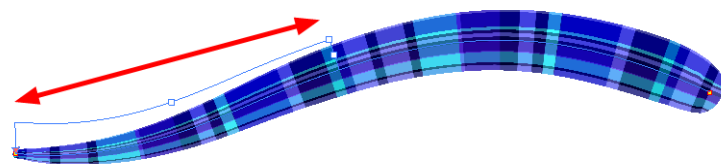

How to use Edit Gradient/Texture tool to edit both the texture and the gradient of a pencil line

1. Do one of the following:
 - ▶ In the Tools toolbar, select the Edit Gradient/Texture  tool.
 - ▶ Press Shift + F3.
2. Click on the pencil line to be modified to bring up the editor controls.

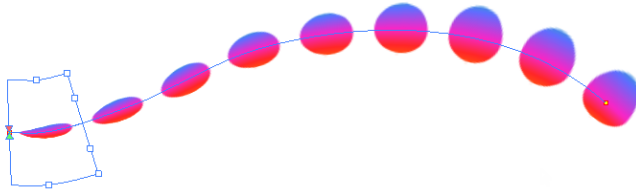

3. Use the top editor controls edit the gradient.

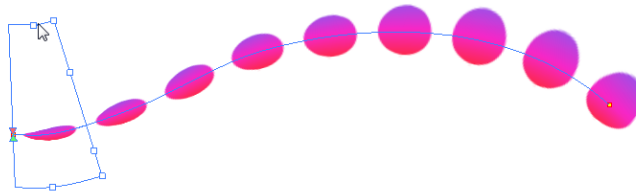

4. Use the bottom controls edit the "brush" texture.

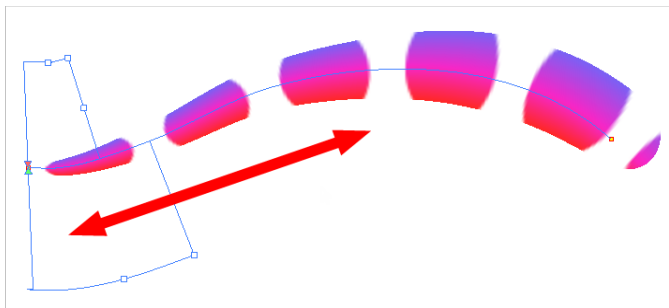
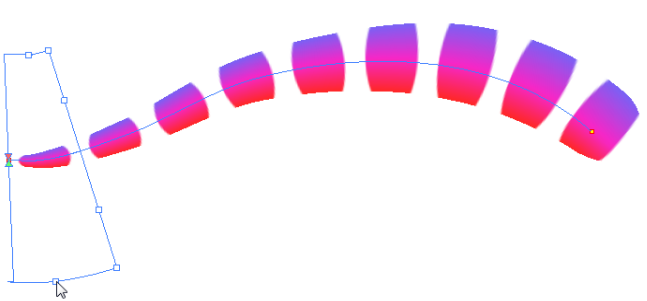

Closing Gaps

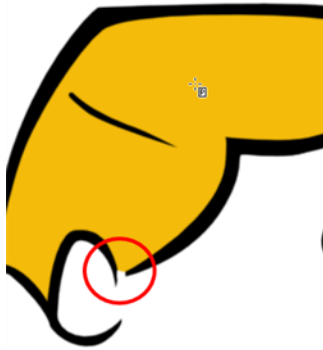

When painting, you may notice that some drawing areas are not closed. To close the zone, you can either draw the missing line with the Brush or Pencil tool, or close the gap with an invisible line using the Close Gap tool.

The Close Gap tool lets you close small gaps in a drawing by creating small, invisible strokes between the two closest points to close the colour zone. You do not need to trace directly over the gap. You can draw it a few millimeters away. The two closest points automatically close the gap.

How to close gaps

1. From the top menu, select **View > Show Strokes** or press K to see a preview of the result.
2. Enable the Auto-Flatten  option in the Tool Properties view if you want the strokes you draw to be flattened in your drawing instead of being on top.

The Close Gaps dialog box opens.

3. Adjust the slider to set the size of the gap you want to be closed.

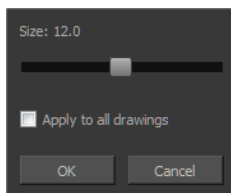

4. To close all gaps in the drawings of the selected layer, select the **Apply to all drawings** option and click **OK**.
5. In the Tools toolbar, select the Close Gaps  tool.
6. In the Drawing view, trace a line near the gap to be closed. Your strokes will be invisible. The gap automatically closes.

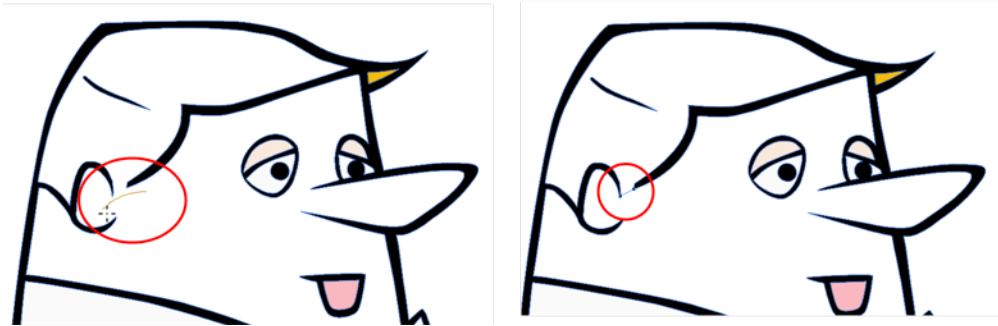

Protecting Colours

When you are finished painting some zones, you can protect the colour swatch they are associated with, so the work cannot be accidentally painted over.

When you are done inking one colour, you can lock it so that if you ever paint over it accidentally, the work already done will not be affected. You can also use the Protect Colour feature to block the filling colours if you painted all of the animation in Line Art and you plan to repaint the lines.

How to protect colours

1. In the Colour view, select the colour to be protected.

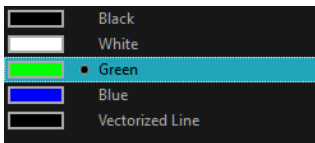

2. Do one of the following:
 - Right-click and select **Protect Colour**.
 - From the Colour view menu, select **Colours > Protect Colour**.

A red bar appears beside the colour to indicate that it is locked.

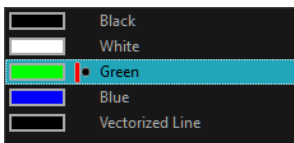

Respecting Protected Colours

When painting, the Respect Protected Colour  option is enabled by default. In the Colour view, you can protect a colour swatch to avoid repainting or unpainting the zones linked to that swatch. If you disable this option, the Paint tool will not follow the protect colour rule and you will repaint or unpaint the protected colours on your drawings until you enable the option again.

How to toggle the Respect Protected Colours option

Do one of the following:

- Paint tool properties, click the Respect Protected Colour  button.
- Press Shift + S.

Highlighting the Selected Colour

The Highlight Selected Colour option is used to identify colour swatch used in a drawing. For example, if you have unnamed colours in your palette and want to know if a particular colour was used on the current model or drawing, you can select the colour and use the Highlight Selected Colour option. Harmony will dim all the colours in the drawing except the selected one, so it stands out and can be identified. You can rename it accordingly.

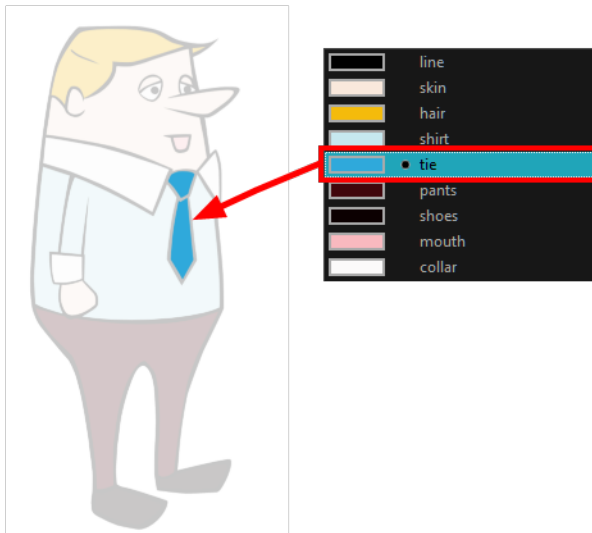

How to use the Highlight Selected Colour option

1. In the Colour view, select the colour you want to highlight.
2. From the Drawing menu, select **View > Show > Highlight Selected Colour**.

Inverting a Colour Selection

When you need to select all colour swatches but one, or select only a few swatches here and there, it might be faster to select the only colour you do not need, in order to select and invert the selection.

How to invert a colour swatch selection in the Colour view

1. In the Colour view, select the colour swatch you **DO NOT** want to have in your final selection.

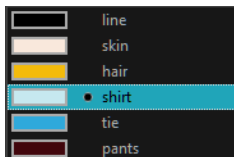

2. Do one of the following:
 - ▶ From the top menu, select **Edit > Invert Selection**.
 - ▶ Press **Ctrl + Shift + I** (Windows/Linux) or **⌘ + Shift + I** (Mac OS X).

Inking the Lines

Some animation styles require you to paint the lines, a process also be called *inking*. To ink your lines, you must be in Line Art mode. You can repaint any type of lines including the texture lines—see [Art Layers on page 226](#).

Unless you are repainting all of the lines on the whole animation sequence, do not use the Apply Tool to All Drawings option. Since the line positions change a lot over time, you risk painting lines that are not supposed to be painted.

These are the main tools used to ink the lines:

- Repaint Tool
- Repaint Brush Tool
- Ink Tool
- Protecting Colours

The main tool used to ink the lines is the Repaint tool. As the colour filling is probably done in the Colour Art, you will not have to worry about not touching it. The Repaint tool will not paint empty zones either.

During the vectorization process on traditional scanned drawings, triangles are added on the lines' intersections to break the artwork in segments. This way, when you paint a line, it will not repaint the whole drawing, only the relevant segment.

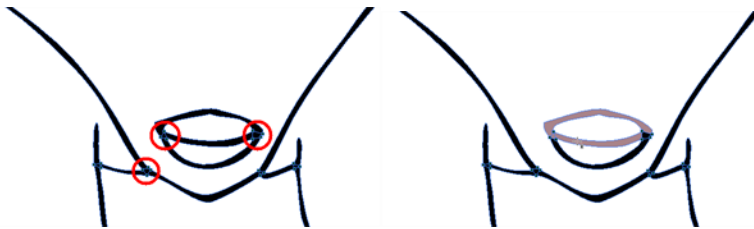

The Repaint Brush tool is used to paint a section by manually painting over the lines. This is useful when the vectorization triangles are not placed as you would like or you simply need to repaint a section of a segment. It is also useful for paperless animation, where there are no triangles. So, the Repaint Brush is used to paint a certain area. It acts like the Brush tool, but will only show on painted areas that are already painted.

Unlike the Brush tool, the Repaint Brush flattens automatically. The brush strokes are not added one on top of each other.

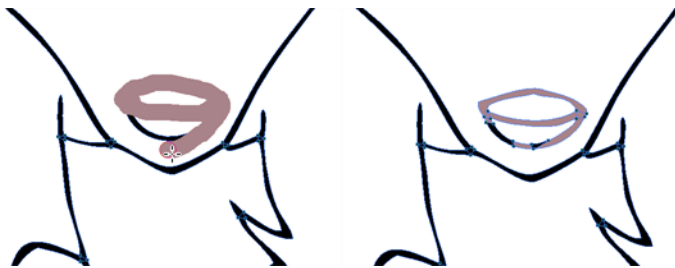

When you are done inking one colour, you can lock it so if you ever paint over it accidentally, the work already done will not be affected. You can also use the Protect Colour feature to block the filling

colours if you painted all of the animation in Line Art and you plan to repaint the lines—see [Protecting Colours](#) on page 247.

The Brush tool is often the most intuitive and rapid tool for creating rough sketches and clean lines. A single colour, such as black, is often used when tracing a clean version of a rough sketch. However, when it comes time to soft trace the lines in different colours, the flattened or unflattened clean brush strokes can suddenly become time consuming to ink.

Toon Boom Harmony lets you create triangular breaks at natural line intersections. These intersections are the probable locations where colour line breaks may occur, such as where a sleeve meets a hand.

Although pencil lines can be painted in much the same way as closed zones, you can use the Paint, Repaint, Repaint Brush, and Ink tools to make painting segmented lines easier. Normally when you have a drawing, such as the one below, and you use the Paint tool to paint one of the lines, the entire line is painted.

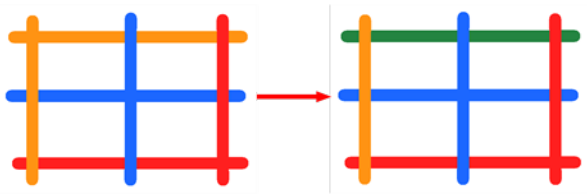

However, if you select the Ink  tool instead and click on the same pencil line, only the segment that you clicked on between two intersections will be painted.

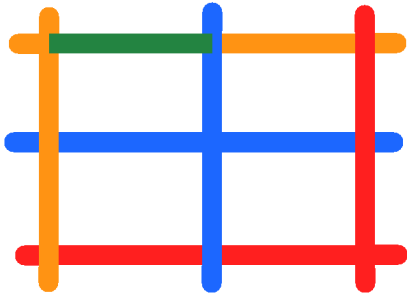

The newly inked segment will always be moved to the front of all other pencil strokes, even if it was behind all other pencil strokes before it was inked.

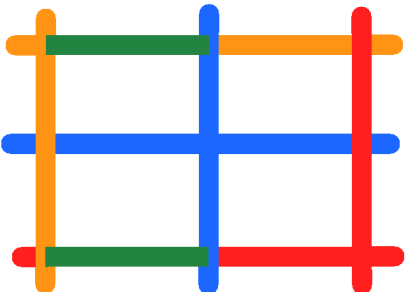

That is, unless you hold down Alt while clicking a segment. Then the opposite becomes true. The inked segment will be sent to the back, even if it was in front of all other segments to begin with.

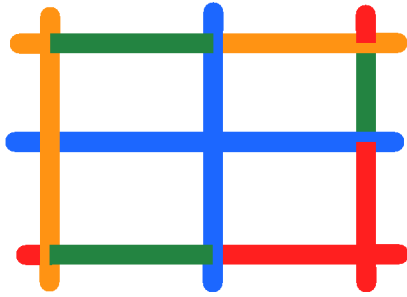



Painting and Inking can be used in combination depending on what it is that you need to paint. If you need to ink a character's outline in black, it might be easier to use the Paint tool. If you need to paint the outline of a character's neck with a tan colour and its shirt outline blue and both the neck and shirt belong to the same continuous outline, then the Ink tool might prove more useful.

How to select the Repaint Tool

1. In the Tools toolbar, select the Repaint  tool located in the Paint tool drop-down menu.

How to select the Repaint Brush

1. In the Tools toolbar, select the Brush  tool.
2. In the Tool Properties view, enable the Repaint Brush  mode.

How to select the Ink Tool

1. In the Tools toolbar, select the Ink  tool located in the Paint tool drop-down menu.

How to protect colours

1. In the Colour view, select a colour to lock.

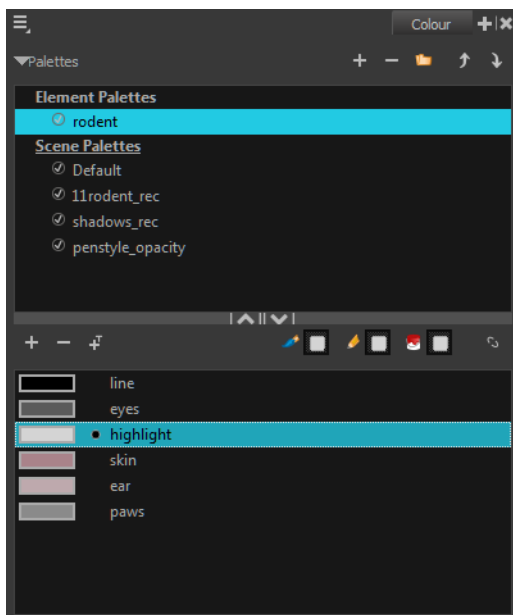

2. Do one of the following:

- ▶ Right-click and select **Protect Colour**.
- ▶ From the Colour view menu, select **Colours > Protect Colour**.

A red bar appears beside the colour to indicate that it is locked.

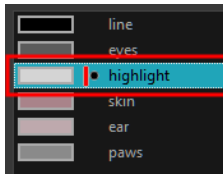

Verifying the Zones are Painted

When the ink and paint process is completed, it is always a good idea to verify that every zone was painted properly.

The backlight produces a silhouette effect by changing the drawing's coloured areas into a single dark, solid colour use this to verify the completeness of the ink and paint process. Any unpainted zones can be seen as the light shows through the unpainted areas of the silhouetted drawing.

How to use the backlight

This feature is only available in the Drawing view.

1. Do one of the following:
 - ▶ From the top menu, select **View > Backlight**.
 - ▶ In the Drawing View toolbar, click the Backlight  button.
 - ▶ Press Alt + Shift + B.
2. Verify the drawings in the Colour Art to make sure that all the areas are painted. In the Colour View, click on the Colour Art button.
3. In the Colour View, click on the Preview button to see the colour zones with lines to ensure that you did not forget any spots between the colour filling and lines.

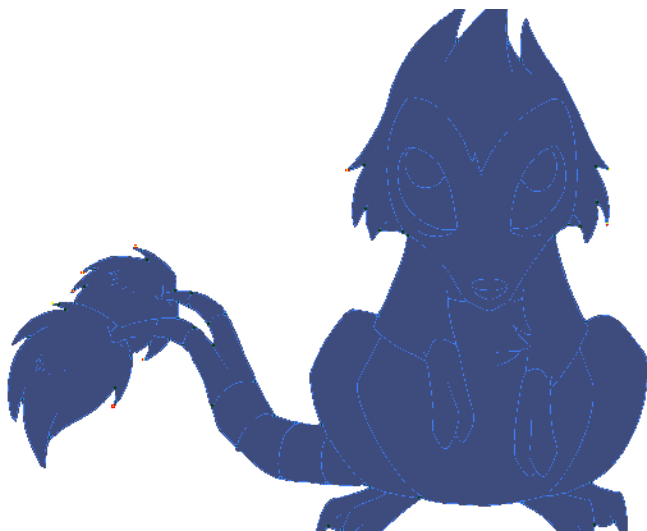

Ink and Paint Tool Properties





The Ink and Paint tool properties contain many options that will help you along with your task.



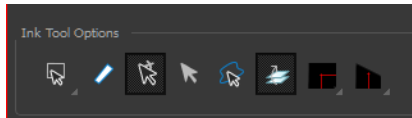





- [Ink Tool Properties](#) below
- [Paint Tool Properties](#) on the facing page

Ink Tool Properties

When you select the Ink tool, its properties and options appear in the Tool Properties view.



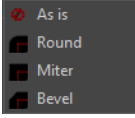

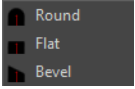





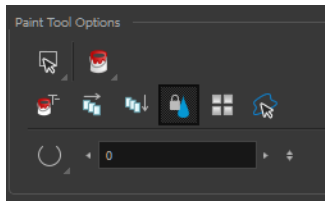

Icon	Tool Name	Tool
	Lasso and Marquee	<p>The Lasso and Marquee options let you choose the type of selection the current tool will perform. The default selection mode is Marquee.</p> <ul style="list-style-type: none"> • Lasso  lets you draw a custom selection box around zones. • Marquee  makes a rectangle selection box. <hr/> <p>Hold down the Alt key to switch to the opposite mode of your selection.</p> <hr/> <p>How to invert a selection</p> <ol style="list-style-type: none"> 1. Do one of the following: <ul style="list-style-type: none"> ▶ From the top menu, select Edit > Invert Selection. ▶ From the Drawing menu, select Edit > Invert Selection. ▶ Press Ctrl + Shift + I (Windows/Linux) or ⌘ + Shift + I (Mac OS X).
	Show Inkable Lines	<p>Highlights all pencil lines (no brush strokes) on the selected layer. Pencil line segments that are already inked with the selected swatch colour from the colour palette are also not highlighted.</p>

	Be Smart on Connecting Lines	<p>As you hover and move the cursor across intersecting pencil lines, the path that you create will be highlighted. When you click on your mouse or stylus the highlighted segments are inked.</p> <p>With this option disabled, all the intersecting segments that your cursor comes near will be highlighted and become part of the selection, even if they were not situated in the direction of the chosen path.</p> <p>Note: This option only works if the Ink tool is in Hover mode.</p>
	Select Mode	<p>Use this  mode instead of the Hover Mode. In the Hover Mode, any potentially inkable pencil line will have its central vector line highlighted as the Ink tool's cursor hovers over it. Use Ctrl (Windows/Linux) or ⌘ (Mac OS X) to toggle between the two modes.</p>
	Select Newly Painted, Repainted, Unpainted Contours and Lines	Keeps a selection highlighted around the latest painted zone after using the Paint, Repaint, Unpaint, or Paint Unpainted tool.
	Arrange Ink Lines	Brings all newly-inked lines to the front. Disable this option if you want all newly-inked lines to be sent to the back. Press Alt to toggle between the two options.
	Mitre	<p>As you hover over two perpendicular or nearly perpendicular segments, a highlighted path with a corner is created. Clicking on these highlighted segments inks both segments and makes them appear as a single stroke with a corner or bend.</p> <p>Click the Mitre  button to choose from As is, Round, Mitre, and Bevel.</p> 
	Tip Style	<p>Lets you customize the edge of the Ink tool. Options include: Round, Flat, and Bevel.</p> 

Paint Tool Properties



When you select the Paint tool, its properties and options appears in the Tools Properties view.



Icon	Tool
	Lasso and Marquee below
	Painting Modes below
	Paint and Remove Texture on page 258
	Apply to Multiple Drawings on page 258
	Apply to All Visible Drawings on page 259 Apply to All Visible Drawings on page 259
	Respect Protected Colour on page 259
	Use Stored Colour Gradient on page 260
	Select Newly Painted/Repainted/Unpainted Contours/Lines on page 260
	Automatic Close Gap on page 260

Lasso and Marquee

The Lasso and Marquee options let you choose the type of selection the current tool will perform. The default selection mode is Marquee.

- Lasso  lets you draw a custom selection box around zones.
- Marquee  makes a rectangle selection box.

Hold down the Alt key to switch to the opposite mode of your selection.

How to invert a selection

1. Do one of the following:
 - From the top menu, select **Edit > Invert Selection**.
 - From the Drawing menu, select **Edit > Invert Selection**.
 - Press Ctrl + Shift + I (Windows/Linux) or ⌘ + Shift + I (Mac OS X).

Painting Modes

The Paint tool has four different modes available:

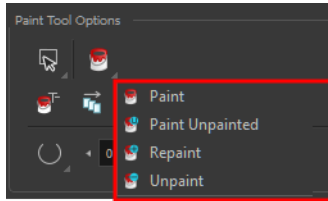

You can also find these tools directly in the Tools toolbar and in the Drawing Tools menu.

Paint Mode



The Paint  mode paints everything it touches, including empty and filled zones.

Paint Unpainted Mode

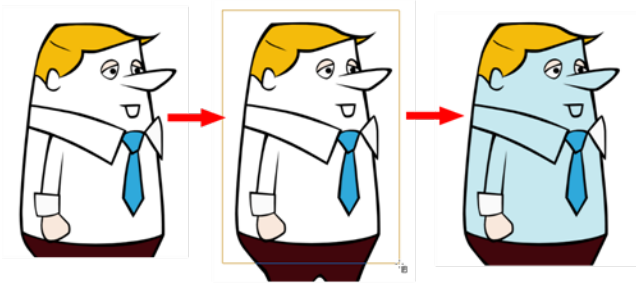

The Paint Unpainted  mode paints only empty zones. Any line or filled zone will remain unchanged.

Repaint Mode

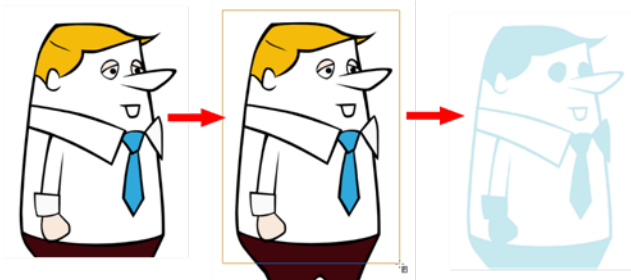

The Repaint  mode paints everything it touches except empty zones. Any zone that is not painted will remain intact.

Unpaint Mode

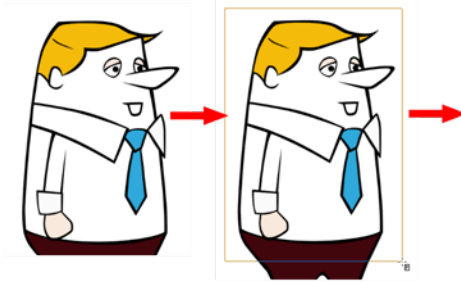

The Unpaint  mode unpaints everything it touches, including empty and filled zones.

Paint and Remove Texture

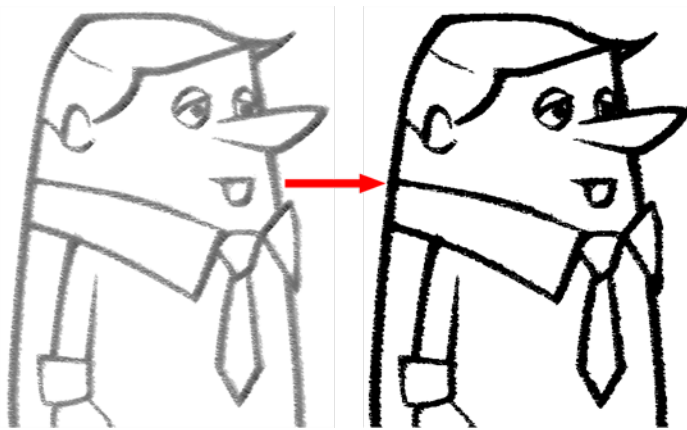

The Paint and Remove Texture  option is used when you vectorized images as greyscale texture style. An image vectorized as texture is a mix of bitmap filling encapsulated in a vector-based frame. Painting a textured zones with the Paint tool will change the tint of the textured lines. Painting the textured zones using the Paint and Remove Texture option transforms the bitmap filling into a 100% vector based zone and fills it with a solid colour.

Apply to Multiple Drawings

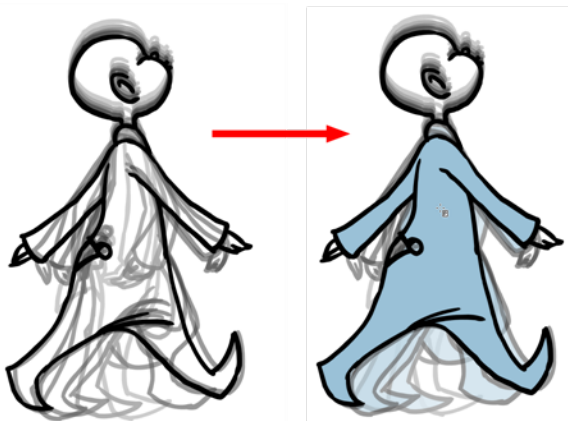

The Apply to Multiple Drawings  option is used for fast painting in hand-drawn animation. When you want to paint several drawings in a same layer at once, such as a walk cycle, you can enable this option and make a selection in your Camera or Drawing view. All the closed zones located within your Paint tool selection are painted with the selected colour swatch.

You do not need to enable the Onion Skin preview to use this option. The option will stay enabled only for the next action. If you want to use it again, you must click on the Apply to Multiple Drawings button again, or press Alt + A.

Apply to All Visible Drawings

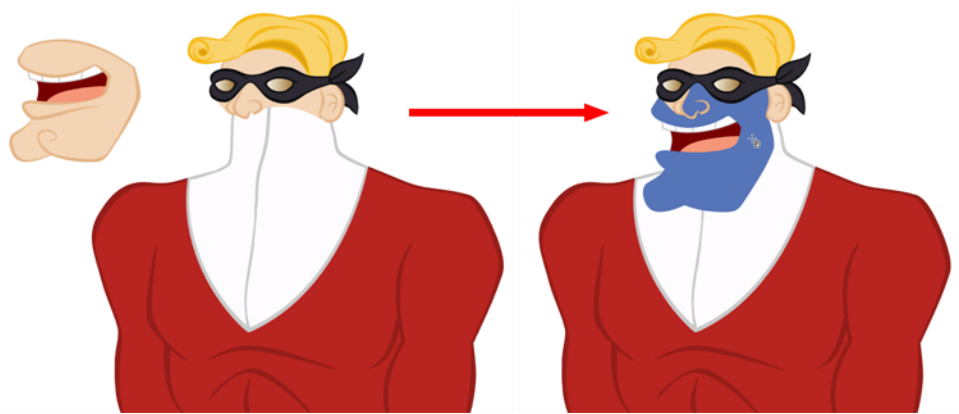

The Apply to All Visible Drawings  option is used to paint several drawings on separated layers on the current frames. If you have a character broken in several layers, you can enable this option to paint all your layers at once. The operation is only applied on the current frame. This option will stay enabled only for the next action. If you want to use it again, you must click on the Apply to All Visible Drawings button again.

This option is only available in the Camera view and does not affect symbols.



Respect Protected Colour

The Respect Protected Colour  option is enabled by default. In your Colour view, you can protect some colour swatches to avoid repainting or unpainting the zones linked to that swatch.

If you disable this option the Paint tool will not follow the protect colour rule and will repaint or unpaint the protected colours on your drawings until you enable the option again—see [Protecting Colours](#) on page 247.

Use Stored Colour Gradient



When you paint a zone with a gradient or textured colour swatch, the gradient or texture's position is set relative to the size of the zone you are painting. If you want the Paint tool to use a particular size and position, you must first store your desired position and size using the Select  tool and then enable the Use Stored Colour Gradient  option in the Paint tool Tool Properties view—see [Editing Gradients and Textures](#) on page 240.

Select Newly Painted/Repainted/Unpainted Contours/Lines

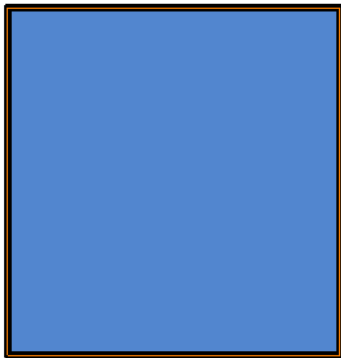

In the Paint tool Tool Properties view, enabling this option  will keep a selection highlighted around the latest painted zone after using the Paint, Repaint, Unpaint, or Paint Unpainted tool.

Automatic Close Gap

The Automatic Close Gap option has four modes available:

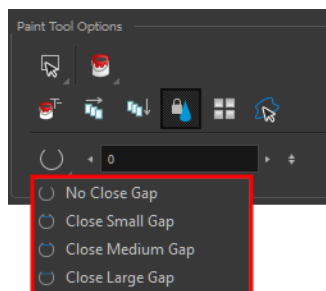

The Automatic Close Gap  options are used while painting drawings with small gaps. Instead of having to close them manually with the Brush tool or Close Gap tool, Toon Boom Harmony will analyze the drawing and close the gaps while you paint according to the selected mode. The automated gap closing should be done using the zoom function setting of your Camera or Drawing view. If your eye does not see the gap, Toon Boom Harmony won't either—see [Closing Gaps on page 245](#).

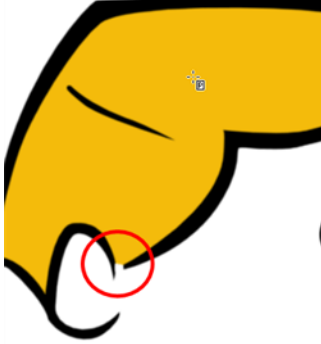

Glossary

alpha channel	The image's channel carrying the transparency information. An image already has three channels: red, green and blue (RGB). The alpha channel is the fourth channel (RGBA). The matte, or the transparency information, is stored in this fourth channel. An image without an alpha channel is always opaque.
animatic	A movie with sound that is developed from the storyboard. The storyboard panel is exposed for the duration of the scene and at times, the characters are placed on a trajectory to indicate motion. The camera moves are also animated. The animatic is used to determine the rhythm of a project and provides a good overview of the project before beginning production.
animation	A simulation of movement created by displaying a series of pictures or frames.
anime	An animation style known for its sinister and dark feel; popular in Japan.
arc	Action rarely occurs in a straight-forward manner; rather it typically unfolds in what storytellers refer to as an arc. The purpose of a story arc is to move a character or a situation from one state or scenario to the next.
aspect ratio	The relationship between the width and height dimensions for any scene, frame or film format. Television ratio is 4:3 and widescreen ratio is 16:9.
auto-feed	An automated method of feeding drawings into a scanner in which multiple drawings are stacked into a sheet feeder. When the scanner is activated, the drawings are scanned consecutively, without further user intervention.
automatic lip-sync detection	Automatically mapping drawings in an element to the mouth chart generated for a sound. This can save time when lip-syncing a voice track.
axis	An imaginary line around which an object rotates. For 2D graphics, there are two axes: <ul style="list-style-type: none"> • X: Horizontal • Y: Vertical For 3D graphics, there are three axes: <ul style="list-style-type: none"> • X: Horizontal • Y: Vertical • Z: Depth
background	The part of a scene that is farthest to the rear. The background is the artwork, or decor, against which the animation takes place.
Bézier	A method of defining curved lines invented by French

	<p>mathematician Pierre Bézier. A Bézier curve is a mathematical or parametric curve. Bézier curves use at least three points to define a curve.</p> <p>In Toon Boom, a function can be hooked to a Bézier curve and vary along with the curve value information. Bézier curves are also very useful in vector graphics. They are used to model smooth curves and can be scaled indefinitely.</p>
bitmap	<p>An image composed of pixels with a single resolution (size). If it is enlarged too much, it will lose definition and pixels will begin to appear. This is known as <i>pixelation</i>.</p>
breakdown	<p>In cut-out animation, breakdown is the action of breaking a character into pieces to create a puppet with articulations. To break down a character, the artist cuts part, such as hands and arms, from the character's model and pastes them in separate layers. Next, the joints are fixed and the pivots set.</p> <p>In traditional animation, a breakdown is an animation pose generally found between two key poses. The key poses are the main poses in an animation and the breakdowns are secondary poses, ones that help to describe the motion and the rotation curve.</p>
camera shake	<p>Camera shake occurs in a scene when the camera moves slightly and quickly in several directions. This gives the impression of an impact, vibration or, for example, bumps on the road.</p>
caption	<p>In a storyboard, a caption is a text field containing dialogue, effects, sound, or slugging information.</p>
cel	<p>In traditional animation, a cel, also known as a <i>celluloid</i>, is a transparent sheet on which the animation is inked and painted before being sent to the camera. The picture's outline is drawn on the front of the cel and then coloured along the back.</p> <p>In Toon Boom, a cel is an individual space encountered in an Xsheet's column, from which you can expose a drawing or a function's coordinate.</p>
character design	<p>Each character in an animated film is drawn from multiple angles in poster-style format, called a <i>model sheet</i>, which serves as a reference for the animators.</p>
clean up	<p>After rough drawings have been tested and approved, all the noise in the image (excess lines, notes, etc) is removed to create final drawings which can be inked, painted and shot. The cleanup process refers to either tracing a clean line over a rough drawing to achieve the final version, or removing dirt and extra lines left by the scanning process.</p>
CMYK	<p>Cyan, Magenta, Yellow, Black. Refers to the process used by printers to define colour on the printed page.</p>
colour card	<p>A Colour Card is a solid colour card that is the same size as the camera. The Colour Card can be used to fill the background with a solid colour when there is no background image included.</p>

colour model	In animation, a colour model is the official colour design that must be used to paint the animation. A model is the definitive character, prop, or location design that each artist must follow for the production.
colour wheel	A display of the colour spectrum in the form of a circle.
compositing	Compositing is the action of incorporating all of a scene's elements to create the final result prior to rendering. For example, the compositing artist will import all the animation sequences, background, overlays and underlays in the scene and position them correctly. The artist will then set the camera frame and animate it, if needed. Finally, the animator will create all the computer-generated effects for the project.
cross dissolve	An effect used to fade two scenes, one into the other.
cut	A direct transition between two scenes. When a cut is used, there are no transition effects inserted to pass from one scene to the next. The first scene ends and the second one starts immediately.
cut-out animation	The action of animating characters made of several pieces by moving them around frame by frame. Cut-out animation can either be computer generated or done traditionally using paper.
cycle	A group of images that together make up an action, such as walking. A cycle is an action repeated as a loop over a period of time. It can be a series of animated drawings or keyframes.
dialogue	The text spoken by a character in a movie or animation.
dope sheet	Used by animators, directors and other members of a crew to track the sequence and timing of images, dialogue, sound effects, sound tracks and camera moves. Also known as an <i>exposure sheet</i> or <i>Xsheet</i> .
doping	To assign a particular drawing to a range of frames.
DPI	Dots Per Inch is the standard measure of resolution for computerized printers. It is sometimes applied to screens, in which case it should more accurately be referred to as <i>pixels per inch</i> . Either way, the dot is the smallest discrete element making up the image.
ease/velocity	In animation, the ease, also known as <i>velocity</i> , is the acceleration and deceleration of a motion. It can be a motion created by a function curve, or a series of animated drawings. Other common terms for ease-in and ease-out are slow-in and slow-out.
ease-in	Gradual acceleration in the action. Another common term for ease-in is slow-in.
ease-out	Gradual deceleration in the action. Another common term for ease-out is slow-out.
establishing shot	A scene in which the viewer can see the whole area in which a sequence is happening. For example, if a child is playing on the ground in front of his house, the establishing shot would be a scene

	where the viewer can see the house, the ground, a part of the street and the buildings around the central point of action. This helps the viewer understand the story location and scene orientation.
exposure	In animation, an exposure is the number of cels on which a drawing appears in the scene. For a drawing to appear longer, the exposure must be extended over a greater number of cels.
exposure sheet (Xsheet)	<p>The exposure sheet or Xsheet, is a sheet with several vertical columns and horizontal frames used to indicate a scene's timing.</p> <p>Each column represents a scene's layer. In each column, the drawing's numbers are indicated and repeated over the particular amount of frames they need to appear.</p> <p>The exposure sheet is used by animators, directors and other members of a crew to track the sequence and timing of images, dialogue, sound effects, sound tracks and camera moves. Also known as a <i>dope sheet</i>.</p>
fade in/fade out	Fade in or fade out is a transition effect used to open or close a sequence. A fade in occurs when the first scene appears progressively, from complete transparency to its complete opacity. A fade out occurs when the last scene progressively disappears, going from complete opacity to complete transparency.
fast-in	Dramatic acceleration at the start of the action.
fast-out	Dramatic acceleration at the end of the action.
field	In animation, a field is a measurement unit used to calculate motion, registration and camera positioning. A standard animation scene will vary between 6 to 12 fields.
field chart	A guide containing all the field units that animation and layout artists use to determine a scene size or camera motion.
film-1.33	Use this resolution setting for the widescreen film format that conforms to the standard 4:3 pixel aspect ratio.
film-1.66	Use this resolution setting for the widescreen film format that conforms to the 16:9 pixel aspect ratio. (The pixels are wider than they are high).
flipping	In traditional animation, flipping is the action of going through the drawings of an animation sequence very quickly in order to see the animation in motion. Flipping can also be the action of creating a mirror transformation of an object.
follow-through	The follow-through is the secondary motion caused by the main action. For example, a character wearing a cloak is running. The main action is the body running. This will cause the cloak to follow the motion, although it will not move at the same time, but react a few frames later and follow the main motion curve.
forward kinematics	Forward kinematics is a feature used to animate principally 3D characters and cut-out puppets with hierarchy. It is used to animate

	<p>a puppet from one of parent parts, such as a shoulder, and make the rest of the arm move with it as a single piece.</p>
frame	<p>A frame is a single photographic image in a movie. In traditional animation, the North American standard generally contains 24 frames per second, while in Europe the standard is 25 frames per second.</p>
frame rate	<p>This is the measurement of the frequency (rate) at which an imaging device produces unique consecutive images, called frames. The term applies equally to computer graphics, video cameras, film cameras, and motion capture systems.</p> <p>Frame rate is most often expressed in frames per second (FPS) and in progressive-scan monitors as hertz (Hz).</p> <p>The frame rate is the speed at which the frames are played. They are generally calculated by frame per second. For example, a scene could be played back at 12, 24, 25, 30 or 60 frames per second or any other number</p>
functions	<p>A function is a computer generated motion, trajectory or path that elements, other trajectories and effects parameters can be attached to. The function can be controlled by adding keyframes and control points on the function curve.</p>
gamut	<p>The range of colours that a particular device can represent.</p>
HDTV	<p>High Definition Television delivers a higher quality image than standard television does because it has a greater number of lines of resolution. To take advantage of the superior quality and make full use of your resolution setting, your output device must be compatible with HDTV technology.</p>
hold	<p>This is a frame in the animation in which the character maintains its position without moving. A hold can be created between any two keyframes.</p>
HSV	<p>Hue, Saturation, Value. A method of defining colours in terms of hue (tint), saturation (shade) and value (tone or luminance).</p>
in-between	<p>The drawings that exist between the key poses. These are drawn to create fluid transitions between poses.</p>
ink and paint	<p>The ink and paint process is the action of painting the empty zones and colouring the lines on the final animation drawings, while following a colour model.</p>
interpolation	<p>In animation, the interpolation is the computer generated motion created between two keyframes. You have the choice to create interpolation, or not, between your keyframes.</p>
jump cut	<p>A jump cut is a jerky cut between two scenes. Typically, a jump cut is not visually pleasing. It is generally caused by one scene ending, and a second one starting, with similar a image. The lack of difference causes the eye to see a little jump between the two scenes.</p>

key pose	Important positions in the action defining the starting and ending points of any smooth transition. Keys, or key poses, are the main drawings in an animation sequence describing the motion. For example, if an arm is waving, the keys will be of the arm at one extremity of the wave motion and the other extremity. By flipping those drawings, the animator can see the skeleton of the motion without having all of the drawings.
keyboard shortcuts	<p>One or more keyboard keys which, when used, cause an operation to be performed. Keyboard shortcuts are used throughout the Toon Boom software and form an integral part of the workflow. It is, in most cases, possible to customize the shortcuts in the Preferences dialog of the software.</p> <p>The shortcuts are written as follows in the Toon Boom user documentation: Each key in a sequence is shown inside square brackets as in: [Ctrl]+[A]. The brackets "[" "]" separate the key from the plus sign (+). Neither the brackets, nor the plus sign are part of the sequence. To use a shortcut, press the key and the character simultaneously.</p>
keyframe	Important positions in the action defining the starting and ending points of any action. A keyframe is a computer generated position at a specific moment (frame) on a given trajectory.
layer	In animation, a layer is an individual column, level or character. A scene's layers are superposed to form the final image.
layout	The layout process is the communication step between the storyboard and the animation. The layout and posing process is the action of putting the storyboard on model, that is drawing the character following the design in the model pack, so that the animator can start his work. The layout artist will draw the background, create the camera and field guide matching the scene and the camera motion. Lastly, he will draw on model the main action poses.
layout and posing	The action of putting on model, that is, at the right scale, the storyboard for the animator to start his work.
library	A library is a storage area containing templates and assets that can be reused in any project or scenes.
light table	The Light Table feature allows you to see the other layers in transparency while you are working on a particular one in the Drawing view.
line of action	Direction that the action will follow. Also known as the Path of Action
lip-sync	The lip-sync is the character's mouth synchronization with the dialogue sound track. Frame by frame, the mouth will be adjusted to fit the sound to give the illusion of the character is speaking.
low resolution	This format is ideal for videos destined for the web, where size and fast download of a video file might take precedence over quality. A low-resolution image is one that lacks fine detail.

manual lip-sync detection	The manual swapping of mouth position drawings to match a voice track. For this process, both sound scrubbing (listening to a sound wave broken up frame-by-frame) and drawing substitutions from the Library view are used.
master palette	A master palette is a group of colours attributed to a character or a prop. The palette is used throughout the entire production to maintain consistency in the look and to ensure that the same colours are used throughout the production. Also known as palette.
model/colour model	In animation, a model is the definitive character, prop or location design that each artist must follow for the production. A colour model is the official colour design that must be used to paint the animation.
motion keyframe	In Toon Boom, the motion keyframe is a keyframe with computer-generated interpolation.
mouth chart	Adding a lip-sync to a project can really enhance its quality and storytelling. However, it can be difficult to shape a character's mouth so that it matches the sound at the precise frame. To solve this problem, Toon Boom provides a lip-sync feature which analyses the contents of a sound element and generates a mouth chart based on the eight animation phonemes (A, B, C, D, E, F, G, and X, which is used to represent silence).
multiplane	The effect of passing through multiple levels of drawings to create a sense of depth in a shot. A multiplane is a scene in which the layers are placed at different distances from the camera so that when the camera moves, a depth illusion occurs. With a multiplane, all the perspective and scale is calculated automatically.
NTSC	The standard analogue television broadcasting system used in North America. NTSC conforms to North American standards on how rectangular pixels are displayed for computer and television screens.
nudge	A small push (left, right, up, down, forward or backward) done with the keyboard arrow keys on a selected element. Nudging is used to move a selection very slightly and precisely.
onion skin	A feature that lets you see the previous and next drawings of a sequence.
overlay	A part of the scene environment, such as a chair or a bush, that is placed in front of the main animation.
PAL	A resolution that works best with the European format for television and computer screens, as the rectangular pixels are displayed at a different orientation.
palette/master palette	A palette or master palette is a group of colours attributed to a character or a prop. The palette is used throughout the entire project to maintain a consistency in the look and avoid the colour changing during the animation. Also referred to as a master palette.

palette style	A palette style is a second version of an existing palette with a slight change in the tint and value. A palette style can be used to create the night version of a palette. It may also be called a clone palette.
pan	To move the camera across the scene in any direction.
panel	In a storyboard, a panel is a frame in a shot. A shot can be composed of one or several panels.
paperless animation/tradigital	The paperless animation process is the action of animating digitally. The main paperless animation process is to draw, frame by frame, the animation directly in the software.
passing position	When drawing a walk sequence for a character, the passing position is the point at which one leg passes the other.
path of action	Direction that the action will follow. Also known as the Line of Action.
peg	In traditional animation, a tool used to ensure accurate registration of action as cel layers move. In digital animation, in which you are doing a more advanced puppet rigging, you can use peg layers. Peg layers are trajectory layers that do not contain drawings. They are motion paths that you can use to add path articulations. For the latter, you can also use the Inverse Kinematics tool.
phoneme	Unit of sound in a language.
pivot	A pivot is the point around which a peg or a drawing rotates.
pixel	Smallest element of an image displayed on a monitor or TV screen. Pixel, short for Picture Element, is a single point in a graphic image. It is a small sample of an image, a dot, a square, or a very small section made out of smooth filtering. If you zoom in close enough on a digital image, you will see the pixels, which look like small squares of different colours and intensity.
pose-to-pose animation	The pose-to-pose animation process is the action of creating all the main action poses, called key poses, and then placing the secondary poses between the keys. The secondary poses are called breakdown. Finally, the animator fills the gaps with the in-between drawings to achieve a smooth animation.
rendering	The final step when animating by computer. During rendering, the computer takes each pixel that appears on screen and processes all of the components as well as adding motion blur before it produces a final image. In animation, the rendering process is the action of calculating the final images after the compositing process.
resolution	The resolution is the size of a scene, generally calculated in pixel. For example, the NTSC resolution is 720 x 480. Resolution type should match your final output: HDTV, film-1.33, film-1.66, NTSC, PAL, low.
RGB	Red, Green, Blue: method of defining colour by specifying amounts

	of these three colour components.
rigging	The rigging process is the action of attaching the cut-out puppet parts one to the other.
rotary table	The Rotary Table is equivalent to the animation disk/table and allows one to rotate the workspace to be more comfortable while drawing.
rotoscoping	Is an animation technique in which animators trace over live-action film movement, frame by frame, for use in animated films. The act of sketching over live-action footage to create an animated sequence.
roughs	The roughs are the skeleton sketch of an animation or a design. Roughs mainly consist of sketch lines and shapes, though they can also contain design details.
safety area	In animation and movie parlance, the safety area is the zone at the centre of the scene's frame, one safe from being cropped by the TV frame. As a TV frame cuts a margin off the original frame size, maintaining a safety area ensures that the scene's main action will remain clearly visible once the film is screened on television.
scene	A scene is a shot in a movie or show. A sequence is composed of several scenes. A scene changes to another scene by a simple cut, or a transition.
script	The script is the original text containing all the movie or show information. In animation, the script contains all of the location descriptions, dialogues, time and more. A project starts with a script.
sequence	In animation, a sequence is a series of scenes or shots forming a distinct part of the story or movie, usually connected by unity of location or time.
shot	A shot is a scene in a movie or show. A sequence is composed of several shots. A shot changes to another shot by a simple cut, or a transition.
slow-in	Gradual acceleration in the action. Another common term for slow-in is ease-in.
slow-out	Gradual deceleration in the action. Another common term for slow-out is ease-out.
slugging	In Storyboard Pro, slugging refers to indicating the start and stop times of dialogue and relevant actions.
sound scrubbing	A process that lets you hear sound in real time while you move the playhead forward or backward. This is very useful for finely-tuned lip-syncing.
stop-motion keyframe	A stop-motion keyframe is a keyframe with no computer generated interpolation.
storyboard	A visual plan of all the scenes and shots in an animation. The storyboard indicates what will happen, when it will happen and

	how the objects in a scene are laid out.
straight-ahead	A technique in which an entire sequence is drawn from the first position to the last, in order. There is very little planning in this methodology, and where the character ends up and how it gets there can be a surprise for both the audience and the animator. While this approach is a lot more spontaneous and creative, it can create inaccurate results.
strokes	Strokes are invisible vector lines forming the drawing zones. They can be adjusted with Bézier handles.
tablet/pen	Device used in conjunction with, or instead of, a mouse to move a mouse pointer (sometimes referred to as the cursor) around the computer screen.
template	In Toon Boom, a template is an asset stored in the library, one that can be reused in any project. A template can be a drawing, a series of keyframes, a sound file, a panel, a cut-out character, an effect, a trajectory, an animation, or anything else used in the software.
thumbnails	A thumbnail is a very small image used as a reference or indicator.
timecode	Timecode is timing information printed on a movie clip to indicate what scene, hour, minute and second is currently displayed on the screen.
timeline	The timeline is a horizontal representation of the scene's elements, timing and keyframes.
trace and paint	After the rough animations have gone through cleanup and a final line or pencil test, each drawing is traced and painted for the final animation. In today's digital world, this may be done in a variety ways other than via the traditional celluloid or acetate methods.
track breakdown	The soundtrack for animated film is broken down into individual sounds documenting the precise frame-by-frame position of each sound.
traditional animation	The traditional animation process is the action of drawing on paper all of the animation sequences, before either scanning them or inking them on cels.
trajectory	A computer generated path or trajectory that elements can follow. The trajectory can be controlled by control points, keyframes and velocity.
transition	A transition is an effect placed between two scenes as they pass from one to the other. Common transition effects are cross-dissolve and wipe.
underlay	In animation, an underlay is a specific part of the decor placed behind the main animation.
aspect ratio	The aspect ratio describes the shape of the grid unit. A square grid unit would have the ratio 1:1, whereas a grid unit of aspect ratio 4:3 is a unit with one side 1.33 times as big as the other side.

vector	A vector-based image is composed of points and Bézier curves. The computer reads the points and traces the segments, linking them to reproduce the image shape. There is no fixed size or resolution in a vector image. The graphic can be enlarged and distorted as much as desired and the system will simply recalculate the segments and rebuild the shapes. Vector images are translated and displayed in pixels once the calculation is done.
velocity/ease	In animation, the velocity, also known as ease, is the acceleration or deceleration of a motion. This can be achieved by a function curve, or via a series of animated drawings. Other common terms for ease-in and ease-out are slow-in and slow-out.
walk cycle	To avoid making innumerable drawings, animators routinely make a walk cycle for their character. This comprises a series of drawings "on the spot" that describe the walk for that character. The illusion of movement is created via the use of background pans.
workspace	In Toon Boom, the workspace is made up of the views, toolbars, and menus.
Xsheet (exposure sheet)	<p>The Xsheet or exposure sheet, is a sheet with several vertical columns and horizontal frames used to indicate a scene's timing.</p> <p>Each column represents a scene's layer. In each column, the drawing numbers are indicated and spread over the specific amount of frames they need to appear.</p> <p>The exposure sheet is used by animators, directors and other members of a crew to track the sequence and timing of images, dialogue, sound effects, sound tracks and camera moves. Also known as a Dope Sheet.</p>
zone	An area which can be painted with colour.

Index

about

- Cloud module 20
- Draw module 17
- Harmony 15
- Harmony Control Center 16
- Paint module 19
- Play module 19
- Scan 18
- Sketch module 18
- Stage 17
- Xsheet module 19

adding

- views 42

alpha channel

- _defined 262

animatic

- _defined 262

animation

- _defined 262

anime

- _defined 262

arc

- _defined 262

aspect ratio

- _defined 262
- defined 271

auto-feed

- _defined 262

axis

- _defined 262

background

- _defined 262

backing up

palettes 188

Bezier

_defined 262

bitmap images

_defined 263

bitmap resolution

height 104

resolution factor 104

width 104

breakdown

_defined 263

camera shake

_defined 263

caption

_defined 263

cel

_defined 263

celluloid

See cel. 263

character design

_defined 263

checking

colours 32

files, project 32

project files 32

clean up

_defined 263

clockwise

rotating 60

closing

views 42

Cloud module

about 20

CMYK

- _defined 263

colour card

- _defined 263

colour model

- _defined 268

- defined 264

colour palettes

- back up 188

- location 185

- storage location 187

- switching display modes 49

Colour view 48

- switching palette display modes 49

colour wheel

- defined 264

colours

- checking 32

commands

- basic 34

compositing

- defined 264

Control Center

- about 16

counterclockwise

- rotating 61

cross dissolve

- defined 264

customizing

- toolbars 46

cut

- defined 264

cut-out animation

- defined 264

cycle

defined 264

dialogue

defined 264

dope sheet

defined 264

doping

defined 264

DPI

defined 264

Draw module

about 17

Drawing view 54

ease

defined 264

ease-in

defined 264

ease-out

defined 264

establishing shot

defined 264

exporting

palettes 187

exposure

_defined 265

exposure sheet

_defined 272, 265

fade-in

_defined 265

fade-out

_defined 265

field

_defined 265

field chart

 _defined 265

File toolbar 59

files

 checking project files 32

film-1.33

 _defined 265

film-1.66

 _defined 265

flipping

 _defined 265

follow-through

 _defined 265

forward kinematics

 _defined 265

frame

 _defined 266

frame rate

 _defined 266

functions

 _defined 266

gamut

 _defined 266

Harmony

 interface 39

 modules 15

 starting 21, 23

Harmony Network

 centralized database 22

 interface 39

 network connections 22

 starting 21, 23

HDTV

 _defined 266

Help

- Harmony 9
- structure 10

hiding

- views temporarily 43

Hold

- _defined 266

HSV

- _defined 266

in-between

- _defined 266

ink and paint

- _defined 266

integrity

- project, checking 32

interface 39

interpolation

- _defined 266

jump cut

- _defined 266

key pose

- _defined 267

keyboard shortcuts

- _defined 267

keyframes

- _defined 267

layers

- _defined 267

layout

- _defined 267

layout and posing

- _defined 267

library

- _defined 267

light table

 _defined 267

line of action

 _defined 267

lip-sync

 _defined 267

 auto detection, defined 262

lip-sync detection

 manual, defined 268

low resolution

 _defined 267

manual lip-sync detection

 _defined 268

master palette

 _defined 268

 exporting 187

menus 40

Message Log view 56

model

 _defined 268

model sheet See character design

Model view 57

modules

 Cloud 20

 Control Center 16

 Draw 17

 Harmony 15

 Paint 19

 Play 19

 Scan 18

 Sketch 18

 Stage 17

 Xsheet 19

motion keyframe

 _defined 268

mouth

 chart 268

moving

 toolbars 45

multiplane

 _defined 268

navigating 60

 centering screen on mouse 61

 panning 60

 recentering view 60

 resetting pan 60

 resetting rotation 60

 resetting views 60

 resetting zoom 60

 rotating clockwise 60

 rotating counterclockwise 61

 zooming in 60

 zooming in or out 60

 zooming out 60

network connection 22

NTSC

 _defined 268

nudge

 _defined 268

onion skinning

 _defined 268

overlay

 _defined 268

Paint module

 about 19

PAL

 _defined 268

palettes

- _defined 268

- backup 188

- exporting 187

- location 185

- storage location 187

- style, defined 269

- switching display modes 49

panel

- _defined 269

panning 60

- _defined 269

- resetting 60

paperless animation

- _defined 269

passing position

- _defined 269

path of action

- _defined 269

pegs

- _defined 269

pen

- _defined 271

phoneme

- _defined 269

pipeline

- Toon Boom 15

pivot

- _defined 269

pixel

- _defined 269

pixelation See bitmap image

Play module

- about 19

pose-to-pose

 _defined 269

preferences 38

Preferences dialog box 38

product requirements

 Harmony 13

 Harmony Network 13

 Harmony Stand Alone 13

projects

 checking colours 32

 checking files 32

 colours, checking 32

 files, checking 32

 verifying integrity 32

recentering

 view 60

rendering

 _defined 269

resetting

 pan 60

 rotation 60

 views 60

 zoom 60

resizing

 toolbars 45

 views 42

resolution

 _defined 269

 factor, bitmap 104

 height, bitmap 104

 scene 104

 width, bitmap 104

RGB

 _defined 269

rigging

 _defined 270

rotary table

 _defined 270

rotating

 resetting rotation 60

 rotating clockwise 60

 rotating counterclockwise 61

rotoscoping

 _defined 270

roughs

 _defined 270

safe area

 _defined 270

saving

 scenes 29

Scan module

 about 18

scene resolution 104

scenes

 _defined 270

 saving 29

script

 _defined 270

scrubbing

 _defined 270

sequences

 _defined 270

shot

 _defined 270

Sketch 18

 about 18

slow-in

 _defined 270

slow_out

 _defined 270

slugging

 _defined 270

sound

 scrubbing

 _defined 270

Stage 17

 about 17

starting

 Harmony 21, 23

 ToonBoomProductName 23

stop-motion keyframe

 _defined 270

storyboard

 _defined 270

straight-ahead

 _defined 271

strokes

 _defined 271

system requirements

 Harmony 13

 Harmony Network 13

 Harmony Stand Alone 13

tablet

 _defined 271

technical specifications

 Harmony 13

 Harmony Network 13

 Harmony Stand Alone 13

templates

 _defined 271

thumbnails

 _defined 271

timecode

 _defined 271

timeline

 _defined 271

Tool Properties view 58

toolbars 59

 customizing 46

 Edit 59

 File 59

 hiding 44

 managing 44

 moving 45

 resizing 45

 showing and hiding 44

 Tools 59

 top 59

 view 59

tools

 Zoom 61

Tools toolbar 59

trace and paint

 _defined 271

track breakdown

 _defined 271

tradigital

 _defined 269

traditional animation

 _defined 271

trajectory

 _defined 271

transition

 _defined 271

underlay

 _defined 271

vector

 _defined 272

velocity

 defined 264, 272

views 42

 adding 42

 closing 42

 Colour 48

 Drawing 54

 hiding temporarily 43

 managing 42

 Message Log 56

 Model 57

 recentering 60

 resetting 60

 resizing 42

 Tooll Properties 58

walk cycle

 _defined 272

workspace

 _defined 272

Xsheet view 19

 _defined 272

zone

 _defined 272

Zoom tool 61

zooming

 in 60

 in or out 60

 out 60

 resetting zoom 60

 Zoom tool 61