



**Toon Boom Harmony 11.1
Traditional Animation Guide (Network)**

Legal Notices

Toon Boom Animation Inc.
4200 Saint-Laurent, Suite 1020
Montreal, Quebec, Canada
H2W 2R2

Tel: +1 514 278 8666
Fax: +1 514 278 2666

toonboom.com

Disclaimer

The content of this guide is covered by a specific limited warranty and exclusions and limit of liability under the applicable License Agreement as supplemented by the special terms and conditions for Adobe® Flash® File Format (SWF). For details, refer to the License Agreement and to those special terms and conditions.

The content of this guide is the property of Toon Boom Animation Inc. and is copyrighted.

Any reproduction in whole or in part is strictly prohibited.

Trademarks

Harmony™ is a trademark of Toon Boom Animation Inc.

Credits

Art Development: Marie-Eve Chartrand, Anouk Whissell

Technical Editor: Peter Cawthorne, Liven Tam

Technical Reviewer: Lindsay Brown, Steve Masson, Lilly Vogelesang

Technical Writer: Marie-Eve Chartrand, Liven Tam, Tamu Townsend, Anouk Whissell

Publication Date

2014-11-28

Copyright © 2014 Toon Boom Animation Inc. All rights reserved.

Contents

| | |
|---------------------------------------------------------------------------|-----------|
| Toon Boom Harmony 11.1 Traditional Animation Guide (Network) | 1 |
| Legal Notices | 2 |
| Contents | 3 |
| Chapter 1: Traditional Animation - An Introduction | 9 |
| Chapter 2: Scanning | 11 |
| The Scanning Process | 12 |
| Scanning and Importing Drawings | 13 |
| Custom Vectorization Parameters | 21 |
| Options Tab | 22 |
| Help Tab | 24 |
| File IO Options | 24 |
| Registration Options | 24 |
| Filtering Options | 25 |
| Options for bitmap that has no registration information | 27 |
| RGB Keying Options | 27 |
| Colour Vectorization Options | 27 |
| Bubble Usage (implemented only for colour vectorization's line art) | 28 |
| 4 Colour Vectorization | 28 |
| Creating a Vectorization Style | 29 |
| Setting the VectOptions.conf File | 30 |
| Setting the VectOptions.conf File on Windows and Mac OS X | 31 |
| Setting the VectOptions.conf File on Linux | 33 |
| Chapter 3: Timing | 37 |
| Preparation | 39 |
| Frames | 41 |
| Creating Drawing Elements | 44 |
| Layer and Column Concepts | 44 |
| Layer and Column Types | 45 |
| Advanced Column Types | 48 |
| Adding New Drawing Elements | 48 |
| Deleting Layers and Columns | 52 |
| Layer and Column Properties | 54 |
| Modifying Layers and Columns | 55 |

| | |
|---------------------------------------------------|----|
| Duplicating Layers and Columns | 58 |
| Cloning Layers and Columns | 58 |
| Adding an Annotation Column | 59 |
| Drawing and Typing in the Annotation Column | 60 |
| Changing the Drawing Settings | 62 |
| Displaying Tick Marks | 63 |
| Importing an Annotation File | 64 |
| Linking External Files with Timing Columns | 65 |
| Filling Exposure | 67 |
| Filling Exposure Mode | 67 |
| Typing Exposure | 68 |
| Holding Exposure | 70 |
| Extending a Single Exposure | 71 |
| Extending an Exposure Sequence | 72 |
| Dragging Cells | 72 |
| Increasing and Decreasing Exposure | 75 |
| Deleting Exposure | 77 |
| Inserting Blank Cells | 78 |
| Setting the Exposure | 79 |
| Filling a Selection with a Single Exposure | 80 |
| Filling a Selection with a Sequence | 81 |
| Filling a Selection Randomly | 83 |
| Filling Empty Cells | 84 |
| Creating Cycles | 85 |
| Managing Drawings | 89 |
| Renaming a Drawing | 89 |
| Deleting a Drawing | 90 |
| Duplicating a Drawing | 91 |
| Copying and Pasting Drawings | 91 |
| Merging Drawings | 94 |
| Modifying the Layer and Column Display | 96 |
| Expanding and Collapsing Layers and Columns | 96 |
| Showing and Hiding Layers | 97 |
| Showing and Hiding Columns | 99 |

| | |
|----------------------------------------------------------|------------|
| Modifying the Look of the Column | 101 |
| Drawing Identification | 103 |
| Xsheet Thumbnails | 106 |
| Changing the Colour of a Layer or Column | 106 |
| Setting Scene Markers | 108 |
| Setting Tempo Markers | 111 |
| Printing the Xsheet | 112 |
| Chapter 4: Colour Styling and Colour Models | 115 |
| Preparation | 116 |
| Colour Model Storage | 116 |
| Scene Creation | 116 |
| Colour Model Scene Structure | 117 |
| Setting Up the Workspace | 117 |
| Naming | 118 |
| Working with Palettes | 121 |
| Palette Lists | 122 |
| Palette File Storage | 125 |
| Element Level | 126 |
| Scene Level | 126 |
| Where to Save the Palette File | 127 |
| What happens when you export a palette file? | 127 |
| Palette Backup | 128 |
| Creating a Colour Palette | 128 |
| Duplicating a Colour Palette | 132 |
| Cloning a Colour Palette | 134 |
| Palette Operations | 136 |
| Importing and Linking Palettes | 140 |
| Colours | 146 |
| Adding a Colour Swatch | 147 |
| Colour Display Modes | 153 |
| Copying and Pasting Colours | 154 |
| Mixing Colours | 155 |
| Painting the Model | 158 |
| Chapter 5: Ink and Paint | 161 |

| | |
|---------------------------------------------------------------|------------|
| Preparation | 163 |
| Dirt Clean Up | 167 |
| Art Layers | 170 |
| Creating Strokes | 176 |
| Painting | 178 |
| Painting Using the Paint Tool | 179 |
| Advanced Painting Features | 180 |
| Selecting a Colour in a Drawing | 184 |
| Importing Models | 185 |
| Editing Gradients and Textures | 189 |
| Closing Gaps | 194 |
| Protecting Colours | 196 |
| Respecting Protected Colours | 196 |
| Highlighting the Selected Colour | 196 |
| Inverting a Colour Selection | 197 |
| Inking the Lines | 198 |
| Verifying the Zones are Painted | 203 |
| Ink and Paint Tool Properties | 206 |
| Ink Tool Properties | 206 |
| Paint Tool Properties | 207 |
| Lasso and Marquee | 208 |
| Painting Modes | 208 |
| Paint Mode | 209 |
| Paint Unpainted Mode | 209 |
| Repaint Mode | 209 |
| Unpaint Mode | 210 |
| Paint and Remove Texture | 210 |
| Apply to Multiple Drawings | 210 |
| Apply to All Visible Drawings | 211 |
| Respect Protected Colour | 211 |
| Use Stored Colour Gradient | 212 |
| Select Newly Painted/Repainted/Unpainted Contours/Lines | 212 |
| Automatic Close Gap | 212 |
| Glossary | 214 |

Index225

Chapter 1: Traditional Animation - An Introduction

Harmony is a high-performance animation software which not only offers a wide range of features, but also handles more than one animation type and workflow. In this guide, you will learn how to perform tasks related to the traditional animation workflow from start to finish using Harmony.

Before reading this guide, be sure to take some time to familiarize yourself with the basic concepts in the Fundamentals Guide. Each chapter is self-contained, so you can concentrate only on the chapter pertaining to your task. You do not need to read the entire guide, but you should read the whole chapter before starting to work.

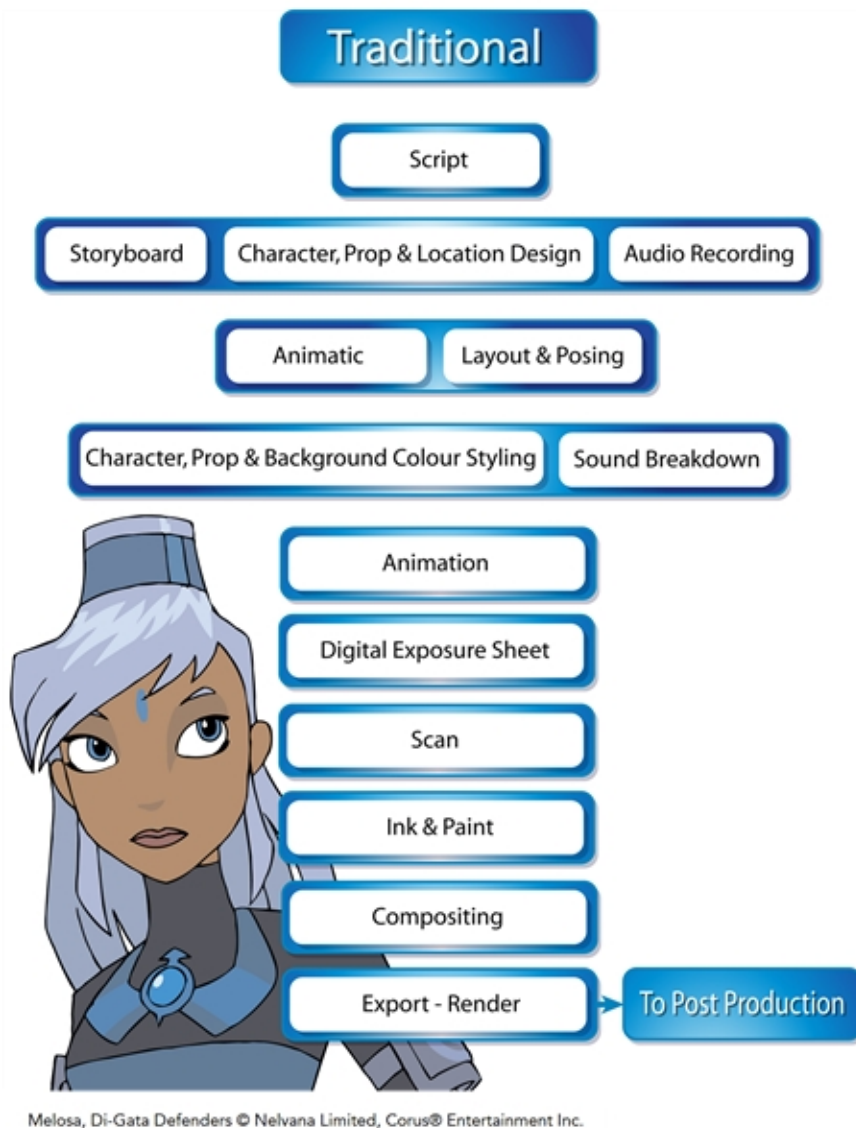

Topics in this section:

- Scanning on page 11
- Timing on page 37
- Colour Styling and Colour Models on page 115
- Ink and Paint on page 161

Chapter 2: Scanning



Once your traditional animation sequences are completed and cleaned up, you are ready to scan and import them in Harmony. The scan process is the point where the traditional production becomes digital. It is the moment where you use Harmony to control the project.

This chapter is divided as follows:

- [The Scanning Process on the next page](#)
- [Scanning and Importing Drawings on page 13](#)
- [Custom Vectorization Parameters on page 21](#)

The Scanning Process

There are three steps in the scanning process which Harmony handles automatically:

- Vectorization
- Line art and colour art creation
- Optical registration

You can choose the following vectorization styles, which are set at the vectorization step:

- Solid lines
- Texture lines

This keeps your texture from the original drawing and applies it to your vectorized drawing as a bitmap filling zone.



Harmony receives images from any TWAIN device, such as scanners or digital cameras. These images can either be loaded as bitmaps into your scene or converted into vector-based images that can be edited using Harmony.

You must install a TWAIN driver for your device in order to access its contents. Refer to the manufacturer of your device to get a TWAIN driver. Once all the animation layers are scanned in, you can set the timing in the digital exposure sheet.

Scanning and Importing Drawings

Once your scene length is set, you can start scanning drawings and importing them into Harmony in one of the following ways:

A bitmap image is an image composed of pixels that are both size and resolution dependent. In Harmony, you can scan an image as a bitmap drawing.

You can turn bitmap images into vector drawings, while maintaining the sketchiness of a pencil line or into vector images with a bitmap fill. Both options can add life to an animation, which straight vectorization with smoothing does not usually afford.

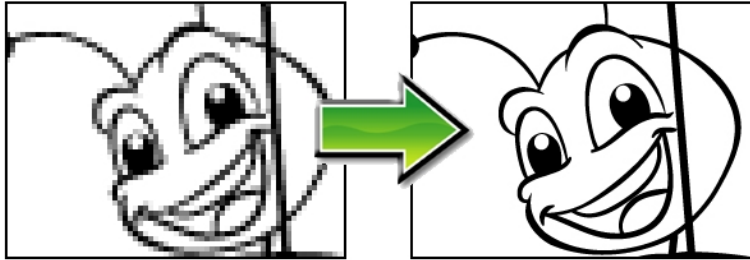

How to scan images as bitmap drawings

1. From the top menu, select **File > Import > From Scanner**.

The Scan Drawings window opens.

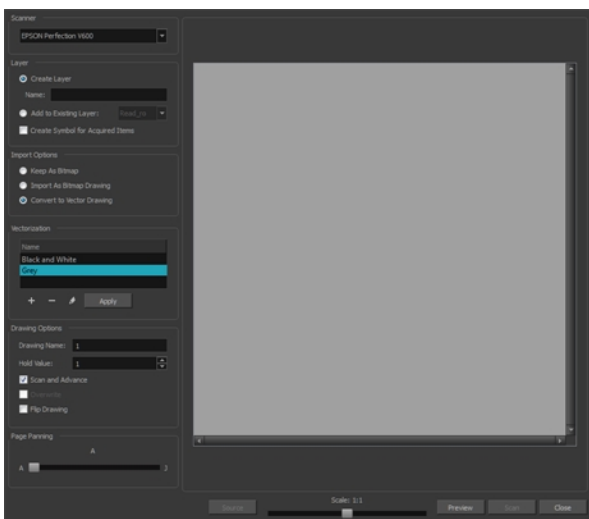

2. Select your scanner from the Scanner list.

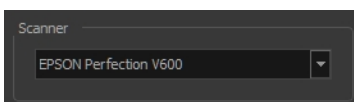

3. In the Layer section, decide if the scanned or imported image will be placed on a new layer or existing layer.
 - ▶ **Create Layer:** Scans or imports the image into a new layer. Select one of the following options:

| Parameter | Description |
|------------------------------------|-----------------------------------------------------------------------------------------------------------------------------------------------------------------------------------------------------------------------------------------------------------------------------------------------------------------|
| Create Single Layer Named | Creates a layer you can name. |
| Create Layer(s) Based on Filenames | Creates a layer based on each unique filename prefix. For example, the filenames a-1.tga, a-2.tga and b-1.tga will create layers named "a" and "b", where "a" has two drawings and "b" has one. When creating a single layer from these three filenames, all three drawings will be inserted in the new layers. |

- ▶ **Add to Existing Layer:** Scans or imports the image into an existing layer. Select a layer from the Layer list. You must scan into the same layer type if you are using an existing layer.
- ▶ **Create Symbol for Acquired Items:** Encapsulates the bitmap image in a symbol. To mix bitmap images with vector drawings on the same layer, the bitmap image must be encapsulated in a symbol and vice versa. Symbols will also be automatically added to the Symbol folder in the Library view.

4. In the Import Options section, select one of the following:

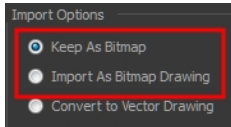

- ▶ **Keep As Bitmap:** Retains the imported image as a bitmap. In the Alignment section, decide on the size and placement of your image within the camera frame. Depending on the Scene Settings (the height and width in pixels that you chose for your project), an image that you import may get scaled to the point where all its individual pixels become visible. There are three options available in the Alignment section:

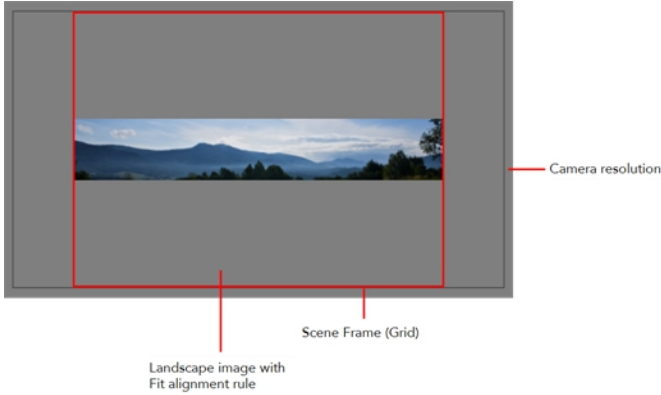
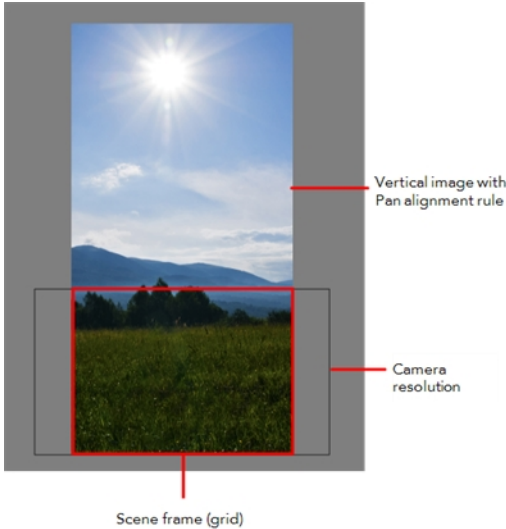

| Parameter | Description |
|-----------|----------------------------------------------------------------------------------------------------------------------------------------------------------------------------------------------------------------------------------------------------------|
| Fit | <p>Enlarges or shrinks (but not distorts) the image height to match the full height of the scene grid.</p> <p>If the image orientation is landscape, this will enlarge or shrink (but not distort) your image width to match that of the scene grid.</p> |

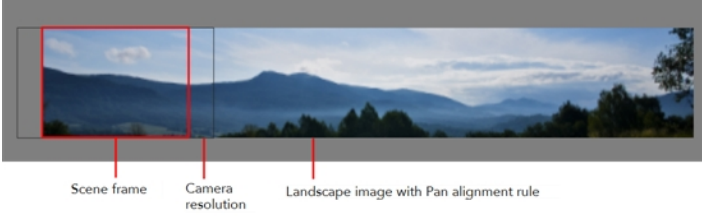
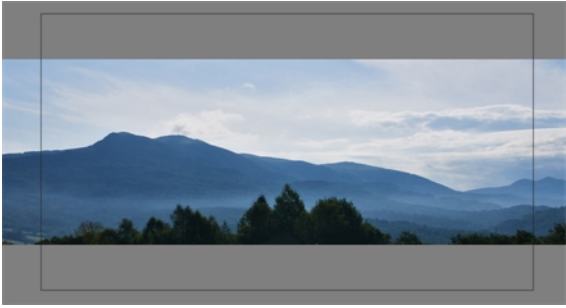
| | |
|------------|--------------------------------------------------------------------------------------------------------------------------------------------------------------------------------------------------------------------------------------------------------------------------------------------------------------------------------------------------------------------------------------------------------------------------------------------------------------------------------------------------------------------------------------------------------------------------------------------------------------------------------------------------------------------------------------------------------|
| |  <p>Note that the Fit alignment rule equals the Center Fit rule in the layer properties.</p> |
| <p>Pan</p> | <p>This is the opposite of the Fit parameter. If the image orientation is portrait, its width will be made to match the width of the scene grid. As a result, part of the image's height will extend beyond the height of the frame. This can be useful if you want to make your background move up and down, or from left to right to make it appear as if the camera is panning, or to actually perform a camera pan.</p>  <p>The opposite will apply to a landscape image. Its height will be fit to the scene grid, therefore it is possible that the image will extend beyond the scene grid's boundaries.</p> |

| | |
|---------------------------|-------------------------------------------------------------------------------------------------------------------------------------------------------------------------------------------------------------------------------------------------------------------------------------------------------------------------------------------------------------------------------------------------------------------------------------------------------------------------------------------------------------------------------------------------------------------------------------------------------------------------------------------------------------|
| |  <p>Note that the Pan alignment rule equals the Center First Page rule in the layer properties.</p> |
| <p>Project Resolution</p> | <p>Scales the image in proportion to the scene's resolution. The system looks at the resolution of the bitmap image, for example 4000 x 2000, then compares it to the scene's resolution, for example 1920 x 1080, and adjusts the scale factor in proportion. So, in this example, the bitmap would appear at 208% (4000/1920). If you import a bitmap that is 960 x 540, it will be displayed at 50% (960/1920) of the size of the project resolution.</p>  <p>Note that the Project Resolution alignment rule is equal to the As Is rule in the layer properties.</p> |

- ▶ **Import As Bitmap Drawing:** Imports a bitmap drawing into a vector layer where you can edit the image using the drawing tools. In the Alignment section, select one of the following:

| Parameter | Description |
|--------------|--------------------------------------------------------------------------------------------------------------------------|
| Vertical Fit | Enlarges or shrinks (but not distort) to your image height to match the full height of the scene frame (alignment grid). |

| | |
|----------------|--------------------------------------------------------------------------------------------------------------------------------------------------------------------------------------------------------------------------------------------------------------------------------------------------------------------------------------------------------------------------------------------------------------------------------------------------------------|
| |  |
| Horizontal Fit | <p>Enlarges or shrinks (but not distort) to your image height to match the full width of the scene frame (alignment grid).</p>  |
| Actual Size | <p>Scales the image in proportion to the scene's resolution. The system looks at the resolution of the bitmap image, for example 4000 x 2000, then compares it to the scene's resolution, for example 1920 x 1080, and adjusts the scale factor in proportion. So, in this example, the bitmap would appear at 208% (4000/1920). If you import a bitmap that is 960 x 540, it will be displayed at 50% (960/1920) of the size of the project resolution.</p> |

5. In the Drawing Options section, set the following options if desired:

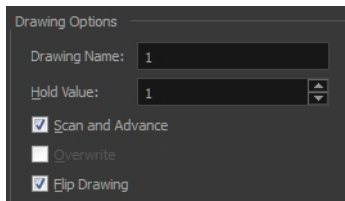

- ▶ **Drawing Name:** Name of the drawing to import.
- ▶ **Hold Value:** Type the number of frames that the drawing will be exposed.

- **Scan and Advance:** Lets you scan one drawing after another every time you click **Scan**.
 - **Flip Drawing:** Mirrors the drawings horizontally and scans it this way.
6. Adjust the **Scale** control and sliders in the Preview Image window until you are satisfied with the view.

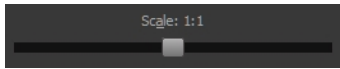

7. Click **Scan** to scan your drawing.
8. If you are scanning panoramic drawings, in the Page Panning section, move the slider to the next letter to capture your next frame.

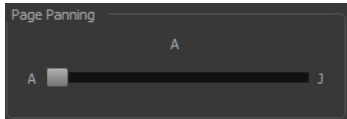

9. If you have more than one drawing, set the next drawing in place and click **Scan** again. Repeat until you have finished scanning all your drawings.

How to import and vectorize bitmap drawings

1. From the top menu, select **File > Import > From Scanner**.
The Scan Drawings window opens.

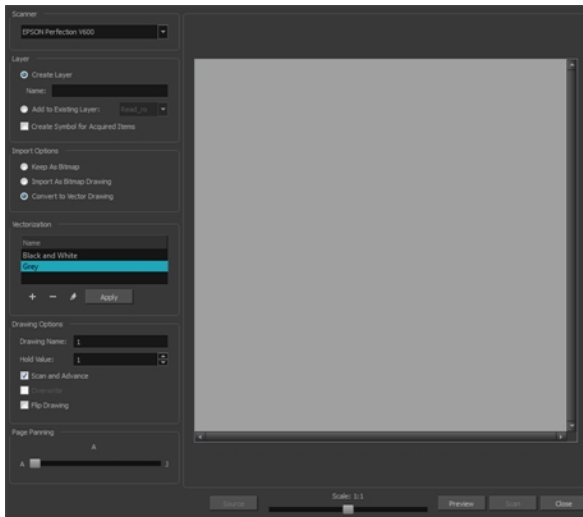

2. Select your scanner from the Scanner list.

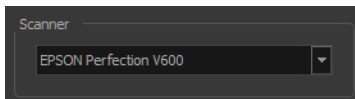

3. Click **Preview** to get a test scan of your drawing.
4. In the Layer section, select one of the following:
 - **Create Layer:** Imports an image into a new layer. Type a name for the layer in the **Name** field.

- ▶ **Add to Existing Layer:** Imports the image into an existing layer. Select a layer from the Layer list.
5. In the Import Options section, select the **Convert to Vector Drawing** option.
 6. In the Vectorization section, select one of the following:

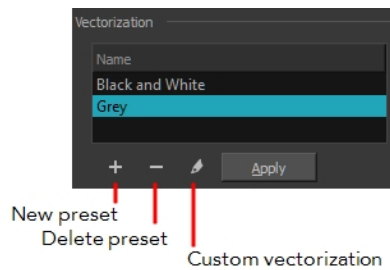

- ▶ **Black and White:** Vectorizes drawings as a solid black line; creates a 100% vector-based drawing.
 - ▶ **Grey:** Vectorizes the image as a mix of vector contour and greyscale bitmap filling. Lines keep the texture from the scan, and the white of the paper becomes transparent.
 - ▶ **New Preset:** Lets you create a new preset.
 - ▶ **Delete Preset:** Lets you delete any preset in the list.
 - ▶ **Custom vectorization:** Lets you set custom vectorization parameters—see [Creating a Vectorization Style](#) on page 29.
7. In the Drawing Options section, set the following options if desired:

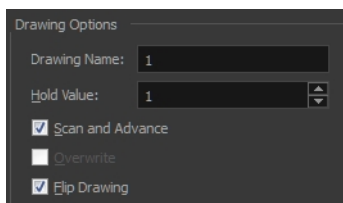

- ▶ **Drawing Name:** Name of the drawing to import.
 - ▶ **Hold Value:** Type the number of frames that the drawing will be exposed.
 - ▶ **Scan and Advance:** Lets you scan one drawing after another every time you click **Scan**.
 - ▶ **Flip Drawing:** Mirrors the drawings horizontally and scans it this way.
8. Adjust the **Scale** control and the sliders in the Preview Image window until you are satisfied with the view.

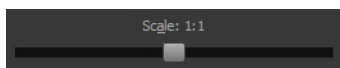

9. Click **Scan** to import your drawing.
10. If you are scanning panoramic drawings, in the Page Panning section, move the slider to the next letter to capture your next frame.

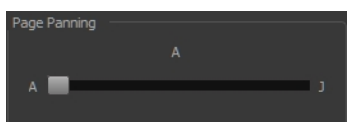

11. If you have more than one drawing, set the next drawing in place and click **Scan** again. Repeat until you have finished scanning all your drawings.

Custom Vectorization Parameters

You can create your own vectorization settings with Harmony.

The vectorization parameters you will create here can be saved, shared and also inserted into the **VectOptions.conf** file used by the Harmony Scan and Control Center modules when scanning or vectorizing a series of drawings.

You can use an interface to select and test the different options and you can also type in some advanced settings.

How to open the Vectorization Parameters dialog box

1. From the top menu, select **File > Import > From Scanner**.
You can also open it from any other import option that allows you to customize the vectorization parameters (i.e. from the scanner).
2. Select your file, decide on the layer options, and click **Preview**.
3. In the Vectorization section, click the New Preset **+** button.

The Vectorization Parameters dialog box opens.

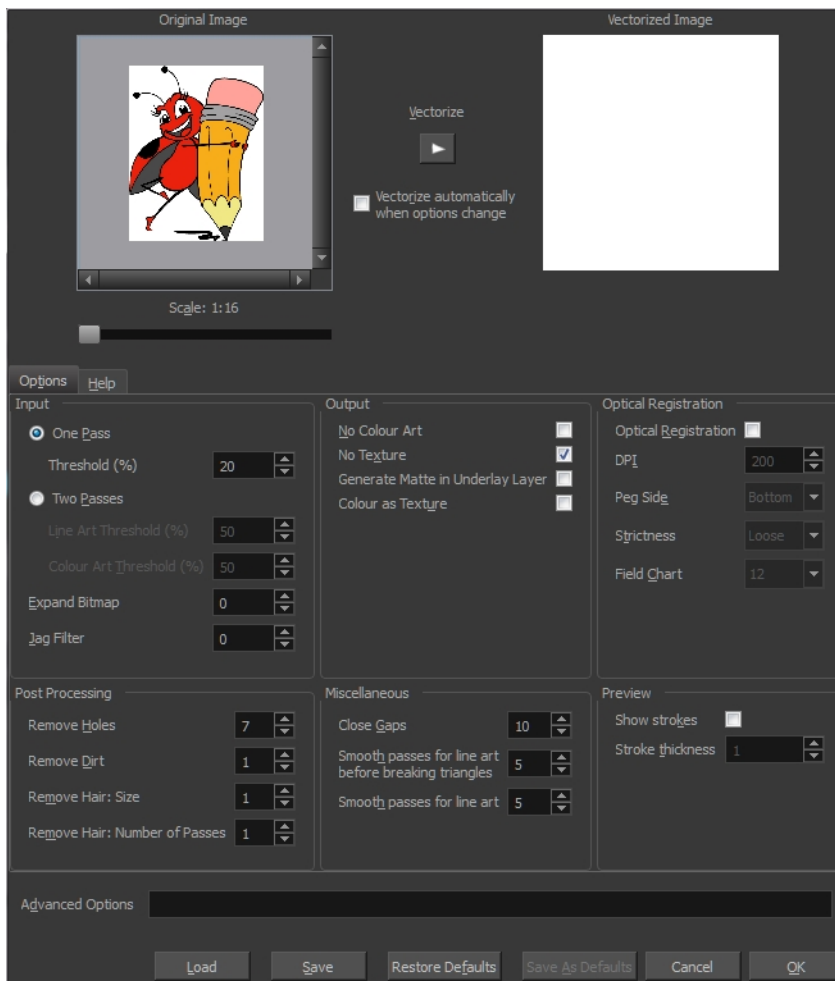

- Options Tab below
- Help Tab on page 24

Options Tab

The Options tab contains the main vectorization settings. More settings are available in the Help tab.

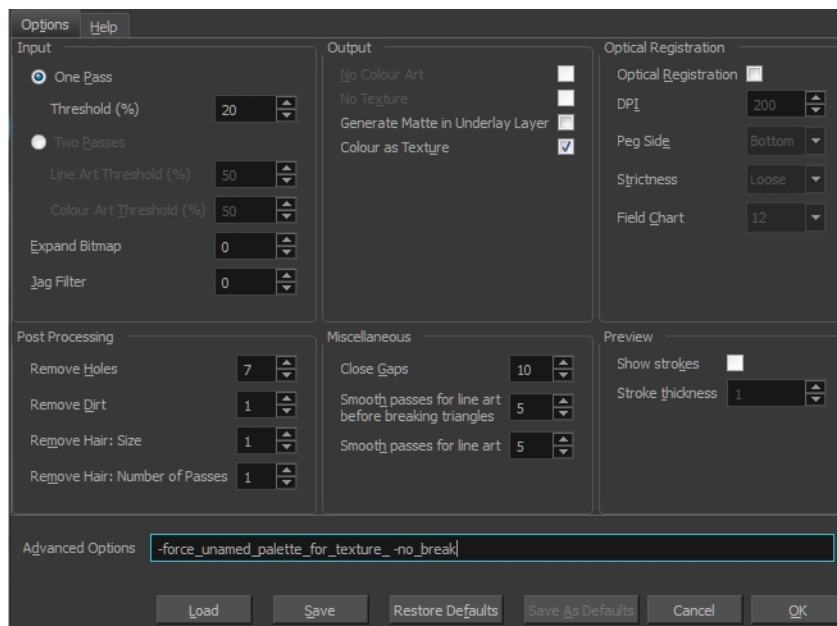

| Parameter | Description |
|-----------|-------------------------------------------------------------------------------------------------------------------------------------------------------------------------------------------------------------------------------------------------------|
| Input | The input filters are applied to the bitmap image before it is vectorized. |
| | One Pass: One threshold value is applied to both the Line and Colour Art. For drawings with distinct vector-style lines of mattes, you only need one pass. |
| | Two Passes: Applies a different threshold value to each layer. |
| | For greyscale drawings, you may want to perform the vectorization process twice to apply different threshold values to the Line and Colour Art layers. |
| | Threshold: Determines which values in the scanned image are considered part of the Line or Colour Art layer and what will be eliminated from the vectorized drawing; 0% is white and 100% is black. The threshold is between these two values. |
| | Expand Bitmap: Lets you enter a value to scale the bitmap to detect small variations in the line. Use this option if you scanned a greyscale image and want to preserve small variations in the texture to apply to the line art. |
| | Jag Filter: Lets you enter a value to scale back the bitmap to remove some of the line's roughness. This is useless when you have a drawing that appears quite rough; the Jag filter will |

| | |
|----------------------|------------------------------------------------------------------------------------------------------------------------------------------------------------------------------------------------------------------------------------------------------------------------------------------------------------------------------------------------------------------------------------------------------------------|
| | eliminate excess strokes in the final drawing. |
| Output | The output filters are applied during the vectorization process. |
| | No Colour Art: Does not generate filling zones in the Colour Art layer. |
| | No Texture: Does not generate texture in the Line Art in the final images. Select this option to create solid lines in the final line art. |
| | Generate Matte in Underlay Layer: Creates an opaque zone behind your drawing's lines to avoid seeing through the layers. |
| | Colour as Texture: Converts colour values into a texture layer. |
| Optical Registration | The optical registration options are used to automatically align drawings based on the position of the peg holes on the animation paper. The peg holes must appear in the scanned drawings for the optical registration to work. |
| | DPI: Lets you enter the dots-per-inch value of your image. You must enter the same value as the DPI used to scan the image. |
| | Peg Side: Lets you select the position of the peg holes on your drawings. Identify whether they are on the top, bottom, left or right. |
| | Strictness: Determines how exact the location of the peg holes must be for the software to recognize them. You have two values to choose from: <ul style="list-style-type: none"> • Strict: The peg holes must be in a tightly defined area to be recognized. • Loose: The peg holes can be recognized somewhere in a larger area. This is the recommended setting. |
| | Field Chart: Lets you indicate the size of the animation paper; 12 or 16. |
| Post Processing | The Post Processing filters are applied to the final vector images. |
| | Remove Holes: Removes holes of a specified value that might make painting difficult. |
| | Remove Dirt: Removes stray marks and dirt of a specified value. Try a value around 500. |
| | Remove Hair: Removes small strokes that have no line art. |
| | Remove Hair: Number of Passes: The number of times the drawing will be analyzed to identify hair marks. |
| Miscellaneous | Close Gaps: Closes gaps in the Colour Art so that you can paint it. |
| | Smooth Passes for Line Art before Breaking Triangles: The number of times the smoothing operation runs before creating |

| | |
|---------|-----------------------------------------------------------------------------------------------------------------------------------------------------------------------|
| | the triangles that break lines in your drawing. If unnecessary triangles are appearing in your drawing, increase this value. |
| | Smooth Passes for Line Art: The number of times the smoothing operation is performed after the triangles have been created. This further smooths the Line Art. |
| Preview | Show Strokes: Shows the strokes in the Vectorized Image panel. |
| | Stroke Thickness: Shows the size of the strokes. |

Help Tab

The Help tab contains the most advanced vectorization settings which you type in the Advanced Option fields at the bottom of the Options tab.

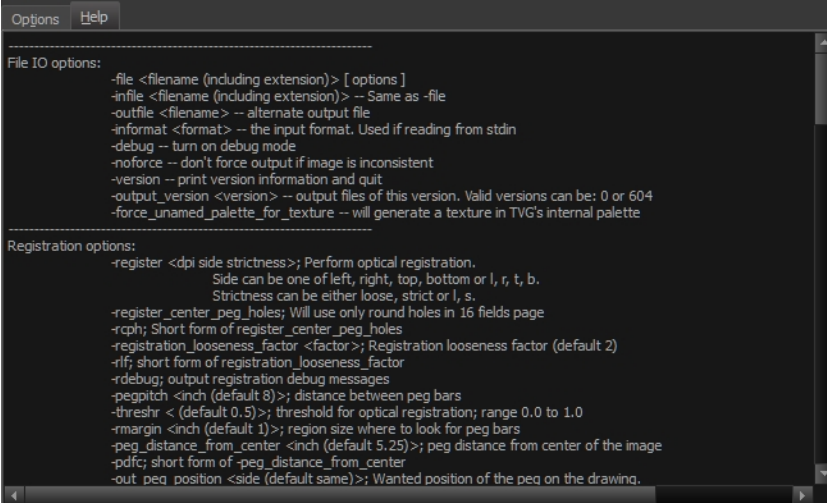

```
Options Help
-----
File IO options:
-file <filename (including extension)> [ options ]
-infile <filename (including extension)> -- Same as -file
-outfile <filename> -- alternate output file
-informat <format> -- the input format. Used if reading from stdin
-debug -- turn on debug mode
-noforce -- don't force output if image is inconsistent
-version -- print version information and quit
-output_version <version> -- output files of this version. Valid versions can be: 0 or 604
-force_unnamed_palette_for_texture -- will generate a texture in TVG's internal palette
-----
Registration options:
-register <dpi side strictness>; Perform optical registration.
    Side can be one of left, right, top, bottom or l, r, t, b.
    Strictness can be either loose, strict or l, s.
-register_center_peg_holes; Will use only round holes in 16 fields page
-rph; Short form of register_center_peg_holes
-registration_looseness_factor <factor>; Registration looseness factor (default 2)
-rif; short form of registration_looseness_factor
-rdebug; output registration debug messages
-pegpitch <inch (default 8)>; distance between peg bars
-threshr <(default 0.5)>; threshold for optical registration; range 0.0 to 1.0
-rmargin <inch (default 1)>; region size where to look for peg bars
-peg_distance_from_center <inch (default 5.25)>; peg distance from center of the image
-pdfc; short form of -peg_distance_from_center
-out_peg_position <side (default same)>; Wanted position of the peg on the drawing.
```

File IO Options

- file <filename (including extension)> [options]
- infile <filename (including extension)>; same as -file
- outfile <filename>; alternate output file
- informat <format>; the input format. Used if reading from stdin
- debug; turn on debug mode
- noforce; don't force output if image is inconsistent
- version; print version information and quit
- output_version <version>; output files of this version. Valid versions can be: 0 or 604
- force_unnamed_palette_for_texture; will generate a texture in TVG's internal palette

Registration Options

- register <dpi side strictness>; perform optical registration.

- Side can be one of left, right, top, bottom or l, r, t, b.
 - Strictness can be either loose, strict or l, s.
- register_center_peg_holes**; will use only round holes in 16 fields page
- rcph**; short form of register_center_peg_holes
- registration_looseness_factor** <factor>; registration looseness factor (default 2.000000)
- rlf**; short form of registration_looseness_factor
- rdebug**; output registration debug messages
- pegpitch** <inch (default 8.000000)>; distance between peg bars
- threshr** <(default 0.500000)>; threshold for optical registration; range 0.0 to 1.0
- rmargin** <inch (default 1)>; region size where to look for peg bars
- peg_distance_from_center** <inch (default 5.25)>; peg distance from centre of the image
- pdfc**; short form of -peg_distance_from_center
- out_peg_position** <side (default same)>; wanted position of the peg on the drawing.
- Can be one of right, left, top, bottom (or r, l, t, b) or same.
 - A rotation will be performed if it is different from the side passed to -register.
- output_peg_matrix**; output the peg transformation matrix on standard output.
- scanner_calibrate**; <(default 1.0000 1.0000) > x and y scale factors to be applied to scanner image.

Filtering Options

- pixel** <pixel_shape (default '4x3')>; Valid values: 4x3
- gap** <worldUnits (default 10)>; close gaps up to this big
- pencil**; generate line art only
- keep_dirt**; don't filter out dirt
- thresh** <threshold (default 0.2)>; range 0.0 to 1.0
- rmv_hairs** <worldUnits (default 1)> <passes (default 1)>
- remove hairs of size smaller than "size" in "passes" passes
- rmv_holes** <area (default 7)>; remove holes smaller than "area"
- rmv_dirt** <area (default 1)>; remove dirt smaller than "area"
- try values between 100 and 500 for rmv_holes and rmv_dirt. The area is in world units squared
- rmv_triangles** <worldUnits (default 30.000000)>; remove triangles at "pixels"
- distance from each other. Use -no_break to remove all triangles
- no_texture**; don't generate textured strokes
- color_as_texture**; will vectorize the alpha channel and put the RGB colour in a textured colour
- noclosegap**; disable all gap closing algorithms
- no_break**; disable the breaking of line art
- jag_filter** <pixels (default 0)>; expand the pixels in the vectorization bitmap

-expand_bitmap <pixels (default 0)>; expand the pixels in the vectorization bitmap

-fit_errorc <error (default 1.000000)>; fitting error for the colour art

-fit_errorl <error (default 1.000000)>; fitting error for the line art

-smoothl <passes (default 1)>; number of smooth passes for line art

-smoothc <passes (default 1)>; number of smooth passes for colour art

-first_smooth <passes (default 0)>; number of smooth passes for line art before breaking triangles

-first_smoothl <passes (default 0)>; number of smooth passes for line art before breaking triangles

-first_smoothc <passes (default 0)>; number of smooth passes for line art in colour art pass (needs -2pass)

-2pass; specify two sets of parameters; one for line art "l", one for colour art "c"
(-thresh, -rmv_holes and -rmv_dirt will be overridden by -threshl, threshc, -rmv_holesl, -rmv_holesc, -rmv_dirtl and -rmv_dirtc)

-threshl <threshold for line art (default 0.5)>; range 0.0 to 1.0

-threshc <threshold for color art (default 0.5)>; range 0.0 to 1.0

-jag_filterl <pixels (default 0)>; expand the pixels in the vectorization bitmap for line art

-jag_filterc <pixels (default 0)>; expand the pixels in the vectorization bitmap for colour art

-expand_bitmapl <pixels (default 0)>; expand the pixels in the vectorization bitmap for line art

-expand_bitmapc <pixels (default 0)>; expand the pixels in the vectorization bitmap for colour art

-rmv_holesl <area (default 7)>; remove line art holes smaller than "area"

-rmv_holesc <area (default 7)>; remove colour art holes smaller than "area"

-rmv_dirtl <area (default 1)>; remove line art dirt smaller than "area"

-rmv_dirtc <area (default 1)>; remove colour art dirt smaller than "area"
try values between 100 and 500 for rmv_holesl, rmv_holesc, rmv_dirtl and rmv_dirtc. The values are in world units squared

-margins <inch (default 0.25)>; remove margin around bitmap

-top_margin <inch (default 0.25)>; remove margin at top of bitmap

-bottom_margin <inch (default 0.25)>; remove margin at bottom of bitmap

-left_margin <inch (default 0.25)>; remove margin at left of bitmap

-right_margin <inch (default 0.25)>; remove margin at right of bitmap

-remove_peg_bars; remove the peg bar holes

-field_size <fields (default 12 or use value in scan file)>; set the drawing to this field size

-fs; short hand for -field_size

-peg_bar_size <inch (default 1)>; the size of the peg bar region

-noframe; do not put a frame around the colour art

-frame_fields <default -1.000000>; put a frame of the specified dimension around the colour art

- downscale_input** <default 1>; downscale the raw input by this integer factor
 - downscale_texture** <default 1>; downscale the output texture by this integer factor
 - buildmatte**; generate a matte on underlay for line test
 - buildmatte_colourart**; generate a matte on colour art for line test
- Note: -buildmatte and -buildmatte_colourart are mutually exclusive
- copystrokes**; copy original strokes when building matte.

Options for bitmap that has no registration information

- pixel_margins** <inch (default 0)>; remove margin around bitmap
- top_pixel_margin** <inch (default 0)>; remove margin at top of bitmap
- bottom_pixel_margin** <inch (default 0)>; remove margin at bottom of bitmap
- left_pixel_margin** <inch (default 0)>; remove margin at left of bitmap
- right_pixel_margin** <inch (default 0)>; remove margin at right of bitmap
- dpi** <(default -1)>; dpi information of input bitmap

RGB Keying Options

- rgb**; generate separate zones for red, green and blue lines
- rgb_alpha** <value (default 255)>; generate red, green and blue colour with alpha of this value
- no_red**; ignore red colour in vectorization
- no_green**; ignore green colour in vectorization
- no_blue**; ignore blue colour in vectorization
- flatten**; flatten the drawing after generating colours
- rmv_rgb_dirt** <threshold area default 0.0>; remove red, green and blue regions smaller than area
- expand_bitmap_rgb** <pixels (default 0)>; expand the pixels in the vectorization bitmap for rgb
- threshrgb** <value> <threshold for rgb vectorization default 0.200000>;
- threshsv** <saturation threshold default 0.500000> <value threshold default 0.500000>; thresholds on saturation and value to consider a pixel to be grey

Colour Vectorization Options

- color_vectorize**; perform a colour vectorization
- file2** <colour art filename>; specify the colour art bitmap
- penstyle** <center alpha (0.0-20.0)> <edge alpha (0.0-20.0)> <gamma (0-10)><centre pressure effect (0.0-1.0)> <edge pressure effect (0.0-1.0)><texture bitmap downscaling (0.2-20)> <texture bitmap file (valid filename or "" if no file)>; generate brush texture for the line art
- pressure_variation** <strategy (0, 1 or 2)> <min pressure (0.0-1.0)> <max pressure (0.0-1.0)> <max variation (0.0-1.0)>; specify a pressure strategy for the centre line.
- blur_radius** <pixels (default 0)>; blur the penstyle texture generated

-color_contour_smooth_passes <times (default 3)>; perform number of smooth passes on contour before computing texture

-ccsp <times (default 3)>; short for -color_contour_smooth_passes

-color_rmv_holesl <world units (default 0.000000)>; remove holes of this size when computing texture

-color_fill_holesl <world units (default 0.000000)>; fill holes of this size for colour line art

Bubble Usage (implemented only for colour vectorization's line art)

-create_bubbles; add bubbles into the LineArt. Implemented for colour vectorization only

-bubble_gap <value (default 3)>; max number of colour art points between 2 bubbles

-bubble_length <value (default 10)>; max number of circles in a bubble

-min_radius <value (default 1.5000)>; min radius of a circle in a bubble relative to the line thickness (must be ≥ 1.0)

-max_radius <value (default 3.5000)>; max radius of a circle in a bubble relative to the line thickness (must be ≥ 1.0)

-uniform_gap; the space between bubbles is constant

4 Colour Vectorization

-4colours [key:value] ... [key:value] ; The key value list can be empty. The list of keys is:

rgbdiff:value ; between [0.0-1.0] or [0-255]

dark:value ; between [0.0-1.0] or [0-255]

grey:value ; between [0.0-1.0] or [0-255]

white:value ; between [0.0-1.0] or [0-255]

dirt:value ; dirt area. 200 is a good value

rt:value ; between [0.0-1.0] or [0-255]

gt:value ; between [0.0-1.0] or [0-255]

bt:value ; between [0.0-1.0] or [0-255]

There must be no space between the colon and the key/value. For example: -4colours rgbdiff:20 dark:20 grey:120 white:250 dirt:200 rt:240 gt:240 bt:240

The Vectorization Parameters dialog box lets you vectorize pencil drawings, along with any red, blue or green pencil marks you may have used to indicate highlights and shadows. The drawing will be vectorized into pure red, blue, green and black (RGB values), while creating colour art zones wherever lines connect. After painting in your tones and highlights, change your pure RGB colours to transparent (0 Alpha) in the Colour Picker window and watch the indicator colour zone lines disappear.

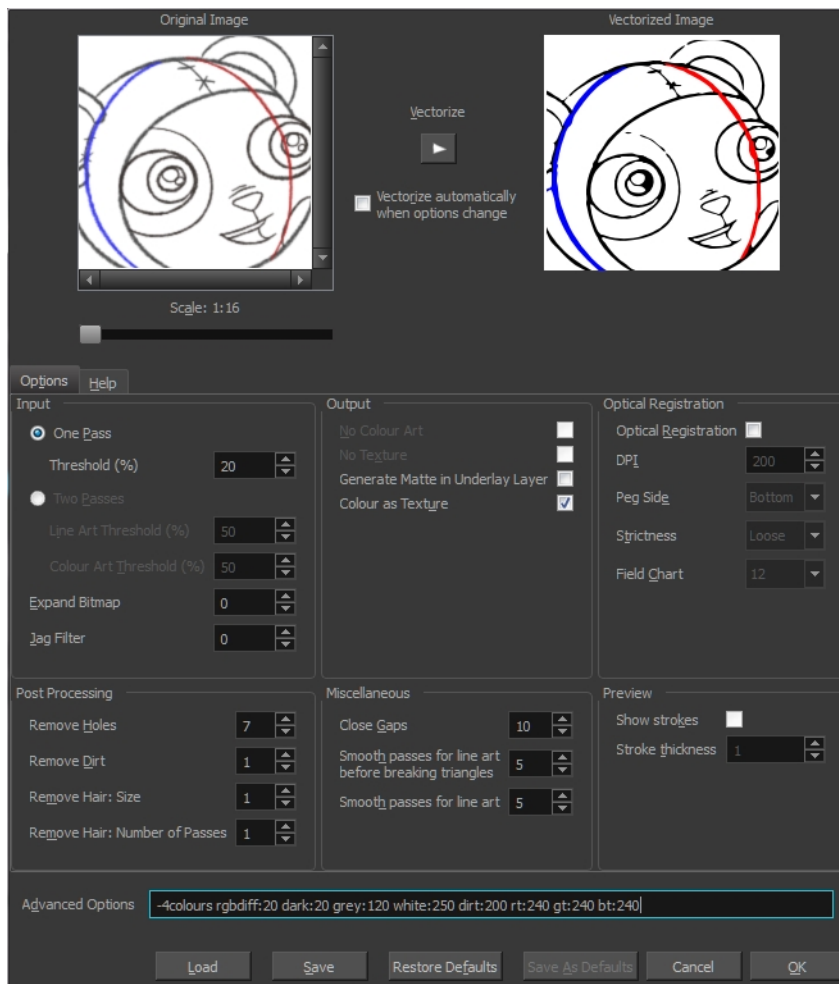

Creating a Vectorization Style

With Harmony, you have the possibility to create custom vectorization parameters that can be saved and reused.

You can vectorize drawings using one of the following methods:

- **Black and White:** All the lines become vector based and 100% black. The white areas become completely transparent.
- **Greyscale:** All the lines preserve their initial textured look in grey shades as a bitmap image contained inside a vector frame. The white areas become completely transparent.
- **Four Colours:** With the advanced parameters, you can isolate the red, green, blue, and black lines and turn them into 100% vector lines, preserving their original colours—see [Custom Vectorization Parameters](#) on page 21.

How to create or modify the vectorization parameters

1. Set the different options available in the Vectorization Parameters dialog box.

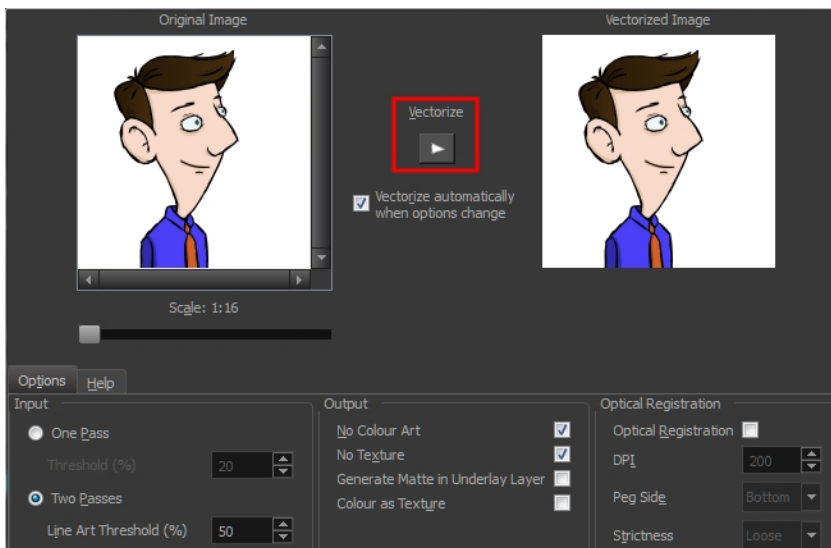

2. Click the **Vectorize** button to update the Vectorized Image preview.
The vectorized image is just a preview. The actual vectorization happens when you click **OK** in the Import Images dialog box. There are many options to try in the Vectorization Options dialog box. These are applied during the vectorization process.
3. To set advanced parameters, read the information on the Help tab, then type in the Advanced Options field at the bottom of the Options tab.
4. To save your vectorization parameters to reuse them later, share them, or use them to set the Harmony Scan module vectorization style list, click **Save**.
5. In the Browser window, name and save the file.

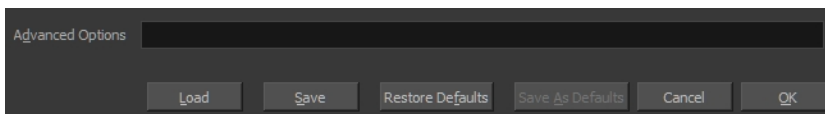

6. To save the current settings as your default settings, click **Save As Default**. To restore the default settings, click **Restore Defaults**.
7. To load a vectorization style, click **Load** and locate the existing ***.vof** file.
8. Click **OK**.

Setting the VectOptions.conf File

Toon Boom Harmony Server uses a file called **vectOptions.conf** to get the vectorization style when batch vectorizing a series of drawings. A series of default styles is available in this file, but you will certainly want to create your own to fit your production style.

This section deals with setting the VectOptions.conf file on:

- [Setting the VectOptions.conf File on Windows and Mac OS X below](#)
- [Setting the VectOptions.conf File on Linux on page 33](#)

Setting the VectOptions.conf File on Windows and Mac OS X

How to set the VectOptions.conf file on Windows or Mac OS X

1. Open the vectOptions.conf file:
 - Windows: Select **Programs / All Programs > Harmony 11.1 > Tools > Configuration Editor**.
 - Mac OS X: Select **Applications > Harmony 11.1 > Tools > Configuration Editor**.

The Configuration Editor window opens.

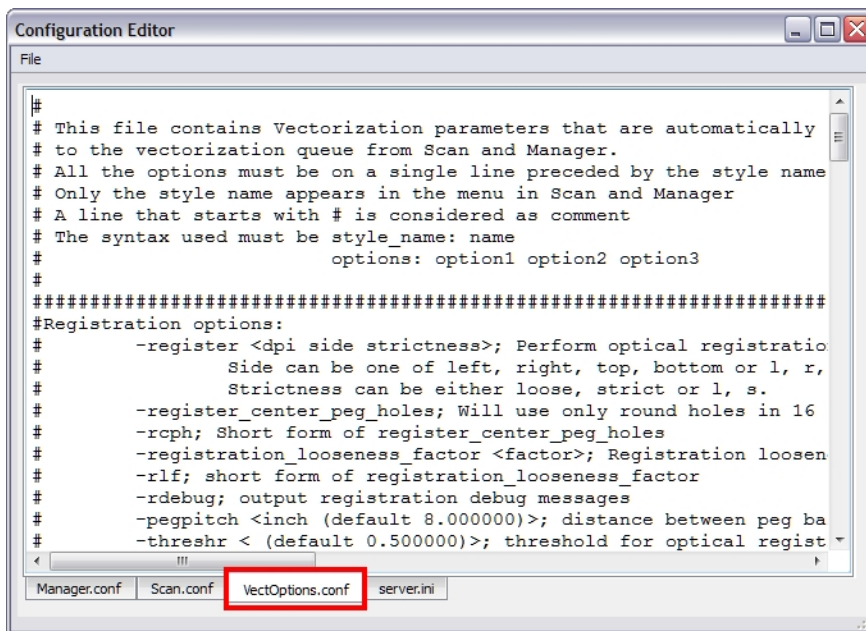

2. In the bottom section of the window, select the **VectOptions.conf** tab.
3. Scroll down the VectOptions.conf file to see all the different options available for creating your custom vectorization style. These options are the same as in the Vectorization Parameters dialog box. It is recommended that you create your vectorization style using Harmony and the Vectorization Parameters window and copy the result parameters in this file—see [Creating a Vectorization Style on page 29](#)
4. Scroll down toward the bottom of the file to see the default styles. You can modify them or add new ones to the list using the parameters you got using the Vectorization Parameters window. Notice that some of the lines have a “#” sign at the beginning to indicate that the line is a comment and will not appear in the style list. The lines that have no sign at the beginning appear in the style list.

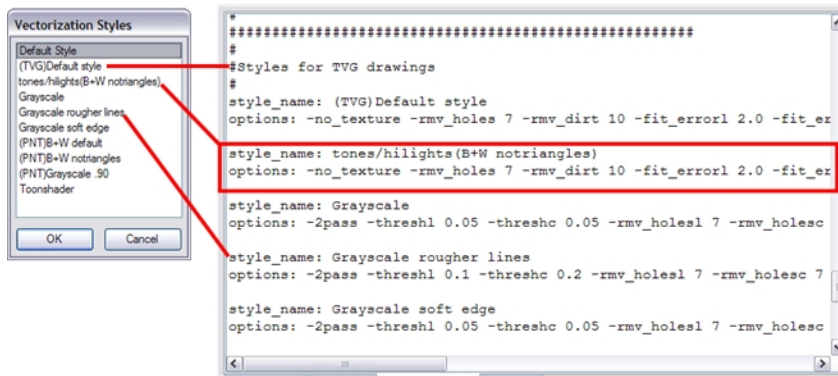

5. To create a new style, type the following below the existing styles:
style_name:
 This should be followed by the name of your new style. For example: **style_name: Black Lines.**
6. Under the style name line, type the following:
options:
7. Copy and paste the information in your *.vof style when saving your settings in the Vectorization Parameters window.
 - To open the *.vof file, use any plain text editor application.

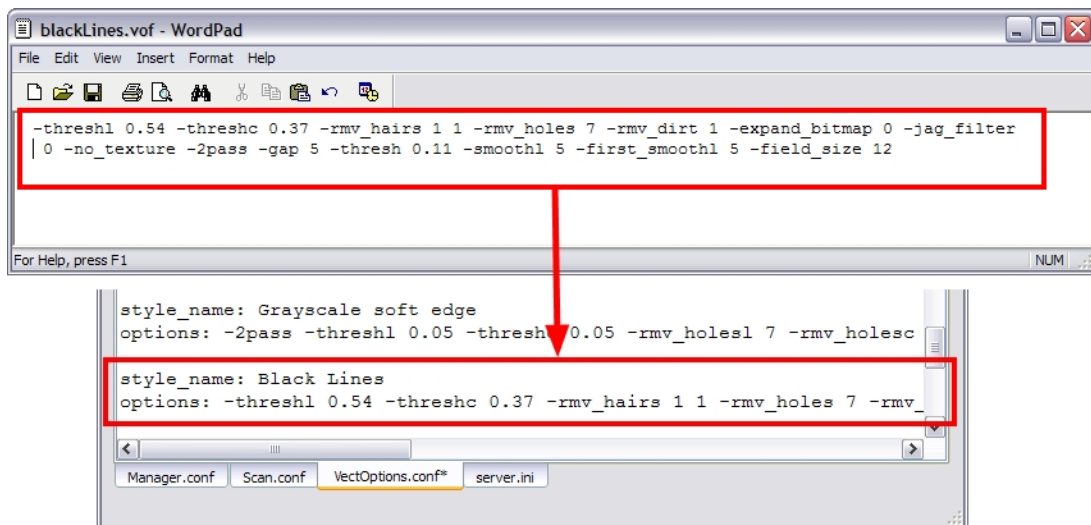

8. In the Configuration Editor's top menu, select **File > Save**.
9. If you have Toon Boom Harmony Scan on your computer, you can start the application and verify that the new style appears in the Vectorization Style list under **Edit > Vectorization Style**.

If you are using the batch processing method available with Toon Boom Harmony Server to scan and vectorize your drawings, the selected style must be available on all the machines included in the batch processing list.

Refer to the Control Center Guide to learn more about setting up and using batch processing.

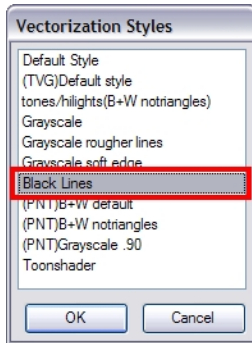

Setting the VectOptions.conf File on Linux

These are the two methods used to edit the `VectOptions.conf` file on Linux.

- Using the "vi" text editor
- Using the "gedit" text editor

How to set the VectOptions.conf file on Linux using the "vi" text editor

1. Open a Terminal window:

Menu: **Applications > System Tools > Terminal**

2. Open the etc folder inside the installation directory:

```
$ cd /usr/local/ToonBoomAnimation/harmony_11.0/etc
```

3. Change your user to "root":

```
$ su
```

- If your user is part of the sudoers list, enter the following command and go to See "Open the 'VectOptions.conf using the "vi" text editor:" on page 33:

```
$ sudo vi VectOptions.conf
```

4. Enter the "root" password.
5. Open the 'VectOptions.conf using the "vi" text editor:

```
$ vi VectOptions.conf
```

6. To start editing, press the [i] key on your keyboard to enter Insert mode.
7. Once you are done editing the file, press Esc to exit Insert mode.
8. To save the changes made to the file, type the following and press Enter/Return:

```
$ :w!
```

- To exit the "vi" editor and return to the Terminal, type the following and press Enter/Return:

```
$ :q
```

- If you have Toon Boom Harmony Scan on your computer, you can start the application and verify that the new style appears in the Vectorization Style list under **Edit > Vectorization Style**.

If you are using the batch processing method available with Toon Boom Harmony Server to scan and vectorize your drawings, the selected style must be available on all the machines included in the batch processing list.

Refer to the Control Center Guide to learn more about setting up and using batch processing.

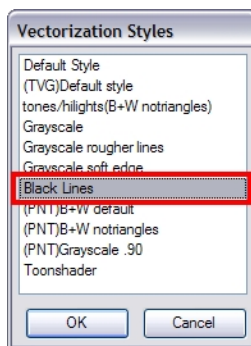

How to set the VectOptions.conf file on Linux using the "gedit" text editor

- Open a Terminal window:
Menu: **Applications > System Tools > Terminal**
- Open the etc folder inside the installation directory:

```
$ cd /usr/local/ToonBoomAnimation/harmony_11.0/etc
```

- Change your user to "root":

```
$ su
```

- If your user is part of the sudoers list, enter the following command and go to See "Open the 'VectOptions.conf using the "gedit" text editor:" on page 34:

```
$ sudo gedit VectOptions.conf
```

- Enter the **root** password.
- Open the 'VectOptions.conf using the "gedit" text editor:

```
$ gedit VectOptions.conf
```

- Edit the parameters of the **VectOptions.conf** file like you would do in most text editor application.
- Select **File > Save**.
- Select **File > Quit**.

9. If you have Harmony Scan on your computer, you can start the application and verify that the new style appears in the Vectorization Style list under **Edit > Vectorization Style**.

If you are using the batch processing method available with Toon Boom Harmony Server to scan and vectorize your drawings, the selected style must be available on all the machines included in the batch processing list.

Refer to the Control Center Guide to learn more about setting up and using batch processing.

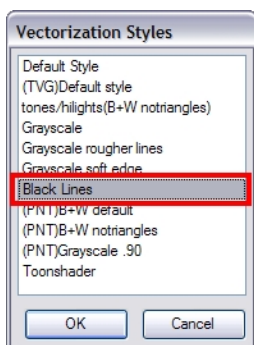

Chapter 3: Timing

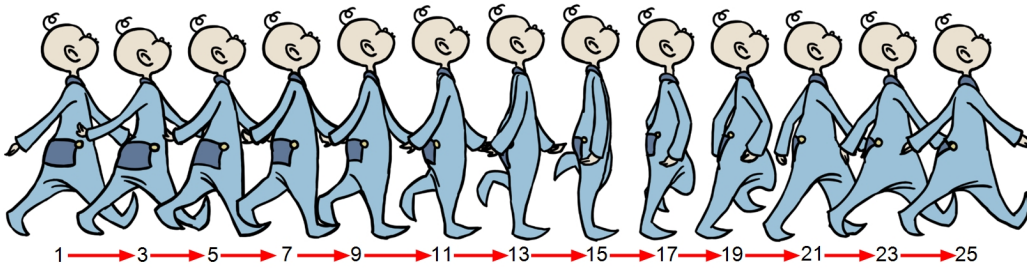

When you create hand-drawn animation traditionally or in a paperless environment, it is important to know how to set and modify the timing of your drawings.

In a traditional workflow, the person in charge of the digital exposure sheet reproduces the paper exposure sheet created by the animator. In a paperless workflow, the animator creates and manages his own exposure sheet directly in Harmony without the need for reproduction.

If you are more of a traditional animator, you are more likely to work with an exposure sheet. If you are a digital animator, you may prefer to work with a timeline to visualize your timing. Harmony offers both.

The Xsheet view displays the digital reproduction of a traditional paper exposure sheet used in hand-drawn animation. You can set the animation sequence's exposure and name the drawings.

The Timeline view is also used to visualize timing, and represents elements and groups of elements as layers.

You can adjust timing in both views; your choice depends on which technique you are used to working with. Depending on your working style, some actions may seem preferable to do in one view instead of another. Many of the actions you perform in the Xsheet can also be accomplished in the Timeline. This chapter will often show both techniques. You will be able to choose which one you prefer.

In this topic, you will learn how to work on your drawing's exposure and length. The exposure and animation paths for symbols are covered in separate chapters.

The exposure sheet is not mandatory for Cut-out animation. It can be useful for creating characters and parts, but is not really needed for animation and timing. If you plan to work with Cut-out animation, you can still gain useful tips by reviewing the section on exposure sheets.

The basic digital exposure sheet process is divided into the following steps:

- Preparation on the facing page
- Frames on page 41
- Filling Exposure on page 67
- Managing Drawings on page 89
- Modifying the Layer and Column Display on page 96
- Printing the Xsheet on page 112

Preparation

The digital exposure task is quite simple. There are very few things to prepare in order to get ready.

Opening the Scene

The scene is generally created during a previous step such as scanning (in a traditional animation workflow), scene setup, digital layout, or production organization.

Using the Workspace

The person creating the exposure sheet will need only the Xsheet view to create the digital exposure sheet, although the Timeline view may also be helpful. If you are doing paperless animation, use the Camera or Drawing view if you want to sketch at the same time.

If you work with this layout often, you can use the Workspace Manager to save it as a workspace, and name it **xsheet**, for example.

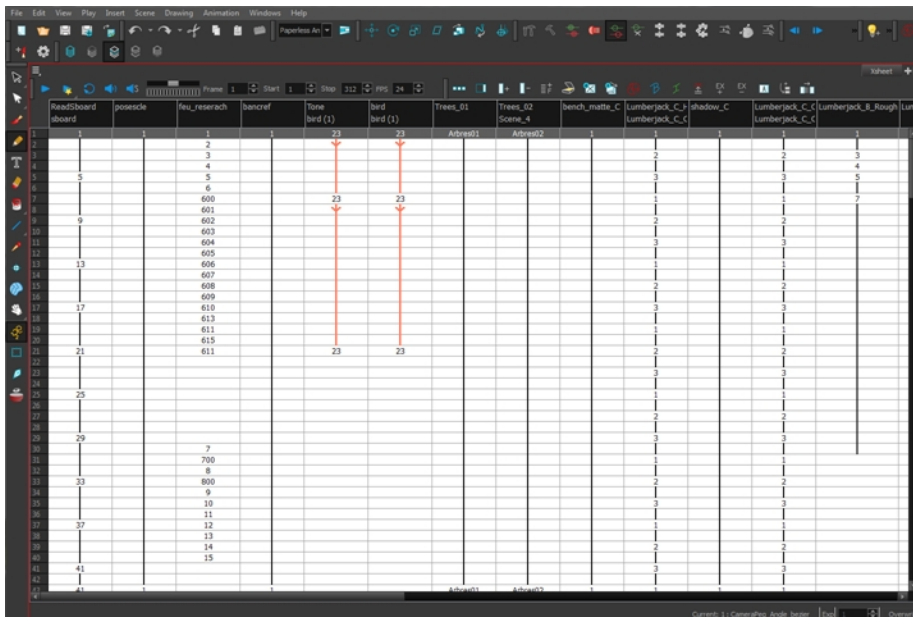

While drawing and animating paperless animation, you can use the Workspace Manager to save a frequently used layout and name it **Paperless Animation**, for example.

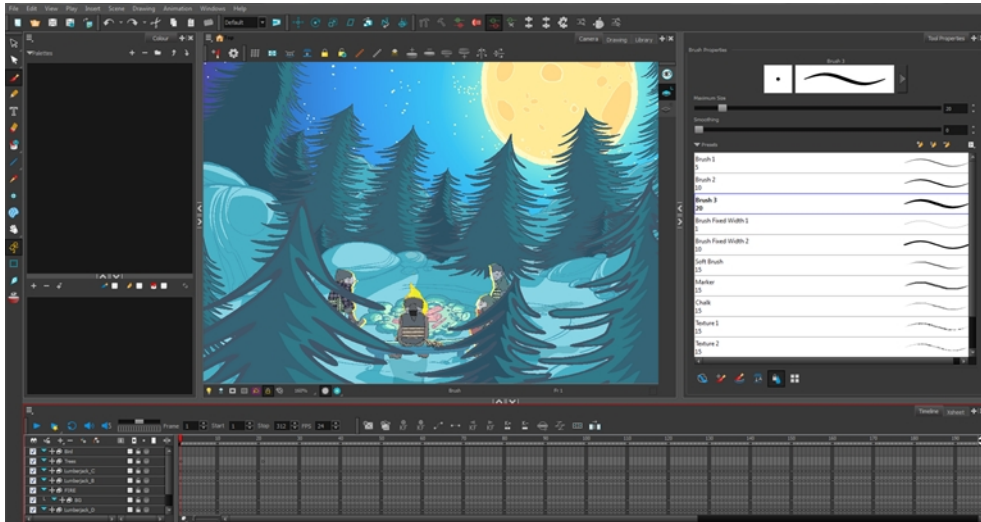

Preparing References



To start an exposure sheet, you need to prepare your references. For traditional animation, you will need to reproduce the animator's paper exposure sheet. If you are working remotely, the studio can scan the paper exposure sheet using third-party software and send the digital files to be opened and viewed digitally.

In paperless animation, you will usually create an exposure sheet from the Xsheet view. The information from your layout and posing or storyboard will help you approximate how many elements are required in the scene.

Frames

Once the references are ready, you need to set the scene length by adding the right number of frames to your scene. You can set the global scene length from the top menu.

In the Xsheet and Timeline view, you can add and remove frames from a scene to edit its length.

How to set the scene length

1. From the top menu, select **Scene > Scene Length**.
The Set Scene Length dialog box opens.

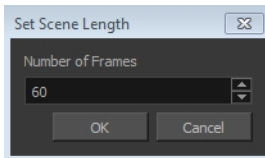

2. In the Number of Frames field, enter the number of frames needed.

How to extend a scene in the Timeline view

1. In the Timeline view, drag the scene length bracket to the right to add more frames to your scene.



How to add frames before or after a selection to the extend scene length in the Xsheet view

You can add frames anywhere in the middle of the scene. If you select a frame row in the Xsheet view, Harmony will add the new frames before or after the selection, depending on your choice.

1. In the Xsheet view, select a frame row.

| | Drawing_3 | Drawing_2 | Drawing_1 | Drawing |
|---|-----------|-----------|-----------|---------|
| 1 | 13 | 15 | 1 | 1 |
| 2 | 14 | | 2 | |
| 3 | 1 | | 3 | |
| 4 | | | 4 | |
| 5 | | 1 | 5 | 1 |
| 6 | | 2 | 6 | |
| 7 | | 3 | | |
| 8 | 2 | 4 | | |

2. Do one of the following:
 - ▶ From the top menu, select **Scene >Frame > Add Frames Before Selection** or **Add Frames After Selection**.
 - ▶ In the Xsheet view, right-click and select **Frames > Add Frames Before Selection** or **Add Frames After Selection**.

- ▶ In the Xsheet view toolbar, click the Add Frames  button to add frame after your selection.
- ▶ Press Ctrl + G and Ctrl + H (Windows/Linux) or ⌘ + G and Ctrl + H (Mac OS X).

The Add Frames dialog box opens.

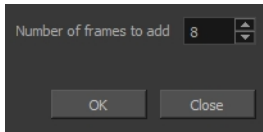

3. In the Number of Frames to Add field, enter the number of frames needed in the scene.

How to add frames at the start or end to extend the scene length from the top menu

1. From the top menu, select **Scene > Frame > Add Frames At Start** or **Add Frames At End**.

- ▶ In the Xsheet view toolbar, press the Add Frames  button to add frame after your selection.

The Add Frames dialog box opens.

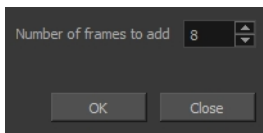

2. In the Number of Frames to Add field, enter the number of frames needed in the scene.

How to reduce the scene length in the Timeline view

When you remove frames at the end of a scene to reduce the scene length in the Timeline view, the exposed drawings and symbols are not deleted. They are still available if you extend the scene afterwards.

1. In the Timeline view, drag the scene length bracket to the left to remove frames from the scene.

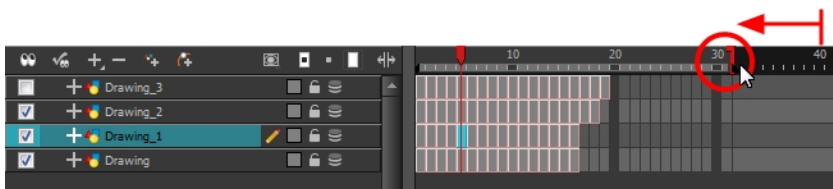

How to remove a frame or a range of frames to reduce the scene length in the Xsheet view

In the Xsheet view, you can remove any selected frame range, such as the last frame.

1. In the Xsheet view, do one of the following:
 - ▶ Select a frame in a given column.
 - ▶ Select a frame range by clicking the first frame's number and then dragging the selection highlight down to the last frame to delete.

| | Drawing_3 | Drawing_2 | Drawing_1 | Drawing |
|----|-----------|-----------|-----------|---------|
| 1 | | | | |
| 2 | 13 | 15 | 1 | 1 |
| 3 | 14 | | 2 | |
| 4 | 1 | | 3 | |
| 5 | | 1 | 4 | |
| 6 | | 2 | 5 | |
| 7 | | 3 | 6 | |
| 8 | 2 | 4 | | |
| 9 | 3 | 5 | | 2 |
| 10 | 4 | 6 | | 3 |
| 11 | 5 | 7 | | 4 |
| 12 | 6 | 8 | | |
| 13 | 6 | 9 | | |
| 14 | 7 | 10 | | 5 |
| 15 | 8 | 11 | | 6 |
| 16 | 9 | 12 | 7 | 7 |
| 17 | 10 | 13 | | 8 |
| 18 | 11 | 14 | | |
| 19 | 12 | | | |
| 20 | | | | |
| 21 | | | | |

2. To delete the selected frames, do one of the following:

- ▶ From the top menu, select **Scene > Frame > Remove Selected Frames**.
- ▶ Press Delete to delete the selection.
- ▶ Click Remove Frames  button. To remove several frame selections, click the button repeatedly.

If you selected a range of frames, the Warning dialog box may open.

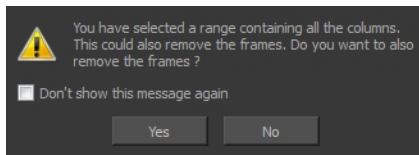

3. To complete the operation:

- ▶ Click **Yes** to delete the selection.
- ▶ Click **No** to delete only the exposure in the cell and not the frames.
- ▶ Select the **Don't Show This Message Again** option to prevent the warning message from being displayed each time you delete a frame range.

Creating Drawing Elements

Before filling any value or setting any timing or exposure, you need to add different drawing elements.

Each drawing element is represented as a vertical element column in the Xsheet view and a horizontal element layer in the Timeline view.

In Harmony, whether you work in the Timeline or Xsheet view, any modification you do to one view will be applied to both. You can also see your layers displayed in the Network view as modules.

To start an exposure sheet, you will use drawing elements. Drawing elements are drawing containers. Any image file, either bitmap or vector, will use a drawing element.

When you add a drawing element to your scene, a folder is added to the scene directory. This folder is named the same way as the drawing element. Its purpose is to contain all the drawings related to this element. For example, in cut-out animation, a character can have many heads available. All of the head drawings will be contained in this folder, even if they are not exposed in the Timeline or the Xsheet view. There is always a drawing container connected to a drawing element (layer, column).

There are different element types available such as Sound and Expression. A sound element will contain sound files. Expressions, Beziers, Eases, 3D Path, Quadmaps and Pegs are for motion purposes during the compositing step. It is not necessary to create these types to create your exposure sheet.

You can add drawing elements from the Timeline view, Xsheet view, and the Scene menu.

This section is divided as follows:

- [Layer and Column Concepts below](#)
- [Layer and Column Types on the facing page](#)
- [Adding New Drawing Elements on page 48](#)
- [Deleting Layers and Columns on page 52](#)
- [Layer and Column Properties on page 54](#)
- [Modifying Layers and Columns on page 55](#)
- [Duplicating Layers and Columns on page 58](#)
- [Cloning Layers and Columns on page 58](#)
- [Adding an Annotation Column on page 59](#)

Layer and Column Concepts

A layer is linked to a directory, the location where all its drawings are saved. This directory has the same name as the layer. When a name is typed in a cell, Harmony searches the layer's directory for the corresponding drawing to display. If there is no corresponding drawing, a new one is created.

Drawings are exposed in cells, and linked to the drawings saved in the layer's directory. Removing a drawing from a cell means it is not displayed. It will not be deleted from the directory.

A drawing that is exposed multiple times (for example, in a walk cycle) would be linked to the same original drawing in the layer's directory. If you modify, repaint, or correct the drawing, all exposed

drawings with the same name are updated simultaneously. You must duplicate or create a new drawing to modify a single exposure and retain the others.

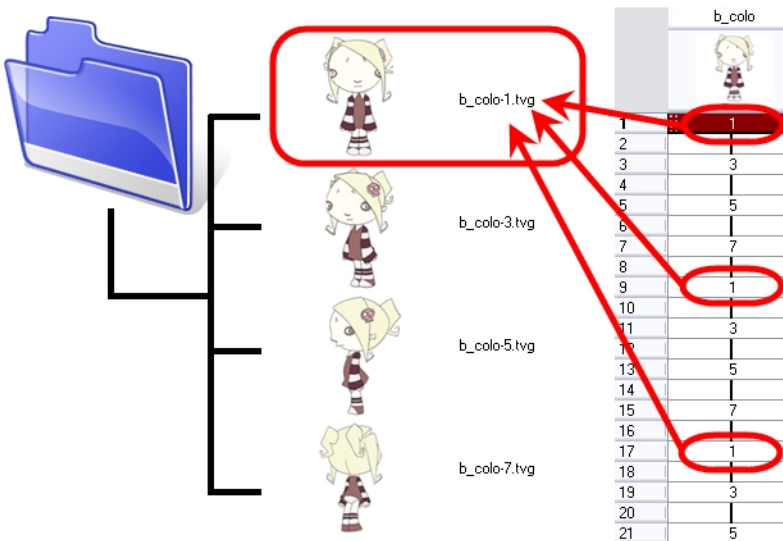

When you create a drawing cycle, all of the repeated drawings are linked to the original files. This means that when you modify, repaint, or correct a drawing named "1," all drawings named "1" are updated simultaneously. In order to modify a drawing independently from its other exposures, you must duplicate the drawing.

Layer and Column Types

A column is also known as a layer. There are several types of layers that you can add in the Xsheet and Timeline view. Each layer is tagged with an icon to help differentiate them. Some layers are represented differently in the Xsheet view.

Drawing Layer



The most common layer type is the drawing layer. Any time you need to create a vector drawing or import a symbol or image, you can use a drawing layer. You can also create bitmap artwork on a drawing layer.

Bitmap images are contained in Bitmap layers.

Bitmap Layer



If you import a picture or bitmap images in your project, they are inserted in a Bitmap layer. If you choose to vectorize your image when you import, the bitmap object will be placed on a Drawing layer. This way, you can have bitmap images mixed with vector drawings on a Drawing layer.

When importing a bitmap image, you have the option of encapsulating the image in a symbol. If you place a non-vectorized bitmap into a symbol, you will still not be able to mix vector drawings with it on the same layer. If you place a vectorized bitmap in a symbol, you must enter the symbol to be able to mix it with vector artwork.

Camera Layer



You can only have one Camera layer at a time in your timeline. By default, there is no Camera layer when you create a scene. You need to add a Camera layer when you want to create a camera motion.

The Camera layer is not visible in the Xsheet view.

If you want to have several cameras with different settings, you can keep adding Camera layers in your Timeline view (however, only one will ever be visible at a time as you can only have one camera at a time in your timeline). To switch to a different camera, select **Scene > Camera** and select another camera layer.

Effect Layer



To enhance the look of your scene, you can add effect layers and attach your drawings to them. In Harmony, there is a series of effect modules in the Module Library view.

When you select the Effect layer in the Timeline view, the effect's parameter columns are displayed in the Functions section of the Xsheet view.

Colour-Card Layer



The Colour-Card layer is used to add a plain colour background to a scene. By default, your scene has no background colour and if you render it as a QuickTime movie or image sequence, it will have a black background.

This layer is not visible in the Xsheet view.

Group Layer



A Group layer can be used to organize both the Timeline and Network views. You can drag and drop other layers onto a Group layer and then collapse the Group layer to hide these other layers from view.

If you create the Group layer in the Timeline view, a corresponding module will appear in the Network view. Any layers that you connect to the Group layer will appear in the Group module connected to an Input and Output port.

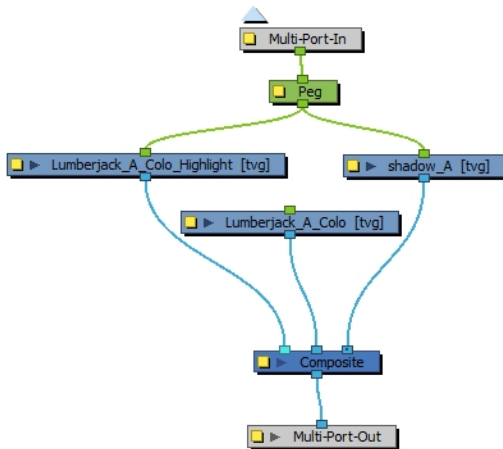

Peg Layer



A Peg layer is a trajectory or motion path layer that does not contain drawings. It can be attached to any drawing layer, cut-out puppet, or other peg layers; they will all follow the trajectory you set in the Peg layer.

When you select the Peg layer in the Timeline view, the peg's function columns are displayed in the Functions section of the Xsheet view.

Quadmap Layer



A Quadmap layer can be described as a deformation transformation layer that does not contain drawings. This can be attached to any drawing layer, cut-out puppet, or even other peg layers. They will all follow the deformation you set in the Quadmap layer.

When you select the Quadmap layer in the Timeline view, the Quadmap's function columns are displayed in the Functions section of the Xsheet view.

Sound Layer



You can import sound files to add dialog and sound effects to your project. The sound layer will be added to your Timeline and Xsheet view when you import a sound file in your scene.

In the Xsheet view, the Sound layer is a dark grey colour.

Advanced Column Types

In the Xsheet view, you can add several advanced column types to create particular animation paths. When you create these columns, they are not linked automatically to any particular drawing layer. You can create a motion path using these columns and then link or unlink several drawing or peg layers to it.

Advanced column types include:

- Timing
- 3D Path
- 3D Rotation
- Bezier Curve
- Ease Curve
- Expression
- Annotation

Adding New Drawing Elements

There are different ways to add a drawing layer to your project. By default, when you create a new scene there is one Drawing column in the Xsheet view and one corresponding Drawing layer in the Timeline view.

You can add an element for each drawing and it will appear as a column in the Xsheet view, a layer in the Timeline view, and a module in the Network view.

How to add a drawing element from the Timeline view

1. Do one of the following:
 - In the Timeline View menu, select **Insert > Drawing**.
 - In the Timeline view toolbar, click the Add Layers **+** button.

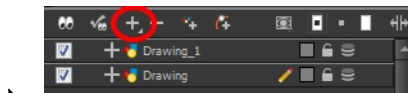

- Press **Ctrl + R** (Windows/Linux) or **⌘ + R** (Mac OS X).

The Add Drawing Layer dialog box opens.

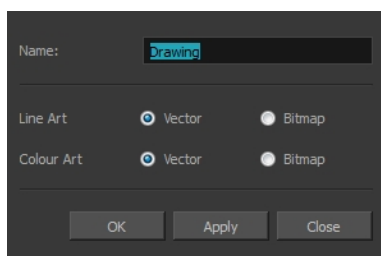

- In the Name field, enter a relevant element name.

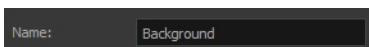

- Do one of the following:
 - Click **OK** to add the layer and close the dialog box.
 - Click **Apply** to add the layer and keep the dialog box open to add another layer.
 - Click **Close** to cancel the operation.

The new drawing element appears in the Timeline, Xsheet and Network Views.

How to add multiple drawing elements from the Timeline view

- In the Timeline View menu, select **Insert > Add Layer(s)**.

The Add Layers dialog box opens.

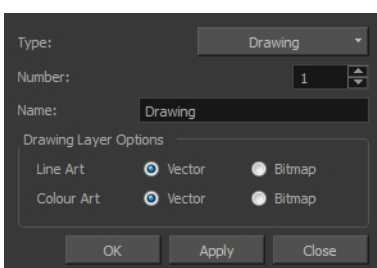

- In the Type menu, select the **Drawing** option.
- In the Number field, enter the number of layers you want to add.
- In the Name field, type the name of the layer you want to add. If you are adding more than one layer, a numerical suffix will be added to subsequent layers.
- Do one of the following:
 - Click **OK** to add the layers and close the dialog box.
 - Click **Apply** to add the layers and keep the dialog box open to add another layer.
 - Click **Close** to cancel the operation.

The new drawing elements appear in the Timeline, Xsheet and Network views.

How to add a drawing element from the top menu

- From the top menu, select **Insert > Drawing**.

The Add Drawing Layer dialog box opens.

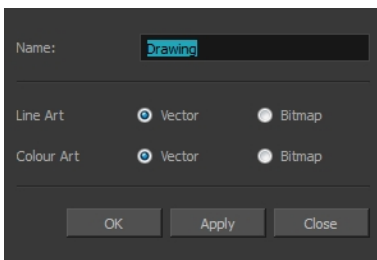

- In the Name field, type a relevant element name.

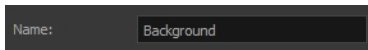

3. Click **OK**.

The new drawing element appears in the Timeline, Xsheet and Network views.

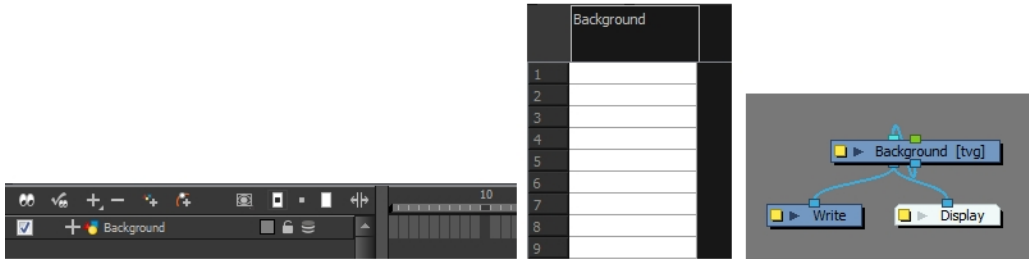

How to add a drawing element from the Xsheet view

1. Do one of the following:
 - ▶ In the Xsheet view menu, select **Columns > Add Columns**.
 - ▶ Click the Add Columns  button.
 - ▶ Press Shift + C.

The Add Column dialog box opens.

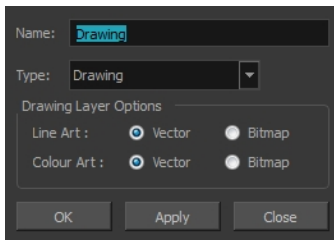

2. In the Name field, type a relevant element name.

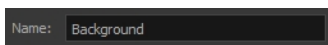

3. In the Type field, select Drawing.

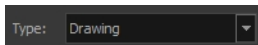

4. To complete the operation:
 - ▶ Click **OK** to add your new layers and close the dialog box.
 - ▶ Click **Apply** to add your new layers and keep the dialog box open to add column.
 - ▶ Click **Close** to cancel the operation.

The new drawing element appears in the Timeline, Xsheet and Network Views—see [Layer and Column Types on page 45](#).

How to create a column in Harmony using the advanced Add Column dialog box

You can use the advanced Add Column dialog box to make more file format and field size options available when you insert the column.

1. From the top menu, select **Edit > Preferences** (Windows/Linux) or **Stage > Preferences (Mac OS X)** and select the **Advanced** tab.
2. In the Advanced Options section, select the **Advanced Element Mode** option to access the advanced Add Column dialog box.

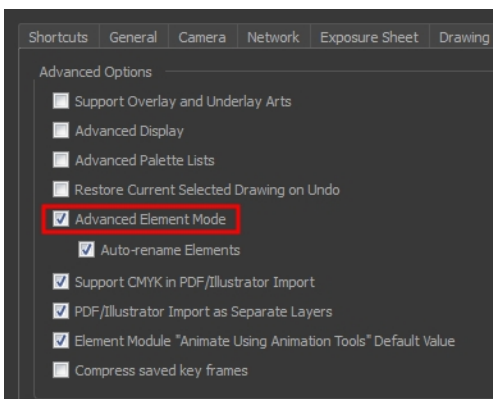

3. Click **OK**.
4. In the Xsheet View menu, select **Columns > Add Column** or press Shift + C. The Add Column dialog box opens.

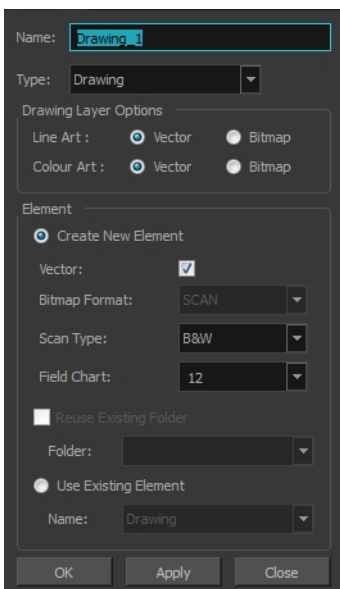

5. In the Name field, type the new column's name.
6. In the Type drop-down menu, select the **Drawing** type.
7. In the Element section, select one of the following:
 - **Create New Element:** Create an independent column with its own drawing folder.
 - **Reuse Existing Folder:** Link your column to an existing folder within the Element folder of your scene. If you select this option, in the Folder drop-down field, select the folder to which you want to link your new column.
 - **Use Existing Element:** Use drawings from an existing column in the new column. Both columns will be attached to the same set of drawings, but their timing will remain

independent from one another. If you modify one of the drawings, it will be modified in both columns. This is the same principle as the Clone column.

If you selected the **Use Existing Element** option, in the Name drop-down field, select the column to which you want to link your new column.

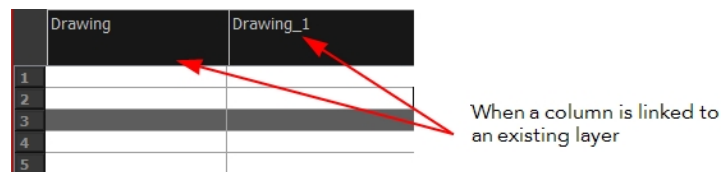

8. If you selected the **Create New Element** option:

- ▶ Deselect the **Vector** option if you want your layer to contain bitmap images or enable it if you want the layer to contain vector drawings. Most of the time, the **Vector** option will be enabled.
- ▶ If you deselected the **Vector** option, from the **Bitmap Format** list, select which type of bitmap image you want to insert in the column. Select the **SCAN** type if you are planning to scan drawings using the Toon Boom Harmony Scan module.
- ▶ If you deselected the **Vector** option and you chose the **SCAN** type, from the Scan Type menu, select what kind of scanning you want to achieve.
- ▶ In the **Field Chart** field, when importing traditional animation, indicate the size of paper on which the animation or background was drawn. If you are not using perforated animation paper, leave the 12 field default value as is.

9. Do one of the following:

- ▶ Click **OK** button to create the new column and close the dialog box.
- ▶ Click **Apply** to create the new column but keep the dialog box opened to create other new columns.

Deleting Layers and Columns

You can delete an element in the Timeline view or Xsheet view.

How to delete layers in the Timeline view

1. In the Timeline view, select the layers to be deleted.

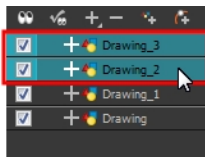

2. Do one of the following:

- ▶ In the Timeline's Layer toolbar, click the Delete Layers  button.
- ▶ Right-click on the selection and select **Delete**.

The Confirm Delete dialog box opens.

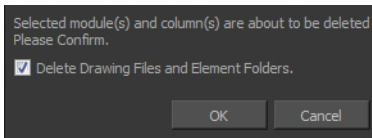

- ▶ Select the **Delete Drawing Files and Element Folders** option to delete all drawings and folder linked to this layer.
3. Select the **Delete Xsheet Columns** option if you also want to delete the existing column in the Xsheet view.

How to delete columns in the Xsheet view

1. In the Xsheet view, select the columns to be deleted by clicking on their header.

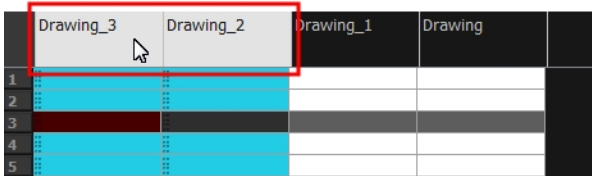

2. Do one of the following
 - ▶ Right-click on the selection and select **Delete Columns**.
 - ▶ In the Xsheet View toolbar, click the Delete Columns  button.
 - ▶ Press Delete.

The Confirm Delete dialog box opens.

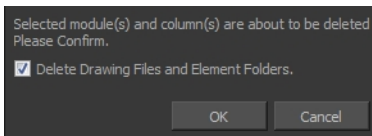

- ▶ Select the **Delete Drawing Files and Element Folder** option if you want to delete the drawings and folders linked to the selected column.
3. To complete the operation:
 - ▶ Click **OK** to delete the selected layers.
 - ▶ Click **Cancel** to cancel the operation.

The Warning dialog box may open.

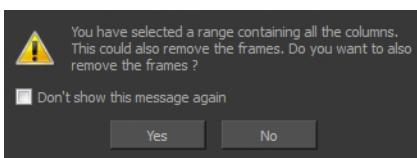

4. Do one of the following:
 - ▶ Click **Yes** to delete all the frames from your scene.
 - ▶ Click **No** to keep the frames in your scene.
 - ▶ Select the **Don't Show This Message Again** option if you do not want the dialog box to display again in the future.

Layer and Column Properties

Each element has its own set of properties that can be modified, including effect and peg layers.

If you want to modify some of the element's properties, display the Layer Properties or Column Properties editor. You can display the Layer Properties editor from the Timeline or Network view as a dialog box or open the Layer Properties as a view of its own.

The Layer Properties editor allows you to:

- Rename the layer
- Enable or disable the layer
- Lock the layer
- Change the track colour
- Activate the onion skin preview
- Adjust the positioning and animation parameters
- Adjust many other advanced parameters

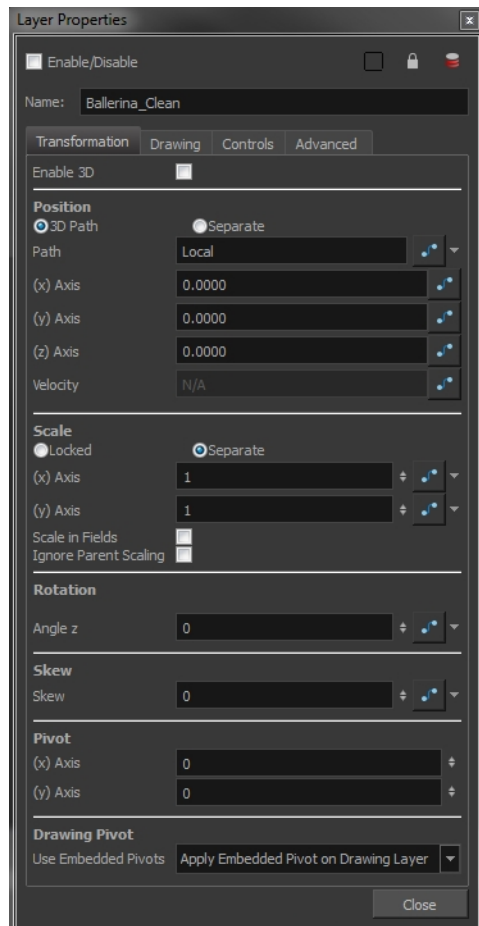

The Column Properties editor allows you to:

- Rename the layer
- Enable or disable the layer
- Adjust parameters for bitmap format, scan type and field chart

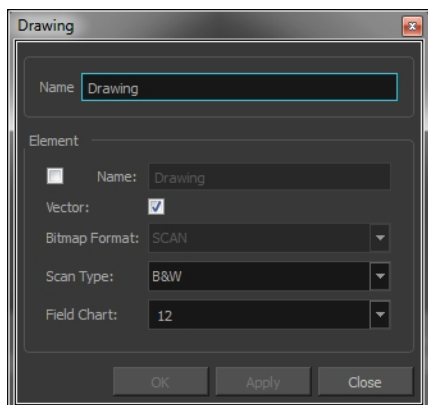

How to display the Column Properties editor from the Xsheet view

1. Do one of the following:
 - ▶ In the Xsheet view, double-click on a column's header.
 - ▶ In the Xsheet view, right-click on a column's header and select **Column Editor**.
 - ▶ Press Shift + E.

How to display the Layer Properties editor

1. Do one of the following:
 - ▶ In the top menu, select **Windows > Layer Properties**.
 - ▶ In the Timeline view, double-click on a layer.
 - ▶ Press Shift + E.
 - ▶ In the Network view, click on the module's yellow properties button.
2. In the Timeline or Xsheet view, select the layer whose properties you want to view.

The Xsheet column will not open the Layer Properties editor, but it will show the column properties allowing you to modify settings related to the Xsheet column.

Modifying Layers and Columns

Once you add layers and columns to your project, you can modify their properties, names, or ordering.

You can change the order of your elements in the Timeline view and Xsheet view. When you change the order of your elements in one view, the other one is updated.

The Element Manager lets you add, delete or modify elements (drawing folders) in your scene. If you have drawing folders that are not linked to a column in your scene, use the Element Manager to delete them if needed.

How to rename a layer in the Timeline view

1. In the Timeline view, double-click on the name of the layer to rename.
2. In the Name field, rename the layer and press Enter/Return.



How to rename a layer in the Layer Properties editor

1. In the Timeline view, double-click anywhere on the layer except the layer name to rename. The Layer Properties editor opens.
2. In the Name field, rename the layer.

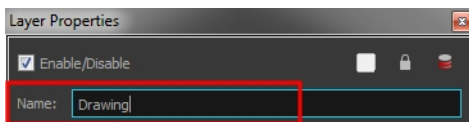

3. Click **Close**.

How to rename a column

1. In the Xsheet view, double-click on a column name. Do not click on the drawing folder name that the column is linked to (this also appears in the column header just below the column name). The Drawing dialog box opens.

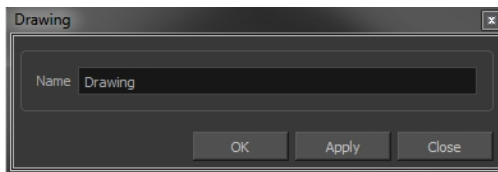

2. In the Name field, rename the column.
3. Click **OK**.

How to reorder layers in the Timeline view

1. In the Timeline view, select the layers to move.
2. Drag the selection to the new location.
3. Do one of the following:
 - Drop the selection on an existing layer to make it a child of another element layer.
 - Drop it between the existing layers. Timeline layers that are located above the selection are displayed in front it. Layers located under it in the Timeline View are displayed behind it.

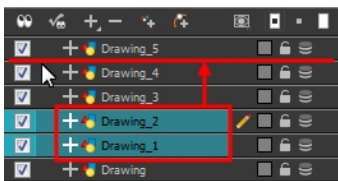

How to reorder columns in the Xsheet view

1. In the Xsheet view, click on the column's header with the middle mouse button.
2. Drag the column to its new position.

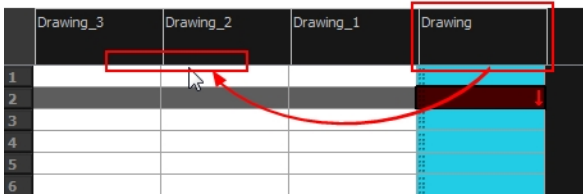

How to use the Element Manager dialog box

- ▶ From the top menu, select **Scene > Element Manager**.

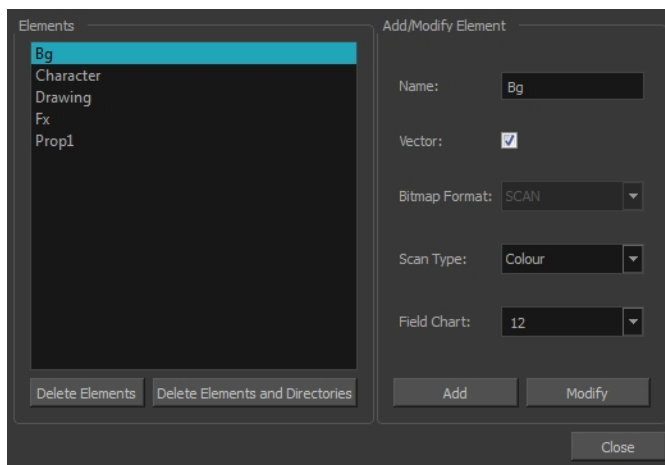

| Interface Element | Action |
|----------------------------------------|---------------------------------------------------------------------------------------------------------------------------------------------|
| Elements | Displays a list of the elements contained in your scene. |
| Delete Elements | Deletes the selected elements. |
| Delete Elements and Directories | Deletes the selected layer, as well as its directories (drawing folder). |
| Add/Modify Element | Use this area to add or modify an element. |
| Name | Type a new name in this field to create an element or to rename the selected element. |
| Vector | Check this box if the new element is a vector drawing or if you want to enable the parameters on the selected element in the Elements list. |

| Interface Element | Action |
|----------------------|----------------------------------------------------------------------------------------------------------------------------|
| Bitmap Format | Select the file format of the bitmap layer from the drop-down list |
| Scan Type | If you are planning to scan elements with the Toon Boom Harmony Scan module, select the scan type from the drop-down list. |
| Field Chart | If you are importing traditional animation, select the size of the paper on which the animation was drawn. |
| Add | Creates a new element with the current parameters entered in the Add/Modify Element section. |
| Modify | Applies the parameter changes made to the selected element. |

Duplicating Layers and Columns

Duplicating an element provides you with a copy of the drawings and their exposure. You can modify anything you want in the duplicated element without affecting the original one. In the Network view, you can duplicate the selected modules in the same way.

How to duplicate an element

1. In the Timeline or Xsheet view, click the layer you want to duplicate.



2. From the top menu, select **Edit > Duplicate**.
3. In the Xsheet view or Timeline view toolbar, click the Duplicate Drawing  button.

The new duplicated layer or column appears.

Cloning Layers and Columns

Cloning a layer or column provides you with a copy of the selected element that uses the same drawings as the original. For example, if you modify a drawing in the cloned or original column, it is updated in both columns.

You can choose whether or not to copy the column timing to the cloned columns.

- You can modify the column timing independently from each other, but the drawings remain linked.
- You can copy the columns timing, so drawings and timings remain linked.

You can clone selected modules from the Network view in the same way.



This feature is useful when you want to reuse a hand-drawn animation but have different timings.

How to clone an element

1. In the Timeline or Xsheet view, select the layer or column you want to clone.



2. Do one of the following:

- ▶ From the top menu, select **Edit > Clone**.
- ▶ In the Xsheet View toolbar, click the Clone Selected Columns: Drawings Only  button.
- ▶ From the top menu, select **Edit > Clone** to clone the columns' drawings only.
- ▶ From the Timeline View menu, select **Layers > Clone Selected Layers: Drawings Only** or **Layers > Clone Selected Layers: Drawings Only**.
- ▶ In the Xsheet View or Timeline View toolbar, click the Clone Selected Layers/Columns: Drawings Only  button.

The new cloned layer or column appears.

Adding an Annotation Column

The Annotation columns are useful for marking actions, corrections or other information related to your animation that you want to draw or write. This way, you can print your Xsheet, take it back to your animation table and work with the annotations.

How to add an annotation column

1. Do one of the following:

- ▶ In the Xsheet View menu, select **Columns > Add Columns**.
- ▶ In the Xsheet View toolbar, click the **Add Columns**  button.
- ▶ Press Shift + C.

The Add Column dialog box opens.

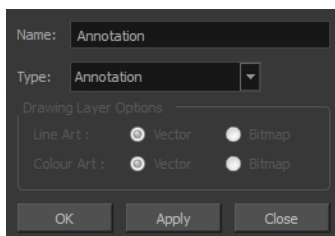

2. In the Name field, type in an appropriate name.
3. From the Type list, select **Annotation** and click OK.

The new column appears.

Drawing and Typing in the Annotation Column

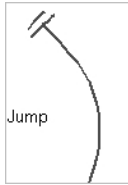

In the annotation column, you can type in your notes and relevant information, as well as draw sketches and ideas that will be useful in producing your animation.

How to draw in the Annotation column

Before you can draw in the Annotation column, you must first activate the Enable Drawing option to activate the Drawing mode.

Pen tablet pressure sensitivity is not supported in the Annotation column.

1. Do one of the following:
 - In the Xsheet View menu, select **Annotation > Enable Drawing**.
 - In the Annotation column header, click to cycle through the icons, until the Brush  icon is displayed.

The Drawing mode is enabled.

2. To draw in an Annotation column, simply use your mouse or pen tablet.



How to type in an Annotation column

Typing in an Annotation column is independent from the Drawing mode. You can be in either mode

and the typing will work.

1. Do one of the following:

- ▶ In the selected cell, press Ctrl (Windows/Linux) or ⌘ (Mac OS X).
- ▶ In the selected cell, hold down Ctrl + Shift + click (Windows/Linux) or ⌘ + Shift + click (Mac OS X)..

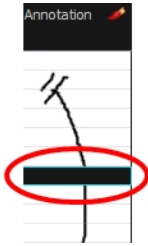

2. In the selected cell, type the desired text.

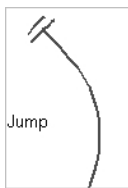

To learn about typing values in the Xsheet view, refer to [Typing Exposure on page 68](#).

How to erase part of a drawn annotation using Erasing mode

You can erase part or all of the Annotation column's text and drawn annotations.

Annotations that you type in cannot be erased using this method.

1. In the Annotation column header, click to cycle through the icons until the Eraser 🧽 icon is displayed.
2. In the column, click and drag the cursor on top of the drawn annotation to erase parts of it.

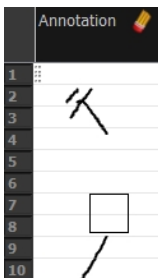

When using a pen on a tablet, you MUST flip your pen to the eraser side for the eraser to work.

How to erase an Annotation column selection

1. In the Annotation column header, click to cycle through the icons until the Select  icon is displayed.
2. In the Xsheet view, select the cell range you want to clear of text or drawn annotations. A selection is indicated by four pairs of dots on the left side of a cell. Do not select any cells if you plan to clear everything.

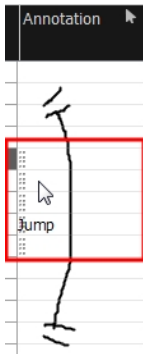

3. In the Xsheet view, right-click in the Annotation column.
4. Do one of the following:
 - ▶ Select **Annotation > Erase All** to erase the entire content of the column.
 - ▶ Select **Annotation > Erase Selected Images** to erase the images contained in the selected cell range.
 - ▶ Select **Annotation > Erase Selected Texts** to erase the text contained in the selected cell range.

Changing the Drawing Settings

You can change the pen size and colour when you draw in the Annotation column.

How to change the pen width

1. Right click on a frame within an annotation column or in the Xsheet View menu, select **Annotation > Pen Width**.
2. Do one of the following:
 - ▶ Select a pen width preset.
 - ▶ Select **Change Current**.

If you selected the Change Current option, the Pen Width dialog box opens.

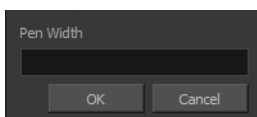

3. In the Pen Width field, type the number of pixels you want the pen size to be.
4. Click **OK**.

How to change the pen colour

1. In the Xsheet View menu, select **Annotation > Change Pen Colour**.
The Select Colour dialog box opens.

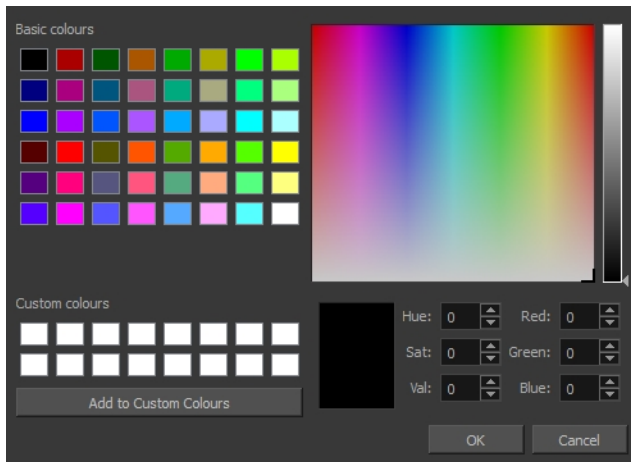

2. Choose the new colour.
3. Click **OK**.

Displaying Tick Marks

When working with the Annotation columns, it is useful to display tick marks on odd-numbered frames.

| shadow_d | Lumberjack_D_Colo | bench_matte_D_1 | Annotation |
|-------------------|-------------------|-----------------|------------|
| Lumberjack_D_Colo | Lumberjack_D_Colo | | |
| 1 | 1 | 1 | |
| 2 | 2 | | |
| 3 | 3 | | |
| 1 | 1 | | |
| 2 | 2 | | |
| 3 | 3 | | |
| 1 | 1 | | |
| 2 | 2 | | |
| 3 | 3 | | |
| 1 | 1 | | |
| 2 | 2 | | |

Tick marks in Annotation column

To display the tick marks, you must run a short script.

How to display tick marks

1. From the top menu, select **Windows > Script Editor**.

2. From the Script Editor menu, select **File > New Script**.
3. Type in a name for your script and click **OK**.
4. In the File list, select the script you created.
5. On the right side of the view, type the following script:

```
function display_tick_marks()
{
  preferences.setBool("XSHEET_ANNOTATION_FRAME_MARKER", true);
  MessageLog.trace(preferences.getBool("XSHEET_ANNOTATION_FRAME_MARKER",
  false));
}
```
6. Click **Verify**.
The script is verified.
7. From the File menu, select **Play/Debug > Run**.
A dialog box opens with your script selected in the Files column.
8. In the Functions column, select **display_tick_marks** and click **OK**.
Tick marks appear on odd frames in the Annotation column.

If you do not see tick marks, close and restart Harmony.

How to turn off the display of tick marks

1. Follow steps 1 to 5 of *How to display tick marks* and use the following script:

```
{
  preferences.setBool("XSHEET_ANNOTATION_FRAME_MARKER", false);
  MessageLog.trace(preferences.getBool("XSHEET_ANNOTATION_FRAME_MARKER",
  false));
}
```
2. Follow steps 6 to 8.
All tick marks are removed from the Annotation column.

Importing an Annotation File

If you scanned your paper exposure sheet's annotations or if you need to place some pictures or drawings in the annotation columns, you can easily import them.

How to import annotation files

1. In the Xsheet view, select the first cell in the annotation column where you want the imported image to start.



2. Right click on the frame or from the Xsheet view menu, select **Annotation > Import File**.
3. Browse for the bitmap image to import.
4. Click **Open**.

The image appears in the annotation column.



Linking External Files with Timing Columns

Timing columns are unique in that they can reference a source folder outside of the project folder to bring images into the project. For example, you may have background scenes created in a third party software that you might need to update in the future; by using Timing columns, you can dynamically link your backgrounds, expose different backgrounds at different times, and have live, automatic updating capabilities.

If the project file is moved, or the folder that the column is linked to is moved, then dynamic linking is broken and the images that were in that folder will disappear in Toon Boom Harmony.

How to use a Timing column

1. In the Xsheet view, click on the Add Columns  button.
2. In the Add Column dialog box, type in the name of the new column, then from the Type menu, select **Timing**.
3. Do one of the following:
 - Click **OK** if you are finished.
 - Click **Apply** if you want to continue adding more columns and column types.

A peach coloured column appears in the Xsheet with the name you typed in, and for the header, <unused>.

| | Drawing | <unused> Timing |
|----|---------|--------------------|
| 1 | | |
| 2 | | |
| 3 | | |
| 4 | | |
| 5 | | |
| 6 | | |
| 7 | | |
| 8 | | |
| 9 | | |
| 10 | | |
| 11 | | |

4. In the Network view, add a new element module.
5. Open the **Layer Properties** editor by clicking on the yellow square of the module.
6. In the Drawing tab, select the **Timing Columns** option.
7. In the Name field, enter the path of the folder you want to access. If you use the Browse button to locate a folder, you must select a file in the folder you want and then delete the dash and the suffix (for example, **background-01** should be renamed to **background**) from the file name in the field. If you leave the full file name selected, Harmony will display that file for the entire duration of the scene, regardless of the contents of the Timing Column field.

This means that all the images in the folder that you are linking to are named using the naming convention described above. If for some reason you are unable to access a certain directory, type the directory extension directly in the path extension field at the top of the browser window.

8. In the Timing Column field, click the **Arrow** button to create a new timing column, or select the name of the column from the list. If you have an element directory selected in the Name field, the Timing Column will indicate which files are called from that element directory. Remember that the file displayed at each frame is based on the element name, cell label, and extension. If the element is **toto**, the timing column is labeled 1, 2, and 3, and the extension is **TVG**, Harmony will display drawings **totobody-1.tvg**, **totobody-2.tvg**, and **totobody-3.tvg** at the selected frames.

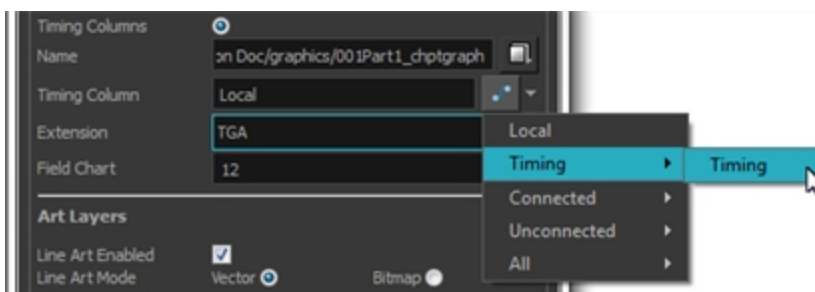

In the Xsheet, the <unused> header changes to the name of the module in the Network view.

9. From the Extension list, select the file format of the files you want to display.
10. Click **OK**.
11. In the Xsheet view, in the Timing column, type the number that corresponds to the suffix of the drawing file that you want to expose to make it appear in the Camera view.

Filling Exposure

Harmony provides different tools to fill in exposures and values, create cycles, and set increments.

This section is divided as follows:

- [Filling Exposure Mode below](#)
- [Typing Exposure on the next page](#)
- [Holding Exposure on page 70](#)
- [Extending a Single Exposure on page 71](#)
- [Extending an Exposure Sequence on page 72](#)
- [Dragging Cells on page 72](#)
- [Increasing and Decreasing Exposure on page 75](#)
- [Inserting Blank Cells on page 78](#)
- [Deleting Exposure on page 77](#)
- [Setting the Exposure on page 79](#)
- [Filling a Selection with a Single Exposure on page 80](#)
- [Filling a Selection with a Sequence on page 81](#)
- [Filling a Selection Randomly on page 83](#)
- [Filling Empty Cells on page 84](#)
- [Creating Cycles on page 85](#)
- [Managing Drawings on page 89](#)
- [Renaming a Drawing on page 89](#)
- [Deleting a Drawing on page 90](#)
- [Duplicating a Drawing on page 91](#)
- [Copying and Pasting Drawings on page 91](#)
- [Merging Drawings on page 94](#)

Filling Exposure Mode

In the Xsheet view, you can fill columns using two different filling modes: Overwrite or Insert. These modes control the filling behaviour. The Timeline view only uses the Overwrite mode.

How to toggle between Overwrite and Insert modes

1. Do one of the following:
 - In the bottom-right corner of the Xsheet view, click the **Overwrite/Insert** button.
 - Press I.



Overwrite Mode

By default, the Xsheet view is set to Overwrite mode. Adding a new value or a new value sequence overwrites existing ones. The existing timing sequence remains in the same place and is not pushed down the column.

| | Drawing |
|----|---------|
| 1 | 1 |
| 2 | 2 |
| 3 | 3 |
| 4 | 4 |
| 5 | 5 |
| 6 | 6 |
| 7 | 7 |
| 8 | 8 |
| 9 | 9 |
| 10 | 10 |
| 11 | |
| 12 | |

| | Drawing |
|----|---------|
| 1 | 1 |
| 2 | 2 |
| 3 | 3 |
| 4 | 100 |
| 5 | |
| 6 | |
| 7 | |
| 8 | 100 |
| 9 | 9 |
| 10 | 10 |
| 11 | |
| 12 | |

Insert Mode

The Insert mode is the opposite of the Overwrite mode. When you add a new value or a new value sequence over existing ones, the new values are inserted between the old ones. The existing timing sequence is pushed down the column.

| | Drawing |
|----|---------|
| 1 | 1 |
| 2 | 2 |
| 3 | 3 |
| 4 | 4 |
| 5 | 5 |
| 6 | 6 |
| 7 | 7 |
| 8 | 8 |
| 9 | 9 |
| 10 | 10 |
| 11 | |
| 12 | |

| | Drawing |
|----|---------|
| 1 | 1 |
| 2 | 2 |
| 3 | 3 |
| 4 | 100 |
| 5 | |
| 6 | |
| 7 | |
| 8 | 100 |
| 9 | 4 |
| 10 | 5 |
| 11 | 6 |
| 12 | 7 |
| 13 | 8 |
| 14 | 9 |
| 15 | 10 |

Typing Exposure

To fill in your exposure, you can directly type the values in the Xsheet view and Timeline view.

How type a value in the Timeline view

If you want to type an exact drawing name or value into the Timeline view, you must use the Data view section of the Timeline.

You can only use alphanumeric values. (0-9, a-z, underscore (_) and dash (-)).

1. In the Timeline view, click the **Show Data View**  button.



2. In the Drawing Substitution field, type the name of the drawing you want to create, and press Enter/Return.

How to type values in the Xsheet view

You can only use alphanumeric values. (0-9, a-z, underscore (_) and dash (-)).

1. In an Xsheet column, double-click on one cell.

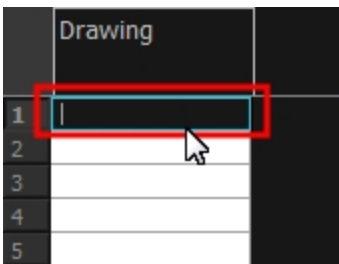

2. Type a value or drawing name in the cell.

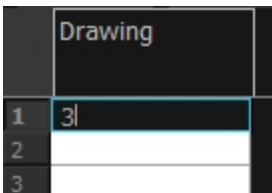

3. Press Enter/Return to move to the next cell.

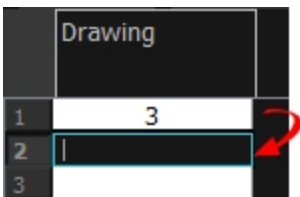

4. Press Esc to exit the typing mode and return to normal mode.

| | Drawing |
|---|---------|
| 1 | 3 |
| 2 | |
| 3 | |

Holding Exposure

Drawings in an animation project are not always exposed on a single frame; they are often exposed for more than one frame. The most common exposure of a drawing is two frames. In the industry, this type of exposure is known as animation in double frames or animation on twos. A drawing can also be exposed for three, four, five cells and so on. To prevent mistakes and save time, the Xsheet lets you hold your cells automatically as you type.

The Set Exposure option allows you to choose how many frames you want to hold for your exposure.

- This option is only available in the Xsheet view.
- The selected Set Exposure settings will be kept from session to session. You will not have to set them every time you use Toon Boom Harmony.

How to hold exposure

1. In the Xsheet View menu, select **Exposure > Hold Exposure > Hold 2 Cells**.
2. In the Xsheet view, right-click and select **Exposure > Set Exposure To > Set Exposure to 1, 2, 3, or Set Exposure**.
3. Type a value or drawing name in the cell.
 - Press Enter/Return to move on to the next cell.
 - Press Esc to quit the typing mode.

| | Drawing |
|----|---------|
| 1 | 3 |
| 2 | |
| 3 | |
| 4 | |
| 5 | 4 |
| 6 | |
| 7 | |
| 8 | |
| 9 | |
| 10 | |



- If you selected Set Exposure, the Set Exposure dialog box opens. You can hold as many cells as needed.

| | | |
|------------------|---|--------|
| Set Exposure to: | 1 | ↕ |
| OK | | Cancel |

Extending a Single Exposure

Extending the exposure lets you select an Xsheet cell that contains a value and pull it down to the desired frame.

How to extend a cell exposure gesturally

1. In the Xsheet view, select the red arrow  in the cell's right side. Make sure you see the drag down  cursor.

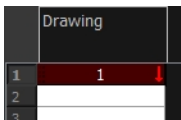

2. Pull down the selected cell to the desired frame.

The red selection box must be visible when releasing the mouse button. If not, the action is considered cancelled.

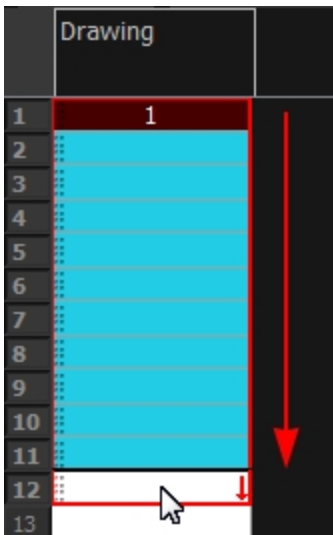

How to extend a sequence from the top menu

1. Do one of the following:
 - In the top menu, select **Animation > Cell > Extend Exposure**.
 - Press F5.

The Extend Exposure dialog box opens.

2. Enter the frame number you want to extend the cell to.

Extending an Exposure Sequence

When working with a sequence that contains only numbers, you can extend an exposure sequence in a similar manner to extending a single exposure.

How to extend an exposure to create a sequence

1. In the Xsheet view, select a cell containing a number.
2. In the selected cell, click the red arrow on the cell's right side. Make sure to see the drag down cursor.

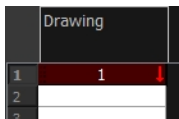

3. Hold down the Shift key. Make sure a plus (+) sign appears.
4. Pull down the selection box to the desired frame.

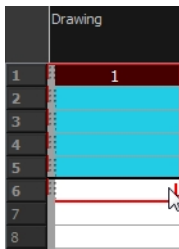

The red selection box must be visible when releasing the mouse button. If not, the action is considered cancelled.

5. First release the Shift key, then release the mouse button.

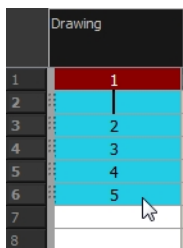

Dragging Cells

To readjust your timing, you can drag one or several cells to a new location. You can drag a cell to any other frame in the same column or into another column.

How to drag a cell to another location in the Timeline view

1. In the Timeline view, select one or several cells to move.

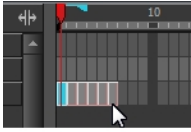

- Click on the cells selection and drag it to the new location.

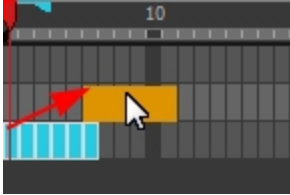

- Drop the selection. Do one of the following:

- Drop by simply releasing the mouse or pen to overwrite the existing cells.

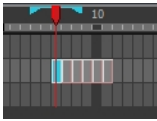

- Hold Ctrl (Windows/Linux) or ⌘ (Mac OS X) while dropping the selection to copy the cells. The original cells will not be moved.

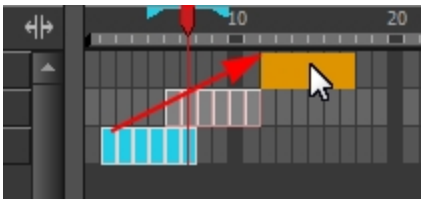

- Press Shift while dropping to insert the selection between the existing frames.

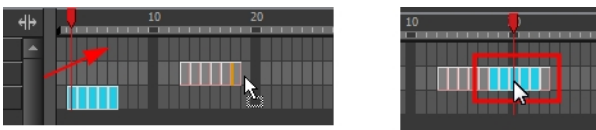

How to drag a cell to another location in the Xsheet view

- In the Xsheet view, select one or more cells.

| | Drawing_2 | Drawing_1 | Drawing |
|---|-----------|-----------|---------|
| 1 | | | 1 |
| 2 | | | 2 |
| 3 | | | 3 |
| 4 | | | 4 |
| 5 | | | 5 |
| 6 | | | 6 |
| 7 | | | |
| 8 | | | |
| 9 | | | |

- In the Xsheet view, select the small dotted area  on the left side of the selected cells.

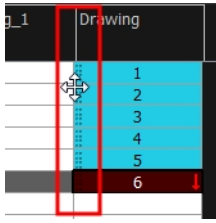

3. Drag the selection to any other cell in the same column or in another column.

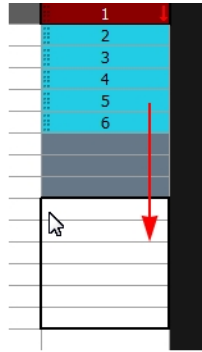
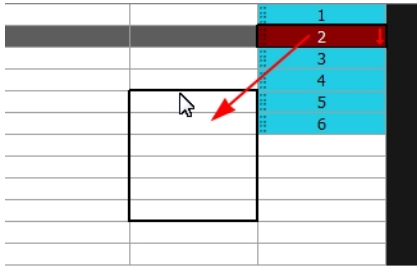

4. Do one of the following:

- ▶ Drop the selection to overwrite the existing cells.

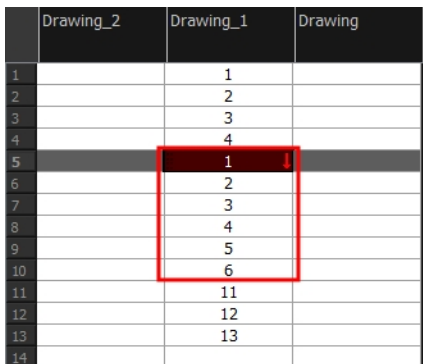

- ▶ Hold down Ctrl (Windows/Linux) or ⌘ (Mac OS X) while dropping the selection to copy the cells. The original selection will not be moved.

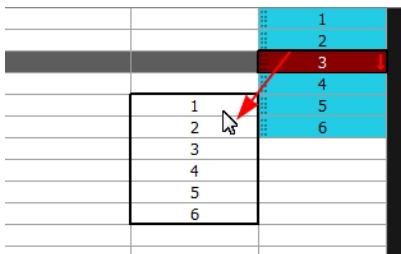

- ▶ Press Shift while dropping the selection to insert it between the existing frames.

| | Drawing_2 | Drawing_1 | Drawing |
|----|-----------|-----------|---------|
| 1 | | 1 | |
| 2 | | 2 | |
| 3 | | 3 | |
| 4 | | 4 | |
| 5 | | 5 | |
| 6 | | 6 | |
| 7 | | 7 | |
| 8 | | 1 | |
| 9 | | 2 | |
| 10 | | 3 | |
| 11 | | 4 | |
| 12 | | 5 | |
| 13 | | 6 | |
| 14 | | 8 | |
| 15 | | 9 | |
| 16 | | 10 | |
| 17 | | 11 | |
| 18 | | 12 | |
| 19 | | 13 | |

You can turn off the Gestural Drag Mode for the Xsheet view to prevent drawings from being dragged from one location to another.

How to turn off the Gestural Drag mode

- Do one of the following:
 - In the Xsheet view, right-click and deselect the **Gestural Drag Mode** option.
 - Click the Toggle Gestural Drag Mode button (you may have to customize the toolbar to display it).

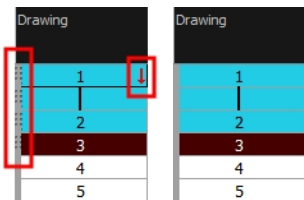

The dragging pad disappears when the Gestural Drag mode is off.

This feature does not apply to Annotation columns.

Increasing and Decreasing Exposure

Once a value is entered in the Timeline or Xsheet view, you can increase and decrease its exposure.

How to increase exposure

Increasing the exposure adds one more exposure to a selected cell; repeating this action adds an extra cell each time. This is an efficient way of extending a drawing exposure and is always set in Insert mode. Increasing an exposure pushes the existing exposure ahead.

- In the Timeline or Xsheet view, select a cell.

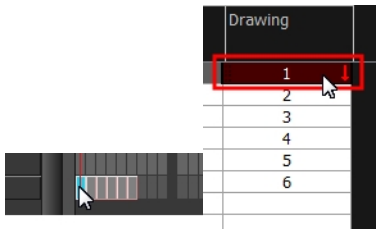

2. Do one of the following:

- ▶ In the top menu, select **Animation > Cell > Increase Exposure**.
- ▶ Right-click on the selected cell and select **Exposure > Increase Exposure**.
- ▶ Press +.
- ▶ In the Xsheet or Timeline View toolbar, click the Increase Exposure  button.

How to decrease exposure

1. In the Timeline or Xsheet view, select a cell.

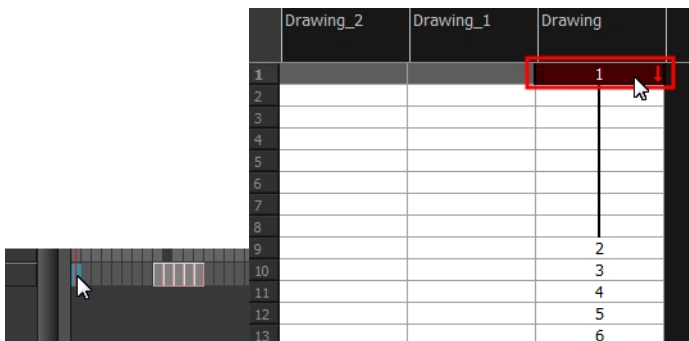

2. Do one of the following:

- ▶ In the top menu, select **Animation > Cell > Decrease Exposure**.
- ▶ Right-click on the selected cell and select **Exposure > Decrease Exposure**.
- ▶ In the Xsheet or Timeline View toolbar, click the Increase Exposure  button.
- ▶ Press -.

How to increase and decrease exposure using the Increase/Decrease Exposure field

You can use this option in the Xsheet view to increase or decrease the exposure of a selected drawing.

1. In the Xsheet view, select the cell to modify.

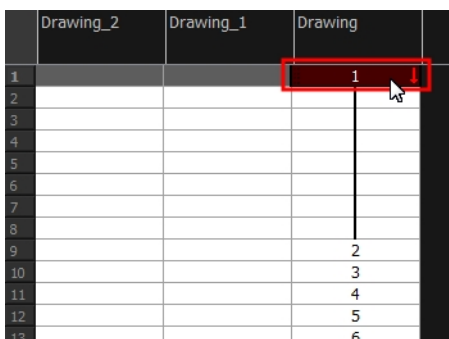

2. Do one of the following:

- ▶ In the Xsheet's bottom right-corner, enter the number of cells over which the drawing will be exposed.
- ▶ In the Xsheet's bottom-right corner, increase or decrease the drawing's exposure by clicking the up or down arrows.
- ▶ Press + to increase exposure.
- ▶ Press - to decrease exposure.

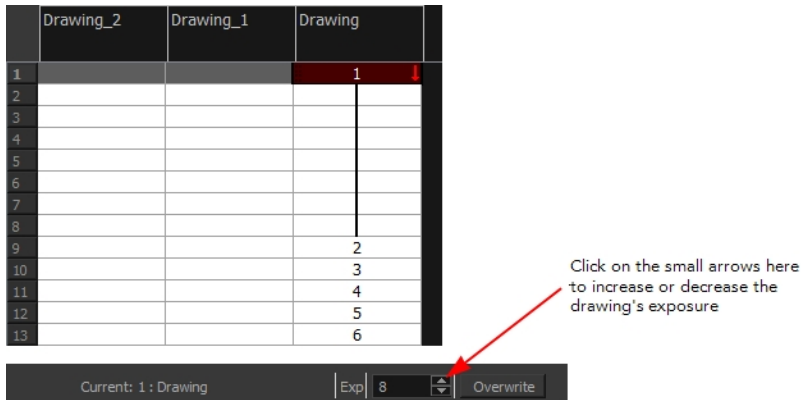

How to use the Clear Exposure and Pull feature

You can use this option to reduce a drawing's exposure.

1. In the Timeline or Xsheet view, select or range of cells.

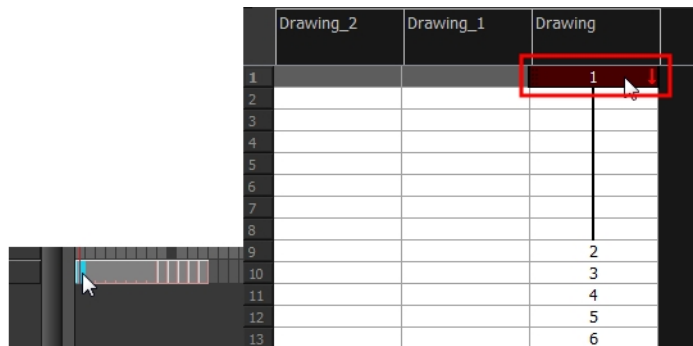

2. Do one of the following:

- ▶ From the top menu, select **Animation > Cell > Clear Exposure and Pull**.
- ▶ Right-click on the selected cell and select **Exposure > Clear Exposure and Pull**.
- ▶ In the Xsheet or Timeline View toolbar, click the Clear Exposure and Pull  button.

3. The exposure is reduced by the selected number of cells.

Deleting Exposure

You can delete a drawing's exposure in several ways. When you delete a drawing's exposure from the Timeline or Xsheet view, you are not deleting the actual drawing file. You can always retrieve it by typing its name again in a cell.

You can delete the exposure contained in a selected cell range or delete the entire exposure of a drawing exposed over several cells. Note that you can also delete the exposure for drawings contained inside a collapsed group.

How to delete selected exposures

1. In the Timeline or Xsheet view, select the exposure you want to delete.
2. Do one of the following:
 - ▶ Right-click and select **Delete**.
 - ▶ Press Delete.

How to clear the entire exposure of a drawing

1. In the Timeline or Xsheet view, select a cell of a drawing exposed over several cells.
2. Do one of the following:
 - ▶ In the top menu, select **Animation > Cell > Clear Exposure**.
 - ▶ In the Timeline view, right-click on the selection and select **Exposure > Clear Exposure**.
 - ▶ In the Xsheet View toolbar, click the Clear Exposure  button (you may have to customize the toolbar to display it).

Inserting Blank Cells

You can place an empty cell between other cells. This is always done in Insert mode and pushes down existing exposure, even if you are set to Overwrite mode.

How to insert blank cells

1. In the Xsheet or Timeline view, select the cell in which you want to insert a blank cell.

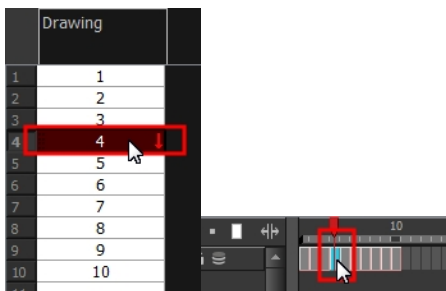

2. Do one of the following:
 - ▶ In the top menu, select **Animation > Cell > Insert Blank Cell**.
 - ▶ Right-click on the selected cell and select **Exposure > Insert Blank Cell**.
 - ▶ In the Xsheet or Timeline view toolbar, click the Insert Blank Cell  button (you may have to customize the toolbar to display it).
 - ▶ Press Shift + J.

The blank cell is inserted.

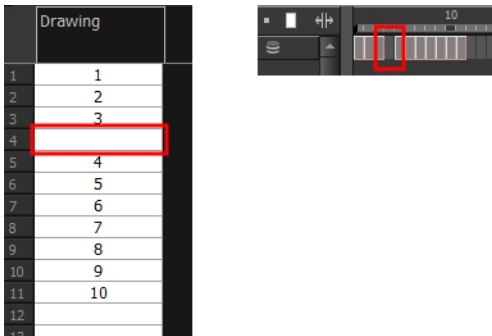

How to clear a selected cell range without changing the exposure and timing

1. In the Xsheet view, select the frame range to clear.

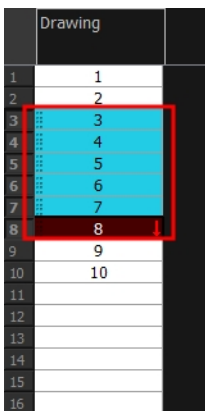

2. Right-click on the selected cells and select **Clear**.

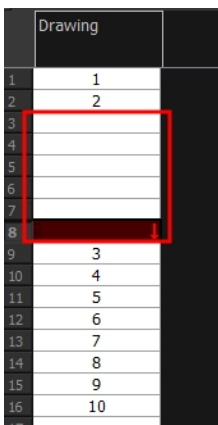





Setting the Exposure

You can easily increase or decrease the exposure for a selected cell range by using the Set Exposure options.

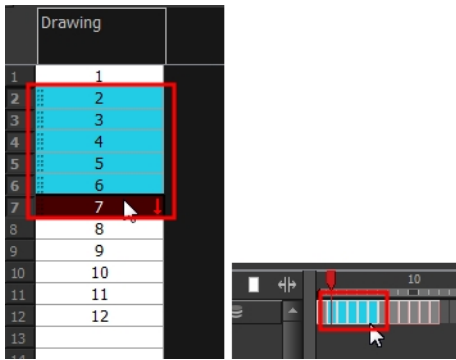
How to set the exposure

1. In the Timeline or Xsheet view, select the cell range on which you want to set the exposure.



2. Do one of the following:
 - ▶ From the top menu, **Animation > Cell > Set Exposure to > Set Exposure to 1, 2, or 3, or Set Exposure**.
 - ▶ In the Xsheet view, right click and select **Exposure > Set Exposure to > Set Exposure to 1, 2, or 3, or Set Exposure**.
 - ▶ In the Timeline View toolbar, click one of the Set Exposure     buttons (you may have to customize the toolbar to display them).
3. In the Xsheet view, right-click and select **Exposure > Set Exposure to > Set Exposure to 1, 2, or 3, or Set Exposure**.

If you chose the Set Exposure option, the Set Exposure dialog box opens.

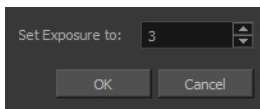

4. Type the number of frames you want the drawings to display and click **OK**.
The new timing is displayed in the Xsheet view.

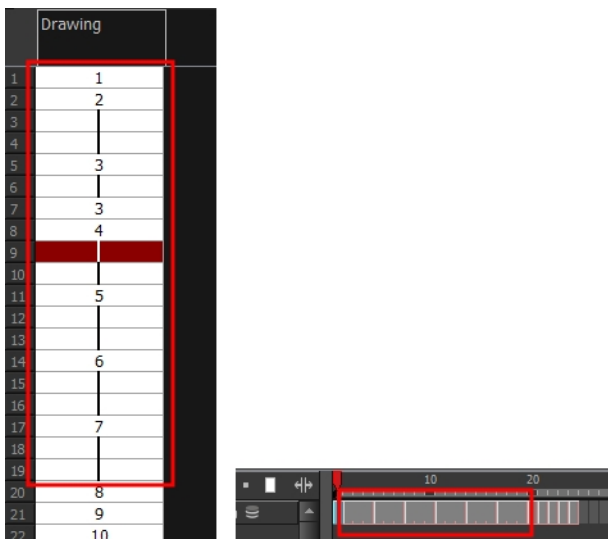

Filling a Selection with a Single Exposure

The Fill Selection option lets you fill the same value over an entire selection. The selection can be over one cell, a cell range in one column, a cell range over many columns, an entire column, or many columns. You can use numbers, words, letters, or any alphanumeric value.

How to fill a selection with a single exposure

1. In the Xsheet or Timeline view, select a cell range.



2. Do one of the following:

- ▶ In the top menu, select **Animation > Cell > Fill Selection**.
- ▶ Click the Fill Selection  button in the Xsheet or Timeline view toolbar (you may have to customize the toolbar to display it).
- ▶ Press **Ctrl + T** (Windows/Linux) or **⌘ + T** (Mac OS X).

The Fill Selection dialog box opens.

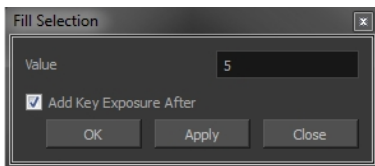

3. In the Value field, type the desired value.
4. To insert a keyframe in the frame following the last cell in the selection, select the **Add Key Exposure After** option. Otherwise, leave it deselected.
5. Click **OK**.



Filling a Selection with a Sequence

You can create a numbered sequence over a selection. The sequence can be forward, backward, single, double or higher increment, as a cycle, and so on. The sequence can be over one cell, a cell range in one or more columns, or one or more columns.

How to fill a selection with a sequence

1. In the Xsheet or the Timeline view, select a cell range.

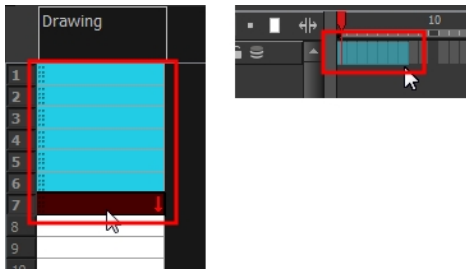

2. Do one of the following:

- ▶ From the top menu, select **Animation > Cell > Sequence Fill**.
- ▶ In the Timeline view, right-click and select **Exposure > Sequence Fill**.
- ▶ In the Xsheet View toolbar, click the **Sequence Fill**  button (you may have to customize the toolbar to display it).
- ▶ Press **Ctrl + M** (Windows/Linux) or **⌘ + M** (Mac OS X).

The Sequence Fill dialog box opens.

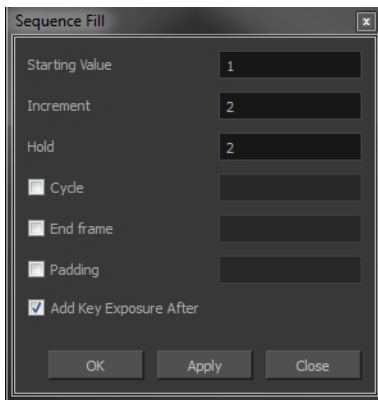

3. In the Starting Value field, type the first number in the sequence.
4. In the Increment field, type the number by which the drawing number will increase from frame to frame. For example, an increment of 1 is used in this sequence: **1-2-3-4**; this sequence increments by 2: **1-3-5-7**; and this one, by -2: **8-6-4-2**.
5. In the Hold field, select an exposure holding value.
6. Select the **Cycle** option if you want a cycle; enter the number of cells for this cycle's duration.



If you choose a two-cell hold, a cycle of three drawings will last for six cells.

7. If you selected a larger range than the amount of frames needed, select the **End Frame** option and type the last frame needed.



- If you want to have more than one digit in your numbers such as "001" instead of "1", select the Padding option and add as many pound signs (#) as digits needed. In the field, you can type a letter or word to add before the drawing number.



- To insert a keyframe in the frame following the last cell in the selection, select the **Add Key Exposure After** option. Otherwise, leave it deselected.
- Click **OK**.

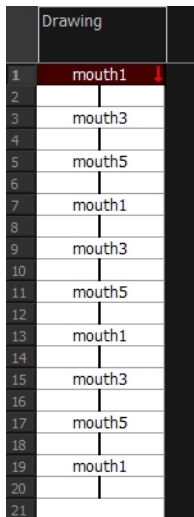

Filling a Selection Randomly

You can fill in random values over a selection. You can give a maximum and a minimum value and create a range for the system to choose the random values from. The selection can be over one cell, a cell range in one column or more, or an entire column or many entire columns.

How to fill cells randomly

- In the Xsheet view, select a cell range.



- Do one of the following:
 - Select **Animation > Cell > Fill Cells Randomly**.
 - In the Xsheet view, click the Fill Cells Randomly  button (you may have to customize the toolbar to display it).

The Fill Cells Randomly dialog box opens.

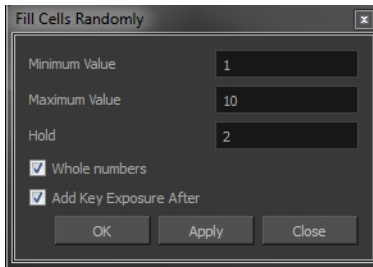

3. In the Minimum Value field, enter the lowest acceptable value.
4. In the Maximum Value field, enter the highest acceptable value.
5. In the **Hold** field, choose an exposure holding value.
6. If you are applying this option to a drawing column, enable the **Whole Numbers** option to avoid decimal points.
7. Click OK.

| | Drawing | |
|----|---------|--|
| 1 | 5 | |
| 2 | | |
| 3 | 3 | |
| 4 | | |
| 5 | 9 | |
| 6 | | |
| 7 | 2 | |
| 8 | | |
| 9 | | |
| 10 | | |
| 11 | | |

Filling Empty Cells

The Filling Empty Cells feature is used to extend the exposure of single frame drawings to fill the range of empty cells after each one.

When creating drawings on cells that are not side-by-side, the exposure of the first drawing no longer fills automatically. You need to select the frame range where you want your drawings to hold their exposure up to the next drawing and use the Fill Empty Cells command.

How to fill empty cells

1. In the Xsheet view or Timeline view, select a cell range.



2. Do one of the following:

- ▶ From the top menu, select **Animation > Cell > Fill Empty Cells**.
- ▶ In the Timeline View toolbar, click on the Fill Empty Cells  button.

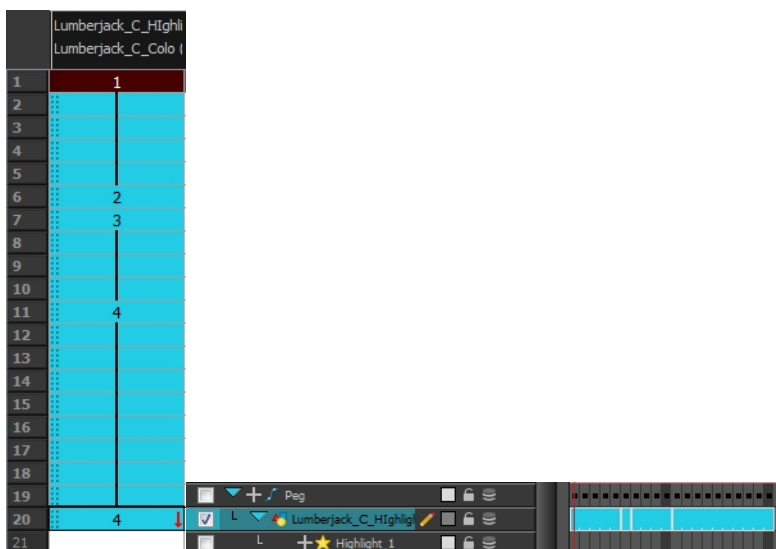

Each drawing in the selection is exposed in the range of empty cells that follow it.

Creating Cycles

Once you have entered a series of drawings and exposures, you can create cycles out of them in several ways.

You can loop your drawings using the following commands:

- Paste Cycle
- Paste Reverse
- Create Cycle

When you create a drawing cycle, all of the repeated drawings are linked to the same original files. This means that when you modify, repaint, or correct a drawing named "1," all drawings named "1"

are updated simultaneously. In order to modify a drawing independently from its other exposures, you must duplicate the drawing.

How to create a cycle

1. In the Timeline view, select the cell range to loop.



2. In the Timeline View toolbar, click the Create Cycle  button (you may have to customize the toolbar to display it).

The Create Cycle dialog box opens.

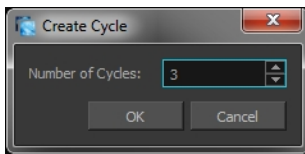

3. Enter the number of cycles you want, including the current selection.

How to paste a cycle

1. In the Xsheet or Timeline view, select the cell range to loop.



2. From the top menu, select **Edit > Copy**.
3. In the Xsheet or Timeline view, select the cell where you want your cycles to start.

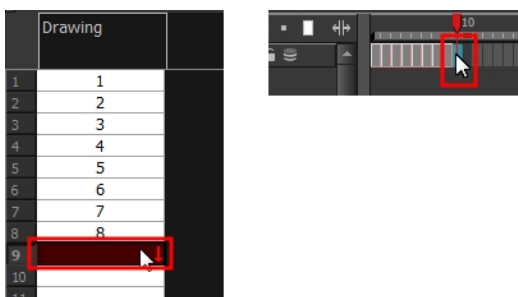

4. Do one of the following:

- ▶ From the top menu, select **Edit > Paste Cycle**.
- ▶ Right-click and select **Paste Cycle**.
- ▶ Press Ctrl + / (Windows/Linux) or ⌘ + / (Mac OS X).

The Paste Cycle dialog box opens.

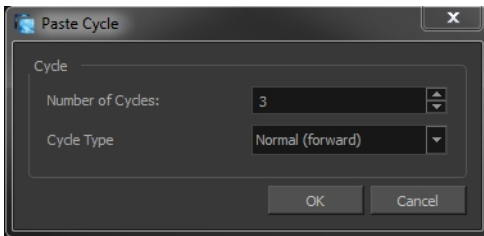

5. Do one of the following:
 - ▶ In the Number of Cycles field, enter the number of cycles you want to paste.
 - ▶ Increase or decrease the number of cycles you want to paste.
6. In the Cycle Type menu, select the type of cycle you want to paste.



- ▶ **Normal (forward)**: Pastes cycles as for all cycles, starting with the first cell of your selection and ending with the last.
 - ▶ **Reverse**: Pastes cycles in the reverse order of the original selection, starting with the last cell of your selection and ending with the first one.
 - ▶ **Forward > Reverse**: Pastes the first cycle in your selection as is, then the following one in reverse order. This repeated until all cycles are pasted.
 - ▶ **Reverse > Forward**: Pastes the first cycle in your selection in reverse order, then the following one as is. This repeated until all cycles are pasted.
7. Click **OK**.

You can perform the same operation using the Paste Special dialog box. To open the Paste Special dialog box, select **Edit > Paste Special** or press Ctrl + B (Windows/Linux) or ⌘ + B (Mac OS X).

How to paste a reversed cycle

1. In the Xsheet or Timeline view, select the cell range to paste in reverse order.



2. From the top menu, select **Edit > Copy**.
3. In the Xsheet or Timeline view, select the cell where you want your cycles to start.



4. Do one of the following:
 - ▶ From the top menu, select **Edit > Paste Reverse**.
 - ▶ Right-click and select **Paste Reverse**.
 - ▶ Press **Ctrl + .** (Windows/Linux) or **⌘ + .** (Mac OS X).

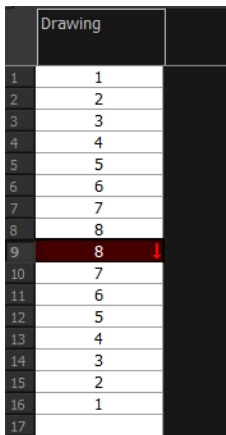

Managing Drawings

Drawings that are created in Toon Boom Harmony are not stored in their cells. They are actual files stored in the project's folder. If you want to rename a drawing or delete a drawing from your project, you need to edit the file and not the cells.

This section is divided as follows:

- [Renaming a Drawing below](#)
- [Deleting a Drawing on the next page](#)
- [Duplicating a Drawing on page 91](#)
- [Copying and Pasting Drawings on page 91](#)
- [Merging Drawings on page 94](#)

Renaming a Drawing

To rename a drawing, you need to select the drawing cell and use the Rename Drawing command.

How to rename a drawing

1. In the Xsheet or Timeline view, select the drawing to rename.

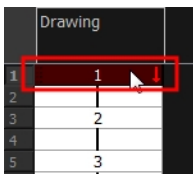

2. Do one of the following:

In the Xsheet or Timeline View toolbar, click the Rename Drawing  button (you may have to customize the toolbar to display it).

- Press Ctrl + D (Windows/Linux) or ⌘ + D (Mac OS X).

The Rename Drawing dialog box opens.

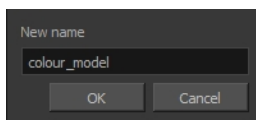

3. In the New Name field, type in the new drawing name.

How to rename a drawing sequence with a prefix

You can rename a drawing sequence with a prefix, which can be quite useful for cut-out puppet breakdown and deformation animation.

1. In the Xsheet or Timeline view, select your drawing sequence. Note that you can only select a drawing range in one column or layer at the time.
2. Right-click and select **Drawings > Rename Drawing with Prefix**.

The Rename Drawing with Prefix dialog box opens.

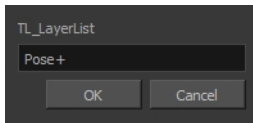

3. In the Prefix to Add field, type the prefix to add before the drawing name.

How to rename drawings by their frame position

You can rename a series of drawings relative to their frame position. This is useful in hand-drawn animation.

1. In the Xsheet or Timeline view, select the drawing sequence to be renamed.



2. From the top menu, select **Drawing > Rename by Frame**.

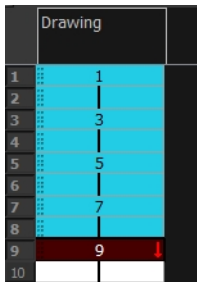

Deleting a Drawing

You can permanently delete a drawing file from a project's folder.

Deleting a drawing file is an operation that cannot be undone.

How to delete a drawing

1. In the Xsheet or Timeline view, select the drawings to delete.

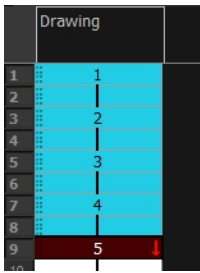

2. Do one of the following:
 - ▶ From the top menu, select **Drawing > Delete Selected Drawings**.
 - ▶ Right-click and select **Drawings > Delete Selected Drawings**.

Duplicating a Drawing

If you want to modify a drawing that already exists, but keep the original drawing intact, you can duplicate the drawing and work on the copy. When duplicating a drawing, the selected cell is replaced with the new drawing. The exposure of the original drawing that was on the current cell is removed. The original drawing is not deleted from the project folder or other cells in which it is exposed.

With Toon Boom Harmony you can create a keyframe at the same time as you duplicate your drawing. This way you can modify and reposition drawings without affecting the original drawing.

How to duplicate a drawing

1. In the Xsheet or Timeline view, select the drawing to duplicate.

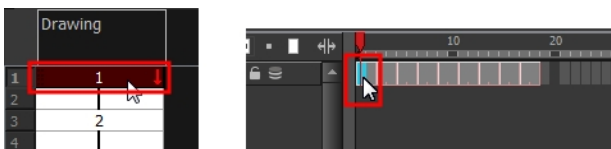

2. Do one of the following:
 - ▶ From the top menu, select **Drawing > Duplicate Drawing**.
 - ▶ Right-click and select **Drawings > Duplicate Drawings**.
 - ▶ In the Xsheet view toolbar, click the Drawing > Duplicate Drawing  button.
 - ▶ Press Alt + Shift + D.

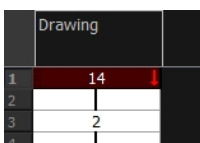

Copying and Pasting Drawings

When you copy and paste a selection in the Timeline or Xsheet view, you are not copying and pasting the actual drawings, you are pasting the exposure.

If you want to copy and paste the selected drawings into a different layer or paste the selection in the same layer to duplicate the drawings, you must use the Paste Special feature.

There are three methods of pasting your selected drawings with the Paste Special dialog box:

- **Never Create Drawing Files:** Pastes all of your drawings as is. If there is a drawing in a cell, it is overwritten by the pasted selection.
- **Always Create Drawings:** Pastes all of your drawings as is, unless a pasted drawing has the same name as an existing one. In this case, the pasted drawing is duplicated and renamed.
- **Only Create Drawings When They Do Not Exist:** Pastes only the drawings that are named differently from existing drawings. If a drawing has the same name as an existing one, it is ignored and not pasted. This avoids the duplication of drawings in your layers.

This option is useful when you are pasting cut-out character templates containing drawings you may already have in your scene and some new ones. Using this option, you only paste the new drawings and are not duplicating all of the other parts you already have.

If you want to perform another Paste Special operation using the same settings you used previously, you can use the Paste Special Again command instead. You can paste your selection using the same settings as in the most recent Paste Special operation, without opening the Paste Special dialog box.

How to paste drawings with the Paste Special command

1. In the Xsheet or Timeline view, select the drawings to copy and press Ctrl + C (Windows/Linux) or ⌘ + C (Mac OS X).



2. In the Xsheet or Timeline view, select the cell where you want your pasted selection to start.



3. Do one of the following:
 - Right-click and select **Paste Special**.
 - From the top menu, select **Edit > Paste Special**.
 - In the Xsheet or Timeline View toolbar, click the Paste Special  button (you may need to customize the toolbar to display it).
 - Press Ctrl + B (Windows/Linux) or ⌘ + B (Mac OS X).

The Paste Special dialog box opens.

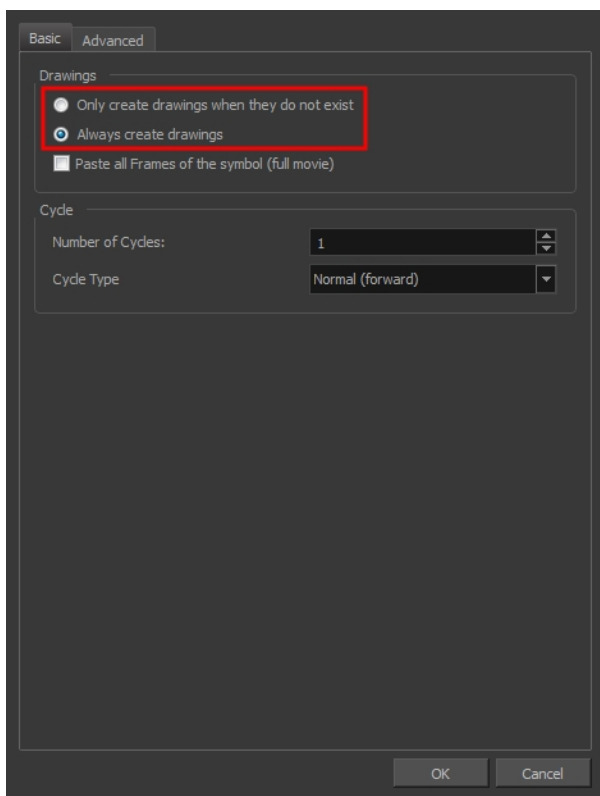

4. Select the **Basic** tab.
5. In the Drawings section, select an option: **Always Create Drawings** or **Only Create Drawings When They Do Not Exist**.

How to paste new drawings with the previous Paste Special settings

1. Do one of the following:
 - ▶ From the top menu, select **Edit > Paste Special Again**.
 - ▶ Right-click and select **Paste Special Again**
 - ▶ In the Xsheet or Timeline view toolbar, click the Paste Special Again  button (you may have to customize the toolbar to display it).
 - ▶ Press **Ctrl + Shift + B** (Windows/Linux) or **⌘ + Shift + B** (Mac OS X).

Merging Drawings

There are two methods of merging drawings.

- You can merge selected drawings in adjacent elements. The columns and layers will be left intact, and each new merged drawing will reside in the frames of the left-most column or lower layer.
- You can merge elements. All drawings will be merged. Unused columns and layers will be deleted, but the original drawing files are still accessible.

How to merge selected drawings

1. In the Xsheet view, select the drawings you want to merge.

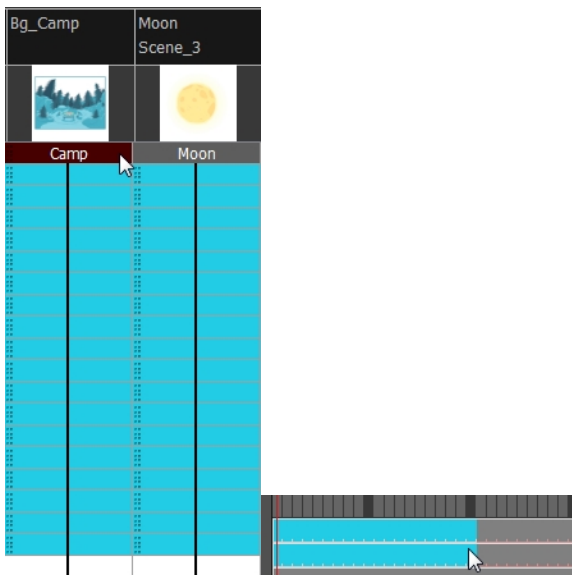

2. Do one of the following:
 - ▶ In the Xsheet View menu, select **Columns > Merge Selected Drawings**.
 - ▶ In the Timeline View menu, select **Layers > Merge Selected Drawings**.

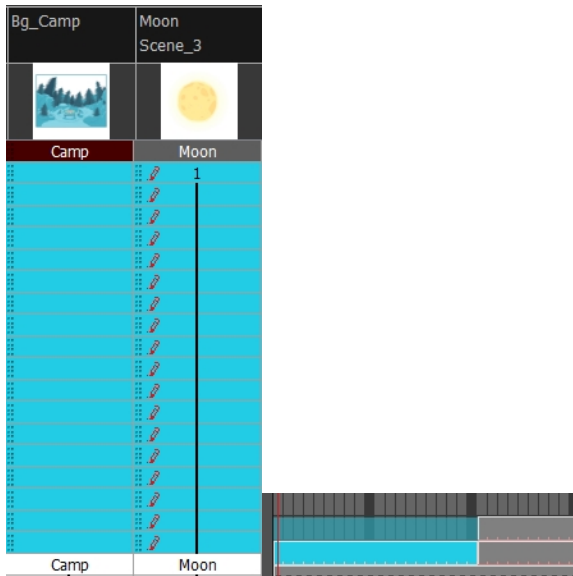

3. Do one of the following:

- ▶ In the Xsheet View menu, select **Columns > Merge Selected Columns**.
- ▶ In the Timeline View menu, select **Layers > Merge Selected Layers**.

In the Xsheet view, the right-most column will contain the merged drawings and the remaining columns will be left blank at the corresponding frames. In the Timeline view, the bottom timeline layer will contain the merged drawings from all layers and the other layers will be left blank at the corresponding frames. Drawings are not deleted and are still accessible.

How to merge drawings in entire layers or columns

1. Do one of the following:

- ▶ In the Timeline view, select the layers you want to merge.
- ▶ In the Xsheet view, Shift-click the headers of the columns you want to merge.



2. Do one of the following:

- ▶ In the Xsheet View menu, select **Columns > Merge Selected Columns**.
- ▶ In the Timeline View menu, select **Layers > Merge Selected Layers**.

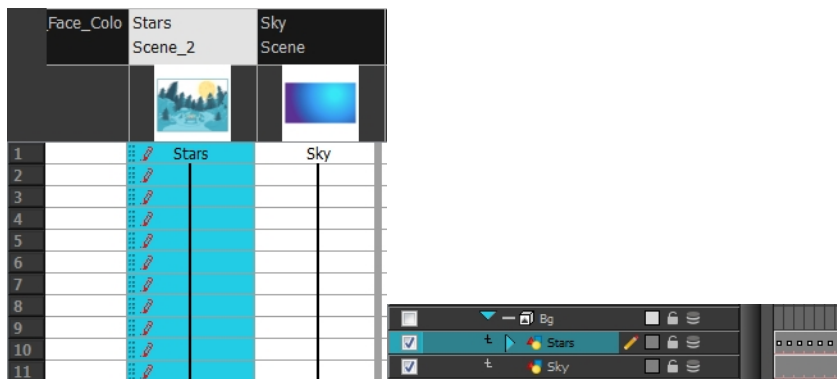

In the Xsheet view, the right-most column will contain the merged drawings and the other columns will be deleted. In the Timeline view, the bottom timeline layer will contain the merged drawings from all layers and the other layers will be deleted. Drawings are not deleted and are still accessible.

Modifying the Layer and Column Display

You can change the way a layer in the Timeline view or a column in the Xsheet view display. You can stay organized without changing the content of elements or your animation output.



This section is divided as follows:

- [Expanding and Collapsing Layers and Columns below](#)
- [Showing and Hiding Layers on the facing page](#)
- [Showing and Hiding Columns on page 99](#)
- [Modifying the Look of the Column on page 101](#)
- [Xsheet Thumbnails on page 106](#)
- [Changing the Colour of a Layer or Column on page 106](#)
- [Setting Scene Markers on page 108](#)
- [Setting Tempo Markers on page 111](#)

Expanding and Collapsing Layers and Columns



To simplify the look of the Xsheet or Timeline view, you can expand and collapse your timeline layers and 3D columns. If some timeline layers are parented to other ones, you can collapse the parent layer to hide its children.

How to collapse or expand a layer selection in the Timeline view

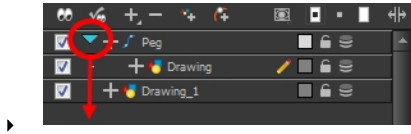

1. In the Timeline view, select the layer(s) to collapse or expand.
2. Do one of the following:
 - ▶ Right-click on the selection and select **Collapse/Expand > Collapse/Expand**.
 - ▶ Click the Expand Children Arrow  button on the parent layer.
 - ▶ Press Ctrl + I (Windows/Linux) or ⌘ + I (Mac OS X).
 - ▶ Click the Collapse/Expand  button (you may have to customize the toolbar to display it).



How to collapse or expand all layers in the Timeline view



- Do one of the following:
 - Right-click on the layers and select **Collapse/Expand > Expand All** or **Collapse All**.
 - In the Timeline View toolbar, click the Collapse All  or Expand All  buttons (you may have to customize the toolbar to display them).
 - Press 0 and 9.

How to collapse and expand 3D path or rotation columns in the Xsheet view

- In the Xsheet View toolbar, click the Show Column List  button to display the Functions list.
- In the Xsheet view, select the column header of the 3D path or 3D rotation column to collapse or expand.
- Do one of the following:
 - Right-click on the column's header and select **Expand/Collapse > Collapse Selection** or **Expand Selection**.
 - In the Xsheet View toolbar, click the Collapse Selection  or Expand Selection  buttons (you may have to customize the toolbar to display it).

How to collapse or expand all 3D path and 3D rotation columns in the Xsheet view



Do one of the following:

- Right-click on any column's header and select **Expand/Collapse > Expand All** or **Collapse All**.
- Press 0 and 9.
- In the Xsheet View toolbar, click the Collapse All  or Expand All  buttons (you may have to customize the toolbar to display it).

Showing and Hiding Layers

As you work in the Drawing or Camera view, some layers may be in the way or are used as references. You can hide these layers to make your work area less cluttered and easier to navigate. You can show and hide layers in the Timeline view in several different ways.

How to show or hide all layers

- Do one of the following:
 - In the Timeline View toolbar, click the Enable All  button (you may have to customize the toolbar to display it).
 - In the Timeline view's Layer toolbar, click the Enable/Disable All  button to show or hide all layers.

How to show or hide individual layers

- Do one of the following:
 - In the Timeline View toolbar, click the Enable/Disable button (you may have to customize the toolbar to display it).
 - On the right side of the Timeline view, select or deselect the layer's checkbox.



When you deselect a layer in the Timeline view, the corresponding column is hidden in the Xsheet view.

How to enable the selected layer and disable all others

- Do one of the following:
 - In the Timeline View toolbar, click the Disable All Others button (you may have to customize the toolbar to display it).
 - In the Timeline view's Layer toolbar, click the Show Selection and Hide All Others button.

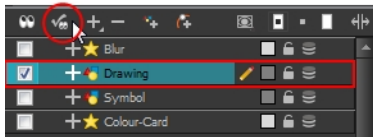

In the Timeline view, you can hide or show certain types of layers such as Group and Effect.

How to show and hide layer types in the Timeline view

- Do one of the following:
 - From the Timeline View menu, select **View > Show > Show Manager**.
 - You can also select **View > Show > Show Sounds**, **Show Effects** or **Show Groups** to immediately show or hide the selected type. This option will remain only for the current session. When you close and reopen Harmony, the default settings will return.

The Show Manager dialog box opens.

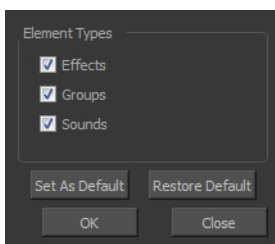

- Select the types of layers you want to display and deselect the ones you want to turn off.
- Click **Set As Default** to make these new settings the default ones that will be used each time to start the application. Click **Restore Default** to restore the settings used when installing the application.

In the Xsheet view, you have the choice of hiding or showing certain types of columns such as Annotation and Functions.

Showing and Hiding Columns



The Xsheet view has a Column List section that can display all the columns contained in the exposure sheet. It can be used to hide individual columns.

If you need to see a column after it has been hidden, you can display it directly from the Xsheet view without using the Column List section.

You can also hide an entire column type, such as Drawing or Sound.

When a column is hidden in the Xsheet view, the corresponding layer is disabled in the Timeline view.

How to show or hide columns in the Xsheet view

1. In the Xsheet View toolbar, click the Show Column List  button.
2. On the right side of the Functions section, click the Expand  button to display the Column List section.
3. Do one of the following:
 - In the Column List section, select the columns to display and deselect the columns to hide.
 - In the Xsheet view toolbar, click the Hide Selected Column  button (you may have to customize the toolbar to display it).

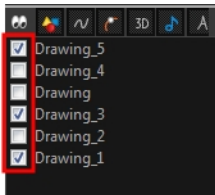

How to show a hidden column in the Xsheet view

1. In the Xsheet view menu, click on the thick grey line that represents a hidden column. You can also right-click on the column header and select **Show Hidden Columns**.

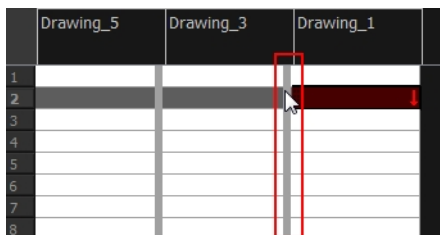

The Show Hidden Columns dialog box opens.

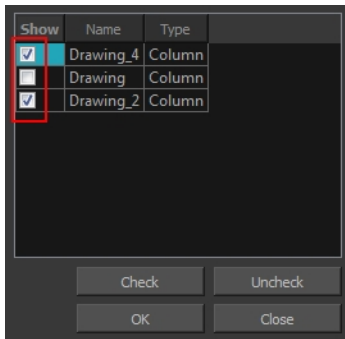

- In the Show column, select the hidden columns you want to display in the Xsheet view.
 - Click **Check** to select all the selected columns.
 - Click **Uncheck** to deselected all selected columns.

How to show all columns

- In the Xsheet view menu, select **View > Unhide All Columns**.

How to show and hide column types

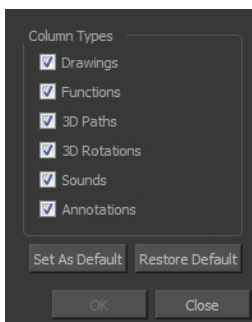

- In the Xsheet view, select **View > Column Types Manager**.

The Column Types dialog box opens.



- Select the types of columns you want to display and disable the ones you want to hide.
- Click **Set As Default** if you want to make these new settings the default ones that will be used each time to start the application.
- Click **Restore Default** if you want to restore the settings used when installing the application.

How to show or hide Xsheet columns using the Column List



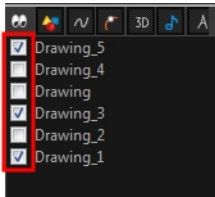



- In the Xsheet view toolbar, click the Show Column List  button.
- On the right side of the Functions section, click the Expand  button to display the Column List section.
- In the Column List section, select the columns to display and deselect the columns to hide.

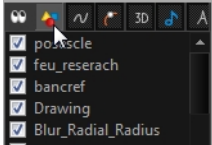

How to show or hide an Xsheet column type using the Column List

1. In the Column List section, click the button corresponding to the type you want to show or hide.



| Column Type button | Action |
|-------------------------------------------------------------------------------------|-------------------------------|
|  | Show/Hide All Columns |
|  | Show/Hide Drawing Columns |
|  | Show/Hide Function Columns |
|  | Show/Hide 3D Path Columns |
|  | Show/Hide Sound Columns |
|  | Show/Hide 3D Rotation Columns |
|  | Show/Hide Annotation Columns |

How to show or hide function columns on the left side of the Xsheet view

1. Right-click on a column and select **Tag > Function Columns Visible** or **Function Columns Invisible**.

Modifying the Look of the Column

In Harmony, you can modify the way the column displays drawings, empty cells and the column width.

You can modify the following elements:

- Empty cells
- Row units
- Held exposure
- Column width

How to modify the look of empty cell

1. From the Xsheet View menu, select **View > Empty Cells > With an "X"** or **Blank**.

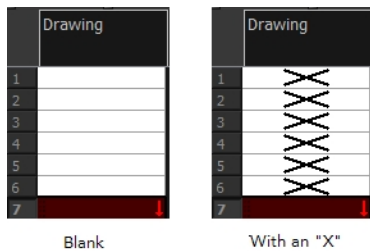

How to modify row units

1. From the Xsheet View menu, select **View > Row Units > Frames** or **Feet**.

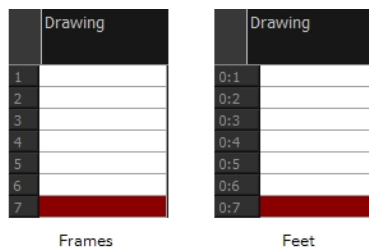

How to modify the look of a held exposure

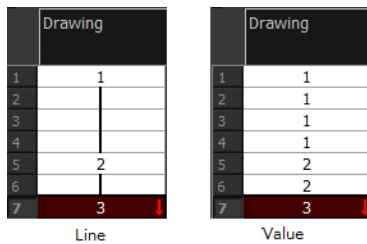

- In the Xsheet View menu, select **View > Held Exposures > Line** or **Value**.

How to modify column width

1. In the Xsheet view, select any column to modify the width.
2. From the Xsheet view menu, select **View > Set Columns Width**.

The Xsheet Column Width dialog box opens.

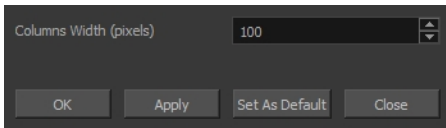

3. In the Column Width field, enter the desired width in pixels.
4. To end the operation:
 - ▶ Click **OK** to validate and close the dialog box.
 - ▶ Click **Apply** to validate the operation and keep the dialog box opened to adjust the next column's width.
 - ▶ Click **Set As Default** to create all the new columns to this width.
 - ▶ Click **Close** to cancel the operation.
5. To restore all columns to the default value, in the Xsheet View menu, select **All Columns to Default Width**.

Drawing Identification

In the Xsheet view, you can identify drawings as Key, Breakdown or In-between. This helps to keep the Xsheet well organized while animating.

When working with several animators, directors, or even other studios, the necessity for retakes will often arise. Harmony also gives you the possibility to mark new drawings as either Retake Key, Retake Breakdown, or Retake Inbetweens.

If your production requires you to mark drawings with a custom marker, you also have the option to create your own.

Make custom marks for the Xsheet by creating your own icons, then cutting, pasting and changing a bit of code. Not only is it possible to have your custom mark appear in the Xsheet and Mark Drawing toolbars, but also in the Onion Skin and Flip toolbars.

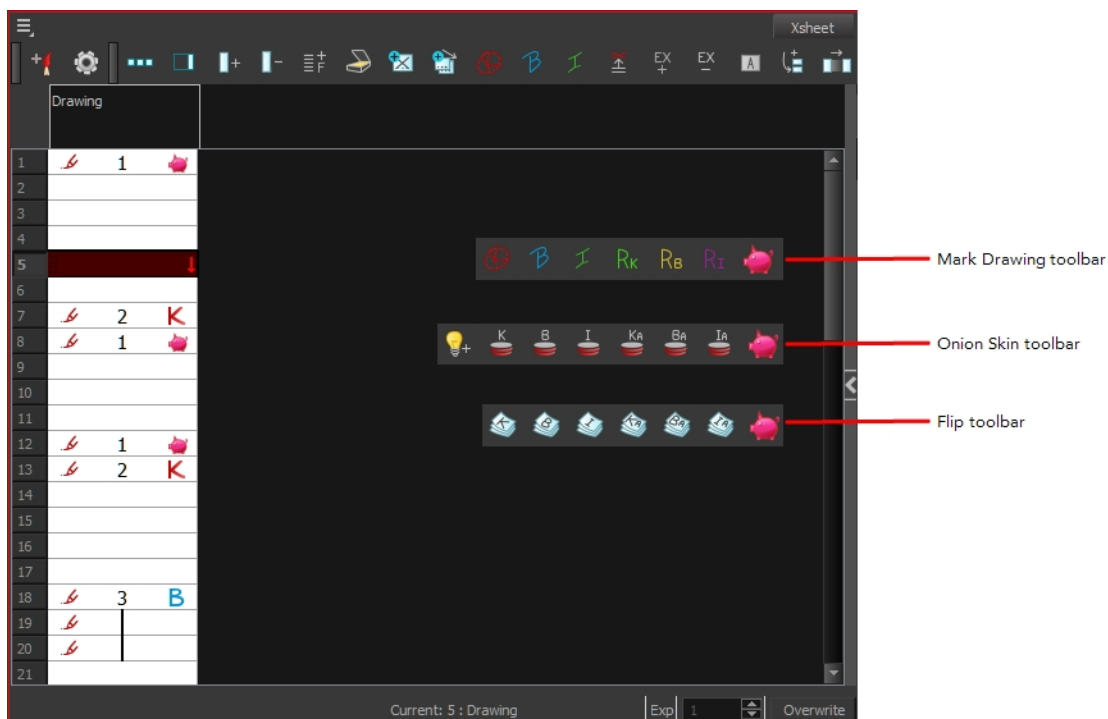



You can create custom shortcuts for the Drawing Identification options in the Preferences dialog box.































How to mark a drawing as Key, Breakdown or In-between

1. From the top menu, select **Windows > Toolbars > Mark Drawing**.

The Mark Drawing toolbar displays.



2. In the Xsheet view, select the cell you want to identify. This option is not available in the Timeline view.
3. In the Mark Drawing toolbar, click one of these buttons: Mark as Key Drawing , Mark as Breakdown Drawing  or Mark as In-between Drawing . In the Xsheet View menu, you can also select **Drawing > Mark Drawing As > Key Drawing, Breakdown Drawing, In-between Drawing, Retake Key, Retake BD and Retake IB**.
 - ▶ If you selected Mark as Key Drawing, a **K** icon appears in the cell.
 - ▶ If you selected Mark as Breakdown Drawing, a **B** icon appears in the cell.
 - ▶ If you selected Mark as In-Between Drawing, there is no icon displayed in the cell since it is used to remove a Key or Breakdown marker.

| | Drawing_1 | | |
|----|-------------------------------------------------------------------------------------|---|----------------------|
| 1 |  | 1 | K |
| 2 |  | | |
| 3 |  | | |
| 4 |  | | |
| 5 |  | | |
| 6 |  | | |
| 7 |  | 2 | R_b |
| 8 |  | | |
| 9 |  | | |
| 10 |  | | |
| 11 |  | | |
| 12 |  | | |
| 13 |  | 3 | B |
| 14 |  | | |
| 15 |  | | |
| 16 |  | | |
| 17 |  | 4 | R_k |
| 18 |  | | |
| 19 |  | | |
| 20 |  | 5 | |
| 21 |  | | |
| 22 |  | 6 | R_i |
| 23 |  | | |
| 24 |  | | |
| 25 |  | | |
| 26 |  | 7 | K |
| 27 |  | | |
| 28 |  | | |
| 29 |  | | |
| 30 |  | | |
| 31 |  | 8 | |

How to create custom markers

1. With a bitmap editing software, create the following icons in PNG format:
 - Mark Drawing Toolbar icon (24 x 24 pixel)
 - Onion Skin Toolbar icon (24 x 24 pixel)
 - Flip Toolbar icon (24 x 24 pixel)
 - Xsheet Column icon (16 x 16 pixel)
2. Close Harmony.
3. When your icons are ready, open the Toon Boom Harmony `drawingTypes.d` folder.

If the `drawingTypes.d` folder does not exist, you must create it. To do so, copy the `resources` folder from the following location.

- Windows: C:/Program Files (x86)/Toon Boom Animation/Harmony 11.1/resources/drawingTypes.d
 - Mac OS X: /Applications/Harmony 11.1/resources/drawingTypes.d
 - Linux: /usr/local/ToonBoomAnimation/ProductVersion/resources/drawingTypes.d
-

Stand-alone

- Windows: C:\Users\USERNAME\AppData\Roaming\Toon Boom Animation\Toon Boom Harmony\full-1100-pref\drawingTypes.d
- Mac OS X: /Users/USERNAME/Library/Preferences/Toon Boom Animation/Toon Boom Harmony/full-1100-pref/drawingTypes.d

The Library folder is usually hidden in the Finder. To see all the hidden folders and files, type the following in a terminal window:

```
defaults write com.apple.Finder AppleShowAllFiles YES
```

- Linux: /home/USERNAME/Toon Boom Animation/Toon Boom Harmony/full-1100-pref/drawingTypes.d/

Network

In Harmony Network, the path is global for all users so you must create the folder and place in /USA_DB.

- /USA_DB/drawingTypes.d

4. Paste your icons in the `drawingTypes.d` directory.
5. In the same directory, open the `drawingTypes.xml` file in a text editor.
6. For each custom icon you want to create, add the following line. Make sure to place it before this closing tag: `</DrawingTypes>`.

- `<DrawingType text="NewButtonName" pixmapFile="XsheetIcon.png" commandIcon="MarkDrawingIcon.png" flipIcon="FlipIcon.png" onionIcon="OnionIcon.png" />`
7. In that line, replace the following information with your new icon information:
 - **NewButtonName:** Write the name of your new marker. This name will appear in the button tooltip.
 - **XsheetIcon.png:** Write the name of the icon that you created to appear in the Xsheet column. Include the file extension.
 - **MarkDrawingIcon.png:** Write the name of the icon that you created to appear in the Mark Drawing toolbar. Include the file extension.
 - **FlipIcon.png:** Write the name of the icon that you created to appear in the Flip toolbar. Include the file extension.
 - **OnionIcon.png:** Write the name of the icon that you created to appear in the Onion Skin toolbar. Include the file extension.
 8. Save the file and close it.
 9. Start Harmony.







Xsheet Thumbnails

When there are a large number of columns in the exposure sheet, it is not always easy to quickly identify a particular column. Displaying the column thumbnails makes this easier. This option displays a small thumbnail picture of the current frame below the column header.

How to display the thumbnails

1. In the Xsheet view, select **View > Show Thumbnails**.

The thumbnails appear.

| | Bg_Camp | Moon Scene_3 | Stars Scene_2 | Sky Scene | Fire_Colo | Lumberjack_D_F Lumberjack_D_C |
|---|-------------------------------------------------------------------------------------|-------------------------------------------------------------------------------------|-------------------------------------------------------------------------------------|-------------------------------------------------------------------------------------|-------------------------------------------------------------------------------------|--------------------------------------------------------------------------------------|
| |  |  |  |  |  |  |
| 1 | Camp | Moon | Stars | Sky | 1 | 1 |
| 2 | | | | | 1 | 1 |
| 3 | | | | | 2 | 2 |

Changing the Colour of a Layer or Column

To easily identify elements in the Timeline or Xsheet view, you can change the colour of layers and columns. The colours you choose will be reflected in the Network view.

How to change the layer's colour in the Timeline view

1. Do one of the following:
 - In the Timeline view, click the colour swatch of the layer you want to modify.

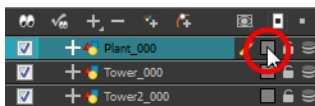

2. In the Select Colour dialog box, select a new colour for your layer.

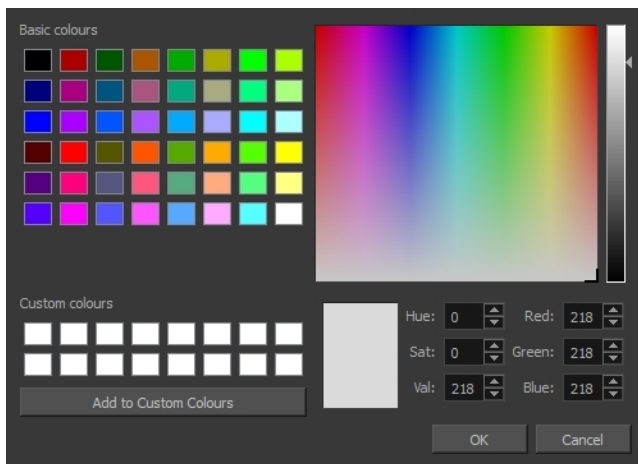

3. Click **OK**.

The layer's background colour is updated. In a Drawing layer, exposed cells are the brighter, selected colour for easy identification. The corresponding column colour is also updated.



How to reset a layer's colour in the Timeline view

1. In the Timeline view, select the layers to reset.
2. In the Timeline View toolbar, click the Default Track Colour  button (you may have to customize the toolbar to display it).

How to change a column's colour in the Xsheet view

1. In the Xsheet view, select one or more columns to modify.
2. Right-click on the column's header and select **Colour > Change Columns Colour**.
3. In the Select Colour dialog box, select a new colour for your columns.

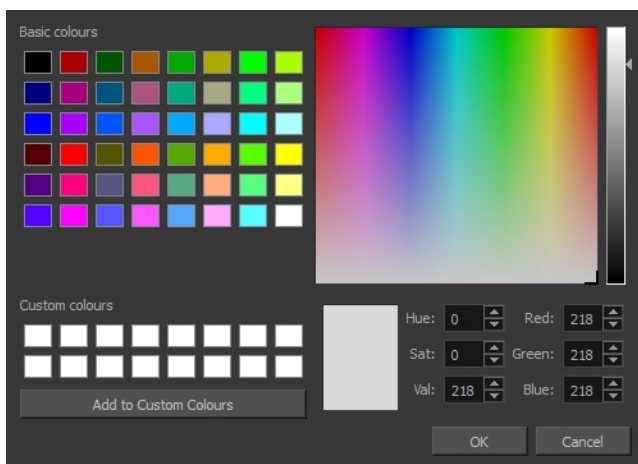

4. Click **OK**.

The column's colour is updated. The corresponding column colour is also updated.

| | Plant_000 | Tower_000 | Tower2_000 | Moon |
|---|-----------|-----------|------------|------|
| 1 | 1 | 1 | 1 | 1 |
| 2 | | | | |
| 3 | | | | |
| 4 | | | | |
| 5 | | | | |
| 6 | | | | |
| 7 | | | | |
| 8 | | | | |

How to reset the column's colour in the Xsheet view

1. In the Xsheet view, select the columns to reset.
2. Right-click on the column's header and select **Colour > Default Columns Colour**.

Setting Scene Markers

Scene markers are visual indicators displayed at the top of the timeline in the frame counter area. You can use it to denote anything relevant to your work. You can indicate at the frames you want to clean up, a change in action, an impact, or where you intend to apply an effect. You can also add a note to a scene marker, which is displayed when you hover over the scene marker.

There are two ways to add a scene marker. You can make a frame range selection and mark that whole section or simply mark the current frame.

How to mark the current frame

1. In the Timeline view, make sure the playhead is set on the frame you want to mark. Even if you right-click on a different frame, the scene marker will be created on the current frame, which means where the red playhead is.
2. Right-click in the frame counter area and select **Scene Markers > Mark Current Frame**.



The Timeline Scene Marker dialog box opens. The Colour box displays a black colour swatch, or the colour of the last scene marker you created.

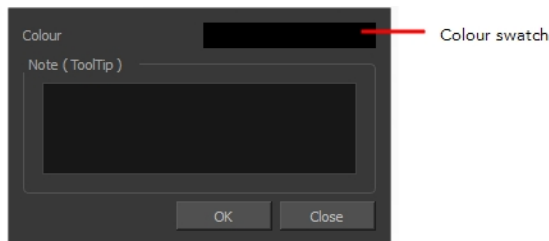

3. Double-click the Colour box to select a colour for your scene marker.
4. In the Note field, enter text to display a tooltip.

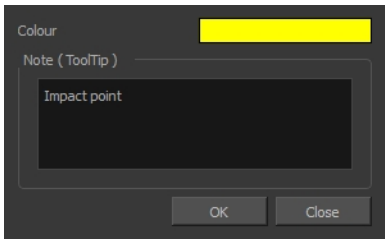

5. Click **OK**.
6. In the Timeline view, the scene marker is displayed at the current frame. Hover over the scene marker to display its note as a tooltip.

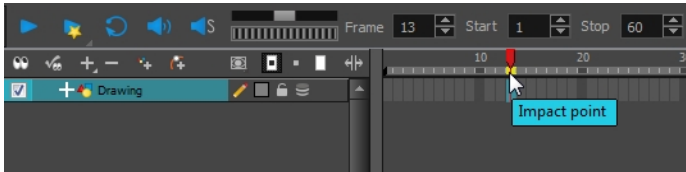

How to create a scene marker on a frame range

1. In the Timeline view frame counter, select the frame range on which you want to mark your scene.



2. Right-click and select **Scene Markers**.

The Timeline Scene Marker dialog box opens. The Colour box displays a black colour swatch, or the colour of the last scene marker you created.

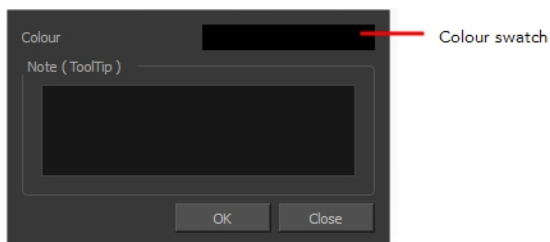

3. Click the colour swatch and select a colour for the scene marker.
4. In the Note field, enter text to display as a tooltip.

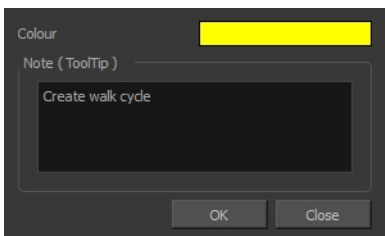

5. Click **OK**.
6. In the Timeline view, the scene marker is displayed over the selected frame counters. Hover over the scene marker to display its note as a tooltip.



How to edit a scene marker

If you select only a part of a scene marker, you will not open the scene marker for editing. You will only be able to create a new scene marker to overwrite it.

1. In the Timeline view frame counter, select the entire scene marker.



2. Right-click the selection and select Edit Scene Marker.

The Timeline Scene Marker dialog box opens.

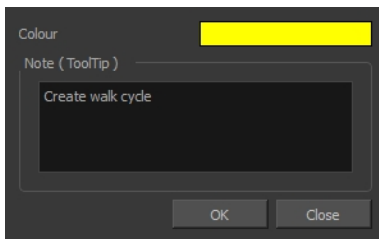

3. Make your changes.
4. Click OK.

How to delete a scene marker

1. In the Timeline view frame counter, at least one frame counter in the scene marker you want to delete.

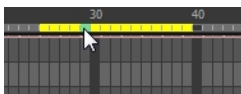

2. Right-click the selection and select Delete Scene Marker.

Setting Tempo Markers

Tempo markers are used to synchronize your animation with a musical score. This lets you reproduce the FPB (Frames Per Beat) and use the tempo signature as tempo markers. The Xsheet view allows you to pace your animation according to the tempo or beat of the soundtrack music or to any rhythmic sound, such as the ticking of a clock or water leaking from a spout.

| | Drawing | Limpa_Colour | Kalimba 100% |
|----|---------|--------------|-----------------|
| 1 | 1 | 1 | |
| 2 | | 2 | |
| 3 | | 3 | |
| 4 | | 4 | |
| 5 | | 5 | |
| 6 | | 6 | |
| 7 | | 7 | |
| 8 | | 8 | |
| 9 | | 9 | |
| 10 | | 10 | |
| 11 | | 11 | |
| 12 | | 12 | |
| 13 | | 13 | |
| 14 | | 14 | |
| 15 | | 15 | |
| 16 | | 16 | |
| 17 | 2 | 17 | |
| 18 | 3 | 18 | |
| 19 | 4 | 19 | |
| 20 | 5 | 20 | |
| 21 | 7 | 21 | |
| 22 | 8 | 22 | |
| 23 | 9 | 23 | |
| 24 | 10 | 24 | |
| 25 | 11 | 25 | |

How to set the tempo markers

1. In the Xsheet View menu, select **View > Set Tempo Marker** or in the sound column, right-click and select **View > Set Tempo Marker**.

The Tempo Marker dialog box opens.

2. Reproduce the tempo and beat value of your music or sound for the Xsheet view marker display.
 - **Starting Frame:** Enter the number of the frame where you want the tempo markers to begin.
 - **Frames/Beat:** Set the frames per beat value. This will determine the frequency (in frames) in which a beat marker will appear. Keep in mind that, by default, 24 frames represent 1 second.
 - **Beat/Bar:** Set the tempo of your music or sound. This will determine the frequency (in beats) in which a tempo marker will appear in the Xsheet view.
3. Click **OK**.

Printing the Xsheet

Once you have marked all the information, corrections, and timing you want in the Xsheet view, you can print your exposure sheet. Printing the Xsheet allows you to take it with you to your animation table or give a copy to the animator. You can also use it to create your Xsheet skeleton directly in Harmony.

How to print your exposure sheet

1. Select **File > Print > Xsheet**.

The Print dialog box opens.

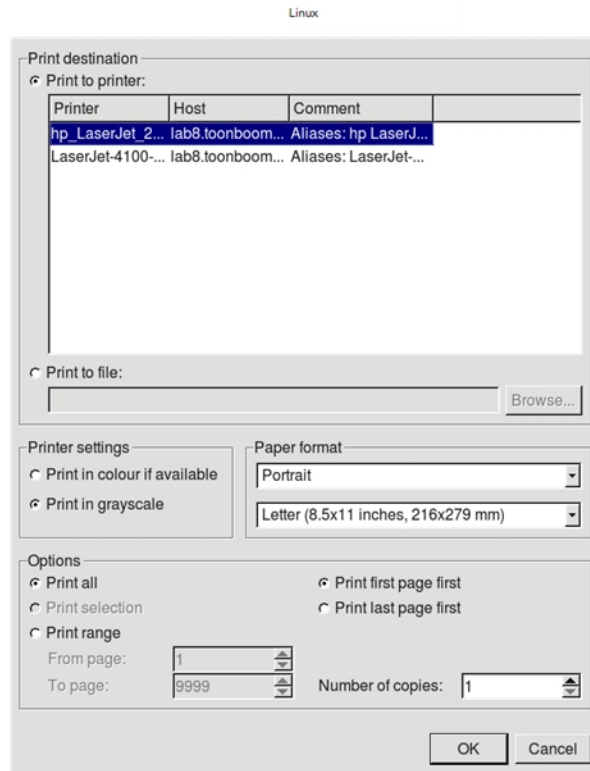
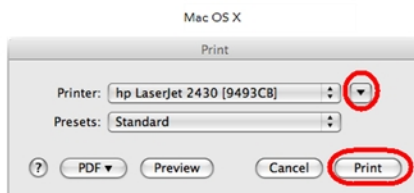
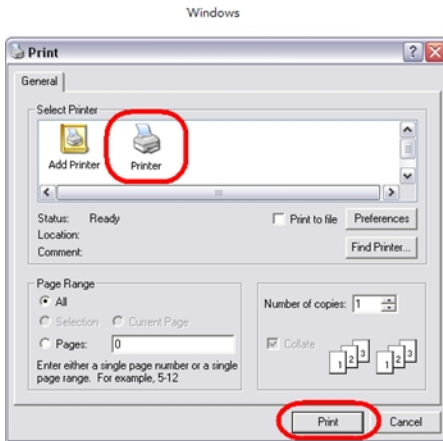
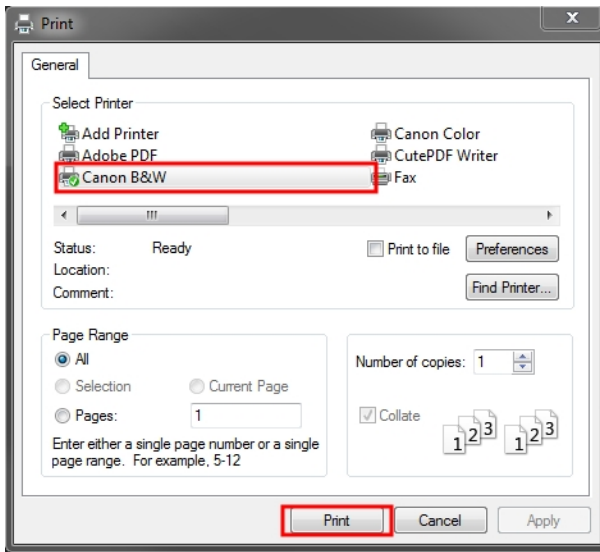

2. To set up your print:

- ▶ **Windows:** In the Select Printer section, select your printer and adjust the rest of the printing settings.
- ▶ **Linux:** In the Print Destination section, select your printer and adjust the rest of the printing settings.
- ▶ **Mac OS X:** In the Printer section, select your printer and adjust the rest of the settings by clicking on the Parameters  button. You can also click **PDF** and select an option from the menu if you want to save a PDF version of your exposure sheet.

Refer to your printer user guide to learn more about its options.

3. Do one of the following:

- ▶ **Windows and Mac OS X:** Click **Print**.
- ▶ **Linux:** Click **OK**.

| | A | B | C | D | Annotation |
|----|----|-----|---|----|------------|
| 1 | 1 | 001 | 6 | 1 | |
| 2 | 2 | 001 | 6 | 1 | |
| 3 | 3 | 001 | 9 | 1 | |
| 4 | 4 | 001 | 9 | 1 | |
| 5 | 5 | 001 | 9 | 1 | |
| 6 | 6 | 001 | 9 | 1 | |
| 7 | 7 | 001 | 1 | 1 | |
| 8 | 8 | 001 | 1 | 1 | |
| 9 | 9 | 001 | 3 | 1 | |
| 10 | 10 | 001 | 3 | 1 | |
| 11 | 11 | 001 | 1 | 1 | |
| 12 | 12 | 001 | 1 | 1 | |
| 13 | 13 | 001 | 5 | 1 | |
| 14 | 14 | 001 | 5 | 1 | |
| 15 | 15 | 001 | 2 | 1 | |
| 16 | 16 | 001 | 2 | 1 | |
| 17 | 17 | 001 | 7 | 1 | |
| 18 | 18 | 001 | 7 | 1 | |
| 19 | 19 | 001 | 2 | 1 | |
| 20 | 20 | 001 | 2 | 1 | |
| 21 | 21 | 001 | 7 | 2 | |
| 22 | 22 | 001 | 7 | 3 | |
| 23 | 23 | 001 | 4 | 4 | |
| 24 | 24 | 001 | 4 | 5 | |
| 25 | 25 | 001 | 9 | 6 | |
| 26 | 26 | 001 | 9 | 7 | |
| 27 | 27 | 001 | 2 | 8 | |
| 28 | 28 | 001 | 2 | 9 | |
| 29 | 29 | 001 | 4 | 10 | |



Chapter 4: Colour Styling and Colour Models

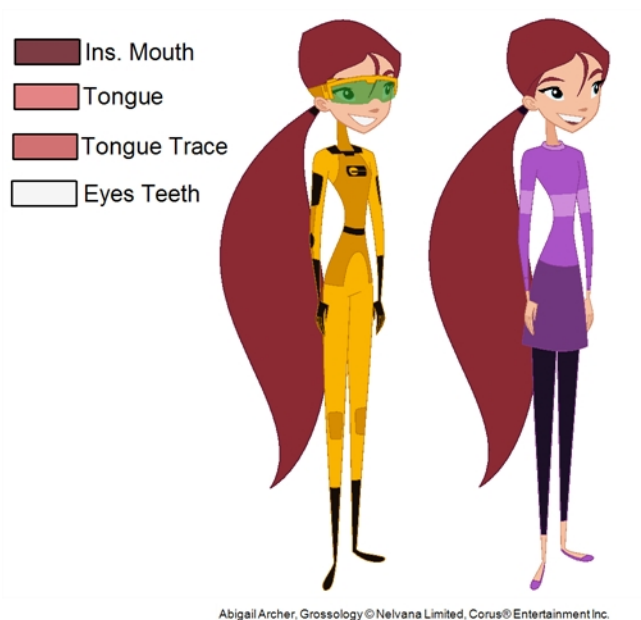

Once the characters, props and locations are designed, it is time for the colour styling and colour models creation. This is when the colours and moods are determined. The line models created during the design step are painted and organized as colour models for the colourists.

Harmony has a great concept of colour palettes. Each character can have its own set of colours that is carried through the entire project called the *master palette*. If the master is modified, the colours in the entire project are updated simultaneously.

By doing the colour styling in Harmony, your master palette will be created at the same time, so you do not need to use third party software. Also you will not have to recreate the colour palette again in Harmony. It is possible to create this step in an external software, but it is a great time saver to do it directly in Harmony.

To create the colour style and colour models, follow these steps:

- [Preparation on the next page](#)
- [Working with Palettes on page 121](#)
- [Colours on page 146](#)
- [Painting the Model on page 158](#)

Preparation

Before painting, you need to organize the colour model scenes and bring in your references. The colour styling preparation is done in five steps:

- [Colour Model Storage below](#)
- [Scene Creation below](#)
- [Setting Up the Workspace on the facing page](#)
- [Naming on page 118](#)

Colour Model Storage

First, you will need to create a storage location for all your models and palettes. The best way to do this is to create a colour model scene. There are different possibilities available to structure your designs and colour model scenes. We strongly recommend that you put all of your colour models in the same scenes. It is important to maintain a structure for your models so they do not end up scattered throughout the project.

There are four main model categories:

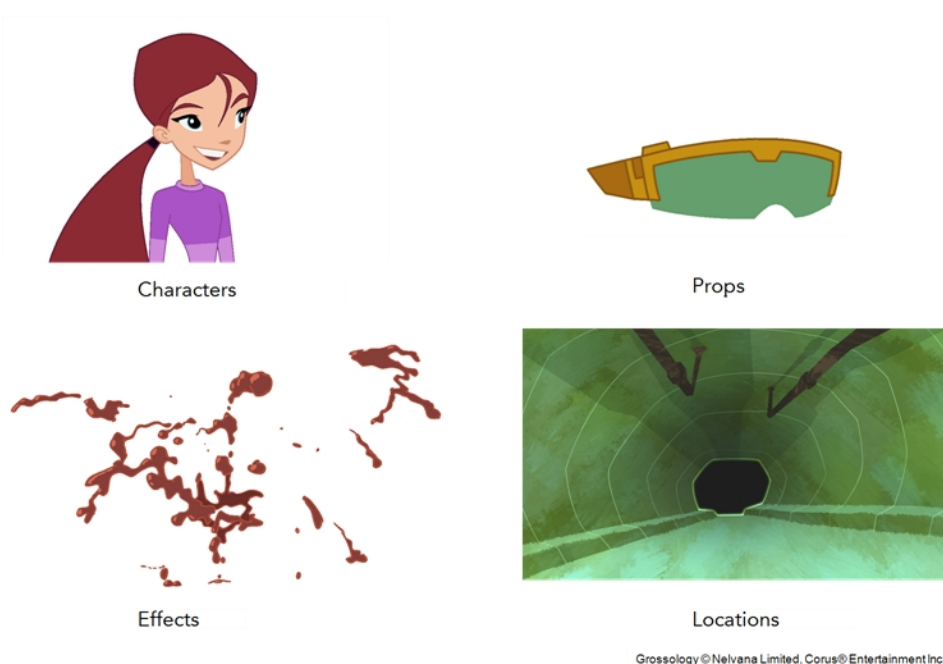

If you have a small project, such as a short or an advertising contract, you can always place all the characters, props, effects, and locations in the same scene. For large projects such as feature-length productions or series, you should create four separate model scenes following these categories.

Scene Creation

In order to create colour models, you need to create your scenes.

When working on a paperless or cut-out animation project, if you have designed your characters, props, effects and locations directly in Harmony, you can paint your models directly in your design scene. You can also create a new colour model scene and import your designs in that one. Refer to the Fundamentals Guide to learn more about creating a scene.

If you have not already done so, refer to the Fundamentals Guide to learn about production structure, file organization, and how to create a Project root directory. We recommend storing your colour model scenes in the root directory or in a colour models subdirectory for even better organization.

A useful way to name your colour model scene is to include the project name, then the colour model type such as characters, props, effects, or locations, and finally `colourmodel`. For example, a character colour model scene for the Adventure project would be named `adventure_characters_colourmodel`. This ensures that you always know what scene corresponds to what.

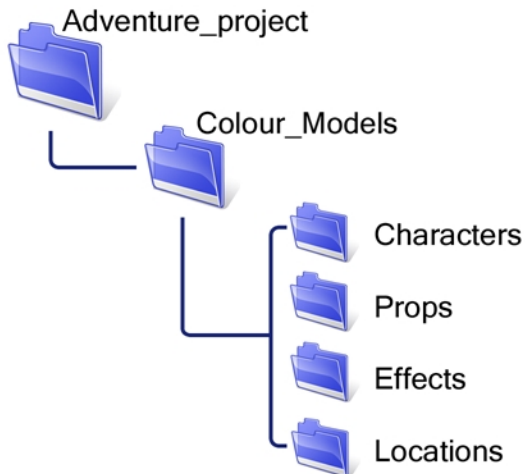

To learn how to create environment, job, and scene for your colour models, refer to the Control Center and Server Guide.

Colour Model Scene Structure

To store your colour models in a scene, it is recommended that you create one drawing layer for each character, prop, effect, or location. You should name these according to the model.

You can also load other colour references in the scene to balance your overall colours. For example, if you work in a character colour model scene, it is a good idea to import some of the key locations to compare and adjust the colours so they match well.

Setting Up the Workspace

Now that your scenes are created and structured, you can open the corresponding colour model scene. For the optimal workspace for inking and painting, set up your workspace with these views:

- Xsheet
- Camera
- Drawing
- Colour
- Model

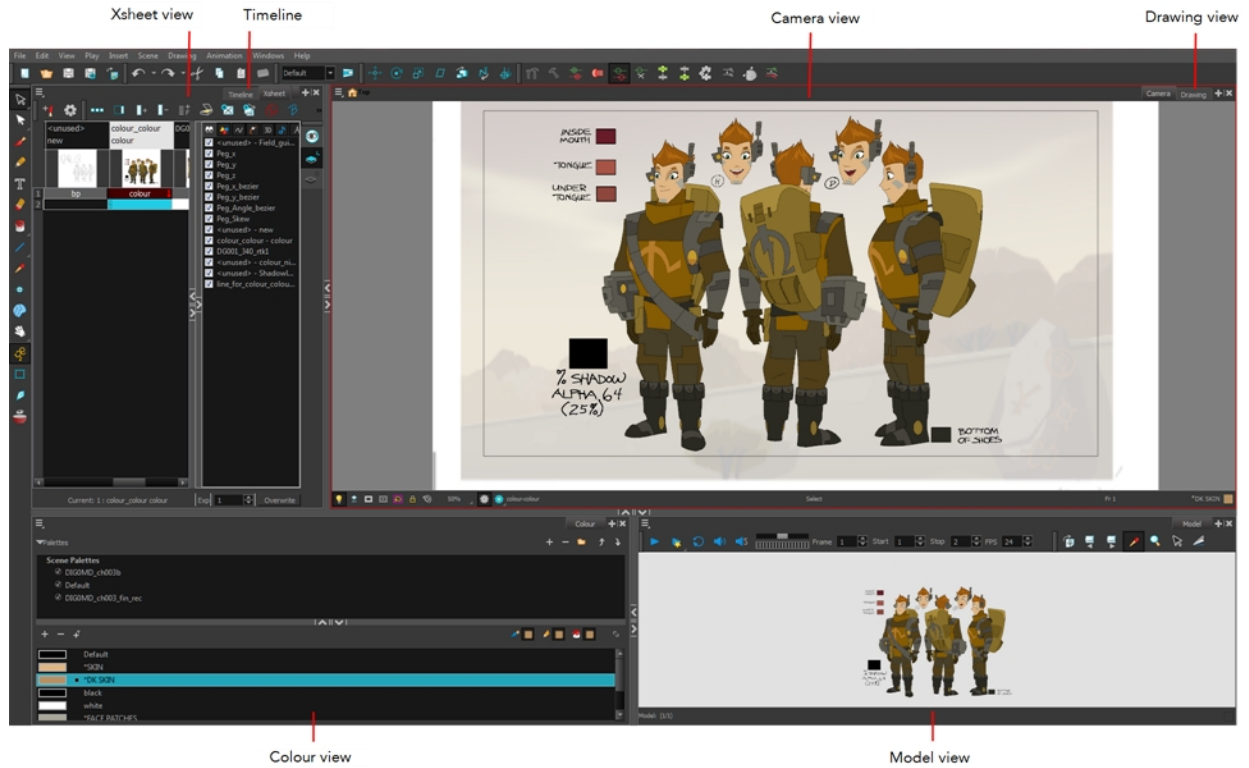

Erik, Di-Gata Defenders © Nelvana Limited, Corus@Entertainment Inc.

Naming

Now that your models are imported, you can rename them appropriately. You should rename elements (layers) and drawings corresponding to the model. This will help keep the work organized and make it easy for others to follow.

For example, if there is a black and white character model called **Erik** in one drawing element and its colour models in another one, rename your elements to include the character's name. For example, the colour model for Erik's armour could be named: **erik_armour_colour**.

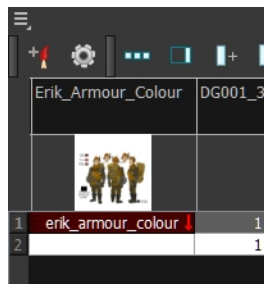

How to rename a drawing element

1. Do one of the following:

- ▶ In the Xsheet view, double-click on the column header of the drawing element.

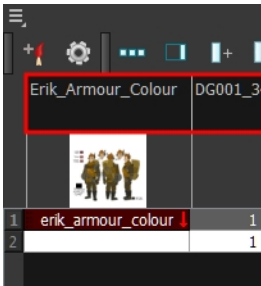

- ▶ In the Timeline view, double-click on the drawing element's layer.

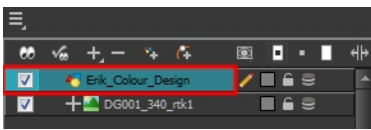

The Layer Properties window opens.

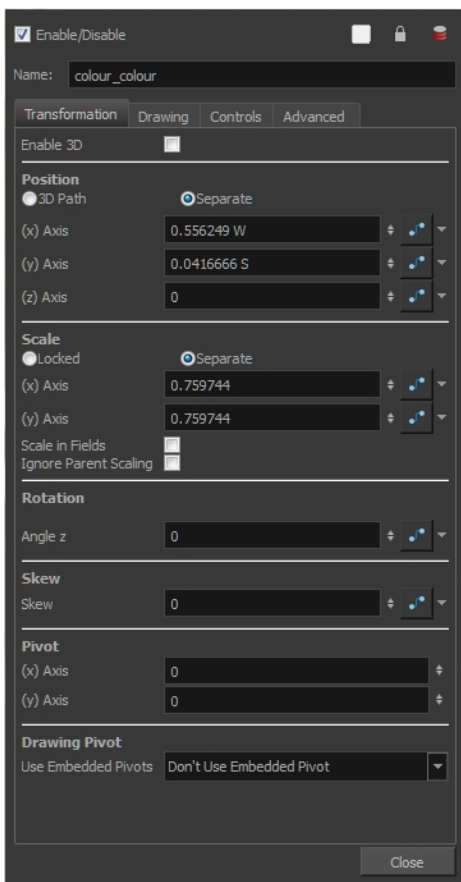

2. Type in a new name.

Name: colour_colour

How to rename a drawing

1. In the Xsheet view, click on a drawing name.



2. Do one of the following:
 - ▶ From the Xsheet menu, select **Drawings > Rename Drawing**.
 - ▶ Right-click on the drawing name and select **Drawings > Rename Drawing**.
 - ▶ Press Ctrl + D (Windows/Linux) or ⌘ + D (Mac OS X).

The Rename Drawing dialog box opens.

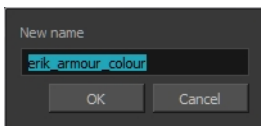

3. Type in a new name and click **OK**.

Working with Palettes

In animation, specific colours are used to paint each particular character. In order to maintain absolute consistency, a colour palette is created for each character, prop and effect throughout the production. These are referred to as **master palette**¹s.

Master palettes contain a colour swatch for each zone to colour with a precise RGBA colour value.

Using a master colour palette has many benefits, including:

- Each character consistently retains their dedicated colours.
- You cannot accidentally use a colour which is not in the master palette.
- Standardization and colour consistency throughout the production
- Multiple artists can use the same colour palette and produce the same results.

Toon Boom Harmony uses palettes to hold all the colours needed to paint your elements, allowing complete control and consistency in your painting process.

A **palette**² is created by assigning a set of colours to each character, prop or effect. You will create a new palette and add a new colour, known as a *colour swatch*, for each zone of the character, such as the skin, hair, tongue, shirt, pants, and so on.

In Harmony, palettes are individual files that you can copy, transfer, and store. Palettes have a ***.plt** file name extension—see [Palette File Storage](#) on page 125.

When a zone on the character is painted with the colour contained in a colour swatch, a link is automatically created between that colour swatch and the zone. This means that if the tint of the colour in the colour swatch is changed, any zone linked to it will update to the new tint. This is one way that colour palettes can save time and money in your production.

Another advantage of this system is that you can create complete palettes for different lighting situations. For instance, in addition to the regular palette for a character, you could have one for that character in the rain using colours that are duller and less vibrant than the dry daytime colours, or yet another for using in a night scene. Using palettes linked to your character in this way allows you to instantly change its colouring to suit the mood and atmosphere of the scene without tediously repainting each element.

¹A master palette is a group of colours attributed to a character or a prop. The palette is used throughout the entire production to maintain consistency in the look and to ensure that the same colours are used throughout the production. Also known as palette.

²A palette or master palette is a group of colours attributed to a character or a prop. The palette is used throughout the entire Toon Boom Studio project to maintain a consistency in the look and avoid the colour changing during the animation. Also referred to as a master palette.

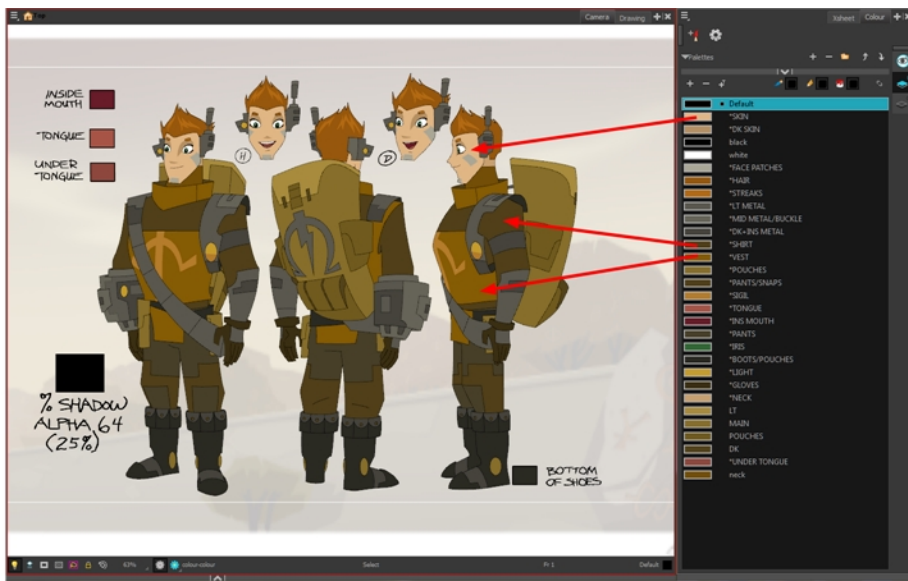

This section is divided as follows:

- [Palette Lists below](#)
- [Palette File Storage](#) on page 125
- [Creating a Colour Palette](#) on page 128
- [Duplicating a Colour Palette](#) on page 132
- [Cloning a Colour Palette](#) on page 134
- [Palette Operations](#) on page 136
- [Importing and Linking Palettes](#) on page 140

Palette Lists

The Colour view has two modes: basic and advanced.

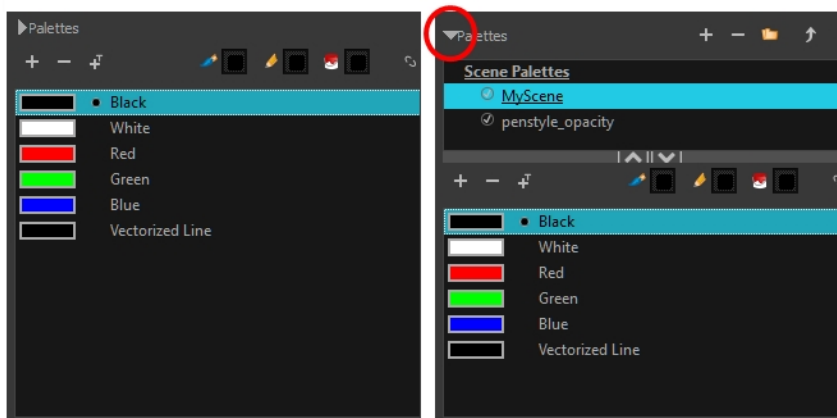

Basic mode

Advanced mode

- **Basic Mode**

The Colour view's basic mode only shows the Colour list. When you open Toon Boom Harmony, you only see the colours available in the Default palette which contains six basic colour swatches and is automatically named the same as your scene. For simple projects, you can manage with the default palette, but for movies, series, or shorts it is recommended that you create palettes for your characters. To create a palette, you have to switch to the Advanced mode of the Colour view and show the Palette list.

- **Advanced Mode**

The Advanced mode displays the list of all palettes that are linked to the scene. To create palettes for your characters, you must display the Palette list.

A palette list is a file containing all of the links to the original palette files. Every drawing layer has a palette list. The scene also has a palette list. For example, a drawing layer can use three different palettes stored in three different locations, while another drawing layer can use two of these palettes plus another one coming from another scene. The palette list keep track of the locations of the palettes.

There are two types of palette lists:

- **Scene Palette List**

The Scene Palette list is mainly used with cut-out animation, but is also very useful for paperless and traditional animations. A cut-out character will often be divided into 20 to 30 different drawing elements that use the character's master palette.

The palette list is stored at the scene level instead of the Element directory. This way, all palettes linked to this list will appear in every drawing element created in the scene. There is no need to manually load the palette in each element.

The Scene Palette list is the simplest one to use. By default, Toon Boom Harmony is set to use only Scene Palette lists.

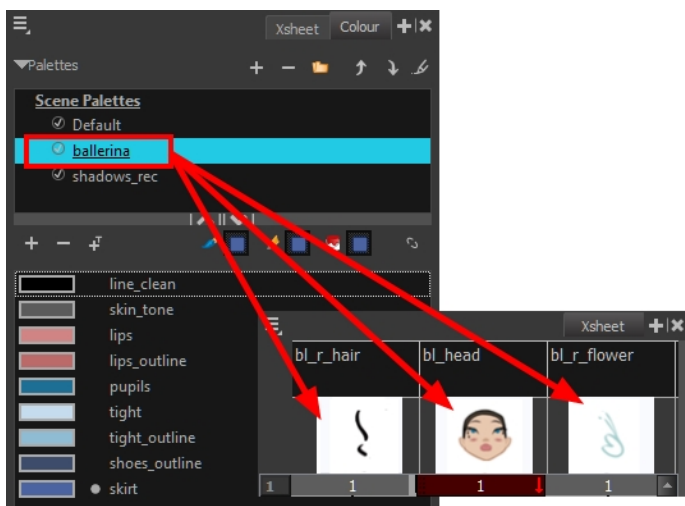

- **Element Palette List**

In Toon Boom Harmony, you can switch to Advanced Palette List mode and choose to save your palette at an element's level. The Element Palette list is mainly used with traditional and paperless animation. Unlike cut-out animation, all columns (drawing elements) contain different characters,

props, backgrounds, and effects. The Element Palette list is used when you do not necessarily want all of the palettes for all of your elements linked in every column.

The palette list is stored in the drawing element's directory instead of directly in the Scene level. This ensures that the links to the palettes appear only in the appropriate element. If you prefer to access a global palette list, link your palettes to the Scene Palette list.

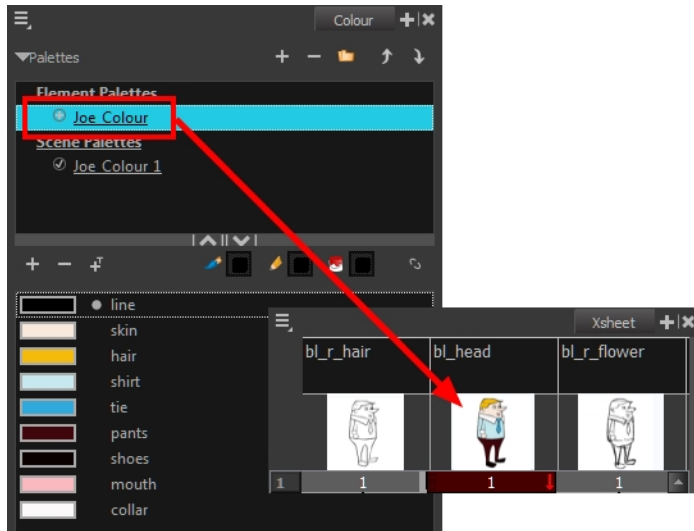

To prevent users from accidentally removing a link to a palette, the palette lists are locked. To link or create a new palette, the palette list must first be unlocked.

When you are using several cloned palettes that are related to the same original palette, Toon Boom Harmony uses the highest palette in the list to determine the colour of the painted zones—see [Cloning a Colour Palette on page 134](#).

How to show or hide the Palette list

- ▶ In the Colour view, click the Show/Hide Palette List View  button to expand or collapse the Palette List area.

The Palette List window opens and displays all your palettes.

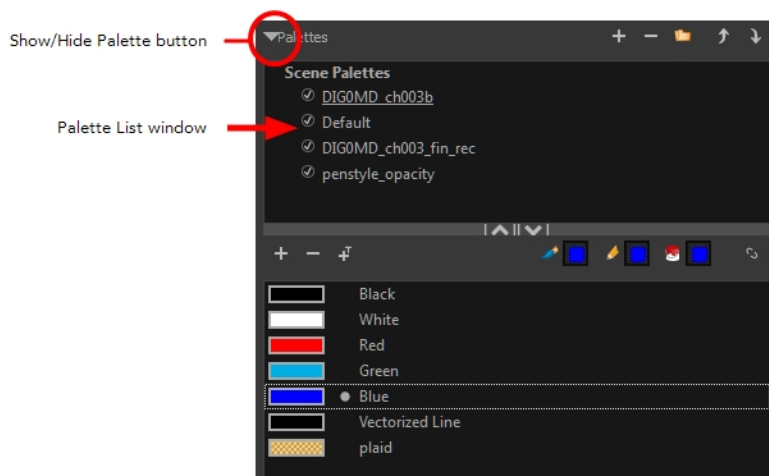

How to lock and unlock to the palette list

- ▶ From the top menu, select **Edit > Edit Palette List Mode**.

A grey pencil appears on the top-right corner of the Palette list to indicate that it can be modified.

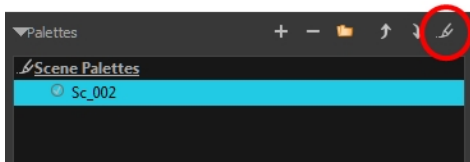

How to set the Advanced Palette Lists mode

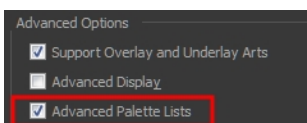

1. Do one of the following:
 - ▶ From the top menu, select **Edit > Preferences** (Windows/Linux) or **Stage > Preferences** (Mac OS X).
 - ▶ Press **Ctrl + U** (Windows/Linux) or **⌘ + U** (Mac OS X).
2. Select the **Advanced** tab.
3. Select the **Advanced Palette Lists** option.



4. Click **OK**.

How to reorder palettes in the Palette list

Do one of the following:

- ▶ From the Colour View menu, select **Palettes > Move Up** or **Move Down**.
- ▶ In the Palette list, click the Up  and Down  buttons.

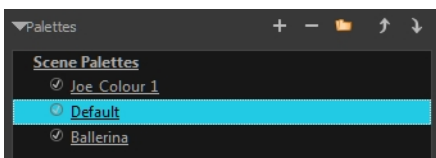

Palette File Storage

In Harmony, palettes are individual ***.p1t** files that can be copied, transferred and stored. When a palette is created from Harmony, it needs to be stored somewhere. By default, the palette file is stored in the scene directory in a palette-library folder unless you specify a different location. There are four locations where you can find palette-library folders:

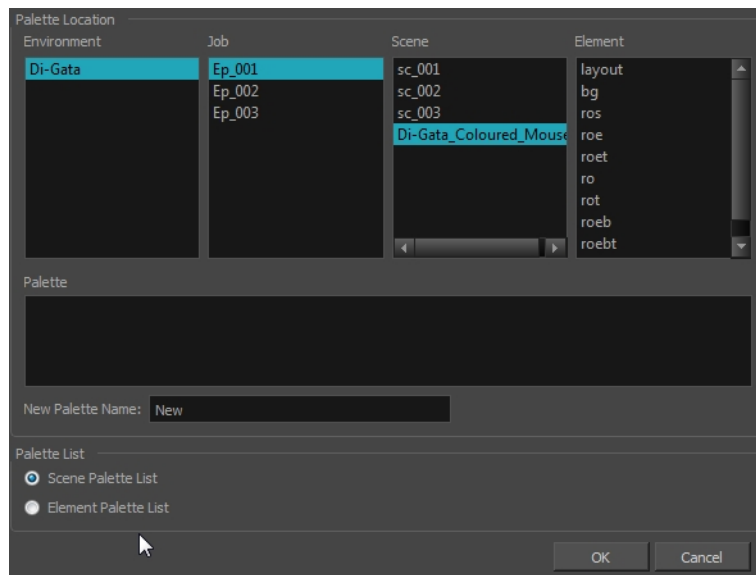

- **Element**

The Palette Library folder is stored directly in the drawing Element folder.

- **Scene**

The Palette Library folder is stored directly in the Scene folder.

- **Job**

The Palette Library folder is stored in a Job folder contained in the Scene folder.

- **Environment**

The Palette Library folder is stored in an Environment folder contained in the Scene folder.

By default, the palette is stored at the scene level. For simple projects and standalone projects, it is recommended to keep it as is. If you work with a larger studio, it is recommended to verify with them on the file structure.

This existing structure is compatible with Toon Boom Harmony Server. Toon Boom Harmony's database has a leveled structure starting from the Environment down to the Element. Its client-server configuration allows all data, such as palettes and scenes, to be shared between a series of client machines.

Element Level

Working with Harmony as a stand alone, the Element level is very useful when there are a lot of different palettes. When a colour model drawing is created, it is stored in its element folder. By storing the corresponding palette file with the colour model, the colourist can load them both from the same location. This also creates a more organized structure.

Scene Level

Working with Toon Boom Harmony as a stand alone, a palette file can also be saved at the scene level, so that all of the palettes from the scene are stored together. The palette naming must be structured so the colourist or character builders can find the correct one. Saving the palettes at the scene level makes it very easy to back up the palettes and retrieve their location.

The scene level can also be useful for cut-out animation. Instead of creating a colour model scene that includes all of the characters, props, effects, and location, the colour palette or model will often be directly imported to, or created in, the character building scene. Just as with a cut-out character building scene, each element uses the same palette so it would not be efficient to save the palette inside one element. Instead, it is saved at the scene level. This prevents a palette overload because all of the models are in different scenes. It also allows each scene to have its own set of palettes corresponding to its model.

When working on a cut-out animation production, it is highly recommended that you work with the Scene level.

Where to Save the Palette File

The palette storage location depends on the type of production and the backup plan being used. Some studios like to store their palettes at the Element level and others at the Environment level as this will not create a problem so long as the scene is in the Harmony structure. In fact, as long as the Harmony structure is maintained it can be stored at any level. However, difficulties may occur when the scene is backed up or transferred to another studio or database and removed from the structure.

What happens when you export a palette file?

It is important to understand what is happening to a palette file when the scene is exported.

Because of the Harmony client-server configuration, all of the data can be shared through all of the scenes in the database. This also includes the palette files, even if they are stored at the Element, Scene, Job, Drawing or Environment level. The palette files can be accessed from any scene of any project.

When you export scenes from Harmony to either archive or send them to other users or studios, the palettes stored in external scenes, jobs or environment will **NOT** be exported.

An exported scene will carry palettes stored in its own Element's Palette Library, scene's palette library, the Job and the Environment where it is stored. Any other palette from other Environments, Jobs, Elements or Scenes (even from the same job) will **NOT** follow. Instead a recovery palette will be created when the scene is reopened in another Harmony system. A recovery palette is a local palette created by the system when palettes and colours are missing. This palette is no longer shared with the rest of the project.

For example, in the following chart, if you export Scene 2 from Job 1, the package will carry the palettes from Scene 2, Job 1 and Environment. It **WILL NOT** carry the palettes from Element 3 in Scene 1, Scene 1 and Job 2. If Scene 2 was linked to any of these, the system will create a recovery palette the next time Scene 2 is opened in another Harmony system.

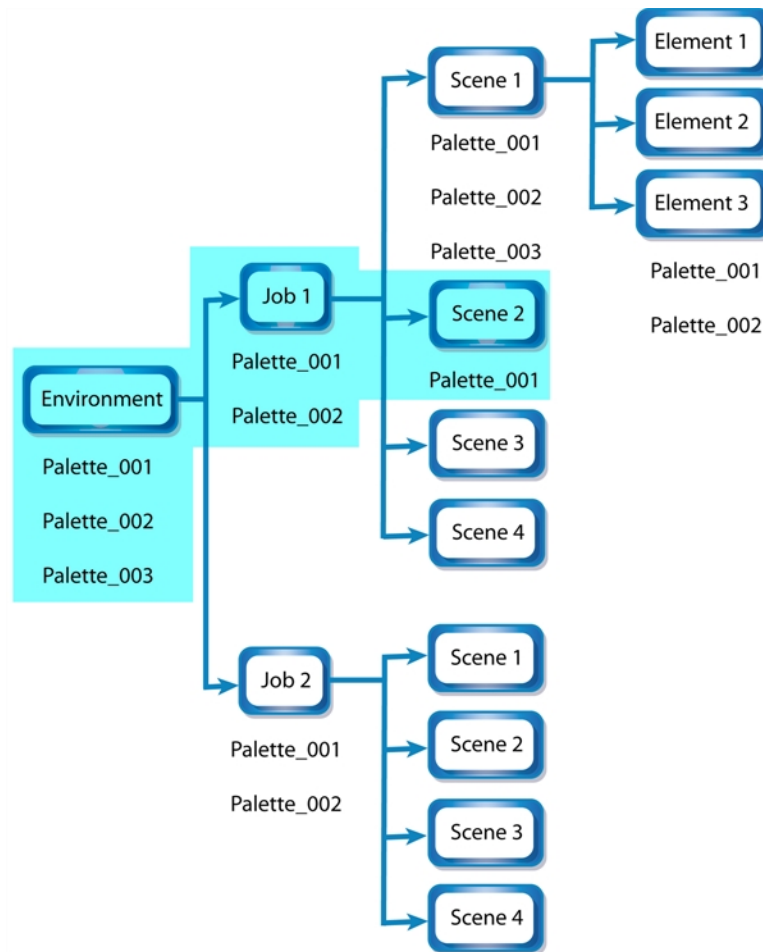

The best place to store your palette is:

- Environment level for a movie or series
- Job level for a publicity or small project
- Scene level for a student exercise

To store your palette with their colour models, you can use the Element level, however, it will require more structure when exporting the scenes. The scene will have to be exported along with its colour model scene. The other studio you are working with must recreate an identical structure to yours, then import the received scenes into the same location as you have them in order to maintain the links.

Palette Backup

When sharing palettes between scenes, some users may accidentally modify the colours, even though the palettes are locked by default. That is why it is a good idea to copy and back up your palette libraries and master palette directories.

When a palette file is copied, it automatically becomes a clone palette, so there will not be any trouble replacing an altered file. Harmony automatically updates all of the files and drawings linked to it.

Creating a Colour Palette

You can create a palette in either Basic or Advanced mode.

By default, Toon Boom Harmony is set to the Basic mode. For simple productions, it is recommended to use the Basic mode. This setting stores the palettes automatically for you and saves them at the Scene level. When you use the Advanced Palette Lists mode, you can decide at which level you want to store your palettes: Environment, Job, Scene, or Element.

If you are using Harmony Network, see [Palette File Storage](#) on page 125.

Before you can create a palette in the Advanced Palette Lists mode, you must first set your preferences to Advanced Palette Lists mode in the Preferences dialog box. You also need to have the rights to modify the palette list. If you do not, select **Edit > Edit Palette List Mode** from the top menu.

You can remove palettes from your Palette list if they are not needed in your scene. The actual palette file will not be deleted and you can reimport it in your Palette list later on.

How to set the Advanced Palette Lists mode

- Do one of the following:
 - From the top menu, select **Edit > Preferences** (Windows/Linux) or **Stage > Preferences** (Mac OS X).
 - Press **Ctrl + U** (Windows/Linux) or **⌘ + U** (Mac OS X).
- Select the **Advanced** tab.
- Select the **Advanced Palette Lists** option.

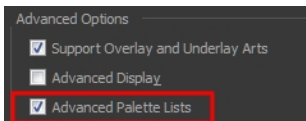

- Click **OK**.

How to create a new palette (Basic Palette Lists mode)

- From the Colour View menu, select **Palettes > New** or click the New Palette **+** button.
 - Make sure that you have the necessary rights to modify the palette list. If you do not, select **Edit > Edit Palette List Mode**.

The Create Palette window opens.

- Enter the palette name according to the model.

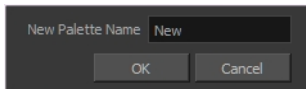

- Click **OK**.

The palette appears in the drawing element's palette list.

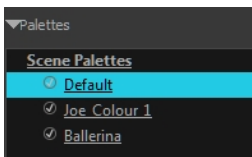

How to create a palette from the Advanced Palette Lists mode

1. In the Timeline or Xsheet view, select the drawing that requires a palette.
2. Make sure that you have the necessary rights to modify the palette list. If you do not, select **Edit > Edit Palette List Mode**.
3. In the Colour view, click the **Show Palette List View** button to display the palette list.

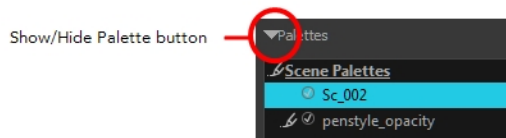

4. Do one of the following:
 - ▶ From the Colour view menu, select **Palettes > New**.
 - ▶ Click the Create Palette **+** button.

The Palette Browser: Create Palette dialog box opens.

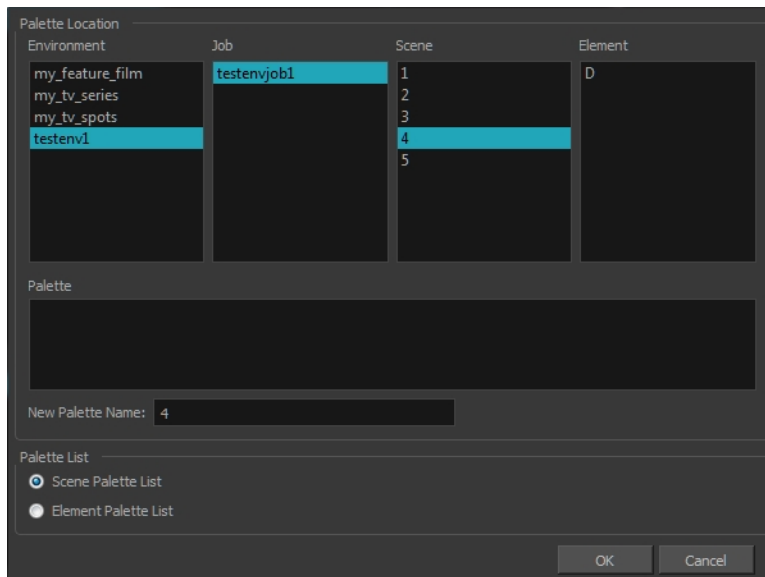

5. Select the level to store the palette file.
 - ▶ **Environment:** The palette-library folder is stored in the scene's parent environment folder.
 - ▶ **Job:** The palette-library folder is stored in the scene's parent job folder.
 - ▶ **Scene:** The palette-library folder is stored directly in the scene folder.
 - ▶ **Element:** The palette-library folder is stored directly in the drawing element folder.

When you select a level that has a palette stored in it, the palette names are displayed in the Palette field.

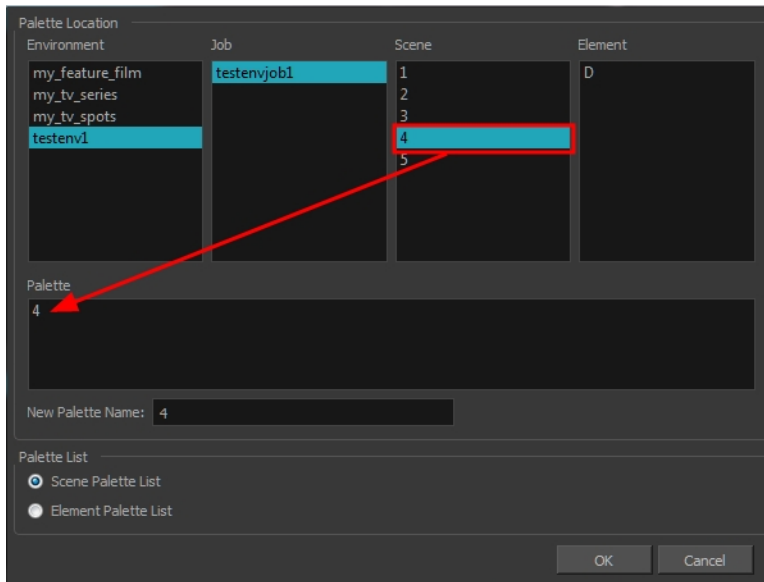

6. Name the palette. There is no need to add the suffix "palette" to the name as it is always recognized as a palette file.

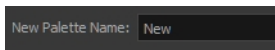

7. Select a Palette List option.

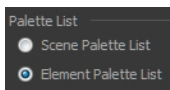

- ▶ The Scene Palette List is mainly used with cut-out animation. A cut-out character will often be divided in twenty to thirty different drawing elements that use the character's master palette.
The palette list is stored at the scene level instead of the Element directory. This way, all palettes linked to this list will appear in every drawing element created in the scene. There is no need to manually load the palette in each element.
- ▶ The Element Palette List is mainly used with traditional and paperless animation. Unlike cut-out animation, all columns (drawing elements) contain different characters, props, backgrounds and effects. The Element Palette List is used because you do not necessarily want all of the palettes for all of your elements linked in every column.
The palette list is stored in the drawing element's directory instead of directly in the Scene level. This ensures that the links to the palettes appear only in the appropriate element. If you prefer to access a global palette list, link your palettes to the Scene Palette List.

8. Click **OK**.

The new palette appears in the palette list.

How to rename a palette

1. In the Colour view, select the palette to rename.



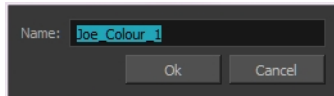

2. Do one of the following:
 - Right-click and select **Rename**.
 - From the Colour View menu, select **Palettes > Rename**.
3. In the Rename dialog box, give the palette a new name and click **OK**.

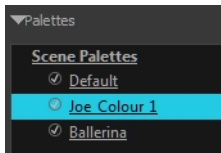

How to remove a palette

1. In the Colour view, select the palette to remove.



2. Do one of the following:
 - From the Colour View menu, select **Palettes > Remove**.
 - Right-click on the selected palette and select **Remove**.
 - Click the Remove Palette  button located above the Palette list.

If the palette was used in your scene, the zones painted with its colours turn red.



Duplicating a Colour Palette

A duplicated palette is a simple copy of the original palette. It uses the same names, colour values, but has a different ID and is independent from the original palette. This ensures that both palettes are completely independent.

This option is used when there are similar models and you want to avoid recreating and naming all of the colours. You can change the values and the names afterward without affecting the original palette. You can also keep some RGBA values, such as the eyes, teeth, tongue, inside mouth, etc.

How to duplicate a palette

1. In the Colour view, select the palette to be duplicated.

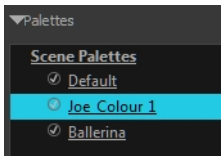

2. Do one of the following:
 - From the Colour View menu, select **Palettes > Duplicate**.
 - Right-click on the selected palette and select **Duplicate**.

The Palette Browser: Duplicate Palette window opens.

3. If you are in Advanced Palette List mode, select the palette storage level—see [Palette File Storage on page 125](#).

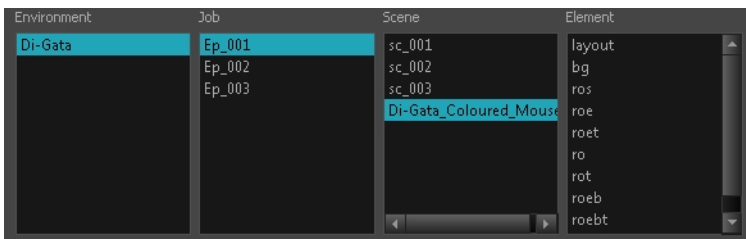

4. In the New Palette Name field, name the palette.

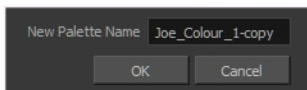

5. In the New Palette Name field, name the palette.
6. Click **OK**.

The palette appears in the palette list.

Cloning a Colour Palette

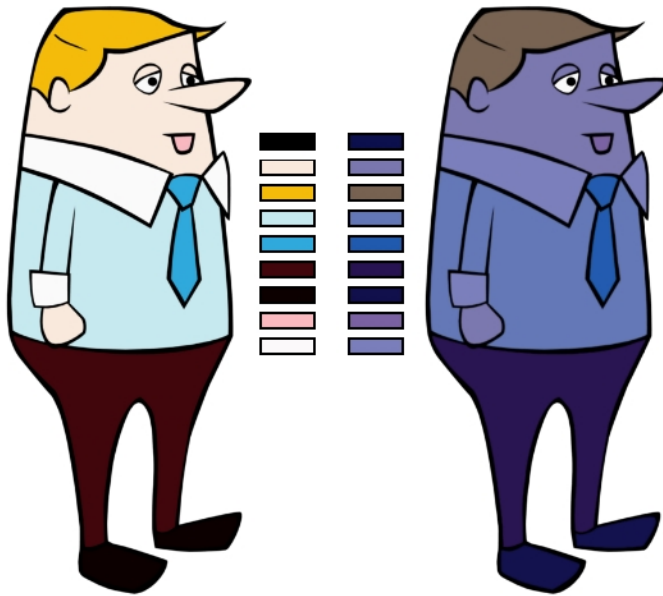

A character usually has only one master palette, although there are times when the characters are placed in different lighting conditions and require a different colour shading. The night palette is a popular choice when a scene or sequence changes from day to night. It can be difficult and time-consuming to repaint everything and creating two independent palettes can be quite complex. As an alternative, Toon Boom Harmony provides clone palettes.

The clone palette is a copy of the master palette. The colours in each palette have the same properties. The colours have the same identification number pointing to the same colour zones, but they can have different names and RGBA values. Depending on the activated palette (night or day), the painted drawing will update. So there is no need to repaint the animation, but to create or import a clone palette (palette style).

How to clone a palette

1. In the Colour view, select a palette to clone.

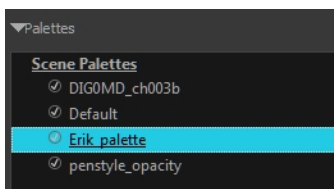

2. From the Colour View menu, select **Palettes > Clone** or right-click and select **Clone**.

The Palette Browser: Clone Palette dialog box opens.

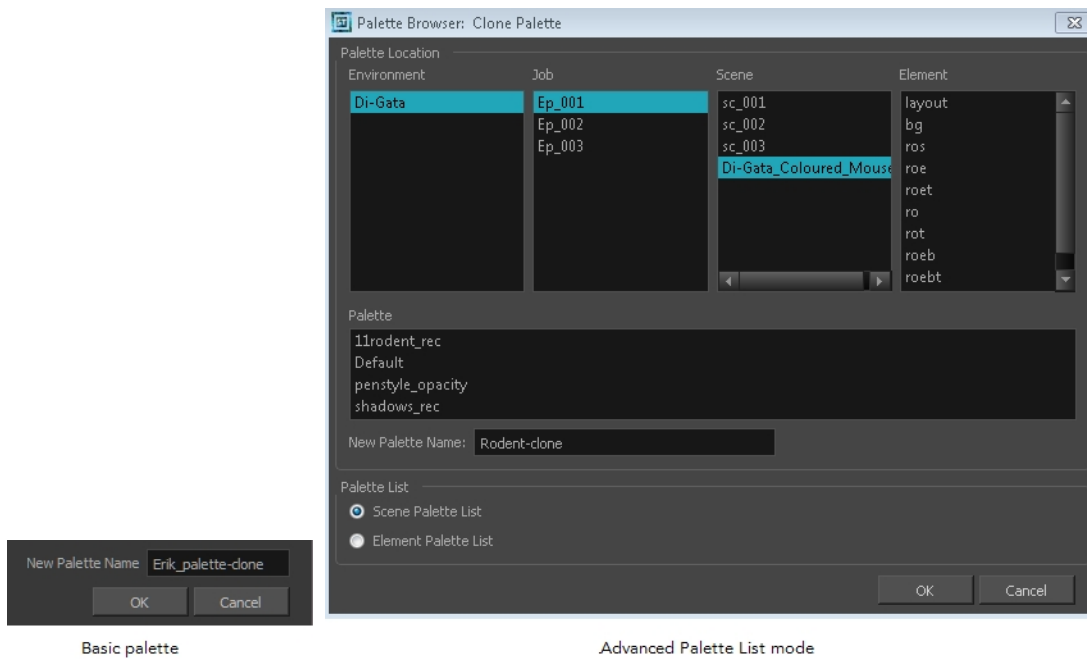

3. If you are in Advanced Palette List mode, select the palette storage level—see [Palette File Storage on page 125](#).

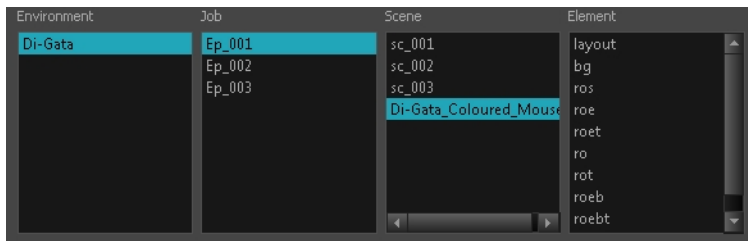

4. In the New Palette Name field, name the palette. It is recommended that you keep the "-clone" in the name.
5. Click OK.

The cloned palette appears in the palette list.

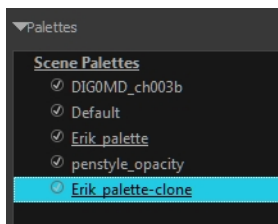

6. In the Palette list, select the clone palette you created to offset or blend colours—see [Mixing Colours on page 155](#).
7. From the Colour View menu, select **Palettes > Tint Panel** or right-click and select **Tint Panel**. The Blend/Offset Tint panel opens.

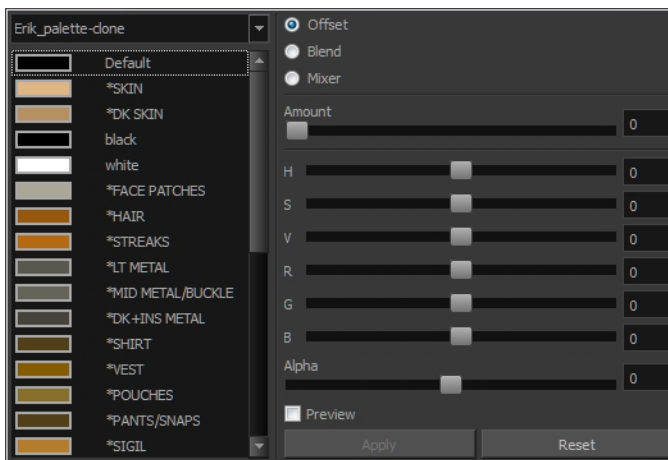

8. Select one or more colours to modify. You can select all your colours by pressing Ctrl + A (Windows/Linux) or ⌘ + A (Mac OS X).
9. Offset, blend, or mix the colours using the sliders and increasing the Amount value.

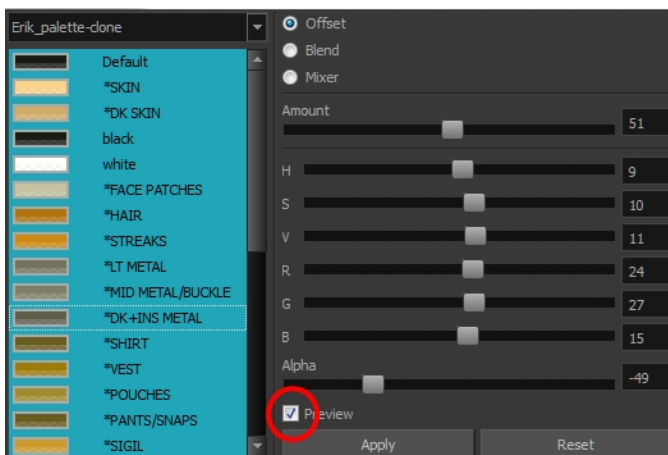

10. Select the **Preview** option to see a preview of the colours while you adjust them.

You can also modify the colours individually with the Colour Picker window.

Palette Operations

When you start Toon Boom Harmony connected to the database, you can access the Palette Operations dialog box which lets you clone, rename, or delete palettes.

How to open the Palette Operations dialog box

1. Start Harmony and log in.
2. Close the Database Selector dialog box.
3. From the top menu, select **Tools > Palette Operations**.

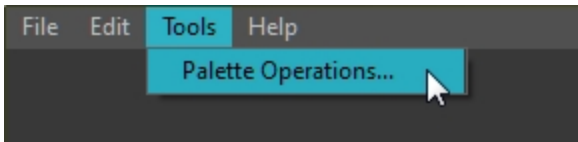

The Palette Operations dialog box opens.

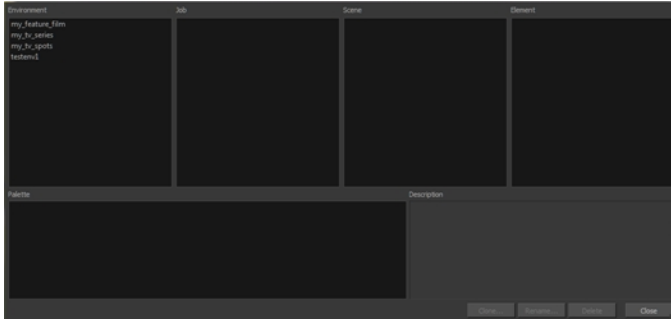

How to clone a palette in the Palette Operations dialog box

1. Select the palette you want to clone at the location and level in which it was stored.

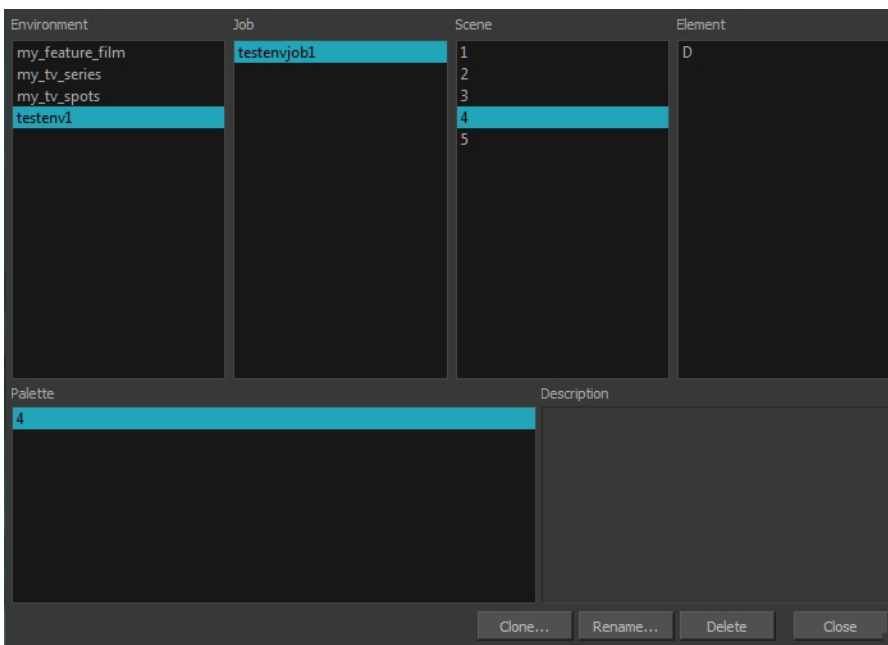

2. Click **Clone**.

A Warning dialog box opens.

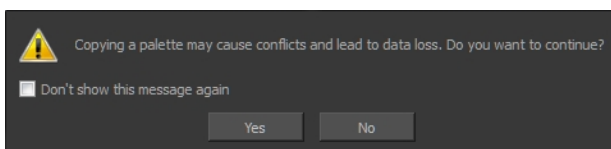

3. Select the **Don't show this message again** option if you do not want to see this message every time you perform this operation.
4. Click **Yes**.

The Palette Browser dialog box opens.

5. Select the level to store the palette file.

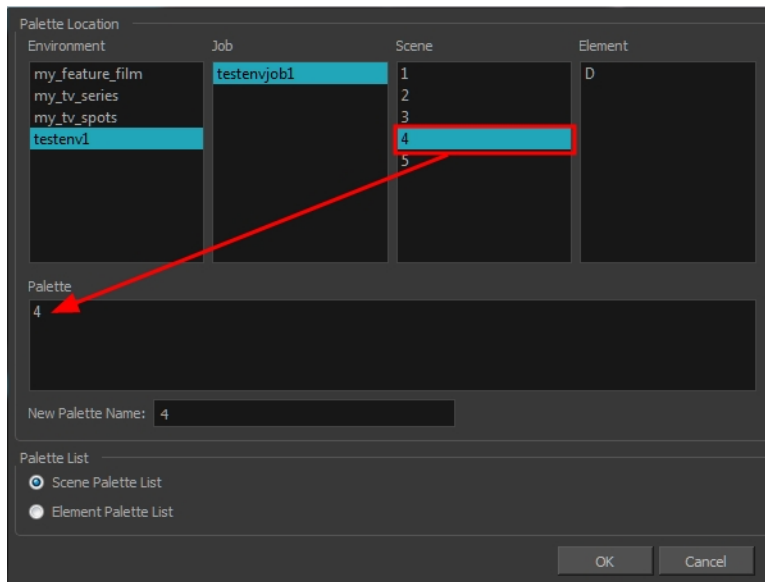

6. Name the palette. There is no need to add the suffix "palette" to the name as it is always recognized as a palette file.

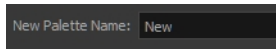

7. Select a Palette List option.

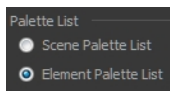

- ▶ The Scene Palette List is mainly used with cut-out animation. A cut-out character will often be divided in twenty to thirty different drawing elements that use the character's master palette.

The palette list is stored at the scene level instead of the Element directory. This way, all palettes linked to this list will appear in every drawing element created in the scene. There is no need to manually load the palette in each element.

- ▶ The Element Palette List is mainly used with traditional and paperless animation. Unlike cut-out animation, all columns (drawing elements) contain different characters, props, backgrounds and effects. The Element Palette List is used because you do not necessarily want all of the palettes for all of your elements linked in every column.

The palette list is stored in the drawing element's directory instead of directly in the Scene level. This ensures that the links to the palettes appear only in the appropriate element. If you prefer to access a global palette list, link your palettes to the Scene Palette List.

8. Click OK.

How to rename a palette in the Palette Operation dialog box

1. Select the palette you want to rename at the location and level in which it was stored.

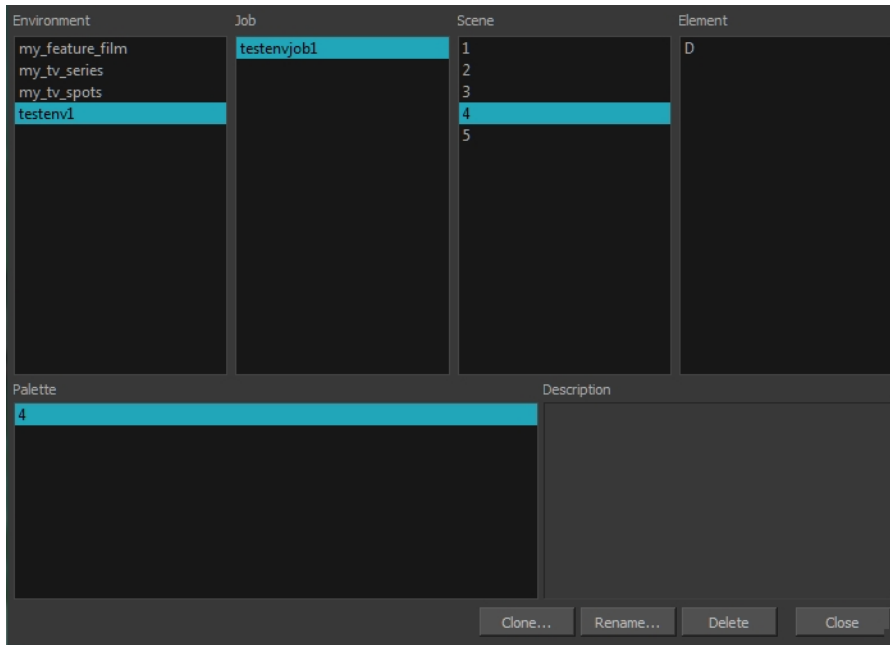

2. Click **Rename**.

A Warning dialog box opens.

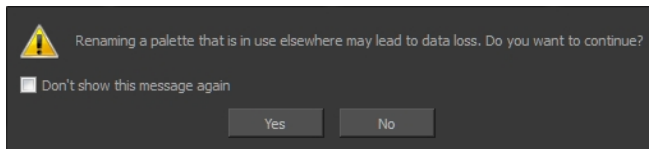

3. Select the **Don't show this message again** option if you do not want to see this message every time you perform this operation.
4. Click **Yes**.

The Rename Palette dialog box opens.

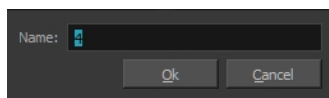

5. Type in a name for the palette.
6. Click **OK**.

How to delete a palette in the Palette Operation dialog box

1. Select the palette you want to delete at the location and level in which it was stored.

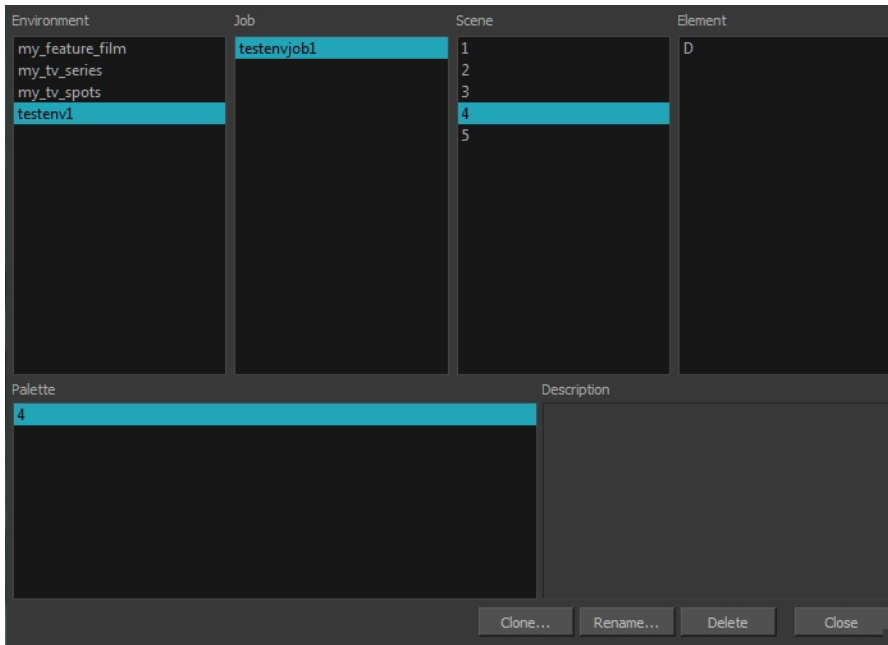

2. Click **Delete**.

A Warning dialog box opens.

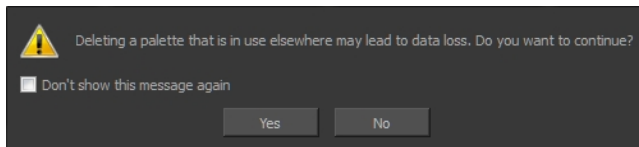

3. Select the **Don't show this message again** option if you do not want to see this message every time you perform this operation.

It is not recommended to disable the warning message as deleting a palette cannot be undone.

4. Click **Yes**.

Importing and Linking Palettes



Before starting colouring work such as Ink and Paint or even creating new colour models, you may want to load existing colour palettes to your scene. You can do so by linking colour palettes to your palette lists.

You may encounter a case where only a colour palette is visible when a layer is selected. If you need that palette in a second layer, you can link the palette to the second layer's palette list. A good example would be a scene where there is a character on one layer and its arm is on another. In order for both layers to access the palette, you must link both Element Palette lists to that palette. If you palette is linked to the Scene Palette list, it will be accessible by all layers.

If you created a palette in another project and you want to import it in your current project, you can browse for the palette file on your computer and add it to your scene. When the palette is imported in your scene, the file is copied in the project's directory. It is not linked to the original file.

Harmony lets you link an external palette to your scene without copying it in your project. This method is not recommended. It is always safer to have the palettes contained within the database to avoid data loss if the source palette were to be deleted or the project exported without including the external palettes.

You will notice that when you create or link a palette, a small icon appears on its left. These icons represent the palette linkage status.

| Icon | Description |
|-------------------------------------------------------------------------------------|--------------------------------------------------------------------------------------------------------------------------------------------------------------------------------------------------------------------------------------------------------------------------------------------------------------------------------------------------------------------------------------------------------|
|  | <p>Indicates that the palette is safe.</p> <p>There won't be any trouble once the scene will be exported. For example, the palette file is stored in the scene folder and is linked to the Scene Palette List.</p> |
|  | <p>Indicates that the palette file is stored in a directory external to the scene's structure.</p> <p>The palette file is probably stored in a Master Palette directory on a hard drive external to the palette-libraries planned for the palette storage. The warning in this case is that if you move your Master Palette directory to another location, you may lose the palette in your scene.</p> |
|  | <p>Indicates that a palette file stored in a level such as Element, Scene, Job or Environment is linked to a Palette list that is not on the same level.</p> <p>For example, a palette file is stored into the Environment folder and is linked to the Element Palette list. The palette is shared.</p> |

How to link a colour palette

- Do one of the following:
 - From the Colour View menu, select **Palettes > Link**.
 - Right-click and select **Link**.
 - Click the Import  button.

The Palette Browser: Link Palette dialog box opens.

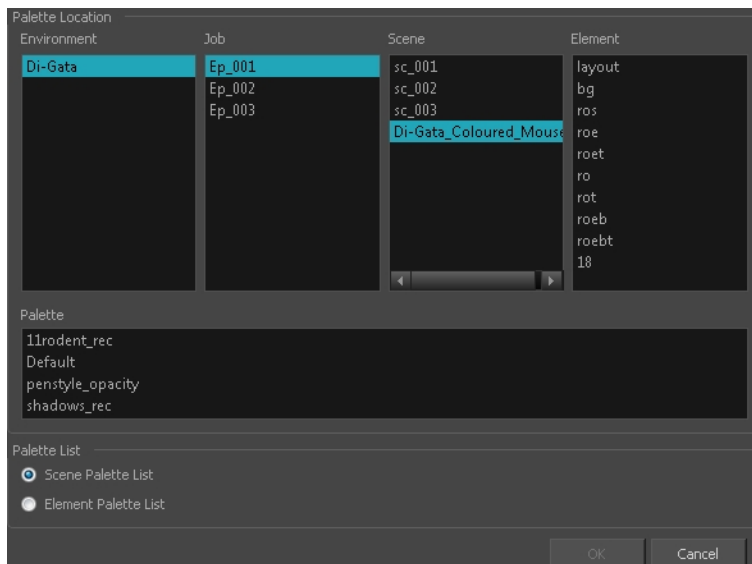

2. Select the level where the palette file is stored—see [Palette File Storage](#) on page 125.
3. Select the palette list linking level by enabling either **Scene Palette List** or **Element Palette List**—see [Palette Lists](#) on page 122.

The palette appears in the Colour view.

How to import a palette into your project

4. Do one of the following:
 - From the Colour View menu, select **Palettes > Import**.
 - Right-click and select **Import**.

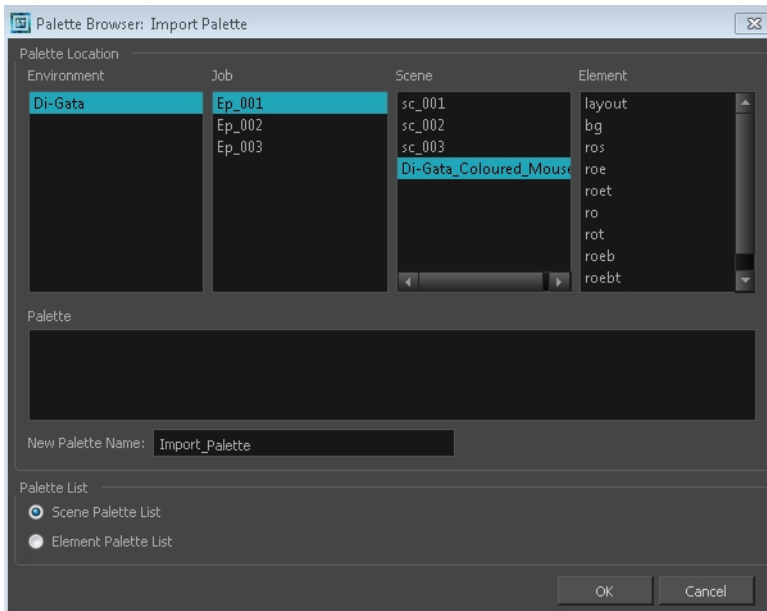

The Browser window opens.
5. Browse for a palette file located (***.plt**) on your hard drive. You will generally find the palettes in your project's palette-library directory.
6. Click **Open**.

The Palette Browser opens.



7. If you are in Advanced Palette mode, select the level where the palette file is stored—see [Palette File Storage on page 125](#).
8. If you are in Advanced Palette mode, select the palette list linking level by enabling either **Scene Palette List** or **Element Palette List**—see [Palette Lists on page 122](#).
9. In the New Palette Name, name the imported palette.
The palette appears in the Colour view and the file is copied in your project.

How to link to an external palette

1. In the Colour view, click on the **Create Palette**  button to create your palette to be used as external.
2. Save your scene by selecting **File > Save** from the top menu or by clicking the Save  button or press Ctrl + S (Windows/Linux) or ⌘ + S (Mac OS X).
3. On your computer or server, create a master directory. Ideally, this should be created in your Root folder to keep it within the project directory. You could also place it inside your Colour Model's subdirectory. Refer to the Fundamentals Guide to learn more about project organization.

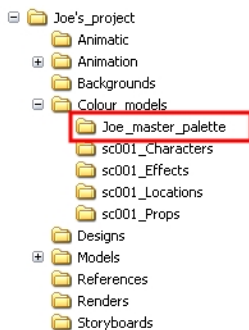

4. Name the folder appropriately, for example: **Joe_master_palette**.
5. From your operating system, browse to your Toon Boom Harmony scene and open the palette-library folder.

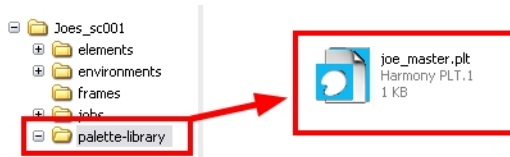

6. Select and copy your palette *.plt file to copy it to the master palette directory.

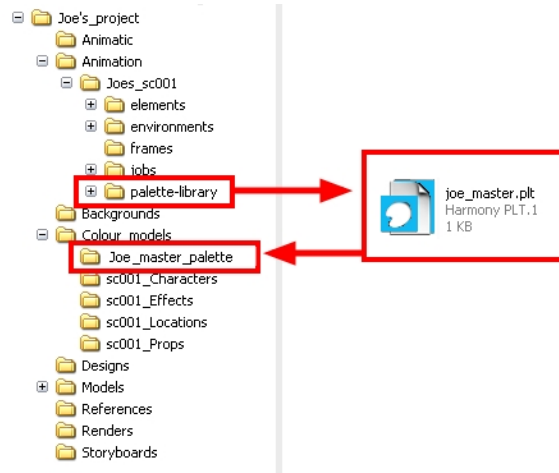

7. Create a new Toon Boom Harmony scene or open the scene where you will link this palette.
8. In the Timeline or Xsheet view, select the element to link the palette to.

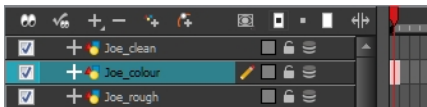

9. From the Colour View menu, select **Palettes > Link to External**.

The Link to External Palette dialog box opens.

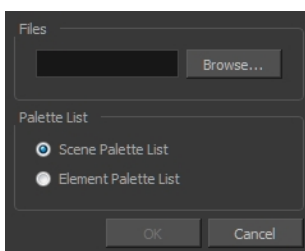

10. Click **Browse** to search for your master palettes folder and select the palette *.plt file you want to link.
11. In the Palette list section, select how you want to load the palette; at the scene or element level.
12. Click **OK**.

The linked palette appears in the Colour view.

If a palette is outside the scene, the External  icon appears beside the palette name.

To link an element (such as a colour model) to the palette that is stored in the external palette directory, you must remove the original palette from the element's palette list. You will then load the duplicated palette into the palette list using the Link to External command, like you did for the other elements.

Colours

Toon Boom Harmony has some very powerful colouring features when it comes to painting. To paint your drawings, you will use different colour swatches, unlike some other painting programs where you modify the main swatch each time you want to paint with a different colour.



In the Colour view, you choose a different colour swatch for each colour you want to paint in your drawing. You can add as many swatches as you want. You can also rename them and modify existing ones.

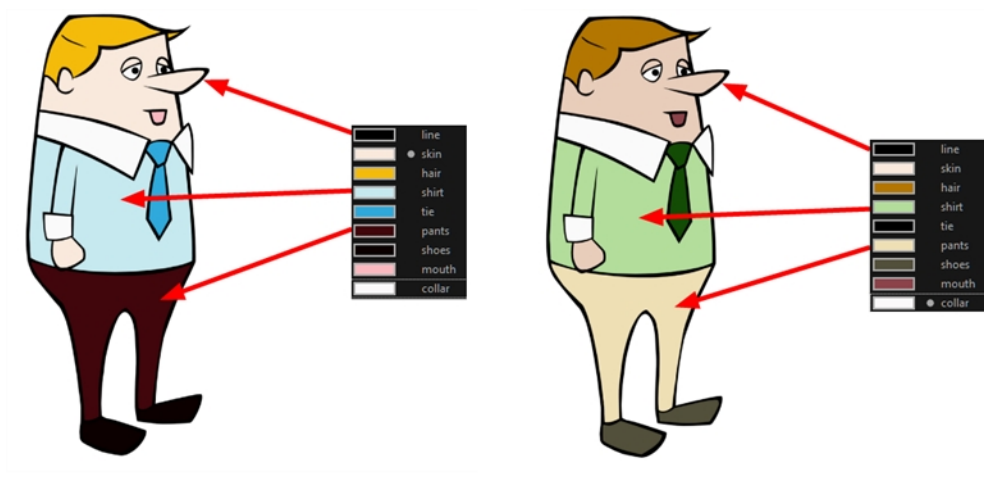

When you modify the colour of an existing swatch, it automatically updates all the zones painted with this swatch throughout the entire project. The colour swatch has a unique ID number that associates it with the painted zones. This way, you can change the look of your character at any time without having to repaint it!

This section is divided as follows:

- [Adding a Colour Swatch below](#)
- [Colour Display Modes on page 153](#)
- [Copying and Pasting Colours on page 154](#)
- [Mixing Colours on page 155](#)

Adding a Colour Swatch

You can use several different types of colour swatches.

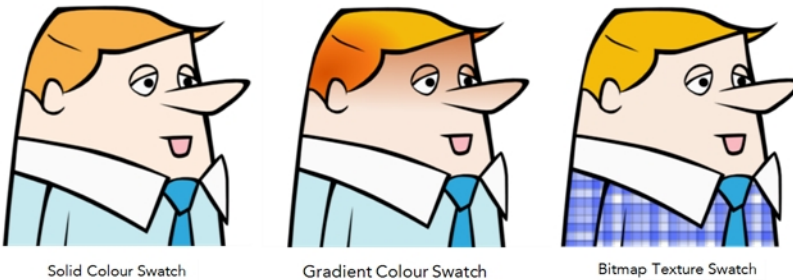

A colour palette is an actual file that is on the hard drive. These palette files can be stored in a different location on the server. They can be stored in the Environment, Job, Scene, or Element folder and linked to any palette list. This means that if the original palette file is modified, it will update in every drawing element the palette is linked to.

To avoid accidentally modifying the palette, the palette files can be locked. If a palette must be modified, you must get the rights to modify them before doing so.

In Toon Boom Harmony, when you click on the Add Colour **+** button, a new colour swatch is created using the colour of the currently selected swatch from your palette. However, you can set a default colour to be used every time you create a new colour in your colour palette. This might be useful if you want to create different shades of the same basic colour.

The default colour is also the colour used when you choose to vectorize images that you are scanning into your scene, however you add the Default colour swatch to your palette in a different way, so that it is unique. It has a unique ID number that makes it recognizable from all the other colours in your colour palettes. Being able to change this colour allows you to change the basic colour of all scanned drawings. This can be useful on more than just an aesthetic level as sometimes when you go to NTSC or PAL, pure colours, such as pure black, can create problems.

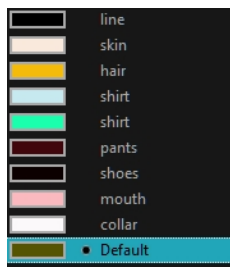

How to lock or unlock the palette list

- In the Colour view, click the Edit Palette Mode  button.

A grey pencil icon appears in the top-right corner of the Palette list.



How to add or modify a solid colour swatch

1. In the Colour view, click the New Colour **+** button.
2. From the Colour View menu, select **Colours > Edit** or double-click on the colour swatch.

The Colour Picker window opens.

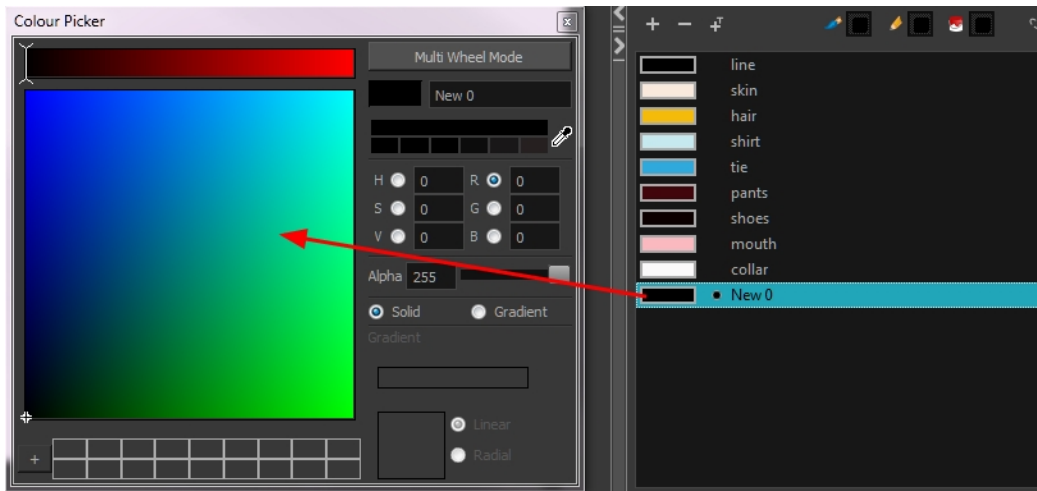

3. To set your colour, do one of the following:
 - ▶ In the colour wheel, select a colour.
 - ▶ Enter the HSV or RGB values in the corresponding fields. Select the **R,G,B,H,S** or **V** options to change the look of the colour picking area.



- ▶ Click the Dropper  button to select any colour on your screen. It can be from the Toon Boom Harmony interface, your operating system or any other open application.

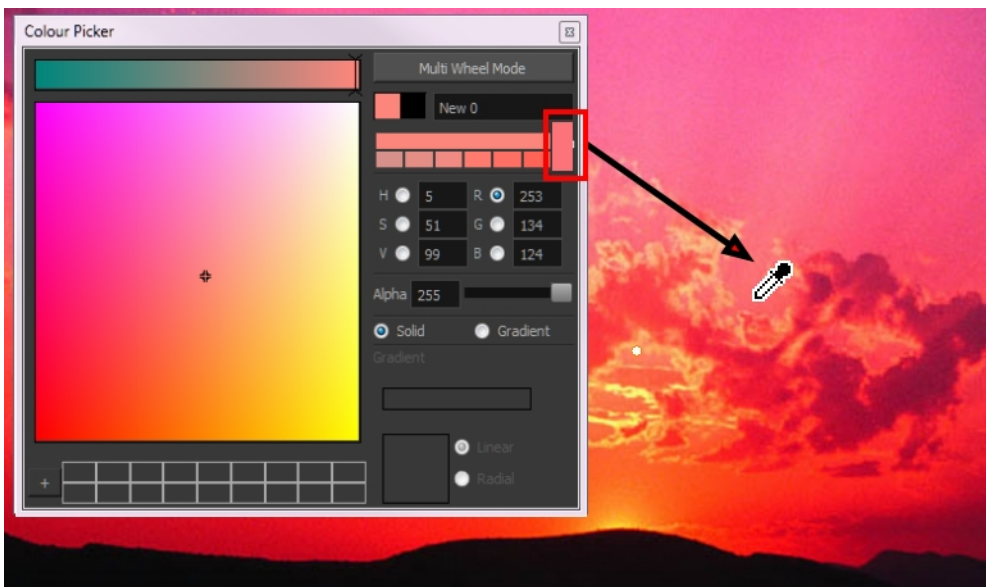

You can also click **Multi Wheel Mode** to open the Multiwheel Colour dialog box. This displays all the picking area styles together and also contains a picking undo list. To return to the regular Colour Picker window, click **Single Wheel Mode**.

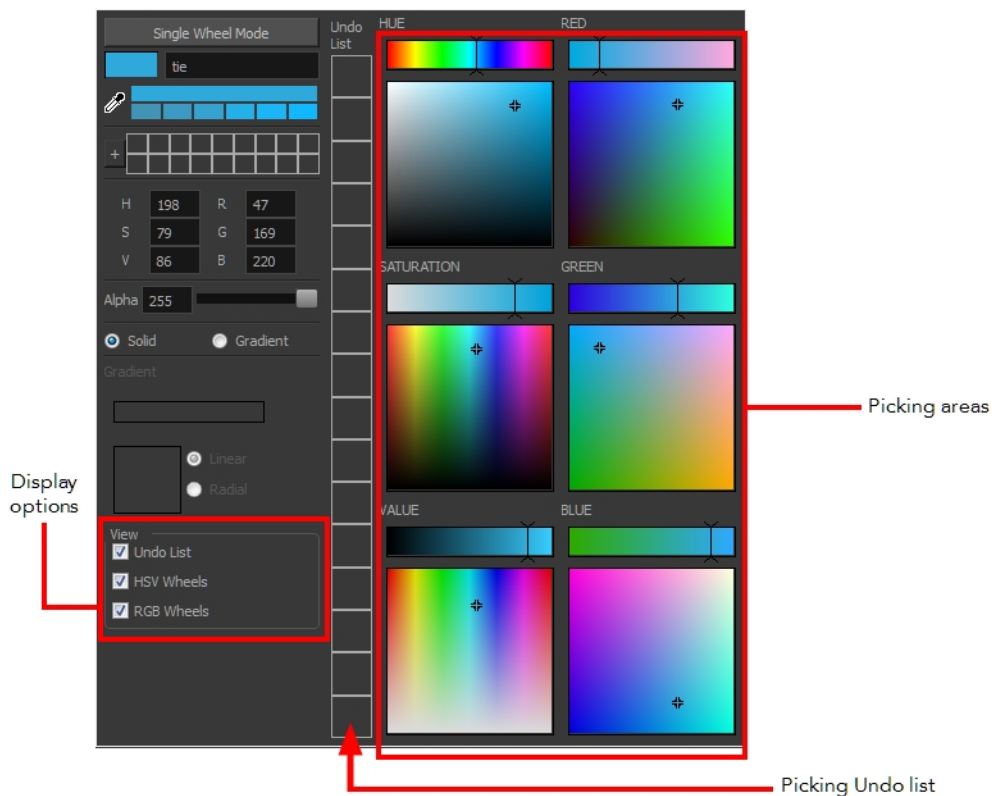

- Click on the Shade Scale swatches to modify the shade of the selected colour.

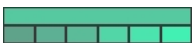

- Adjust the desired level of transparency with the Alpha slider, or type the value directly in the Alpha field.



- Click the **Add** button to add the current selected colour to the Colour Storage Library, so you can quickly access it later.



- You can rename the colour swatch in the Colour Picker window or directly in the colour list by double-clicking on its name.

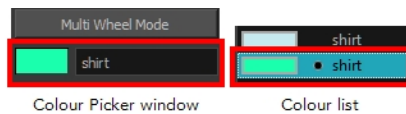

How to change the default swatch colour for all your colour palettes

- From the top menu, select **Edit > Preferences** (Windows/Linux) or **Stage > Preferences** (Mac OS X).
- In the Preferences dialog box, select the **Drawing** tab.
- In the New Colour Pots section, select the **Create New Colour Pot Using the Default Colour** option. You can also click on the colour swatch beside the option to change the Default colour.

How to add a new colour swatch using the default colour

- From the Colour View menu, select **Colours > New**.

A new swatch is added to your palette using the default colour swatch colour. The new swatch created with the New command will be named **New 0**.

How to create a gradient colour swatch

- In the Colour view, select a colour to modify .
- Do one of the following:
 - Click the new colour and from the Colour View menu, select **Colours > New**.
 - Double-click on the colour swatch.



The Colour Picker window opens.

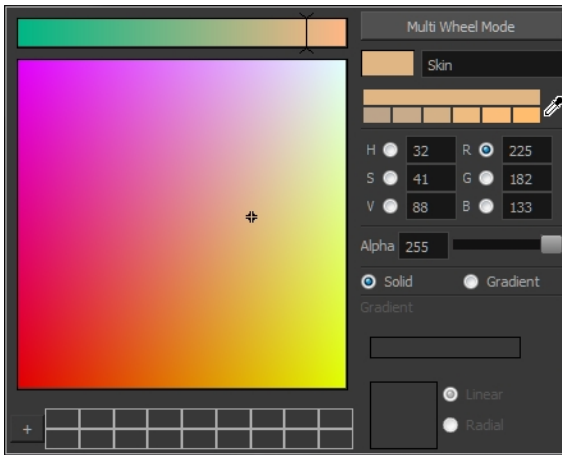

3. Select the **Gradient** option.
4. Select the **Linear** or **Radial** option.
5. Adjust the Gradient arrows to modify the colours.

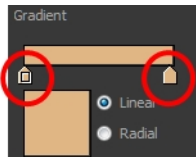

- ▶ Add extra colours by clicking between the arrows below the gradient bar. Then click on the Colour Preview to select a colour.
- ▶ Pull down the arrows to remove them.

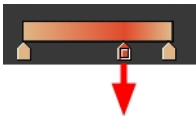

- ▶ Move the arrows left and right to modify the gradient distance.



Refer to the [Editing Gradients and Textures](#) on page 189 topic to learn how to reposition the gradient zones in your drawings.

How to create a texture colour

1. From the Colour View menu, select **Colours > New Texture** or click the New Texture  button. The Browser window opens.
2. Browse for a PSD or TGA bitmap file created with a third party software and click **Open**. The texture is added to the colour list.



Refer to the [Editing Gradients and Textures on page 189](#) topic to learn how to reposition your textured zones in your drawings.

You can also replace a texture once it is painted. If you decide to make the character's shirt wool instead of plaid, just update the texture file in the swatch and the entire project updates. Any transformation previously applied to the texture's position in your drawings will be kept.

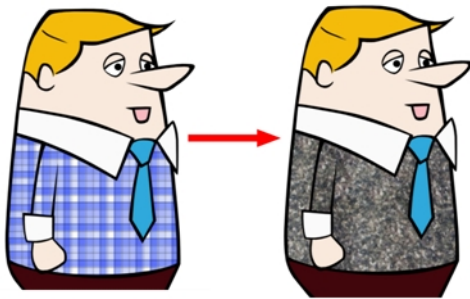

How to replace a texture swatch

1. In the Colour view, select the texture swatch that contains the bitmap texture you want to replace.

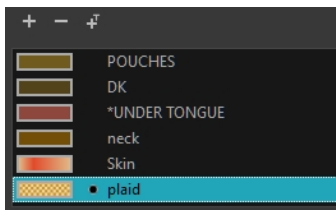

2. From the Colour View menu, select **Colours > Edit Texture** or double-click on the swatch. The Browser window opens.
3. Browse for the new PSD or TGA bitmap file created in a third party software.

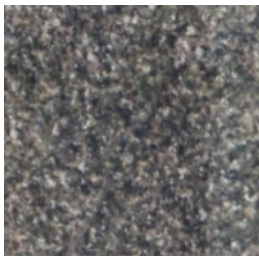

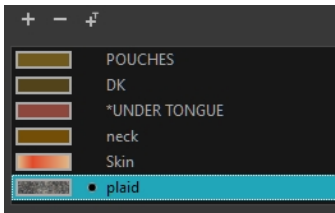

4. Click **Open** to update the colour swatch.

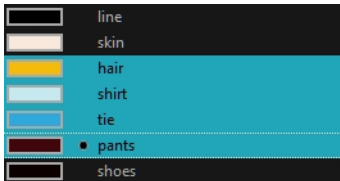

How to delete a colour swatch

1. In the Colour view, select the colour swatches to delete.



2. Do one of the following:
 - From the Colour View menu, select **Colours > Delete**.
 - Click the Delete Colour  button.
 - Right-click and select **Delete**.
 - Press Delete.

If the colour swatch is used in a drawing, the Delete Colour dialog box opens.

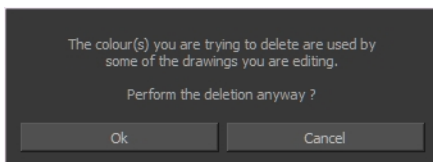

3. Click **OK** to delete the colours or click **Cancel** to abort the operation.
 - If you delete colour swatches already in use, the zones painted with them turn red so you can easily identify them.



Colour Display Modes

The Colour view has two display modes:

- List
- Swatch

You can also display the RGB values and names of your solid colour swatches instead of only the name. This option is not available when displaying the colours in Swatch mode.



How to switch between the display modes

- From the Colour View menu, and do one of the following:
 - ▶ Select **Colours > Swatch Mode** to display the swatches.
 - ▶ Deselect **Colours > Swatch Mode** to display the colour list.



How to display the swatch colour values

- ▶ From the Colour View menu, select **Palettes > Display Colour Values**.

The solid colour swatches' RGB values will be displayed between the colour swatch and its name.
The gradient colour swatches will be identified as (gradient).

Copying and Pasting Colours

When you are creating palettes, you may want to copy colour swatches or their values and paste them in other palettes to save time. You can also quickly copy a colour value from a palette in your scene to a selected colour swatch in a different palette.

You can copy a selected colour swatch and paste it as a clone. Since it produces a clone colour swatch, it is impossible to use the Paste as Clone command in the same palette as you copied the original colour swatch from.

If you would like to keep a reference file of some colour IDs or use them with custom plug-ins, you can copy the colour swatch IDs. Here is an example of colour ID: **075cf5b552401130**.

```
ToonBoomAnimationInc PaletteFile 2
Solid Black 0x075cf5b15fe006a1 0 0 0 255
Solid White 0x075cf5b15fe006a3 255 255 255 255
Solid Red 0x075cf5b15fe006a5 255 0 0 255
Solid Green 0x075cf5b15fe006a7 0 255 0 255
Solid Blue 0x075cf5b15fe006a9 0 0 255 255
Solid Custom 0x075cf5b15fe006a8 0 0 150 255
Solid "Vectorized Line" 0x0000000000000000 0 0 0 255
```

How to copy and paste colours

1. In the Colour view, select one or more colours to copy.
 - In the Colour view, click the Edit Palette Mode  button to be able to edit the colour list.

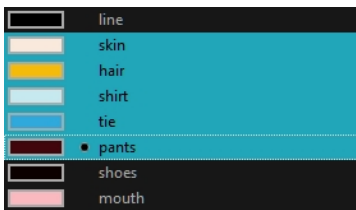

2. In the Colour View menu, select **Colours > Copy** or press Ctrl + C (Windows/Linux) or ⌘ + C (Mac OS X).
3. In the Palette list, select the palette in which you want to paste the colours.

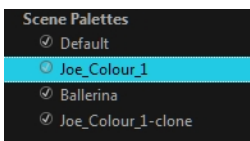

4. From the Colour View menu, select **Colours > Paste as New Colours** or press Ctrl + V (Windows/Linux) or ⌘ + V (Mac OS X).
 - To paste the colour values of the copied swatch over an existing colour swatch, select **Colours > Paste Colour Values**.

How to clone a colour swatch

1. In the Colour view, select the colour swatch you want to clone.
 - In the Colour view, click the Edit Palette Mode  button to be able to edit the colour list.
2. From the Colour View menu, select **Colours > Copy** or press Ctrl + C (Windows/Linux) or ⌘ + C (Mac OS X).
3. In the Colour view, select the colour palette you want to paste the clone into or create a new palette.
4. From the Colour View menu, select **Colours > Paste as Clone**.
The cloned colour swatch appears in the palette.

How to copy a colour ID

1. In the Colour view, select the colour swatch you want to get the ID from.
 - In the Colour view, click the Edit Palette Mode  button to be able to edit the colour list.
2. From the Colour View menu, select **Colours > Copy Colour ID** or press Ctrl + C (Windows/Linux) or ⌘ + C (Mac OS X).
3. Paste the copied value as plain text in the desired document.

Mixing Colours

If you want to modify a series of colours at once to blend a tint in them or offset their RGBA values, you can use the Tint panel. This panel is quite useful when creating palette styles such as night and day

styles.

How to mix colours

1. In the Colour view, select the palette that contains the colours you want to offset or blend.

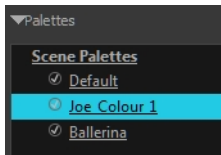

2. Do one of the following:
 - ▶ From the Colour View menu, select **Palettes > Tint Panel**.
 - ▶ Right-click and select **Tint Panel**.

The Blend/Offset Tint panel opens.

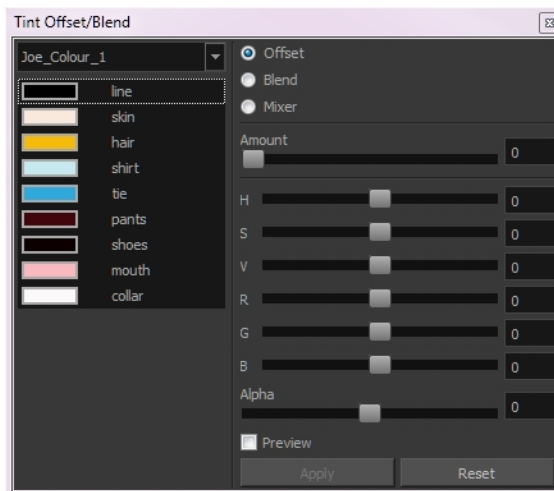

3. Select one or more colours to modify in the colour list. To select all the colours, press **Ctrl + A** (Windows/Linux) or **⌘ + A** (Mac OS X).

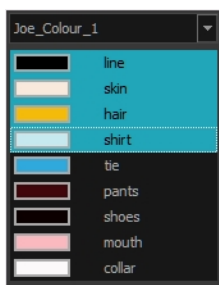

4. Select **Preview** option.
5. Select the **Offset**, **Blend**, or **Mix** option.

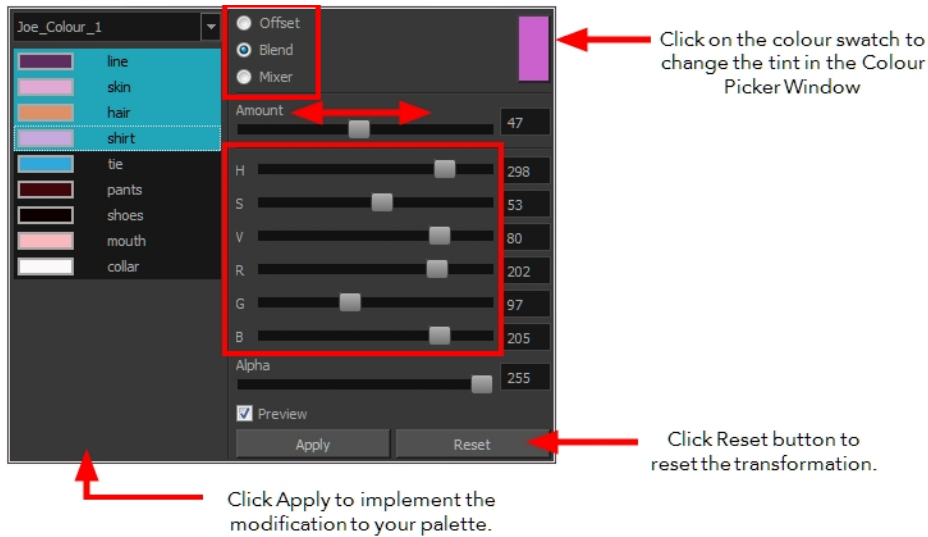

| Parameter | Description |
|-----------|----------------------------------------------------------------------------------------------------------------------------------------------------------------------------------------------------------------------------------------------------------------------------------------------------------------------------------------------------------------------------------------------------------------|
| Offset | Offsets the selected colours by the adjustments made using the HSB and RGB sliders. Use the Amount slider to adjust the degree of offset. Use the Alpha slider to adjust the opacity of the selected colour. |
| Blend | Blends the selected colours with the colour swatch in the top-right corner. Use the Amount slider to adjust the degree of blend. A blend of 100% turns the selected colours into the same colour as the swatch. Adjusting the HSB and RGB sliders affect the swatch colour, which in turn affects the selected colours on the left. Use the Alpha slider to adjust the opacity of the swatch. |
| Mixer | Select a Base and Tint colour to form a third colour swatch. Use the slider just beneath to mix the Base and Tint colours by different amounts. This will affect the mixed swatch whether it is selected or not. Select either the Tint or Base swatch and use the HSB and RGB sliders to adjust its colour. This will affect the mixed swatch colour, which in turn affects the selected colours on the left. |

6. Click **Apply**.

Painting the Model

Now that you have created the colours and the palette, you are ready to paint your model.

The colour model needs to be painted in order to adjust the colours with the other elements in the production. You can paint your model regardless of the colour RGBA and adjust them later when all the elements are together.

Once your palette is created and your model is painted, you can import a key background and other characters using the Import Drawings option or the Library to compare and adjust the palettes—see [Importing Models on page 185](#) to learn how to import your background file.



Abigail Archer, Grossology © Nelvana Limited, Corus® Entertainment Inc.

For paperless and cut-out animation, it is a good idea to provide a line-up template with the colour model to show the scale ratio between the characters, props and backgrounds.







Nautilus © Gava Productions and Indiana Productions

Once your colour model is completed, create a line-up template by pasting one of the production's main characters, or even just a hand, beside the colour model to show the relative size. This allows the animator, layout artist, or scene setup artist to retain the correct scaling throughout the entire project when setting the elements in the scene. You can store your template in the Library.

How to paint a colour model

1. From the Drawing or Camera View menu, select **View > Switch to Colour Art/Switch to Line Art** or press L.

2. Create your master colour palette—see [Creating a Colour Palette](#) on page 128
3. Add new colours to the palette—see [Adding a Colour Swatch](#) on page 147.
4. Select your Paint Bucket    tool. We recommend the Paint Unpainted  tool.
5. In the Colour view, select the colour you need to paint your drawing.

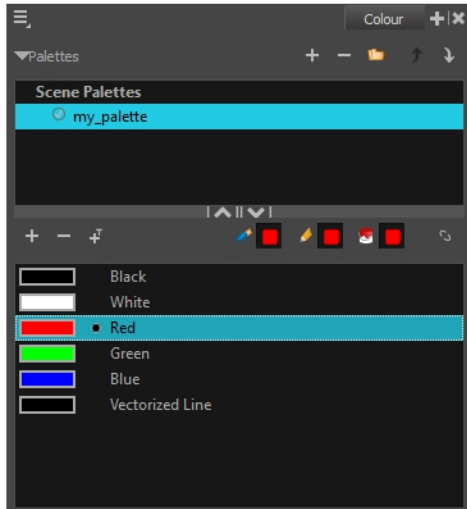

Colour view when working with vector layers

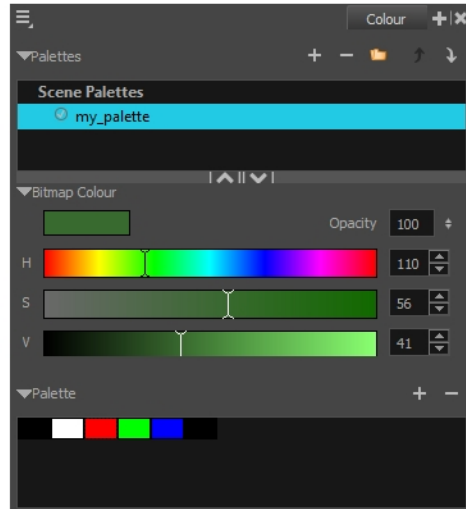

Colour view when working with bitmap layers

6. Paint the model by selecting colour swatches in the palette and clicking on your drawing. Note that only closed zones will be painted. If there is a gap in your artwork, you will need to close it in order to paint it.



Abigail Archer, Grossology © Nelvana Limited, Corus © Entertainment Inc.

7. If you would like to separate your lines and fill zones on separated art layers, see [Art Layers](#) on page 170.
8. Adjust the colours—see [Mixing Colours](#) on page 155.

Chapter 5: Ink and Paint



Di-Gata Defenders © Nelvana Limited, Corus® Entertainment Inc.

When traditional animation is traced, cleaned up, scanned in and properly exposed, it is time for the ink and paint process. This consists of cleaning all dirt and hair (for example, dust that was in the scanner, dots that do not belong in the drawing, extra floating artwork around the drawing that must be removed), painting the lines and filling the colours in the empty zones on an entire animation sequence.

For paperless animation, the drawings are cleaned up directly in Harmony, so there is generally no dirt to clean, only painting and inking.

For cut-out animation, once the character builder paints the pieces, there is no more ink and paint process because the same parts are always reused and moved around. The ink and paint process applies only to traditional and paperless animation workflows.

Harmony is optimized to ink and paint drawings efficiently. Since most of the drawings are vector-based, the colour zones are completely filled and there are no scattered spots left blank. Also, there are some actions that can be applied on an entire animation sequence at once, like dirt removal, some colour filling, line repainting, and so on.

Harmony uses palettes to hold all the colours you need to paint your elements. A palette is created by assigning a set of colours to each character, prop or effect. The colour styling artist will create a new palette and add a new colour for each zone of the character, such as the skin, hair, tongue, shirt, pants, and so on. Each colour is known as a *colour swatch*—see [Working with Palettes on page 121](#).



Di-Gata Defenders © Nelvana Limited, Corus® Entertainment

When a zone on the character is painted with the colour contained in a colour swatch, a link is automatically created between that colour swatch and the zone. This means that if the tint of the colour in the colour swatch is changed, any zone linked to it will update to the new tint. This is one way that colour palettes can save time and money in your production.

Another advantage of this system is that you can create complete palettes for different lighting situations. For instance, in addition to the regular palette for a character, you could have one for that character in the rain using colours that are duller and less vibrant than the dry daytime colours, or yet another for using in a night scene. Using palettes linked to your character in this way allows you to instantly change its colouring to suit the mood and atmosphere of the scene without tediously repainting each element.

The ink and paint process is divided into the following steps:

- [Preparation on the facing page](#)
- [Dirt Clean Up on page 167](#)
- [Art Layers on page 170](#)
- [Creating Strokes on page 176](#)
- [Painting on page 178](#)
- [Inking the Lines on page 198](#)
- [Verifying the Zones are Painted on page 203](#)
- [Ink and Paint Tool Properties on page 206](#)

Preparation

The optimal workspace for creating colour models and inking/painting in traditional animation includes the following views:

- Xsheet
- Camera
- Drawing
- Colour
- Model

As there is no default workspace for these tasks you will need to create a custom workspace for yourself—refer to the Fundamentals Guide.

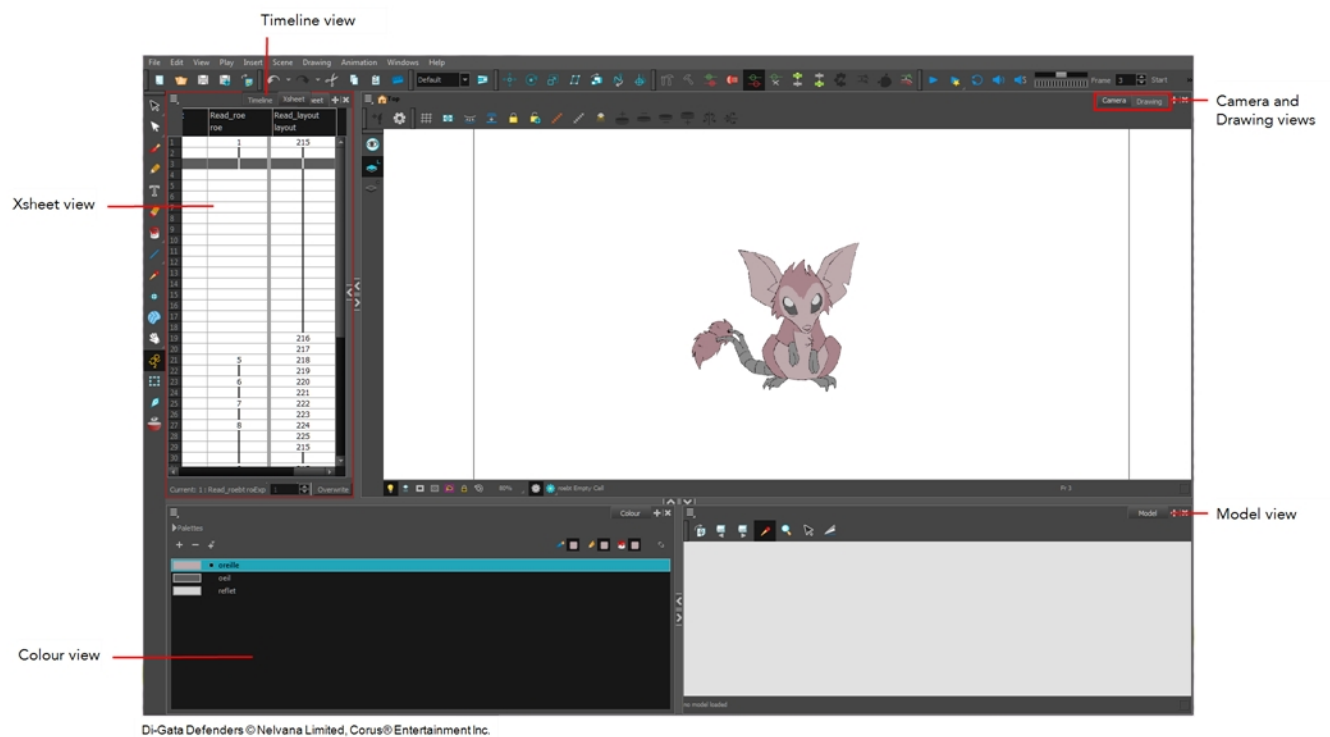

You may have a character or element palette that has colours that are very similar to the Drawing and Camera view's background colour. For example, a white eyeball colour on a white background which makes it difficult to know if the zone was painted. You can change the background colour of the Camera or Drawing view in the Preferences dialog box.

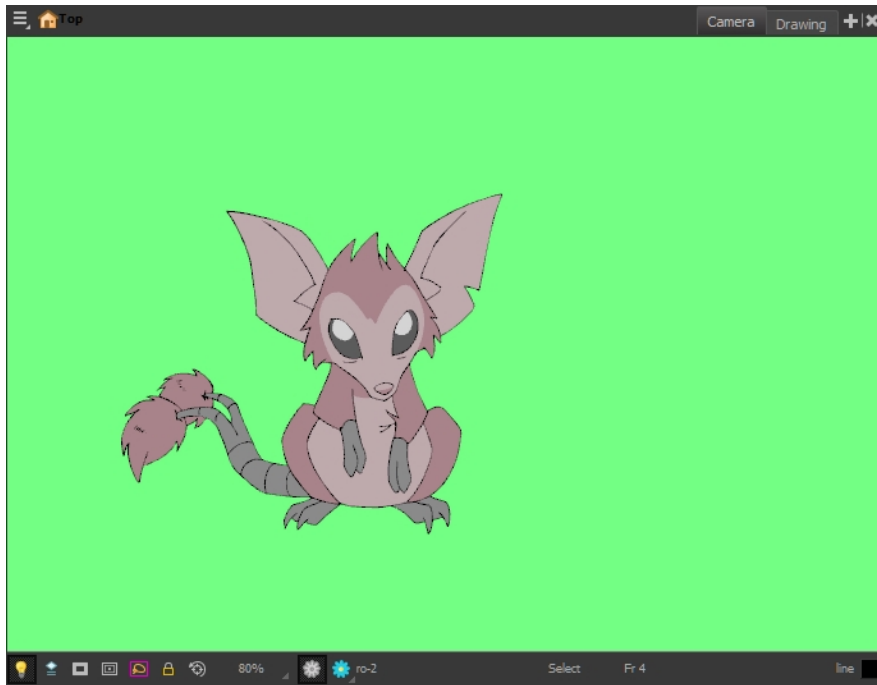

Di-Gata Defenders © Nelvana Limited, Corus® Entertainment Inc.

How to change a view's background colour

1. Do one of the following:
 - ▶ From the top menu, select **Edit > Preferences**.
 - ▶ Mac OS X: Select **Stage > Preferences**.
 - ▶ Press **Ctrl + U** (Windows/Linux) or **⌘ + U** (Mac OS X).The Preferences dialog box opens.
 2. Select the **General** tab.
 3. In the Colours section, click **Edit Colours**.
- The Colours dialog box opens.

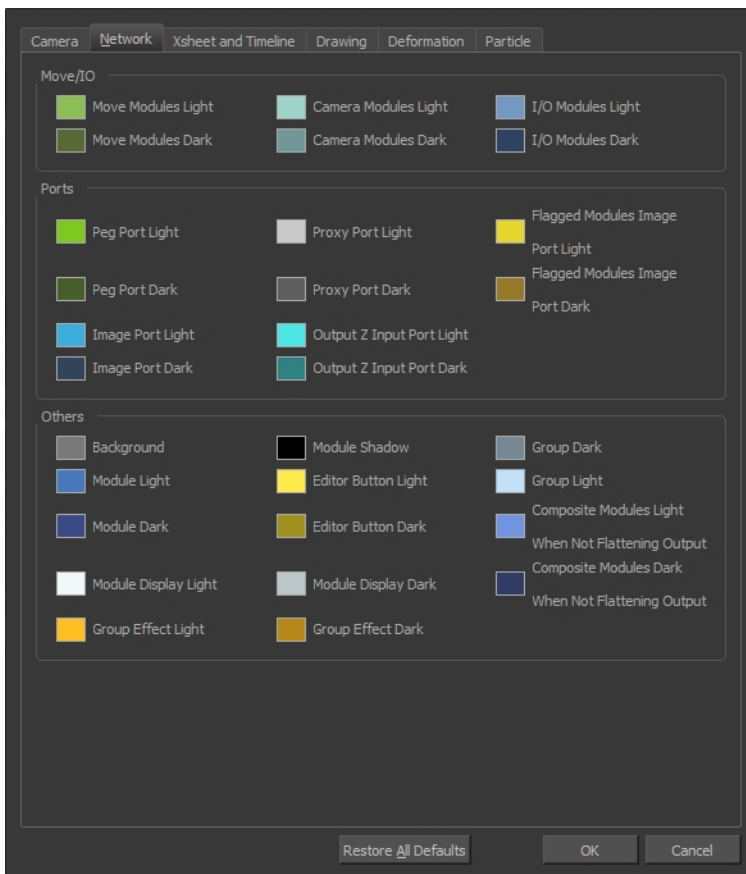

4. Select the **Camera** or **Drawing** tab.

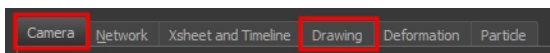

5. Change the background colour of:
 - **Camera View**: Click the **Clear** colour swatch.

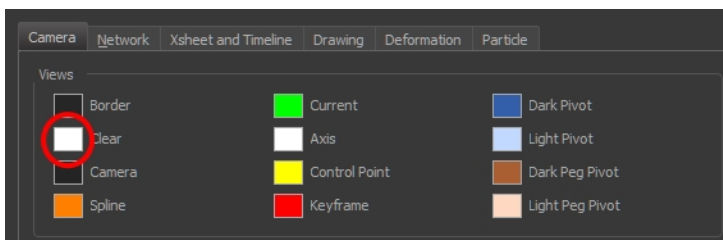

- **Drawing View**: Click the **Background** colour swatch.

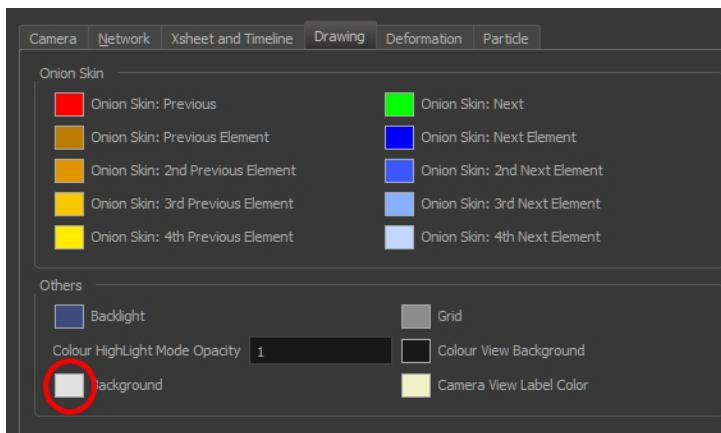

The Select Colour dialog box opens.

6. Select a colour by clicking a colour swatch, clicking a colour in the colour gradient, or entering a HSV/RGB Value.

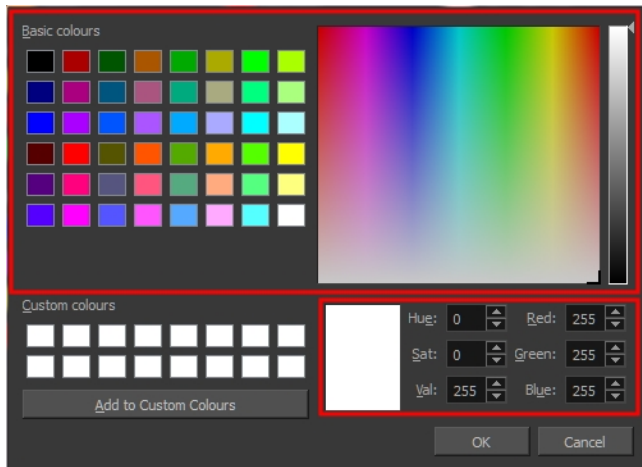

7. Click **OK** in the three opened dialog boxes to apply your changes.

When you need to paint drawings with similar colours throughout the palette, you can create a clone of that palette and change all the colours to very bright tints to facilitate the paint process—see .

Dirt Clean Up

When paper drawings are passed through a scanner, there can be some hair and dirt scattered across them. These lines and dots need to be cleaned. Harmony provides different tools to help get rid of them quickly.

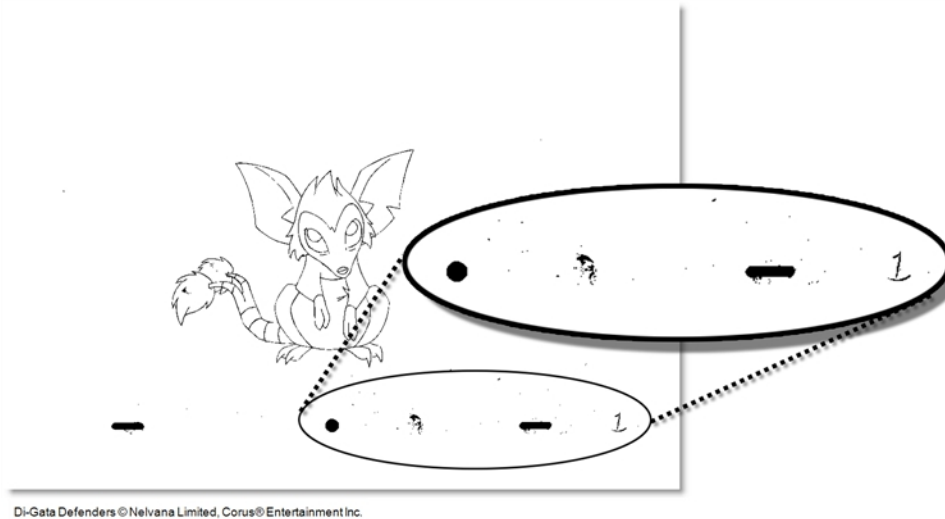

Di-Gata Defenders © Nelvana Limited, Corus® Entertainment Inc.

The Remove Dirt tool selects small dots and hairs on the drawing. Raising the Remove Dirt level will select bigger dots. When selecting larger dots, be careful not to lose small details like pupils and nostrils. Once you have chosen the level, you can apply it to the current drawing or the entire animation sequence. This is a quick way to get rid of most dirt and dust.

During this process, the dirt that will be removed is highlighted in red.

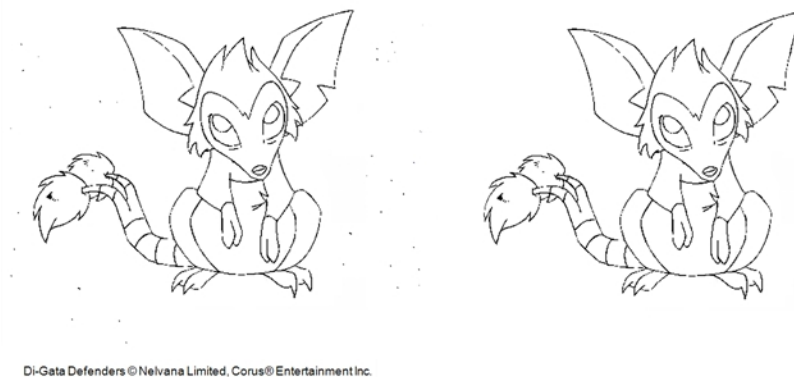

Di-Gata Defenders © Nelvana Limited, Corus® Entertainment Inc.

The Remove Art Outside Selection option lets you remove any art existing outside a selection. It is recommended that you clean your Colour Art level as well. If you have a stroke accumulation in your Colour Art, it can result in large output files, especially if you work in high-definition resolutions.

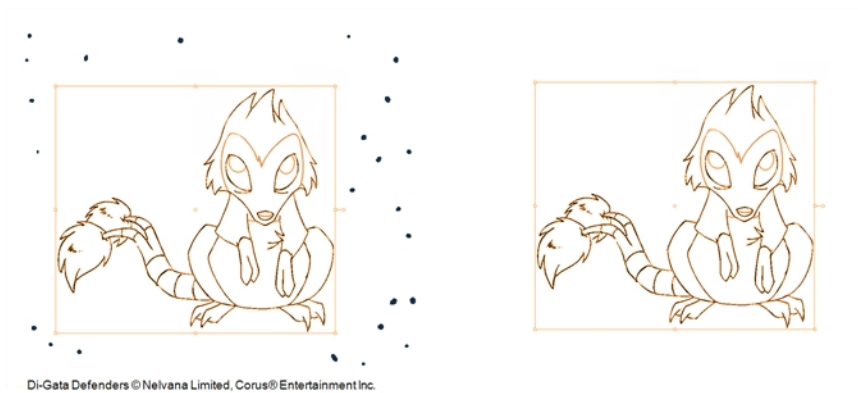

If there are some marks that cannot be removed with the automated tools, you can erase them with the Eraser tool or select them with the Select tool and then delete them. It is always safer to select and delete them than to erase them, so you do not overlook anything.

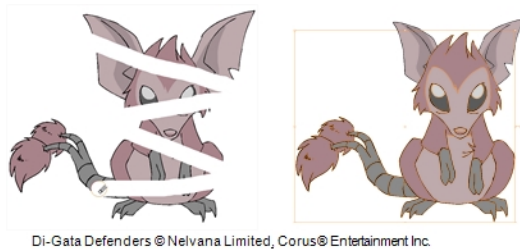

How to use the Remove Dirt tool

1. Do one of the following:
 - ▶ From the top menu, select **Drawing > Clean Up > Remove Dirt**.
 - ▶ From the Camera or Drawing View menu, select **Drawing > Clean Up > Remove Dirt**.
 - ▶ Press Shift + D.

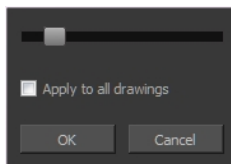

2. Increase the Remove Dirt value by moving the slider to the right.
3. Enable the Apply to All Drawings if you want to operation to be apply to all drawings in the layer.

How to clean dirt with Remove Art Outside Selection

1. In the Tools toolbar, select the Select  tool.
2. In the Tool Properties view, enable the **Permanent Selection** option.
3. Draw a selection around the animation making sure to include the entire animation sequence.

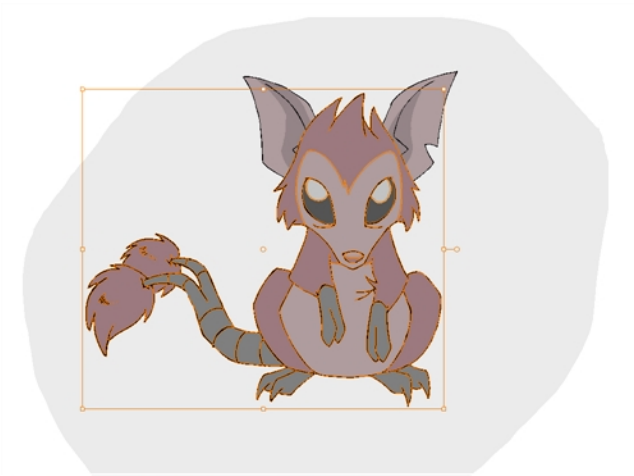

Di-Gata Defenders © Nelvana Limited, Corus © Entertainment Inc.

4. In the Camera or Drawing View menu, select **Drawing > Clean Up** and one of the following options:
 - ▶ **Remove Art Outside Selection** to delete artwork outside your selection on a single drawing.
 - ▶ **Remove Art Outside Selection on All Drawings** to delete artwork outside your selection on all the drawings.

The art outside the selection is removed.

How to access the Eraser tool

- ▶ From the Tools toolbar, click the Eraser  button.
- ▶ From the top menu, select **Drawing > Drawing Tools > Eraser**.
- ▶ From the Camera or Drawing View menu, select **Drawing Tools > Eraser**.
- ▶ Press Alt + E.

How to access the Select tool



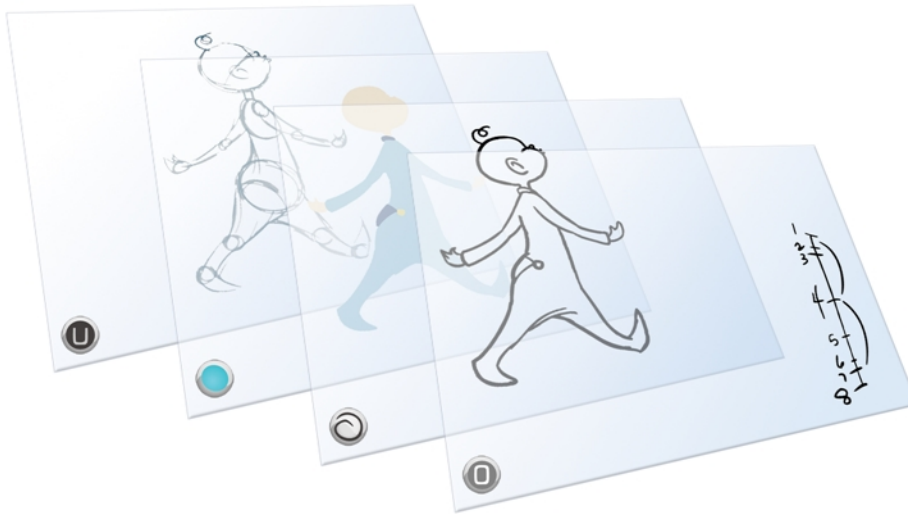

- ▶ From the Tools toolbar, click the Select  button.
- ▶ From the top menu, select **Drawing > Drawing Tools > Select**.
- ▶ From the Camera or Drawing View menu, select **Drawing Tools > Select**.
- ▶ Press Alt + S.

Art Layers



Art layers give you the possibility to divide the artwork in your drawing on different layers. For example, you can separate the outline and colour fill on two art layers, similar to 1950s traditional cell animation. These art layers are contained within a single drawing as opposed to the timeline layers or Xsheet columns where individual drawings with individual timing are stacked one on top of the other—see [Creating Strokes](#) on page 176.

Toon Boom Harmony drawings include four art layers.

-  **Overlay on the facing page**
-  **Line Art on page 172**
-  **Colour Art on page 172**
-  **Underlay on page 173**

You can access the art layers through the Art Layer toolbar. By default, only the Line Art and Colour Art are displayed. You need to enable the Support Overlay and Underlay Arts option in the Preferences dialog box.

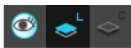

Each layer can be used for separate hand-drawn animation tasks, letting you organize your work and facilitate creation and revision.

Overlay



The Overlay layer can serve multiple purposes:

- Highlights and tones
- Annotations and corrections



- Sketching

You can also draw in the Overlay layer as it is a regular layer.



Line Art



In hand-drawn animation, the Line Art layer is mainly used to trace and clean up animation. The outline is drawn in the Line Art layer and colour is painted in the Colour Art layer.

Colour Art



In hand-drawn animation, you use the Colour Art layer to paint your animation. The outline is drawn in the Line Art layer and colour is painted in the Colour Art layer. Strokes (invisible lines) are generated from Line Art to contain the painted area.

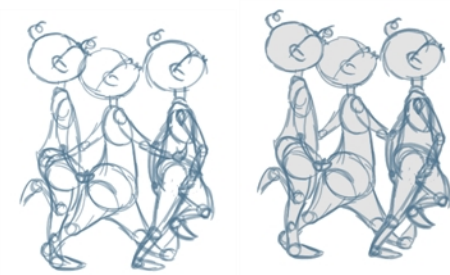

When you are doing rough animation, you may want to send a clip to somebody for feedback or approval before carrying on with your work. If you have several characters in your project that are overlapping, it may be difficult to understand what is going on as you can see through the characters. Toon Boom Harmony can generate a matte automatically in the Underlay, or even in the Colour Art layer, and fill all the zones inside your characters making them opaque. This process is fast and easy and allows you to send easy-to-understand movies.

Underlay





The Underlay layer can serve multiple purposes. It is frequently used by animators to sketch rough animation or generate a matte colour when doing line testing.



How to enable the Support Overlay and Underlay Arts option

1. From the top menu, select **Edit > Preferences** (Windows/Linux) or **Stage > Preferences** (Mac OSX).
2. In the Preferences dialog box, select the **Advanced** tab.
3. In the Advanced Options section, select the **Support Overlay and Underlay Arts** option.
4. Click **OK**.

How to switch between drawing layers

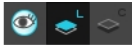



1. In the Art Layer toolbar, click the Line Art  or Colour Art  buttons. When switching art layer, it will allow you to edit the select layer without affecting the other one.





2. Click the Preview All Enabled Art Layers  button to display both layers together. Even when the Preview mode is enabled, you will only be able to edit the select art layer. The other ones are only displayed as a reference. By default, the Preview mode is always enabled in the Camera view. You will only be able to see the select art layer by itself if you enable the Current Drawing on Top  option located in the Camera bottom toolbar.

To edit both Line Art and Colour Art at the same time, you must enable the Apply to Line Art and Colour Art button in the Tool Properties of the tools supporting the operation.

How to switch between the drawing layers in Advanced Art mode

1. In the Art Layer toolbar, click the Overlay Art , Line Art , Colour Art  or Underlay Art  buttons to display the appropriate layer—see [How to enable the Support Overlay and Underlay Arts option above](#). When switching art layer, it will allow you to edit the select layer without affecting the other one.



- Click the Preview All Enabled Art Layers  button to display all the layers together. The other ones are only displayed as a reference. By default, the Preview mode is always enabled in the Camera view. You will only be able to see the select art layer by itself if you enable the Current Drawing on Top  option located in the Camera bottom toolbar.

How to generate a matte

- Do one of the following:
 - In the Tools toolbar, select the Select  tool.
 - Press Alt + S.
- In the Camera or Drawing view, select the drawing you want to create a matte for.

You can also apply the operation to all the drawings in the layer at the same time.

- Do one of the following:
 - From the top menu, select **Drawing > Generate Auto-Matte**.
 - In the Camera or Drawing view menu, select **Drawing > Generate Auto-Matte**.

The Auto-Matte dialog box opens.

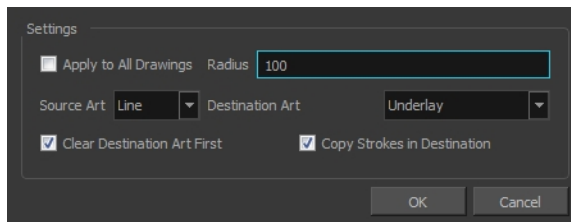

- If you want to create a matte for all the drawings included in your layer, select the **Apply to Multiple Drawings** option.
- Depending on how precise or rough your line is, increase or decrease the radius value. The lower the value is, the closer to your lines' contours the matte will be shaped. The higher the value is, the looser the matte will be shaped.

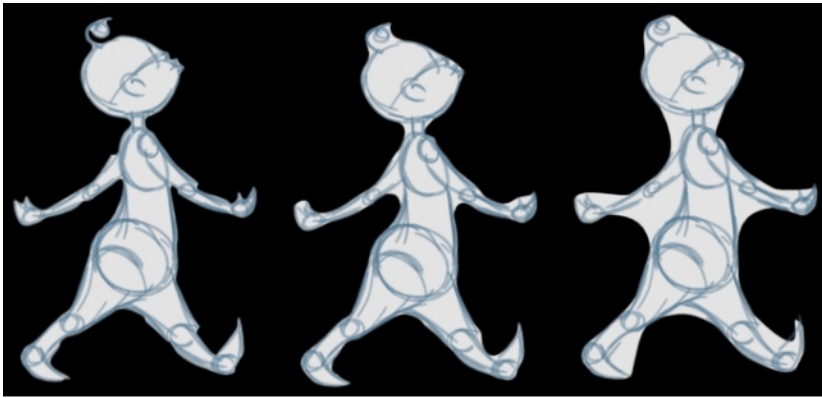

Radius: 20

Radius: 100

Radius: 300

6. In the Source Art menu, select the layer from which you want the matte created: **Line Art, Colour Art, Underlay** or **Overlay**.
7. In the Destination Art menu, select the layer you want the matte to be created on: **Line Art, Colour Art, Underlay** or **Overlay**.
8. If you already have artwork on the destination layer and you want the content to be deleted before the matte is added into it, select the **Clear Destination Art First** option.
9. If you want the contour of your lines to be copied as invisible lines in your matte drawing (in case you ever need to keep them for later), select the **Copy Stroke in Destination** option.
10. Click **OK**.

Creating Strokes

A drawing is composed of Line and Colour filling layers. Lines and colours can be separated or kept together, depending on which animation process you use. The following diagram presents Line Art and Colour Art recommendations based on the selected animation workflow.

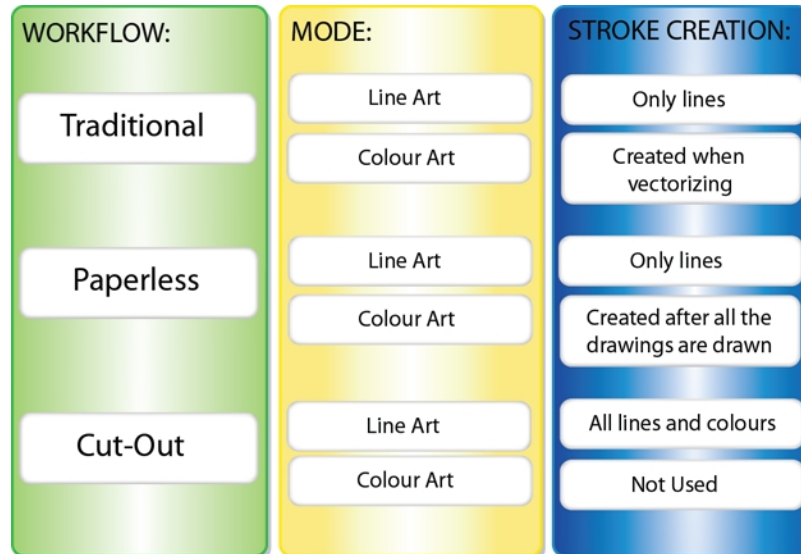

When a traditional drawing is scanned, strokes are automatically created in the Colour Art from the Line Art when drawings are vectorized unless you specified otherwise.

When working with Cut-out animation, we recommend that you do all of the work in the Line Art.



Once the drawing sequence is completed for paperless drawings, you can proceed with creating Colour Art strokes if you plan to paint the animation in the Colour Art. Use the Create Colour Art from Line Art option to create strokes from your lines.

You can create strokes in the Colour Art during the following stages:

- After the full drawing is completed in Line Art
- While drawing in Line Art

You may have some traditional drawings that need to be fixed; for example, needing extra lines to patch gaps. Use the Auto-Create Colour Art from Brush option to create the strokes at the same time as the lines are drawn. This creates strokes from the lines and brush strokes created in the Line Art while you draw and is useful for fixing drawings. However, if you are drawing a new sketch, it is better to create the strokes afterward using the Create Colour Art from Line Art option.

How to create Colour Art zones out of the Line Art content

1. In the Tools toolbar, select the Select  tool or press Alt + S.
2. In the Tool Properties view, enable the Permanent Selection  option if you want to apply the operation on all drawings in the layer.
3. In the Camera or Drawing view, select the artwork to transfer to the Colour Art. Create a selection around the entire animation sequence if you want to apply the operation to all your drawings.

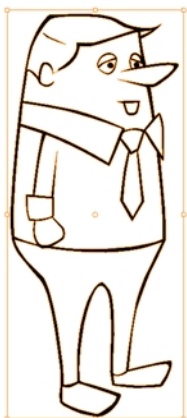

4. In the Drawing View toolbar, click the Create Colour Art from Line Art  button or press *.

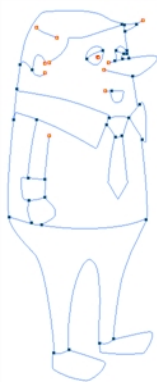

How to create strokes with the Auto-Created Colour Art From Brush option

1. From the Camera or Drawing View menu, select **Drawing >Auto-Created Colour Art from Brush** or press [Shift]+[F2].
2. Draw the required lines.
3. Once you are done, deselect the **Auto-Created Colour Art from Brush** option. You are now ready to paint your model.

Painting

You can choose to paint your animation in the Line Art or Colour Art level. You can paint in Line Art, but for traditional and paperless animation, you should fill your colour zones in Colour Art. You can access the art layers through the Art Layer toolbar—see [Art Layers on page 170](#).

There are many advantages to separating the lines and colour zones, but the main one concerns the painting process. To paint very quickly, it is useful to not worry about painting over the lines. If the lines are separated, you can fill the zones very quickly and you will never accidentally paint the lines. Conversely, if you are inking the lines, you will not repaint the colour zones either.

If you have transparent lines, bitmap lines or textured lines with transparency, it is better to have your colour zones bleeding under your lines to avoid seeing the backgrounds and other elements through the lines.

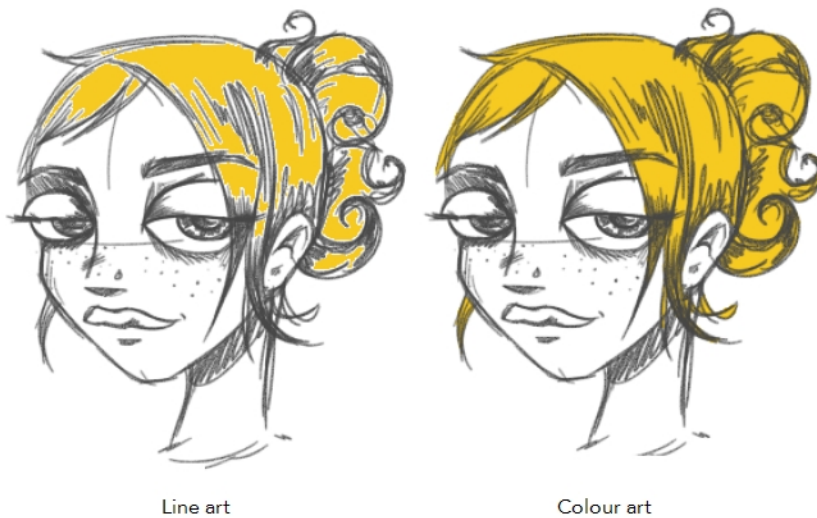

To avoid painting in Line Art by mistake, turn off the Preview mode and paint in the Drawing view rather than the Camera view. Press P to turn the mode on or off.

This section is divided as follows:

- [Painting Using the Paint Tool on the facing page](#)
- [Advanced Painting Features on page 180](#)
- [Selecting a Colour in a Drawing on page 184](#)
- [Importing Models on page 185](#)
- [Editing Gradients and Textures on page 189](#)
- [Closing Gaps on page 194](#)
- [Protecting Colours on page 196](#)
- [Highlighting the Selected Colour on page 196](#)
- [Inverting a Colour Selection on page 197](#)

Painting Using the Paint Tool

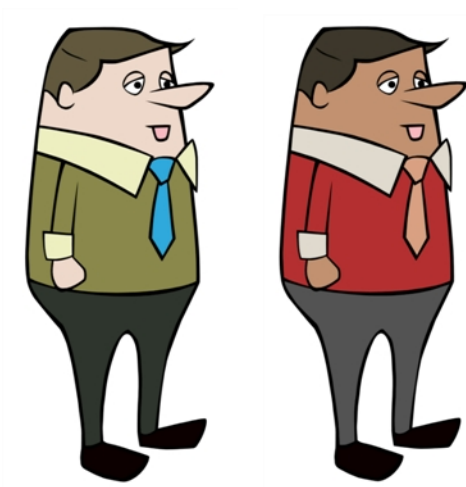

The main tool you will use to paint your drawings with is the Paint tool. The Paint tool can be used in several different modes, which can be customized in the Tool Properties view.

The Paint tool paints closed zones, including brush strokes and pencil lines. If there are gaps in the lines defining a zone, you must close them using the Brush, Pencil, or Close Gap tools or the Automatic Close Gap option.

How to paint with the Paint tool

1. In the Timeline or Xsheet view, select the cell on which you want to paint.



2. Do one of the following:
 - ▶ In the Tools toolbar, click the Paint  tool.
 - ▶ Press Alt + I.
3. In the Colour view, select a colour.

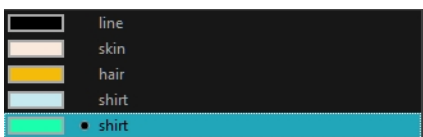

4. In the Drawing or Camera view, start painting. You can click on a zone or pencil line to paint it, or you can trace a lasso or marquee selection to paint several zones or pencil lines at once.

The last colour you select while using the Paint tool will be remembered the next time you select the Paint tool if you are using the unlocked painting tools in the Colour view.

Advanced Painting Features

The following advanced painting features are available in Toon Boom Harmony and are described in this section:

- Repaint Selection
- Repaint Selection On All Drawings
- Repaint Outside Selection
- Repaint Outside Selection On All Drawings
- Unpaint Selection
- Unpaint Selection On All Drawings
- Unpaint Outside Selection
- Unpaint Outside Selection On All Drawings

The Repaint Selection command is used to repaint any art inside a selection. You must first draw a selection using the Select tool in order for this command to be available.

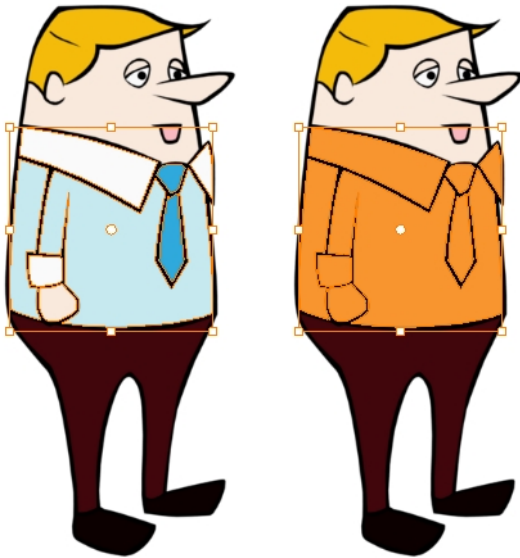

The Repaint Selection On All Drawings command is used to repaint any art inside a selection on all the drawings contained within the same layer. You must enable the Permanent Selection  option in the Select tool Tool Properties view and then select an area of your drawing using the Select tool in order for this command to be available. The Permanent Selection option lets you maintain the same selection throughout the drawings of a same layer.

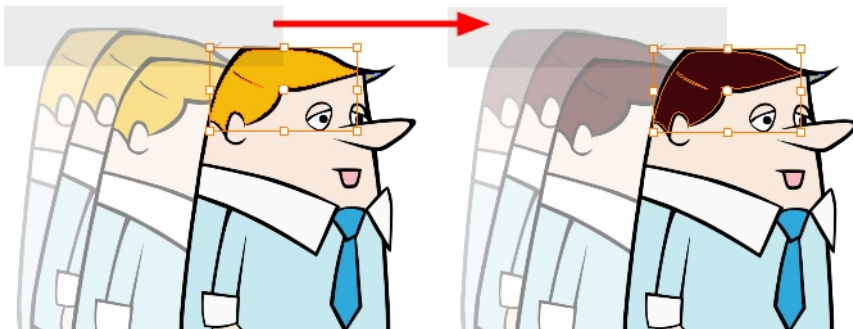

The Repaint Outside Selection command is used to repaint any art outside a selection. If no selection has been drawn using the Select tool, the entire drawing will be repainted.

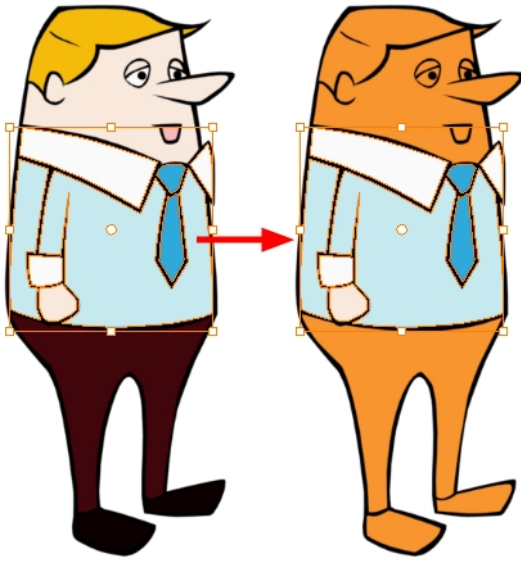

The Repaint Outside Selection On All Drawings command is used to repaint any art outside a selection on all the drawings contained within the same layer. You must enable the Permanent Selection  option in the Select tool Tool Properties view and then select an area of your drawing using the Select tool in order for this command to be available. The Permanent Selection option lets you maintain the same selection throughout the drawings of a same layer.

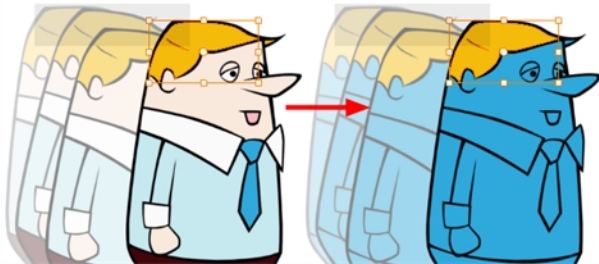

The Unpaint Selection command is used to unpaint any art existing inside a selection. You must first draw a selection using the Select tool in order for this command to be available.

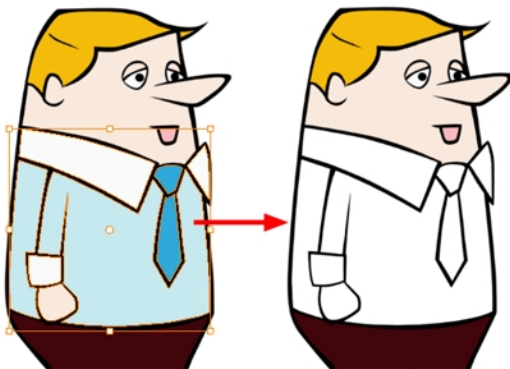

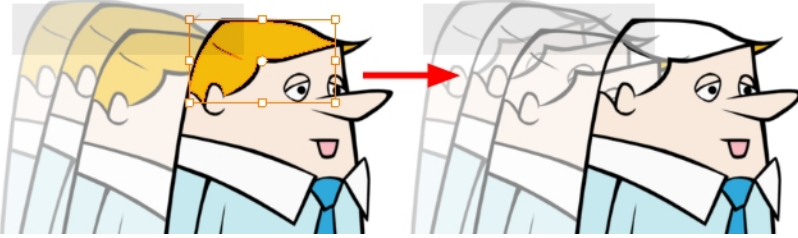

The Unpaint Selection on All Drawings command is used to unpaint all art contained inside a selection on all the drawings within the same layer.

You must enable the Permanent Selection  option in the Select tool Tool Properties view and then select an area of your drawing using the Select tool in order for this command to be available. The Permanent Selection option lets you maintain the same selection throughout the drawings of a same layer.

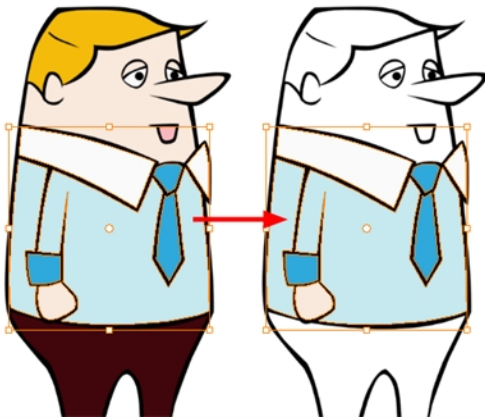

The Unpaint Outside Selection command is used to unpaint any art existing outside a selection. If no selection have been drawn using the Select tool, the entire drawing will be unpainted.



The Unpaint Outside Selection on All Drawings command is used to unpaint all art outside a selection on all the drawings within the same layer. You must enable the Permanent Selection  option in the Select tool Tool Properties view and then select an area of your drawing using the Select tool in order for this command to be available. The Permanent Selection option lets you maintain the same selection throughout the drawings of a same layer.

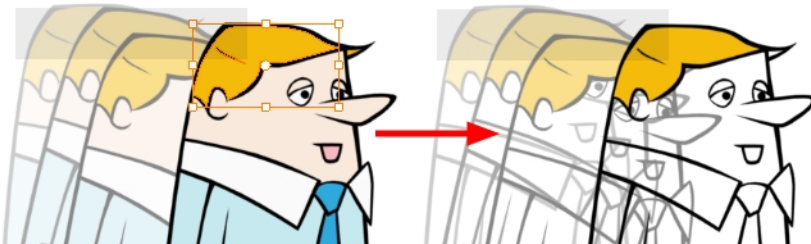

How to access the Repaint Selection command

- From the top menu, select **Drawing > Paint > Repaint Selection**.
- From the Camera or Drawing view menu, select **Drawing > Paint > Repaint Selection**.

How to access the Repaint Selection On All Drawings command

- From the top menu, select **Drawing > Paint > Repaint Selection On All Drawings**.

- ▶ From the Camera or Drawing view menu, select **Drawing > Paint > Repaint Selection On All Drawings**.

How to access the Repaint Outside Selection command

- ▶ From the top menu, select **Drawing > Paint > Repaint Outside Selection**.
- ▶ From the Camera or Drawing view menu, select **Drawing > Paint > Repaint Outside Selection**.

How to access the Repaint Outside Selection on All Drawings command

- ▶ From the top menu, select **Drawing > Paint > Repaint Outside Selection on All Drawings**.
- ▶ From the Camera or Drawing view menu, select **Drawing > Paint > Repaint Outside Selection on All Drawings**.

How to access the Unpaint Selection command:

- ▶ From the top menu, select **Drawing > Paint > Unpaint Selection**.
- ▶ From the Camera or Drawing view menu, select **Drawing > Paint > Unpaint Selection**.

How to access the Unpaint Selection On All Drawings command:

- ▶ From the top menu, select **Drawing > Paint > Unpaint Selection On All Drawings**.
- ▶ From the Camera or Drawing view menu, select **Drawing > Paint > Unpaint Selection On All Drawings**.

How to access the Unpaint Selection command

- ▶ From the top menu, select **Drawing > Paint > Unpaint Outside Selection**.
- ▶ From the Camera or Drawing view menu, select **Drawing > Paint > Unpaint Outside Selection**.

How to use the Unpaint Outside Selection On All Drawings command

- ▶ From the top menu, select **Drawing > Paint > Unpaint Outside Selection On All Drawings**.
- ▶ From the Camera or Drawing view menu, select **Drawing > Paint > Unpaint Outside Selection On All Drawings**.

Selecting a Colour in a Drawing



While working in your Camera or Drawing view, you can use the Dropper tool to pick a colour from your drawing without going to the Colour view.

How to use the Dropper tool

1. Do one of the following:
 - ▶ In the Tools toolbar, select the Dropper  tool.
 - ▶ From the top menu, select **Drawing > Drawing Tools > Dropper**.
 - ▶ Press Alt + D.
2. In the Camera or Drawing view, click on the desired colour.
 - ▶ If you are using another drawing tool such as the Paint tool, you can temporarily hold down the D key and click in your drawing before releasing the key to pick your colour. When you release the key, Toon Boom Harmony will return to your previous tool. You may also want to select the zones painted with the colour currently selected in the Colour view. This can be useful for removing rough lines from a clean drawing.

How to select the zones painted with the current colour

1. In the Colour view, select the colour you want to select the corresponding zones from.

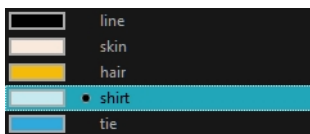

2. Do one of the following:
 - ▶ Select **Drawing > Select Strokes with Current Colour**.
 - ▶ Press Ctrl + Shift + A (Windows/Linux) or ⌘ + Shift + A (Mac OS X).

Importing Models

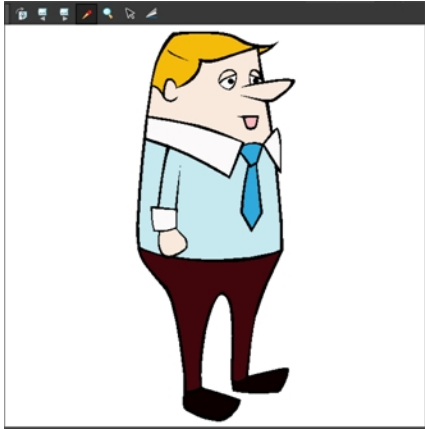

Once you have a fully painted drawing, you can use it as a colour model and load it in the Model view. That drawing can be used and loaded in any of your Harmony scenes.

Once a drawing is loaded in the Model view, you can use the Dropper  to select a colour from the model and use it to paint in your Camera or Drawing view without having to pick the colour from the colour palette.

You can do more than just copy colours from a colour model. Harmony gives you the ability to copy parts of the character directly from its colour model and paste these elements into the Drawing or Camera views.

How to load a colour model from the Timeline or Xsheet view

1. In the Timeline or Xsheet view, select a drawing (*.tvg).

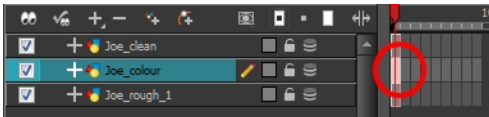

2. Bring the model into the Model view by doing one of the following:
 - ▶ In the Timeline view, drag the selected drawing and drop it directly in the Model view.
 - ▶ From the Model View menu, select **Use Current Drawing as Model**.
 - ▶ In the Model View toolbar's extra buttons, click Current Drawing  button.

The model appears in the Model view.

How to browse for a colour model drawing on your hard drive

1. Do one of the following:
 - ▶ From the Model View menu, select **Import Model**.
 - ▶ Click the Import Model  button or from the Model View's toolbar.
 - ▶ Select **File > Import > Colour Model**.
2. In the Browser window, browse for any *.tvg drawing file on your hard drive or in the database.
3. Click **Open**.

The model appears in the Model view.

How to load the default models

1. In your scene's folder, create a new folder and name it models.
2. On your hard drive copy the *.tvg drawing file you want to use as colour models in your scene.
3. Do one of the following:
 - From the Model View menu, select **Load Default Model**.
 - In the Model View toolbar's extra buttons, click the Load Default Model  button .

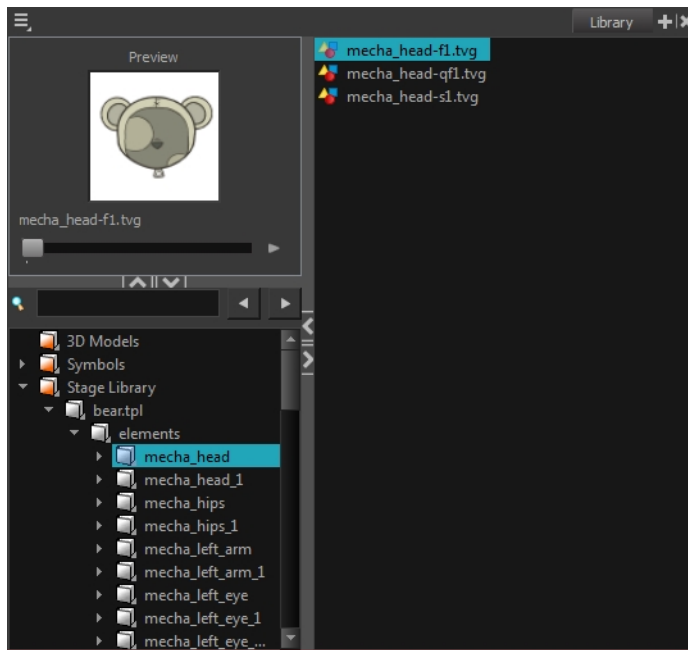

How to load a single drawing from the Library view

1. In the Library view, click the template containing the drawing to import in the Model view.
2. Right-click on the template and select **Open As Folder**.
3. In the Library view's left side, select the template's folder and continuing expanding its subfolders until *.tvg files appear on the right side.



4. In the Library view's right side, select the TVG drawing to import and drag it into the Model view.

How to load a template with multiple drawings from the Library view

1. In the Library view, find the template you want to import in the Model view.
2. In the Library view's right side, drag the template (*.tpl file) and drop it directly in the Model view.
3. Use the Previous Model  and Next Model  buttons in the Model view's toolbar to view all the drawings contained in the template. This can often be the front, profile, and 3/4 views of a character.

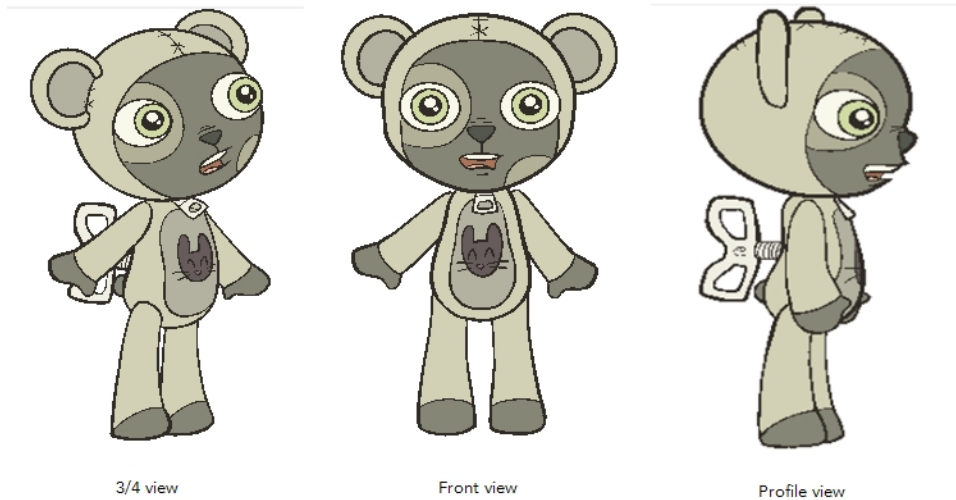

How to load a symbol from the Library view

1. In the Library view's left side, select the **Symbols** folder.
2. In the Library view's right side, select the symbol that you want to use as a model, and drag and drop it directly into the Model view.

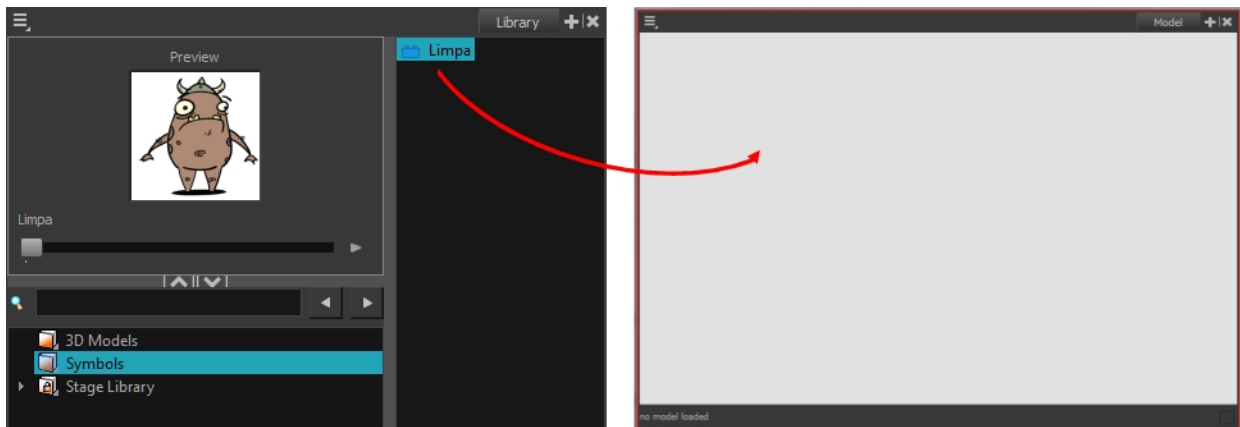

3. Use the **Previous Model** and **Next Model** buttons in the Model view's toolbar to view all the drawings contained in the template. This can often be the front, profile, and 3/4 views of a character.

How to clear a colour model

- In the Model View menu, select **Clear Model** or press Delete.

How to copy the entire model from the Model view

1. In the Model view's toolbar, select the **Select**  tool.
2. In the Model view, select your model.



3. From the top menu, select **Edit > Copy Drawing Object** or press Ctrl + C (Windows/Linux) or ⌘ + C (Mac OS X).
4. In the Timeline view, make sure that you have the correct layer and frame selected.
5. Select either the Drawing or Camera view then go to the top menu and select **Edit > Paste Drawing Object**, or select the Timeline view and from the top menu select **Edit > Paste cells in the Timeline** or press Ctrl + V (Windows/Linux) or ⌘ + V (Mac OS X).

The model now appears in the selected view.

How to copy part of the model from the Model view

1. In the Model view's toolbar, select the Cutter  tool or press Alt + T.
2. In the Model view, use the Cutter tool to create a selection around the part of your model that you want to copy.

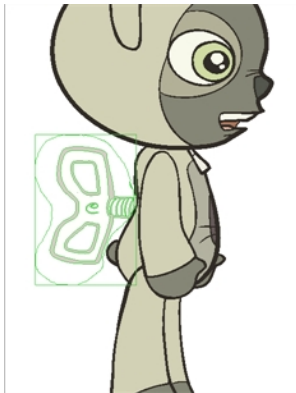

3. From the top menu, select **Edit > Copy Drawing Object** or press Ctrl + C (Windows/Linux) or ⌘ + C (Mac OS X).
4. In the Timeline view, make sure you have the correct layer and frame selected.
5. Do one of the following:
 - Select the Drawing or Camera view and select **Edit > Paste Drawing Object**.
 - Select the Timeline view and select **Edit > Paste cells in the Timeline** or press Ctrl + V (Windows/Linux) or ⌘ + V (Mac OS X).

The model appears in the selected view.

Editing Gradients and Textures



If you paint a zone with a gradient or texture colour, you can use the Edit Gradient/Texture tool to modify its position in the zone. You can move, scale, rotate and skew. If you want to match the colour to the animation, set the first texture position and copy the Edit Gradient/Texture position. When moving to the next drawing, you can select the next texture and paste the previous position to continue the modifications.

If you are painting a hand-drawn animation or if you want the Brush tool and Paint tool to use your gradient's position, angle and scale settings instead of the default ones, you can store your own settings and reuse them afterward.

This way of editing a texture using the Edit Gradient/Texture tool also works with pencil lines drawn with textured "brushes". If you then paint your textured pencil line with a gradient, you can do so and then edit both elements independently at the same time.

How to use Edit Gradient/Texture tool

1. Do one of the following:
 - In the Tools toolbar, click the Edit Texture  tool.
 - From the Camera or Drawing View menu, select **Drawing Tools > Edit Gradient/Texture**
 - Press Shift + F3.
2. Click the gradient or texture colour to modify.



Erik, Di-Gata Defenders © Nelvana Limited, Corus Entertainment

A blue selection frame surrounds the selected gradient or texture.



3. Edit the gradient or texture by adjusting the control handles around the selection frame.

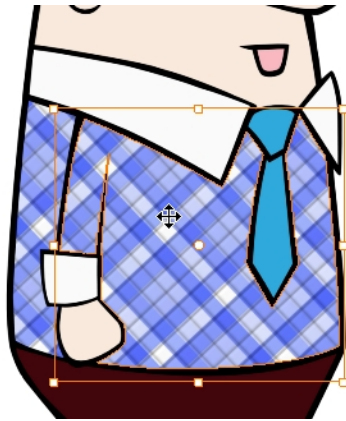

How to store your gradient and texture settings

1. In the Tools toolbar, select the Select  tool or press Alt + S.
2. In the Camera or Drawing view, select the gradient or texture zone to store.



3. In the Tool Properties view, click the Store Colour Gradient  button.

How to use the stored gradient and texture settings

1. In the Tools toolbar, select the Brush  or Paint  tool.
2. In the Tool Properties view, click the Use Stored Colour Gradient  button.
3. In the Camera or Drawing view, draw and paint.

How to use Pencil Editor tool to edit the texture or gradient on a pencil line

1. Do one of the following:
 - ▶ In the Tools toolbar, select the Pencil Editor  tool.
 - ▶ From the top menu, **Drawing > Drawing Tools > Pencil Editor**.
 - ▶ Press Alt + W.
2. Click on the pencil line to be modified to bring up its contour envelope.

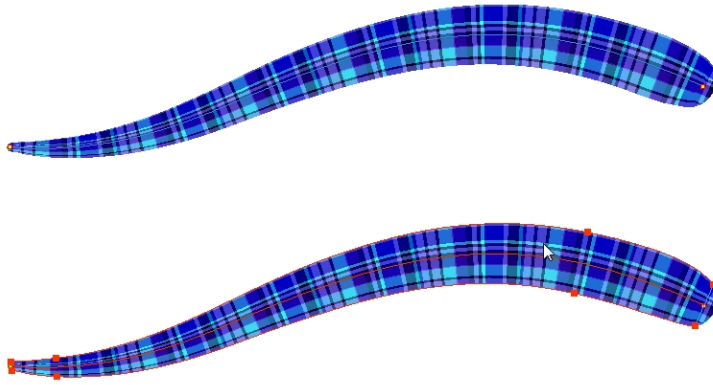

3. Select one of the contour points around the envelope and move its position to change the size of the tiled texture or gradient. You can also pull directly on the lines of the contour envelope or play with the Bezier handles of any given point in order to continue to modify the envelope form.

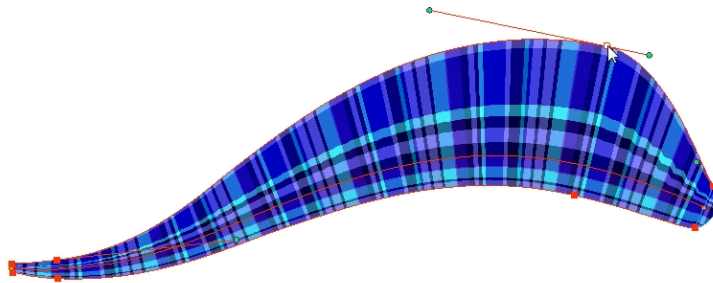

Expanding the width of the envelope parallel to the pencil line's central vector will cause the tiled texture to be stretched. Conversely, reducing the envelope's width will cause the tiled texture to look squashed.

Reducing the contour's width perpendicular to the pencil line's central vector will reduce the number of tiles, while expanding it will increase the number of tiled images.

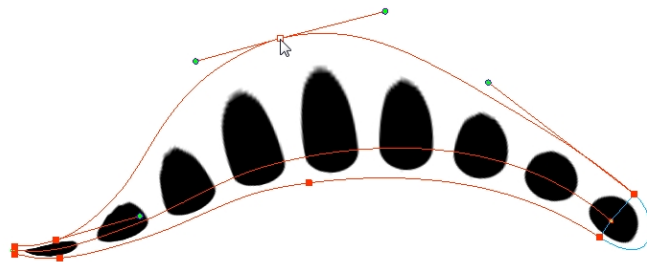

This editing technique does not just work on texture fills, but can also be applied to pencil lines drawn with a textured "brush".

How to use Edit Gradient/Texture tool to edit the texture or gradient on a pencil line

1. In the Tools toolbar, select the **Edit Gradient/Texture**  tool. You can also select this tool from the top menu under **Drawing > Tools > Edit Gradient/Texture** or press Shift + F3.
2. Click on the pencil line to be modified to bring up the editor controls.

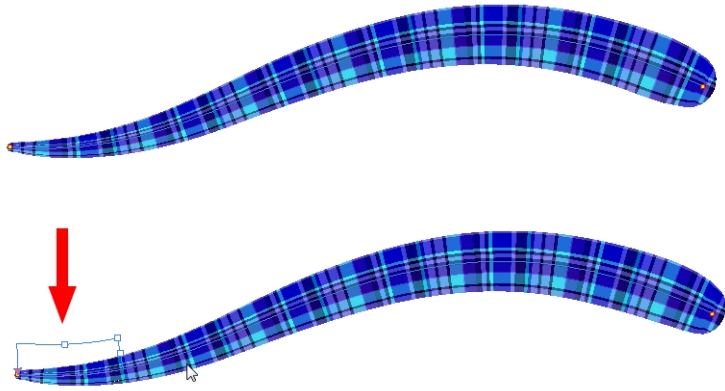

3. The editor controls delineate a single tile in the texture. For gradients, this is less applicable. Pull on the top of the editor controls to stretch the tiled texture throughout the length of the stroke. As gradients are parallel to the stroke's central vector, this will stretch the way that the gradient is distributed in the pencil line's envelope. The envelope still acts as a boundary for the texture or gradient.

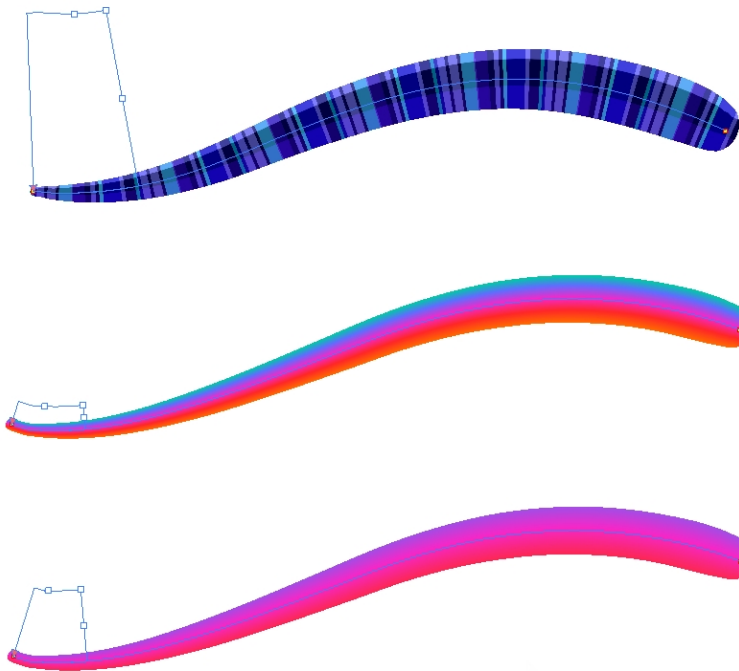

4. Drag the editor control perpendicular to the stroke. You will feel it glide along the stroke's central vector line. This is another way to resize the texture tile. Instead of stretching or shrinking it vertically, this motion stretches or shrinks it vertically. As gradients are parallel to the pencil line's central vector, stretching them vertically gives no visual result.

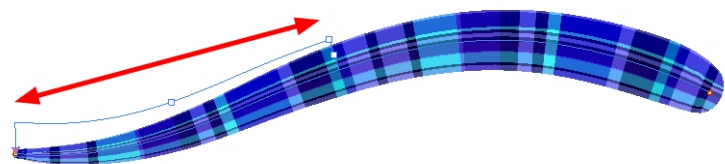

How to use Edit Gradient/Texture tool to edit both the texture and the gradient of a pencil line

1. Do one of the following:
 - ▶ In the Tools toolbar, select the Edit Gradient/Texture  tool.
 - ▶ From the top menu, **Drawing > Drawing Tools > Edit Gradient/Texture**.
 - ▶ Press Shift + F3.
2. Click on the pencil line to be modified to bring up the editor controls.

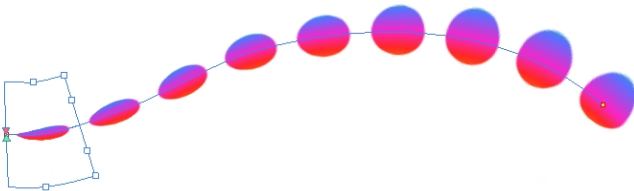

3. Use the top editor controls edit the gradient.

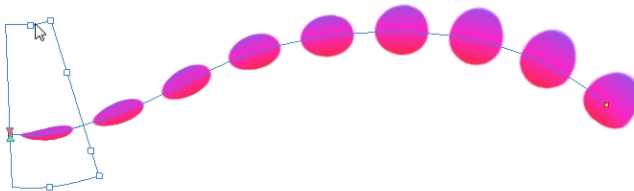

4. Use the bottom controls edit the "brush" texture.

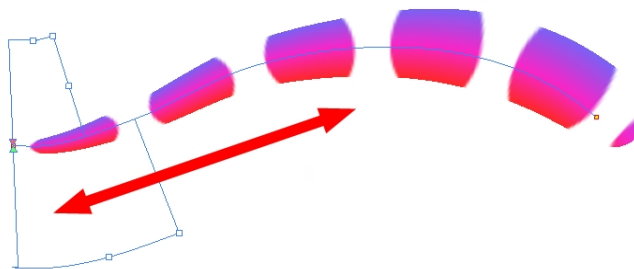
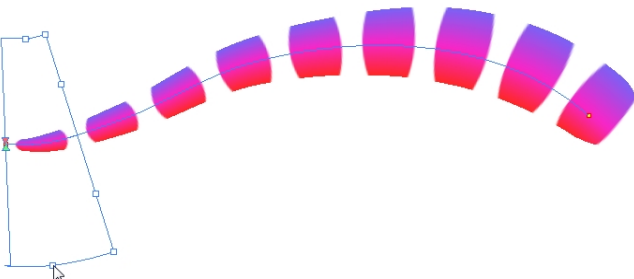

Closing Gaps

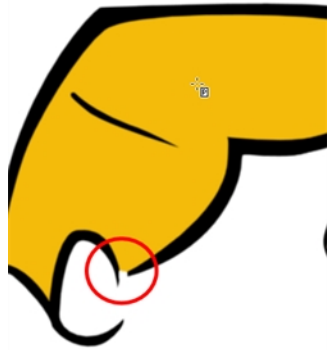

When painting, you may notice that some drawing areas are not closed. To close the zone, you can either draw the missing line with the Brush or Pencil tool, or close the gap with an invisible line using the Close Gap tool.

The Close Gap tool lets you close small gaps in a drawing by creating small, invisible strokes between the two closest points to close the colour zone. You do not need to trace directly over the gap. You can draw it a few millimeters away. The two closest points automatically close the gap.

How to close gaps

1. From the top menu, select **View > Show > Show Strokes** or press K to see a preview of the result.
2. Enable the Auto-Flatten  option in the Tool Properties view if you want the strokes you draw to be flattened in your drawing instead of being on top.
3. From the top menu, select **Drawing > Clean Up > Close Gaps** or press Shift + F10 (Windows/Linux only).

The Close Gaps dialog box opens.

4. Adjust the slider to set the size of the gap you want to be closed.

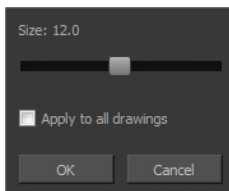

5. To close all gaps in the drawings of the selected layer, select the **Apply to all drawings** option and click **OK**.
6. In the Tools toolbar, select the Close Gaps  tool.
7. In the Camera or Drawing view, trace a line near the gap to be closed. Your strokes will be invisible. The gap automatically closes.



Protecting Colours

When you are finished painting some zones, you can protect the colour swatch they are associated with, so the work cannot be accidentally painted over.

When you are done inking one colour, you can lock it so that if you ever paint over it accidentally, the work already done will not be affected. You can also use the Protect Colour feature to block the filling colours if you painted all of the animation in Line Art and you plan to repaint the lines.

How to protect colours

1. In the Colour view, select the colour to be protected.

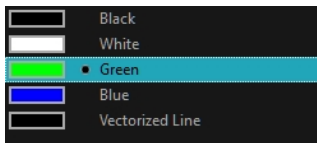

2. Do one of the following:

- Right-click and select **Protect Colour**.
- From the Colour view menu, select **Colours > Protect Colour**.

A red bar appears beside the colour to indicate that it is locked.

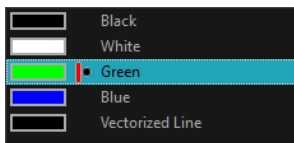

Respecting Protected Colours

When painting, the Respect Protected Colour  option is enabled by default. In the Colour view, you can protect a colour swatch to avoid repainting or unpainting the zones linked to that swatch. If you disable this option, the Paint tool will not follow the protect colour rule and you will repaint or unpaint the protected colours on your drawings until you enable the option again.

How to toggle the Respect Protected Colours option

Do one of the following:

- Paint tool properties, click the Respect Protected Colour  button.
- From the top menu, select **Drawing > Colour Protection > Respect Colour Protection**.
- Press Shift + S.

Highlighting the Selected Colour

The Highlight Selected Colour option is used to identify colour swatch used in a drawing. For example, if you have unnamed colours in your palette and want to know if a particular colour was used on the current model or drawing, you can select the colour and use the Highlight Selected Colour option. Harmony will dim all the colours in the drawing except the selected one, so it stands out and can be identified. You can rename it accordingly.

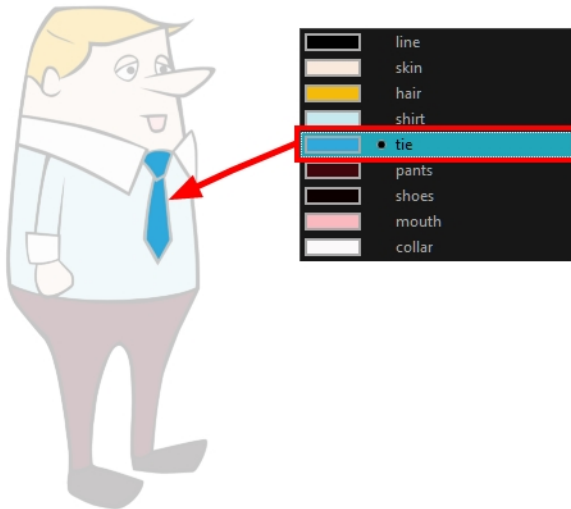

How to use the Highlight Selected Colour option

1. In the Colour view, select the colour you want to highlight.
2. From the Camera or Drawing menu, select **View > Show > Highlight Selected Colour**.

Inverting a Colour Selection

When you need to select all colour swatches but one, or select only a few swatches here and there, it might be faster to select the only colour you do not need, in order to select and invert the selection.

How to invert a colour swatch selection in the Colour view

1. In the Colour view, select the colour swatch you **DO NOT** want to have in your final selection.

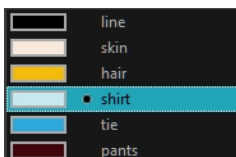

2. Do one of the following:
 - From the Camera or Drawing View menu, select **Edit > Invert Selection**
 - Press **Ctrl + Shift + I** (Windows/Linux) or **⌘ + Shift + I** (Mac OS X).

Inking the Lines

Some animation styles require you to paint the lines, a process also be called *inking*. To ink your lines, you must be in Line Art mode. You can repaint any type of lines including the texture lines—see [Art Layers on page 170](#).

Unless you are repainting all of the lines on the whole animation sequence, do not use the Apply Tool to All Drawings option. Since the line positions change a lot over time, you risk painting lines that are not supposed to be painted.

These are the main tools used to ink the lines:

- Repaint Tool
- Repaint Brush Tool
- Ink Tool
- Protecting Colours
- Breaking Triangles

The main tool used to ink the lines is the Repaint tool. As the colour filling is probably done in the Colour Art, you will not have to worry about not touching it. The Repaint tool will not paint empty zones either.

During the vectorization process on traditional scanned drawings, triangles are added on the lines' intersections to break the artwork in segments. This way, when you paint a line, it will not repaint the whole drawing, only the relevant segment.

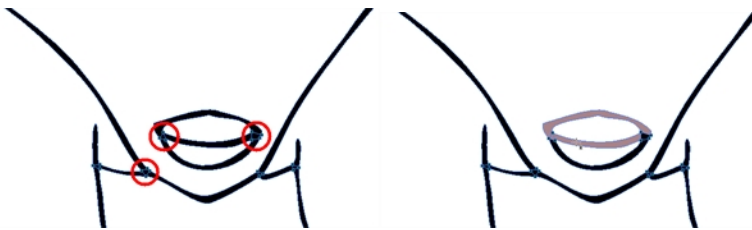

The Repaint Brush tool is used to paint a section by manually painting over the lines. This is useful when the vectorization triangles are not placed as you would like or you simply need to repaint a section of a segment. It is also useful for paperless animation, where there are no triangles. So, the Repaint Brush is used to paint a certain area. It acts like the Brush tool, but will only show on painted areas that are already painted.

Unlike the Brush tool, the Repaint Brush flattens automatically. The brush strokes are not added one on top of each other.



When you are done inking one colour, you can lock it so if you ever paint over it accidentally, the work already done will not be affected. You can also use the Protect Colour feature to block the filling

colours if you painted all of the animation in Line Art and you plan to repaint the lines—see [Protecting Colours](#) on page 196.

The Brush tool is often the most intuitive and rapid tool for creating rough sketches and clean lines. A single colour, such as black, is often used when tracing a clean version of a rough sketch. However, when it comes time to soft trace the lines in different colours, the flattened or unflattened clean brush strokes can suddenly become time consuming to ink.

Toon Boom Harmony lets you create triangular breaks at natural line intersections. These intersections are the probable locations where colour line breaks may occur, such as where a sleeve meets a hand.

Although pencil lines can be painted in much the same way as closed zones, you can use the Paint, Repaint, Repaint Brush, and Ink tools to make painting segmented lines easier. Normally when you have a drawing, such as the one below, and you use the Paint tool to paint one of the lines, the entire line is painted.

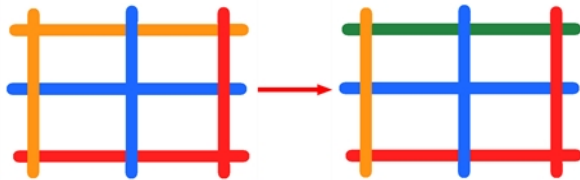

However, if you select the Ink  tool instead and click on the same pencil line, only the segment that you clicked on between two intersections will be painted.

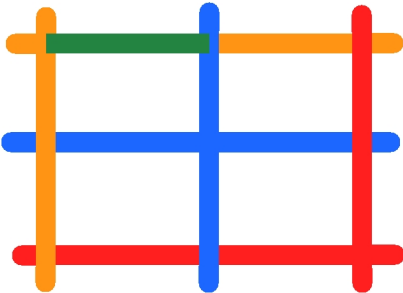

The newly inked segment will always be moved to the front of all other pencil strokes, even if it was behind all other pencil strokes before it was inked.

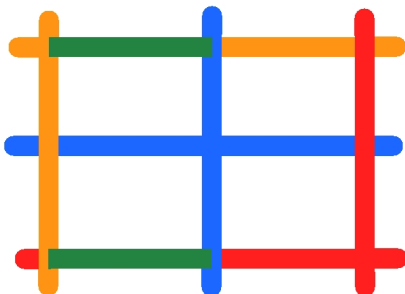

That is, unless you hold down Alt while clicking a segment. Then the opposite becomes true. The inked segment will be sent to the back, even if it was in front of all other segments to begin with.

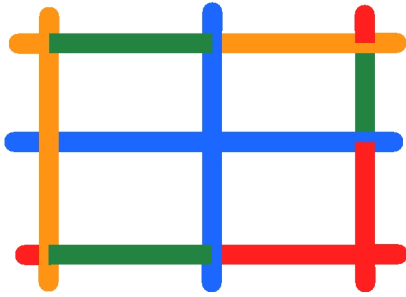



Painting and Inking can be used in combination depending on what it is that you need to paint. If you need to ink a character's outline in black, it might be easier to use the Paint tool. If you need to paint the outline of a character's neck with a tan colour and its shirt outline blue and both the neck and shirt belong to the same continuous outline, then the Ink tool might prove more useful.

How to select the Repaint Tool

1. In the Tools toolbar, select the Repaint  tool located in the Paint tool drop-down menu.

How to select the Repaint Brush

1. In the Tools toolbar, select the Brush  tool.
2. In the Tool Properties view, enable the Repaint Brush  mode.

How to select the Ink Tool

1. In the Tools toolbar, select the Ink  tool located in the Paint tool drop-down menu.

How to protect colours

1. In the Colour view, select a colour to lock.

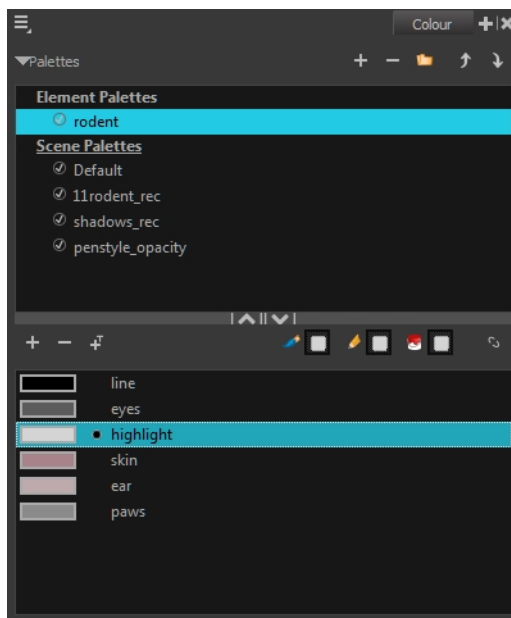

2. Do one of the following:

- ▶ Right-click and select **Protect Colour**.
- ▶ From the Colour view menu, select **Colours > Protect Colour**.

A red bar appears beside the colour to indicate that it is locked.

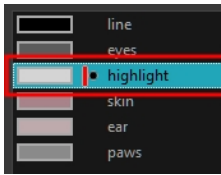

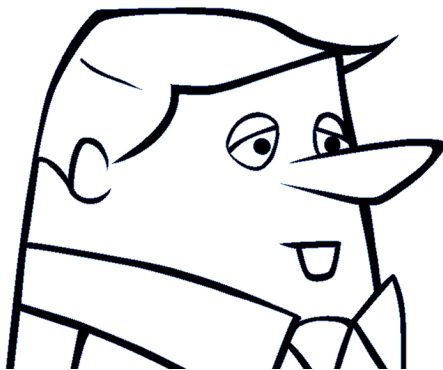

How to create breaking triangles on a drawing

1. In the Drawing or Camera view, use the Select  tool to select part or all of the drawing to be broken.

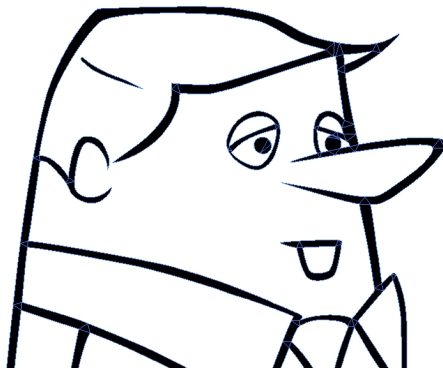

2. From the top menu, select **Drawing > Create Breaking Triangles**. If your brush strokes are not flattened, they will be flattened automatically before the breaking occurs.



3. Use the Repaint tool  to paint the outline of different colour zones with different colours.

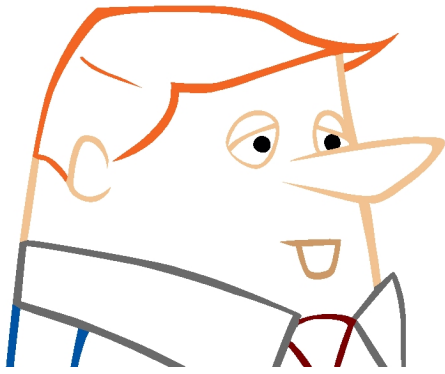

Verifying the Zones are Painted

When the ink and paint process is completed, it is always a good idea to verify that every zone was painted properly.

The first step to check your ink and paint is to go through all your drawings and verify that there are no colour mistakes. You can use the F and G keyboard shortcuts or the Preview option available in the Xsheet.

The backlight produces a silhouette effect by changing the drawing's coloured areas into a single dark, solid colour use this to verify the completeness of the ink and paint process. Any unpainted zones can be seen as the light shows through the unpainted areas of the silhouetted drawing.

How to preview drawings from the Xsheet

1. First, save your scene.
2. Do one of the following:
 - ▶ From the top menu, select **File > Save**.
 - ▶ Click the Save  button.
 - ▶ Press Ctrl + S (Windows/Linux) or ⌘ + S (Mac OS X).
3. In the Xsheet view, select the range of drawings or the whole column to preview.

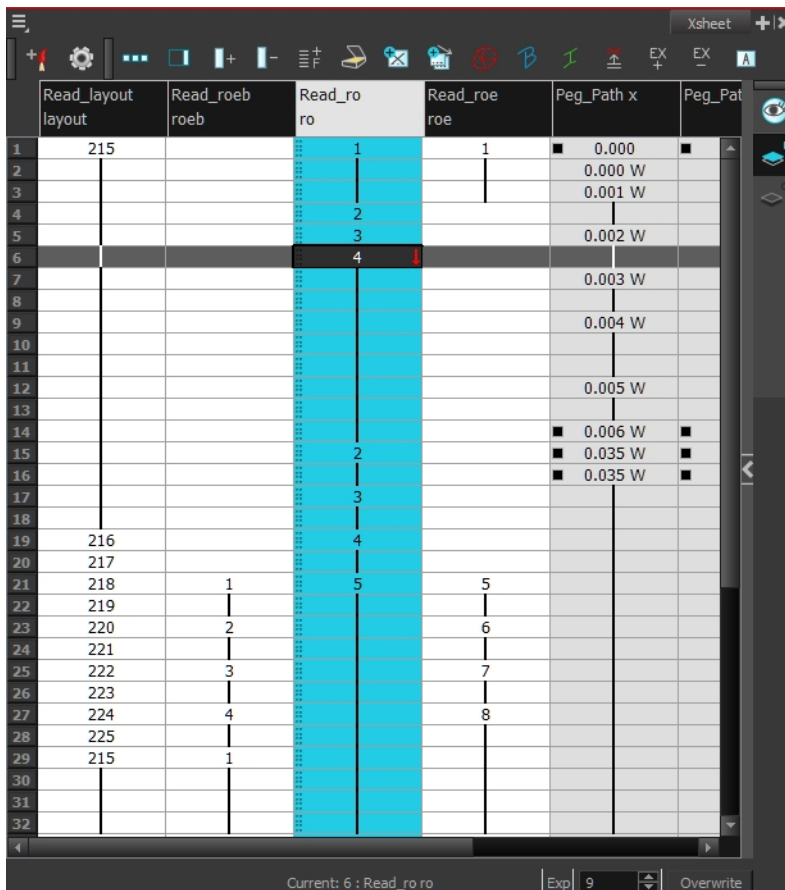

4. In the Xsheet View menu, select **View > Preview Selected Drawings** or press Alt + P.
The Play window opens.

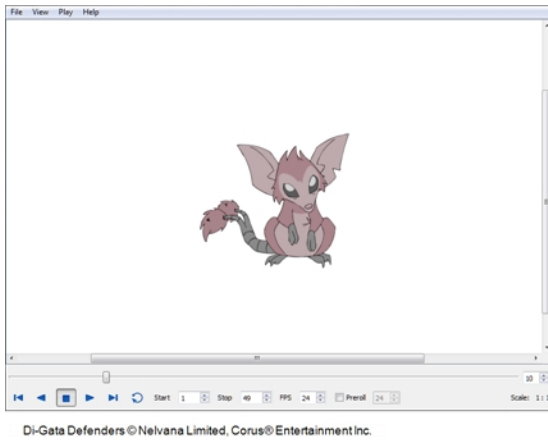

5. Play your drawings.





6. Select the **Preroll** option to see blank frames at the beginning and end of the animation sequence while looping the playback.



How to use the backlight

This feature is only available in the Drawing view.

1. Do one of the following:
 - ▶ From the top menu, select **View > Backlight**.
 - ▶ In the Drawing View toolbar, click the Backlight  button.
 - ▶ Press Alt + Shift + B.
2. Verify the drawings in the Colour Art to make sure that all the areas are painted. From the Camera or Drawing View menu, select **View > Switch to Colour Art** or press L.
3. In the Art Layer toolbar, click the Preview All Art Layers  button to see the colour zones with lines to ensure that you did not forget any spots between the colour filling and lines.



Ink and Paint Tool Properties





The Ink and Paint tool properties contain many options that will help you along with your task.



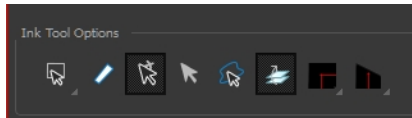





- [Ink Tool Properties](#) below
- [Paint Tool Properties](#) on the facing page

Ink Tool Properties

When you select the Ink tool, its properties and options appear in the Tool Properties view.



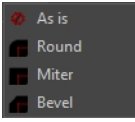

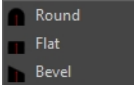





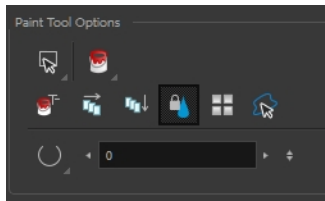

| Icon | Tool Name | Tool |
|-------------------------------------------------------------------------------------|--------------------|---------------------------------------------------------------------------------------------------------------------------------------------------------------------------------------------------------------------------------------------------------------------------------------------------------------------------------------------------------------------------------------------------------------------------------------------------------------------------------------------------------------------------------------------------------------------------------------------------------------------------------------------------------------------------------------------------------------------------------------------------------------------------------------------------------------------------------------------------------------------------------------------------------------------------------------------------------------------------------------------------|
|  | Lasso and Marquee | <p>The Lasso and Marquee options let you choose the type of selection the current tool will perform. The default selection mode is Marquee.</p> <ul style="list-style-type: none"> • Lasso  lets you draw a custom selection box around zones. • Marquee  makes a rectangle selection box. <hr/> <p>Hold down the Alt key to switch to the opposite mode of your selection.</p> <hr/> <p>How to invert a selection</p> <ol style="list-style-type: none"> 1. Do one of the following: <ul style="list-style-type: none"> ▸ From the top menu, select Edit > Invert Selection. ▸ From the Camera or Drawing menu, select Edit > Invert Selection. ▸ Press Ctrl + Shift + I (Windows/Linux) or ⌘ + Shift + I (Mac OS X). |
|  | Show Inkable Lines | <p>Highlights all pencil lines (no brush strokes) on the selected layer. Pencil line segments that are already inked with the selected swatch colour from the colour palette are also not highlighted.</p> |

| | | |
|-------------------------------------------------------------------------------------|---------------------------------------------------------------|------------------------------------------------------------------------------------------------------------------------------------------------------------------------------------------------------------------------------------------------------------------------------------------------------------------------------------------------------------------------------------------------------------------------------------------------------------------------------------------------------------|
|  | Be Smart on Connecting Lines | <p>As you hover and move the cursor across intersecting pencil lines, the path that you create will be highlighted. When you click on your mouse or stylus the highlighted segments are inked.</p> <p>With this option disabled, all the intersecting segments that your cursor comes near will be highlighted and become part of the selection, even if they were not situated in the direction of the chosen path.</p> <p>Note: This option only works if the Ink tool is in Hover mode.</p> |
|  | Select Mode | <p>Use this  mode instead of the Hover Mode. In the Hover Mode, any potentially inkable pencil line will have its central vector line highlighted as the Ink tool's cursor hovers over it. Use Ctrl (Windows/Linux) or ⌘ (Mac OS X) to toggle between the two modes.</p> |
|  | Select Newly Painted, Repainted, Unpainted Contours and Lines | <p>Keeps a selection highlighted around the latest painted zone after using the Paint, Repaint, Unpaint, or Paint Unpainted tool.</p> |
|  | Arrange Ink Lines | <p>Brings all newly-inked lines to the front. Disable this option if you want all newly-inked lines to be sent to the back. Press Alt to toggle between the two options.</p> |
|  | Mitre | <p>As you hover over two perpendicular or nearly perpendicular segments, a highlighted path with a corner is created. Clicking on these highlighted segments inks both segments and makes them appear as a single stroke with a corner or bend.</p> <p>Click the Mitre  button to choose from As is, Round, Mitre, and Bevel.</p>  |
|  | Tip Style | <p>Lets you customize the edge of the Ink tool. Options include: Round, Flat, and Bevel.</p>  |

Paint Tool Properties



When you select the Paint tool, its properties and options appears in the Tools Properties view.



| Icon | Tool |
|------------------------------------------------------------------------------------|----------------------------------------------------------------------------------------|
|  | Lasso and Marquee below |
|  | Painting Modes below |
|  | Paint and Remove Texture on page 210 |
|  | Apply to Multiple Drawings on page 210 |
|  | Apply to All Visible Drawings on page 211 Apply to All Visible Drawings on page 211 |
|  | Respect Protected Colour on page 211 |
|  | Use Stored Colour Gradient on page 212 |
|  | Select Newly Painted/Repainted/Unpainted Contours/Lines on page 212 |
|  | Automatic Close Gap on page 212 |

Lasso and Marquee

The Lasso and Marquee options let you choose the type of selection the current tool will perform. The default selection mode is Marquee.

- Lasso  lets you draw a custom selection box around zones.
- Marquee  makes a rectangle selection box.

Hold down the Alt key to switch to the opposite mode of your selection.

How to invert a selection

1. Do one of the following:
 - From the top menu, select **Edit > Invert Selection**.
 - From the Camera or Drawing menu, select **Edit > Invert Selection**.
 - Press Ctrl + Shift + I (Windows/Linux) or ⌘ + Shift + I (Mac OS X).

Painting Modes

The Paint tool has four different modes available:

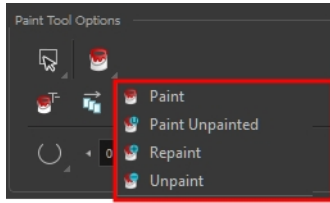

You can also find these tools directly in the Tools toolbar and in the Drawing Tools menu.

Paint Mode



The Paint  mode paints everything it touches, including empty and filled zones.

Paint Unpainted Mode

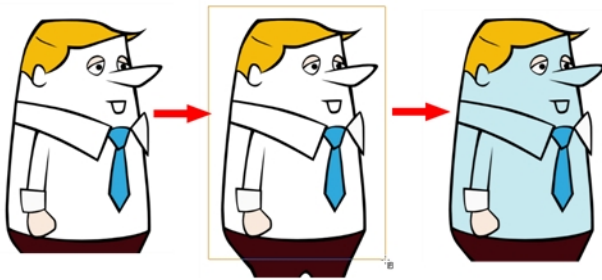

The Paint Unpainted  mode paints only empty zones. Any line or filled zone will remain unchanged.

Repaint Mode

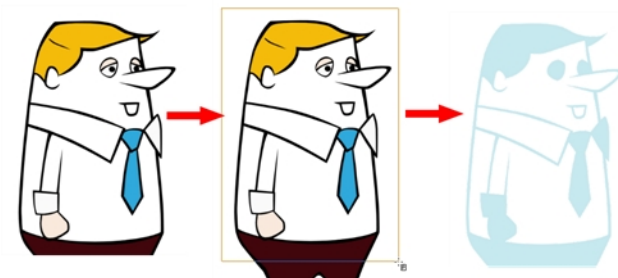

The Repaint  mode paints everything it touches except empty zones. Any zone that is not painted will remain intact.

Unpaint Mode

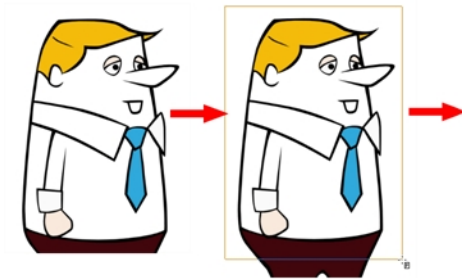

The Unpaint  mode unpaints everything it touches, including empty and filled zones.

Paint and Remove Texture

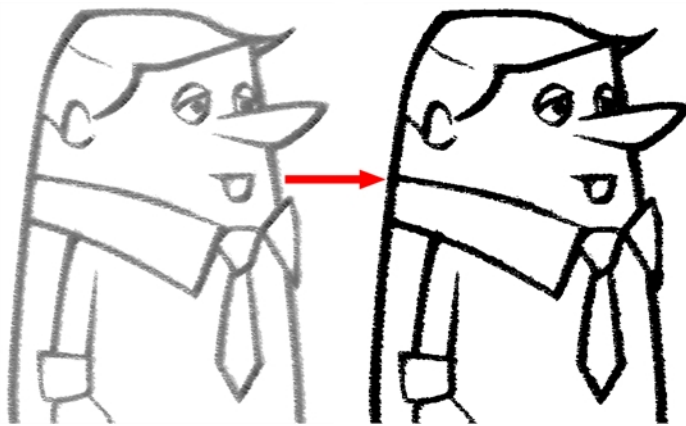

The Paint and Remove Texture  option is used when you vectorized images as greyscale texture style. An image vectorized as texture is a mix of bitmap filling encapsulated in a vector-based frame. Painting a textured zones with the Paint tool will change the tint of the textured lines. Painting the textured zones using the Paint and Remove Texture option transforms the bitmap filling into a 100% vector based zone and fills it with a solid colour.

Apply to Multiple Drawings

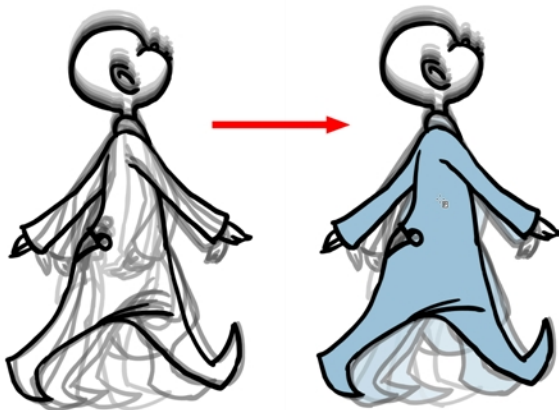

The Apply to Multiple Drawings  option is used for fast painting in hand-drawn animation. When you want to paint several drawings in a same layer at once, such as a walk cycle, you can enable this option and make a selection in your Camera or Drawing view. All the closed zones located within your Paint tool selection are painted with the selected colour swatch.

You do not need to enable the Onion Skin preview to use this option. The option will stay enabled only for the next action. If you want to use it again, you must click on the Apply to Multiple Drawings button again, or press Alt + A.

Apply to All Visible Drawings

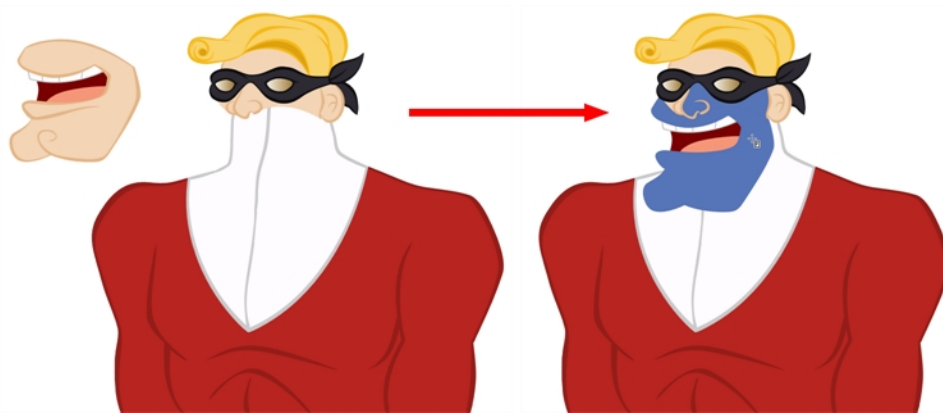

The Apply to All Visible Drawings  option is used to paint several drawings on separated layers on the current frames. If you have a character broken in several layers, you can enable this option to paint all your layers at once. The operation is only applied on the current frame. This option will stay enabled only for the next action. If you want to use it again, you must click on the Apply to All Visible Drawings button again.

This option is only available in the Camera view and does not affect symbols.



Respect Protected Colour

The Respect Protected Colour  option is enabled by default. In your Colour view, you can protect some colour swatches to avoid repainting or unpainting the zones linked to that swatch.

If you disable this option the Paint tool will not follow the protect colour rule and will repaint or unpaint the protected colours on your drawings until you enable the option again—see [Protecting Colours](#) on page 196.

Use Stored Colour Gradient



When you paint a zone with a gradient or textured colour swatch, the gradient or texture's position is set relative to the size of the zone you are painting. If you want the Paint tool to use a particular size and position, you must first store your desired position and size using the Select  tool and then enable the Use Stored Colour Gradient  option in the Paint tool Tool Properties view—see [Editing Gradients and Textures](#) on page 189.

Select Newly Painted/Repainted/Unpainted Contours/Lines

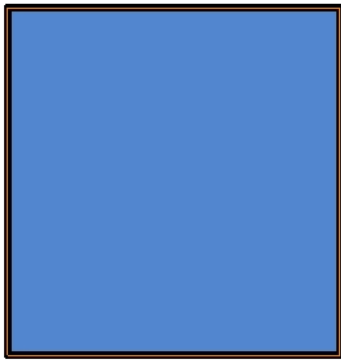

In the Paint tool Tool Properties view, enabling this option  will keep a selection highlighted around the latest painted zone after using the Paint, Repaint, Unpaint, or Paint Unpainted tool.

Automatic Close Gap

The Automatic Close Gap option has four modes available:

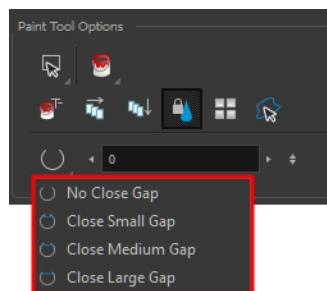

The Automatic Close Gap  options are used while painting drawings with small gaps. Instead of having to close them manually with the Brush tool or Close Gap tool, Toon Boom Harmony will analyze the drawing and close the gaps while you paint according to the selected mode. The automated gap closing should be done using the zoom function setting of your Camera or Drawing view. If your eye does not see the gap, Toon Boom Harmony won't either—see [Closing Gaps on page 194](#).

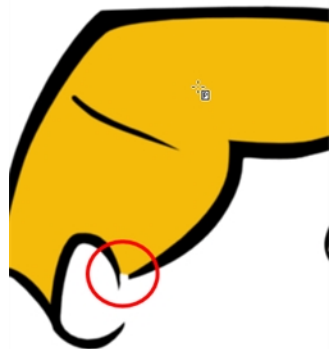

Glossary

| | |
|-------------------------------------|----------------------------------------------------------------------------------------------------------------------------------------------------------------------------------------------------------------------------------------------------------------------------------------------------------------------------------------------------------------------------|
| alpha channel | The image's channel carrying the transparency information. An image already has three channels: red, green and blue (RGB). The alpha channel is the fourth channel (RGBA). The matte, or the transparency information, is stored in this fourth channel. An image without an alpha channel is always opaque. |
| animatic | A movie with sound that is developed from the storyboard. The storyboard panel is exposed for the duration of the scene and at times, the characters are placed on a trajectory to indicate motion. The camera moves are also animated. The animatic is used to determine the rhythm of a project and provides a good overview of the project before beginning production. |
| animation | A simulation of movement created by displaying a series of pictures or frames. |
| anime | An animation style known for its sinister and dark feel; popular in Japan. |
| arc | Action rarely occurs in a straight-forward manner; rather it typically unfolds in what storytellers refer to as an arc. The purpose of a story arc is to move a character or a situation from one state or scenario to the next. |
| aspect ratio | The relationship between the width and height dimensions for any scene, frame or film format. Television ratio is 4:3 and widescreen ratio is 16:9. |
| auto-feed | An automated method of feeding drawings into a scanner in which multiple drawings are stacked into a sheet feeder. When the scanner is activated, the drawings are scanned consecutively, without further user intervention. |
| automatic lip-sync detection | Automatically mapping drawings in an element to the mouth chart generated for a sound. This can save time when lip-syncing a voice track. |
| axis | <p>An imaginary line around which an object rotates.</p> <p>For 2D graphics, there are two axes:</p> <ul style="list-style-type: none"> • X: Horizontal • Y: Vertical <p>For 3D graphics, there are three axes:</p> <ul style="list-style-type: none"> • X: Horizontal • Y: Vertical • Z: Depth |
| background | The part of a scene that is farthest to the rear. The background is the artwork, or decor, against which the animation takes place. |
| Bézier | A method of defining curved lines invented by French |

| | |
|-------------------------|----------------------------------------------------------------------------------------------------------------------------------------------------------------------------------------------------------------------------------------------------------------------------------------------------------------------------------------------------------------------------------------------------------------------------------------------------------------------------------------------------------------------------------------------------------------------------------------|
| | <p>mathematician Pierre Bézier. A Bézier curve is a mathematical or parametric curve. Bézier curves use at least three points to define a curve.</p> <p>In Toon Boom, a function can be hooked to a Bézier curve and vary along with the curve value information. Bézier curves are also very useful in vector graphics. They are used to model smooth curves and can be scaled indefinitely.</p> |
| bitmap | <p>An image composed of pixels with a single resolution (size). If it is enlarged too much, it will lose definition and pixels will begin to appear. This is known as <i>pixelation</i>.</p> |
| breakdown | <p>In cut-out animation, breakdown is the action of breaking a character into pieces to create a puppet with articulations. To break down a character, the artist cuts part, such as hands and arms, from the character's model and pastes them in separate layers. Next, the joints are fixed and the pivots set.</p> <p>In traditional animation, a breakdown is an animation pose generally found between two key poses. The key poses are the main poses in an animation and the breakdowns are secondary poses, ones that help to describe the motion and the rotation curve.</p> |
| camera shake | <p>Camera shake occurs in a scene when the camera moves slightly and quickly in several directions. This gives the impression of an impact, vibration or, for example, bumps on the road.</p> |
| caption | <p>In a storyboard, a caption is a text field containing dialogue, effects, sound, or slugging information.</p> |
| cel | <p>In traditional animation, a cel, also known as a <i>celluloid</i>, is a transparent sheet on which the animation is inked and painted before being sent to the camera. The picture's outline is drawn on the front of the cel and then coloured along the back.</p> <p>In Toon Boom, a cel is an individual space encountered in an Xsheet's column, from which you can expose a drawing or a function's coordinate.</p> |
| character design | <p>Each character in an animated film is drawn from multiple angles in poster-style format, called a <i>model sheet</i>, which serves as a reference for the animators.</p> |
| clean up | <p>After rough drawings have been tested and approved, all the noise in the image (excess lines, notes, etc) is removed to create final drawings which can be inked, painted and shot. The cleanup process refers to either tracing a clean line over a rough drawing to achieve the final version, or removing dirt and extra lines left by the scanning process.</p> |
| CMYK | <p>Cyan, Magenta, Yellow, Black. Refers to the process used by printers to define colour on the printed page.</p> |
| colour card | <p>A Colour Card is a solid colour card that is the same size as the camera. The Colour Card can be used to fill the background with a solid colour when there is no background image included.</p> |

| | |
|--------------------------|------------------------------------------------------------------------------------------------------------------------------------------------------------------------------------------------------------------------------------------------------------------------------------------------------------------------------------------------------------------------------------------------------------------------------------------|
| colour model | In animation, a colour model is the official colour design that must be used to paint the animation. A model is the definitive character, prop, or location design that each artist must follow for the production. |
| colour wheel | A display of the colour spectrum in the form of a circle. |
| compositing | Compositing is the action of incorporating all of a scene's elements to create the final result prior to rendering. For example, the compositing artist will import all the animation sequences, background, overlays and underlays in the scene and position them correctly. The artist will then set the camera frame and animate it, if needed. Finally, the animator will create all the computer-generated effects for the project. |
| cross dissolve | An effect used to fade two scenes, one into the other. |
| cut | A direct transition between two scenes. When a cut is used, there are no transition effects inserted to pass from one scene to the next. The first scene ends and the second one starts immediately. |
| cut-out animation | The action of animating characters made of several pieces by moving them around frame by frame. Cut-out animation can either be computer generated or done traditionally using paper. |
| cycle | A group of images that together make up an action, such as walking. A cycle is an action repeated as a loop over a period of time. It can be a series of animated drawings or keyframes. |
| dialogue | The text spoken by a character in a movie or animation. |
| dope sheet | Used by animators, directors and other members of a crew to track the sequence and timing of images, dialogue, sound effects, sound tracks and camera moves. Also known as an <i>exposure sheet</i> or <i>Xsheet</i> . |
| doping | To assign a particular drawing to a range of frames. |
| DPI | Dots Per Inch is the standard measure of resolution for computerized printers. It is sometimes applied to screens, in which case it should more accurately be referred to as <i>pixels per inch</i> . Either way, the dot is the smallest discrete element making up the image. |
| ease/velocity | In animation, the ease, also known as <i>velocity</i> , is the acceleration and deceleration of a motion. It can be a motion created by a function curve, or a series of animated drawings. Other common terms for ease-in and ease-out are slow-in and slow-out. |
| ease-in | Gradual acceleration in the action. Another common term for ease-in is slow-in. |
| ease-out | Gradual deceleration in the action. Another common term for ease-out is slow-out. |
| establishing shot | A scene in which the viewer can see the whole area in which a sequence is happening. For example, if a child is playing on the ground in front of his house, the establishing shot would be a scene |

| | |
|--------------------------------|-----------------------------------------------------------------------------------------------------------------------------------------------------------------------------------------------------------------------------------------------------------------------------------------------------------------------------------------------------------------------------------------------------------------------------------------------------------------------------------------------------------------------------------------------|
| | where the viewer can see the house, the ground, a part of the street and the buildings around the central point of action. This helps the viewer understand the story location and scene orientation. |
| exposure | In animation, an exposure is the number of cels on which a drawing appears in the scene. For a drawing to appear longer, the exposure must be extended over a greater number of cels. |
| exposure sheet (Xsheet) | <p>The exposure sheet or Xsheet, is a sheet with several vertical columns and horizontal frames used to indicate a scene's timing.</p> <p>Each column represents a scene's layer. In each column, the drawing's numbers are indicated and repeated over the particular amount of frames they need to appear.</p> <p>The exposure sheet is used by animators, directors and other members of a crew to track the sequence and timing of images, dialogue, sound effects, sound tracks and camera moves. Also known as a <i>dope sheet</i>.</p> |
| fade in/fade out | Fade in or fade out is a transition effect used to open or close a sequence. A fade in occurs when the first scene appears progressively, from complete transparency to its complete opacity. A fade out occurs when the last scene progressively disappears, going from complete opacity to complete transparency. |
| fast-in | Dramatic acceleration at the start of the action. |
| fast-out | Dramatic acceleration at the end of the action. |
| field | In animation, a field is a measurement unit used to calculate motion, registration and camera positioning. A standard animation scene will vary between 6 to 12 fields. |
| field chart | A guide containing all the field units that animation and layout artists use to determine a scene size or camera motion. |
| film-1.33 | Use this resolution setting for the widescreen film format that conforms to the standard 4:3 pixel aspect ratio. |
| film-1.66 | Use this resolution setting for the widescreen film format that conforms to the 16:9 pixel aspect ratio. (The pixels are wider than they are high). |
| flipping | In traditional animation, flipping is the action of going through the drawings of an animation sequence very quickly in order to see the animation in motion. Flipping can also be the action of creating a mirror transformation of an object. |
| follow-through | The follow-through is the secondary motion caused by the main action. For example, a character wearing a cloak is running. The main action is the body running. This will cause the cloak to follow the motion, although it will not move at the same time, but react a few frames later and follow the main motion curve. |
| forward kinematics | Forward kinematics is a feature used to animate principally 3D characters and cut-out puppets with hierarchy. It is used to animate |

| | |
|----------------------|-------------------------------------------------------------------------------------------------------------------------------------------------------------------------------------------------------------------------------------------------------------------------------------------------------------------------------------------------------------------------------------------------------------------------------------------------------------------------------------------------------------------------------------------------------------------------------------------------|
| | <p>a puppet from one of parent parts, such as a shoulder, and make the rest of the arm move with it as a single piece.</p> |
| frame | <p>A frame is a single photographic image in a movie. In traditional animation, the North American standard generally contains 24 frames per second, while in Europe the standard is 25 frames per second.</p> |
| frame rate | <p>This is the measurement of the frequency (rate) at which an imaging device produces unique consecutive images, called frames. The term applies equally to computer graphics, video cameras, film cameras, and motion capture systems.</p> <p>Frame rate is most often expressed in frames per second (FPS) and in progressive-scan monitors as hertz (Hz).</p> <p>The frame rate is the speed at which the frames are played. They are generally calculated by frame per second. For example, a scene could be played back at 12, 24, 25, 30 or 60 frames per second or any other number</p> |
| functions | <p>A function is a computer generated motion, trajectory or path that elements, other trajectories and effects parameters can be attached to. The function can be controlled by adding keyframes and control points on the function curve.</p> |
| gamut | <p>The range of colours that a particular device can represent.</p> |
| HDTV | <p>High Definition Television delivers a higher quality image than standard television does because it has a greater number of lines of resolution. To take advantage of the superior quality and make full use of your resolution setting, your output device must be compatible with HDTV technology.</p> |
| hold | <p>This is a frame in the animation in which the character maintains its position without moving. A hold can be created between any two keyframes.</p> |
| HSV | <p>Hue, Saturation, Value. A method of defining colours in terms of hue (tint), saturation (shade) and value (tone or luminance).</p> |
| in-between | <p>The drawings that exist between the key poses. These are drawn to create fluid transitions between poses.</p> |
| ink and paint | <p>The ink and paint process is the action of painting the empty zones and colouring the lines on the final animation drawings, while following a colour model.</p> |
| interpolation | <p>In animation, the interpolation is the computer generated motion created between two keyframes. You have the choice to create interpolation, or not, between your keyframes.</p> |
| jump cut | <p>A jump cut is a jerky cut between two scenes. Typically, a jump cut is not visually pleasing. It is generally caused by one scene ending, and a second one starting, with similar a image. The lack of difference causes the eye to see a little jump between the two scenes.</p> |

| | |
|---------------------------|-------------------------------------------------------------------------------------------------------------------------------------------------------------------------------------------------------------------------------------------------------------------------------------------------------------------------------------------------------------------------------------------------------------------------------------------------------------------------------------------------------------------------------------------------------------------------------------------------------------------------------------------------------------------|
| key pose | Important positions in the action defining the starting and ending points of any smooth transition. Keys, or key poses, are the main drawings in an animation sequence describing the motion. For example, if an arm is waving, the keys will be of the arm at one extremity of the wave motion and the other extremity. By flipping those drawings, the animator can see the skeleton of the motion without having all of the drawings. |
| keyboard shortcuts | <p>One or more keyboard keys which, when used, cause an operation to be performed. Keyboard shortcuts are used throughout the Toon Boom software and form an integral part of the workflow. It is, in most cases, possible to customize the shortcuts in the Preferences dialog of the software.</p> <p>The shortcuts are written as follows in the Toon Boom user documentation: Each key in a sequence is shown inside square brackets as in: [Ctrl]+[A]. The brackets "["]" separate the key from the plus sign (+). Neither the brackets, nor the plus sign are part of the sequence. To use a shortcut, press the key and the character simultaneously.</p> |
| keyframe | Important positions in the action defining the starting and ending points of any action. A keyframe is a computer generated position at a specific moment (frame) on a given trajectory. |
| layer | In animation, a layer is an individual column, level or character. A scene's layers are superposed to form the final image. |
| layout | The layout process is the communication step between the storyboard and the animation. The layout and posing process is the action of putting the storyboard on model, that is drawing the character following the design in the model pack, so that the animator can start his work. The layout artist will draw the background, create the camera and field guide matching the scene and the camera motion. Lastly, he will draw on model the main action poses. |
| layout and posing | The action of putting on model, that is, at the right scale, the storyboard for the animator to start his work. |
| library | A library is a storage area containing templates and assets that can be reused in any project or scenes. |
| light table | The Light Table feature allows you to see the other layers in transparency while you are working on a particular one in the Drawing view. |
| line of action | Direction that the action will follow. Also known as the Path of Action |
| lip-sync | The lip-sync is the character's mouth synchronization with the dialogue sound track. Frame by frame, the mouth will be adjusted to fit the sound to give the illusion of the character is speaking. |
| low resolution | This format is ideal for videos destined for the web, where size and fast download of a video file might take precedence over quality. A low-resolution image is one that lacks fine detail. |

| | |
|----------------------------------|----------------------------------------------------------------------------------------------------------------------------------------------------------------------------------------------------------------------------------------------------------------------------------------------------------------------------------------------------------------------------------------------------------------------------------------------|
| manual lip-sync detection | The manual swapping of mouth position drawings to match a voice track. For this process, both sound scrubbing (listening to a sound wave broken up frame-by-frame) and drawing substitutions from the Library view are used. |
| master palette | A master palette is a group of colours attributed to a character or a prop. The palette is used throughout the entire production to maintain consistency in the look and to ensure that the same colours are used throughout the production. Also known as palette. |
| model/colour model | In animation, a model is the definitive character, prop or location design that each artist must follow for the production. A colour model is the official colour design that must be used to paint the animation. |
| motion keyframe | In Toon Boom, the motion keyframe is a keyframe with computer-generated interpolation. |
| mouth chart | Adding a lip-sync to a project can really enhance its quality and storytelling. However, it can be difficult to shape a character's mouth so that it matches the sound at the precise frame. To solve this problem, Toon Boom provides a lip-sync feature which analyses the contents of a sound element and generates a mouth chart based on the eight animation phonemes (A, B, C, D, E, F, G, and X, which is used to represent silence). |
| multiplane | The effect of passing through multiple levels of drawings to create a sense of depth in a shot. A multiplane is a scene in which the layers are placed at different distances from the camera so that when the camera moves, a depth illusion occurs. With a multiplane, all the perspective and scale is calculated automatically. |
| NTSC | The standard analogue television broadcasting system used in North America. NTSC conforms to North American standards on how rectangular pixels are displayed for computer and television screens. |
| nudge | A small push (left, right, up, down, forward or backward) done with the keyboard arrow keys on a selected element. Nudging is used to move a selection very slightly and precisely. |
| onion skin | A feature that lets you see the previous and next drawings of a sequence. |
| overlay | A part of the scene environment, such as a chair or a bush, that is placed in front of the main animation. |
| PAL | A resolution that works best with the European format for television and computer screens, as the rectangular pixels are displayed at a different orientation. |
| palette/master palette | A palette or master palette is a group of colours attributed to a character or a prop. The palette is used throughout the entire project to maintain a consistency in the look and avoid the colour changing during the animation. Also referred to as a master palette. |

| | |
|---------------------------------------|---------------------------------------------------------------------------------------------------------------------------------------------------------------------------------------------------------------------------------------------------------------------------------------------------------------------------------------------------------------------------------------------------------|
| palette style | A palette style is a second version of an existing palette with a slight change in the tint and value. A palette style can be used to create the night version of a palette. It may also be called a clone palette. |
| pan | To move the camera across the scene in any direction. |
| panel | In a storyboard, a panel is a frame in a shot. A shot can be composed of one or several panels. |
| paperless animation/tradigital | The paperless animation process is the action of animating digitally. The main paperless animation process is to draw, frame by frame, the animation directly in the software. |
| passing position | When drawing a walk sequence for a character, the passing position is the point at which one leg passes the other. |
| path of action | Direction that the action will follow. Also known as the Line of Action. |
| peg | In traditional animation, a tool used to ensure accurate registration of action as cel layers move. In digital animation, in which you are doing a more advanced puppet rigging, you can use peg layers. Peg layers are trajectory layers that do not contain drawings. They are motion paths that you can use to add path articulations. For the latter, you can also use the Inverse Kinematics tool. |
| phoneme | Unit of sound in a language. |
| pivot | A pivot is the point around which a peg or a drawing rotates. |
| pixel | Smallest element of an image displayed on a monitor or TV screen. Pixel, short for Picture Element, is a single point in a graphic image. It is a small sample of an image, a dot, a square, or a very small section made out of smooth filtering. If you zoom in close enough on a digital image, you will see the pixels, which look like small squares of different colours and intensity. |
| pose-to-pose animation | The pose-to-pose animation process is the action of creating all the main action poses, called key poses, and then placing the secondary poses between the keys. The secondary poses are called breakdown. Finally, the animator fills the gaps with the in-between drawings to achieve a smooth animation. |
| rendering | The final step when animating by computer. During rendering, the computer takes each pixel that appears on screen and processes all of the components as well as adding motion blur before it produces a final image. In animation, the rendering process is the action of calculating the final images after the compositing process. |
| resolution | The resolution is the size of a scene, generally calculated in pixel. For example, the NTSC resolution is 720 x 480. Resolution type should match your final output: HDTV, film-1.33, film-1.66, NTSC, PAL, low. |
| RGB | Red, Green, Blue: method of defining colour by specifying amounts |

| | |
|-----------------------------|--------------------------------------------------------------------------------------------------------------------------------------------------------------------------------------------------------------------------------------------------------------------------------------------------------------------------------------------|
| | of these three colour components. |
| rigging | The rigging process is the action of attaching the cut-out puppet parts one to the other. |
| rotary table | The Rotary Table is equivalent to the animation disk/table and allows one to rotate the workspace to be more comfortable while drawing. |
| rotoscoping | Is an animation technique in which animators trace over live-action film movement, frame by frame, for use in animated films. The act of sketching over live-action footage to create an animated sequence. |
| roughs | The roughs are the skeleton sketch of an animation or a design. Roughs mainly consist of sketch lines and shapes, though they can also contain design details. |
| safety area | In animation and movie parlance, the safety area is the zone at the centre of the scene's frame, one safe from being cropped by the TV frame. As a TV frame cuts a margin off the original frame size, maintaining a safety area ensures that the scene's main action will remain clearly visible once the film is screened on television. |
| scene | A scene is a shot in a movie or show. A sequence is composed of several scenes. A scene changes to another scene by a simple cut, or a transition. |
| script | The script is the original text containing all the movie or show information. In animation, the script contains all of the location descriptions, dialogues, time and more. A project starts with a script. |
| sequence | In animation, a sequence is a series of scenes or shots forming a distinct part of the story or movie, usually connected by unity of location or time. |
| shot | A shot is a scene in a movie or show. A sequence is composed of several shots. A shot changes to another shot by a simple cut, or a transition. |
| slow-in | Gradual acceleration in the action. Another common term for slow-in is ease-in. |
| slow-out | Gradual deceleration in the action. Another common term for slow-out is ease-out. |
| slugging | In Storyboard Pro, slugging refers to indicating the start and stop times of dialogue and relevant actions. |
| sound scrubbing | A process that lets you hear sound in real time while you move the playhead forward or backward. This is very useful for finely-tuned lip-syncing. |
| stop-motion keyframe | A stop-motion keyframe is a keyframe with no computer generated interpolation. |
| storyboard | A visual plan of all the scenes and shots in an animation. The storyboard indicates what will happen, when it will happen and |

| | |
|------------------------------|------------------------------------------------------------------------------------------------------------------------------------------------------------------------------------------------------------------------------------------------------------------------------------------------------------------------------------------------------------------|
| | how the objects in a scene are laid out. |
| straight-ahead | A technique in which an entire sequence is drawn from the first position to the last, in order. There is very little planning in this methodology, and where the character ends up and how it gets there can be a surprise for both the audience and the animator. While this approach is a lot more spontaneous and creative, it can create inaccurate results. |
| strokes | Strokes are invisible vector lines forming the drawing zones. They can be adjusted with Bézier handles. |
| tablet/pen | Device used in conjunction with, or instead of, a mouse to move a mouse pointer (sometimes referred to as the cursor) around the computer screen. |
| template | In Toon Boom, a template is an asset stored in the library, one that can be reused in any project. A template can be a drawing, a series of keyframes, a sound file, a panel, a cut-out character, an effect, a trajectory, an animation, or anything else used in the software. |
| thumbnails | A thumbnail is a very small image used as a reference or indicator. |
| timecode | Timecode is timing information printed on a movie clip to indicate what scene, hour, minute and second is currently displayed on the screen. |
| timeline | The timeline is a horizontal representation of the scene's elements, timing and keyframes. |
| trace and paint | After the rough animations have gone through cleanup and a final line or pencil test, each drawing is traced and painted for the final animation. In today's digital world, this may be done in a variety ways other than via the traditional celluloid or acetate methods. |
| track breakdown | The soundtrack for animated film is broken down into individual sounds documenting the precise frame-by-frame position of each sound. |
| traditional animation | The traditional animation process is the action of drawing on paper all of the animation sequences, before either scanning them or inking them on cels. |
| trajectory | A computer generated path or trajectory that elements can follow. The trajectory can be controlled by control points, keyframes and velocity. |
| transition | A transition is an effect placed between two scenes as they pass from one to the other. Common transition effects are cross-dissolve and wipe. |
| underlay | In animation, an underlay is a specific part of the decor placed behind the main animation. |
| aspect ratio | The aspect ratio describes the shape of the grid unit. A square grid unit would have the ratio 1:1, whereas a grid unit of aspect ratio 4:3 is a unit with one side 1.33 times as big as the other side. |

| | |
|--------------------------------|----------------------------------------------------------------------------------------------------------------------------------------------------------------------------------------------------------------------------------------------------------------------------------------------------------------------------------------------------------------------------------------------------------------------------------------------------------------------------------------------------------------------------------|
| vector | A vector-based image is composed of points and Bézier curves. The computer reads the points and traces the segments, linking them to reproduce the image shape. There is no fixed size or resolution in a vector image. The graphic can be enlarged and distorted as much as desired and the system will simply recalculate the segments and rebuild the shapes. Vector images are translated and displayed in pixels once the calculation is done. |
| velocity/ease | In animation, the velocity, also known as ease, is the acceleration or deceleration of a motion. This can be achieved by a function curve, or via a series of animated drawings. Other common terms for ease-in and ease-out are slow-in and slow-out. |
| walk cycle | To avoid making innumerable drawings, animators routinely make a walk cycle for their character. This comprises a series of drawings "on the spot" that describe the walk for that character. The illusion of movement is created via the use of background pans. |
| workspace | In Toon Boom, the workspace is made up of the views, toolbars, and menus. |
| Xsheet (exposure sheet) | <p>The Xsheet or exposure sheet, is a sheet with several vertical columns and horizontal frames used to indicate a scene's timing.</p> <p>Each column represents a scene's layer. In each column, the drawing numbers are indicated and spread over the specific amount of frames they need to appear.</p> <p>The exposure sheet is used by animators, directors and other members of a crew to track the sequence and timing of images, dialogue, sound effects, sound tracks and camera moves. Also known as a Dope Sheet.</p> |
| zone | An area which can be painted with colour. |

Index

A

- alpha channel
 - _defined 214
- animatic
 - _defined 214
- animation
 - _defined 214
- anime
 - _defined 214
- Annotation column 59
 - changing drawing settings 62
 - drawing 60
 - erasing annotations 61-62
 - importing Annotation file 64
 - pen colour 63
 - pen width 62
 - tick marks, displaying 63
 - typing 60
- annotations
 - changing drawing settings 62
 - changing pen colour 63
 - changing pen width 62
 - drawing 60
 - erasing 61-62
 - typing 60
- arc
 - _defined 214
- aspect ratio
 - _defined 214
 - defined 223
- auto-feed
 - _defined 214

axis
 _defined 214

B

background
 _defined 214

backing up
 palettes 128

Bezier
 _defined 214

bitmap images
 _defined 215

Bitmap layer 45

breakdown
 _defined 215

C

Camera layer 46

camera shake
 _defined 215

caption
 _defined 215

cel
 _defined 215

celluloid
 See cel. 215

character design
 _defined 215

clean up
 _defined 215

cloning
 layers and columns 58

CMYK
 _defined 215

Colour-Card
 layer 46

colour card

 _defined 215

colour model

 _defined 220

 defined 216

colour palettes

 back up 128

 location 125

 storage location 127

colour wheel

 defined 216

Column Properties editor

 displaying in Xsheet 55

columns

 advanced types 48

 cloning 58

 deleting 52

 duplicating 58

 modifying 55

 properties 54

 renaming 56

 reordering 57

 Timing 65

 types 45

 Xsheet 44

compositing

 defined 216

cross dissolve

 defined 216

cut

 defined 216

cut-out animation

 defined 216

cycle
 defined 216

D

dialogue
 defined 216

dope sheet
 defined 216

doping
 defined 216

DPI
 defined 216

drawing elements
 adding 48
 creating 44
 duplicating 58

Drawing layer 45

drawings
 importing 13
 scanning 13

E

ease
 defined 216

ease-in
 defined 216

ease-out
 defined 216

editors
 Column Properties 55

Effect layer 46

Element Manager dialog box
 parameters 57

establishing shot
 defined 216

exporting
 palettes 127

exposure

 _defined 217

exposure sheet

 _defined 217, 224

F

fade-in

 _defined 217

fade-out

 _defined 217

field

 _defined 217

field chart

 _defined 217

film-1.33

 _defined 217

film-1.66

 _defined 217

flipping

 _defined 217

follow-through

 _defined 217

forward kinematics

 _defined 217

frame

 _defined 218

frame rate

 _defined 218

frames 41

 adding 42

 adding before/after selection 41

functions

 _defined 218

G

gamut

 _defined 218

H

HDTV

_defined 218

Hold

_defined 218

HSV

_defined 218

I

importing

Annotation file 64

bitmap drawings 18

drawings 13

in-between

_defined 218

ink and paint

_defined 218

interpolation

_defined 218

J

jump cut

_defined 218

K

key pose

_defined 219

keyboard shortcuts

_defined 219

keyframes

_defined 219

L

Layer Properties editor

displaying 55

renaming layers 56

layers 44

_defined 219

bitmap 45

camera 46

- cloning 58
- Colour-Card 46
- deleting 52
- drawing 45
- duplicating 58
- effect 46
- Group 46
- modifying 55
- Peg 47
- properties 54
- Quadmap 47
- renaming 56
- reordering 56
- Sound 47
- types 45

layout

- _defined 219

layout and posing

- _defined 219

library

- _defined 219

light table

- _defined 219

line of action

- _defined 219

linking

- external files 65

lip-sync

- _defined 219
- auto detection, defined 214

lip-sync detection

- manual, defined 220

low resolution

- _defined 219

M

manual lip-sync detection

 _defined 220

master palette

 _defined 220

 exporting 127

model

 _defined 220

model sheet See character design

motion keyframe

 _defined 220

mouth

 chart 220

multiplane

 _defined 220

N

NTSC

 _defined 220

nudge

 _defined 220

O

onion skinng

 _defined 220

overlay

 _defined 220

P

PAL

 _defined 220

palettes

 _defined 220

 backup 128

 exporting 127

 location 125

 storage location 127

 style, defined 221

panel

 _defined 221

panning

 _defined 221

paperless animation

 _defined 221

passing position

 _defined 221

path of action

 _defined 221

Peg layer 47

pegs

 _defined 221

pen

 _defined 223

phoneme

 _defined 221

pivot

 _defined 221

pixel

 _defined 221

pixelation See bitmap image

pose-to-pose

 _defined 221

Q

Quadmap layer 47

R

rendering

 _defined 221

resolution

 _defined 221

RGB

 _defined 221

rigging

 _defined 222

rotary table
 _defined 222

rotoscoping
 _defined 222

roughs
 _defined 222

S

safe area
 _defined 222

scanning 11
 drawings 13
 images as bitmap drawings 13
 process 12
 VectOptions.conf file 30

scenes
 _defined 222
 adding frames before/after selection 41
 extending 41-42
 reducing length 42
 removing frames 42
 setting length 41

script
 _defined 222

scrubbing
 _defined 222

sequences
 _defined 222

shot
 _defined 222

slow-in
 _defined 222

slow_out
 _defined 222

slugging

 _defined 222

sound

 scrubbing

 _defined 222

Sound layer 47

stop-motion keyframe

 _defined 222

storyboard

 _defined 222

straight-ahead

 _defined 223

strokes

 _defined 223

T

tablet

 _defined 223

templates

 _defined 223

thumbnails

 _defined 223

tick marks, Xsheet

 displaying 63

 turning off 64

timecode

 _defined 223

timeline

 _defined 223

Timeline view

 cloning layers and columns 58

 modifying layers and columns 55

 reducing scene length 42

 renaming layers 56

 reordering layers 56

timing

- adding frames before/after selection 41

- Annotation column, adding 59

- changing drawing settings 62

- drawing in Annotation column 60

- erasing annotation 61-62

- extending scenes 41-42

- frames 41

- importing Annotation file 64

- linking external files 65

- preparing 39

- reducing scene length 42

- references 40

- removing frames 42

- scene length 41

- Timing column 65

- typing in Annotation column 60

Timing column 65

- linking external files 65

- using 65

trace and paint

- _defined 223

track breakdown

- _defined 223

tradigital

- _defined 221

traditional animation

- _defined 223

- introduction 9

- scanning 11

trajectory

- _defined 223

transition

- _defined 223

-
- U**
- underlay
 - _defined 223
- V**
- VectOptions.conf file 30
 - Linux 33
 - Mac 31
 - setting 31
 - Windows 31
 - vector
 - _defined 224
 - vectorization
 - creating a style 29
 - parameters, creating 29
 - parameters, custom 21
 - parameters, modifying 29
 - Vectorization Parameters dialog box
 - Help tab 24
 - opening 21
 - Options tab 22
 - vectorizing
 - bitmap drawings 18
 - velocity
 - defined 216, 224
- W**
- walk cycle
 - _defined 224
 - workspace
 - _defined 224
- X**
- Xsheet
 - typing in Annotation column 60
 - Xsheet view
 - _defined 55, 224
 - adding frames before/after selection 41
 - advanced column types 48

Annotation column, adding 59
changing drawing settings 62
cloning layers and columns 58
columns 44
erasing annotations 61-62
importing Annotation file 64
layers 44
modifying layers and columns 55
removing frames 42
renaming columns 56
reordering columns 57
tick marks, displays 63
Timing column 65

Z

zone

 _defined 224