



**Toon Boom Harmony 11.1
Compositing Guide (Standalone)**

Legal Notices

Toon Boom Animation Inc.
4200 Saint-Laurent, Suite 1020
Montreal, Quebec, Canada
H2W 2R2

Tel: +1 514 278 8666
Fax: +1 514 278 2666

toonboom.com

Disclaimer

The content of this guide is covered by a specific limited warranty and exclusions and limit of liability under the applicable License Agreement as supplemented by the special terms and conditions for Adobe® Flash® File Format (SWF). For details, refer to the License Agreement and to those special terms and conditions.

The content of this guide is the property of Toon Boom Animation Inc. and is copyrighted.

Any reproduction in whole or in part is strictly prohibited.

Trademarks

Product Trademark

Credits

Art Development:

Technical Editor:

Technical Reviewer:

Technical Writer:

Publication Date

11/28/2014

Copyright © 2014 Toon Boom Animation Inc. All rights reserved.

Contents

Toon Boom Harmony 11.1 Compositing Guide (Standalone)	1
Legal Notices	2
Contents	3
Chapter 1: Compositing - An Introduction	15
Chapter 1: Import	17
Importing Bitmap Images	18
Importing a Bitmap Image Without Vectorization	18
Adding Images to a Bitmap Layer	22
Bitmap Image Quality	26
Importing and Vectorizing Bitmap Images	26
Linking Your Layer to an External Image	28
Importing PSD Files as Separate Layers	34
Exporting and Reimporting a PSD Layout	41
Exporting a Layout	41
Importing a Photoshop Layout	45
Scanning Images	52
Importing AI and PDF Files	60
Importing Adobe Flash Files	63
Redistributing Elements	65
Importing QuickTime Movies	67
Custom Vectorization Parameters	69
Options Tab	70
Help Tab	72
File IO Options	72
Registration Options	72
Filtering Options	73
Options for bitmap that has no registration information	75
RGB Keying Options	75
Colour Vectorization Options	75
Bubble Usage (implemented only for colour vectorization's line art)	76
4 Colour Vectorization	76
Creating a Vectorization Style	77
Setting the VectOptions.conf File	78

Setting the VectOptions.conf File on Windows and Mac OS X	79
Setting the VectOptions.conf File on Linux	81
Chapter 2: Scene Setup	85
Importing the Scene Components	86
Setting the Camera Frame	87
Positioning the Scene Components	92
Animate Mode	92
Selecting a Layer	92
Locking Layers in the Timeline View	95
Positioning an Element Using the Transform Tool	97
Transform Tool Properties	101
Flipping an Element	103
Positioning an Element Using the Advanced Animation Tools	105
Positioning an Element Using the Layer Properties	108
Layer Properties Options	111
Setting Properties for Many Layers	120
Auto Apply Option	121
Resetting a Transformation	122
Cloning and Duplicating Layers	124
Cloning Layers	124
Duplicating Layers	125
Setting Up the Network	128
Network View	128
Modules	130
Network Navigation and Basic Rules	133
About Modules	133
Input and Output Ports	134
Viewing Port Information	135
Navigating the Network View	136
Adding Modules	136
Composite Module	136
Organizing Modules	137
Connecting and Disconnecting Modules	137
Cable Styles	139

Navigator Display	139
Showing or Hiding the Navigator	140
Positioning the Navigator	140
Magnifying the Network view:	140
Panning the Network View	141
Composite Module	141
Groups	143
Enabling and Disabling Modules	152
Module Thumbnails	153
Display Concepts	157
Display Modules	157
Global Display	158
Display All	158
Show All Modules	159
Display Modes	159
Timeline View Modes	160
Creating a Multiplane	163
Setting Up the Multiplane	163
Distributing Elements on the Z-axis	164
Positioning Elements in the Top and Side Views	165
Cumulative Z Value	166
Top View	167
Side View	169
Perspective View	170
Orthographic Camera	172
Chapter 3: 3D Space	173
Enabling the 3D Option	174
3D Parameters	175
Scale	176
Rotation	177
Quaternion Rotation	178
Euler Angles Rotation	178
Pivot	179
3D Tools	180

3D Translate Tool	180
3D Rotate Tool	181
3D Scale Tool	181
3D Transform Tool	182
Positioning Elements in 3D Space	184
Planning Your Pieces	185
Using Complex Sets in Production Scenes	187
Positioning the Layers	188
3D Camera Motion	192
Camera Clipping Planes	194
Playing Back Your 3D Camera Moves	195
Locking Flat Drawings to the Camera Angle	195
Managing a Network with a 3D Scene Setup	197
Input and Output Options	197
3D Input Ordering Option	198
2D Input Ordering Option	198
How to Organize Your 3D Composite Modules	199
Chapter 4: Animation Paths	201
Animating a Layer	202
Differences between Pegs and Animated Layers	204
Layer Parameters	211
Adding and Deleting Keyframes	214
Motion and Stop-motion Keyframes	216
Constant Z	220
Animating the Camera	221
Animating a Camera Shake Using the Quake Module	224
Camera Truck-ins and Line Thickness	226
Modifying a Path in the Camera, Top and Side Views	228
Offsetting a Trajectory	234
Modifying a Path in the Timeline View	236
Modifying a Path in the Function View	239
Function View	243
Modifying a Path in the Xsheet View	246
Function Curves	248

Copying and Pasting a Motion	255
Paste Special Options	260
Adjusting the Ease	265
Expression Columns	271
Writing Expressions	271
Expression Editor	271
Expression JavaScript Program	272
Valid Expression Column JS Program	272
Errors	272
API	273
Using Column Names and Frame Numbers	273
Predefined Functions	273
Building an Expression for an Effect	274
Chapter 5: Sound	279
Importing a Sound File	280
Sound Layer Properties - Sound Element Editor	281
Sound Displays	283
Sound Playback	285
Mute	285
Sound Scrubbing	286
Analog Sound Scrubbing	286
Performing an Analog Sound Scrub in Harmony	287
Editing a Sound File	289
Changing the Start or End Frame of a Sound	290
Trimming the Start and End of a Sound File	292
Looping a Sound	293
Mixing the Sound Volume	294
Customizing the Playback Range	295
Adding an Empty Sound Layer	297
Lip-sync	299
Generating a Lip-sync Detection	300
Mapping the Lip-Sync Detection	301
Modifying the Lip-sync	302
Recomputing the Mouth Chart	304

Manual Lip-sync	304
Exporting a Sound File	306
Chapter 6: 2D-3D Integration	309
How 2D-3D Integration Works	310
Importing a Reference Model	310
Rendering	310
Working in the Different Views	312
Perspective View	312
Camera View	312
Top and Side Views	313
Exporting a 3D Object for Harmony Using Autodesk Maya	315
Importing a 3D Object from Autodesk Maya to Harmony	318
Using Peg Modules to Control the Position of 3D Objects	319
Manipulating the 3D Object	320
Using Transformation Tools to Manipulate 3D Models	320
Translate Tool	320
Rotate Tool	321
Scale Tool	322
Transform Tool	323
Translating an Element with the Transform Tool	323
Rotating an Element with the Transform Tool	324
Scaling an Element with the Transform Tool	324
Rendering and Compositing 3D Models	325
Preparing the Project Directory	325
Setting the Path on Windows	326
Setting the Path on Mac OS X	328
Creating and Setting Up the Script on Mac OS X	328
Setting Up the Environment Variable on Mac OS X	328
Creating and Setting Up the Script on Mac OS X	329
Setting Up the Network View	330
Rendering 3D Models	332
Chapter 7: Effects	335
Adding Effects	336
Network View	336

Modules	338
Module Library View	341
Module Library View Toolbar	341
Module Tabs	342
Importing a Module	342
Adding Effects Through the Timeline View	343
Grouping from the Timeline View	344
Previewing Effects	346
Animating an Effect Over Time	347
How Does an Effect Work?	351
Using Effects	353
Anti-Flicker	354
Apply Peg Transformation	355
Advanced Apply Peg Transformation	358
Apply Image Transformation	360
Auto Patch	362
Blending	364
Blur - Box	370
Blur-Directional	372
Blur - Gaussian	375
Blur - Radial	377
Blur - Radial Zoom	379
Brightness and Contrast	385
Blur-Variable	386
Channel Selector	387
Channel Swap	389
Chroma-Keying	390
Colour-Art	394
Colour Banding	396
Colour-Card	398
Colour-Override	399
Colour-Override Editor Interface	400
Palettes	401
Colours	401

Palette Overrides	401
Colour Overrides	402
Overriding a Colour	402
Overriding a Colour With a Texture	403
Texture - Original Matrix	406
Texture - Global Bbox Matrix	406
Texture - Global Bbox Centered	406
Texture - Contour Bbox Matrix	406
Texture - Scale to Screen	406
Override with this Texture Centered on Overridden Objects Centre	406
Texture - Use Input Peg	406
Rendering Selected Colours Only	407
Modifying a Texture Fill's Transformation	408
Overriding a Colour with a Bitmap Image Sequence	410
Overriding a Texture on a Pencil Line	411
Modifying a Texture Fill on a Pencil Line	411
Modifying a Pencil Texture	413
Colour-Scale	416
Composite-Generic	417
Composite-Generic Effect Properties	418
Contrast	422
Cutter	424
Dither	425
External	426
Flatten	428
Focus	429
Focus Multiplier	431
Glow	432
Glue	434
Gradient	436
Controlling the Gradient in the Camera View	438
Grain	438
Greyscale	440
How to Use the Matte Output Option	441

Grid / Field Chart	442
Size	443
Display Text	444
Red/Green/Blue/Alpha	444
Fill	444
Fit Vertical	445
Aspect Ratio	445
Highlight	446
Hue-Saturation	449
Image Switch	452
Layer Selector	454
Lens Flare	456
Line Art	458
Matte-Blur	459
Matte-Resize	462
Mesh Warp	463
Motion-Blur	466
Multi-Port-In	467
Multi-Port-Out	468
Negate	469
Note	470
Overlay Layer	471
Pixelate	473
Placeholder	474
Quadmap	474
Refract	476
Remove Transparency	478
Shadow	479
Sparkle	482
Tone	484
Transparency	487
Underlay Layer	488
Visibility	489
Particle Effects	491

Basic Structure	492
Colour Coding	492
Help Notes	493
Accessing Default Particle Effect Templates	494
Creating a Custom Particle Effect	494
Particle Effect Modules	495
3D Region	496
Layer Properties	496
Baker Composite	497
Baker	497
Layer Properties	498
Bounce	499
Layer Properties	500
Explosion	500
Layer Properties	501
Gravity	502
Layer Properties	503
Image Fracture	504
Layer Properties	506
Generation Tab	507
Rendering Tab	520
Kill	540
Layer Properties	541
Move Particles	541
Layer Properties	542
Orbit	543
Layer Properties	544
Planar Region	546
Layer Properties	547
Random	548
Layer Properties	549
Region Composite	550
Repulse	551
Layer Properties	551

Rotation Velocity	552
Layer Properties	552
Sink	554
Layer Properties	554
Size	555
Layer Properties	555
Sprite Emitter	556
Layer Properties	556
Generation Tab	558
Rendering Tab	567
System Composite	570
Turbulence	572
Turbulent Noise	576
Velocity	579
Layer Properties	579
Visualizer	581
	581
Vortex	582
Layer Properties	583
Wind-Friction	584
Layer Properties	584
Previewing and Playing Back Effects	586
Preview Resolution	586
Extra Commands	588
Chapter 8: Export	589
Exporting a QuickTime Movie	590
Exporting an SWF Movie	595
Exporting OpenGL Frames	597
Exporting a Sound File	599
Advanced Export	601
Multiple Renders	606
Rendering Images and Movies from the Network	614
Partitioning Renders	615
Glossary	618

Index629

Chapter 1: Compositing - An Introduction

Once the ink and paint is done, the animation completed and the timing locked, you are ready to move on to compositing. This includes different components, such as the elements' positioning, scene resolution, trajectories, camera moves, effects and filters, and so on. During compositing, you are working with computer-generated effects done with Harmony's many effect modules. You can create many types of interesting effects and then customize it to suit your animation style.

It is during the compositing phase that the three animation workflows merge together. Whatever your chosen path, they all end up in the same animation, together in the same scene. However, the cut-out compositing can be a bit more complex due to the advanced networking of the different puppets.

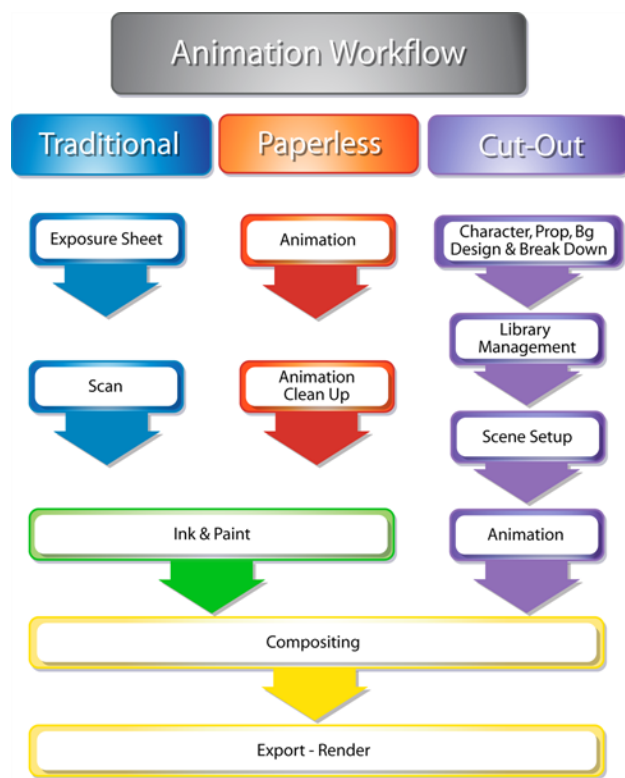

Topics in this section:

- [Import](#) on page 17
- [Scene Setup](#) on page 85
- [3D Space](#) on page 173
- [Animation Paths](#) on page 201
- [Sound](#) on page 279
- [2D-3D Integration](#) on page 309
- [Effects](#) on page 335
- [Export](#) on page 589

Chapter 1: Import



Toon Boom Harmony allows you to import external content as well as being able to draw directly in the software. This means that characters, backgrounds and videos created in other drawing, painting and multimedia programs can be brought in and animated. You can import QuickTime videos, pictures, multilayered PSD files, as well as AI, SWF and PDF files. You can also scan your images and import them as bitmap or vectorize them.

This chapter contains the following topics:

- [Importing Bitmap Images](#) on the next page
- [Importing PSD Files as Separate Layers](#) on page 34
- [Exporting and Reimporting a PSD Layout](#) on page 41
- [Scanning Images](#) on page 52
- [Importing AI and PDF Files](#) on page 60
- [Scanning Images](#) on page 52
- [Importing Adobe Flash Files](#) on page 63
- [Importing QuickTime Movies](#) on page 67
- [Custom Vectorization Parameters](#) on page 69

For sound import, refer to [Importing a Sound File](#) on page 280.

Importing Bitmap Images



Images can come in many different file formats and are usually saved in a format that retains the original specifications set by the image creator. Some formats can preserve the transparency or transparent layers, while others are not resolution dependent due to their vector nature. Toon Boom Harmony supports the following formats: JPEG, BMP, PNG, TGA, PSD, TIFF, SGI, TVG, OMF, PAL, SCAN.

When importing images and 3D models and linking images, your settings are saved in your user settings.

In this section, you will cover the following topics:

- [Importing a Bitmap Image Without Vectorization](#) below
- [Importing and Vectorizing Bitmap Images](#) on page 26
- [Linking Your Layer to an External Image](#) on page 28

Importing a Bitmap Image Without Vectorization

How to open the Import Images dialog box

1. Do one of the following:
 - ▶ From the top menu, select **File > Import > Images**.
 - ▶ In the File toolbar, click the Import Images  button.
 - ▶ In the Xsheet view, right-click anywhere in the frame area and select **Import > Images**.

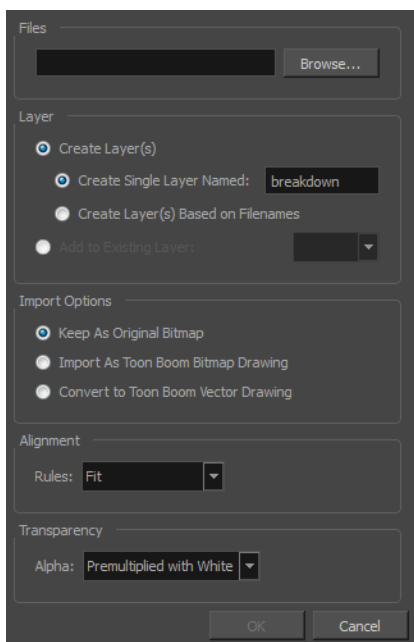

The Import Images dialog box opens.



How to import a bitmap image in its original format

1. In the Files section of the Import Images dialog box, click **Browse** to find and select one or more images on your computer.
2. Decide if the bitmap image will go on a new layer or an existing layer. To add the bitmap image to a new layer, go to step 4. To add the bitmap image to an existing layer, go to step 5.
3. Add the bitmap image to a new layer by selecting the **Create Layer(s)** option and one of the following options:
 - **Create Single Layer Named:** Creates a layer you can name.
 - **Create Layer(s) Based on Filenames:** Creates a layer based on each unique filename prefix. For example, the filenames a-1.tga, a-2.tga and b-1.tga will create layers name "a" and "b", where "a" has two drawings and "b" has one. When creating a single layer from these three filenames, all three drawings will be inserted in the new layers.
4. Select the **Add to Existing Layer** option if you want to place the bitmap image on a layer you select from the list. If only vector  layers are available in your scene, they will not be displayed in the list. You can choose to encapsulate the bitmap in a symbol by selecting the **Create Symbols for Imported Items** option.
5. In the Import Options section, select the **Keep As Original Bitmap** option. In the Alignment section, decide on the size and placement of your image within the camera frame. Depending on the Scene Settings (the height and width in pixels that you chose for your project), an image that you import may be scaled to the point where all its individual pixels become visible. There are three options available in the Alignment section:

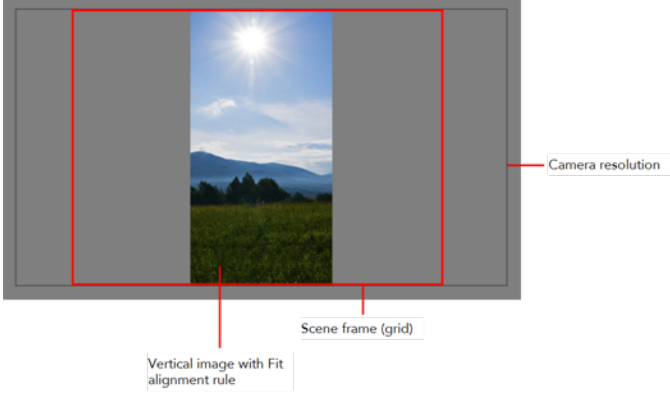
Parameter	Description
Fit	Enlarges or shrinks (but not distorts) the image height to match the full height of the scene grid.

	 <p data-bbox="646 611 1312 709">If the image orientation is landscape, this will enlarge or shrink (but not distort) your image width to match that of the scene grid.</p>  <p data-bbox="646 1173 1312 1236">Note that the Fit alignment rule equals the Center Fit rule in the layer properties.</p>
<p data-bbox="358 1360 407 1392">Pan</p>	<p data-bbox="646 1262 1344 1493">This is the opposite of the Fit parameter. If the image orientation is portrait, its width will be made to match the width of the scene grid. As a result, part of the image's height will extend beyond the height of the frame. This can be useful if you want to make your background move up and down, or from left to right to make it appear as if the camera is panning, or to actually perform a camera pan.</p>

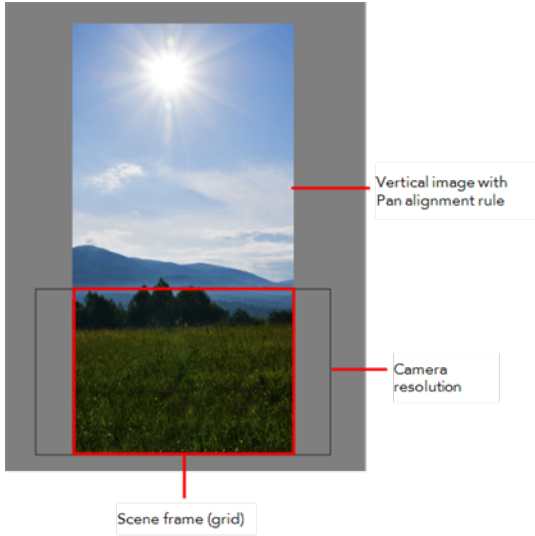
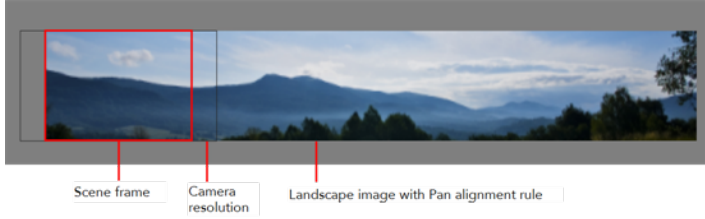
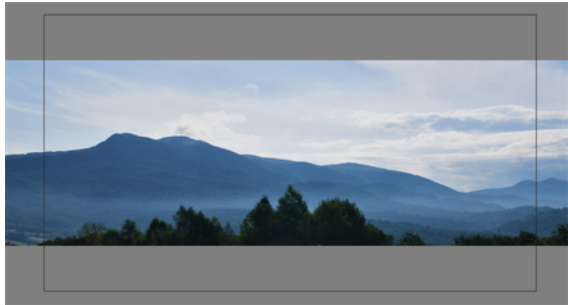
	 <p>Vertical image with Pan alignment rule</p> <p>Camera resolution</p> <p>Scene frame (grid)</p> <p>The opposite will apply to a landscape image. Its height will be fit to the scene grid, therefore it is possible that the image will extend beyond the scene grid's boundaries.</p>  <p>Scene frame</p> <p>Camera resolution</p> <p>Landscape image with Pan alignment rule</p> <p>Note that the Pan alignment rule equals the Center First Page rule in the layer properties.</p>
<p>Project Resolution</p>	<p>Scales the image in proportion to the scene's resolution. The system looks at the resolution of the bitmap image, for example 4000 x 2000, then compares it to the scene's resolution, for example 1920 x 1080, and adjusts the scale factor in proportion. So, in this example, the bitmap would appear at 208% (4000/1920). If you import a bitmap that is 960 x 540, it will be displayed at 50% (960/1920) of the size of the project resolution.</p> 

	Note that the Project Resolution alignment rule is equal to the As Is rule in the layer properties.
--	---

6. In the Transparency section, select one of the following from the Alpha menu:

Parameter	Description
Premultiplied with White	Individual pixels at the edge of an image are blended with white.
Premultiplied with Black	Semi-transparent pixels in the original image are blended with black.
Straight	Pixels at the edge of an image are blended with black, white and greys.
Clamp Colour to Alpha	Premultiplies the colour value with the alpha value. When the colour is clamped to the alpha, the colour value cannot be higher than the alpha value. It calculates the real colour value faster. When the RGB values are multiplied with the alpha value, that is, if you have a pixel of value R=247, G=188, B=29 and the alpha is 50% or the image has a 50% transparency, then the actual RGB values that are output would be half of the amounts listed above.

7. Click OK.

Adding Images to a Bitmap Layer

How to add more bitmap images to an existing bitmap layer

1. In the Timeline view, if the bitmap image is contained in a symbol, double-click on the bitmap symbol cell to edit the symbol. Otherwise, if the bitmap image is on a bitmap  layer, leave it as is.



2. If necessary, in the Timeline view, pull on the red bracket to extend the exposure.
3. From the top menu, select **File > Import > Images** or click the Import Image  button. The Import Images dialog box opens.

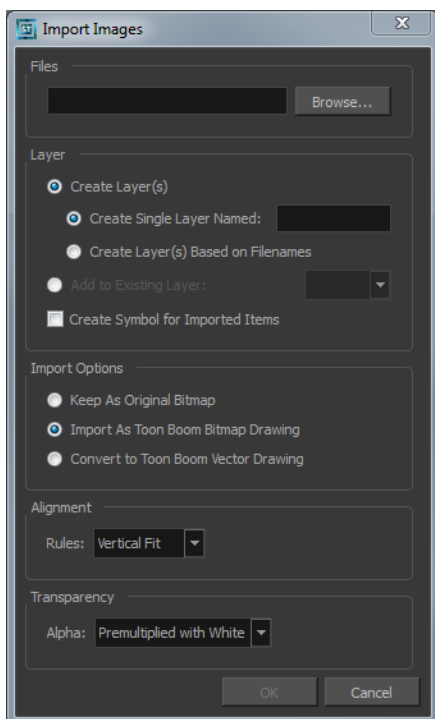

4. Click **Browse** to find and select one or several images on your computer.
5. In the Layer section, select the **Add to Existing Layer** option and select an existing bitmap layer from the menu.
6. Deselect the **Create Symbol for Imported Items** option.
7. In the Import Options section, select the **Keep As Original Bitmap** option. In the Alignment section, decide on the size and placement of your image within the camera frame. Depending on the Scene Settings (the height and width in pixels that you chose for your project), an image that you import may get scaled to the point where all its individual pixels become visible. There are three options available in the Alignment section:

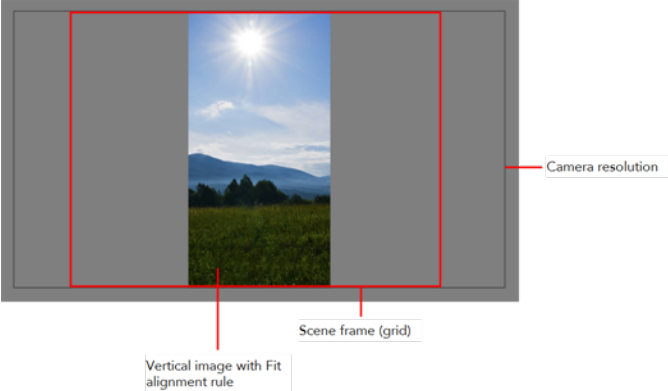
Parameter	Description
Fit	<p>Enlarges or shrinks (but not distorts) the image height to match the full height of the scene grid.</p>  <p>If the image orientation is landscape, this will enlarge or</p>

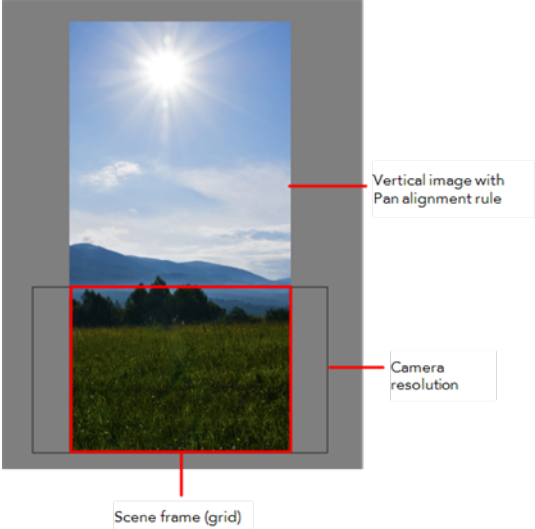
	<p>shrink (but not distort) your image width to match that of the scene grid.</p>  <p>Note that the Fit alignment rule equals the Center Fit rule in the layer properties.</p>
<p>Pan</p>	<p>This is the opposite of the Fit parameter. If the image orientation is portrait, its width will be made to match the width of the scene grid. As a result, part of the image's height will extend beyond the height of the frame. This can be useful if you want to make your background move up and down, or from left to right to make it appear as if the camera is panning, or to actually perform a camera pan.</p>  <p>The opposite will apply to a landscape image. Its height will be fit to the scene grid, therefore it is possible that the image will extend beyond the scene grid's boundaries.</p>

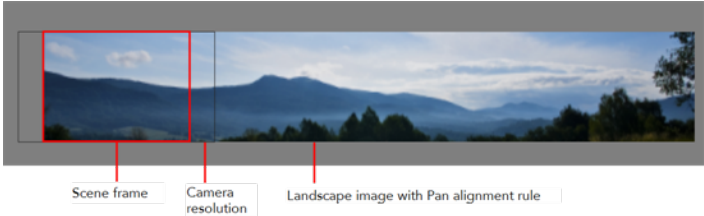
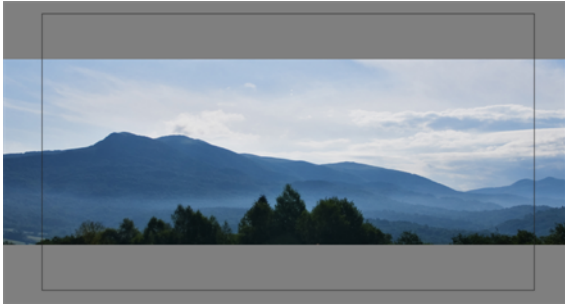
	 <p>Note that the Pan alignment rule equals the Center First Page rule in the layer properties.</p>
<p>Project Resolution</p>	<p>Scales the image in proportion to the scene's resolution. The system looks at the resolution of the bitmap image, for example 4000 x 2000, then compares it to the scene's resolution, for example 1920 x 1080, and adjusts the scale factor in proportion. So, in this example, the bitmap would appear at 208% (4000/1920). If you import a bitmap that is 960 x 540, it will be displayed at 50% (960/1920) of the size of the project resolution.</p>  <p>Note that the Project Resolution alignment rule is equal to the As Is rule in the layer properties.</p>

8. In the Transparency section, select one of the following from the Alpha menu:

Parameter	Description
Premultiplied with White	Individual pixels at the edge of an image are blended with white.
Premultiplied with Black	Pixels at the edge of an image are blended with black.
Straight	Pixels at the edge of an image are blended with black, white and greys.
Clamp Colour to Alpha	Premultiplies the colour value with the alpha value. When the colour is clamped to the alpha, the colour value cannot be higher than the alpha value. It calculates the real colour value faster. When the RGB values are multiplied with the alpha value, that is to say, if you have a pixel of value R=247, G=188, B=29 and the alpha is 50% or the image has a 50% transparency, then the actual RGB values that are output would be half of the amounts listed above.

9. Click **OK**.

Bitmap Image Quality

If the bitmap images that you imported look blurry or slightly pixelated, you can clean up the image. You can change the quality of the preview in the Camera view and it will not affect the final render.

How to change the bitmap image quality

1. In the Camera view, double-click on the bitmap image to enter its symbol if the image is encapsulated or simply select the bitmap image layer in the Timeline view if it is not.
2. From the top menu or Camera menu, select **View > Bitmap File Quality** or press **Ctrl + Q** (Windows/Linux) or **^ + Q** (Mac OS X).

The Bitmap Image Quality dialog box opens.

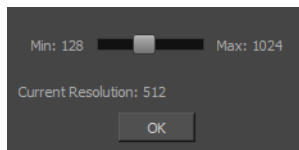

3. Drag the slider to the right to improve the quality.
4. Click **OK**.
5. If you are inside a symbol, go to the top of the Camera view and click **Top** to exit the symbol and return to your scene.

Importing and Vectorizing Bitmap Images

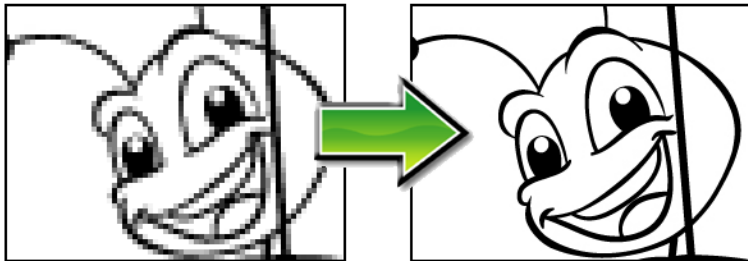

You can turn bitmap images into vector drawings, while maintaining the sketchiness of a pencil line or into vector images with a bitmap fill. Both options can add life to an animation, which straight vectorization with smoothing does not usually afford.

How to import and vectorize a bitmap image

1. From the top menu, select **File > Import > Images** or click the Import Image  button in the File toolbar.

The Import Images dialog box opens.

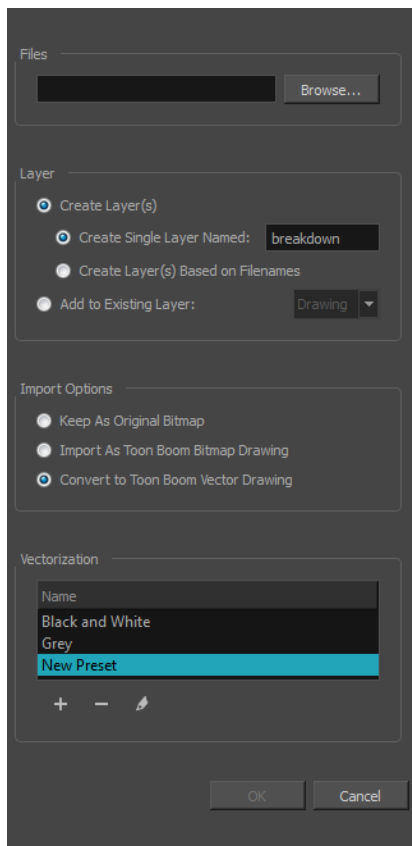

2. Click **Browse** to locate images.
3. In the Layer section, decide if the scanned or imported image will be placed on a new layer or existing layer.
 - ▶ **Create Layer:** Scans or imports the image into a new layer. Select one of the following options:

Parameter	Description
Create Single Layer Named	Creates a layer you can name.
Create Layer(s) Based on Filenames	Creates a layer based on each unique filename prefix. For example, the filenames a-1.tga, a-2.tga and b-1.tga will create layers named "a" and "b", where "a" has two drawings and "b" has one. When creating a single layer from these three file-names, all three drawings will be inserted in the new layers.

- ▶ **Add to Existing Layer:** Scans or imports the image into an existing layer. Select a layer from the Layer list. You must scan into the same layer type if you are using an existing layer.
 - ▶ **Create Symbol for Acquired Items:** Encapsulates the bitmap image in a symbol. To mix bitmap images with vector drawings on the same layer, the bitmap image must be encapsulated in a symbol and vice versa. Symbols will also be automatically added to the Symbol folder in the Library view.
4. In the Import Options section, select the **Convert to Toon Boom Vector Drawing** option.
 5. In the Vectorization section, decide whether you want to import your image in colour, black and white, or grey. In the Vectorization section, decide whether you want to import your image in colour, black and white, grey, or if you want to add a new preset.

- ▶ **Black and White:** Vectorizes drawings as a solid black line; creates a 100% vector-based drawing.
- ▶ **Grey:** Vectorizes your image as a mix of vector contour and greyscale bitmap filling. Lines keep the texture from the scan, and the white of the paper becomes transparent.
- ▶ **New Preset:** The New Preset **+** button lets you create custom vectorization parameters via the Vectorization Parameters interface.

You can double-click on any of the presets at any time to open the Vectorization Parameters dialog box to customize your option.

The vectorized images are painted with the Vectorize Line colour swatch from the colour palette.

6. Click **OK**.

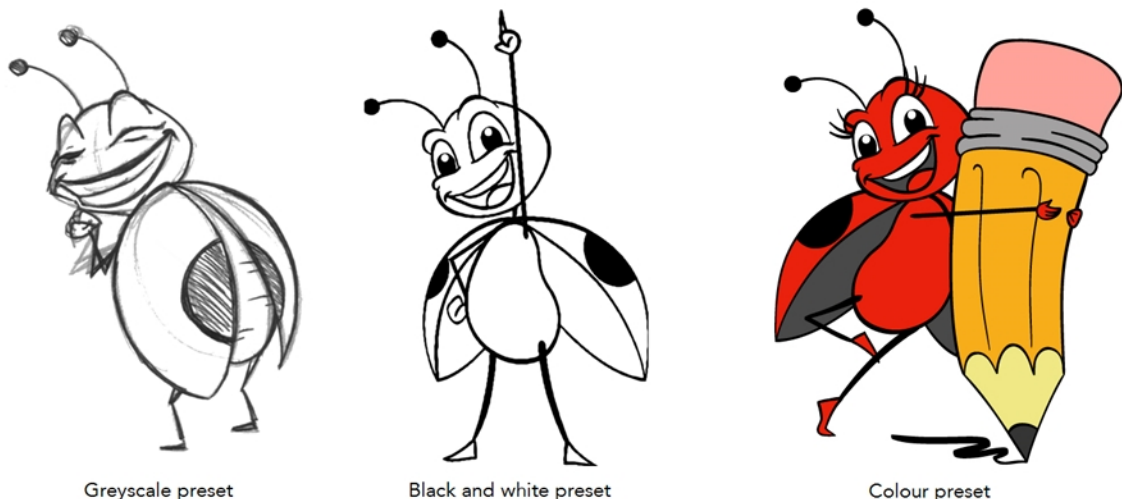

A symbol or new layer contains the vector drawing. For images contained in a symbol, double-click on the image's first cell in the Timeline view to enter the symbol so you can edit the image.

Linking Your Layer to an External Image

When working on a large production, you may want to centralize your backgrounds into one directory instead of duplicating your background several times in different scenes. As backgrounds are generally reused in many scenes, some studios like to save space on the server and link the different scenes to the background directory. Also, if they modify one background, it is modified everywhere at the same time without having to reimport it. To do so, you must use the Timing columns.

Timing columns are exposure sheet columns that link to files that are outside the scene's structure. Because of these external links, care must be taken not to break the links by moving the scene's location or the background directory's location. Breaking a link will result in images not appearing in your scene.

Refer to the chapter to learn more about using Timing columns.

If you are working with Toon Boom Harmony Server and all your scenes are located on a centralized server, you can also use the Link to Images option.

How to link the scene to an external image (Harmony Server only)

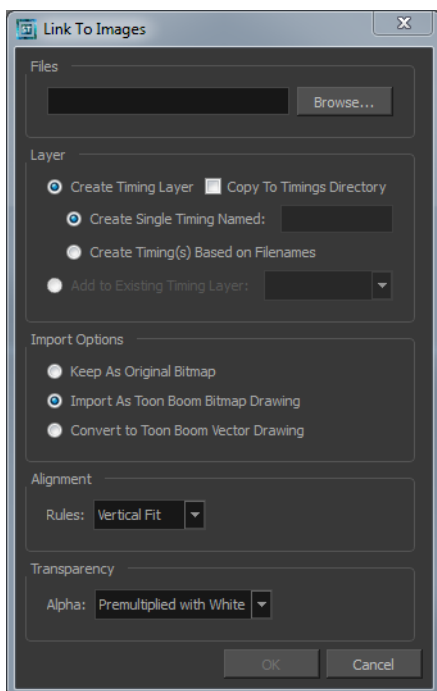

1. From the top menu, select **File > Import > Link to Images**.

The Link to Images dialog box opens.

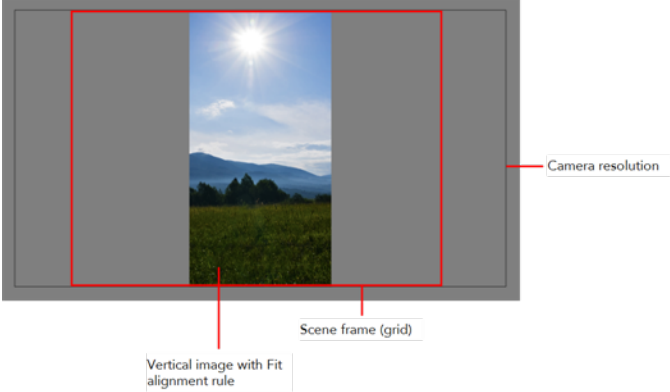

2. Click the **Browse** button to select the image you want to link your scene to.
3. Do one of the following:
 - ▶ Select the **Create Timing Layer** option to create a new Timing column in your Xsheet view. Then select one of the following:
 - Create Single Timing Named:** Type the new column name in the text field.
 - Create Timing(s) Based on Filenames:** Creates file names based on the selected file's name.
 - ▶ Select the **Add to Existing Timing Layer** option to insert the file into an existing Timing column.
4. Select the **Copy to Timing Directory** option if you want to copy the selected file into the Timing folder located in the scene directory. Note that the Timing column will link to the Timing folder.
5. In the Import Options section, select one of the following:
 - ▶ **Keep As Original Bitmap:** Retains an imported image as a bitmap. In the Alignment section, decide on the size and placement of your image within the camera frame. Depending on the Scene Settings (the height and width in pixels that you chose for your

project), an image that you import may get scaled to the point where all its individual pixels become visible. There are three options available in the Alignment section:

Parameter	Description
<p>Fit</p>	<p>Enlarges or shrinks (but not distorts) the image height to match the full height of the scene grid.</p>  <p>If the image orientation is landscape, this will enlarge or shrink (but not distort) your image width to match that of the scene grid.</p>  <p>Note that the Fit alignment rule equals the Center Fit rule in the layer properties.</p>
<p>Pan</p>	<p>This is the opposite of the Fit parameter. If the image orientation is portrait, its width will be made to match the width of the scene grid. As a result, part of the image's height will extend beyond the height of the frame. This can be useful if you want to make your background move up and down, or from left to right to make it appear as if the camera is panning, or to actually perform a camera pan.</p>

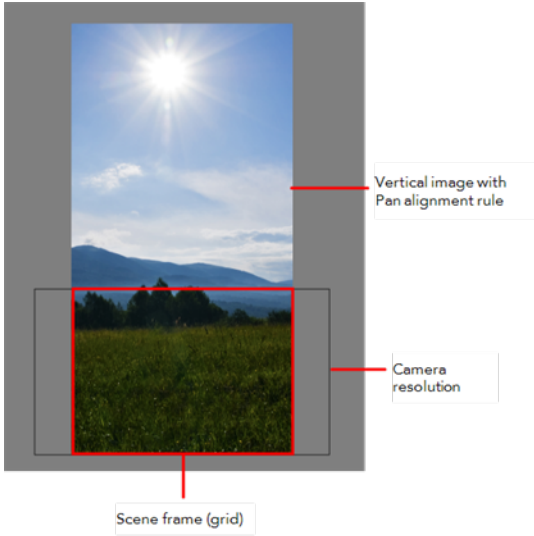
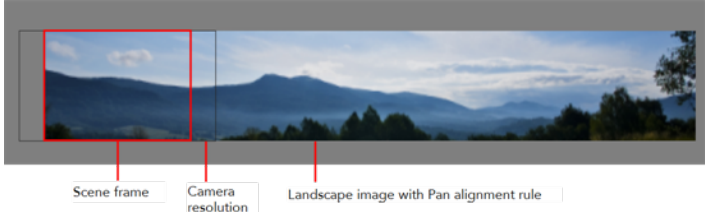
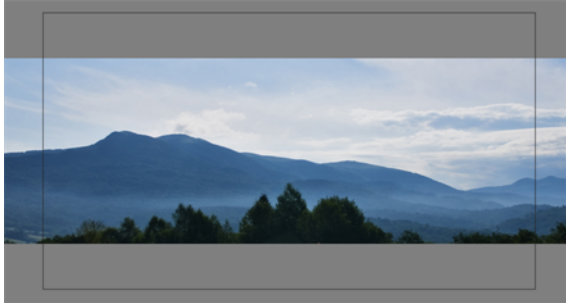
	 <p>Vertical image with Pan alignment rule</p> <p>Camera resolution</p> <p>Scene frame (grid)</p> <p>The opposite will apply to a landscape image. Its height will be fit to the scene grid, therefore it is possible that the image will extend beyond the scene grid's boundaries.</p>  <p>Scene frame</p> <p>Camera resolution</p> <p>Landscape image with Pan alignment rule</p> <p>Note that the Pan alignment rule equals the Center First Page rule in the layer properties.</p>
Project Resolution	<p>Scales the image in proportion to the scene's resolution. The system looks at the resolution of the bitmap image, for example 4000 x 2000, then compares it to the scene's resolution, for example 1920 x 1080, and adjusts the scale factor in proportion. So, in this example, the bitmap would appear at 208% (4000/1920). If you import a bitmap that is 960 x 540, it will be displayed at 50% (960/1920) of the size of the project resolution.</p> 

Note that the Project Resolution alignment rule is equal to the As Is rule in the layer properties.

- ▶ **Import As Toon Boom Bitmap Drawing:** Imports a drawing into a vector layer where you can edit the image using the drawing tools. In the Alignment section, select one of the following:

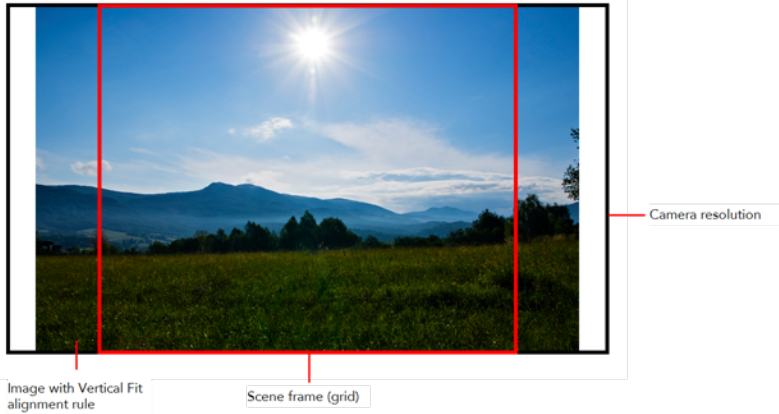
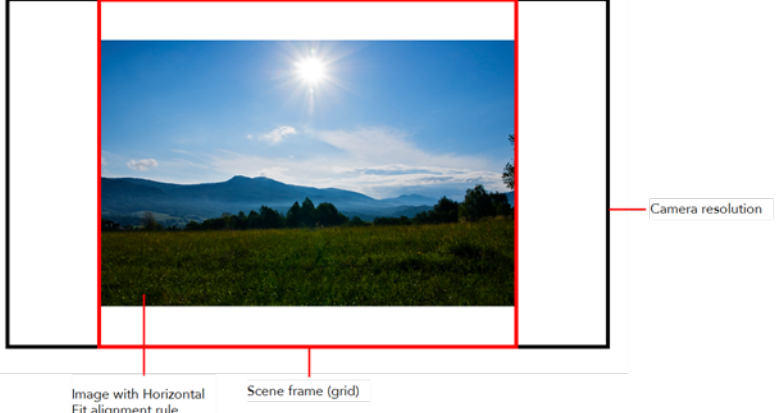
Parameter	Description
Vertical Fit	<p>Enlarges or shrinks (but not distort) to your image height to match the full height of the scene frame (alignment grid).</p> 
Horizontal Fit	<p>Enlarges or shrinks (but not distort) to your image width to match the full width of the scene frame (alignment grid).</p> 
Actual Size	<p>Scales the image in proportion to the scene's resolution. The system looks at the resolution of the bitmap image, for example 4000 x 2000, then compares it to the scene's resolution, for example 1920 x 1080, and adjusts the scale factor in proportion. So, in this example, the bitmap would appear at 208% (4000/1920). If you import a bitmap that is 960 x 540, it will be displayed at 50% (960/1920) of the size of the project resolution.</p>

- ▶ **Convert to Toon Boom Vector Drawing:** Imports a drawing and converts it to a Toon Boom vector drawing. In the Vectorization section, select one of the following:

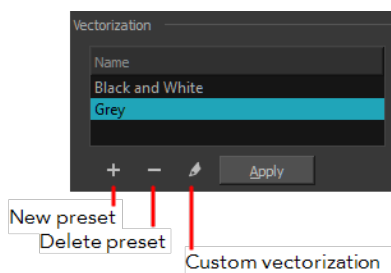

Black and White: Vectorizes drawings as a solid black line; creates a 100% vector-based drawing.

Grey: Vectorizes the image as a mix of vector contour and greyscale bitmap filling. Lines keep the texture from the scan, and the white of the paper becomes transparent.

New Preset: Lets you create a new preset.

Delete Preset: Lets you delete any preset in the list.

Custom vectorization: Lets you set custom vectorization parameters—see [Creating a Vectorization Style](#) on page 77.

6. Click **OK**.

Importing PSD Files as Separate Layers



PSD files (a format exportable exclusively from Adobe Photoshop) are unique in that they are able to retain multiple layers. This is advantageous as the image remains fully editable in terms of any colour correction, effects, masking, transparency, or compositing that were made to the PSD file in Adobe Photoshop.

Note that your PSD image file must be set to RGB mode within Adobe Photoshop prior to being imported into Harmony.

How to import the separated layers of a PSD file

1. Organize your Adobe Photoshop file so that all your layers are “grouped” into individual folders, or that all the elements you want to import as a single layer in Harmony are grouped together in their own folder. Any layer that is not in a folder group, by itself or otherwise, will not be imported.

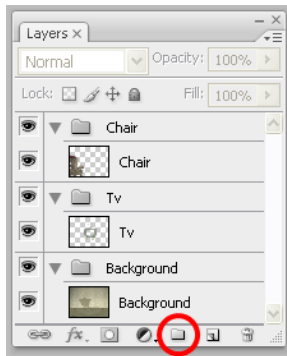

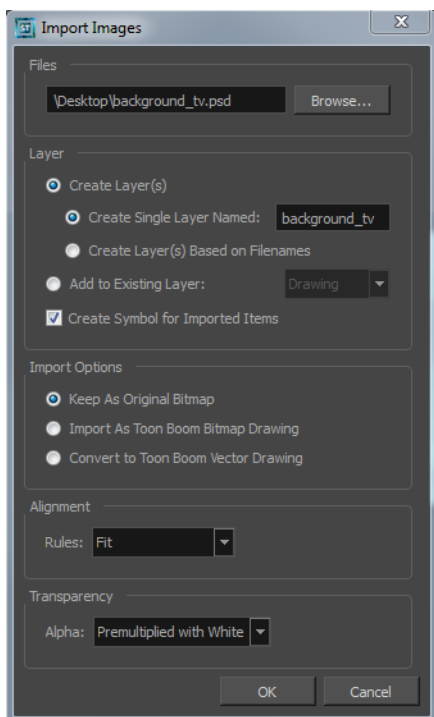

2. In Harmony, go to the top menu and select **File > Import > Images** or click the Import Image  button.

The Import Drawings dialog box opens.

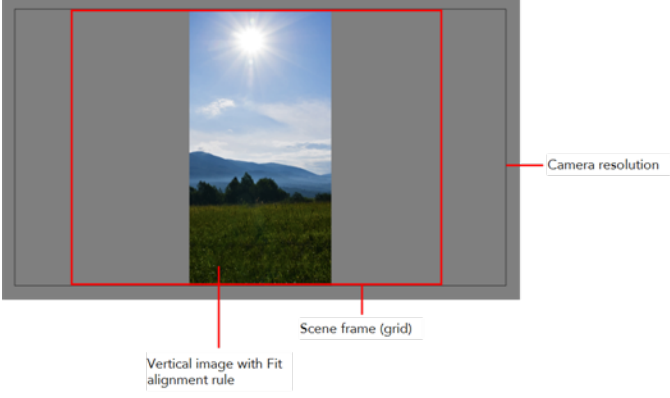

3. In the Files section, click **Browse** to find and select the PSD image on your computer.
4. In the Layer section, select the **Create Layer(s)** option, then select one of the following options:
 - **Create Single Layer Named:** Creates a layer you can name.
 - **Create Layer(s) Based on Filenames:** Creates a layer based on each unique filename prefix. For example, the filenames a-1.tga, a-2.tga and b-1.tga will create layers name "a" and "b", where "a" has two drawings and "b" has one. When creating a single layer from these three filenames, all three drawings will be inserted in the new layers.
5. Select the **Create Symbol for Imported Items** option if you want the layers to be contained in symbols.
6. In the Import Options section, select one of the following:
 - **Keep As Original Bitmap:** Retains an imported image as a bitmap. In the Alignment section, decide on the size and placement of your image within the camera frame. Depending on the Scene Settings (the height and width in pixels that you chose for your project), an image that you import may get scaled to the point where all its individual pixels become visible. There are three options available in the Alignment section:

Parameter	Description
Fit	Enlarges or shrinks (but not distorts) the image height to match the full height of the scene grid.

	 <p>If the image orientation is landscape, this will enlarge or shrink (but not distort) your image width to match that of the scene grid.</p>  <p>Note that the Fit alignment rule equals the Center Fit rule in the layer properties.</p>
<p>Pan</p>	<p>This is the opposite of the Fit parameter. If the image orientation is portrait, its width will be made to match the width of the scene grid. As a result, part of the image's height will extend beyond the height of the frame. This can be useful if you want to make your background move up and down, or from left to right to make it appear as if the camera is panning, or to actually perform a camera pan.</p>

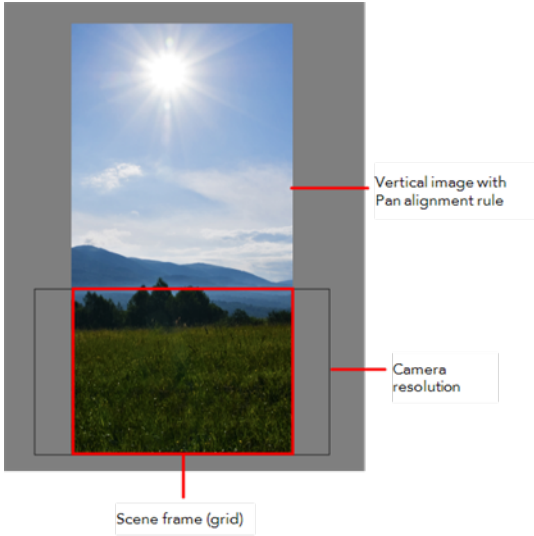
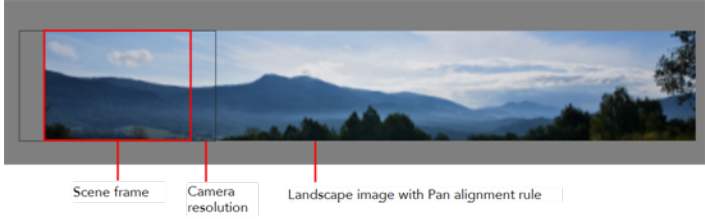
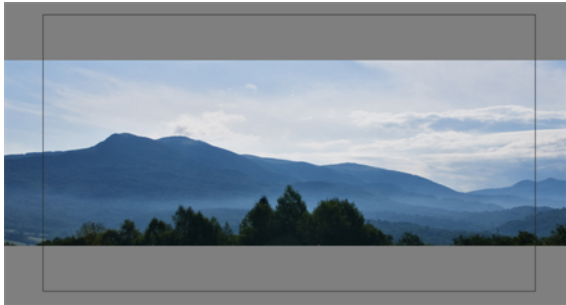
	 <p>Vertical image with Pan alignment rule</p> <p>Camera resolution</p> <p>Scene frame (grid)</p> <p>The opposite will apply to a landscape image. Its height will be fit to the scene grid, therefore it is possible that the image will extend beyond the scene grid's boundaries.</p>  <p>Scene frame</p> <p>Camera resolution</p> <p>Landscape image with Pan alignment rule</p> <p>Note that the Pan alignment rule equals the Center First Page rule in the layer properties.</p>
Project Resolution	<p>Scales the image in proportion to the scene's resolution. The system looks at the resolution of the bitmap image, for example 4000 x 2000, then compares it to the scene's resolution, for example 1920 x 1080, and adjusts the scale factor in proportion. So, in this example, the bitmap would appear at 208% (4000/1920). If you import a bitmap that is 960 x 540, it will be displayed at 50% (960/1920) of the size of the project resolution.</p> 

Note that the Project Resolution alignment rule is equal to the As Is rule in the layer properties.

- ▶ **Import As Bitmap Drawing:** Imports a drawing into a vector layer where you can edit the image using the drawing tools. In the Alignment section, select one of the following:

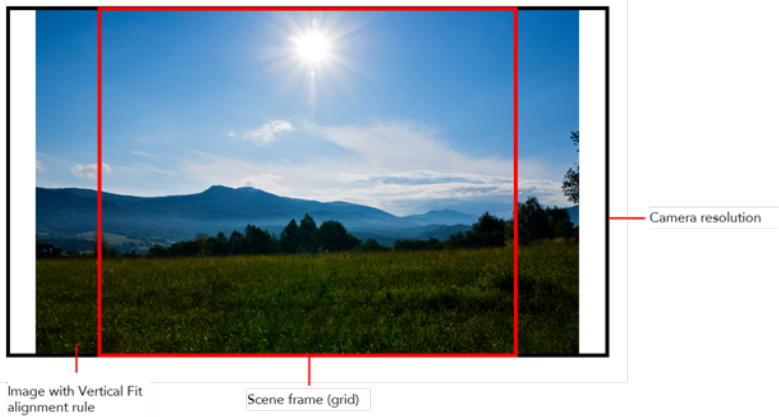
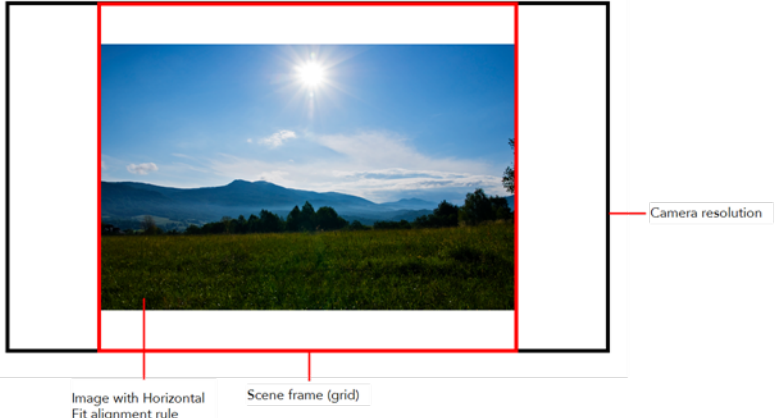
Parameter	Description
Vertical Fit	<p>Enlarges or shrinks (but not distort) to your image height to match the full height of the scene frame (alignment grid).</p> 
Horizontal Fit	<p>Enlarges or shrinks (but not distort) to your image height to match the full width of the scene frame (alignment grid).</p> 
Actual Size	<p>Scales the image in proportion to the scene's resolution. The system looks at the resolution of the bitmap image, for example 4000 x 2000, then compares it to the scene's resolution, for example 1920 x 1080, and adjusts the scale factor in proportion. So, in this example, the bitmap would appear at 208% (4000/1920). If you import a bitmap that is 960 x 540, it will be displayed at 50% (960/1920) of the size of the project resolution.</p>

- ▶ **Convert to Toon Boom Vector Drawing:** Imports a drawing and converts it to a Toon Boom vector drawing. In the Vectorization section, select one of the following:

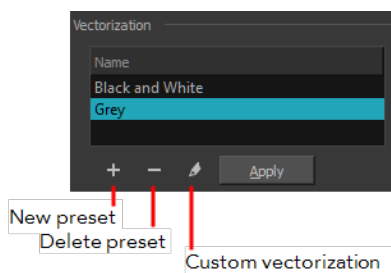

Black and White: Vectorizes drawings as a solid black line; creates a 100% vector-based drawing.

Grey: Vectorizes the image as a mix of vector contour and greyscale bitmap filling. Lines keep the texture from the scan, and the white of the paper becomes transparent.

New Preset: Lets you create a new preset.

Delete Preset: Lets you delete any preset in the list.

Custom vectorization: Lets you set custom vectorization parameters—see [Creating a Vectorization Style](#) on page 77.

7. Decide whether to select **Vectorize Imported Items** option.

If you decide to use the Vectorize Imported Items option, see [Importing and Vectorizing Bitmap Images](#) on page 26 to learn more about vectorization settings.

If you disable the Vectorize Imported Items options, the Transparency and Alignment settings will appear in place of the Vectorization settings—see [Importing a Bitmap Image Without Vectorization](#) on page 18.

8. Click **OK**.

The Multilayer Image Import Settings dialog box opens.

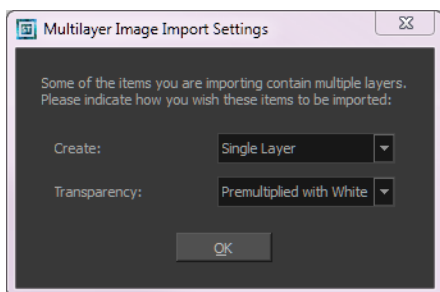

9. From the Create menu, select one of the following:
 - ▶ **Single Layer:** To import the Camera and Layout layers merged together.
 - ▶ **Separated Layers:** To keep your Camera and Layout layers separated.
10. From the Transparency menu, select one of the following if applicable:

Parameter	Description
Premultiplied with White	Individual pixels at the edge of an image are blended with white.
Premultiplied with Black	Pixels at the edge of an image are blended with black.
Straight	Pixels at the edge of an image are blended with black, white and greys.
Clamp Colour to Alpha	Premultiplies the colour value with the alpha value. When the colour is clamped to the alpha, the colour value cannot be higher than the alpha value. It calculates the real colour value faster. When the RGB values are multiplied with the alpha value, that is to say, if you have a pixel of value R=247, G=188, B=29 and the alpha is 50% or the image has a 50% transparency, then the actual RGB values that are output would be half of the amounts listed above.

11. Click **OK**.

Your image appears as separate layers in the Timeline view, corresponding to the PSD layer group folders.

The artwork displayed in every one of your layers as a result of a multilayer PSD file import is linked to the same source image. This means that if you use the **Drawing > Delete Selected Drawings** command to physically delete the drawing from the project folder, the exposed drawing will be deleted in all layers at once. Once deleted from the project folder, the image cannot be retrieved unless you reimport your psd file.

Exporting and Reimporting a PSD Layout

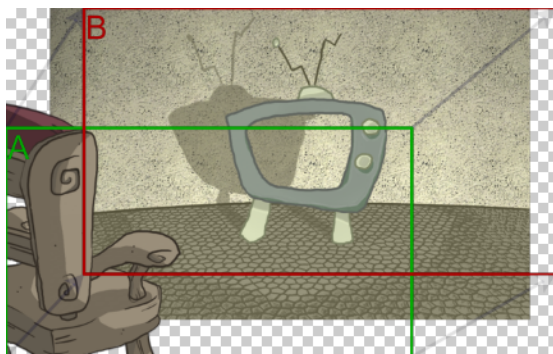

Toon Boom Harmony allows you to export the content of your scene as a PSD layout. This can be helpful for scene setup, background art retakes or even planning of animation.

Refer to [Scene Setup on page 85](#) to learn more about the scene setup task.

Exporting a Layout

Before exporting a layout, all the elements must be well positioned. For example, if you plan to include a camera movement in this scene, you should also set this up, as you can export the camera keyframes to generate a clear and complete layout.

You can also create all the layouts for your production in the same Harmony project which can be imported later on when you start each scene's project. This will help set up the scene and begin its creation. You can use these layout PSD files to create the background art of each scene and make sure everything is correctly framed and at the right size. Finally, you can also have a layer with a drawing of the rough poses of the character or action and generate your layout posing from there.

Note that only the first frame of your drawing layers will be exported, as the layout image is one static PSD file.

For more information, refer to [Scene Setup on page 85](#) and [Animation Paths on page 201](#) and the Drawing chapter in the Paperless Animation Guide.

How to export your scene as a layout

Before exporting your scene as a layout, position your background elements, and everything you need as a reference in your scene, including a camera movement.

1. From the top menu, select one of the following:

- ▶ **File > Export > Layout Image** to export all the elements in your scene to the layout PSD file.
- ▶ **File > Export > Layout Image from Selection** to export only the elements.

The Export Layout Image dialog box opens.

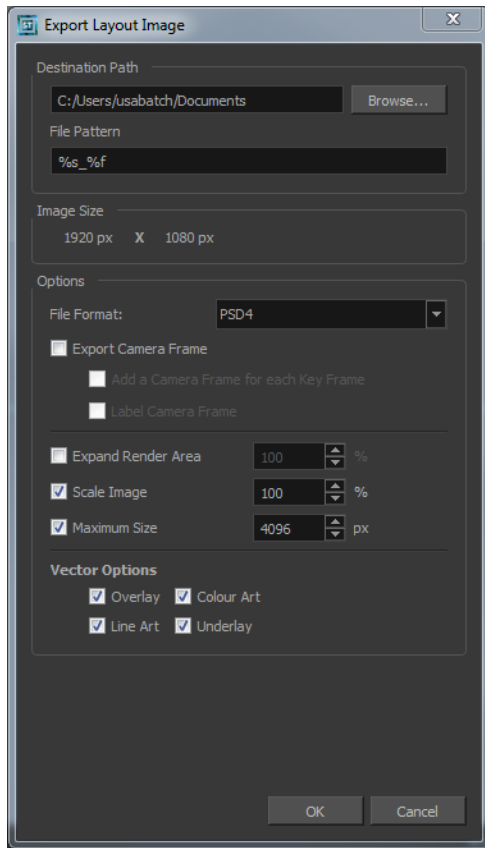

2. In the Export Layout Image dialog box, set the export parameters:

Parameter	Description
Destination Path	Use the Browse button to select a location to save your layout and name the resulting PSD file.
	File Pattern: Automatically puts the name of the scene and/or the frame number in the name of the file you create.
Image Size	The size of the PSD image file that will be exported. The resulting image will be 72 dpi as the standard television resolution and its size in pixel will fit your scene resolution settings. i.e HDTV, NTSC, PAL, etc. Note that if you have a camera movement going over the normal camera frame limit, for example a pan, the image will be bigger.
Options	File Format: Lets you select the format to export your layout.
	Export Camera Frame: This option is disabled by default. You can enable it to export an additional layer to your PSD file displaying the camera frame on it.
	Add a Camera Frame for each Key Frame: This option is

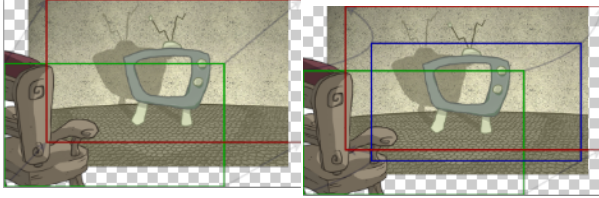
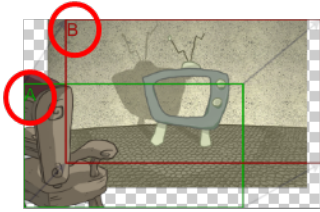
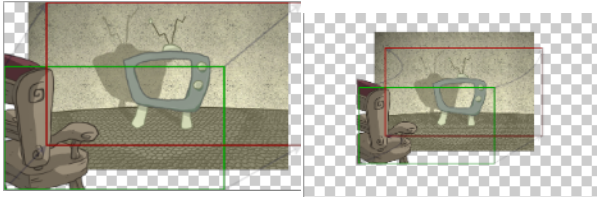
	<p>disabled by default, meaning that if you have a camera movement with more than a starting and an ending point, only these positions of the camera frame will appear on the camera layer of the exported layout PSD file. You must enable this option if you need to the in-between keyframes to also be displayed.</p> 
	<p>Label Camera Frame: Adds the camera position label in the top corner of the camera frames. The camera label is a single alphabet letter determining the order of the camera frame position.</p> 
	<p>Add Border to Layout: This option is disabled by default, meaning the layout image will take the complete PSD area, cropped at the very edge of the canvas. You can enable this option to add a transparent area all around the layout. You must setup the size of this area by using the Scale field lower. The resulting image will be larger.</p> 
	<ul style="list-style-type: none"> • Scale: Sets the size of the transparent border around the layout image. By default the value is set to 100% to export the image as is with no transparent area around it. Increase the percentage value to add the extra around the image to create the border.
	<p>Adjust Scaling Factor: This option is enabled by default, meaning that when you have a camera zoom movement, the size of the layout image will be adjusted accordingly. The resulting percentage will be calculated following the maximal camera zoom value appearing in the layout. This allows the image to be exported at an appropriate resolution,</p>

	preventing the layout image from appearing pixelated or blurry when the camera zoom occurs. You can disable this option to export the image layout at the normal size.
	<ul style="list-style-type: none"> • Scale: When the Adjust Scaling Factor option is enabled, the Scale value is automatically calculated according to the maximum camera zoom in your layout. You can modify this value.
	<p>Vector Options: If you export one or more vector-based drawing layers in your layout image, you have the option to export only the drawing layers you want. Enable or disable the following options to export or prevent the export of the corresponding art layers.</p>
	<ul style="list-style-type: none"> • Overlay: Exports the art in the Overlay layer of the drawings to be exported to the layout image.
	<ul style="list-style-type: none"> • Line Art: Exports the art in the Line layer of the drawings to be exported to the layout image.
	<ul style="list-style-type: none"> • Colour Art: Exports the art in the Colour layer of the drawings to be exported to the layout image.
	<ul style="list-style-type: none"> • Underlay: Exports the art in the Underlay layer of the drawings to be exported to the layout image.

3. Click **OK** to validate the settings and export a PSD file of your layout.

The resulting image is a PSD file with one or two layers, each of which is contained in a corresponding group. These groups make the layout PSD file ready for a multilayer PSD import.

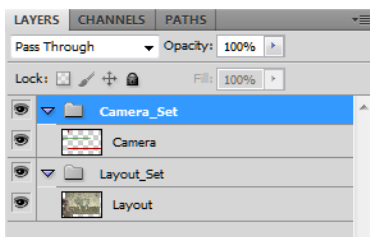

The Camera_Set group contains the camera drawing layer. If you selected the Export Camera option, this group and layer appear in your layout image.

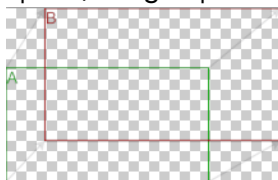

The Layout_Set group contains a merged drawing layer of all the content of your scene's first frame when you exported the layout image.

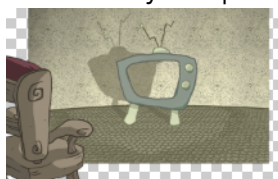

An XLI file is exported along with your PSD file. This file contains all the necessary information for correctly importing and automatically positioning your layout image in a Harmony project. Do not delete the XLI file or rename it. Also, always keep it at the same location as the layout PSD file.

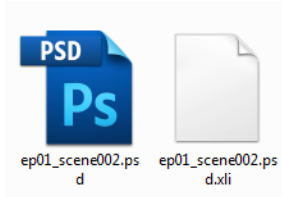

Importing a Photoshop Layout

If you exported a Photoshop layout image from a Harmony project, you can easily import it back into Harmony. Just be sure to import it at the beginning of the project for accurate scene planning.

How to import a PSD layout

1. In your Harmony project, select **File > Import > Images**.

The Import Images dialog box opens.

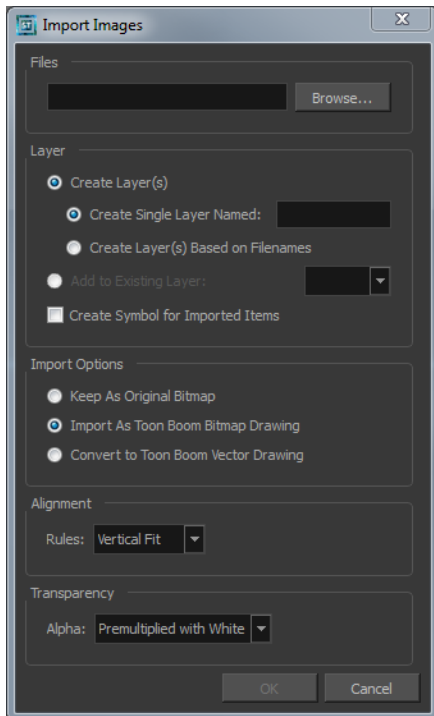

2. In the Files section, click **Browse** to find and select the PSD layout file on your computer. Note that this layout file must have its corresponding XLI file in the same folder.

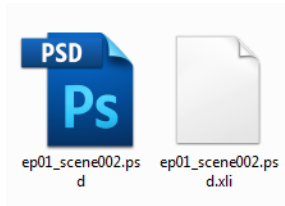

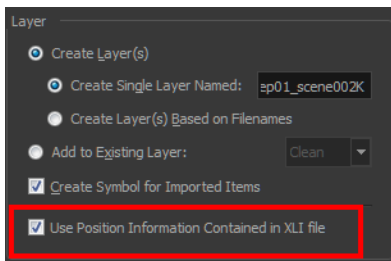

3. Once you have selected the layout file, the Use Position Information Contained in XLI file option appears in the Layer section.

This option is enabled by default. When you import the layout image in your scene, it will be automatically positioned to fit the original layout scene creating an accurate layout guide. You can disable this option if you want the imported layout image to be imported according to the normal behaviour of the import process. The layout image will be incorrectly aligned as it was when it was first created.

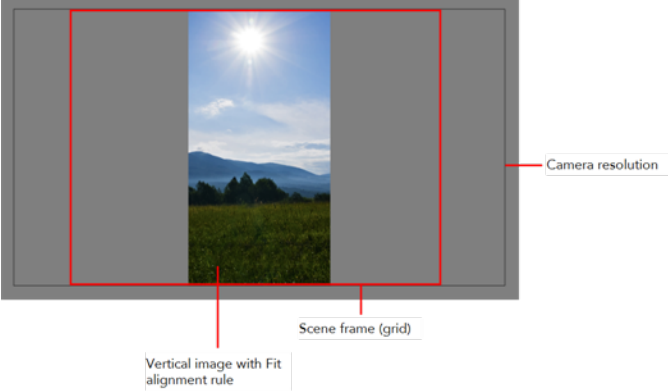

4. In the Layer section, select the **Create Layer(s)** option, then select one of the following options:
 - **Create Single Layer Named:** Creates a layer you can name.
 - **Create Layer(s) Based on Filenames:** Creates a layer based on each unique filename prefix. For example, the filenames a-1.tga, a-2.tga and b-1.tga will create layers name "a" and "b", where "a" has two drawings and "b" has one. When creating a single layer from these three filenames, all three drawings will be inserted in the new layers.
5. Select the **Create Symbol for Imported Items** option if you want the layers to be contained in symbols.
6. In the Import Options section, select one of the following:
 - **Keep As Original Bitmap:** Retains an imported image as a bitmap. In the Alignment section, decide on the size and placement of your image within the camera frame. Depending on the Scene Settings (the height and width in pixels that you chose for your project), an image that you import may get scaled to the point where all its individual pixels become visible. There are three options available in the Alignment section:

Parameter	Description
Fit	Enlarges or shrinks (but not distorts) the image height to match the full height of the scene grid.

	 <p>If the image orientation is landscape, this will enlarge or shrink (but not distort) your image width to match that of the scene grid.</p>  <p>Note that the Fit alignment rule equals the Center Fit rule in the layer properties.</p>
Pan	<p>This is the opposite of the Fit parameter. If the image orientation is portrait, its width will be made to match the width of the scene grid. As a result, part of the image's height will extend beyond the height of the frame. This can be useful if you want to make your background move up and down, or from left to right to make it appear as if the camera is panning, or to actually perform a camera pan.</p>

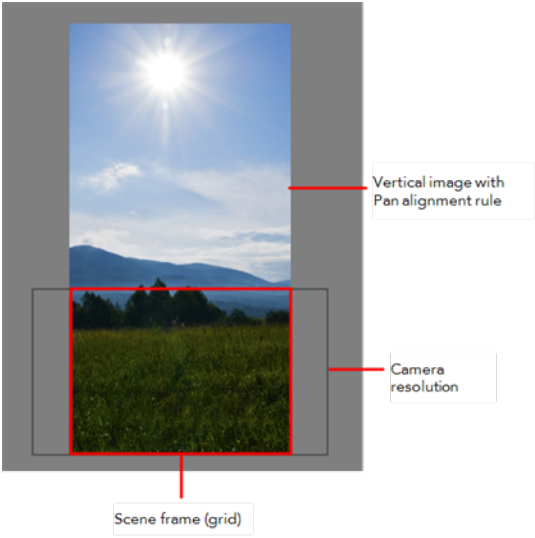
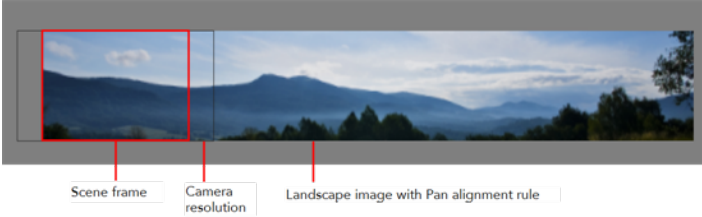
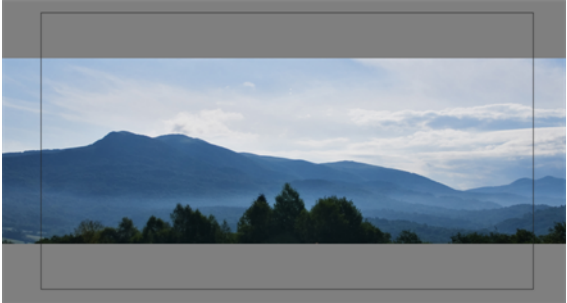
	 <p>Vertical image with Pan alignment rule</p> <p>Camera resolution</p> <p>Scene frame (grid)</p> <p>The opposite will apply to a landscape image. Its height will be fit to the scene grid, therefore it is possible that the image will extend beyond the scene grid's boundaries.</p>  <p>Scene frame Camera resolution Landscape image with Pan alignment rule</p> <p>Note that the Pan alignment rule equals the Center First Page rule in the layer properties.</p>
<p>Project Resolution</p>	<p>Scales the image in proportion to the scene's resolution. The system looks at the resolution of the bitmap image, for example 4000 x 2000, then compares it to the scene's resolution, for example 1920 x 1080, and adjusts the scale factor in proportion. So, in this example, the bitmap would appear at 208% (4000/1920). If you import a bitmap that is 960 x 540, it will be displayed at 50% (960/1920) of the size of the project resolution.</p> 

Note that the Project Resolution alignment rule is equal to the As Is rule in the layer properties.

- ▶ **Import As Toon Boom Bitmap Drawing:** Imports a drawing into a vector layer where you can edit the image using the drawing tools. In the Alignment section, select one of the following:

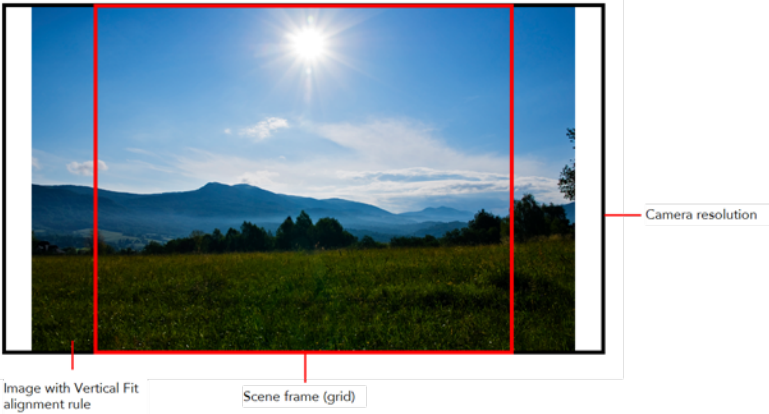
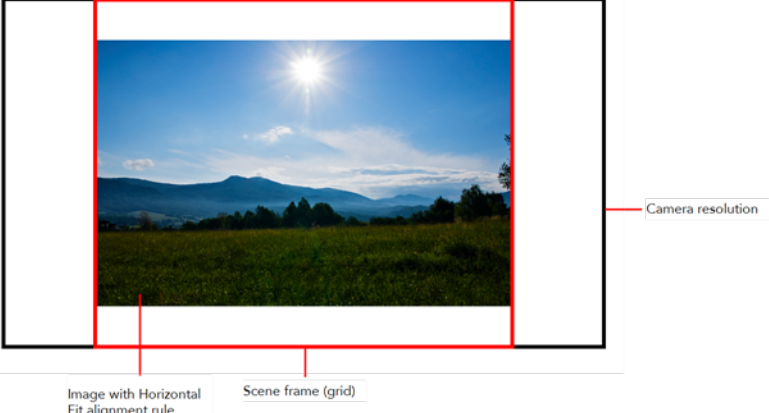
Parameter	Description
Vertical Fit	<p>Enlarges or shrinks (but not distort) to your image height to match the full height of the scene frame (alignment grid).</p> 
Horizontal Fit	<p>Enlarges or shrinks (but not distort) to your image width to match the full width of the scene frame (alignment grid).</p> 
Actual Size	<p>Scales the image in proportion to the scene's resolution. The system looks at the resolution of the bitmap image, for example 4000 x 2000, then compares it to the scene's resolution, for example 1920 x 1080, and adjusts the scale factor in proportion. So, in this example, the bitmap would appear at 208% (4000/1920). If you import a bitmap that is 960 x 540, it will be displayed at 50% (960/1920) of the size of the project resolution.</p>

- ▶ **Convert to Toon Boom Vector Drawing:** Imports a drawing and converts it to a Toon Boom vector drawing. In the Vectorization section, select one of the following:

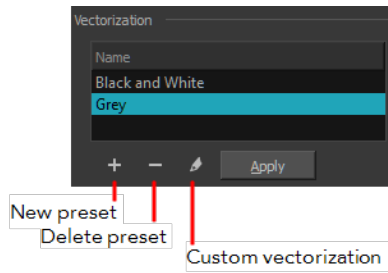

Black and White: Vectorizes drawings as a solid black line; creates a 100% vector-based drawing.

Grey: Vectorizes the image as a mix of vector contour and greyscale bitmap filling. Lines keep the texture from the scan, and the white of the paper becomes transparent.

New Preset: Lets you create a new preset.

Delete Preset: Lets you delete any preset in the list.

Custom vectorization: Lets you set custom vectorization parameters—see [Creating a Vectorization Style](#) on page 77.

7. Click **OK**.

The Multilayer Image Import Settings dialog box opens.

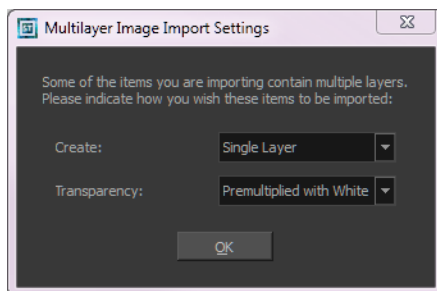

8. From the Create menu, select one of the following:
 - ▶ **Single Layer:** To import the Camera and Layout layers merged together.
 - ▶ **Separated Layers:** To keep your Camera and Layout layers separated.
9. From the Transparency menu, select one of the following if applicable:

Parameter	Description
Premultiplied with White	Individual pixels at the edge of an image are blended with white.
Premultiplied with Black	Pixels at the edge of an image are blended with black.
Straight	Pixels at the edge of an image are blended with black, white and greys.
Clamp Colour to Alpha	Premultiplies the colour value with the alpha value. When the colour is clamped to the alpha, the colour value cannot be higher than the alpha value. It calculates the real colour value faster. When the RGB values are

	multiplied with the alpha value, that is to say, if you have a pixel of value R=247, G=188, B=29 and the alpha is 50% or the image has a 50% transparency, then the actual RGB values that are output would be half of the amounts listed above.
--	--

10. Click OK.

Your image appears as separate layers in the Timeline view, corresponding to the PSD layer group folders **Camera_Set** and **Layout_Set**. You can now use this layout as a guide for scene settings.

Refer to [Scene Setup on page 85](#) to learn more about the scene setup task.

Scanning Images



Toon Boom Harmony can receive images from any TWAIN device such as scanners and digital cameras. These images can either be loaded into your scene as bitmaps or converted into vector-based images that can be edited using Toon Boom Harmony.

If your operating system does not automatically recognize your device after it has been connected, you must install the correct TWAIN drivers in order to access its contents. You can usually download the drivers from the device manufacturer's website.

How to open the Scan Drawings window and set your scanner

1. From the top menu, select **File > Import > From Scanner**.

The Scan Drawings window opens.

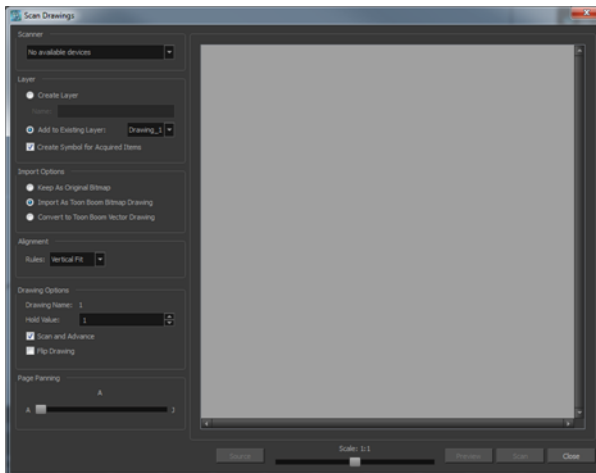

2. In the Scan Drawings window, select your scanner or other supported TWAIN device from the Scanner menu. If none are available, check your device to ensure that it is properly connected to your computer. If your device still does not appear in the menu, you may have to shut down and restart the software.

How to scan an image in its original format

3. In the Layer section, decide if the scanned or imported image will be placed on a new layer or existing layer.

- ▶ **Create Layer:** Scans or imports the image into a new layer. Select one of the following options:

Parameter	Description
Create Single Layer Named	Creates a layer you can name.
Create Layer(s) Based on Filenames	Creates a layer based on each unique filename prefix. For example, the filenames a-1.tga, a-2.tga and b-1.tga will create layers named "a" and "b", where "a" has two drawings and "b" has one. When creating a single layer from these three filenames, all three drawings will be inserted in the new layers.

- ▶ **Add to Existing Layer:** Scans or imports the image into an existing layer. Select a layer from the Layer list. You must scan into the same layer type if you are using an existing layer.
 - ▶ **Create Symbol for Acquired Items:** Encapsulates the bitmap image in a symbol. To mix bitmap images with vector drawings on the same layer, the bitmap image must be encapsulated in a symbol and vice versa. Symbols will also be automatically added to the Symbol folder in the Library view.
4. In the Import Options section, select the **Keep As Original Bitmap** option.
 5. In the Alignment section, decide on the size and placement of your scanned image within the camera frame. Depending on the scene settings (the height and width, in pixels, that you chose for your project), an image that you scan may be scaled to the point where all its individual pixels become visible.

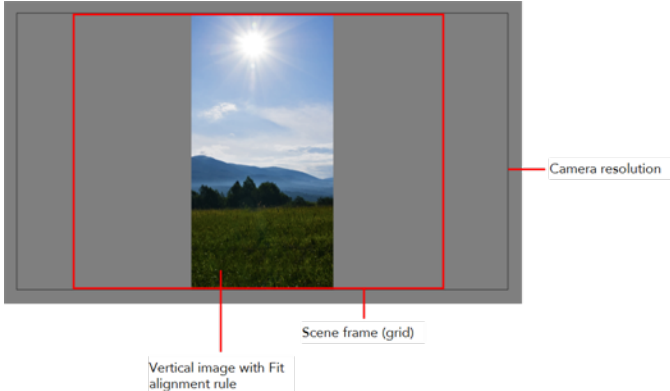
Parameter	Description
Fit	<p>Enlarges or shrinks (but not distorts) the image height to match the full height of the scene grid.</p>  <p>If the image orientation is landscape, this will enlarge or shrink (but not distort) your image width to match that of the scene grid.</p>

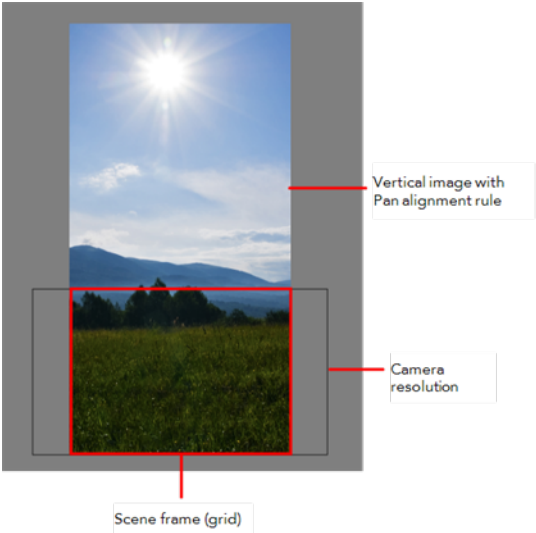
	 <p>Note that the Fit alignment rule equals the Center Fit rule in the layer properties.</p>
<p>Pan</p>	<p>This is the opposite of the Fit parameter. If the image orientation is portrait, its width will be made to match the width of the scene grid. As a result, part of the image's height will extend beyond the height of the frame. This can be useful if you want to make your background move up and down, or from left to right to make it appear as if the camera is panning, or to actually perform a camera pan.</p>  <p>The opposite will apply to a landscape image. Its height will be fit to the scene grid, therefore it is possible that the image will extend beyond the scene grid's boundaries.</p>

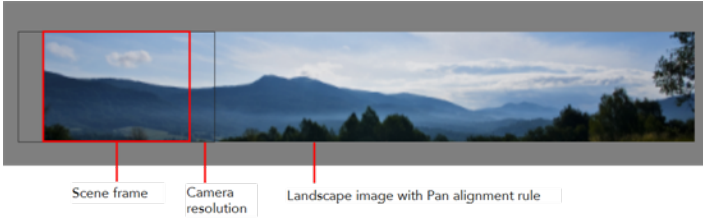
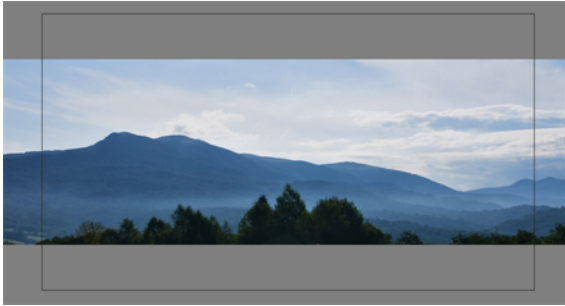
	 <p>Note that the Pan alignment rule equals the Center First Page rule in the layer properties.</p>
Project Resolution	<p>Scales the image in proportion to the scene's resolution. The system looks at the resolution of the bitmap image, for example 4000 x 2000, then compares it to the scene's resolution, for example 1920 x 1080, and adjusts the scale factor in proportion. So, in this example, the bitmap would appear at 208% (4000/1920). If you import a bitmap that is 960 x 540, it will be displayed at 50% (960/1920) of the size of the project resolution.</p>  <p>Note that the Project Resolution alignment rule is equal to the As Is rule in the layer properties.</p>

6. In the Drawing Options section, set the following options if desired:

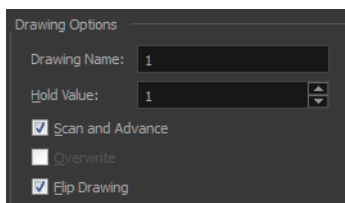

- **Drawing Name:** Name of the drawing to import.
 - **Hold Value:** Type the number of frames that the drawing will be exposed.
 - **Scan and Advance:** Lets you scan one drawing after another every time you click **Scan**.
 - **Flip Drawing:** Mirrors the drawings horizontally and scans it this way.
7. Adjust the **Scale** control and sliders in the Preview Image window until you are satisfied with the view.

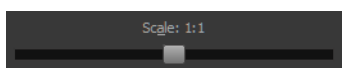

8. Click **Scan** to scan your drawing.
9. If you are scanning panoramic drawings, in the Page Panning section, move the slider to the next letter to capture your next frame.

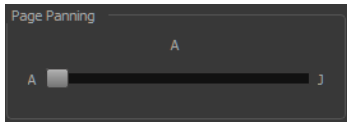

10. If you have more than one drawing, set the next drawing in place and click **Scan** again. Repeat until you have finished scanning all your drawings.

How to scan an image as a Toon Boom bitmap drawing

1. In the Import Options section, select the **Import as Toon Boom Bitmap Drawing** option.
2. In the Layer section, decide if the scanned or imported image will be placed on a new layer or existing layer.
 - **Create Layer:** Scans or imports the image into a new layer. Select one of the following options:

Parameter	Description
Create Single Layer Named	Creates a layer you can name.
Create Layer(s) Based on Filenames	Creates a layer based on each unique filename prefix. For example, the filenames a-1.tga, a-2.tga and b-1.tga will create layers named "a" and "b", where "a" has two drawings and "b" has one. When creating a single layer from these three filenames, all three drawings will be inserted in the new layers.

- **Add to Existing Layer:** Scans or imports the image into an existing layer. Select a layer from the Layer list. You must scan into the same layer type if you are using an existing layer.
 - **Create Symbol for Acquired Items:** Encapsulates the bitmap image in a symbol. To mix bitmap images with vector drawings on the same layer, the bitmap image must be encapsulated in a symbol and vice versa. Symbols will also be automatically added to the Symbol folder in the Library view.
3. In the Alignment section, decide on the size and placement of your scanned image within the camera frame. Depending on the scene settings (the height and width, in pixels, that you chose for your project), an image that you scan may be scaled to the point where all its individual pixels become visible.

Make sure you are in the Camera view's Render Mode when judging an imported image, otherwise it may appear blurry.

The following three Alignment Rules options are available:

Parameter	Description
Vertical Fit	Enlarges or shrinks (but not distort) to your image height to match the full height of the scene frame (alignment grid).

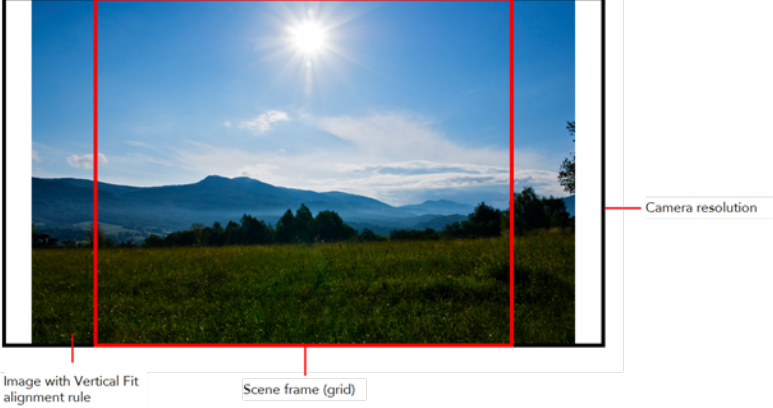
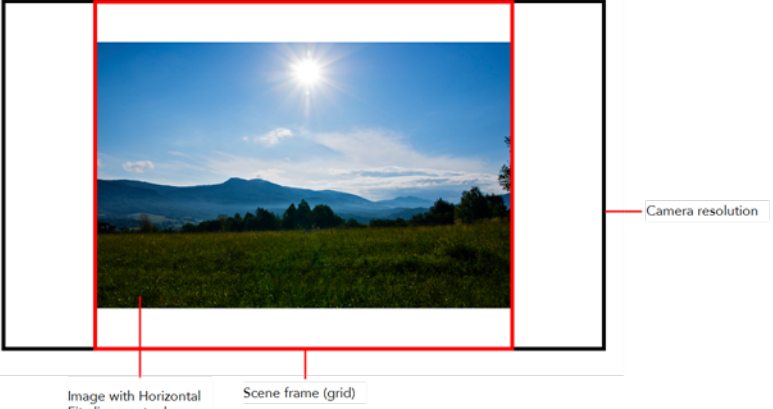
	
Horizontal Fit	<p>Enlarges or shrinks (but not distort) to your image height to match the full width of the scene frame (alignment grid).</p> 
Actual Size	<p>Scales the image in proportion to the scene's resolution. The system looks at the resolution of the bitmap image, for example 4000 x 2000, then compares it to the scene's resolution, for example 1920 x 1080, and adjusts the scale factor in proportion. So, in this example, the bitmap would appear at 208% (4000/1920). If you import a bitmap that is 960 x 540, it will be displayed at 50% (960/1920) of the size of the project resolution.</p>

4. In the Drawing Options section, set the following options if desired:

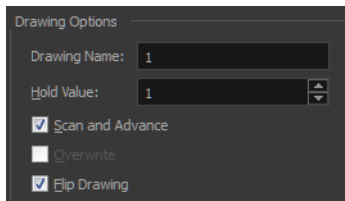

- ▶ **Drawing Name:** Name of the drawing to import.
- ▶ **Hold Value:** Type the number of frames that the drawing will be exposed.

- **Scan and Advance:** Lets you scan one drawing after another every time you click **Scan**.
 - **Flip Drawing:** Mirrors the drawings horizontally and scans it this way.
5. Adjust the **Scale** control and sliders in the Preview Image window until you are satisfied with the view.

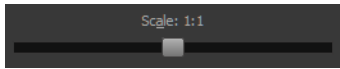

6. Click **Scan** to scan your drawing.
7. If you are scanning panoramic drawings, in the Page Panning section, move the slider to the next letter to capture your next frame.

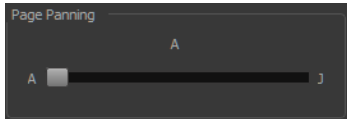

8. If you have more than one drawing, set the next drawing in place and click **Scan** again. Repeat until you have finished scanning all your drawings.

How to scan an image and convert it to a Toon Boom vector drawing

1. In the Import Options section, select the **Convert to Toon Boom Vector Drawing** option. You can choose to encapsulate the image in a symbol by selecting the **Create Symbols for Imported Items** option.
2. In the Layer section, decide if the scanned or imported image will be placed on a new layer or existing layer.
 - **Create Layer:** Scans or imports the image into a new layer. Select one of the following options:

Parameter	Description
Create Single Layer Named	Creates a layer you can name.
Create Layer(s) Based on Filenames	Creates a layer based on each unique filename prefix. For example, the filenames a-1.tga, a-2.tga and b-1.tga will create layers named "a" and "b", where "a" has two drawings and "b" has one. When creating a single layer from these three filenames, all three drawings will be inserted in the new layers.

- **Add to Existing Layer:** Scans or imports the image into an existing layer. Select a layer from the Layer list. You must scan into the same layer type if you are using an existing layer.
 - **Create Symbol for Acquired Items:** Encapsulates the bitmap image in a symbol. To mix bitmap images with vector drawings on the same layer, the bitmap image must be encapsulated in a symbol and vice versa. Symbols will also be automatically added to the Symbol folder in the Library view.
3. In the Vectorization section, decide whether you want to import your image in black and white or grey.

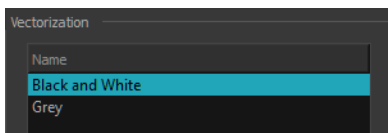

Parameter	Description
Black and White	Vectorizes drawings as a solid black line; creates a 100% vector-based drawing.
Grey	Vectorizes your image as a mix of vector contour and greyscale bitmap filling. Lines keep the texture from the scan, and the white of the paper becomes transparent.

4. In the Drawing Options section, set the following options if desired:

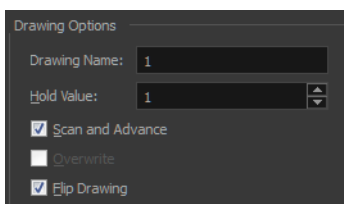

- ▶ **Drawing Name:** Name of the drawing to import.
 - ▶ **Hold Value:** Type the number of frames that the drawing will be exposed.
 - ▶ **Scan and Advance:** Lets you scan one drawing after another every time you click **Scan**.
 - ▶ **Flip Drawing:** Mirrors the drawings horizontally and scans it this way.
5. Adjust the **Scale** control and sliders in the Preview Image window until you are satisfied with the view.

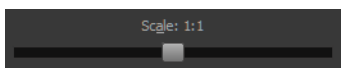

6. Click **Scan** to scan your drawing.
7. If you are scanning panoramic drawings, in the Page Panning section, move the slider to the next letter to capture your next frame.

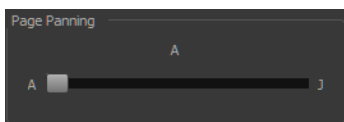

8. If you have more than one drawing, set the next drawing in place and click **Scan** again. Repeat until you have finished scanning all your drawings.

Importing AI and PDF Files



You can import AI (Adobe Illustrator) and PDF files into Toon Boom Harmony to convert your files to the Toon Boom format (TVG) and create a colour palette based on the colour settings of the original file.

When importing AI and PDF files:

- RGB is supported, CMYK is not.
- Gradients and textures are not supported.
- Only legacy versions of Adobe Illustrator are supported. Exported SWFs, including Actionscript 2 and Actionscript 3, cannot be imported.
- When importing an Illustrator or PDF file in Toon Boom Harmony, by default the file will be imported as separate layers. The import will use the Illustrator file's top level groups as separate layer names. However, you can change this behaviour by deselecting the PDF/Illustrator Import as Separate Layers option, to import your file as a single layer .

How to import an AI or PDF file

1. In Library view, right-click on the Stage Library folder and select **Right to Modify** to unlock the library folder. Make sure the Lock icon disappears from the folder. If not, your library will remain locked and you will not be able to import files.

For more information, refer to the Library chapter in the Cut-out Animation Guide.

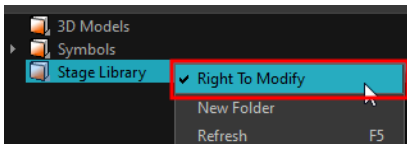

2. Do one of the following:
 - ▶ In the top menu, select **File > Import > SWF, Illustrator Files to Library**.
 - ▶ Right-click on any unlocked folder and select **Import Files**.

The browser window opens.

3. Find and select your AI or PDF file in the Import Files dialog box and click **Open**.

The Rename dialog box opens.

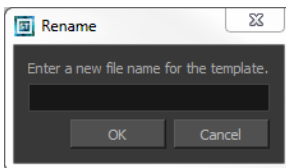

4. Type in a name for the new template or keep the name of the original AI or PDF file.
5. Click **OK**.

A new template folder is created in the Library view.

6. Drag the new template folder from the Library view to the left side of the Timeline view. Wait until the copy cursor  appears before releasing the folder.

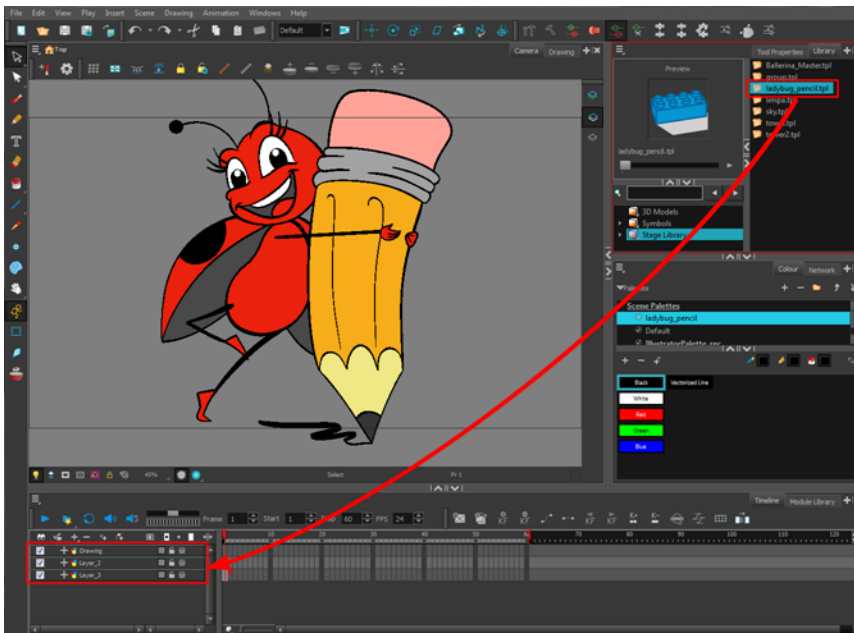

The message window opens.

7. Click **Yes** to perform a colour recovery. Note that you can select the **Do Not Ask Again For This Session** option if you plan to import multiple AI or PDF files.

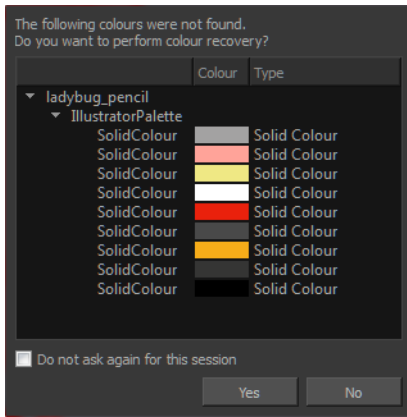

The colour palette used to create the AI or PDF file is imported and a new palette is created under the imported file's name.

To learn about the Support CMYK in PDF/Illustrator Import option, refer to the Preferences Guide.

Importing Adobe Flash Files



If a project was started in Adobe Flash and it needs a more professional boost, such as camera movements or multiplaning, it can easily be imported into Harmony. The actual *.fla file is not supported, so you must export your project as a *.swf movie.

How to import a Flash file

1. In Library view, right-click on the Stage Library folder and select **Right to Modify** to unlock the library folder. Make sure the Lock icon disappears from the folder. If not, your library will remain locked and you will not be able to import files.

For more information, refer to the Library chapter in the Cut-out Animation Guide.

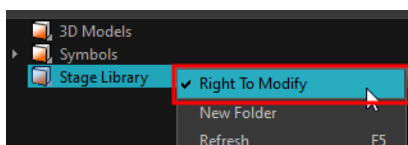

2. Do one of the following:
 - ▶ In the top menu, select **File > Import > SWF, Illustrator Files to Library**.
 - ▶ Right-click on any unlocked folder and select **Import Files**.

The browser window opens.

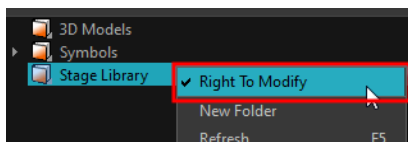

For more information, refer to the Library chapter in the Cut-out Animation Guide.

3. Find and select your **.swf** file in the Import Files dialog box and click **Open**.

The Rename dialog box opens.

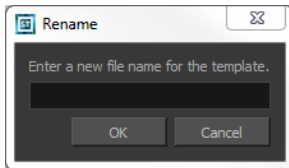

4. Type a name for the new template or keep the name of the original ***.swf** file.
5. Click **OK**.

A new template folder is created in the Library view.

6. Drag the new template folder from the Library view to the left side of the Timeline view. Wait until the copy cursor  appears before releasing the folder.

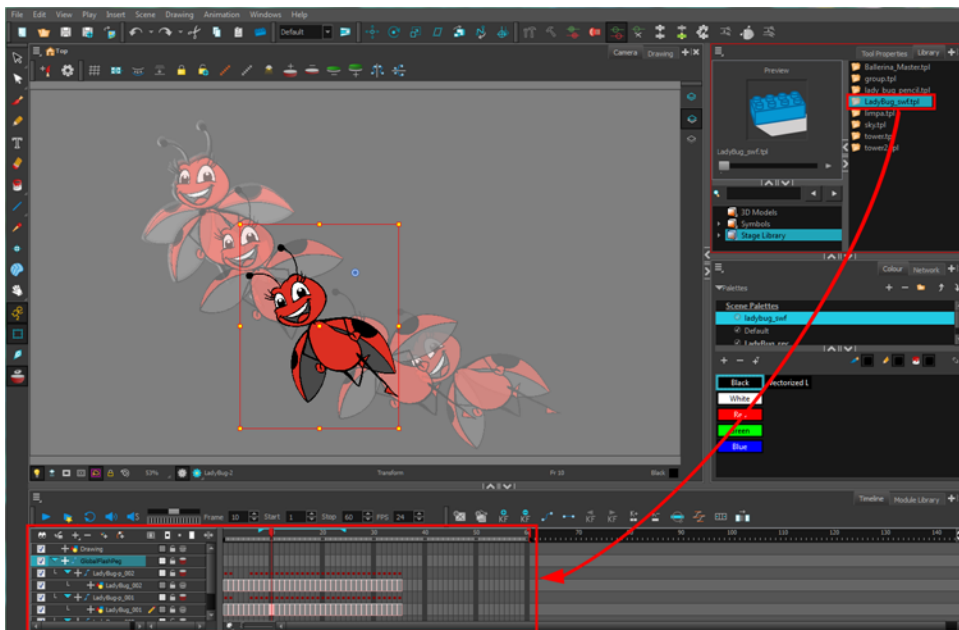

7. The colour recovery dialog box appears, requesting that a colour recovery should occur. Before clicking the Yes button, you have the option of selecting the **Do Not Ask Again For This Session** option. This might be useful if you plan to import multiple ***.swf** movies.

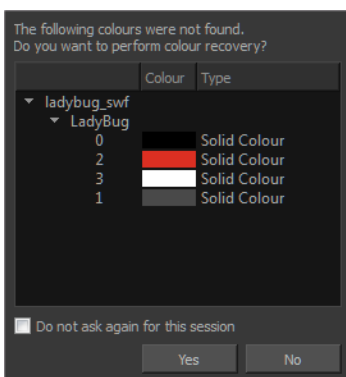

The colour palette used to create the AI or PDF file is imported and a new palette is created under the imported file's name.

All the Flash layers are automatically attached to a parent peg called GlobalFlashPeg. **DO NOT DELETE THIS PEG.** To maintain the look of your movie, it is important that this peg is not deleted, nor its child layers detached.

The Adobe Flash file layers appear in the Timeline view. Symbols that were created in Flash become regular drawing layers, but can be reconverted into symbols in Harmony. Symbols within symbols or drawings within symbols collapse into their corresponding parent symbol.



Some layers in your SWF movie may be combined in a single layer as a result of optimization enhancements in your movie file. You can easily move these elements back onto separate layers—see [Redistributing Elements](#) below.

In addition, all drawing elements that are dynamically linked to the Toon Boom Harmony file are grouped together in one folder. In our example, this means that when you scroll through the Drawing Substitution preview in the Library view, the different hand, leg, tentacles, antennae, torso and facial positions are all organized together.

Redistributing Elements

In some instances, due to an optimization enhancement in the exported SWF file (CS4), some of the layers might be combined as a single layer. If so, you can quickly redistribute these elements onto individual layers again.

How to distribute to layers

1. In the Tools toolbar, click the Select  tool.
2. In the Camera view, select the drawing that contains elements you want to redistribute onto individual layers. To select the all the elements of the selected drawing layer, press Ctrl + A (Windows/Linux) or ⌘ + A (Mac OS X).
3. From the top menu, select **Drawing > Distribute to Layers** or click the Distribute to Layers  button in the Select tool's Tool Properties view.

The number of drawing layers corresponding to the different grouped elements are created in the Timeline view.

- The selected elements in the original drawing layer are removed. Each element is distributed onto a new drawing layer.
4. Repeat the process for each drawing that contains elements to redistribute.

Importing QuickTime Movies

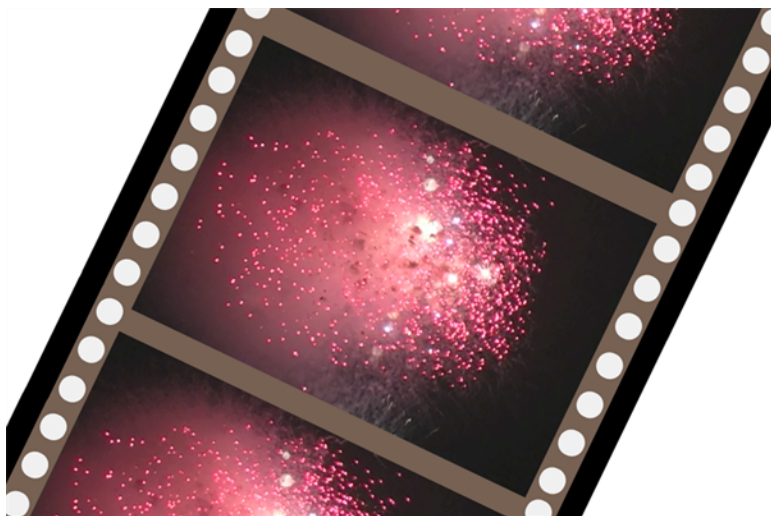

When creating an animation, it is not unusual to embed moving elements saved as videos within the animation. Toon Boom Harmony allows you to import QuickTime movies into your project.

How to import a QuickTime movie

1. From the top menu, select **File > Import > Movie**.
2. Browse for the QuickTime movie to import and click **Open**.

The Import Drawings dialog box opens.

Do not browse for the movie file again. Leave the automatically generated field text as “many files selected”.

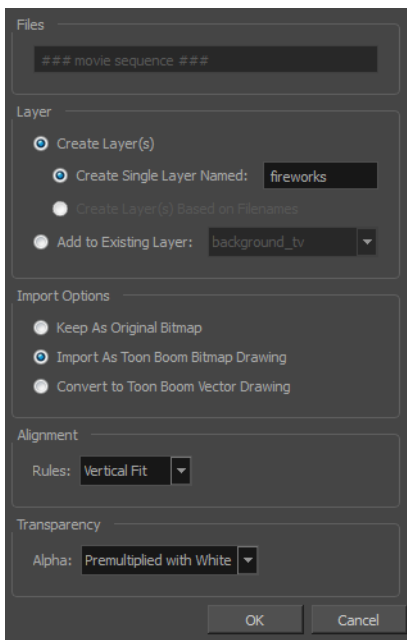

3. Make your decisions for the Layer, Alignment and Transparency sections of this dialog box—see [Importing a Bitmap Image Without Vectorization](#) on page 18.
4. Click **OK**.

The QuickTime video appears in the Timeline view as an image sequence. You can scroll through the film frame-by-frame just as you would scroll through your animation drawing-by-drawing.

Custom Vectorization Parameters

You can create your own vectorization settings with Harmony.

The vectorization parameters you will create here can be saved, shared and also inserted into the **VectOptions.conf** file used by the Harmony Scan and Control Center modules when scanning or vectorizing a series of drawings.

You can use an interface to select and test the different options and you can also type in some advanced settings.

How to open the Vectorization Parameters dialog box

1. From the top menu, select **File > Import > From Scanner**.
You can also open it from any other import option that allows you to customize the vectorization parameters (i.e. from the scanner).
 2. Select your file, decide on the layer options, and click **Preview**.
 3. In the Vectorization section, click the New Preset **+** button.
- The Vectorization Parameters dialog box opens.

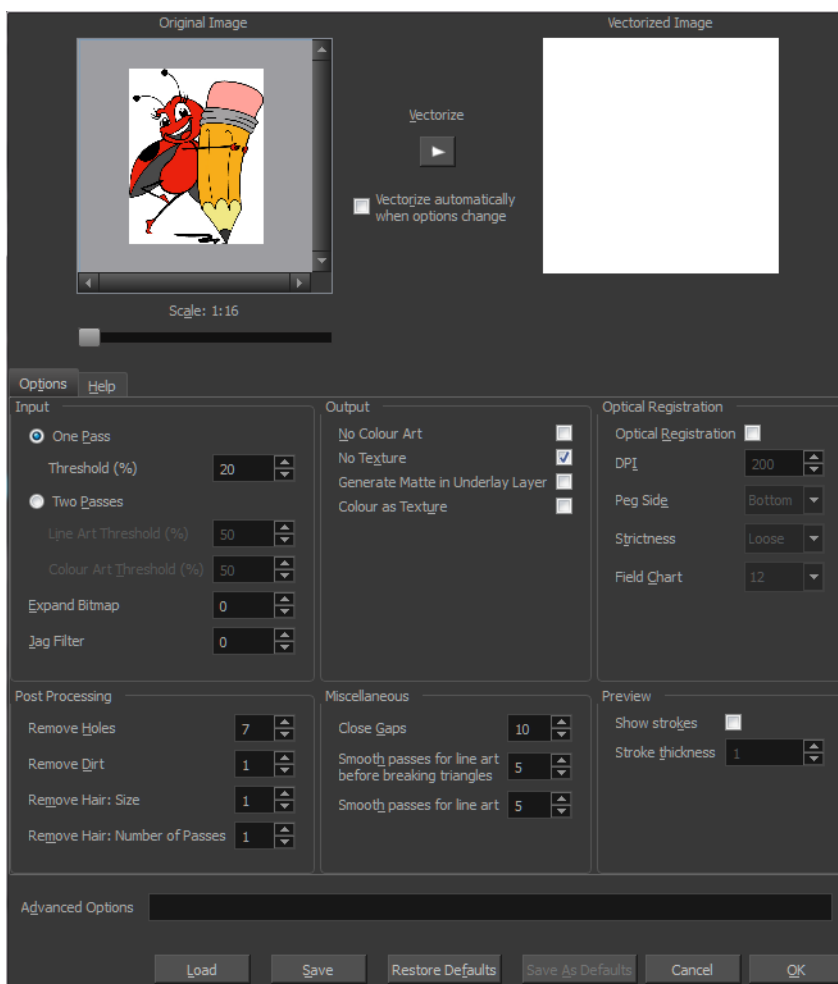

- Options Tab below
- Help Tab on page 72

Options Tab

The Options tab contains the main vectorization settings. More settings are available in the Help tab.

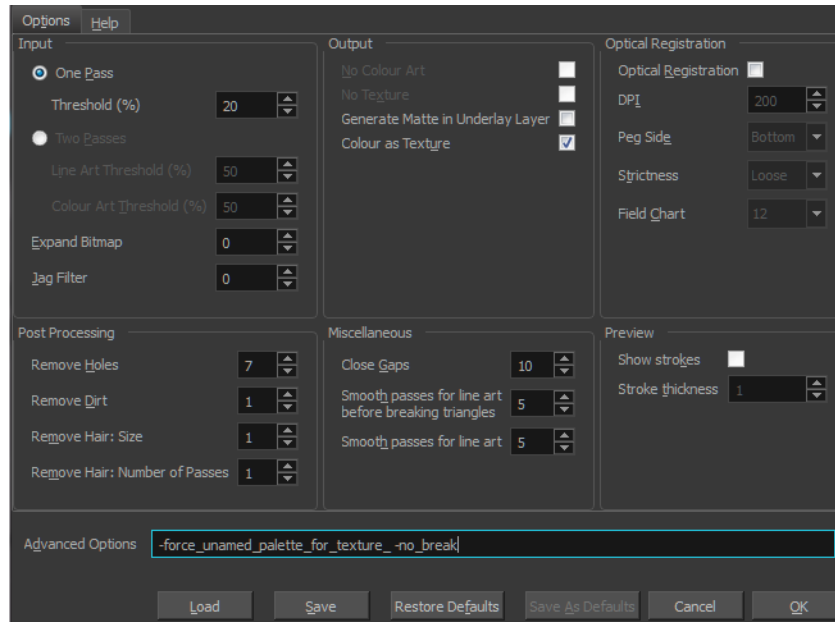

Parameter	Description
Input	The input filters are applied to the bitmap image before it is vectorized.
	One Pass: One threshold value is applied to both the Line and Colour Art. For drawings with distinct vector-style lines of mattes, you only need one pass.
	Two Passes: Applies a different threshold value to each layer.
	For greyscale drawings, you may want to perform the vectorization process twice to apply different threshold values to the Line and Colour Art layers.
	Threshold: Determines which values in the scanned image are considered part of the Line or Colour Art layer and what will be eliminated from the vectorized drawing; 0% is white and 100% is black. The threshold is between these two values.
	Expand Bitmap: Lets you enter a value to scale the bitmap to detect small variations in the line. Use this option if you scanned a greyscale image and want to preserve small variations in the texture to apply to the line art.
	Jag Filter: Lets you enter a value to scale back the bitmap to remove some of the line's roughness. This is useless when you have a drawing that appears quite rough; the Jag filter will

	eliminate excess strokes in the final drawing.
Output	The output filters are applied during the vectorization process.
	No Colour Art: Does not generate filling zones in the Colour Art layer.
	No Texture: Does not generate texture in the Line Art in the final images. Select this option to create solid lines in the final line art.
	Generate Matte in Underlay Layer: Creates an opaque zone behind your drawing's lines to avoid seeing through the layers.
	Colour as Texture: Converts colour values into a texture layer.
Optical Registration	The optical registration options are used to automatically align drawings based on the position of the peg holes on the animation paper. The peg holes must appear in the scanned drawings for the optical registration to work.
	DPI: Lets you enter the dots-per-inch value of your image. You must enter the same value as the DPI used to scan the image.
	Peg Side: Lets you select the position of the peg holes on your drawings. Identify whether they are on the top, bottom, left or right.
	Strictness: Determines how exact the location of the peg holes must be for the software to recognize them. You have two values to choose from: <ul style="list-style-type: none"> • Strict: The peg holes must be in a tightly defined area to be recognized. • Loose: The peg holes can be recognized somewhere in a larger area. This is the recommended setting.
	Field Chart: Lets you indicate the size of the animation paper; 12 or 16.
Post Processing	The Post Processing filters are applied to the final vector images.
	Remove Holes: Removes holes of a specified value that might make painting difficult.
	Remove Dirt: Removes stray marks and dirt of a specified value. Try a value around 500.
	Remove Hair: Removes small strokes that have no line art.
	Remove Hair: Number of Passes: The number of times the drawing will be analyzed to identify hair marks.
Miscellaneous	Close Gaps: Closes gaps in the Colour Art so that you can paint it.
	Smooth Passes for Line Art before Breaking Triangles: The number of times the smoothing operation runs before creating

	the triangles that break lines in your drawing. If unnecessary triangles are appearing in your drawing, increase this value.
	Smooth Passes for Line Art: The number of times the smoothing operation is performed after the triangles have been created. This further smooths the Line Art.
Preview	Show Strokes: Shows the strokes in the Vectorized Image panel.
	Stroke Thickness: Shows the size of the strokes.

Help Tab

The Help tab contains the most advanced vectorization settings which you type in the Advanced Option fields at the bottom of the Options tab.



```

Options Help
-----
File IO options:
-file <filename (including extension)> [ options ]
-infile <filename (including extension)> -- Same as -file
-outfile <filename> -- alternate output file
-informat <format> -- the input format. Used if reading from stdin
-debug -- turn on debug mode
-noforce -- don't force output if image is inconsistent
-version -- print version information and quit
-output_version <version> -- output files of this version. Valid versions can be: 0 or 604
-force_unnamed_palette_for_texture -- will generate a texture in TVG's internal palette

Registration options:
-register <dpi side strictness>; Perform optical registration.
    Side can be one of left, right, top, bottom or l, r, t, b.
    Strictness can be either loose, strict or l, s.
-register_center_peg_holes; Will use only round holes in 16 fields page
-rph; Short form of register_center_peg_holes
-registration_looseness_factor <factor>; Registration looseness factor (default 2)
-rif; short form of registration_looseness_factor
-rdebug; output registration debug messages
-pegpitch <inch (default 8)>; distance between peg bars
-threshr <(default 0.5)>; threshold for optical registration; range 0.0 to 1.0
-margin <inch (default 1)>; region size where to look for peg bars
-peg_distance_from_center <inch (default 5.25)>; peg distance from center of the image
-pdfc; short form of -peg_distance_from_center
-out_peg_position <side (default same)>; Wanted position of the peg on the drawing.

```

File IO Options

- file <filename (including extension)> [options]
- infile <filename (including extension)>; same as -file
- outfile <filename>; alternate output file
- informat <format>; the input format. Used if reading from stdin
- debug; turn on debug mode
- noforce; don't force output if image is inconsistent
- version; print version information and quit
- output_version <version>; output files of this version. Valid versions can be: 0 or 604
- force_unnamed_palette_for_texture; will generate a texture in TVG's internal palette

Registration Options

- register <dpi side strictness>; perform optical registration.

- Side can be one of left, right, top, bottom or l, r, t, b.
 - Strictness can be either loose, strict or l, s.
- register_center_peg_holes**; will use only round holes in 16 fields page
- rcph**; short form of register_center_peg_holes
- registration_looseness_factor** <factor>; registration looseness factor (default 2.000000)
- rlf**; short form of registration_looseness_factor
- rdebug**; output registration debug messages
- pegpitch** <inch (default 8.000000)>; distance between peg bars
- threshr** <(default 0.500000)>; threshold for optical registration; range 0.0 to 1.0
- rmargin** <inch (default 1)>; region size where to look for peg bars
- peg_distance_from_center** <inch (default 5.25)>; peg distance from centre of the image
- pdfc**; short form of -peg_distance_from_center
- out_peg_position** <side (default same)>; wanted position of the peg on the drawing.
- Can be one of right, left, top, bottom (or r, l, t, b) or same.
 - A rotation will be performed if it is different from the side passed to -register.
- output_peg_matrix**; output the peg transformation matrix on standard output.
- scanner_calibrate**; <(default 1.0000 1.0000) > x and y scale factors to be applied to scanner image.

Filtering Options

- pixel** <pixel_shape (default '4x3')>; Valid values: 4x3
- gap** <worldUnits (default 10)>; close gaps up to this big
- pencil**; generate line art only
- keep_dirt**; don't filter out dirt
- thresh** <threshold (default 0.2)>; range 0.0 to 1.0
- rmv_hairs** <worldUnits (default 1)> <passes (default 1)>
- remove hairs of size smaller than "size" in "passes" passes
- rmv_holes** <area (default 7)>; remove holes smaller than "area"
- rmv_dirt** <area (default 1)>; remove dirt smaller than "area"
- try values between 100 and 500 for rmv_holes and rmv_dirt. The area is in world units squared
- rmv_triangles** <worldUnits (default 30.000000)>; remove triangles at "pixels"
- distance from each other. Use -no_break to remove all triangles
- no_texture**; don't generate textured strokes
- color_as_texture**; will vectorize the alpha channel and put the RGB colour in a textured colour
- noclosegap**; disable all gap closing algorithms
- no_break**; disable the breaking of line art
- jag_filter** <pixels (default 0)>; expand the pixels in the vectorization bitmap

-expand_bitmap <pixels (default 0)>; expand the pixels in the vectorization bitmap

-fit_errorc <error (default 1.000000)>; fitting error for the colour art

-fit_errorl <error (default 1.000000)>; fitting error for the line art

-smoothl <passes (default 1)>; number of smooth passes for line art

-smoothc <passes (default 1)>; number of smooth passes for colour art

-first_smooth <passes (default 0)>; number of smooth passes for line art before breaking triangles

-first_smoothl <passes (default 0)>; number of smooth passes for line art before breaking triangles

-first_smoothc <passes (default 0)>; number of smooth passes for line art in colour art pass (needs -2pass)

-2pass; specify two sets of parameters; one for line art "l", one for colour art "c"
(-thresh, -rmv_holes and -rmv_dirt will be overridden by -threshl, threshc, -rmv_holesl, -rmv_holesc, -rmv_dirtl and -rmv_dirtc)

-threshl <threshold for line art (default 0.5)>; range 0.0 to 1.0

-threshc <threshold for color art (default 0.5)>; range 0.0 to 1.0

-jag_filterl <pixels (default 0)>; expand the pixels in the vectorization bitmap for line art

-jag_filterc <pixels (default 0)>; expand the pixels in the vectorization bitmap for colour art

-expand_bitmapl <pixels (default 0)>; expand the pixels in the vectorization bitmap for line art

-expand_bitmapc <pixels (default 0)>; expand the pixels in the vectorization bitmap for colour art

-rmv_holesl <area (default 7)>; remove line art holes smaller than "area"

-rmv_holesc <area (default 7)>; remove colour art holes smaller than "area"

-rmv_dirtl <area (default 1)>; remove line art dirt smaller than "area"

-rmv_dirtc <area (default 1)>; remove colour art dirt smaller than "area"
try values between 100 and 500 for rmv_holesl, rmv_holesc, rmv_dirtl and rmv_dirtc. The values are in world units squared

-margins <inch (default 0.25)>; remove margin around bitmap

-top_margin <inch (default 0.25)>; remove margin at top of bitmap

-bottom_margin <inch (default 0.25)>; remove margin at bottom of bitmap

-left_margin <inch (default 0.25)>; remove margin at left of bitmap

-right_margin <inch (default 0.25)>; remove margin at right of bitmap

-remove_peg_bars; remove the peg bar holes

-field_size <fields (default 12 or use value in scan file)>; set the drawing to this field size

-fs; short hand for -field_size

-peg_bar_size <inch (default 1)>; the size of the peg bar region

-noframe; do not put a frame around the colour art

-frame_fields <default -1.000000>; put a frame of the specified dimension around the colour art

- downscale_input** <default 1>; downscale the raw input by this integer factor
 - downscale_texture** <default 1>; downscale the output texture by this integer factor
 - buildmatte**; generate a matte on underlay for line test
 - buildmatte_colourart**; generate a matte on colour art for line test
- Note: -buildmatte and -buildmatte_colourart are mutually exclusive
- copystrokes**; copy original strokes when building matte.

Options for bitmap that has no registration information

- pixel_margins** <inch (default 0)>; remove margin around bitmap
- top_pixel_margin** <inch (default 0)>; remove margin at top of bitmap
- bottom_pixel_margin** <inch (default 0)>; remove margin at bottom of bitmap
- left_pixel_margin** <inch (default 0)>; remove margin at left of bitmap
- right_pixel_margin** <inch (default 0)>; remove margin at right of bitmap
- dpi** <(default -1)>; dpi information of input bitmap

RGB Keying Options

- rgb**; generate separate zones for red, green and blue lines
- rgb_alpha** <value (default 255)>; generate red, green and blue colour with alpha of this value
- no_red**; ignore red colour in vectorization
- no_green**; ignore green colour in vectorization
- no_blue**; ignore blue colour in vectorization
- flatten**; flatten the drawing after generating colours
- rmv_rgb_dirt** <threshold area default 0.0>; remove red, green and blue regions smaller than area
- expand_bitmap_rgb** <pixels (default 0)>; expand the pixels in the vectorization bitmap for rgb
- threshrgb** <value> <threshold for rgb vectorization default 0.200000>;
- threshsv** <saturation threshold default 0.500000> <value threshold default 0.500000>; thresholds on saturation and value to consider a pixel to be grey

Colour Vectorization Options

- color_vectorize**; perform a colour vectorization
- file2** <colour art filename>; specify the colour art bitmap
- penstyle** <center alpha (0.0-20.0)> <edge alpha (0.0-20.0)> <gamma (0-10)><centre pressure effect (0.0-1.0)> <edge pressure effect (0.0-1.0)><texture bitmap downscaling (0.2-20)> <texture bitmap file (valid filename or "" if no file)>; generate brush texture for the line art
- pressure_variation** <strategy (0, 1 or 2)> <min pressure (0.0-1.0)> <max pressure (0.0-1.0)> <max variation (0.0-1.0)>; specify a pressure strategy for the centre line.
- blur_radius** <pixels (default 0)>; blur the penstyle texture generated

-color_contour_smooth_passes <times (default 3)>; perform number of smooth passes on contour before computing texture

-ccsp <times (default 3)>; short for -color_contour_smooth_passes

-color_rmv_holesl <world units (default 0.000000)>; remove holes of this size when computing texture

-color_fill_holesl <world units (default 0.000000)>; fill holes of this size for colour line art

Bubble Usage (implemented only for colour vectorization's line art)

-create_bubbles; add bubbles into the LineArt. Implemented for colour vectorization only

-bubble_gap <value (default 3)>; max number of colour art points between 2 bubbles

-bubble_length <value (default 10)>; max number of circles in a bubble

-min_radius <value (default 1.5000)>; min radius of a circle in a bubble relative to the line thickness (must be ≥ 1.0)

-max_radius <value (default 3.5000)>; max radius of a circle in a bubble relative to the line thickness (must be ≥ 1.0)

-uniform_gap; the space between bubbles is constant

4 Colour Vectorization

-4colours [key:value] ... [key:value] ; The key value list can be empty. The list of keys is:

rgbdiff:value ; between [0.0-1.0] or [0-255]

dark:value ; between [0.0-1.0] or [0-255]

grey:value ; between [0.0-1.0] or [0-255]

white:value ; between [0.0-1.0] or [0-255]

dirt:value ; dirt area. 200 is a good value

rt:value ; between [0.0-1.0] or [0-255]

gt:value ; between [0.0-1.0] or [0-255]

bt:value ; between [0.0-1.0] or [0-255]

There must be no space between the colon and the key/value. For example: -4colours rgbdiff:20 dark:20 grey:120 white:250 dirt:200 rt:240 gt:240 bt:240

The Vectorization Parameters dialog box lets you vectorize pencil drawings, along with any red, blue or green pencil marks you may have used to indicate highlights and shadows. The drawing will be vectorized into pure red, blue, green and black (RGB values), while creating colour art zones wherever lines connect. After painting in your tones and highlights, change your pure RGB colours to transparent (0 Alpha) in the Colour Picker window and watch the indicator colour zone lines disappear.

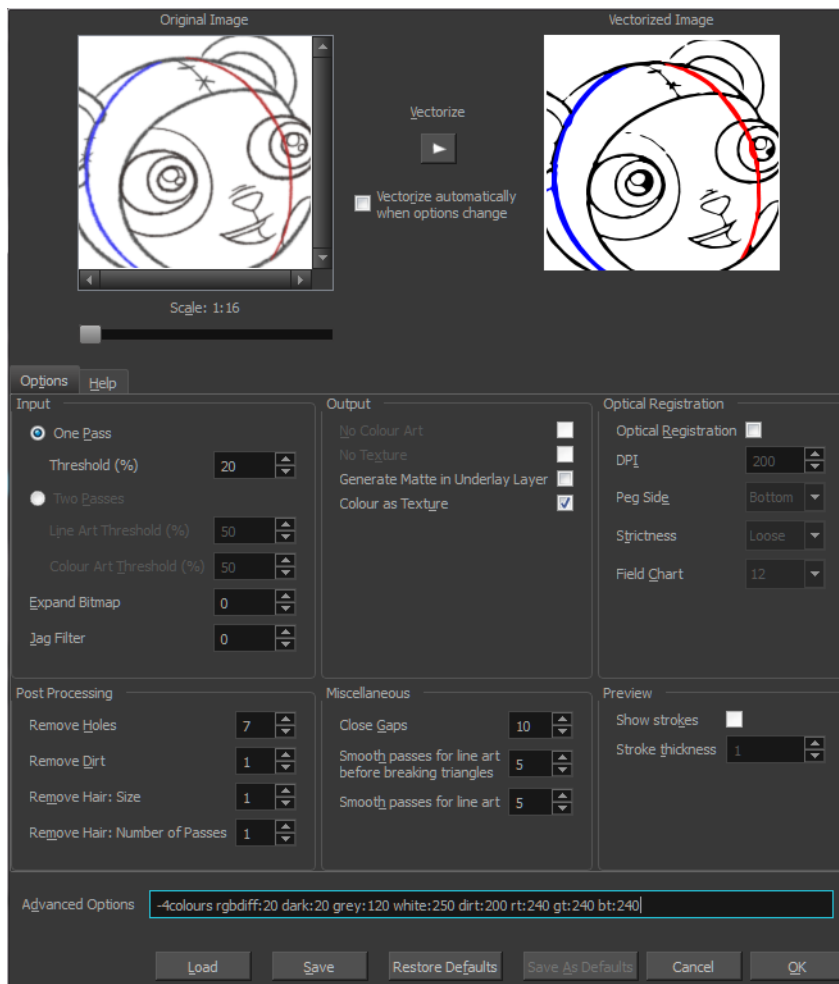

Creating a Vectorization Style

With Harmony, you have the possibility to create custom vectorization parameters that can be saved and reused.

You can vectorize drawings using one of the following methods:

- **Black and White:** All the lines become vector based and 100% black. The white areas become completely transparent.
- **Greyscale:** All the lines preserve their initial textured look in grey shades as a bitmap image contained inside a vector frame. The white areas become completely transparent.
- **Four Colours:** With the advanced parameters, you can isolate the red, green, blue, and black lines and turn them into 100% vector lines, preserving their original colours—see [Custom Vectorization Parameters](#) on page 69.

How to create or modify the vectorization parameters

1. Set the different options available in the Vectorization Parameters dialog box.

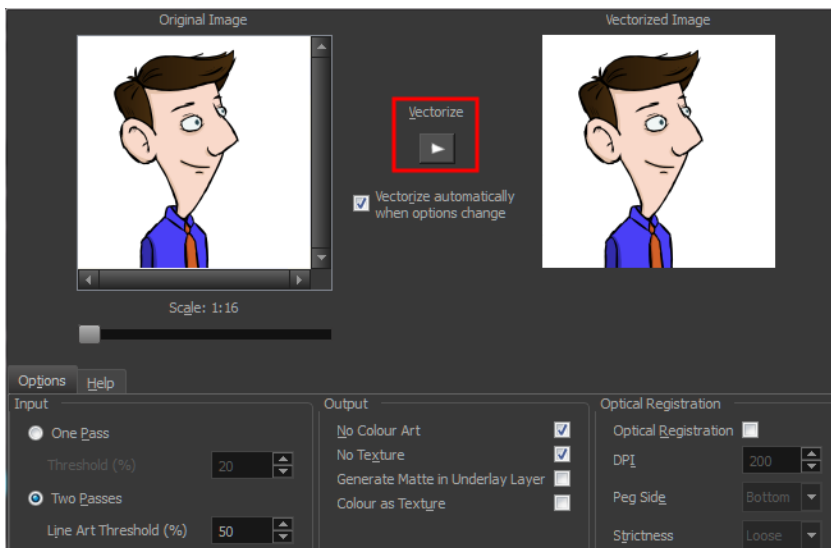

2. Click the **Vectorize** button to update the Vectorized Image preview.
The vectorized image is just a preview. The actual vectorization happens when you click **OK** in the Import Images dialog box. There are many options to try in the Vectorization Options dialog box. These are applied during the vectorization process.
3. To set advanced parameters, read the information on the Help tab, then type in the Advanced Options field at the bottom of the Options tab.
4. To save your vectorization parameters to reuse them later, share them, or use them to set the Harmony Scan module vectorization style list, click **Save**.
5. In the Browser window, name and save the file.

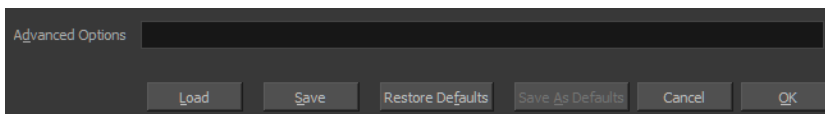

6. To save the current settings as your default settings, click **Save As Default**. To restore the default settings, click **Restore Defaults**.
7. To load a vectorization style, click **Load** and locate the existing ***.vof** file.
8. Click **OK**.

Setting the VectOptions.conf File

Toon Boom Harmony Server uses a file called **vectOptions.conf** to get the vectorization style when batch vectorizing a series of drawings. A series of default styles is available in this file, but you will certainly want to create your own to fit your production style.

This section deals with setting the VectOptions.conf file on:

- [Setting the VectOptions.conf File on Windows and Mac OS X below](#)
- [Setting the VectOptions.conf File on Linux on page 81](#)

Setting the VectOptions.conf File on Windows and Mac OS X

How to set the VectOptions.conf file on Windows or Mac OS X

1. Open the vectOptions.conf file:
 - Windows: Select **Programs / All Programs > Harmony 11.1 > Tools > Configuration Editor**.
 - Mac OS X: Select **Applications > Harmony 11.1 > Tools > Configuration Editor**.

The Configuration Editor window opens.

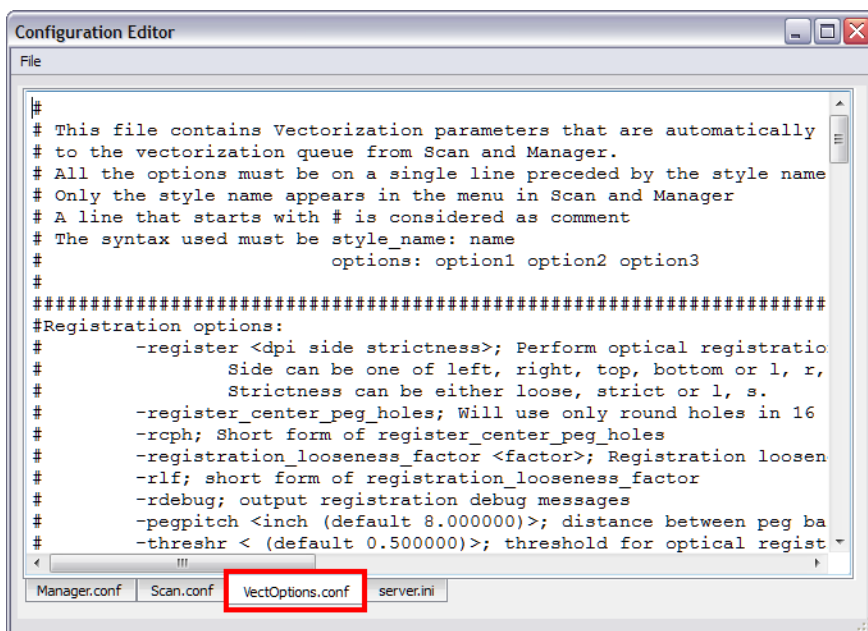

2. In the bottom section of the window, select the **VectOptions.conf** tab.
3. Scroll down the VectOptions.conf file to see all the different options available for creating your custom vectorization style. These options are the same as in the Vectorization Parameters dialog box. It is recommended that you create your vectorization style using Harmony and the Vectorization Parameters window and copy the result parameters in this file—see [Creating a Vectorization Style on page 77](#)
4. Scroll down toward the bottom of the file to see the default styles. You can modify them or add new ones to the list using the parameters you got using the Vectorization Parameters window. Notice that some of the lines have a “#” sign at the beginning to indicate that the line is a comment and will not appear in the style list. The lines that have no sign at the beginning appear in the style list.

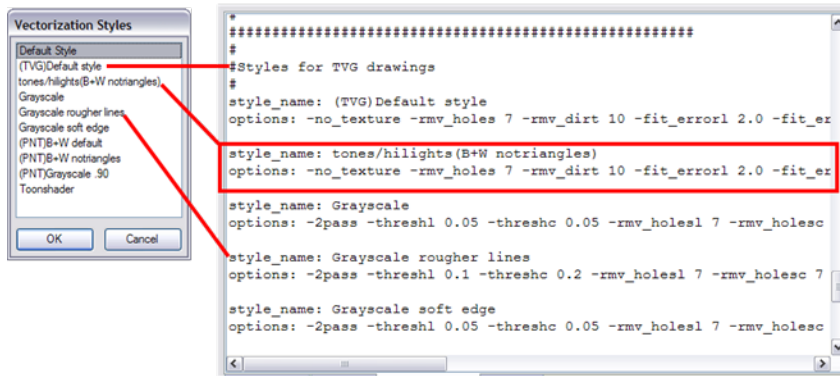

5. To create a new style, type the following below the existing styles:
style_name:
 This should be followed by the name of your new style. For example: **style_name: Black Lines.**
6. Under the style name line, type the following:
options:
7. Copy and paste the information in your *.vof style when saving your settings in the Vectorization Parameters window.
 - To open the *.vof file, use any plain text editor application.

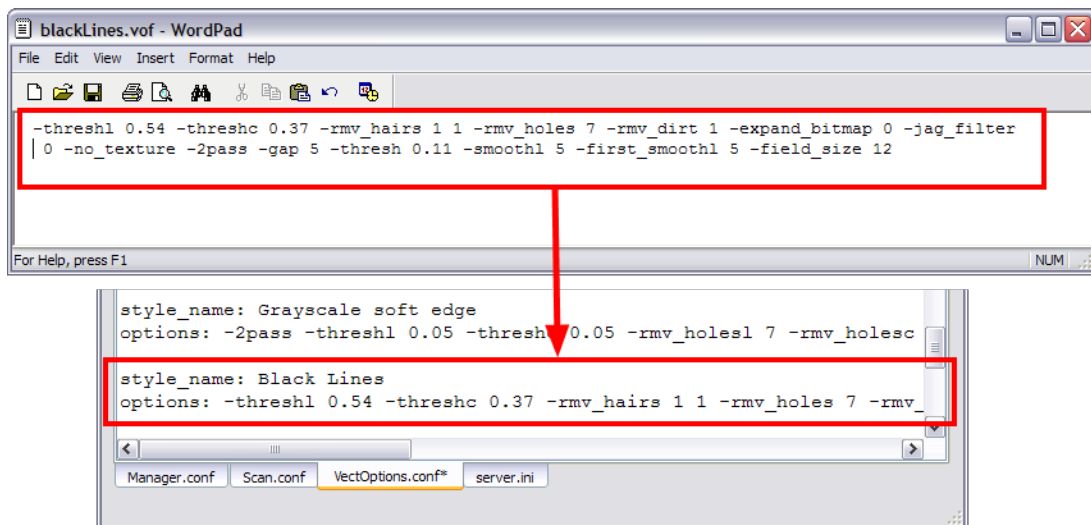

8. In the Configuration Editor's top menu, select **File > Save**.
9. If you have Toon Boom Harmony Scan on your computer, you can start the application and verify that the new style appears in the Vectorization Style list under **Edit > Vectorization Style**.

If you are using the batch processing method available with Toon Boom Harmony Server to scan and vectorize your drawings, the selected style must be available on all the machines included in the batch processing list.

Refer to the Control Center Guide to learn more about setting up and using batch processing.

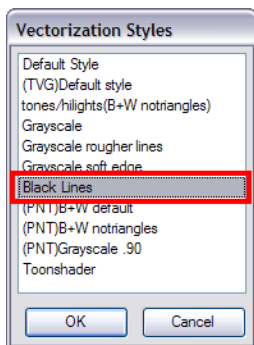

Setting the VectOptions.conf File on Linux

These are the two methods used to edit the `VectOptions.conf` file on Linux.

- Using the "vi" text editor
- Using the "gedit" text editor

How to set the VectOptions.conf file on Linux using the "vi" text editor

1. Open a Terminal window:

Menu: **Applications > System Tools > Terminal**

2. Open the etc folder inside the installation directory:

```
$ cd /usr/local/ToonBoomAnimation/harmony_11.0/etc
```

3. Change your user to "root":

```
$ su
```

- If your user is part of the sudoers list, enter the following command and go to See "Open the 'VectOptions.conf using the "vi" text editor:" on page 81:

```
$ sudo vi VectOptions.conf
```

4. Enter the "root" password.
5. Open the 'VectOptions.conf using the "vi" text editor:

```
$ vi VectOptions.conf
```

6. To start editing, press the [i] key on your keyboard to enter Insert mode.
7. Once you are done editing the file, press Esc to exit Insert mode.
8. To save the changes made to the file, type the following and press Enter/Return:

```
$ :w!
```

- To exit the "vi" editor and return to the Terminal, type the following and press Enter/Return:

```
$ :q
```

- If you have Toon Boom Harmony Scan on your computer, you can start the application and verify that the new style appears in the Vectorization Style list under **Edit > Vectorization Style**.

If you are using the batch processing method available with Toon Boom Harmony Server to scan and vectorize your drawings, the selected style must be available on all the machines included in the batch processing list.

Refer to the Control Center Guide to learn more about setting up and using batch processing.

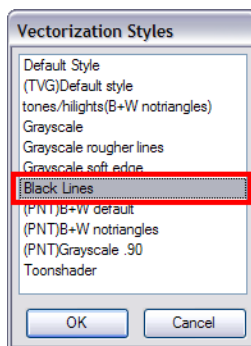

How to set the VectOptions.conf file on Linux using the "gedit" text editor

- Open a Terminal window:
Menu: **Applications > System Tools > Terminal**
- Open the etc folder inside the installation directory:

```
$ cd /usr/local/ToonBoomAnimation/harmony_11.0/etc
```

- Change your user to "root":

```
$ su
```

- If your user is part of the sudoers list, enter the following command and go to See "Open the 'VectOptions.conf using the "gedit" text editor:" on page 82:

```
$ sudo gedit VectOptions.conf
```

- Enter the **root** password.
- Open the 'VectOptions.conf using the "gedit" text editor:

```
$ gedit VectOptions.conf
```

- Edit the parameters of the **VectOptions.conf** file like you would do in most text editor application.
- Select **File > Save**.
- Select **File > Quit**.

9. If you have Harmony Scan on your computer, you can start the application and verify that the new style appears in the Vectorization Style list under **Edit > Vectorization Style**.

If you are using the batch processing method available with Toon Boom Harmony Server to scan and vectorize your drawings, the selected style must be available on all the machines included in the batch processing list.

Refer to the Control Center Guide to learn more about setting up and using batch processing.

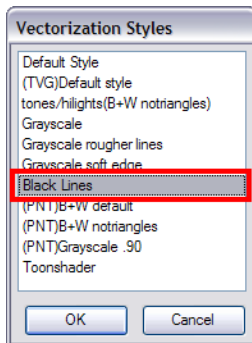

Chapter 2: Scene Setup



Setting up your scene can be compared to building a set for a television show. This is the point when you position each scene element such as the camera frame, the background elements and the characters.

This chapter contains the following topics:

- [Importing the Scene Components](#) on the next page
- [Setting the Camera Frame](#) on page 87
- [Positioning the Scene Components](#) on page 92
- [Cloning and Duplicating Layers](#) on page 124
- [Setting Up the Network](#) on page 128
- [Display Concepts](#) on page 157
- [Creating a Multiplane](#) on page 163
- [Orthographic Camera](#) on page 172

Importing the Scene Components

The first step in the scene setup task is gathering the scene's different components and then importing them into your project. You might need to import some backgrounds, sound files or movie clips to complete your scene. You can refer to the following topics to learn how to bring those elements in.

- [Importing Bitmap Images](#) on page 18
- [Importing QuickTime Movies](#) on page 67
- [Importing a Sound File](#) on page 280

If you have trouble finding elements you imported, it is a good idea to verify if your elements are connected to your Composite module in the Network view. Refer to [Setting Up the Network](#) on page 128 and [Display Concepts](#) on page 157 to learn more about the Network view connections and display concepts.

Setting the Camera Frame



The scene action occurs inside the camera frame, so it's really important to set it up correctly.

The Camera layer is static which means that if you need to animate it, you must add a peg—see [Animating the Camera on page 221](#) and [3D Camera Motion on page 192](#).



To set the camera frame, you need to add a camera layer to your scene, so you can edit the camera frame. If you have added more than one camera to the scene, you can switch the active camera by selecting **Scene > Camera** and then selecting a camera.

In Toon Boom Harmony, you can also use the Network and Module Library views to add a camera to your scene.

In the Timeline view, you can only see one camera at the time. If you add several cameras to your scene, you can use the Camera List to select the active one. You could use this feature if you are still working on your scene composition and have different camera framing to try out.

You can reposition your camera frame directly in the Camera view, using the Translate  and Rotate  tools.

Another way to set up your camera frame is to type the coordinates directly in the camera's Layer Properties dialog box. Doing this positions the camera precisely where you want it to be rather than gauging it visually—see [Positioning an Element Using the Layer Properties on page 108](#).

Once you set up your camera frame, you can always easily reset it to its original position. Use the Reset command to reset the value of the selected element to the initial value of the active tool. For example, if the Rotate  tool is active, the transformation angle will be reset to 0 and if the Transform  tool is active, then all parameters values will be reset.

You cannot add a camera inside a symbol.

How to add a camera layer in the Timeline view

- Do one of the following:
 - In the Timeline view, click the Add Layer  button and select **Camera**.
 - From the top menu, select **Insert > Camera**.

A new camera layer is added to the scene and appears in the Timeline view.

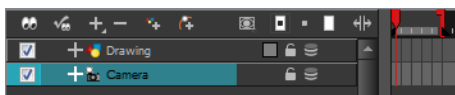

How to add a Camera module in the Network view

- Display the Network view.
- In the Module Library view, select a Camera module from the Favorites, Move or All Modules tab.

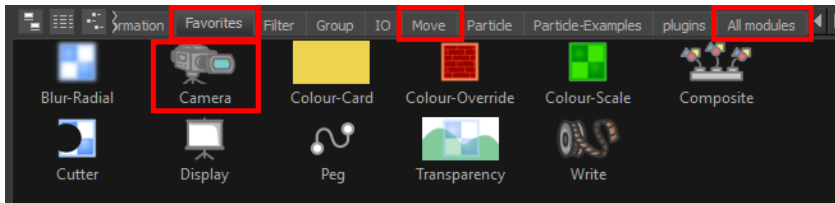

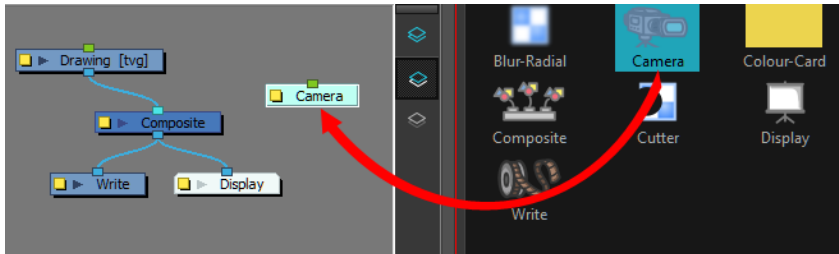

3. Drag the **Camera** module into the Network view.



How to select a camera from the Camera list (set the active camera)

1. From the top menu, select **Scene > Camera > the desired camera**.
If you only add one camera to your scene, you will only see Default Camera in your list.

How to reposition the camera frame directly in the Camera view

1. In the Tools toolbar, disable the Animate  mode.
2. Do one of the following:
 - From the top menu, select **Animation > Tools > Translate**.
 - In the Advanced Animation toolbar, click the Translate  tool.
 - Press Alt + 2.
3. In the Camera view, click on the camera frame to select it. You can also select the camera layer from the Timeline or Network view.

The selected camera frame is highlighted in purple.

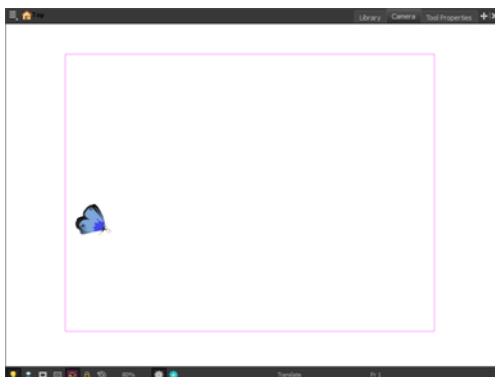

4. Drag the camera frame to a new position.

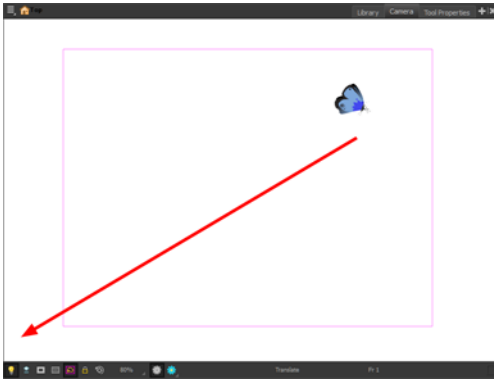

5. To tilt the camera frame, do one of the following to select the Rotate tool:
 - ▶ From the top menu, select **Animation > Tools > Rotate**.
 - ▶ In the Advanced Animation toolbar, select the Rotate  tool.
 - ▶ Pres Alt + 3.
6. In the Camera view, drag to rotate the camera frame until it reaches the desired rotation angle.

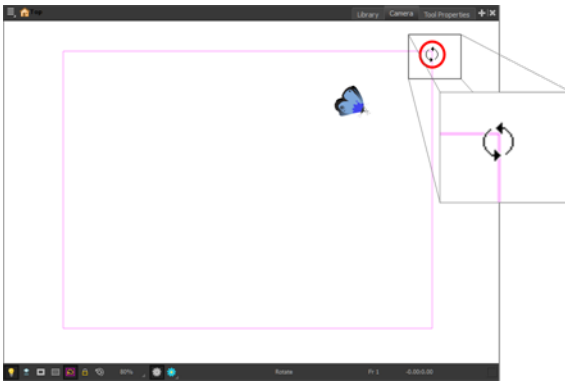

How to set up the camera frame using the camera Layer Properties

- ▶ In the Timeline view, double-click on the Camera layer.
The camera Layer Properties dialog box opens.

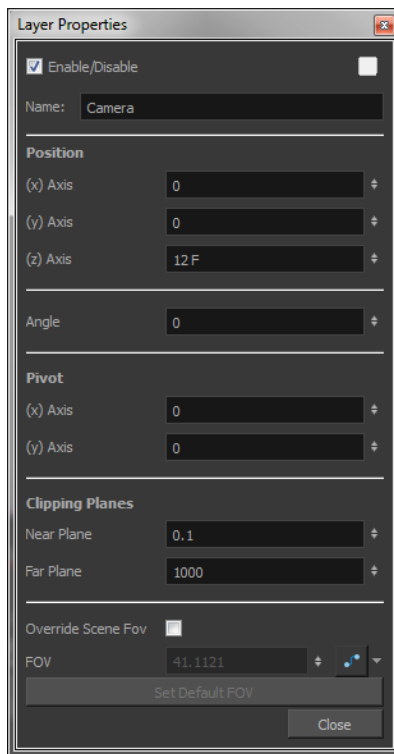

Parameter	Description
Enable/Disable	Turns the camera layer on or off.
Change Track Colour	The Change Track Colour <input type="checkbox"/> button lets you change the colour of the exposed frames; this helps you to quickly locate a layer in the Timeline view. Double-click on the colour swatch to open the Select Colour window and choose a new colour. You can modify the layer for any type of layer, such as group, peg, drawing, and effects.
Name	Displays the current layer name. You can rename the layer by typing in a new layer name.
Position	Displays the current position of the camera layer using X-axis (East/West), Y-axis (North/South) and Z-axis (Forward/Backward) coordinates. To reposition your camera frame, type in the new values corresponding to the desired position coordinates. You can also use the up and down arrows to set the value of each field—see Positioning an Element Using the Layer Properties on page 108.
Angle	Displays the current rotation value. To set a new rotation position, type in a new angle value. You can also use the up and down arrows to set the new angle value.
Pivot	Displays the current position of the rotation pivot of the camera layer. The camera will perform a rotation taking the position of the pivot as its angle centre. By default, the pivot is set at the centre of the camera frame. To reposition the pivot point, type in new X and Y coordinates values in the appropriate field. You can also use the up and down arrows to set the position values.

	In order to see the pivot's position you will need to have the Rotate tool selected.
Clipping Planes	You can change the near and far clipping planes of the camera. The near plane is the point on the camera cone where the camera is located. The far clipping plane is the far end of the camera cone. Nothing outside that range is visible. This is useful when dealing with 3D elements and 3D sets. For example, the camera can be looking inside a 3D box or room and you might want the foreground wall to not obstruct the view of the interior. By default, the near clipping plane is set to 1 field and the far clipping plane is set to 1000 fields.
Override Scene FOV	Enable the FOV field in which you can type in a new field-of-view value.
FOV	Displays the current field-of-view default value. When enabled, you can type in a new zoom value for your camera frame. You can also use the up and down arrows to set the new zoom value. Click on the Create Function button to animate the camera zoom value—see Animation Paths on page 201 to learn more about creating functions.
Set Default FOV	Resets the custom zoom value to its default value.

How to reset the camera position

1. In the Tools toolbar, select the Transform  tool or press Shift + T.
2. In the Timeline or directly in the Camera view, select the camera layer.
3. From the top menu, select **Animation > Reset** or press Shift + R.

The camera automatically returns to its original position.

Positioning the Scene Components

Setting up the scene also involves positioning the different scene elements within the camera frame.

Here are the main features and topics you need to know about to position your elements:

- [Animate Mode below](#)
- [Selecting a Layer below](#)
- [Positioning an Element Using the Transform Tool on page 97](#)
- [Positioning an Element Using the Advanced Animation Tools on page 105](#)
- [Flipping an Element on page 103](#)
- [Positioning an Element Using the Layer Properties on page 108](#)
- [Auto Apply Option on page 121](#)
- [Resetting a Transformation on page 122](#)

Animate Mode

When positioning elements, make sure the Animate Mode is turned off, or it will create a keyframe on your drawing layer. The animate mode is used to animate layers over time.



How to turn off the Animate mode

- In the Tools toolbar, click the Animate Mode  button.
- In the top menu, disable **Animation > Animate**.

Selecting a Layer

There are different ways to select the layers you want to reposition in the Camera view.

You can select your elements directly in the Camera view using the Transform tool. When using this tool, its properties and options appear in the Tool Properties view. Always make sure that the Peg Selection Mode option in the Tool Properties view is disabled or it will limit the selection to pegs only.

You can change the display style of selected elements to a bounding box style. This removes the default overlay highlight and leaves only the bounding box around the selected element.

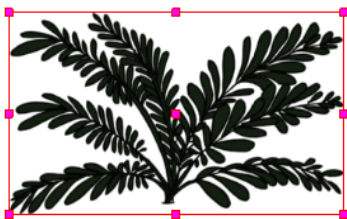

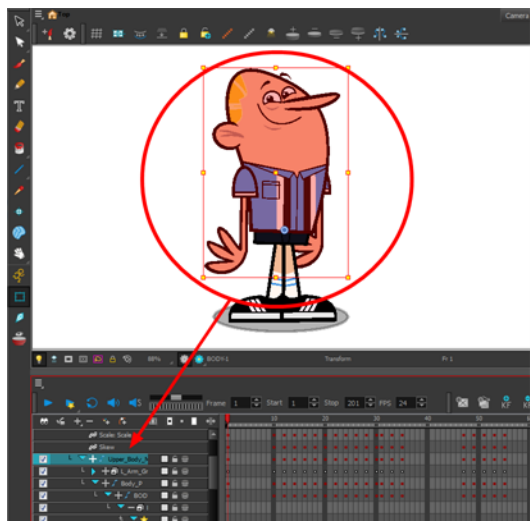

When you have several layers in the Timeline view, you may find it hard to locate which one is selected. You can use the Centre on Selection feature to display the selected layer in the Timeline view.



Like the Timeline view with its many layers, when you have several modules in the Network view, you may find it hard to locate which one is selected. You can use the Centre on Selection feature to focus on the selected module in the Network view. You can also select elements in the Timeline or Xsheet view. This can be useful when there are too many objects in the scene or when an object is hard to grab. Finally, you can select all the elements within a group at once via via the Network or Timeline view.

How to select a layer in the Camera view

1. In the Tools toolbar, select the Transform  tool or press Shift + T.
2. In the Transform Tool Properties view, make sure that the Peg Selection Mode  is deselected.
3. In the Camera view, select the element to be repositioned. You can select more than one element at a time.

The corresponding layers and columns are highlighted in the Timeline and Xsheet views.

How to set the bounding box selection style

1. Do one of the following:
 - From the top menu, select **View > Show > BBox Selection Style**.
 - In the Camera View bottom toolbar, click the BBox Selection Style  button.

How to center on the selected layer in the Timeline view

1. In the Camera view, select a layer.
2. Click anywhere in the Timeline view to make it the currently active view.
3. Do one of the following:
 - From the Timeline view menu, select **View > Centre on Selection** or press O. If your selected layer is in a group or is a child of one or more elements, continue pressing O to expand the layers in the Timeline until your selected layer becomes visible.

- ▶ In the Timeline View toolbar, click the Centre on Selection  button.

How to center on the selected layer in the Network view

1. In the Camera or Timeline view, select a layer.
2. Click anywhere in the Network view to make it the currently active view.
3. Do one of the following:
 - ▶ From the Network View menu, select **View > Centre on Selection**.
 - ▶ In the Network View toolbar, click the Centre On Selection  button.
 - ▶ Press O.

How to select from the Timeline or Xsheet view

- ▶ In the Timeline view, click the layer corresponding to the element you want to reposition.
- ▶ In the Xsheet view, click the column header corresponding to the element you want to reposition.

The selected element is highlighted in the Camera view.

How to select all elements within a group in the Network view

1. In the Network view, navigate to the group whose elements you want to select.
2. Drag a marquee selection around the group module.

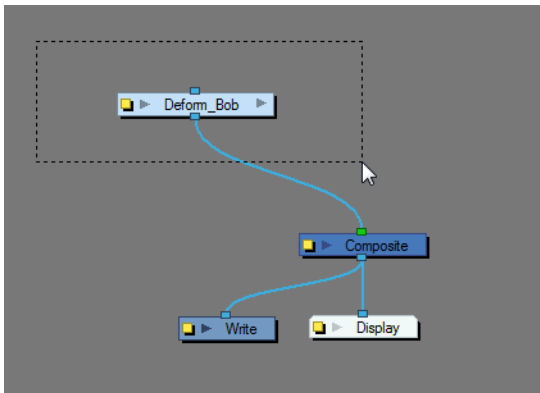

All elements within that group are selected.

How to select all elements within a group in the Timeline view

1. With a group collapsed or expanded, hold down Alt and click on the group in the Timeline view.

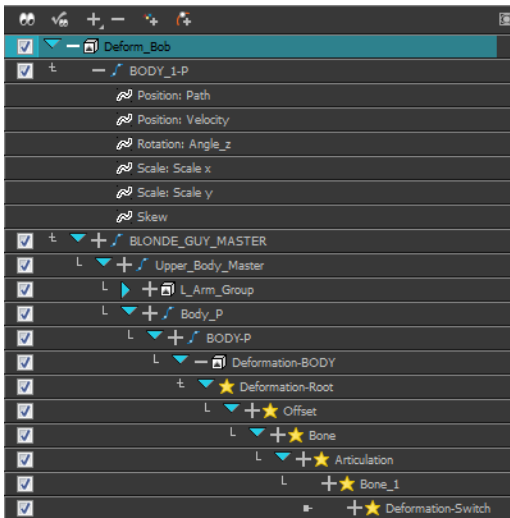



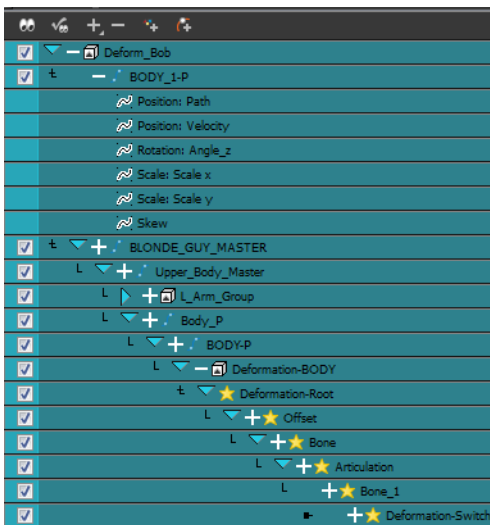

All elements contained within the group are selected.



Locking Layers in the Timeline View

You can prevent correctly positioned layers from being selected by locking them in the Timeline view. This is useful for making a multiple selection inside the Camera view and leaving them visible. Once a layer has been locked, its locked state will be remembered the next time you open a saved project.

You can perform five types of locking actions on your layers:

- The Lock  option lets you lock one or a multiple selection of layers.
- The Unlock  button lets you unlock one or a multiple selection of locked layers.
- The Lock All  option lets you lock all the layers in the Timeline view.
- The Unlock All  button lets you unlock all the layers in the Timeline view.
- The Lock All Others  button lets you lock every layer except the selected ones.

How to lock a layer or a selection of layers

1. In the Timeline view, select one or more layers.

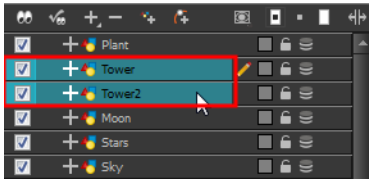

2. Do one of the following:

- ▶ From the top menu, select **Animation > Lock > Lock**.
- ▶ Click one of the selected layer's Lock  icon.
- ▶ Press Ctrl + Alt + L (Windows/Linux) or ⌘ + Alt + L (Mac OS X).

All selected layers are locked.

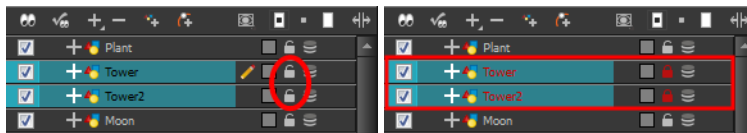

How to unlock a locked layer or a selection of locked layers

1. In the Timeline view, select one or more locked layers.

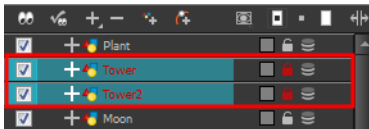

2. Do one of the following:

- ▶ From the top menu, select **Animation > Lock > Unlock**.
- ▶ Click a selected layer's Lock  icon.
- ▶ Press Ctrl + Shift + K (Windows/Linux) or ⌘ + Shift + K (Mac OS X).

All selected layers are unlocked.

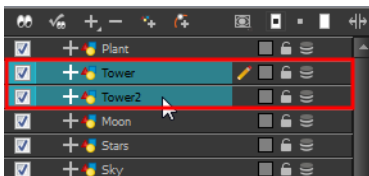

How to lock all layers

1. Do one of the following:

- ▶ From the top menu, select **Animation > Lock > Lock All**.
- ▶ In the Timeline view, select all layers and click Lock  icon of a selected layer.
- ▶ Press Ctrl + Shift + L (Windows/Linux) or ⌘ + Shift + L (Mac OS X).

All layers are locked.



How to unlock all layers

- Do one of the following:
 - From the top menu, select **Animation > Lock > Unlock All**.
 - Press **Ctrl + Alt + Shift + L** (Windows/Linux) or **⌘ + Alt + Shift + L** (Mac OS X).

All layers are unlocked.

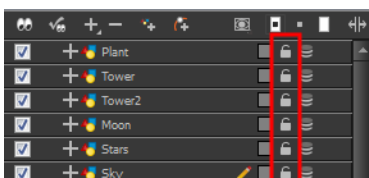

How to lock all other layers

- In the Timeline view, select the layers you do not want to lock.

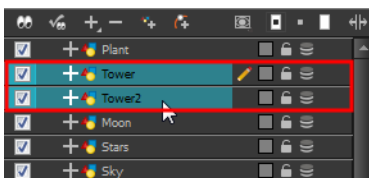

- Do one of the following:
 - From the top menu, select **Animation > Lock > Lock All Others**.
 - Press **Ctrl + Alt + Shift + O** (Windows/Linux) or **⌘ + Alt + Shift + O** (Mac OS X).

All layers are locked except the selected ones.



Positioning an Element Using the Transform Tool

Using the Transform tool, you can easily reposition, scale, rotate and even skew layers directly in the Camera view.

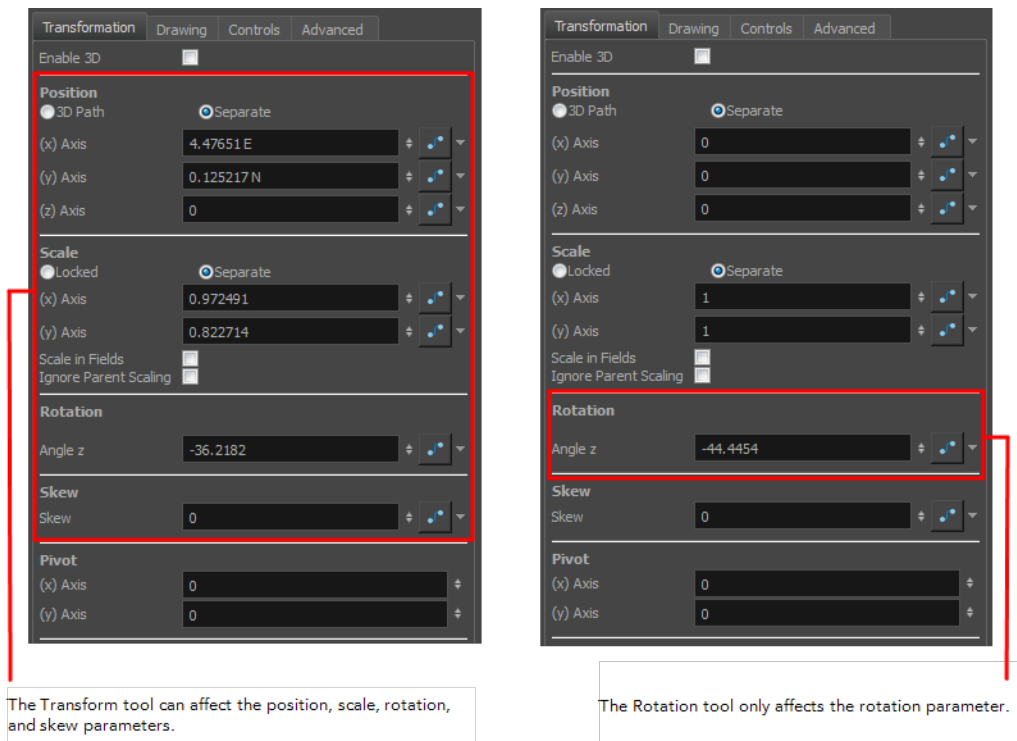

When positioning a drawing layer using the Transform tool, always make sure the Peg Selection Mode  is deselected in the Tool Properties view. Otherwise, it will limit the selection to pegs in the Camera view.



Refer to [Positioning Elements in 3D Space](#) on page 184 to learn about the 3D Transform tool and how to position elements in 3D space.

Transformations, such as rotation, scale, skew and flip are made relative to the pivot point position. You can temporarily reposition the pivot point for each transformation using the Transform tool. Note that the pivot is only moved temporarily. When animating the position, the interpolation is calculated from the permanent pivot position—see [Positioning an Element Using the Advanced Animation Tools](#) on page 105.

How to temporarily reposition the pivot point

1. In the Tools toolbar, select the Transform  tool.
2. In the Tool Properties view, make sure the Peg Selection Mode  is disabled.
3. In the Camera view, select your element.

The pivot point appears in the Camera view.

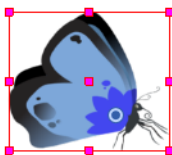



4. Click on the pivot point and drag it to a new position.

This will be the new position of the pivot point for the current transformation. It will remain in this position as long as you do not deselect the drawing. Using the Transform tool to reposition your pivot will temporarily override the existing pivot point position until you complete the current transformation. Then it returns automatically to its original position.

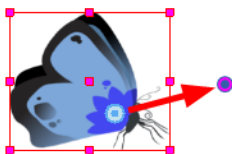
When you translate the pivot point using the Transform tool, the permanent pivot will appear as a ghost so you know where it is and also from where the animation will be interpolated when you create motion paths. The animation is always interpolated from the original pivot and not the temporary pivot.



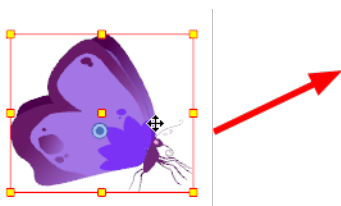

How to pan a layer using the Transform tool

1. In the Tools toolbar, disable the Animate  mode.
2. In the Tools toolbar, select the Transform  tool or press Shift + T.
3. In the Tool Properties view, make sure the Peg Selection Mode  is deselected.
4. In the Camera view, select a drawing layer and drag the selection to a new area. You can select multiple layers to reposition them at the same time. Press Shift and select the different layers.



How to rotate a layer using the Transform tool

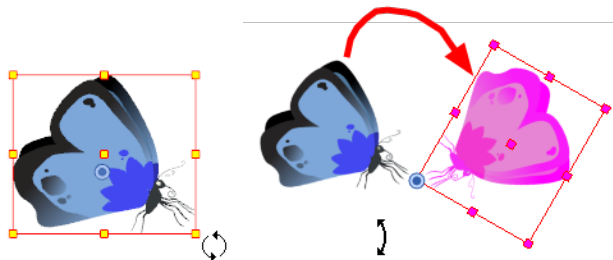

1. In the Tools toolbar, disable the Animate  mode.
2. In the Tools toolbar, select the Transform  tool or press Shift + T.
3. In the Tool Properties view, make sure the Peg Selection Mode  is deselected.
4. In the Camera view, select a drawing layer.
5. Place the pointer outside of a corner of the bounding box and drag to rotate.

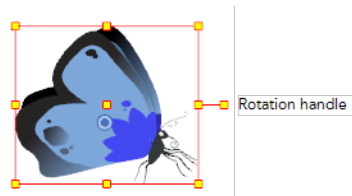

You can display a rotation handle on the bounding box when transforming a layer. In the Preferences dialog box, select the Camera tab and then select the **Use Rotation Lever with Transformation Tools** option. This preference is off by default.



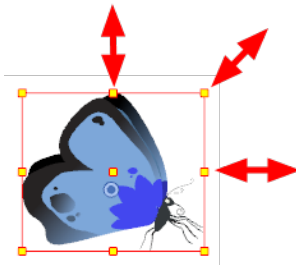

How to scale a layer using the Transform tool

1. In the Tools toolbar, disable the Animate  mode.
2. In the Tools toolbar, select the Transform  tool or press Shift + T.
3. In the Transform Tool Properties view, make sure the Peg Selection Mode  is deselected.
4. In the Camera view, select a drawing layer and pull or push on the size, top, or corner control point. Hold down Shift to lock the selection's aspect ratio.



How to skew a layer using the Transform tool

1. In the Tools toolbar, disable the Animate  mode.
2. In the Tools toolbar, select the Transform  tool or press Shift + T.
3. In the Tool Properties view, make sure the Peg Selection Mode  is deselected.
4. In the Camera view, select a drawing layer.
5. Place the cursor between two control points and drag sideways or up and down.

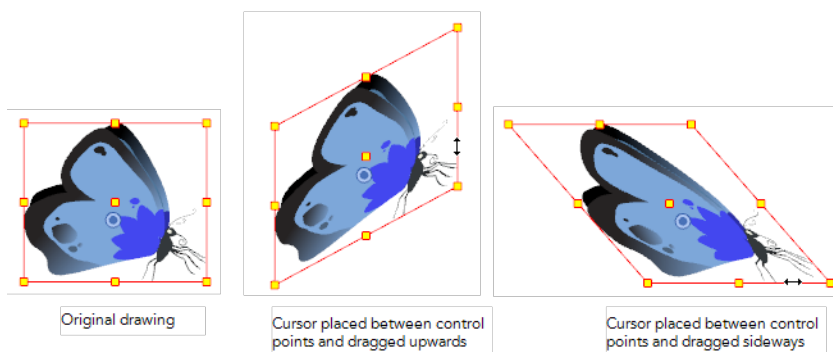

Transform Tool Properties

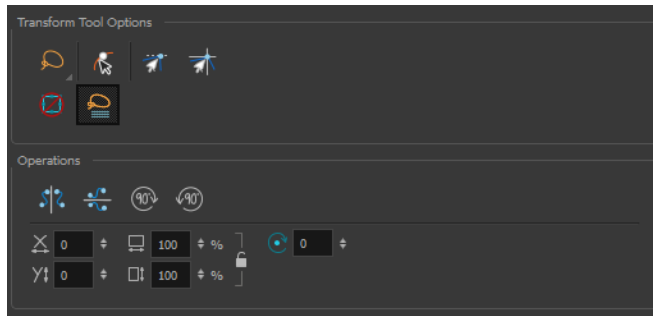

Icon	Tool
	Lasso and Marquee below
	Peg Selection Mode on the next page
	Snap Options on the next page
	Hide Manipulator Controls on the next page
	Works on Single Drawing on the next page
	Flip Horizontal and Flip Vertical on the next page
	Rotate 90 Degrees CW and CCW on page 103
	Offset X and Y on page 103
	Width and Height on page 103
	Angle on page 103

Lasso and Marquee

The Lasso and Marquee options let you choose the type of selection the current tool will perform. The default selection mode is Marquee.

- Lasso lets you draw a custom selection box around zones.
- Marquee makes a rectangle selection box.

Hold down the Alt key to switch to the opposite mode of your selection.

How to invert a selection

1. Do one of the following:
 - From the top menu, select **Edit > Invert Selection**.
 - From the Camera or Drawing menu, select **Edit > Invert Selection**.

- ▶ Press **Ctrl + Shift + I** (Windows/Linux) or **⌘ + Shift + I** (Mac OS X).



Peg Selection Mode

In the Camera view, the Peg Selection Mode  limits the selection to peg layers instead of drawing layers. This mode is useful when you have created a character rig using peg layers for each drawing. That way, you do not accidentally select the drawing layer when you want to animate on the peg.

When disabled, the Transform tool selects the drawing layers.

Snap Options

When transforming or repositioning a layer using the Transform tool, you can enable different snap options to help you.

-  **Snap and Align:** Snaps the selected layer to any existing line, while automatically displaying temporary rulers that guide you and that you can also snap your object to.
-  **Snap to Grid:** Snaps your selection according to the currently enabled grid.

Hide Manipulator Controls

The Hide Manipulator Controls  button lets you hide the bounding box and manipulator controls from the Camera view when an element is selected.

Flip Horizontal and Flip Vertical

The Flip Horizontal  and Flip Vertical  buttons let you flip the selected element horizontally or vertically. You can also select **Animation > Flip > Flip Horizontal** and **Flip Vertical** from the top menu or press 4 or 5.

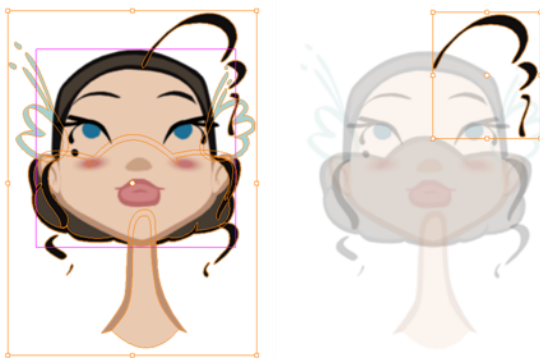

Works on Single Drawing



By default, when you draw a selection box in the Camera view, the Select tool will select only the drawing strokes of the current drawing. If you prefer the Select tool to select all the strokes on all layers, deselect the Works on Single Drawing  button.



Rotate 90 Degrees CW and CCW



The Rotate 90 Degrees CW  and Rotate 90 Degrees CCW  operations rotate the current selection 90 degrees clockwise or counter-clockwise.

- ▶ From the top menu, select **Drawing > Transform > Rotate 90 Degrees CW** and **Rotate 90 Degrees CCW**.
- ▶ Press Ctrl + 7 and Ctrl + 9 (Windows/Linux) or ⌘ + 7 and ⌘ + 9 (Mac OS X).

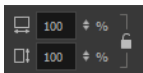

Width and Height

The Width  and Height  fields allow you to enter specific values for accurately resizing a selected layer.



- **Width:** Enter a width value in this field to resize the width of your selection.
- **Height:** Enter a height value in this field to resize the height of your selection.
- **Lock:** Click the Lock icon to lock or unlock the ratio between the width and height values.

Offset X and Y

Use the Offset X  and Offset Y  fields to enter specific values to reposition the selected layer accurately.

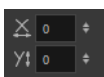

- **X:** Enter an offset value in this field to reposition the selected layer along the X-axis.
- **Y:** Enter an offset value in this field to reposition the selected layer along the Y-axis.

Angle

The Angle  field lets you enter specific values to rotate the selected layer accurately. A positive value rotates the layer counterclockwise and a negative value rotates the layer clockwise.

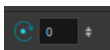

- **Angle:** Enter a degree value in this field to rotate the selected layer.

Flipping an Element

There are two different options you can use when you want to flip your element.





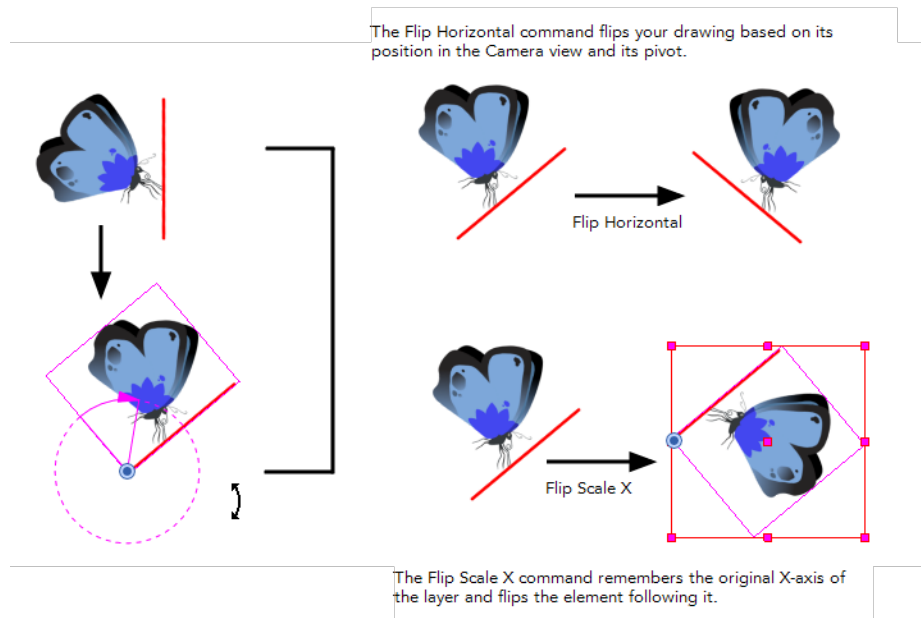

The Flip Horizontal and Flip Vertical options let you flip a drawing layer along the Camera view's horizontal and vertical axis.

Once your drawing layer is rotated, the original horizontal and vertical axes change. The Flip Scale X and Flip Scale Y will perform a flip on your drawing layer following its original axis.

- The Flip Horizontal command flips the layer following the Camera view X-axis.
- The Flip Scale X command uses the original X-axis of the layer and flips the element following it.



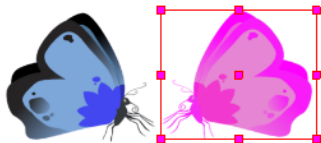

How to flip a layer

1. In the Tools toolbar, disable the Animate  mode.
2. In the Tools toolbar, select the Transform  tool or press Shift + T.
3. In the Transform Tool Properties view, make sure the Peg Selection Mode  is deselected.
4. In the Camera view, use the Transform  tool to select a drawing layer to flip.
5. Do one of the following:
 - ▶ From the top menu, select **Animation > Flip > Flip Horizontal** or **Flip Vertical**.
 - ▶ In the Tool Properties view, click the Flip Horizontal  and the Flip Vertical  buttons.
 - ▶ Press 4 or 5.



How to flip an element following its original axis

1. In the Tools toolbar, disable the Animate

- mode.
- In the Tool Properties view, make sure the Peg Selection Mode  is deselected.
- In the Camera view, use the Transform  tool to select an element that has already been transformed.
- From the top menu, select **Animation > Flip > Flip Scale X** or **Flip Scale Y**.



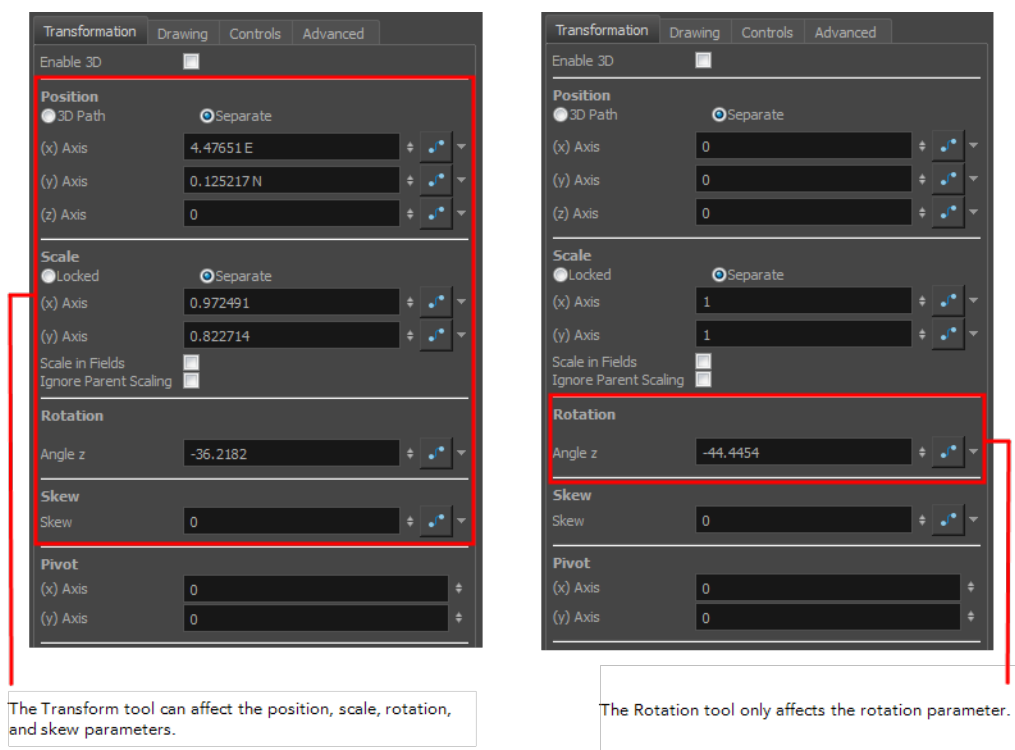

Positioning an Element Using the Advanced Animation Tools

You can also use the advanced animation tools to position your layers. The difference between these tools and the Transform tool is that they modify only one parameter of the position such as the rotation or the scale as the Transform tool adjusts all parameters together.



Transformations, such as rotation, scale, skew and flip, are made relative to the pivot point position. You can reposition this pivot point anywhere using the advanced animation tools.

How to permanently reposition the pivot point

- In the Advanced Animation toolbar, select the Translate , Rotate , Scale , or Skew  tool.
- In the Camera view, Ctrl + click (Windows/Linux) or  + click (Mac OS X) to select your element. The pivot point appears in the Camera view.

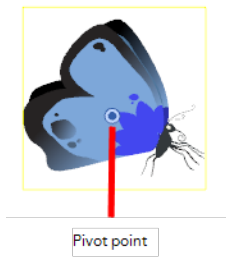

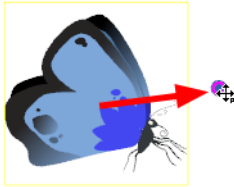

3. Drag the pivot point to a new position.



All transformations, including existing ones will be recalculated from this new pivot position.

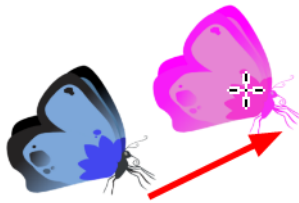

How to pan a layer using the Translate tool

1. In the Tools toolbar, disable the Animate  mode.
2. Do one of the following:
 - ▶ From the top menu, select **Animation > Tools > Translate**.
 - ▶ In the Advanced Animation toolbar, click the Translate  tool.
 - ▶ Press Alt + 2.
3. In the Camera view, Ctrl + click (Windows/Linux) or  + click (Mac OS X) on the element to select it and drag the selection to a new area.



You can select multiple layers to reposition them at the same time. Press Ctrl + Shift + click (Windows/Linux) or  + Shift + click (Mac OS X) on each element to select them.

How to rotate a layer using the Rotate tool

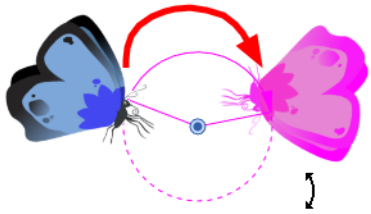

1. In the Tools toolbar, disable the Animate  mode.
2. Do one of the following:
 - ▶ From the top menu, select **Animation > Tools > Rotate**.
 - ▶ In the Advanced Animation toolbar, click the Rotate  tool.
 - ▶ Press the Alt + 3.

3. In the Camera view, Ctrl + click (Windows/Linux) or ⌘ + click (Mac OS X) on the element to select it and rotate the layer.



You can select multiple layers to rotate them at the same time. Press Ctrl + Shift + click (Windows/Linux) or ⌘ + Shift + click (Mac OS X) on each element to select them.

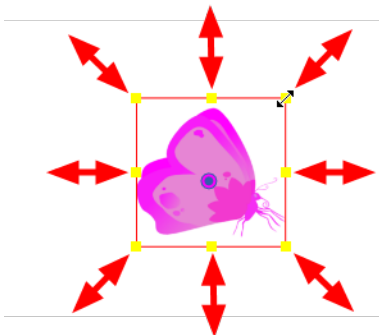

How to scale a layer using the Scale tool

1. In the Tools toolbar, disable the Animate  mode.
2. Do one of the following:
 - From the top menu, select **Animation > Tools > Scale**.
 - In the Advanced Animation toolbar, click the Scale  tool.
 - Press Alt + 4.
3. In the Camera view, Ctrl + click (Windows/Linux) or ⌘ + click (Mac OS X) on the element to select it and pull or push either on the side, top or corner control point. Hold down Shift to lock the selection's ratio when using the corner control points.



You can select multiple layers to scale them at the same time. Press Ctrl + Shift + click (Windows/Linux) or ⌘ + Shift + click (Mac OS X) on each element to select them.

How to scale a layer using the Skew tool

1. In the Tools toolbar, disable the Animate  mode.
2. Do one of the following:
 - Select **Animation > Tools > Skew**.
 - In the Advanced Animation toolbar, click the Skew  tool.
 - Press Alt + 5.
3. In the Camera view, Ctrl + click (Windows/Linux) or ⌘ + click (Mac OS X) on the element to select it and drag a side of the bounding box up, down or sideways.

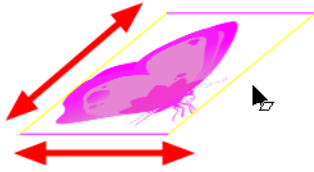

You can select multiple layers to skew them at the same time. Press Ctrl + Shift + click (Windows/Linux) or ⌘ + Shift + click (Mac OS X) on each element to select them.

Positioning an Element Using the Layer Properties

Each layer has a series of parameters that can be modified to adjust the object's position. These parameters can be accessed in the Layer Properties view. In the Layer Properties view, you can type in a value rather than moving the object in the Camera view. These values can also be animated over time.

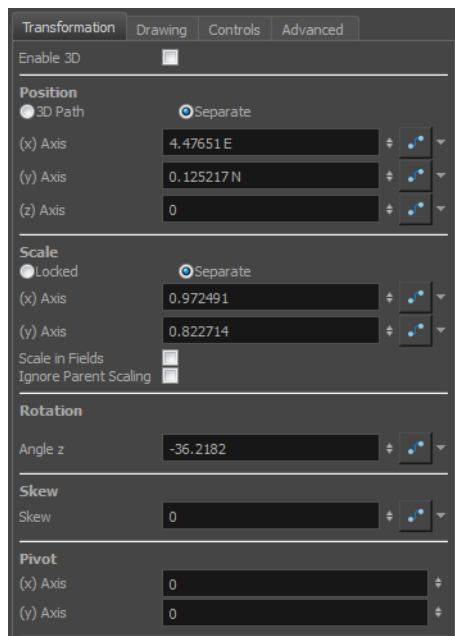

You can also access a layer's parameters in the Timeline view. Click on the Expand Parameters arrow and the Show Data View button.

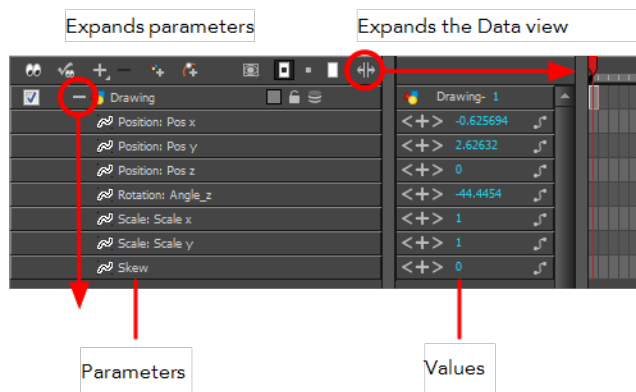

It is important to understand the coordinate values in Harmony. Harmony's core is based on the origins of animation. In traditional animation, a scene's size and camera motion are calculated in fields. A field has a 4:3 ratio and measures 0.5 inch in width. A specific grid has been created for this purpose. It is known as a *field chart*. Harmony uses this unit of measurement as its coordinate system.

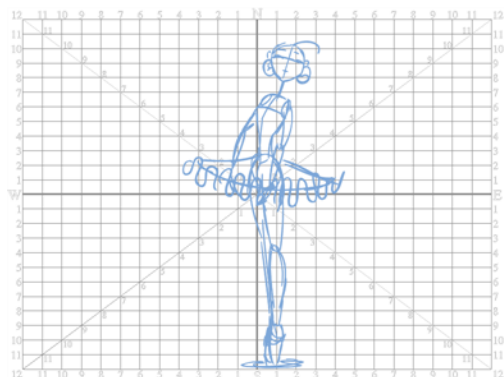

A field chart uses cardinal directions. The X axis is the east-west direction, the Y axis is the north-south direction and the Z axis is the forward-backward direction.

In Harmony, a drawing's pivot is located at the centre of the field chart, regardless where your drawing has been drawn on the page. Your drawing is the entire sheet of paper, not only the drawing strokes you have drawn on the page. This allows scanned drawings, imported images and paperless drawings to be properly registered together.

If you want to move your drawing in the upper left region of the camera frame, you would type in something like the following:

- X Axis: -4 or 4W (4 West)
- Y Axis: 5 or 5N (5 North)

If you want to move your drawing in the lower right region of the camera frame, you would type in something like the following:

- X Axis: 3 or 3E (3 East)
- Y Axis: -2 or 2S (2 South)

How to position an element using its Layer Properties dialog box

1. Do one of the following:
 - In the Timeline view, right-click on the drawing layer and select **Layer Properties**
 - In the Network view, clicking the module's square yellow button.
 - Single-click or double-click on the layer.
 - Press Shift + E.

The Layer Properties dialog box opens.

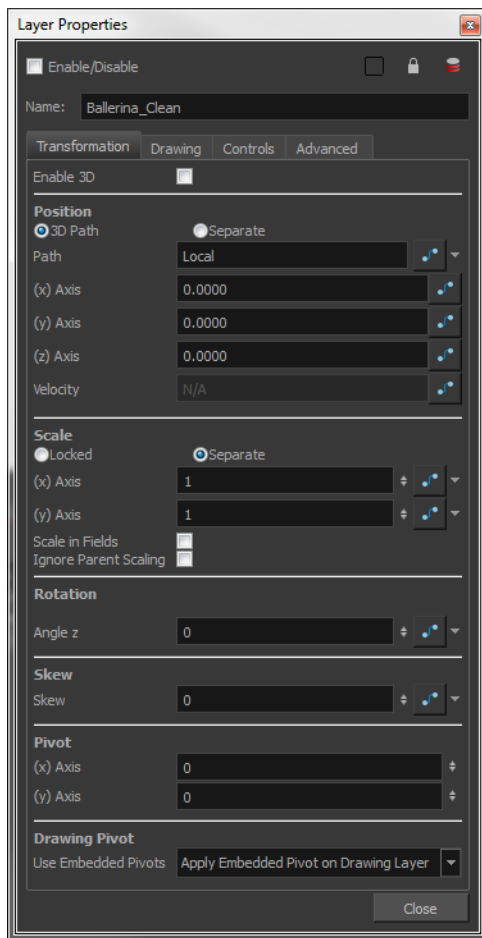

The Enable 3D check box displays the 3D parameters in the Layer Properties—see [Enabling the 3D Option on page 174](#).

2. In the Position section, type in the desired values:

- ▶ X - Left/right or east/west
- ▶ Y - Up/down or north/south
- ▶ Z - Forward/backward

As you type in the new values, the element's position is updated in the Camera view.

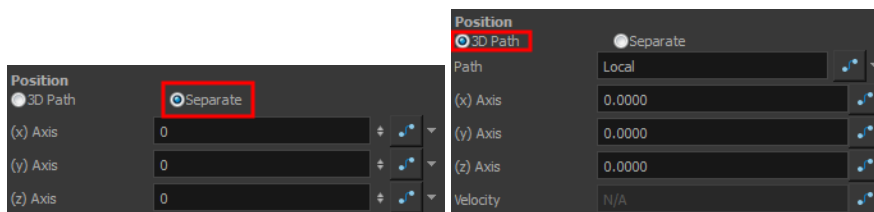

- ▶ Select the **Separate** option to enable the independent edit of the different coordinate fields or select the **3D Path** option to enable the use of a 3D path function when animating your element—see [Layer Parameters on page 211](#).
- ▶ In the (x) Axis field, type in a new East/West coordinate corresponding to the desired position.

- In the (y) Axis field, type in a new North/South coordinate corresponding to the desired position.
 - In the (z) Axis field, type in a new Forward/Backward coordinate corresponding to the desired position—see [Creating a Multiplane on page 163](#).
 - The Function  buttons are used to create function curves to add keyframes when animating.
3. In the Scale section, select one of the following:

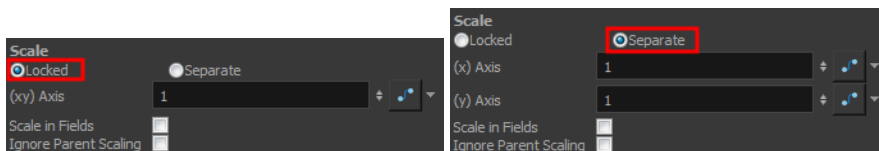

- **Locked:** Resizes the element while keeping its ratio.
(xy) Axis: Type in the horizontal and vertical scales value.
 - **Separate:** Resizes the element with independent X and Y scales. This allows you to squash and stretch.
(x) Axis: Type in the horizontal scale value.
(y) Axis: Type in the vertical scale value.
 - The Function  buttons are used to create function curves to add keyframes when animating.
4. In the Angle Z field, type in a degree value for the rotation angle. Note that you can enter values greater than 360 and -360 degrees. If you enter 720, the object will rotate twice.

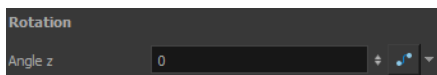

5. In the Skew field, type in a degree value between -90 to 90 for the skew angle.

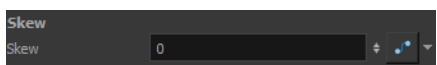

6. In the Pivot section, type in the desired coordinate value to reposition the transformation pivot. This will change the permanent position of the pivot.

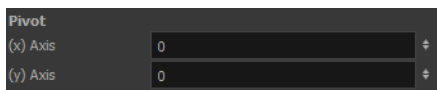

- In the (x) Axis field, type in a new East/West coordinate corresponding to the desired position.
- In the (y) Axis field, type in a new North/South coordinate corresponding to the desired position.

Layer Properties Options

A drawing layer properties dialog box is composed of four tabs.

- Transformation Tab
- Drawing Tab on the facing page
- Advanced Tab on page 114
- Controls Tab on page 119

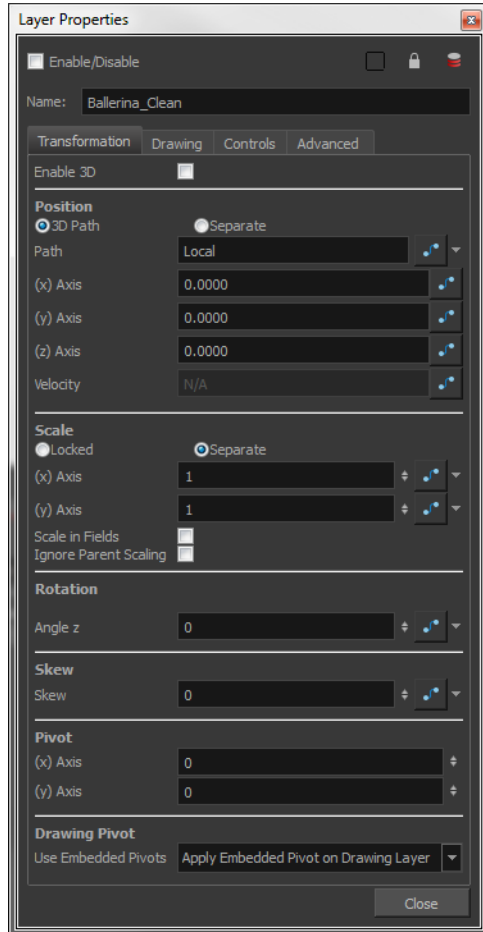

Drawing Tab

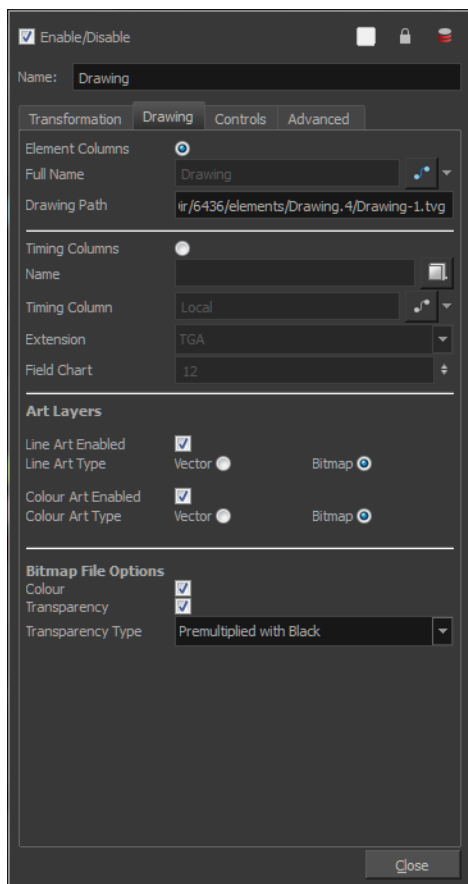

Parameter	Description
Element Columns	<p>Full Name: Select which element to connect to the module from the drop-down list of elements that already exist in your scene.</p> <p>Drawing Path: Displays the full path to the current drawing.</p>
Timing Columns	<p>Name: Path to the file that you want to link to.</p> <p>Timing Column: Link to the column that contains the desired timing.</p> <p>Extension: When linking to a background file, enter its filename extension.</p> <p>Field Chart: If you are importing traditional animation, select the size of the paper on which the animation was drawn.</p>
Art Layers	<p>Line Art/Colour Art Enabled: Lets you set layers as line art, colour art, or both.</p> <p>Line Art Type: Designates the layer as a Line Art layer.</p> <p>Colour Art Type: Designates the layer as a Colour Art layer.</p>

Bitmap File Options	<p>When an image is created with an external software and that image has some transparency, there are several formats the software can use when writing the RGB channels. The purpose of the four import options for the transparency is for the user to tell Harmony how to interpret the RGB channels of the imported image. The correct option has to match the output format of the software that was used to create the image in the first place. For instance, if the you used Adobe Photoshop and exported an image as Straight, then it should be imported in Harmony as Straight in order to get the correct result.</p> <p>Note that if the image has no alpha channel, or if it does have an alpha channel and all the pixels are 100% opaque, it does not make any difference which option is selected.</p> <p>Colour: Controls the production of colour information from bitmap images. If this module reads 3 or 4-channel bitmaps, this selection determines whether the colour should be read or ignored. If this module reads 1-channel bitmaps, this selection determines whether the channel should be read as colour. When this option is selected with 1-channel images, the resulting image will be a greyscale image.</p> <p>Transparency: Controls the production of alpha information from bitmap images. If this module reads a 1 or 3-channel image, this option will create a matte from the colour values in the image. If the module reads a 4-channel image and this option is not selected, the alpha information in the image will be ignored.</p>
	<p>Transparency Type</p> <ul style="list-style-type: none"> • Premultiplied with Black: Semi-transparent pixels in the original image are blended with black. • Premultiplied with White: Semi-transparent pixels in the original image are blended with white. • Straight: Semi-transparent pixels in the original image are left as is (unmatted). • Clamp Colour to Alpha: Semi-transparent pixels in the original image are blended with black. On import, each of the RGB channels is clamped so that a color value never exceed the alpha value for a given pixel. When the RGB values are multiplied with the alpha value, that is to say, if you have a pixel of value R=247, G=188, B=29 and the alpha is 50% or the image has a 50% transparency, then the actual RGB values output would be half of the amounts listed above.

Advanced Tab

In the drawing layer's Layer Properties dialog box, you will find an Advanced tab containing some

very useful options:

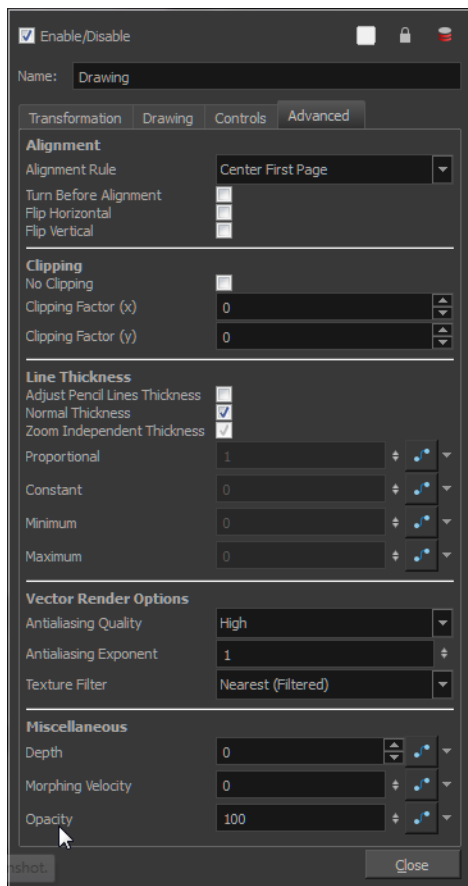

Parameter	Description
Alignment	<p>Alignment Rule: The alignment rule selections are intended to deal with drawings that were created on paper of a different size or orientation from the default alignment rule (set up in the Scene Setting dialog box) or imported bitmap images. The drawings are then scaled to match Toon Boom Harmony alignment rectangle. Note that alignment rules are not based on the camera frame, but on the scene frame. Refer to the Fundamentals Guide to learn more about scene alignment and scene settings.</p> <ul style="list-style-type: none"> • Left: The default alignment for drawings; aligns the drawings on the left side of the scene’s alignment rectangle. Toon Boom Harmony scales the drawings to match their height to the alignment rectangle of the scene. • Right: Aligns the drawings on the right side of the alignment rectangle. Toon Boom Harmony scales the drawings to match their height to the height of the alignment rectangle of the scene. • Top: Aligns the drawings on the top of the alignment rectangle. Toon Boom Harmony scales the drawings to match

	<p>their widths to the width of the alignment rectangle of the scene.</p> <ul style="list-style-type: none"> • Bottom: Aligns the drawings on the bottom of the alignment rectangle. Toon Boom Harmony scales the drawings to match their widths to the width of the alignment rectangle of the scene. • Centre Fit: Centres the drawings. • Centre Fill: Centres the drawings and then scales them so that the width or height fills the available space. • Centre LR: Aligns the drawings in the left-right centre of the alignment rectangle. Toon Boom Harmony scales the drawings to match their height to the height of the alignment rectangle of the scene. • Centre TB: Aligns the drawings in the top-bottom centre of the alignment rectangle. Toon Boom Harmony scales the drawings to match their widths to the width of the alignment rectangle of the scene. • Stretch: Scales the drawings so that they fit within the alignment rectangle of the scene. This is particularly useful for images that you will manipulate with a Quadmap module. If the drawings in the Quadmap module do not have the same aspect ratio as the alignment rectangle of the scene (from the Scene Settings dialog box), the handles on the quadmap will not appear on the corners of the image, making it difficult to manipulate the quadmap. In this case, you would set the drawing layer of the quadmap images to Stretch so that the handles appear on the corner of the image. This can have the effect of distorting the images, but this is not an issue with images that will be distorted through the Quadmap module anyway. • As Is: Leaves the drawings aligned as they are. • Centre First Page: Aligns the centre of the first part of a standard panel with the centre of the field chart.
	<p>Turn Before Alignment: This option rotates the drawings in the selected element 90 degrees to the left before scaling and aligning them according to the alignment rule, and before performing any offset, rotation or scaling for the element or the peg. This and the Alignment Rule are intended for drawings that were created on paper of a different size or orientation than the other paper in the scene, and requires alignment so as to be able to accurately treat them.</p>
	<p>Flip Horizontal: Flips the drawing on the X-axis.</p>
	<p>Flip Vertical: Flips the drawing on the Y-axis.</p>
Clipping	<p>No Clipping: Select this option if you do not want to clip the</p>

	<p>images in this module before an effect is applied to it.</p> <p>Clipping Factor (X)/(Y): This is an option for rendering images that are larger than the final frame. With this option enabled, images can be moved by an Apply Peg Transformation module without black entering into the composite as a result of early clipping. In addition, this option is useful for images that have a blur that should appear in the frame even though the image itself is not in frame—see Apply Image Transformation on page 360 and Apply Peg Transformation on page 355.</p>
Line Thickness	<p>As you move the camera in your scene along the Z-axis, notice that, logically, the lines of the elements become thicker the closer the camera gets to the drawing. If you prefer the lines to remain the same size or become thicker at a different speed, you can use the thickness feature to adjust your brush stroke and pencil line thickness. You can modify the size of the lines even if the camera is not animated.</p> <p>To learn how to use this feature, see Camera Truck-ins and Line Thickness on page 226.</p> <p>Adjust Pencil Lines Thickness: Lets you work with pencil lines and adjust their thickness. You will not see any changes to lines in the Camera view OpenGL mode. You must switch to the Render mode.</p> <p>Normal Thickness: Disables all overrides on the brush stroke line thickness. This option must be enabled in order for the pencil line thickness parameter and pencil lines to appear. If you want to modify the brush stroke thickness, deselect this option. To enable brush strokes to work with the line thickness feature, you must first create central strokes in the Colour Art layer. The central strokes control the line variation of your brush strokes in the Line Art layer. Select Drawing > Create Colour Art from Line Art.</p> <p>Zoom Independent Thickness: Select this if you want your line thickness to remain constant independently from the camera move. Everything else will increase in size, but the line thickness will stay the same.</p> <p>Proportional: Enter a multiple by which you want to increase the line thickness base on its original thickness. A value of 1 will result in no change; a value of 0 (zero) will hide the lines.</p> <p>Constant: Enter a value in pixels (based on a 720x540 screen resolution) to indicate the amount of pixels you want to add around the existing line.</p> <p>Minimum: Enter a value in pixels (based on a 720x540 screen resolution) for the minimum line thickness allowed.</p> <p>Maximum: Enter a value in pixels (based on a 720x540 screen</p>

	resolution) for the maximum line thickness allowed.
Vector Render Options	<ul style="list-style-type: none"> • Antialiasing Quality: A smoothness (antialiasing) setting applied to the final rendered image. <ul style="list-style-type: none"> • Low: No antialiasing • Medium Low: Basic antialiasing • Medium: Improved antialiasing (Blurs the textures) • High: High quality antialiasing (Does not blur the textures) <p>Higher quality images require more time to render and more system memory. Choose a lower quality if you are rendering a pencil test.</p> • Antialiasing Exponent: Controls the size of the area around the final image edges that is used in the antialiasing process. A higher value uses less area, resulting in sharper edges, while a lower value uses more area, resulting in softer edges. If the Antialiasing Quality value is set to Low (no antialiasing) or Medium Low, this value is ignored. The accepted values are between 0 and 1. • Texture Filter: This option changes the way coloured pixels of TVG textures are calculated when rendered for different degrees of accuracy. <ul style="list-style-type: none"> • Bilinear: This option takes the four pixels around each point and makes a bilinear interpolation between them. (Medium Quality) • Nearest: This option chooses the colour of the closest pixel to a point. (Lower Quality) • Nearest (Filtered): This option is an improved version of Bilinear and improves the quality when zooming on a texture. (Best Quality)
Miscellaneous	<ul style="list-style-type: none"> • Depth: Overrides the order of cables in the network to determine in which order this element is rendered. The Z position value overrides the depth value. • Morphing Velocity: Creates a velocity function curve for morphing sequences in the layer. This function modifies the interpolation percentage between the 2 drawings. If set, the morphing between the two drawings will not be linear over time between the two drawings but will be modulated according to this curve. This can be used to create a periodic morphing over a long period of time. • Opacity: Lets you quickly change the transparency of the selected element. Opacity settings here will be reflected in both OpenGL preview, and full render.

Controls Tab

The Controls tab contains animation control options.

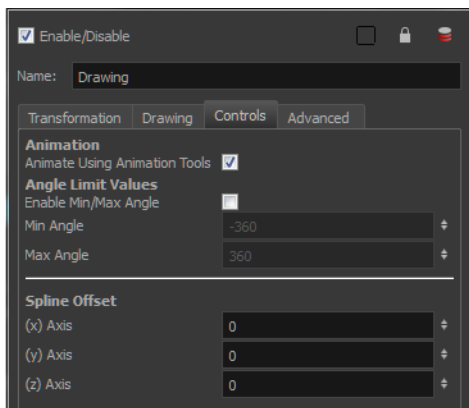

Parameter	Description
Animation	<ul style="list-style-type: none"> • Animate Using Animation Tools: By default, a drawing layer can be animated using the same parameters as a peg, but you can disable this feature. Being able to switch your drawing layers so they can no longer be animated without a peg has certain advantages. In cut-out animation, it is easier to separate your drawing exposure and keyframes to change timing easier and rearrange keyframe position in the Timeline view. This feature is also available for backward compatibility when bringing in templates created in older versions of the software, so as not to lose their offset keyframes or drawing substitution keyframes.
Angle Limit Values	<p>Lets you set a maximum and minimum rotation angle for a drawing. This option is used mainly for a cut-out character when you do not want an elbow to bend too far in or out.</p> <ul style="list-style-type: none"> • Enable Min/Max Angle: Activates the minimum and maximum angle constraints. • Min Angle: Type the minimum angle you want the drawing to rotate too. • Max Angle: Type the maximum angle you want the drawing to rotate too.
Spline Offset	<p>In the X, Y and Z axis fields, type the coordinates of where you want to offset the visual trajectory. By default, the trajectory is displayed at the centre drawing, using the layer's pivot position. If you want to move it so it corresponds better with your drawing, either type new coordinates or use the Spline Offset  tool available in the Advanced Animation toolbar.</p> <p>To display the trajectory in the Camera view, select your drawing and select View > Show > Control. You can also</p>

press Shift + F11 (Windows/Linux) or ⌘ + F11 (Mac OS X).

Setting Properties for Many Layers

When working with several modules, you may frequently want to modify a series of settings. Instead of opening the properties for each individual layer, you can set the properties for many layers so you can change a common setting in a single click.

This allows you to modify the following settings:

- 3D Path or Separate mode
- Use Embedded Pivot
- Overlay
- Line Art
- Colour Art
- Underlay
- Animate Using Animation Tools

You can access this function in the Network View toolbar. You can also add the button to the Timeline View toolbar through the Toolbar Manager. In the Toolbar Manager, you will find the feature in the script section under the name Script: TB_Set_Properties_on_manu_layers in TB_Set_Properties_on_many_layers.js.

How to properties for many layers

1. In the Network or Timeline view, select all the layers you want to modify at the same time.

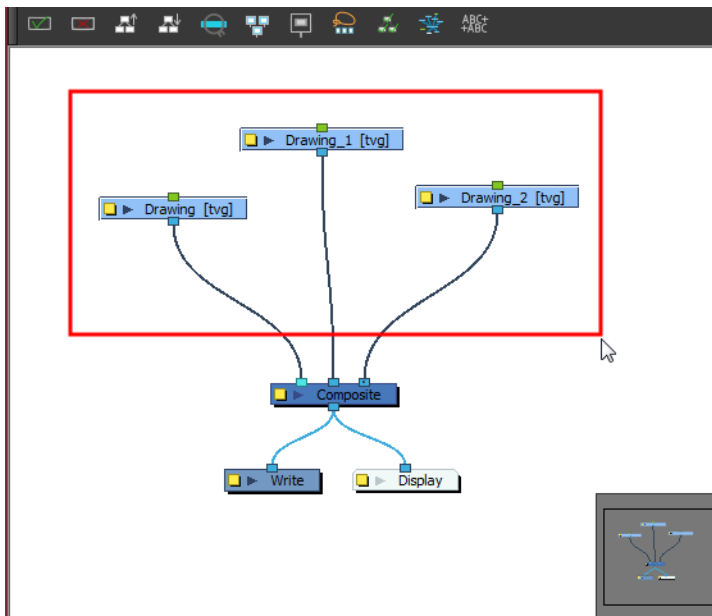

2. In the Network or Timeline View toolbar, click the Set Properties for Many Layers  button. The Set Properties for Many Layers dialog box opens.

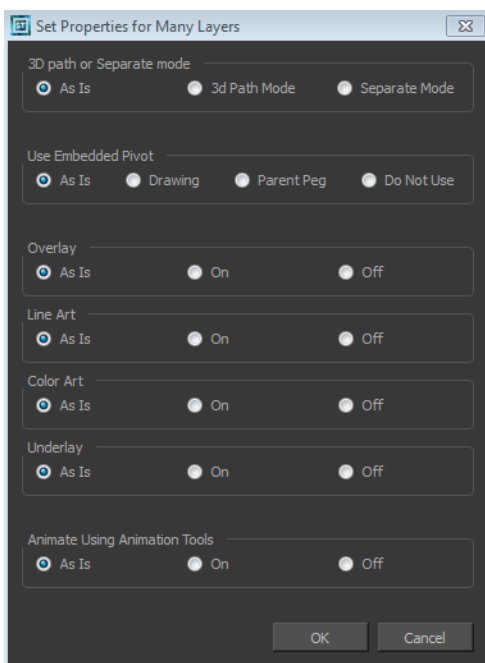

3. Modify the properties. If your modules have different parameters enabled for a certain setting, leave the **As Is** option selected to avoid modifying it. Each module will keep its original setting. Select any other options for all modules to change to this parameter regardless of their original setting.
4. Click **OK**.

Auto Apply Option

When you modify a parameter in a property dialog box, Toon Boom Harmony calculates the modification automatically and displays the result immediately in the Camera view. If you do not want to immediately display every change made to your scene, you can turn off this default setting by deselecting the Auto Apply option. This is useful when you are working on a very heavy scene.

When you disable this function, Apply and OK buttons are added at the bottom of the Layer Properties view and any other parameter dialog box.

- Click **Apply** to apply the current change.
- Click **OK** to apply the current change and close the Layer Properties.

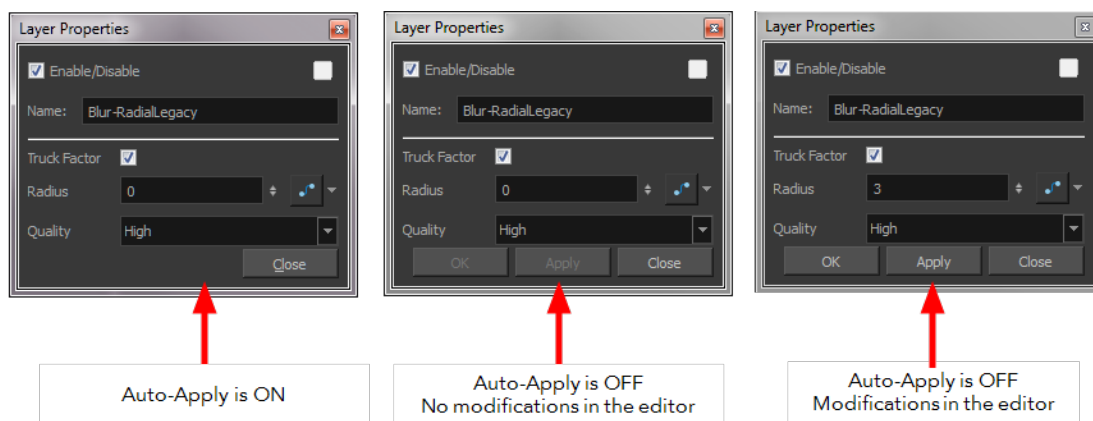

If you want to always work in Auto-Apply mode, you can deselect the Auto-Apply option in the Preferences dialog box. Then, each time you start Harmony, the Auto-Apply mode will be off. You must click the Apply button to see any modifications.

How to enable or disable the Auto Apply option



- ▶ From the top menu, select **Edit > Auto-Apply**.

How to enable or disable the Auto-Apply preference

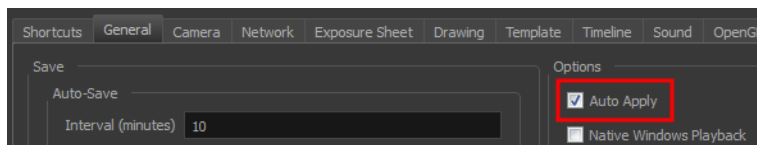
1. In the top menu, select **Edit > Preferences** (Windows/Linux) or **Stage > Preferences** (Mac OS X).
The Preferences dialog box opens.
2. In the Preferences dialog box, select the **General** tab.
3. In the Options section, select or deselect the **Auto Apply** option.



Resetting a Transformation

You can easily reset layers to their original position. With the Reset command, you can return the value of a selected element to the initial value of the active tool. For example, if the Rotate  tool is active, the transformation angle will be reset to 0 and if the Transform  tool is active, the all transformation parameters values will be reset.





When selecting elements in the Camera view using the Transform tool, always make sure that the Peg Selection Mode  is deselected in the Tool Properties view. Otherwise, it will limit the selection to pegs only.

How to completely reset the layers' position

1. In the Tools toolbar, select the Transform  tool or press Shift + T.
2. In the Timeline or Camera view, select one or more drawing layers to reset.
3. Do one of the following:
 - ▶ From the top menu, select **Animation > Reset** or press R.
 - ▶ Right-click the selected layers and select **Clear All Values**.
 - ▶ In the Timeline view menu, select **Layers > Clear All Values**.

The selected layers return to their original position.

How to reset a layer's parameter

1. In the Advanced Tools toolbar, select the Translate , Rotate , Scale , or Skew  tool based on the parameter to reset.

2. In the Timeline or Camera view, select the layer to reset.
3. From the top menu, select **Animation > Reset** or press R.
The selected parameter returns to its original position.

How to reset all transformation values except Z

1. In the Tools toolbar, select the Transform  tool or press Shift + T.
2. In the Timeline or Camera view, select one or more drawing layers to reset.
3. From the top menu, select **Animation > Reset All Except Z**.
All values except for those set on the Z axis are reset.

Cloning and Duplicating Layers

At times, you will need to create a large group of characters such as a crowd, school of fish or flock of birds. You can do this by cloning or duplicating a layer during production. The difference between cloning and duplicating is that a clone uses the same drawings for all layers. A duplicate is simply an independent copy.

If you want to maintain the ability to modify drawings and propagate the changes through all layers, then you should clone drawings. If you simply want to copy your drawings and be able to modify your drawings without affecting the original layer, use the duplicate option.

Cloning Layers

A cloned layer is linked to the original element directory. If a drawing is modified in the original or cloned layer, both will be updated. However, clone layers can have linked or different timings.



Cloned layer - Changes to the original layer propagate to the cloned layer.

In the Timeline view, the left part of the layer is a module, same as in the Network view. These modules are linked to columns. The right part of the Timeline view corresponds to the Xsheet column. These columns can contain drawing exposures or value keyframes. One module can be linked to several columns; one drawing column and parameter columns (rotation, position, scale, pivot, etc.).

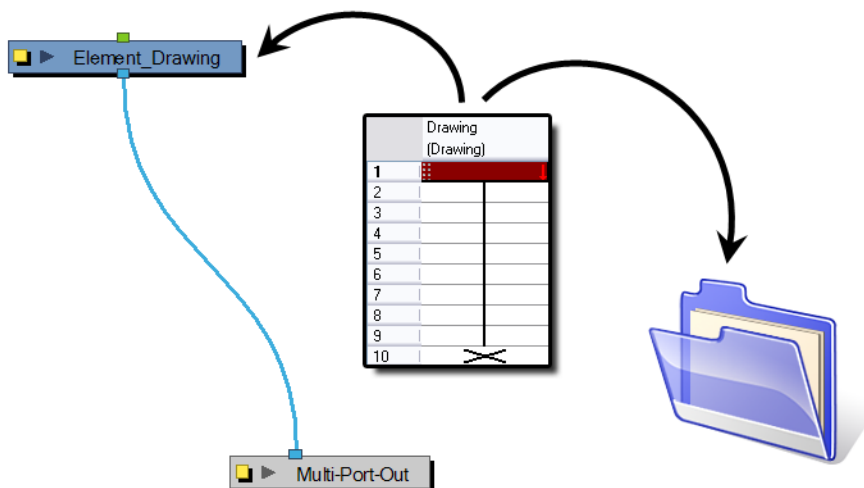

When cloning layers, you have the ability to clone the drawings and the corresponding columns (timing) or only the drawings. If you choose to clone the drawings and timing, your module will be linked to the same element folder as well as the same drawing and function columns. Therefore, if you change the drawing exposure or keyframe on one layer, all cloned layers will be updated.

You may want to create a large group of characters reusing the same animation, but want to slightly offset the timing so they are not dancing or walking quite on the same beat. For example, if you create a walk-cycle for a soldier and want to use it for an entire army, you may want to have 50 layers with 50 different drawing exposures to produce a slight difference in the timing. If you copy your layers and their drawings 50 times over, it will create a heavier scene. It is better to clone the 50 layers with only their drawings without linking to the same function and exposure columns.

How to clone a layer

1. In the Timeline, Xsheet or Network view, select a layer to clone. You can select multiple layers.



2. Do one of the following:

- ▶ From the Xsheet view menu, select **Columns > Clone Selected Columns: Drawings Only** or **Columns > Clone Selected Columns: Drawings and Timing**.
- ▶ From the top menu, select **Edit > Clone** to clone the columns' drawings only.
- ▶ From the Timeline view menu, select **Layers > Clone Selected Layers: Drawings Only** or **Layers > Clone Selected Layers: Drawings and Timing**.
- ▶ In the Xsheet View or Timeline View toolbar, click the Clone Selected Layers/Columns: Drawings Only  button. You might need to add this button to your toolbar using the Toolbar Manager.
- ▶ In the Network View menu, select **Modules > Clone Selected Layers: Drawings Only** or **Modules > Clone Selected Layers: Drawings and Timing**. When you clone a module, it does not automatically connect itself to the Composite module of your scene.

The cloned layer appears.



By default, when you select a module in the Network view and perform a copy/paste using Ctrl + C and Ctrl + V (Windows/Linux) or ⌘ + C and ⌘ + V (Mac OS X), this creates a **CLONE** not a duplicate. Modules will be linked to the same drawings. Pegs will be linked to the same function columns.

To duplicate a layer in the Network view using shortcuts, press Ctrl + C (Windows/Linux) or ⌘ + C (Mac OS X) and Ctrl + B (Windows/Linux) or ⌘ + B (Mac OS X) for Paste Special, and select **Create New Columns**.

Duplicating Layers

You can duplicate a layer to have a copy of the drawings that are independent from the original ones, as well as an independent timing (exposure). When you need the drawings to be modified

independently, you will want to duplicate the layer instead of cloning it.



Duplicated layer - Changes to the original layer do not propagate to the duplicated layer.

How to duplicate a layer

1. In the Timeline, Xsheet or Network view, select a layer to clone. You can select multiple layers.



2. Do one of the following:

- ▶ In the Timeline view menu, select **Layers > Duplicate Selected Layers**.
- ▶ In the Network view menu, select **Modules > Duplicate Selected Modules**. When you duplicate a module, it does not automatically connect itself to the Composite module of your scene.
- ▶ From the Xsheet view menu, select **Columns > Duplicate Selected Layers**.
- ▶ From the top menu, select **Edit > Duplicate**.
- ▶ In the Xsheet View or Timeline View toolbar, click the Duplicate Selected Layers/Columns  button. You might need to add this button to your toolbar using the Toolbar Manager. The duplicated layer appears.



By default, when you select a module in the Network view and perform a copy/paste using Ctrl + C and Ctrl + V (Windows/Linux) or ⌘ + C and ⌘ + V (Mac OS X), this creates a **CLONE** not a duplicate. Modules will be linked to the same drawings. Pegs will be linked to the same function columns.

To duplicate a layer in the Network view using shortcuts, press Ctrl + C (Windows/Linux) or ⌘ + C (Mac OS X) and Ctrl + B (Windows/Linux) or ⌘ + B (Mac OS X) for Paste Special, and select **Create New Columns**.

Setting Up the Network

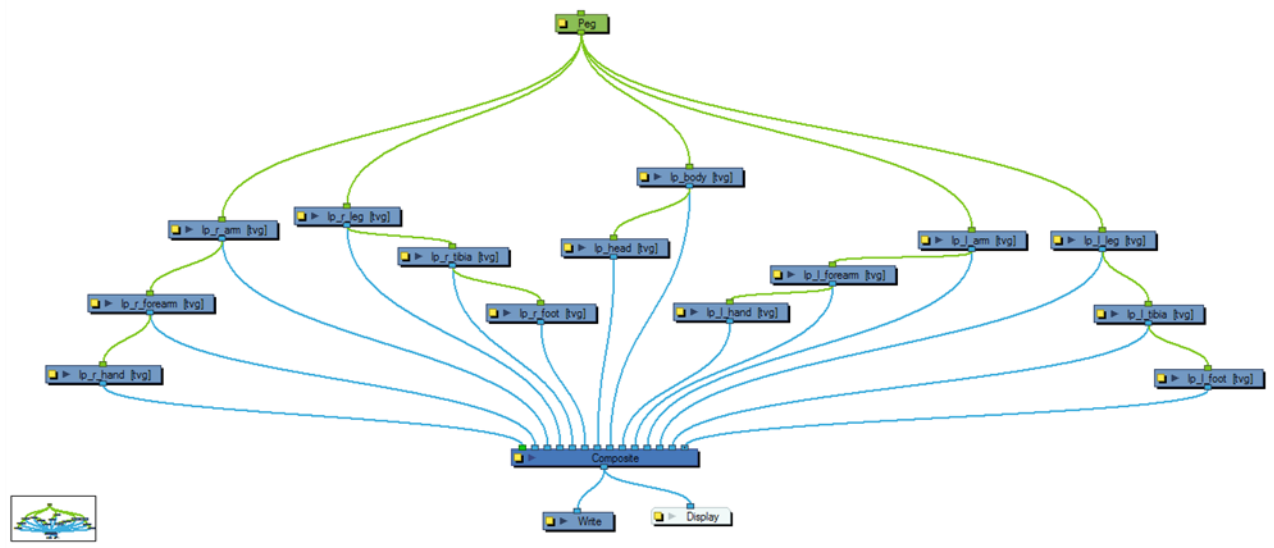

The Network view uses a visual set of connections (nodes) to show how each element in the scene is connected and brought to the final image. It allows you to add extra elements and effects, and to move beyond the possibilities offered by the Timeline and Xsheet views.

This section is divided as follows:

- [Network View](#) on page 336
- [Network Navigation and Basic Rules](#) on page 133
- [Composite Module](#) on page 141
- [Groups](#) on page 143
- [Enabling and Disabling Modules](#) on page 152
- [Module Thumbnails](#) on page 153

Network View

In the Network view, you can connect effects and compositing modules to form a network, also known as a *node system*. This view is very useful for rigging puppets, creating advanced effects and having a clear view of complex scenes. The organization and order of the modules determines the flow of data during the compositing process and how your animation elements will be composited.

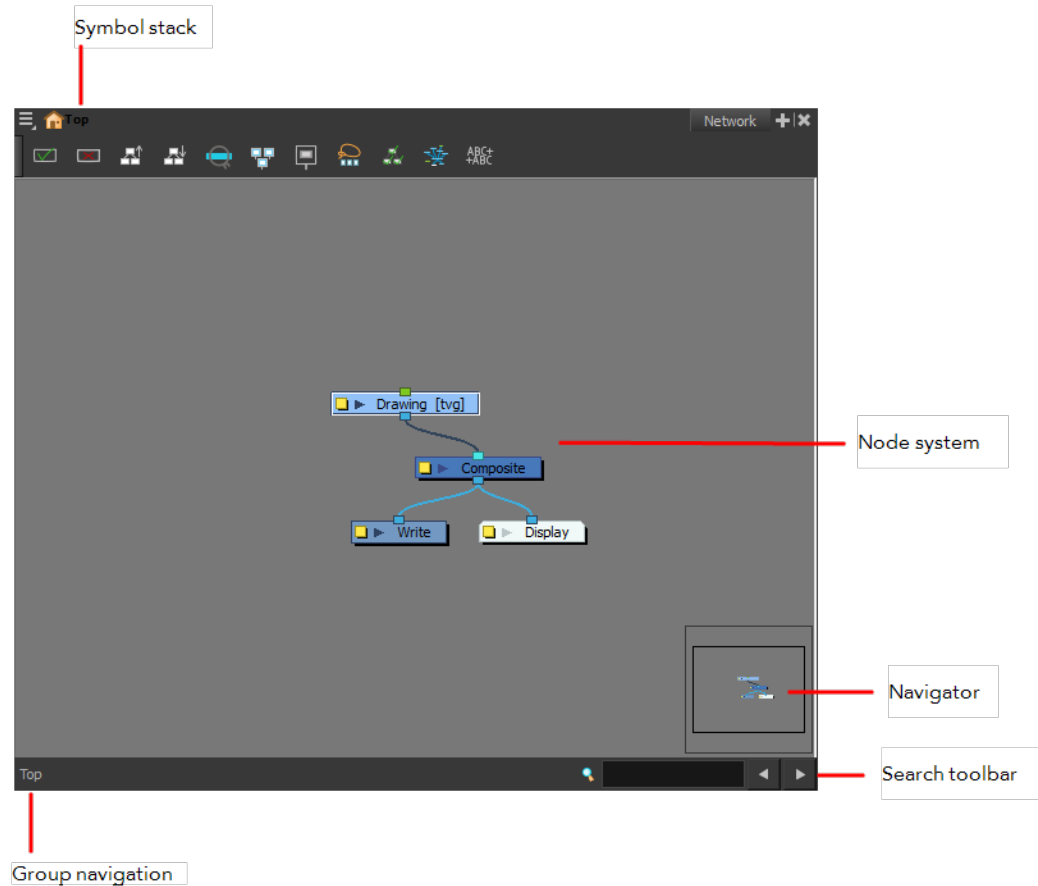

Symbol Stack

When entering symbols, the Symbol Stack lets you navigate back to the top and see the hierarchy of the symbol in which you are working.

Node System

The main area of the Network view is the node system area where you can add and organize different modules to represent a scene.

Navigator

The Navigator view lets you pan the visible area to move quickly through extensive node sets.

Search Toolbar

The Search toolbar is used to find and match a module in the project. The search is not case-sensitive. Once you have entered characters in the search field, press Enter/Return to validate and find the pattern in the module names. If successful, the module is selected and centred in the view. If many instances are found, use the Previous and Next buttons to cycle through each node.

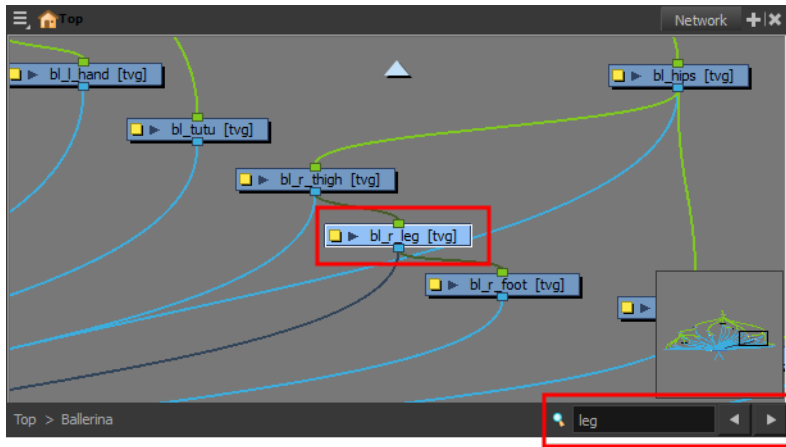

Group Navigation

When entering a group, the Group Navigation allows you to navigate back to the top and see the hierarchy of the group in which you are.

Modules

There is a series of modules available to compose the network. Here are some basic types and information about the main modules.

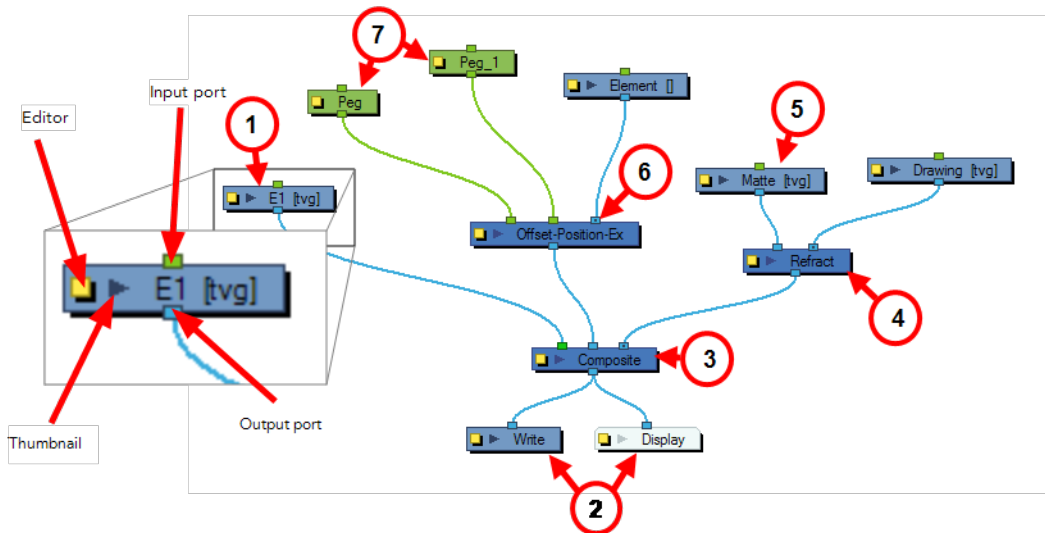

1. Drawing Module

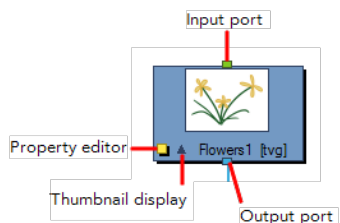

This is an example of an average module, a simple drawing module that represents a layer in the Timeline view. This module has an input port (top) that allows information to flow through it. It has an output port (bottom) that exports its information in a downward flow. On the left is a yellow box that displays the module's property editor, where you can adjust its parameters. Lastly, there is a dark arrow that displays a thumbnail of the module's contents.

2. Write and Display Modules

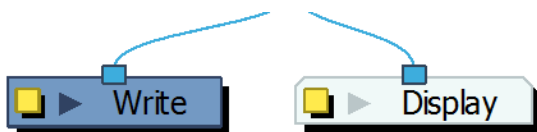

Both the Write and Display modules do not have output ports. This is because the information that flows into them can go no further in the network. The Write module records the images and renders the final output. The Display module captures the visual information and outputs it to the Camera view.

3. Composite Module

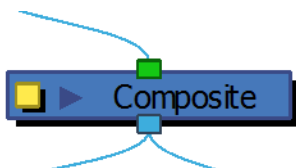

The Composite module combines multiple source images (drawing and effect modules), including all transformations and effects, into a single bitmap or vector image for each frame.

The Composite module layers the images based on the composition order rule. First, the Z-values of the elements are analyzed to determine depth. When multiple elements have the same Z-value, the Depth values in the drawing modules are used. If the Depth values are also the same between elements, the composition order is determined by the cable order of modules on the Composite module. By default, modules connected to the right are rendered below those connected to the left. You can override this default in the Composite module editor—see [Composite Module on page 141](#). The Composite module is an example of a module that can have an infinite number of input ports that can take in multiple, individual sources of information. The leftmost input port on the Composite module is always green. This lets you know that, in terms of stacking order, whatever is plugged into this port will appear on top of the composite after the Z-depth is taken into account.

4. Effect Module

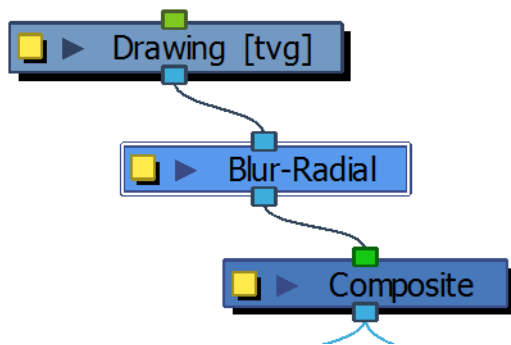

An Effect module can often have two input ports. The right input port is for the drawing layer that is to be acted upon by this effect, while the left port is usually reserved for a matte.

5. Matte Drawing

A matte, also called mask, is the shape that will be used by the effect module to modify the original image. The effect will only be applied where the matte overlaps with the original image. Sometimes the matte will act as a negative shape that the effect will exclude. This all depends on the nature and editing properties of the effect.

6. Position Ports

Some effects contain three input ports. If they are green, then they require a Peg module connection (coordinate and value information). In the case above, the effect can accommodate two pegs.

7. Peg Module

The Peg modules control the transformation of elements (position, scale, skewing and rotation) over time. The green ports at the top and bottom of the module indicate that it accepts position information and can then pass this information on.

One peg can be used to control many different modules or one module can accept more than one peg. In a situation like the latter, one peg might be used to modify the rotation, while the other used to modify the position of the effect and then animated differently over time.

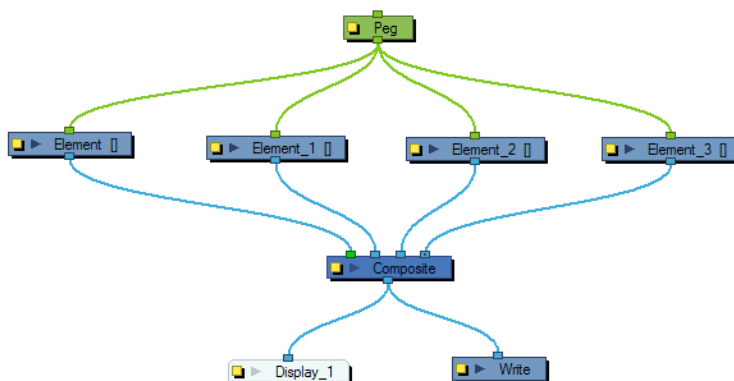

Network Navigation and Basic Rules



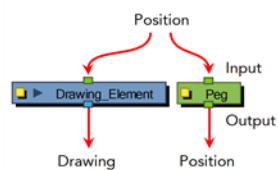

The basic rules of the Network view are quite simple. Once you understand them, a lot can be accomplished.

- [About Modules](#) below
- [Input and Output Ports](#) on the next page
- [Adding Modules](#) on page 136
- [Composite Module](#) on page 136
- [Organizing Modules](#) on page 137
- [Connecting and Disconnecting Modules](#) on page 137
- [Cable Styles](#) on page 139
- [Navigator Display](#) on page 139
- [Panning the Network View](#) on page 141

About Modules

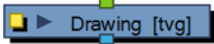

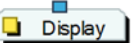
Each element in the Network view is called a *module*. Modules are often referred to as *nodes*. There are several different types of modules:

Module		Description
Drawing		Transfers drawing information.
Effect		Processes effects on drawings and transfers drawing information.
Input/Output		Act as the interface between each module and network.
Move		Controls the camera and element transformations over time.
Compositing		Combines multiple source images.

Input and Output Ports

Each module has an input port at the top and an output port at the bottom. Some are blue and others are light-green or bright green.

- Blue indicates drawing information.



- Light green indicates position and movement.



- Bright green shows the element on top of the composition and outputs that element's Z position to the Composite module. When many elements have different Z positions (multiplane, different distances from the camera) and are placed through a Composite module that flattens them together (producing one image with one Z value), the system needs to give a Z position to this new image. It uses the bright green port information.

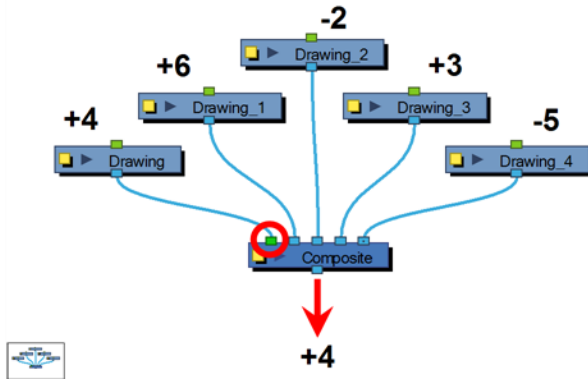

Finally, some modules contain more than one input port. These are usually effect modules needing different drawing or position information in order to perform their calculation. When the two ports are blue, the Drawing is on the right and the Matte is on the left. If it is light green, the drawing needs extra position information.

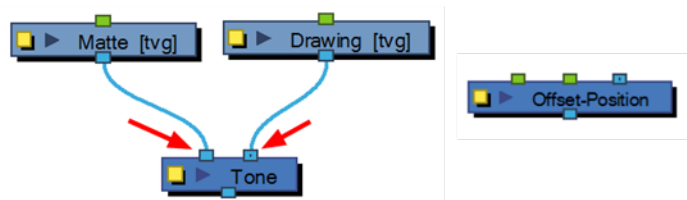

Viewing Port Information

On each port is a tooltip which displays the source of input ports and the destination(s) of the output ports.

How to display port information

- Hover the pointer over a port.
- The port's tooltip displays source and destination information.

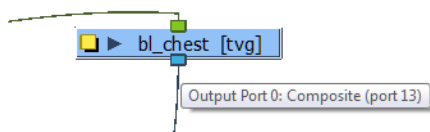

Navigating the Network View

You can navigate to the parent or child module of the selected module or selected cable in the Network view.

How to navigate the Network view

- ▶ In the Network view, select a module or cable, and press the Ctrl + Up/Down arrows.

Adding Modules

Each module used to build a network is available in the Module Library view. In addition, each time you create a layer from the Timeline or Xsheet views, the corresponding module is created in the Network view.

How to import modules from the Module Library

- ▶ In the Module Library, select a module and drag it to the Network view.

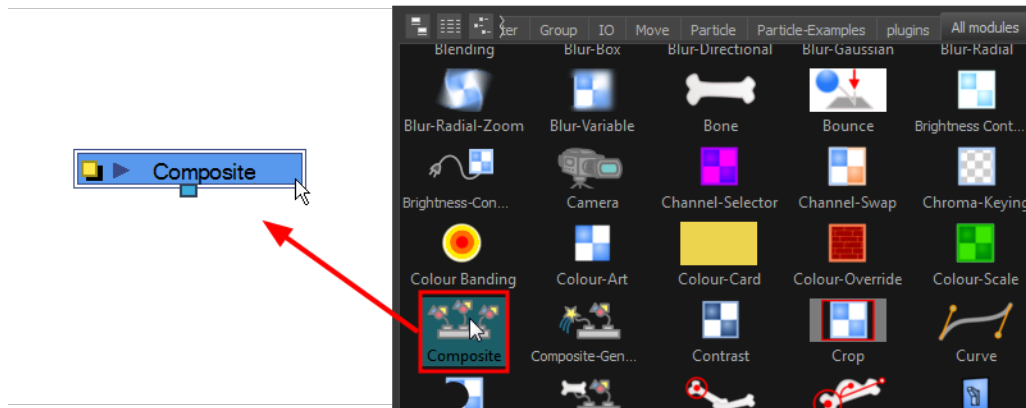

Composite Module

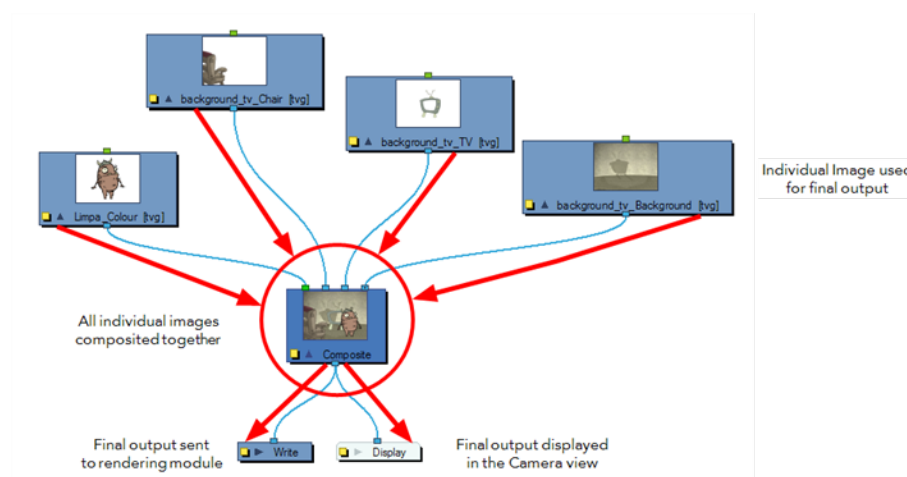

The Composite module allows you to use several images and output a single image. You can compare that to doing pre-compositions in editing software. You connect several drawing modules in your Composite module and one bitmap comes out of it—see [Composite Module on page 141](#).

By default, the image resulting from the Composite module is a bitmap. The layers are composited together depending on their position on the Z-axis (forward-backward) first, then their order in the Composite module. If two images are at the same position on the Z-axis, their order in the Composite module will determine which one is displayed in front and which one is displayed behind.



Organizing Modules

When you are working in the Network view and adding many modules, your scene may look a bit messy and be difficult to follow. Harmony provides scripts which organize and display the modules in a more orderly fashion.

How to organize the network

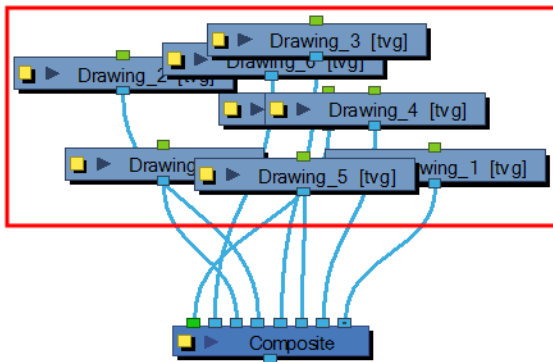
1. In the Network view, select some or all of your modules.



2. Display the Network View toolbar by selecting **Window > Toolbars > Network View**.
3. Click the Order Network Up  or Order Network Down  button.

The Order Network Settings dialog box opens.

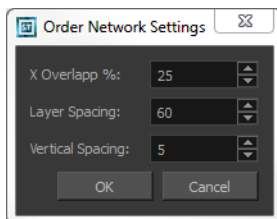

4. Set values for the X Overlap%, Layer Spacing and Vertical Spacing. The default value is set for optimal organization.
5. Click OK.

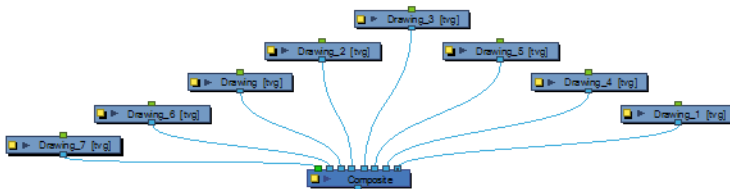

Connecting and Disconnecting Modules

Making or removing connections between modules is quite simple.

How to connect modules

- In the Network view, do one of the following:
 - Extend a cable from the first module's output port (bottom port) and connect it to the second module's input port (top port).
 - Select the module to connect, hold down the Alt key and drag the module on an existing cable.

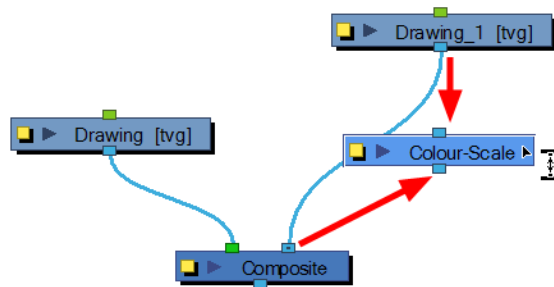

It is possible to create links between nodes in the Network views by clicking on one node and ctrl-clicking on a second port.

Select a node and Ctrl-click a port:

- Click a node and then Ctrl-click the input port of a different node. The nodes are linked.
- Click the output port of a node, and then Ctrl-click a different node. The nodes are linked.
- Click the output port of a node, and then Ctrl-click a Composite node. The node is linked to a new input port of the Composite.
- Click a port of a node and then Ctrl + Alt-click a port of a Composite node. The selected port replaces the link in the Composite's input port.
- Click an output port of a node and then Ctrl-click the input port of a Group node. The selected output port replaces the link to the group.
- Click an output port of a node and then Ctrl + Alt-click the input port of a Group node. The selected output port links to a new in-port of the group.

You can reconnect a module's output port without disconnecting its destination port by dragging the link while holding Ctrl (Windows/Linux) or ⌘ (Mac OS X).

How to disconnect modules

- In the Network view, do one of the following:
 - Select the module to disconnect, hold down the Alt key and drag the module away.

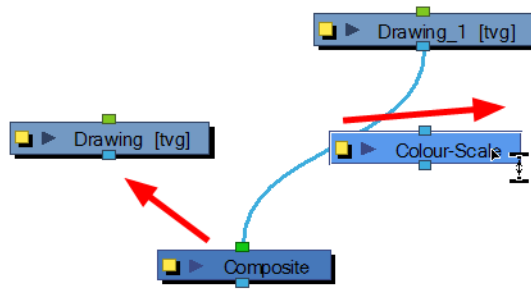

Cable Styles

You can customize the look of the cables in the Network view to fit your style of working. You can display the cable lines as Bezier (curved) lines or straight lines.

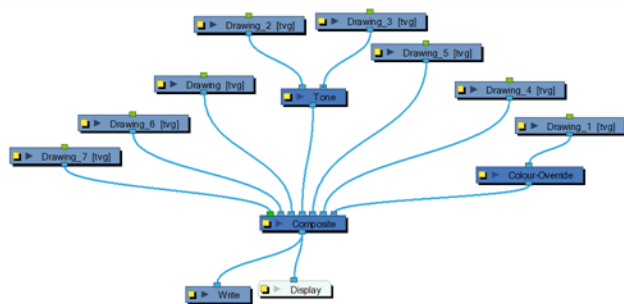

Bezier cable style

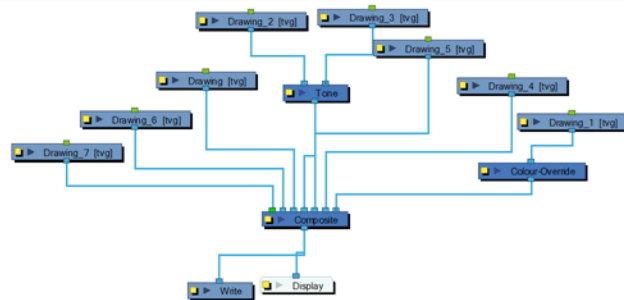

Line cable style

How to switch cable styles

- ▶ In the Network View menu, select **View > Cable Style > Bezier** or **Line**.

Navigator Display

The Navigator is a small square window inside the Network view that displays a bird's eye view of the network. The view displayed in the Network view is shown framed in the Navigator display. You can drag this frame to pan the current Network view display.

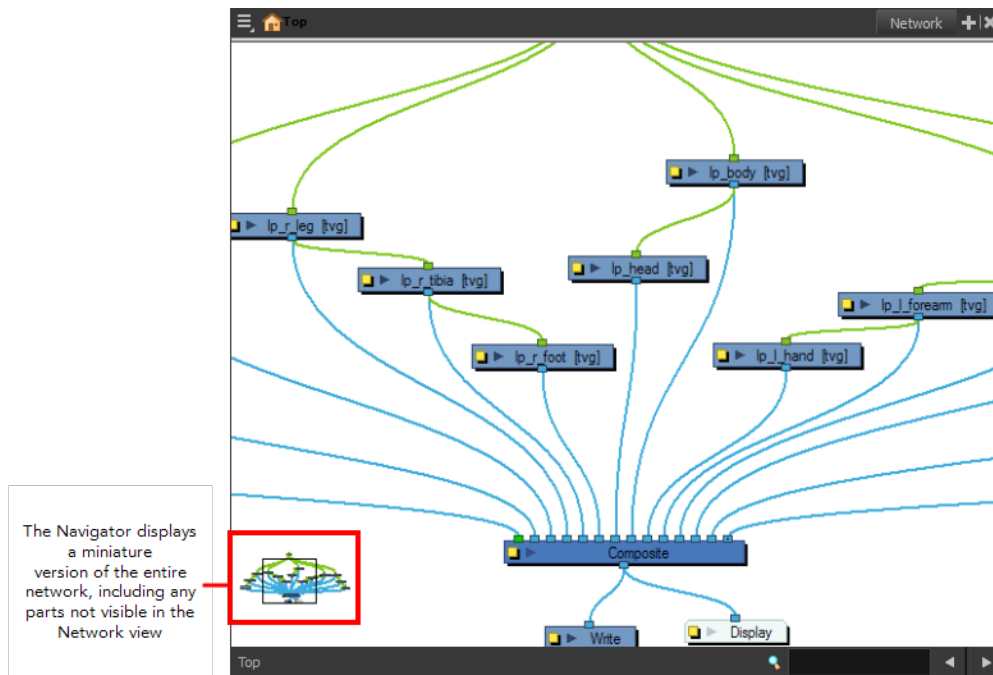

Showing or Hiding the Navigator

You can show or hide the Navigator from the Network view.

How to show or hide the navigator, do one of the following

- ▶ In the Network view menu, select **View > Navigator > Hide Navigator** or **Show Navigator**.
- ▶ Press **Ctrl + Shift + W** (Windows/Linux) or **⌘ + Shift + W** (Mac OS X).

Positioning the Navigator

The Navigator display can be placed in any corner of the Network view.

How to position the navigator

- ▶ In the Network view menu, select **View > Navigator >** and select **Top Left**, **Top Right**, **Bottom Left**, or **Bottom Right**.

Magnifying the Network view:

The magnifier helps you view the entire network so you can navigate and view the different modules.

How to magnify the Network view

1. Press **Z**.
A black outline surrounds the area you were at before pressing **Z**.
2. Change the magnification level of the magnifier by rolling the mouse wheel.

When the magnifier is displayed, it is possible to temporarily switch in and out of the magnified view by clicking in the magnifier.

Panning the Network View

When your networks grows more complex, you can pan the Network view to locate and work on specific modules.

How to pan the Network view

1. Select a node, press Spacebar and drag to a new location.

Composite Module

The Composite module allows you to use several images and output a single image. You can compare that to doing pre-compositions in editing software. You connect several drawing modules in your Composite module and one bitmap comes out of it.

For more information about the Composite module options in a 3D environment context, refer to [Managing a Network with a 3D Scene Setup on page 197](#).

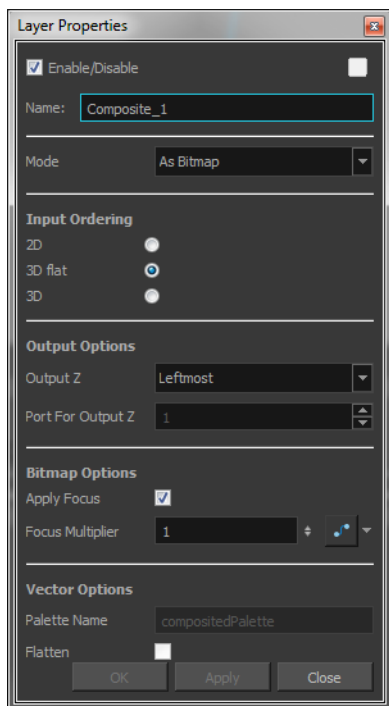

Parameter	Description
Mode	<p>As Bitmap: Composites all images into a single, flat bitmap image. The Z value of the final image is based on the Output Z selection.</p> <p>As Vector: Composites all the images as a single vector image. The Z value of the final image is based on the Output Z</p>

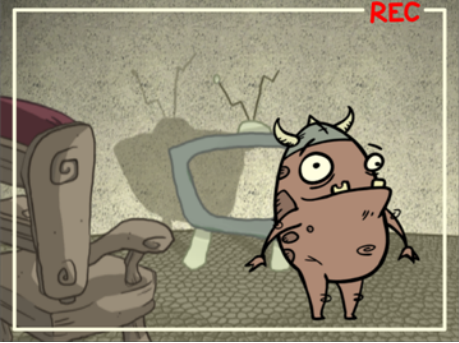
	<p>selection. Bitmap elements are ignored and do not appear in the final frame.</p> <p>As Seamless Bitmap: Composites all the images into a single, flat bitmap image (just like the As Bitmap compositing mode). The main difference between the As Bitmap and As Seamless Bitmap modes is that the seamless version ensures that there is no visible seam between adjacent vector drawings that have matching geometries. This can be useful for cut-out animation, where multiple drawings may align perfectly like pieces of a puzzle (using masking/cutter). This can also be useful when building a 3D set out of flat drawings rotated in 3D. In this case, using the Seamless mode will produce the correct result when two drawings are intersecting or nearly intersecting. When using this mode, the following effects are not supported: Shadow, Glow, Blending and Focus.</p> <p>Pass Through: No compositing operations occur. No image is merged or flattened. Each individual image keeps its own properties. The compositing operations happen only in the next Composite module connected below. In this case, the port ordering is ignored.</p> <p>If a Composite set to Pass Through it is the last one in the compositing chain, it will act the same as the As Bitmap option. At that point, the Input Ordering options are considered.</p>
Input Ordering	<p>2D: Elements connected in the module are composited based on their port ordering. The Z-axis (forward-backward) values are ignored. The scaling value will be correct, but the actual position on the Z-axis is ignored.</p> <p>You can use the 2D composite type to create effects such as a camera recording overlay on your scene. Since you always want this element to be in front regardless of the other elements' Z-axis position, you can set the option to 2D.</p>  <p>3D Flat: The Z-axis value of the elements connected in the Composite module are considered, so the visual representation is correct in the Camera view. The output is a flat image.</p>

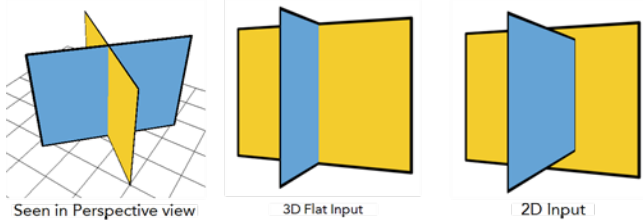
	 <p>3D: The Z-axis value of the elements connected in the composite module are considered, so the visual representation is correct in the Camera view. The image is not flattened. The 3D aspect of the elements are kept. For example, if you rotated elements on the three axes, the information is retained and elements composited in lower levels are able to intersect with the elements coming from a 3D Composite module. The 3D Composite module should only be used in advanced cases. It is better to use a Pass Through composite type than a 3D composite type. This way, all the elements are composited in the final Composite module.</p>
Output Options	<p>Output Z: Identifies which element's front-back value from the current composition is applied to the entire composited image in the next operation. If you select Portnumber, identify the appropriate port by its position using the Port For Output Z menu. The port used appears in a bright green colour on the Composite module. By default, the leftmost port is displayed in front and the rightmost port is displayed behind.</p>
Bitmap Options	<p>These options are active when you select the As Bitmap mode.</p> <p>Apply Focus: Activates the Focus effect for this module in the composite operation.</p> <p>Focus Multiplier: The value entered in this field is used as a multiplier for the radius value specified in the Focus or Focus-Multiplier modules.</p>
Vector Options	<p>These options are active when you select the As Vector mode.</p> <p>Palette Name: When you render files, use this field to set the name of the palette files that Toon Boom Harmony will create for them.</p> <p>Flatten: Flattens vector drawings into one vector drawing file. Any transparency will be lost in the process. This creates smaller vector files, but might increase the time required to composite the drawings. This can be useful when reusing drawings. Because they will be vector files, you can still apply vector-based transformations and effects.</p>

Groups

With so many connections and modules possible, the network can quickly become crowded. Keep things organized by grouping your modules.

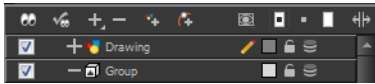

There are several advantages to using the Group Selection With Composite command over the simple Group Selection (which references both the Group layer in the Timeline view and the Group module in the Network view).

One of the advantages of using this command is that it groups all the selected elements into a neat module that has a nested composite. This means that there is only one connection coming out of the Group module. With the simple Group module or command, the Group displays the same number of connections as elements in the group. Both grouping commands display the same structure in the Timeline view.

The Group Selection With Composite command should only be used before any work has been done in the Network view and it is recommended for objects whose stacking order is of no consequence.

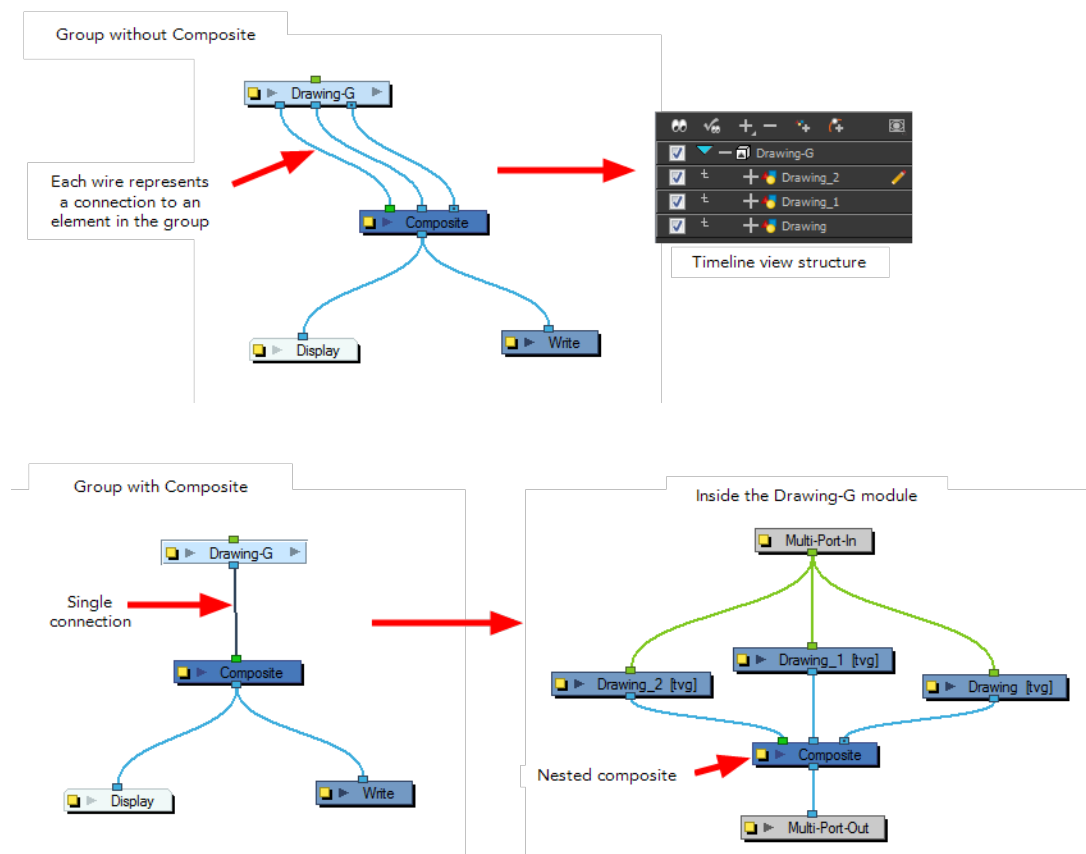

Using the Group Selection from Composite command on elements that have effects, have been tweaked in the Network view, or whose stacking order is of consequence, may cause the grouped elements to lose their properties once grouped in this way. In addition, though you may only select a few modules to group, if there are other layers in the timeline that exist between the selected layers, they will automatically be grouped, even if not selected.

Once you create a group module, it is easy to enter into or exit from it.

Using the Move to Parent Group command allows you to move the selected module to the parent level, maintaining all connections. If the operation cannot maintain the connections between the modules, you will be notified and the operation will be terminated.

To quickly access parameters for modules that are grouped, you can use the Publish Attribute Mode feature to select your most common parameters to modify and make them appear in the group Layer Properties editor. This way, you can access them directly without having to enter the group every time.

How to group selected modules

1. In the Network view, drag a selection around the modules you want to group.

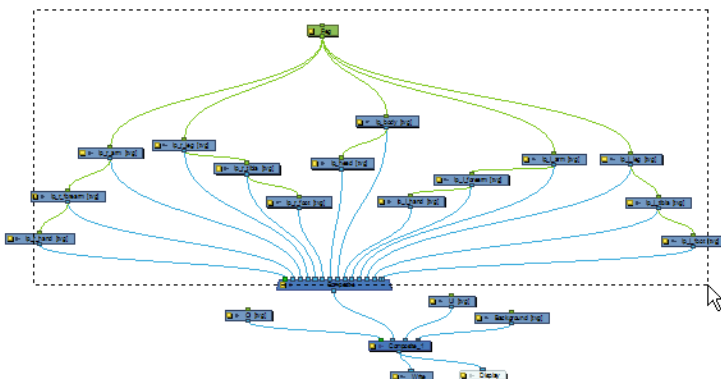

2. In the Network View menu, do one of the following:
 - ▶ Select **Edit > Group > Group Selected Layers**.
 - ▶ Press **Ctrl + G** (Windows/Linux) or **⌘ + G** (Mac OS X).

The modules are grouped.

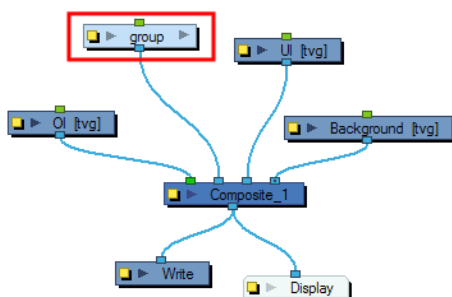

To ensure that you have a Multi-Port Out Module in your group and that your group remains connected, include a Composite module in your selection and make sure it is connected to the main Composite module of the scene before grouping.

How to group selected elements using the Group Selection With Composite command in the Network view

1. In the Network view, select the elements that you want to group.

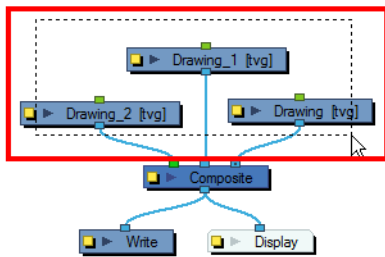

- Right-click in the Network view and select **Group > Group Selection With Composite**.
The selected modules are grouped.

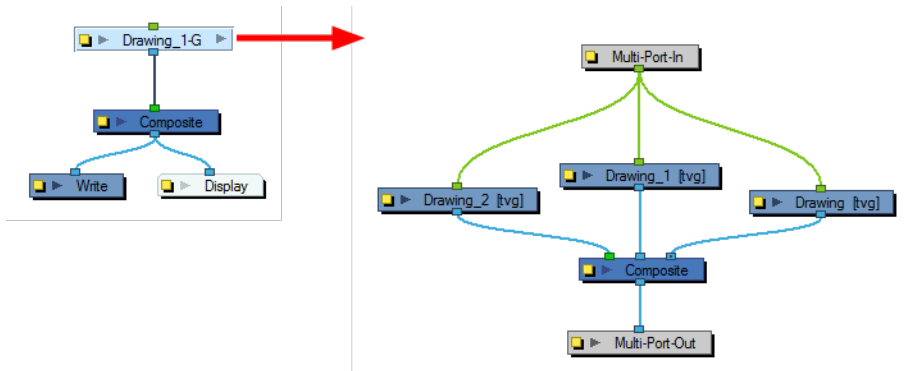

How to group selected elements using the Group Selection With Composite command in the Timeline view

- In the Timeline view, in the layers section, select the elements that you want to group.
Any layers between the selected layers will be automatically grouped as well, so if the stacking order does not matter, move extra layers above or below the layers want to group.
- Right-click on one of the highlighted layers and select **Group Selection With Composite**.
The layers appear indented under a new Group layer in the Timeline view and in a new Group module in the Network view.

How to ungroup a group

- In the Network view, select the group of modules you want to ungroup.

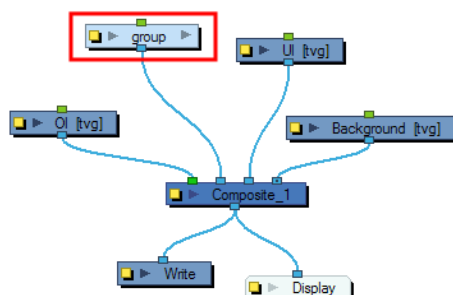

- In the Network View menu, select **Edit > Group > Ungroup** or press Ctrl + Shift + G (Windows/Linux) or ⌘ + Shift + G (Mac OS X).

The selected group is ungrouped.

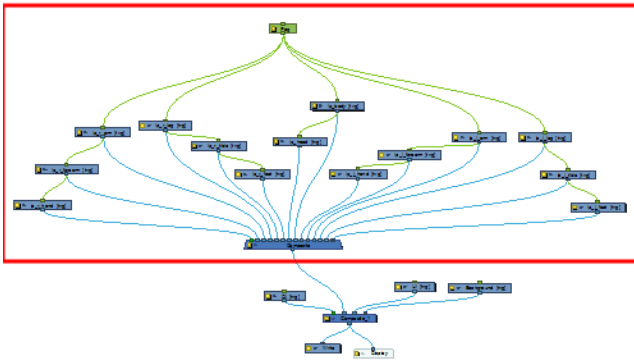

How to enter a group module

3. In the Network view, click the arrow on the right side of the group module you want to enter.



- Inside the group module, the Multi-Port In and Multi-Port Out modules ensure that your connections continue beyond the group.

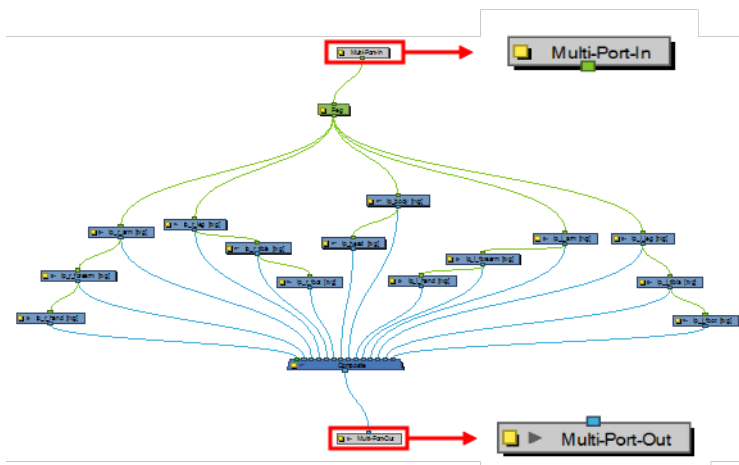

How to exit a group module

1. In the Network view, click the destination in the Group Hierarchy menu. You can also select **Modules > Exit Group** from the Network View menu.
 - You can click on the top and bottom blue arrows appearing in the Network view to exit the current group.
 - When you enter a group, the Group Hierarchy Menu displays the path to where you are. In this example, we are inside the group named group. To exit this group, click on **Top** located at the bottom left corner of the Network view.

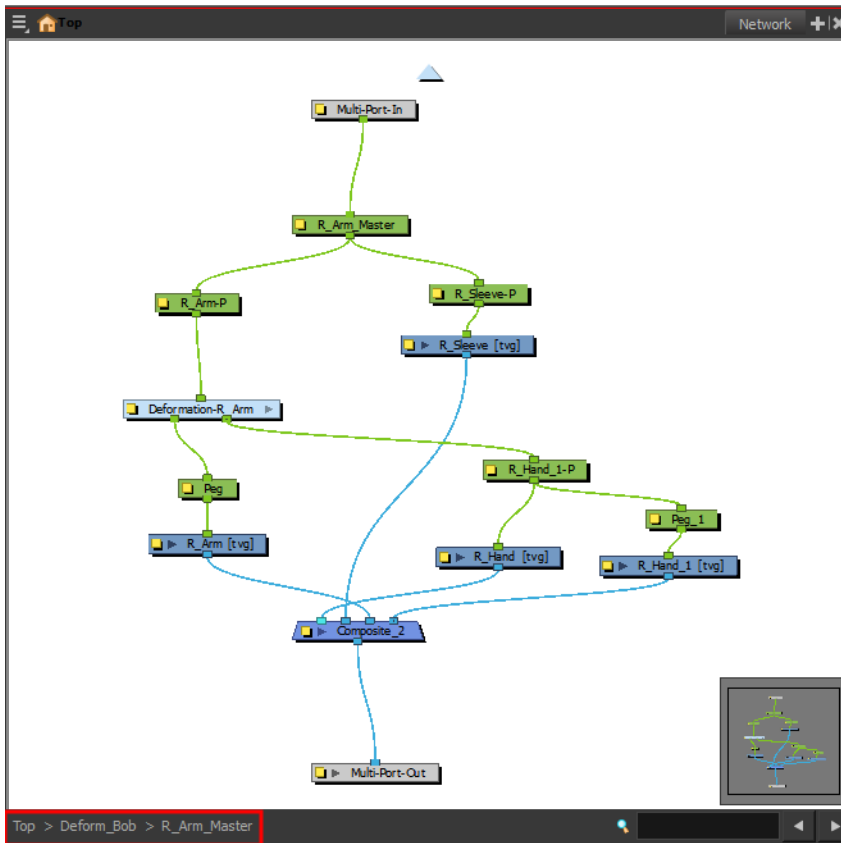

How to move up a level in a group

- ▶ Click the arrow at the top of the Network view.

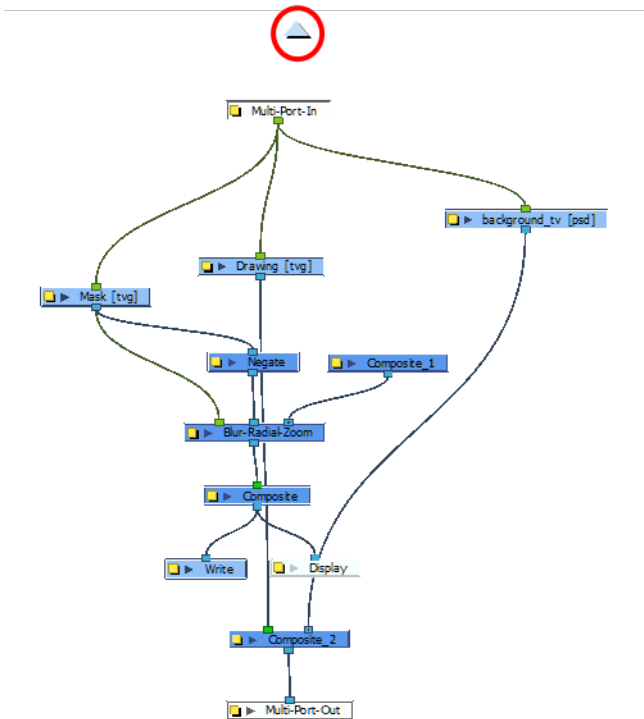

How to move a selected module to its parent group

1. In the Network view, go inside the group and select the modules you wish to move up to the parent group level.

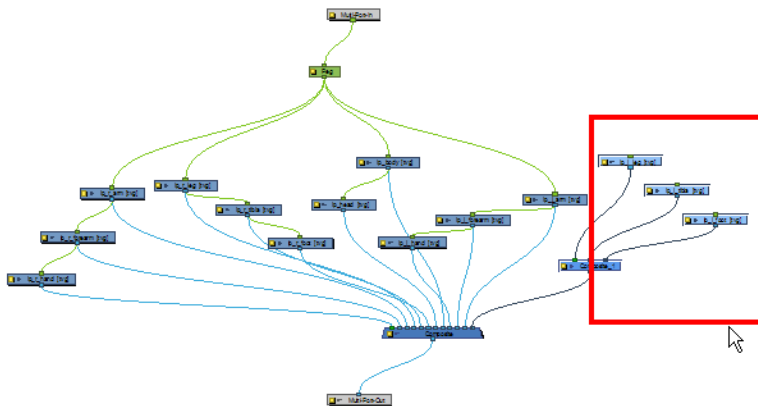

2. In the Network View menu, select **Modules > Move to Parent Group** or press Ctrl + Shift + U (Windows/Linux) or ⌘ + Shift + U (Mac OS X).

The selected modules are moved to the parent group level.

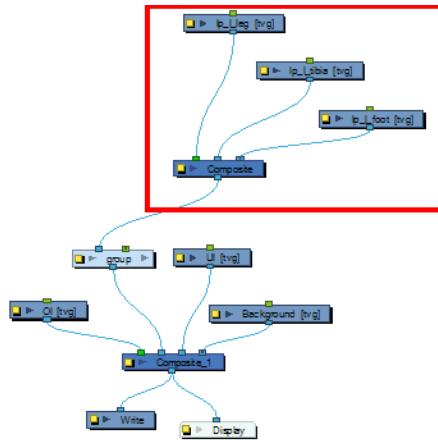

How to use the Publish Attribute Mode function

1. In the Network View menu, select **View > Publish Attribute Mode**.
2. In the Network view, enter the group containing the modules you want to promote.
3. Select the module you want to publish attributes for.
4. In the Layer Properties view, enable or disable the publishing checkboxes for the different parameters. You can easily distinguish them as they are labeled in red.

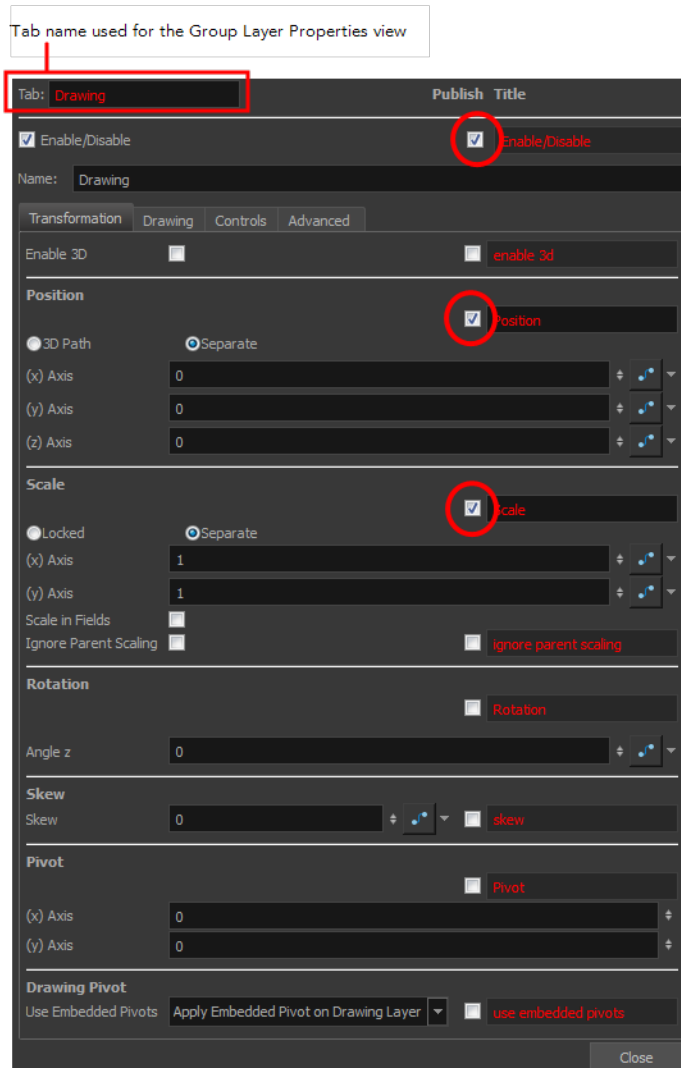

5. Repeat the previous step for all the modules you want to publish attributes for.
6. In the Network view, exit the group.
7. Select the Group module.

In the Layer Properties view, you can see all published attributes. The different modules are tabbed for easy access and organization.

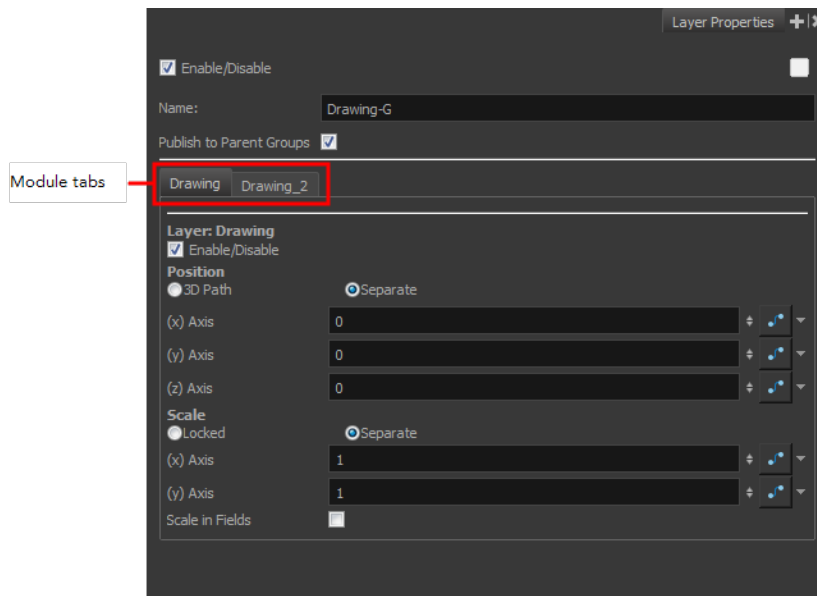

Enabling and Disabling Modules

As with the Timeline layers, you can turn the Network view modules on or off. When you turn off a module in the Network view, its corresponding layer in the Timeline view is also turned off. Modules that are turned off are displayed in red.

How to enable modules

1. In the Network view, select the disabled module(s) you want to enable.

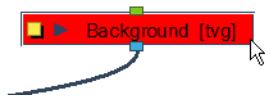

2. In the Network view menu, select **Modules > Enable** or press A. This keyboard shortcut is also valid in the Timeline view.

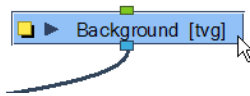

How to enable all modules

1. In the Network view menu, select **Modules > Enable All**.

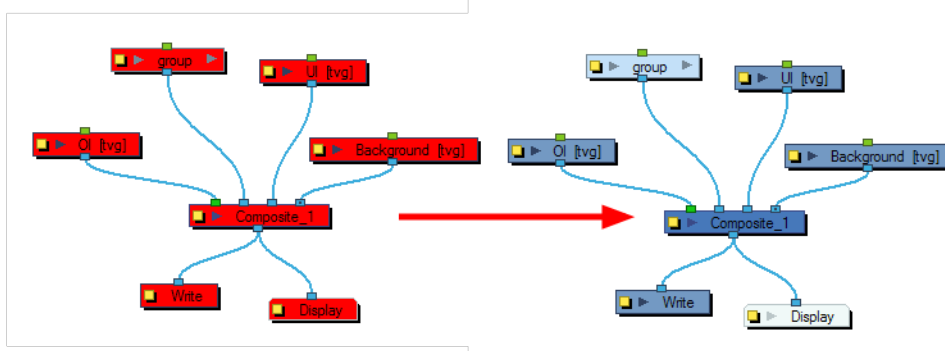

How to disable modules

1. In the Network view, select the module(s) you want to enable.
2. In the Network View menu, select **Modules > Disable** or press D.

How to disable all other modules

1. In the Network view, select the module(s) to remain enabled.

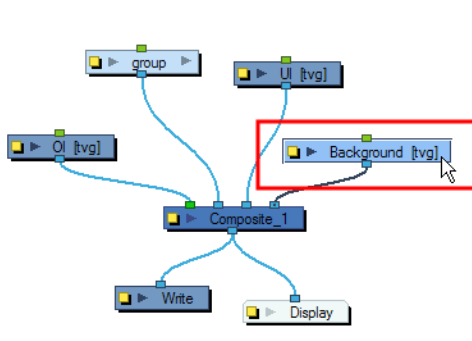

2. In the Network view menu, select **Modules > Disable All Others**.

All modules are disabled except for those selected. This operation only affects the current level layers. It does not affect the nested modules within a group.

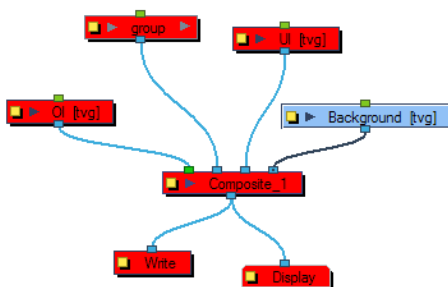

Module Thumbnails

In the Network view, some modules have a thumbnail option, identified by an arrow next to the square yellow button. Thumbnails can be very useful when navigating the network to easily identify the content of each module or analyze the flow of images and effects.

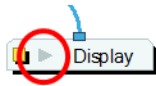

How to display a module's thumbnail

- ▶ In the Network view, click on the arrow in the module.

The thumbnail opens.

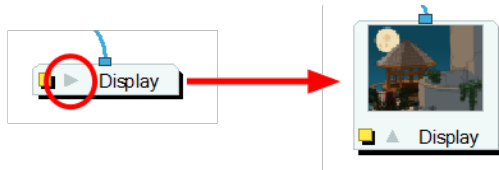

- ▶ If no thumbnail appears, click the Render View Mode  button in the Camera view (bottom toolbar) to generate them.

How to show thumbnails of selected modules

1. In the Network view, select the module(s) whose thumbnails you want to display.

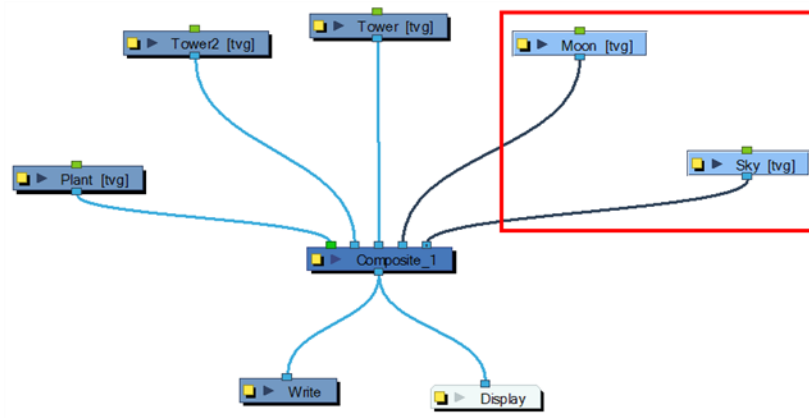

2. In the Network view menu, select **View > Show Selected Thumbnails** or press T.

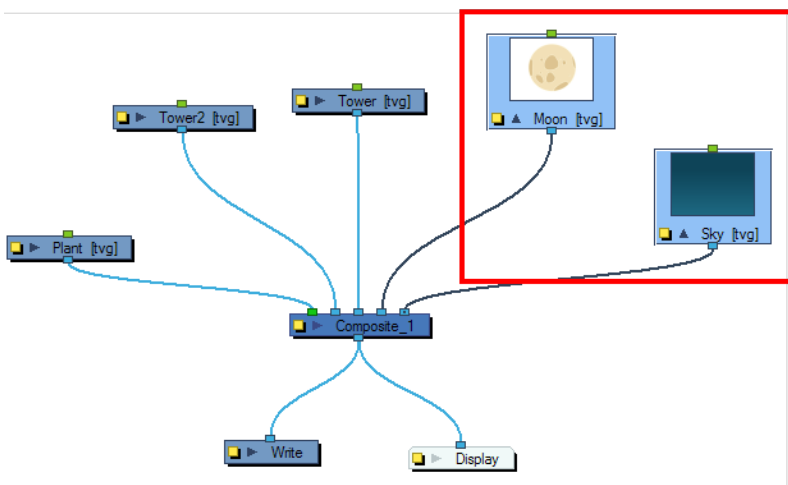

- ▶ If no thumbnail appears, click the Render View Mode  button in the Camera view (bottom toolbar) to generate them.

How to hide a module's thumbnail

- ▶ In the Network view, click the arrow in the module.
The thumbnail closes and the module returns to its closed state.

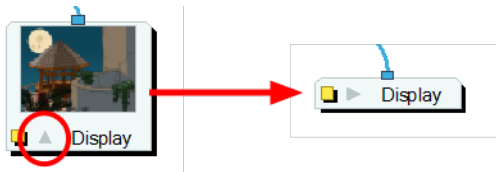

How to hide thumbnails for the selected modules

1. In the Network view, select the module(s) whose thumbnails you want to hide.

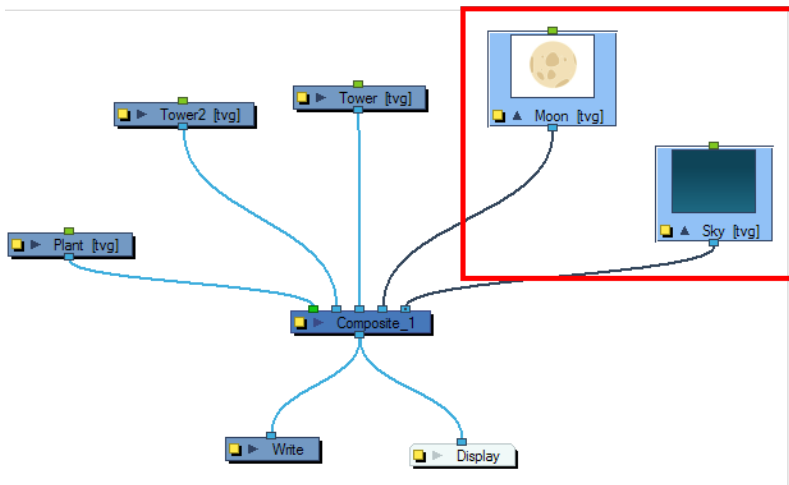

2. In the Network view menu, select **View > Hide Selected Thumbnails** or press T.

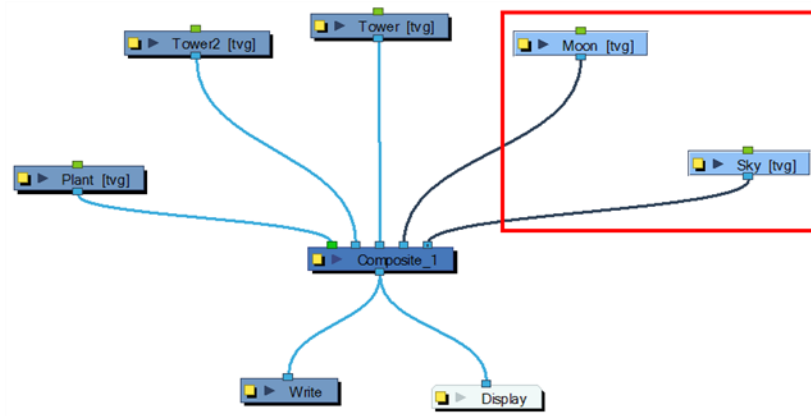

How to hide all modules thumbnails

1. In the Network View menu, select **View > Hide All Thumbnails**.

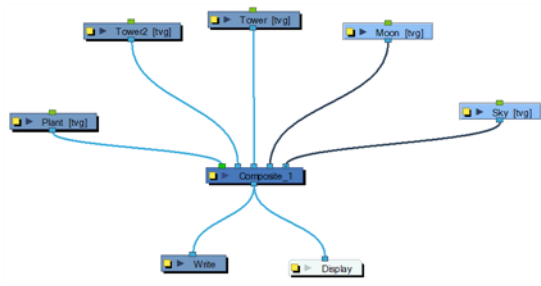

Display Concepts

The Display module is an important module. This is the module used by the export and views to display your scene, primarily the Camera and Timeline views. By default, a scene's network always has a display module. It is also available in the Module Library and can be imported in the Network view to be connected to any module that outputs drawing images, such as drawing elements, effects or composite modules.

The Display module can be used to either show your entire scene, a single module or a group of module through a composite or group module. You might use it to see one single character as you animate it, debug your network as you create complex effects or export your complete scene or a portion of it.

This topic is divided as follows:

- [Display Modules](#) below
- [Global Display](#) on the next page
- [Display All](#) on the next page
- [Display Modes](#) on page 159

Display Modules

You can have more than one display module in the Network view, allowing you to visualize different sections of the scene without disabling or disconnecting elements that could be in the way. This technique is useful in cut-out animation as it allows you to see one puppet without viewing all of the other characters. It is also useful during compositing and helps you visualize and debug effects.

You can add a display module to the Network view by dragging one from the Module Library view.

To use this display concept, you must first show the Display toolbar. The Display toolbar will show you a drop-down list of all display modules available in your Network view. Simply select the desired display to update the Camera and Timeline views content.

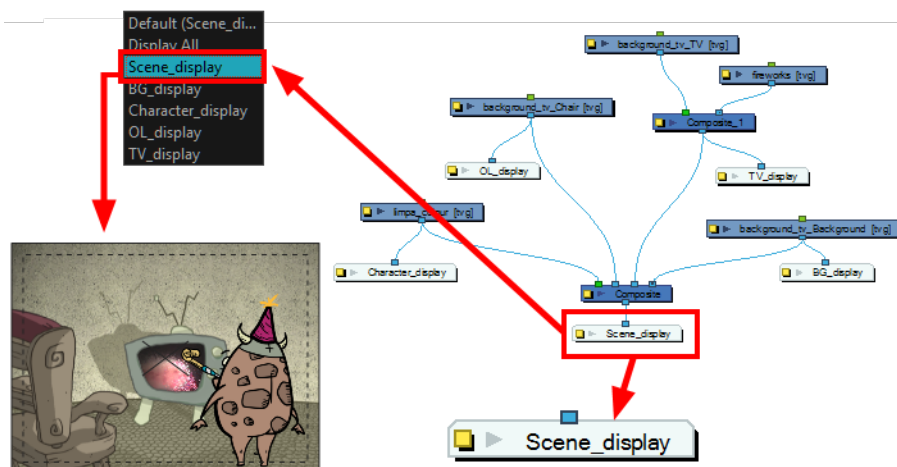

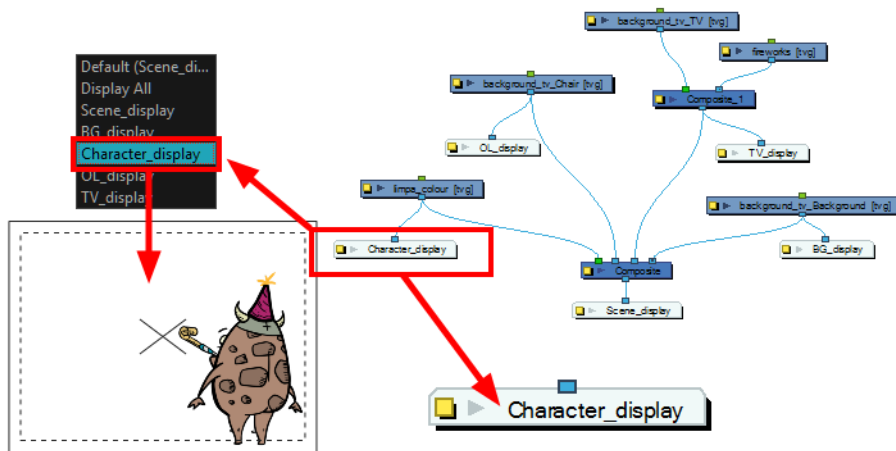

Global Display

The Display toolbar let you select the different display modules available in the network.

When selecting a new display, all the views update to show the content of the new display module. The concept of all views following the display selected in the Display toolbar is called Global Display.

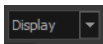

How to select a different display module as a global display

- ▶ Open the Display toolbar drop-down list and select a display from the list. Each view display is updated.

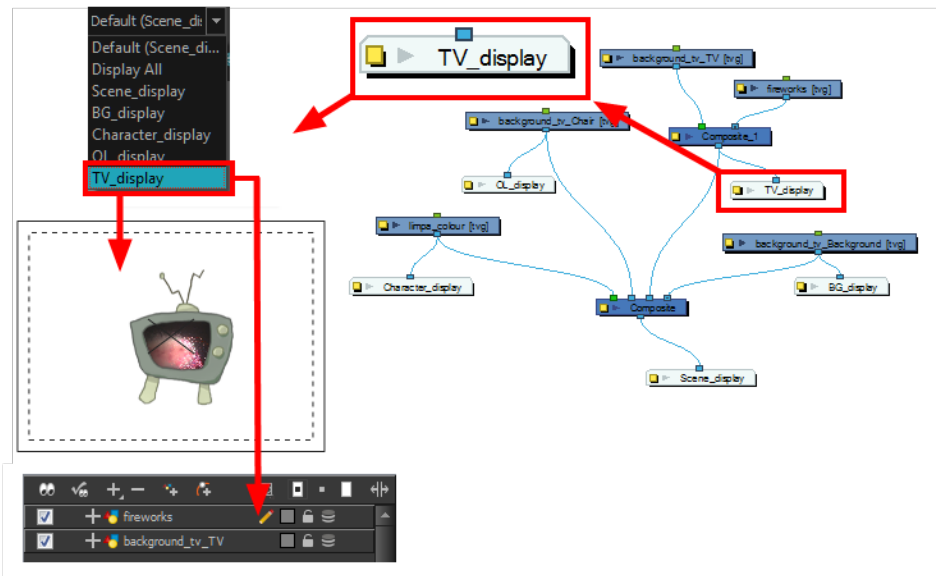

Display All

When your scene does not have a Display module, it is automatically set to Display All which uses the Timeline view ordering and shows floating modules from the Network view.

You can also set your display to Display All using the Display toolbar.

If you try to add a peg layer in the Timeline view without having a layer selected, the peg layer will be floating in the Network view and will not be visible in the Timeline view. The Timeline view shows only layers that are connected to the Composite module.

If you switch to Display All, you run the risk of not realizing when you have floating modules that are not connected to your composite. For this reason, it is not recommended to work in Display All mode.

Show All Modules

When your scene contains many modules and you cannot see them all, you can display all modules at that level.

How to display all modules

- From the Network View menu, select **View > Show All Modules** or press Shift + comma (,).

Display Modes

Toon Boom Harmony has two display modes. By default, it is set to the Basic Display mode.

When creating a scene in Basic Display mode, a display module is automatically added to the network and connected to the final composite module. All of the views are set to use this display module. This means that only the elements connected in that composite module will show in the Camera view.

You can add and connect more display modules to your network and select the one you want using the Display menu. In Basic mode, every view is set to the same Display module.

In Advanced Display mode, every view has its own Display menu and each one can be set to a different display module. To switch from Basic to Advanced Display mode, you must enable the Advanced Display preference. These menus allow you to set the views for different displays. By default, all views are set to Default to follow the main Display toolbar selection. However, you may want different views set on different displays. For example, you can have one Camera view to display the full scene and another Camera view to only display the character being animated. In this case, you can set the first Camera view on the final display and the second on the character's display module.

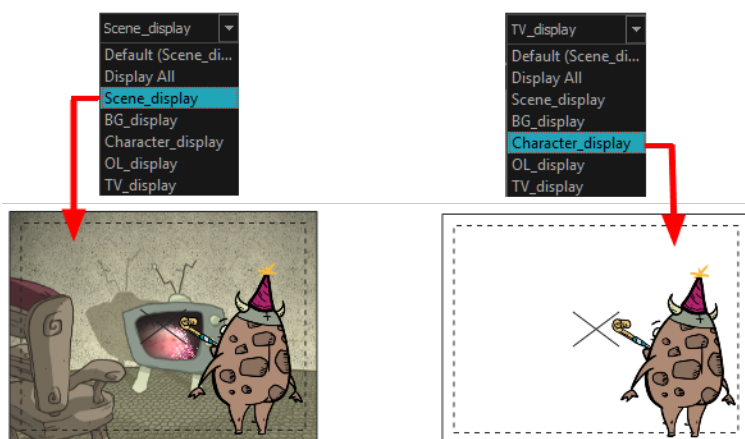

If you want the views to follow the main Display toolbar selection, set the view display menu to **Default** display.

How to enable the Advanced Display preference

1. From the top menu, select **Edit > Preferences** (Windows/Linux) or **Stage > Preferences** (Mac OS X) to open the Preferences dialog box. The Ctrl + U (Windows/Linux) or ⌘ + U (Mac OS X).
2. In the Preferences dialog box, select the **Advanced** tab.
3. In the Advanced Options section, select the **Advanced Display** option.

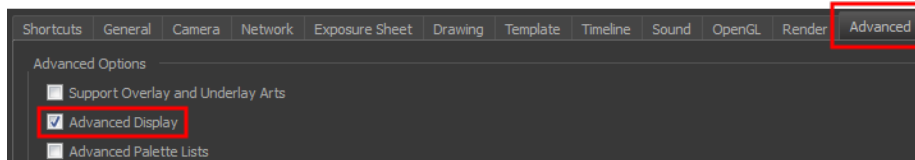

A Display drop-down menu appears in the top-left corner of the Camera, Timeline, Perspective, Top, and Side views.

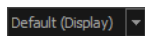

Timeline View Modes

To streamline the process of working with elements in the Timeline view, there are three different view modes you can choose to work in. With each mode you select, certain elements may or may not be visible in the Timeline view. Depending on your workflow, this can be useful for quickly hiding elements when you want to focus on specific ones. To select a view mode, use the drop-down menu in the Timeline view.

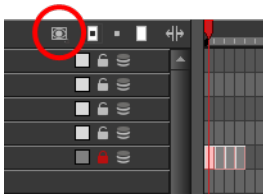

Normal View Mode

Normal View  mode is the default Timeline view mode. It shows everything that is connected to the chosen display. While in this mode, anything not connected to the currently set default display will not be shown in the Timeline view. This also means that you cannot add certain elements to the Timeline view, as by default, when added they are not connected to any display or composite module. An example of such an element is a peg.

If you prefer to work as you did before, where you see everything in the Timeline whether it is connected to a Display or not, you can change the Always Display Unconnected Modules setting in the Preferences dialog box, Timeline tab.

Selection Only Mode

When working in Selection Only  mode, only elements currently selected in the Camera or Network view will be visible in the Timeline. This makes it easier to concentrate on one or a few

elements at a time.

View Tagged Modules

The View Tagged Modules  mode lets you see only elements which have been assigned a Tagged status. An item that has been tagged will appear in the Timeline view with a small asterisk beside its name.



Once your elements are tagged and you have switched over to View Tagged Modules mode, the Timeline view will display only tagged elements. The red bar along the far left of the Timeline indicates you are in this view mode.

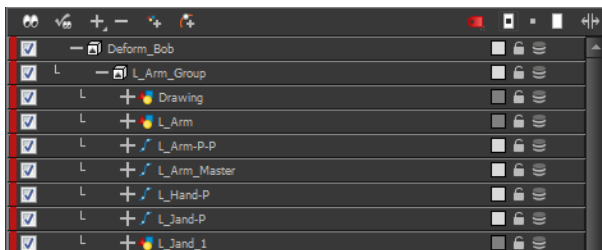

While in View Tagged Modules mode, the asterisks will no longer be displayed beside the tagged elements.

How to tag or untag elements in the Camera view

1. In the Camera view, select one or more elements.
2. Right-click and select **Tag** or **Untag**.

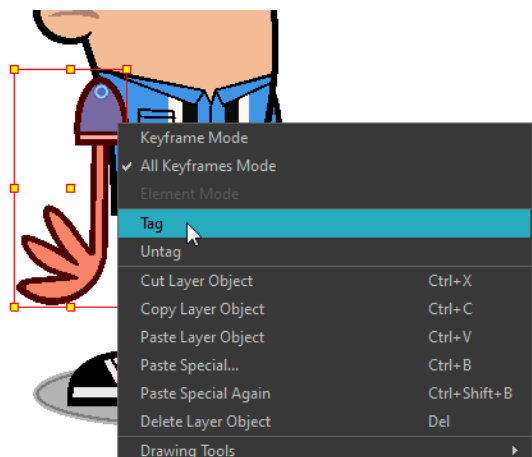

How to tag or untag elements in the Network or Timeline view

1. In the Network or Timeline view, select one or more elements.

2. Do one of the following:

- Right-click on the selection and select **Tag** and one of the following:
 - **Timeline Tag**
 - **Timeline Untag**
 - **Timeline Untag All**
 - **Timeline Untag All Others**

- In the Timeline view or Network view menu, select **Edit > Tag** and one of the following:
 - **Timeline Tag**
 - **Timeline Untag**
 - **Timeline Untag All**
 - **Timeline Untag All Others**

Creating a Multiplane



One of the most exciting features in Harmony is the multiplane or Z-depth. In the multiplane, you can create backgrounds in several layers, spread them on the Z-axis to add depth, and then move the camera through this environment to create an impressive perspective illusion.

Setting Up the Multiplane

To construct a multiplane, you must imagine what a real environment is like. Take a look at your background picture and imagine a camera moving through the space. Notice that objects in the picture move at different speeds depending on where they are in relation to the camera lens.

Building a multiplane requires an understanding of the scene's background, as well as the positioning of the elements on different layers.

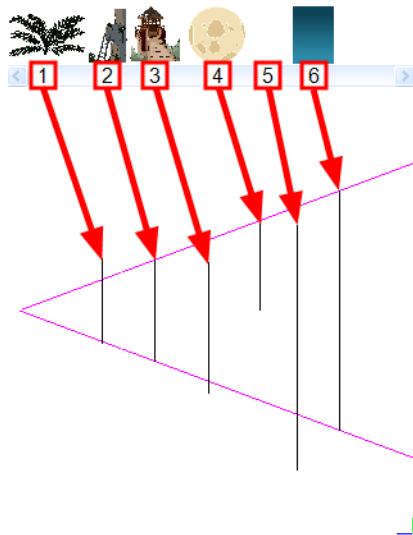

For example, in the background illustrated above, the main objects to be separated are:

1. Fern
2. Front tower
3. Second tower
4. Moon
5. Stars
6. Sky

Although the bottom of the tower is hidden behind the plant and the ladder, each of the multiplane layers should be a complete drawing. This is because hidden portions may show up during a camera move later on in the scene.

Distributing Elements on the Z-axis

Now is the time to distribute the layers that comprise your multiplane along the Z-axis. You can position layers on the Z-axis using the Side and Top view.

Positioning your element closer to the camera makes them appear bigger. You can also move element towards the camera or away from the camera while keeping the same size aspect ratio in the Camera view.

It is a good idea to keep a Camera view open to see what your scene looks like while positioning elements in the Top or Side view—see [Top View on page 167](#), [Side View on page 169](#) and [Perspective View on page 170](#).

Positioning Elements in the Top and Side Views

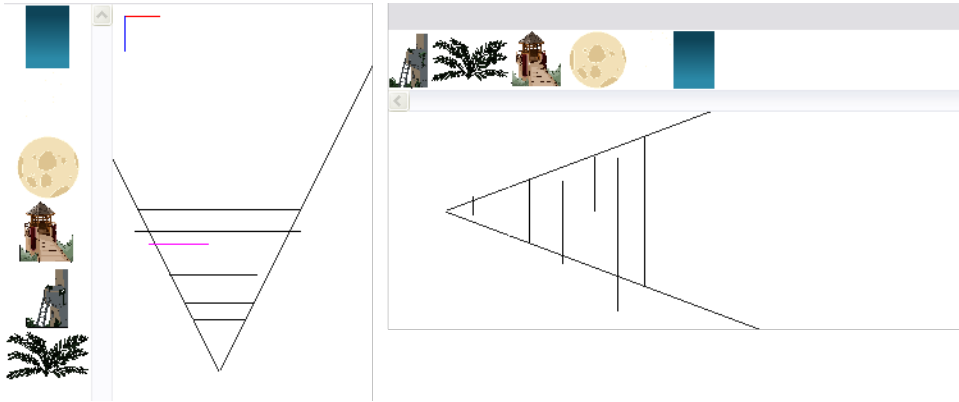

Before distributing layers along the Z-axis using the Top and Side views, deselect the No Z Dragging option by selecting **Animation > No Z Dragging**. This option is disabled by default.

How to position an element in the Top and Side views

1. To maintain the visual scale in the Camera view as you move your element, in the Advanced Animation toolbar, select the Maintain Size  tool or press Alt + 6.
2. In the Side view, select one of the layers in the thumbnails section of the Top or Side view. You can also select a layer from the Timeline view.

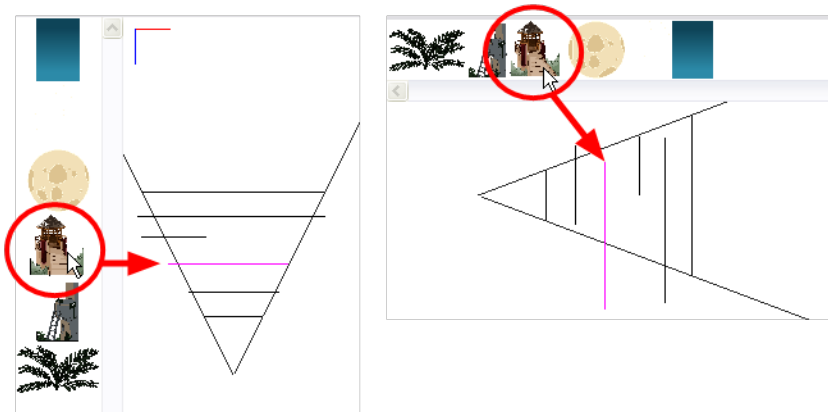

The selected layer is highlighted in the Top, Side and Camera views.

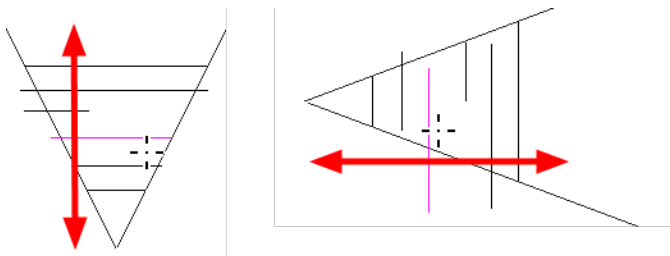

3. Drag the layer to the correct depth position in the camera cone. Your element aspect will remain the same in the Camera view.



4. For your element to scale up or down in relation to their distance to the camera, do one of the following:

- ▶ In the Tools toolbar, select the Transform  tool. Make sure the Peg Selection Mode  option is disabled in the Tool Properties view.
- ▶ In the Advanced Animation toolbar, select the Translate  tool and select a layer from the thumbnails section of the Top or Side view.
- ▶ Select a layer from the Timeline view.
The selected layer is highlighted in the camera cone.

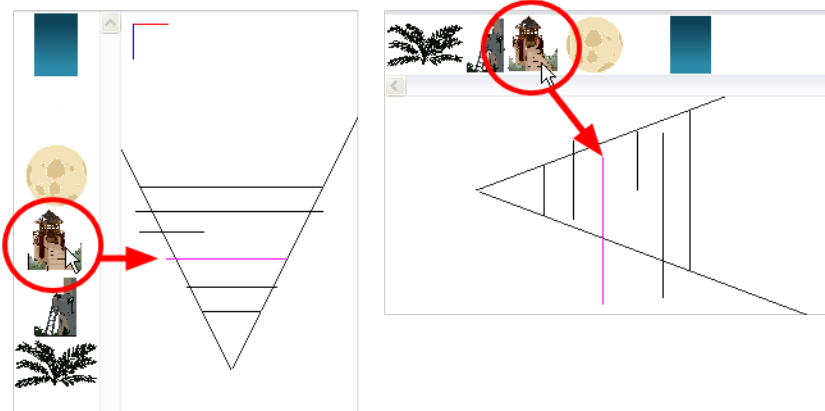

5. In the Top view, drag the element sideways to position it horizontally . Hold Shift while dragging the element to make sure it only moves along the X-axis.
6. In the Side view, drag the selected element up or down to position it vertically. Hold Shift while dragging the element to make sure it only moves along the Y-axis.

Cumulative Z Value

You can see the cumulative Z value information in the Coordinates and Control Points view. When you select a drawing cell that includes a keyframe, it will display the cumulative Z value.

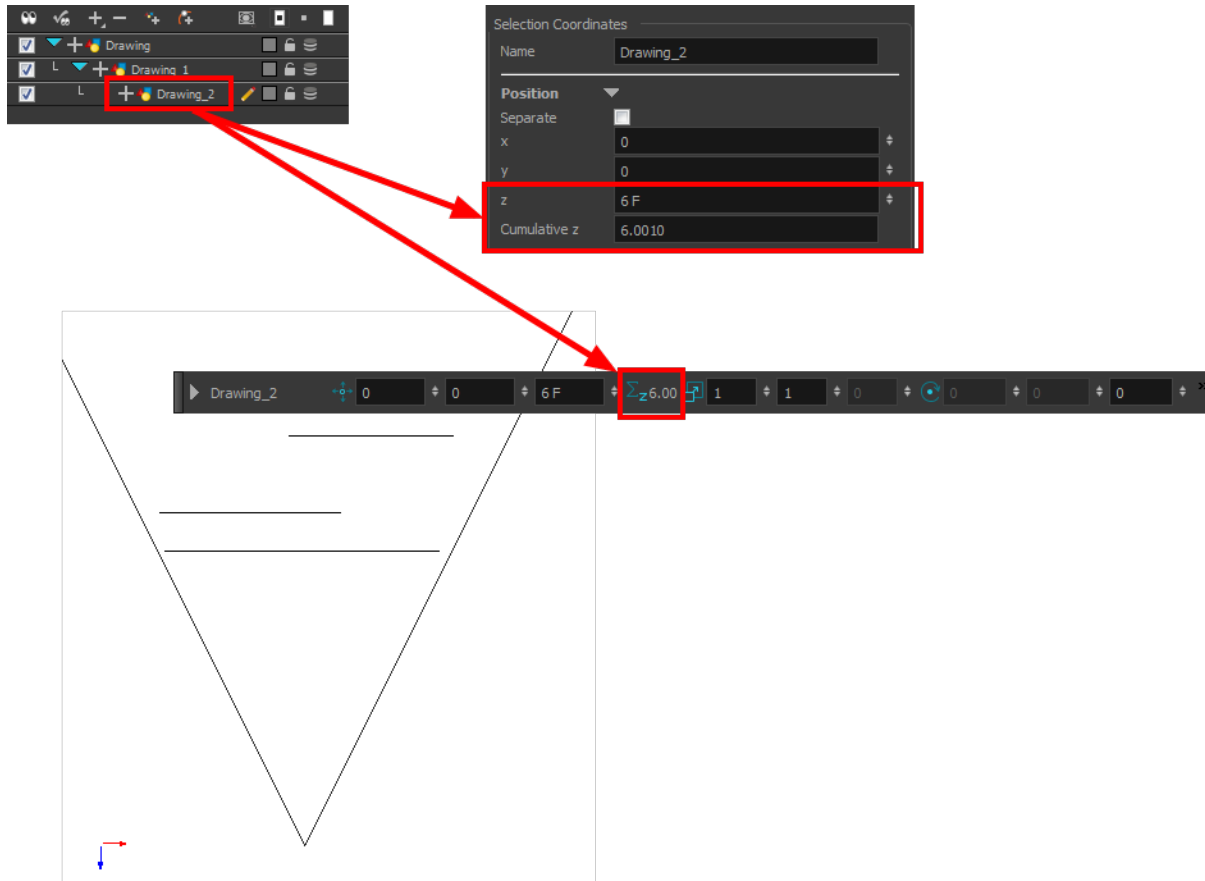

When a layer is parented to other layers that are moved forward or backward on the Z-axis, the currently selected layer's position Z value may not be accurate since its parent will also have an offset on the Z-axis. The Cumulative Z value is a compilation of all the Z-axis offsets to give the real Z-axis offset value related to the (0,0) centre.

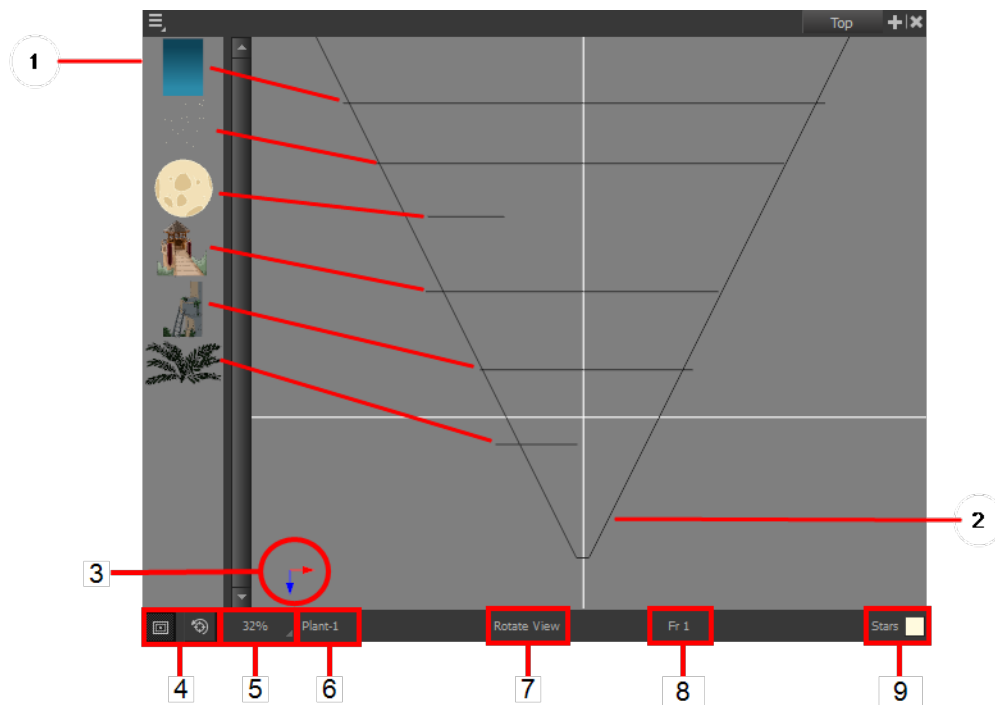

Top View

The Top view is used mainly for multiplane scenes and to position elements in 3D Space. It allows you to see the scene's stage from above. This lets the camera cone and the spacing between the elements to be seen.



1. A thumbnail of each drawing layer in the scene. The order of the thumbnail images is based on each element's FB position in the scene space. You can see a representation of the FB position of each layer in the camera cone.
2. The camera cone represents the camera's position and field-of-view (FOV).
3. The axis reference arrows let you maintain your orientation when navigating in the Perspective view.
4. There are two view option buttons displayed in the lower-left corner of the view.
 -  **Show/Hide Camera:** Shows or hides the camera frame in the Perspective view.
 -  **Reset View:** Resets the pan, rotation and zoom of the Perspective view.
5. This field displays the current zoom level in the Perspective view. You can use the Zoom menu to select a zoom level from 2.5% to 6400%. You can also select Fit To View to automatically use a zoom level that lets you see all of the scene layers and information in the Perspective view at once.

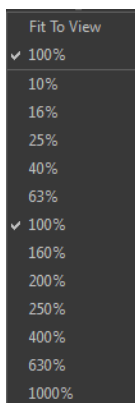



6. Displays the currently selected layer and drawing name.
7. Displays the currently selected tool.
8. Displays the currently selected frame of your animation.

- Displays the currently selected colour in the palette.

Side View

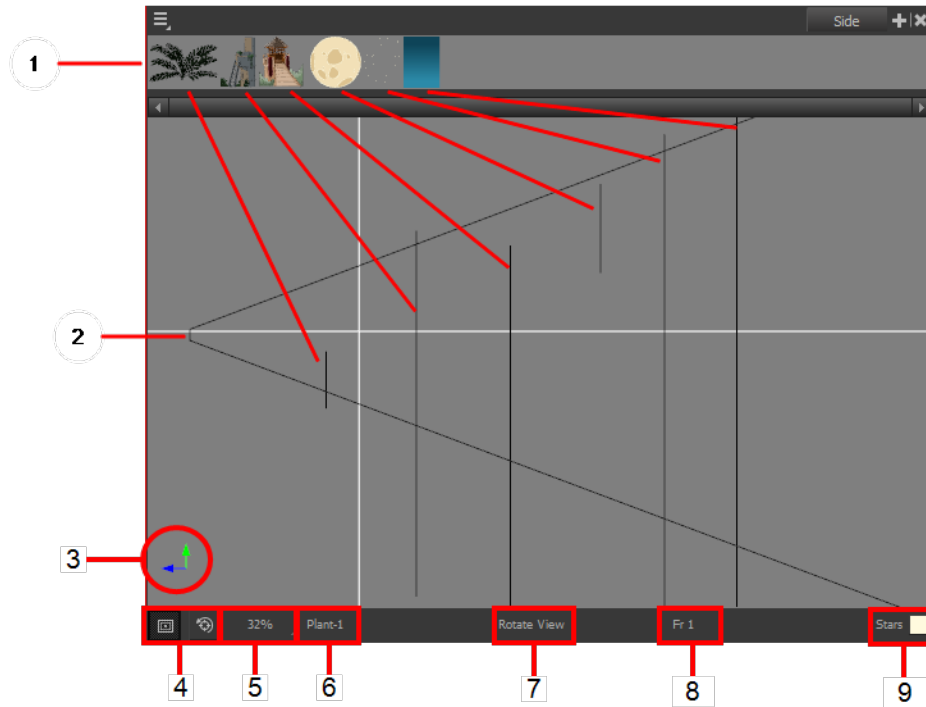
The Side view is used mainly for multiplane scenes and to position elements in 3D Space. It allows you to see a scene's stage from the side. This lets the camera cone and spacing between the elements to be seen.



- A thumbnail of each drawing layer in the scene. The order of the thumbnail images is based on each element's FB position in the scene space. You can see a representation of the FB position of each layer in the camera cone.
- The camera cone represents the camera's position and field-of-view (FOV).
- The axis reference arrows let you maintain your orientation when navigating in the Perspective view.
- There are two view option buttons displayed in the lower-left corner of the view.
 - ▶  **Show/Hide Camera:** Shows or hides the camera frame in the Perspective view.
 - ▶  **Reset View:** Resets the pan, rotation and zoom of the Perspective view.
- This field displays the current zoom level in the Perspective view. You can use the Zoom menu to select a zoom level from 2.5% to 6400%. You can also select Fit To View to automatically use a zoom level that lets you see all of the scene layers and information in the Perspective view at once.

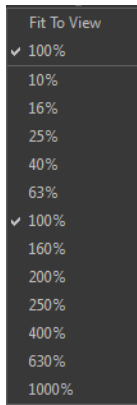



6. Displays the currently selected layer and drawing name.
7. Displays the currently selected tool.
8. Displays the currently selected frame of your animation.
9. Displays the currently selected colour in the palette.

Perspective View

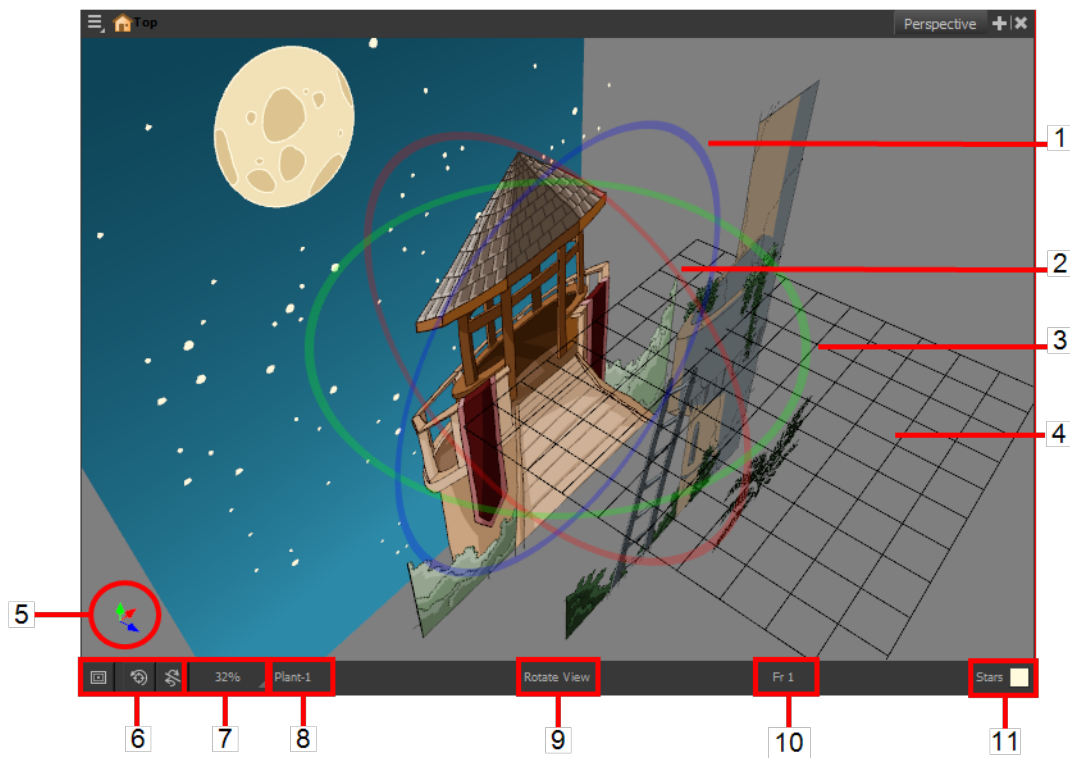
The Perspective view is used during scene setup. It allows you to see a multiplane scene's orientation. The Perspective view is similar to a 3D display, as it lets you rotate the scene through all possible angles to understand the spacing between the elements. You can also position and rotate your layers and the camera inside the 3D display to achieve some 3D setup and camera moves.



1. The red circle rotates the view on its X axis.
2. The green circle rotates the view on its Y axis.
3. The blue circle rotates the view on its Z axis.

4. This is a perspective grid reference.
5. The axis reference arrows let you maintain your orientation when navigating in the Perspective view.
6. There are three view option buttons displayed in the lower-left corner of the view.
 - ▶  **Show/Hide Camera:** Shows or hides camera frame in the Perspective view.
 - ▶  **Reset View:** Resets the pan, rotation, and zoom of the Perspective view.
 - ▶  **Reset Rotation:** Resets the rotation of the Perspective view.
7. This field displays the current zoom level in the Perspective view. You can use the Zoom level drop-down menu to select a specific zoom level from the list. Zoom levels from 2.5% to 6400% are available; you can also select Fit To View to automatically use a zoom level that lets you see all your scene layers and information in the Perspective view at once.

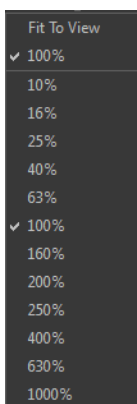

8. This field displays the currently selected layer and drawing name.
9. This field displays the currently selected tool.
10. This field displays the currently selected frame of your animation.
11. This field displays the currently selected colour in the palette.

How to rotate a scene in the Perspective view

1. In the Tools toolbar, select the Rotate View  tool.
 - ▶ Click in the view, and drag the cursor around to rotate the view.
 - ▶ Press and hold Ctrl + Alt (Windows/Linux) or ⌘ + Alt (Mac OS X) and click and drag to rotate the view one axis at a time.

Orthographic Camera

The orthographic camera is specific to the gaming pipeline. It changes the camera type from perspective to orthographic. It becomes a camera without vanishing points. This means there is no more perspective in the Camera view. Objects, when moved on the Z-axis, will not change in size or scale.

Refer to the Gaming Guide to learn more about orthographic cameras and exporting animation for interactive games.



The orthographic camera can be set in the Scene Settings dialog box. In order to create scenes with the orthographic camera, by default, you need to create a new custom scene resolution. Refer to the Fundamentals Guide to learn about custom resolutions.



How to set an orthographic camera

1. From the top menu, select **Scene > Scene Settings**.
2. Select the **Resolution** tab.
3. In the Projection section, select **Orthographic** option.

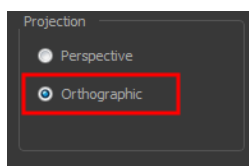

Chapter 3: 3D Space



Harmony is well known for its multiplane space where you can move your layers forward and backward on the Z-axis. Harmony brings you a true three-dimensional space where you can actually rotate your camera and layers on all axes. This lets you perform a 360 degree rotation around elements, create a floor and even build sets!

If you are using 3D effects in your animation, do not render your project as a SWF as these effects are not supported by that format.

This chapter contains the following topics:

- [Enabling the 3D Option on the next page](#)
- [3D Tools on page 180](#)
- [Positioning Elements in 3D Space on page 184](#)
- [3D Camera Motion on page 192](#)

Enabling the 3D Option

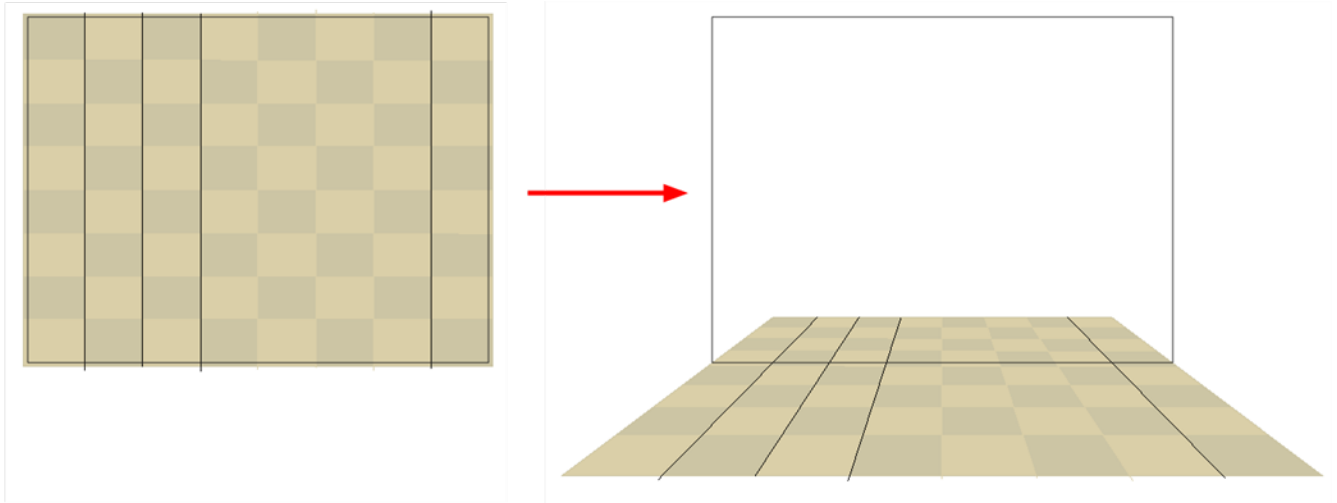

Before you can rotate layers in three axes instead of two, you must enable the 3D option in the layer properties. By default, when you create layers in Harmony, you can only move them as flat layers.

How to enable the 3D option

1. In the Timeline view, select the layer you want to move in 3D space.

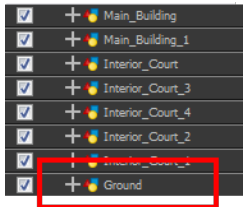

2. Double-click on the selected layer to open its Layer Properties dialog box.
3. Select the **Transformation** tab.

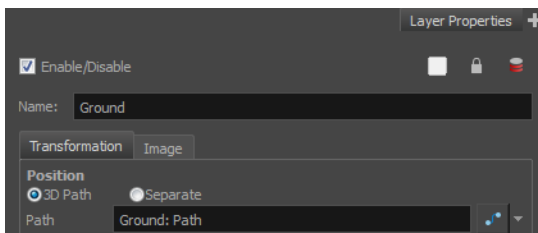

4. Select the **Enable 3D** option to display the 3D parameters for that layer.
5. Click **Close**.

New parameters appear in the Layer Properties window.

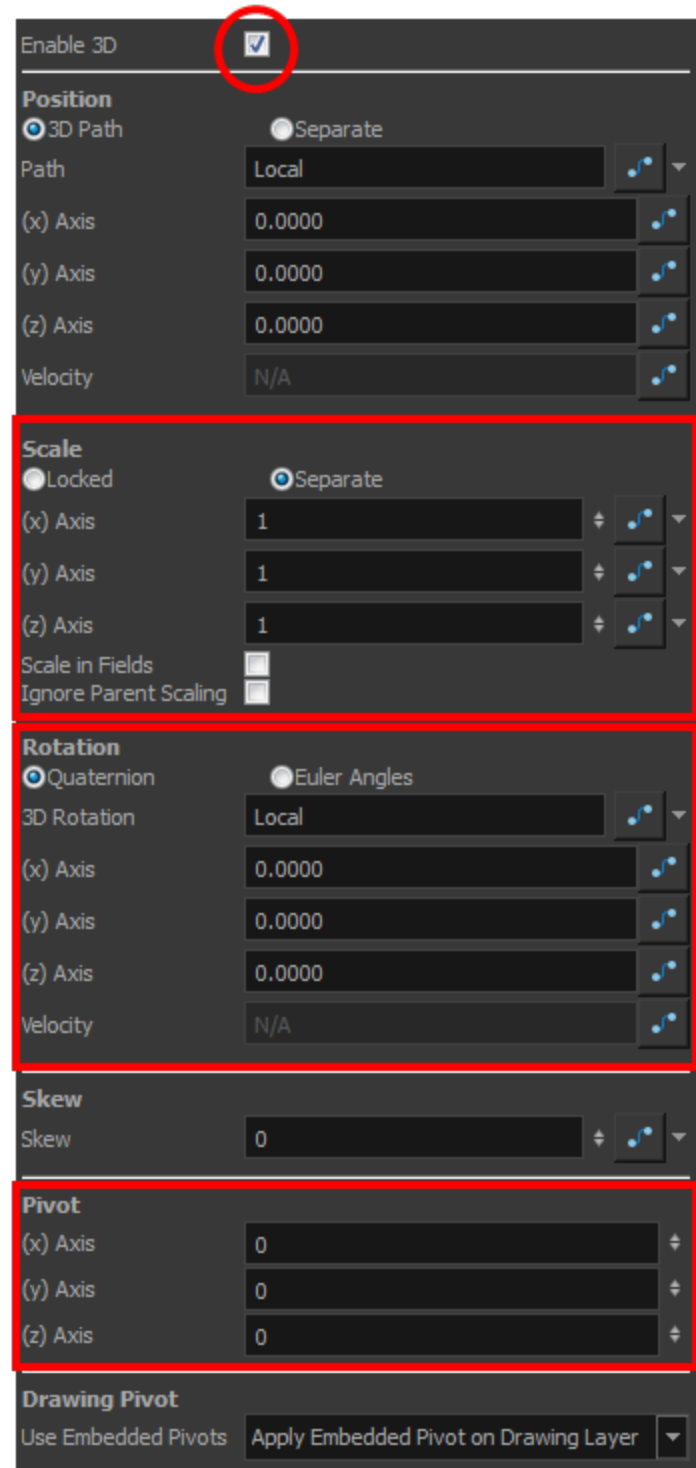
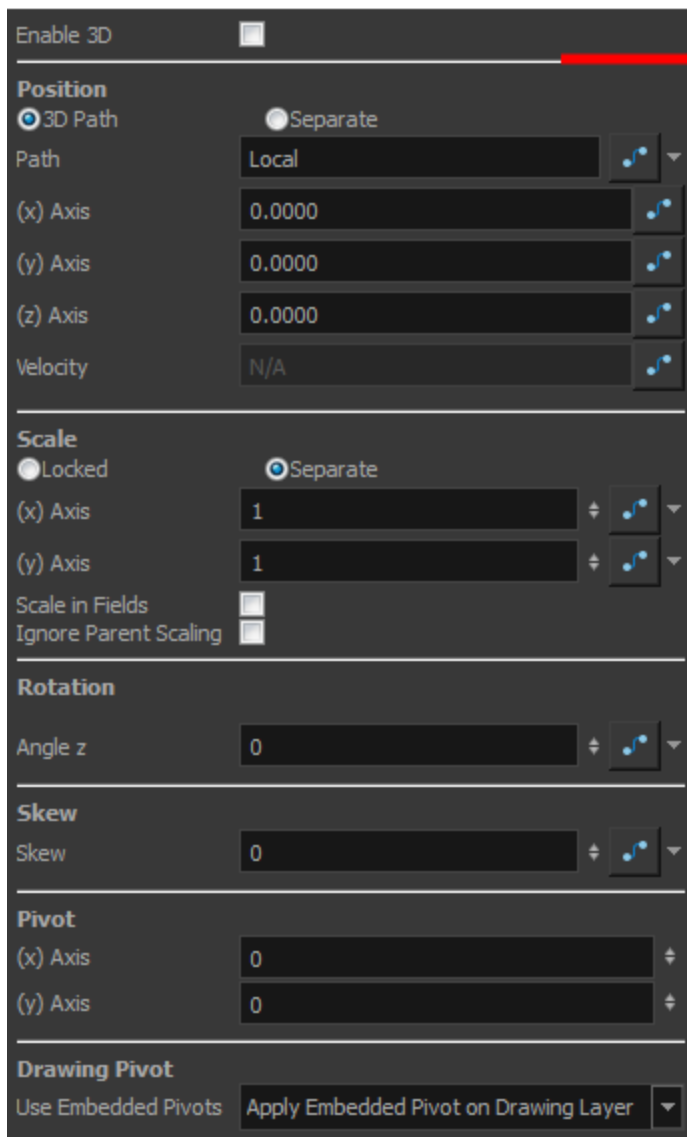

3D Parameters

When working in 3D, notice that three sets of parameters are modified:

- Scale below
- Rotation on the facing page
- Pivot on page 179

Scale

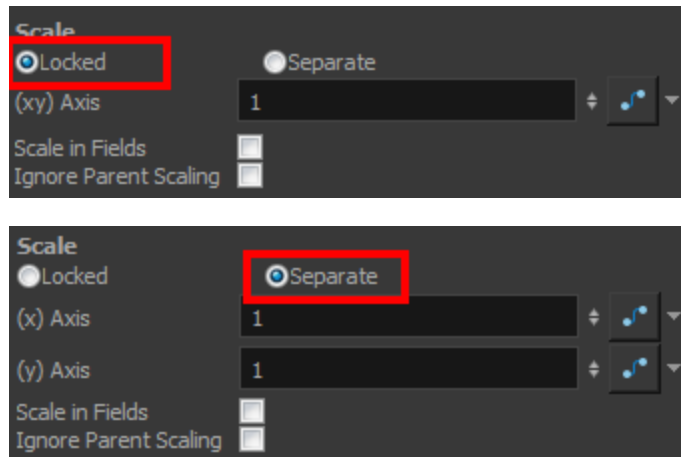

When using 3D, the Z-axis parameter appears in the list of settings. You can have the Scale locked or separated. When the Scale is locked, the object you are scaling is uniformly resized in three directions. When the Scale is separated, the object you are scaling can be squashed and stretched in any direction without affecting the other ones.

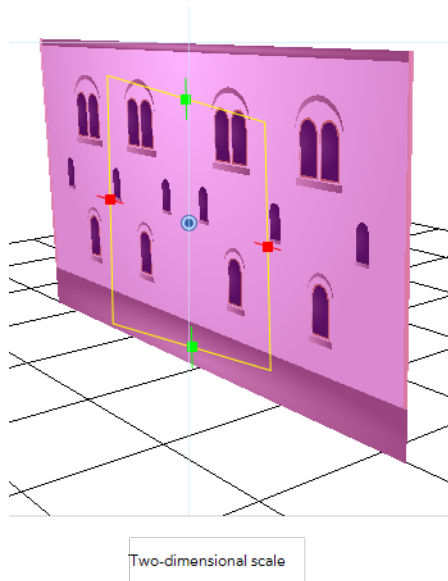

You cannot add thickness to an object by scaling it in the third dimension. Three-dimensional scaling is used to scale objects that were rotated on their axes or to scale a group of objects laid out in three dimensions.

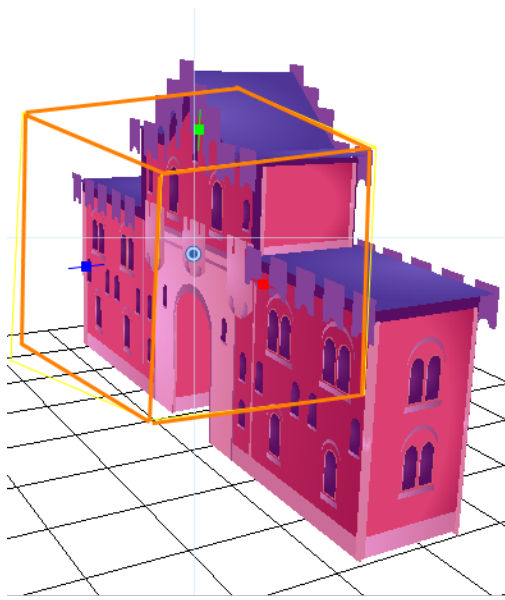

Three-dimensional scale

Rotation

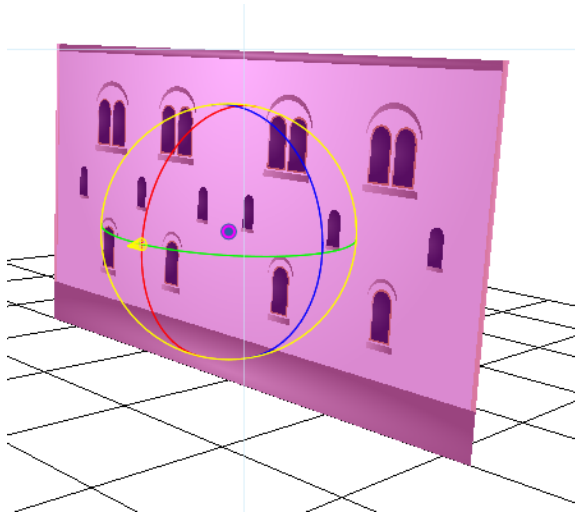

The main parameter you will use when working in three-dimensions is rotation. Without using 3D rotation, you are simply working using the multiplane technique.

3D rotation can be used in two different ways:

- Quaternion Rotation below
- Euler Angles Rotation below

Quaternion Rotation

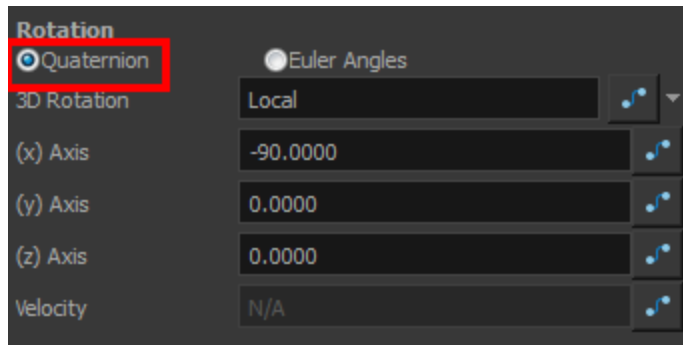

Quaternion Rotation is very similar to the 3D path position parameters. A Quaternion is composed of three rotation functions: X, Y and Z to control the rotation on three axes, and a velocity function to control the velocity of the three rotation functions simultaneously.

The X, Y and Z functions are linked. When you add a keyframe on one of them, it also adds it to the two others.

If you are planning to animate an element such as the camera, you should use the Quaternion rotation rather than Euler Angles. Quaternion creates a smooth trajectory and interpolation since the path is controlled by the same keyframes and a single velocity.

Euler Angles Rotation



The Euler Angles Rotation is very similar to the Separate position parameters. The Euler Angles parameter is composed of three functions: X, Y and Z to control the rotation on three axes. These three functions are independent of each other; each has its own velocity.

When you add a keyframe on one function, the other ones do not receive it, allowing you to control each axis independently.

Euler Angles are mainly used to position elements with exact coordinates and rotate elements on a single axis. The interpolation between the keyframes will not be as smooth as the Quaternion one since each function works individually.

Pivot

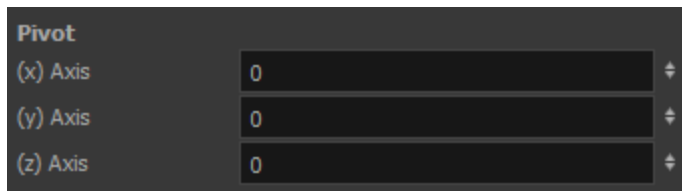

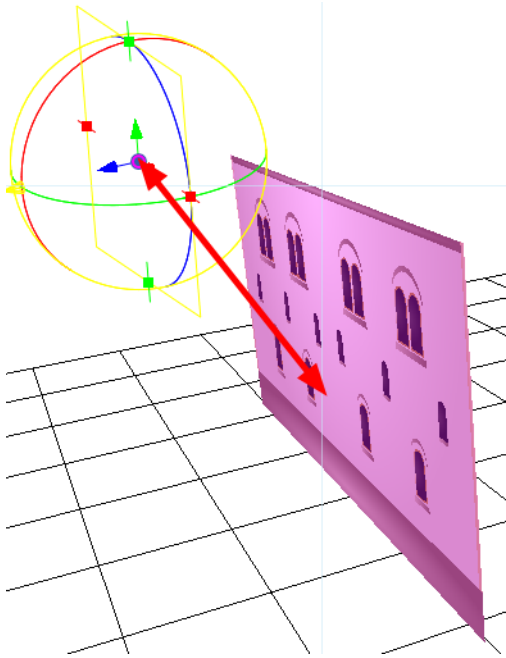

When working in 3D, the drawing or layer pivot becomes a location that can move on three axes. When you work in two dimensions, the pivot is mainly an anchor point somewhere in the drawing from where the transformations will be performed. In 3D, the transformations are made on three axes, so the centre of rotation and scaling also becomes three-dimensional.

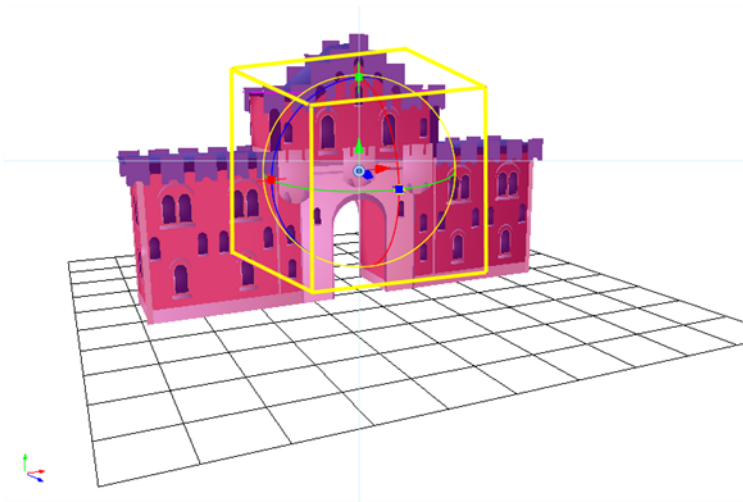

By default, the pivot is positioned at the centre of the stage: (0,0,0). When you use the Pivot  tool to reposition the centre of transformation, the pivot position is changed on the X and Y axes, but the Z-axis remains at zero until you change it in the Top, Side or Perspective view using the transformation tools.

3D Tools



Once the 3D option is enabled, your transformation tools become 3D transformation tools. These tools are found in the Advanced Animation toolbar as well as the Transform  tool. Instead of letting you move elements only on the X and Y axes, you can also manipulate them on the Z-axis.

3D Translate Tool

Once you enable the 3D option, the 3D Translate  tool becomes available and you will see direction arrows appear around the pivot points to indicate the different axes.

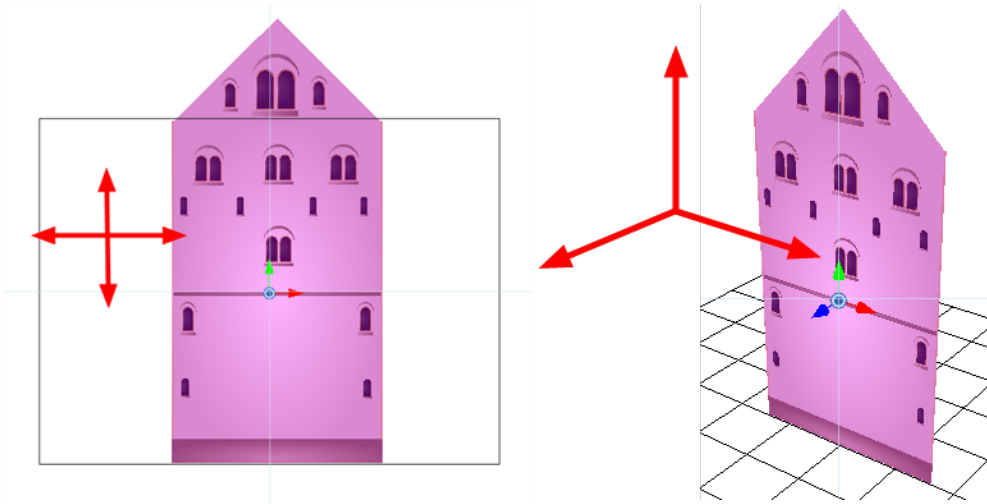

You can click on the direction arrows to move your layer on only one axis. If you click anywhere else, the layer can move freely on two axes at once. Once the arrow is selected, it will turn pink.

If you move the layers in the Perspective view, it may be difficult to control the motion since you may not have the optimum point of view on your stage to understand the setup. In this case, it is best to use the direction arrows.

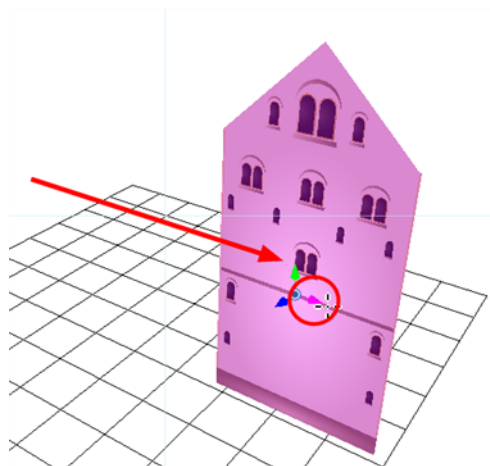

3D Rotate Tool

Once you enable the 3D option, the 3D Rotate  tool becomes available and you will see a rotation sphere appear around the pivot points indicating the different axes.

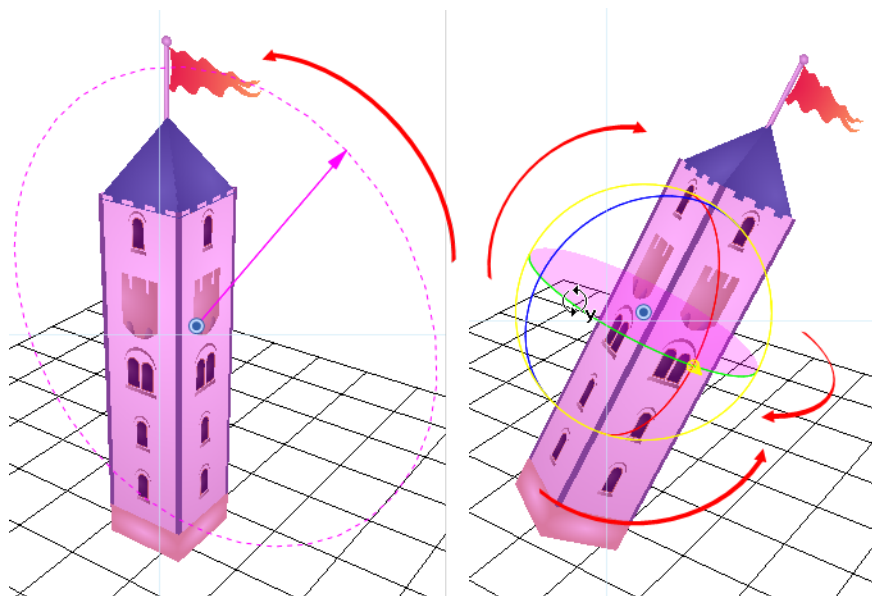

You can click on the direction ellipses to rotate your layer on one axis only. If you click anywhere else, the layer rotates freely on two axes at once. Once the ellipse is selected, it will turn pink.

If you move the layers in the Perspective view, it may be difficult to control the motion since you may not have the optimum point of view on your stage to understand the setup. In this case, it is best to use the direction ellipses.

3D Scale Tool

Once you enable the 3D option, the 3D Scale  tool is available. You will see one of two things:

- A scaling rectangle appears if your drawing is flat.
- A scaling cube appears if your object has some rotated layers around the pivot points, indicating the different axes.

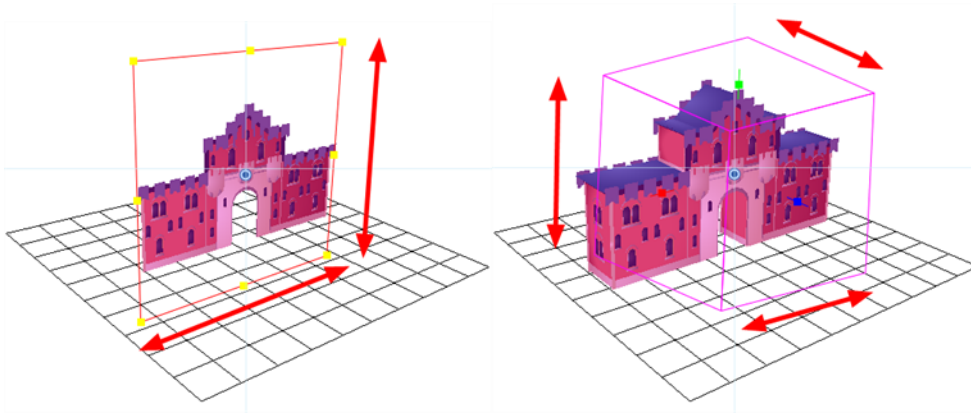

Click on one of the three control points to scale the shape on one axis. Hold down the Shift key to scale the object proportionally. Once the control point is selected, it will turn pink.

If you move the layers in the Perspective view, it may be difficult to control the motion since you may not have the optimum point of view on your stage to understand the setup.

3D Transform Tool

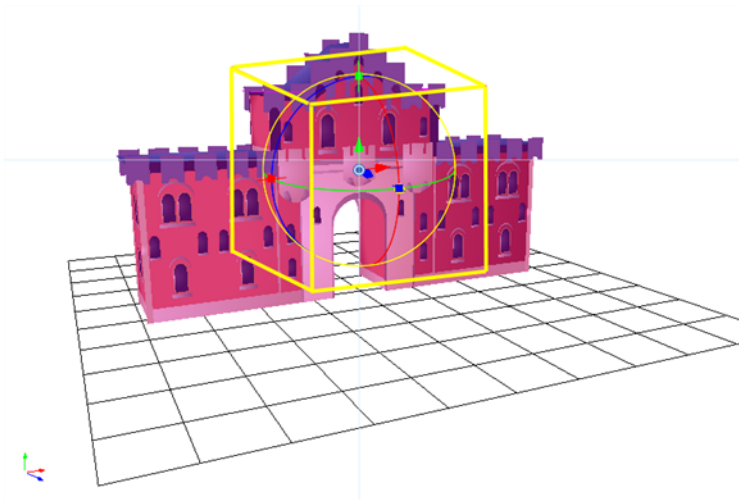

Once you enable the 3D option, the 3D Transform tool become available. This tool is a combination of the 3D Translate, 3D Rotate and 3D Scale tools.

To translate an element, grab the direction arrows in the same way that you would with the Translate tool.

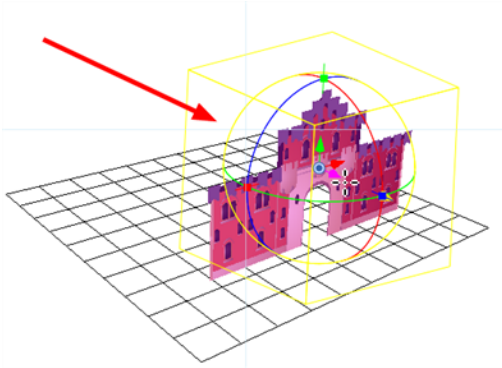

To rotate an element, grab the rotation ellipses in the same way that you would with the Rotate tool.

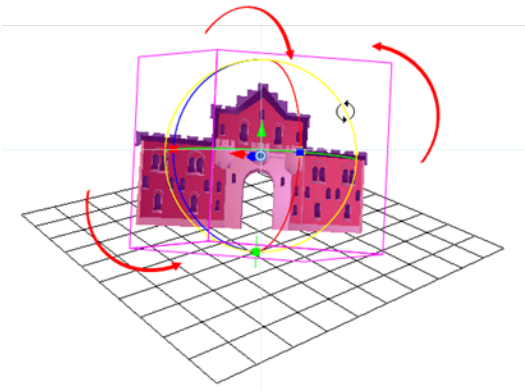

To scale an element, grab the scaling control points in the same way that you would with the Scale tool.

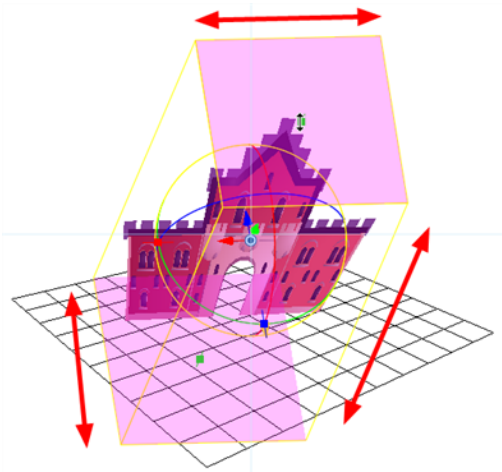

Positioning Elements in 3D Space

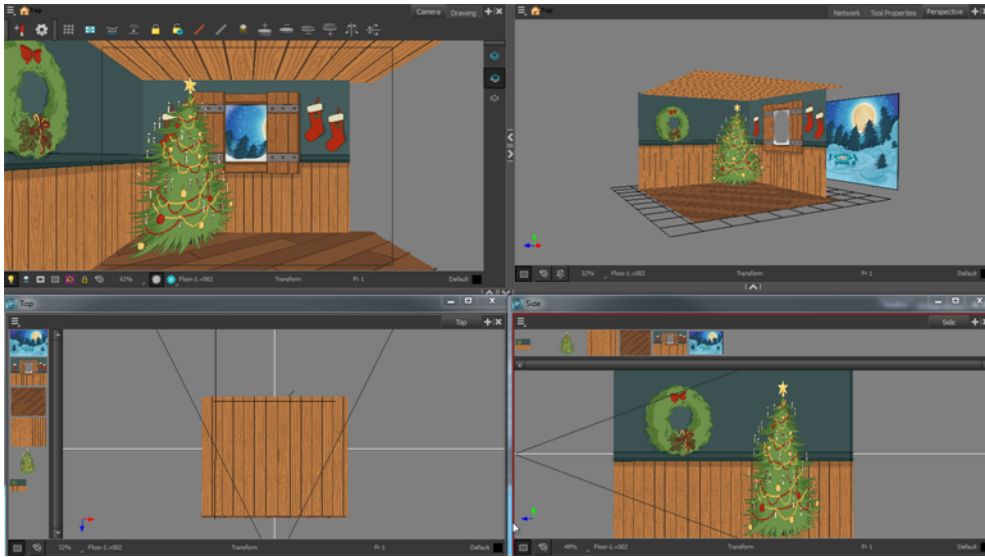

To position elements in 3D space, you need to understand what you want to build and what is involved in building it.

Simple sets like the above one are easy to build, light to manage and probably what you will use 3D staging for most often.

If you have a project based on a room, it can be useful to build it in 3D. This saves you from having to redraw the background for each scene and it will be entirely vector based.

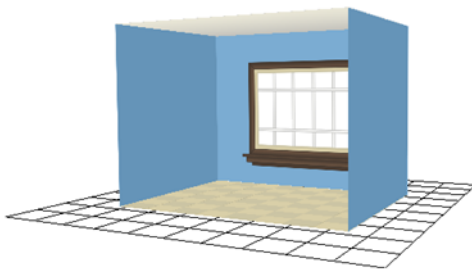

Here, you can see some of the different backgrounds you can get in only three seconds from this set.



Planning Your Pieces

When you are building a room, there are only a few pieces to prepare. Before starting to build your set, map out the parts you need.

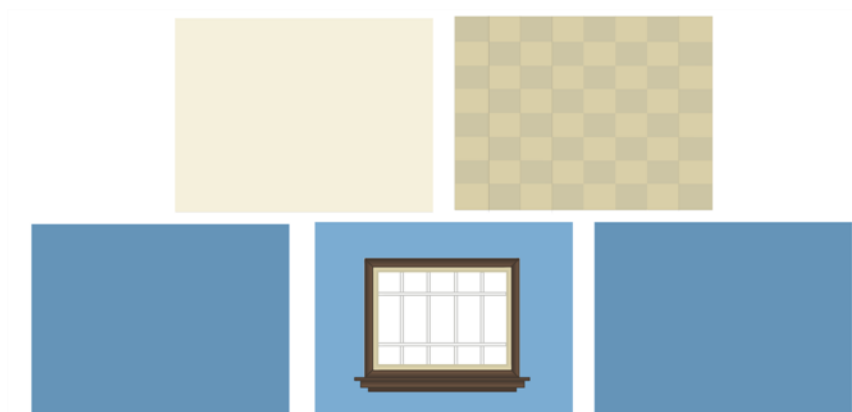

A complex set that is more intricate in its design will require more careful planning. Not only will you have to list the pieces you need, but you will also have to think about what can be reused. If you have a series of windows in your set, you would create a symbol from the drawing, rather than copy paste it several times all over your set. This way, if you need to make any correction to its design, you will only need to do it once and all the instances of your symbol throughout your set will be corrected. The same can be done with for each piece of your set.

Here is an example of all the source drawings required to build the castle.



These are the only drawings required to build the entire castle. As you can see, there are not that many considering the final result. The rest is constructed by assembling symbols and through reuse. However, keep in mind that although you are using simple drawings and symbols to optimize your set, the more you add to your project, the heavier the toll it takes on your machine's RAM. While the scene's package itself is really light, running the scene places heavy demands on your RAM and video card.

Using the drawings shown previously, here are a couple of pieces that were put together.



Here is the final result. A large and impressive fortress.

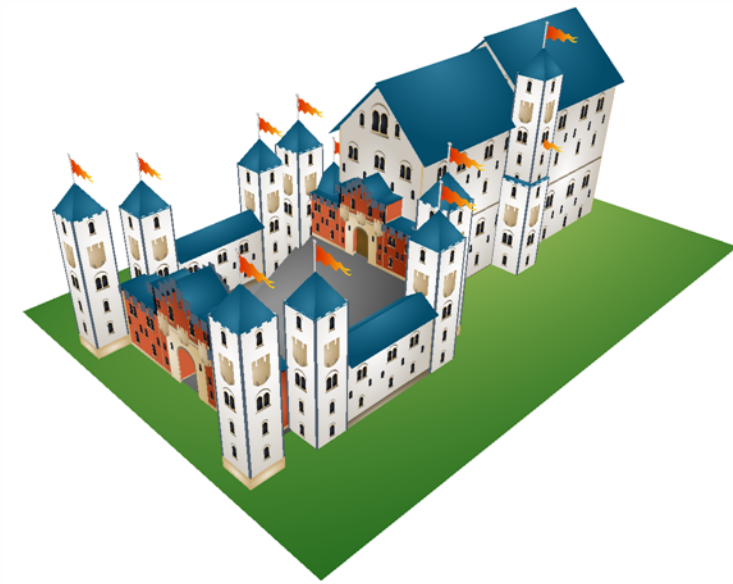

Using Complex Sets in Production Scenes

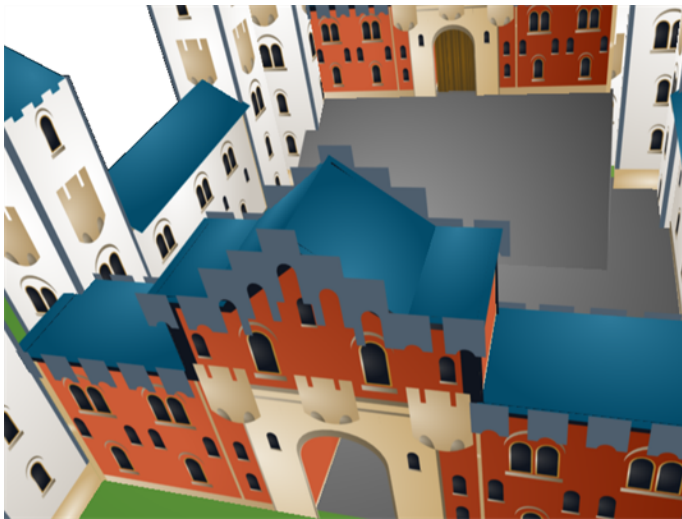

When your main set is built, you will want to store it in the Library. It is important to know that when you import such a large structure in one of your production scenes, the set may be slow to run. To avoid long rendering sessions or slow manipulation, remove all faces and planes that are not visible in your scene.

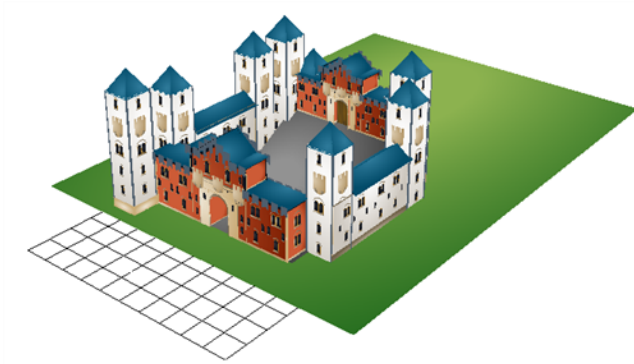

Positioning the Layers

Once your drawings and symbols are assembled, it is time to position them. This section explains how this is done using the example of a simple room.

To position your layers, the following elements are required:

- Camera view
- Top view
- Side view
- Perspective view
- Library view
- Timeline view
- 3D Transformation tools
- Layer Properties view or dialog box

How to position layers in 3D space

1. In the Timeline view, double-click on the new layer to open the Layer Properties dialog box.

- In the Transformation tab, select the **Enable 3D** option.

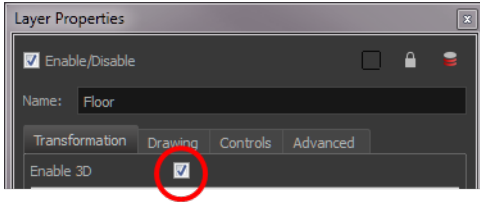



- In the Rotation section, select the **Euler Angles** option.

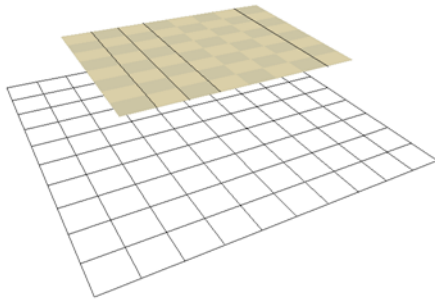

- In the (x) Axis field, type **90** to flip the floor so it is flat on the ground.



- To position the height of the floor, type values in the Position section of the Layer Properties, use the 3D Translate  tool or 3D Transform  tool.

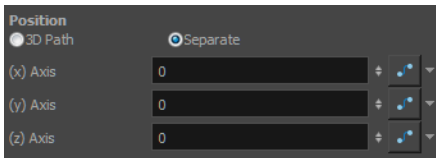

- Repeat the process for the other pieces to import.
- If you have parallel walls, once you have positioned one, select the Wall layer in the Timeline view.
- From the top menu, select **Edit > Duplicate** to duplicate the layer.

If the drawing is contained within a symbol, the symbol will not be duplicated, only the layer containing the symbol. This way, you are still using the same drawing.

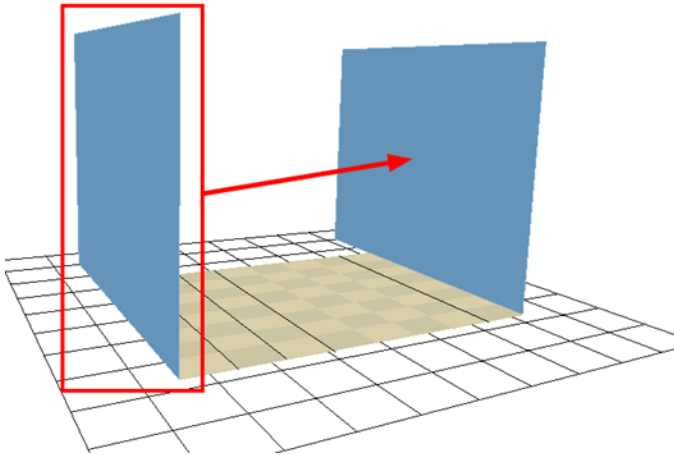

9. Once the layer is duplicated, use the Layer Properties window to enter the positioning values or use the 3D transformation tools.
10. When using the transformation tools, use the Camera, Top, or Side view to position the elements instead of the Perspective view to position your layers precisely.

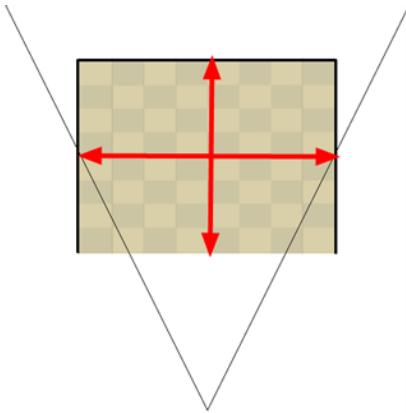

11. If your walls are touching each other, you should make them intersect by extending one end of the wall through the other wall. This prevents seeing a small gap between them.

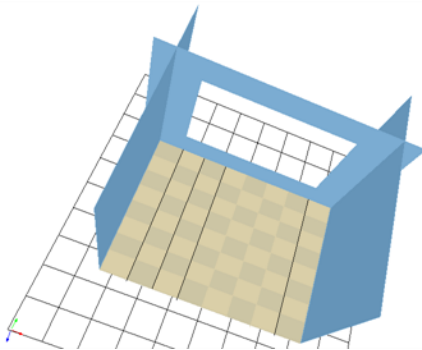

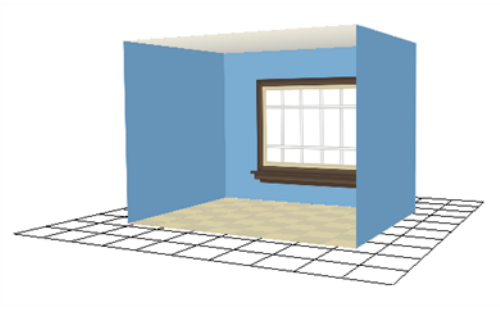

Now have a complete 3D room.



3D Camera Motion

Once you have a 3D set, the exciting part is to do a camera move in it. This section teaches you the main steps required to perform a 3D camera move. Once you know how to do this, you can enjoy the delights of working in 3D space and travelling through your creations!

How to create a 3D camera move

1. In the Tools toolbar, enable the Animate  mode.
2. In the Timeline view, click the Add Layers  button and select **Camera** to add a camera to your scene.
3. In the Timeline view, select the new camera layer.
4. In the Timeline Layer toolbar, click the Add Peg  button to add a parent peg to the camera.
5. In the Timeline view, double-click on the new peg layer to open the Layer Properties dialog box.

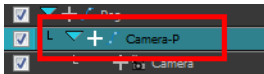

6. In the Layer Properties dialog box, go to the Transformation tab and select the **Enable 3D** option.

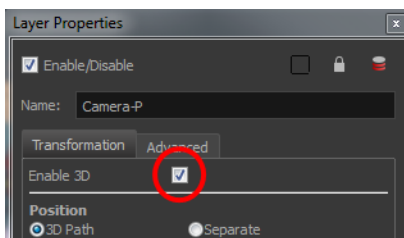

7. In the Rotation section, select the **Quaternion** option.
8. In the Perspective view, click the **Show/Hide Camera** button to see your camera cone.
9. Setup your workspace to display the Camera view and Perspective view at the same time so you can compare the results.

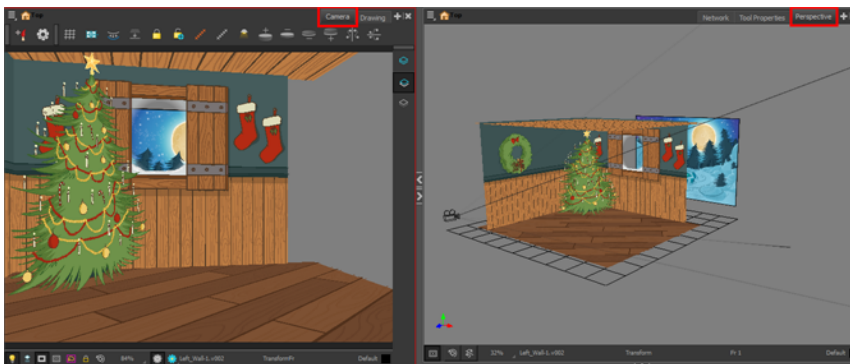

10. In the Tools toolbar, select the Transform  tool.
11. In the Timeline view, select the Camera-Peg layer first frame and select **Insert > Keyframe**.



12. In the Timeline view, select the **Camera-Peg** layer.

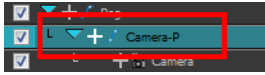

13. In the Timeline view, go to the last frame.

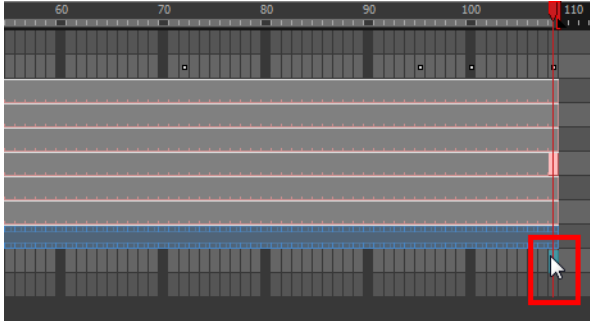

14. In the Perspective view, grab one of the rotation ellipses and rotate the camera on one axis only. Always do one axis at a time to keep control of the positioning.

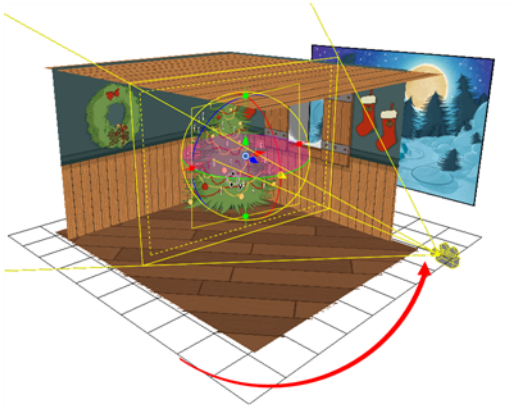

15. Once the camera is rotated at the correct angle, grab one of the direction arrows to move the camera to the correct position.

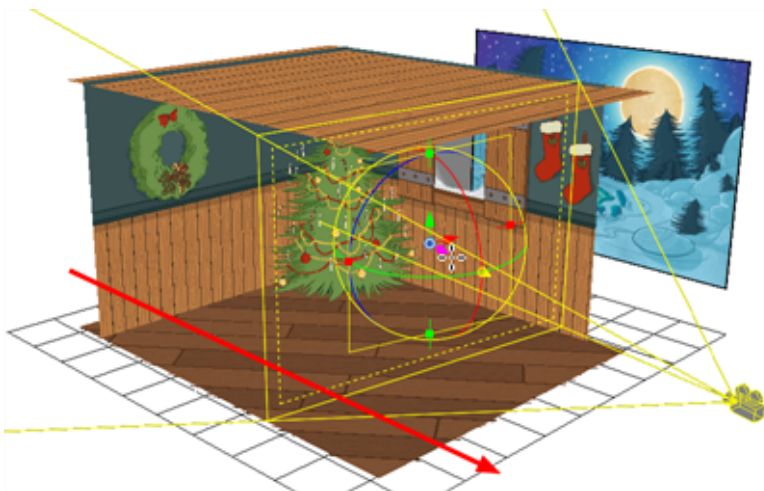

Camera Clipping Planes

You can change the near and far clipping planes of the camera. The near plane is the point on the camera cone where the camera is located. The far clipping plane is the far end of the camera cone. Nothing outside that range is visible. This is useful when dealing with 3D elements and 3D sets. For example, the camera can be looking inside a 3D box or room and you might want the foreground wall to not obstruct the view of the interior. By default, the near clipping plane is set to 1 field and the far clipping plane is set to 1000 fields.

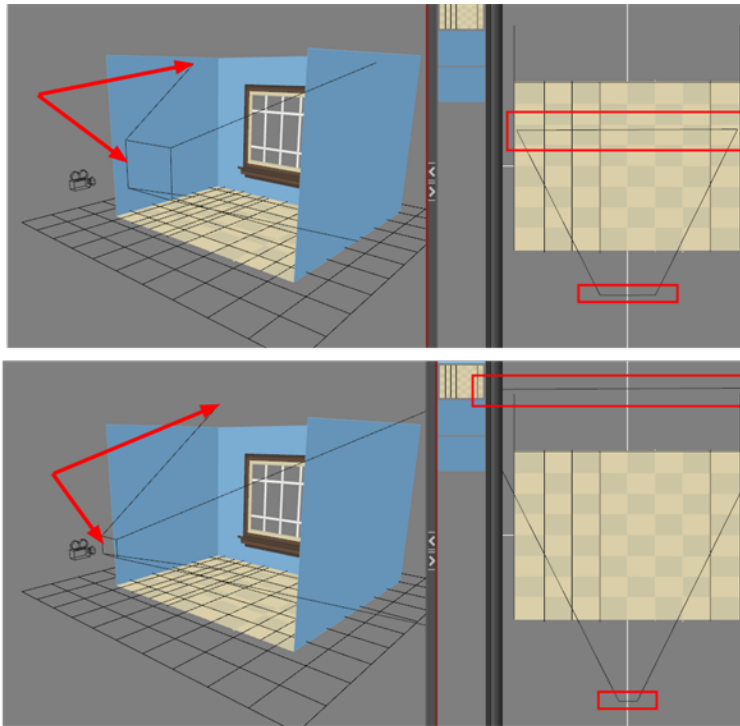

How to modify the camera clipping plane

1. In the Timeline or Network view, select the Camera module.
2. In the Layer Properties view, go to the **Clipping Planes** section.

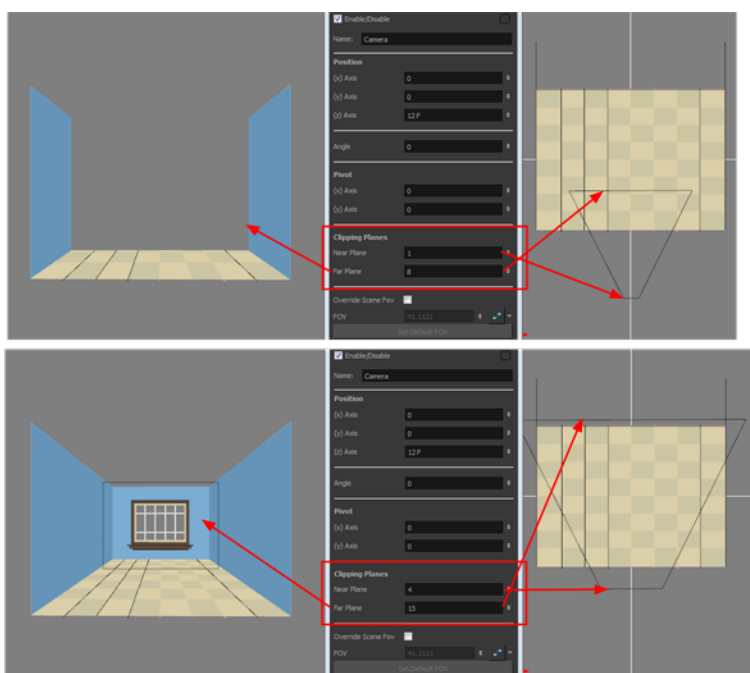

3. Modify the value of the Near Plane to pull or push the clipping area closer to the camera. Anything behind this plane will no longer be visible.
4. Modify the value of the Far Plane to pull or push the clipping area closer to the camera. Anything beyond this plane will no longer be visible.

Playing Back Your 3D Camera Moves

If you want to view your 3D camera move, you must be in the Perspective view.

How to enable the playback mode in 3D

1. From the top menu, select **Play > Enable Playback > Perspective View**.
2. In the Playback toolbar, click the Play  button to see the results.

Locking Flat Drawings to the Camera Angle



When you create a 3D camera move in your scene, notice that layers are treated as flat objects. That is, animation layers that are supposed to face the camera at all times will look like a flat sheet of rotating paper. Use the Ortholock layer when mixing flat animation layers with a set built in 3D.

Ortholock forces your drawing layer to always follow the Camera angle. It does not follow its position or zooming level, only the rotation. This prevents drawings from being distorted by the camera motion.

Adding an Ortholock layer in a symbol will not give the correct result. The Ortholock contained inside a symbol does not consider the position of the camera contained in the root scene. Keep your Ortholock layers in the root scene.

How to add an Ortholock layer

1. In the Module Library view, select the **Move** tab.
2. Select the **Ortholock** module and drag it to the Network view.
3. In the Network view, drag an output cable from the Ortholock module and connect it to the module you want to keep facing the camera.

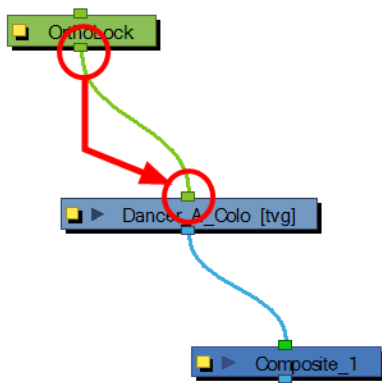

Managing a Network with a 3D Scene Setup

In Harmony, you can create very advanced networks using effects, complex connections and multiple-level compositing.

The Composite module's main task takes all of your image's output and converts it into a single flat image that you can render out. You can alter it further by manipulating a three-dimensional scene setup. You can also modify a Composite's behaviour as seen in the [Scene Setup on page 85](#) chapter.

Input and Output Options

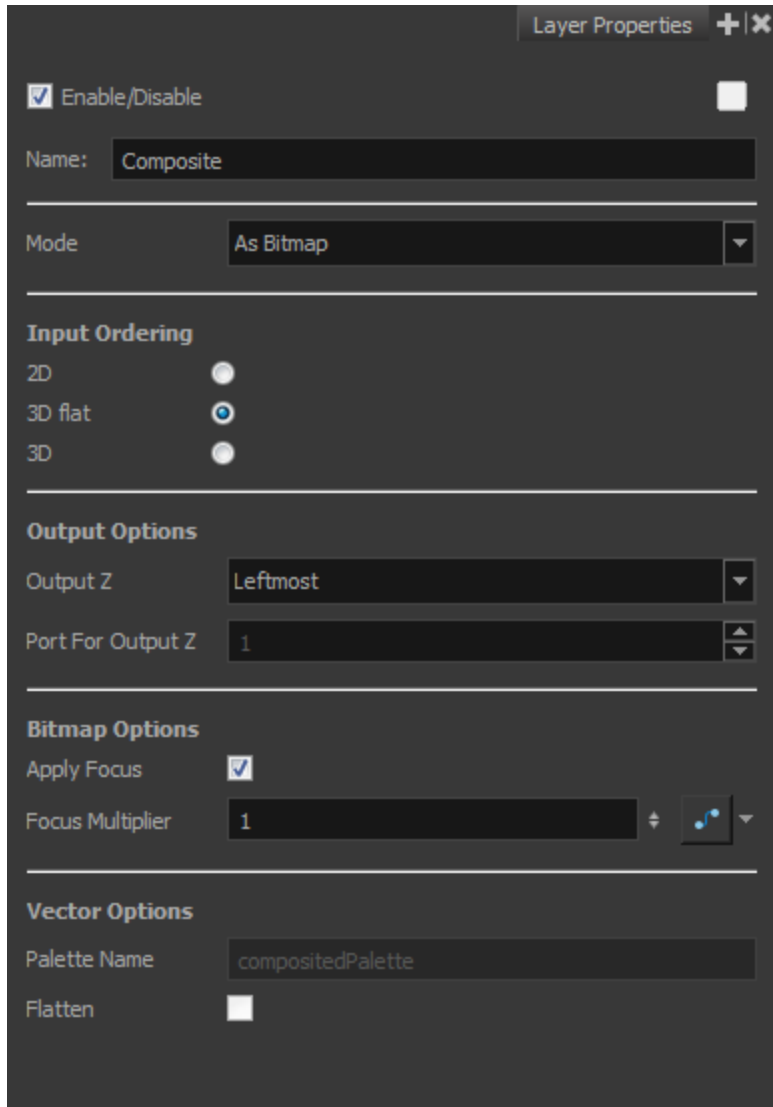

The default options combination is:

- As **Bitmap**, for the output behaviour
- **3D flat**, for the input ordering

By default, a Composite module is set to output a flat bitmap image and to correctly composite elements positioned in 3D space.

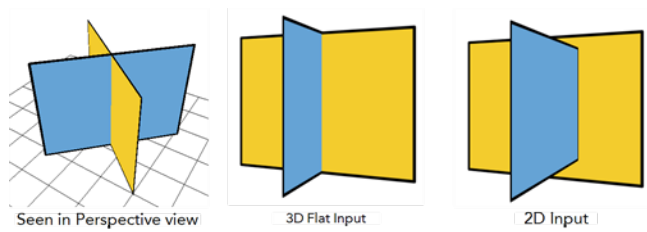

For example, if you have two intersecting walls, and use the default combination, you will see the following result:

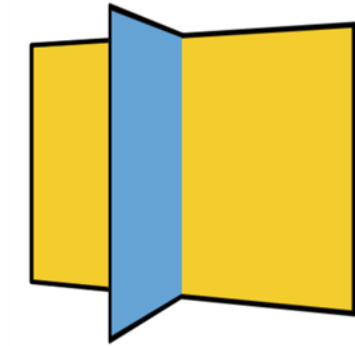

This image is correctly represented in the Camera view and is output from the Composite module as a flat drawing. The Z-axis value of your elements are not retained, it becomes an independent composition with only one forward-backward value.

When building a 3D set out of planes, it is recommended that you set the composite mode to As Seamless Bitmap. This avoids intersection issues when rendering the 3D objects created out of planes.

3D Input Ordering Option

The visual result for the 3D Input Ordering option is the same as the 3D Flat option. The visual result in the Camera view will be correct, but the elements will not be converted into a flat image. The 3D position of your images will be remembered until the next Composite module. This mode is quite advanced and should only be used in very advanced cases. Most of the time you will use the 3D Flat Input ordering option.

2D Input Ordering Option

If you switch the Input Ordering option to 2D, the walls will be calculated as flat 2D objects and not as 3D objects. The perspective caused by the 3D rotation will be correctly represented, but the elements will not intersect. The result will be similar to the following:

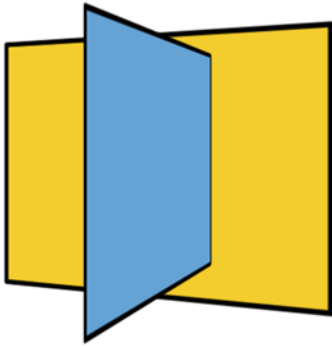

How to Organize Your 3D Composite Modules

If you start combining several composite modules in your Network view, it is important to understand how they work if you want to get the desired result.

There is a specific order in which you should set your Composite modules. Each time you process images through a 3D Flat Composite module, the images will be merged together. Images processed in later Composite modules cannot be inserted between images of the previous composite since it is a flat image.

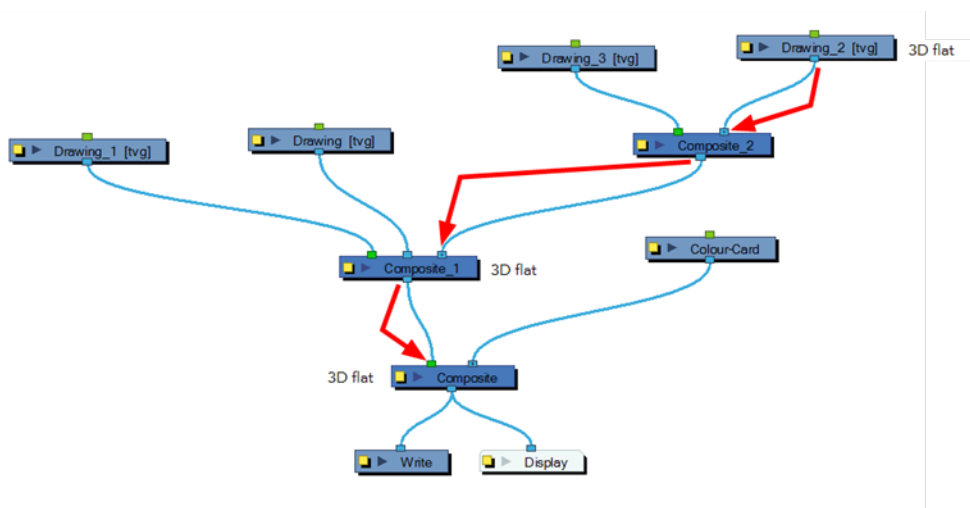

If you used Pass-Through type Composite modules in your network, the images will not be processed together before the final Composite. It is important to keep your final Composite as a 3D Flat Composite in order to read the layer ordering correctly.

The most efficient networking system for obtaining the desired result is likely the Pass-Through composite mode throughout the whole network. This way, you can create individual compositions to keep your network clean and organized, but process everything together at the end.

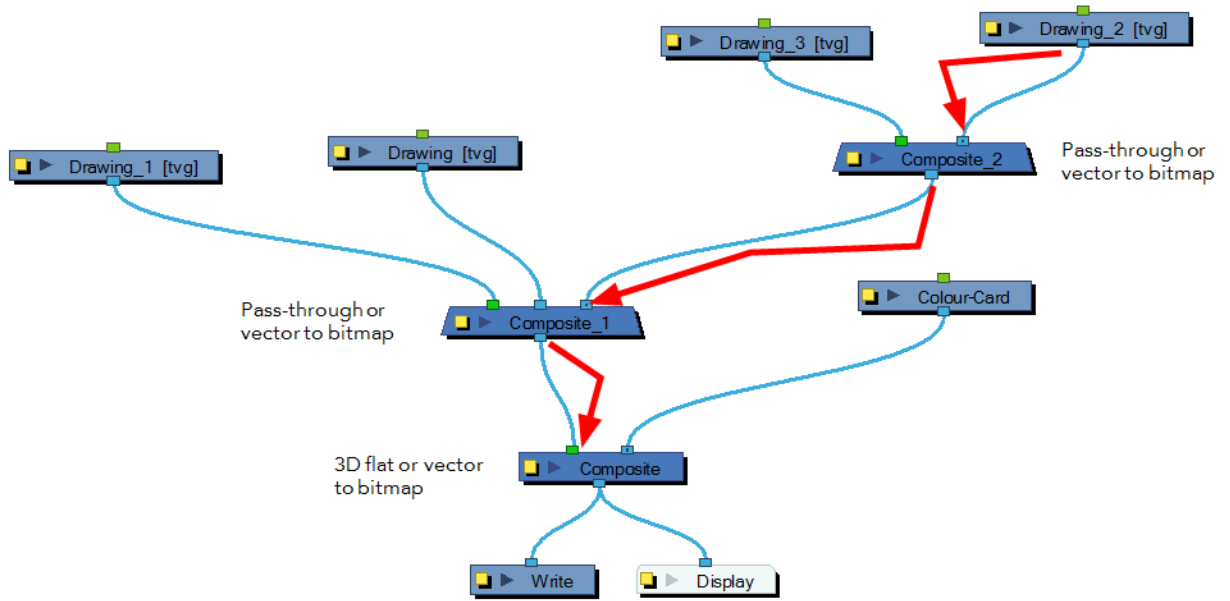

When building a 3D set out of planes, it is recommended that you set the composite mode to As Seamless Bitmap. This avoids intersection issues when rendering the 3D objects created out of planes.

Chapter 4: Animation Paths

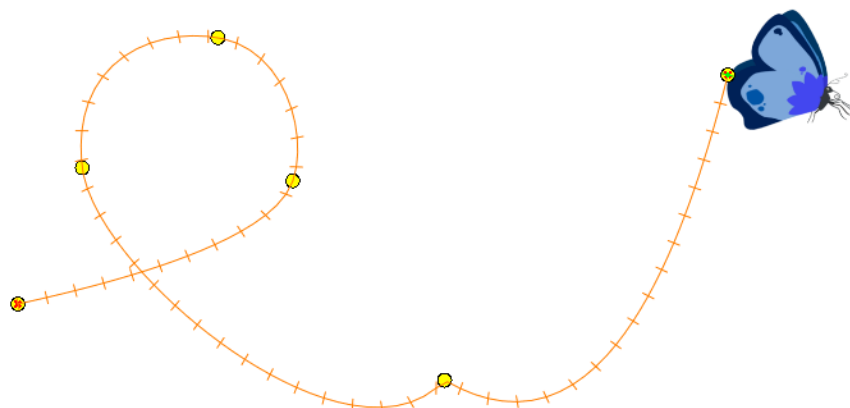

With Harmony, you can animate layers using computer-generated trajectories, create multiplane camera moves and camera shakes, adjust the easing, shape your paths with control points and much more.

This chapter contains the following topics:

- [Animating a Layer on the next page](#)
- [Differences between Pegs and Animated Layers on page 204](#)
- [Layer Parameters on page 211](#)
- [Adding and Deleting Keyframes on page 214](#)
- [Motion and Stop-motion Keyframes on page 216](#)
- [Animating the Camera on page 221](#)
- [Modifying a Path in the Camera, Top and Side Views on page 228](#)
- [Modifying a Path in the Timeline View on page 236](#)
- [Modifying a Path in the Function View on page 239](#)
- [Modifying a Path in the Xsheet View on page 246](#)
- [Function Curves on page 248](#)
- [Copying and Pasting a Motion on page 255](#)
- [Adjusting the Ease on page 265](#)
- [Expression Columns on page 271](#)

Animating a Layer

Before animating the position of drawing layers, you need to create motion paths which are trajectories on which you can attach drawing objects. Using keyframes, you can then record key positions along the trajectory.

Harmony's wide range of features let you produce simple and advanced motions and trajectories. By creating a simple motion, you will learn the basics animating a layer.



The Animate mode lets you keyframe drawing layers to create computer-generated animation. When the Animate mode is enabled, you can animate a layer's position and disable it to reposition a layer for the entire scene. In this mode, keyframes are created on selected layers at the current frame.

Depending on what transformations were performed (rotation, translation, skew, etc.), the new keyframes are added on the corresponding parameters (function curves).

How to turn the Animate mode on or off

1. In the Tools toolbar, click the Animate  button or select **Animation > Animate**.

How to animate a layer

1. In the Tools toolbar, select the Transform  tool or press Shift + T.
2. In the Tool Properties view, make sure that the Peg Selection Mode  is deselected.
3. In the Tools toolbar, enable the Animate  mode. This will create keyframes at the current frame when moving objects.
4. In the Timeline view, go to the first frame.



5. In the Camera view, select the element to animate and move it to its first position.

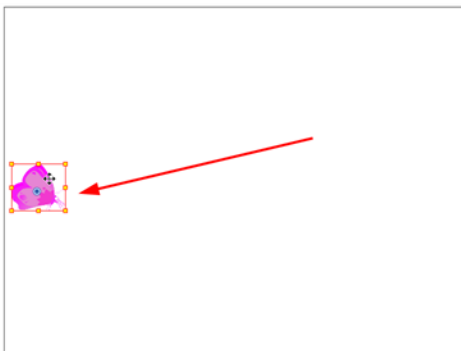

A keyframe is created on the first frame of the Timeline view.

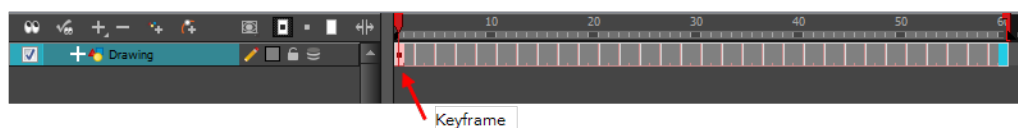

6. In the Timeline view, go to the frame on which you want to set the second position.

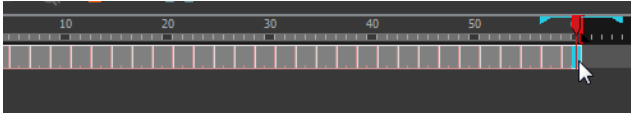

7. In the Camera view, move the element to its second position.

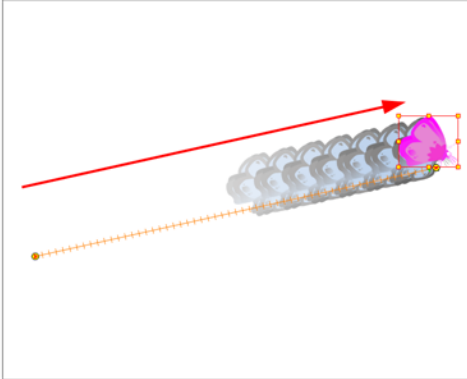

A second keyframe is created on the Timeline view.



8. Play back  your animation.

To see your motion animations in the Top, Side or Perspective views while you play back, you must turn on the Playback option. From the top menu, select **Play > Enable Playback > Top View** or **Side View** or **Perspective View**.

Differences between Pegs and Animated Layers

There are two ways to create motion paths: animated drawing layers and pegs. They each have different purposes.

You can create a motion path directly on layers (animated layers).

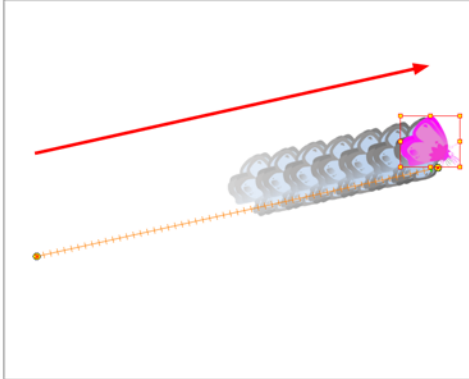

You can control and define a trajectory using several different parameters, including:

- X, Y and Z positions (3D Path or Separate Positions)
- Angle (rotation)
- Skew
- X and Y Scales
- Euler Angle or Quaternion Angle (when 3D option is enabled)
- Z Scale (when 3D option is enabled)

Each parameter has its own function curve where you can add keyframes and control the easing.

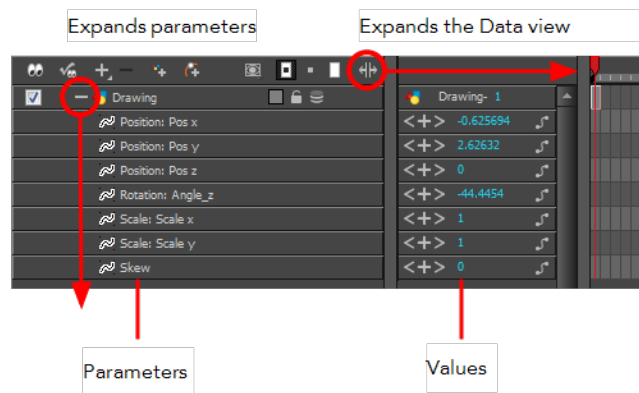

If you are not familiar with graphs and function curves, Harmony has a series of easy-to-use tools for visually controlling trajectories in the Camera and Timeline view.

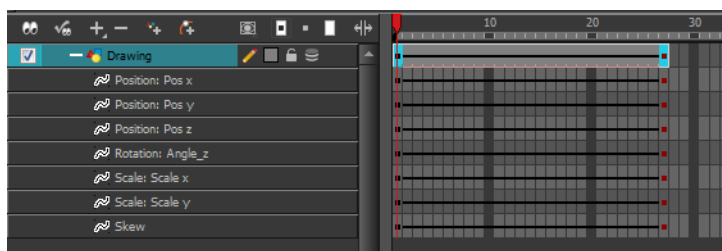

By default, a drawing layer can be animated using the same parameters as a peg, but you can disable this feature. Being able to switch your drawing layers so they can no longer be animated without a peg has certain advantages. In cut-out animation, it is easier to separate drawing exposure and keyframes to change the timing easier and rearrange keyframe position in the Timeline view. This also works for backward compatibility when bringing in templates created in older versions of the software, so as not to lose their offset keyframes or drawing substitution keyframes.

If you do not want to animate a drawing layer, you have the option of disabling its animation parameter. To do so, simply select the layer and in the Layer Properties view, deselect the **Animate Using Animation Tools** option on the Controls tab.

If your layer was already animated and you deselect the Animate Using Animation Tools option, your keyframes will be dimmed, enabling you to easily identify them as ones that cannot be modified. Select the Animate Using Animation Tools option in order to modify them again.

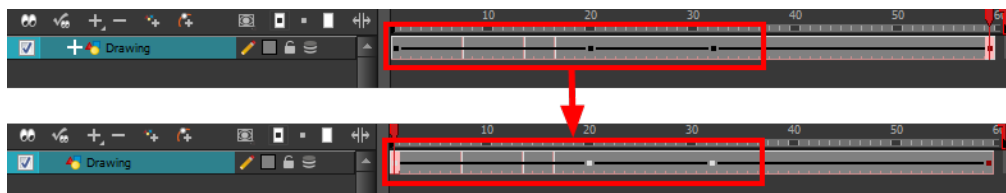

A Peg layer is a trajectory that contains no drawings on which you can hook your drawings.



Pegs have been used for a long time in the traditional animation process, mainly for registration purposes. Peg holes at the bottom or top of the animation paper are used to keep all the sheets even and at the same registration.

There are three peg holes in regular animation paper. The centre peg hole is round while the left and right ones are oval shaped. The oval peg holes are located on each side of the page, four inches away from the centre peg hole.

To keep the drawings together, the animator uses a peg bar. This peg bar has three pins that correspond to the shape and location of the peg holes. Peg bars are normally found at the bottom and top of animation discs.

Before digital compositing, the peg bars were also used to move layers on the camera stand to create pans and camera moves. They were the equivalent of digital trajectories. Harmony makes use of these concepts to create animation and camera motion.

A peg is composed of many customizable parameters. These parameters are:

- X, Y and Z positions (3D Path or Separate Positions)
- Angle (rotation)
- Skew
- X and Y Scales
- Euler Angle or Quaternion Angle (when 3D option is enabled)
- Z Scale (when 3D option is enabled)

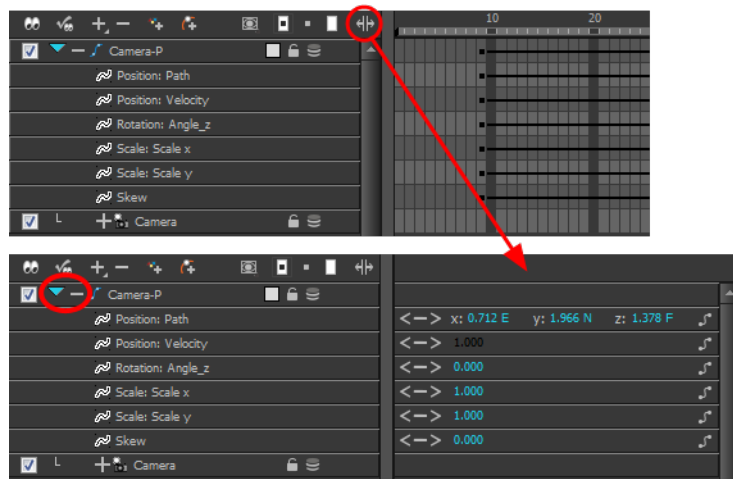

You can control a peg's trajectory the same way as the animated drawing layer.

A peg layer is mainly used to control a series of drawing layers, such as clouds, a school of fish or a flock of birds. You can attach them to a peg layer and make them follow a trajectory as a single unit. This makes trajectory modifications much easier and faster. When building a puppet, most of the time you will add a master peg to control your puppet as one object.

In Harmony, you can add pegs to the Network view using the Module Library view and they will instantly appear in the Timeline view. The modules you add to the Network view are synchronized with the ones in the Timeline view.

You can automatically create connections between modules in the Network view without having to drag cables out of the ports.

In the Tool Properties view, the Peg Selection Mode  lets you automatically select the peg layers in the Camera view instead of the drawing layers. If you animate with pegs instead of animating the drawing layers directly, enable the **Peg Selection Mode** to avoid having to select in the Timeline view or use the Select Parent Skipping Effects command.

How to disable the animation feature on a layer

1. In the Timeline view, double-click the layer on which you want to set the parameter.
The Layer Properties editor opens.

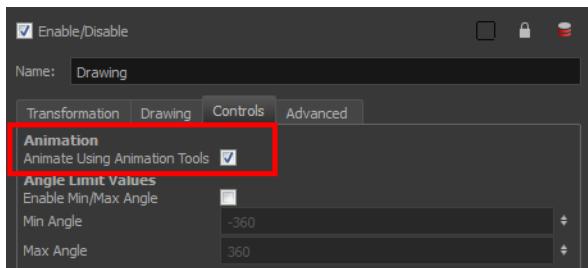

2. In the Advanced tab, deselect the **Animate Using Animation Tools** option.

How to add a peg in the Timeline view

1. In the Timeline view, select the layer on which you want to attach a peg.



2. Do one of the following:

- ▶ From the Timeline View layers toolbar, click the Add Peg  button.
- ▶ From the top menu, select **Insert > Peg**.
- ▶ Right-click on the layer and select **Add > Peg**.
- ▶ In the Module Library, select a Peg module and drag it to the Network view.

The layer that was originally selected becomes a child of the new parent Peg layer. The new Peg layer automatically takes the name of its child layer, with the addition of the suffix -P.

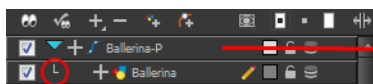

The indentation of the layer, along with the L indicates hierarchy and that the layer is attached to the Peg layer. This relationship is called a parent-child relationship.

3. If you intend to add multiple pegs or if the layer name that was added to the peg does not accurately represent the content of the Peg layer, you can rename it. Clicking the layer name and type in a new name. Or double-click the layer and type a new name into the dialog box.

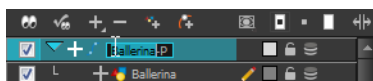

4. If you did not create your peg layer directly above the layer you intended on parenting it to, then drag the layer you want to attach to the peg and drop it directly below the Peg layer. The indentation of the layer below the Peg layer indicates whether it was correctly attached or not.

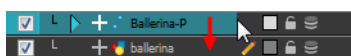

How to add a peg in your Network view via the Module Library

1. In the Module Library view, select the **Move** tab.

2. Select a Peg module and drag it to the Network view.

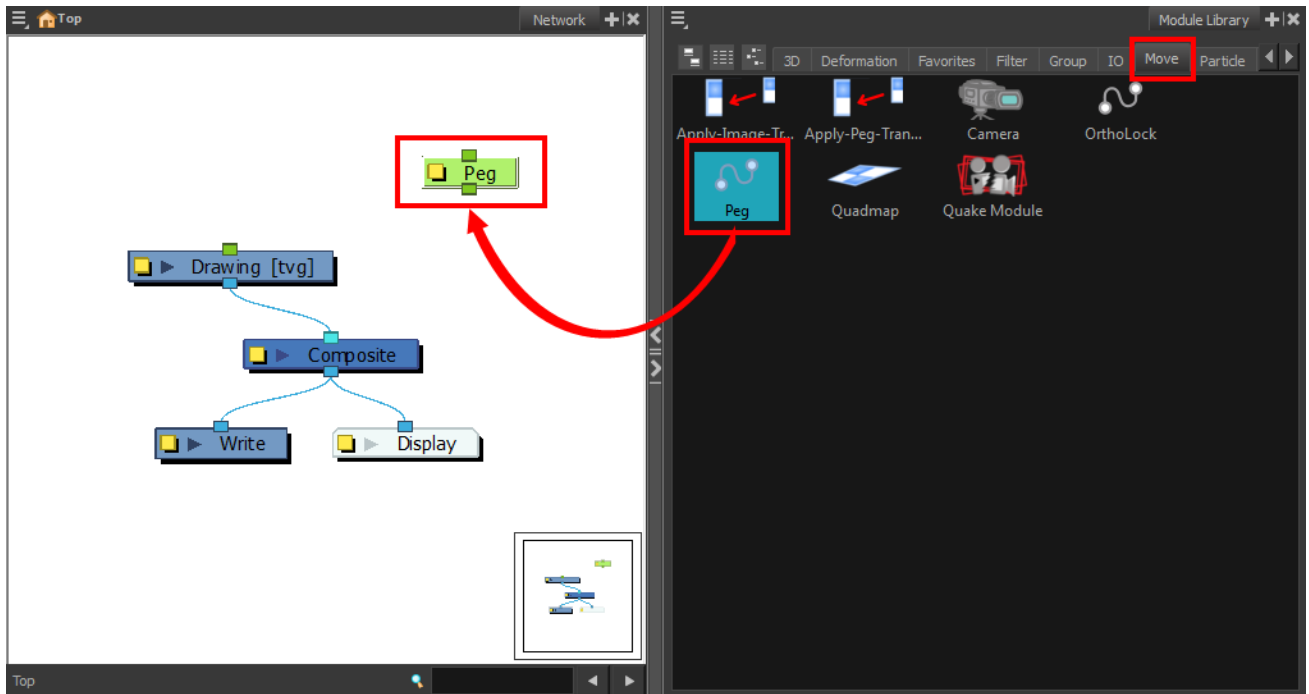

3. In the Network view, select the Peg module's output port and connect it to a Drawing or Camera module.

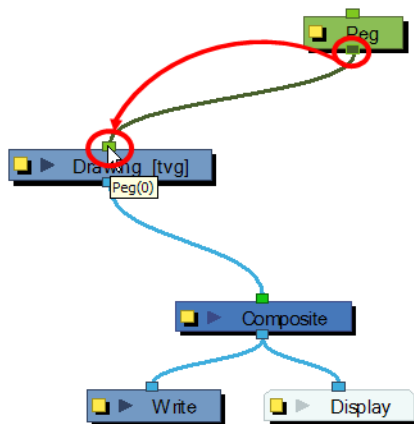

The advanced connections in the Network view are shown in the Timeline view, unless they cannot be reproduced in a timeline layout.

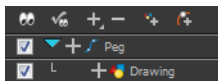

How to add a peg to the Network view using a keyboard shortcut

1. In the Network view, position the pointer at the location at which you want to add the new peg module.
2. Press Ctrl + P (Windows/Linux) or ⌘ + P (Mac OS X).

The new peg appears in the Network view.

How to create an automatic connection to a parent peg

- ▶ In the Network view, select one or more drawing modules that are not parented to any other module.

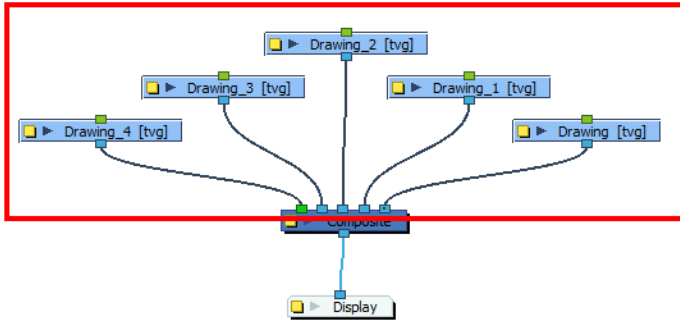

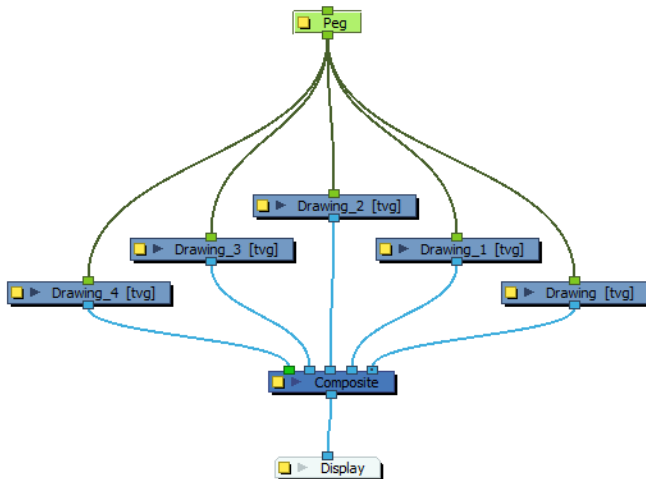

- ▶ Press Ctrl + P (Windows/Linux) or ⌘ + P (Mac OS X) to add a new peg module to the Network view and automatically connect it to the selected modules.



- ▶ Press Ctrl + Shift + P (Windows/Linux) or ⌘ + Shift + P (Mac OS X) to add a peg to each module.

How to enable the Peg Selection Mode

1. In the Tools toolbar, select the Transform  tool or press Shift + T.
2. In the Tool Properties view, click the Peg Selection Mode  button.
3. In the Camera view, select an element parented to a peg.

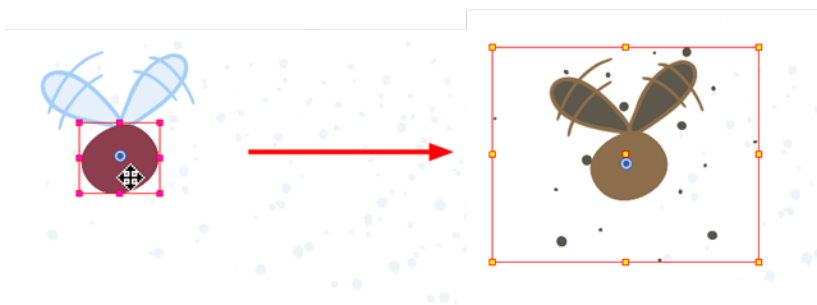

Layer Parameters

A layer is composed of many customizable parameters, such as the X, Y and Z positions, angle (rotation), skew and scales. Each parameter has its own function which is a mathematical formula expressing the relationship between position values. You can view each function on a graph as a simple curve, such as the one below.

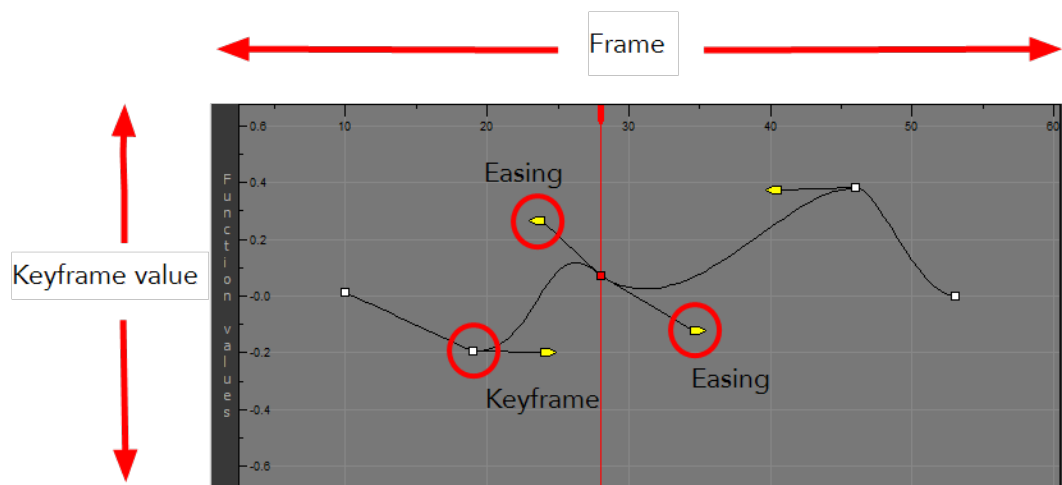

There are six options available for setting up function parameters:

- ▶ Locked Positions (3D Path)
- ▶ Separate Positions
- ▶ Locked Scales
- ▶ Separate Scales
- ▶ Quaternion (3D Rotation)
- ▶ Euler Angles (3D Rotation)

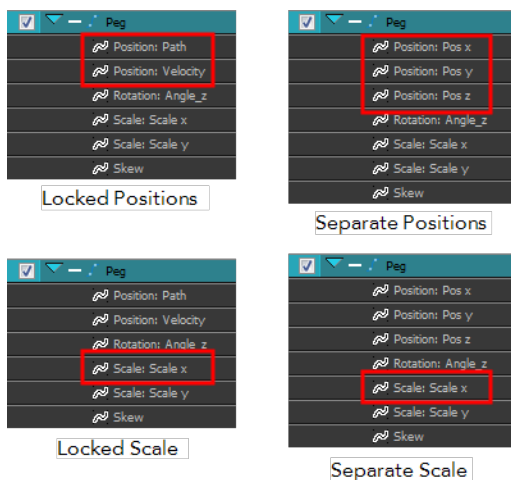

You must select 3D Path, Separate Positions, Separate Scale, or Locked Scale before starting the animation. When you lock or unlock parameters, this does not convert the functions from one to the other, but creates new ones.

In a 3D Path, the X, Y and Z curves are locked together and controlled by a single velocity function. When you add a keyframe, it is added on all three trajectories at once, as is the velocity. This is very useful for long, smooth trajectories.

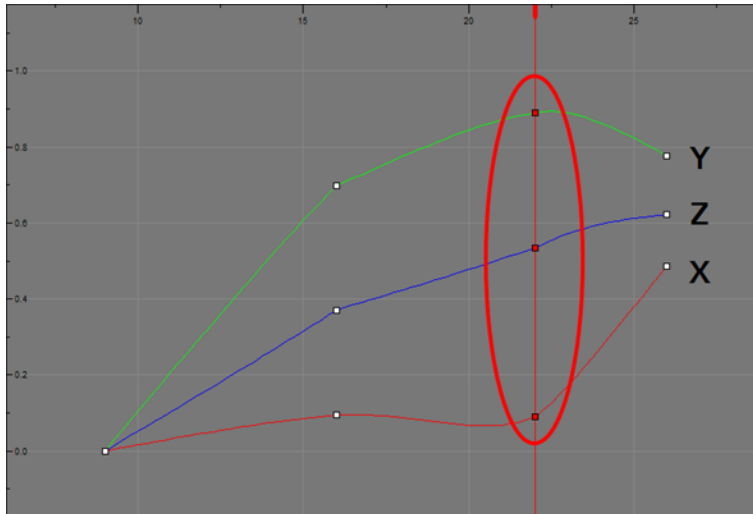

When the Separate Positions option is used, the X, Y and Z curves are independent and have velocity controls directly on their function curve. This is useful when you want to set keyframes on one of the curves without affecting the others.

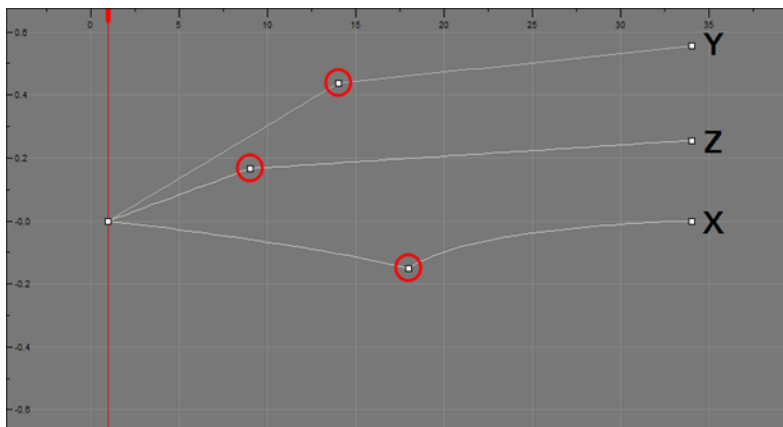

When using the Scale parameter, you can use a single function curve controlling both the vertical and horizontal scale, or two separate scales. When using a single function curve, the values are the same for the X (horizontal) and Y (vertical) axes for uniform size changes without distortion. However, if you separate the scale functions, you can squash, stretch and skew your elements.

How to display the Layer parameters in the Timeline view

- Do one of the following:
 - In the Timeline's left side, click a layer's Expand  button or press Alt + F.
 - In the Timeline view menu, select **View > Show Functions**.



How to set the layer parameters

1. In the Timeline view, double-click on the layer on which you want to set the parameter. You can also see the parameters in the Layer Properties view when you select the layer in the Timeline view.

The Layer Properties editor opens.

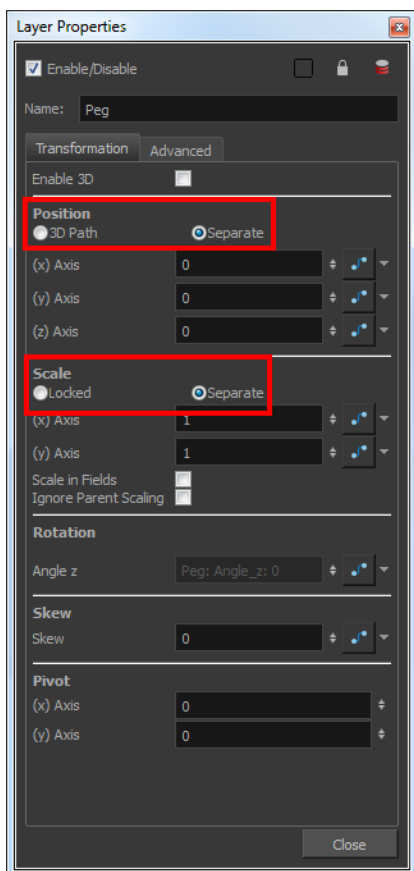

2. Select the **Transformation** tab.
3. In the Position section, select the **3D Path** or **Separate** option.
4. In the Scale section, select the **Locked** or **Separate** option.
5. Click **Close**.

Adding and Deleting Keyframes

There are several different ways you can create keyframes. You can add a coordinate keyframe, position keyframe or a keyframe along with your drawing duplication.

You can create a keyframe without a drawing. This adds new coordinate points but the drawing in the layer stays the same. At the same time, you may also want to duplicate your drawing if you need to modify it and do not want to modify the original.

You can also add a Position keyframe instead of a regular keyframe. When you add a Position keyframe, keyframes will only be added on the X, Y and Z parameters of the selected layer. Keyframes are not added on the Angle, Scale and Skew parameters.

If you select a keyframe in the Timeline view and press the Delete key, you will also delete the drawing exposure. To only delete the keyframe, you must use the Delete Keyframe command.

How to create keyframes

1. In the Timeline view, select the cell on which you want to add a keyframe.



2. Add a keyframe by doing one of the following:
 - ▶ From the top menu, select **Insert > Keyframe**.
 - ▶ Right-click on the selection and select **Insert Keyframe**.
 - ▶ Press F6.
 - ▶ In the Timeline View toolbar, click the Add Keyframe  button.

If the Animate mode is enabled in the Camera view, a keyframe is automatically created on the current frame.

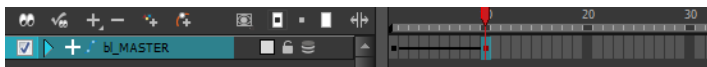

How to create a keyframe and duplicate the drawing at the same time

1. In the Timeline view, select the cell containing the drawing where you want to add a keyframe and duplicate.



2. To add a keyframe and duplicate, do one of the following:
 - ▶ From the top menu, select **Insert > Keyframe and Duplicate Drawing**.
 - ▶ Right-click on the selection and select **Insert Keyframe and Duplicate Drawing**.
 - ▶ Press F6.



How to add a Position keyframe

1. In the Timeline view, select the cell where you want to add a position keyframe.



2. In the top menu, select **Insert > Position Keyframe**.

How to delete a keyframe

1. Do one of the following:
 - ▶ Use the Transform  tool to select a keyframe to delete from the trajectory in the Camera view and press Delete.

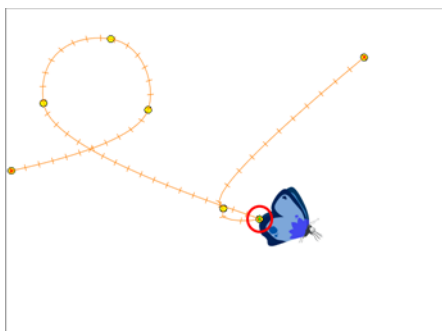

- ▶ In the Timeline view, select a keyframe, right-click and select **Delete Keyframes**, or press F7.
- ▶ In the Timeline view, select a keyframe and in the Timeline view menu, select **Motion > Delete Keyframes**.
- ▶ In the Timeline view, select a keyframe, and from the top menu, select **Animation > Delete Keyframe**.

Motion and Stop-motion Keyframes

Interpolation is the computer-generated motion between two keyframes. Some animators and compositors like to create their own in-betweens, while others like to have the computer do it. Harmony has stop-motion (no interpolation) and motion keyframes (computer-generated interpolation).

A stop-motion keyframe means there is no computer-generated motion between two keyframes. The segment is constant or flat. The drawing remains still until the playback reaches the next keyframe, then the drawing pops to its new location.

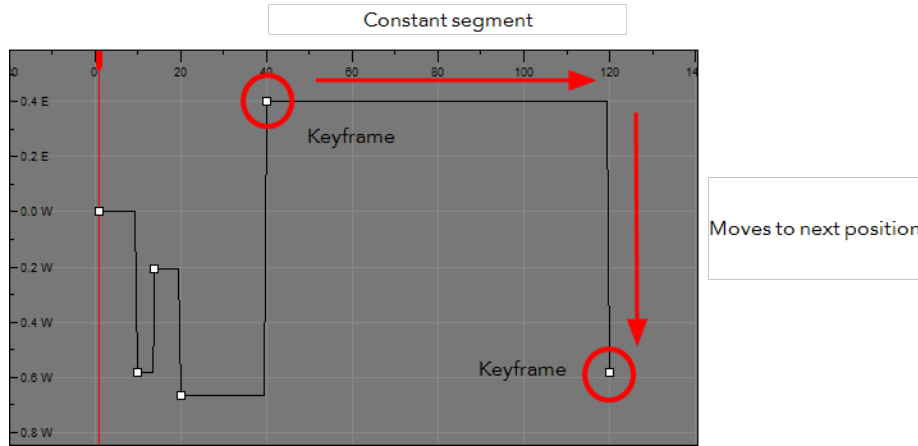

A motion keyframe means that there is computer-generated motion between two keyframes. The segment has a variation over time. The drawing progressively moves towards the next keyframe location as the animation is played back.

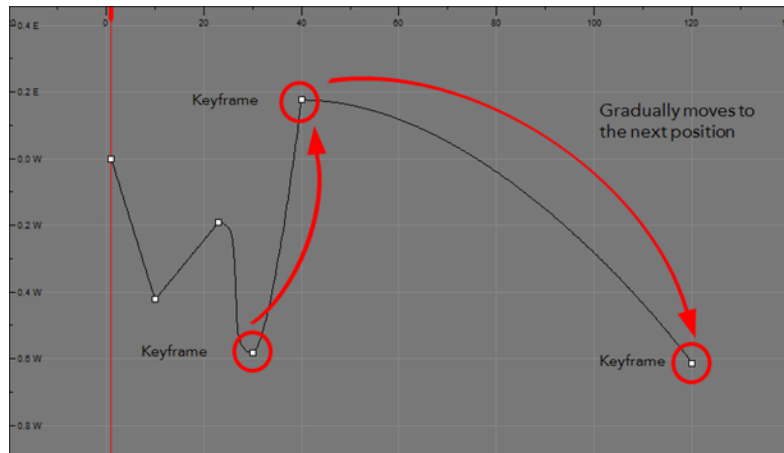

You can switch a keyframe from stop-motion to motion at any time in the Timeline view and Function Editor.

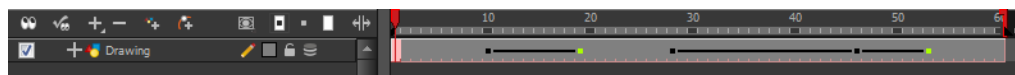

In the Preferences dialog box, you can set a different colour for your stop-motion keyframes in order to create a greater visual difference in the Timeline view.

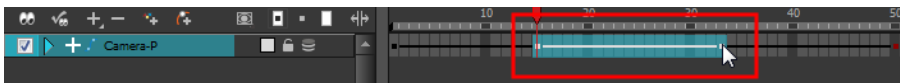

How to switch between motion and stop-motion in the Timeline view

1. On the right side of the Timeline, select one or more keyframes to modify.



2. Switch between motion and stop-motion by doing one of the following:
 - ▶ Right-click on the selected keyframes and select **Set Motion Keyframes** or **Set Stop-Motion Keyframes**.
 - ▶ Press Ctrl + K (Windows/Linux) or ⌘ + K (Mac OS X) for motion keyframes and Ctrl + L (Windows/Linux) or ⌘ + L (Mac OS X) for stop-motion keyframes.
 - ▶ In the Timeline View toolbar, click the Motion Keyframe  or Stop-Motion Keyframe  button.

How to switch between motion and stop-motion in Coordinates and Control Point view

1. Using the Transform tool, in the visible path in the Camera view or Timeline view, select the keyframe to convert.
2. In the Coordinates and Control Point view, select/deselect the **Stop-Motion Keyframe** option.

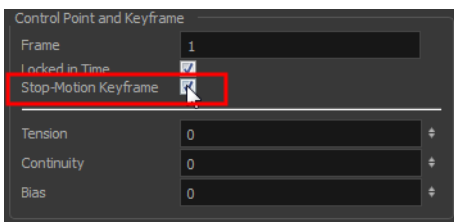

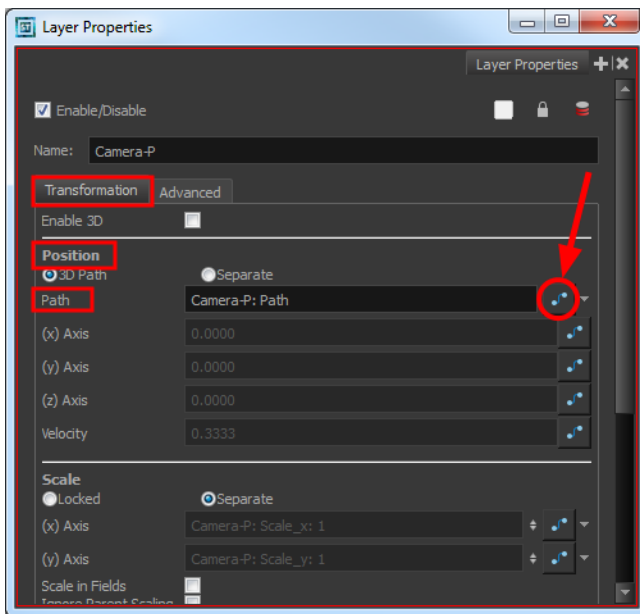

How to switch between motion and stop-motion keyframes in the Function Editor

1. Open the Function Editor.
2. In the Timeline view, double-click on the layer that contains the keyframes you want to convert.
The Layer Properties dialog box opens.



3. Do one of the following:

- ▶ In the Transformation tab, click the Function Editor  button.
- ▶ In the Timeline view, click the Expand Function  button and double-click on the function to edit. Or press Alt + F.

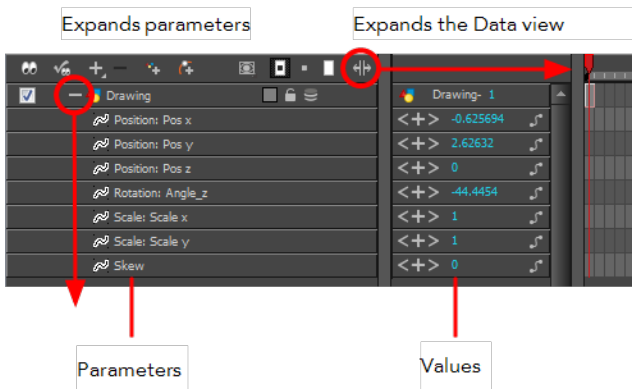

4. On the function curve, select one or more keyframes to modify.

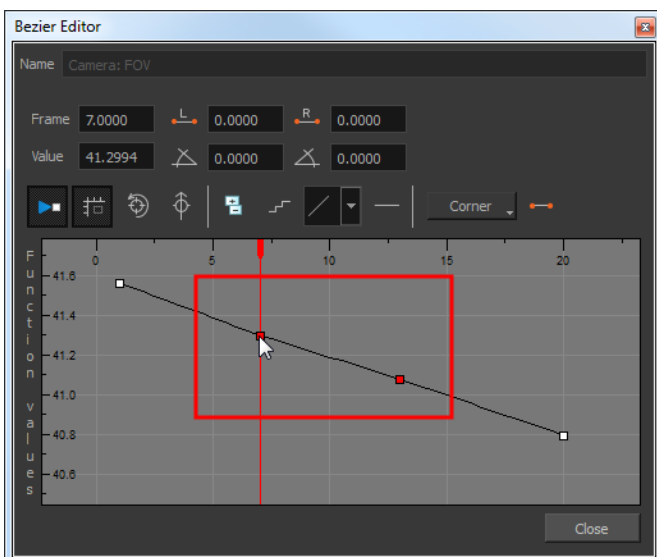

5. Select or deselect the Stop-motion Keyframe  button to set a stop-motion or motion keyframe.

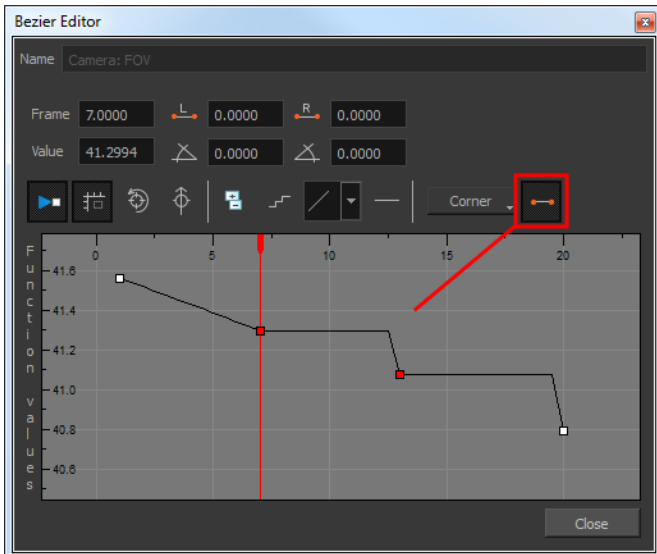

How to set the stop-motion keyframe colour

1. Open the Preferences dialog box by pressing Ctrl + U (Windows/Linux) or ⌘ + U (Mac OS X).
2. Select the **General** tab.
3. In the Colours section, click **Edit Colours**.
4. In the Colours dialog box, select the **Xsheet and Timeline** tab.
5. In the Timeline section, click the **Stop Motion Keyframe** switch.
6. In the Select Colour window, select a new colour.
7. Click **OK** to close the Select Colour window.
8. Click **OK** to close the Colours dialog box.
9. Click **OK** to close the Preferences dialog box.

Constant Z

When using a 3D path, the X, Y and Z functions are working together using the same keyframes. This allows for the velocity to control the curve and create a smooth trajectory. Even if a function does not have any variation on its curve (for example, all keyframes are at zero), the velocity might add a slight motion to ensure a smooth trajectory. This can cause elements that are very close to each other on the Z-axis to pop in front of one another. This is why in cut-out animation it is recommended to use separate position settings. But if you work with 3D path, you can enable the Constant Z feature to avoid this from happening.

The Constant Z feature is used when creating motion keyframes. The Z function will use stop-motion keyframes and will not be interpolated, which can be very useful for cut-out animation. The Constant Z feature only works with 3D paths.

You can also enable the Constant Z option directly in the Function Editor for specific functions.

How to enable the Constant Z option

1. In the Timeline view, expand the layer on which you want to set the Constant Z feature. Note that the 3D Path option must be enabled for that particular layer.
2. Double-click on one of the position functions to open the Function editor.
3. In the Function Editor window, select the Constant Z  button.

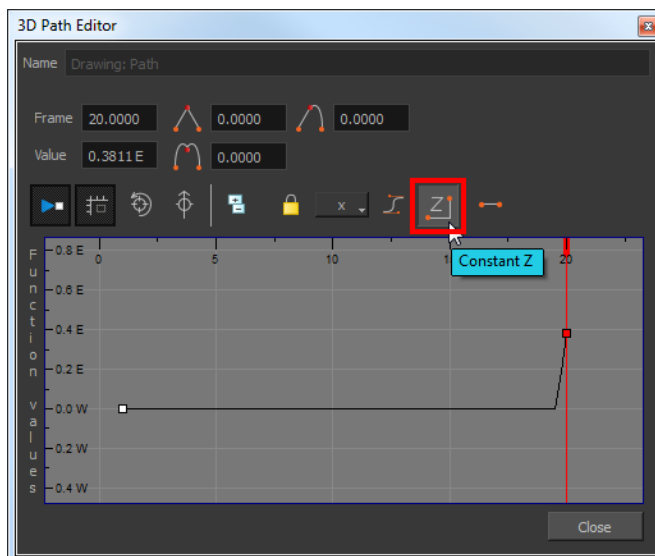

Animating the Camera

-Harmony has a camera that can move along the X, Y, and Z axes. Having the camera move on the Z-axis offers the possibility to create truck in and truck out, as well as multiplane camera moves. The default camera position is centred and backed up to 12 fields.

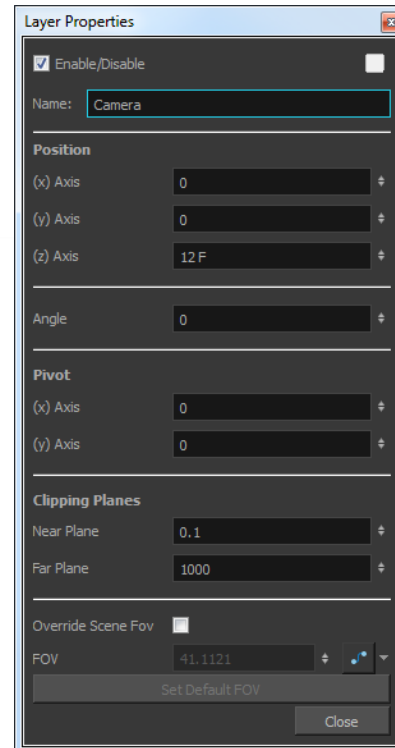
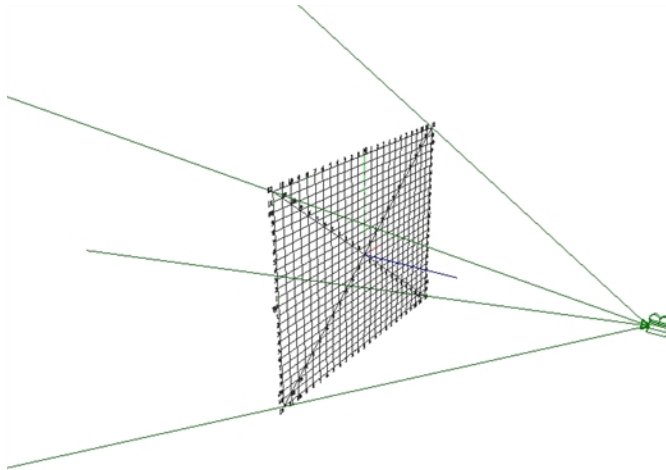

It is important to understand the coordinate values in Harmony. Harmony's core is based on the origins of animation. In traditional animation, a scene's size and camera motion are calculated in fields. A field has a 4:3 ratio and measures 0.5 inch in width. A specific grid has been created for this purpose. It is known as a *field chart*. Harmony uses this unit of measurement as its coordinate system.

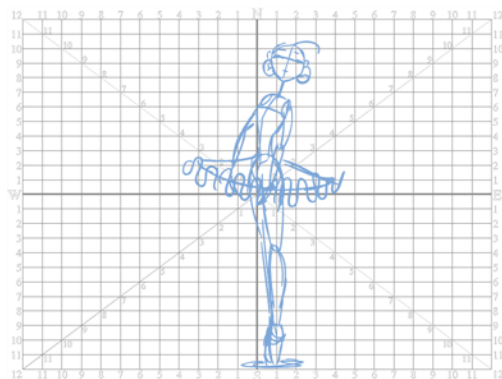

A field chart uses cardinal directions. The X axis is the east-west direction, the Y axis is the north-south direction and the Z axis is the forward-backward direction.

The camera is treated the same way as any other element. The same tools and selection modes are used to offset or animate it, but the camera is a static object. To animate the camera, you need to connect it to a peg layer. A peg is a trajectory layer.

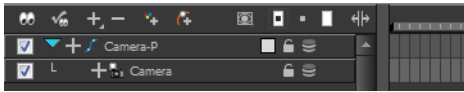

While making camera moves, you can use the Top, Side, and Camera views.

How to open the Top and Side views

- ▶ From the top menu, select **Windows > Top** or **Side**.
- ▶ From any existing window already open in your project, click the Add View **+** button at the top-right corner and select **Top** or **Side**.

How to add a camera and parent it to a peg

1. If you do not already have a camera layer, do one of the following:
 - ▶ From the top menu, select **Insert > Camera**.
 - ▶ From the Timeline view layers toolbar, click the Add Layers **+** button and select **Camera**.
 - ▶ From the Module Library view, select a Camera module and drag it to the Network view.

A new camera layer is added to the scene and appears in the Timeline view.

2. In the Timeline view, select the Camera layer.

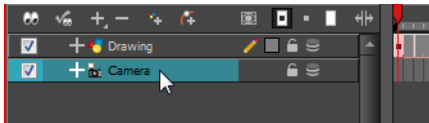

3. From the Timeline View Layer toolbar, click the Add Peg **+** button.

A Peg layer appears directly above the Camera layer. The Camera layer is automatically attached to it.

The Peg layer automatically takes the name of the camera and adds the suffix **-P** to indicate that it is a Peg layer, for example **Camera-P**.



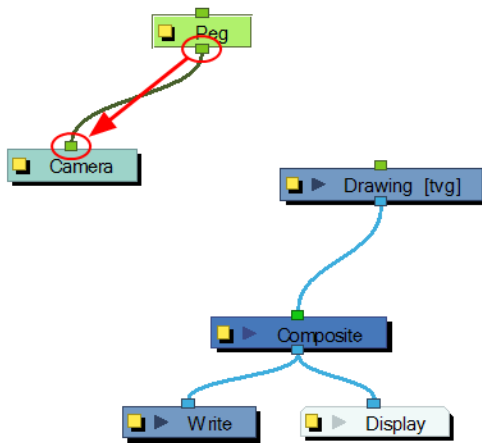

If the new Peg layer did not appear directly above the camera, you may have clicked elsewhere in the scene, which deactivated the layer on which you want to add the Peg layer.

- ▶ Select the Camera layer and drag and drop it under the new Peg layer. Or delete the misplaced Peg layer, select the Camera layer and click the Add Peg **+** button again.
- ▶ From the Module Library view, you can select a Peg module and drag it to the Network view. Then you can connect the peg's output port to the camera's input port.



How to animate the camera

1. In the Tools toolbar, enable the Animate  mode.
2. In the Tools toolbar, select the Transform  tool or press Shift + T.
3. On the right side of the Timeline view, on the Camera Peg layer, select the frame at which you want the camera move to start.
4. Do one of the following:
 - ▶ Right-click and select **Insert Keyframe**.
 - ▶ In the Timeline View toolbar, click the Add Keyframe  button.

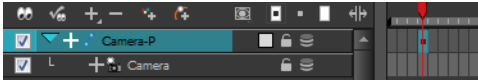

A keyframe appears in that cell. Any frames preceding this keyframe cell will hold the same camera position as in this keyframe.

5. In the Top, Side or Camera view, select the camera (the large V-shaped cone) and move it to the desired position. In the Camera view, the camera is represented by a thin frame. You need to click directly on one of the edges.

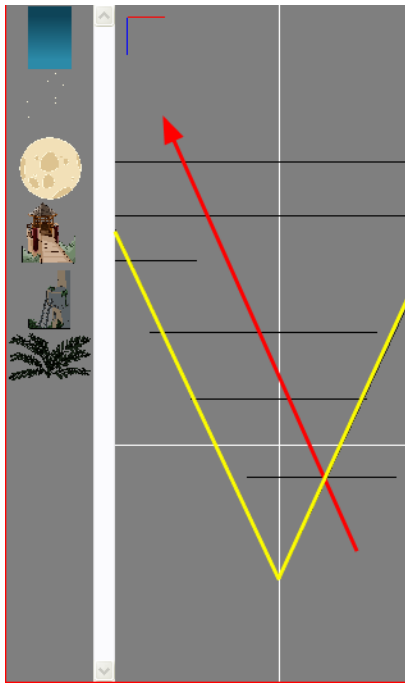

In the Camera view, the camera is represented by a thin frame. In the Top and Side views, the camera is represented by a thin cone. You need to click directly on one of the edges.

6. On the Timeline view, click on another cell a bit further down in time to indicate where the camera move will end.
7. Select the camera in the Camera, Top or Side view and move it to the desired position.

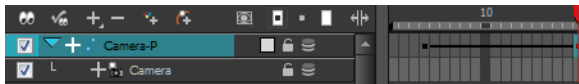

A second keyframe appears and a line is created between the two frames to indicate that the subsequent motion between the frames will be calculated and rendered by the program.

8. Play back  your animation.

Animating a Camera Shake Using the Quake Module

One very common camera move you will do is a camera shake. You can use the Quake module to generate an automated quake instead of manually entering random keyframes. This way, you can simulate the shock of something heavy falling on the ground, like an earthquake or a strong vibration.

How to use the Quake module to create a camera shake

1. From the Module Library view, drag a **Quake** module to the Network view.
2. If you do not have a Camera module already, drag one from the Module Library view to the Network view.
3. Connect the Quake module to the Camera module.

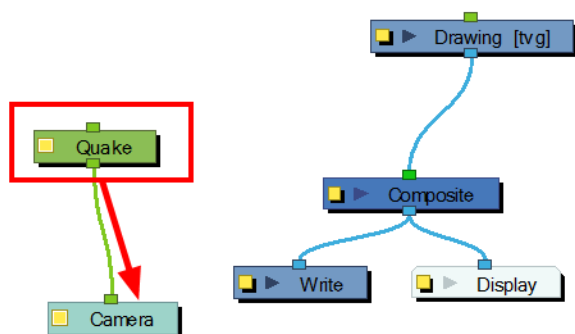

4. Click on the Quake module's square yellow button to open the Quake layer properties.

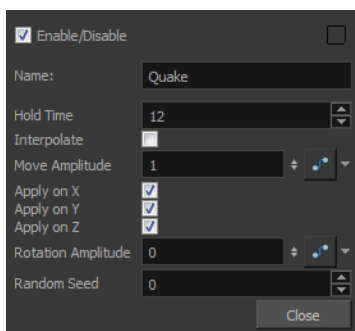

5. In the Quake Layer Properties window, adjust the following parameters:
- ▶ **Hold Time:** Enter the number of frames you want one of the quake vibrations (position) to hold for. Most camera shakes are done in a single frame (1) or double frame (2).
 - ▶ **Interpolate:** An interpolation is generated between the random values. Instead of jumping to the next position, it will slowly progress forwards to the next position. It is the same principle as stop-motion keyframes and motion keyframes.
 - ▶ **Move Amplitude:** This is the strength of the quake. The higher the value, the stronger the quake. If the value is set to 0, there will be no motion. To have the motion start and stop at a specific frame during the scene, you can create a function curve and animate the amplitude over time. Simply click the Function  button to generate the function, then click on it

again to open the Function Editor.

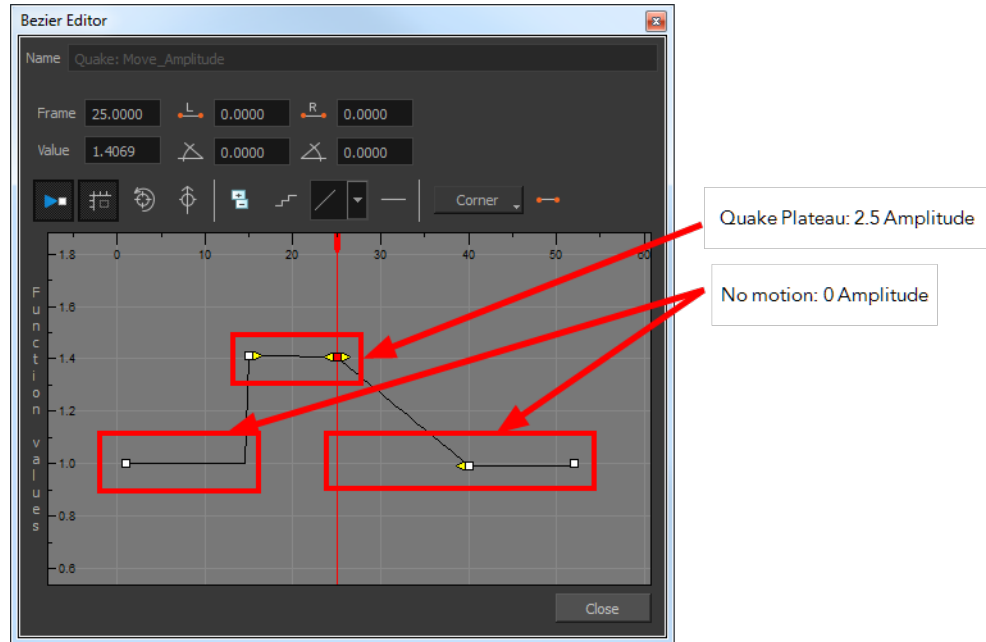

- ▶ **Apply on X, Y, Z:** Applies the quake to the X, Y and Z-axis.
- ▶ **Rotation Amplitude:** When the value is higher than 0, a rotating quake is applied. The higher the value, the stronger the quake.
- ▶ **Random Seed:** Generates a different randomization pattern. If you cascade two Quake modules or more to apply a different amplitude on a different axis, you can change the Random Seed value to generate a different randomization pattern. If the X quake has a strong amplitude and the Y quake a weak amplitude and you do not want them to follow the same random pattern, then set the Random Seed value of the Quake modules to different numbers.

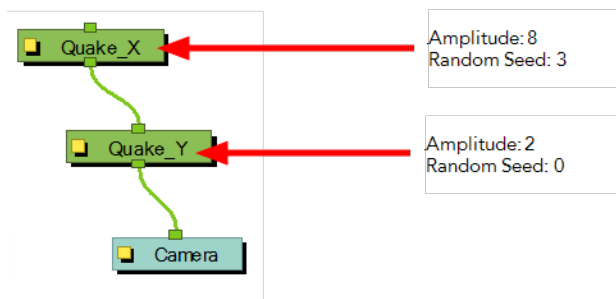

Camera Truck-ins and Line Thickness

As you move the camera in your scene along the Z-axis, notice that, logically, the lines of the elements become thicker the closer the camera gets to the drawing. If you prefer the lines to remain the same size or become thicker at a different speed, you can use the thickness feature to adjust your brush stroke and pencil line thickness. You can modify the size of the lines even if the camera is not animated.

This feature can only be viewed in the Camera view's render mode.

How to adjust the pencil line thickness of a drawing layer in the Camera view

1. In the Timeline view, double-click on a drawing layer to display the Layer Properties panel.
2. Select the **Advanced** tab.
3. In the Line Thickness section, adjust some of the following parameters until you achieve the desired effect.

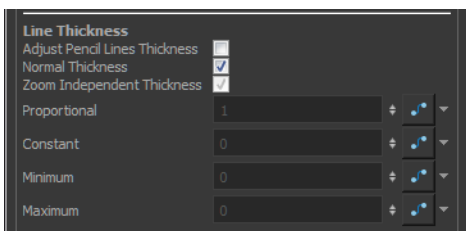

Adjust Pencil Lines Thickness: Lets you work with pencil lines and adjust their thickness. You will not see any changes to lines in the Camera view OpenGL mode. You must switch to the Render mode.

Normal Thickness: Disables all overrides on the brush stroke line thickness. This option must be enabled in order for the pencil line thickness parameter and pencil lines to appear. If you want to modify the brush stroke thickness, deselect this option. To enable brush strokes to work with the line thickness feature, you must first create central strokes in the Colour Art layer. The central strokes control the line variation of your brush strokes in the Line Art layer. Select **Drawing > Create Colour Art from Line Art**.

Zoom Independent Thickness: Select this if you want your line thickness to remain constant independently from the camera move. Everything else will increase in size, but the line thickness will stay the same.

Proportional: Enter a multiple by which you want to increase the line thickness base on its original thickness. A value of 1 will result in no change; a value of 0 (zero) will hide the lines.

Constant: Enter a value in pixels (based on a 720x540 screen resolution) to indicate the amount of pixels you want to add around the existing line.

Minimum: Enter a value in pixels (based on a 720x540 screen resolution) for the minimum line thickness allowed.

Maximum: Enter a value in pixels (based on a 720x540 screen resolution) for the maximum line thickness allowed.

Modifying a Path in the Camera, Top and Side Views

Camera moves and motion paths can become quite advanced, especially with moves through 3D space. Harmony provides tools to view your camera's path and make adjustments to it from both a 2D and 3D perspective.

You can display the trajectory of a motion path when you select an object in the Timeline or Camera view.

If you want to see the trajectory, enable the **Show Control Points on Selected Layers** option in the Preferences dialog box.

A motion path is easy to manipulate. One important concept to understand is that a trajectory contains both keyframes and control points. Both can be used to shape a path; each have their own significance and behaviour, however only keyframes appear in the Timeline view.

- **Keyframe:** Has a transformation value and a position in space at a given frame. Keyframes are locked in time.
- **Control Point:** Has a position but no fixed frame or timing. It is mainly used to deform a trajectory. There are no velocity handles available on a control point. The velocity segments are set between keyframes only, making curves and trajectories much smoother. Control points can only be added on a 3D path.

You can edit keyframes and control point parameters, such as the position, continuity, bias, tension and lock-in-time using the Coordinates and Control Point view.

Each time a keyframe or control point is selected in the Camera, Timeline or Xsheet view, its parameters appear in the Coordinates and Control Point view. You can also see the same information in the Coordinate and Control Point toolbars.

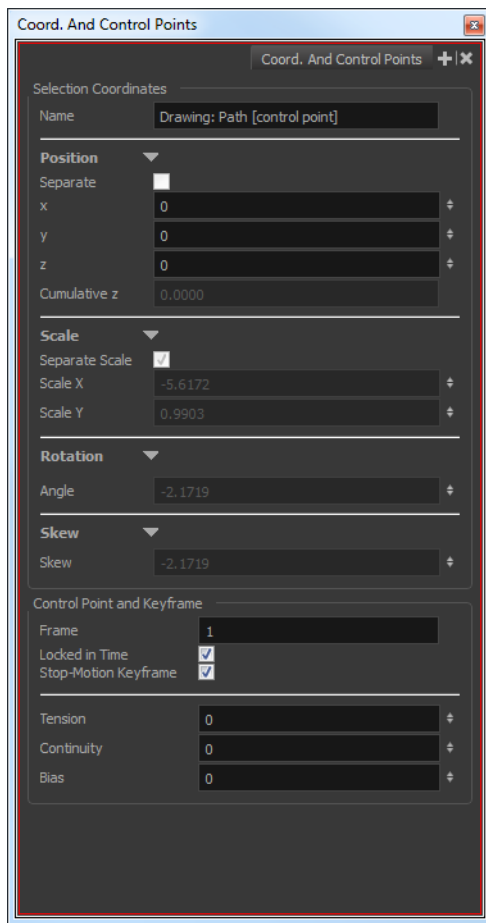

You can adjust these parameters by selecting the control points and keyframes in the Camera, Top and Side views with the Transform  tool.

- **Continuity** controls the smoothness of a transition between the segments joined by a point.

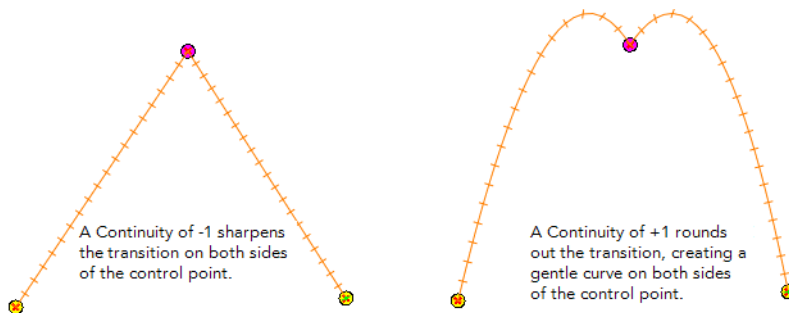

- **Tension** controls how sharply the path bends as it passes through a control point or keyframe.

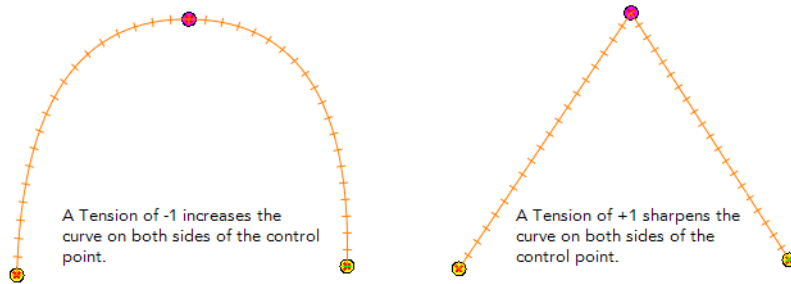

- **Bias** controls the slope of the path so that it flows towards one side of the motion point or the other.

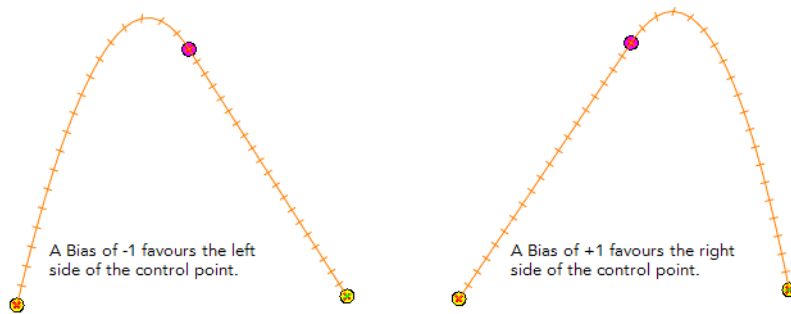

If you find that you are using the same Continuity, Tension and Bias settings, you can set a preference to remember your settings.

When you select a control point on a path, you can switch between a rounded or square corner by using the Linear/Curve command.

How to view the layer's trajectory using the Control command

1. Verify that the Camera view (click its tab) is selected and that the layer whose trajectory you want to display is selected in the Timeline view.

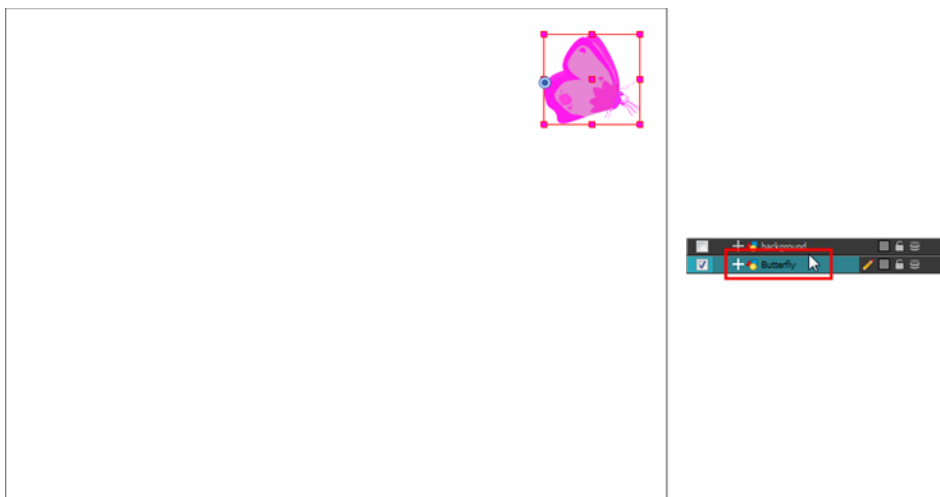

2. From the top menu, select **View > Show > Control** or press Shift + F11.

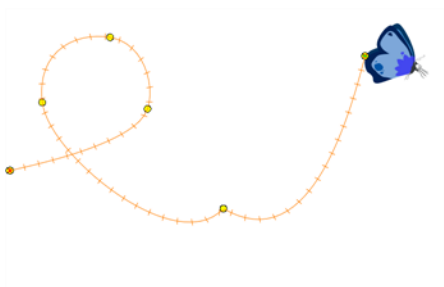

If nothing appears in the Camera view, you may not have animated or selected the layer.

How to add a control point on a trajectory

1. In the Timeline or Camera view, select the peg or layer on which you want to add a control point.
2. If the selected element's trajectory is not displayed, select **View > Show > Control** from the top menu or press Shift + F11.

The Trajectory appears in the Camera, Top, Side and Perspective views.

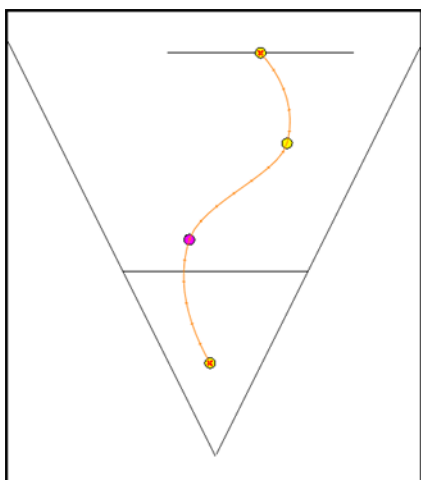

3. Add control points on a 3D path trajectory by placing the cursor where you want to add the point and press P once. If you hold the key down, control points will be added continuously until you release the key.

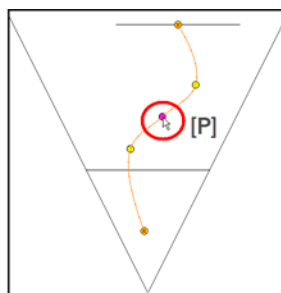
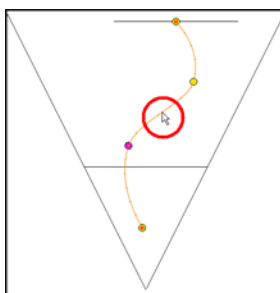

How to display control points on selected layers

1. In the top menu, select **Edit > Preferences** (Windows/Linux) or **Stage > Preferences** (Mac OS X) or press **Ctrl + U** (Windows/Linux) or **⌘ + U** (Mac OS X).

The Preferences dialog box opens.

2. Select the **Camera** tab.
3. In the Control Points section, select the **Show Control Points on Selected Layers** option.

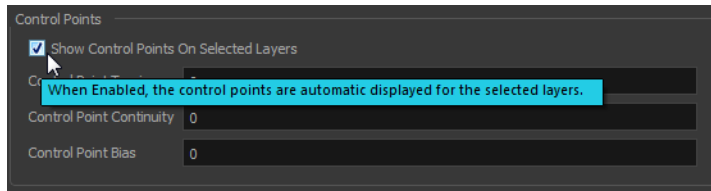



4. Click **OK**.

If the trajectory is hidden when you select an element, you may want to display it using the Control command.

How to switch between keyframe and control point

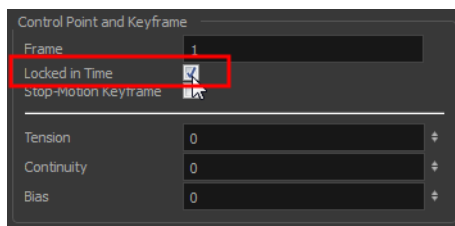
1. In the Camera view, use the Transform  tool select a point to convert.
2. To convert the point:
 - ▶ In the Coordinates and Control Point view, select or deselect the **Locked in Time** option.



- ▶ From the top menu, select **Animation > Lock in Time** or press **Alt + L**.
- ▶ In the Function view or Function Editor, select the keyframe to convert and click the Lock in Time  button.

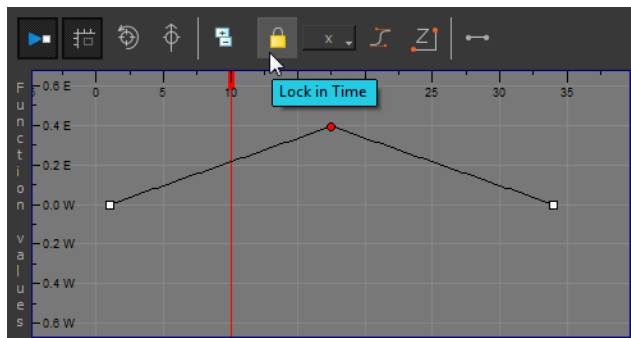

How to adjust the Continuity, Tension and Bias parameters

1. In the Tools toolbar, select the Transform  tool or press **Shift + T**.

- In the Timeline view, select the layer that contains the parameters you want to adjust.



- From the top menu, select **View > Show > Control** or press Shift + F11 to display the trajectory.
- In the Camera view, select a control point or keyframe.

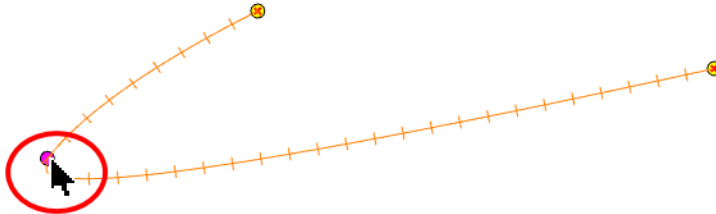

- In the Coordinates and Control Points view, adjust the Continuity, Tension and Bias parameters.

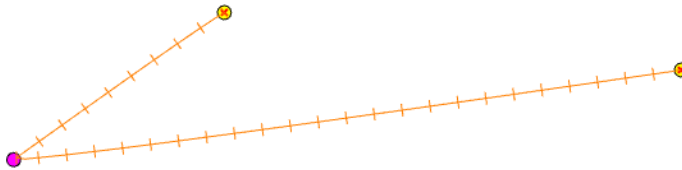
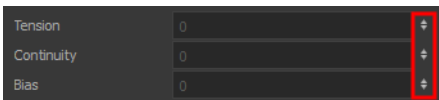

How to adjust the control point preferences

- From the top menu, select **Edit > Preferences (Windows)** or **Stage > Preferences (Mac OS X)**. The Preferences dialog box opens.
- Select the **Camera** tab and adjust the parameters in the Control Points section.

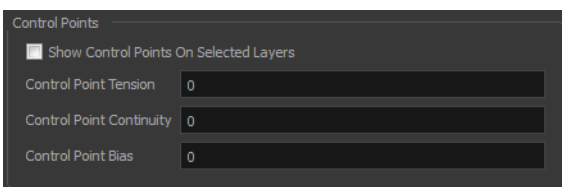

How to toggle between a linear and curved corner

- In the Tools toolbar, select the Transform  tool or press Shift + T.
- In the Camera view, select the point to convert.
- From the top menu, select **Animation > Linear/Curve**.

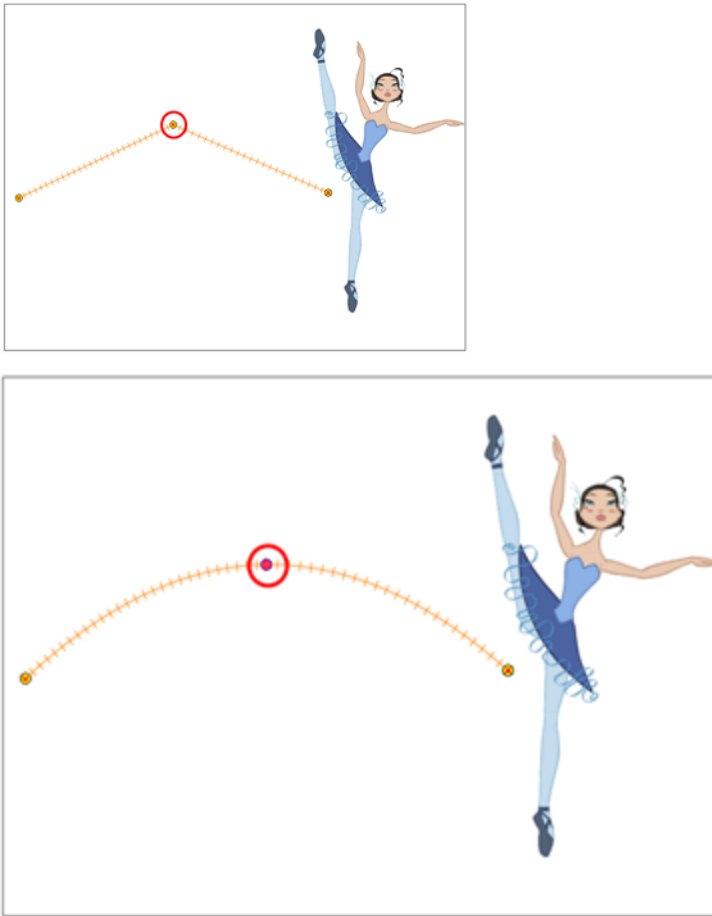

Offsetting a Trajectory

By offsetting a trajectory, you reposition the visual trajectory without offsetting or modifying your animation. By default, the trajectory is located at 0,0,0 fields. If your elements were drawn in a different location than the centre in the drawing area, it will look like the trajectory is not aligned with your drawing. Also, if you have several elements attached to one trajectory, you might want your trajectory to be a different location to represent the group's motion better.

How to offset a trajectory

1. In the Animation Tools toolbar, select the Spline Offset  tool or press Alt + 8.
2. In the Camera Top, Side or Timeline view, select the layer whose trajectory you want to offset.
3. From the top menu, select **View > Show > Control** to display the trajectory. If you do not display the trajectory, any transformation done using the Spline Offset tool will be ignored.

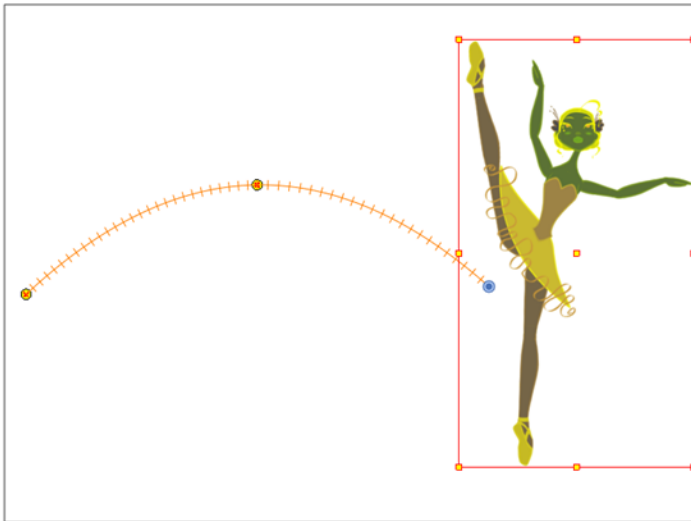

4. In the Camera view, move the trajectory to the proper position. You can move it on the X and Y axes, but also on the Z-axis using the Top and Side views.

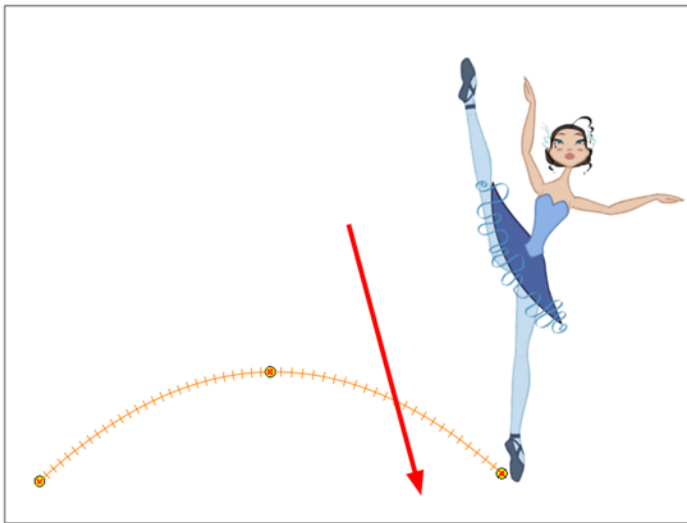

Modifying a Path in the Timeline View

When you select a peg or drawing layer in the Camera view and move it around, Harmony will automatically create keyframes on the corresponding function curves. If you want to modify these curves, you can do it through the peg or drawing layer parameters in the Timeline view.

Harmony lets you also flip between the selected layer's keyframes in the Timeline view.

How to create the function curve in the Timeline view

1. In the Timeline view, double-click on a drawing or peg layer.
The Layer Properties window opens.
2. Identify the section for the type of function you want to create.
3. Click the drop-down arrow at the end of the corresponding row and select **Create Bézier** or **Create Ease**.

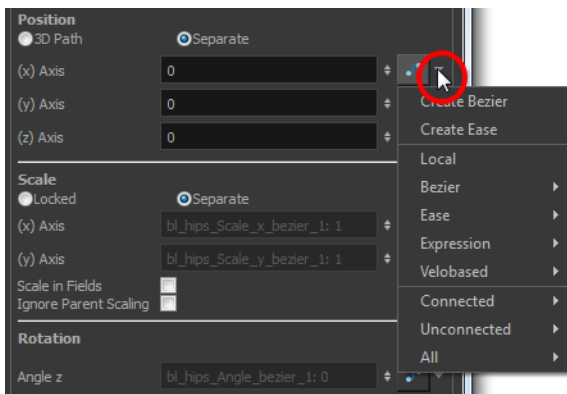

How to add a keyframe in the Timeline view

1. On the right side of the Timeline view, select a cell on the layer's function that you want to animate.



2. Do one of the following:
 - ▶ Right-click the selected cell and select **Insert Keyframe**.
 - ▶ Press F6.
 - ▶ In the Timeline view menu, select **Motion > Insert Keyframe**.
 - ▶ In the Timeline View toolbar, click the Add Keyframe  button.

How to delete a keyframe in the Timeline view

1. On the right side of the Timeline, select a keyframe to delete. You can [Shift]+click several keyframes to select a group before deleting the keyframes.
2. Do one of the following:

- ▶ Right-click on the selected keyframe and select **Delete Keyframes**.
- ▶ Press F7.
- ▶ In the Timeline view menu, select **Motion > Delete Keyframes**.
- ▶ In the Timeline View toolbar, click on the Delete Keyframes  button.

If you select a keyframe or group of keyframes and press Delete, the corresponding drawings on that cell are also deleted.

How to change the keyframe values in the Timeline view

1. In the Timeline view, open the drawing or layer's parameters by clicking the Expand  button or press Alt + F.



2. At the top of the Timeline view, click the Show/Hide Data View  button.

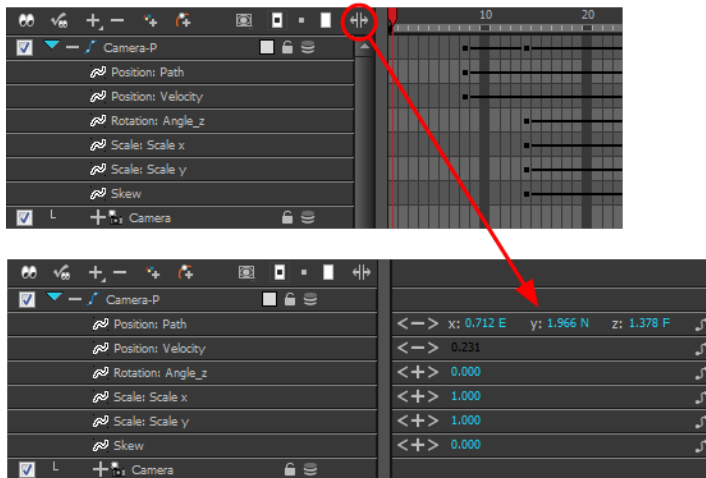

3. Select the parameter for which you want to create a function curve: Path, Velocity, Scale; x or y, Angle, or Skew.
4. Pass the cursor over the blue number value of the parameter layer being modified.
 - ▶ Wait until the cursor changes to a white hand with a two-way arrow and then drag the hand slightly to the left or right to decrease or increase the value.



OR

- ▶ Double-click on the blue number and enter a value into the field that appears.

How to flip through poses

1. In the Camera or Timeline view, select the layer that contains the keyframes you want to flip through.



2. From the top menu, select **Animation > Go to Previous Keyframe** or **Go to Next Keyframe** or press semicolon (;) and single quote (').

Modifying a Path in the Function View

If you are used to graphs and function curves, you can use the Function view to define trajectories.

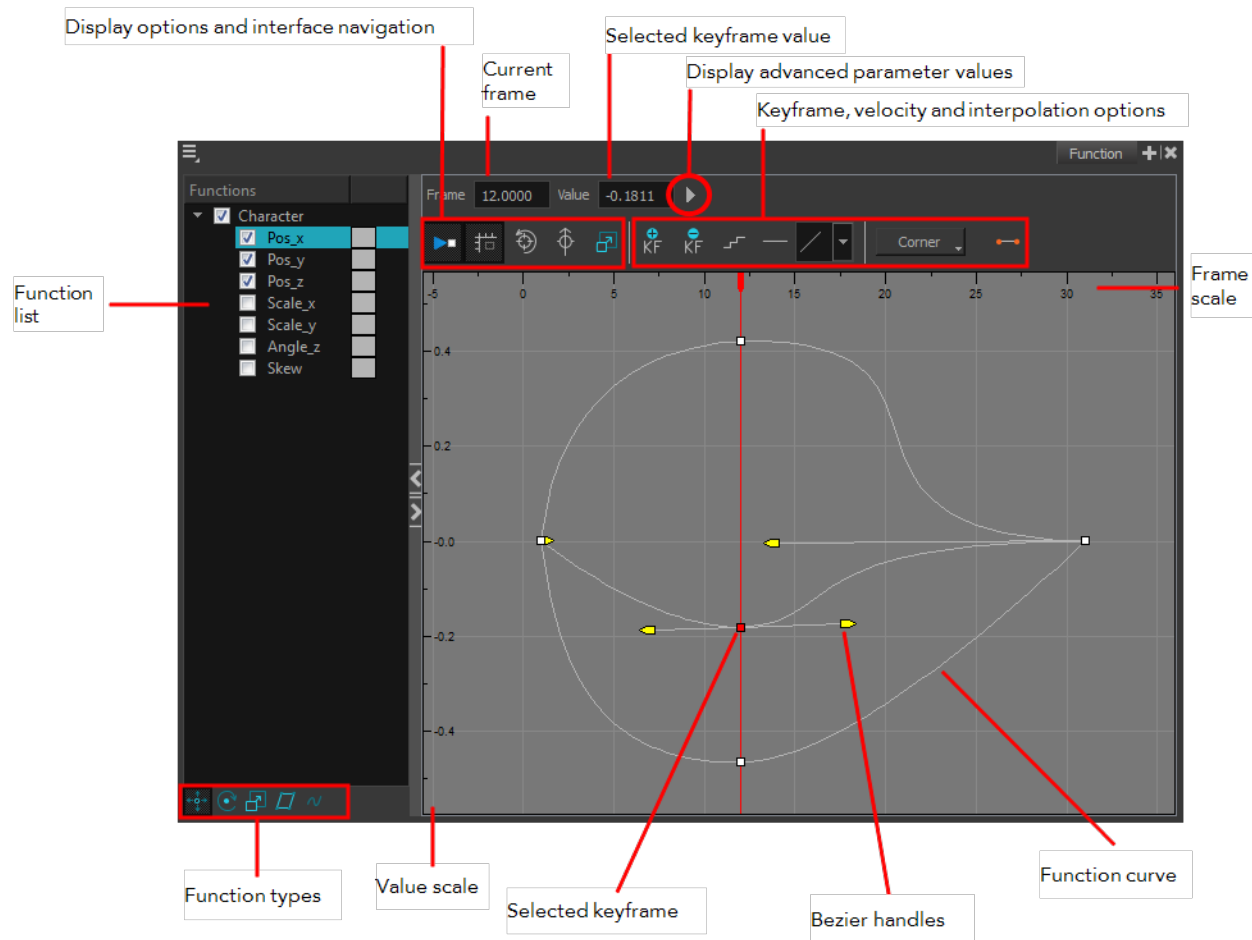

The Function view graph displays the motion over the first and last keyframes set in the scene, as well as any keyframes created between. If the scene is 60 frames, but the character's motion ends at frame 40, then the editor will only display up to frame 40.

The Function view lets you edit function curves and parameters. It is a visual graph for adding, removing, and editing keyframes, as well as adjusting the velocity. The Function view allows you to display multiple functions in the background as a reference.

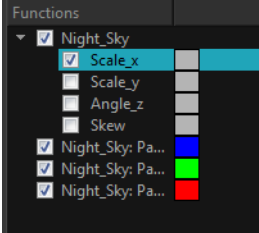

How to display functions in the Function view

1. Open the Function view.
The Function view is blank until you select the layer containing the functions you want to display.
2. To display a function in the Function view, click on the layer containing the functions to adjust in the Timeline view.
3. To select the functions you want to edit, select them in the Functions List section.

Parameter	Description
Function List	 <p>When selecting a layer in the Timeline view, all the corresponding functions are displayed. Until a keyframe is added on the function in the Timeline view, it will not be displayed in the Function view. Select all the functions you want to see and edit; hide the ones you do not.</p>
	<p>The Display toolbar allows you to modify how the editing area is displayed. You can hide the grid, disable the synchronization with the current frame, reset the zoom level and normalize the function display by stacking them one over the other to compare them regardless of their value range.</p>
Current Frame	Displays the current scene frame.
Selected Keyframe Value	Displays the value of the selected keyframe.
Display Advanced Parameter Values	 <p>Displays the Projection, Bias, Tension and Continuity parameters to adjust the curve around the selected keyframe.</p>
Keyframe, Velocity and Interpolation Options	<p>This toolbar lets you add and delete keyframes, adjust the velocity curve, adjust the segments to motion or stop-motion keyframes and set the velocity to create steps instead of a constant progression.</p>
Function Type	<p>This toolbar lets you click on the different function types to enable or disable all the listed functions of that type.</p>
Value Scale	<p>displays the value range for the displayed editing area. It can be referenced to know the value of a keyframe.</p>
Selected Keyframe	<p>The selected keyframe is displayed in red. When selected, the keyframe values are displayed in the corresponding fields.</p>
Bezier Handles	<p>The Bezier handles let you adjust the ease in and ease out of each keyframe. The more the handle is pulled out horizontally, the slower the animation will be. The more the handle is pulled out vertically, the faster the animation will be.</p>
Function Curve	<p>The thin line going from keyframe to keyframe is the actual curve. The section of a curve located between two keyframes is called a segment.</p>
Frame Scale	<p>The Frame Scale displays the frame range for the displayed editing area. It can be referenced to know the current frame of</p>

a keyframe.

How to edit a function in the Function view

1. In the graph of the Function editor, select a white keyframe.
The keyframe turns red and displays a pointed yellow handle.
2. Drag the point up or down, or click and pull one of the handles to adjust the curve of the graph.

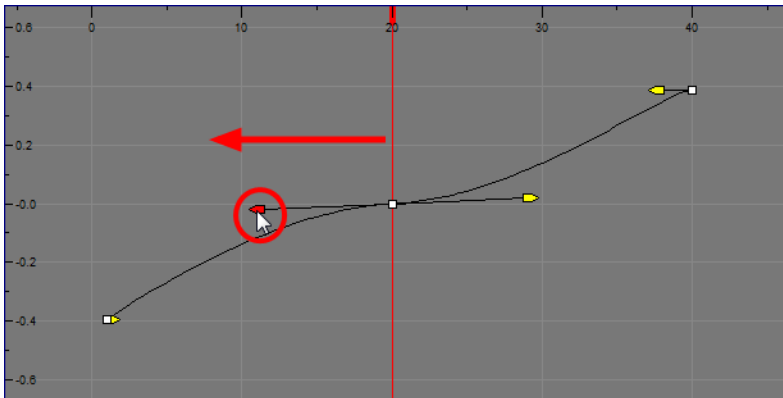

In this case, changing the velocity from a straight line (constant velocity) to a curved one, changes the ease-in (where the curve shoots up and then flattens out) and ease-out (where the curve flattens out and then shoots up) values.

The centre keyframe cannot be dragged up or down because the velocity is set. Theoretically, dragging it downwards towards zero would put it back to a place of nonmovement.

3. Press the Enter/Return key with the editor still open to watch the result of your curve adjustment in the Camera view.

How to add or delete keyframes in the Function editor

1. In the Timeline view, open the layer parameters by clicking the Expand Function **+** button next the layer's name.

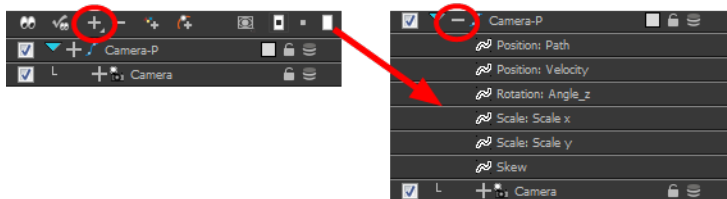

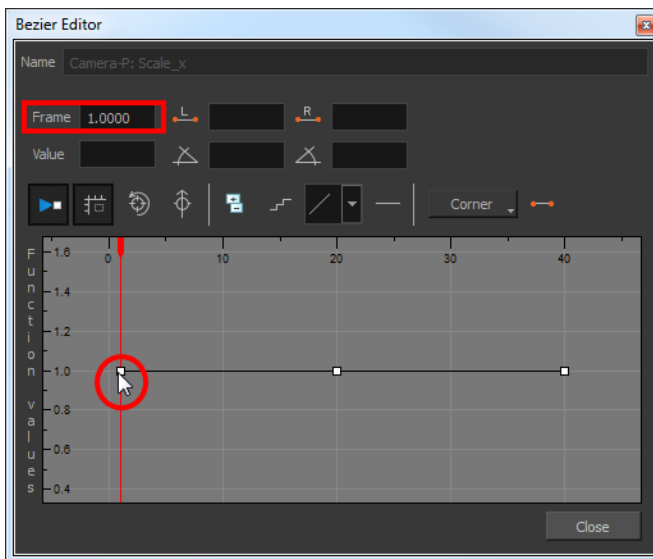

2. Select the parameter for which you want to create a function curve: Path, Velocity, Scale: x or y, Angle or Skew.
3. Double-click on the parameter layer name to open the Function editor window or click once on the parameter layer to display it in the Function view.



4. In the graph section, click on the frame number where you want like to make changes, or enter the frame number in the Frame field.

In the graph section, a vertical blue line indicates the selected frame number.

5. Do one of the following:
 - ▶ In the Function editor, click the Add/Remove Keyframes  button.
 - ▶ In the Function view, click the Add Keyframe  and Delete keyframe buttons.



6. Click on the newly created keyframe and drag it up (to decrease the width of the object) or down (to increase the width of the object) or pull on the handles to create a smooth fluctuation of the drawing object's width.
7. If you do not like the changes you just made, select and delete the new keyframe by pressing Delete or clicking the Add/Remove Keyframes  button.

You can delete an existing keyframe by using the same process.

How to change a keyframe value in the Function view

1. In the Timeline view, open the peg element's parameters by clicking the Plus  sign next the peg layer's name.

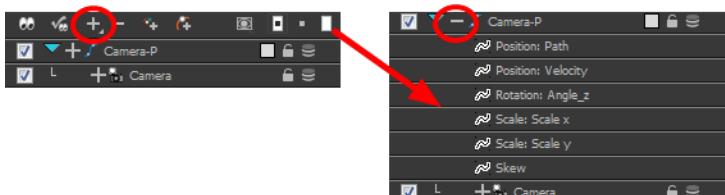

2. Select the parameter for which you want to create a function curve: Path, Velocity, Scale:x or y, Angle or Skew.
3. Double-click on the parameter layer name to open the Editor window or click once on the parameter layer to display it in the Function view.

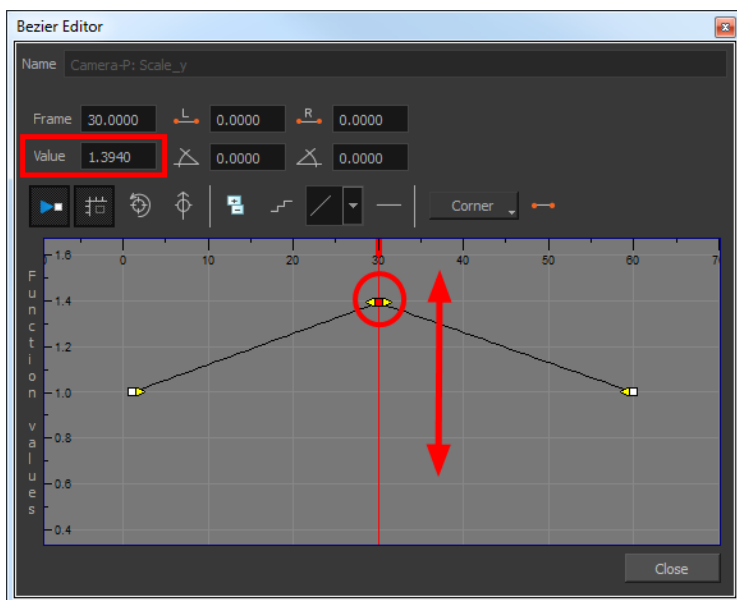

4. In the Value field, enter a value. You can also drag the keyframe up or down in the function graph.
5. Press Enter/Return or click the Play  button to view the changes made in the Camera view.
6. Keep adjusting the values until you are satisfied with the results.
7. Click **Close**.

Function View

The Function view lets you edit function curves and parameters. It is a visual graph for adding, removing, and editing keyframes, as well as adjusting the velocity. The Function view allows you to display multiple functions in the background as a reference.

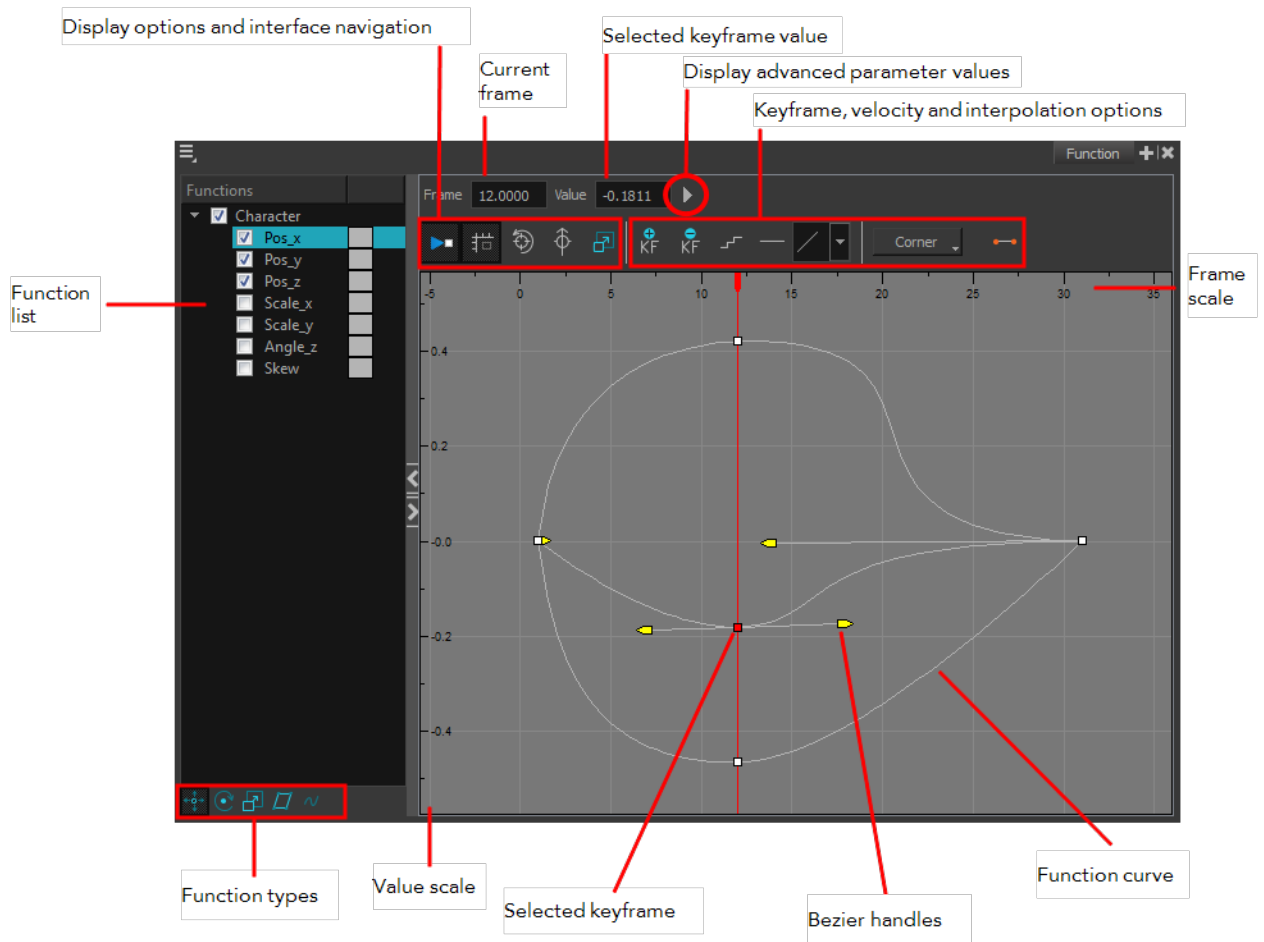

How to display functions in the Function view

1. Open the Function view.
The Function view is blank until you select the layer containing the functions you want to display.
2. To display a function in the Function view, click on the layer containing the functions to adjust in the Timeline view.
3. To select the functions you want to edit, select them in the Functions List section.

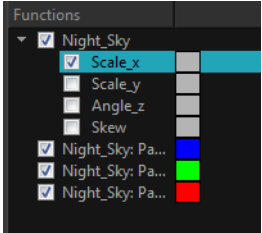
Parameter	Description
Function List	 <p>When selecting a layer in the Timeline view, all the corresponding functions are displayed. Until a keyframe is added on the function in the Timeline view, it will not be</p>

	displayed in the Function view. Select all the functions you want to see and edit; hide the ones you do not.
	The Display toolbar allows you to modify how the editing area is displayed. You can hide the grid, disable the synchronization with the current frame, reset the zoom level and normalize the function display by stacking them one over the other to compare them regardless of their value range.
Current Frame	Displays the current scene frame.
Selected Keyframe Value	Displays the value of the selected keyframe.
Display Advanced Parameter Values	 <p>Displays the Projection, Bias, Tension and Continuity parameters to adjust the curve around the selected keyframe.</p>
Keyframe, Velocity and Interpolation Options	This toolbar lets you add and delete keyframes, adjust the velocity curve, adjust the segments to motion or stop-motion keyframes and set the velocity to create steps instead of a constant progression.
Function Type	This toolbar lets you click on the different function types to enable or disable all the listed functions of that type.
Value Scale	displays the value range for the displayed editing area. It can be referenced to know the value of a keyframe.
Selected Keyframe	The selected keyframe is displayed in red. When selected, the keyframe values are displayed in the corresponding fields.
Bezier Handles	The Bezier handles let you adjust the ease in and ease out of each keyframe. The more the handle is pulled out horizontally, the slower the animation will be. The more the handle is pulled out vertically, the faster the animation will be.
Function Curve	The thin line going from keyframe to keyframe is the actual curve. The section of a curve located between two keyframes is called a segment.
Frame Scale	The Frame Scale displays the frame range for the displayed editing area. It can be referenced to know the current frame of a keyframe.

Modifying a Path in the Xsheet View

If you prefer working with the Xsheet view, you can also create keyframes and type values in the Xsheet view.

You cannot create function curves directly in the Xsheet view. You must do this in the Layer Properties editor or the Timeline view.

To edit a function column in the Xsheet view, you must first display the Functions section of the Xsheet view and then select the layer you want to modify. If you double-click on a function column's header, you will display the corresponding function curve in the Function editor.

How to display the function columns in the Xsheet view

1. In the Xsheet view, click on the Expand Function Section button.
2. In the Timeline view, select the layer containing the parameters to modify.

The columns appear in the Xsheet view. The columns will not appear if function curves were not previously created by adding keyframes or through the Layer Properties view.

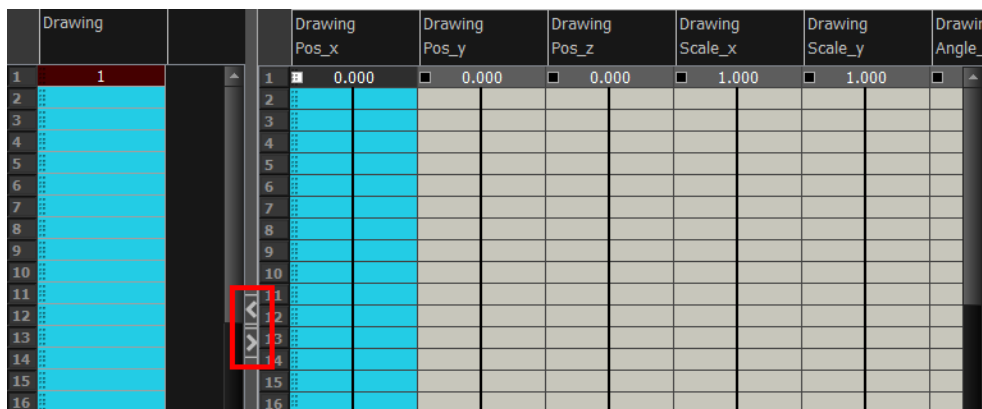

Drawing	Drawing Pos_x	Drawing Pos_y	Drawing Pos_z	Drawing Scale_x	Drawing Scale_y	Drawing Angle
1	0.000	0.000	0.000	1.000	1.000	
2						
3						
4						
5						
6						
7						
8						
9						
10						
11						
12						
13						
14						
15						
16						

How to add a keyframe in the Xsheet view

1. In the Xsheet view, go to the function column on which you want to add a keyframe.

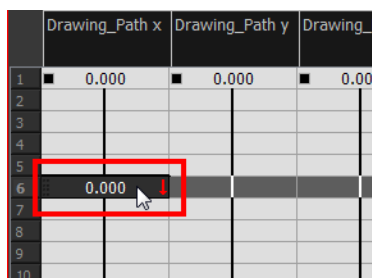

Drawing_Path x	Drawing_Path y	Drawing_Path z
0.000	0.000	0.00

2. Double-click on the cell on which you want to add a keyframe and type a numeric value.

	Drawing_Path x	Drawing_Path y	Drawing_Path z
1	0.000	0.000	0.000
2			
3			
4			
5			
6	5		
7			
8			
9			
10			

3. Press Enter/Return to continue to the next cell.
4. Press Esc to exit the typing mode.

	Drawing_Path x	Drawing_Path y	Drawing_Path z
1	0.000	0.000	0.000
2	1.000 E		
3	2.000 E		
4	3.000 E		
5	4.000 E		
6	5.000 E	0.000	0.000
7	4.687 E		
8	4.375 E		
9	4.062 E		
10	3.750 E		

How to convert a cell into a keyframe

1. In the Xsheet view, go to the function column on which you want to add a keyframe.
2. Select the cell to convert.

	Drawing_Path x	Drawing_Path y	Drawing_Path z
1	0.000	0.000	0.000
2	1.000 E		
3	2.000 E		
4	3.000 E		
5	4.000 E		

3. Right-click on the cell and select **Set Selection As Keyframe** or press F6.

	Drawing_Path x	Drawing_Path y	Drawing_Path z	Drawing_Path velocity
1	0.000	0.000	0.000	0.000
2	1.000 E			0.100
3	2.000 E			0.200
4	3.000 E			0.300
5	4.000 E			0.400
6	5.000 E	0.000	0.000	0.500
7	4.687 E			0.531

- If you want to remove a keyframe, select the keyframe, right-click on the cell and select **Clear Keyframe in Selection** or press F7.

Function Curves

By default, when a drawing layer or peg is added to a scene, no function curves are created. You will generally create the ones needed to avoid being overloaded with too many functions you might not use.

When you select an element in the Camera view and move it around, it will automatically create the corresponding function curves. If you need to create certain functions manually, you can always do it through the Layer Properties view or editor. You can then share it with other layer parameters or set your keyframes directly on the function curve instead of the Timeline or Camera view.

You can also link a layer's parameter to an existing function curve or attach several parameters to the same function curve. For example, if you have an aircraft performing loops between clouds, you may want the camera to follow the aircraft's motion path. If you attach the camera to the aircraft's layer, the camera will also loop, but this may produce undesirable results and even induce a feeling of motion sickness as you watch the final animation. Instead, you can share the X, Y and Z position of the aircraft with the camera's peg layer, but ignore the angle, scale and skew.

By default all the function curves you create are private. This means that the function curves can only be used and modified using their original parameter. If you want another layer or parameter to use the same function curve, you must make the function public by sharing it.

There are two ways to share a function:

- Share Functions command
- Layer Properties Editor

When you create a function curve in the Layer Properties view or editor, there are several choices available:

- **Create 3D Path:** Creates a new 3D Path Column set
- **Create Bezier:** Creates a new Bezier curve
- **Create Ease:** Creates a new Ease curve
- **Local:** Disconnects the parameter from any function and turns it public
- **3D Path:** Displays the list of every public 3D Path function available
- **Bezier:** Displays the list of every public Bezier curve available
- **Ease:** Displays the list of every public Ease curve available
- **Velobased:** Displays the list of every public velocity based curve available
- **Expression:** Displays the list of every public Expression function available
- **3D Rotation:** Displays the list of every public 3D Rotation function available
- **Connected:** Displays the list of every public connected function curve
- **Unconnected:** Displays the list of every public unconnected function curve
- **All:** Displays the list of every public function curve

You have the choice of creating a new function curve or linking it to an existing public one. This way, you can have two or more parameters following the same function.

Depending on your favourite working method, you can create different types of function curves to suit your needs.

You have several choices available:

- Ease function
- Bezier function
- Velobased function

When you create a function to control a parameter over time (Scale, X, Y, Z, Rotate), you have the choice of an Ease or Bezier function.

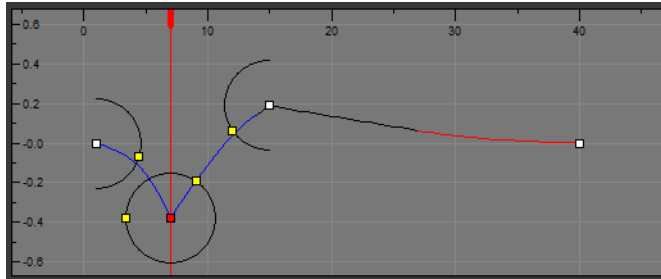

Ease function

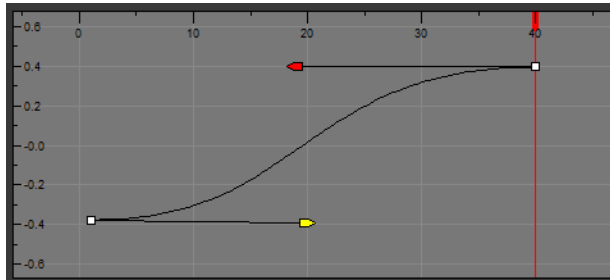

Bezier function

These function editors present different ways of editing the values over time. The shape of the created graph indicates the velocity of the function, regardless of the chosen editor. The type of function that you choose is largely based on your working preference.

With the Ease editor, you can edit the shape of the function curves using the ease-in and ease-out controls.

You can also create Velobased functions for certain effects, like changes in rotation or size over time. In these cases, the Velobased functions are linked to the velocity of a 3D path. You cannot change the shape of a Velobased function to control its velocity.

With Velobased functions, you can link changes in rotation or scaling to the velocity of a 3D path. This makes it possible for changes in rotation or scaling to progress at the same speed as changes to the position of an element.

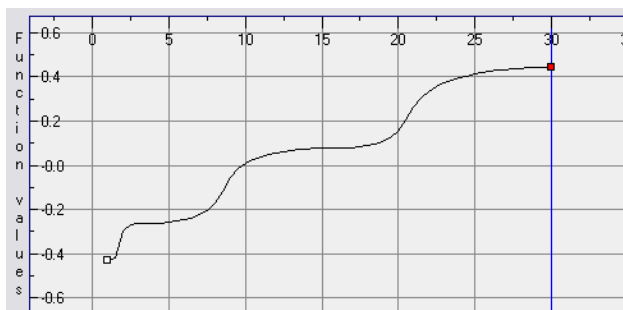

You can convert Ease and Bezier functions so you can edit them using the controls offered by that type of function.

How to create the function curves

1. In the Timeline view, double-click on a layer.

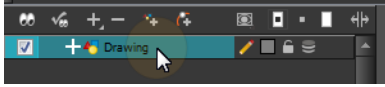

The Layer Properties Editor opens.

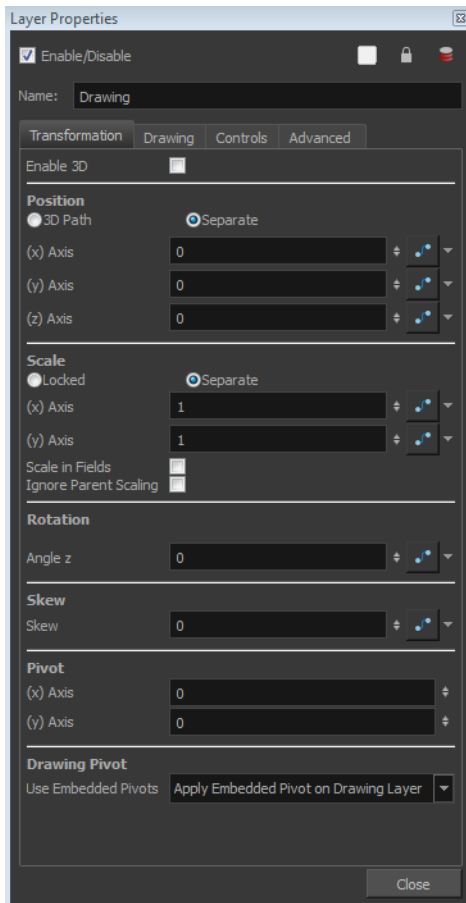

2. Select the **Transformation** tab.
3. Click the Function Arrow button beside the local function information.
4. Create a 3D Path, Bezier, Ease or Velobased curve. You can also create an Expression column—see [Expression Columns on page 271](#).

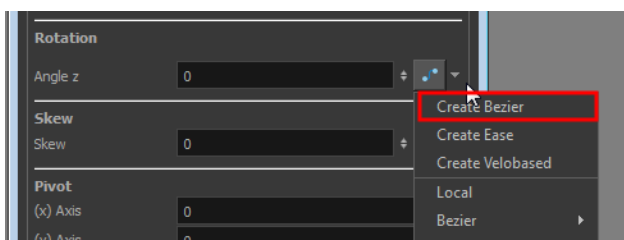

You can click the Function  button to open the Function editor.

5. Click **OK**.

How to share a function using the Share Functions command

1. In the Timeline view, select the function layer to share.



2. Right-click and select **Share Functions**.

The function becomes public to the other layers and parameters, and can be shared.

Public functions are visible in the main section of the Xsheet view.

	Drawing_Pos_x_	Drawing_Pos_y	Drawing_Pos_z	Drawing_Angle_	Drawing
1	0.000	0.000	0.000		1
2	-0.021		0.072		
3	-0.050		0.148		
4	-0.092		0.225		
5	-0.156		0.303		
6	-0.248		0.381		
7	-0.375		0.370		
8	-0.284		0.359		
9	-0.195		0.347		
10	-0.110		0.336		
11	-0.032		0.325		
12	0.038		0.314		
13	0.098		0.303		
14	0.146		0.291		
15	0.187		0.280		
16	0.177		0.269		
17	0.166		0.258		
18	0.156		0.247		
19	0.145		0.235		
20	0.135		0.224		
21	0.125		0.213		
22	0.114		0.202		
23	0.104		0.191		
24	0.093		0.179		
25	0.083		0.168		
26	0.072	0.000	0.157		1
27	0.062	0.000	0.146		1

3. In the Timeline view, open the Layer Properties editor of the layer that contains the parameters you want to link to the public function.
4. To open the Layer Properties editor, in the Timeline view, double-click on the layer containing the function to share or click once to display it in the Layer Properties view.

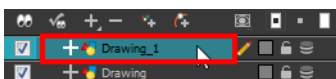

The Layer Properties Editor opens.

5. Select the **Transformation** tab.
6. Click the Function Arrow  button beside the function you want to link to the function column.
7. From the menu, select the function you just made public from the 3D Path, Bezier, Ease, Velobased, Expression, Connected, Unconnected, or All menu and attach it to your parameter.

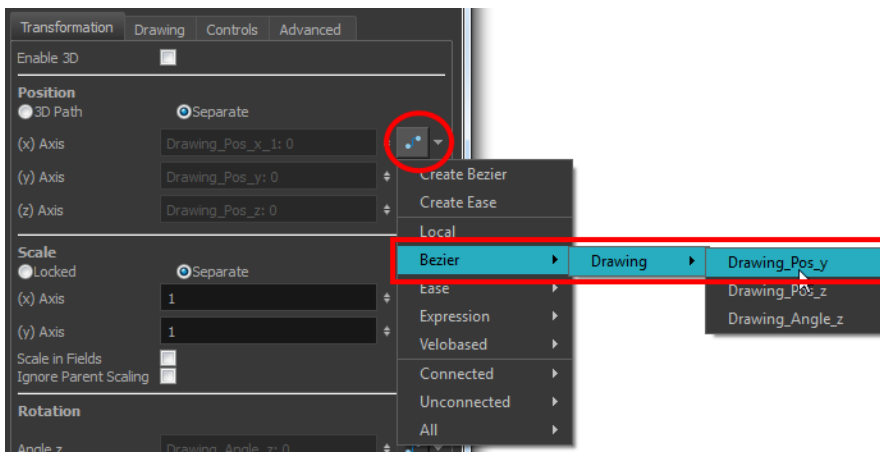



The two parameters are now both linked to the same function curve and should follow the same path. If you modify the curve, both parameters will update.

How to share function curves

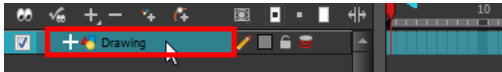
1. To open the Layer Properties editor, in the Timeline view, double-click on the layer containing the function to share or click once to display it in the Layer Properties view.



2. Select the **Transformation** tab.
3. Click the Function Arrow  button beside the function to share.
4. In the drop-down menu, select **Local**.
5. Click the Function Arrow  button beside the Function field and choose a function from the drop-down menu.

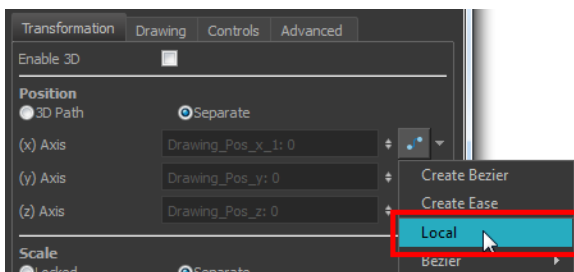

The function becomes public to the other layers and parameters, and can be shared. Public functions are visible in the main section of the Xsheet view.

	Drawing_Pos_x	Drawing_Pos_y	Drawing_Pos_z	Drawing_Angle	Drawing
1	0.000	0.000	0.000		1
2	-0.021		0.072		
3	-0.050		0.148		
4	-0.092		0.225		
5	-0.156		0.303		
6	-0.248		0.381		
7	-0.375		0.370		
8	-0.284		0.359		
9	-0.195		0.347		
10	-0.110		0.336		
11	-0.032		0.325		
12	0.038		0.314		
13	0.098		0.303		
14	0.146		0.291		
15	0.187		0.280		
16	0.177		0.269		
17	0.166		0.258		
18	0.156		0.247		
19	0.145		0.235		
20	0.135		0.224		
21	0.125		0.213		
22	0.114		0.202		
23	0.104		0.191		
24	0.093		0.179		
25	0.083		0.168		
26	0.072	0.000	0.157		1
27	0.062	0.000	0.146		1

- In the same drop-down menu, where you chose the Local option (in our example), select the function you just made public from the 3D Path, Bezier, Ease, Velobased, Expression, 3D Path, Connected, Unconnected or All menu and attach it to your parameter.

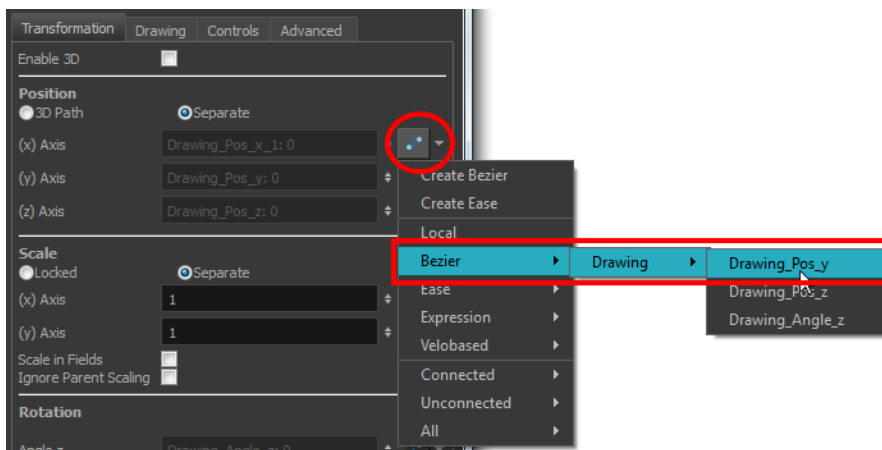

- In the Timeline view, open the Layer Properties editor of the other layer that contains the parameters you want to link to the public function.
- In the Layer Properties editor or view, attach the parameter to the public function the same way you did for the first layer.

The two parameters are both linked to the same function curve and follow the same path. If you modify the curve, both parameters will update.

How to convert Ease and Bezier functions

- In the Xsheet view, show the function columns.
- In the Xsheet view, click on the Expand button located on the right side of the main section to show the Functions section. Click on the same button to collapse it. You can also use the Show Column List  button in the Xsheet View toolbar.

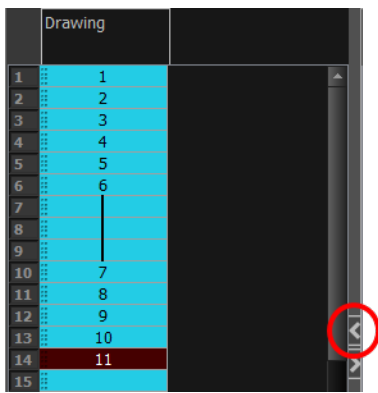

3. Click the Expand button on the right side of the Functions section to display the Column List section.

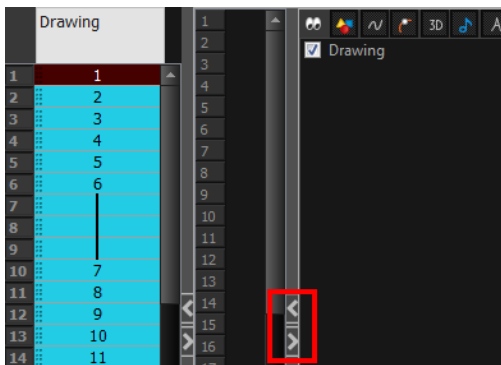

4. In the Timeline view, click the layer that contains you function columns you want to display.

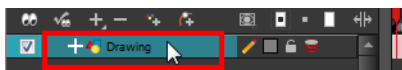

5. In the Xsheet view, right-click on the column header and select one of the following from the menu:
 - ▶ **Convert the column:** The values of multiple effects may be linked to the original column. When you use the Convert the Column command, all links to the original column will transfer to the new converted column.
 - ▶ **Create a new column and update links:** Creates a new function from the original. All links to the original column will transfer to the new column. The original function column will remain in the exposure sheet in case you decide you want to switch back to it.
 - ▶ **Create a new unused column:** Creates a new column based on the values in the original column and leaves all links pointing to the original column. You can use this command to experiment with various functions and then link effect values to the new function curve column.

Copying and Pasting a Motion

In the Timeline view, you can easily drag keyframes to change the animation timing, delete them, cycle them and even copy them.

As you animate, you will find that you reuse many positions, drawings, and keys. However, you may only want to paste the drawings or just the keys or maybe everything. There are different paste options available in the Timeline view which give you maximum flexibility when reusing and pasting.

Note that these modes also apply when you use drag instead of copy and paste.

There are three different modes for pasting your selection:

- **Paste Mode: All Drawing Attributes:** Pastes the drawing exposure and keyframes.
- **Paste Mode: Keyframes Only:** Pastes only the keyframes.
- **Paste Mode: Exposures Only:** Pastes only the drawing exposure.

When you have position keyframes set in your drawing layer and you want to move them around when moving your drawing's timing, you can use the Paste Special feature to only move selected keyframes.

You can also use the Paste Cycle and Paste Reverse feature to cycle your selection including keyframes and drawings.

If you want to cycle a portion of your animation, you can use the Paste Cycle command. You can also use the Paste Reverse command to completely reverse the flow of your animation.

How to paste a selection using the different Timeline pasting and dragging modes

1. In the Timeline view, select the cells you want to copy and paste.

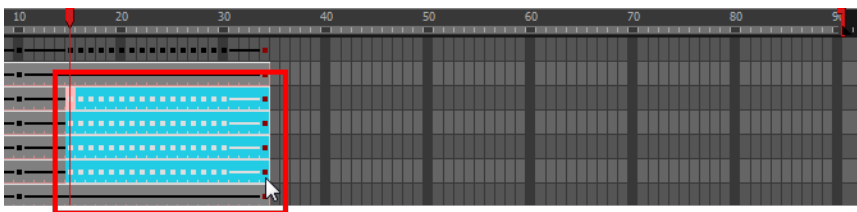

2. In the Timeline view's left side, enable the desired Paste mode.
3. From the top menu, select **Edit > Copy cells from the Timeline** or press Ctrl + C (Windows/Linux) or ⌘ + C (Mac OS X).
4. In the Timeline view's right side, select the cell on which you want to paste your selection.

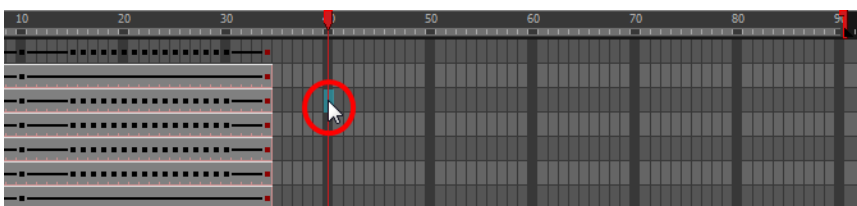

5. From the top menu, select **Edit > Paste Cells in the Timeline** or press Ctrl + V (Windows/Linux) or ⌘ + V (Mac OS X).

Paste Mode: All Drawing Attributes

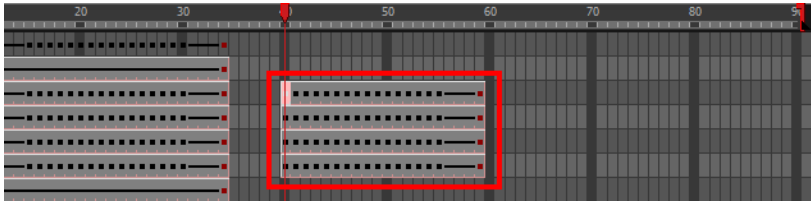

Paste Mode: Keyframes Only

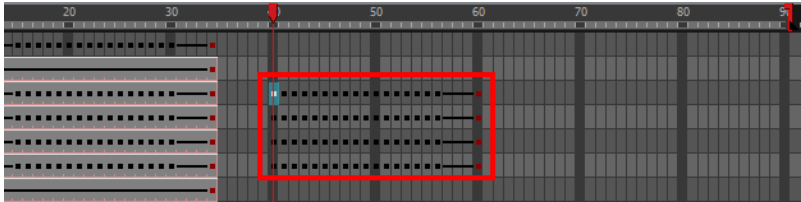

Paste Mode: Exposures Only

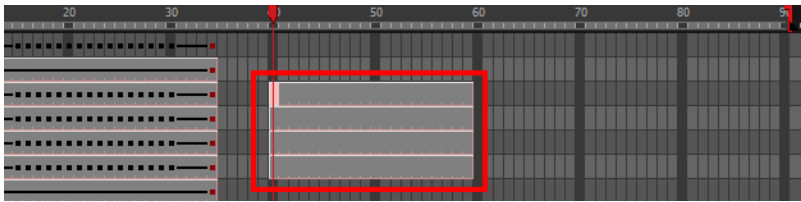

How to copy and paste a motion using Paste Special

1. In the Timeline view, select the keyframes, to copy and paste. If you want to move the keyframes, move on to step 3.



2. In the top menu, select **Edit > Copy**.
3. Edit your selection by doing the following:
 - ▶ To paste the selection, in the Timeline view, select the first cell on which you want to paste your keyframes and from the top menu, select **Edit > Paste Special**.
 - ▶ To move the selection, in the Timeline view, drag the selection and hold down Alt (Windows/Linux) or ⌘ (Mac OS X). Drop the selection where you need it and release the hot key.

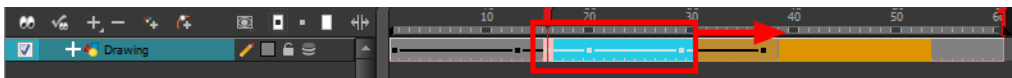

The Paste Special window opens.

4. Set the Drawing, Pegs and Functions, and Cycles parameters.

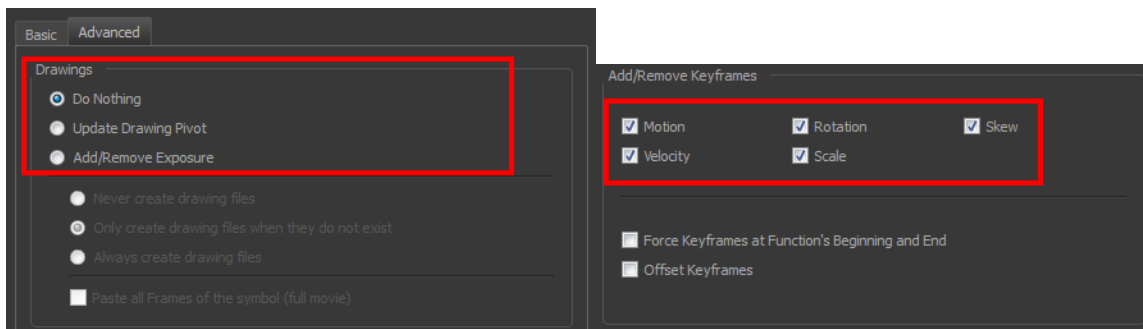

5. Click OK.

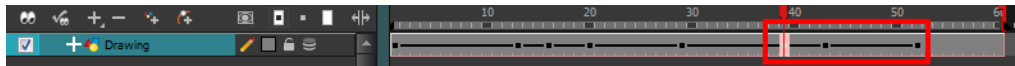

How to open the Paste Special dialog box

1. In the Library view, select the symbol or template to import.
2. While dragging the selection to the Timeline view, hold down the Alt (Windows/Linux) or ⌘ (Mac OS X). Drop the selection in the Timeline view before releasing the hot key.

The Paste Special window opens.

3. Set the parameters.

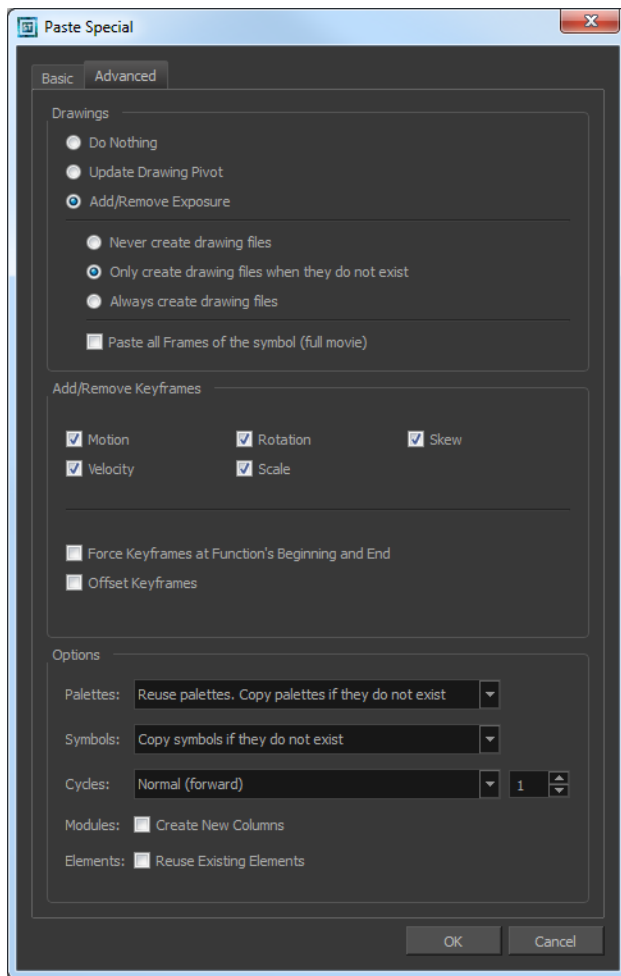

How to cycle a portion of an animation

1. In the Xsheet or Timeline view, select the cell range and keyframes to loop.
2. From the top menu, select **Edit > Copy**.
3. In the Xsheet or Timeline view, select the cell on which you want the cycles to start.

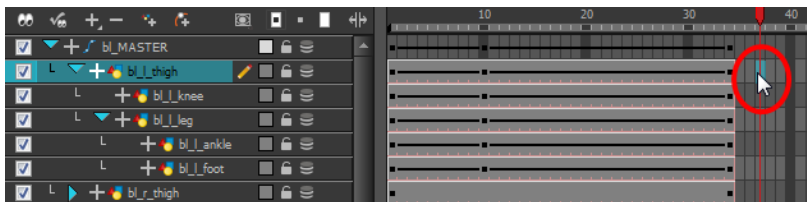

4. From the top menu, select **Edit > Paste Cycle** or press **Ctrl + /** (Windows/Linux) or **⌘ + /** (Mac OS X).

The Paste Cycle dialog box opens.

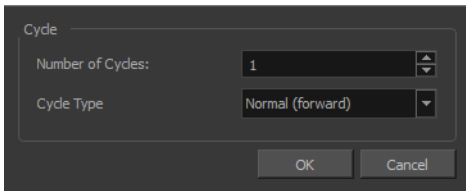

5. In the Number of Cycles field, increase or decrease the number of cycles you want to paste.
6. In the Cycle Type, select the type of cycle to paste.

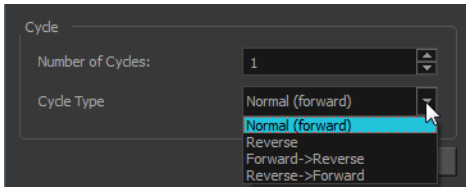

- **Normal (forward):** Pastes your selection as it is, starting with the first cell and ending with the last.
- **Reverse:** Pastes your selection reversed, starting with the last cell and ending with the first.
- **Forward > Reverse:** Pastes your selection as a yo-yo, starting with the first cell, going to the last one and ending with the first cell.
- **Reverse > Forward:** Pastes your selection as a reversed yo-yo, starting with the last cell, going to the first one and ending with the last cell.

How to reverse the animation flow

1. In the Xsheet or Timeline view, select the cell range and keyframes to paste inverted.

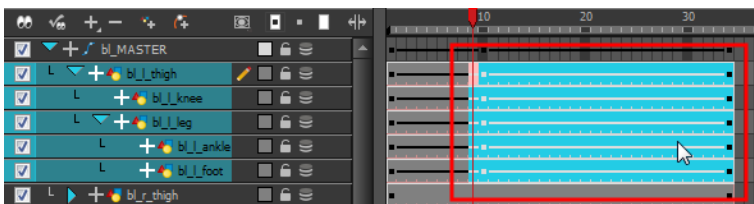

2. From the top menu, select **Edit > Copy**.
3. In the Xsheet or Timeline view, select the cell on which you want the cycles to start.
4. From the top menu, select **Edit > Paste Reverse** or press **Ctrl + .** (Windows/Linux) or **⌘ + .** (Mac OS X).

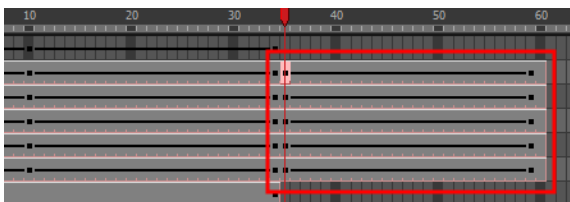

Paste Special Options

Basic Tab

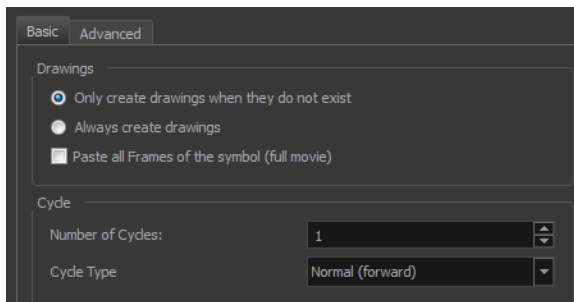

Parameter	Description
Drawings	Only create drawing files when they do not exist: When adding exposures to a drawing layer, new drawings will be created only when drawings with the same name do not already exist in the destination.
	Always create drawing files: When adding exposures to a drawing layer, new drawings will always be created. If drawing files with the same name already exist, Harmony will create a new name for the drawing.
	Paste all Frames of the Symbols (full movie): When enabled, the Paste Special command will expose all the Symbol's frames instead of the first one only.
Cycle	Number of Cycles: Use the up and down arrows to increase or decrease the number of cycles you want to paste. You can also type the value directly in the field.
	Cycle Type <ul style="list-style-type: none"> • Normal (forward): This pastes your selection as it is, starting with the first cell and ending with the last one. • Reverse: This pastes your selection in reverse, starting with the last cell and ending with the first one. • Forward -> Reverse: This pastes your selection as a yo-yo, starting with the first cell, going to the last one and ending with the first cell. • Reverse -> Forward: This pastes your selection as a reverse yo-yo, starting with the last cell, going to the first one and ending with the last cell.

Advanced Tab

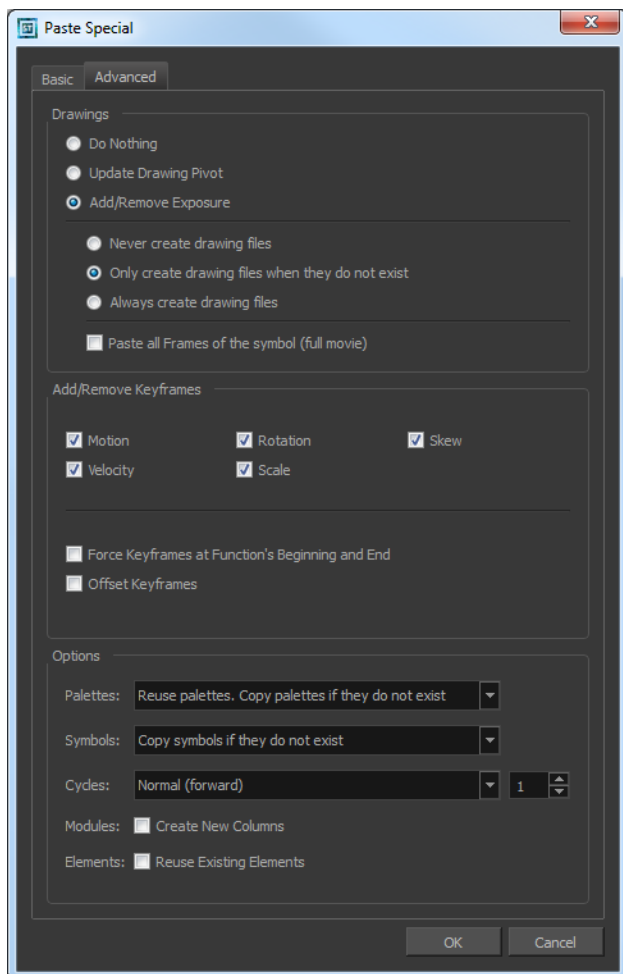

Parameter	Description
Drawings	Do Nothing: Does not create or overwrite drawings.
	Update Drawing Pivot: Revises the drawing pivot in the destination to use the same drawing pivot as the first drawing in the template. If you have a range of drawings selected in the destination, the pivot points of all selected drawings will be updated.
	Add/Remove Exposure: Creates/deletes exposure values in the selected layer.
	You have the following choices as to how to treat drawings that will be created when adding an exposure: <ul style="list-style-type: none"> • Never create drawing files: When adding exposures to a drawing layer, drawing files will not be created. • Only create drawing files when they do not exist: When adding exposures to a drawing layer, new

	<p>drawings will be created only when drawings with the same name do not already exist in the destination.</p> <ul style="list-style-type: none"> • Always create drawing files: When adding exposures to a drawing layer, new drawings will always be created. If drawing files with the same name already exist, Harmony will create a new name for the drawing. • Extend Exposure: Extends the exposure of drawings to fill the range of cells to the destination frame. • Key Drawing Mode (Substitution): Pasting an exposure value replaces the cell value in the current frame and in all frames following in sequence with the original cell value. • Paste all Frames of the Symbols (full movie): When enabled, the Paste Special command exposes all the Symbol's frames instead of only the first one.
Add/Remove Keyframes	<p>Motion: Copies the properties of the selected motion keyframe to the new frame.</p>
	<p>Velocity: Copies the properties of the selected velocity keyframe to the new frame.</p>
	<p>Rotation: Copies the properties of the selected rotation keyframe to the new frame.</p>
	<p>Skew: Copies the properties of the selected skew keyframe to the new frame.</p>
	<p>Scale: Copies the properties of the selected scale keyframe to the new frame.</p>
	<p>Force Keyframes at Function's Beginning and End: Adds a keyframe to the beginning and end of the pasted function, reproducing the source function.</p>
	<p>Offset Keyframes: When pasting functions, this option offsets the keyframes from the function's last value by the values in the pasted function. This will continue the progression of a function rather than repeat the values.</p>
Options	<p>Palettes</p> <ul style="list-style-type: none"> • Do nothing: Does not create, overwrite, merge or link palettes. • Reuse palettes. Copy palettes if they do not exist: Palettes in the destination drawings are left as they are. • Copy and overwrite existing palettes: Overwrites destination palettes with the palettes from the source drawings. • Copy and create new palette files: Creates new palette files, placing them at the same relative environment and scene level as the source. If the palettes in the templates

	<p>were stored at the environment level of the source scene, the paste operation will place the palettes in the environment level of the destination scene.</p> <ul style="list-style-type: none"> • Copy and create new palette files in element folder: Creates new palette files in the element folders of the destination scene, rather than in the same relative job or environment. • Copy palette and merge colours. Add new colours only: Adds new colours to the destination palettes and ignores colours that are the same in the two palettes. • Copy palette and update existing colours only: Adds new colours to the destination palette and updates duplicate colours in the destination with colour values from the source. • Link to original palettes (colour model): Links the colour palettes in the destination scene to the palettes in the source. Use this to link drawings to the palettes in a colour model. • Copy scene palettes and merge colours. Add new colours only: Adds new colours to the destination scene palettes and ignores colours that are the same in the two palettes. • Copy scene palettes and update existing colours: Adds new colours to the destination scene palette and updates duplicate colours in the destination with the colour values from the source. • Duplicate All Symbol Content: Instead of linking the Symbol instance to the original one, the Symbol will be duplicated. A new Symbol is created in the Library.
	<p>Symbols</p> <ul style="list-style-type: none"> • Copy symbols if they do not exist: This is the default setting for this operation and will prevent Symbols in an Action template from being copied. • Duplicate symbols: Creates a duplicate of the symbol instead of linking the Symbol instance to the original one. The new Symbol is created in the Library. • Overwrite symbols: If a modification was made to a Symbol that does not exist in the basic rig template for a character, select this option to overwrite the previous Symbol.
	<p>Cycles</p> <ul style="list-style-type: none"> • Normal (forward): Pastes your selection as is, starting with the first cell and ending with the last. • Reverse: Pastes your selection in reverse, starting with the last cell and ending with the first. • Forward > Reverse: Pastes your selection as a yo-yo, starting with the first cell, going to the last one and ending

	<p>with the first cell.</p> <ul style="list-style-type: none"> • Reverse > Forward: Pastes your selection as a reverse yo-yo, starting with the last cell, going to the first one and ending with the last cell. • Number of Cycles: Lets you set the number of cycles.
	<p>Modules: Create New Columns: A new column is created when you copy and paste modules from the Network view or Layer in the Timeline view. If the layers are linked to function curves, the function curves, drawings and timing will be duplicated.</p>
	<p>Elements: Reuse existing elements: Lets you paste existing elements without creating new ones. This should be used only when pasting within versions of the same scene.</p>

Adjusting the Ease

To add ease in and ease out on motion paths, you can display the function curve and modify the Bezier or Ease curve. To apply ease to multiple functions and keyframes, you can use the Set Ease For Multiple Parameters script and set the amount.

The Velocity, or ease, is used on motion keyframes. The Velocity must be adjusted directly on the function curve in the Function view or Function editor. When a keyframe is selected, easing values appear in the right handle and left handle fields, as well as Bezier handle or Ease wheel controls on each selected keyframe. Pull on them to adjust the ease in and ease out, or type values in the fields.

You can reshape the velocity function using Bezier controls.

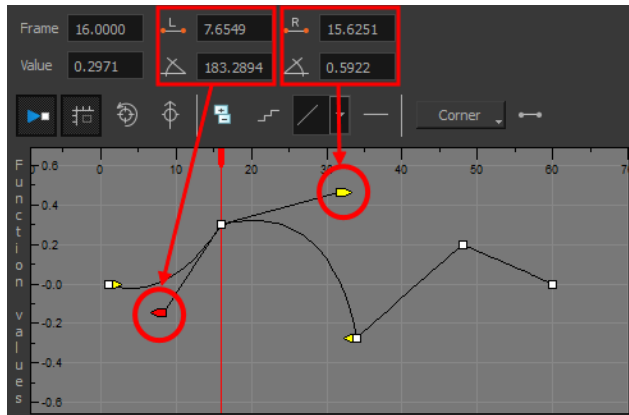

You can also reshape the velocity function using Ease controls.

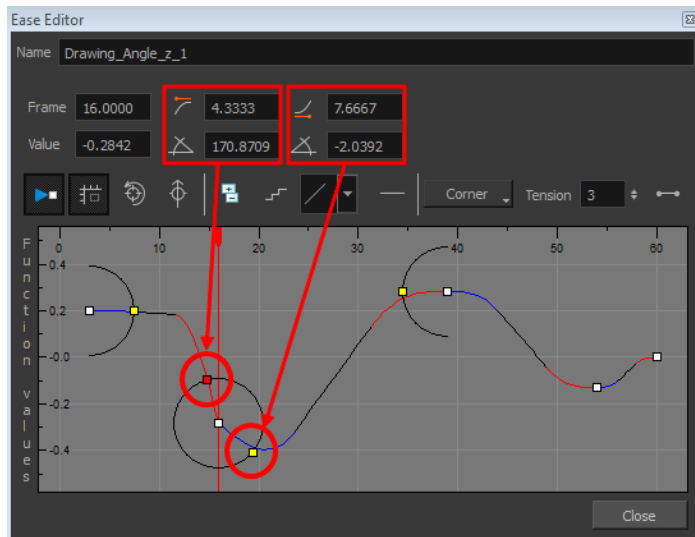

You can create a stepped curve to hold the same value over a selected number of frames. This works well when you are animating drawings on 2s, for example, and you want to hold the same value for a function over those two frames.

If you have several functions whose velocity you want to adjust at the same time, you can use the Set Ease for Multiple Parameters dialog box. It allows you to apply the same velocity parameters to all the selected keyframes in the same frame.

How to display the velocity curve

1. In the Timeline view, click the Expand **+** button on a layer or press **Alt + F** to display the layer's functions.

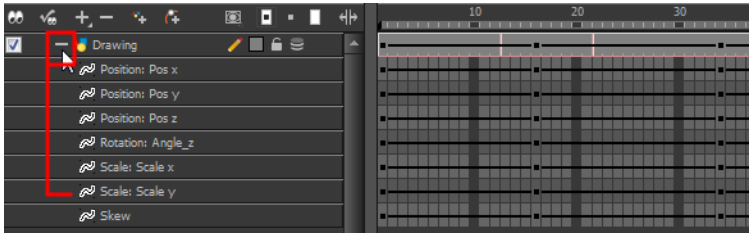

2. Double-click the desired function.

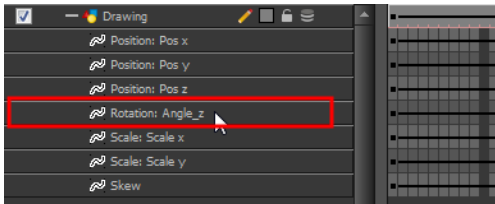

The Function Editor opens as the Ease Editor or Bezier Editor.

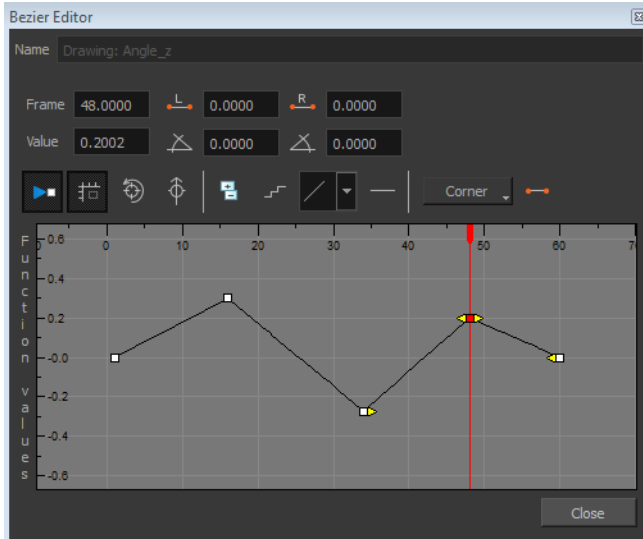

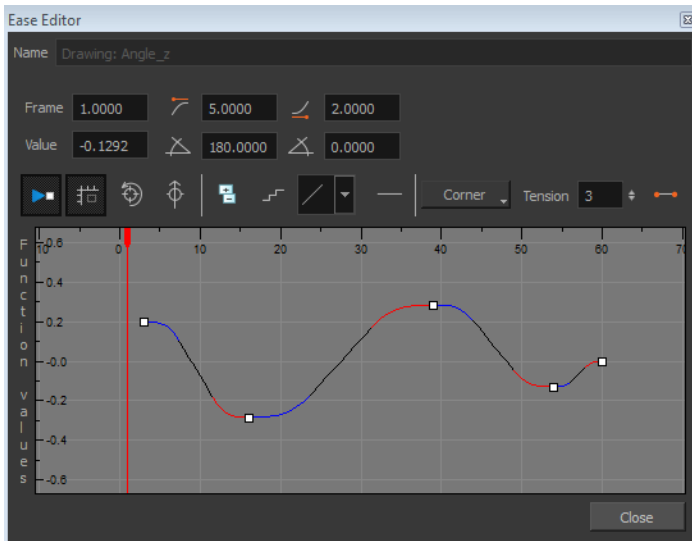

The editor will not be displayed if the function does not already exist. You can reshape the function using the Bézier or Ease controls.

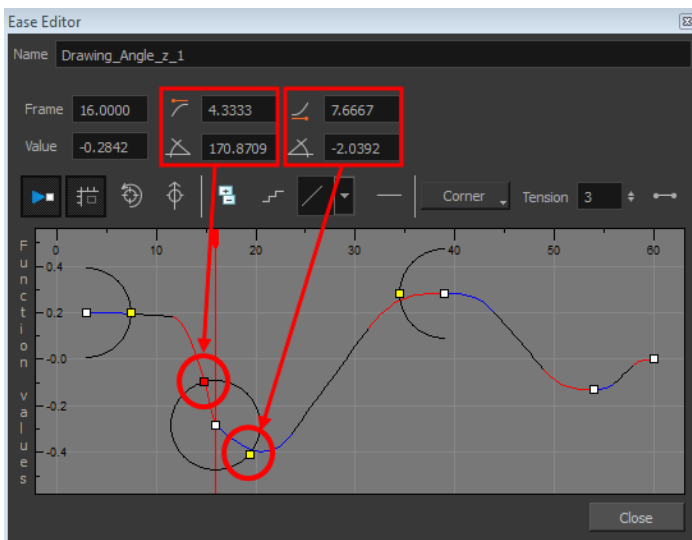
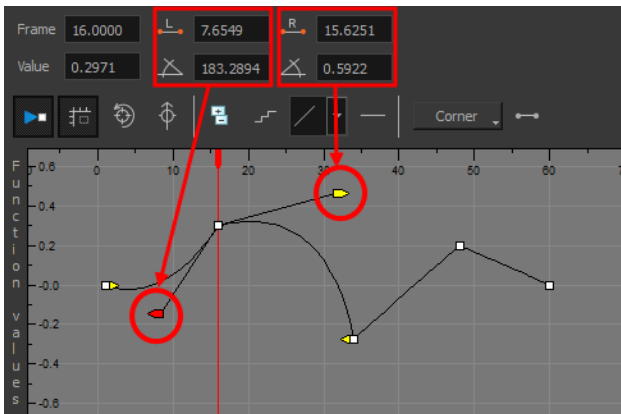

How to reshape a function using Bézier controls

1. Select a keyframe.
2. Drag the handles to modify the shape of the curve.
3. The Continuity options influence how you can move the handles:
 - **Straight:** Lets you move the handles together, maintaining the same angle to the point.
 - **Corner:** Lets you move the handles independently.
 - **Smooth:** Lets you move the handles together, maintaining the same distance and angle to the point.

How to reshape the function using Ease controls

1. Click on the keyframe to select it.
2. To set the number of frames in the ease-in, press Alt, click to the right of the keyframe and drag the green line. The ease in slope is indicated in blue.

As you change the values visually, the value in the Ease In field is updated. This value represents the number of frames in the ease-in.
3. To set the number of frames in the ease-out, press Alt, click to the left of the keyframe and drag the green line. The ease out slope is indicated in red.

As you change the values visually, the value in the Ease Out field is updated. This value represents the number of frames in the ease-out.
4. To adjust the ease-in or ease-out, drag the handles around the keyframe.

The Continuity options, Corner and Straight, influence how you can move the handles:

 - **Straight:** allows you to move the handles together, maintaining the same angle to the point.
 - **Corner:** allows you to move the handles independently.

How to hold the same value over several frames

1. Click the Hold Value Editor  button.

The Hold Value editor opens.

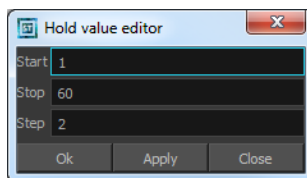

2. In the Hold Value Editor, enter the following values:
 - **Start:** Enter the starting frame for the effect.
 - **Stop:** Enter the last frame for the effect.
 - **Step:** Enter the number of frames to hold the value.

The function curve is updated based on the values you entered.

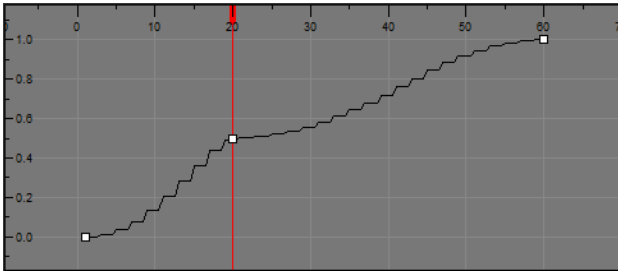

You can reshape the curve to create a linear velocity, so the values are interpolated (tweened) consistently between keyframes. That is, there is no acceleration in the effect.

How to set eases on multiple parameters

1. In the Timeline view, select a keyframe on one or more layers.

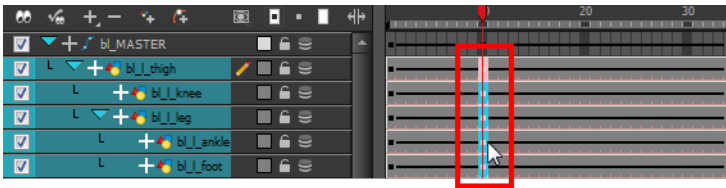

Only the first selected keyframe will be considered when using the Set Ease For Multiple Parameter function. If many keyframes are selected on a same layer, the ease values will be applied only to the first one and the rest will be ignored.

2. In the Timeline view, right-click and select **Set Ease For Multiple Parameters**. In the Timeline View toolbar, you can click the Set Ease For Multiple Parameters  button.

The Set Ease For Multiple Parameters dialog box opens.

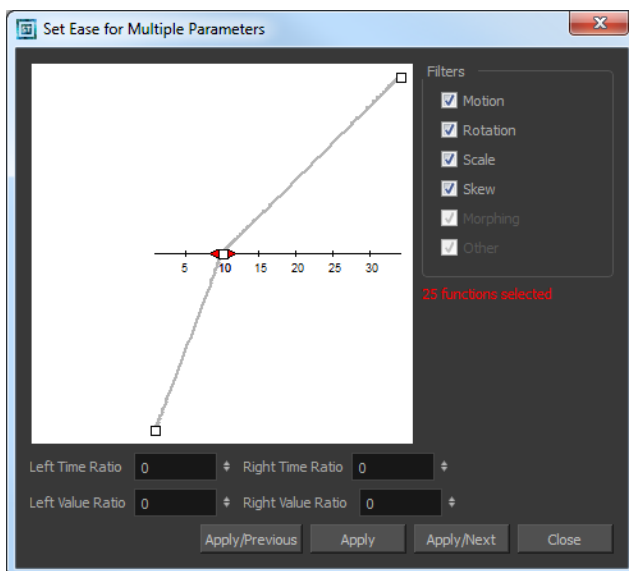

3. In the graph, pull on the Bezier handle to adjust the velocity for all the selected functions.

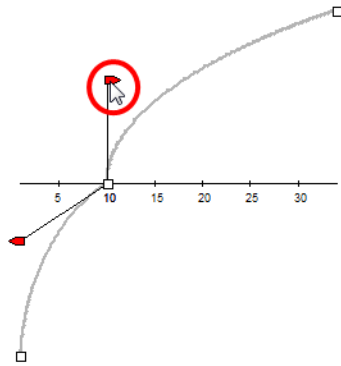

4. In the Filters section, you can apply the easing parameters to a specific type of function only, such as Rotation or Scale. Deselect the function types you do not want to affect.
 - ▶ **Motion:** If this option is enabled, the easing parameters will be applied to the selected Position X, Position Y, Position Z and 3D Path functions
 - ▶ **Rotation:** If this option is enabled, the easing parameters will be applied to the selected **Angle** functions.
 - ▶ **Scale:** If this option is enabled, the easing parameters will be applied to the selected **Scale** functions.
 - ▶ **Skew:** If this option is enabled, the easing parameters will be applied to the selected **Skew** functions.
 - ▶ **Morphing:** If this option is enabled, the easing parameters will be applied to the selected Morphing Velocity functions. Note that it applies to the Morphing velocity function found in the Layer Properties dialog and not to the basic morphing ease in the Tool Properties view.
 - ▶ **Other:** If this option is enabled, the easing parameters will be applied to all the other the selected functions such as all functions created to animate effect parameters.
5. You can also adjust the easing by typing values in the Time Ratio and Value Ratio fields. The values are calculated in percentage.
 - ▶ In the Left Time Ratio and Right Time Ratio fields, type the percentage value corresponding to the length of time you want the easing to last for. It is recommended to remain between 0% and 100%. If you go beyond 100%, your motion will overshoot.
 - ▶ In the Left Value Ratio and Right Value Ratio fields, type the percentage value of how strong you want the easing out to be. It is recommended to remain between 0% and 100%. If you go beyond 100%, your motion will overshoot.
 - ▶ If your Time Ratio and Value Ratio values are equal, you will have a linear motion.
6. Once done, click on one of the following buttons:
 - ▶ **Apply:** Applies the easing parameters to the selected keyframes.
 - ▶ **Apply/Previous:** Applies the easing parameters to the selected keyframes and then selects the previous keyframe in the timeline.
 - ▶ **Apply/Next:** Applies the easing parameters to the selected keyframes and then selects the next keyframe in the timeline.
 - ▶ **Close:** Close the dialog box. If you did not apply the modifications, they will be cancelled.

Expression Columns



In Harmony, you can use expressions to automate the calculation of effect values based on the values in another function. An expression is a mathematical formula that allows you to manipulate the value in the source function to create new values for the destination effect.

For example, there are two characters. One is walking across the stage and the other is following the same path two steps behind. Without expressions, you would have to manually enter the values for the position of the peg so it is one frame behind the original element. However, you can save time by building an expression that does this for you. Then, if you change the position of the element in the original column, Harmony automatically updates the Expression columns linked to it.



When you want to create an expression for an effect, you must add an Expression column to the Xsheet view, build the expression and then link the Expression column to the parameter you want to control.

Writing Expressions

Expressions are based on a JavaScript (JS) program. You can access the full capability of the JS language and write any type of program, as long as it executes relatively quickly.

The entire JavaScript must be defined within the expression code. There are no common repository of JS functions and services available to the expression column scripting environment. However, with the Harmony C++ SDK, you can extend the API of functions available to the expression scripting environment.

If you are working with an old project that contains expressions, they are converted to a JS program. Only simple expressions are updated. Complex expression and expressions using non-ported services cannot be converted. For these type of expressions, you must convert them manually.

Expression Editor

The Expression editor is where you write expressions. It is a simple text editor that can handle incomplete or invalid JS programs although they will not be evaluated, Harmony can save and load invalid JS programs.

The Expression editor evaluates the current script at the current global frame and reports any errors or returns the numerical result of the program.

Expression JavaScript Program

An expression JavaScript program can be any valid program. The only requirement is the last statement of the script must leave a number on the stack. The “return” statement is NOT needed as the script is not a function.

Valid Expression Column JS Program

Example 1

```
10
```

This is a simple program returning 10.

Example 2

```
currentFrame
```

This is another simple program returning the current frame. The variable “currentFrame” is one of the predefined variables and services available.

Example 3

```
value( "MyBezierFunction", currentFrame - 1 );
```

A simple expression program that returns the value of the Bezier function “MyBezierFunction” at the previous frame. If this function does not exist in the scene, the expression column will be blank in the XSheet. If this function does exist, the expression column will show the value of that function at the frame.

Example 4

```
function fib( v )
{
  if( v == 0 || v == 1 )
    return 1;
  else
    return fib( v - 1 ) + fib( v - 2 )
}

fib( currentFrame );
```

This programs evaluates the Fibonacci series starting at the current frame. The value will be computed up to a certain frame. After that frame, the program is too complex and will be stopped by the engine before finishing.

Errors

Programs that take too long to execute, do not generate a numerical value, or has syntax errors will not be compiled and will not compute a value. The scripting editor will show the condition that triggers this, but the Xsheet will simply display a blank field.

API

Using Column Names and Frame Numbers

To refer to the values in a column, use the column name and the frame number. If you do not state the frame number, then Harmony uses the value of the current frame. You can refer to the frame numbers in the following ways:

- **currentFrame**: Refers to the current frame number.
- **numFrames**: refers to the total number of frames in a scene.

Consider the expression: `value ("peg x", currentFrame-1)`

- This expression says that the current frame value will be the same as the previous frame value of the element `peg x`.

Now consider this expression: `value ("peg_angle", currentFrame - 2] * 3`

- In this expression, Harmony is to look two frames before the current frame in the column "`peg_angle`" and multiply the value by 3 to derive the value for the current frame of the expression column.

Predefined Functions

Most mathematic functions are obvious. They either take an angle or value or return an angle or a value. Angles are always specified in degrees. If the input argument is not valid, the function will log an error (which is visible in the script editor) and the Xsheet does not display anything.

The two variants of the function `value()` are used to get the value of 2D functions at the current frame or the specified frame. The first argument is always a string that identifies the function. The optional second argument is the frame to use.

For example: `value("myFavBezier", currentFrame-1)`

Function	Description
<code>sin (angle)</code>	Returns the sinus from angle specified in degrees
<code>cos (cosine)</code>	Returns the cosinus from the angle specified in degrees
<code>tan (angle)</code>	Returns the tangent from the angle specified in degrees
<code>asin(v)</code>	Returns the arcsin in degrees
<code>acos(v)</code>	Returns the arccos in degrees
<code>atan(v)</code>	Returns arctan as an angle in degrees from the first quadrant
<code>atan2(x, y)</code>	Returns the arc tangent in degrees
<code>int</code>	Returns the integer value of the "v". Undefined behaviour for negative number.
<code>ceil(v)</code>	Returns the next integer greater or equal than "v"
<code>floor(v)</code>	Returns the integer value of v. Remove the fractional part.
<code>abs(v)</code>	Return the absolute value

<code>sqrt(v)</code>	Returns the square root for $v \geq 0$
<code>exp(v)</code>	Returns the "e" exponent v . (see c library <code>exp(f)</code>)
<code>ln(v)</code>	Returns the natural logarithmic of v for $v > 0$
<code>ln</code>	Logarithm of a value
<code>value(columnName)</code>	Value of the function specified by "columnName" at the current frame
<code>value(columnName, frame)</code>	the value of the function specified by "columnName" at the frame specified by "frame"
<code>column(columnName)</code>	<p>Identify the text wrapped by columnName to be renamed whenever the column named "columnName" is renamed.</p> <p><code>column()</code> is a keyword that does nothing at runtime, but, it helps Harmony track which references to a function needs to be renamed in the script when a function is renamed. For example, if you have a function named "B" and this one gets renamed to "C" through some scripts or by the user, all expression script referencing "B" will automatically be updated to refer to "C" if their call was wrapped as <code>column("B")</code>.</p>
<code>node(nodeName)</code> <code>module(nodeName)</code>	<p>Identifies a module/node that is in the same group as another module which is using this expression column.</p> <p><code>node(nodeName)</code> and <code>module(nodeName)</code> are two functions that return a proxy to a module that must live in the same group as another module using that expression column. For this method to work, the expression must be connected to a module "A" and the script must refer to a module "B" in the same group as module "A". The resulting object is a proxy to a module which cannot be converted to a number. This proxy object is only usable by an SDK plugin.</p>
<code>numFrames</code>	A constant that represents the number of frames in the current scene
<code>currentFrame</code>	A constant that represents the current frame (1 based)

Building an Expression for an Effect

How to build an expression for an effect

1. In the Xsheet view menu, select **Columns > Add Columns** or press Shift + C. The Add Column dialog box opens.

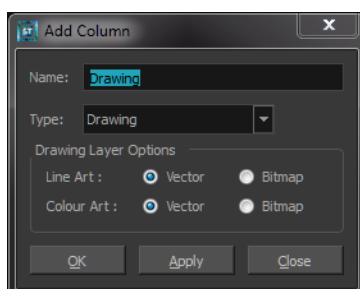

2. In the Name field, type a name for the column.
3. From the Type menu, select **Expression** and click **OK**.
4. Double-click on the column's header to open the Expression dialog box.

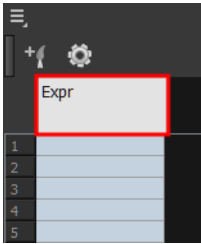

5. Type an expression in the dialog box.

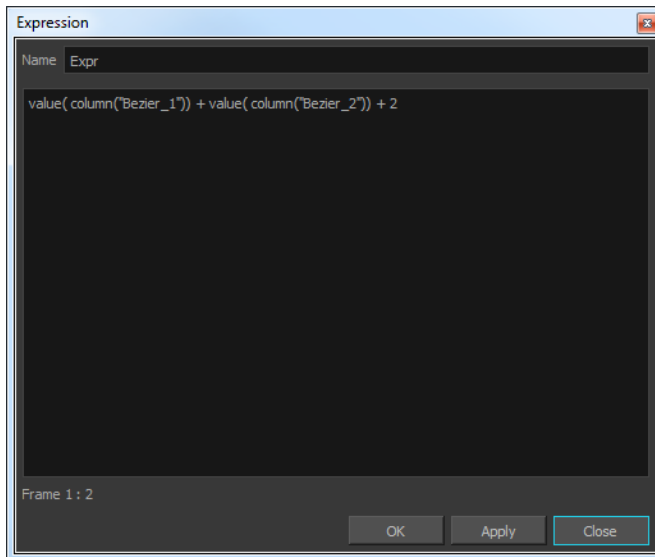

To address a specific component of a 3D Path, the syntax is "Peg x", and not "Peg_x".

6. Click **OK** or **Apply** to activate the expression.
The cells in the Expression column are filled with values based on the expression you created.



	Bezier_1	Expr	Drawing	Bezier_2
1	0.000	2.000		0.000
2	0.153	2.876		0.723
3	0.305	3.752		1.447
4	0.458	4.628		2.170
5	0.610	5.504		2.894
6	0.763	6.380		3.617
7	0.915	7.256		4.340
8	1.068	8.132		5.064
9	1.220	9.008		5.787
10	1.373	9.884		6.511
11	1.525	10.759		7.234
12	1.678	11.635		7.957
13	1.831	12.511		8.681
14	1.983	13.387		9.404
15	2.136	14.263		10.128
16	2.288	15.139		10.851
17	2.441	16.015		11.574
18	2.593	16.891		12.298
19	2.746	17.767		13.021
20	2.898	18.643		13.745
21	3.051	19.519		14.468
22	3.203	20.395		15.191

7. To apply the values in the Expression column to an effect, link the Expression column to the parameter values. In the drawing's layer properties, link the function to the new Expression column.

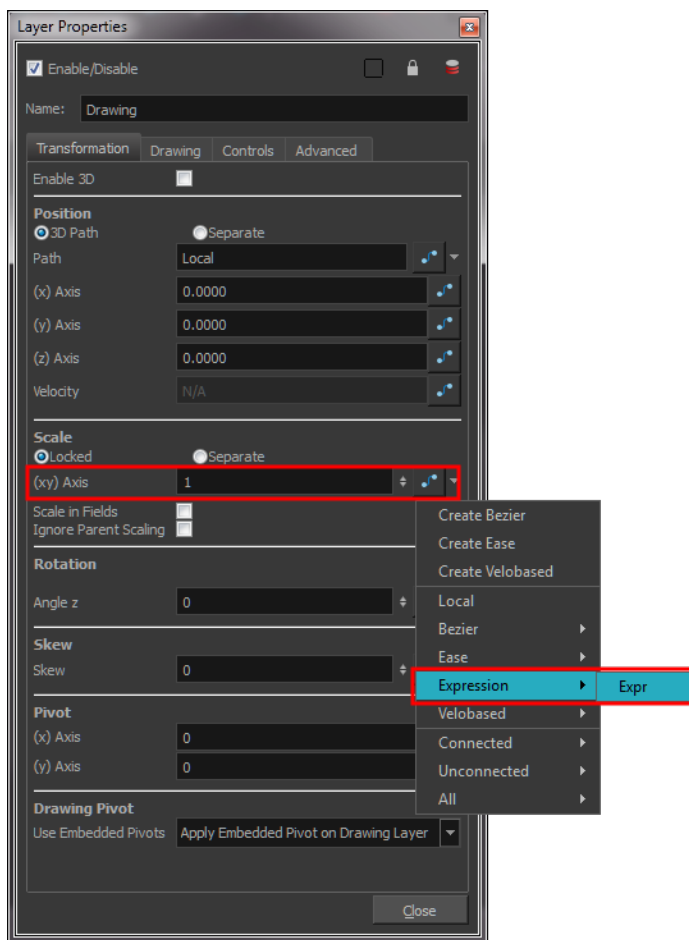

Chapter 5: Sound



With Harmony, you can import soundtracks and dialogue into your animation to make it more engaging and entertaining. There are several sound editing features you can use to synchronize sounds to individual frames or moments in time. You can also use them to trim unwanted seconds from the beginning and end of your sound files, as well as loop sounds that you want to continue throughout your animation.

Your ability to add dialogue to animation is greatly enhanced with the Harmony lip-sync tools. Harmony can analyze voice tracks to determine which of the eight animation phonemes (lip positions) would best apply to each frame of sound. With the mouth chart that is generated, you can easily draw lip positions for your character. Furthermore, Harmony can automatically apply drawings of lip positions to each frame of your animation based on the mouth chart.

This chapter contains the following topics:

- [Importing a Sound File on the next page](#)
- [Sound Layer Properties - Sound Element Editor on page 281](#)
- [Sound Displays on page 283](#)
- [Sound Playback on page 285](#)
- [Sound Scrubbing on page 286](#)
- [Editing a Sound File on page 289](#)
- [Adding an Empty Sound Layer on page 297](#)
- [Exporting a Sound File on page 599](#)

Importing a Sound File

If you decide to add sound to your movie, you must first prepare the sound outside of Harmony. Once this is done, you must add a sound element in Harmony to the organize the sound files in your animation. Sound will play in the movie until it reaches the end of the file or a stop frame that you have created in the Sound Element Editor.

You can import WAV, AIFF or MP3 sound files.

How to import a sound file

1. Do one of the following:

- ▶ From the top menu, select **File > Import > Sounds**.
- ▶ In the Xsheet view, right-click anywhere in the frame area of the Xsheet view and select **Import > Sounds**.
- ▶ From the Xsheet view menu, select **File > Import > Sounds**.
- ▶ From the Timeline view menu, select **Import > Sounds**.

The Select Sound File dialog box opens.

2. From the Select Sound File dialog box, find and select a sound file.

The sound file appears as a layer in the Timeline and Xsheet views.

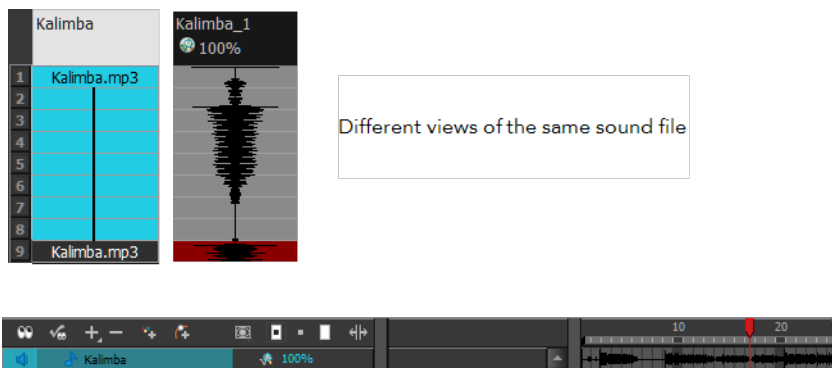

Sound Layer Properties - Sound Element Editor

When you select a sound layer in the Timeline view, the options related to that layer appear in the Layer Properties view or in the Sound Element Editor when you double click on the layer.

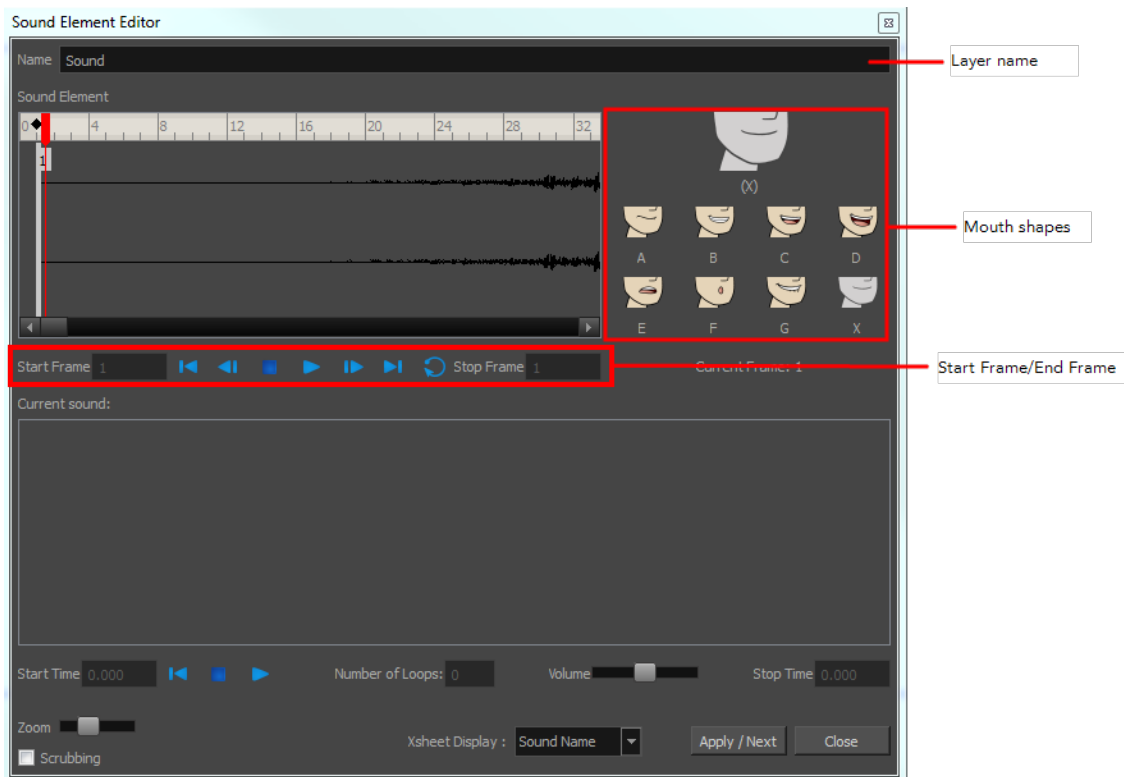
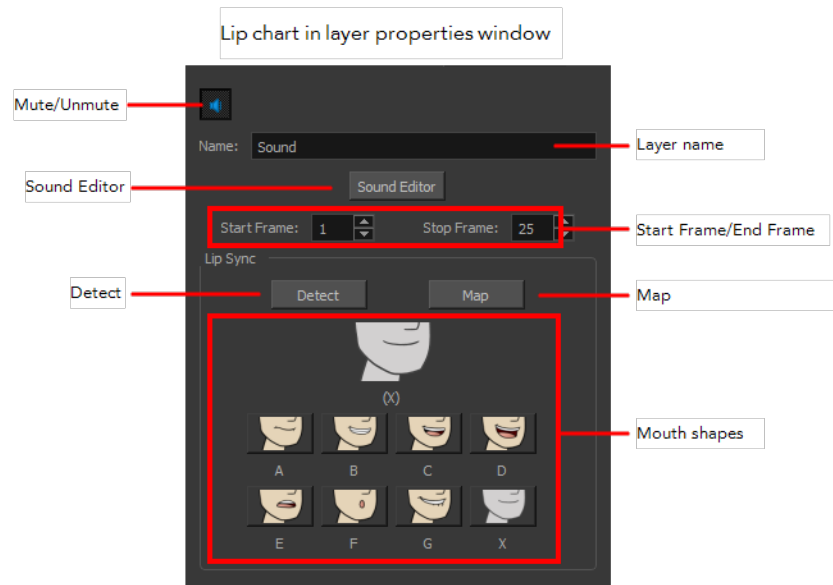

- **Mute/Unmute:** This button mutes and unmutes the sound layer during the scene play back.
- **Layer Name:** This field displays the layer's name.
- **Sound Editor:** This button opens the Sound editor.
- **Start Frame/End Frame:** These fields determine the start and end frame of the sound file.
- **Detect:** This button launches the automated lip-sync detection.
- **Map:** This button opens the Map Lip-sync dialog box.
- **Mouth Shapes:** This section shows the automated lip-sync detection during the scene play back. Click on the thumbnail image of each mouth to change the phoneme assigned to the current frame.

Sound Displays

Within the Xsheet view, you can display the sound file in different ways, depending on your sound editing needs.

You can show or hide the waveform in the Timeline view by selecting the Waveform  button in the Timeline View toolbar. You must customize the toolbar to display this button because it is not included in this toolbar by default.

How to change the sound display in the Timeline view

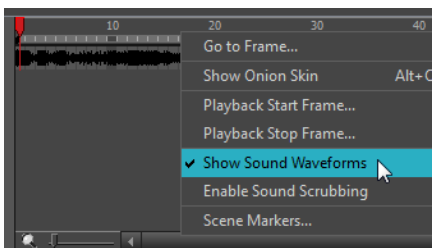

1. In the Timeline view's right area, right-click in the frame section and select **Show Sound Waveforms**.















- ▶ You can change the waveform scale using the Zoom Waveform  icon on individual sound layers in the Timeline view's left side.



How to change the sound display in the Xsheet view

1. Right-click in the sound column or on the sound column header, and select **Sound Display** and one of the following:
 - ▶ **Sound Name:** Shows the name of the sound file, as well as the file format. The line running vertically through the column frames between the same file name indicates a continuity of the same sound file in these frames.
 - ▶ **Mouth Shapes:** Shows the letter (or name depending on the way you named your character's different mouth positions) in the column's frames. There is only one mouth position allotted per frame and this position should correspond to the sound file after performing a lip-sync.
 - ▶ **Waveform:** Shows a vertical display of the sound file's actual waveform. In the column header, in the field under the column name, you can type in a percentage to zoom in or zoom out on the waveform, or pass the scroll cursor  over the Zoom Waveform .

	Sound_Name	Mouth_Shapes	Waveform
28	Sound_Name.wav	X	
29		X	
30		X	
31		X	
32		X	
33		X	
34		X	
35		X	
36		X	
37		X	
38		X	
39		X	



Sound Playback

Before playing back any sound, click the Enable Sound  button in the Playback toolbar or enable it through the Play menu (in the top menu). This will ensure that you can hear the sound layers in your scene, even the ones included within symbols.

How to play back sound

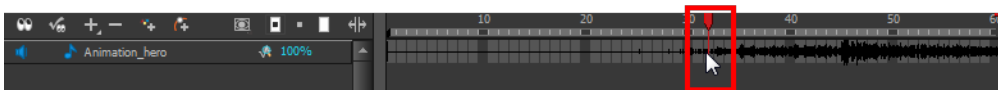
- To select a starting point:
 - ▶ In the Xsheet view, click on a cell in the sound column.
 - ▶ In the Timeline view, click on a cell in the sound layer. You can also slide the red playhead to the correct cell.



- In the Playback toolbar, activate the the Enable Sound  button.
- Do one of the following:
 - ▶ Click the Play  button in the Playback toolbar.
 - ▶ From the top menu, select **Play > Play Scene Forward** or click on the Enter/Return key.
- To hear the sound played back again and again, do one of the following:
 - ▶ Click the Loop  button in the Playback toolbar
 - ▶ From the top menu, select **Play > Loop**.

Mute

If there are two or more sound layers and you want to listen to them independently, you can disable the unwanted sound by clicking the Mute Sound  button on the sound name layer in the Timeline view.

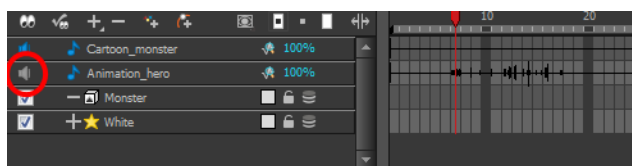

Sound Scrubbing

Harmony uses a process known as Sound Scrubbing to let you hear sound in real-time while you move the playback pointer forward or backward. This is very useful for finely-tuned lip-synching. You can scrub sounds from the Timeline view.

How to scrub a sound from the Timeline view

1. Do one of the following:
 - ▶ From the top menu, select **Play > Enable Sound Scrubbing**.
 - ▶ Right-click in the frame bar of the Timeline view and select **Play > Enable Sound Scrubbing**.
 - ▶ In the Playback toolbar, enable the Sound Scrubbing  button.

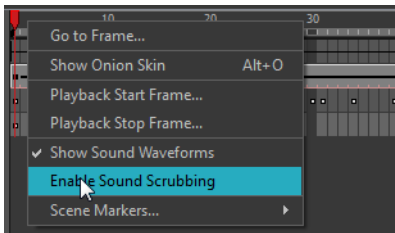

2. At the top of the Timeline view, drag the red playhead to hear the sound at each frame.



Analog Sound Scrubbing

Harmony is set to the digital sound scrubbing mode by default. This means that all sounds are played in real time. It also means that as you scrub over a frame, you will hear the section of your sound file that is allotted to that frame. As you are scrubbing, although it is accurate, the sound can sound clipped. It can also be difficult to hear nuances in pitch and tone.

Harmony has an analog sound scrubbing option. When sound scrubbing in this mode, the sound is played back according to the speed that the playhead or jog is manually adjusted. Harmony's interface offers shuttle and jog sliders to perform analog sound scrubbing, however, external hardware and their corresponding software can be used in conjunction with Harmony for improved analog sound scrubbing results.



Refer to the device's manual to configure its functionality with Harmony.

Performing an Analog Sound Scrub in Harmony

Before you can perform an analog sound scrub in Harmony, you have to learn about the Shuttle and Jog controls.



- **Shuttle:** Pull the Shuttle control backward or forward to make the red playhead in the Timeline view jump by large increments in the direction you are moving the shuttle.
- **Jog:** Drag the Jog control to make the "dial" rotate. The Jog controls finer incremental movements along the soundwave. Use the Frame field to see the frame number which you are on. As you rotate the dial, your speed in fps appears directly after the FPS field.

How to perform an analog sound scrub

1. Do one of the following:
 - From the top menu, select **Play > Enable Sound Scrubbing**.
 - Right-click in the frame bar of the Timeline view and select **Play > Enable Sound Scrubbing**.
 - In the Playback toolbar, enable the Sound Scrubbing  button.

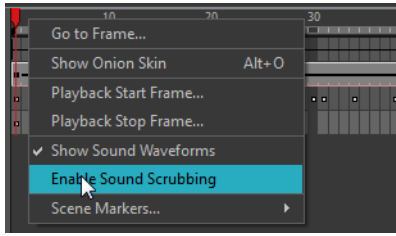

2. In the top menu, select **Edit > Preferences** (Windows/Linux) or **Stage > Preferences** (Mac OS X).
3. In the Sound tab, select the **Analog Sound Scrubbing** option.
4. Click **OK**.
5. Do one of the following:
 - ▶ In the Playback toolbar, use the Shuttle to find the general location of where you want to start your sound scrub.
 - ▶ In the Timeline view, drag the red playhead to the desired location.
6. In the Playback toolbar, use the Jog to fine-tune your scrub to just a few frames.

Editing a Sound File

Now that you have successfully imported a sound file into Harmony, it is time to familiarize yourself with the sound editing interface. The Sound Element editor makes it possible to edit sounds that were created outside of Harmony and imported into your scene.

How to open the Sound Element editor

1. Double-click on the sound layer name in the Timeline view or the sound column header in the Xsheet view.

The Sound Element Editor dialog box opens.

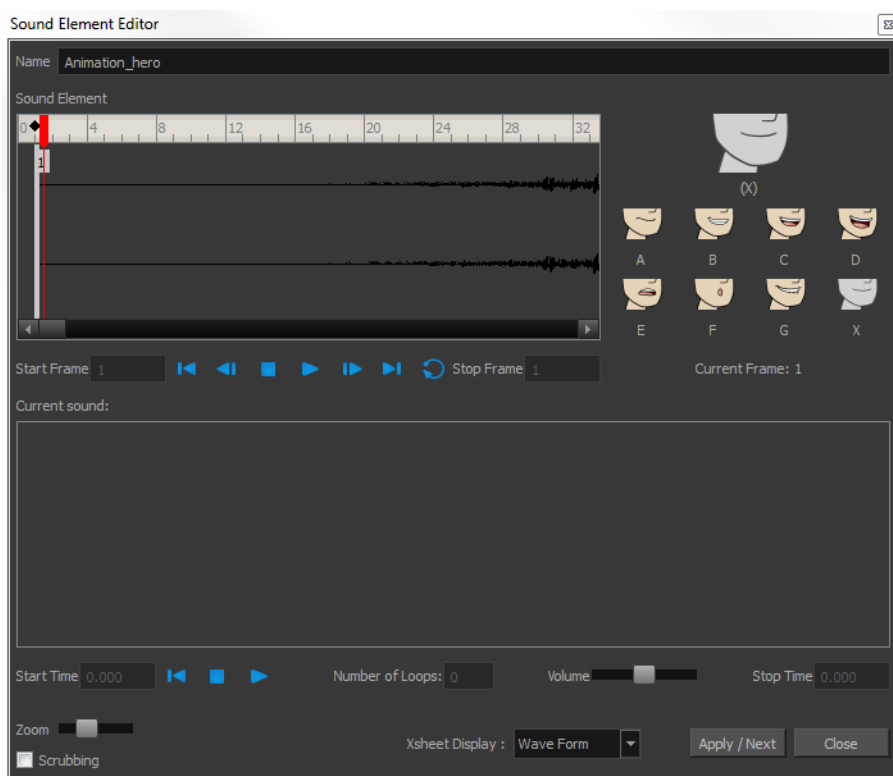

The Sound Element editor consists of three main parts.

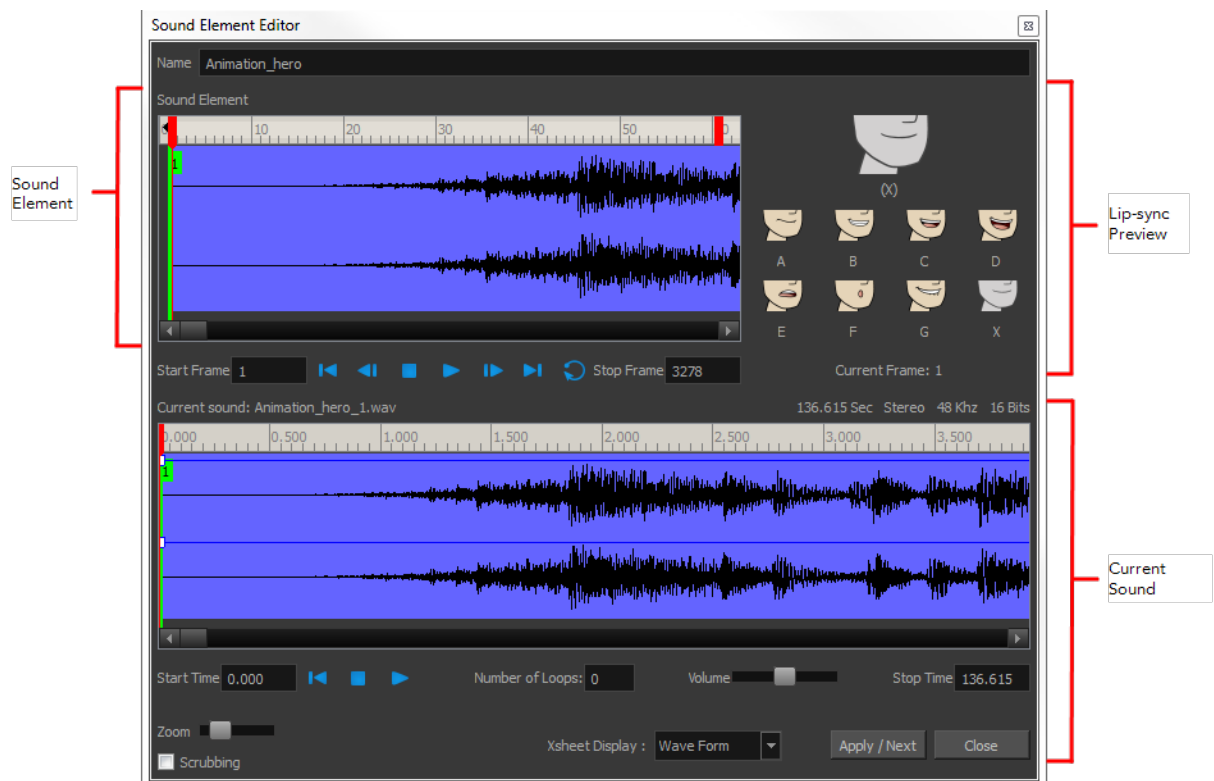

- ▶ **Sound Element:** The waveform in the Sound Element Editor is the actual sample that will be heard when the final movie is rendered. It may be shorter than the original sound sample due to the length of the scene. If any edits are made to the sound sample, they can be heard here. In the Sound Element panel, notice the coloured tabs that indicate the start and end frames of a sound segment. The frame number is displayed in the tab.
- ▶ **Current Sound:** Displays the original sound file in its entirety and is where you can edit its properties. This window remains empty until you click inside the Sound Element Editor.
- ▶ **Lip-sync Preview:** Lets you preview the automated detection and to manually insert different mouth positions to correspond with the sound sample.

You can accomplish the following tasks in the Sound Element Editor:

- Changing the Start or End Frame of a Sound below
- Trimming the Start and End of a Sound File on page 292
- Looping a Sound on page 293
- Mixing the Sound Volume on page 294
- Customizing the Playback Range on page 295
- Recomputing the Mouth Chart on page 304

Changing the Start or End Frame of a Sound

To synchronize the sound with specific images in your scene, you must set a start frame for your sound. To make sure the sound ends by a certain frame, you must set an end frame.

In the Sound Element panel you will see some coloured tabs, these tabs represent the frames. The frame number is shown inside the tab flag marker. These tabs indicate the start and end frames of a sound segment.

How to change start or end frame of a sound

1. Double-click on the sound layer name in the Timeline view or the sound column header in the Xsheet view.
2. In the Sound Element Editor, select a sound sample from the Sound Element panel. To distinguish one sound section from another on the same sound layer, check the frame numbers that appear on tabs flanking the start and stop lines of each waveform section.

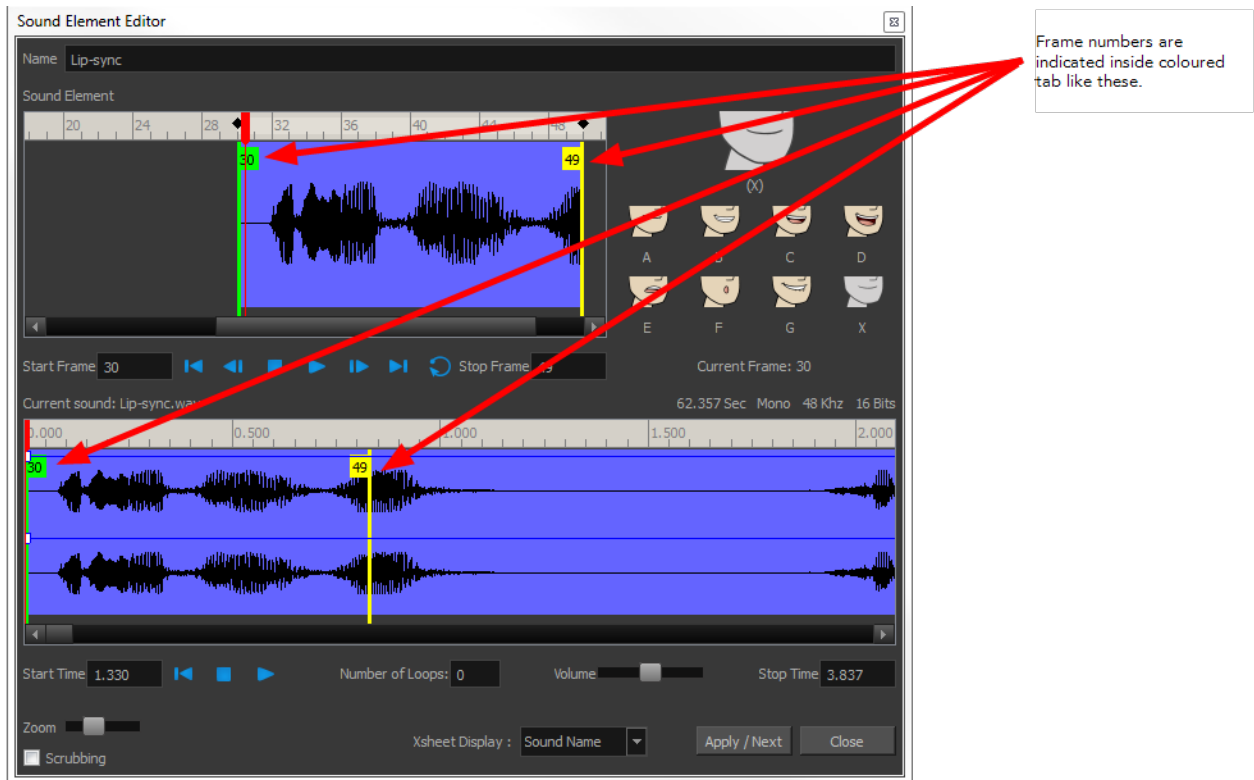

Click the Play ► button in the Current Sound panel (only the selected sound plays).

3. Within the Sound Element panel, drag the selected clip to the frame number where you want it to start playing.



You can only move the clip to a section that does not already contain a clip; you cannot overlap two clips in the same element.

4. To change the end frame, drag the yellow marker at the end of the waveform to the frame position.

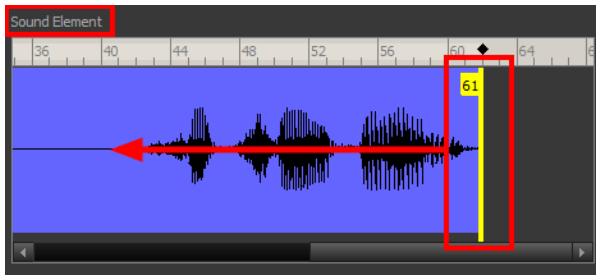

- To hear how all the clips fit together in the element, click the Play ► button in the Sound Element panel.

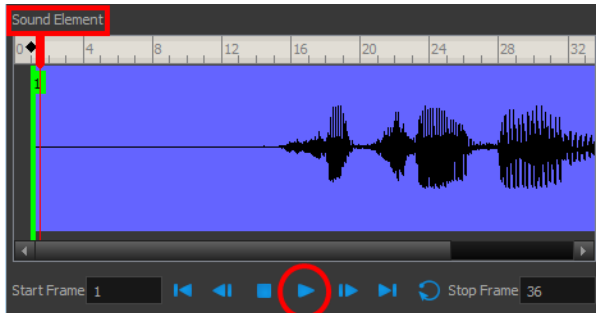

If you only want to hear the selected clip, click the Play ► button in the Current Sound panel.

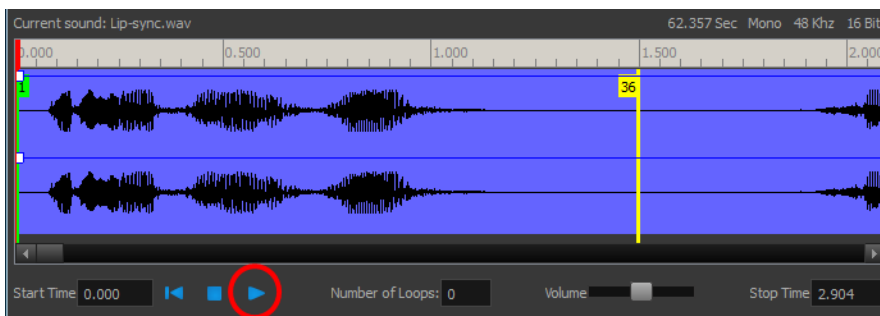

- Click **Apply/Next**.

The Xsheet and Timeline views display the sound clip at the start frame you selected.

Trimming the Start and End of a Sound File

To play only a section of a sound file, use the Sound Element Editor to select the exact part you want to use. For example, if there is a bit of noise at the start of the sound, use the Sound Element Editor to cut the noise.

The Sound Element Editor does not change the original sound file; it only plays a section of it, ignoring the rest. This means that the entire sound file is included on export. If you need to be mindful of file size, it is better to edit sound files completely in a sound editor before bringing them into Harmony.

How to trim the start and end of a sound file

- Double-click on the sound layer name in the Timeline view or the sound column header in the Xsheet view.

- In the Sound Element Editor, select a sound sample from the Sound Element panel. To distinguish one sound section from another on the same sound layer, check the frame numbers that appear on tabs flanking the start and stop lines of each waveform section. Or select a soundwave and click the Play ► button in the Current Sound panel (only the selected sound plays).
- Using the Current Sound panel, decide on the part of the file you want to play by dragging the left and right boundaries of the selection area.

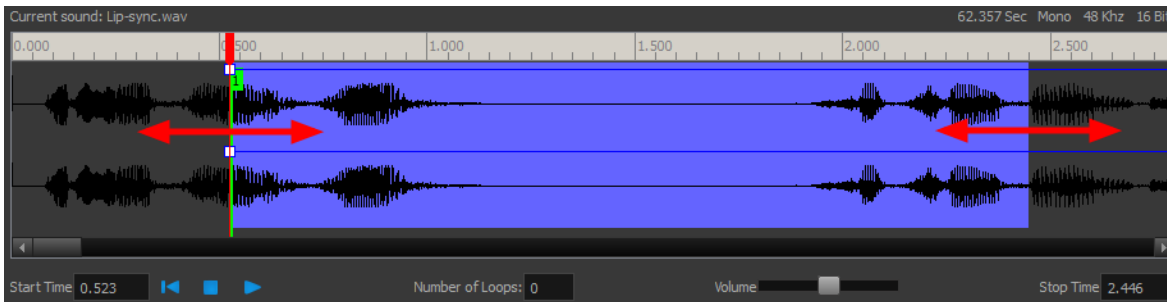

- Click the Play ► button in the Current Sound panel to check that you have trimmed the desired sections. Use the Zoom slider at the bottom of the panel to zoom in on the waveform so you can trim it more accurately.

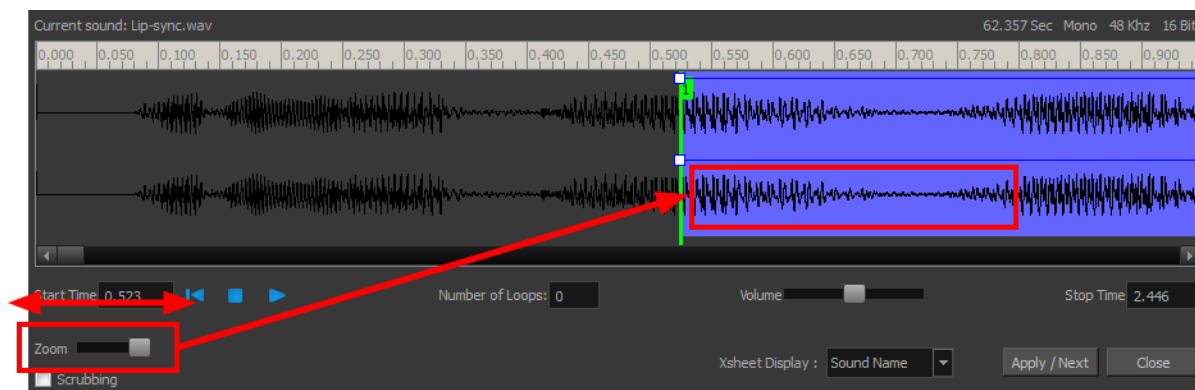

- Click **Apply/Next**.

The trimmed sound sample appears in both the Timeline and Xsheet views at the start and end positions you selected.

Looping a Sound

To repeat a sound, specify the number of times that you want it to loop in the Sound Element editor.

How to loop a sound sample

- Double-click on the sound layer name in the Timeline view or the sound column header in the Xsheet view.
- From the Sound Element panel, select the sound section you want to loop.
- In the Current Sound panel, type the number of times you want the sound to play in the Number of Loops field.

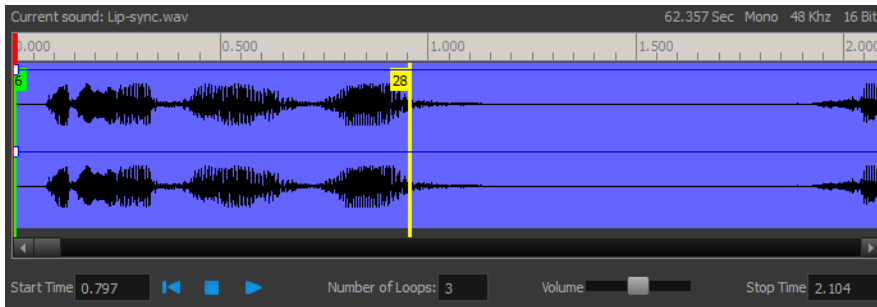

4. Press the Enter/Return key.

The looped sound appears after the current sound. They are indicated by their grey waveforms, as opposed to black.

When you loop a sound, the looped sections fill the cells in the sound element (column or layer) until the next sound sample starts or until the scene ends. This means that the looping could be cut if the next sound sample starts too soon or if the scene ends too quickly.

Mixing the Sound Volume

You can adjust the volume of an entire sound clip or modify the volume in increments by adjusting the fade-in and fade-out times, otherwise known as sound envelopes. The fade edit only affects the playback; the original sound file is not affected.

How to adjust the overall volume of the entire sound clip

1. Double-click on the sound layer name in the Timeline view or the sound column header in the Xsheet view.
2. In the Sound Element panel, select the sound you want to work on.
A more detailed version of the selected sound appears in the Current Sound panel.
3. In the Current Sound panel, use the Volume slider to adjust the volume.



4. Click the Play button in the Current Sound panel to verify the volume.

How to create the fade in/out effect on a sound clip

1. Double-click on the sound layer name in the Timeline view or the sound column header in the Xsheet view.
2. In the Sound Element panel, select the sound you want to work on.
3. In the Current Sound panel, click on the thin blue line above the waveform to add an envelope marker.



4. Drag the envelope markers to adjust the volume at that frame and to create the time of the transition. The line from the edge of the clip to the envelope marker identifies how the volume increases (fades-in) or decreases (fades-out) over time.

Dragging the marker to the bottom of the channel mutes the volume, while dragging it upwards increases the volume.

To create an even effect, be sure to adjust the envelope markers uniformly in both the left and right (bottom and top) channels.

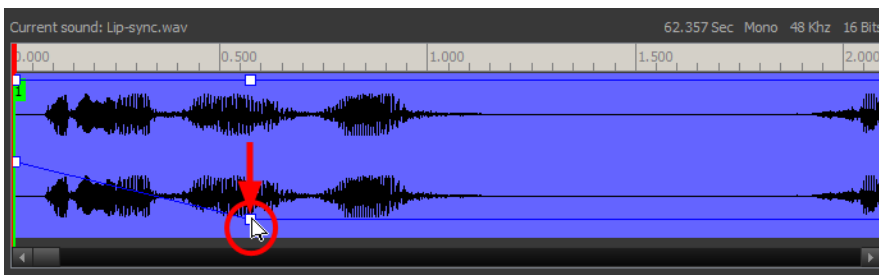

5. Click the Play button in the Current Sound panel to check the fade envelopes.

Customizing the Playback Range

To hear a specific section of the sound element, adjust the playback range in the Sound Element Editor to start or stop at specific frames. This customized playback range does not affect the actual sound in the Sound element.

How to change the playback range in the Sound Element Editor

1. Drag the start or end range markers in the Sound Element panel to the boundary frames you want.



2. When you click the Play ► button to play back your sound in the Sound Element editor, it only plays the sound which exists between the two markers.

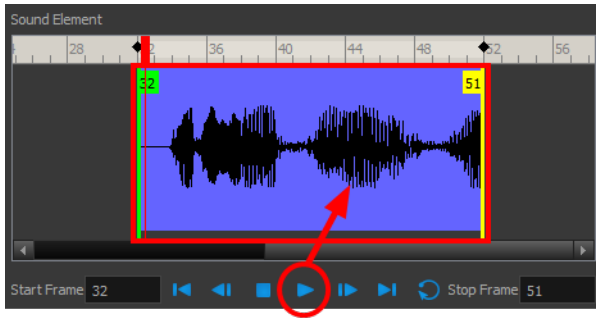

Adding an Empty Sound Layer

When performing sound editing tasks, it can be useful to chop up a sound sample into different layers. For example, when performing a lip-sync, only a single view of the various mouth positions for a character can exist on one layer. Therefore, if you want to have a character turn its head from a profile view to a three-quarter view and have mouth position changes to fit with the sound sample from these two different views, you would need to cut up the sound samples needed for the profile view mouth positions on one layer and the sound samples needed for the three-quarter view on another.

For this task, you will need an empty sound layer.

How to add an empty sound layer

1. From the top menu, select **Windows > Toolbars > Timeline View**.

The Timeline view toolbar appears at the top of the Timeline view.



2. Right-click on the Timeline View toolbar and select **Customize**.
3. Choose the **Add Sound**  button from the Available Tools column on the left and add it to the Toolbar column on the right. Click **Ok** to accept the change.

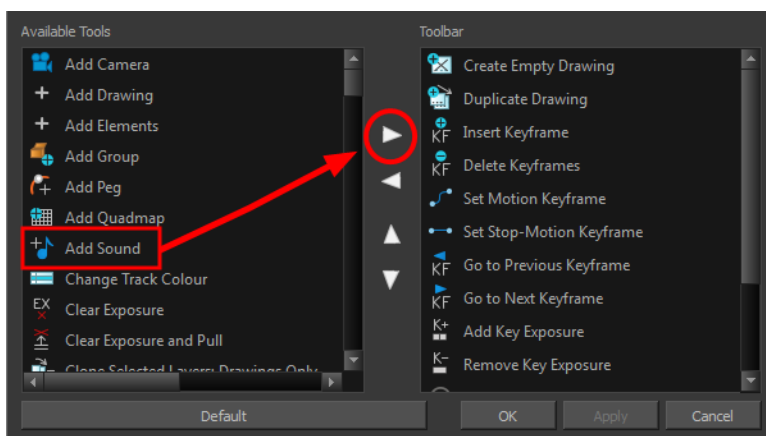

4. Click the **Add Sound**  button.

An empty (silent) sound layer appears in both the Timeline and Xsheet views.



5. Rename the layers accordingly by double-clicking on the layer name and renaming it in the Sound Element Editor. Click **Apply/Next** to accept the change.

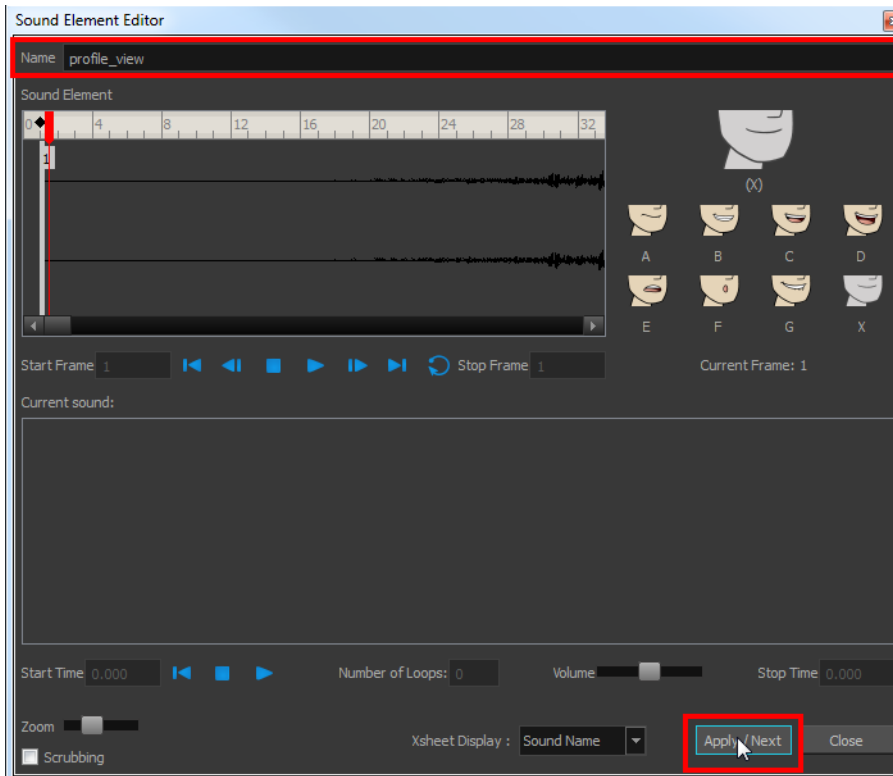

6. Click the cell where you want to start the cut and Shift + click on the final cell of the cut. The sample to be cut becomes highlighted.

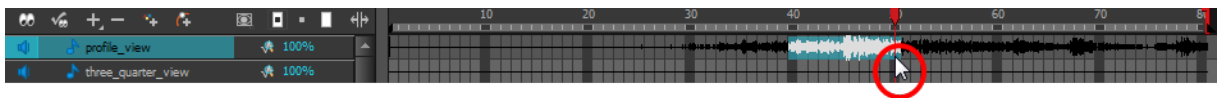

7. Drag the selection into the empty sound layer below.

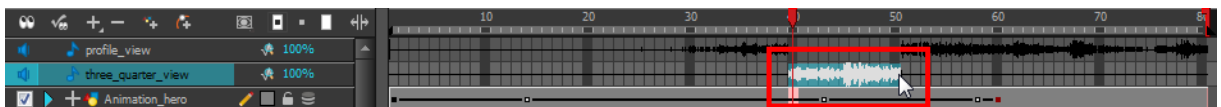

8. You can now continue to cut-up and distribute the sound sample between the two layers or carry on to the lip-syncing process for each layer and its corresponding facial view.

If you need to duplicate your sound layer to keep an unedited copy for safety, select the Duplicate Selected Layers button in the Timeline View toolbar. You must customize the toolbar to display this button because it is not included in this toolbar by default.

Lip-sync



Adding a lip-sync to a project can really enhance its quality and storytelling. However, it can be difficult to shape a character's mouth to match the sound at a precise frame.

To solve this problem, Harmony provides a lip-sync feature which analyzes the contents of a sound element and generates a mouth chart (see below) based on the eight animation phonemes (A, B, C, D, E, F, G, and X, which is used to represent silence).

The mouth shapes used by Harmony are based on the conventional mouth chart used in the animation industry.

The letters used to represent the shapes do **NOT** correspond to an actual sound.

If you are doing cut-out animation, refer to the Cut-out Animation Guide, Character Building chapter, "Adding Extra Drawings" topic to learn how to add extra drawings to your character.

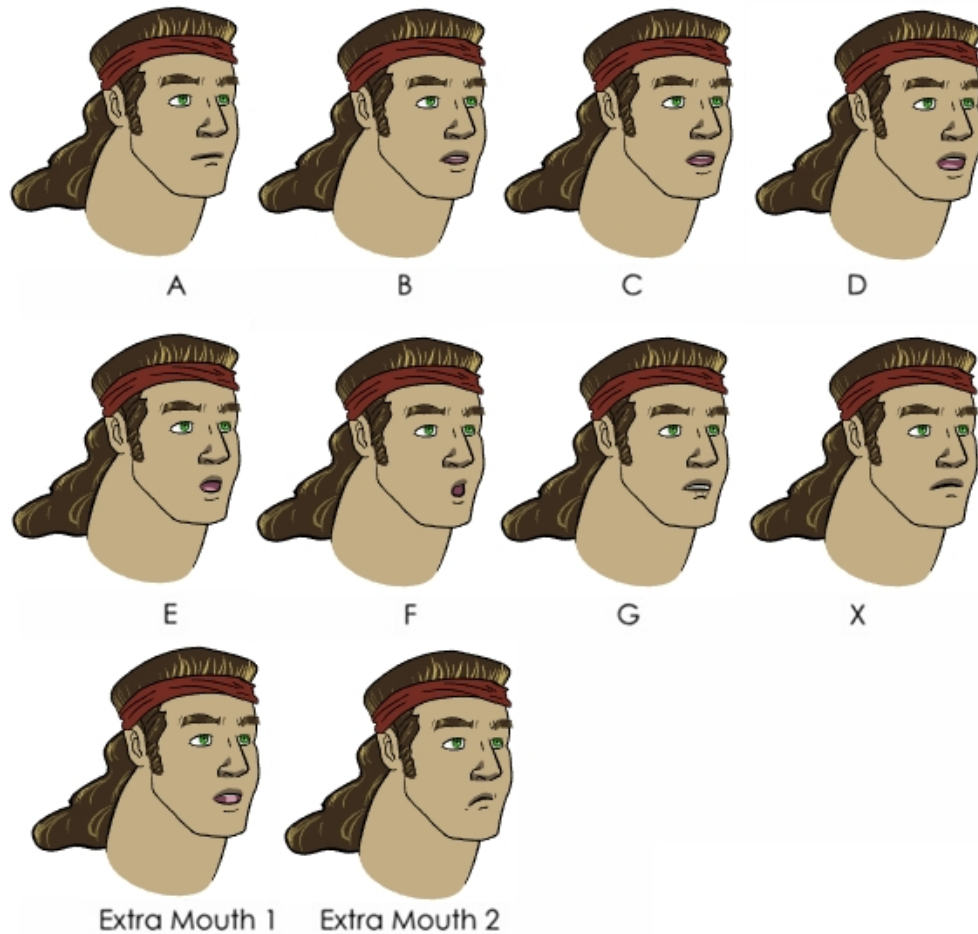

Here is an approximation of which sound each mouth shape can produce:

- A: m, b, p, h
- B: s, d, j, i, k, t
- C: e, a
- D: A, E
- E: o
- F: u, oo
- G: f, ph
- X: Silence, undetermined sound

You can lip-sync the traditional way or let the system automatically create the basic detection.

You can refer to the mouth chart positions as you draw the shape of your character's mouth.

Generating a Lip-sync Detection

There are two places where you can perform a lip-sync detection: Timeline or Xsheet views and Sound Element Editor.

How to generate a sound detection for lip-sync using the Xsheet or Timeline view

1. To show the mouth chart letters, if they are not already present in the Xsheet view, right-click on the sound column and select **Lip-Sync > Sound Display > Mouth Shapes** from the pop-up menu.
2. In the Xsheet view or Timeline view, right-click on the sound layer's cells and select **Lip-Sync > Auto Lip-Sync Detection**. You can also select **Animation > Lip-Sync > Auto Lip-Sync Detection** from the top menu.

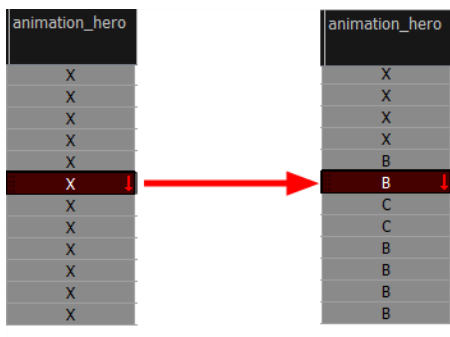

Harmony analyzes the selected sound clips and assigns a lip-sync letter to each frame. The X markers in the frame are replaced by these designated letters.

How to generate a sound detection for lip-sync using the Sound Element Editor

1. Do one of the following:
 - In the Timeline view, double-click on the sound layer.
 - In the Xsheet view, double-click on the sound column header.
 The Sound Element Editor opens.
2. In Sound Element panel, select the waveform for which you want to generate a mouth chart.
3. Right-click on the sound file and select **Auto Lip-Sync Detection**.

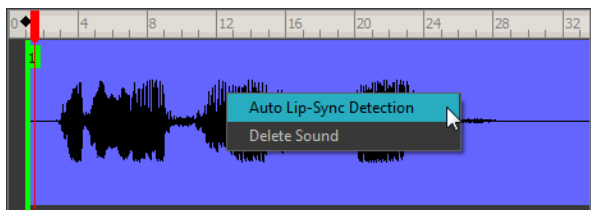

A progress bar appears while Harmony analyzes the selected sound clips and assigns a lip-sync letter to each sound cell.

Mapping the Lip-Sync Detection

Harmony can automatically map drawings in an element to the mouth chart you have generated for a sound. This can save time when you are lip-syncing a voice track.

In the Lip-Sync Mapping dialog box, you can identify each lip drawing of a character. Harmony then automatically labels all of the cells in the character's element with the appropriate name.

How to automatically map lip-sync drawings to a mouth layer

1. To open the Lip-Sync Mapping dialog box, do one of the following:

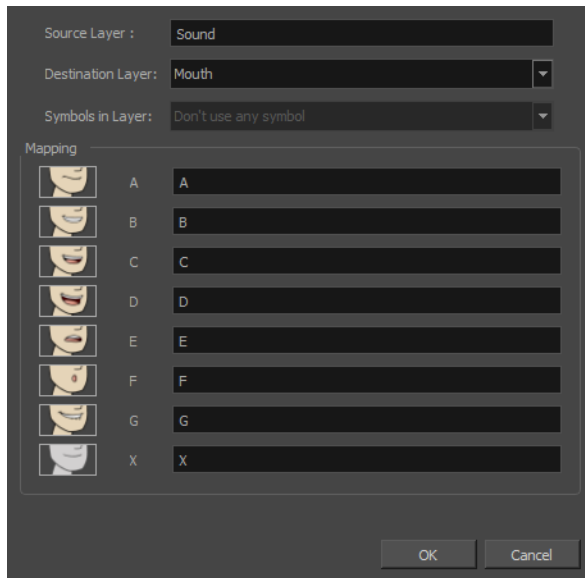

- ▶ In the Timeline view, right-click on any cell in the sound sample layer and select **Lip-Sync > Map Lip-Sync**.
- ▶ From the top menu, select **Animation > Lip-Sync > Map Lip-Sync**.

The Lip-Sync Mapping dialog box opens.

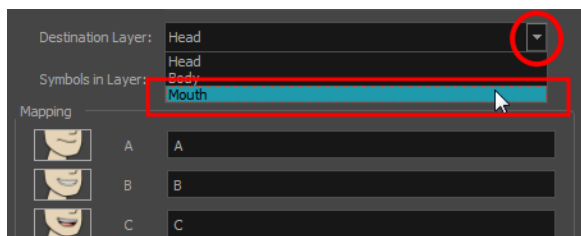

2. From the Destination Layer menu, select the layer that contains the mouth positions for the character's voice track.



3. If the selected layer contains symbols, you can map the lip-sync using drawings located directly on the layer or use the symbol's frames. In the Symbol Layer field select **Don't Use Any Symbol** if you want to use the drawings or select the desired symbol from the drop-down menu.
4. In the Mapping section, type the drawing name or Symbol frames in the field to the right of the phoneme it represents. If your drawings are already named with the phoneme letters, you do not have to do anything.
5. Click **OK**.
6. Press the Play  button in the Playback toolbar to see and hear the results in the Camera view. To play back your scene with sound, enable the Sound  button in the Playback toolbar.

Modifying the Lip-sync

You can change the mouth position assigned to a frame if you think another position is more appropriate.

For example, you may have a character who says nothing for 10 frames between two speeches. Harmony would normally assign an X image for the silent period. However, if you want your character's mouth to hang open in astonishment for these 10 frames, you can change the lip assignment for these frames from an X to an F.

You can also change the mouth assignment of a sound in the Sound Element editor.

How to change the lip assignment of a sound in the Xsheet

1. Right-click in the cell that contains the mouth position you want to change.
2. From the pop-up menu, select **Lip-Sync > Change Mouth Shape to** and choose the letter that reflects the mouth position you want to use for that sound. You can also select **Animation > Lip-Sync > Lip-Sync > the desired mouth shape** from the top menu.

The drawing is automatically updated in the Camera view.

How to change the mouth position assignment of a sound from the Sound Element editor

1. Double-click the sound layer name in the Timeline view or the sound column header in the Xsheet View to open the Sound Element editor.
2. In the Sound Element panel, drag the frame slider to the frame you want to change the mouth position assignment on.

In the Lip-sync image area, the image on top represents the lip position assigned to the current frame.

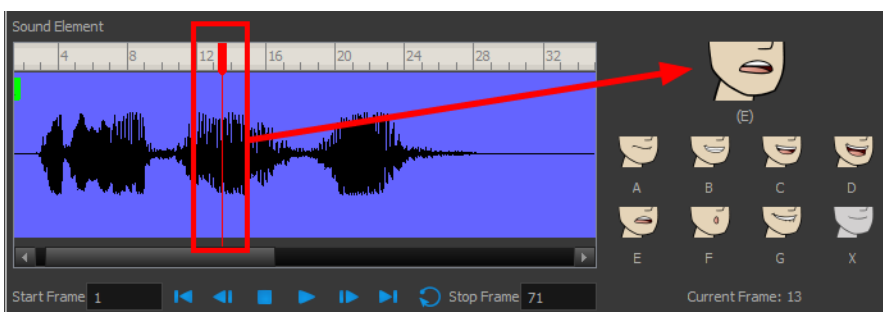

3. To change the image assigned to the frame, click on the image of the mouth position you want from below the preview image. The preview image changes to the mouth position image you select. You can perform the same operation in the Layer Properties view.

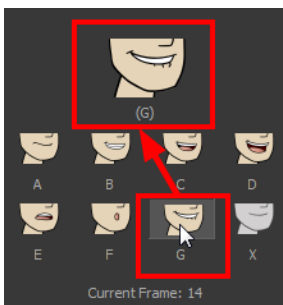

The position is updated in the Timeline and Xsheet views.

Note that if you modify the lip-sync detection you must remap the detection to your mouth layer. See See "Mapping the Lip-Sync Detection" on page 301

Recomputing the Mouth Chart

When you generate the mouth chart for a sound in a sound element, you can either accept the mouth positions assigned by Harmony or assign your own lip-sync images.

However, if you change the sound's start frame or reassign its mouth position, you must reanalyze the sound and regenerate the mouth chart for it. This erases any manual modifications you may have made to the mouth assignments in the mouth chart.

To recompute the mouth chart for a selected sound from the Sound column

1. In a Sound column in the Xsheet or Timeline view, right-click on a cell that contains the sound file you want to recompute the lip-sync for. Select **Lip-Sync > Auto Lip-Sync Detection** from the pop-up menu. The mouth position assignment for each frame is recomputed, erasing any modifications you have made.



To recompute the mouth chart for a selected sound from the Sound Element Editor

1. Double-click the sound layer name in the Timeline view or the sound column header in the Xsheet view to open the Sound Element editor.
2. Click on the waveform in the Sound Element section in the Sound Element editor.
3. Right-click and select **Auto-Lip Sync Detection**.

Manual Lip-sync

Harmony allows for the manual swapping of mouth position drawings to match a voice track. For this process, both sound scrubbing (listening to a soundwave broken up frame-by-frame) and drawing substitutions from the Library View are used.

How to perform a manual lip-sync

1. In the Playback toolbar, enable the **Sound Scrubbing**  button.
2. In the Timeline view, drag the red position indicator along the sound layer waveform.
3. When you reach a frame where a mouth position should go, for example, an open mouth with rounded lips for an "oh" sound, click on that frame on your mouth shapes layer.
4. In the Timeline view, click on the **Expand**  button to display the Data view.
5. Staying on your mouth shapes layer, place your cursor on top of the drawing name (often a letter) until it changes to the swapping  pointer.
6. Pull the cursor to see the list of mouth shape names and choose the one you want. The current drawing automatically changes to the new selection.

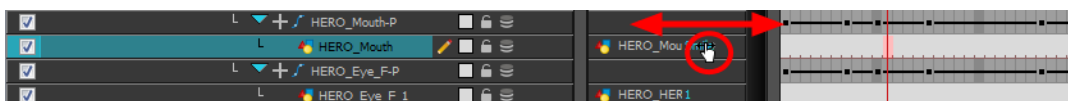

You can also use the Library view to swap drawings.

How to perform a manual lip-sync using the Library view

1. In the Playback toolbar, enable the **Sound Scrubbing**  button.
2. In the Timeline view, drag the red playhead along the waveform of your sound layer.

3. When you reach a frame where a mouth position should go, for example, an open mouth with rounded lips for an "oh" sound, click on that frame on your mouth shapes layer.
4. In the Drawing Substitution window of the Library view, click and drag the slider to choose a mouth shape. The current drawing is swapped for the one in the preview window.

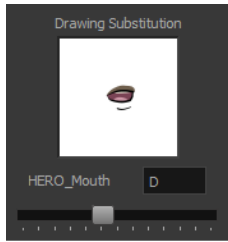

Exporting a Sound File

At some point during the production, you might need to export a sound file to use it in another application, such as an editing software. Harmony allows you to export sound files as a merged soundtrack or as a series of individual files. The exported soundtracks are generated as ***.wav** files.

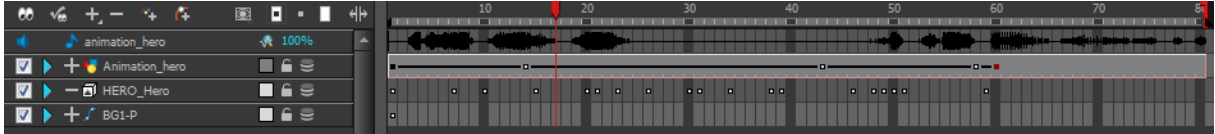

How to export a soundtrack

1. From the top menu, select **File > Export > Soundtrack**.

The Export Soundtracks dialog box opens.

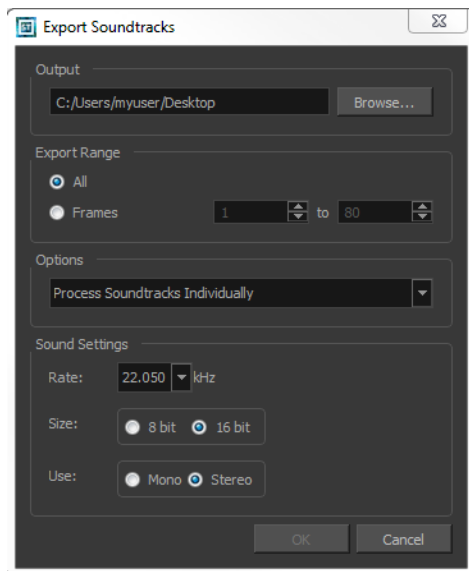

2. In the Output section, click **Browse** and specify where you want to save the exported sound file.
3. In the Export Range section, select one of the following options:
 - **All**: Exports the sound over all the frames of your scene.
 - **Frames**: Sets the start and end frames in the corresponding fields on the right.
4. From the Options menu, select one of the following:
 - **Process Soundtracks Individually**: Each soundtrack from all layers is exported as individual files.
 - **Merge all Soundtracks**: One single file is created, combining all the sound files you imported in your scene. Note that it will only use the sound files in the selected frame range set in the Export Range section. If you selected to export all the frames, all the sound files will be processed.
5. In the Sound Settings section, set the **Rate**, **Size** and **Use** parameters for the soundtracks to export. It is a good idea to verify what is required by the software or device that you may want to use next with the sound file.
6. Click **OK**.

The generated sound files appear in the selected directory and are named according to the scene name. Individual files keep their original name; only a prefix matching the scene name is added.

Chapter 6: 2D-3D Integration

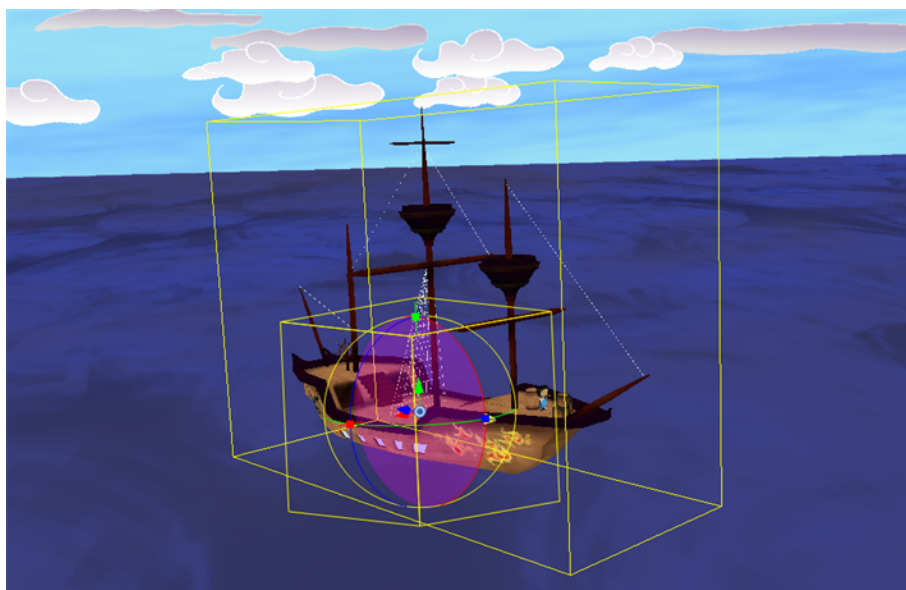

Harmony provides you with impressive 2D-3D integration possibilities. This allows you to combine the two animation genres within the same production resulting in some remarkable scene composition and a unique style.

Harmony supports the following 3D formats:

- 3DS
- OBJ
- FBX
- OSB

You can work with Autodesk Maya, PIXIE, or 3Delight. In this guide, Autodesk Maya will be used. To work with PIXIE or 3Delight, contact support@toonboom.com.

All Harmony licenses include the 3D functionality by default. If you obtained your license at the initial release of Harmony, you might not have the 3D license. If you are unable to work with 3D elements, contact support@toonboom.com.

This chapter contains the following topics:

- How 2D-3D Integration Works on the next page
- Exporting a 3D Object for Harmony Using Autodesk Maya on page 315
- Importing a 3D Object from Autodesk Maya to Harmony on page 318
- Working in the Different Views on page 312
- Manipulating the 3D Object on page 320
- Rendering and Compositing 3D Models on page 325
- Rendering 3D Models on page 332

How 2D-3D Integration Works

Harmony allows you to import 3D models and reposition them in Harmony and animate them over time.

Importing a Reference Model

When working in Harmony, the first thing to do is import a reference model. This model is what will be represented in the OpenGL view. Animators can reposition this model, animate the camera, and interact with it. Although several formats are supported, FBX is the recommended format as this will allow you to embed textures for nicer looking reference models.

The following chapters show you how to import such a model and animate it in Harmony.

When importing an FBX model, remember that model will never be used for the final render. Harmony itself does not have a 3D rendering engine embedded.

Rendering of the OpenGL representation of the model is supported. However, this is not a high enough quality for a final product. Instead, rendering is supported through outside rendering engines. The majority of users use Maya Softrender, although 3Delight and Pixie are also supported.

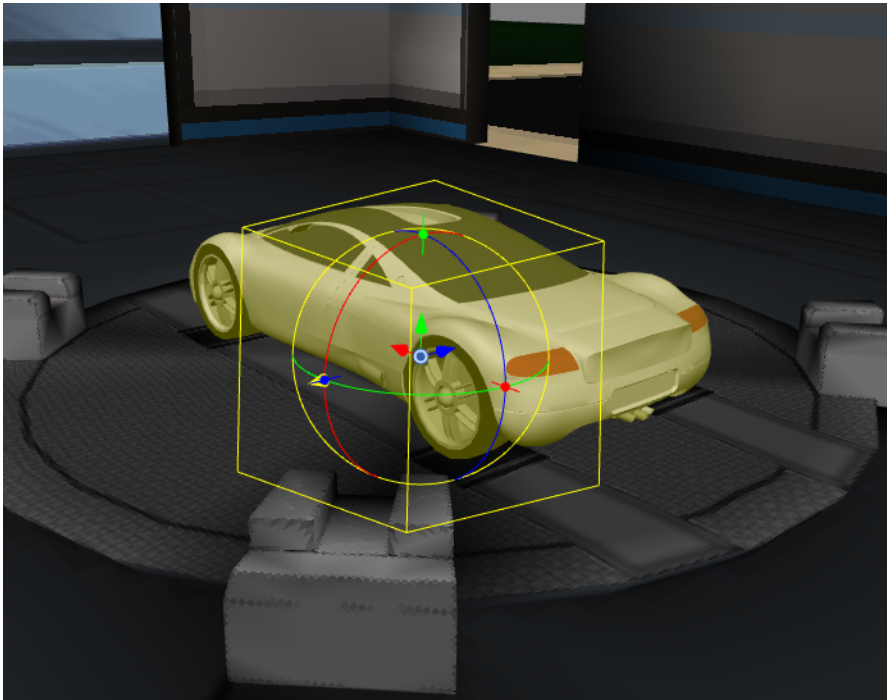

Because this model is never used for a final render, you can optimize this model quite a bit. The imported FBX model does not require high-res textures or sophisticated shaders. It can even have a lower poly count than your final model. It does, however, need to be the same size as your final model, as Harmony will be sending the position, rotation, and scale information of the model in the Harmony scene to Maya later to render. Keeping the imported FBX file as light as possible will give you snappy performance while animating.

Rendering

When it comes to rendering, a connection is opened between Harmony and the rendering engine - in this case Maya Softrender.

Maya Batch is opened in the background, and the information from the Harmony scene file is sent to Maya. All the information needed, including the animation on the model and the position of the camera, is sent to Maya. Maya Batch then opens in the background and the original .mb file is opened. This file should match the FBX model in size, but may have a higher polygon count, a more advanced texturing setup, or even a more advanced set of shaders. Since the full Maya scene is loaded, you can use any shader, lighting setup, and texture that Maya Softrender supports.



The opened scene file repositions the model inside based on the information provided from the Harmony scene file. For consistent lighting effects, you may want to parent the lighting rig to the model so it is also repositioned along with the model.

The frame is then rendered and sent back to Harmony to be composited there. The data comes back into Harmony as a series of Maya .iff images. These images contain not just image data, but also depth information, and Harmony will use this depth information to properly clip any 2D layers that are interacting with the 3D model in the Harmony scene, resulting in a perfect composite without the need to track any masks.

You can also apply any effects that are supported on bitmaps to the rendered sequence, such as blurs and blending modes.

Working in the Different Views

Before you can properly view and set up the 3D element in your scene, you will need to use the Perspective and Camera views together, as well as the Top and Side views.

- [Perspective View below](#)
- [Camera View below](#)
- [Top and Side Views on the facing page](#)

Perspective View

In the Perspective view, you can see your scene in a complete 3D environment. This environment will allow you to setup and animate your 3D model more easily. You can rotate the view on the three axes.

How to rotate the Perspective view

1. Hold down $\text{⌘} + \text{Alt}$ (Mac OS X), and click and drag.

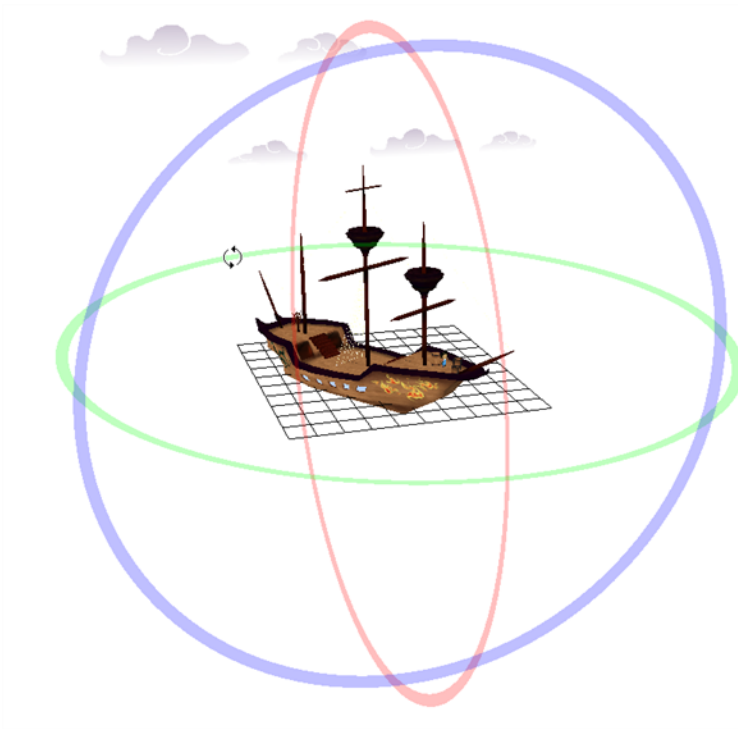

Camera View

You can preview the position of your 3D model in the Camera view and see what it will look like in the camera frame. You can preview your scene in OpenGL  mode.



Before you can view your 3D elements in Render  mode, you must add a script module to your Network view and set up your system with the correct path to the rendering utility you will be using. If you do not complete this setup, the 3D model will simply not appear.

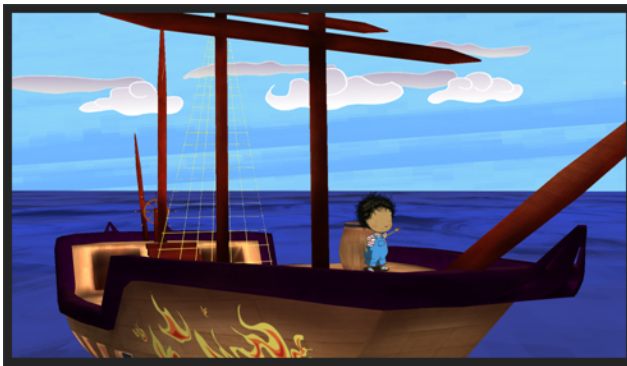

Top and Side Views

You can use the Top and Side views to help you position your element in the 3D environment. This can really help you precisely visualize the actual position of your model without perspective.

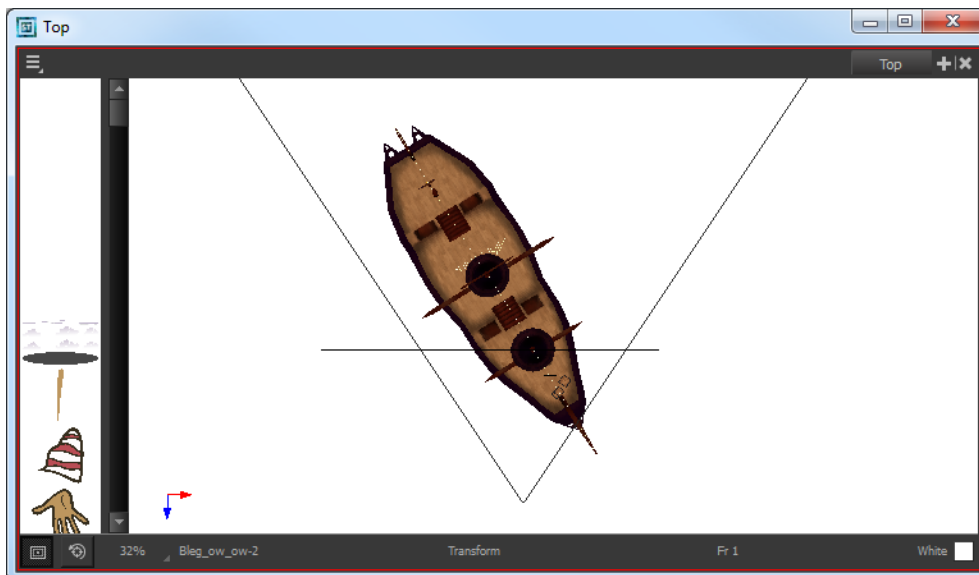

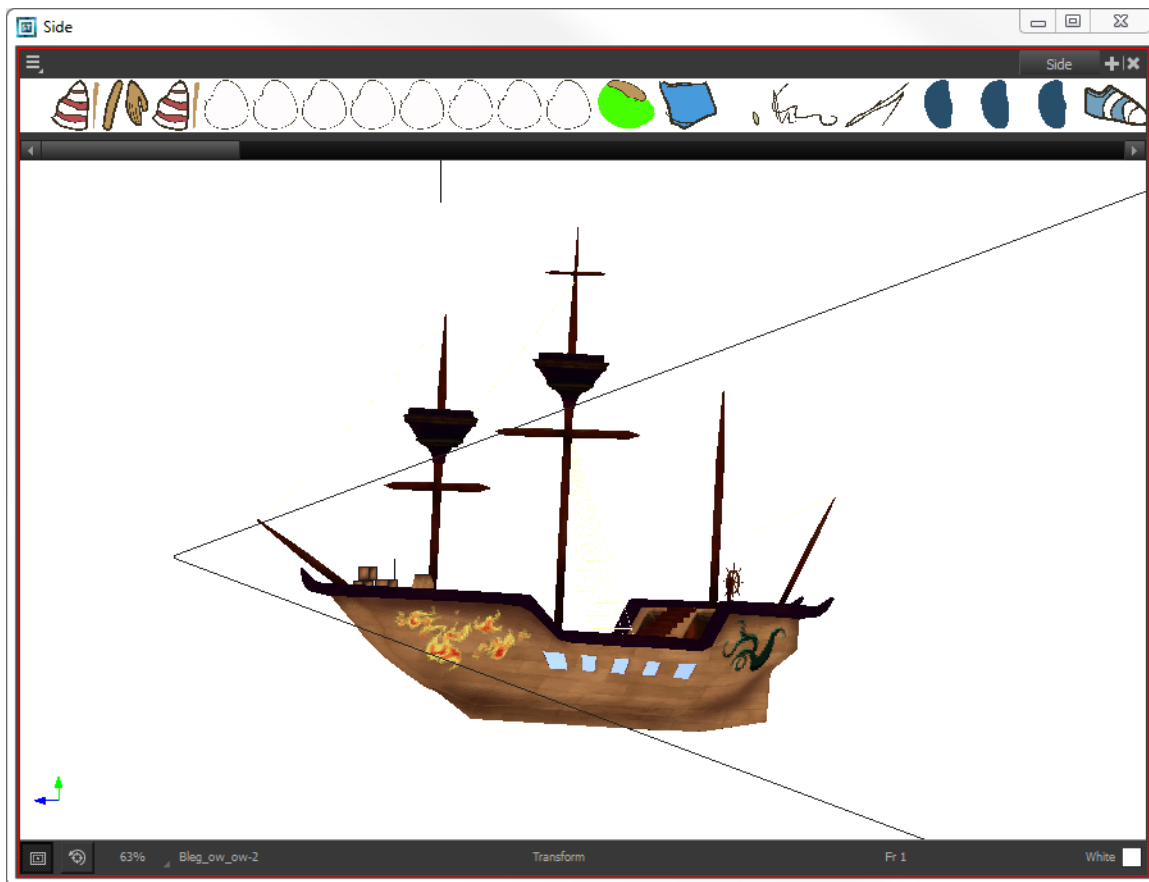

Exporting a 3D Object for Harmony Using Autodesk Maya

Once you set up Toon Boom Harmony and your system for the use of 3D, the next step is to generate the 3D models you plan to import and use in your scene. You will need to use Autodesk Maya for this. Although FBX models can be exported from any software and imported into Harmony, at the moment, only Maya is supported for full rendering with effects.

How to export a 3D object for Harmony

1. In Autodesk Maya, create your 3D object.

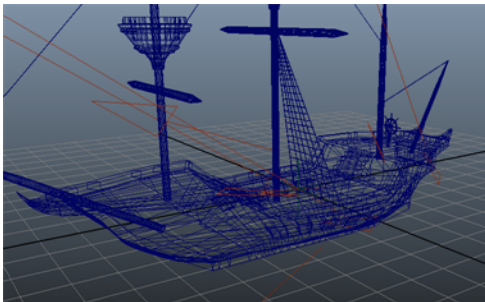

You should also complete the texturing of your 3D object, as well as set up a few lights in your scene. When you render your scene later through Harmony, it will use this original Maya scene to render with the shaders, textures, and lighting of the scene.

When you animate the object in Harmony, it will use this scene file and push the animation from Harmony into this scene. For this reason, you may want to parent the lights to the object, so the lighting you set up moves with the object when it is animated. If not, you may end up with a situation where the object is rotated out of the lighting, and you can see a very dark 3D object. In Maya, you can parent one layer to another by middle-mouse clicking and dragging that layer.

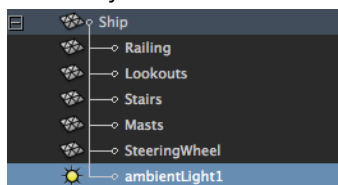

2. Save your Maya binary file *.mb as you will use it later on.
3. Use the export command to export your model. Select **File > Export All**.

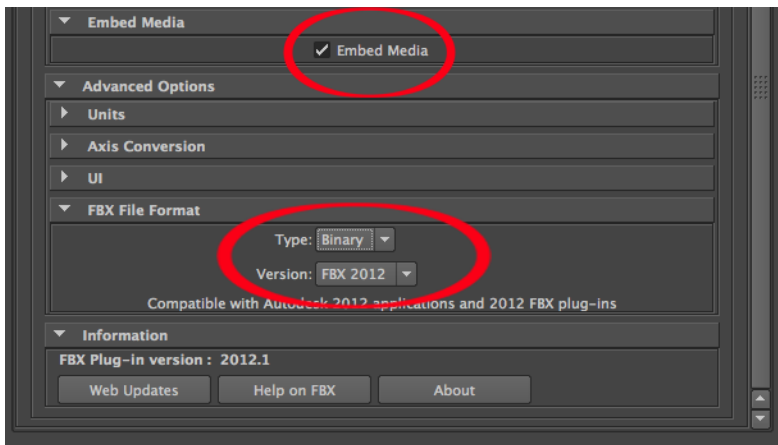
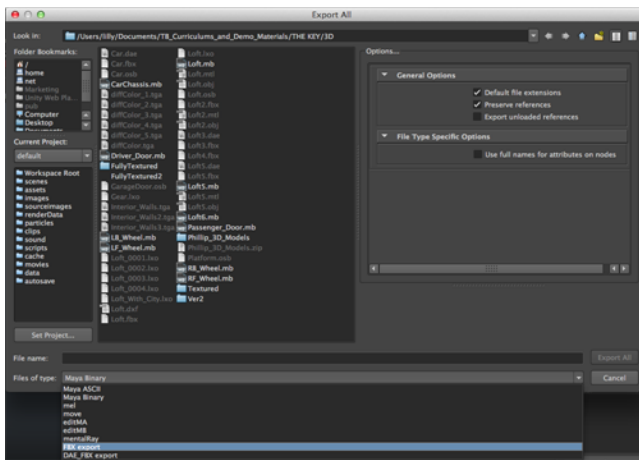
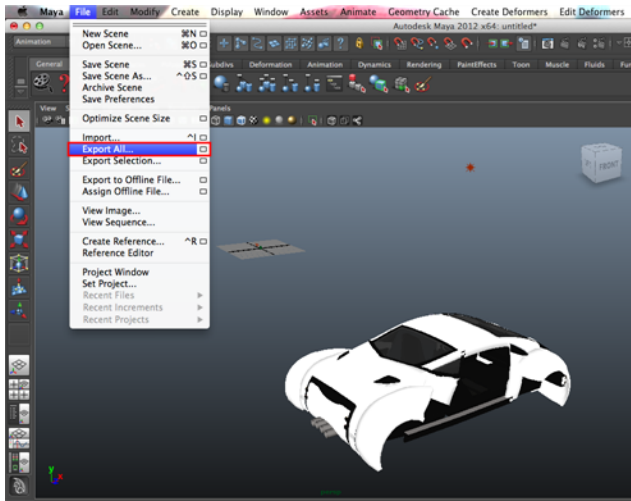

The Export All dialog box opens.

4. In the Files of Type menu, select **FBX Export**.
5. Select the **Embed Media** option to see the textures on the model when you import the FBX model into Harmony.
6. From the Type list, select **Binary**.
7. From the Version list, select **FBX 2012**.
8. When you complete the export, an ***.fbx** file will be created.

Instructions may differ depending on the version of Autodesk Maya you are using. It is therefore important that you refer to their documentation for the correct instructions on how to create and export a 3D model.

Importing a 3D Object from Autodesk Maya to Harmony

Once you have exported a model in using Autodesk Maya, you can import it into Harmony and integrate it to set up your 2D animation scene.

How to import 3D model(s) from Autodesk Maya to Harmony

1. In Harmony, select **File > Import > 3D Models**.

The Import 3D Models dialog box opens.

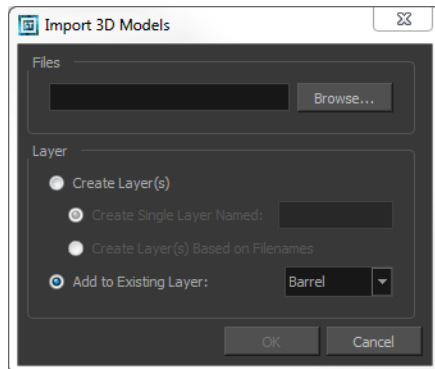

2. Click **Browse** and locate your * .**fbx** files.
3. Click **Open** to validate your choice and close the browsing window.
4. In the **Import 3D Models** dialog box, choose your import options.

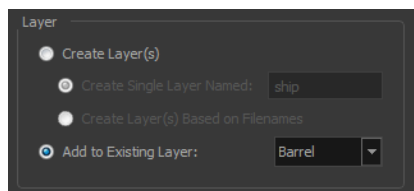



- ▶ **Create Layer(s):** This option is selected by default, meaning that a new layer will be created for the selected files for the import. You have two choices.
- ▶ **Create Single Layer Named:** Imports all your selected * .**fbx** files in the same layer you can name.
- ▶ **Create Layer(s) Based on Filename:** Creates a different layer for each file selected for the import. The layers will be automatically named in accordance with the file names.
- ▶ **Add to Existing Layer:** Imports the selected files into an existing layer in the scene. Use the drop-down menu to select a layer.

If you choose to add to an existing layer which is a vector layer, then it will encapsulate the 3D model inside a symbol.

5. Click **OK** to validate your choices and import the selected file(s).

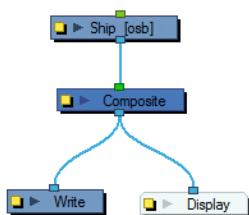
The 3D models are imported in the scene.



Note that, if at this point, the Preview mode is set to Render View  mode, then the 3D model will not be visible in the Camera view. If this is the case, click the OpenGL View  button, you should now be able to see your 3D models.

Using Peg Modules to Control the Position of 3D Objects



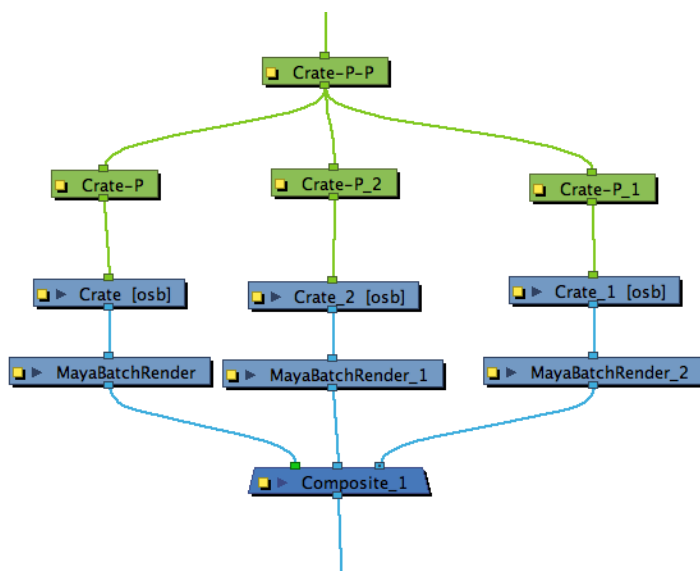

You can use Peg modules to control the position of 3D objects, and connect them as you would with 2D layers to create rigs.



Manipulating the 3D Object

Once you have imported the 3D model into your scene, you can easily manipulate it to set up your scene. You can even add keyframes, just like any other element and animate it on a trajectory.

Using Transformation Tools to Manipulate 3D Models

Once the 3D option is enabled, your transformation tools automatically become 3D transformation tools. This means that you can now manipulate them on the Z-axis as well. The Translate , Rotate  and Scale  tools are found in the Advanced Animation toolbars and the Transform  tool can be found in the Tools toolbar. You can use these tools to set up or animate your 3D model.

If you want to set up the position of your 3D model, you must disable the Animate  mode. **Do not forget to re-enable it when if you want to animate it.**

Translate Tool

Once you enable the 3D option, the 3D Translate tool becomes available. Direction arrows appear around the pivot points to indicate the different axes.

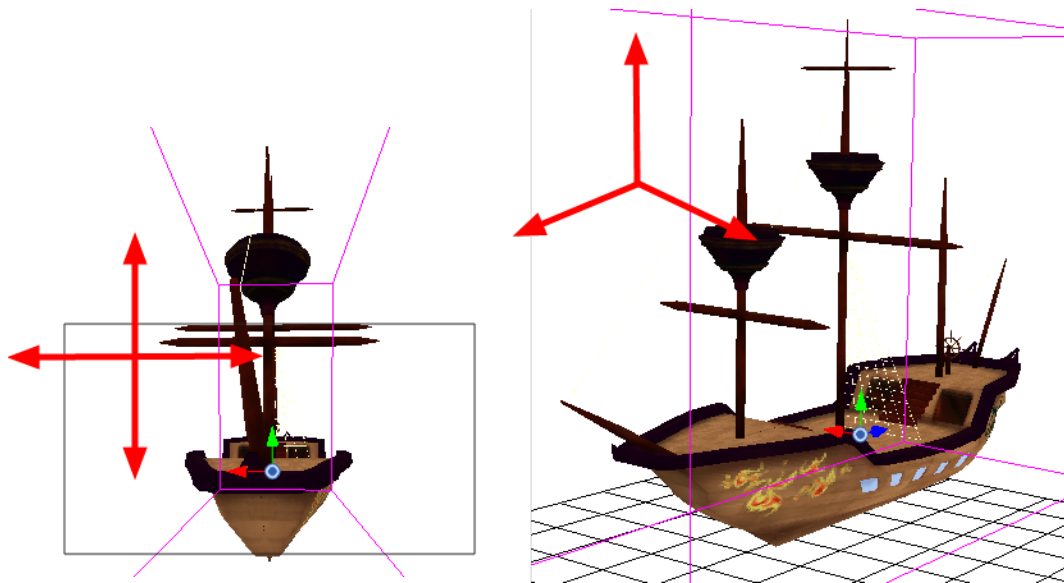

If you click on a direction arrow, you can move a layer on only one axis. If you click anywhere else, the layer can move freely on two axes at once. Once the arrow is selected, it turns pink.

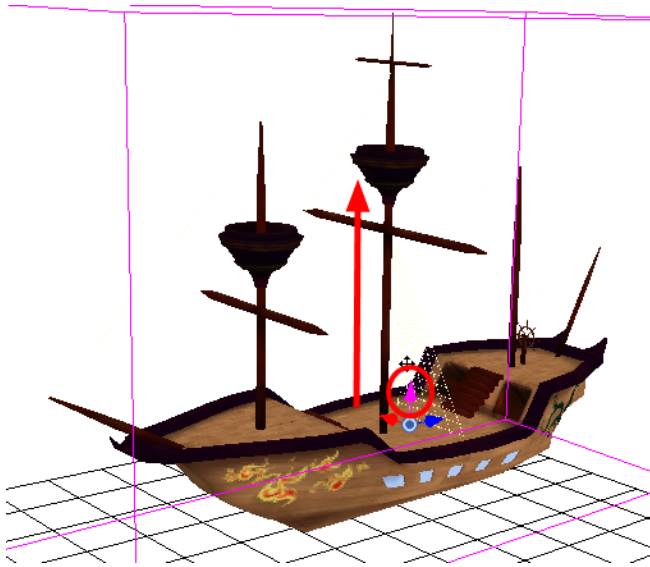

If you move the layers in the Perspective view, it may be difficult to control the motion since you may not have the optimum point of view on your stage to understand the setup. In this case, it is best to use the direction ellipses.

Rotate Tool

Once you enable the 3D option, the 3D Rotate tool becomes available. A rotation sphere appears around the pivot points to indicate the different axes.

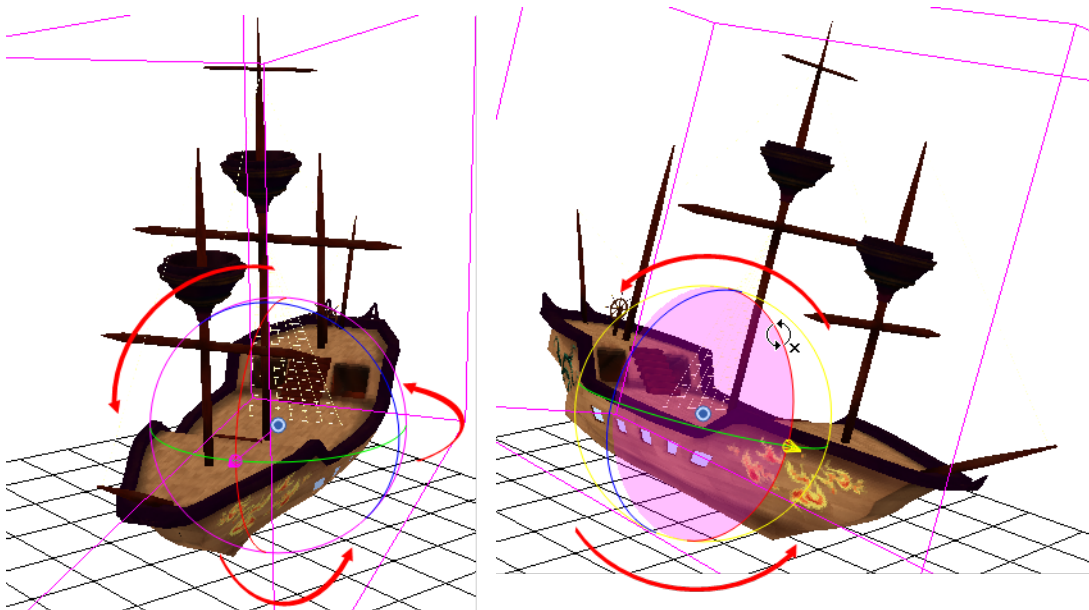

You can click on the direction ellipses to rotate your layer on one axis only. If you click anywhere else, the layer rotates freely on two axes at once. Once the ellipse is selected, it turns pink.

If you move the layers in the Perspective view, it may be difficult to control the motion since you may not have the optimum point of view on your stage to understand the setup.

Scale Tool

Once you enable the **3D Option**, the **3D Scale tool** is available. You will see one of two things:

- A Scaling Rectangle, this appears if your drawing is flat.
- A Scaling Cube, this appears if your object has some rotated layers around the pivot points, indicating the different axes. If you click and drag on this Scaling Cube, it will scale proportionally on all axes.

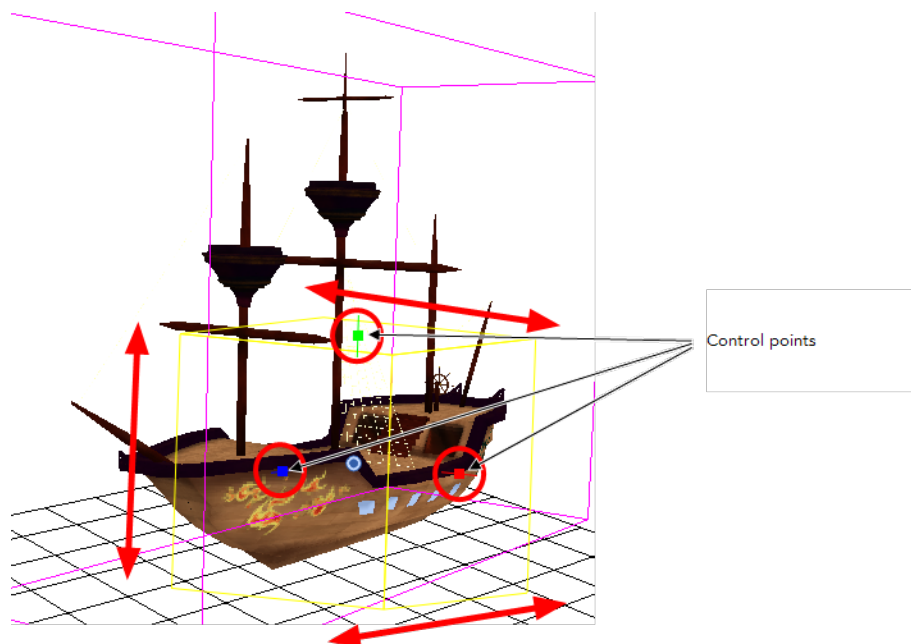

Click on one of the three control points to scale the shape on one axis. Hold down the Shift key to scale the object proportionally. When the control point is selected, it turns pink.

If you move the layers in the Perspective view, it may be difficult to control the motion since you may not have the optimum point of view on your stage to understand the setup.

Transform Tool

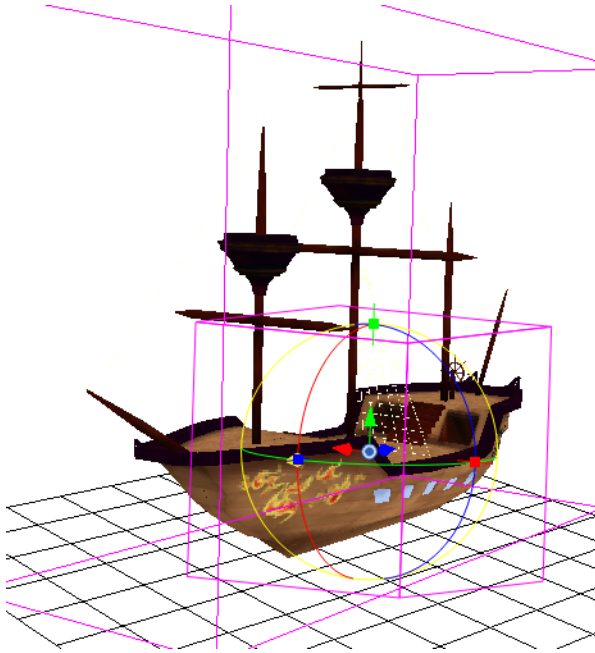

Once you enable the 3D Option, the 3D Transform tool become available. This tool is a combination of the 3D Translate, 3D Rotate and 3D Scale tools.

- Translating an Element with the Transform Tool below
- Rotating an Element with the Transform Tool on the next page
- Scaling an Element with the Transform Tool on the next page

Translating an Element with the Transform Tool

To translate an element, grab the direction arrows in the same way that you would with the Transform  tool.

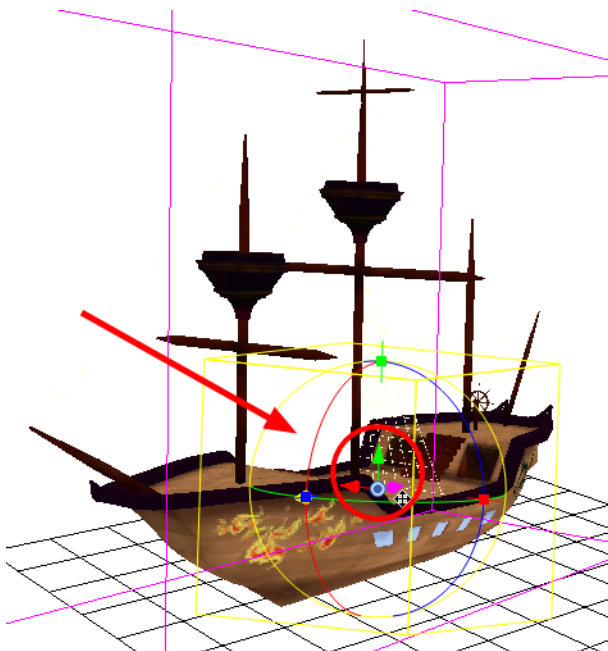

Rotating an Element with the Transform Tool

To rotate an element, grab the rotation ellipses in the same way that you would with the Rotate  tool.

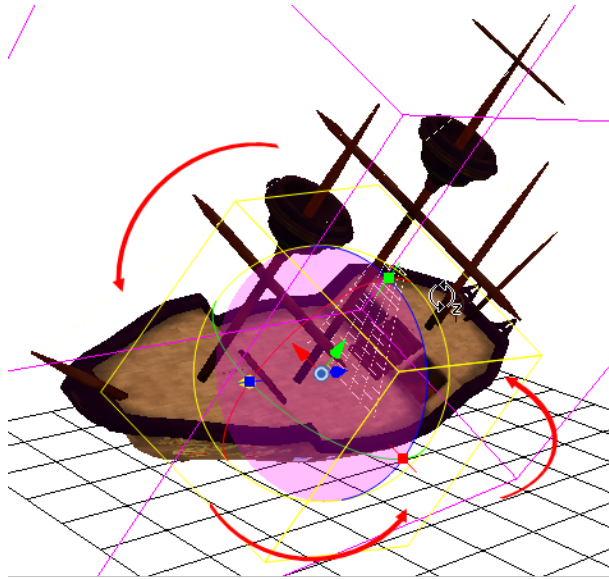

Scaling an Element with the Transform Tool

To scale an element, grab the scaling control points in the same way that you would with the Scale  tool.

If you click and drag on the scaling cube, it will scale proportionally on all axes.

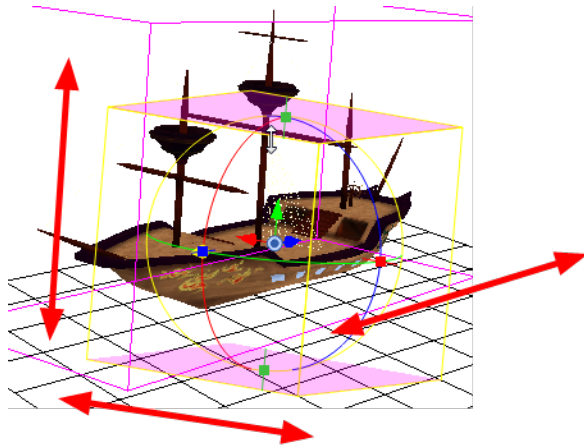

You can also set up all these position parameters using the Layer Properties dialog box—see [3D Parameters](#) on page 175.

Rendering and Compositing 3D Models

There are two ways to preview and render 3D elements in Toon Boom Harmony. You can render your scene using the OpenGL preview, or render calling Autodesk Maya, PIXIE or 3Delight in the background.

If you do not set up a plug-in to preview your model with Maya or your 3D software, the preview and rendering will be done using the OpenGL preview. The result will look flat and jagged, but it can be very handy while working and exporting shots for approval.

If you render a scene calling Autodesk Maya, PIXIE or 3Delight, you will obtain a smooth result with texture and lighting.

Before you can render the 3D objects you imported in Harmony through Autodesk Maya soft render, you must prepare your system by setting some environment variables, and adjusting the Network view in Harmony.

This section is very technical; if you need help, or experience problems while setting up the 3D rendering, please contact the Toon Boom Support team at support@toonboom.com.

Preparing the Project Directory

How to set up rendering

1. Copy your original Maya binary file ***.mb** into your Harmony project directory at the same location as the ***.fbx** file you have imported. This ***.fbx** file should be in the elements folder, inside a subfolder named like the element. For example: if the element is called **PirateShip**, the the subfolder should be named **PirateShip**.

You saved the Maya ***.mb** file in [Exporting a 3D Object for Harmony Using Autodesk Maya](#) on page 315 of this document.

2. Rename the ***.mb** file so it has the same name as the ***.osb** file.
For example: if the ***.fbx** is called **PirateShip-1.fbx**, name the ***.mb** as **PirateShip-1.mb**.

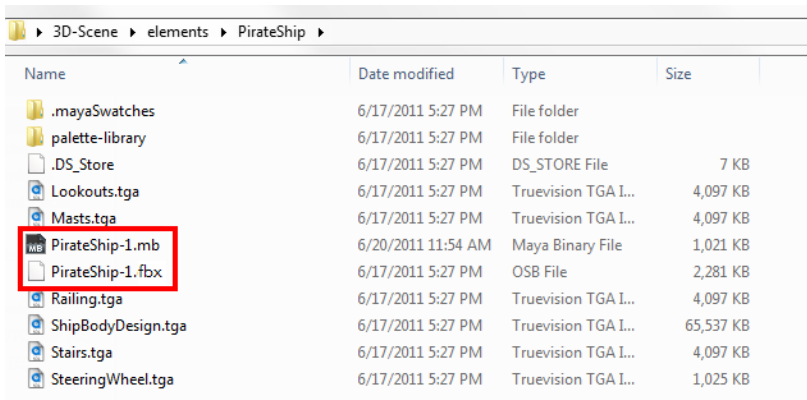

3. Copy any textures used in the Maya project into this same folder.

Setting the Path on Windows

The path needs to be set up so that when Harmony launches Maya, it knows exactly where to look for the application. On Windows, this can be set up using an environment variable.

How to set up the environment variable on Windows

1. In Windows, go to **Start**.
2. Right-click on **Computer** and select **Properties**.
3. From the Computer Properties dialog box, select **Advanced System Settings**.

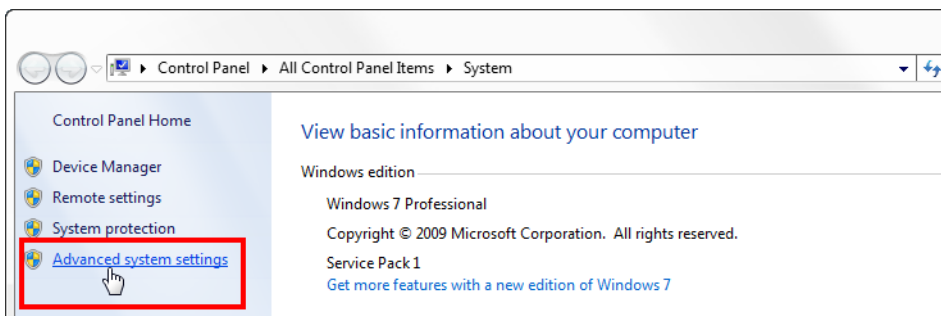

The System Properties dialog box opens.

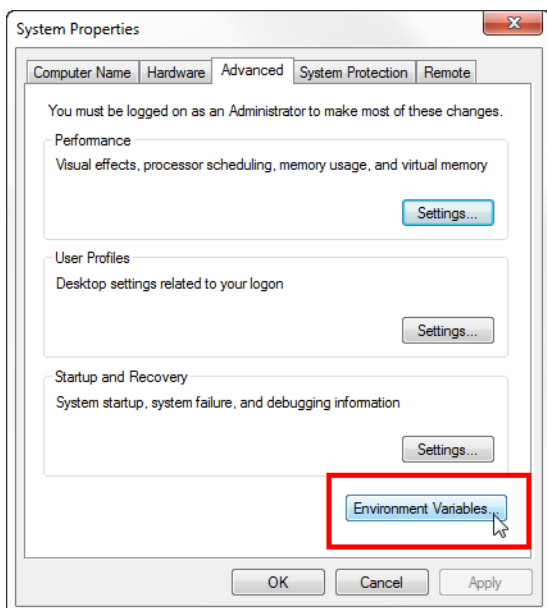

4. In the System Properties dialog box, click **Environment Variables**.

The Environment Variables dialog box opens.

5. The first variable to set up is the Maya path. In the System Variables section, browse for the **Path** variable and select it.

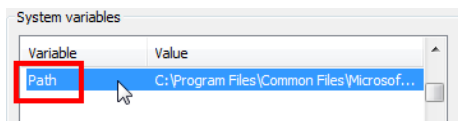

6. Click **Edit**.

The Edit System Variable dialog box opens.

7. In the Variable value field, add a semicolon (;) at the end of the last path.
8. Copy the path to the bin folder of Maya following the semicolon.

For example: For Autodesk Maya 2011 on Windows, the path would be as follows:

C:\Program Files\Autodesk\Maya2011\bin

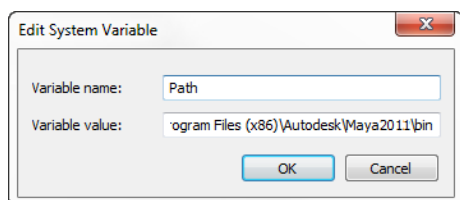

You can browse to the installation folder of Maya and copy the complete path to the `bin` folder from the explorer browsing window to make sure you have the exact path.

9. Click **OK**.

If you receive an error readout in the command line when you try to render, contact Support at support@toonboom.com and provide the error readout content.

Setting the Path on Mac OS X

The Path needs to be set up so that when Harmony launches Maya, it knows where exactly to look for the application. On Mac, you can set this up by placing a script in `usr/bin`.

Creating and Setting Up the Script on Mac OS X

Follow these steps to create the script to call Maya and to set it up.

Contact Support at support@toonboom.com if you experience any problem while creating the script and setting it up or 3D rendering.

From the Terminal, you must create a file in which to save the script.

How to create the script and set it up

1. Switch to the directory in which you want to create the script file:

```
cd /usr/bin
```

2. If the `bin` directory does not exist, then create it:

```
mkdir /usr/bin
```

3. Create the script file called `maya`:

```
sudo vim maya
```

4. Type in your password to grant administrator access.

5. From inside the text editor, select "`i`" to go to **Insert Mode**, and copy and paste the following text. Make sure the path is updated to the version of Maya you have running on your machine.

```
#!/bin/bash
```

```
exec /Applications/Autodesk/maya2014/Maya.app/Contents/MacOS/Maya "$@"
```

6. Save and exit by typing:

```
Esc :wq
```

7. Edit the file to make sure all users can access it. Type the following:

```
chmod ugo+x maya
```

Setting Up the Environment Variable on Mac OS X

Follow these steps to set up the environment variable on Mac OS X.

Contact Support at support@toonboom.com if you experience any problems while setting up the environment variable or 3D rendering.

How to set up the environment variable on Mac OS X

1. Using Terminal, open the folder Mac OS X. This is a hidden folder, so you need to open it using the line:

```
cd; open .MacOSX
```

2. If the folder does not exist, create it by typing the following:

```
mkdir .MacOSX
```

3. Navigate to the Mac OS X folder and create the `environment.plist` file. You can use the following lines:

```
cd .MacOSX/touch environment.plist
sudo vim environment.plist
```

4. Type in your password to edit the file.

From inside the text editor, type "i" to go to Insert Mode.

5. Copy or type the following text into the `environment.plist` file:

```
<?xml version="1.0" encoding="UTF-8"?>
<!DOCTYPE plist PUBLIC "-//Apple//DTD PLIST 1.0//EN"
"http://www.apple.com/DTDs/PropertyList-1.0.dtd">
<plist version="1.0">
<dict>
    <key>TOONBOOM_MAILBOX</key>
    <string>7778</string>
    <key>PATH</key>
    <string>/usr/local/bin:/bin</string>
</dict>
</plist>
```

6. When you have finished copying the text into the `plist` file, type `Esc :wq` to save and quit the vi text editor.

If you receive an error readout in the command line when you try to render, contact support@toonboom.com and provide the error readout content.

Creating and Setting Up the Script on Mac OS X

Follow these steps to create the script to call Maya and to set it up.

Contact Support at support@toonboom.com if you experience any problem while creating the script and setting it up or 3D rendering.

From the Terminal, you must create a file in which to save the script.

You may create this file in either `/usr/local/bin` or `~/bin`. If you save it in `usr/local/bin`, then all users will be able to render on that machine. If you create the file in `~/bin`, then only the current user will be able to render from that machine.

How to create the script and set it up

1. Switch to the directory in which you want to create the script file:

```
cd /usr/local/bin
```

2. If the `bin` directory does not exist, then create it:

```
mkdir /usr/local/bin
```

3. Create the script file called `maya`:

```
sudo vim maya
```

4. Type in your password to grant administrator access.

5. From inside the text editor, select "`i`" to go to **Insert Mode**, and copy and paste the following text:

```
#!/bin/bash
```

```
exec /Applications/Autodesk/maya2012/Maya.app/Contents/MacOS/Maya "$@"
```

6. Save and exit by typing:

```
Esc :wq
```

7. Edit the file to make sure all users can access it. Type the following:

```
chmod ugo+x maya
```

Setting Up the Network View

Now that your environment variables have been properly set up, the final step is to prepare your network to call the Autodesk Maya rendering utility. Once this is done, you can render the 3D objects in your Harmony project and preview them in the Camera view in Render View  mode. This will allow you to composite your 3D scene and effects.

There are two types of script modules that work with the Harmony-Maya connection:

- **Render Maya Batch**

This module uses the script `renderMayaBatch ()` ;

This script starts a Maya Batch session, renders the 3D elements on that frame, and then closes the session. It will open and close the session for every frame to be rendered.

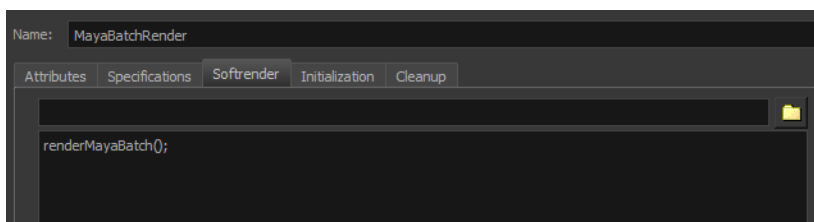

- **Render Maya Batch Server**

This module uses the script `renderMayaBatchServer()` ;

This script starts a Maya Batch session that stays open so that when you render 3D objects through multiple frames, it does not close the session between each of them.

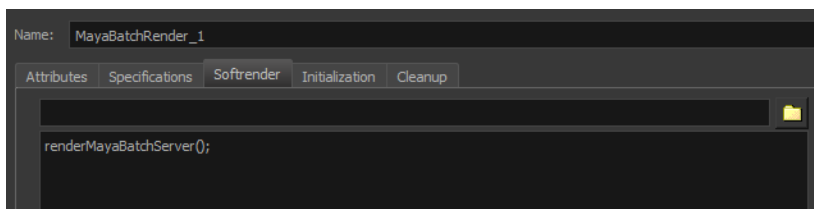



How to prepare the project network

1. Start Toon Boom Harmony.

It is recommended that you run it from the command line. This way, you will have a printout of the process as it renders. Once it is started, you might also want to display the Message Log view.

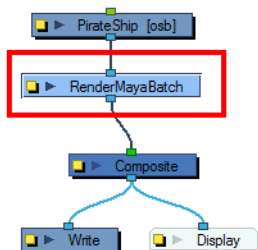
2. In the Network view, locate the 3D object module.
3. In the Module Library view, select the **RenderMayaBatch** or **RenderMayaBatchServer** module and drag it to the Network view.
4. In the Network view, hold the Alt key down while dragging the **Maya Render** module right under the 3D object module to connect it.



5. Repeat the previous steps for each 3D object module in your scene.
6. Save and reload your scene so that Autodesk Maya files can be retrieved from the project folder.
7. In the Camera view, click the Render View  button.

All the elements of your scene appear in this complete preview of the rendered scene.

8. If you want to add effect filter modules to your 3D object, make sure to connect them right under the Maya render module.

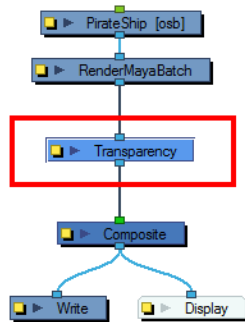

You are now all set to render your animation project.

If it does not render as expected, run Toon Boom Harmony from the command line and see if you received an error readout when clicking the Render View button. Email this information to: support@toonboom.com.

Rendering 3D Models

When batch rendering 3D models originating from Maya, some unwanted artifacts may appear, particularly on models with outlines. This is due to problems with the depth information. You can use the Z-Buffer Smoothing module to smooth out the edges.

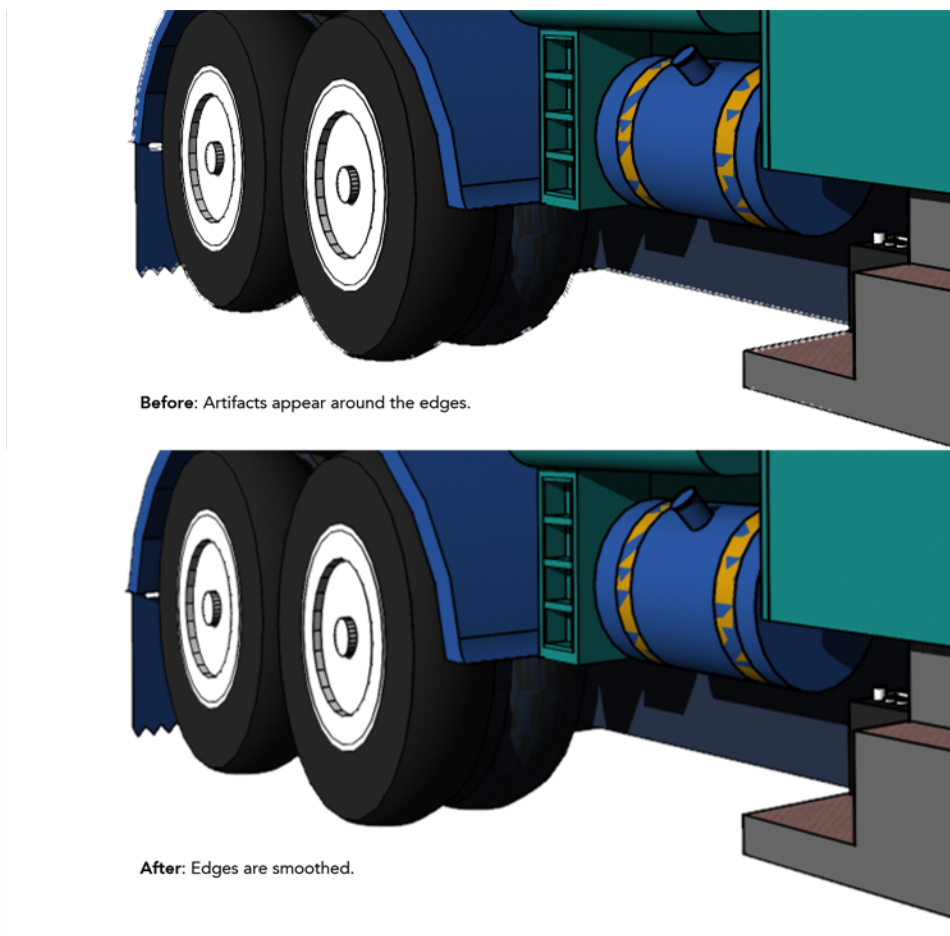

How to render 3D models

1. In the Module Library, select the **3D** tab.
2. Select the **Z Buffer Smoothing** module and drag it to the Network view.
3. In the Network view, place it between a MayaBatchRender module and the final Composite module.

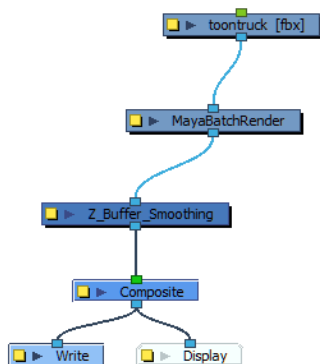

4. Display the **Z Buffer Smoothing** module properties.

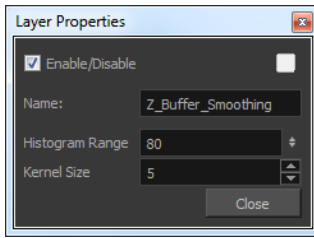

- Adjust the **Histogram Range** and **Kernel Size** parameters to achieve the optimal rendering of your Maya models. In most cases, you will have to experiment with a balance between the histogram range and the kernel size.

Z Buffer Smoothing Module Properties

Parameter	Description
Histogram Range	<p>Lets you define the range of clean pixels in the depth histogram when rendering 3D models. Only opaque or semi-transparent values are considered.</p> <p>A low value means fewer pixels are used in the depth calculations and may flatten your object, while a higher value uses more pixels in the depth calculations, but may not eliminate all the image artifacts.</p>
Kernel Size	<p>Lets you determine the size of the matrix used for calculating the depth of a single pixel. For example, for an operation with a kernel size of 3 pixels, Harmony uses the pixels within a 1-pixel radius to calculate the effect. A larger kernel size means longer calculations.</p>

Chapter 7: Effects

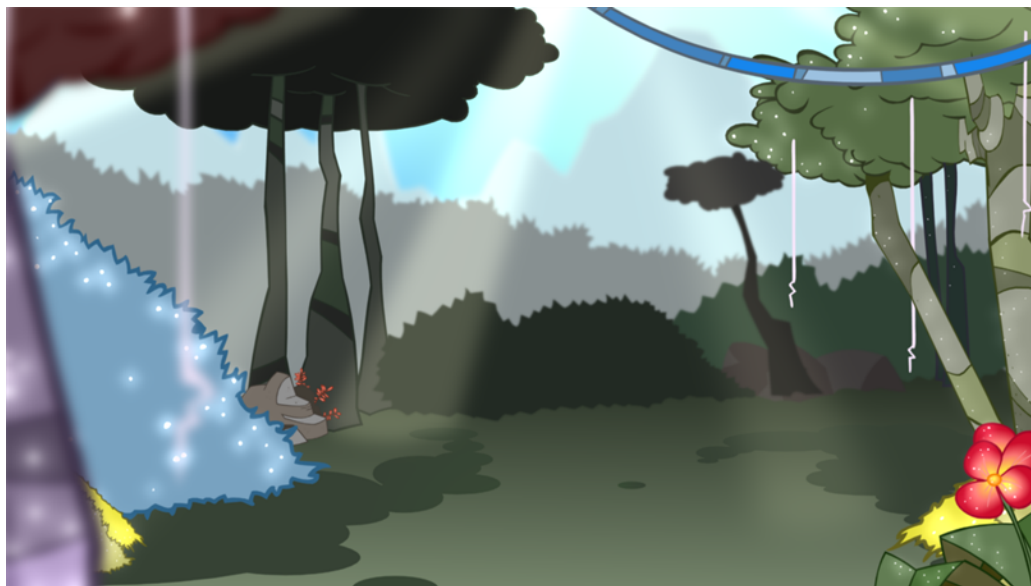

Once your animation is completed, you can add effects such as blurs and glows to make your project look even better! Harmony provides you with a series of essential effects that you can add to your layers.

This chapter contains the following topics:

- [Adding Effects](#) on the next page
- [Animating an Effect Over Time](#) on page 347
- [How Does an Effect Work?](#) on page 351
- [Using Effects](#) on page 353
- [Particle Effects](#) on page 491
- [Extra Commands](#) on page 588

Adding Effects

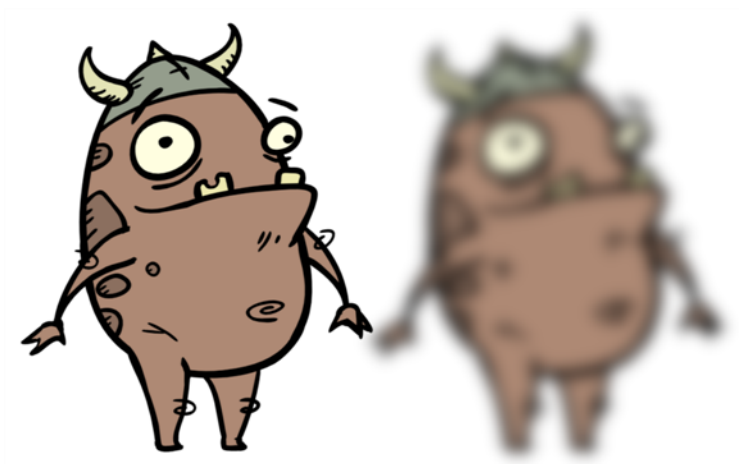

In Harmony, to add an effect, you will use the Network view. You can add an effect module to your network, drag modules from the Module Library view, and connect them to the associated drawing elements and adjust the parameters.

This topic is divided as follows:

- [Network View](#) below
- [Module Library View](#) on page 341
- [Importing a Module](#) on page 342

Network View

In the Network view, you can connect effects and compositing modules to form a network, also known as a *node system*. This view is very useful for rigging puppets, creating advanced effects and having a clear view of complex scenes. The organization and order of the modules determines the flow of data during the compositing process and how your animation elements will be composited.

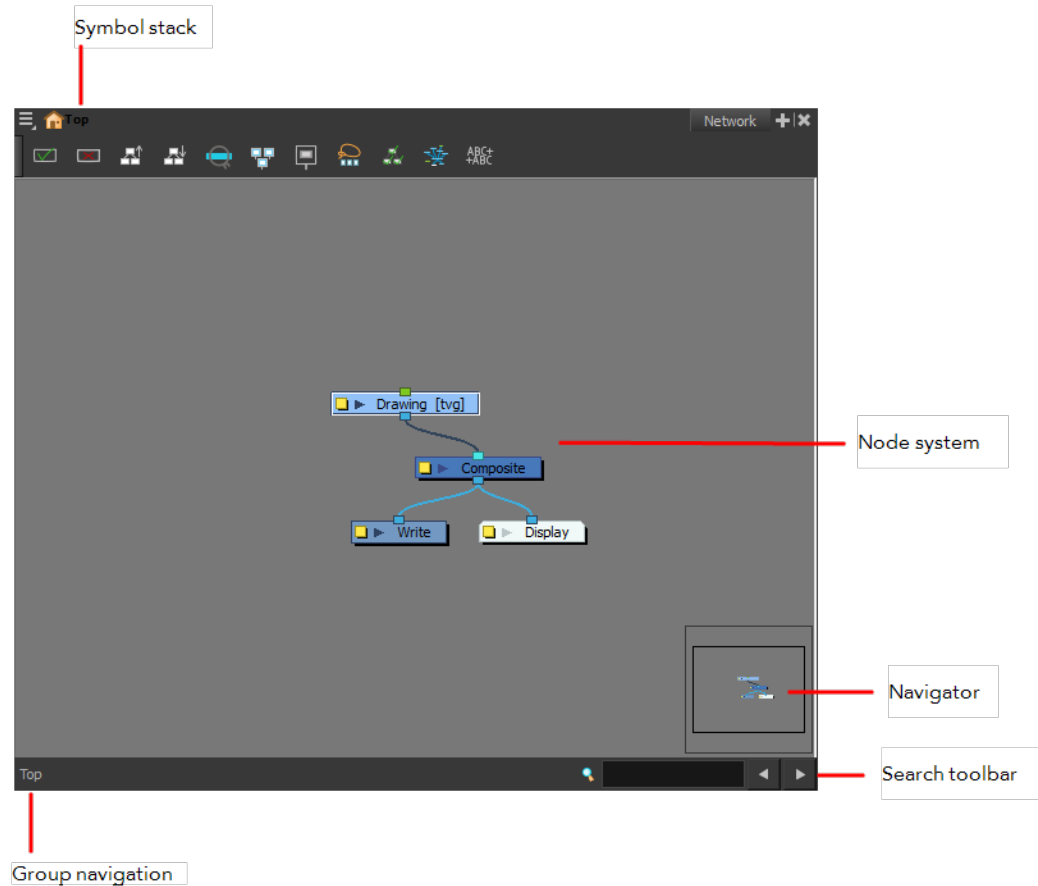

Symbol Stack

When entering symbols, the Symbol Stack lets you navigate back to the top and see the hierarchy of the symbol in which you are working.

Node System

The main area of the Network view is the node system area where you can add and organize different modules to represent a scene.

Navigator

The Navigator view lets you pan the visible area to move quickly through extensive node sets.

Search Toolbar

The Search toolbar is used to find and match a module in the project. The search is not case-sensitive. Once you have entered characters in the search field, press Enter/Return to validate and find the pattern in the module names. If successful, the module is selected and centred in the view. If many instances are found, use the Previous and Next buttons to cycle through each node.

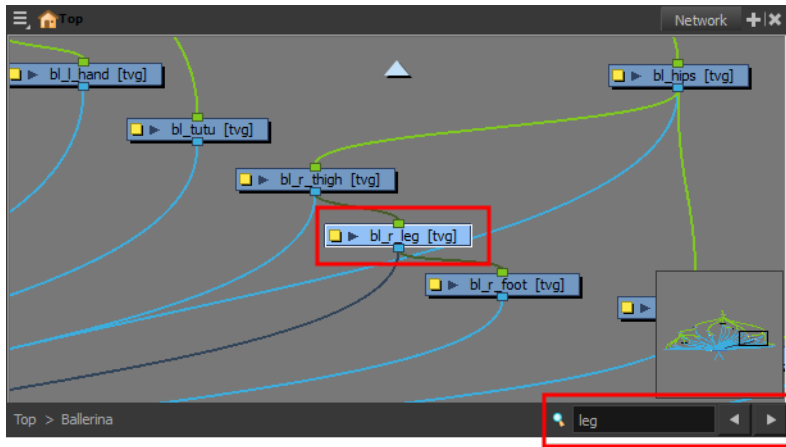

Group Navigation

When entering a group, the Group Navigation allows you to navigate back to the top and see the hierarchy of the group in which you are.

Modules

There is a series of modules available to compose the network. Here are some basic types and information about the main modules.

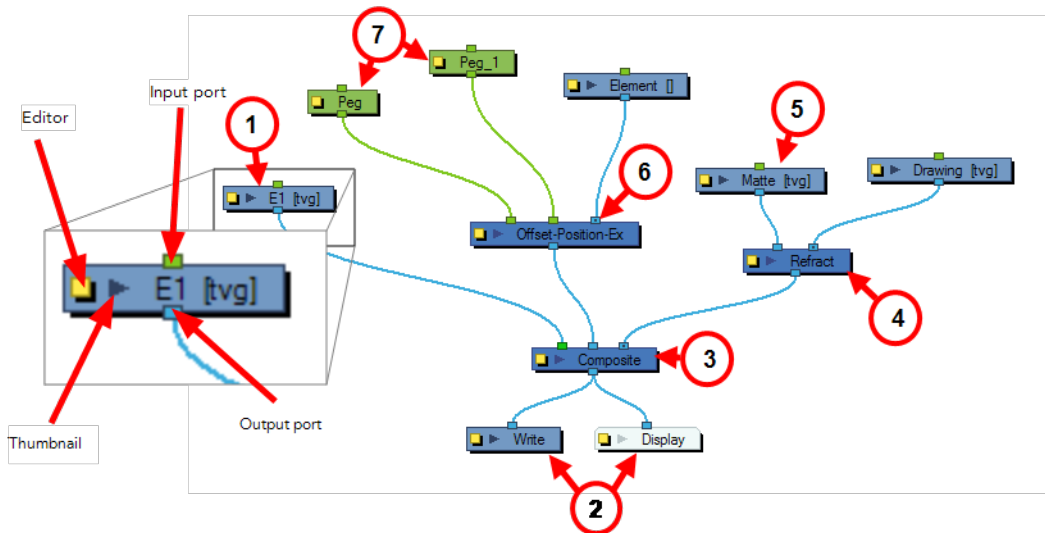

1. Drawing Module

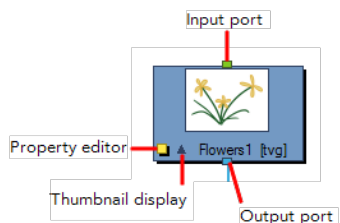

This is an example of an average module, a simple drawing module that represents a layer in the Timeline view. This module has an input port (top) that allows information to flow through it. It has an output port (bottom) that exports its information in a downward flow. On the left is a yellow box that displays the module's property editor, where you can adjust its parameters. Lastly, there is a dark arrow that displays a thumbnail of the module's contents.

2. Write and Display Modules

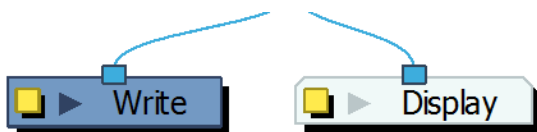

Both the Write and Display modules do not have output ports. This is because the information that flows into them can go no further in the network. The Write module records the images and renders the final output. The Display module captures the visual information and outputs it to the Camera view.

3. Composite Module

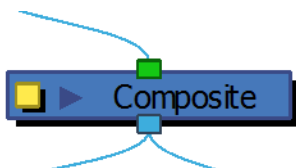

The Composite module combines multiple source images (drawing and effect modules), including all transformations and effects, into a single bitmap or vector image for each frame.

The Composite module layers the images based on the composition order rule. First, the Z-values of the elements are analyzed to determine depth. When multiple elements have the same Z-value, the Depth values in the drawing modules are used. If the Depth values are also the same between elements, the composition order is determined by the cable order of modules on the Composite module. By default, modules connected to the right are rendered below those connected to the left. You can override this default in the Composite module editor—see [Composite Module on page 141](#). The Composite module is an example of a module that can have an infinite number of input ports that can take in multiple, individual sources of information. The leftmost input port on the Composite module is always green. This lets you know that, in terms of stacking order, whatever is plugged into this port will appear on top of the composite after the Z-depth is taken into account.

4. Effect Module

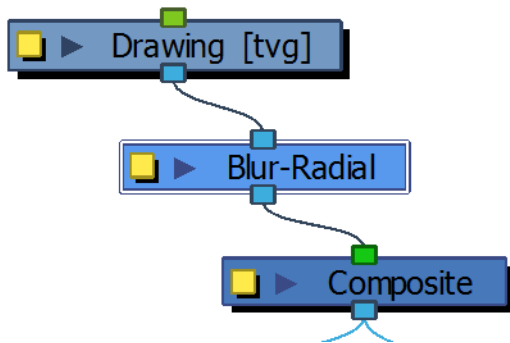

An Effect module can often have two input ports. The right input port is for the drawing layer that is to be acted upon by this effect, while the left port is usually reserved for a matte.

5. Matte Drawing

A matte, also called mask, is the shape that will be used by the effect module to modify the original image. The effect will only be applied where the matte overlaps with the original image. Sometimes the matte will act as a negative shape that the effect will exclude. This all depends on the nature and editing properties of the effect.

6. Position Ports

Some effects contain three input ports. If they are green, then they require a Peg module connection (coordinate and value information). In the case above, the effect can accommodate two pegs.

7. Peg Module

The Peg modules control the transformation of elements (position, scale, skewing and rotation) over time. The green ports at the top and bottom of the module indicate that it accepts position information and can then pass this information on.

One peg can be used to control many different modules or one module can accept more than one peg. In a situation like the latter, one peg might be used to modify the rotation, while the other used to modify the position of the effect and then animated differently over time.

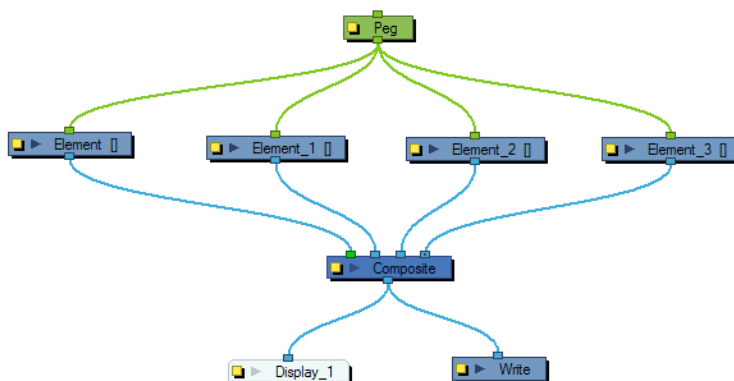

Module Library View

If you need to add new effects and other modules to the Network view, you will need to get them from the Module Library.

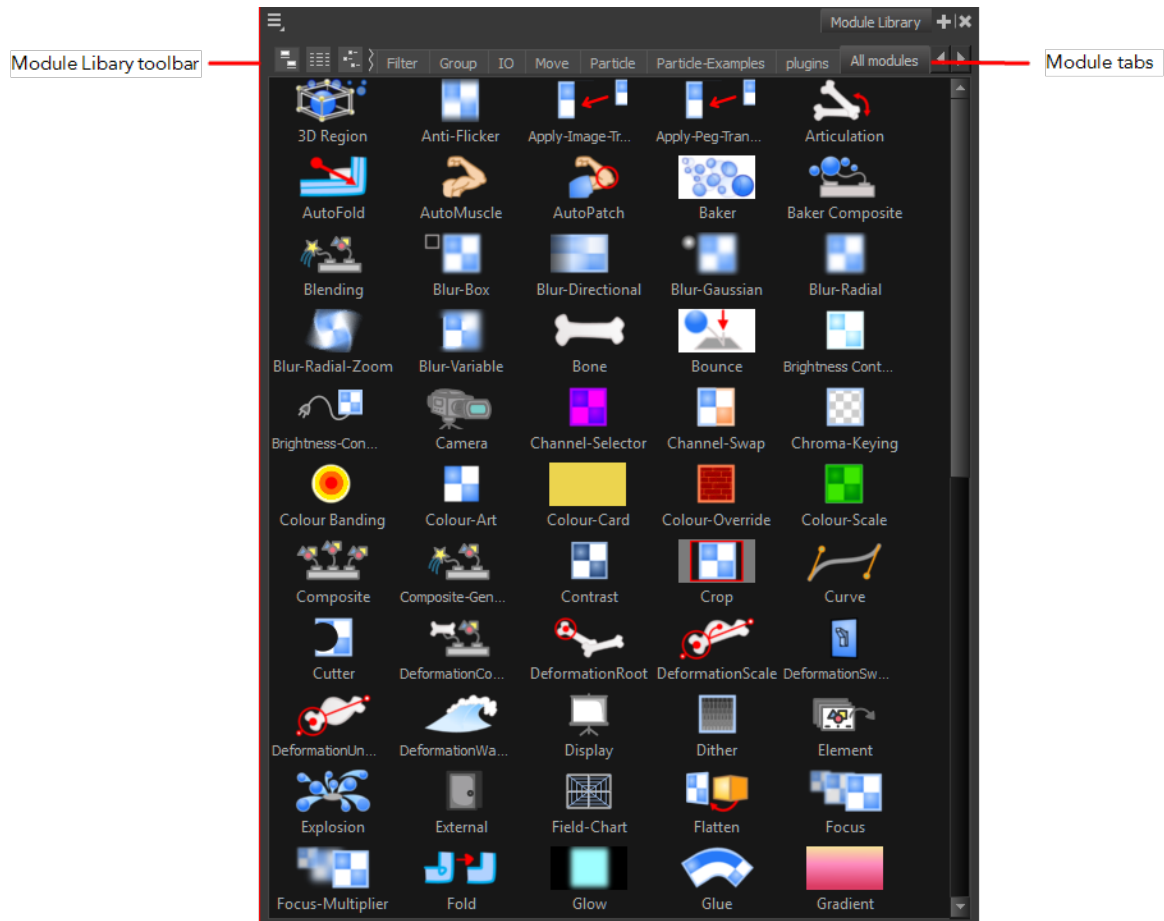

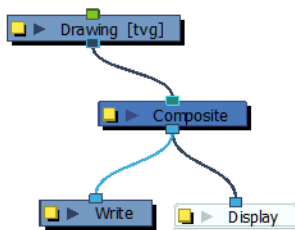

When you create a new project in Harmony, the default network that appears in the Network view looks similar to the one below.



Module Library View Toolbar

In the Module Library View toolbar, you can change how the effects are displayed.

-  View as Icons
-  View as List
-  View as Icons with Names

Module Tabs

The Module Library is conveniently broken up into several sections or tabs:

- **3D:** Includes the modules related to working with 3D models within Harmony.
- **Deformation:** Includes the modules needed for building a deformation chain, as well as advanced effects such as Fold and Auto Muscle.
- **Favorites:** Includes the most common modules. To add extra modules to the Favorites tab, select any module from any other section and drag it onto the Favorites tab.

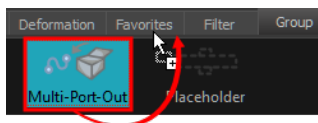

- **Filter:** Effect modules, such as blurs.
- **Group:** Modules for grouping, like Group modules and Multi-Port modules.
- **IO:** Includes Display, Drawing, Write and Note modules.
- **Move:** Modules for changing elements over time, like Peg modules, as well as certain transformations.
- **Particle:** Includes all the modules necessary to construct complex particle systems.
- **Particle-Examples:** Includes a series of examples of particle effects.
- **Plug-ins:** Includes plug-in modules.
- **All Modules:** Lists all of the modules available.

Importing a Module

To bring a module into the Network view, drag it from the Module Library and drop it in the Network view. Once in the Network view, you can click on the input or output port of a module and drag out a cable. You can then connect this cable to the output port or input port of another module.

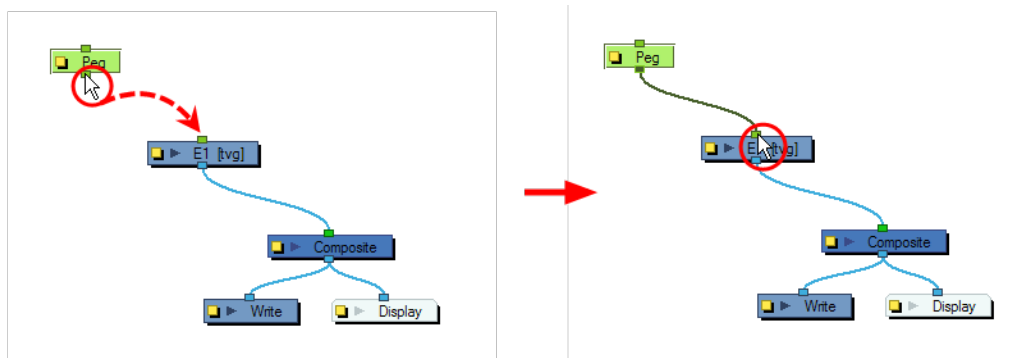

If you want to connect a module between two connected modules, you can use the Alt key as you drag the new module over the existing cable connection. Using the same Alt key, you can also disconnect a module.

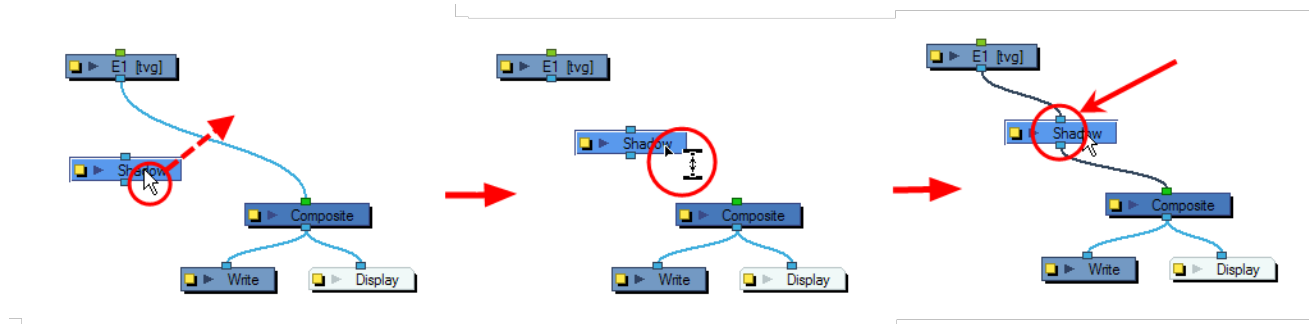

If you want to remove a module, select and press Delete to remove it from the Network view.

Adding Effects Through the Timeline View

Although all effects should be added through the Network view, there are two effects that can be quickly added through the Timeline view. These effects, Colour Card and Quadmap, can also be added through the Network view in the usual manner. In addition, there is a special way of grouping elements that can only be done through the Timeline view.

How to add effects in the Timeline view

1. In the Timeline view, click on the **Add Layers** \oplus button and from the Layers drop-down menu select the desired effect that you would like to add.

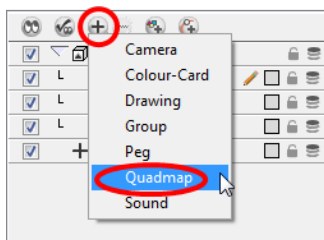

2. The effect appears in the Timeline view. The Colour-Card does not require to be parented to any layer.
3. For the Quadmap, drag the drawing layer onto the Quadmap layer to parent it.

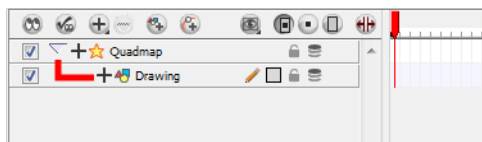

4. In the Timeline view, double-click on the Quadmap layer to open the Layer Properties view.
5. In the Layer Properties view, adjust the parameters.

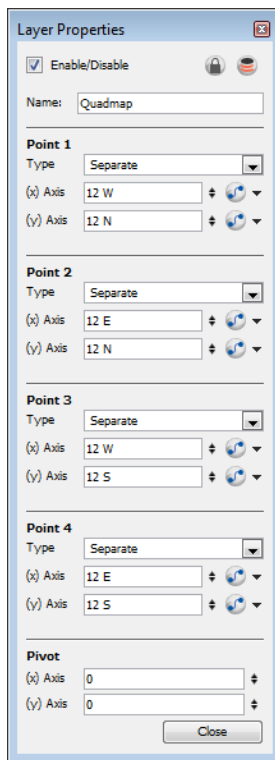

Once you have set the parameters for your effect, you can store it in the Library view as a template so you can quickly reuse it later on without having to set the parameters again. Refer to learn more about creating templates.

Grouping from the Timeline View

There are several advantages to using the Group Selection With Composite command (only found through the Timeline view) over the simple Group Selection (which references both the Group layer in the Timeline view and the Group module in the Network view).

One of the advantages that this command has is that it groups all the selected elements into a neat module that has a nested composite. This means that there is only one connection coming out of the Group module. With the simple Group module or command, the Group displays the same number of connections as elements in the group. Both grouping commands display the same structure in the Timeline view.

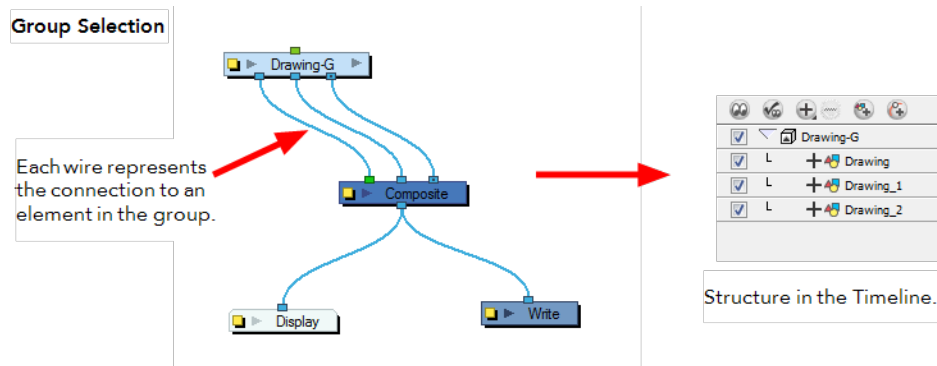

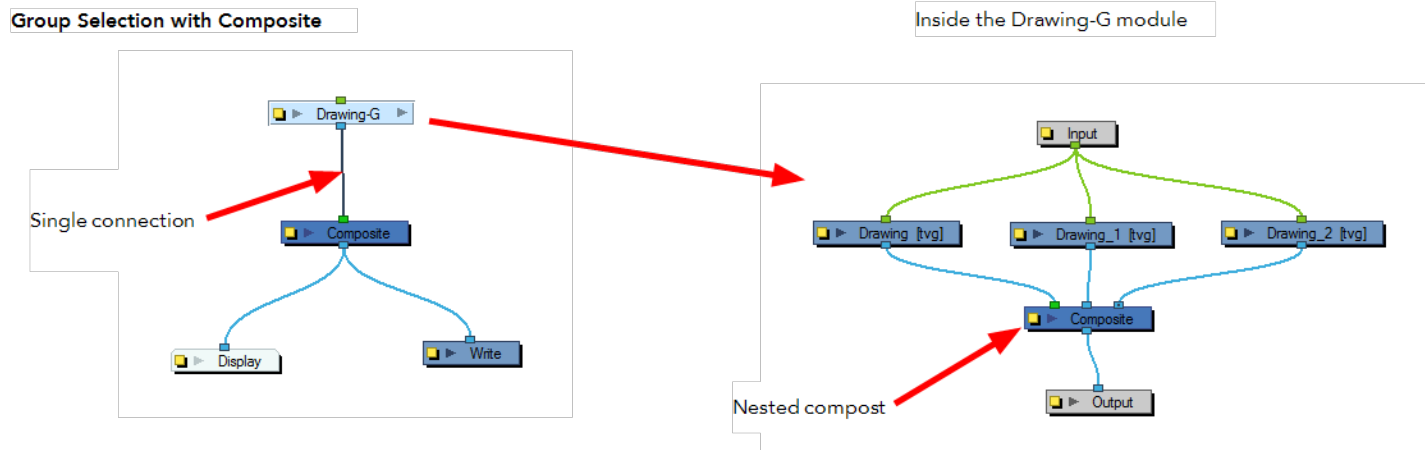

The Group Selection With Composite command should only be used before any work has been done in the Network view and it is recommended for objects whose stacking order is of no consequence.

Using the Group Selection from Composite command on elements that have effects, have been tweaked in the Network view, or whose stacking order is of consequence, may cause the grouped elements to lose their properties once grouped in this way. In addition, though you may only select a few modules to group, if there are other layers in the timeline that exist between the selected layers, they will automatically be grouped, even if not selected.

How to group selected elements using the Group Selection With Composite command

1. In the Timeline view, in the layers section, select the elements that you wish to group.
Any layers between the selected layers will automatically get grouped as well, so if the stacking order is of no consequence, move extra layers either above or below the layers that you wish to group.
2. Right-click on one of the highlighted layers and from the pop-up menu select Group Selection With Composite.

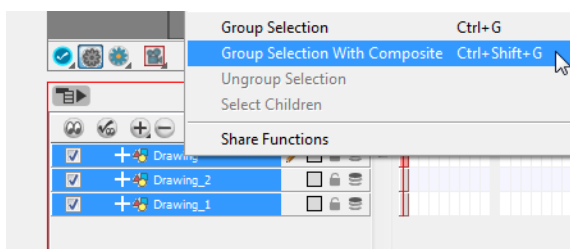

3. The layers appear indented under a new Group layer in the Timeline view and in a new Group module in the Network view.

Previewing Effects

Most effects must be rendered so you can preview them properly. Some effects can be displayed in the OpenGL view, but most of them must be rendered and previewed in the Render Mode of the Camera view.

How to preview effects

1. In the Camera view status bar, click the Render Mode  button.

In the bottom-right corner of the Camera view, the progress bar indicates the status of the rendering. Depending on the size of the frame to render, it may take several seconds.

Once you preview your effect, you may want to adjust it. By default, as soon as you modify a parameter, Harmony will recalculate the preview image. If your scene is heavy and you do not want preview rendered automatically, you can disable the Auto-Render option and request the preview update yourself.

How to disable the Auto-Render option

1. In the Camera view status bar, click the Auto-Render  button.

Once the Auto-Render option is disabled, you must request the preview update by clicking the Auto-Render  button.

How to manually update the rendering preview

- In the Camera view status bar, click the Render  button.



Note that you cannot play back your animation in Render mode. You must perform a render or a preview render to see your animation with the final effects.

Animating an Effect Over Time

In Harmony, to animate an effect over time, create a function curve by adding keyframes to the parameters you want to animate. To do this, you will use the Layer Properties view and the Timeline view. You can fine tune your animation using the Function view.

How to animate an effect over time

1. In the Timeline view, add the effect and connect the layers to it. See [Adding Effects Through the Timeline View](#) on page 343.

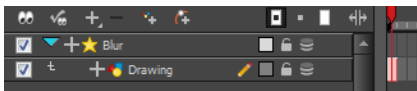

2. Select the Effect layer.

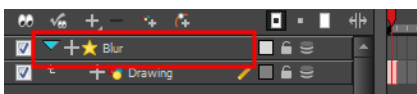

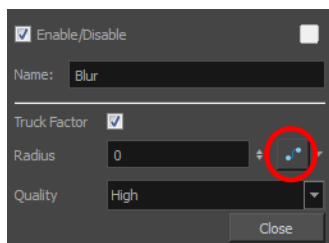

3. To create the function curve:
 - In the Layer Properties view, click on the **Function**  button you want to animate to create a function curve.

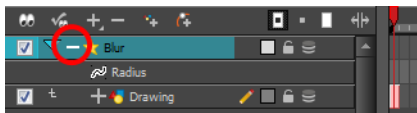

OR

- You can also expand the effect layer's parameters in the Timeline view by clicking on the Expand  Function button and add a keyframe using the F6 key to the parameter you want to animate.



4. In the Timeline view, click on the **Show Data View**  button.
5. In the Timeline view, go to the frame where you want to start animating the effect.



6. In the Data view, click on the **Add Keyframe**  button.

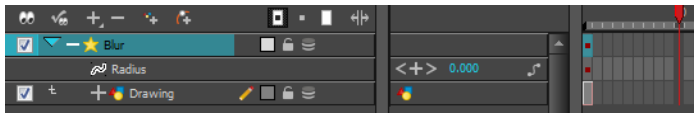

7. In the Value field scroll to the keyframe value or type the value in the field.

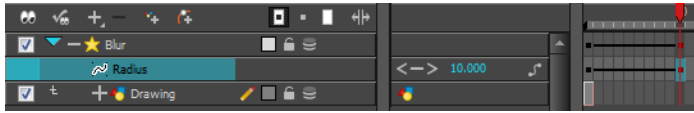

- If your keyframes are stop-motion keyframes, in the Timeline view, select the new keyframes. Right-click on the selection and select **Set Motion Keyframe**.
8. Repeat this process for each keyframe to be added.

When compositing your scene, it will often happen that you want to animate the parameters of an effect over time. You may want to have an object fading in or out by changing the transparency level over time or increasing the colour contrast on one of your drawings over a certain frame range.

To animate an effect over time, create a function curve by adding keyframes to the parameters you want to animate. To do this, you will use these views: Layer Properties, Network and Timeline. You can fine tune your animation using the Function view.

How to animate an effect over time

1. In the Network view, drag an effect module from the Module Library view and to the Network view.

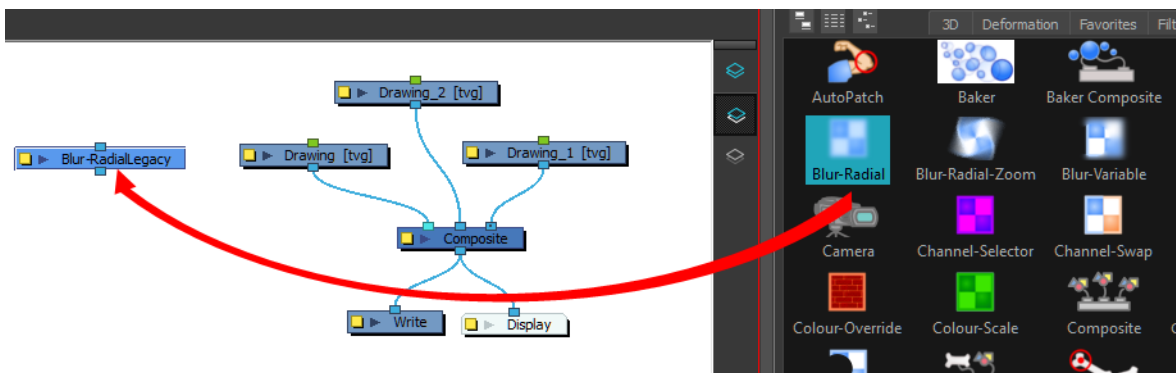

2. Plug the effect between the drawing element on which you want to apply the effect and a composite module. You can do this by manually unplugging and plugging, or by holding down Alt as you drag it through a connection.

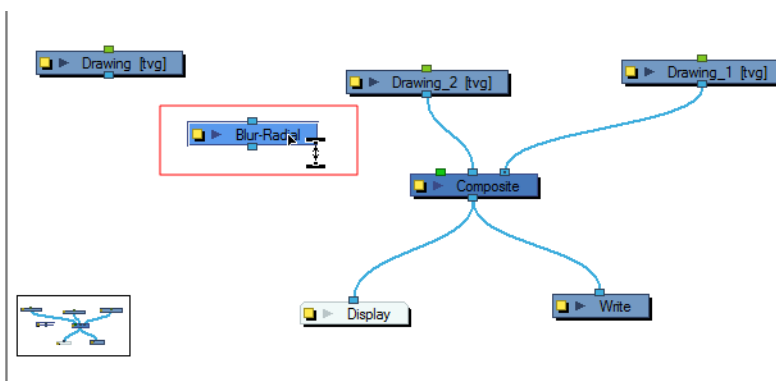

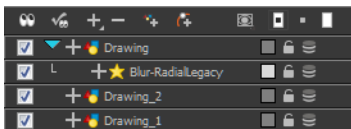

The effect should also appear in the Timeline view.



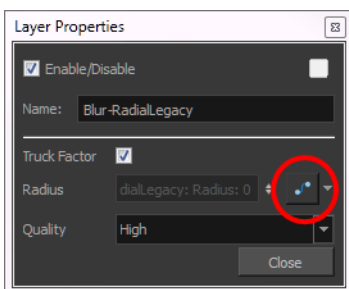

- To animate the value of the parameter, you must create a function curve and add keyframes on it. For example, you can set the Blur-Radial effect to have no blur on the first frame and become very blurry by the end of the scene by animating its Radius parameter. Do one of the following to create the function curve:

- In the Layer Properties view, click the Function  button you want to animate to create a function curve.

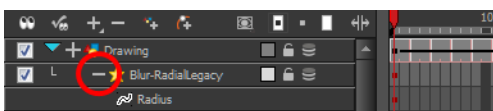

- Expand the effect layer's parameters in the Timeline view by clicking the Expand Function  button and press F6 to add a keyframe to the parameter you want to animate.



- In the Timeline view, click the Show Data View  button.

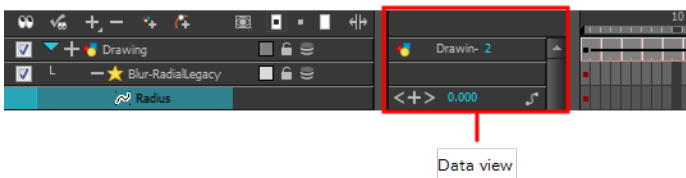

- In the Timeline view, go to the frame on which you want to start animating the effect.

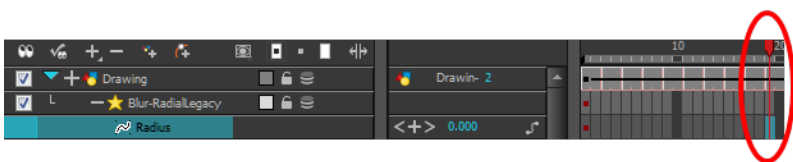

- In the Data view, click the Add Keyframe  button.

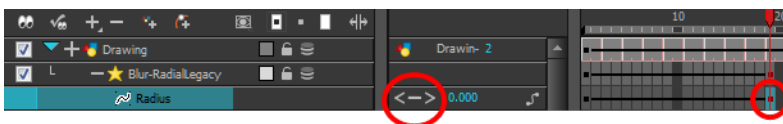

- In the Value field, scroll to the keyframe value or type the value in the field.

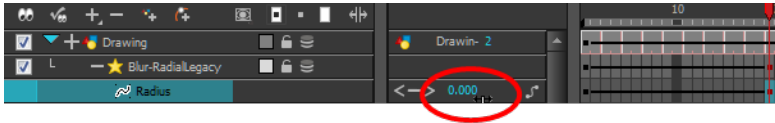

- ▶ If your keyframes are stop-motion keyframes, in the Timeline view, select the new keyframes. Right-click and select **Set Motion Keyframe**.
8. Repeat this process for each keyframe to be added.

Refer to the [Previewing and Playing Back Effects](#) on page 586 to learn how to preview animated effects.

How Does an Effect Work?

An effect always needs a drawing connection and sometimes a matte or shape connection. A matte provides drawing information that determines the area on which the effect will be applied on the drawing. The details and colours within the matte drawing do not matter, as the system will only use the shape and transparencies in it. A matte is also known as mask.

The matte principle can be demonstrated with the Tone effect.

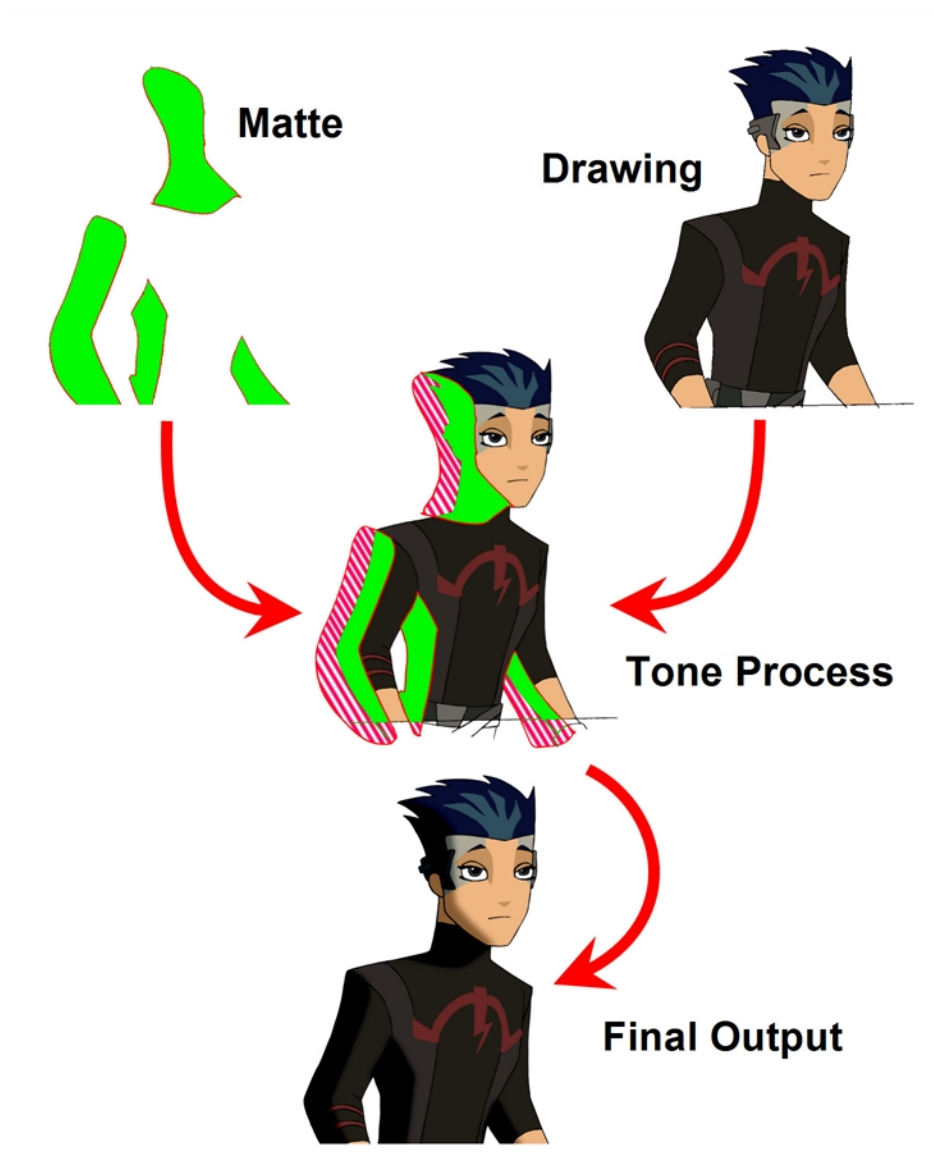

The drawing layer is connected to the right port of the effect and the matte (mask) on the left. The Tone effect then applies darker colours where the matte overlaps the image, blurs the tone edge, and finally clips out the extra tone zone outside the drawing before outputting a final drawing with a tone.

You can adjust the tone's parameters in the Layer Properties view and link any of them to a function column to be animated over time. This means that all of the effects can be customized.

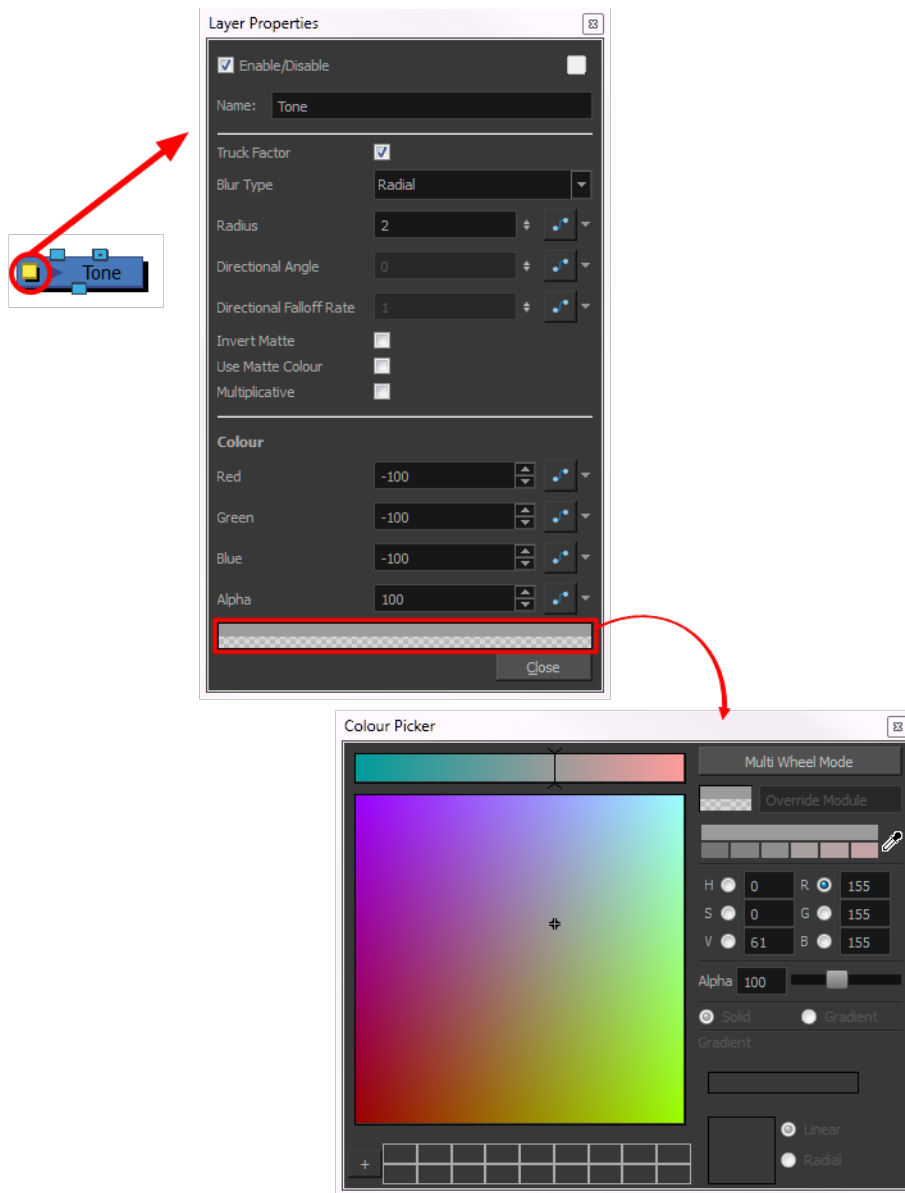

Using Effects

Here is the list of the main effects available in Harmony. Each effect and how to use it is described in the corresponding section.

<ul style="list-style-type: none"> • Anti-Flicker on the next page • Apply Peg Transformation on page 355 • Apply Image Transformation on page 360 • Auto Patch on page 362 • Blending on page 364 • Blur - Box on page 370 • Blur - Gaussian on page 375 • Blur-Directional on page 372 Blur-Directional on page 372 • Blur - Radial on page 377 Blur - Radial on page 377 • Blur - Radial Zoom on page 379 • Blur-Variable on page 386 • Brightness and Contrast on page 385 • Channel Selector on page 387 • Channel Swap on page 389 • Chroma-Keying on page 390 • Colour-Art on page 394 • Colour Banding on page 396 • Colour-Card on page 398 • Colour-Override on page 399 • Colour-Scale on page 416 	<ul style="list-style-type: none"> • Contrast on page 422 • Contrast on page 422 • Cutter on page 424 Cutter on page 424 • Dither on page 425 • External on page 426 • Focus on page 429 • Focus Multiplier on page 431 • Glow on page 432 • Glue on page 434 • Gradient on page 436 • Grain on page 438 • Greyscale on page 440 • Grid / Field Chart on page 442 • Highlight on page 446 • Hue-Saturation on page 449 • Image Switch on page 452 • Layer Selector on page 454 • Lens Flare on page 456 • Line Art on page 458 • Matte-Blur on page 459 • Matte-Resize on page 462 	<ul style="list-style-type: none"> • Motion-Blur on page 466 • Multi-Port-In on page 467 • Multi-Port-Out on page 468 • Negate on page 469 • Note on page 470 • Overlay Layer on page 471 • Pixelate on page 473 • Placeholder on page 474 • Quadmap on page 474 • Refract on page 476 • Remove Transparency on page 478 • Shadow on page 479 • Sparkle on page 482 • Tone on page 484 • Transparency on page 487 • Turbulence on page 572 • Turbulent Noise on page 576
---	---	---

		<ul style="list-style-type: none">• Underlay Layer on page 488• Visibility on page 489
--	--	---

For more information:

- Composite Module on page 136, Composite Module on page 141 and Managing a Network with a 3D Scene Setup on page 197.
- Display Concepts on page 157.
- Rendering Images and Movies from the Network on page 614 and Multiple Renders on page 606.
- Locking Flat Drawings to the Camera Angle on page 195.
- Animating a Camera Shake Using the Quake Module on page 224.
- Particle Effects on page 491.
- Rendering 3D Models on page 332.

Anti-Flicker

Use the Anti-Flicker to compensate for flickering in your output to TV formats. The Anti-Flicker effect applies a vertical blur to the rendered output. You should place the Anti-Flicker before a Write module in the Network view.

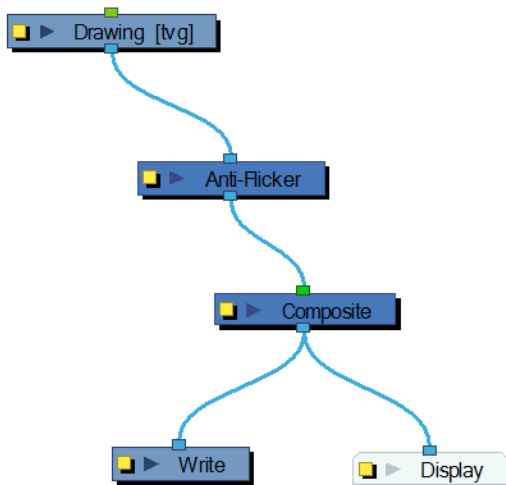

Use the Anti-Flicker editor to control the amount of blur that is applied to rendered output. In the Radius field, enter a value for the number of pixels to be considered in the blur.

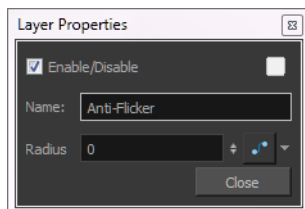

Apply Peg Transformation

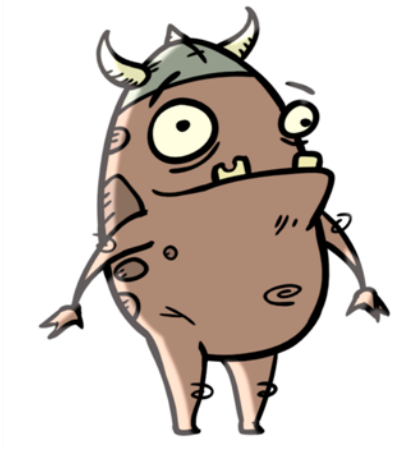

Use the Apply Peg Transformation module to apply a transformation coming from a Peg, Ortholock, or Quadmap module on a single module or a group of modules. When using the drawing layer's No Clipping option, you can use this module to apply all Camera and Peg transformations once all of the effects and modules connected above the drawing module are calculated.

You can use this effect module to create a simple highlight on a cut-out puppet or use the No Clipping option available in the drawing layer.

The No Clipping option, found under the drawing Layer Properties' Advanced tab is used when you do not want to crop your images before all effects are applied to your drawing. No camera motion or peg transformation will be applied to your drawing until you connect an Apply Peg Transformation.

Refer to [Positioning an Element Using the Layer Properties](#) on page 108 to learn more about the drawing layer's Advanced tab.

The advantage of this module is that you can create a second output of your image or puppet and offset it, scale it or apply any kind of transformation on it.

The transformations set in the Peg, Ortholock, or Quadmap module connected to the Apply Peg Transformation module are applied **BEFORE** the image is composited.

Here is an example of how to connect the Apply Peg Transformation module:

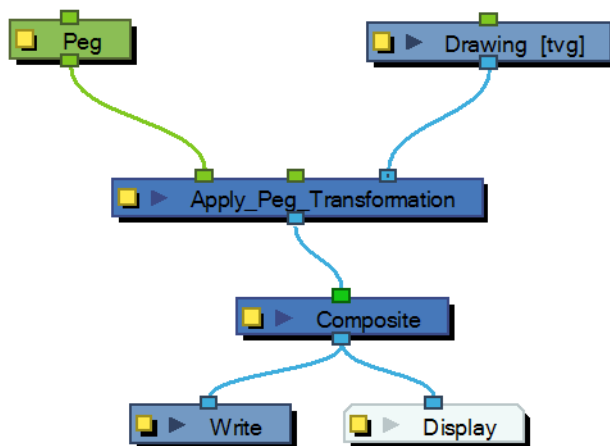

The transformation set in the Peg module from the example above is applied before the image is composited, which is the equivalent of the following network:

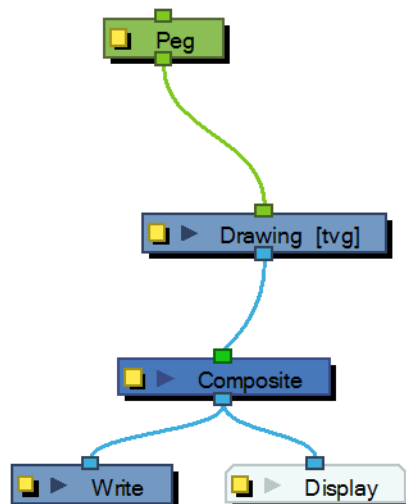

In the following images you can see the result of the transformation without the Apply Peg Transformation module and with it:

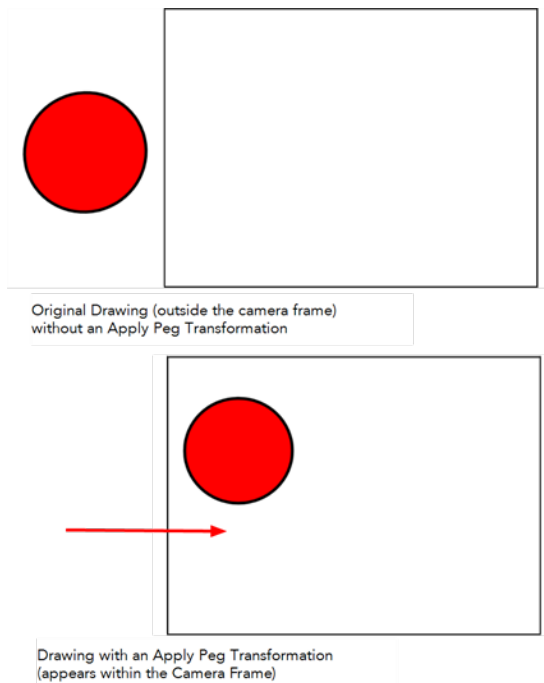

Using the Apply Peg Transformation you can apply transformation on drawings that are outside the camera frame and make them appear inside the frame.

If you are using the Apply Image Transformation module to create a drop-down shadow for a character, it will work correctly so long as the character is not going outside of the camera frame or that the drawing connected in it is a **VECTOR** drawing. The reason is the Apply Image Transformation module applies the transformation once the drawing is rendered, moved by its own set of Pegs, motion paths and quadmap and cropped to the camera frame size. This crop operation does not occur if the drawing is a vector drawing (*.TVG). Although, as soon as the drawing is passed through an effect module or a bitmap type Composite module, the drawing is turned into a bitmap image and gets cropped.

So, if you offset a bitmap half inside and half outside the camera frame, the outside part is cropped out and then moved by the Apply Image Transformation module. A part of the original drawing is cut. You need to use the Apply Peg Transformation module for the transformation to be applied before the image is processed and cropped.

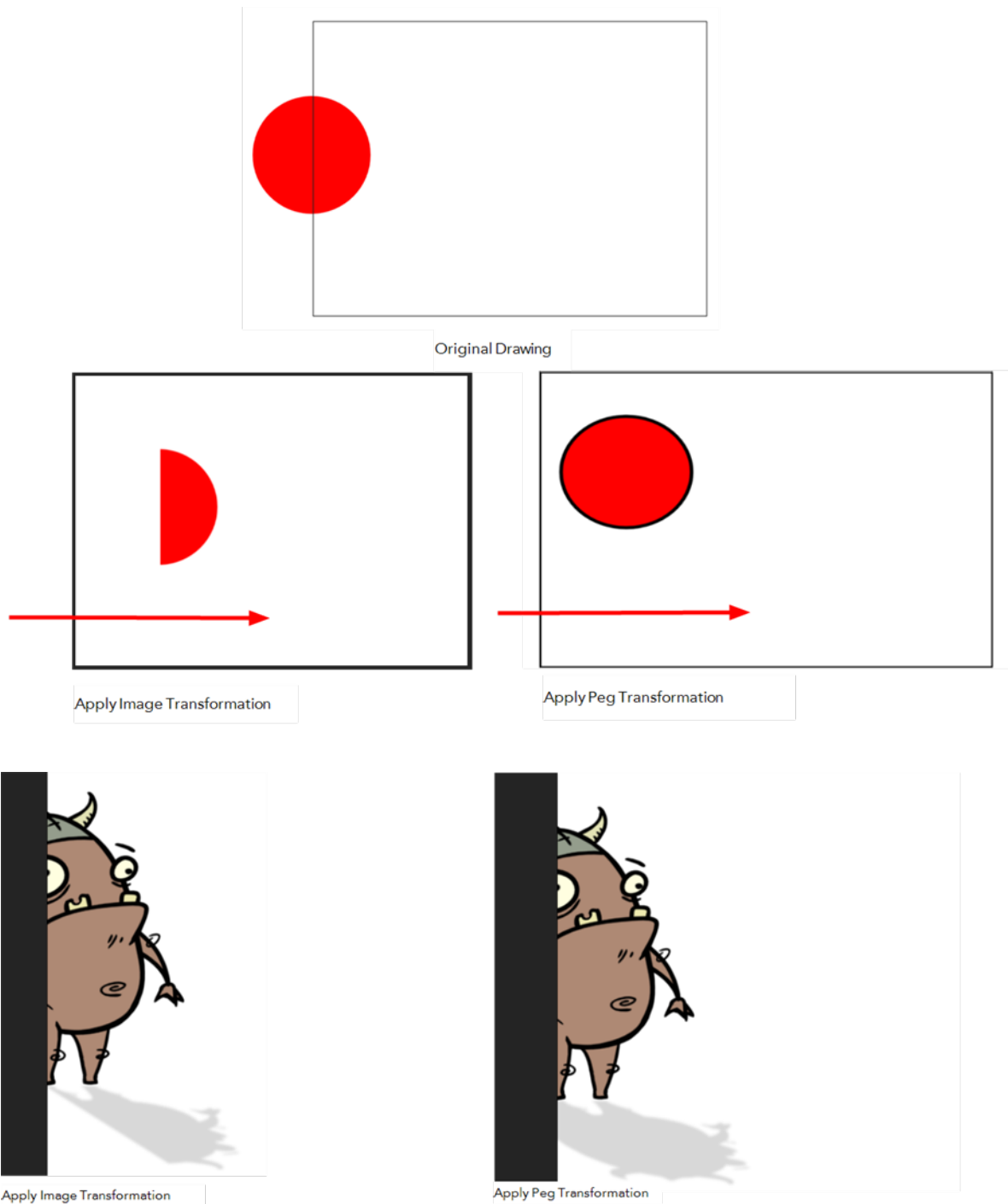

Advanced Apply Peg Transformation

You can use the Apply Peg Transformation's middle port to apply the transformation you connected to the module after one of the Peg or Quadmap connected above the drawing module.

In the following example, two pegs were added to control the different motions on independent trajectories:

- Peg-Translation
- Peg-Scale

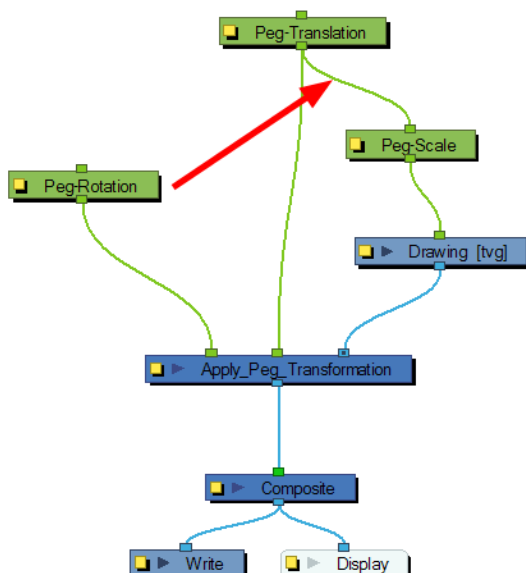

When there is no Apply Peg Transformation module, the Peg-Translation is the first trajectory to affect the drawing module. Then, once the translation is applied, the Scale trajectory affects the drawing module.

When using an Apply Peg Transformation module without using the middle port, the Peg-Rotation connected in the APT module is applied at the top of everything. The order in which the trajectories are applied to the drawing module is:

1. Peg-Rotation
2. Peg-Translation
3. Peg-Scale

When the Peg-Translation is connected in the Apply Peg Transformation's middle port, the Peg-Rotation is applied after the Peg-Translation and before the Peg-Scale. This means that the translation is done before the rotation instead of the rotation before the translation.

The order in which the trajectories are applied to the drawing module is:

1. Peg-Translation
2. Peg-Rotation
3. Peg-Scale

Use the Apply Peg Transformation editor to rename the module.

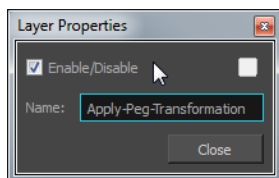

Apply Image Transformation

The Apply Image Transformation effect is mainly used when you want to pan an object out of the camera frame and that object has an effect such as a Glow or a Blur on it. When you use a peg or the Apply Peg Transformation module to translate an object such as the sun out of the camera frame, as soon as the sun starts to go outside of the camera frame, the sun's circle is cropped and the blur is applied on the shape left over. This also means that when the sun is completely out of the frame, the Blur is not calculated anymore and the Blur pops out.

To prevent this from happening, you must use the Apply Image Transformation module to pan the sun out.

The Apply Image Transformation module applies the panning transformation once the full drawing of the sun is blurred, once the image is composited. Here is an example of this network:

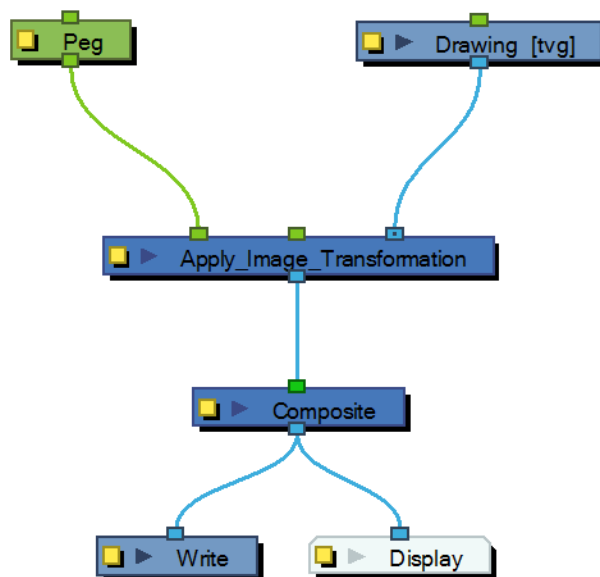

Here is how to connect the Blur effect for a sun panning out:

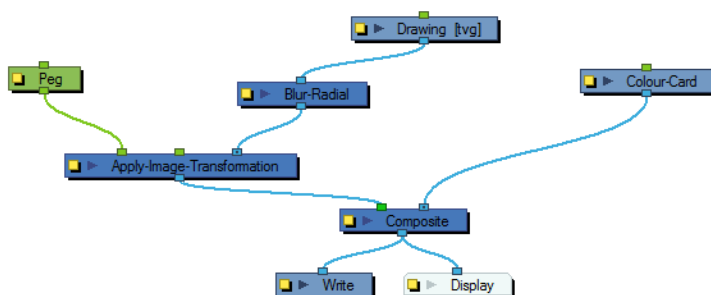

Here is the visual result of the blurred sun:

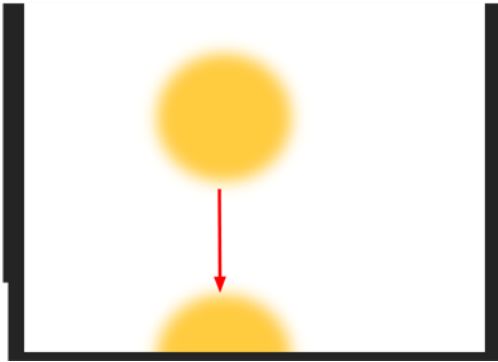

Look at the following example to understand better why using the Apply Image Transformation instead of a regular peg or the Apply Peg Transformation module.

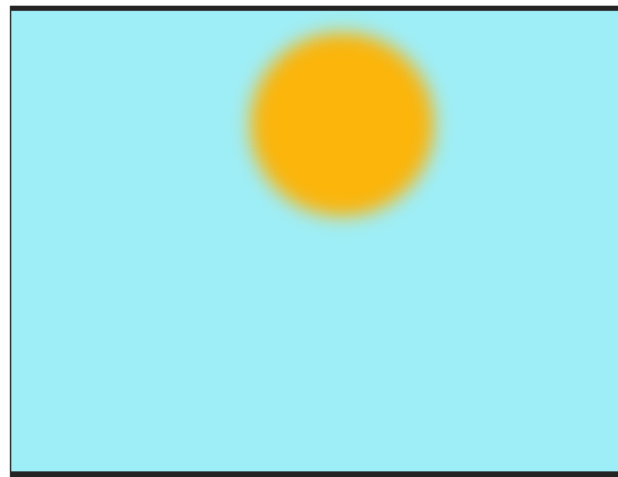

Original Image



Apply Image Transformation



Peg, or Apply Peg, Transformation

The normal rendering behaviour is to crop the image before applying the effects. When planning a sunset using either a Peg or the Apply Peg Transformation module, as soon as the drawing of the sun is out of the camera frame, the drawing is cropped and there is no image left to blur. This means that the glowing edge pops out of the camera instead of panning out gradually. Using the Apply Image Transformation module, the image is blurred before being panned out, so this means that even once

the drawing is out of the camera frame, its glowing edge will still show until the drawing is far enough from the camera border. This way, there is no pop when panning out blurred objects.

Use the Apply Image Transformation editor to change the name of the module.

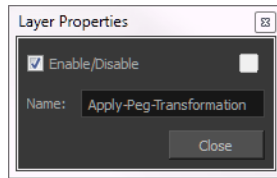

Auto Patch

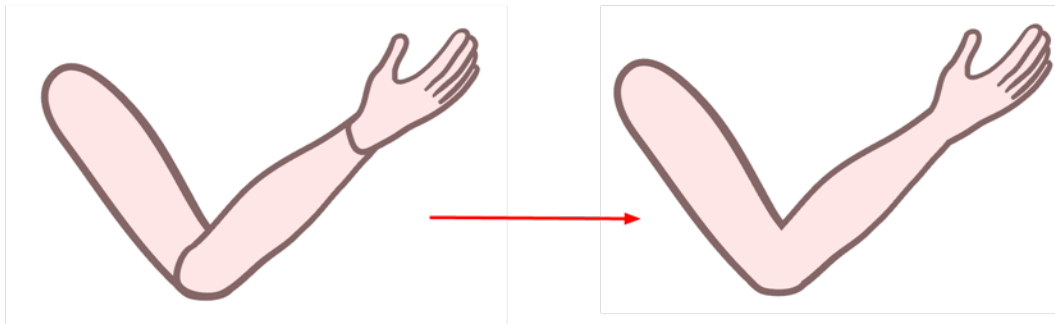

The Auto Patch module is used mainly when creating joint patches for cut-out puppets drawn with pencil lines and painted in the Colour Art layer. Instead of removing a portion of the outline to attempt to create a seamless joint, you can draw complete pieces, and with the Auto Patch module, automatically create a perfect articulation.

The requirements for this effect to work are:

- Drawing outlines must be drawn in pencil lines
- Drawing outlines must be drawn in the Line Art layer
- Drawing fill colours must be painted in the Colour Art layer

Pencil lines are central vector lines. The vector is located along the centre of the line. This means that when you paint a zone delimited by a pencil line, the colour fill will expand to the centre of the pencil line.

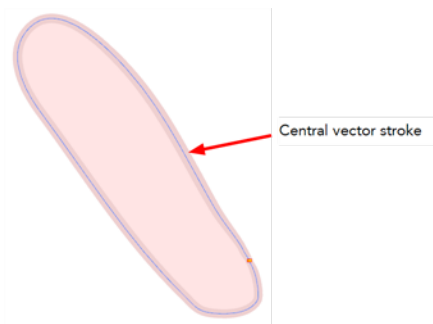

When using the regular patch technique, recommended for the brush line, the result with pencil lines is very odd looking because the colour fill zone is bigger than the pencil line inner contour.

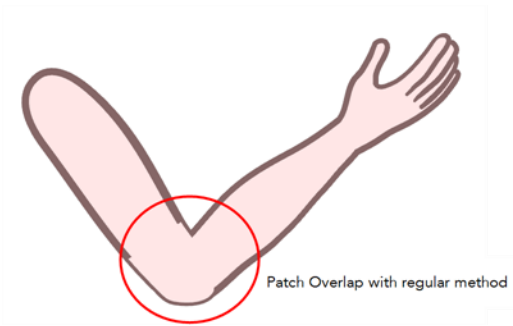

Instead of using the regular patch method, you can use the Auto Patch module. It will automatically extract the Colour Art and clip it to the right size. Then, you can connect it in front of the piece to be covered.

The network connection for the Auto Patch is quite simple. Once your basic character rigging is done, you can add the Auto Patch module to the joints you want to cover. There is no need to set any parameters.

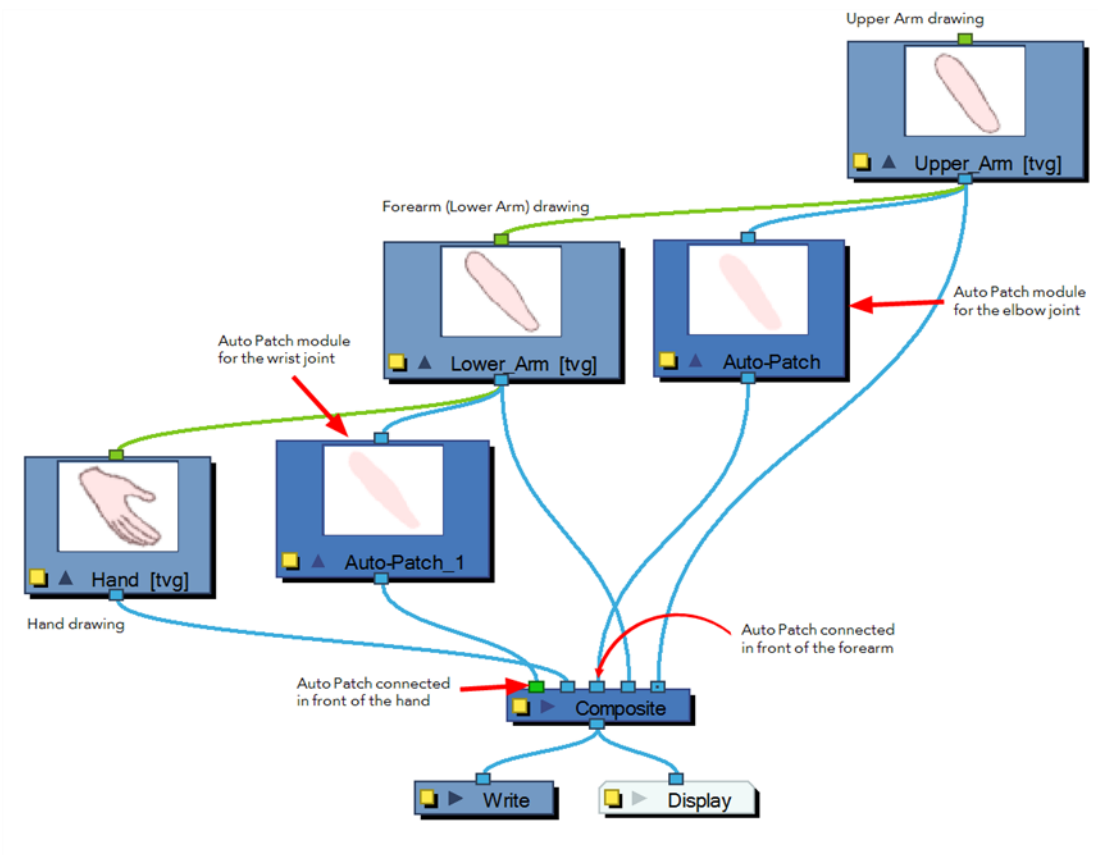

Blending

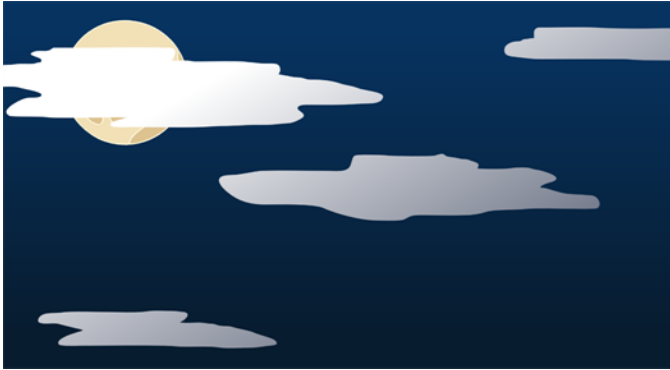

Effects modules, like the Tone module and Highlight module, can control the colour and alpha composite operations for you. These modules were created with pre-set colour and alpha composite operations to fit the most frequently used, composite operations.

You might, however, still want to control the colour and alpha composite operation between two images using the Blending module, to create a multiplicity of lighting, shadow, filter or ambient effects. The Blending module combines two images into one output image, following the parameters you choose for your movie and images sequence or SWF movie exports.

The drawing module connected to the Blending effect will act as the blending image and will be applied to all the drawing layers situated under them in the Composite module or Timeline view order.

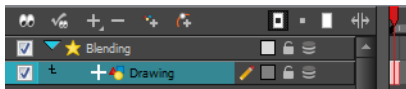

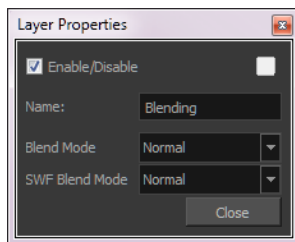
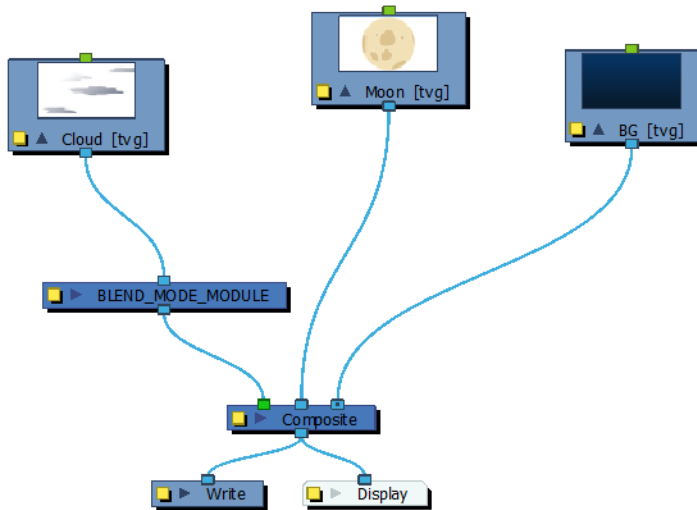

Blending Properties

Parameter	Description
Name	Use this field to rename the module.
Blend Mode and SWF Blend Mode	<p>Choose the blending effect mode you wish to apply to your layer. The Blend Mode type will only be visible when the Camera view is set to Render  mode and will only export to a bitmap movie file or sequence of images.</p> <p>Both the Blending module and Composite-Generic module have regular blending modes and legacy blending modes. The regular blending modes will take the source images and unmultiply them before blending the two inputs together. The images will be remultiplied when being output from the module. The legacy blending modes use the pre-multiplied source images as is in order to apply the effect. Unmultiplying the images before processing them will give a final result closer to what can be found in software such as Adobe Photoshop.</p> <ul style="list-style-type: none"> • Normal: The layer attached to the effect acts as a normal layer and will not create any blending mode effect. • Multiply: This operation multiplies the blending element colour with the output image. This will darken the colour of the

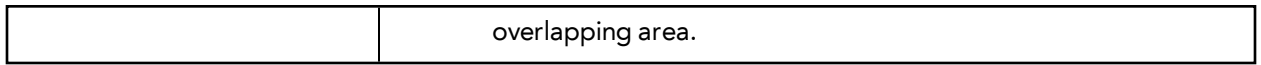

	<ul style="list-style-type: none"> • Screen: This operation multiplies the inverted colour of the blending element with the image. This will lighten the colour of the overlapping area.
	<ul style="list-style-type: none"> • Lighten (Lighten Legacy): This operation lightens the area of the output image which, is darker than the blending element's colours. The lighter colours will remain unchanged.
	<ul style="list-style-type: none"> • Darken: This operation darkens the area of the output image, which is lighter than the blending element's colours. The darker colours will remain unchanged.
	<ul style="list-style-type: none"> • Difference (Difference Legacy): This operation subtracts the blending elements colour from the output image colours or vice-versa, depending on which of them has more bright colours. The final result will be colours that are more vibrant.
	<ul style="list-style-type: none"> • Add (Add Legacy): This operation lightens the output image using the blending element.
	<ul style="list-style-type: none"> • Subtract (Subtract Legacy): This operation darkens the output image using the blending element.
	<ul style="list-style-type: none"> • Invert: This operation inverts the output image colours on the area overlapping the blending layer colours.
	<ul style="list-style-type: none"> • Overlay (Overlay Legacy): This operation multiplies or screens the colours from the blending image, with those of the output image, depending on the base colour. Colours from the blending element overlay the colours of the drawing elements, while preserving the highlights and shadows of the base colour. The base colour is not replaced, but mixed with the blend colour to reflect the lightness, or darkness, of the original colour.
	<ul style="list-style-type: none"> • Hardlight(Hardlight Legacy): This operation multiplies, or screens, the colours of the blending layer with those of the output image, depending on the blend colour. If the blend colour is lighter than 50% grey, the image is lightened, as if it were screened. This is useful for adding highlights to an image. If the blend colour is darker than 50% grey, the image is darkened, as if it were multiplied. This is useful for adding shadows to an image. Painting with pure black or white results in pure black or white. Play with the Opacity value to create a subtler look.
	<ul style="list-style-type: none"> • Alpha: This operation will blend the alpha value of the blending layer with the output image. This effect is not available for SWF Blend Mode.
	<ul style="list-style-type: none"> • Erase: This operation produces a cutter effect using the blending element. This effect is not available for SWF Blend Mode.
	<ul style="list-style-type: none"> • Divide (Divide Legacy): This operation divides the output

	<p>image colour values by the blending layer colour values. The blending image colour values are inverted, creating a negative image. The negative image's colour values are then multiplied by the right image colour values. This effect is not available for SWF Blend Mode.</p>
	<ul style="list-style-type: none"> • Replace: This operation replaces the output image by the blending layer. This effect is not available for SWF Blend Mode.
	<ul style="list-style-type: none"> • Softlight: This operation darkens or lightens the colours in a soft and diffuse way, depending on the blend colour (image in left port). If the blend colour is lighter than 50% grey, the image is lightened. If the blend colour is darker than 50% grey, the image is darkened. Painting with pure black or white produces a distinctly darker or lighter area, but does not result in pure black or white.
	<ul style="list-style-type: none"> • Linear Light: This operation burns or dodges the colours by decreasing or increasing the brightness depending on the colour of the underlying colour. If the blend colour is lighter than 50% grey, the colour is lightened because the brightness is increased. If the blend colour is darker than 50% grey, the colour is darkened because the brightness is decreased.
	<ul style="list-style-type: none"> • Pin Light: This operation will replace the colours, depending on the underlying colour . If the blend colour is lighter than 50% grey, pixels darker than the underlying colour are replaced, and pixels lighter than the underlying colour do not change. If the blend colour is darker than 50% grey, pixels lighter than the underlying colour are replaced, and pixels darker than the underlying colour do not change.
	<ul style="list-style-type: none"> • Vivid Light: This operation burns or dodges the colours by decreasing or increasing the brightness depending on the colour of the underlying colour. If the colour is lighter than 50% grey, the blend colour is lightened because the contrast is decreased. If the colour is darker than 50% grey, the blend colour is darkened because the contrast is increased.
	<ul style="list-style-type: none"> • Exclusion: This operation produces a similar result to the Difference mode, but with a lower contrast.
	<ul style="list-style-type: none"> • Dodge: This operation will lighten the colour.
	<ul style="list-style-type: none"> • Burn: This operation will darken the colour.
	<ul style="list-style-type: none"> • Hue: This operation will result in a colour that will take the luminosity and saturation of the underlying colour, and the hue of the source colour.
	<ul style="list-style-type: none"> • Saturation: This operation will result in a colour that will have the same luminosity and hue of the underlying colour, and the saturation of the source colour.

	<ul style="list-style-type: none">• Colour: This operation will result in a colour that will have the luminosity of the underlying colour, and the hue and saturation of the source colour.
	<ul style="list-style-type: none">• Luminosity: This operation will result in a colour which has the hue and saturation of the underlying colour, and the luminosity of the source colour. This mode is opposite to the Colour mode.

It is possible to select two different blending modes in the same Blending effect layer, in the event that you want to export your project to both a Bitmap and an SWF movie file with different results.

Blur - Box

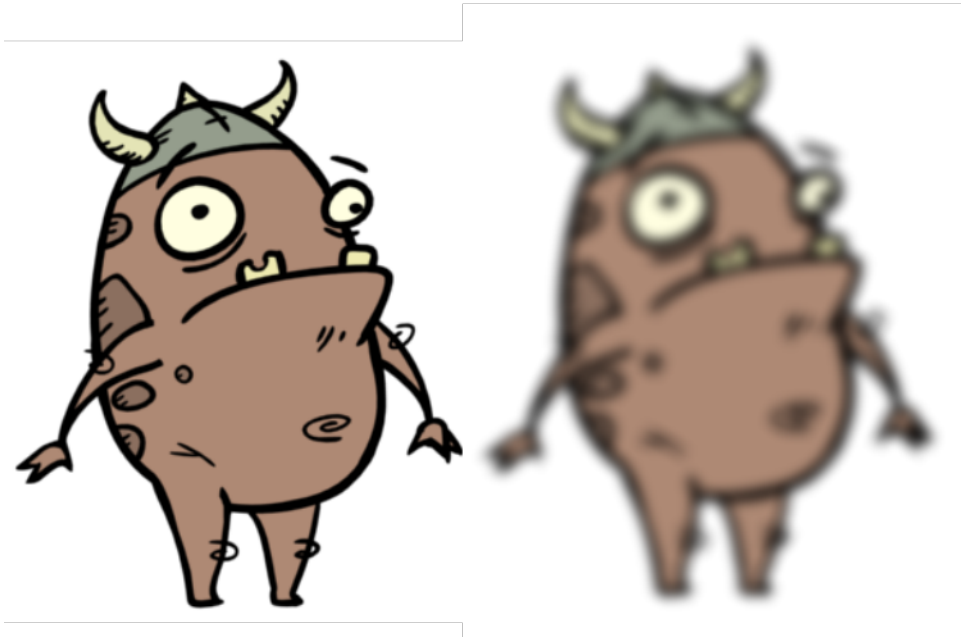

The Blur - Box effect is a quick and easy way to create a blurring effect. The Box blur changes the colour value of each pixel based on the pixels next to it in the vertical and horizontal directions. The look of the blur is similar to the look achieved using Gaussian blur, but renders much faster. This effect is useful when a faster rendering time is important, and the quality of the blur is less important. Also, you can use a matte with this effect to isolate areas of the image.

For detailed video tutorials and sample scenes by Adam Phillips, see toonboom.com/resources/video-tutorials/chapter/adam-phillips-harmony-effects.

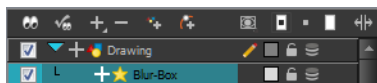
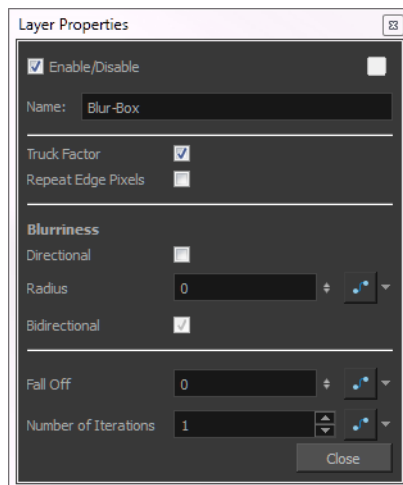

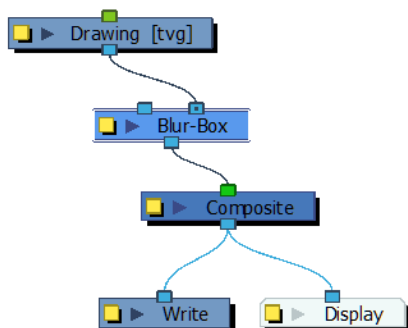

Blur - Box Effect Properties

Parameter	Description
Truck Factor	Activated by default, this option readjusts the blur when the elements undergo a change of depth or scale. When this option is deselected, the effect's values remain unchanged regardless of any depth or scale changes. This option should be deselected when multiple drawings are composited and attached to this effect.
Repeat Edge Pixels	Makes the blur algorithm operate as if the pixel values beyond the edge of the layer are the same as the values of the edge pixels. This keeps edges sharp, preventing them from darkening and becoming more transparent.
Blurriness	Amount of blur applied to the layer.
Directional	<p>Blurs according to the length, width, and angle you specify. For example, if a character is walking east, the blur may fall to the west.</p> <p>Length: Length of the blur.</p> <p>Width: Thickness of the blur.</p> <p>Angle: The direction in which the blur is applied: sideways, up, down, 90 degrees, 45 degrees, and so on.</p>
Radius	Size of the blur. The larger the value, the greater the strength or reach of the blur. The blur radius is affected by the drawing scale and camera position. Click the Edit Curve button to change these values over time by adjusting the function curve.
Bidirectional	Applies the blur on both sides of the pixel.
Fall Off	The distance where the blur fades from the edge of the image. Select a value between 0 and 1. A fall-off rate of 0 causes the blur to fade out slowly, distributing the blur evenly from the edge of the character to the farthest edge of the blur. A fall-off rate of 1 causes the blur to fade out quickly, so the blur is heaviest closer to the edge of the image.
Number of Iterations	The number of times the blur is applied to the image. A higher number of iterations creates smoother transitions between colours and increases the blur, but also increases render time.

Blur-Directional



The Blur-Directional effect creates the effect of a motion blur that pulls and smears the image from one contour edge to a different direction or angle. This effect is useful in creating the impression of speed, such as the streaks of colour that follow a car travelling at high speed.

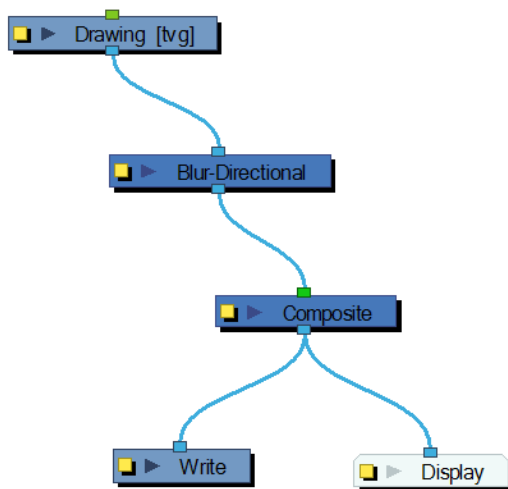
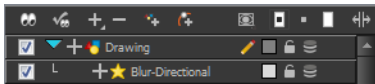

Use the Blur-Directional editor to control the settings of the Blur-Directional effect.

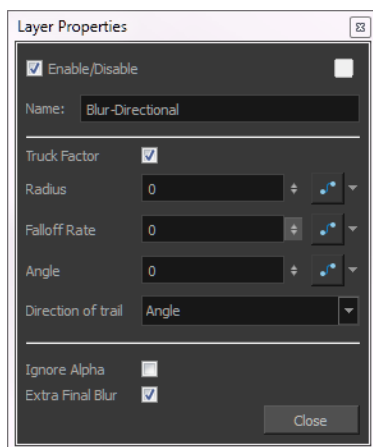

Blur-Directional Property Editor

Parameter	Description
Truck Factor	Activated by default, this option readjusts the blur when the elements undergo a change of depth or scale. When this option is deselected, the effect's values remain unchanged regardless of any depth or scale changes. This option should be deselected when multiple drawings are composited and attached to this effect.
Radius	Size of the blur. The larger the value, the greater the strength or reach of the blur. The blur radius is affected by the drawing scale and camera position. Click the Edit Curve button to change these values over time by adjusting the function curve.
Falloff Rate	The distance where the blur fades from the edge of the image. Select a value between 0 and 1. A fall-off rate of 0 causes the blur to fade out slowly, distributing the blur evenly from the edge of the character to the farthest edge of the blur. A fall-off rate of 1 causes the blur to fade out quickly, so the blur is heaviest closer to the edge of the image.
Angle	The direction of the blur. Enter a value from 0 to 360. 0: Blurs the image to the west. 90: Blurs the image to the south. 180: Blurs the image to the east. 270: Blurs the image to the north.
Direction of trail	If you do not set an Angle for the direction of the blur, you can select a direction (north, south, east, or west) from this menu. The calculations for this feature are faster than the calculations for the Angle setting.
Ignore Alpha	Controls the leading edge of the blur. Deselect this option for a solid or hard leading edge on the blur.
Extra Final Blur	Adds a second blur after the Blur-Directional is created. If you have a Blur-Directional that begins at 0 and gradually gets stronger, deselect this option to ensure a smooth progression.
Number of Iterations	The number of times the blur is applied to the image. A higher number of

	iterations creates smoother transitions between colours and increases the blur, but also increases render time.
--	---

Blur - Gaussian

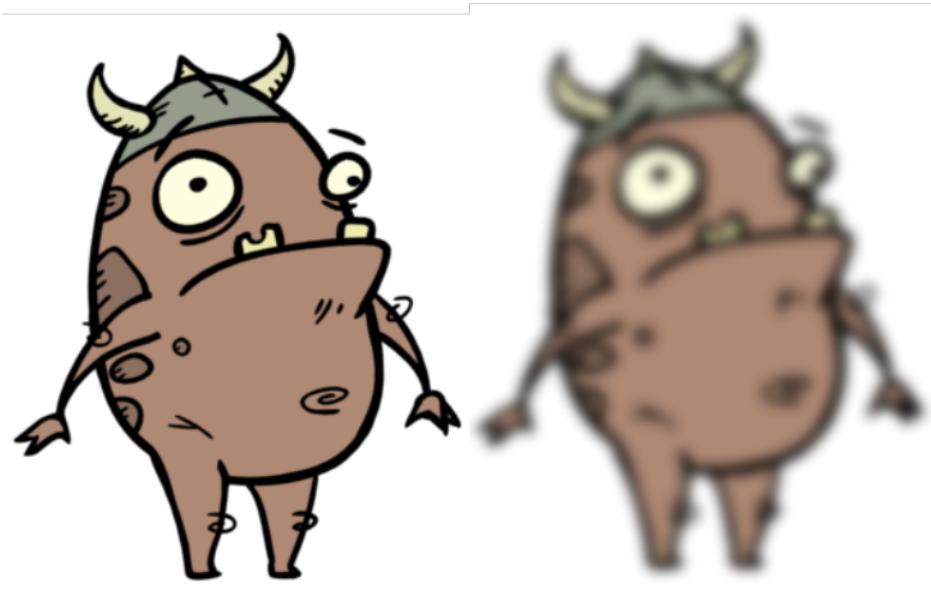

The Blur - Gaussian effect softens the image, reducing the amount of noise and detail. The look of the Gaussian blur is smooth, but does take some rendering time. This effect is useful when rendering time is less important, and quality is more important. Also, you can use a matte with this effect to isolate areas of the image.

For detailed video tutorials and sample scenes by Adam Phillips, see toonboom.com/resources/video-tutorials/chapter/adam-phillips-harmony-effects.

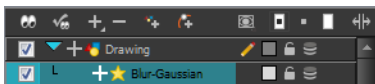
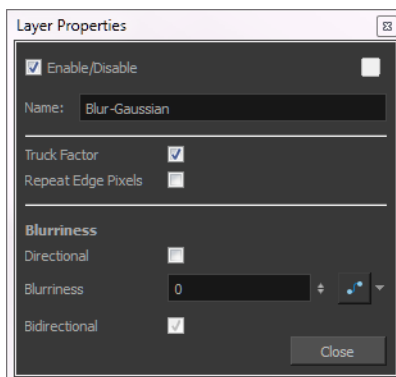

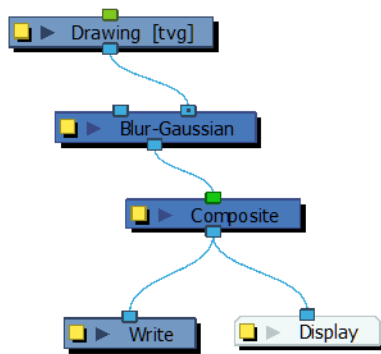

Blur - Gaussian Effect Properties

Parameter	Description
Truck Factor	Activated by default, this option readjusts the blur when the elements undergo a change of depth or scale. When this option is deselected, the effect's values remain unchanged regardless of any depth or scale changes. This option should be deselected when multiple drawings are composited and attached to this effect.
Repeat Edge Pixels	Makes the blur algorithm operate as if the pixel values beyond the edge of the layer are the same as the values of the edge pixels. This keeps edges sharp, preventing them from darkening and becoming more transparent.
Blurriness	Amount of blur applied to the layer.
Directional	Blurs according to the length, width, and angle you specify. For example, if a character is walking east, the blur may fall to the west. Length: Length of the blur. Width: Thickness of the blur. Angle: The direction in which the blur is applied: sideways, up, down, 90 degrees, 45 degrees, and so on.
Blurriness	Amount of blur applied to the layer.
Bidirectional	Applies the blur on both sides of the pixel.

Blur - Radial

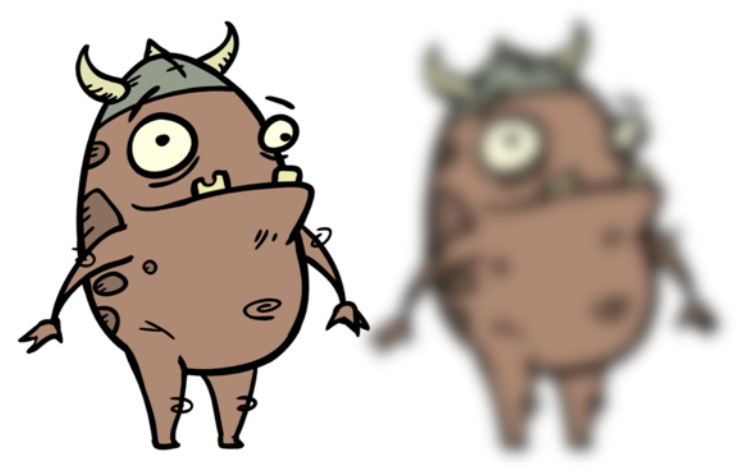

The Blur-Radial effect creates an effect that softens, fogs or obscures the image evenly in all directions. This effect is useful when you want to make cloudy images not realistically seen in detail, such as a drawing object that is farther back or in the background of your scene, usually blurry due to the laws of atmospheric perspective. Other uses include the general softening of objects such as snow, stars and shadows that do not naturally have a hard outline.

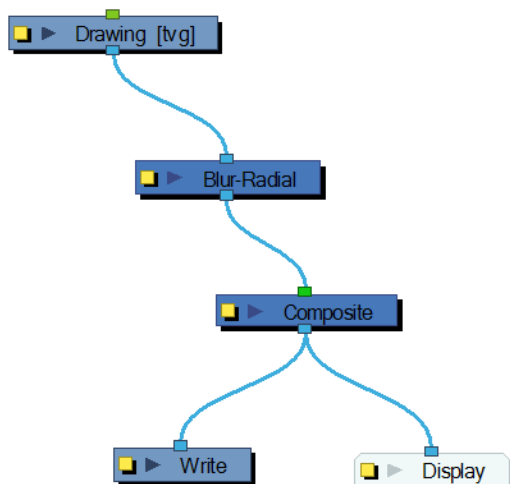
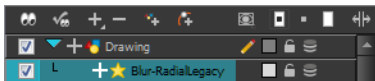

Use the Blur-Radial editor to change the values of the Blur effect.

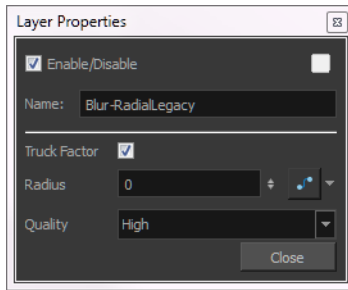

Blur-Radial Properties

Parameter	Description
Truck Factor	Activated by default, this option readjusts the blur when the elements undergo a change of depth or scale. When this option is deselected, the effect's values remain unchanged regardless of any depth or scale changes. This option should be deselected when multiple drawings are composited and attached to this effect.
Radius	Size of the blur. The larger the value, the greater the strength or reach of the blur. The blur radius is affected by the drawing scale and camera position. Click the Edit Curve button to change these values over time by adjusting the function curve.
Quality	Select High for a slow and accurate operation or Low for a faster operation with a more raw look.

Blur - Radial Zoom

The Blur - Radial Zoom effect creates blurs around a centre point, simulating the look of a zooming or rotating camera. You can use a matte to isolate the area of the image from which you want the effect to radiate from. For example, in the illustration below, a circular matte was created to mask the eyeball and a Negate effect was applied so the blur is outside the matte. Then the centre point was positioned on the character's iris, which is the centre of the matte.

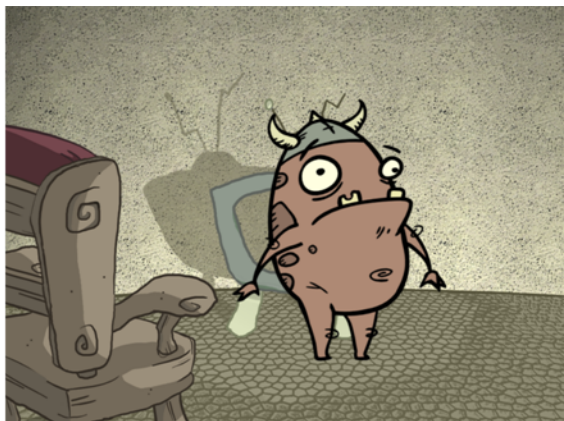

Original image



Image with Radial Zoom blur radiating from a centre point.

For detailed video tutorials and sample scenes by Adam Phillips, see toonboom.com/resources/video-tutorials/chapter/adam-phillips-harmony-effects.

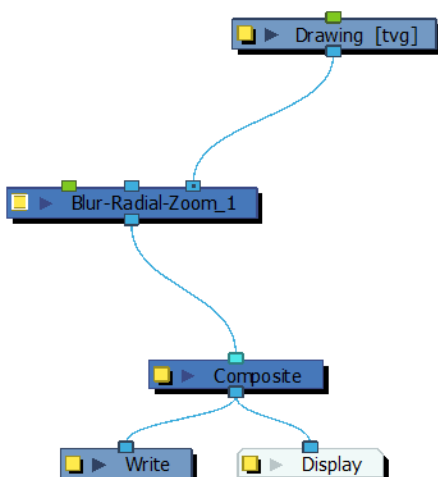

How to use the Blur Radial Zoom

1. In the Camera view, enable the Render mode.
2. From the Module Library view, drag a Blur Radial Zoom module to the Network view.
3. Connect your drawing to the Blur Radial Zoom's right port.
4. Connect the Blur Radial Zoom module to the Composite module.

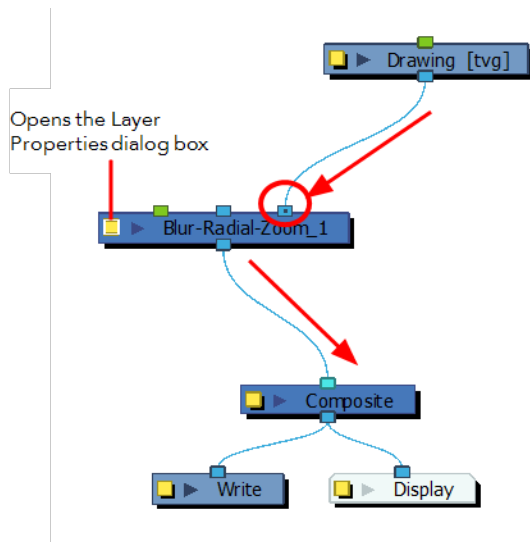

5. Click on the Blur Radial Zoom edit button (yellow square) to open the properties panel.
6. In the Layer Properties dialog box, increase the Blurriness value.

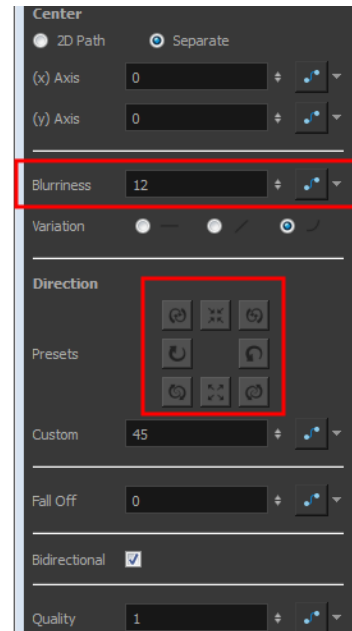

7. In the Direction section, click on any of the direction presets to modify the blur spin or zoom.

How to create a radial-zoom blur around an isolated area

1. Connect a drawing and a background image to a **Composte** module.
2. Connect the Composte module to the **Blur-Radial Zoom** module.

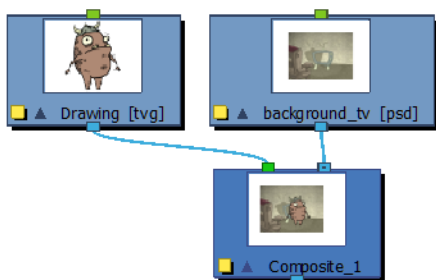

3. Connect a **Blur-Radial-Zoom** module to the Composite module and add the **Write** and **Display** modules.

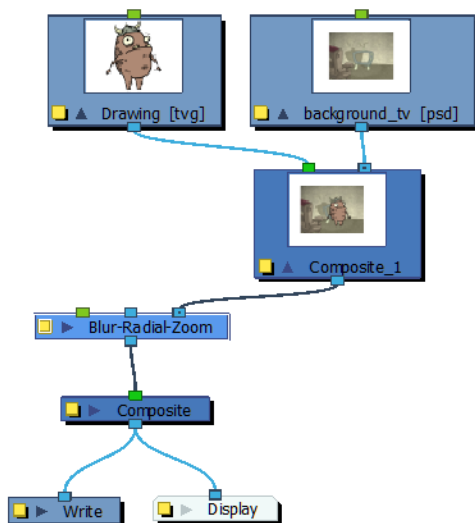

4. Now you will need to create a matte to isolate an area of the image. In the Timeline view, click the Add Layers **+** button and select **Drawing**. Give the layer a name, such as **Mask**.
5. In the Drawing view, draw a filled shape.
6. The blur should radiate outward from the mask. To do this, connect a **Negate** module to the mask. In the Negate properties, select the **Negate Colour** and **Negate Alpha** options. Deselect the **Negate Colour Clamp to Alpha** option.

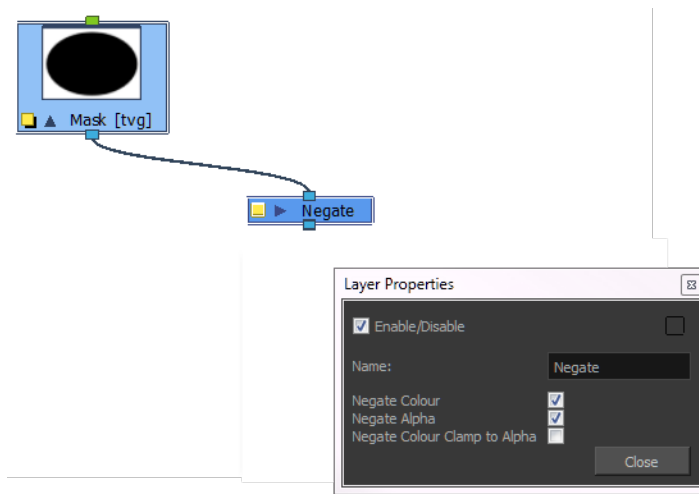

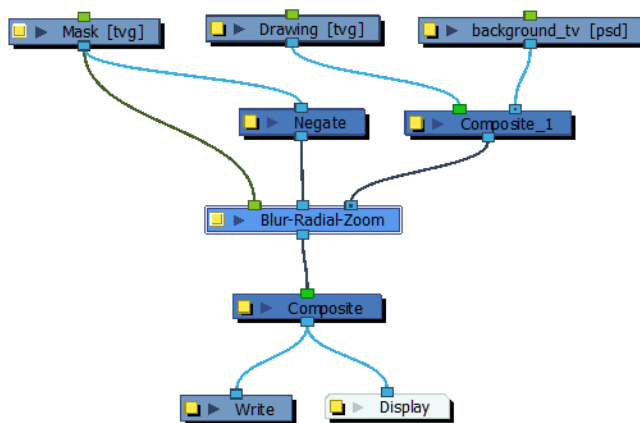

7. Connect these modules to the rest of the tree. Your Network view should look like this:

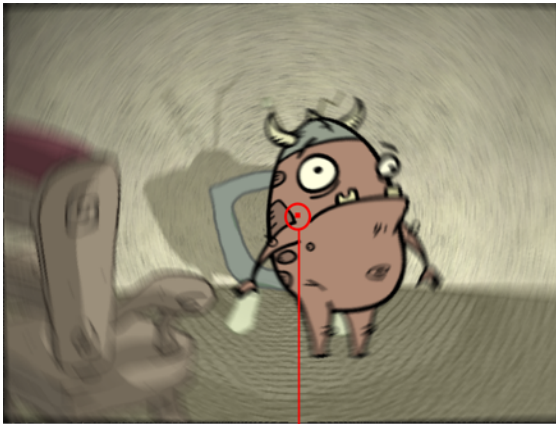

8. Open the Blur - Radial Zoom property editor.
9. From the Center section, select one of the following options:
 - **2D Path:** Lets you move the centre point visually in the Camera view.
 - **Separate:** Lets you control the x and y axis by entering values in the fields or by moving the centre point in the Camera view.
10. Set a value for the Blurriness.
11. With the Blur - Radial Zoom module selected in the Network view, select **View > Show > Control** or press Shift + F11.
A red centre point appears in the centre of the Camera view.



Centre point

12. In the Tools toolbar, select the Transform  tool.
13. Click the Animate Mode  button in the Tools toolbar if you want to create function curves to keyframe over time. Otherwise, values will be created for the duration of the scene.
14. Move the centre point to the desired position. In our example, the centre was moved to the centre of the mask.
15. In the Network view, select the mask you created.
16. In the Camera view, move the mask to the desired position.
17. Continue to adjust the blur values until you achieve the desired effect.

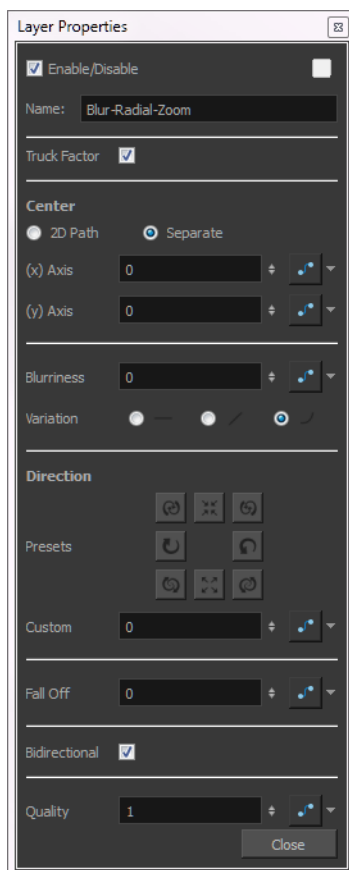

Blur - Radial Zoom Effect Properties

Parameter	Description
Truck Factor	Activated by default, this option readjusts the blur when the elements undergo a change of depth or scale. When this option is deselected, the effect's values remain unchanged regardless of any depth or scale changes. This option should be deselected when multiple drawings are composited and attached to this effect.
Centre	Sets the point where the blur will appear to be "zooming" out from. By default, the centre appears in the middle of the Camera view.
Type	<p>2D Path: Lets you move the centre point visually in the Camera view.</p> <p>Separate: Lets you control the x and y axis by entering values in the fields or by moving the centre point visually in the Camera view.</p>
(x) and (y) Axis	When the Separate type of centre is selected, lets you individually set the x and y coordinates for the centre.
Path	When 2D Path is selected, indicates that the coordinates are confined to the image.
Blurriness	Amount of blur applied to the layer.
Variation	<p>Constant: An equal, constant blur is applied on all pixels.</p> <p>Linear: A gradual blur is applied on all pixels.</p> <p>Quadratic: An exponential blur is applied on all pixels.</p>
Direction	Lets you select preset blur types or create a custom blur.
Presets	A set of preset radial, zoom, and spiral blurs to get you started. You can then adjust the type to customize the blur.
Custom	Create your own blur by entering a value for the direction of the blur lines.
Fall Off	The distance where the blur fades from the edge of the image. Select a value between 0 and 1. A fall-off rate of 0 causes the blur to fade out slowly, distributing the blur evenly from the edge of the character to the farthest edge of the blur. A fall-off rate of 1 causes the blur to fade out quickly, so the blur is heaviest closer to the edge of the image.
Bidirectional	Applies the blur on both sides of the pixel.
Angle Quality	Affects the quality of the blur by defining how fine the reference radial grid is on the image. This determines the width of all the wedges. A higher quality yields achieve better results, but will be slower to render.
Radius Quality	Controls the quality of the blur. A higher quality yields better results, but will be slower to render.

Brightness and Contrast

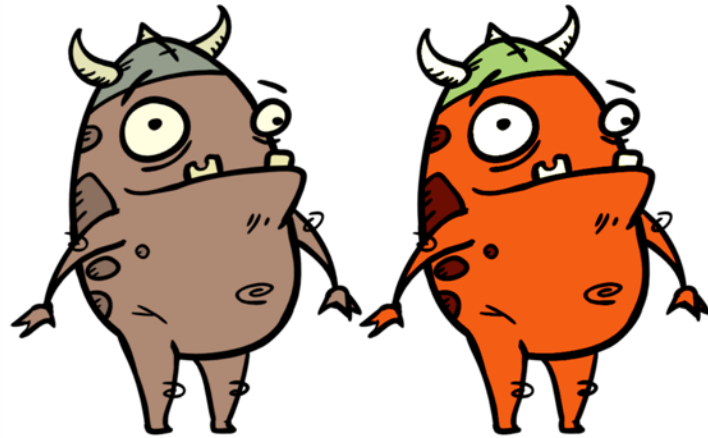

The Brightness and Contrast effect is used to modify the brilliance or dullness of an image or to create a greater difference between the lights and darks of an image by increasing their respective intensities. This effect can be used when an image appears too flat. Increasing the brightness or contrast can give a drawing a more attractive and 3D quality. This can be useful if you want to push your background to the rear by making it look dull and flat and pulling your foreground elements to the front by giving them a higher contrast.

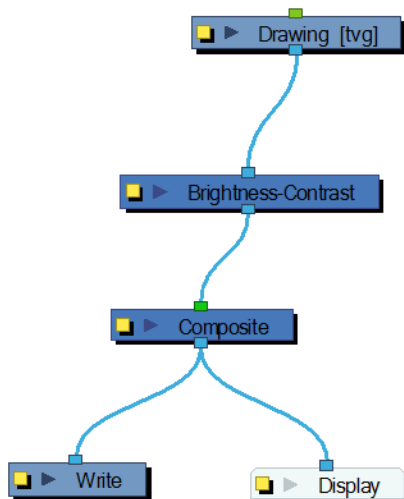
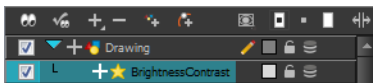

Use the Brightness and Contrast editor to change the values of the Brightness and Contrast effect.

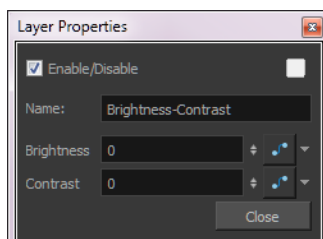

Brightness and Contrast Effect Properties

Brightness	A value that is less than 0 will darken the image; a value greater than 0 will brighten it. Attach a Bezier or Ease function to change the brightness over time.
Contrast	A value that is less than 0 will reduce contrast; a value greater than 0 will increase contrast. Attach a Bezier or Ease function to change the contrast over time.

Blur-Variable

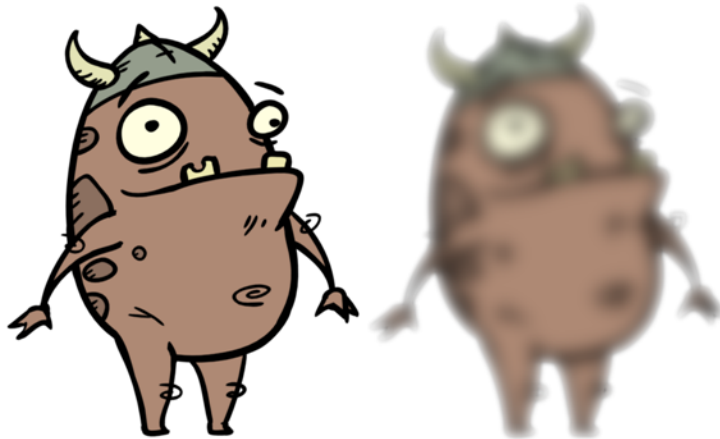

Use the Blur-Variable effect to create a radial blur that varies within a single image based on the white and black values in the matte you supply. You can set one blur value for the black regions in the matte, and another blur value for the white regions. The blur value for each grey region is interpolated between your black and white blur settings.

The following example is a network for a Variable Blur effect. A black and white copy of the character was used to create the effect. Use the Blur-Variable editor to control the blur value for the white and black radius.

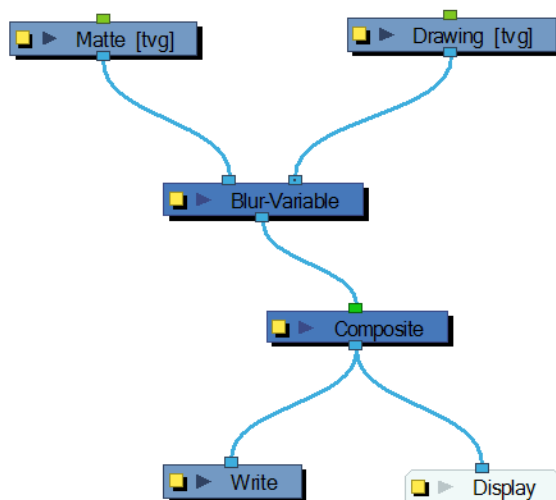

Blur Variable Effect Properties

Black radius	The amount of blur to apply to the black (transparent) values in the matte. Higher values create more blur in the colour image's regions that correspond to the black matte region.
White radius	The amount of blur to apply to the white (opaque) values in the matte. Higher values create more blur in the colour image's regions that correspond to the white matte region.
Quality	Select High for a slow and accurate operation or Low for a faster operation with a more raw look.
Keep inside source image	This option confines the blur to the source image.

Channel Selector



Use the Channel Selector effect to isolate one of the four colour channels of an image:



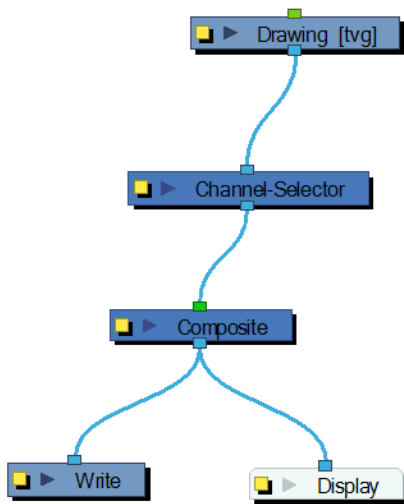

Use the Channel Selector editor to choose which channel to isolate.

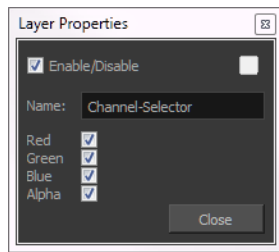

Channel Swap

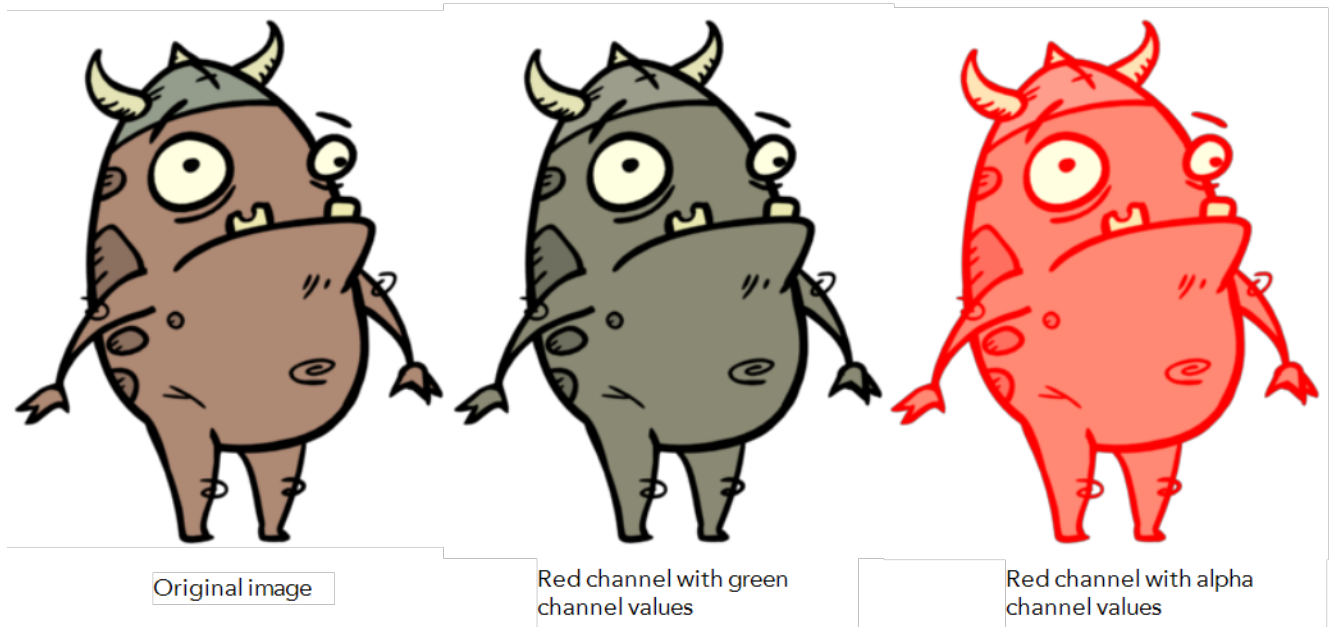

The Channel Swap effect lets you take the image information from one channel and use it in another channel to achieve interesting effects. You can extract the following: red, green, blue, alpha values, hue, saturation, lightness, and luminance, as well as turn the information on or off.

For detailed video tutorials and sample scenes by Adam Phillips, see toonboom.com/resources/video-tutorials/chapter/adam-phillips-harmony-effects.

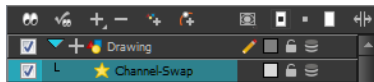
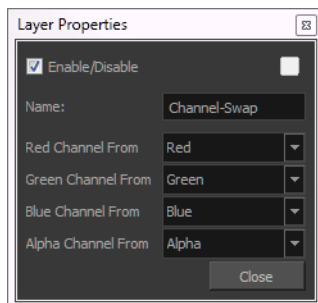

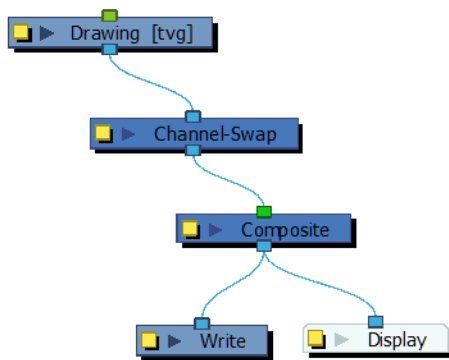

Channel Swap Effect Properties

Parameter	Description
Red, Green, Blue, and Alpha Channel From	Lets you select the image information you want to feed into the red, green, blue, and alpha channels. Full On sets all values to 255 and Full Off sets all values to 0.

Chroma-Keying



The Chroma-Keying effect lets you create an alpha channel (transparency zone) for your bitmap image or image sequence. For example, if you have a series of bitmap images with a character filmed on a green screen or blue screen, you can use this module to create an alpha channel based on the screen colour and cut it out from your image sequence.

The Chroma-Keying module **MUST** be connected to a bitmap image. The Chroma-Keying will create an alpha channel that can be seen in the Camera view in the Matte Render Mode. To cut the background colour from your image, you will need to use a Cutter module.

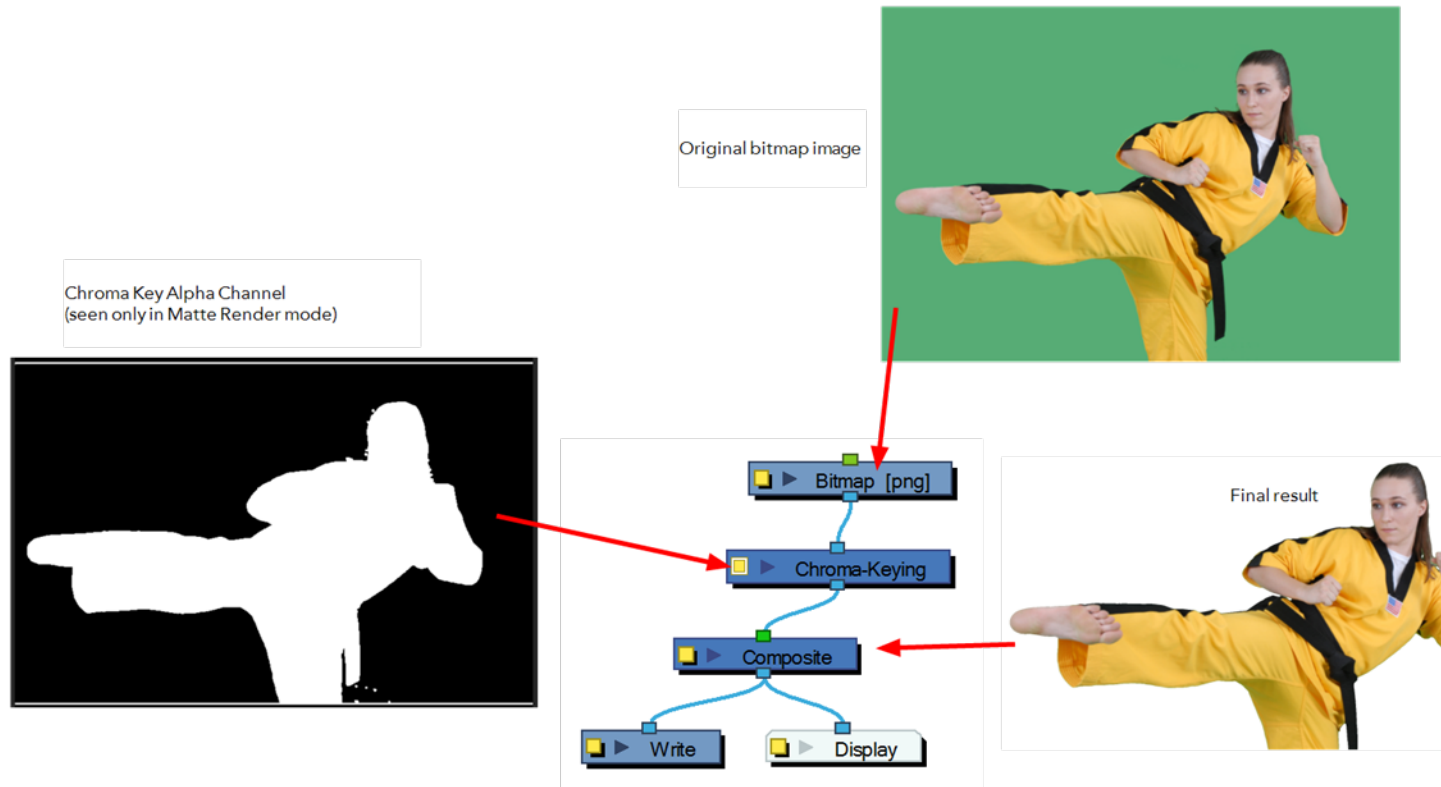

To obtain a better result than just extracting the raw colour, you can adjust some parameters such as the contour blurriness and the matte size. You can see all the options available in the Chroma-Keying Properties window.

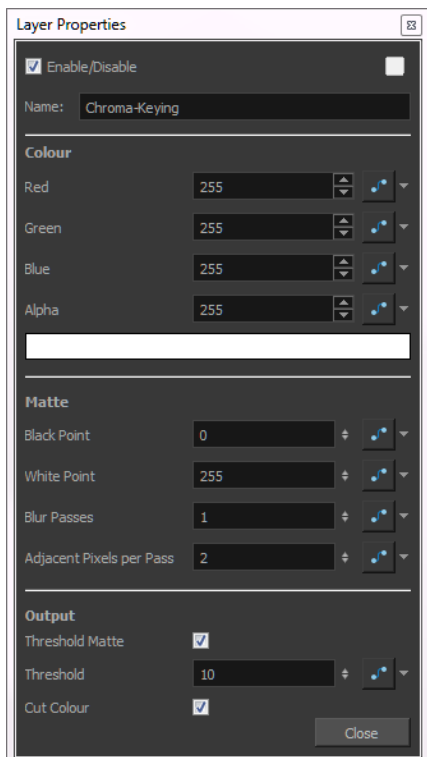

- Red/Green/Blue/Alpha:** In the Colour section, you can enter the RGB value for the colour to extract from your image. You can also click on the colour swatch to open the Colour Picker window and select a new window. To select the exact colour in your image, you can use the Eye Dropper found in the Colour Picker window and pick it directly in your image.

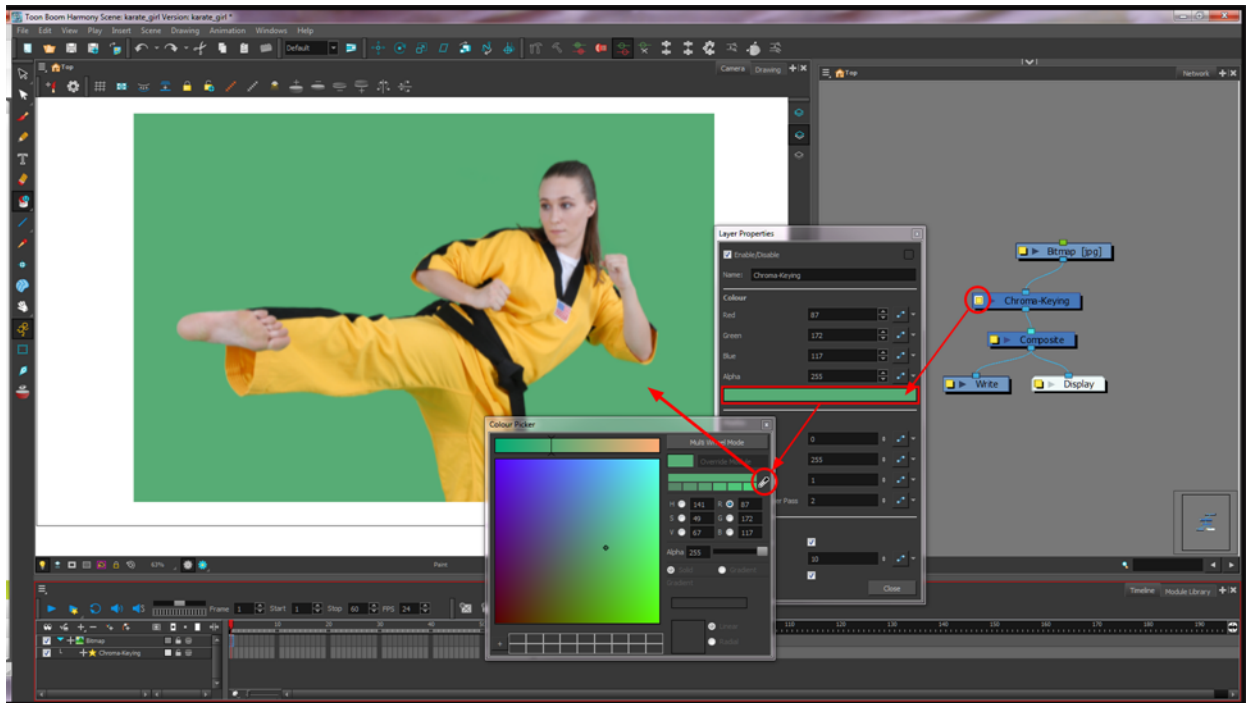

- Black Point:** The Black Point parameter will increase the transparent (black) portion of the Chroma Key matte. This means that it will reduce the edge of the visible image.



Black point: 0



Black point: 38

White Point: The White Point parameter will reduce the transparent (black) portion of the Chroma Key matte. This means that it will increase the edge of the



White point: 0



White point: 38

Blur Intensity: The Blur Intensity parameter will blur the overall edges to make them softer.



- **Adjacent Pixels Per Pass:** When blurring the matte edge's with the Blur Intensity parameter, the Adjacent Pixel parameter will blur the matte border with the next few pixels (amount indicated in the field) to create a nicer edge.



Adjacent Pixel: 0



Adjacent Pixel: 2

- **Threshold Matte:** This option will apply a threshold (tolerance) to the selected colour to be removed. The Threshold amount is set in the Threshold field.
- **Threshold:** The Threshold value will increase or decrease the tolerance for the selected colour to be removed from the image. The higher the value is the more coloured pixels will be considered in the Chroma-Keying matte. The pixel colour value will not have to be such a close RGB value to the one selected in the colour swatch. The lower the Threshold value, the closer RGB value the pixels will have to be to the selected colour to be part of the matte.



Threshold: 1



Threshold: 8

- **Cut Colour:** If this option is enabled, the selected colour will be removed from the image and will leave a transparent zone so that you can see the background and other layers behind the image. If the option is disabled, the colour will remain, but an Alpha channel is created that can be used with any other modules requesting a Matte input.

Colour-Art



Use the Colour-Art effect to isolate the Colour-Art in a layer. Placing a Colour-Art module after a drawing module in the Network view only displays the Colour-Art output. The Colour-Art module can

only be connected after a vector drawing layer or a vector type Composite module. Any bitmap information will not be processed.

This effect will only work if the user drew or painted something into the Colour-Art layer of the drawing.

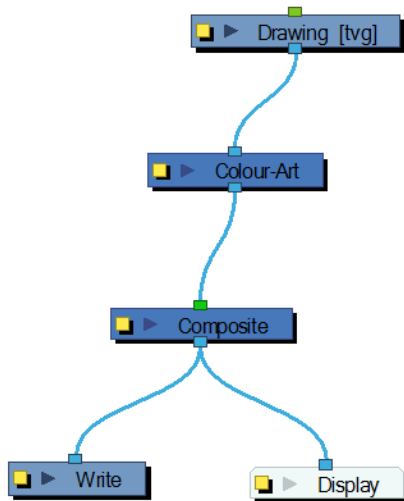

Use the Colour-Art editor to control how the module renders the Colour-Art.

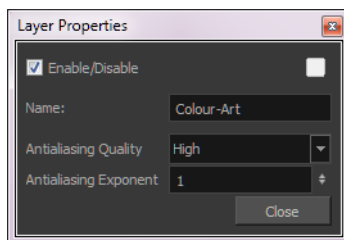

Colour-Art Effect Properties

Parameter	Description
Antialiasing Quality	Smoothness setting applied to Colour-Art. Choose from Low (no anti-aliasing), Medium Low, Medium and High (extensive anti-aliasing). The higher the setting, the greater the amount of anti-aliasing applied. Higher quality images require more time to render and more memory from your system. Use a lower quality when rendering a pencil test.
Antialiasing Exponent	Controls the extent of the area around the Colour-Art edges that is used in the anti-aliasing process. A higher value uses less area, resulting in sharper edges, while a lower value uses more area, resulting in softer edges. If the Antialiasing Quality value is set to Low (no anti-aliasing), this value is ignored.

Colour Banding

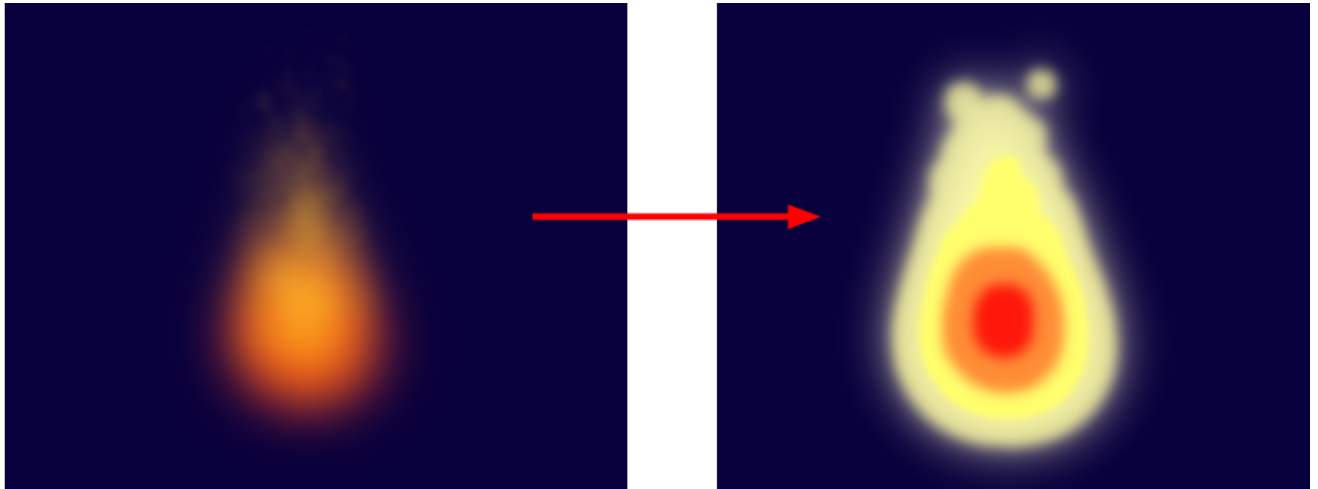

In this example, a Colour Banding module has been connected to a fire created with particle effects.

Use the Colour Banding effect to add a colour banding visual effect to your elements. The module will associate a flat colour to the different regions of your element. These regions are delimited according the alpha values that are set up in the effect module and which will be recognized on the original element. You can use this effect to change the visual style of a particle module, for example, by giving it a more cartoonish look.

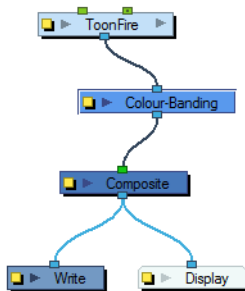

Use the **Colour Banding** layer properties dialog box to set up the colour banding effect.

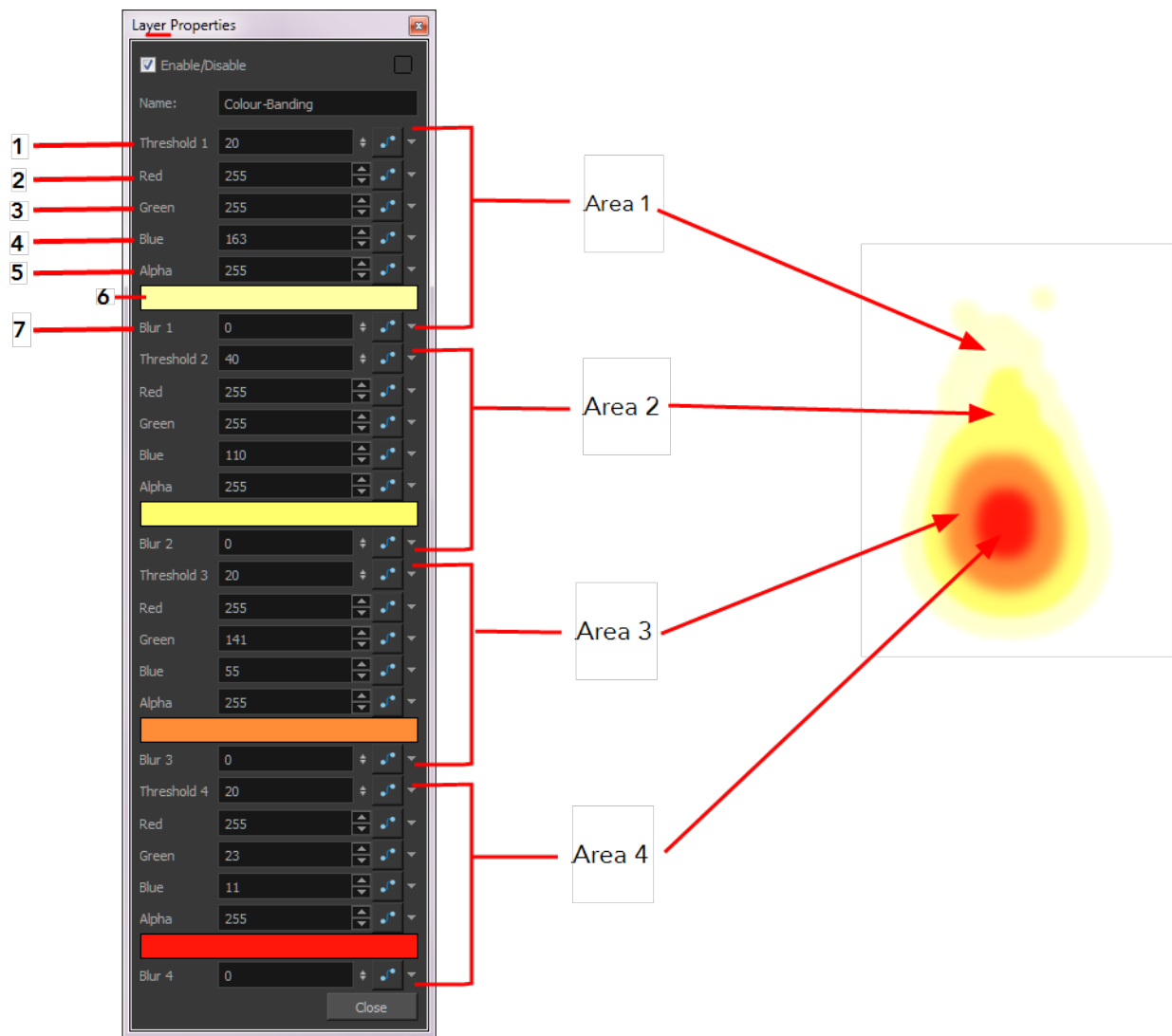

In the Colour Banding layer properties, you have four sections with which to set up the four different regions alpha and colour override values.

This is how the regions range are calculated.

- **Region1:** Threshold 1 to Threshold 2
 - **Region2:** Threshold 2 to Threshold 3
 - **Region3:** Threshold 3 to Threshold 4
 - **Region4:** Threshold 4 to 100% alpha
1. **Threshold 1:** Use this first threshold field to determine the first region outer limit. A value of 0 represent an alpha of 0 which is completely transparent. A value of 100 represents an alpha of 255 which is completely opaque. If for example, you enter a value of 5 for the first threshold, the region of your element which is within the range of alpha going from 5% to the Threshold 2 value, will be coloured with the Area 1 colour value.
 2. **Red:** Use this field to manually enter the value of red for the first region colour.
 3. **Green:** Use this field to manually enter the value of green for the first region colour.
 4. **Blue:** Use this field to manually enter the value of blue for the first region colour.

5. **Alpha:** Use this field to manually enter the transparency value for the first region colour.
6. **Colour:** Click in this colour space to open the Colour Picker dialog box and select a colour for the first region.
7. **Blur1:** Use this field to add a blur effect to the edge of the first region.

The three other sections will set up the regions two, three and four.

Colour-Card



The Colour Card is a solid background the same size as the camera. The Colour Card lets you fill the scene's background with a solid colour when there is no background image. If no background or colour card is added to the scene, the resulting export will appear with a black background.

By default, the Colour Card has a Z ordering value of **12 Backward**. This puts the Colour card behind all elements that have a value lower than **12 Backward**. Most of the time, the Colour card will appear automatically behind all the scene's elements as they are all set to **0 Backward**, unless you have changed the Z ordering of the scene components. If so, the Colour Card will be in front of the elements that are pushed back to more than 12 fields backward.

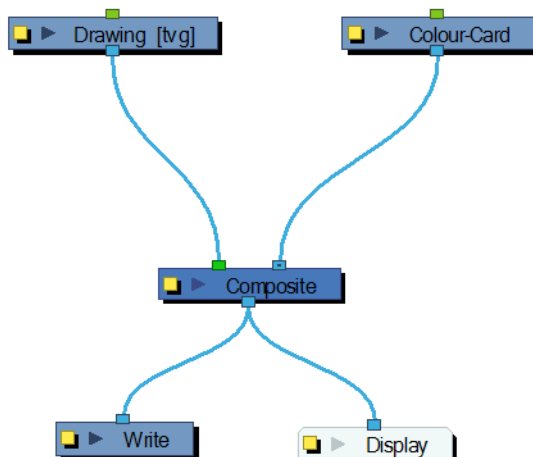

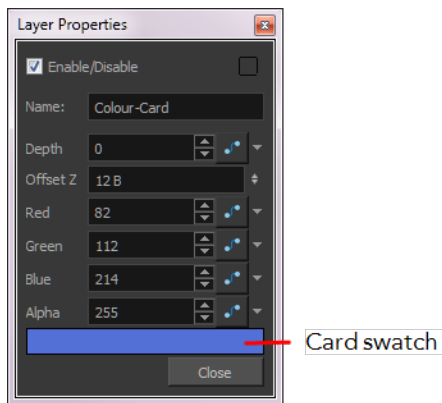

Colour Card Effect Properties

Parameter	Description
Depth	The value used to determine composition order when the Z value of two elements is the same.
Offset Z	The front-back position of the Colour Card layer in 3D space. This value can be verified in the Top view.
Red/Green/Blue/Alpha	The colour and transparency of the Colour Card. You can also attach these parameters to function columns to change their values over time. Click the colour swatch to open the Colour Picker window and select a colour.
Colour Swatch	Opens the Colour Picker where you can specify the colour.

Colour-Override

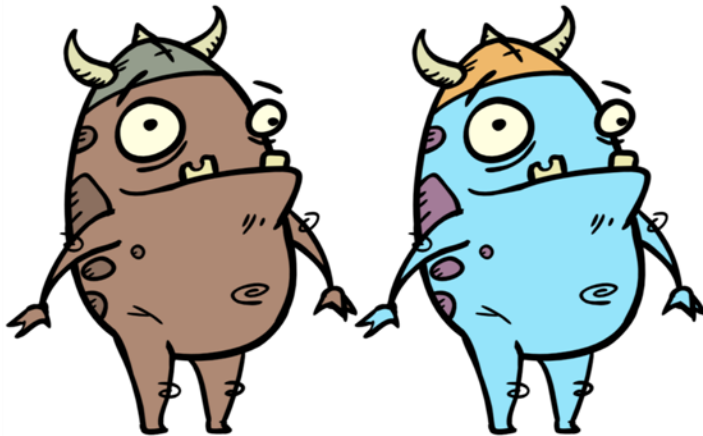

The Colour-Override processes the colours in a drawing layer. The drawings in this layer must be TVG files.

Using this effect you can change colours from the palette without affecting the actual palette, swap clone palettes, replace a specific colour zone with a bitmap texture or hide and display selected colours.

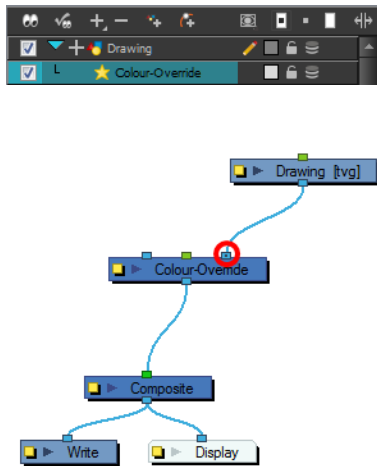

Use the Colour-Override effect to:

- Change colour values in drawings during the compositing process.
- Use colour values from a specific colour palette in the palette list.
- Establish the priority of override palettes in the palette list. For example, you may have different clones of the same palette, for example a daytime and nighttime version.
- Isolate specific areas of a drawing by selecting certain colours. For example, using specific colours to generate a matte for a glow effect.
- Hide certain colours.

Use the Colour-Override editor to set the colour override operations for TVG elements and their drawings.

Colour-Override Editor Interface

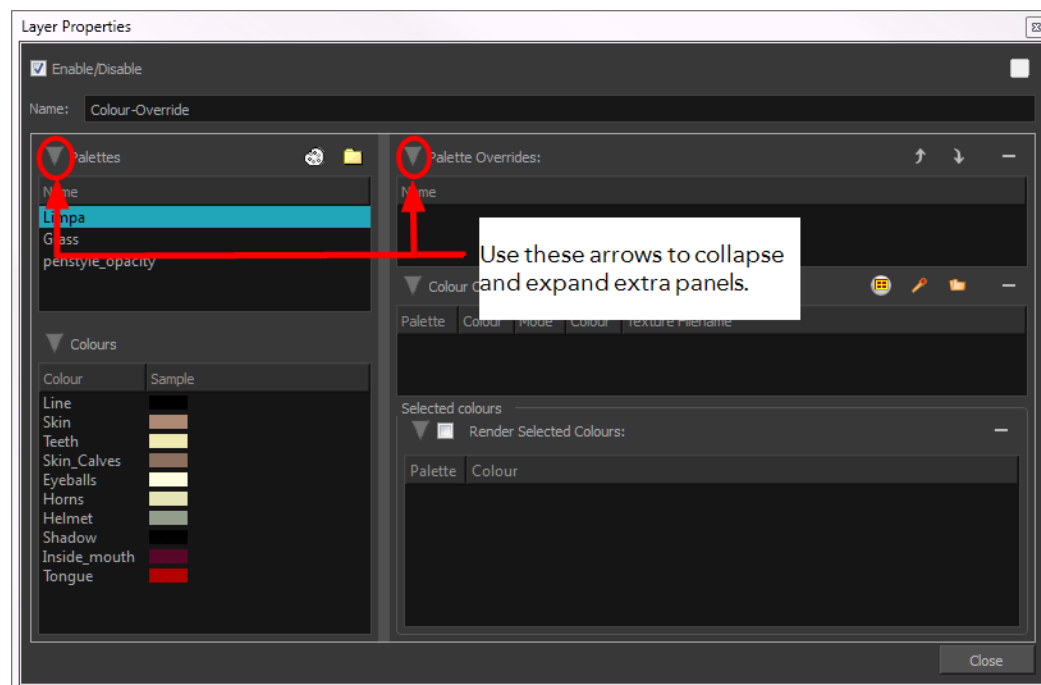

The Colour-Override editor interface is comprised of four sections:

- Palettes below
- Colours below
- Palette Overrides below
- Colour Overrides on the next page

Palettes

This section displays the palettes in the palette list of the selected layer. Drag these palettes into the Palette Overrides section to re-order them. You can load additional palettes in the palette list from either your project, by clicking on The Palette 🎨 button, or your computer by clicking on the Browse 📁 button.

- The Palette 🎨 button allows you to load a palette contained within the project hierarchy (Environment, Job, Scene and Elements).
- The Browse 📁 button allows you to load a palette located outside the project hierarchy, anywhere on your system or server.

Colours

This section displays the colours swatches of the selected palette. Drag a swatch into the Colour-Overrides section to change its value or drag it into the Selected Colours section to render only that colour.

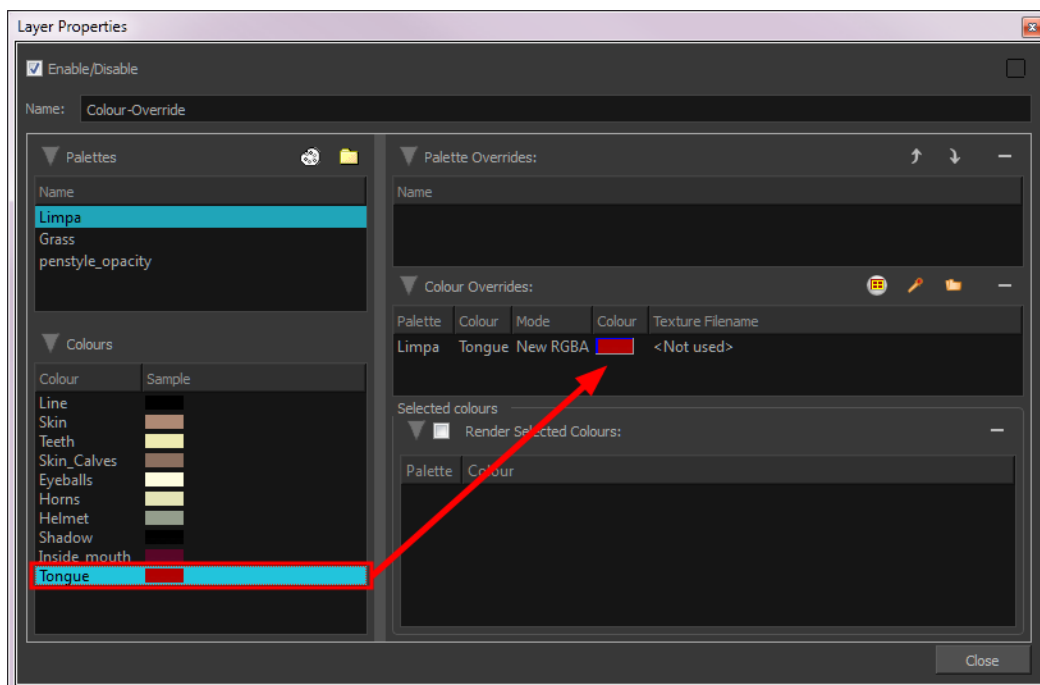

Palette Overrides

This section forces the use of a particular palette or palette list order, during the composition process. You must drag palettes from the Palettes section to change their order. Harmony searches the

palettes in the order that they appear in the palette list to find the colour values associated with the colour IDs of each image. To apply a different version of a colour palette, for example to switch from a day to a night palette, use the override section to change the order of colour palettes (you must be working with cloned palettes).

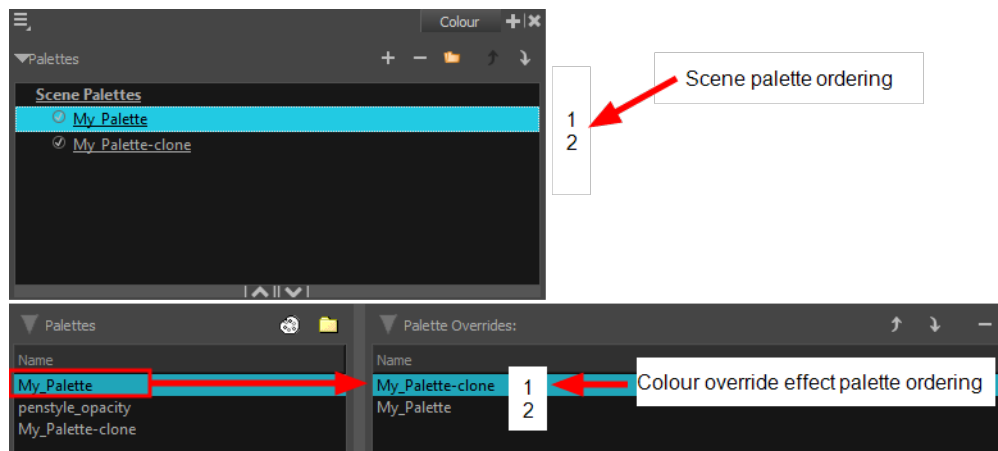

Colour Overrides

Drag a swatch from the Colours section to this section to override its value. You can also override a colour with a texture.

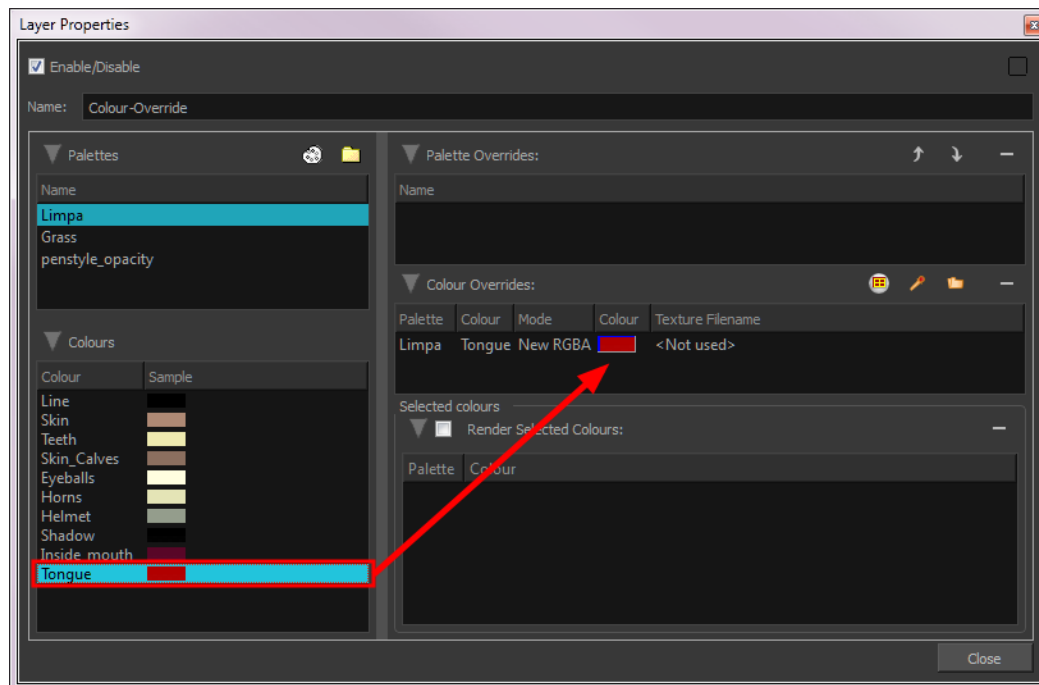

Overriding a Colour

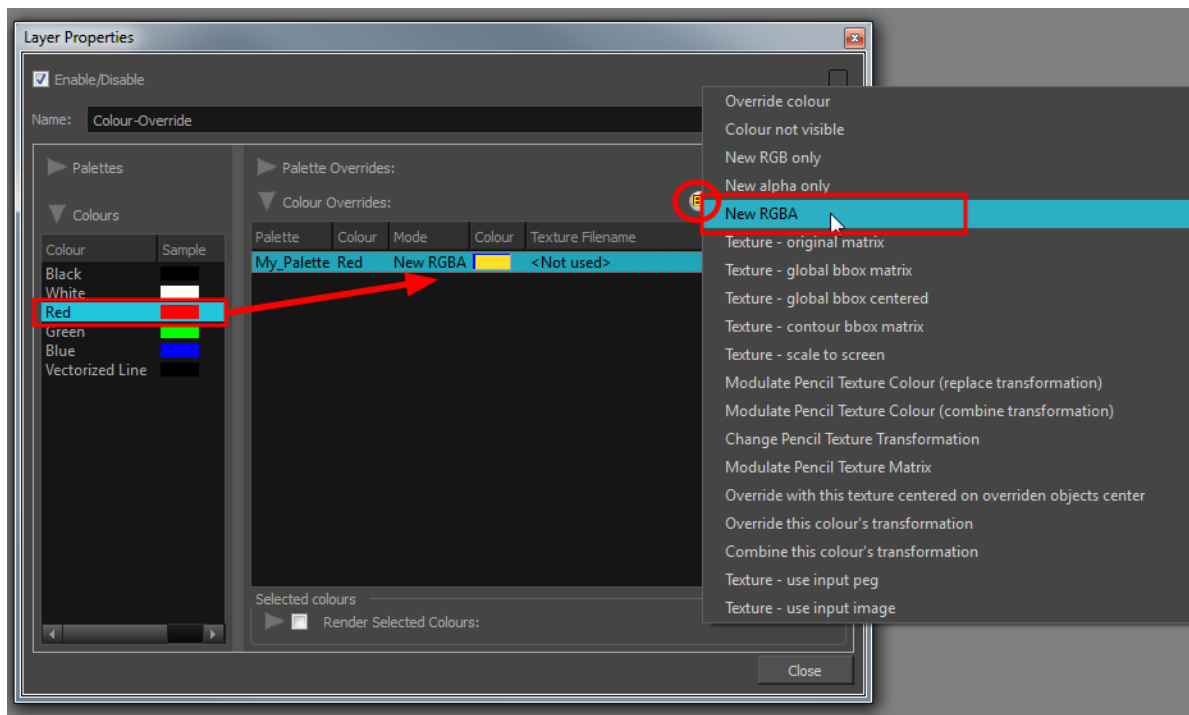

With the Colour-Override module, you can change the colour of some swatches. To do so, from the Colours section, you must drag the colour swatch to modify to the Colour-Overrides section.

Several options are available to modify your colours.



Once the swatch appears in the Colour-Overrides section, click on the Select Override Mode button to right-click on the Override Colour word and select one of the following option in the drop-down menu:



- **Colour not visible:** Renders the selected colour invisible in the Camera view.
- **New RGB only:** Overrides the colour swatch while maintaining its original alpha value. You can select a new colour by pressing the eye dropper  button or clicking directly on the colour swatch and choosing a new colour from the Colour Picker window.
- **New alpha only:** Overrides the swatch's alpha channel while maintaining its original RGB values. You can select a new alpha value by pressing the eye dropper  button or clicking directly on the colour swatch and choosing an alpha value from the Colour Picker window.
- **New RGBA:** Overrides the swatch's colour and alpha values. You can select a new colour by pressing the eye dropper  button or clicking directly on the colour swatch and choosing an alpha value from the Colour Picker window.

Overriding a Colour With a Texture

With the Colour Override module, can apply a texture over a selected colour. Any zone painted with the selected colour swatch will be overridden by the selected texture.

How to Apply a Texture Over a Colour

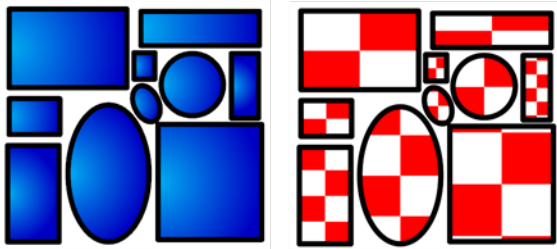

From the Colours section, select the colour swatch to override and drag it to the Colour Override section.

- Once the swatch appears in the Colour Override section, select it and then click on the Select Override Mode button to right-click on the Override Colour word and select one of the following option in the drop-down menu:



- Texture - Original Matrix
- Texture - Global Bbox Matrix
- Texture - Global Bbox Centered
- Texture - Contour Bbbox Matrix
- Texture - Scale to Screen
- Override With This Texture Centered on Overridden Objects Centre
- Texture - Use Input Peg

- In the Colour-Override section, under the Texture Filename section, click on "Not used".

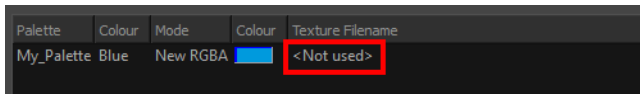

- Browse for your texture file.

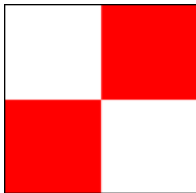

- Click on the Open button.

There are different ways to apply the texture over your colour:

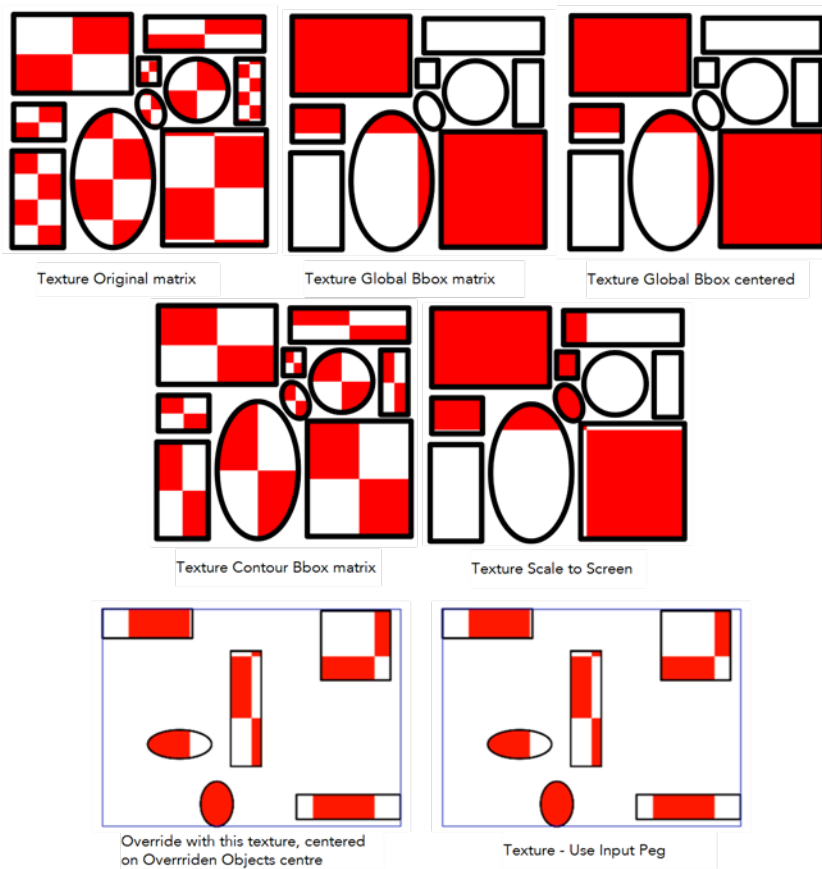

The result will only be visible in the Camera view while in Render mode. In OpenGL mode, you will see your original colour.

The matrix position can be modified using the Edit Gradient and Texture  tool. To do so, your drawing zone must be painted with a gradient swatch or texture swatch.

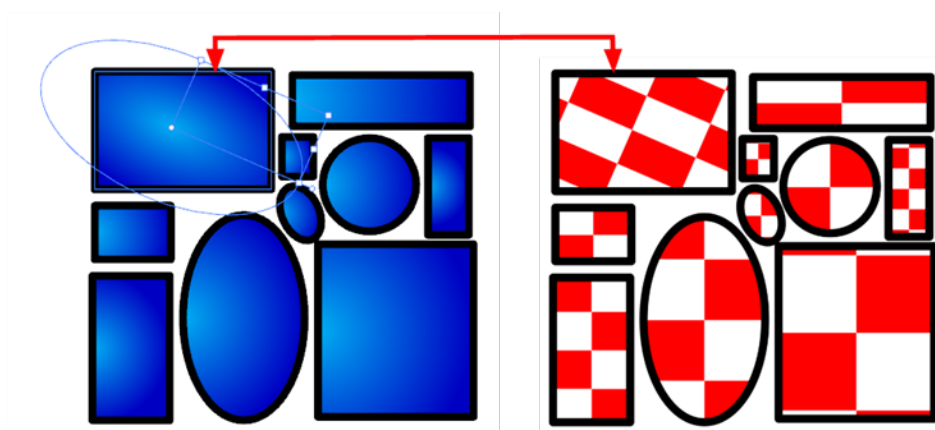

Texture - Original Matrix

Overrides the swatch's colour with a pattern or texture. You must right-click under the Texture header to bring up the Browser window to search for your texture. The texture's default matrix (fixed proportion and orientation) is mapped the full size of the bounding box of each colour area to be overridden.

Texture - Global Bbox Matrix

Overrides the colour with a texture that is scaled non-proportionally to the size of the bounding box encompassing the colour areas to be overridden. With multiple objects, it will look as though their fills were all traced and cut from the same piece of stretched or squashed fabric.

Texture - Global Bbox Centered

Overrides the colour with a texture that is scaled proportionally to the size of the bounding box encompassing all colour areas to be overridden. With multiple objects, it will look as though their fills were all traced and cut from the same piece of fabric.

Texture - Contour Bbox Matrix

Overrides the colour with a disproportionately scaled texture for each individual colour area. In other words, each fill area will not only have the texture scaled to its individual proportions, but also stretched or squashed to fit within its contours.

Texture - Scale to Screen

Disproportionately scales the texture to the output resolution before applying it as an override.

Override with this Texture Centered on Overridden Objects Centre

Overrides the colour with a texture that is centered in the bounding box encompassing all colour areas to be overridden. With multiple objects, it will look as though their fills were all traced and cut from the same piece of fabric. The texture will not be stretched or distorted. It will be tiled in proportion. The centre of the texture zone will be centered in the middle of the bounding box's centre.

With this option, you can connect a Peg in the middle port to apply a transformation on the texture's position. Refer to [How to Animate a Texture Override with a Peg below](#) to learn how.

Texture - Use Input Peg

Overrides the colour with a texture that is scaled non-proportionally to the size of the bounding box encompassing the colour areas to be overridden. With multiple objects, it will look as though their fills were all traced and cut from the same piece of stretched or squashed fabric.

With this option, you can connect a Peg in the middle port to apply a transformation on the texture's position. Refer to [How to Animate a Texture Override with a Peg below](#) to learn how.





How to Animate a Texture Override with a Peg

The advantage of being able to animate the texture is that it can be adjusted, scaled, rotated and

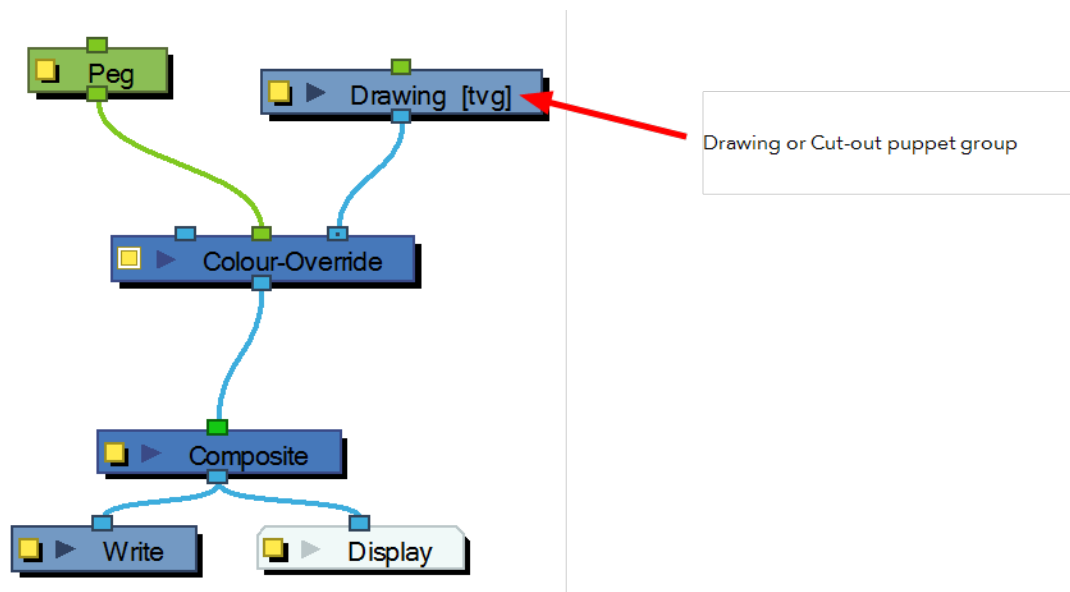
translated to follow the general motion of a character if you want the texture to follow instead of having the character moving across the fixed texture.

1. From the Module Library view, drag a Peg module and drop it in the Network view.



2. Connect the Peg module in the Colour Override's middle port. The green port will take the transformation of the Peg to modify the pencil texture's position.
3. In the Network view, select the Peg module.
4. In the Advanced Animation toolbar, select the Translate , Rotate  or Scale  tool.
5. In the Camera view bottom toolbar, enable the Render  mode.
6. In the Camera view, move the Peg's position. As you move it, you will see the texture getting modified. You can animate the position by adding position keyframes in the Timeline view. You can use the Random Fill function to quickly create a random shake.

Rendering Selected Colours Only

With the Colour-Override module, you can isolate some colours in your drawing and render those ones only.

How to Render Selected Colours

1. From the Colours section, drag the colour swatches to render and drop them into the Render Selected Colours section.

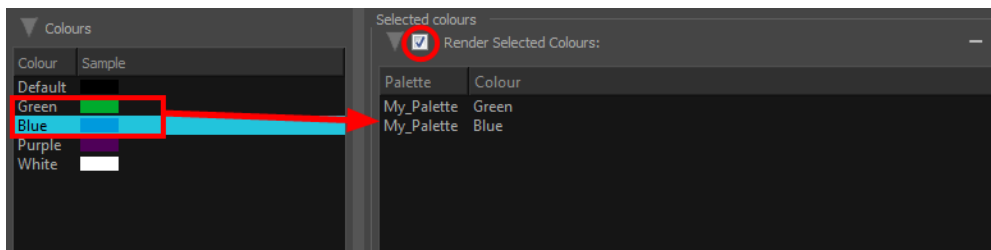

You have to enable the Render Selected Colours option for the module to proceed with the operation.

Modifying a Texture Fill's Transformation

When you paint a zone with a bitmap texture swatch, you might want to modify the size or position of the texture's matrix at the compositing level. Maybe for an effect purpose you need to animate the position of the texture in a zone. With the Colour-Override module and a Peg, you can animate the texture.

How to Modify a Texture Fill's Transformation

1. From the Module Library view, drag a Colour-Override module and drop it in the Network view.
2. From the Module Library view, drag a Peg module and drop it in the Network view.

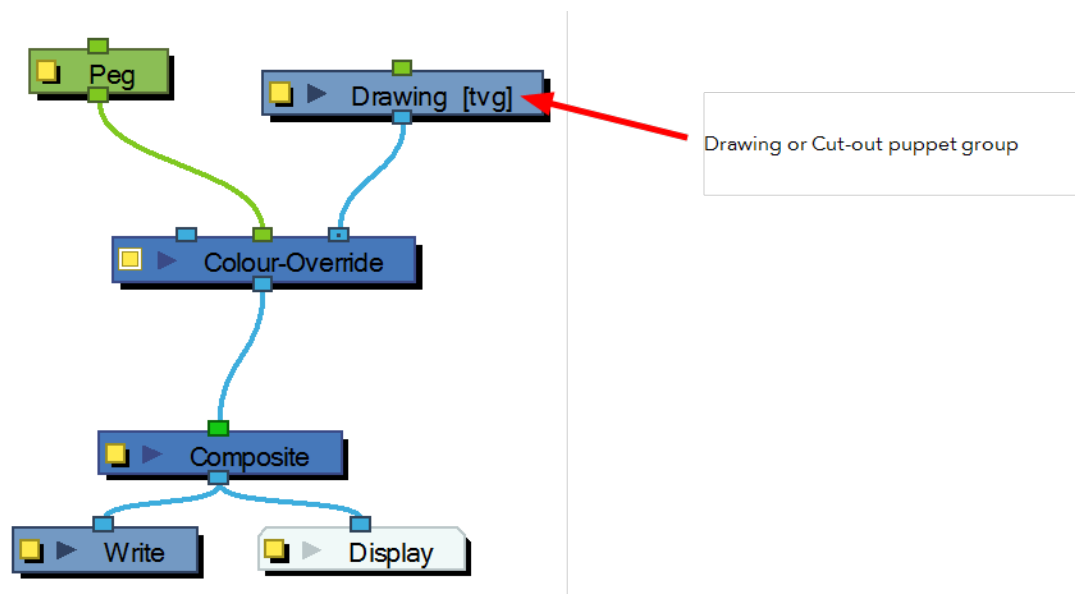



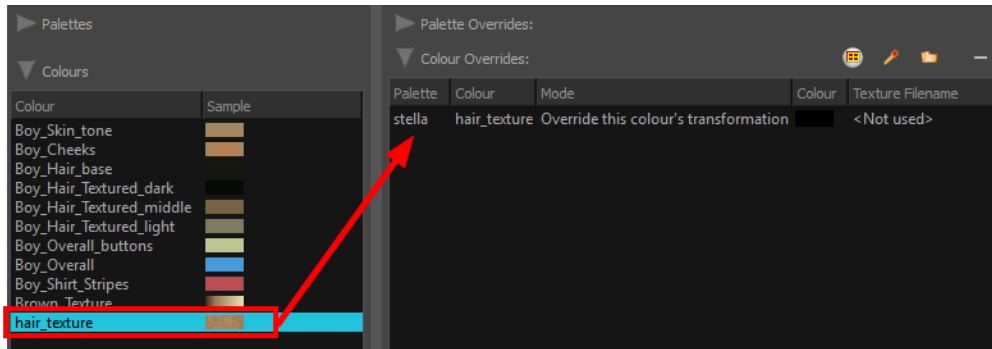



3. In the Network view, connect the Colour-Override module under the drawing module you want to animate the line for. Note that for a cut-out puppet, you would connect the Colour-Override under the final Composite, set as Pass-Through.
4. Connect the Peg module in the Colour-Override's middle port. The green port will take the transformation of the Peg to modify the pencil texture's position.
5. Click on the Colour-Override's yellow button to open the editor.
6. In the Colour-Override window, in the Palettes section, select the palette containing the bitmap texture swatch.
7. In the Colours section, select the texture swatch you used to paint the drawing and drag it to the Colour-Override section.



8. Once the swatch appears in the Colour-Override section, select it and then click on the Select Override Mode button to right-click on the New RGBA word and select one of the following option in the drop-down menu:



- **Override the colour's transformation:** This option will override the initial texture's transformation (matrix) established when you painted the zones or modified with the Edit Gradient and Texture  tool. This transformation override will be done by modifying the Peg's position.
 - **Combine the colour's transformation:** This option will combine the initial texture's transformation (matrix) established when you painted the zones or modified with the Edit Gradient and Texture  tool with the new position transformation you will create when modifying the Peg's position.
9. In the Network view, select the Peg module.
 10. In the Advanced Animation toolbar, select either the Translate , Rotate  or Scale  tool.
 11. In the Camera view bottom toolbar, enable the Render  mode.
 12. In the Camera view, move the Peg's position. As you move it, you will see the texture fills getting modified. You can animate the position by adding position keyframes in the Timeline view.

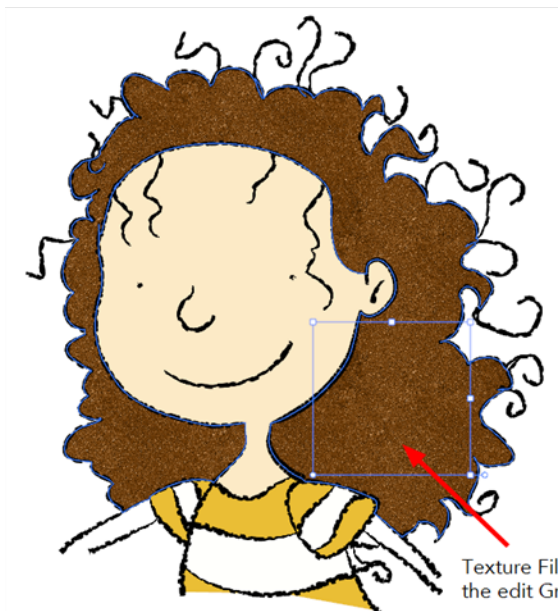

Texture Fill Original Matrix set with the edit Gradient and Texture Tool



Texture Fill modified with the Colour Override and Peg Modules

Overriding a Colour with a Bitmap Image Sequence

In production, it will happen that you need to map a live action sequence or bitmap image sequence into a zone or over several zone. For example, you could have a mirror shattered in several pieces and you want to map in it the video or someone talking. You can paint the mirror pieces with a specific colour swatch and use the Colour-Override module to map the image sequence into the pieces. It can also be a single image without having to be an image sequence.

How to Override a Colour with a Bitmap Image Sequence

1. From the Module Library view, drag a Colour-Override module and drop it in the Network view.

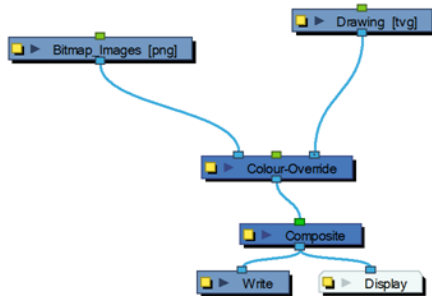



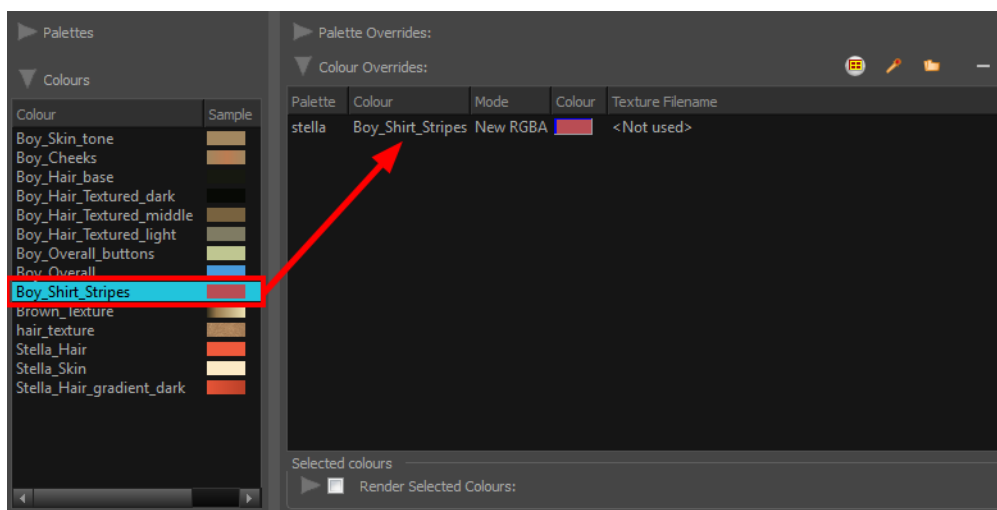

2. In the Network view, connect the Colour-Override module under the drawing module you want to animate the line for.
3. Connect the Live Action or Bitmap Image Sequence module in the Colour-Override's left port. The left blue port will input the images into the colour zones.
4. Click on the Colour-Override's yellow button to open the editor.
5. In the Colour-Override window, in the Palettes section, select the palette containing the colour to override.
6. In the Colours section, select the pencil texture you used to draw your lines and drag it to the Colour-Override section.



7. Once the swatch appears in the Colour-Override section, select it and then click on the Select Override Mode button to right-click on the New RGBA word and select Texture - Use Image Input.



8. In the Network view, select the bitmap image module.
9. In the Advanced Animation toolbar, select either the Translate , Rotate  or Scale  tool.
10. In the Camera view bottom toolbar, enable the Render  mode.
11. In the Camera view, move the Bitmap Image position. As you move it, you will see the texture fills getting modified. You can animate the position by adding position keyframes in the Timeline view.

Overriding a Texture on a Pencil Line

A pencil line can be drawn with a texture but also painted with a texture swatch. With the Colour-Override module, you can either override either the pencil line's texture or texture fill and replace it by another one or you can also animate the texture's position.

With the Edit Gradient and Texture  tool, you can modify the size and position for both types of texture on a pencil line; the drawing texture and the filling texture. By doing that, you are actually modifying the texture's matrix.

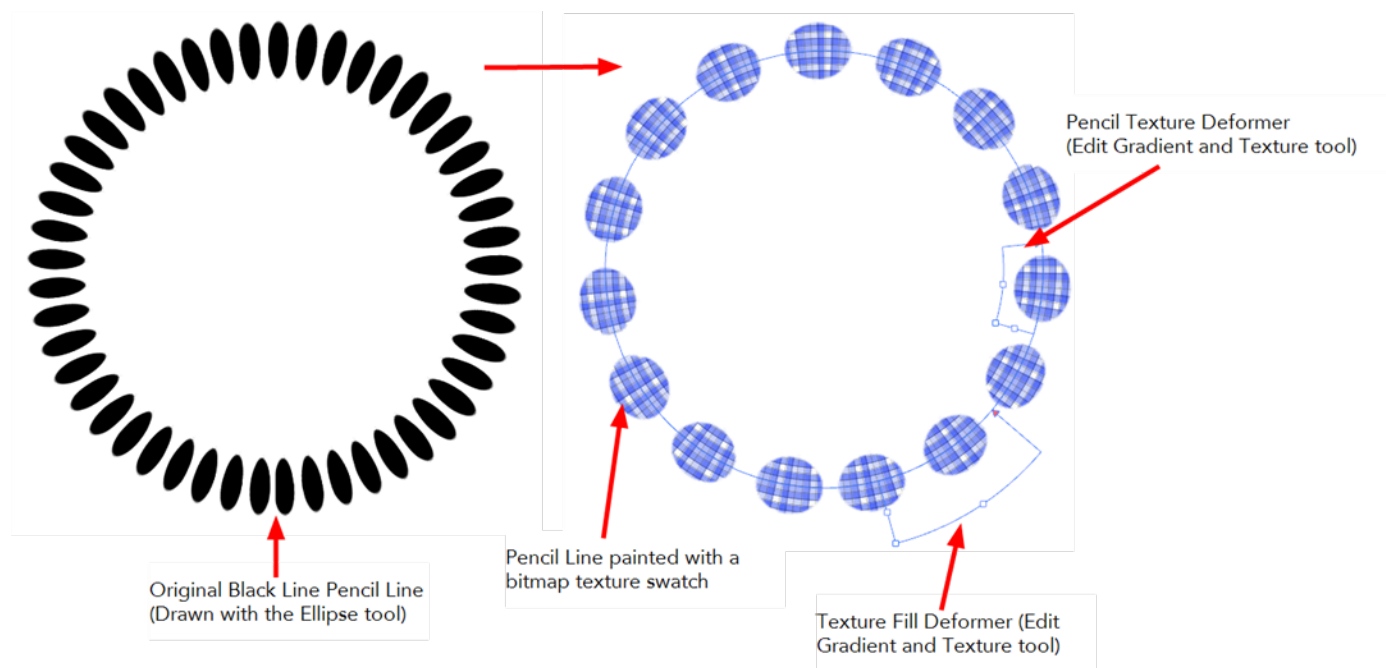

Modifying a Texture Fill on a Pencil Line

When you paint a pencil line with a bitmap colour swatch, you can override the position of the texture fill using the Colour-Override module and a Peg.

How to Modify the Pencil Line Texture

1. From the Module Library view, drag a Colour-Override module and drop it in the Network view.
2. From the Module Library view, drag a Peg module and drop it in the Network view.

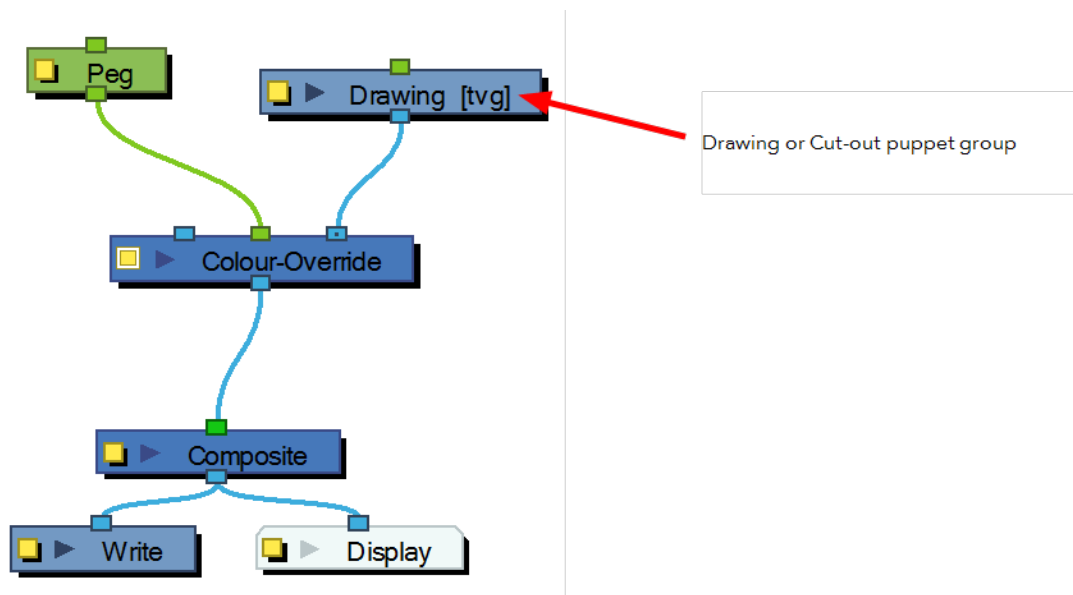



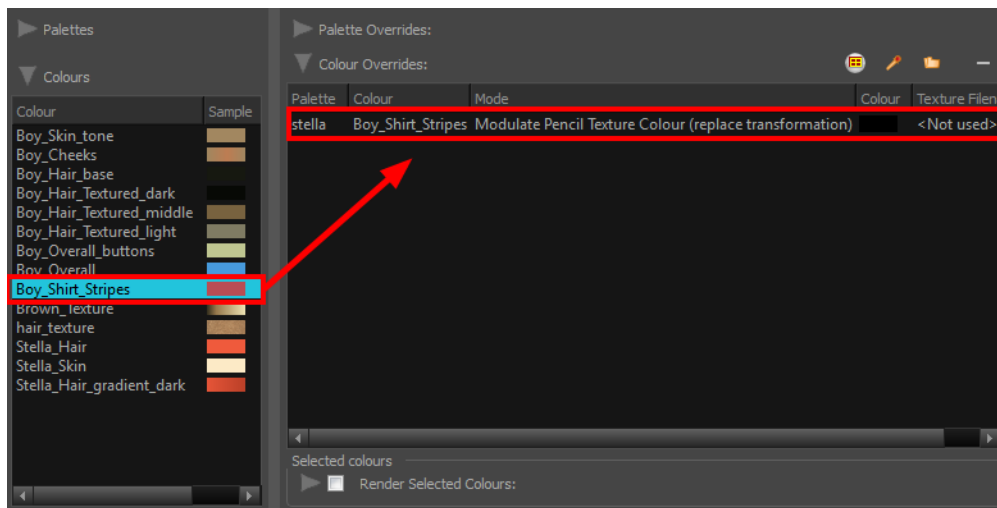



3. In the Network view, connect the Colour-Override module under the Drawing module you want to animate the line for. Note that for a cut-out puppet, you would connect the Colour-Override under the final Composite, set as Pass-Through.
4. Connect the Peg module in the Colour-Override's middle port. The green port will take the transformation of the Peg to modify the pencil texture's position.
5. Click on the Colour-Override's yellow button to open the editor.
6. In the Colour-Override window, in the Palettes section, select the palette containing the colour to override.
7. In the Colours section, select the bitmap texture swatch you used to paint your lines and drag it to the Colour-Override section.



8. Once the swatch appears in the Colour-Override section, select it on Mac OS Xd then click on the Select Override Mode button to right-click on the New RGBA word and select one of the following options in the drop-down menu:



- **Modulate Pencil Texture Colour (replace transformation):** This option will override the initial texture fill's transformation (matrix) established when you painted the line or modified it with the Edit Gradient and Texture  tool. This transformation override will be done by modifying the Peg's position.
 - **Modulate Pencil Texture Colour (combine transformation):** This option will combine the initial texture fill's transformation (matrix) established when you drew the line or modified it with the Edit Gradient and Texture  tool with the new position transformation you will create when modifying the Peg's position.
9. In the Network view, select the Peg module.
 10. In the Advanced Animation toolbar, select either the Translate , Rotate  or Scale  tool.
 11. In the Camera view bottom toolbar, enable the Render  mode.
 12. In the Camera view, move the Peg's position. As you move it, you will see the texture fill getting modified. You can animate the position by adding position keyframes in the Timeline view.

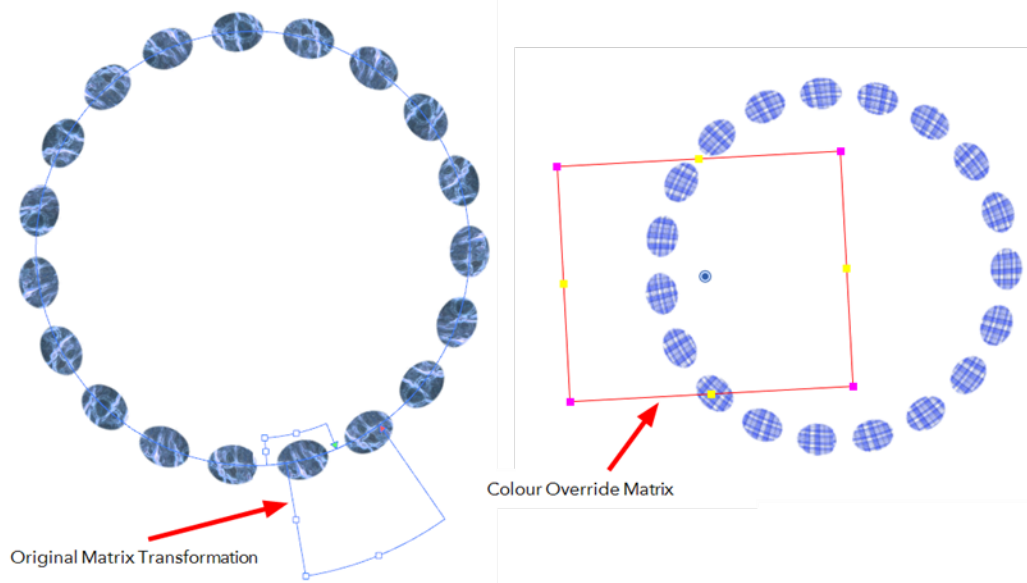

Modifying a Pencil Texture



You can modify and animate a pencil texture's position using the Colour-Override module and a Peg module. This lets you create a shaky line style which is a very popular design style. The main issue with this style is that it works well in traditional and tradigital animation, when the artist draws the line

differently on each drawing, but it does not work in cut-out animation where the same drawing is used for the entire animation. The same issue happens when the same drawing is held for more than a few frames. The line moves during the animation, but stops moving during the drawing hold, which looks bad.

With the Colour-Override module, you can animate the position of the pencil line texture independently from the drawing exposure. Even if a drawing's exposure is held over several frames, the line will move.

How to Modify the Pencil Line Texture

1. From the Module Library view, drag a Colour-Override module and drop it in the Network view.
2. From the Module Library view, drag a Peg module and drop it in the Network view.

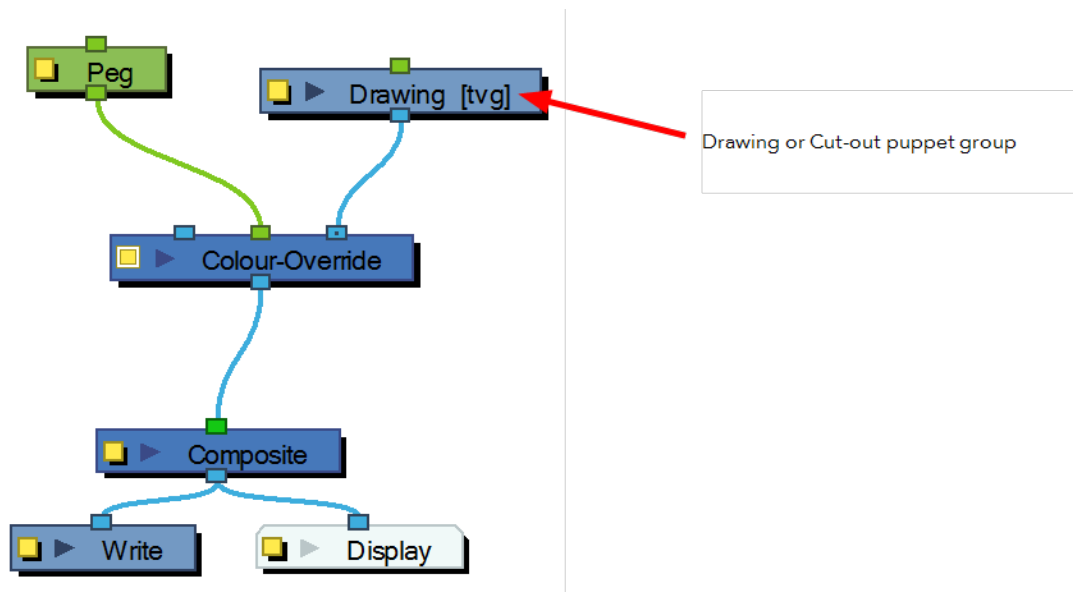

3. In the Network view, connect the Colour-Override module under the drawing module you want to animate the line for. Note that for a cut-out puppet, you should connect the Colour-Override under the final Composite, set as Pass-Through.
4. Connect the Peg module in the Colour-Override's middle port. The green port will take the transformation of the Peg to modify the pencil texture's position.
5. Click the Colour-Override's yellow button to open the editor.
6. In the Colour-Override window, in the Palettes section, select the **penstyle_opacity** palette.

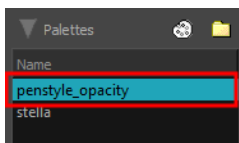



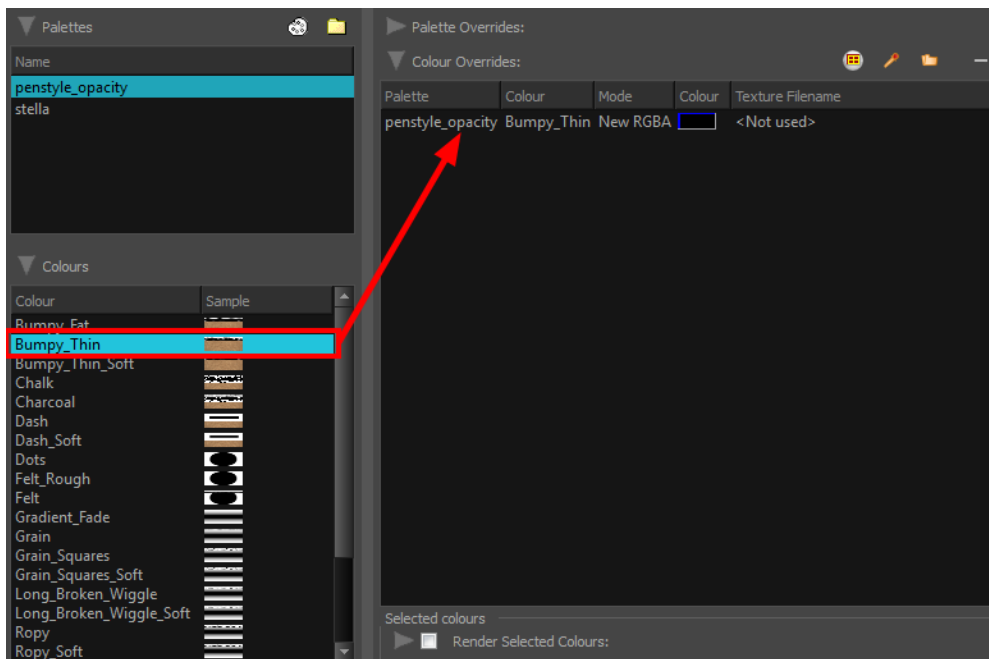



7. In the Colours section, select the pencil texture you used to draw your lines and drag it to the Colour Overrides section.



8. Once the swatch appears in the Colour-Override section, select it and click the **Select Override Mode** button to right-click on the New RGBA word and select one of the following:



- ▶ **Change Pencil Texture Transformation:** Overrides the initial pencil texture's transformation (matrix) established when you drew the line or modified with the Edit Gradient and Texture  tool. This transformation override will be done by modifying the Peg's position.
 - ▶ **Modulate Pencil Texture Matrix:** Combines the initial pencil texture's transformation (matrix) that was established when you drew the line or modified with the Edit Gradient and Texture  tool with the new position transformation you will create when modifying the Peg's position.
9. In the Network view, select the Peg module.
10. In the Advanced Animation toolbar, select the **Translate** , **Rotate**  or **Scale**  tool.
11. In the Camera view bottom toolbar, select the **Render**  mode.
12. In the Camera view, move the Peg's position. As you move it, you will see the pencil texture getting modified. You can animate the position by adding position keyframes in the Timeline view. You can use the Random Fill function to quickly create a random shake.

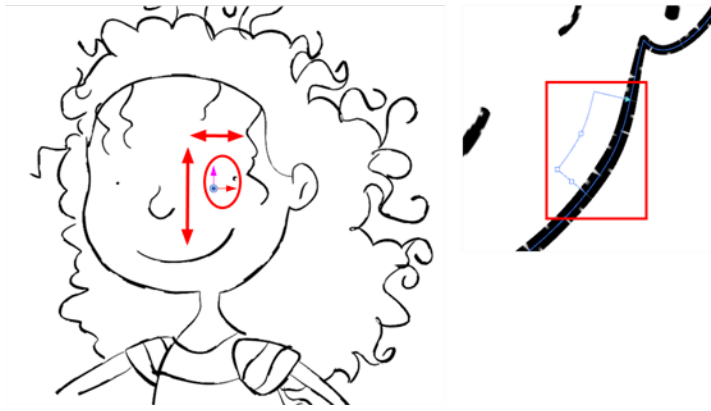

Colour-Scale

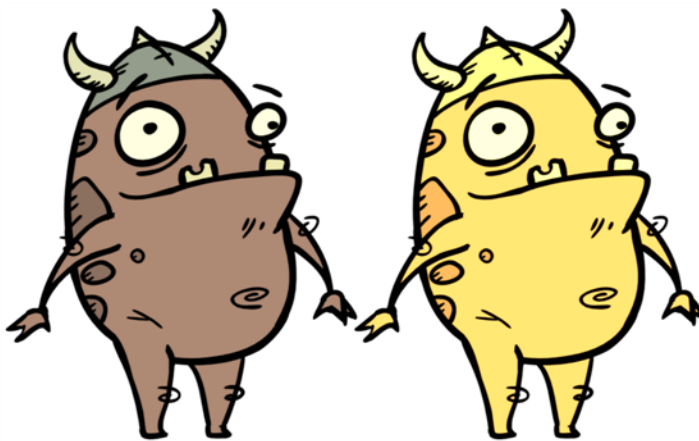

The Colour-Scale effect offsets an images colours. This effect is useful in creating ambient transitions, such as from daytime to nighttime.

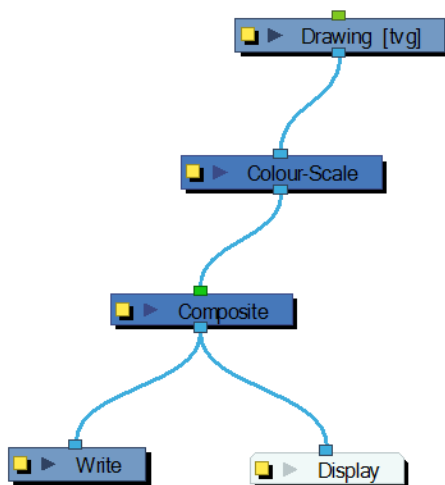
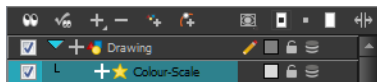

Use the Colour-Scale editor to set the colour scale effect by entering a value in the scale fields.

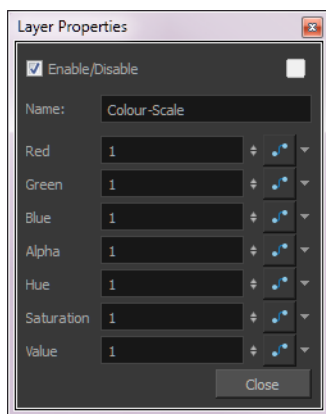

The actual colour values of the image are not changed; instead, the channels are multiplied by a selected amount. For example:

- If you enter a value of 1, the colour values do not change.
- If you enter a value greater than 1, you increase the colour channel value closer to 255 (or white).
- If you enter a value less than 1, you decrease the colour channel value closer to zero (0 or black).

You can set the colour scale value by entering a value in the field. You can also change the values of the colour scale effect over time by attaching it to a Bezier or Ease function curve  and adding keyframes.

Composite-Generic

During the composition of images, colour and alpha values of an input image are combined with the image underneath to produce the output image.

Effects modules, like Tone and Highlight, can control the colour and alpha composite operations for you. A Composite module was created, in which the colour and alpha composite operation are preset to the standard, and more frequently used, composite operations.

You may, however, still want to control the colour and alpha composite operation between two images using the Composite-Generic Module which combines two images into one output image. The image linked to the left port of the module is layered on top of the image in the right port based on the selected colour and alpha composite operation.

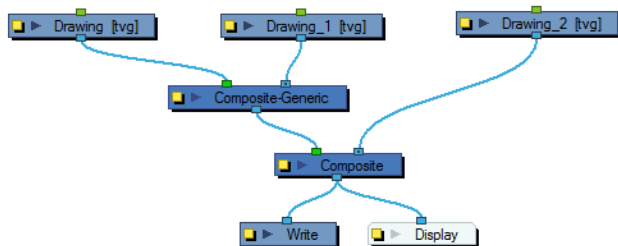

Use the Composite-Generic editor to control the calculation of colour and alpha values during the composition process.

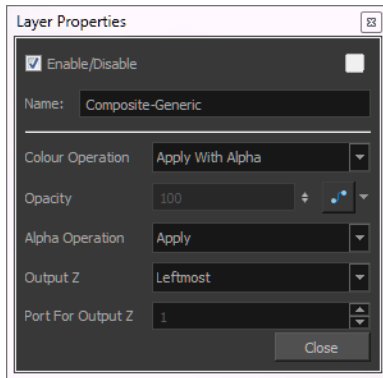

The following abbreviations are used in the descriptions of composite operations:

- **ORGB**: RGB values of the Output Image

The Output Image is the resulting image from a composite operation. In the formulas for the composite operations, this image is also processed through a composite operation, representing the bottom layer in the composited image.

- **LRGB**: RGB values of the Left Image
- **RRGB**: RGB values of the Right Image
- **LA**: Alpha of the Left Image
- **RA**: Alpha of the Right Image
- **OA**: Alpha of the Output Image

Composite-Generic Effect Properties

Parameter	Description
Colour Operation	<p>The colour values of the output image are determined based on the alpha and colour values of the left and right image.</p> <p>Both the Blending module and Composite-Generic module have regular blending modes and legacy blending modes. The regular blending modes will take the source images and unmultiply them before blending the two inputs together. The images will be remultiplied when being output from the module. The legacy blending modes use the pre-multiplied source images as is in order to apply the effect. Unmultiplying the images before processing them will give a final result closer to what can be found in software such as Adobe Photoshop.</p> <p>Right: The colour values in the output image are derived from the image in the right port. Colour values in the left port are ignored.</p> <p>Left: The colour values in the output image are derived from the image in the left port. Colour values in the right port are ignored.</p> <p>Apply With Alpha: $ORGB=[RRGB*(1-LA)]+LRGB$. This is a standard composite operation called "alpha blending." During</p>

this operation, colour values of the left and right images are combined based on the alpha value of the left image. Where the left image is completely opaque ($LA=1$), the ORGB will be replaced completely with LRGB. Where the left image is completely transparent ($LA=0$), the ORGB is unaffected. Where the left image is partially transparent, you get a blend of the RRGB and the LRGB, where the values are added together and clipped to 255. The LA is the opacity of the left image. This operation ($1-LA$) calculates the amount of opacity to retain in the output image. The operation $[RRGB*(1-LA)] + (LRGB*LA)$, which is simply the weighted average of L and R, with LA supplying the weight.

Apply Tone Highlight: $ORGB=RRGB+(LRGB*RA)$. This operation restricts the output of the tone to the region of the matte (RA), and uses the transparency and colour value of the input image to determine the colour values of the output. This is used to lighten or darken the output image. Darkening occurs when RRGB contains negative values.

Apply Add (Apply Add Legacy): $ORGB=RRGB+LRGB$. This operation uses the transparency and colour value of the left image to determine the output values. Effects such as shadows and glows are calculated in this manner. Unlike the Apply Tone Highlight operation, the result is not clipped to the matte (RA) of the output image.

Apply Matte For Overlay: $ORGB=RRGB*(1-LA)$. This operation prepares the output image using the overlay's matte; the matte's RGB values are ignored. This operation prepares the output image to receive the colour portion of the overlay. It is typically used when an overlay and its matte are stored in separate images.

Apply Overlay Into Matte: $ORGB=RRGB+(LRGB*RA)$. This operation maps an overlay into an area prepared by a matte. It is typically used when an overlay and its matte are stored in separate images, and Apply Matte For Overlay has been used to prepare the output image to receive the RGB portion of the overlay.

Apply Transparency: $ORGB=RRGB*(1-LA)$. This operation is used for a cutter matte to prepare the output image to receive the colour values of another image. It has the effect of increasing the transparency of ORGB (but not OA), based on the LA. This function is the equivalent to Apply Matte for Overlay. It is almost always used with Apply Transparency Matte, an Alpha Composite Operation.

Apply Multiplicative Tone: $ORGB=RRGB*(LRGB+1-LA)$. This operation multiplies the left and right images (see the Multiply colours selection), to be combined with the right image colour,

creating a darker output colour. This effect created by this operation is identical to the Multiply Colour Blending effect in Photoshop.

Multiply Colours: $ORGB=RRGB*LRGB$. This operation multiplies the left and right image colours. Multiplying colours filters the colour values of the right image from the output image. For instance, to make the left image less blue, you can add a right image to this module with a blue colour value and select this option.

Linear Light: This operation burns or dodges the colours by decreasing or increasing the brightness depending on the colour of the underlying colour. If the blend colour is lighter than 50% grey, the colour is lightened because the brightness is increased. If the blend colour is darker than 50% grey, the colour is darkened because the brightness is decreased.

Pin Light: This operation will replace the colours, depending on the underlying colour. If the blend colour is lighter than 50% grey, pixels darker than the underlying colour are replaced, and pixels lighter than the underlying colour do not change. If the blend colour is darker than 50% grey, pixels lighter than the underlying colour are replaced, and pixels darker than the underlying colour do not change.

Vivid Light: This operation burns or dodges the colours by decreasing or increasing the brightness depending on the colour of the underlying colour. If the colour is lighter than 50% grey, the blend colour is lightened because the contrast is decreased. If the colour is darker than 50% grey, the blend colour is darkened because the contrast is increased.

Exclusion: This operation produces a similar result to the Difference mode, but with a lower contrast.

Dodge: This operation will lighten the colour.

Burn: This operation will darken the colour.

Hue: This operation will result in a colour that will take the luminosity and saturation of the underlying colour, and the hue of the source colour.

Saturation: This operation will result in a colour that will have the same luminosity and hue of the underlying colour, and the saturation of the source colour.

Colour: This operation will result in a colour that will have the luminosity of the underlying colour, and the hue and saturation of the source colour.

Luminosity: This operation will result in a colour which has the hue and saturation of the underlying colour, and the luminosity of the source colour. This mode is opposite to the Colour mode.

Divide Colours (Divide Colours Legacy): $ORGB=RRGB/LRGB$.

	<p>This operation divides the right image colour values by the left colour values. The left image colour values are inverted, creating a negative image (1/LRGB). The negative's colour values are then multiplied by the right image colour values.</p> <p>Lighten (Lighten Legacy): This operation looks at the colour information coming from both the images in the left and right ports and selects the base or blend colour - whichever is lighter - as the result colour. Pixels darker than the blend colour are replaced, and pixels lighter than the blend colour do not change.</p> <p>Softlight (Softlight Legacy): This operation darkens or lightens the colours in a soft and diffuse way, depending on the blend colour (image in left port). If the blend colour is lighter than 50% grey, the image is lightened. If the blend colour is darker than 50% grey, the image is darkened. Painting with pure black or white produces a distinctly darker or lighter area, but does not result in pure black or white.</p> <p>Hardlight (Hardlight Legacy): This operation multiplies or screens the colours of the image in the left port with those of the image in the right port, depending on the blend colour. If the blend colour (left port image) is lighter than 50% grey, the image is lightened, as if it were screened. This is useful for adding highlights to an image. If the blend colour is darker than 50% grey, the image is darkened, as if it were multiplied. This is useful for adding shadows to an image. Painting with pure black or white results in pure black or white. Play with the Opacity value to create a subtler look.</p> <p>Overlay (Overlay Legacy): This operation multiplies or screens the colours from the image connected to the left port, with those on the right, depending on the base colour. Colours from the left-port element overlay the colours of the drawing elements connected to the right, while preserving the highlights and shadows of the base colour. The base colour is not replaced, but mixed with the blend colour to reflect the lightness or darkness of the original colour.</p>
Opacity	The level of transparency.
Alpha Operation	<p>Right: The transparency of the output image is derived from the alpha values of the image in the right port. The values in the left port are ignored.</p> <p>Left: The transparency of the output image is derived from the alpha values of the image in the left port. The values in the right port are ignored.</p> <p>Apply: $OA=[RA*(1-LA)]+LA$. This operation computes the output alpha of the output image based on the alpha values of the left and right images. This is the standard method of combining alpha channels. Notice its similarity to the Apply With Alpha colour Composite Operation.</p>

	<p>Add: $OA=RA+LA$. This operation adds the alpha values of the two images to produce the alpha value of the output image.</p> <p>Subtract: $OA=RA-LA$. This operation subtracts the alpha values of the input image from the alpha values of the output image. It is useful in situations where two tone levels have been drawn with overlap, but a double-darkening in the overlap is not wanted. This operation will reduce the opacity of overlapping regions.</p> <p>Apply Transparent Matte: $OA=RA*(1-LA)$. This operation is used to increase the transparency of the output alpha in the final composited image.</p> <p>Black: $OA=0$. Sets the matte of the entire output image to black, so that it is transparent.</p> <p>White: $OA=1$. Sets the matte of the entire output image to white, so that it is opaque.</p>
Output Z	<p>Leftmost: Indicates that the Z value for the output image will be taken from the module in the left port.</p> <p>Rightmost: Indicates that the Z value for the output image will be taken from the module in the right port.</p> <p>Backmost: Indicates that the Z value for the output image will be taken from the image that is the farthest back in the scene.</p> <p>Frontmost: Indicates that the Z value for the output image will be taken from the image that is closest to the front of the scene.</p> <p>Portnumber: Indicates that the Z value for the output image will be taken from the module in the selected port. Enter the appropriate port in the Port for Output Z field.</p>

Contrast



Use the Contrast effect to increase or decrease the level of contrast in an image. This is done by changing the contrast in the dark and bright pixels and setting the transition point between dark and bright.

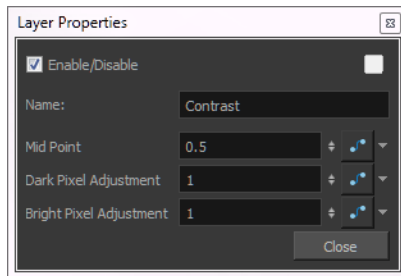
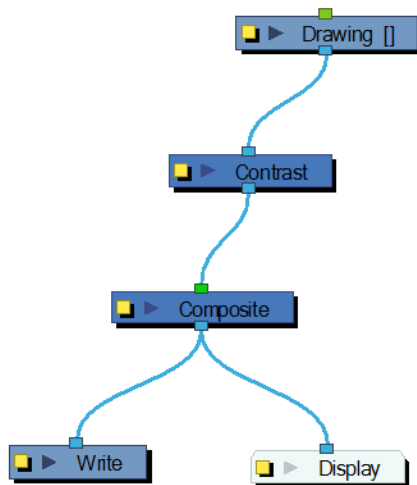

Contrast Effect Properties

Parameter	Description
Mid Point	<p>The value that separates dark from bright colours. The midpoint is a value between 0 and 1 that represents the percentage of the 0 to 255 RGB channel range.</p> <p>Pixels with colour values lower than the midpoint: These are considered dark pixels.</p> <p>Pixels with colour values higher than the midpoint: These are considered bright pixels.</p>
Dark Pixel Adjustment and Bright Pixel Adjustment	<p>The amount of contrast to be applied to pixels that fall on either side of the Mid Point value.</p> <p>A value equal to 1: No change</p> <p>A value less than 1: The module makes the pixel colours brighter</p> <p>A value greater than 1: The module makes the pixel colours darker</p>

You can enter static values in the dialog box fields or you can attach these values to function curves to change over time.

Cutter



The Cutter cuts out a portion of an image using a matte drawing. You can use the Cutter to allow a character to disappear behind a background element or to cut a virtual hole into the layer itself. The Cutter requires a matte input.

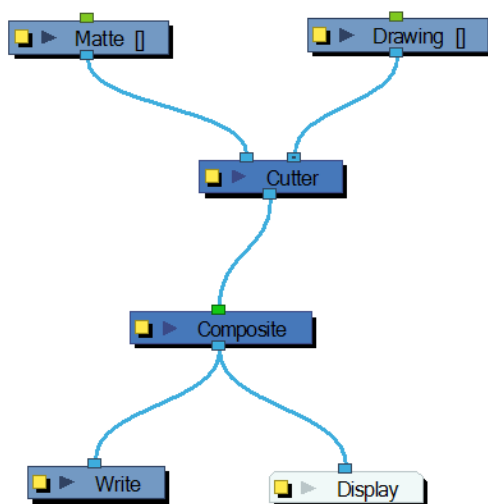

Use the Cutter editor to invert the effect of the matte on an image. Instead of the object being hidden by the mask, it will only be visible where it intersects with the matte shape area.

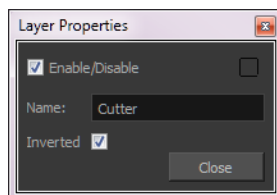

Dither

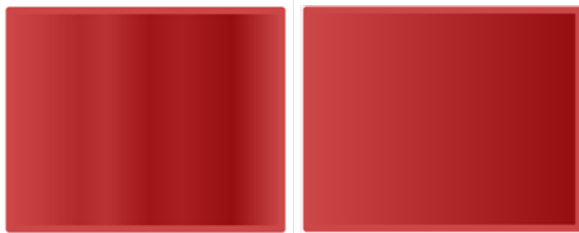

Dithering is the process of approximating a higher number of colours in a low bit-depth colour system. Use the Dither effect to give the appearance of greater colour variability in 8-bit per channel colour images.

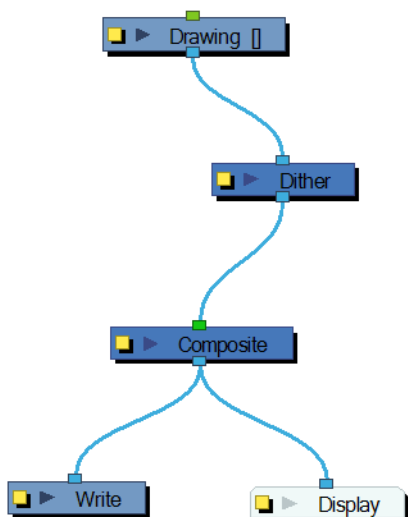

The Dither effect is useful in the case of a gradient that varies between 100 and 105 in the blue channel, for example. Since the difference in the colour values is not great, banding might appear in the image. In this case, use the Dither module to give the impression of greater values of blue, decreasing the unwanted banding effect.

The results of the dither operation may be imperceptible.

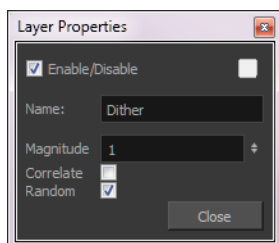

Dither Effect Properties

Parameter	Description
Magnitude	A magnitude of 1 performs a normal dithering operation, using all bands of colour. A magnitude greater than 1 introduces a bias towards brighter colours. A magnitude of less than 1 creates a faster transition between

	bands of colour, lessening the bias towards brighter colours.
Correlate	When selected, the three colour channels (RGB) are changed simultaneously, for better colour accuracy. When this option is not selected, the three channels are dithered separately, resulting in smoother transitions.
Random	The standard algorithm for the dithering operation.

External

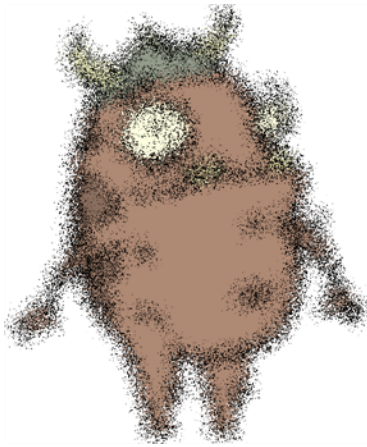

Use the External module to process images through external programs and input the resulting images back into the network. Note that not all programs work with the External module.

Using the External module avoids you having to export your animation to another software to do some processing over it and then bring it back to Harmony. This way, you can modify your scene and animation as much as you want and still use the effects or render process from a third-party software.

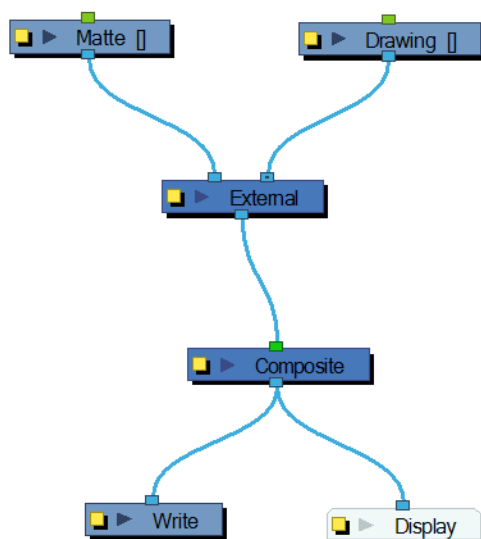

The External module writes input files to temporary files on the system. It then calls the external program, which will process the input images. If two images are input into the module, the program must composite them together to produce one output image. Finally, the file produced by the external program is read back into the network.

The command is sent to the external program in the following format:

```
program_name file_1 file_2 output_file numerical_param extension
```

Use the External editor to control the program that is launched by the module, the files that it reads, and the file that it outputs into the network.

```
Version: ImageMagick 6.3.0 11/06/06 Q16 http://www.imagemagick.org
Copyright: Copyright (C) 1999-2006 ImageMagick Studio LLC

Usage: mogrify [options ...] file [ [options ...] file ...]

Where options include:
-adaptive-blur geometry          adaptively blur pixels; decrease effect near edges
-adaptive-resize geometry       adaptively resize image with data dependent triangulation

-adaptive-sharpen geometry      adaptively sharpen pixels; increase effect near edges
-affine matrix                  affine transform matrix
-annotate geometry text        annotate the image with text
-antialias                      remove pixel-aliasing
-authenticate value             decrypt image with this password
-auto-orient                    automatically orient image
-background color               background color
-bias value                     add bias when convolving an image
```

In this example, the ImageMagick 6.3 software was used without a matte connection.

Use the External editor to write down the parameters matching the chosen external program.

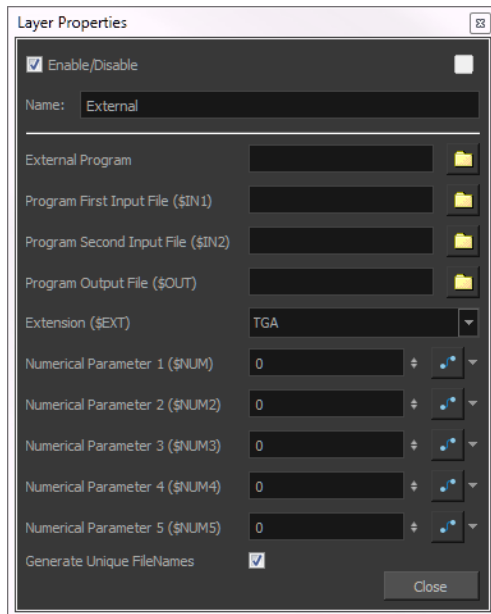

- **External Program:** The name of the program launched by the External module. This field can include a full or relative path to the executable file. If no path is entered, the user's path is searched to locate the program.

Enter the command directly into this field.

For example:

```
mogrify -spread $NUM $IN1
```

Where:

- **mogrify:** Is the name of the program,
- **spread:** Is the option to be applied,
- and **\$NUM** and **\$IN1:** Are the numerical parameter and first input file variable declared in the External module.
- **Program First Input File (\$IN1):** The name and location of the temporary file that Harmony will write to the file system for the external program to read. It must not include the dot or the extension; the External module will add these based on the Extension field.
- **Program Second Input File (\$IN2):** When processing two files through this module (such as an image and a matte), this is the name and location of the second temporary file that Harmony writes to the file system for the external program to read. It must not include the dot or the extension; the External module will add these based on the Extension field.
- **Program Output File (\$OUT):** The name and location of the temporary file that the external program will write to the file system so that Harmony can read it back into the network.
- **Extension (\$EXT):** The file type that will be processed by the external program.
- **Numerical Parameter(\$NUM):** A value passed to the external program as a file processing option. It can be attached to a function curve to change over time.

The program files are temporary files that are overwritten at each frame as the module is executed. They are only meant to temporarily store the image that is being processed at each frame.

- **Generate Unique FileNames:** If this option is enabled, the temporary output file will have a unique identification number added to its name to avoid any file override if another scene or External script is rendered at the same time. It could be possible to have an override when two scenes using the External modules are rendered in batch processing.

Flatten

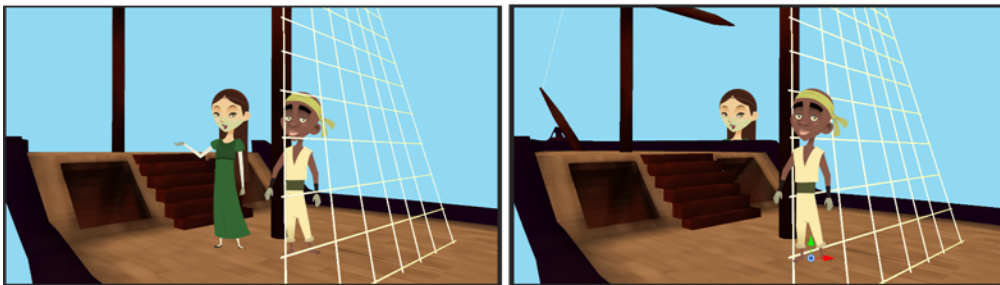

The Flatten module is used to transform 3D objects into flat planes when ordered in the Composite module. That plane can then be moved around like any other drawing. Instead of intersecting with 2D layers, the 3D object will either be behind or in front.

When all objects are at the same distance (z value) from the camera, the order is based on the Composite ports. When elements are placed at different distances from the camera, the z axis value overrides the composite port ordering.

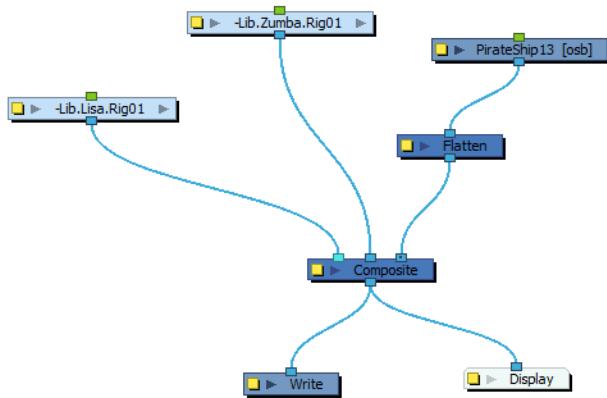

Focus



Use the Focus effect to set up depth-of-field effects for your scene. The Focus module is used to determine how much blur will be applied to images, based on their distance from the focal point.

The focal point can be the zero value of your scene or you can link the Focus module to another module, such as a drawing or peg layer, to retrieve the focal point from the module's Z-axis position.

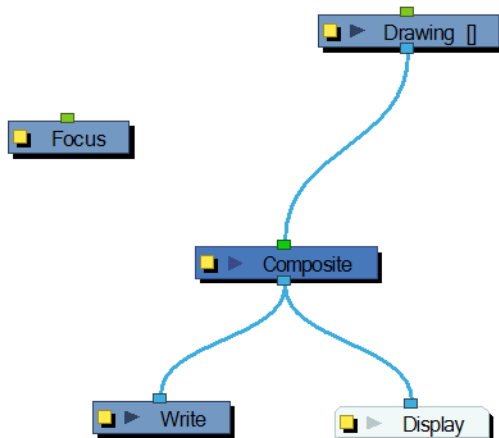

Use the Focus editor to determine how the focus will change as objects move farther from the focal point.

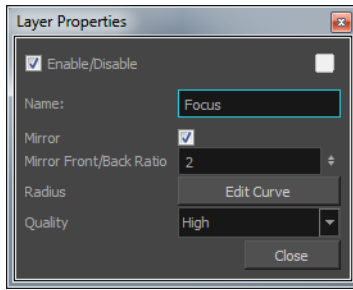

Focus Effect Properties

Parameter	Description
Mirror	Select this option to also blur images in front of the focal point.
Mirror Front/Back Ratio	When the Mirror option is selected, this ratio is applied to the calculation of the blur on images in front of the focal point. The default ratio of 1:2 produces realistic results. Experiment with different values to create customized effects.
Radius	Controls the amount of blur applied to an element based on its distance from the focal point. Click on the Edit Curve button to change these values by adjusting the function curve.
Quality	Controls the quality of the blur. A higher quality will achieve better results but will be slower to render.

In the Side view window, you can see how the blur values change based on their distance from the focal point. Select the Focus module in the Network view, make sure you are using the Transform tool, then right-click on the Side view window and select Control from the pop-up menu.

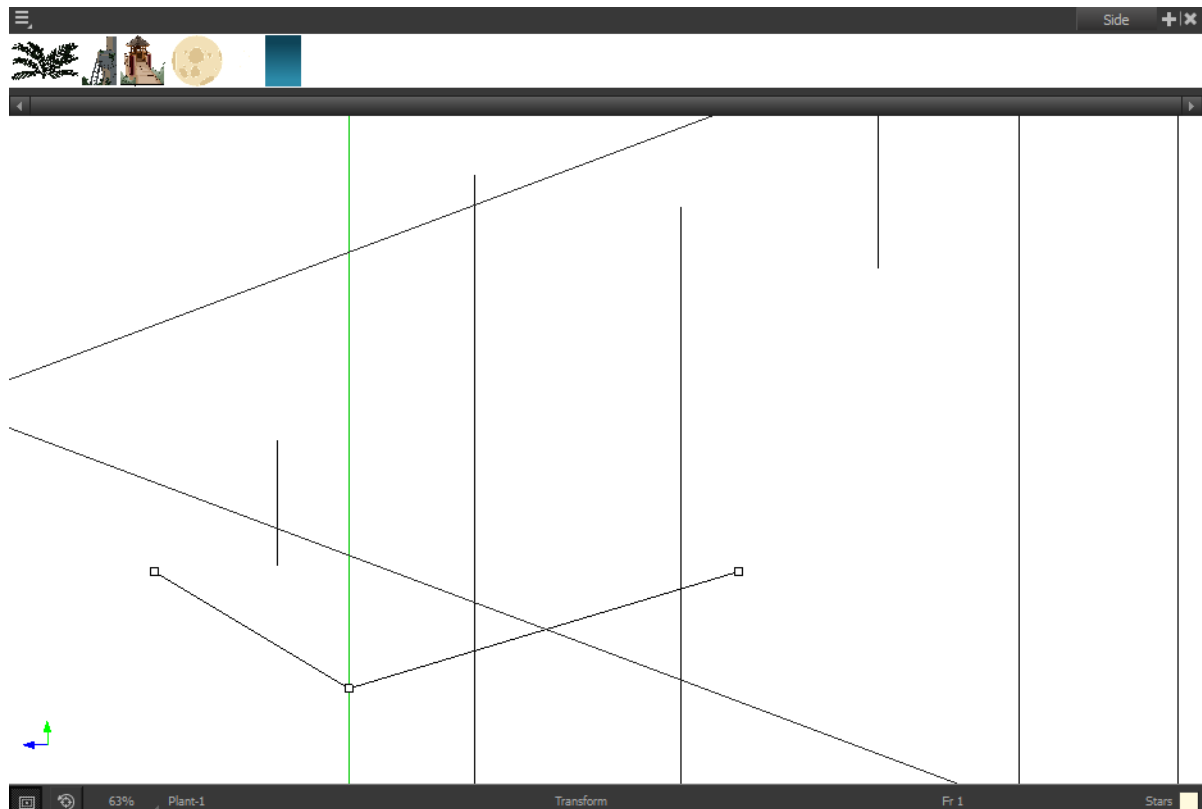

If you edited the function curve and adjusted the velocity, you can also adjust the Bezier handles in the Side view.

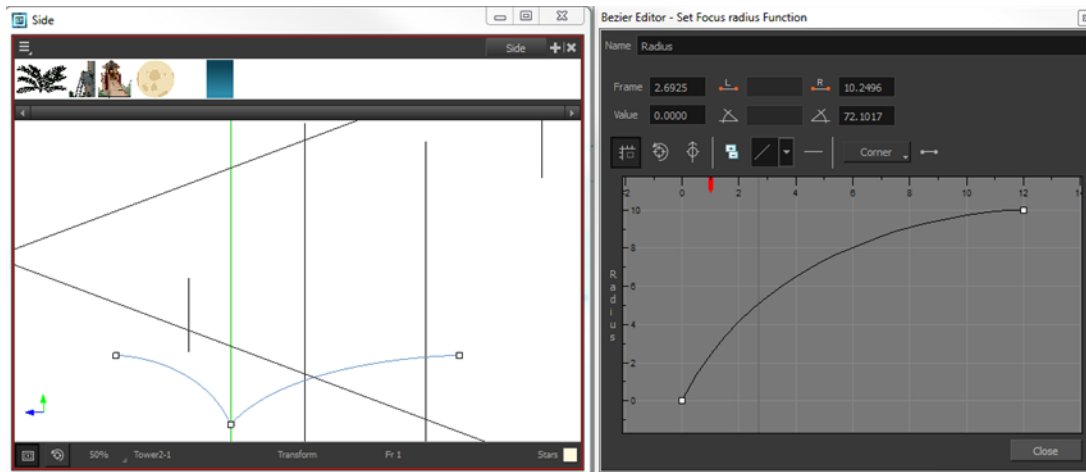

Focus Multiplier

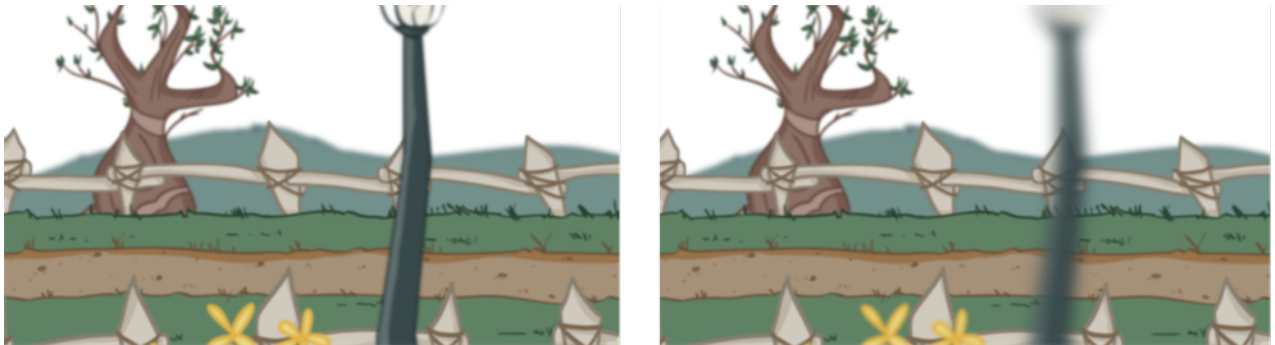

The Focus Multiplier effect works with the Focus effect. This module applies a blur to the selected layer, based on the blur radius in the Focus module.

Use the Focus Multiplier module when you want to apply the focus to selected elements or when you need to apply the focus before doing more effects in a composite operation.

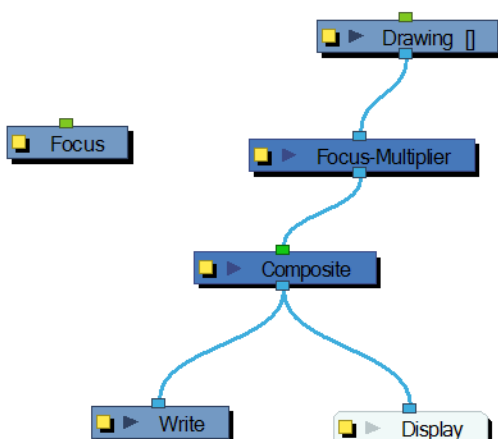

You must disable the Apply Focus option in the Composite module in order to apply the focus effect to the selected module only. If you do not disable that option, the focus effect will be calculated twice on the selected module.

Use the Focus Multiplier editor to multiply the Focus Radius by a selected value. You can enter a static value in the Multiplier field or attach it to a function curve.

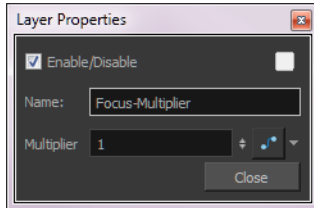

Glow



The Glow effect adds a bright soft-edged light or diffuse light region around an image. The Glow effect is useful in creating a shining rim around objects such as the sun or stars.

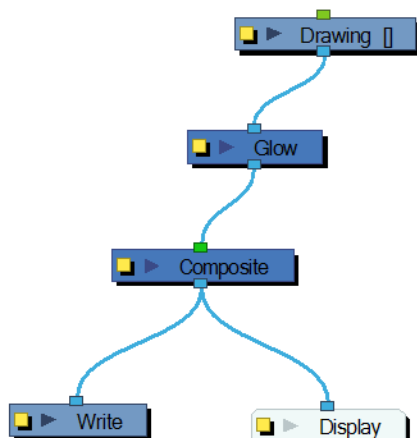
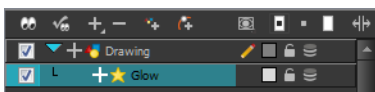

Use the Glow editor to control the direction of the blur that creates the glow, as well as its colour.

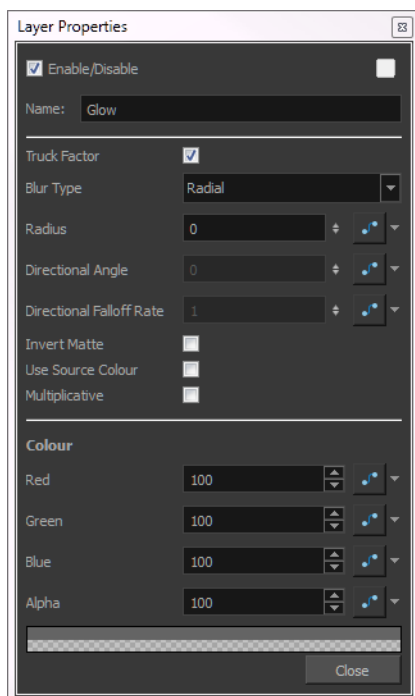

Glow Effect Properties

Parameter	Description
Truck Factor	Activated by default, this option readjusts the blur when the elements undergo a change of depth or scale. When this option is deselected, the effect's values remain unchanged regardless of any depth or scale changes. This option should be deselected when multiple drawings are composited and attached to this effect.
Blur Type	<p>Directional: Blurs the matte in the direction you select. For example, if a character is walking east, the blur may fall to the west.</p> <p>Radial: Blurs the edges of the matte evenly around points that make up its edge.</p>
Radius	Enter a value for the size of the blur. The larger the value, the greater the blur effect. The blur radius is affected by the drawing scale and camera position.
Directional Angle	<p>If you select a Blur Directional type, you can select the direction of the blur by entering a value from 0 to 360 in this field.</p> <ul style="list-style-type: none"> ▶ 0: Blurs the image to the west. ▶ 90: Blurs the image to the south. ▶ 180: Blurs the image to the east. ▶ 270: Blurs the image to the north.
Directional Fall-off Rate	The distance where the blur fades from the edge of the image. Select a value between 0 and 1.

	<ul style="list-style-type: none"> ▶ A fall-off rate of zero causes the blur to fade out slowly, distributing the blur evenly from the edge of the character to the farthest edge of the blur. ▶ A fall-off rate of 1 causes the blur to fade out quickly so that the blur is heaviest closer to the edge of the image.
Invert Matte	Inverts the matte used to create the glow. The matte will become a black silhouette while the glow fills the background space.
Use Source Colour	Uses the colours painted in the matte for the glow effect. If you deselect this option, select a colour and alpha values in the Colour section.
Multiplicative	Creates a more diffused glow.
Colour	Lets you choose the colour and alpha values for the glow effect.

If this effect is connected below a Composite module set to Pass-Through, the effect will be applied to each element connected in the Composite individually. If some of these elements are overlapping, the effect will also overlap.

Glue



The Glue effect lets you repair the cracks that appear between joints during animation.



The Glue module has three ports:

- **Left Port (Matte):** Receives the matte.
- **Middle Port (Port A):** Receives the element that will not be used to fill the joint.
- **Right Port (Port B):** Receives the element that will be used to fill the joint.

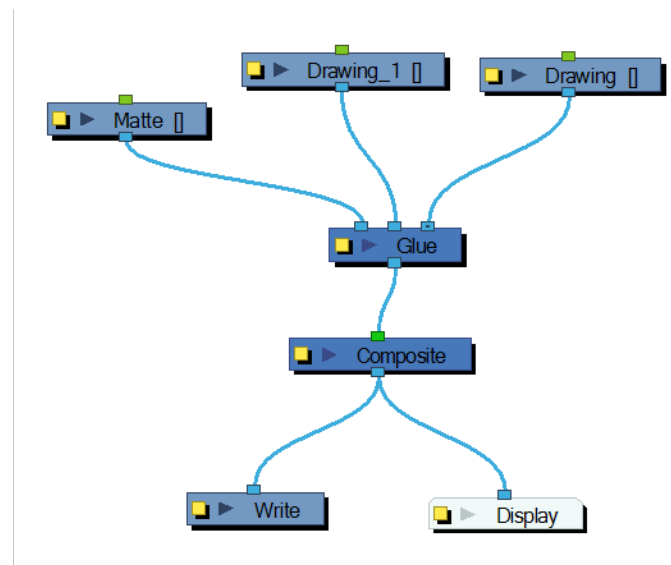
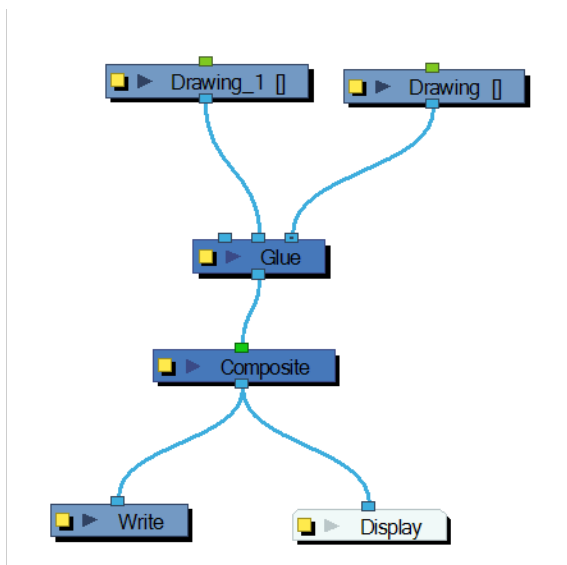

For most effects with the Glue module, the default options are sufficient. However, you can modify these options using the Glue editor.

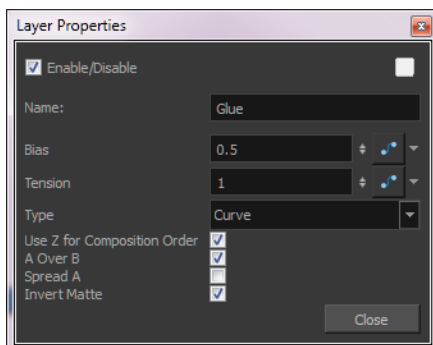

Glue Effect Properties

Parameter	Description
Bias	Indicates the tendency to favour the static or moving element. Set to 0, it favours element A; set to 1 it favours element B; set to 0.5 it is in between A and B.
Tension	Indicates how tight the joint will be. Set to 1, the tension has no effect; set less than 1, the tension decreases; set greater than 1, the tension increases.
Type	From this menu, select the type of joint to create. You can choose from among Curve (default), Line and Corner.
Use Z for Composition Order	You can use this option to choose the drawing with the higher front-back value to create the joint.

A Over B	Indicates which image is rendered on top in the final image. By default, A is rendered on top of B, which indicates that the image in the middle port (A) is rendered on top of the image in the right port (B).
Spread A	By default, the image in port B is spread to fill the joint. You can use this option to choose the image in the A port to create the joint. If you select this option, the drawing module must receive position information from the "B" element. Thus, you must connect the Drawing module of the "B" element to the Drawing module of the matte.
Invert Matte	Activate this option to invert the matte used to fill the joint. If you want to use the "B" element as the matte, you must select this element.

Gradient



The Gradient effect lets you create a transition of colour or alpha values between two areas of colours. You can create a linear or radial gradient. Use two points to indicate where those two coloured areas are. You can then move these points to create the transition.

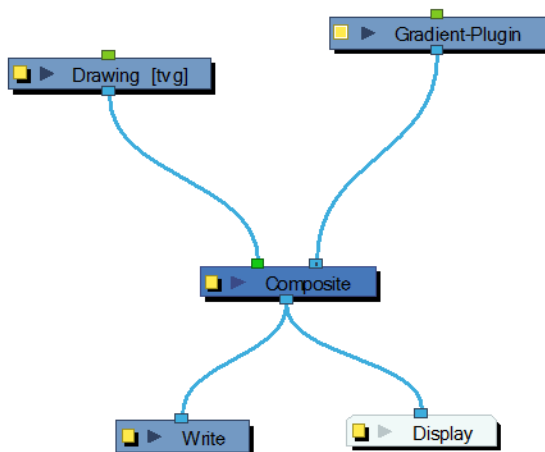

The Gradient module covers the entire camera frame and beyond. You do not need to scale it up or down. It will automatically cover an infinite zone. You simply need to connect it behind your scene's elements. You can connect it in front of some elements you want to cover. By default, the Gradient has a Z ordering value of 0. When you select the Gradient module, the Camera view displays yellow triangles to indicate that it's selected.

Use the Gradient property editor to modify the values of the gradient and the position of its output.

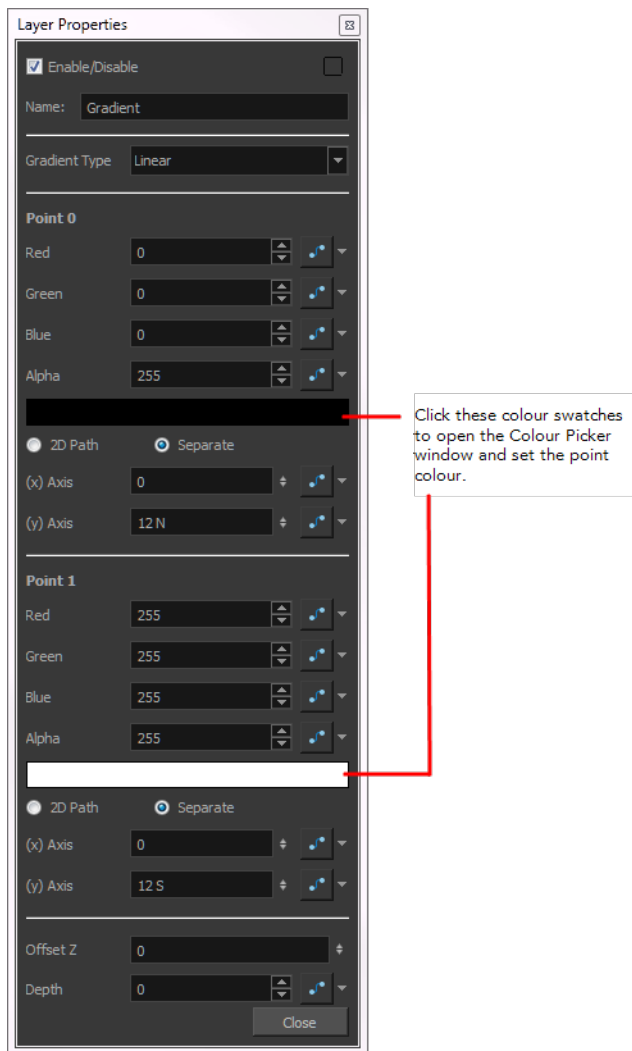

Gradient Effect Properties

Parameter	Description
Gradient Type	Lets you select a linear or radial gradient.
Point 1, Point 1	These sections control the values of the first point (point 0) and the second point (point 1) in the gradient.
Red, Green, Blue, Alpha	The colour and alpha values of the corresponding point. You can also click the colour swatch to open the Colour Picker window and select a new colour. These colours can be animated over time if the value parameter is hooked to a function curve. Default values are 0,0,0 and 255, 255, 255.
(x) Axis	Sets the X coordinate for the corresponding point.
(z) Axis	Sets the Y coordinate for the corresponding point.
Offset Z	Enter the front-back position of the Gradient layer in 3D space. You can verify this value in the Top view.
Depth	Determines the composition order when the Z value of two elements is

	the same.
--	-----------

Controlling the Gradient in the Camera View

If you want to control the gradient's orientation and points position in the Camera view, you can use the Control command to display the points and move them.

How to control the gradient in the Camera view

1. In the Tools toolbar, select the Transform  tool.
2. In the Network view, select the **Gradient** module.
3. From the top menu, select **View > Show > Control**.
4. In the Camera view, click the Gradient's points and move them.

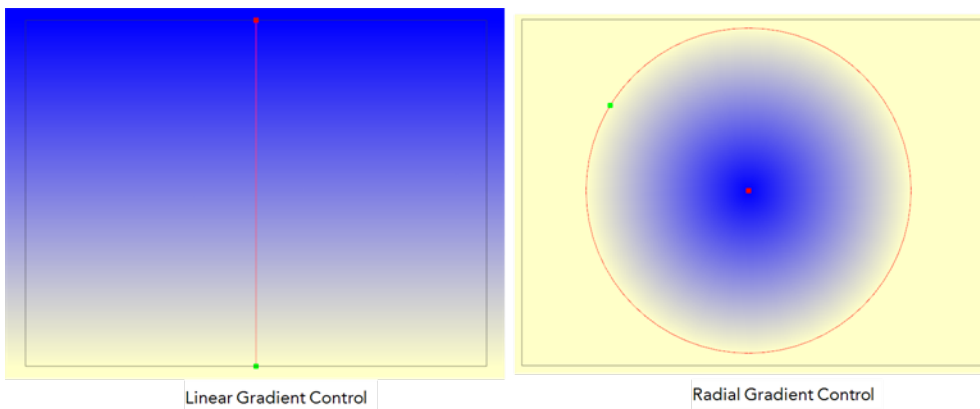

Grain

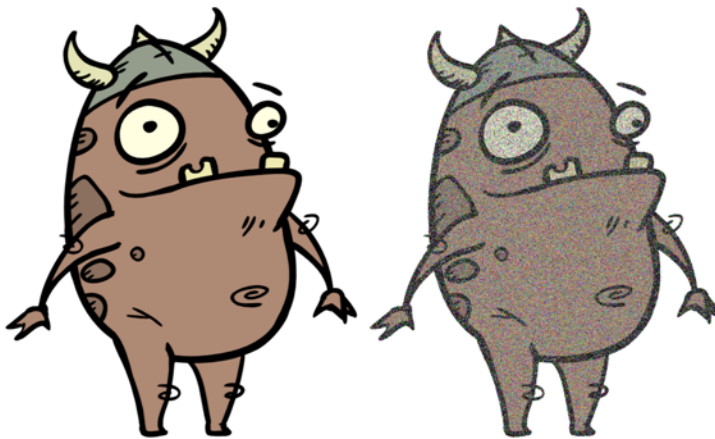

Use the Grain effect to add a film grain to an image; the film grain looks like video noise.

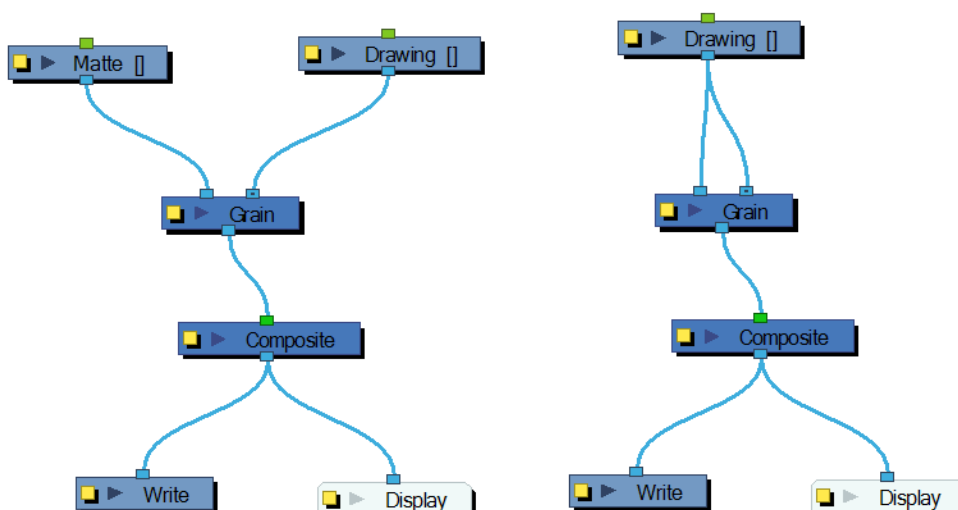

The Grain module has two input ports.

- On the left port, attach the element that will act as the matte defining the grain area.
- On the right port, attach the element on which you want to apply the grain effect.

Use the **Grain** editor to adjust the amount of grain to add to an image; you can also use it to adjust the sharpness or softness of the grain.

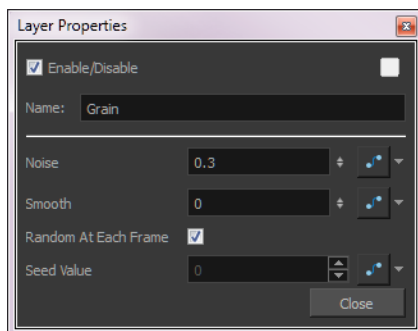

Parameter	Description
Noise	The amount of grain to add to the image based on the percentage of pixels to alter. The larger the value, the coarser the grain. The smaller the value is to 0 (zero), the finer the grain.
Smooth	The amount of blending to apply to the grain effect, based on the blur radius, to make the effect appear less pixelated. The larger the value, the greater the smoothing.
Random at Each Frame	Computes the colour shift in the grain using a different value at each composite. This means that your images will look different each time you render them. Deselect this option and select a Seed Value to ensure the same result every time you composite the grain effect.
Seed Value	This value corresponds to a unique pattern in the grain. If you want to retain this pattern in other frames, you can reuse this value.

Greyscale

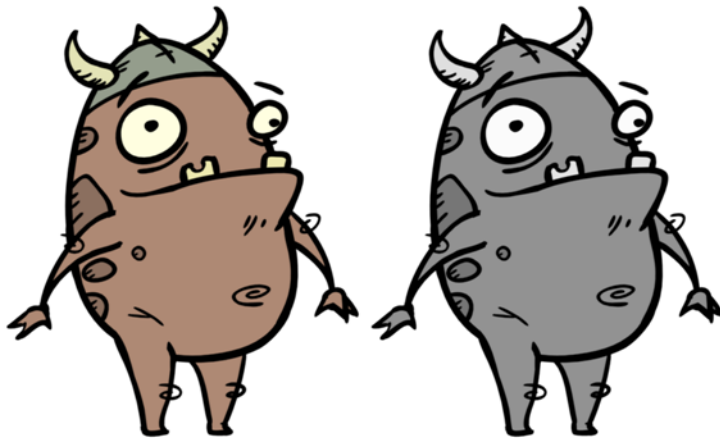

The Greyscale effect lets you convert a colour image to greyscale. This example demonstrates what happens when you set the greyscale to 100% using the Greyscale module. The Contrast module can also be used to adjust the darkness and lightness of the pixels in your element.

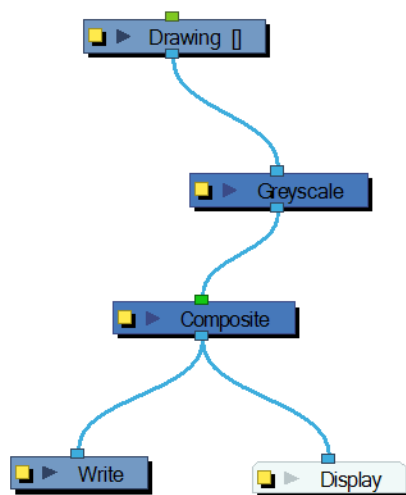

Use the Greyscale editor to enter the percentage of black and white to apply to the image. You can enter a static value in the Percent field or attach the value to a function curve to change over time.

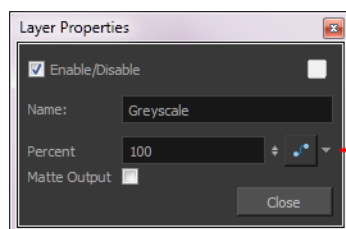

Use these menus to create a function curve and attach the Greyscale values to a function curve.

- **Matte Output:** When this option is activated, the colour values do not change. However, alpha values are read from the colours which you can see in the Camera view Matte View mode.

How to Use the Matte Output Option

You can see in this section a concrete example on how to use the Matte Output option of the Greyscale module. We created a frosted window using a snowflake image over a blue rectangle and a colourful background.

Here are the three drawings used for the example:

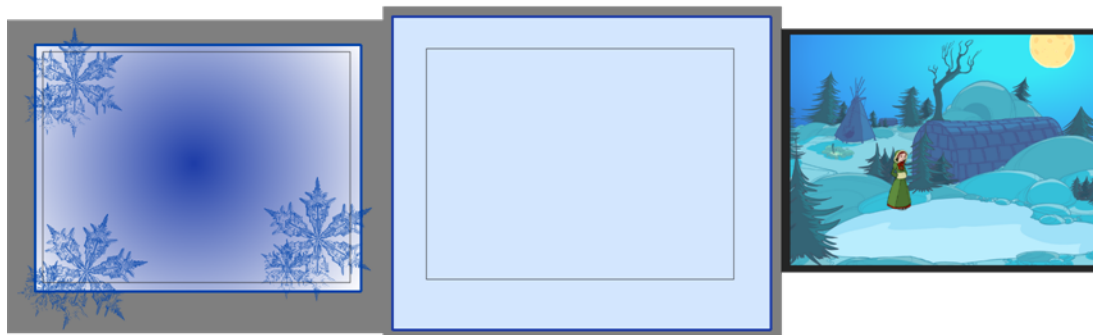

When the snowflake image is connected into the Greyscale module, it turns into a greyscale image. There is no transparency visible in the Camera view Matte View mode.

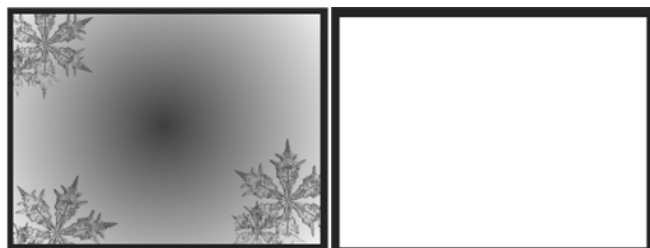

When the Matte Output option is enabled, the snowflake image colours are displayed as normal, but when the Matte View mode of the Camera view is enabled, you can see the transparency levels generated from the colour values.

When you connect the Snowflake images into a Cutter effect's Matte port along with the Window images, the window will be semi-transparent, matching the alpha (transparency) channel generated by the Greyscale module.

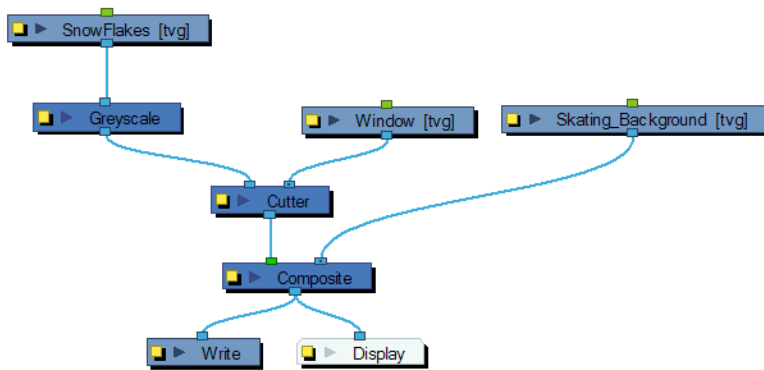

Grid / Field Chart

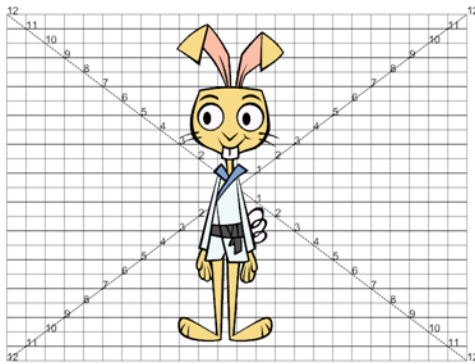

The Grid module displays a grid, in field chart unit, which allows you to position elements in the Camera view windows. The Grid is also referred to as the Field Chart.

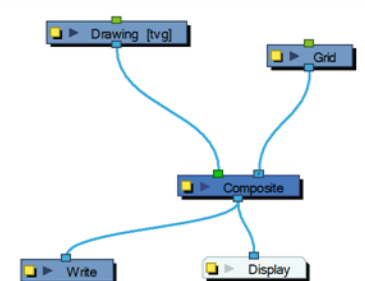

Use the Grid editor to control the quality and alignment of the field chart that appear in the Camera view.

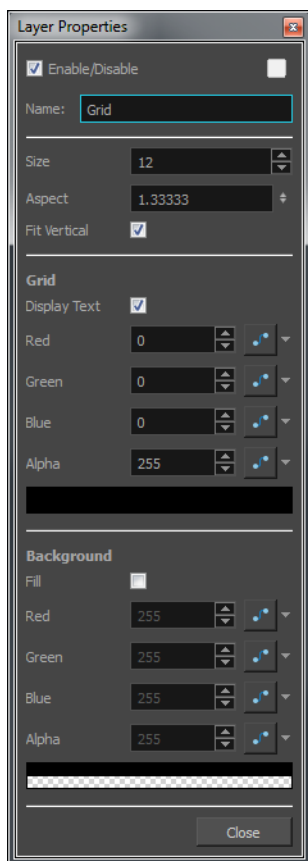

Click on these colour swatches to open the Colour Picker window and select a new colour.

Size

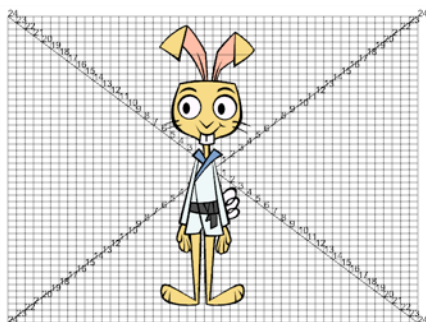

This parameter adjusts the amount of units in the grid (field chart). The grid size will always be a 4:3 ratio, as per traditional animation standards, but will adjust the camera frame width. You can change the grid to adjust to the camera frame by disabling the Fit Vertical option.

Display Text

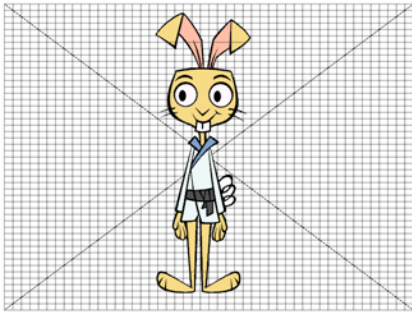

Disable this option if you only want to see the grid but not the numbers. Enable this option to see the number gradation.

Red/Green/Blue/Alpha

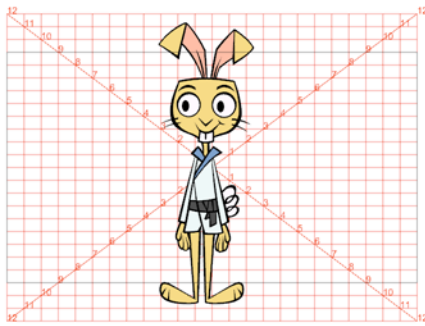

The colour and alpha values of the corresponding point. You can also click on the colour swatch to open the Colour Picker window and select a grid colour. You can click on the second colour swatch to open the Colour Picker window and select a background colour.

Fill

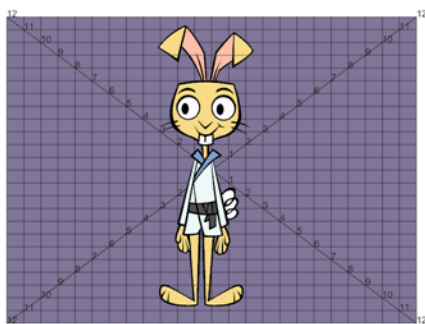

When selected, the grid's background becomes opaque. Nothing behind will be shown. You can also click on the second colour swatch to open the Colour Picker window and select a background colour.

Fit Vertical

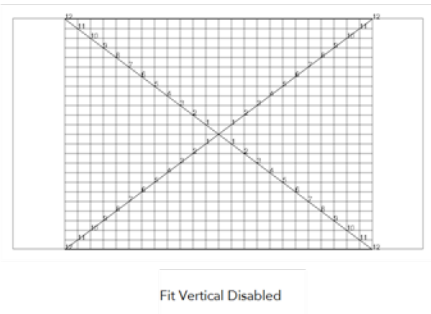
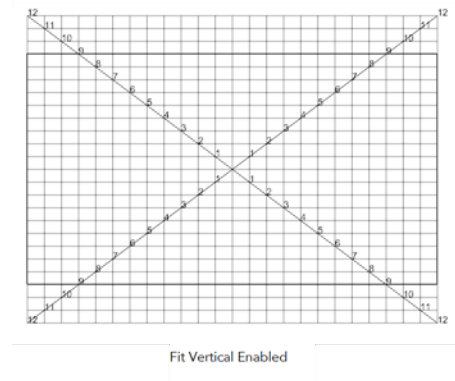

The grid size will adjust the camera frame. You can change the grid to either adjust to the camera width or height by disabling the Fit Vertical option.

Aspect Ratio

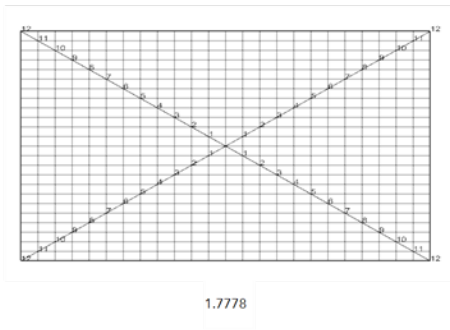
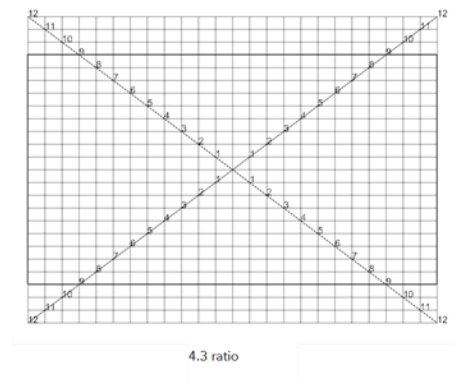

The grid size default format is 4:3 ratio, as per traditional animation standards, but will adjust the camera frame width. You can change the grid ratio by entering a new ratio in the Aspect Ratio field. You can find your scene ratio by selecting **Scene > Scene Settings**.

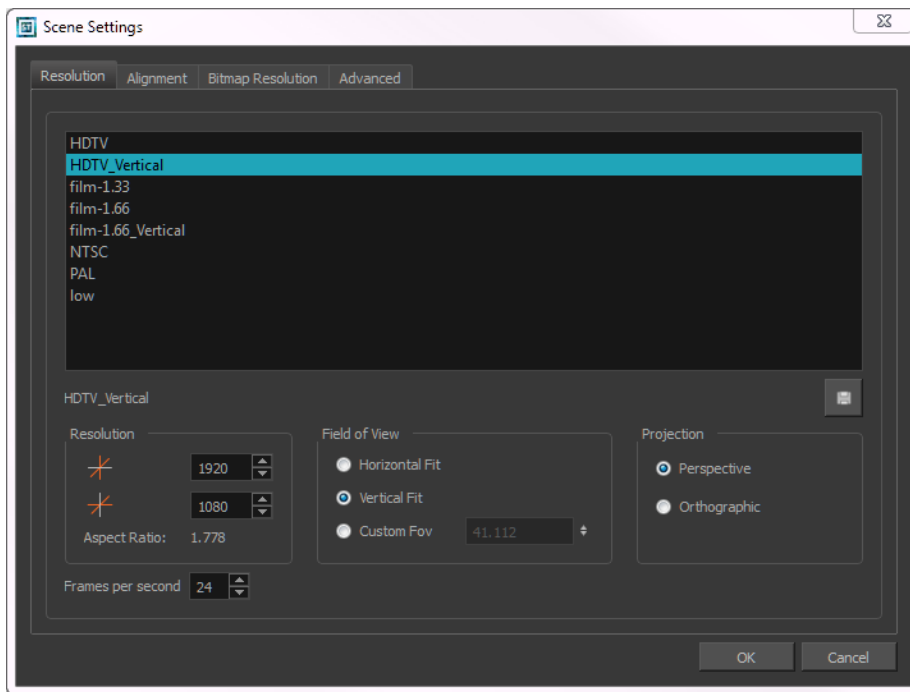

Highlight



Use the Highlight effect to turn a drawing's area lighter to simulate a light source. To produce the highlight effect, you must draw a shape to control where the highlight will appear on the original drawing.

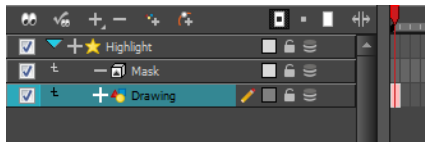

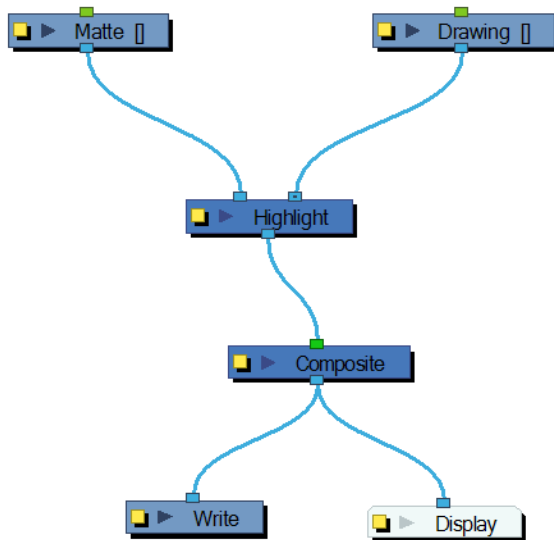

The Highlight effect uses a matte to determine the shape and position of the highlight on another element and can blur the edges to create a softer effect. Use the Highlight editor to control the type and amount of blur, as well as the colour of the highlight effect.

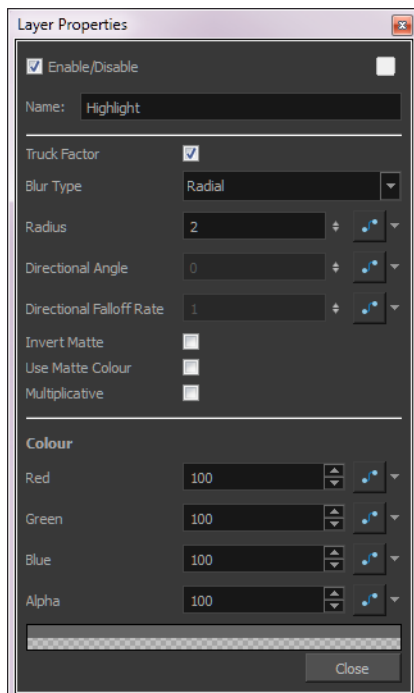

Highlight Effect Properties

Parameter	Description
Truck Factor	Activated by default, this option readjusts the blur when the elements undergo a change of depth or scale. When this option is deselected, the effect's values remain unchanged regardless of any depth or scale changes. This option should be deselected when multiple drawings are composited and attached to this effect.

Blur Type	<p>Directional: Blurs the matte in the direction you select. For example, if a character is walking east, the blur may fall to the west.</p> <p>Radial: Blurs the edges of the matte evenly around points that make up its edge.</p>
Radius	Enter a value for the size of the blur. The larger the value, the greater the blur effect. The blur radius is affected by the drawing scale and camera position.
Directional Angle	<p>If you select a Blur Directional type, you can select the direction of the blur by entering a value from 0 to 360 in this field.</p> <ul style="list-style-type: none"> ▶ 0: Blurs the image to the west. ▶ 90: Blurs the image to the south. ▶ 180: Blurs the image to the east. ▶ 270: Blurs the image to the north.
Directional Fall-off Rate	<p>The distance where the blur fades from the edge of the image. Select a value between 0 and 1.</p> <ul style="list-style-type: none"> ▶ A fall-off rate of zero causes the blur to fade out slowly, distributing the blur evenly from the edge of the character to the farthest edge of the blur. ▶ A fall-off rate of 1 causes the blur to fade out quickly so that the blur is heaviest closer to the edge of the image.
Invert Matte	Inverts the matte used to create the glow. The matte will become a black silhouette while the glow fills the background space.
Use Matte Colour	Uses the colours in the matte for the highlight effect. If you deselect this option, select a colour and alpha values in the Colour section.
Multiplicative	Creates a more diffused glow.
Colour	Lets you choose the colour and alpha values for the glow effect.

Hue-Saturation



The Hue-Saturation effect lets you adjust the hue, saturation and lightness values individually or by using the HLS picker or Hue Range picker. You can achieve effects over the entire image, such as a sepia tone. Changes you make to the values are additive to the final image.

For detailed video tutorials and sample scenes by Adam Phillips, see toonboom.com/resources/video-tutorials/chapter/adam-phillips-harmony-effects.

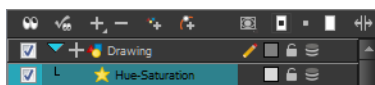
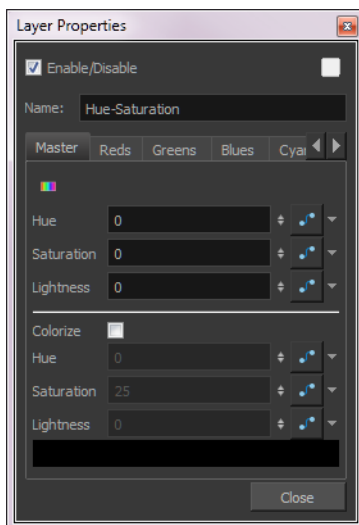

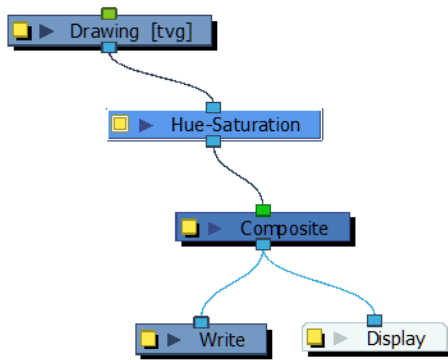

Hue-Saturation Effect Properties

Parameter	Description
Master	<p>Allows you to remap all the colours at the same time using the Hue, Saturation and Lightness fields.</p> <p>Note: When using the Master parameters, the Colorize parameters are disabled.</p>
	<p>Opens the Hue Range Picker which displays the original colour spectrum of the image in the top bar and the new colour spectrum in the bottom bar. The Saturation and Lightness in the upper bar can range from -100 to 100, allowing you to decrease the original values.</p> <div data-bbox="630 1108 1230 1323" style="border: 1px solid gray; padding: 5px; margin: 10px 0;"> </div>
Colourize	<p>Lets you set the hue, saturation, and lightness by entering values or by using the HSL Picker. In the Colorize mode, Lightness can range from -100 to 100.</p>



	 <p>Select a colour by moving the colour picker.</p> <p>Note: When using the Colourize parameters, the Master parameters and other colour tabs are disabled.</p>
Hue	The colour or hue of the image.
Saturation	The amount of colour in the image.
Lightness	The brightness of the image.
Colour Swatch	Opens the HLS Picker where you can specify the colour.
Tabs	Reds, Greens, Blues, Cyans, Magentas, Yellows
	<p>Opens the Hue Range Picker. The top bar displays the colour spectrum with arrows for defining the colour range more precisely. The triangles indicate the falloff of the effect, which you can also adjust.</p>  <p>Specify the hue as an angle from 0° to 360° that corresponds to a location on the color wheel. Specify saturation and lightness (B) as percentages (0 to 100).</p>
Reset Range	Resets only the range of hue values over which the effect is applied, i.e. the arrows and triangles. The HSL adjustments are maintained.

Image Switch



Original image

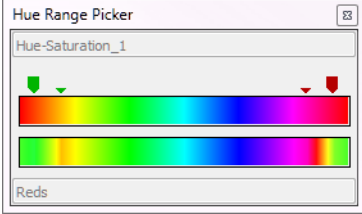
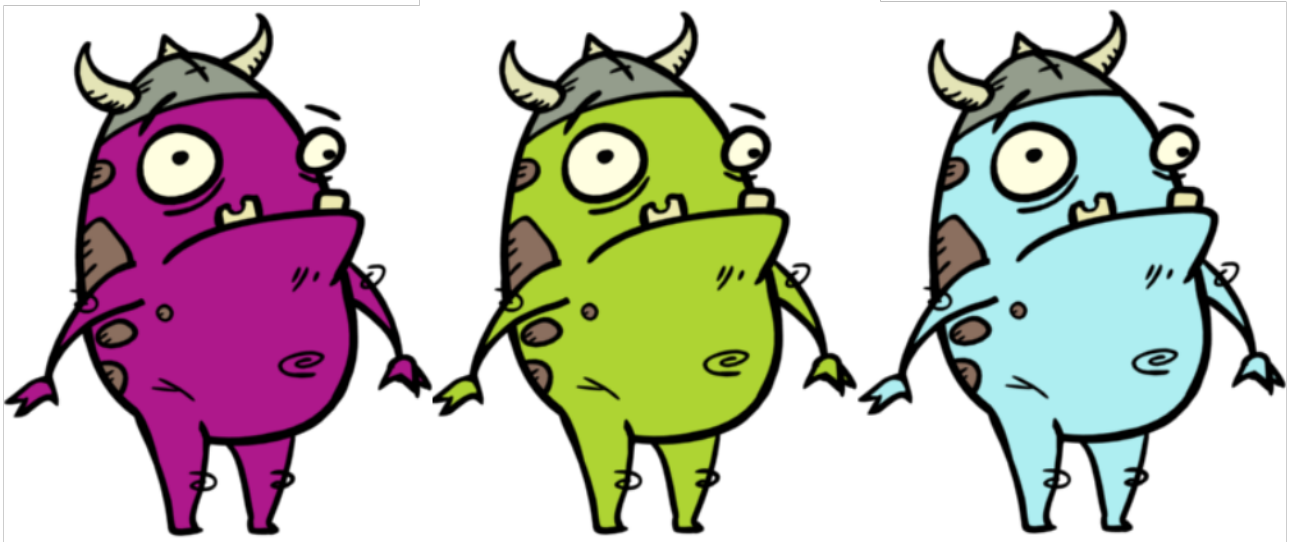

The character's skin was changed with a Colour Override effect to obtain multiple versions of a character.

The Image Switch effect lets you use multiple effects, such as Colour Override, and choose which port will be sent to rendering if you want to apply different variations of an effect that cannot be changed over time. You then create multiple separate versions of the effect, connect them all to the Image Switch, and then if you want to change to a different version of the effect at different points in your scene, you would add a curve and animate the port number. Image Switch simply lets you change over time which port is being rendered.

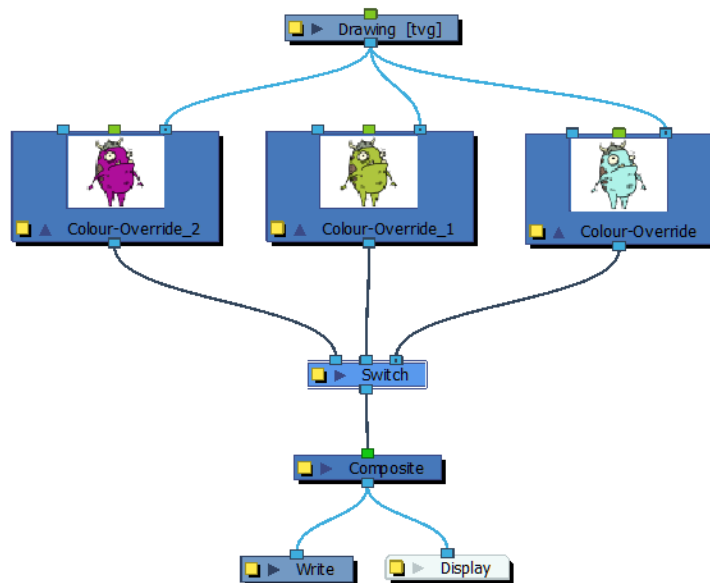
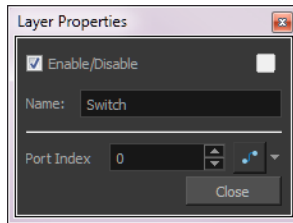



Image Switch Effect Properties

Parameter	Description
Port Index	<p>Switches from one image to another. There is no gradual animation from one colour to another as you are only changing (over time) which port will be rendered. Use whole values.</p> <p>Click the Function  button to open the Function editor to animate a parameter over time—see .</p>

Layer Selector



Use the Layer Selector effect to isolate and display one or several drawing layers:

- Overlay
- Line Art
- Colour Art
- Underlay

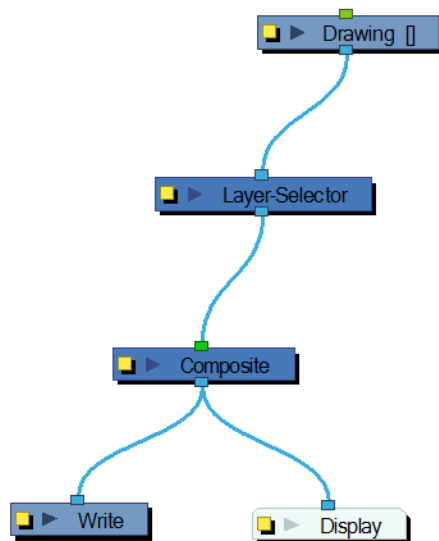

Use the Layer Selector editor to select the desired layers.

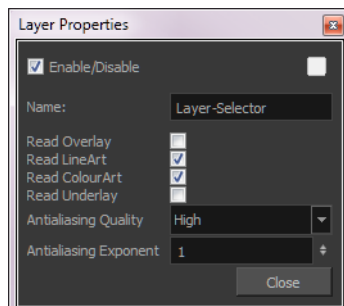

- **Antialiasing Quality:** Smoothness setting applied to Overlay art layer. Choose from Low (no antialiasing), Medium Low, Medium and High (extensive antialiasing). The higher the quality of the chosen setting, the greater the amount of antialiasing that is applied. Higher quality images require more time to render and more memory from your system.
- **Antialiasing Exponent:** Controls the amount of area around the Overlay art layer edges that is used in the antialiasing process. A higher value uses less area, resulting in sharper edges, while a lower value uses more area, resulting in softer edges. If the Antialiasing Quality value is set to Low (no antialiasing), this value is ignored.

Lens Flare

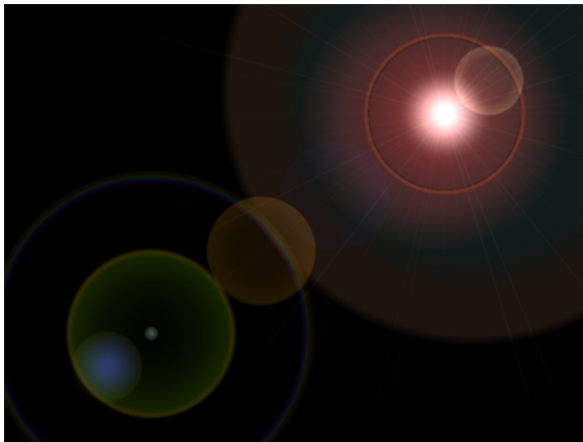

Circular lens flare

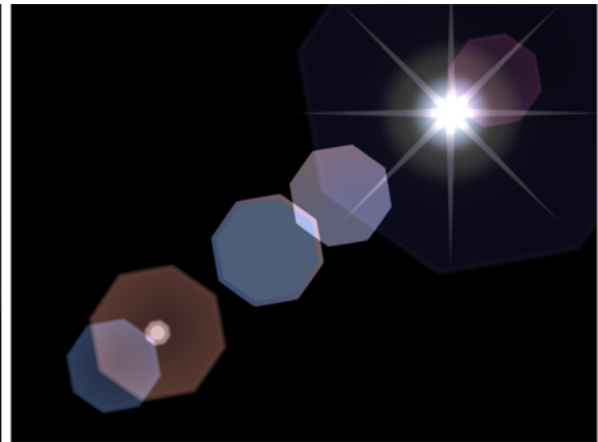

Hexagonal lens flare

The Lens Flare effect simulates the refraction caused by shining a bright light into a camera lens. The shape of the lens flare can be circular or hexagonal.

For detailed video tutorials and sample scenes by Adam Phillips, see toonboom.com/resources/video-tutorials/chapter/adam-phillips-harmony-effects.

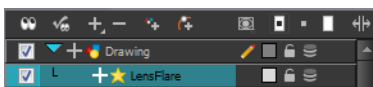
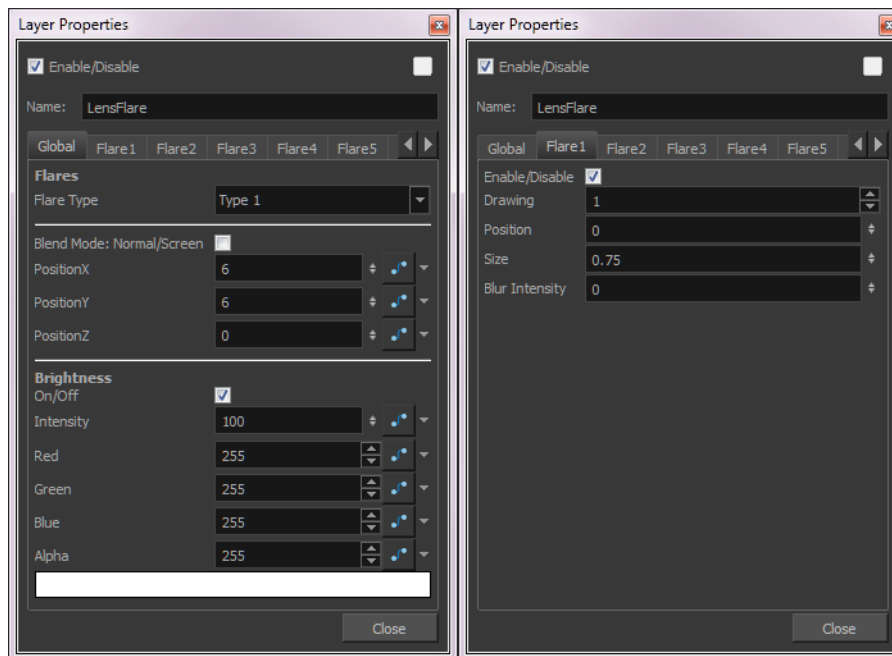

Here is how a typical lens flare can be set up:

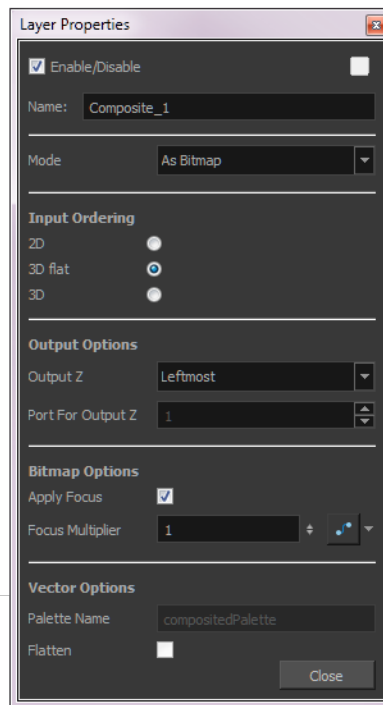
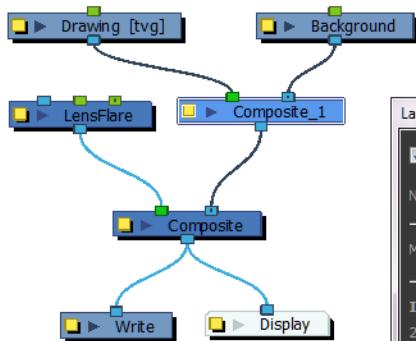
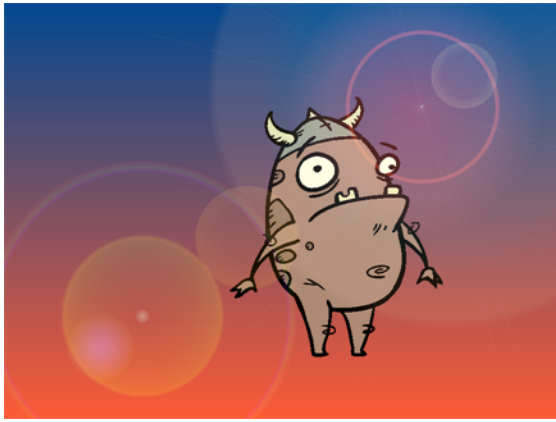

Lens Flare Effect Properties

Parameter	Description
Flares	
Flare Type	Custom: Lets you use your own custom art or drawing. Type 1: Circular lens flare. Type 2: Hexagonal lens flare.
Blend Mode: Normal/Screen	Lets you apply a normal or screen blending mode to the image. Normal: When selected, this operation will not create any blending mode effect.

	Screen: When deselected, this operation multiplies the inverted colour of the blending element with the image. This lightens the colour of the overlapping area. Screen is the default blending mode.
Position X, Y, Z	Lets you precisely orient the flare in the x, y, and z axes.
Brightness	
Intensity	The strength of the lens flare.
Red	Red values of the image.
Green	Green values of the image.
Blue	Blue values of the image.
Alpha	Alpha values of the image.
Colour Swatch	Opens the Colour Picker where you can specify the colour of the main flare.
Flare 1–10	Lets you create custom lens flares by associating them with specific drawings. You can create up to 10 different flares.
	<p>Drawing: Lets you specify a drawing to use for the flare.</p> <p>Position: The position of the flare.</p> <p>Size: The size of the flare.</p> <p>Blur Intensity: The strength of the flare.</p>

Line Art

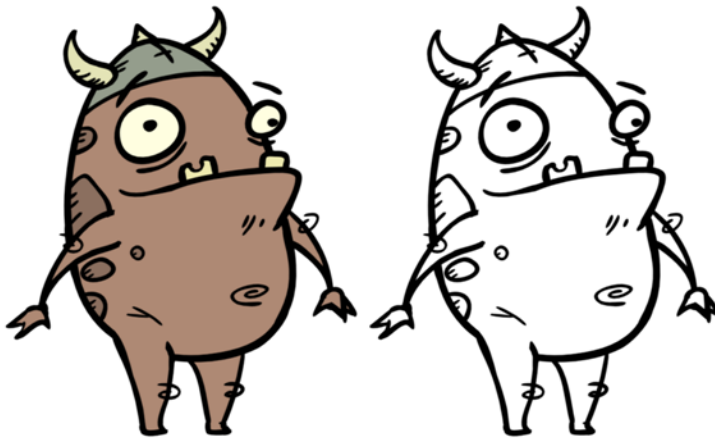

Use the Line Art effect to read only the Line Art in an element. Place a Line Art module after a drawing module in the Network view to display only the module's Line Art output. The Line Art module can only be connected after a vector Drawing layer or a vector type Composite module. Any bitmap information will not be processed.

This effect will only work if the user drew or painted something into the Line Art layer of the drawing.

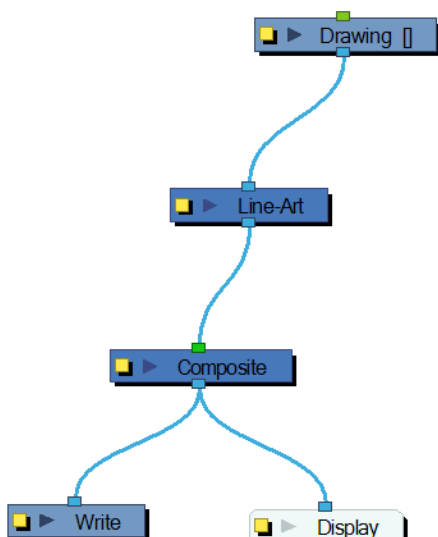

Use the Line Art editor to control how the Line Art is rendered by the module.

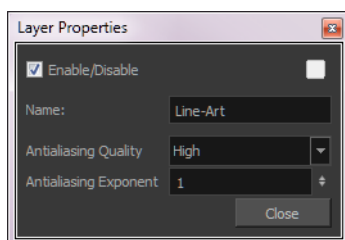

- **Antialiasing Quality:** Smoothness setting applied to Overlay art layer. Choose from Low (no antialiasing), Medium Low, Medium and High (extensive antialiasing). The higher the quality of the chosen setting, the greater the amount of antialiasing that is applied. Higher quality images require more time to render and more memory from your system.
- **Antialiasing Exponent:** Controls the amount of area around the Overlay art layer edges that is used in the antialiasing process. A higher value uses less area, resulting in sharper edges, while a lower value uses more area, resulting in softer edges. If the Antialiasing Quality value is set to Low (no antialiasing), this value is ignored.

Matte-Blur

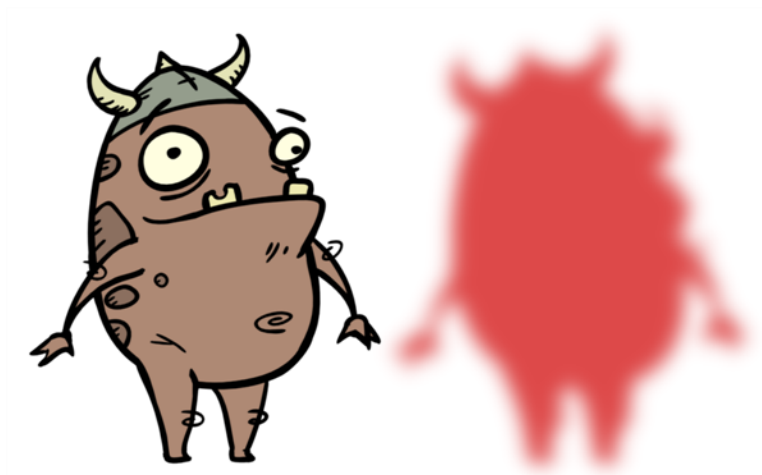

Use the Matte-Blur effect to blur a matte or change its colour. Here is an example of a network with the result of a Matte-Blur effect.

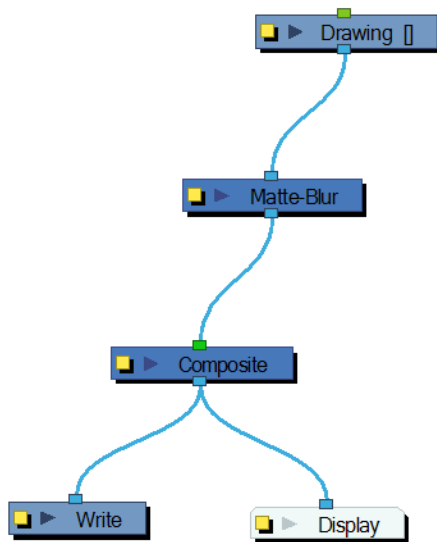

Use the Matte-Blur editor to control the output of the module.

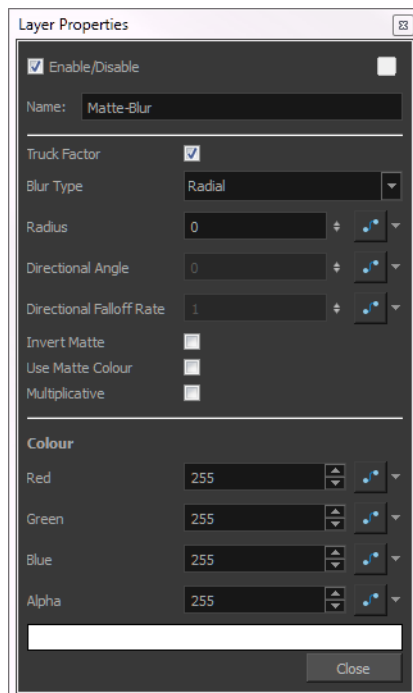

Matte-Blue Effect Properties

Parameter	Description
Truck Factor	Activated by default, this option readjusts the blur when the elements undergo a change of depth or scale. When this option is deselected, the effect's values remain unchanged regardless of any depth or scale changes. This option should be deselected when multiple drawings are

	composited and attached to this effect.
Blur Type	<p>Directional: Blurs the matte in the direction you select. For example, if a character is walking east, the blur may fall to the west.</p> <p>Radial: Blurs the edges of the matte evenly around points that make up its edge.</p>
Radius	Enter a value for the size of the blur. The larger the value, the greater the blur effect. The blur radius is affected by the drawing scale and camera position.
Directional Angle	<p>If you select a Blur Directional type, you can select the direction of the blur by entering a value from 0 to 360 in this field.</p> <ul style="list-style-type: none"> ▶ 0: Blurs the image to the west. ▶ 90: Blurs the image to the south. ▶ 180: Blurs the image to the east. ▶ 270: Blurs the image to the north.
Directional Fall-off Rate	<p>The distance where the blur fades from the edge of the image. Select a value between 0 and 1.</p> <ul style="list-style-type: none"> ▶ A fall-off rate of zero causes the blur to fade out slowly, distributing the blur evenly from the edge of the character to the farthest edge of the blur. ▶ A fall-off rate of 1 causes the blur to fade out quickly so that the blur is heaviest closer to the edge of the image.
Invert Matte	Inverts the matte used to create the glow. The matte will become a black silhouette while the glow fills the background space.
Use Source Colour	Uses the colours painted in the matte for the glow effect. If you deselect this option, select a colour and alpha values in the Colour section.
Multiplicative	Creates a more diffused glow.
Colour	Lets you choose the colour and alpha values for the glow effect.

If you select the Pass Through option in the Layer Properties of a Composite where this effect is connected, the effect will be multiplied in areas where the drawing elements that the effect is acting on overlap.

Matte-Resize

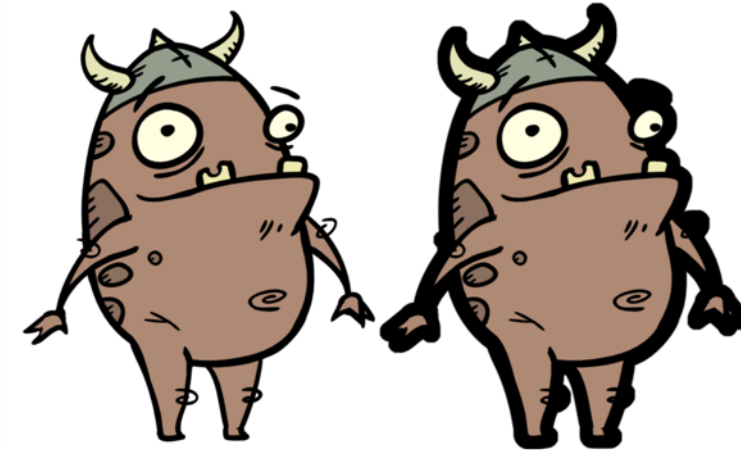

Use the Matte-Resize effect to evenly expand a matte outward in all directions. The Matte-Resize module increases the size of a matte from its centre. Here is an example of a network with the result of a Matte-Resize effect.

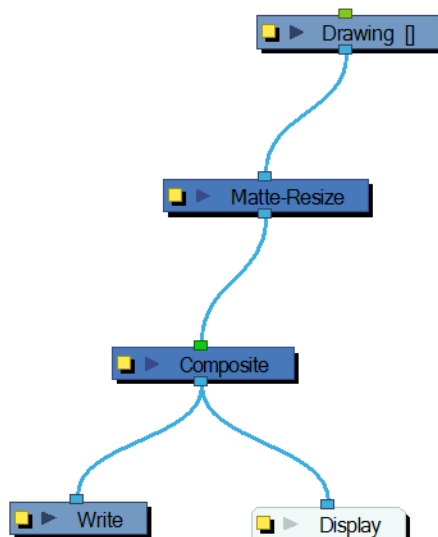

If you use the Matte-Resize module to create a pulsating glow you can enlarge the region without softening the edges. Using the Blur-Radial effect, the effect may be softer than you intend. This module produces a limited antialiased matte, which can have slightly jagged edges. You could use this module in combination with other modules, such as:

- Tone
- Highlight
- Glow
- Shadow
- Matte-Blur

In the Layer Properties, you can enter a static value for the Radius of the resize operation. You can also attach the Radius value to a function column to change the value over time.

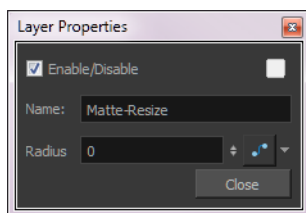

Mesh Warp

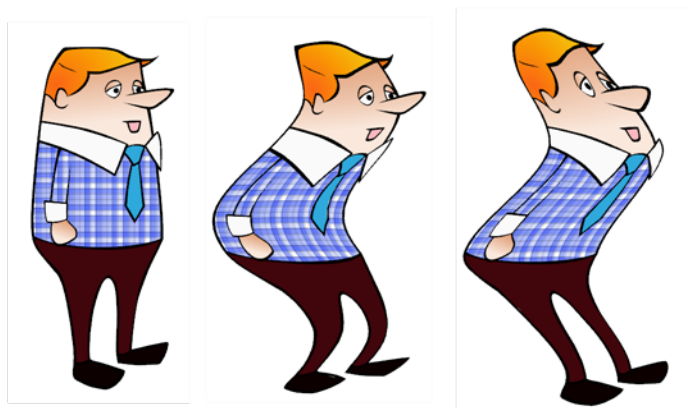

Use the Mesh Warp effect to distort your drawings. With this module you can create effects such as a character in a warped mirror and looking through a glass jar. You can also animate the position of the grid to perform the distortion over time.

The Mesh Warp module is a position module, same as a Peg module.

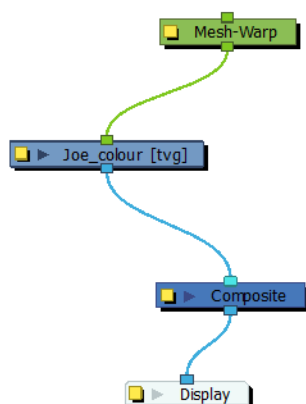

How to use the Mesh Warp Effect

1. In the Module Library, under the Filter tab, select the Mesh Warp module and drag it to the Network view.
2. In the Network view, connect the Mesh-Warp module to your drawing or group modules to deform.

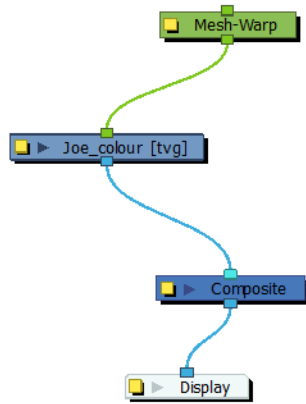

3. In the Network view, select the Mesh Warp module.
4. Select **View > Show > Control** or press Shift + F11 (Windows/Linux) or ⌘ + F11 (Mac OS X) to display the deformation grid.

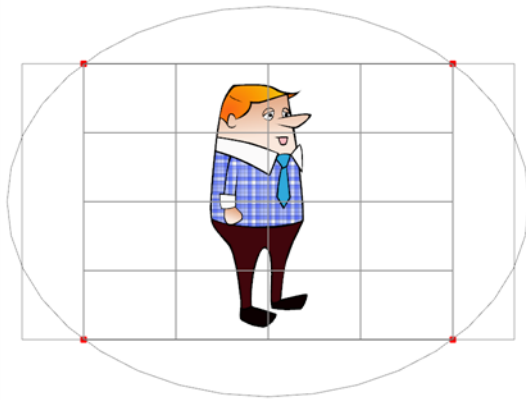

5. Move the intersection points and move the Bezier handles to deform the grid.

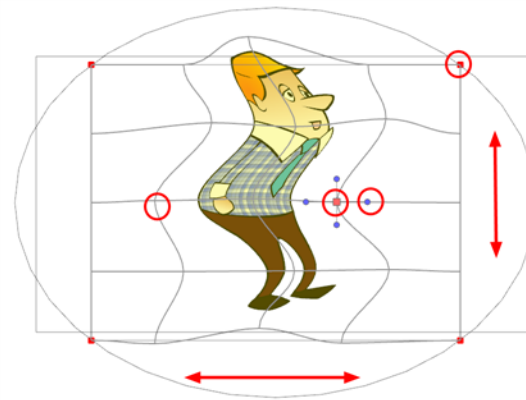

6. Grab the grid in the void spaces to pan it around. Using keyframes, you can animate its position over time.

Mesh Warp Properties

Use the Mesh Warp editor to adjust the grid size, deformation quality and the region of interest.

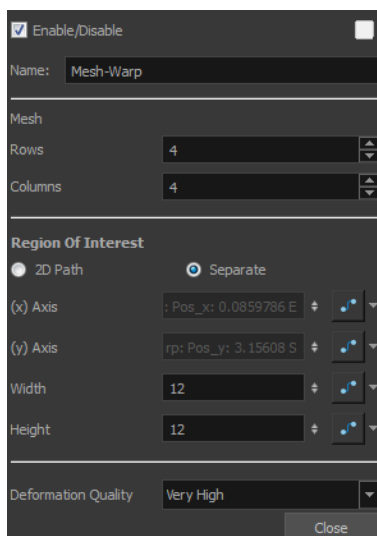

Parameter	Description
Rows	Increase or decrease the Rows value to change the amount of rows to use in the deformation grid.
Columns	Increase or decrease the Columns value to change the amount of columns to use in the deformation grid.
Region of Interest	Select the 2D Path option if you want both your X and Y curves to be controlled by the same velocity function. Select the Separate option if you want your X and Y curves to be independent and have independent velocity.
(x) Axis	This is the X position of the grid. This value can be animated overtime to move the grid horizontally.
(y) Axis	This is the Y position of the grid. This value can be animated overtime to move the grid vertically.
Width	This is the width value of the grid. This value can be animated overtime to squash or stretch the grid horizontally.
Height	This is the height value of the grid. This value can be animated overtime to squash or stretch the grid vertically.
Deformation Quality	This is the quality of the warm deformation. It ranges from Low to Extreme. The higher the quality, the better the formation will look, but the longer it will take to render.

Motion-Blur

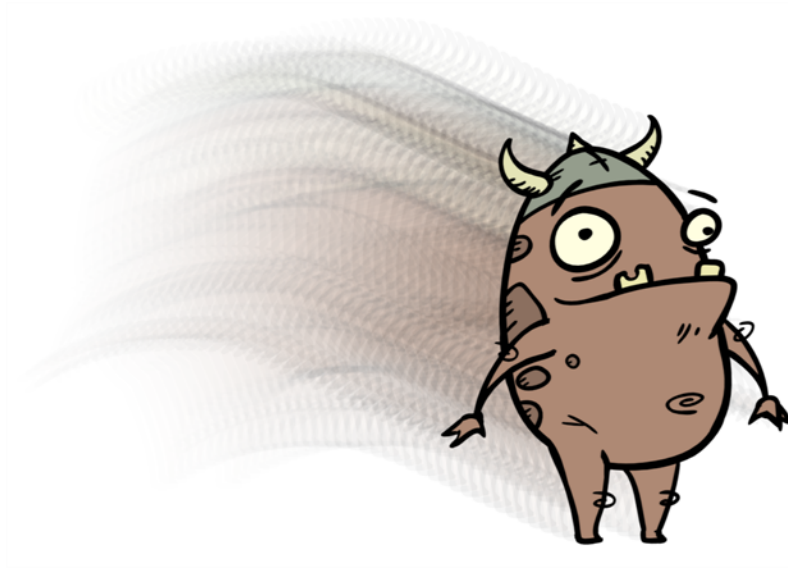

The Motion-Blur effect is used to create a faded trail behind objects animated on a motion path. You cannot create a Motion-Blur on a hand-drawn animation. The layer must be moving along a trajectory (motion path) in order to work properly.

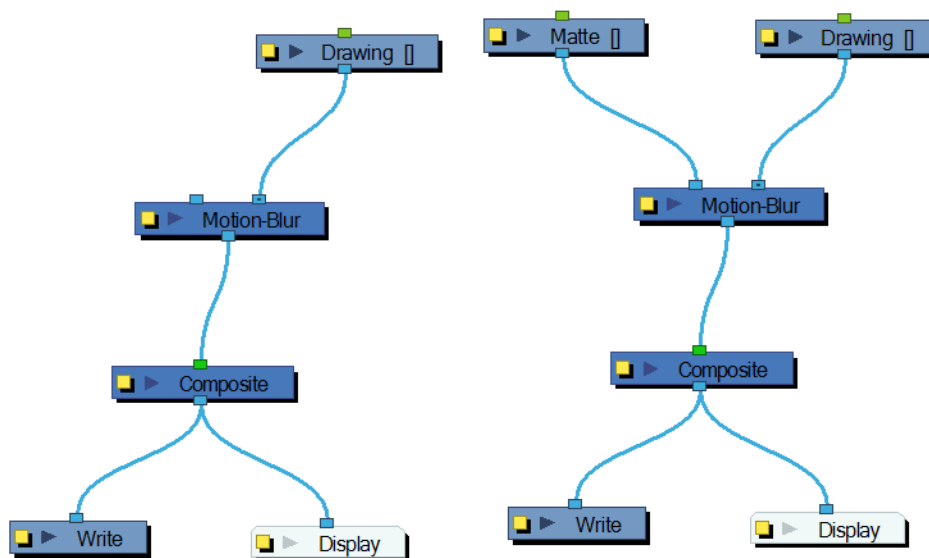
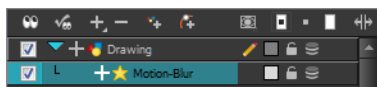

The Motion-Blur effect automatically creates a matte for the drawing layer attached to it, so it is not necessary to connect any matte into the Mask layer.

Use the Motion-Blur editor to modify the motion blur, crowd simulation or particle system effect.

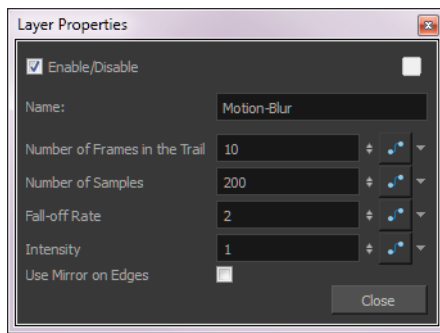

Motion-Blur Effect Properties

Parameter	Description
Number of Frames in Trail	Number of frames before the current frame that will be used in the trail.
Number of Samples	Number of copies of each drawing used in the trail. The higher the number, the more continuous the trail appears.
Fall-off Rate	<p>The distance where the blur fades from the edge of the image. Select a value between 0 and 1.</p> <p>A fall-off rate of 0 causes the trail to fade out slowly, distributing the colour evenly from the edge of the character to the farthest edge of the trail.</p> <p>A fall-off rate of 1 causes the trail to fade out quickly so that the trail is more opaque closer to the edge of the image and transparent at the end of the trail.</p>
Intensity	Select a value to define the opacity of the trail between 0 and 10. A value of 10 will make the trail very dark and almost opaque, where as a value of 0 will make the trail quite pale and ghostly transparent.
Use Mirror on Edges	When enabled this option appear when the image is close to the edge of the camera frame. It forces the software to use a mirror of the image to calculate the blur so that it appears on both sides of the drawing object. Without this option once your drawing reaches the edge of the Camera frame, it gets cropped so does the trail.

Multi-Port-In

A Multi-Port-In module is added by default in a new Group module. Use it to add one or more input ports to the Group module so that you can process an image through the modules in the Group module.

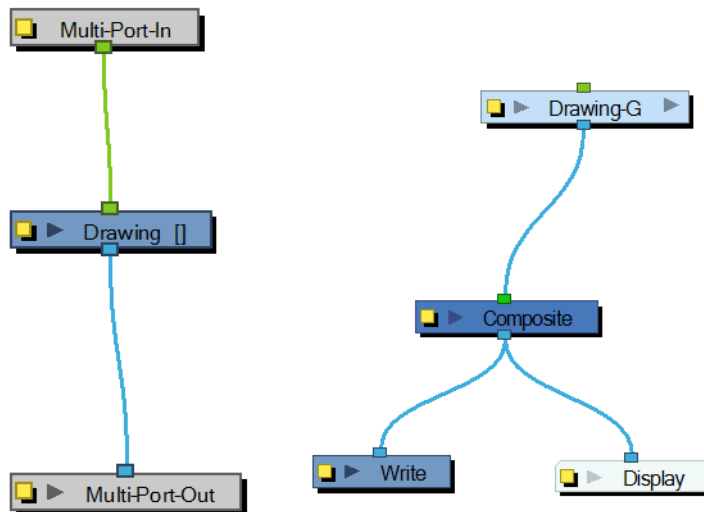

When you plug an element to a Multi-Port-In module, an input port appears at the top of the Group module. You can add additional ports to the modules as needed.

Pass your cursor over the Group module input port to see the name of the Port Image In module that it connects to. You will notice that the Group module in these examples has no output port. It requires a Multi-Port-Out module to output data from its network.

A Multi-Port-In is automatically added when you create a group.

Use the Multi-Port-In editor to rename the module.

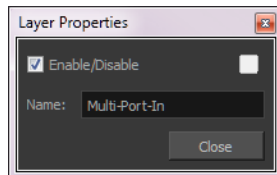

Multi-Port-Out

A Multi-Port-Out module is added in a new Group module by default. Use it to add output ports to the Group module so that you can output the result of the group operation to the rest of the network. After you plug an element to a Multi-Port-Out module, an output port appears on the bottom of your Group module. You can add additional output ports as needed.

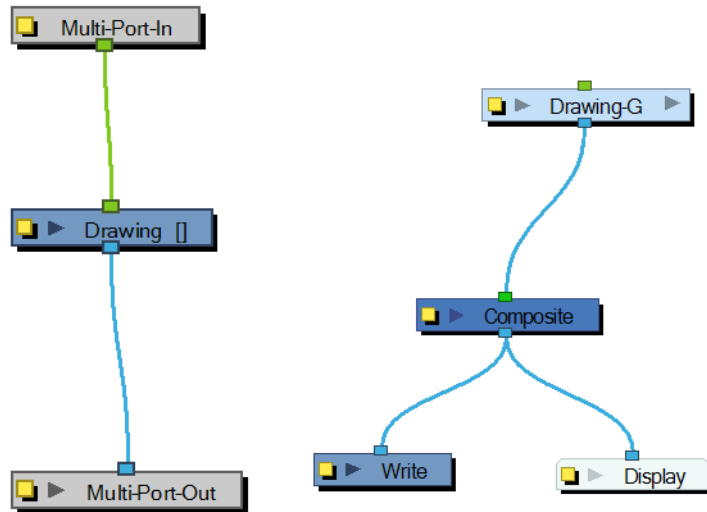

A Multi-Port-Out is automatically added when you create a group. Use the Multi-Port-Out editor to rename the module in the network.

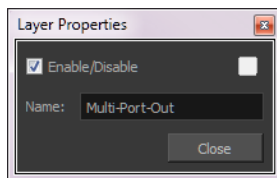

Negate



Use the Negate effect to invert the colour and/or alpha values in the Colour Art and Line Art of an image. The Negate module subtracts the original value of each channel (RGB or A) from the maximum value of that channel (255 for 8-bit channels) to produce the negative image.

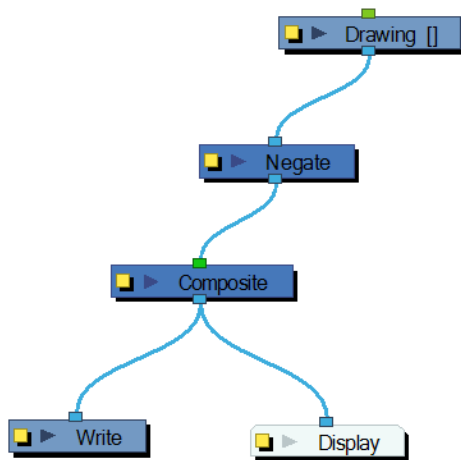

Use the Negate editor to select the colour and/or alpha values to invert.

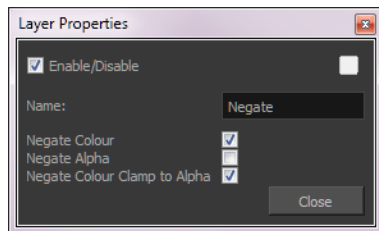

Negate Effect Properties

Parameter	Description
Negate Colour	Inverts the values of the colour channels.
Negate Alpha	Inverts the transparency value (alpha channel).
Negate Colour Clamp to Alpha	Limits the negated area to the alpha channel.

Note

The Note module allows you to record any textual information that is relevant to your project. Use its editor to enter comments, suggestions or reminders. Note modules can be added anywhere in the network, including in groups.

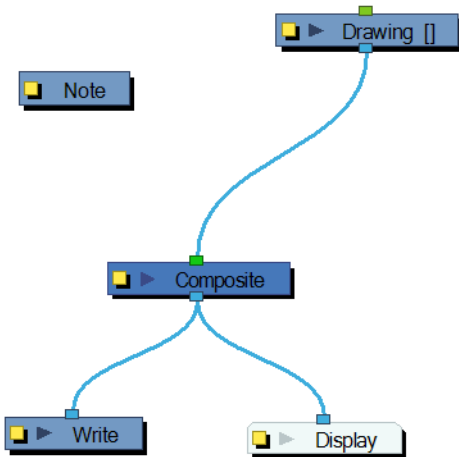

Use the Note editor to add or update relevant notes with any textual information.

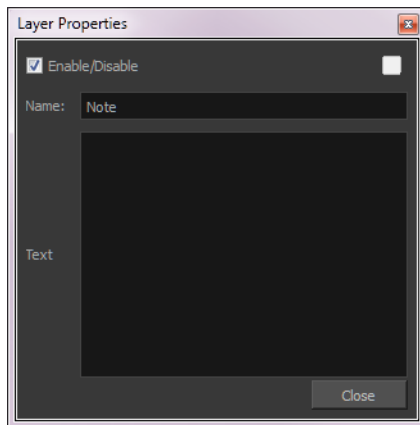

Overlay Layer

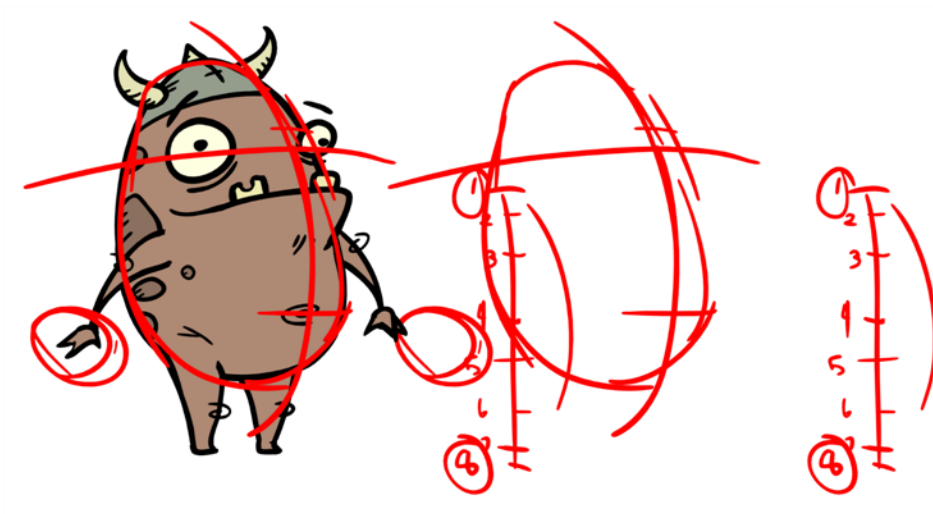

Use the Overlay Layer effect to read only the Overlay layer in an element. Place a Overlay Layer module after a drawing module in the Network view to display only the module's Overlay layer output. The

Overlay Layer module can only be connected after a vector drawing layer or a vector type Composite module. Any bitmap information will not be processed.

This effect will only work if the user drew or painted something into the Overlay layer of the drawing.

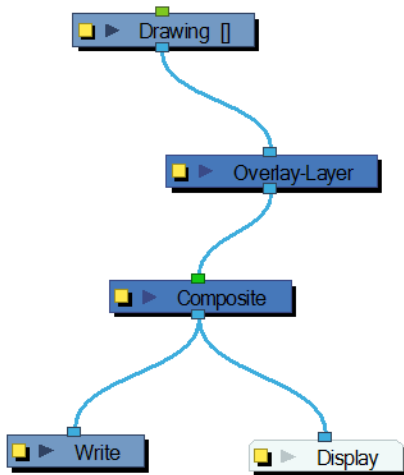

Use the Overlay Layer editor to control how the Overlay layer is rendered by the module.

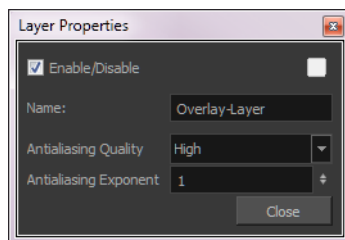

- **Antialiasing Quality:** Smoothness setting applied to Overlay art layer. Choose from Low (no antialiasing), Medium Low, Medium and High (extensive antialiasing). The higher the quality of the chosen setting, the greater the amount of antialiasing that is applied. Higher quality images require more time to render and more memory from your system.
- **Antialiasing Exponent:** Controls the amount of area around the Overlay art layer edges that is used in the antialiasing process. A higher value uses less area, resulting in sharper edges, while a lower value uses more area, resulting in softer edges. If the Antialiasing Quality value is set to Low (no antialiasing), this value is ignored.

Pixelate

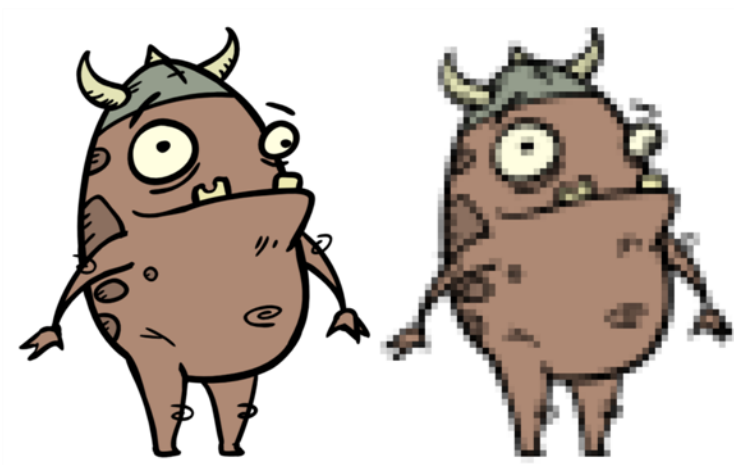

The Pixelate effect lets you apply a mosaic effect to an image (and its matte) based on the matte you supply. Pixelation makes the image look like it is made up of square tiles.

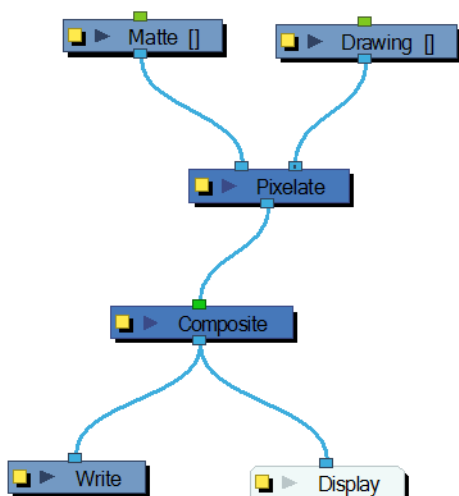

There are two input ports on the Pixelate module:

- The left port receives the matte
- The right port receives the image

Use the Pixelate editor to control the amount (Factor) the image is pixelated. You can attach the Factor value to a function curve to change the value over time.

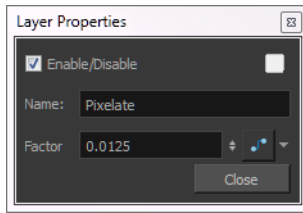

Placeholder

Use the Placeholder module in a network when you are either unsure of which module you will put in its place or if you want to lay out a custom network for future use.

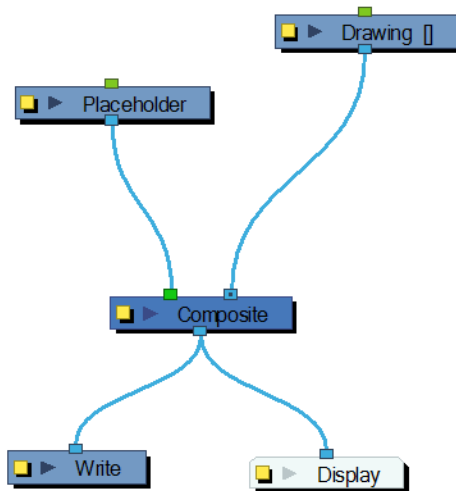

Use the Placeholder editor to rename the module.

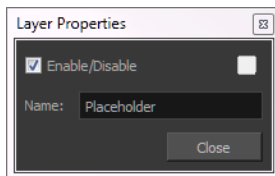

Quadmap



Use the Quadmap transformation layer to deform the shape of an element. For example, you can use it to create a drop-shadow effect on an element.

You can edit the Quadmap visually in the Camera view.

How to edit the Quadmap in the Camera view

1. In the Timeline view, click the Add Layer  button and select **Quadmap**.
2. Do one of the following:
 - Connect the Quadmap layer to the drawing layer that you want to deform.
 - In the Network view, add a Quadmap module and connect it above the drawing element module that you want the effect to act on.

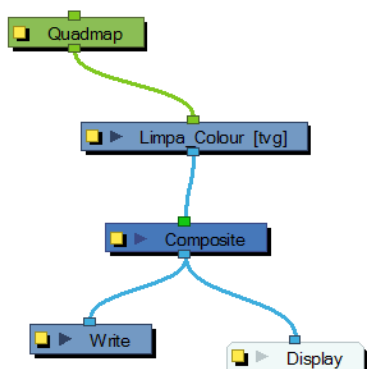
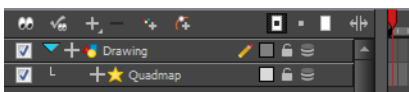

3. In the Tools toolbar, disable the Animate mode to change the value for the Quadmap over the entire duration of the element.
4. In the Timeline view, click on the Quadmap layer to select it.
5. From the top menu, select **View > Show > Control** or press Shift + F11.
The quadmap handles appear around the element in the window. There is also a pivot point at the centre of the quadmap frame that you can reposition.
6. In the Camera view window, use the Transform tool to move the points on the quadmap. Shift + click to select multiple points.

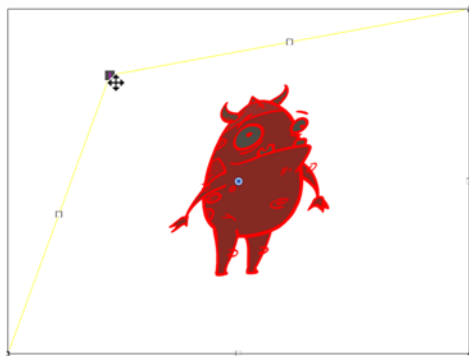

The value of each point on the quadmap can be changed gradually. To do this, use the Quadmap module Layer Properties to attach the points to function curves.

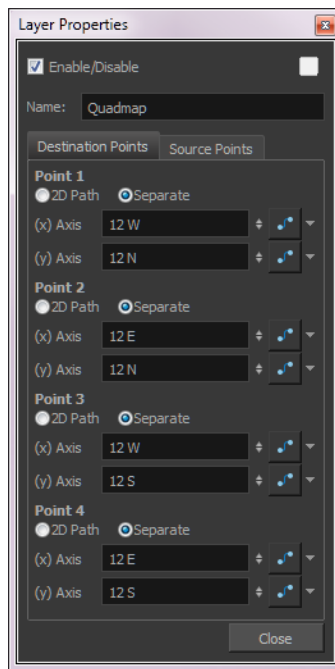

Only the X and Y values of each point in the quadmap can be changed.

- **2D Path:** change the X and Y values simultaneously and control the velocity of the change.
- **Separate:** change the X and Y values separately. Each of these can be attached to separate function curves.

Refract

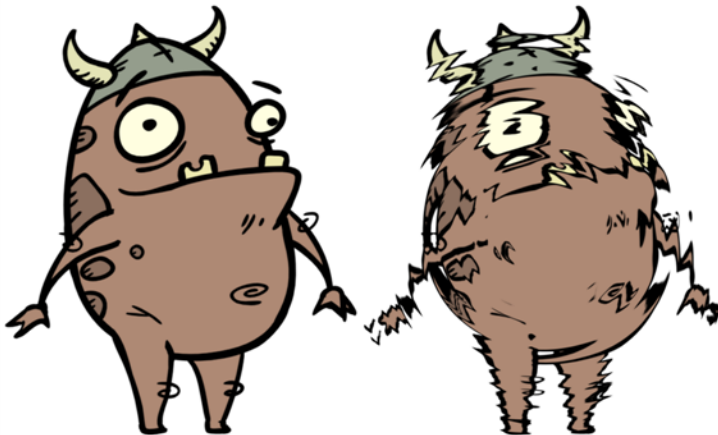

Use the Refract effect to create effects such as ripples and heat haze. This effect is based on the refraction of light, which occurs when a beam of light passes through media of different density, causing the light to refract or change angles. This effect makes objects appear distorted or offset from their actual positions. If you imagine an object in a pool of water the part beneath the surface of the water appears offset from its true position.

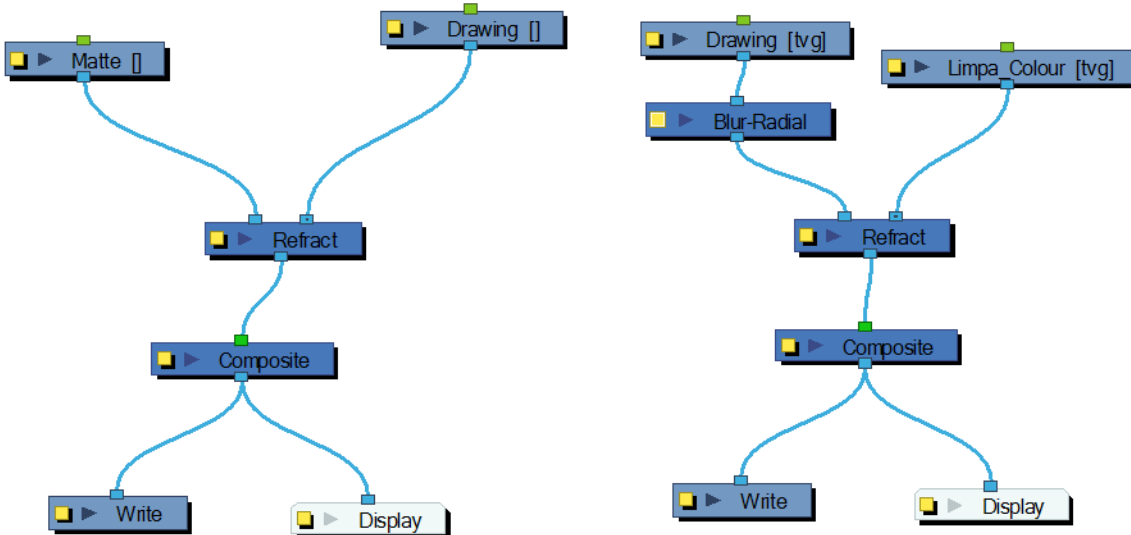

To create a refraction effect, you need a matte with alpha values. This creates the effect of a volume passing over an image, refracting the light that bounces off the contents below. For a ripple effect moving across an image, you must move the matte with a Peg layer.

If your matte is only black and white, meaning that there is no gradients and only solid colours in your matte drawing, you will need to connect a Blur Radial module after your matte Drawing module to soften the edges and get nicer waves.

Use the Refract editor to control the effect.

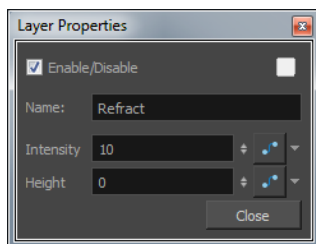

- **Intensity:** The amount of refraction to apply to the image.
- **Height:** The amount of depth to add to the refraction effect. When coupled with the Intensity effect, this value can create the effect of bending the objects below the refraction matte.

Attaching the Intensity and Height values to function curves changes their values over time.

Remove Transparency

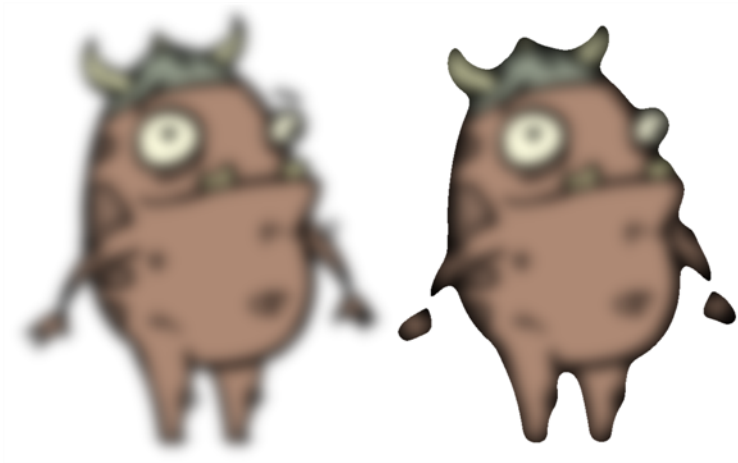

The Remove Transparency effect negates transparent values in an image. You can use the Remove Transparency module to remove the result of antialiasing around an image.

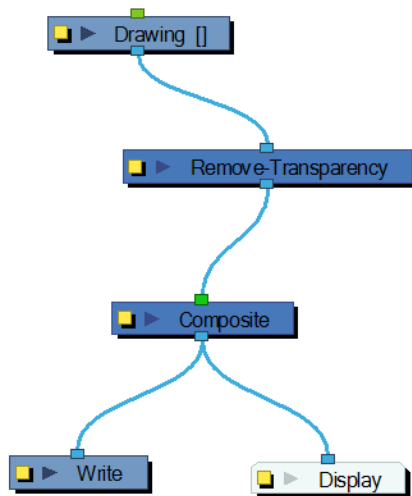

Use the Remove Transparency editor to control the effects of the module.

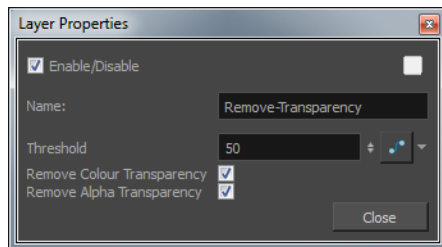

- **Threshold:** All values above the Threshold represent a transparent value. In this field, you must identify the value above which all alpha values are considered transparent. Alpha is measured from 0 to 255.
- **Remove Colour Transparency:** When selected, the Threshold value is used to determine which pixels in the Colour-Art (RGB channels) to make fully opaque or fully transparent.
- **Remove Alpha Transparency:** When selected, the Threshold value is used to determine which pixels in the alpha channel to make fully opaque or fully transparent.

Shadow



With the Shadow effect, you can turn a drawing into a shadow. It does not matter if your drawing layer is a fully coloured character, the Shadow effect will render it into a grey, semi-transparent, slightly blurry silhouette.

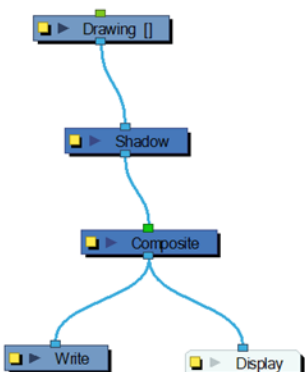
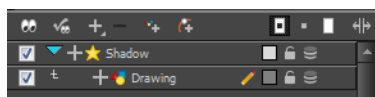

To add a shadow stretched out on the ground, simply add a Quadmap module to flip, stretch and skew the matte. Attach the entire effect to the same trajectory as your drawing layer and watch the shadow move along with your character.

Do not forget that you need to connect your character in both the final Composite module and the Shadow effect if you want to see your character and its shadow.

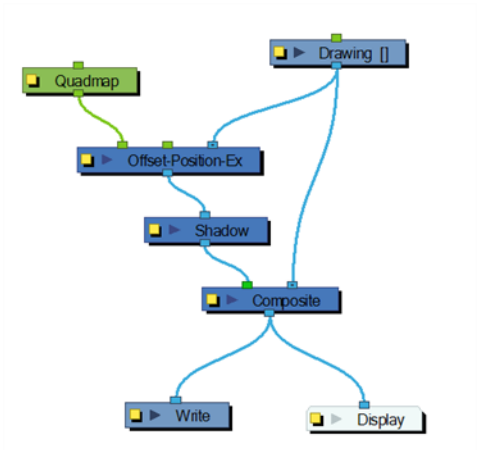

Use the Shadow editor to modify the way the Shadow effect is created.

The Shadow effect uses the shape of the drawing connected to create the shadow behind another element and can blur the edges to create a softer effect. You can control the type and amount of blur, as well as the colour of the shadow, in this dialog box.

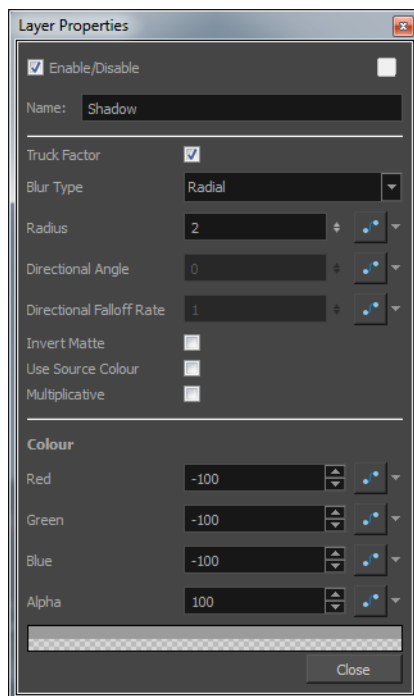

- **Truck Factor:** Activated by default, this option readjusts the blur when the elements undergo a change of depth or scale. When this option is disabled, the effect's values remain unchanged regardless of any depth or scale changes. It is recommended that this option be disabled when multiple drawings are composited and attached to this effect.
- **Blur Type (Directional or Radial):**
 - If Directional is selected, Harmony will blur the matte in the direction you select.
 - If Radial is selected, Harmony will blur the edges of the matte evenly around points that make up the edge of it.
- **Radius:** Enter a value for the size of the blur. The larger the value, the greater the blur effect. The blur radius is affected by the drawing scale and camera position.
- **Directional Angle:** If you select a Directional Blur Type, you can select the direction of the blur by entering a value from 0 to 360 in this field.
 - **0:** blurs the image to the west.
 - **90:** blurs the image to the south.
 - **180:** blurs the image to the east.
 - **270:** blurs the image to the north.
- **Directional Fall-off Rate:** The distance where the blur fades from the edge of the image. Select a value between 0 and 1.
 - A fall-off rate of 0 causes the blur to fade out slowly, distributing the blur evenly from the edge of the character to the farthest edge of the blur.
 - A fall-off rate of 1 causes the blur to fade out quickly so that the blur is heaviest closer to the edge of the image.
- **Invert Matte:** Activate this option to invert the matte used to create the shadow. In the render mode, the background will appear grey, while a the matte shape will act as a cut-out window, allowing you to see the original background colours beneath.
- **Use Source Colour:** Create the shadow using the matte shape's colour. Be sure that you are in render mode  to see this effect and that your background is **NOT** white and that you do **NOT** have a white colour card module attached to the composite. As the shadow matte only gives colour information, but no alpha, the matte is automatically multiplied with the background colours. If there is no colour card attached and the background appears black, you will see the matte colour at full opacity. If it is multiplied with a white background, the colours disappear into the full 255.
- **Multiplicative:** Multiplies the shadow colours with the background.
- **Red/Green/Blue/Alpha:** In the RGBA fields, you can enter the value to add or subtract from the colour channels in the drawings or you can attach these values to function curves.

If this effect is connected below a Composite module set to Pass-Through, the effect will be applied to each element connected in the Composite module individually. If some of these elements are overlapping, the effect will also overlap.

Sparkle



The Sparkle effect transforms a vector drawing into sparkles. You have a high degree of control over the appearance of the sparkles.

The sparkle effect can only be used with vector drawings. If the sparkle effect module is attached to a composite, verify that the Composite editor is set to Vector Flatten Output.

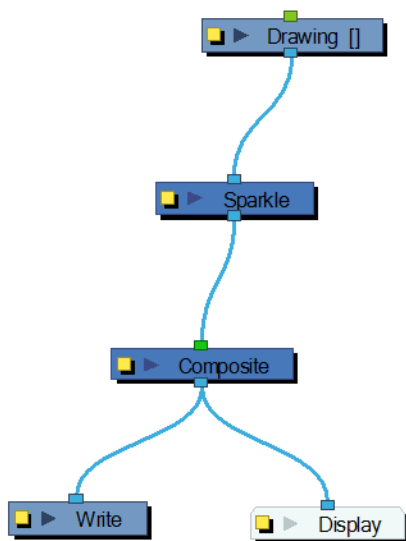

Use the Sparkle editor to modify how the Sparkle module creates the sparkle effect. You can also use Bezier and Ease function curves to change the values of factors over time.

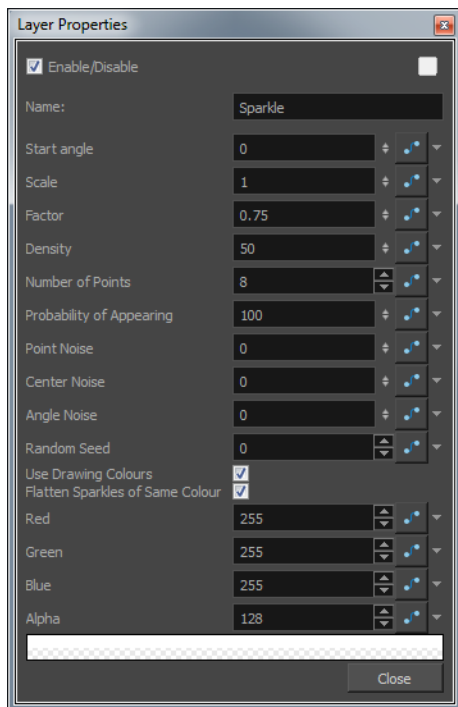

- **Start Angle:** Enter a value between -360 and 360 to indicate the angle of rotation of each sparkle.
- **Scale:** Sparkles are determined by the size of the bounding box of the coloured areas in the drawing. Enter the multiple to use to scale the sparkle size.
- **Factor:** Enter a value between 0.1 and 1 to determine how pointy the sparkle is. A value closer to 0 will result in a more pointed sparkle. A value closer to 1 will result in a more rounded sparkle.
- **Density:** Adjusts the density level.
- **Number of Points:** Enter the number of points you want each sparkle to have.
- **Probability of Appearing:** Enter the percentage of possibility that sparkles will be displayed. Enter 100 to always show sparkles. Enter 0 to always hide sparkles.
- **Point Noise:** Enter a value between 0.1 and 1 to indicate the amount by which points in a sparkle will distort.
- **Centre Noise:** Enter a value between 0.1 and 1 to indicate the amount by which the angles between each point in a sparkle will distort.
- **Angle Noise:** Enter a value between 0.1 and 1 to indicate the amount by which the Start Angle in a sparkle will distort.
- **Random Seed:** Enter a positive integer value that will be used to determine the sparkle pattern.
- **Use Drawing Colours:** Select this option to use the colour attributes of the drawing for the sparkle colour. When this selection is disabled (default setting), the colour values will be used as they are entered in the editor.
- **Flatten Sparkles of Same Colour:** Flatten all drawings of the same colour into a single layer.
- **Red/Green/Blue/Alpha:** In the RGBA fields, enter the values to use for the sparkle colour.

Tone



The Tone effect lets you add a dark-coloured region to your drawing and simulate the shaded area away from a light source. To produce the tone effect, create a drawing to control where the tone will appear. The Tone effect uses a matte to determine the shape and position of the tone on your drawing and can be blurred at the edges to create a softer effect.

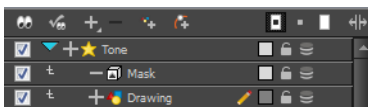

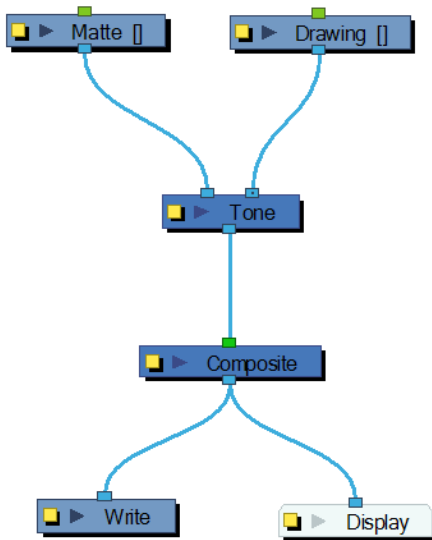

Use the Tone editor to control the type and amount of blur, as well as the colour of the tone.

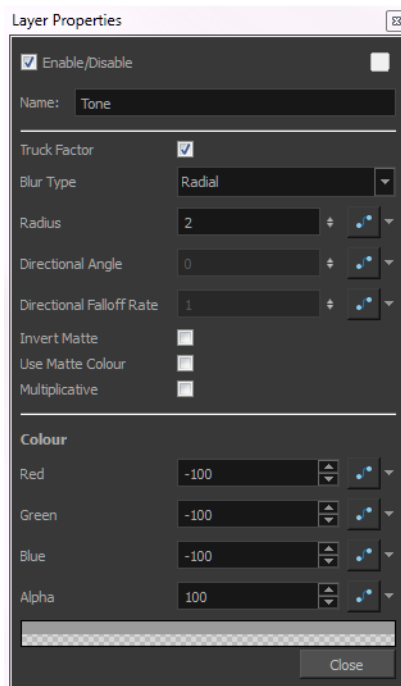

Tone Effect Properties

Parameter	Description
Truck Factor	Activated by default, this option readjusts the blur when the elements undergo a change of depth or scale. When disabled, the effect's values will remain unchanged regardless of depth or scale changes. It is recommended that this option be disabled when multiple drawings are composited and attached this effect.
Blur Type	Radial: The edges of the matte are blurred evenly around

	<p>points that make up the edge of the matte.</p> <p>Directional: The matte is blurred in the direction you select.</p>
Radius	Enter a value for the size of the blur. The larger the value, the greater the blur effect. The blur radius is affected by the drawing scale and camera position.
Directional Angle	<p>If you selected the Directional Blur type, you can set the direction of the blur by entering a value from 0 to 360 in this field.</p> <p>0: Blurs the image to the west.</p> <p>90: Blurs the image to the south.</p> <p>180: Blurs the image to the east.</p> <p>270: Blurs the image to the north.</p>
Directional Falloff Rate	<p>The distance where the blur fades from the edge of the image. Select a value between 0 and 1.</p> <p>0: Makes the blur fade out slowly, distributing the blur evenly from the edge of the character to the farthest edge of the blur.</p> <p>1: Makes the blur fade out quickly. The blur is heaviest closer to the edge of the image.</p>
Invert Matte	Inverts the matte used to create the tone.
Use Matte Colour	Uses the matte shape colour to create the tone.
Multiplicative	Multiplies the tone colours with the background.
Colour	
Red	Red values of the image.
Green	Green values of the image.
Blue	Blue values of the image.
Alpha	Alpha values of the image.
Colour Swatch	Opens the Colour Picker where you can specify the colour of the main flare.

Transparency

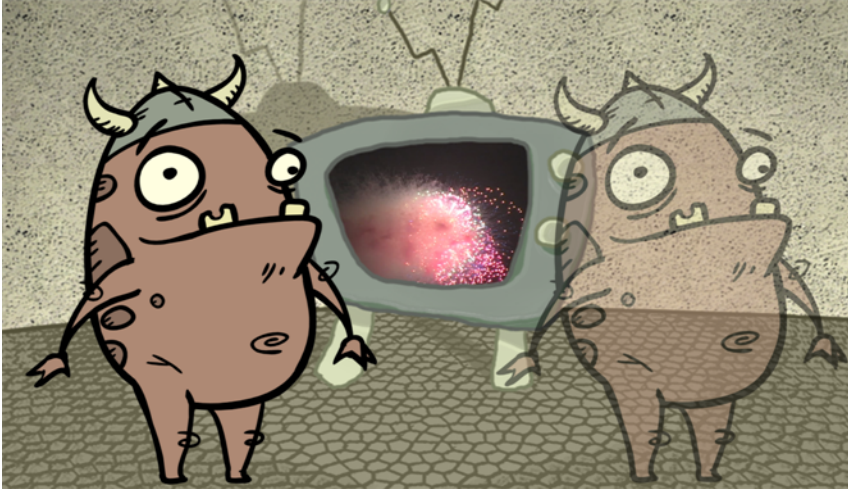

The Transparency effect is used to make an image partially transparent. The Transparency effect is useful when fading images in and out, such as a phantom or to make something partially see-through, such as a window.

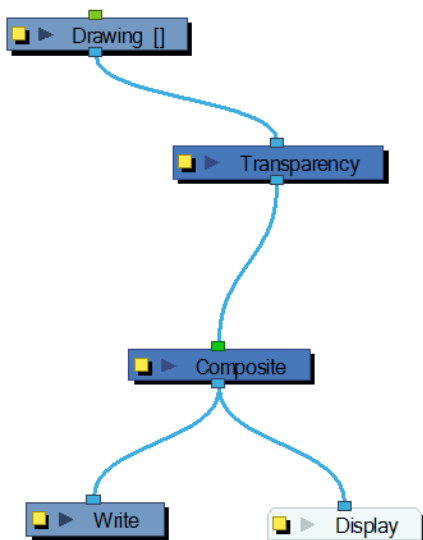
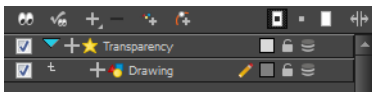

Use the **Transparency** editor to control how translucent the element should be.

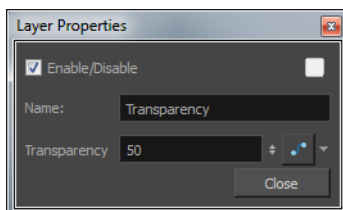

You can enter a value in the Transparency field or change the transparency value over time by linking it to a function curve. Entering a value of 100 in the Transparency field will make the element 100% transparent, in other words, invisible. Entering a value of 0 will render the element completely opaque.

It is also possible to adjust a layer/module's transparency directly in the Layer Properties window without using the Transparency module. In the layer's properties, go to the Drawing tab and adjust the Opacity parameter. This parameter is visible in OpenGL mode.

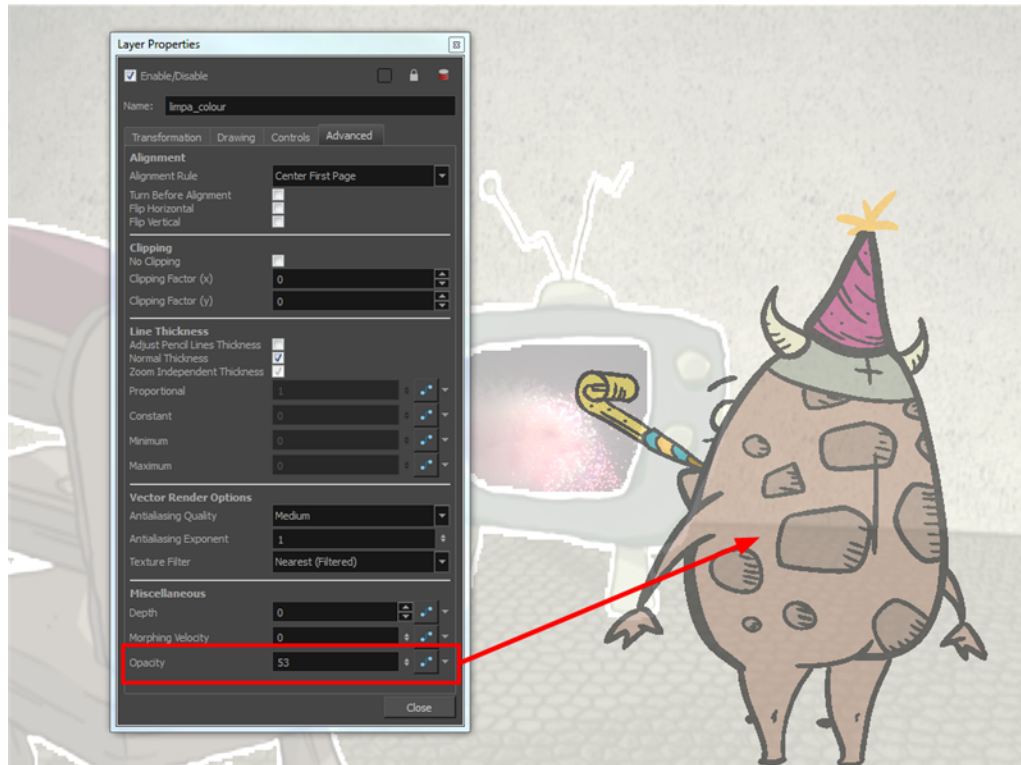

Underlay Layer

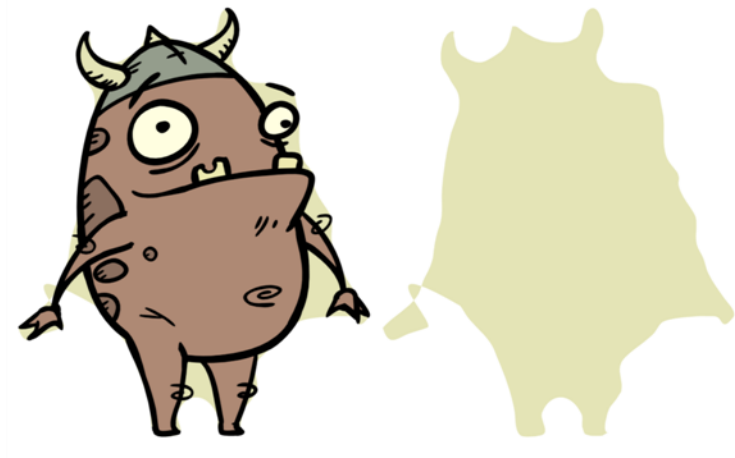

Use the Underlay Layer effect to read only the Underlay layer in an element. Place a Underlay Layer module after a drawing module in the Network view to display only the module's Underlay layer output. The Underlay Layer module can only be connected after a vector drawing layer or a vector type Composite module. Any bitmap information will not be processed.

This effect will only work if the user drew or painted something into the Underlay layer of the drawing.

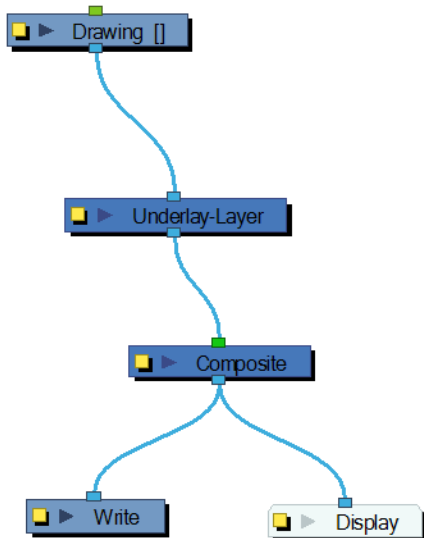

Use the Underlay Layer editor to control how the Underlay layer is rendered by the module.

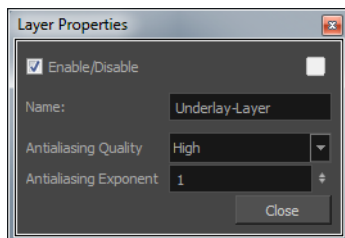

- **Antialiasing Quality:** Smoothness setting applied to the Underlay layer. Choose from Low (no antialiasing), Medium Low, Medium and High (extensive antialiasing). The higher the quality of the chosen setting, the greater the amount of antialiasing that is applied. Higher quality images require more time to render and more memory from your system.
- **Antialiasing Exponent:** Controls the amount of area around the Underlay layer edges that is used in the antialiasing process. A higher value uses less area, resulting in sharper edges, while a lower value uses more area, resulting in softer edges. If the Antialiasing Quality value is set to Low (no antialiasing), this value is ignored.

Visibility

The Visibility module lets you control whether an item is visible in OpenGL mode versus the Soft Render mode in the Camera view. If the Soft Render option is not enabled, the layer will not be exported.

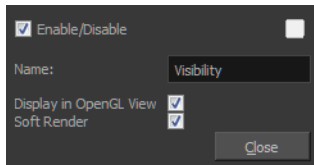

Visibility Properties

Parameter	Description
Display in OpenGL View	Displays your render in OpenGL mode.
Soft Render	

Particle Effects



Particle effects are both cool and a huge time saver. You can create atmospheric effects, such as rain, grass or fire to more complex systems, such as swarms of animated insects and all in a fraction of the time it would usually take.

Particle Effects act in the same way as all other effects in Harmony, except that they always work within their own specifically structured system. You can attach a Blur effect module under a Drawing module and the image contained in the Drawing module will become blurry. Particle effect set-ups are more complex than simply adding a module and playing with its parameters. To keep things simple, just think of each Particle Effect as its own group.

Basic Structure

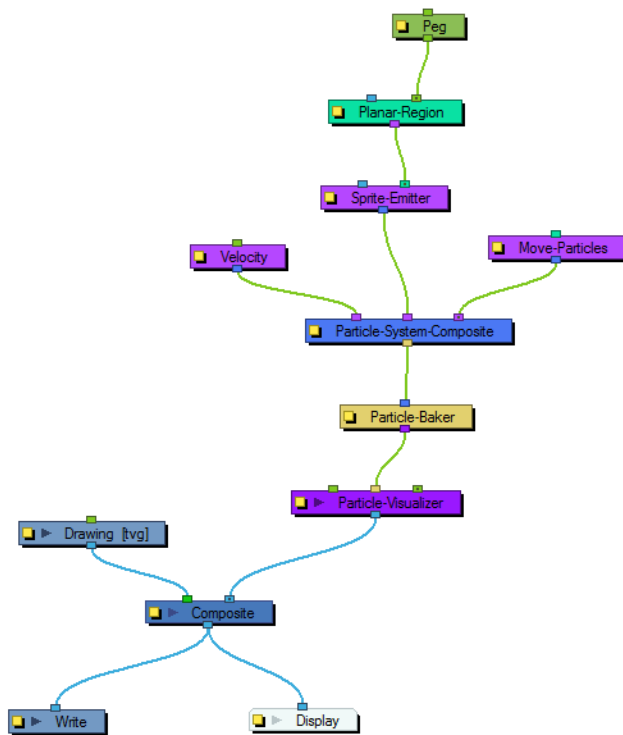

As you can see in this diagram, Particle Effect Modules are colour coded, with each colour representing a different function.

This is what the basic structure of a Particle Effect looks like in the Network view. This structure can change depending on the type of effect that you are trying to create.

Colour Coding

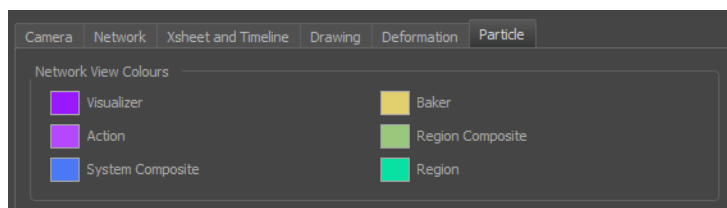

To make particle effects less confusing, the Particle Effects modules have been colour-coded. Each colour represents a different function. For example, Action modules, such as Velocity, Move-Particles and the Sprite Emitter are coloured bright purple. These colours, can be edited in the Preference panel by going to **Edit/File > Preferences > General (tab) > Edit Colours (button) > Particle (tab)**.

In addition to defining groups by colour, module in-ports and out-ports are also colour-coded. In the network shown in the diagram above, the Particle-Baker is dark yellow and the Particle Visualizer purple. If you look closely, you will notice that the in-port on the Particle Visualizer, where the Particle-Baker is connected, is also dark yellow. Similarly, the out-port on the Particle-Baker, where the Particle Visualizer is connected, is purple.

This system gives you an idea, at the very least, of what type of module is needed to fill a specific port.

- **Visualizer** - This module assembles a particle system through its middle port. It can accept a Peg on either side. The system is flattened at this module and generated as a single image. This is so you can move the effect's position in your scene or change its render order.
- **Action** - These modules affect the particles dynamics; they determine how they are created and moved around in space. If there are multiple Action modules hooked to a composite, they are executed from right to left. Due to this execution ordering, there should generally be an emitter on the right-most port.
- **System Composite** - Unlike a regular composite that reads all the position information from its in-port modules and combines them accordingly, a System Composite is specifically designed to handle Action module information.
- **Baker** - These modules allow you to make decisions about the particle systems position, angle, number, etc. the same way that a baker would make decisions about the ingredients that go in a cake.
- **Region Composite** - This module combines Region modules. In case you have more than one Region in your effect, this composite will help define the position and render order of the different Regions.
- **Region** - These modules are used to define the region from where the particles are emitted. These regions can be Planar or 3D.

Help Notes

Display the Integrated Help View and click on a Particle Module in the Network view to find information relating to that module, often with explanations about the options found in the module Layer Properties panel.

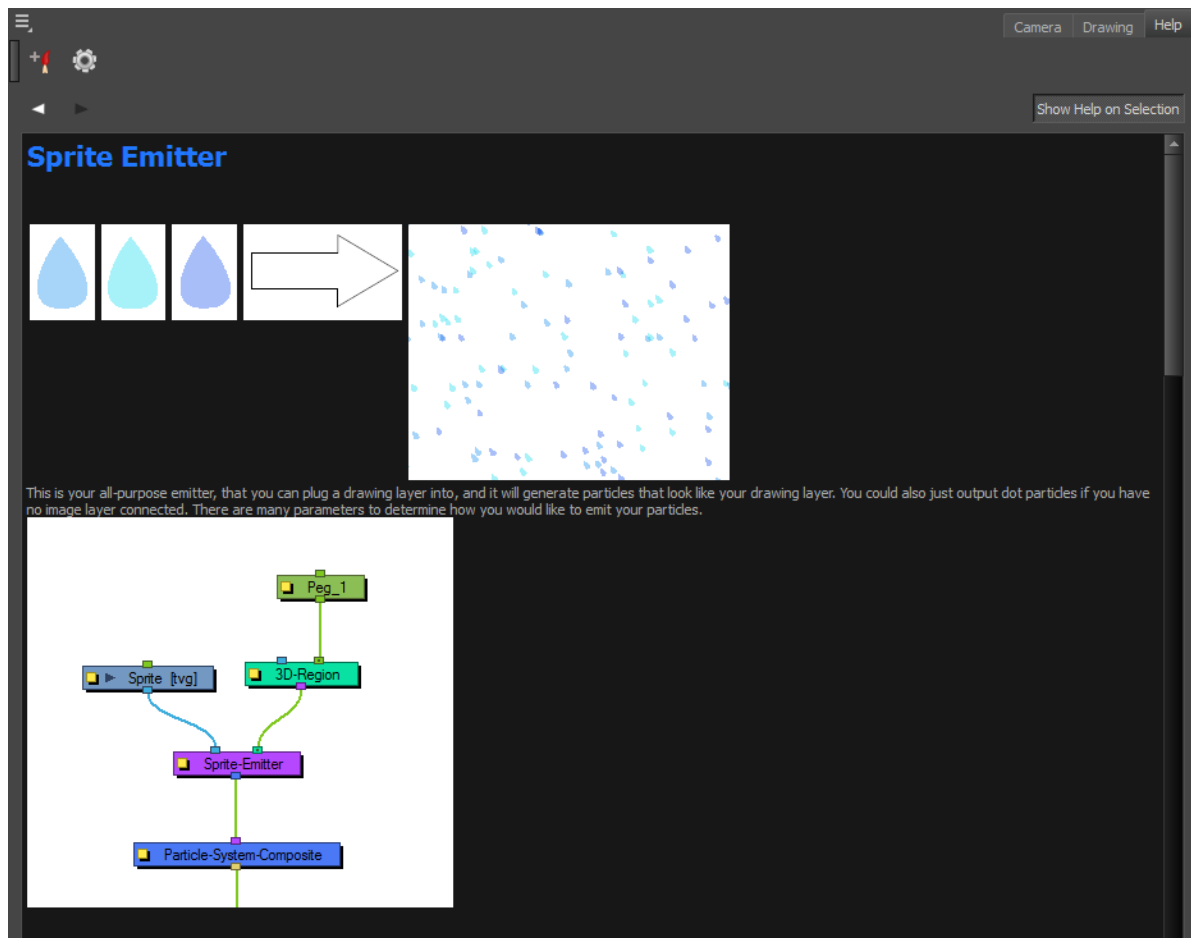

Accessing Default Particle Effect Templates

Harmony comes with some basic Particle Effect templates. Change the effect's "sprite" with a drawing, image or animated sequence of your own. Tweak its properties to adjust the effect to your liking. Or use the templates to analyze their structure so you can build your own.

How to access the Particle Effects Templates

- From the top menu, select **Insert > Particle >** and one of one of the following default Particle Effects templates:
 - Basic Particle System:** This effect template has the simplest structure and the parameters for all of its modules are set to the default values. For example, the Planar-Region has not been rotated or resized, the particles have not been randomized in the Sprite-Emitter, and the particles start their generation on the first frame and die out at the maximum number allotted in the Particle-Baker.
 - Basic Gravity Based System:** Simulates particles being generated from a source with special emphasis on adding gravity to the particle system.

Creating a Custom Particle Effect

There is a new tab in the Module Library view. It is called Particle and it contains all the modules specifically needed to build various Particle effect systems.

To create a custom Particle effect, click and drag the Particle modules from the Module Library to the Network view.

Particle Effect Modules

This section explains the each module's purpose, its layer properties and how to adjust these properties.

This topic is divided as follows:

- ▶ [3D Region on the next page](#)
- ▶ [Baker on page 497](#)
- ▶ [Baker Composite on page 497](#)
- ▶ [Bounce on page 499](#)
- ▶ [Explosion on page 500](#)
- ▶ [Gravity on page 502](#)
- ▶ [Image Fracture on page 504](#)
- ▶ [Kill on page 540](#)
- ▶ [Move Particles on page 541](#)
- ▶ [Orbit on page 543](#)
- ▶ [Planar Region on page 546](#)
- ▶ [Random on page 548](#)
- ▶ [Region Composite on page 550](#)
- ▶ [Repulse on page 551](#)
- ▶ [Rotation Velocity on page 552](#)
- ▶ [Sink on page 554](#)
- ▶ [Size on page 555](#)
- ▶ [Sprite Emitter on page 556](#)
- ▶ [System Composite on page 570](#)
- ▶ [Velocity on page 579](#)
- ▶ [Visibility on page 489](#)
- ▶ [Visualizer on page 581](#)
- ▶ [Vortex on page 582](#)
- ▶ [Wind-Friction on page 584](#)

3D Region

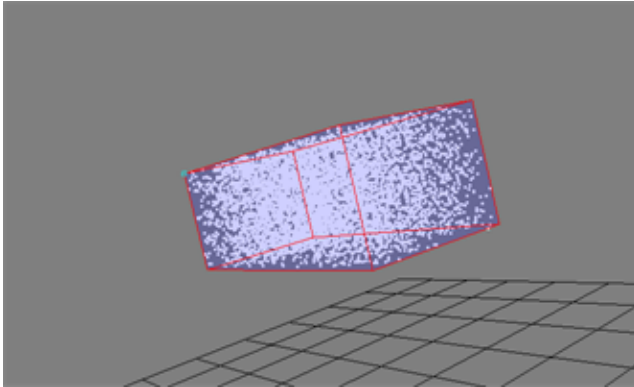

This module defines 3D region. The region can take on many forms, such as a sphere, cone, cylinder or box. The 3D Region module acts in contrast to the Planer Region module, which generates and emits particles from a 2D plane.

A 3D Region can be connected to a Sprite-Emitter, to define the region from which particles are generated. It could also be connected to a Bounce module, to define a region against which particles will bounce. If connected to a Sink, it will define a region where the particles will disappear.

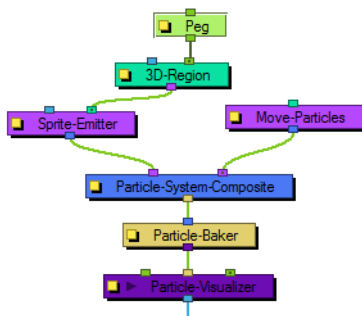

Click on **View > Show > Control** in order to view a preview of what the 3D Region looks like.

Layer Properties

Use the 3D Region's Layer Properties to adjust the 3D region.

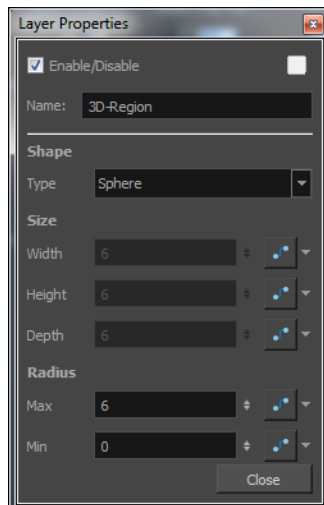

- **Shape:** Choose a shape for the 3D Region by clicking on the Type drop-down menu and selecting either Box, Cylinder, Cones, Sphere or Image.

If you select Image, you must connect the module of a vector drawing or a vectorized bitmap image to the left port (blue node) of the 3D Region module. The particles will then be emitted from that image' shape. Don't forget that you can rotate your vector drawing in 3D space by enabling the 3D option in its Layer Properties.

- **Size:** Enter different values into the Width, Height and Depth fields to change the dimensions of the 3D Region's selected shape. Depending on the shape selected, some fields may be greyed-out if they are not applicable. You can also modify the shape with the Transform Tool by grabbing the control handles (turquoise squares) in the Camera or Perspective views. You can also change the dimensions of the region over time by click on the function button at the end of each field.
- **Radius:** Enter different values into the Min or Max fields to change the inner or outer radius of applicable shapes, such as a cylinder, cone or sphere. The radii can also be modified by grabbing the control handles (turquoise squares) in the Camera or Perspective views. The radii of the region can be changed over time by clicking on the function button at the end of each field.

Baker Composite

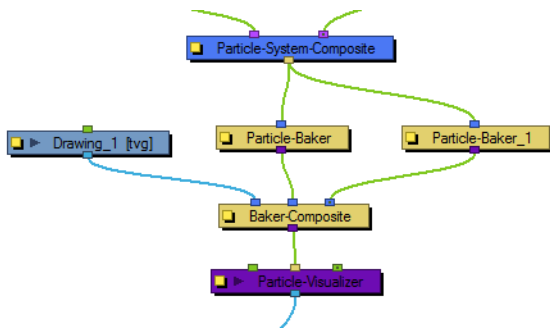

The Baker Composite is used to composite more than one Particle-Baker, as well as any other elements that need to be combined before they pass through the Particle Visualizer.

Baker

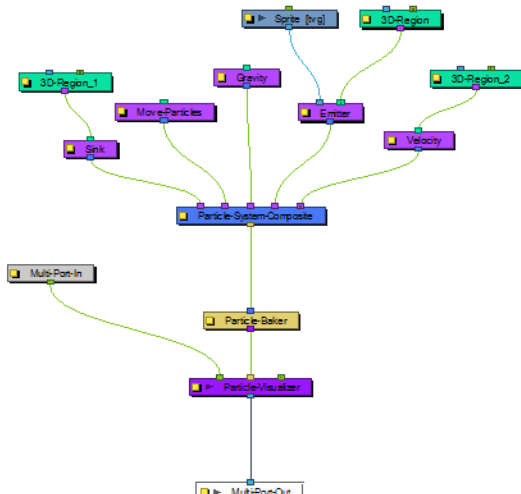

This module, also known as the Particle-Baker, allows you to make decisions about the particle systems position, angle, number, etc. the same way that a baker would make decisions about the ingredients that go into baking a cake. The Baker performs the particle simulation, combining together all the ingredients specified to get the final result. The Baker must always be connected to the Particle-Visualizer.

Layer Properties

Use the Particle Baker's Layer Properties to adjust your particle system's various parameters.

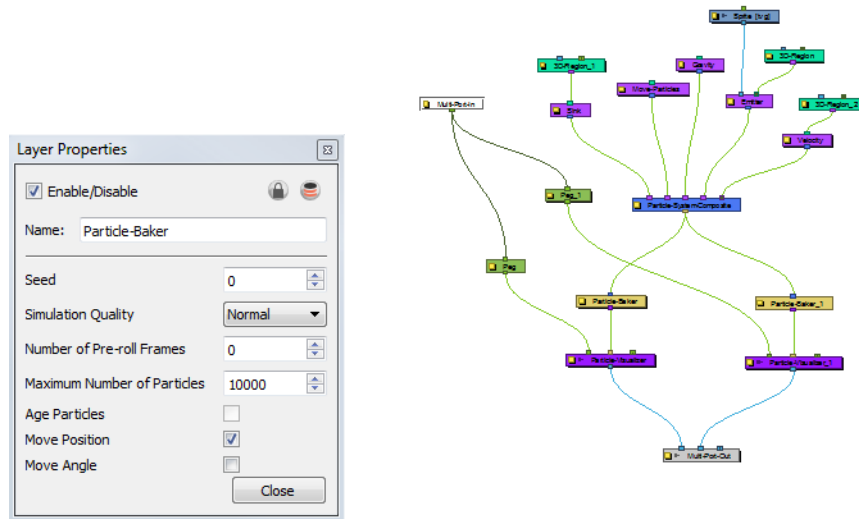

- Seed:** This value allows you to apply a random effect to the particle system. There may be times when you want to copy the particle system to two different locations on your screen. You can take the out port of the Particle System Composite module, and plug this into two separate Bakers and Visualizers. Then you could move one system over by attaching a peg into the left side of one Visualizer. If you do this, the two systems will look exactly the same. Add a random Seed to make them look different.
- Simulation Quality:** This option defines how many simulation steps per frame are performed. The lowest quality creates one step per frame. Raising the quality will divide the simulation time and create two or more steps of simulation for each frame. This increases the computation time, but also increases the quality of the result.
- Number of Pre-roll Frames:** Allows you to select a start position in the particle effect sequence, other than the start (generation) of the sequence. This essentially allows you to start the particle effect part-way through its cycle, even if it starts on frame one of your project. An example of when this parameter might come in handy is when you want it to be already raining at the start of your scene. If you don't change the number of Pre-roll Frames, it will always start to rain at the beginning of your scene.
- Maximum Number of Particles:** Entering a value in this field puts a cap on the number of particles that will be created; the software will stop generating particles once it reaches this number.
- Age Particles:** Check this option if you want the software to keep track of how long a particle has existed in its cycle from the time of its inception. Knowing a particles "age" means that you

can tack other parameters onto its lifespan, such as having the particle start to disappear or change colour at a certain age.

- **Move Position:** Check this option to allow the particles to move position, otherwise the particles will not be able to flow in a specified direction. This option also exists in the Move Particles module. You do not always need a Move Particles module, hence why this option exists in the Baker. This option is also useful for when your Move Particles module is cut-off by a sink, refer to [Sink on page 554](#) for information on that particle effects module.
- **Move Angle:** Check this option to allow the particles to flow from different angles. This option also exists in the Move Particles module. You do not always need a Move Particles module, hence why this option exists in the Baker. This option is also useful for when your Move Particles module is cut-off by a sink.

Related Topics

- [Particle Effect Modules on page 495](#)

Bounce

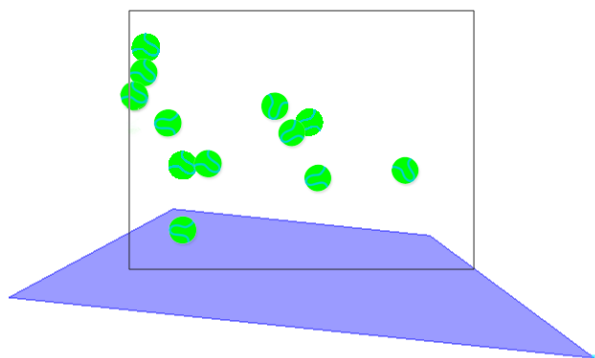

Use this module to make your particles bounce off a surface with realistic physical modeling. This module should have a region connected to it, and that region will act as a bounce plane so that when any particle hits it, it will bounce off at the correct angle.

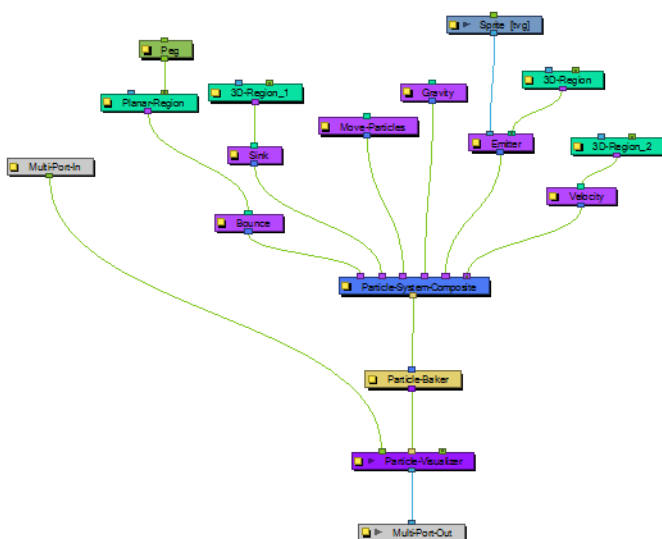

Layer Properties

Use the Bounce's Layer Properties panel to adjust the effect's parameters.

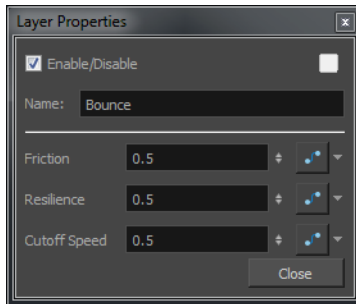

- **Trigger:** Is an on/off switch using binary code, where 1 = on, while 0 = off.
- **Friction:** Enter a value into this field to increase the amount of friction that each particle experiences as it makes contact with the planar surface. A positive value creates more friction and therefore slows the particle down. A negative value lessens the friction and therefore makes the surface appear more slippery.
- **Resilience:** Changing this value effectively increases or decreases the bounciness of the particle. A value of zero causes the particle to hit the planar surface once and slide off any downward facing angle. A positive value, even by decimal increments, causes the particle to become bouncy. A negative value deadens the effect, the same way a lack of Region would.
- **Cutoff:** Increasing this value widens the bounce arc. If the connected Planar Region is completely flat, a value of zero will cause the particle to bounce up and down in place. A tilted plane in the direction of the bounce will also widen the arc.

Explosion

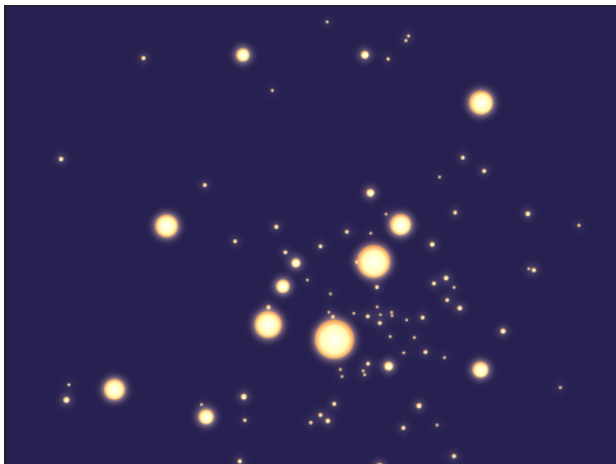

Use this module to create an explosion. As it is an Action module, it should be connected to the Particle System Composite after the Sprite Emitter. As the explosion occurs, the particles will burst rapidly away from the centre of the explosion (the centre of the defined Region), then gradually slow down.

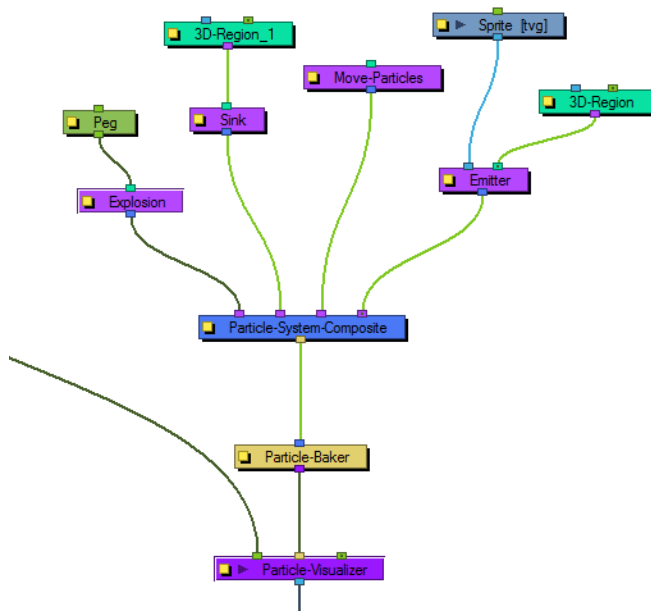

Layer Properties

Use the Explosion's Layer Properties panel to adjust the effect's parameters.

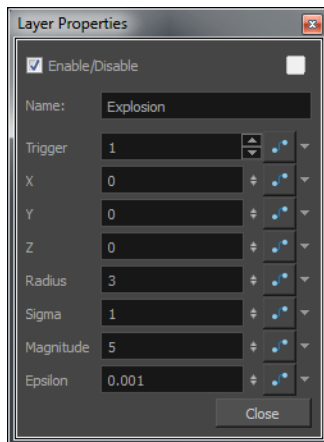

Layer Properties

Use the Gravity module's Layer Properties panel to adjust the effect's parameters.

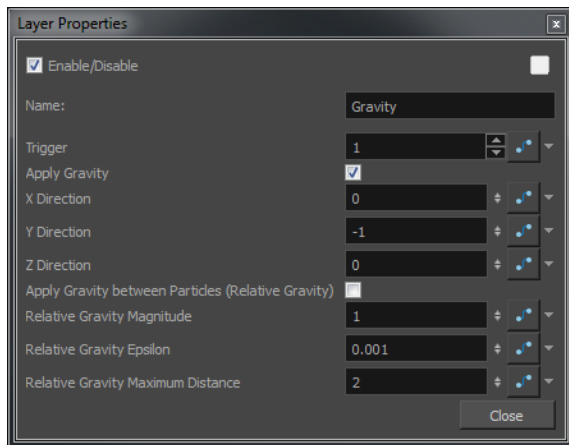

- **Trigger:** Is an on/off switch using binary code, where 1 = on, while 0 = off.
- **Apply Gravity:** Enable this option to force the particle system to adhere to the force of gravity. Values must be entered into the Direction fields, along with enabling this option, in order for it to work. If this option is not enabled, the particle system will explode outwards from its origin point.
- **X Direction:** Directs the particle stream either to the left or the right (along the x-axis). A value of 1 forces the particle stream to the right, while a value of -1 forces the particle stream to the left.
- **Y Direction:** Directs the particle stream either up or down (along the y-axis). A value of 1 forces the particle stream to flow upwards, while a value of -1 forces the particle stream to flow downwards.
- **Z Direction:** Directs the particle stream either forwards or backwards (along the z-axis). A value of 1 forces the particle stream to flow forwards, while a value of -1 forces the particle stream to flow backwards.
- **Apply Gravity between Particles (Relative Gravity):** Relative Gravity will apply gravity between each particle taking their masses into account. The mass of the particle can be specified at emission time via the Sprite or the Image Emitter.
- **Relative Gravity Magnitude:** Adjust the amount of gravity that will be applied between particles.
- **Relative Gravity Epsilon:** The acceleration falls off the further the particles get away from each other, but when the particles are very close to each other, the acceleration becomes very high - so you should define a small region around the particles so that they never actually touch.
- **Relative Gravity Maximum Distance:** Adjusts the radius beyond which particles don't affect each other.

Image Fracture

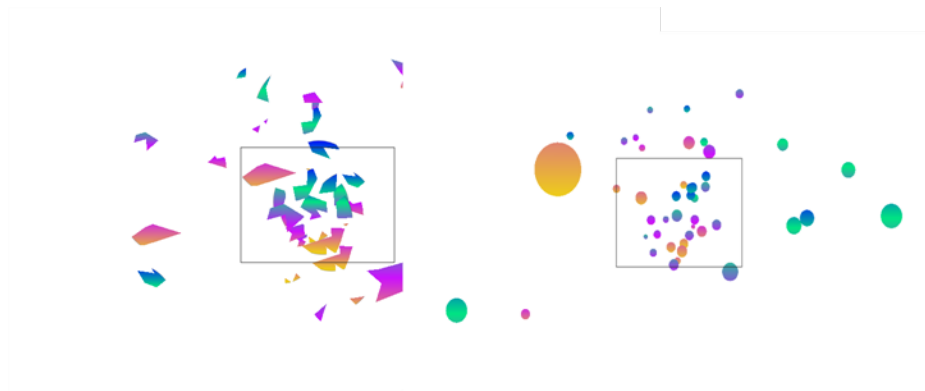

Use the Image Fracture to break an image apart into pieces. This Effect module requires 2 image objects: the image to be cut and the shape of the cut pieces (matte). The image to be cut can be anything from a vector drawing to a bitmap image to an entire scene's composite, with effects and all. The image to be cut should be hooked to the Image Fracture's fight port.

The matte should be a flattened if you want it to work like a cookie cutter (hollow shape with a frame) and can be composed of either brush or pencil lines. It can also be a solid shape, may solid filled shapes and even many solid filled overlapping shapes. When the matte is made up of overlapping

pieces, the cut image will be multiplied at those zones to break apart in multiple layers. The matte drawing should be hooked to the Image Fracture's left port.

The 2 image objects overlap perfectly when they are combined in the Image Fracture. This means that you have to take 12 by 12 field into account when judging the scale and proportion of these objects. If the matte does not overlap at a part of the image, that part of the image will not get cut. The matte does not have to be a continuous shape. It could be 3 separate circles, which would then be cut and pulled away from the image.

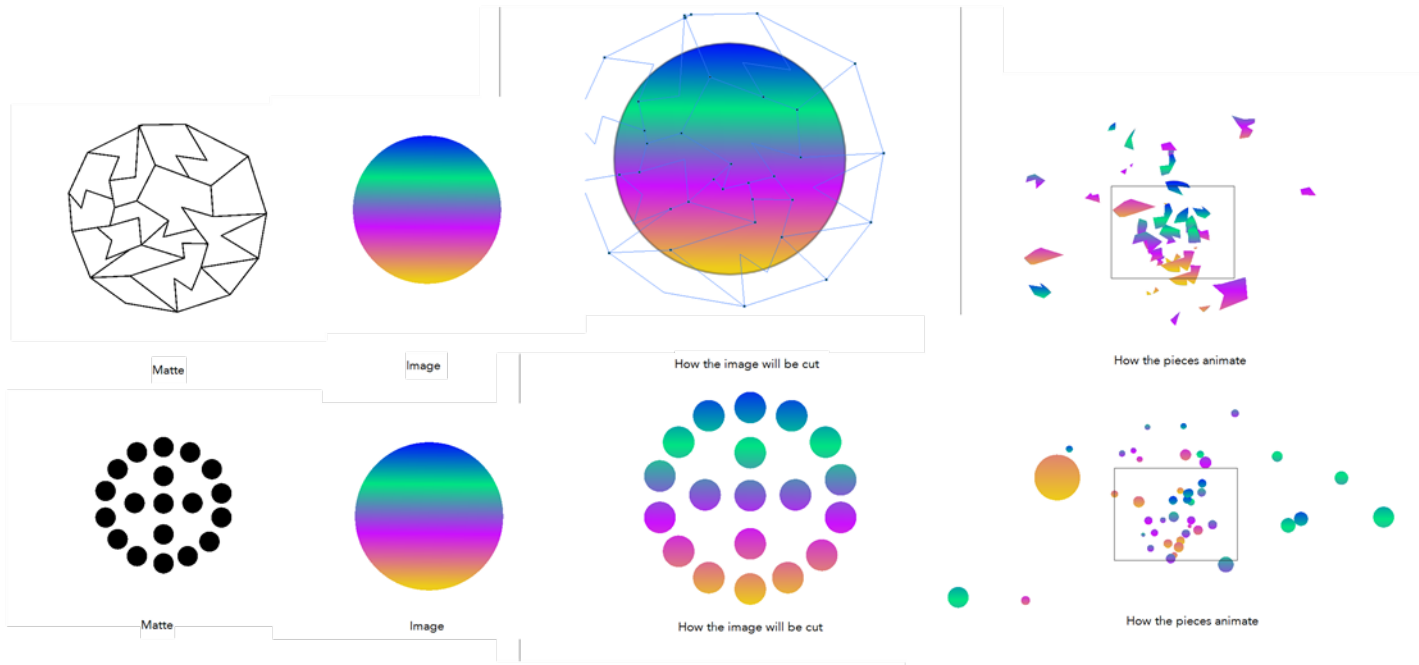

You can turn on the grid and use the Light Table feature in the Drawing view while drawing or scaling the Image and Matte, in order to ensure that they are the correct size relative to one another.

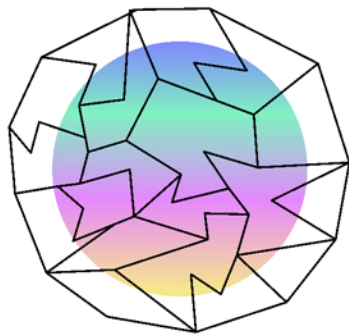

Look at an example of a Network that uses the Image Fracture:

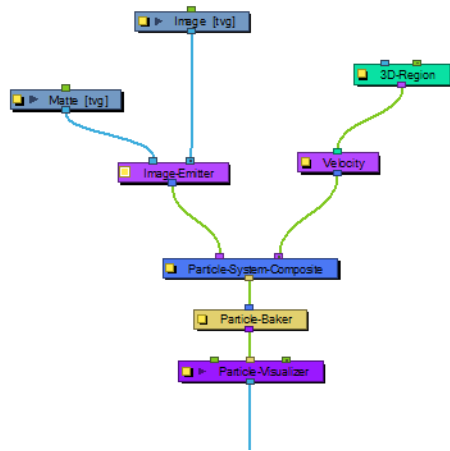

Layer Properties

Use the Image Fracture's Layer Properties panel to adjust the effect's parameters.

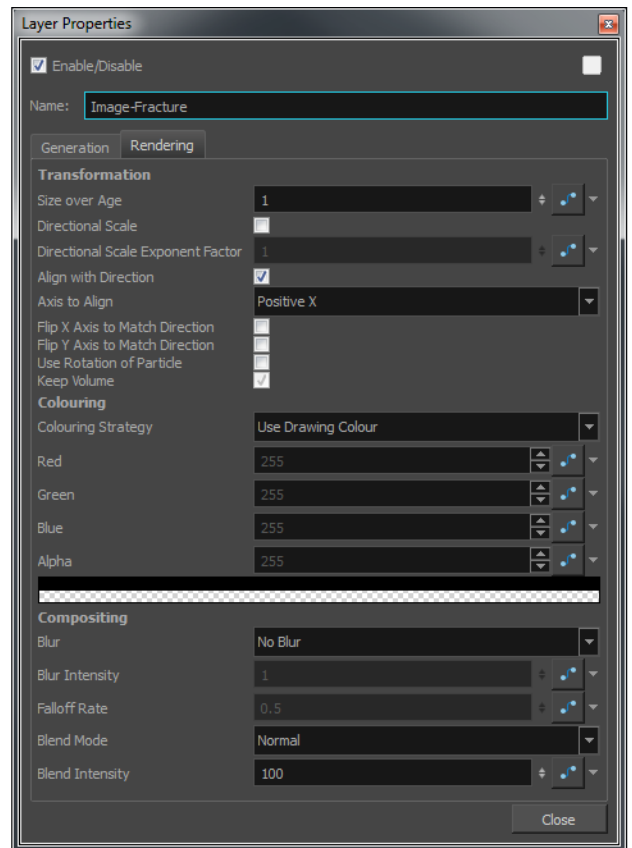
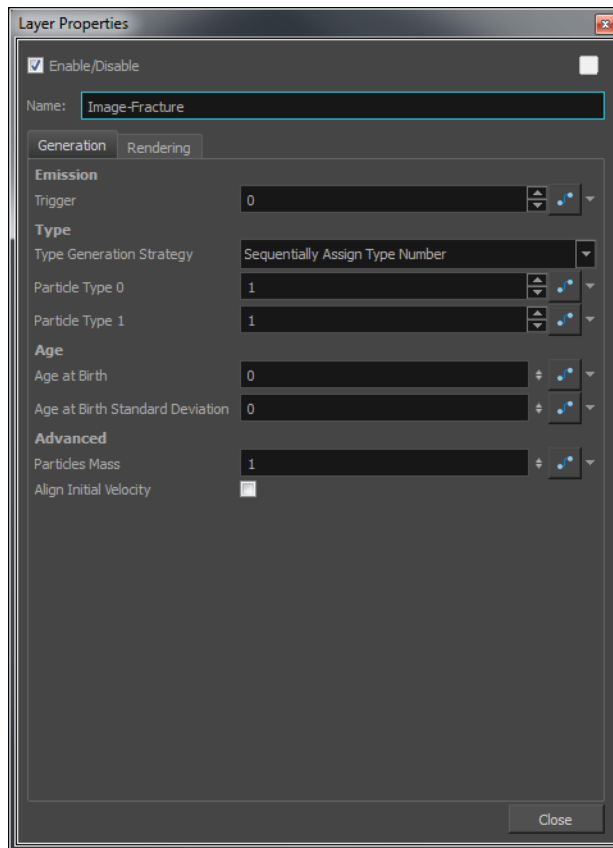

Generation Tab

- **Emission:**

- **Trigger:** Is an on/off switch using binary code, where 1 = on, while 0 = off.

- **Type:** You may want to design a variety of different drawings that will vary up the appearance of your particle system. In this case, you should put each drawing on its own cell in the drawing layer. Each drawing will then be a new Type of particle.

- **Type Generation Strategy:** This allows you to choose between Sequentially assigning a type (moving from one drawing to the next) or Randomly.

- **Particle Type 0:** This is the frame number where the first drawing can be found. If you have a 5-frame cycle that starts on frame 1, you would put a 1 here.

- **Particle Type 1:** This is the frame number where the last drawing can be found. If you have a 5-frame cycle that starts on frame 1, you would put 5 here.

- **Age:**

- **Age at Birth:** A different start frame number can be entered in this field. This means that a particle can start with a different drawing than the drawing that you have on frame 1.

- **Age at Birth Standard Deviation:** Allows a random deviation for the birth of the particles. If you have a 5-frame cycle that starts on frame 1, but you want the particles to be of a random type, then you may want to set the Age and Birth to 3 with a standard deviation of 2. That means that particles will randomly be born at any frame from 1 to 5.

- **Advanced:**

- **Particles Mass:** Define a mass for the particles. This mass will affect how the particles interact with gravity.

- **Align Initial Velocity:** This aligns the initial velocity with the region from which the particles are being emitted. If you are emitting from a sphere, then the particles will all start out moving away from the centre of the sphere.

Rendering Tab

- Transformation:

- **Size over Age:** Use this value to set how you would like the size of the particle to change as it ages. Attach a function to this attribute if you would like to, for example, have the particles get smaller as time goes on.

- **Directional Scale:** Check this checkbox if you would like to scale the particle in the direction of its movement.

- **Directional Scale Exponent Factor:** Set an exponent here for how much you would like that particle to scale.

- **Align with Direction:** Check this checkbox if you would like to align the particle in the direction of its movement.

- **Axis to Align:** Select the axis that you would like to align from the drop-down box. This axis refers to the axis of the Drawing grid from the Drawing module plugged into the emitter

- **Flip X Axis to Match Direction:** You might want to have the particle align to the X direction of movement. You can see this property being used in the Lemmings example.

- **Flip Y Axis to Match Direction:** Similar to flipping the X axis, you may wish to flip the Y axis of a drawing to match the direction of the particle movement.

- **Use Rotation of Particle:** Check this checkbox to enable rotation on the particle.

- **Keep Volume:** When you choose to do a Directional Scale, then this will automatically maintain the volume of the particle by squashing it proportionally to how much it stretches as a result of the directional scale.

- Colouring:

- **Colouring Strategy:** This drop-down box allows you to set how you would like to define the colour of the particle.

- **Use Drawing Colour:** In this case, the particle will remain the same colour as it was drawn with.

- **Map RGB Based on Age:** Attach a function to this to vary the Red, Green, and Blue values of the particle as it ages.

- **Map RGBA Based on Age:** Attach a function to this to vary the Red, Green, Blue, and Alpha values of the particle as it ages.

- **Apply Opacity Based on Age:** Keep the original RGB values from the drawing, but vary the Alpha (Opacity) according to a function that you define here.

- **Map RGB Based on Frame:** Change the Red, Green, and Blue values of the particles based on the frame. Changing based on the frame means that ALL particles will change colour on that frame, regardless of their age.

- **Map RGBA Based on Frame:** Change the Red, Green, Blue, and Alpha values of all particles on a given frame by attaching a function.

- **Apply Opacity Based on Frame:** Use the original RGB values from your drawing, but vary the Alpha (Opacity) of the particles on a certain frame by attaching a function to this.

- **Red, Blue, Green:** This is where you can attach functions to Red, Blue, and Green values. You can also click on the colour swatch to adjust the colour.
- **Alpha:** This is where you can attach a function to the Alpha (Opacity) of your particles.
- **Compositing:**
 - **Blur:** Define whether you would like to apply a Blur to the particles.
 - **No Blur:** No blur will be applied to the particles.
 - **Directional Blur Based on Age:** Attach a function to define how you would like the particles to blur based on the age of each particle. The particle will blur in the direction of movement.
 - **Directional Blur Based on Frame:** Attach a function to define how all particles should be blurred at a particular frame. The particle will blur in the direction of movement.
 - **Low Quality Radial Blur Based on Age:** Attach a function to define how you would like the particles to blur based on the age of each particle. This will be a low quality blur.
 - **Low Quality Radial Blur Based on Frame:** Attach a function to define how all particles should be blurred at a particular frame. This will be a low quality blur.
 - **Low Quality Radial Blur Based on Camera Distance:** Define how you would like the particles to blur based on their distance from the camera. This is a low quality blur.
 - **High Quality Radial Blur Based on Age:** Attach a function to define how you would like the particles to blur based on the age of each particle. This is a high quality blur.
 - **High Quality Radial Blur Based on Frame:** Attach a function to define how all particles should be blurred at a particular frame. This is a high quality blur.
 - **High Quality Radial Blur Based on Camera Distance:** Define how you would like the particles to blur based on their distance from the camera. This is a high quality blur.
 - **Blur Intensity:** This is where you can set a value, or attach a function to animate the blur according to the type of blur that was defined from the drop-down list.
 - **Falloff Rate:** The distance where the blur fades from the edge of the image. Select a value between 0 and 1.
 - A falloff rate of 0 causes the blur to fade out slowly, distributing the blur evenly from the edge of the drawing to the farthest edge of the blur.
 - A falloff rate of 1 causes the blur to fade out quickly so that the blur is heaviest at the edge of the drawing.
 - **Blend Mode:** Define a blend mode for the particles to get cool effects.
 - **Blend Intensity:** This is a percentage of how opaque you would like the particles to be blended. A value of 50 would be 50% transparent. A value of 100 would be fully opaque.

Kill

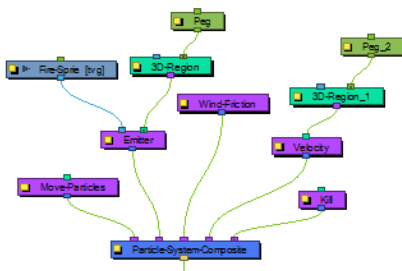

This module determines when you want particles to disappear.

Layer Properties

Use the Kill Module's Layer Properties panel to adjust the effect's parameters.

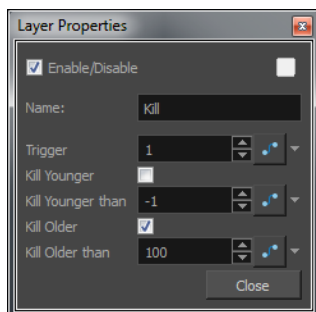

- **Trigger:** Is an on/off switch using binary code, where 1 = on, while 0 = off.
- **Kill Younger:** There are only a couple of specific scenarios where you might want to use this property. In order to make use of Kill Younger, you would generally want to attach a function to this property. The reason for this is, if you just turn on a "Kill Younger" right away at time 0, then you'll never see any particles. For example say that you set Kill Younger to 10, at time 0, there will be no particles that are older than 10, so you'll never see any particles. What you might want to do, however, is have your particles animating over time, and at some point in time, you may suddenly want to kill all the younger particles. Let's take the example of an animation where the particles change from blue to yellow. At every frame, new particles are generated, and the particles that already exist age. There might come a point, perhaps where you do something like an explosion, where you want to kill all the particles that are younger than 10 frames old - so in my example it would kill all of the blue particles, leaving only the yellow particles.
- **Kill Younger Than:** This is where you could animate the effect for "Kill Younger."
- **Kill Older:** When this option is checked, particles will disappear when they reach a certain level of maturity.
- **Kill Older Than:** Set the age at which particle will disappear.

Move Particles

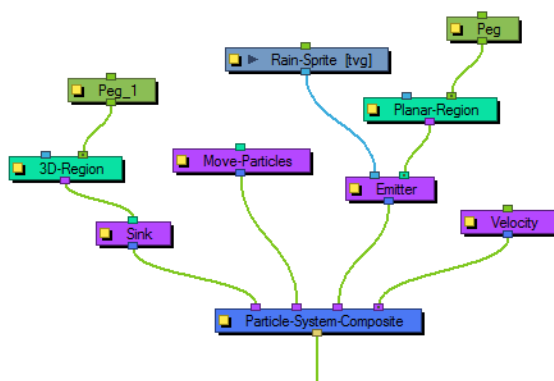

This module allows you to determine whether the particles are stationary (like grass) or moving (like rain), and you can animate this function on and off.

Layer Properties

Use the Move Module's Layer Properties panel to adjust the effect's parameters.

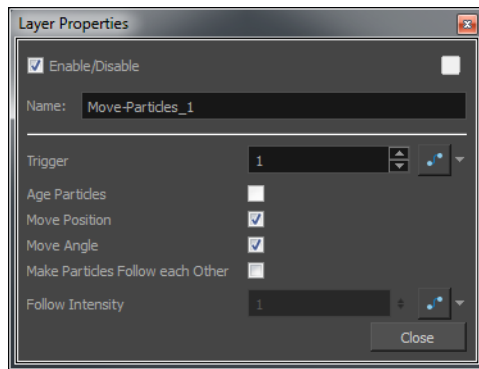

- **Trigger:** Is an on/off switch using binary code, where **1** = on, while **0** = off.
- **Age Particles:** Check this checkbox to age the particles. Be aware that if you check "Move Position" and "Move Angle," then the particles will age implicitly. If you do not want the particles to move, however, and you do still want them to age, then uncheck Move Position and Move Angle, and check Age Particles. The "Age Particles" property also exists in the Baker, however whatever happens in the Baker happens after everything else in the particle system. So, if for example you have a Kill module, it will kill the particles before it ages them, and you probably want to age the particles before you determine whether to kill them. Therefore, if you have a Kill module, make sure to age the particles in your Move module before you kill them. If you age the particles both in the Move module as well as in the Baker, then the particles will age twice on that frame instead of once.
- **Move Position:** Check this checkbox to enable movement on the particles. There is also a "Move Particles" checkbox in the Baker. If it is disabled in the Baker and in the Move module, the particles will not move, they will simply generate in place and stay there. If the checkbox is checked on the Baker, the particles will move, but if you need the particles to interact with another Action, say a Sink, then you want the Particles to move before they reach the sink. This is why you have a separate Move module, so that you can place this Move before (to the right of) the Sink in your Particle System Composite.
- **Move Angle:** Like the Move Position, this checkbox will enable the rotation of particles in the particle system.
- **Make Particles Follow each Other:** This property allows one particle to follow another particle, through an attraction between the particles. This is particularly useful when you want to create a snake-like effect, where the particles are animating across the screen and following each other.
- **Follow Intensity:** Adjust the strength of the attraction between particles that are following each other.

Orbit

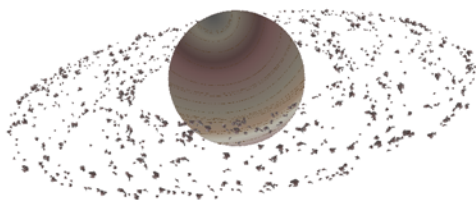

The Orbit module allows you to define an axis that the particles will be attracted to and orbit around. Plug a peg layer into the orbit to move the position of the orbit without adjusting the parameters in the Layer Properties.

Fine-tuning the Orbit module can take a little finesse, because the orbit takes into account the velocity of the particles, and uses this to determine whether the particle will orbit around the axis, whether it will be influenced but eventually escape, or whether it will hardly be influenced at all. This is just like how Gravity between astral bodies works in space.

See a couple of examples of how having the orbit in the wrong place can give some cool (but perhaps not useful) effects:

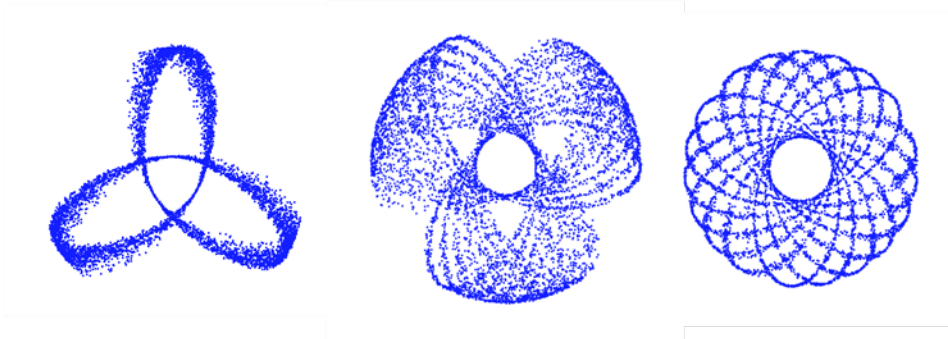

You will also want to make sure that your initial velocity is varied, so use an interpolated speed and set two different values, that way there will be a spread between them. If not, then you will get the effects as shown above.

Also, you should use the peg layer to move the position of the Orbit module around until you find the right spot to get the look you're trying to achieve. It also helps to set some Pre-Roll frames on your Baker to get things ramped-up before you start to manipulate the position of the Orbit module.

See an example of what a typical Network involving an Orbit module looks like:

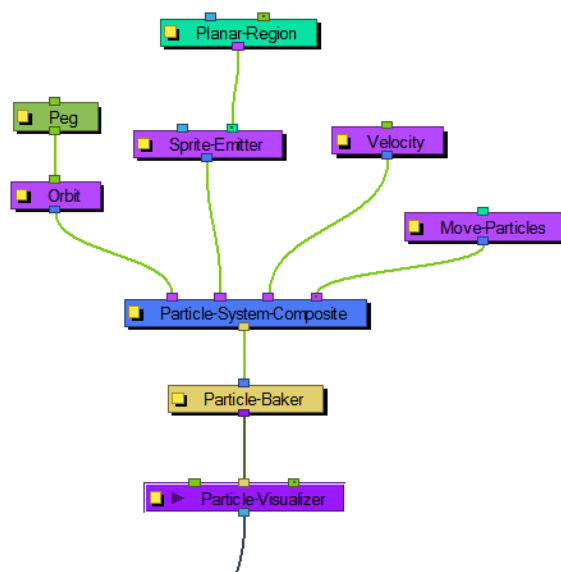

Layer Properties

Use the Orbit Module's Layer Properties panel to adjust the effect's parameters.

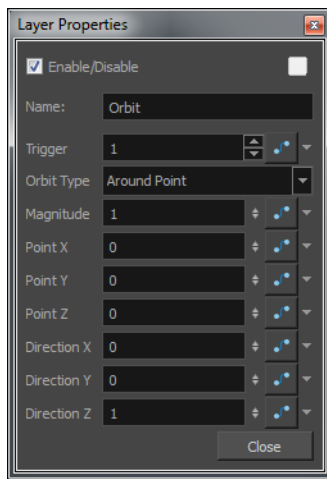

- **Trigger:** Is an on/off switch using binary code, where 1 = on, while 0 = off.
- **Orbit Type:** Select the type of Orbit you'd like to use from the drop-down list. For most scenarios, like asteroids orbiting a planet, then a point will suffice for this. If you would like to rotate around an axis instead, then choose between the X, Y, Z axes or set up your own custom axis.
- **Magnitude:** Adjust the amount that the acceleration of each particle will be adjusted. The higher this value, the more the particle will accelerate towards the orbit. A magnitude of 0.001 is a good number to use for this. When the magnitude is set too high, the particles will simply fly out into space.
- **Point X:** Defines the X position of the centre of the Orbit. You may also leave this at 0 and use a peg to move the position of the Orbit module.
- **Point Y:** Defines the Y position of the centre of the Orbit.
- **Point Z:** Defines the Z position of the centre of the Orbit.
- **Direction X:** Defines the X component of the axis of rotation for the orbit. This is only taken into account if you choose to set up a custom axis. If this is set to 1, and Y and Z are set to 0, then the axis will be going in the same direction as the X axis. If the X component is set to 1, and the Y component is also set to 1, then the axis will be at a 45 degree angle between the two.
- **Direction Y:** Defines the Y component of the axis of rotation for the orbit.
- **Direction Z:** Defines the Z component of the axis of rotation for the orbit.

Planar Region

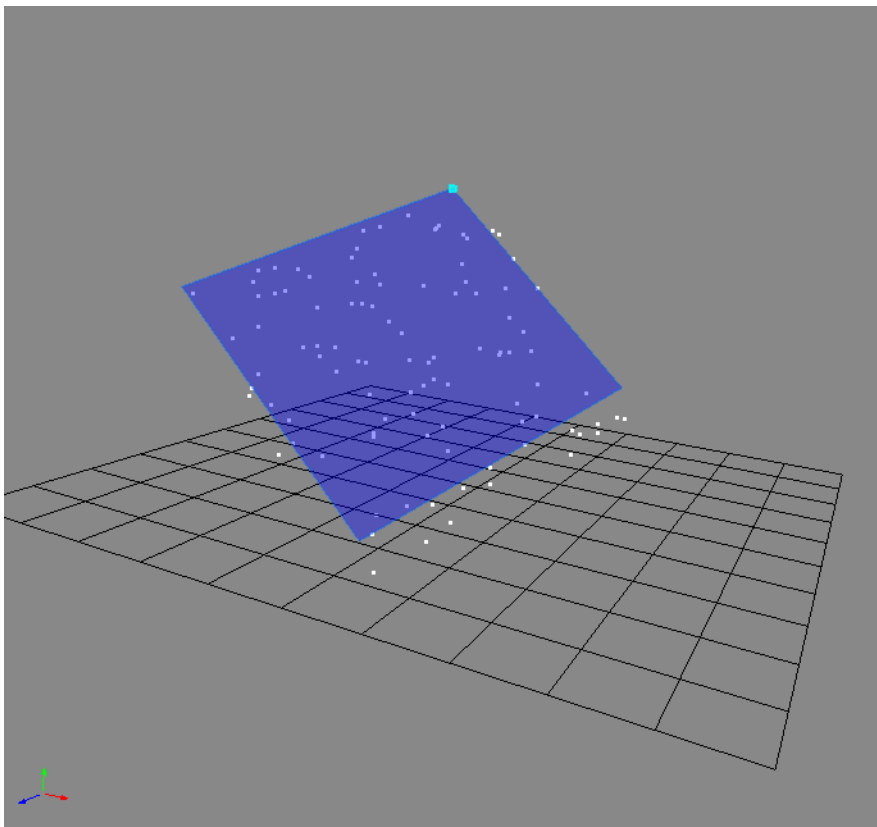

Like the 3D region, this determines a region that could be used as a source or as a bounce plane, but instead of a 3D region it's a 2D plane. Connect a peg to the right in-port to adjust the position of the plane.

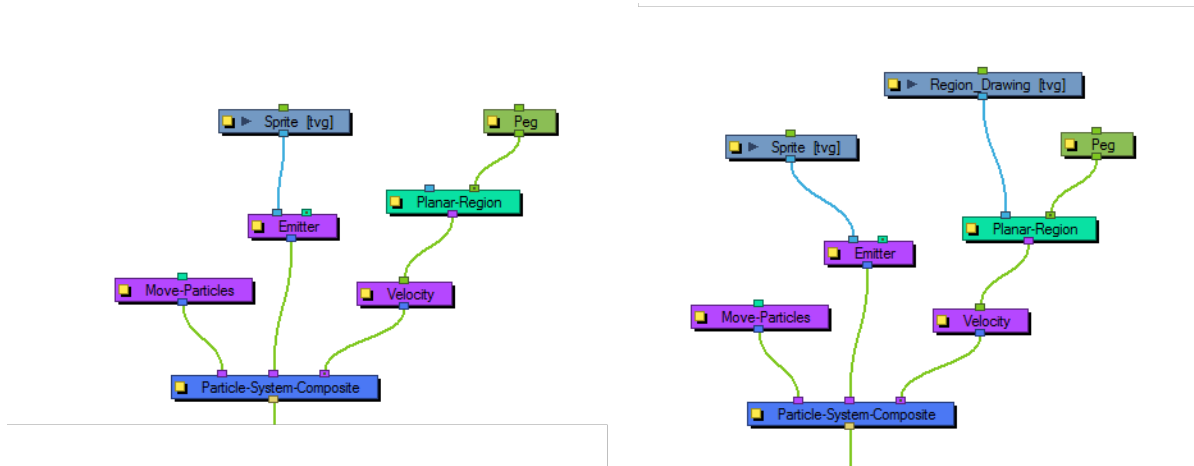

Layer Properties

Use the Planar Region's Layer Properties panel to adjust the effect's parameters.

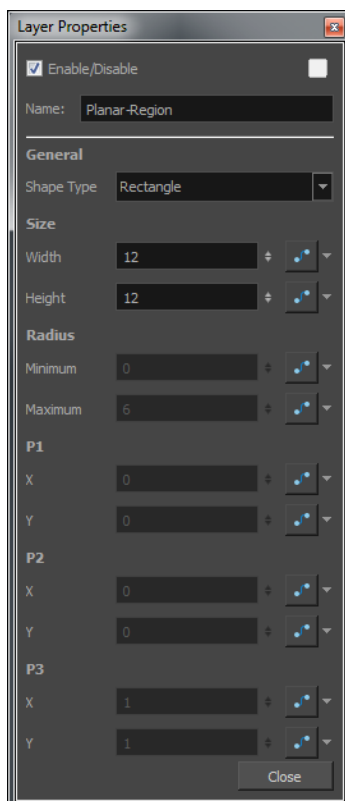

- **General:**
 - **Shape Type:** This is where you can define the shape of the plane. The parameters that you can adjust below will be greyed out depending on which shape type you choose. Each shape can be adjusted from the Camera view using the Transform Tool by selecting the Planar Region and then selecting **View > Show > Control**.
 - **Rectangle:** Adjust the width and height on a rectangle.
 - **Disc:** Adjust the point (the centre) of the disk. You may also adjust values for minimum and maximum radius. A minimum radius of 0 will simply be a circle.
 - **Triangle:** Adjust the three points of the triangle independently.
 - **Line:** Adjust two points on a line.
 - **Point:** Adjust the position of one single point.
 - **Image:** If you choose to use the Image option, then you should make use of the left in-port of the Planar-Region to connect a drawing layer that can be used as a mask.
- **Size:**
 - **Width:** Adjust the width of a rectangular region.
 - **Height:** Adjust the height of a rectangular region.
- **Radius:**
 - **Minimum:** Adjust the minimum radius on a disc region.
 - **Maximum:** Adjust the maximum radius on a disc region.
- **P1:**
 - **X:** Adjust the X position of Point 1. Point 1 could refer to the point on a triangle, a line, or a point.
 - **Y:** Adjust the Y position of Point 1.
- **P2:**
 - **X:** Adjust the X position of Point 2. Point 2 could refer to the point on a triangle or a line.
 - **Y:** Adjust the Y position of Point 2.
- **P3:**
 - **X:** Adjust the X position of Point 3. Point 3 refers to a point on a triangle.
 - **Y:** Adjust the Y position of Point 3.

Random

Allows you to put a random seed on some qualities like acceleration, speed, rotation speed, and position. There is also a Seed value in the Baker, but you may only want to make one particular aspect of the system random. This module gives the control over the randomness of a particular property.

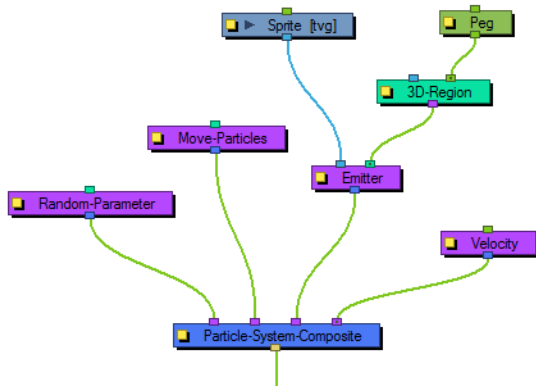

Layer Properties

Use the Random Module's Layer Properties panel to adjust the effect's parameters.

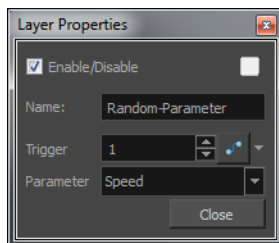

- **Trigger:** Is an on/off switch using binary code, where 1 = on, while 0 = off.
- **Parameter:** Allows you to choose which parameter you would like to make random.
 - None
 - Acceleration
 - Speed
 - Rotation Speed
 - Position

Region Composite

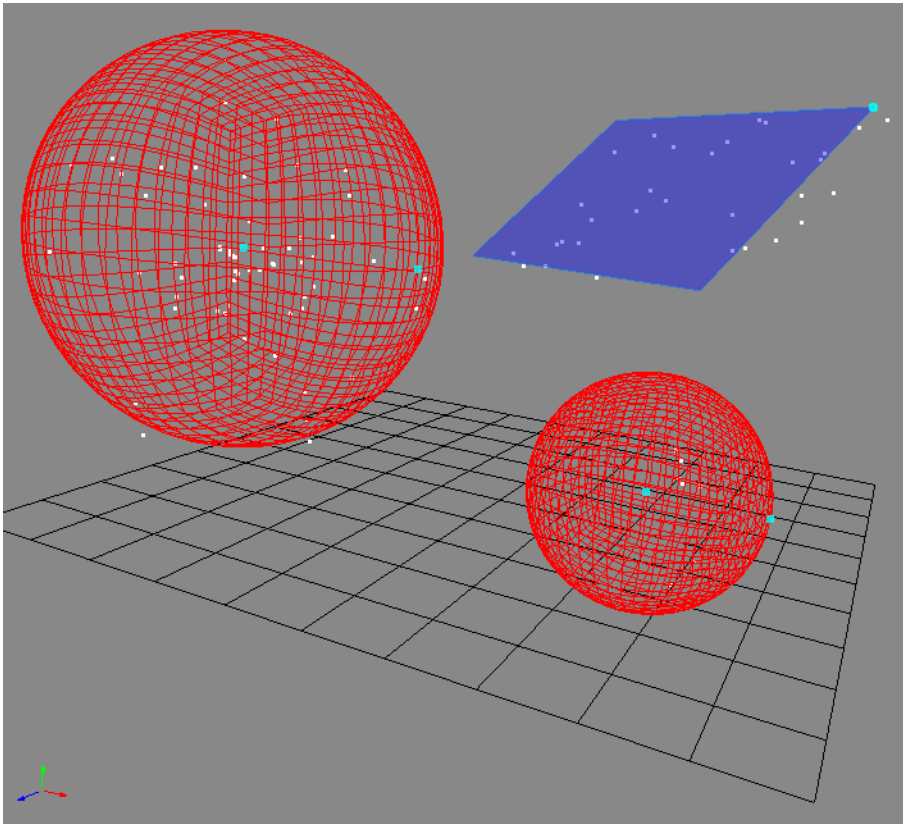

This module can composite together multiple regions, 3D Regions or Planar Regions. You may wish to emit particles from multiple regions in the same particle system.

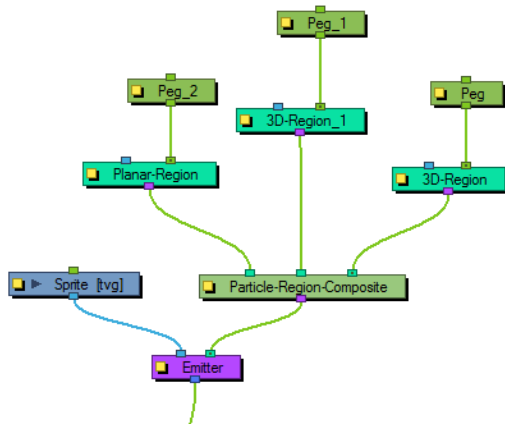

Repulse

This module will repulse a particle around a region, but different from bounce, it's repelled before it physically hits the region.

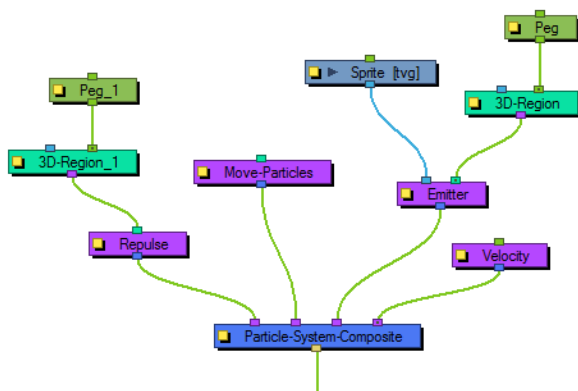

Layer Properties

Use the Repulse Module's Layer Properties panel to adjust the effect's parameters.

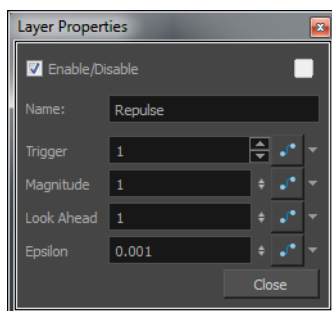

- **Trigger:** Is an on/off switch using binary code, where 1 = on, while 0 = off.
- **Magnitude:** This value should be between 0 and 2. The higher the value, the more drastically the particles will be repulsed.
- **Look Ahead:** This value alters how far ahead of the particle's current position it will look to see whether there's an obstacle coming ahead. This value should be between 0 and 100.
- **Epsilon:** This value affects how quickly the effect of the repulse wears off. The smaller the number, the longer the effect lasts. This value should be between 0.1 and 0.0001.

Rotation Velocity

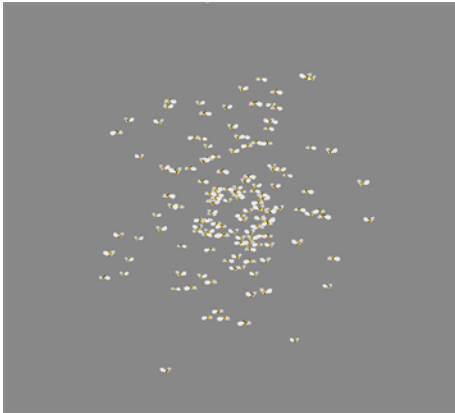

This module allows you to define the initial rotational velocity of the particles. The values that you set up for this module refer to each individual particle's drawing axes. This means that if you choose to rotate around the X axis, it will rotate around each particle's local X axis as defined by its drawing plane.

The rotational velocity should be set before you emit the particles, i.e. to the right, so that the velocity is taken into account when the particles are created.

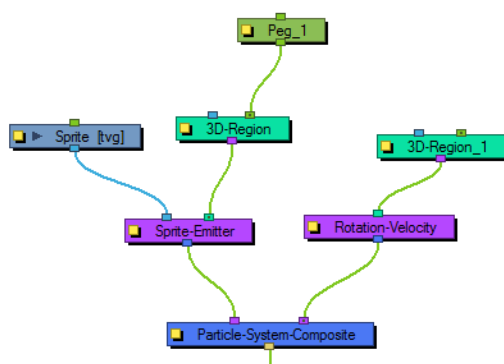

Layer Properties

Use the Rotation Velocity's Layer Properties panel to adjust the effect's parameters.

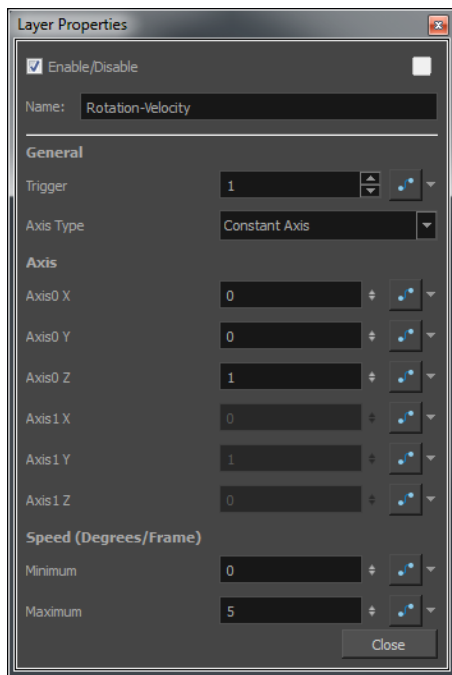

- **General:**
 - **Trigger:** Is an on/off switch using binary code, where 1 = on, while 0 = off.
 - **Axis Type:** Select the type of axis you would like to use.
 - **Constant Axis:** If you choose to rotate the particles around a constant axis, then each particle will rotate around the same axis. This axis will then be defined as Axis0.
 - **Interpolated Axis:** If you choose to rotate the particles around an interpolated axis, that means each particle will have its own rotational velocity which lies somewhere between Axis0 and Axis1.
 - **Use Input Shape:** Use a region to define the rotation axis of the particles. The axis of each particle's rotation will be perpendicular to the plane that particle is created on.
- **Axis:**
 - **Axis0 X:** Define the X component of Axis0. If you set the X to 1, and the Y and Z to 0, then the particle will rotate around its X axis as defined by its drawing plane. If you set X to 1 and also Y to 1, then it will rotate around an axis that is 45 degrees between X and Y.
 - **Axis0 Y:** Define the Y component of Axis0.
 - **Axis0 Z:** Define the Z component of Axis0.
 - **Axis1 X:** Define the X component of Axis1. This applies only when you have selected an Interpolated axis.
 - **Axis1 Y:** Define the Y component of Axis1.
 - **Axis1 Z:** Define the Z component of Axis1.
- **Speed (Degrees / Frame):**
 - **Minimum:** Enter the minimum initial rotation that a particle can have, in degrees per frame.
 - **Maximum:** Enter the maximum initial rotation that a particle can have, in degrees per frame.

Sink

This module will cause the particles to disappear when outside of the region plugged into the sink. It can also be inverted, so that the particles disappear when they enter the region instead.

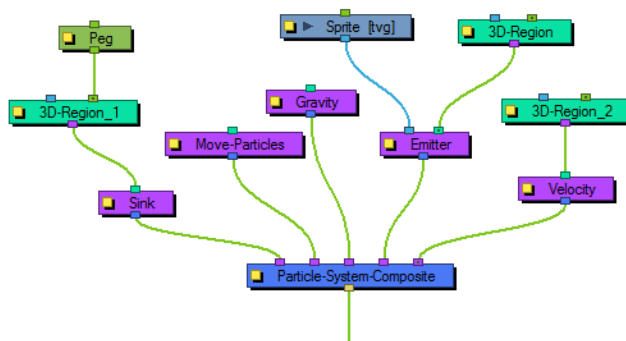

Layer Properties

Use the Sink Module's Layer Properties panel to adjust the effect's parameters.

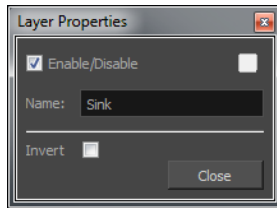

- **Invert:** The default behaviour of the sink is for particles to disappear when they depart the region. When inverted, the particles disappear when they enter the region instead.

Size

This allows you to animate the size of the particles.

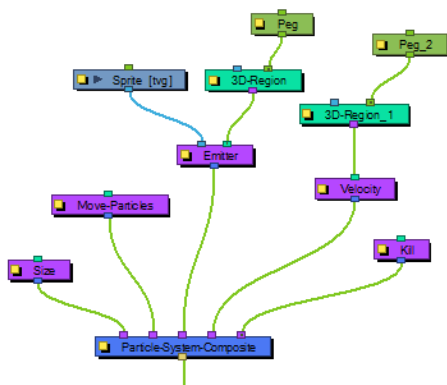

Layer Properties

Use the Size Module's Layer Properties panel to adjust the effect's parameters.

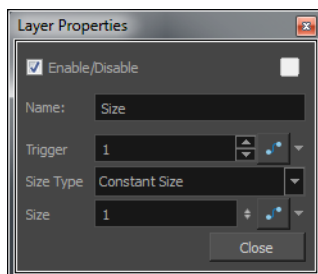

- **Trigger:** Is an on/off switch using binary code, where 1 = on, while 0 = off.
- **Size Type:** If you choose Constant Size, then all particles will be animated to have the same size. If you choose Input Shape instead, then you must input a Region into the in-port of the Size module. It will use this region to determine the size of the particles.
- **Size:** Change this value to adjust the size of the particles.

Sprite Emitter

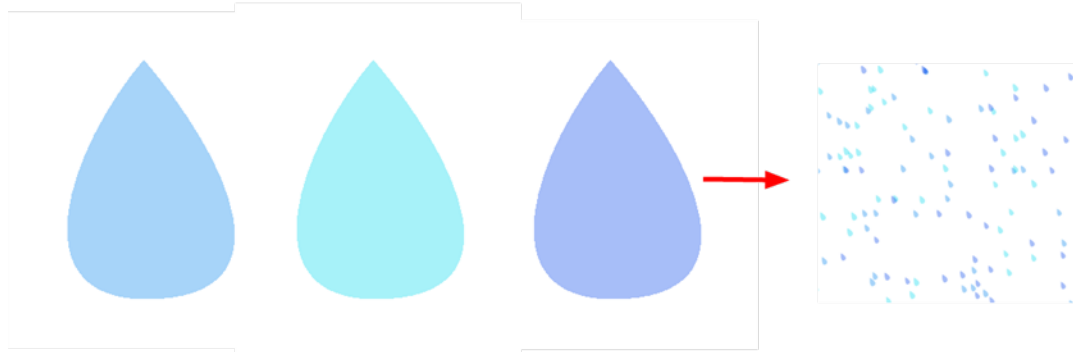

This is your all-purpose emitter, that you can plug a drawing layer into, and it will generate particles that look like your drawing layer. You could also just output dot particles if you have no image layer connected. There are many parameters to determine how you would like to emit your particles.

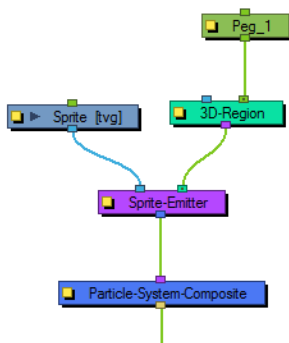

Layer Properties

Use the Sprite Emitter's Layer Properties panel to adjust the effect's parameters.

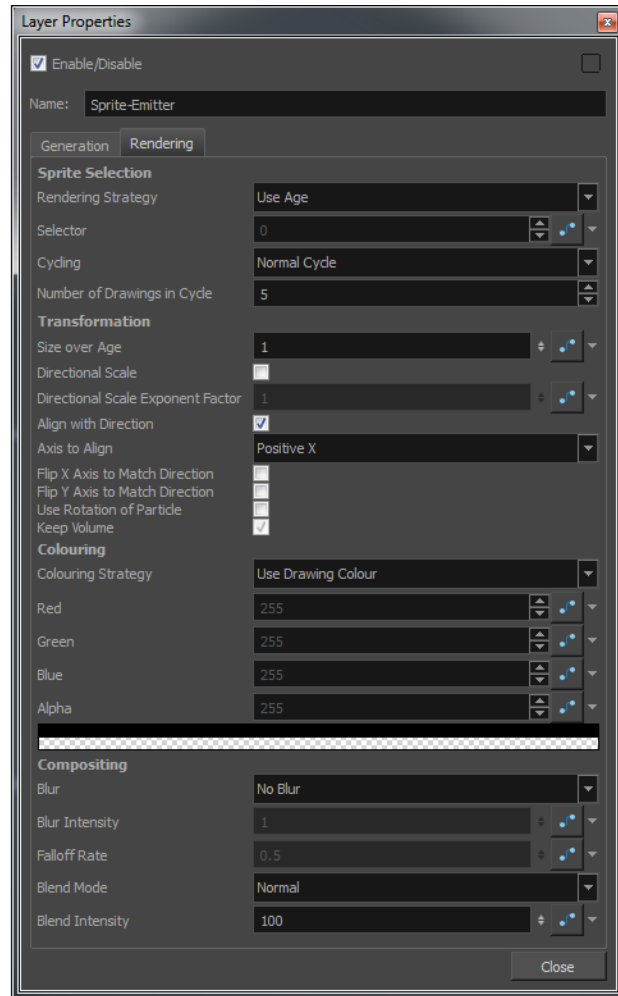
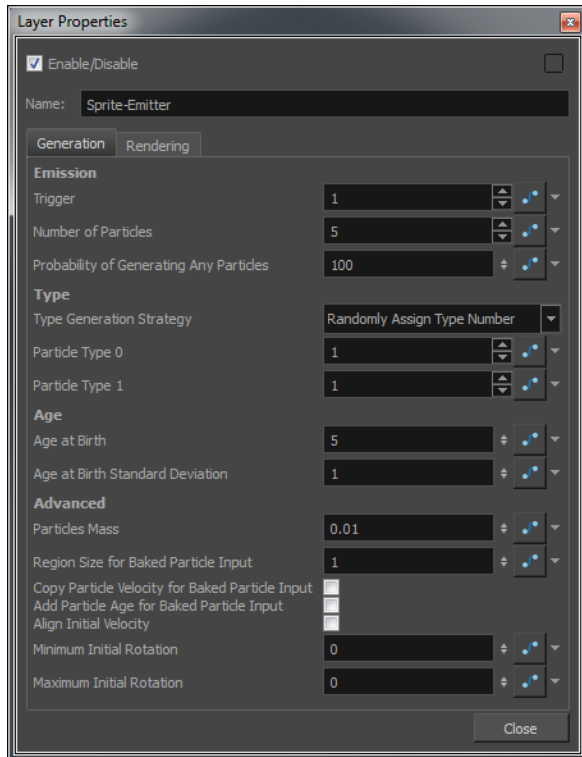

Generation Tab

- **Emission:**

- **Trigger:** Is an on/off switch using binary code, where 1 = on, while 0 = off.

- **Number of Particles:** This is where you can define how many particles will be emitted on each frame.

- **Probability of Generating Any Particles:** This is a probability percentage between 0 and 100. If the probability is set to 100%, it will absolutely generate the Number of Particles specified. If you put the percentage down to 50%, then there's only a 50% chance that it will generate the number of particles set in Number of Particles. Play with this value to add random spacing to the generation of particles.

- **Type:** You may want to design a variety of different drawings that will vary up the appearance of your particle system. In this case, you should put each drawing on its own cell in the drawing layer. Each drawing will then be a new Type of particle.
- **Type Generation Strategy:** This allows you to choose between Sequentially assigning a type (moving from one drawing to the next) or Randomly assigning a type.
- **Particle Type 0:** This is the frame number where the first drawing can be found. If you have a 5-frame cycle that starts on frame 1, you would put a 1 here.
- **Particle Type 1:** This is the frame number where the last drawing can be found. If you have a 5-frame cycle that starts on frame 1, you would put 5 here.
- **Age:**
 - **Age at Birth:** A different start frame number can be entered in this field. This means that a particle can start with a different drawing than the drawing that you have on frame 1.
 - **Age at Birth Standard Deviation:** Allows a random deviation for the birth of the particles. If you have a 5-frame cycle that starts on frame 1, but you want the particles to be of a random type, then you may want to set the Age and Birth to 3 with a standard deviation of 2. That means that particles will randomly be born at any frame from 1 to 5.
- **Advanced:**
 - **Particles Mass:** Define a mass for the particles. This mass will affect how the particles interact with gravity.
 - **Region Size for Baked Particle Input:** The Baked Particle Input property refers to when you use a Baker as an input to a Sprite Emitter. You can do this when you want to generate particles from other particles. When you do this, you have the option of setting a sphere around the source particle from which the new particle system will generate particles. That is the region which is referred to in this value. If you look at the following example, you'll see that the purple smiley faces are generating smaller green, blue, and yellow smiley faces. This is done by plugging the Baker from the purple smiley faces into the Sprite Emitter of the other smiley faces. See the following images:

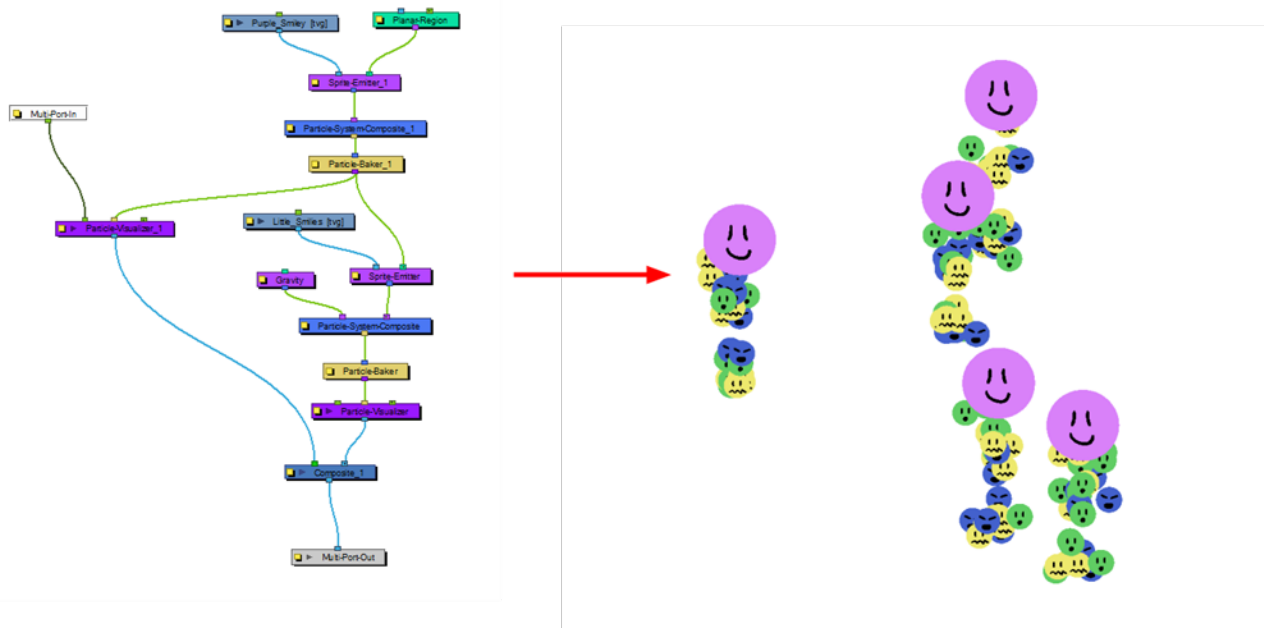

- **Copy Particle Velocity for Baked Particle Input:** If you select this option, the velocity of the parent system will be applied to the child system when a Baker is used as the region for a Sprite Emitter.

- **Add Particle Age for Baked Particle Input:** If you select this option, the age of the parent system will be inherited by the child system when a Baker is used as the region for a Sprite Emitter.

- **Align Initial Velocity:** This aligns the initial velocity with the region from which the particles are being emitted. If you are emitting from a sphere, then the particles will all start out moving away from the centre of the sphere.

- **Minimum Initial Rotation:** Define a minimum rotation in degrees that the particle can have when it is generated. There is also a separate Rotation-Velocity module in which you can define this parameter.
- **Maximum Initial Rotation:** Define a maximum rotation in degrees that the particle can have when it is generated.

Rendering Tab

- **Sprite Selection:**
 - **Rendering Strategy:** Select a method to use to decide which particle type will be defined for each particle that is created.
 - **Render as Dot:** This will simply render each particle as a dot. This is useful mainly for previewing the effects of your particle system without using the drawing layer (sprite)
 - **Use Frame Number:** As the frame number increases, the type of particle will change to match the frame number. This means that ALL particles in the system will change together as the frame number changes. If you only have a few drawings, then you may want to enable Cycling in order to cycle those drawings.
 - **Use Frame Number as Index in Selector:** When you select this option, then you may use the Selector option to animate the Frame Number that it uses over time. Meaning, instead of taking the current frame as the Frame Number, you can write your own function instead. For example, if I were to animate the selector so that at frame 1, it starts out at 2, then 8 frames later I add another keyframe to set the value to 4, between the frame 1 and frame 8 the particles will all change type together from what they look like on frame 2 to what they look like on frame 4.
 - **Use Particle Type:** Each particle that is generated will look like the Particle Type that was assigned under the Generation tab. For example, if you put 1 for Particle Type 0, and then you put 6 for Particle Type 1, then each particle will be assigned a type from 1 to 6. This type corresponds to the drawing that appears on the sprite on that frame number. So if I have a drawing layer called Sprite that I have plugged into the left in-port of my Emitter, it will look for the drawings in cells 1 to 6 of Sprite to assign those drawings to each Particle.
 - **Use Particle Type as Index in Selector:** This option allows you to use the Selector to manually create a function that assigns how many of which particle will be created. For example, we can set the Particle Type to go from 1 to 100, in the Generation tab. Then we will use the Selector to remap the particle types to a certain drawing. So for example I could create 5 drawings, labelled 1 to 5, and I can use my selector to say I'd like to create mainly 1s, no 2s, a few 3s, 4s, and a very few 5s. What it's doing is, it is looking at the x-axis to find what the particle "type" is, then it is looking at the y-axis to find out which drawing to assign to that "type." When you use 1 to 100 as a type, then when you're setting the values, they act in fact as a percentage. See the following images for further clarification:

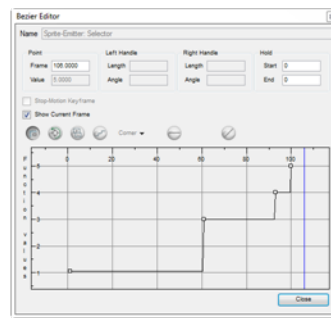
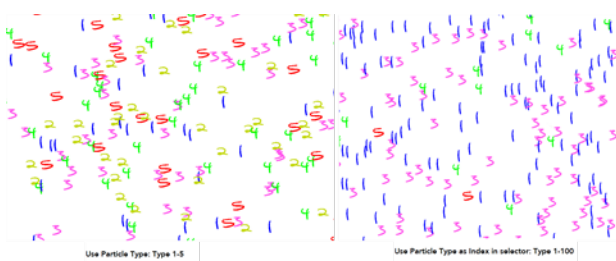

Selector: Bezier Editor, Type 1-100, Drawings 1-5

- **Use Age:** As the particle ages, it will change appearance from what appears on the Sprite's first drawing to the subsequent drawings. This means that each particle can have its appearance animated as it gets older.

- **Use Age as Index in Selector:** You can animate the Selector in order to change how a particle ages over time. For example, if I have a Sprite that has 6 drawings on it, I might want to animate it so that it changes from drawing 1, on frame 1, to drawing 2, on frame 10, then drawing 3 on frame 14, drawing 4 on frame 16, drawing 5 on frame 17, etc. so that the particle rapidly ages. This allows me to change the timing of the aging dynamically through the selector, instead of having to modify the exposure of the cells on the Sprite.
- **Selector:** Animate the Selector in conjunction with the Rendering Strategy to adjust the parameters that control the particle's appearance at birth and over time.
- **Cycling:** If you're using rendering strategies like Frame Number or Age, you may want to cycle the drawings. For example, if you are using Frame Number, but you've only got 5 frames worth of drawings in your Sprite, then if you use "No Cycle," your Particles will disappear after frame 5. You can choose to cycle Normally, 1-2-3-4-5-1-2-3-4-5, or Back and Forth, 1-2-3-4-5-4-3-2-1.
- **Number of Drawings in Cycle:** You should indicate how many frames from your Sprite you'd like to cycle.
- Transformation:
 - **Size over Age:** Use this value to set how you would like the size of the particle to change as it ages. Attach a function to this attribute if you would like to, for example, have the particles get smaller as time goes on.
 - **Directional Scale:** Click this checkbox if you'd like to scale the particle in the direction of its movement.
 - **Directional Scale Exponent Factor:** Set an exponent here for how much you'd like that particle to scale.
 - **Align with Direction:** Check this checkbox if you'd like to align the particle in the direction of its movement.
 - **Axis to Align:** Select the axis that you'd like to align from the drop-down box. This axis refers to the axis of the Drawing grid from the Drawing module plugged into the emitter.
 - **Flip X Axis to Match Direction:** You might want to have the particle align to the X direction of movement. You can see this property being used in the Lemmings example.
 - **Flip Y Axis to Match Direction:** Similar to flipping the X axis, you may wish to flip the Y axis of a drawing to match the direction of the particle's movement.
 - **Use Rotation of Particle:** Check this checkbox to enable rotation on the particle.
 - **Keep Volume:** If you choose the Directional Scale option, then Keep Volume will become available. This option maintains the volume of the object by squashing it in one axis when it stretches it in another.
- Colouring:
 - **Colouring Strategy:** This drop-down box allows you to set how you would like to define the colour of the particle.
 - **Use Drawing Colour:** In this case, the particle will remain the same colour as it was drawn with.
 - **Map RGB Based on Age:** Attach a function to this to vary the Red, Green, and Blue values of the particle as it ages.
 - **Map RGBA Based on Age:** Attach a function to this to vary the Red, Green, Blue, and Alpha values of the particle as it ages.
 - **Apply Opacity Based on Age:** Keep the original RGB values from the drawing, but vary the Alpha (Opacity) according to a function that you define here.
 - **Map RGB Based on Frame:** Change the Red, Green, and Blue values of the particles based on the frame. Changing based on the frame means that ALL particles will change colour on that

frame, regardless of their age.

- **Map RGBA Based on Frame:** Change the Red, Green, Blue, and Alpha values of all particles on a given frame by attaching a function.
- **Apply Opacity Based on Frame:** Use the original RGB values from your drawing, but vary the Alpha (Opacity) of the particles on a certain frame by attaching a function to this.
- **Red, Blue, Green:** This is where you can attach functions to Red, Blue, and Green values. You can also click on the colour swatch to adjust the colour.
- **Alpha:** This is where you can attach a function to the Alpha (Opacity) of your particles.
- **Compositing:**
 - **Blur:** Define whether you'd like to apply a Blur to the particles.
 - **No Blur:** No blur will be applied to the particles.
 - **Directional Blur Based on Age:** Attach a function to define how you would like the particles to blur based on the age of each particle. The particle will blur in the direction of movement.
 - **Directional Blur Based on Frame:** Attach a function to define how all particles should be blurred at a particular frame. The particle will blur in the direction of movement.
 - **Low Quality Radial Blur Based on Age:** Attach a function to define how you would like the particles to blur based on the age of each particle. This will be a low quality blur.
 - **Low Quality Radial Blur Based on Frame:** Attach a function to define how all particles should be blurred at a particular frame. This will be a low quality blur.
 - **Low Quality Radial Blur Based on Camera Distance:** Define how you would like the particles to blur based on their distance from the camera. This is a low quality blur.
 - **High Quality Radial Blur Based on Age:** Attach a function to define how you would like the particles to blur based on the age of each particle. This is a high quality blur.
 - **High Quality Radial Blur Based on Frame:** Attach a function to define how all particles should be blurred at a particular frame. This is a high quality blur.
 - **High Quality Radial Blur Based on Camera Distance:** Define how you would like the particles to blur based on their distance from the camera. This is a high quality blur.
 - **Blur Intensity:** This is where you can set a value, or attach a function to animate the blur according to the type of blur that was defined from the drop-down list.
 - **Falloff Rate:** The distance where the blur fades from the edge of the image. Select a value between 0 and 1.
 - A falloff rate of 0 causes the blur to fade out slowly, distributing the blur evenly from the edge of the drawing to the farthest edge of the blur.
 - A falloff rate of 1 causes the blur to fade out quickly so that the blur is heaviest at the edge of the drawing.
 - **Blend Mode:** Define a blend mode for the particles to get cool effects.
 - **Blend Intensity:** This is a percentage of how opaque you would like the particles to be blended. A value of 50 would be 50% transparent. A value of 100 would be fully opaque.

System Composite

This is where you connect together all of the "Actions" of your particle system. An action is any of the light purple modules, like Gravity, Emitters, velocity parameters. All of the "Actions" help to define the behaviour of the particle system.

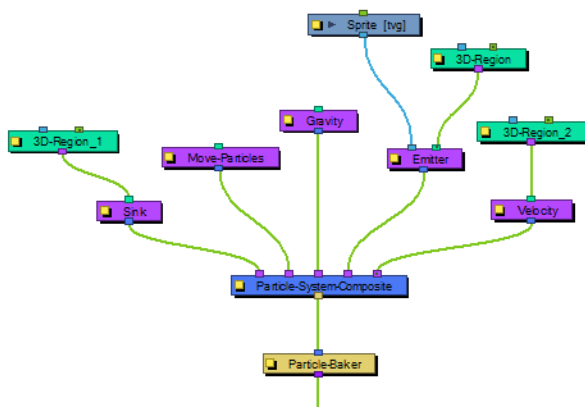

Turbulence



Image courtesy of Adam Phillips

The Turbulence effect is a mathematically generated effect that uses fractal noise to create turbulent distortions in an image. You can see the effect when used with an image as the background. You can create flowing water, funhouse mirrors, and waving flags.

For detailed video tutorials and sample scenes by Adam Phillips, see toonboom.com/resources/video-tutorials/chapter/adam-phillips-harmony-effects.

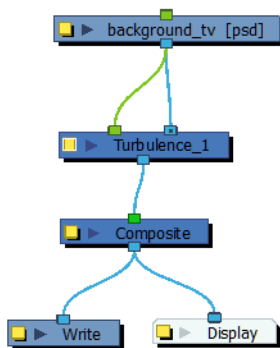
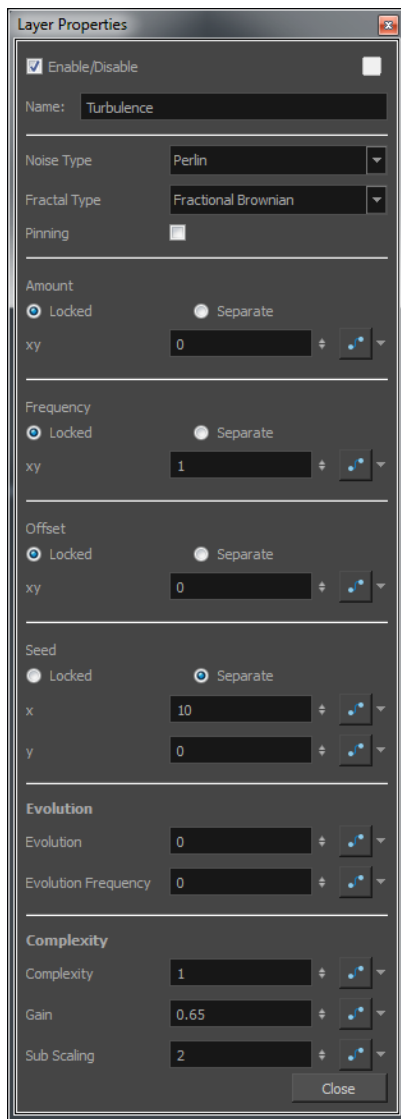

Turbulence Effect Properties

Parameter	Description
-----------	-------------

Noise Type	Lets you select a type of noise pattern.
	Perlin: Creates pseudo random patterns. The greyscale contains a continuity between different tones of grey.
	Simplex: Creates a more contrasted noise pattern with more variation than Perlin. There is a smooth variation of intensity.
	Sinusoidal: Creates a repeated wavelike pattern.
	Sub Scaling: Applies Perlin noise twice. The second noise is added where dark areas appear in the original. The frequency of the second iteration is higher so the noise is smaller.
	Rocky: Uses the Perlin pattern but converts the very high and low values to more moderate values. For example, the whites become light greys and the blacks become dark greys.
	Small Bumps: Uses the Perlin pattern. The transitional grey areas between blacks and whites become inverted so they look like dark lines. The extremes, black and white areas, become whitish.
Fractal Type	Transforms the noise pattern, created by the Noise type and controls the way layers are composited. These are variations of the basic noise.
	Turbulent Twist: Applies a turbulent effect on the pattern so it changes the transition between black and white by adding more modulation.
	Fractional Brownian: Applies a basic application of noise and composites by adding subsequent layer with the Complexity parameter.
	Threshold: Changes the dark greys into black values so there is more black in the noise for higher contrast.
	Invert Threshold: Inverts all the values of the Threshold type so a negative image of it is created.
	Terrain: Adds contrast and converts the dark greys into white or light greys.
Pinning	Constrains the effect within the image boundaries.
Amount	Specifies the amplitude of displacement.
Frequency	The density of displacement appearing in the noise. A higher value produces a greater amount of displacement in a given area; a lower value produces a smaller amount.
Offset	Moves the entire image.
Seed	This value determines the starting noise pattern on the first evolution of the effect.
Locked	Applies parameter value while retaining the X and Y ratio.
Separate	Allows you to apply different parameter values to X and Y.
xy	When locked, applies parameter values to both X and Y. When separated, allows you to apply different value to X and Y.

Evolution	Determines the displacement pattern over time.
	Evolution Frequency: This factor makes the complexity iterations animate or transform at a higher speed. In other words, the second, third, etc. passes, controlled by the Complexity parameter, will mutate faster than the main one.
Complexity	Complexity: The number of noise layers that make up the noise. Each successive layer has a higher frequency, resulting in a smaller noise effect. You can have up to seven passes. Increasing this number increases the depth and amount of detail in the noise. Use Complexity with Sub Scaling when the value is 1 or greater. Note: Increasing the Complexity results in longer rendering times.
	Gain: Controls the amount of opacity present in the iteration of noise. This also affects the layer when using Sub Scaling. With a value of 0, you will not see the sub noise. A value of 1 will show the sub noise just as strong as the main one. For example, with water ripples, a higher amount of Gain will reveal more ripple or subripples.
	Sub Scaling: The factor by which the main noise is modified at each iteration of complexity. A value of 1 make the two noises identical. A value of 2 makes the sub noise twice as small. The next iteration would be 4 times smaller. Values must be greater than 1.

Turbulent Noise

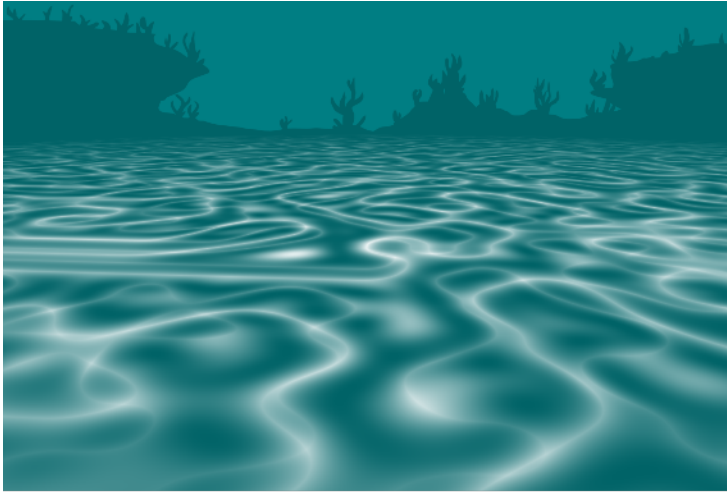
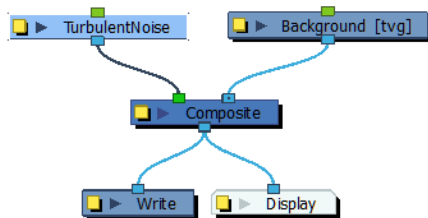
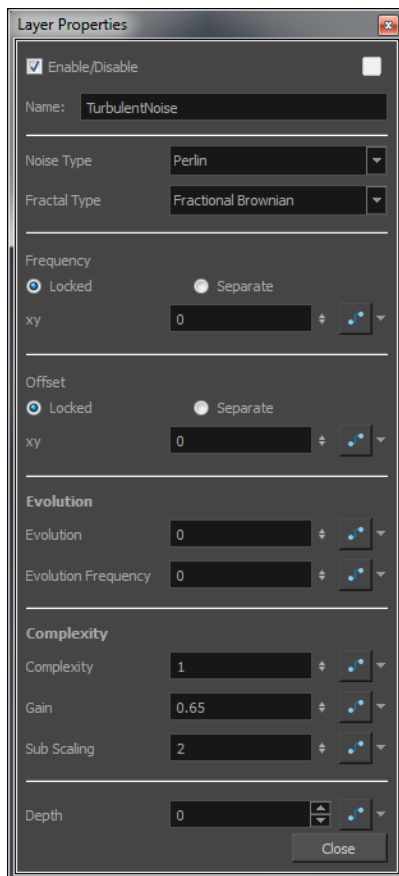

Image courtesy of Adam Phillips

The Turbulent Noise effect uses Perlin noise to create greyscale noise for organic-looking backgrounds, displacement maps, and textures, or to simulate clouds, fire, lava, steam, flowing water, or vapour. The Turbulent Noise effect models turbulent systems with smaller noise features moving more quickly than larger noise features. The Turbulent Noise effect creates smooth animations and takes less time to render than other noise or grain effects.

For detailed video tutorials and sample scenes by Adam Phillips, see toonboom.com/resources/video-tutorials/chapter/adam-phillips-harmony-effects.



Turbulent-Noise Effect Properties

Parameter	Description
Noise Type	Perlin: Creates pseudo random patterns. The greyscale contains a continuity between different tones of grey.
	Simplex: Creates a more contrasted noise pattern with more variation than Perlin. There is a smooth variation of intensity.
	Sinusoidal: Creates a repeated wavelike pattern.
	Sub Scaling: Applies Perlin noise twice. The second noise is added where dark areas appear in the original. The frequency of the second iteration is higher so the noise is smaller.
	Rocky: Uses the Perlin pattern but converts the very high and low values to more moderate values. For example, the whites become light greys

	and the blacks become dark greys.
	Small Bumps: Uses the Perlin pattern. The transitional grey areas between blacks and whites become inverted so they look like dark lines. The extremes, black and white areas, become whitish.
Fractal Type	Transforms the noise pattern, created by the Noise type and controls the way layers are composited. These are variations of the basic noise.
	Turbulent Twist: Applies a turbulent effect on the pattern so it changes the transition between black and white by adding more modulation.
	Fractional Brownian: Applies a basic application of noise and composites by adding subsequent layer with the Complexity parameter.
	Threshold: Changes the dark greys into black values so there is more black in the noise for higher contrast.
	Invert Threshold: Inverts all the values of the Threshold type so a negative image of it is created.
	Terrain: Adds contrast and converts the dark greys into white or light greys.
Frequency	The density of displacement appearing in the noise. A higher value produces a greater amount of displacement in a given area; a lower value produces a smaller amount.
Offset	Moves the entire image.
Locked	Applies parameter value while retaining the X and Y ratio.
Separate	Allows you to apply different parameter values to X and Y.
xy	When locked, applies parameter values to both X and Y. When separated, allows you to apply different value to X and Y.
Evolution	Determines the displacement pattern over time.
	Evolution Frequency: This factor makes the complexity iterations animate or transform at a higher speed. In other words, the second, third, etc. passes, controlled by the Complexity parameter, will mutate faster than the main one.
Complexity	Complexity: The number of noise layers that make up the noise. Each successive layer has a higher frequency, resulting in a smaller noise effect. You can have up to seven passes. Increasing this number increases the depth and amount of detail in the noise. Use Complexity with Sub Scaling when the value is 1 or greater. Note: Increasing the Complexity results in longer rendering times.
	Gain: Controls the amount of opacity present in the iteration of noise. This also affects the layer when using Sub Scaling. With a value of 0, you will not see the sub noise. A value of 1 will show the sub noise just as strong as the main one. For example, with water ripples, a higher amount of Gain will reveal more ripple or subripples.
	Sub Scaling: The factor by which the main noise is modified at each iteration of complexity. A value of 1 make the two noises identical. A value of

	2 makes the sub noise twice as small. The next iteration would be 4 times smaller. Values must be greater than 1.
	Depth: This value determines the composition order when the Z value of two elements is the same.

Velocity

This defines the initial velocity of the particles that are emitted in the particle system. You may select this module and select **View > Show > Control** to display manipulation handles to help you set the parameters of this module. Use your Transform Tool to modify the manipulation handles in the Camera View or the Perspective View.

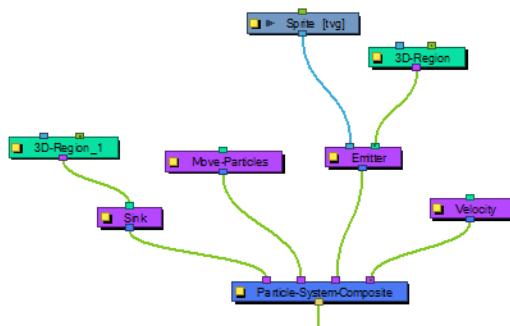

Layer Properties

Use the Velocity Module's Layer Properties panel to adjust the effect's parameters.

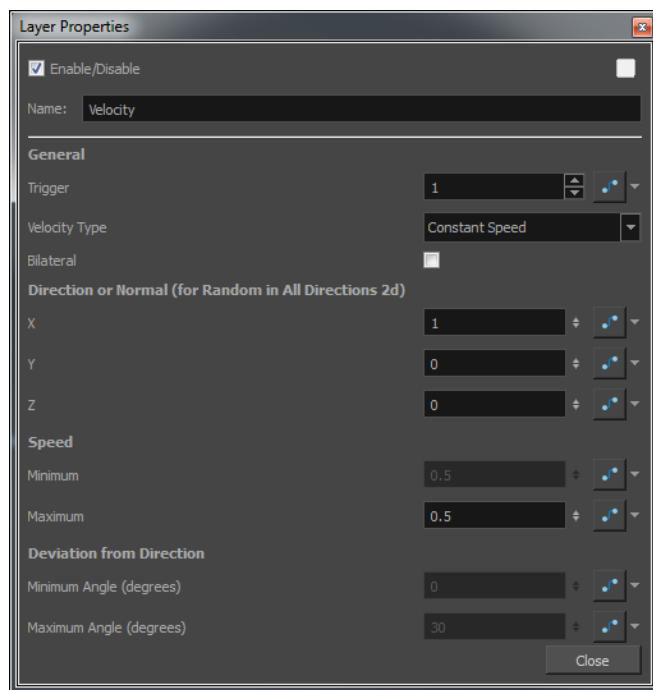

- **General:**
 - **Trigger:** Is an on/off switch using binary code, where 1 = on, while 0 = off.
 - **Bilateral:** This option serves to generate positive and negative velocities in a given direction. For example, you can generate particles with cone-shaped velocity, (e.g. a bazooka firing) going only in the forward direction, but you can also generate velocities in the opposite direction.
- **Velocity Type:**
 - **Use Input Shape:** If you plug a Region into the in-port of the Velocity module, it will take the shape of this region to determine the initial velocity of the particles. They will take a velocity that is perpendicular to the surface of the shape.
 - **Constant Speed:** Set a constant speed for the initial velocity of the particles.
 - **Interpolated Speed:** Each particle will be assigned an initial speed that is somewhere between the two values set for Interpolated Speed.
 - **Random in All Directions 2D:** All particles will be assigned a random velocity in any direction on a 2D plane.
 - **Random in All Directions 3D:** All particles will be assigned a random velocity in any direction.
 - **Random in Cone:** Particles will be assigned an initial velocity anywhere in the shape of a cone.
 - **Random in 2D-Pie:** Particles will be assigned an initial velocity anywhere in the shape of a pie slice on a 2D plane.

- **Direction of Normal** (for Random in All Directions 2D): Use these values to input the perpendicular direction for the property Random in All Directions 2D.
 - **X**: Set a value between 0 and 1 to determine how much influence the X axis has over the direction of the normal. For example, if the X value is set to 1, and Y and Z are set to 0, then the perpendicular (normal) will be going in the X direction. If X is set to 1, and Y is also set to 1, then the axis will be 45 degrees, halfway between X and Y. Feel free to use the Manipulation Handles for the velocity module by selecting the Velocity module and then selecting **View > Show > Control**. This will allow you to use the Transform tool in the Camera View or the Perspective View to set the appropriate values.
 - **Y**: Set a value between 0 and 1 to determine how much influence the Y axis has over the direction of the normal.
 - **Z**: Set a value between 0 and 1 to determine how much influence the Z axis has over the direction of the normal.
- **Speed:**
 - **Minimum**: There are some speeds that are constant, and some that are a range of values between a minimum and maximum. Set the minimum speed here.
 - **Maximum**: Set the maximum speed for interpolated speeds.
- **Deviation from Direction:**
 - **Minimum Angle**: This is used for Cone and Pie shapes. Put a non-zero value here if you want there to be a hole in the middle of your cone or pie.
 - **Maximum Angle**: Set the maximum angle for your cone or pie here.

Visualizer

The Partical-Visualizer module renders and flattens the particle system down to a single plane. You can plug a peg module into the left port to animate the position of the whole particle system. Plugging a peg into the right port will move the depth where the flat plane is generated, so you can move it behind or in front of various other drawing layers in your scene. You can even have two Visualizers with pegs in the right in-ports that are at different depths to display some particles in front of and some particles behind a character or drawing in the scene.

Visualizer Properties

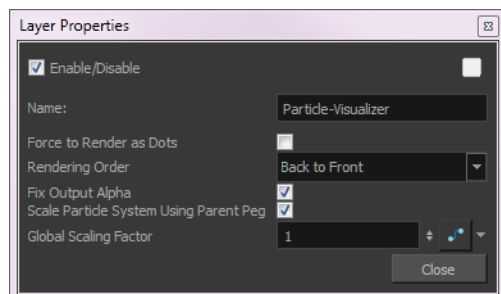

Parameter	Description
Force Render as Dots	Temporarily renders your system as Dots when previewing a simulation. All drawings are ignored and the system is forced to render as dots.

	<p>Note: You can also use the option View > Particle > Show Particles as Dots in OpenGL. When enabled, the particles will always be displayed as dots in the OpenGL preview mode to make playback speed faster for heavy scenes.</p>
Rendering Order	<p>Lets you set the order in which you want the particles to appear in the render.</p> <ul style="list-style-type: none"> • Back to Front: Added particles will appear behind existing particles. • Front to Back: Added particles will appear in front of existing particles. • Oldest to Youngest: Older particles will appear behind younger particles. • Youngest to Oldest: Older particles will appear in front of younger particles. • Ascending Types: Lower types will appear behind higher types. • Descending Types: Lower types will appear in front of higher types.
Fix Output Alpha	<p>This is an important option when using some filters like Screen or Multiply in the Blend Mode that can be specified in the Rendering tab of the Emitter. When working with premultiplied images, if the alpha is not fixed in the visualizer, you may see some unusual artifacts.</p>
Scale Particle System Using Parent Peg	<p>Respects the scaling of a particle system so you can position and resize it as you like. Old scenes with particle system will still work as this option is disabled.</p>
Global Scaling Factor	<p>Lets you set the scaling factor for particle system.</p>

Vortex

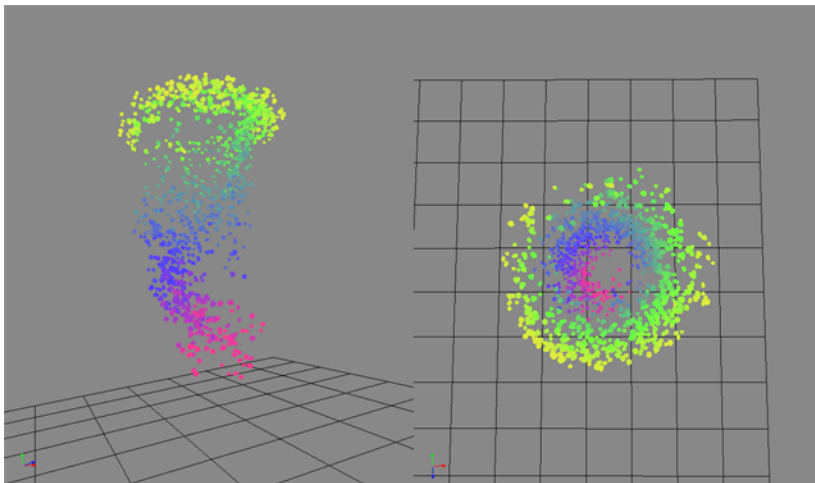

This particle allows you to define an axis as a vortex, so the particles will spin around this axis.

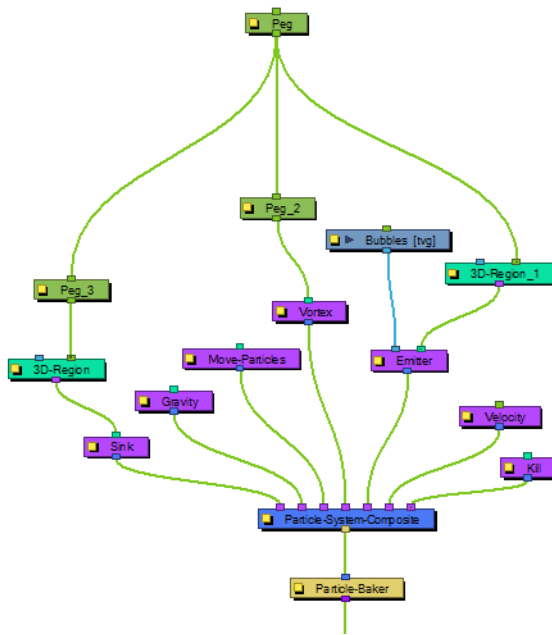

Layer Properties

Use the Vortex Module's Layer Properties panel to adjust the effect's parameters.

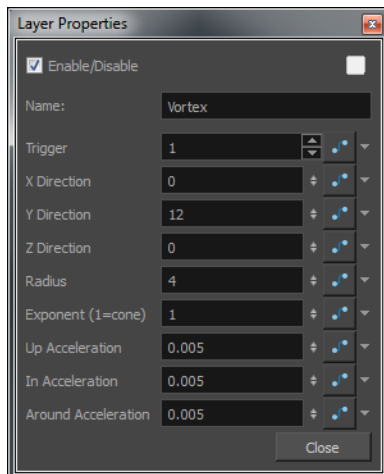

- **Trigger:** Is an on/off switch using binary code, where 1 = on, while 0 = off.
- **X Direction:** Defines the X portion of the axis of rotation for the Vortex.
- **Y Direction:** Defines the Y portion of the axis of rotation for the Vortex.
- **Z Direction:** Defines the Z portion of the axis of rotation of the Vortex.
- **Radius:** Defines the radius at the top of the vortex.
- **Exponent (1=cone):** Defines a curve that gives the Vortex a certain silhouette. 1 forms a cone, greater than 1 curves inward.
- **Up Acceleration:** Defines the vertical acceleration of the particles that are inside the Vortex.
- **In Acceleration:** Defines the inward acceleration of particles that are outside the Vortex.
- **Around Acceleration:** Defines the acceleration around the vortex of particles that are inside the Vortex.

Wind-Friction

This module allows you to define the amount of wind in the scene, and animate the wind over time.

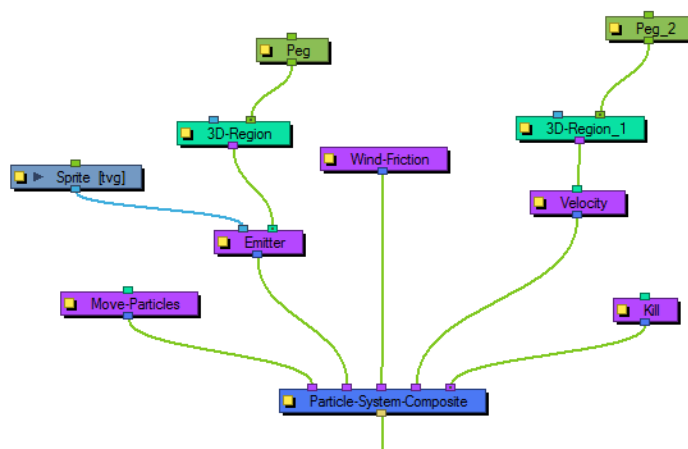

Layer Properties

Use the Wind Friction's Layer Properties panel to adjust the effect's parameters.

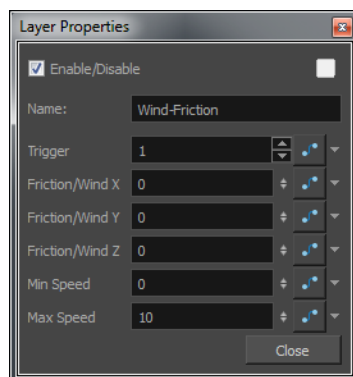

- **Trigger:** Is an on/off switch using binary code, where 1 = on, while 0 = off.
- **Friction/Wind X:** Defines the amount that the wind will dampen or increase the speed of the particles in the X direction.
- **Friction/Wind Y:** Defines the amount that the wind will dampen or increase the speed of the particles in the Y direction.
- **Friction/Wind Z:** Defines the amount that the wind will dampen or increase the speed of the particles in the Z direction.
- **Min Speed:** The minimum speed of particles that will be affected by the wind. Particles moving slower than this will not be affected.
- **Max Speed:** The maximum speed of particles that will be affected by the wind. Particles moving faster than this will not be affected.

Previewing and Playing Back Effects

To preview your effects, you will have to perform a quick render. Effects must be calculated before they can be viewed in real time.

How to preview effects

1. In the Playback toolbar, click the Render and Play  button.
The Play module opens and loads the frames.

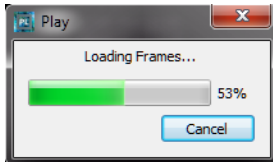

2. Once the frames are loaded, click the Play  button in the Play window.

Tip: While previewing effects, press Spacebar to stop and start playback.

Preview Resolution

To make your previews calculate faster, you may want to render them out at a smaller resolution. You can use the Preview Resolution command so you will not have to modify the resolution of your scene every time you make a check preview.

The Preview Resolution command allows you to quickly ask for a preview at either a quarter, half or three-quarter of the scene resolution. You can even customize the preview resolution size.

How to use the Preview Resolution command

1. From the top menu, select **View > Preview Resolution** and a resolution: **Same as Scene Resolution, 3/4 of Scene Resolution, 1/2 of Scene Resolution, 1/3 of Scene Resolution, 1/4 of Scene Resolution** or **Custom**.

If you selected the Custom option, the Custom Preview Resolution dialog box opens.

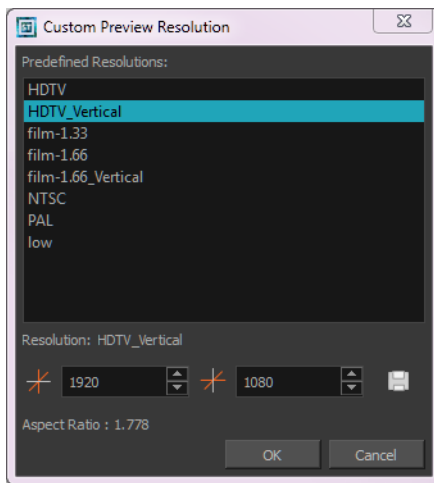

2. In the dialog box, select a resolution from the presets or type a new X-Y value.
3. Click **OK**.
4. Preview your effects animation.

Extra Commands

These are some useful commands you can find only in Harmony.

Recalculate All	Refreshes the network and rerenders the display when the Camera View is in render mode.	In the select Network View menu, select Edit > Recalculate All.
Recalculate Selected	Refreshes the network and rerenders the display of selected elements when the Camera View is in render mode.	In the Network View menu, select Edit > Recalculate Selected.
Auto Render Write	Renders a frame each time the current frame is changed. You must have a Write module in your network to use this command.	In the Network View menu, select Edit > Auto Render Write or press Ctrl + W (Windows/Linux) or ⌘ + W (Mac OS X).
Print Network	Prints the Network view.	Select File > Print > Network. In the Network View menu, select File > Print.

Chapter 8: Export

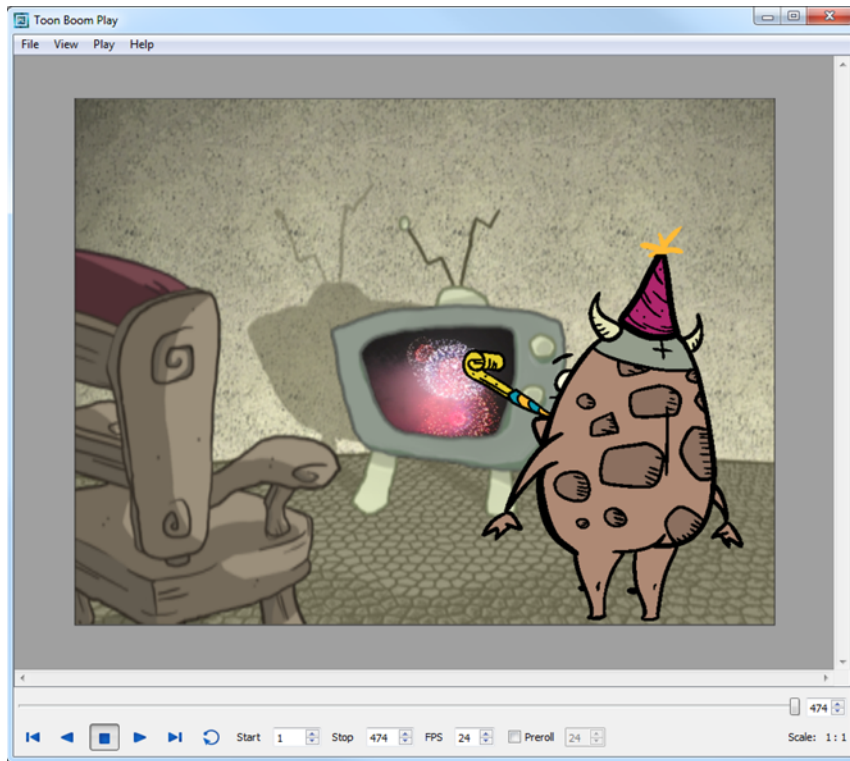

Now that you have finished your animation, it is time to render your movie. Depending on whether you plan to further edit your movie in a third party software, composite the movie in a larger body of work or put it up directly on the web, Harmony supports several formats for all your rendering needs.

This chapter contains the following topics:

- [Exporting a QuickTime Movie on the next page](#)
- [Exporting an SWF Movie on page 595](#)
- [Exporting OpenGL Frames on page 597](#)
- [Exporting a Sound File on page 599](#)
- [Advanced Export on page 601](#)

Exporting a QuickTime Movie

If you require a video file, you can export your animation as a QuickTime movie. To render a QuickTime movie with transparency, you need to set the Depth setting to Millions of Colours +.

If your exported video is too small or too large, change the project size from the top menu in **Scene > Scene Settings**. This will change the size of the video output.

How to export a QuickTime Movie

1. From the top menu, select **File > Export > Movie**.

The Export to QuickTime Movie dialog box opens.

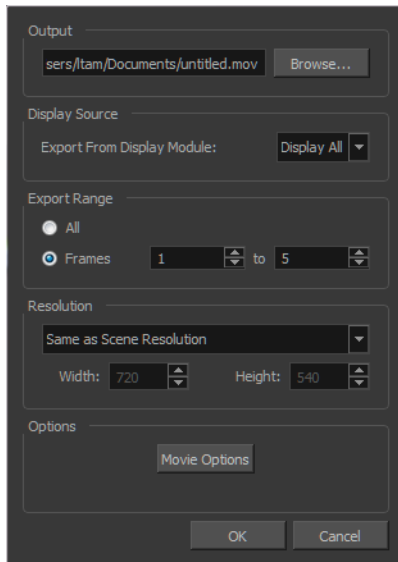

2. Click **Browse** and select a folder in which to save your movie and give it an appropriate file name for the export.
3. Click **OK**.
4. In the Display Source section, select the Display module to use for rendering your project.
If there is no Display module in the scene, the drop-down list will indicate Display All and render the scene in the same order as the Timeline view, including modules floating in the Network view. It is always recommended to render from the Display module, located under the final Composite module, unless you want to render a specific section isolated by a particular Display module.
5. From the Export Range section, decide whether you want to export the entire scene (All) or a specific frame range. If you decide on the latter, enter the frame range.

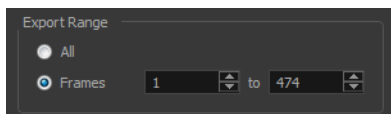

6. In the Resolution section, select one of the following from the menu:
 - ▶ A preferred resolution ratio.
 - ▶ **Custom**: Enables the Width and Height fields so you can enter a specific size.

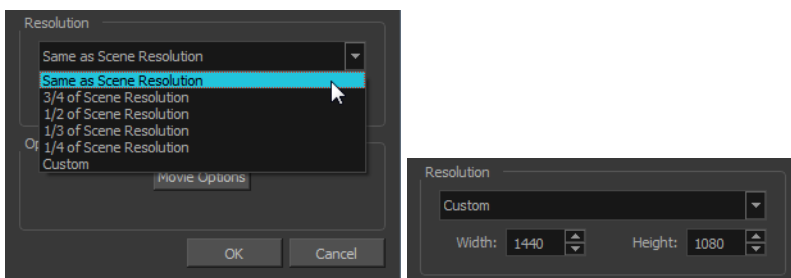

7. In the Options section, click **Movie Options**.

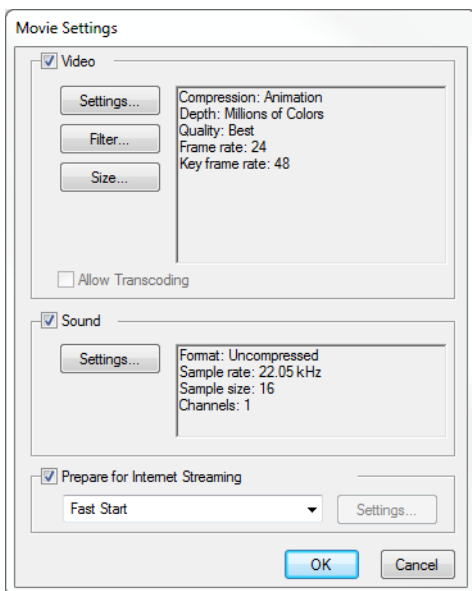

Parameter	Description
Video	Enables the customization of the video settings, filters and size.
	Settings: Opens the Standard Video Compression Settings dialog box (see below).
	Filter: Opens the Choose Video Filter dialog box, where you can select from a range of filters to apply to your video export.
Sound	Size: Opens the Export Size Settings dialog box. The size settings are overridden by the Harmony's scene settings.
	Check this box to enable the customization of the sound settings.
Prepare for Internet Streaming	Settings: Opens the Sound Settings dialog box (see below).
	Select this option to enable the customization of the Internet streaming options.

8. In the Video section, click **Settings**.

The Standard Video Compression Settings dialog box opens.

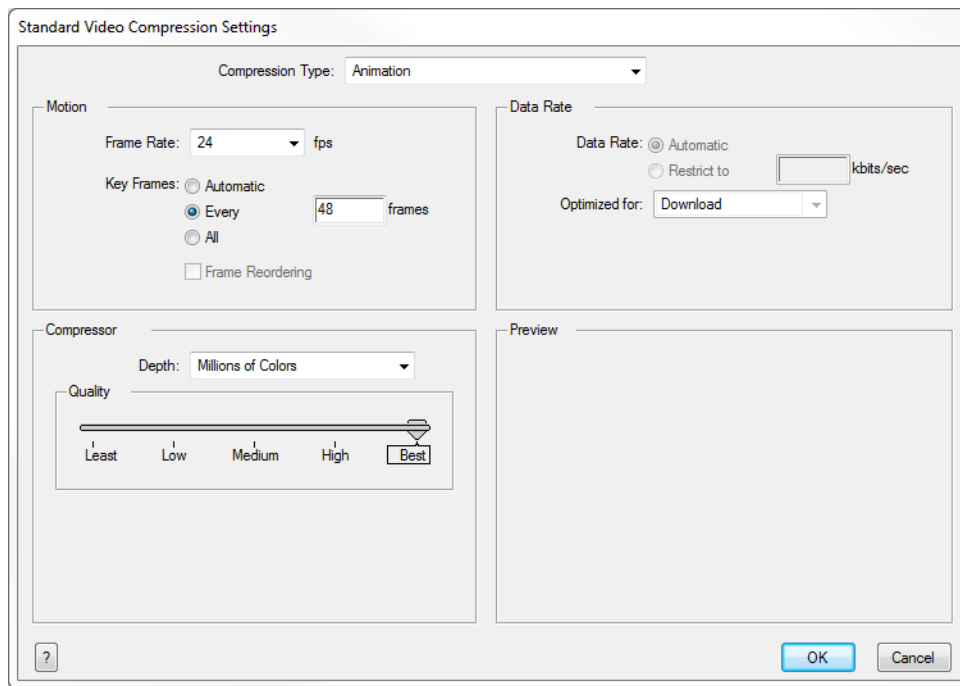

9. From the Compression Type menu, select a codec. The availability of certain compression settings depends on the Compression Type selected. For example, Animation is the default compression type and as a result the Data Rate option is greyed out.
10. In the Motion section, choose a **Frame Rate** from the list.
By default, it is set to match the frames-per-second (fps) of your Harmony project. If you choose a lower frame rate, your export playback will be faster than your actual project. The reverse is also true for a higher frame rate.
11. If you want key frames inserted, select the **Every** option and set the number per frame.
This is the option is recommended by QuickTime. Refer to the QuickTime documentation for further details.
12. In the Compressor section, choose a **Depth** based on your movie's needs. For example, Millions of Colours+ houses an alpha channel.
13. In the Quality section, use the slider to choose a quality setting. Remember that the better the quality of the export, the larger the file.

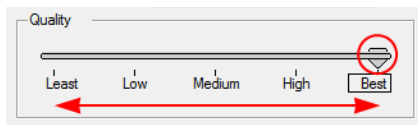

14. From the Data Rate section, either choose to allow the program to automatically select the most optimal bit rate, or enter a Restricted rate to save space and allow for faster downloading at a cost to the quality of the export.
15. In the same section, from the Optimized For menu, select the intended viewing method for the export.
16. Click **OK**.
17. From the Movie Settings dialog box, click **Sound Settings**.
The Sound Settings dialog box opens.

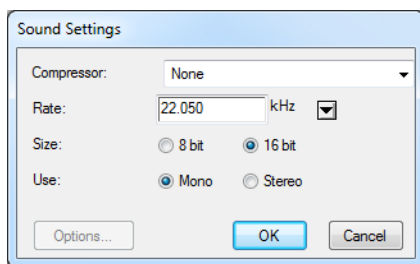

18. From the Compressor menu, select a compression type.

The default setting is None. This will preserve your original sound file without the loss of information. However, an uncompressed sound file will inevitably add “weight” to the overall size of your video export.

19. Select a **Rate** by pressing the arrow button next to kHz.

It is best to check and match the original properties of your sound file. For example, if your file has an audio sample rate of 48 kHz and you choose a conversion rate of 22.05 kHz, the sound will play at the same speed, but with higher frequencies missing.

For a standard film sound quality, choose **44.1 kHz**, or **48 kHz** for DVD quality. Anything less will make the sound “dull” or less bright. For things like recorded voice this doesn't matter so much, but for music it can make an audible difference.

If file size is a consideration, such as with videos for the Internet, then a lower rate might be more practical.

20. Next, choose the **Size** and the **Use**, which are related. Once again, it is advisable to check your original sound file properties. If the file was recorded in one channel (mono), there is little point in choosing the two channel (stereo) option. Although Mono can support a 16-bit channel, the extra information is unnecessary. Mono is generally paired with 8-bit and Stereo with 16-bit.

21. Click **OK**.

22. In the Export to QuickTime Movie dialog box, click **OK**.

A progress bar appears.

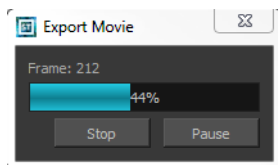



23. Browse to the location on your computer where you saved your QuickTime video and double-click on it to view the export.

How to set the depth to Millions of Colours + to export a QuickTime movie with transparency

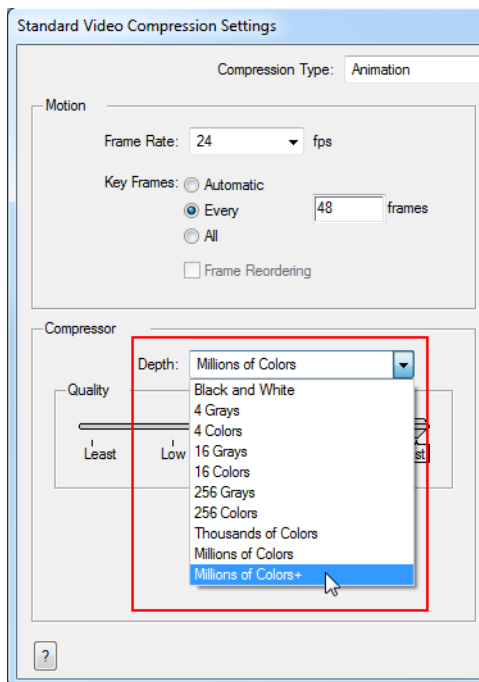
- ▶ In the Standard Video Compression Settings dialog box, select **Millions of Colors+** from the Depth menu—see [Exporting a QuickTime Movie](#) on page 590.



Exporting an SWF Movie

The SWF export supports some bitmap effects (which can be previewed in Render View  mode) and SWF Blend Modes (vector effects which can be previewed in OpenGL View  mode).

The following are also supported:

- Pencil line thickness: They are converted to brush strokes in the SWF file.
- Auto Patch module for creating joint patches.

If you have not already done so, you should preview the SWF by using the SWF preview  button to see what the two types of effects look like when blended together. Once you are satisfied with the results, go ahead and export your movie.

How to export a SWF movie

1. From the top menu, select **File > Export > SWF**.

The Export to Flash Movie (SWF) dialog box opens.

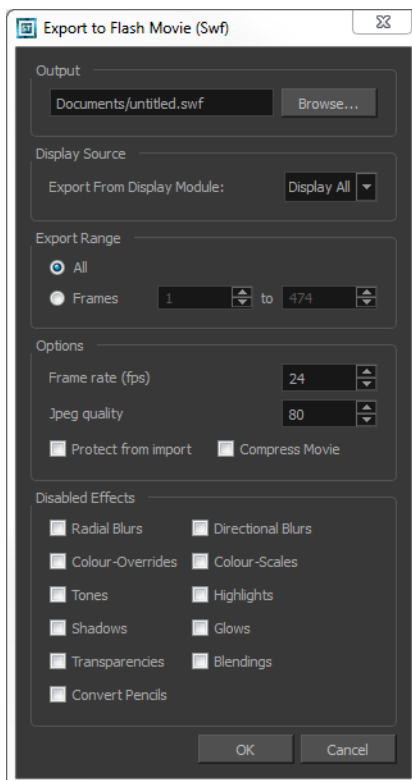

2. Click **Browse** and choose an appropriate file name and a destination path for your movie.
3. In the Display Source section, select a Display module to read from in the Export From Display Module menu.
4. In the Export Range section, select one of the following options:
 - **All**: To export all the frames of your movie.
 - **Frames**: To export a frame range. Enter the frame range in the fields.

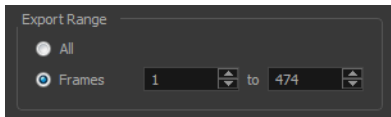

5. In the Options section, enter your Frame rate (fps). By default, it will be set to match the fps of your Harmony project. If you choose a lower frame rate, your export playback will be faster than your actual project. The reverse is also true for a higher frame rate.
6. In the same section, select the JPEG quality:
 - 100 = Full quality
 - 50 = Average quality at about 1/5th of the size.
 - 25 = Medium quality where loss of high image resolution starts to occur.
 - 10 = Low quality where "macro-blocking" or large pixelation become obvious.
 - 1 = Lowest quality where there is extreme loss of colour and detail and the image becomes nearly unrecognizable.
7. If you want to prevent your movie from being imported in another application, select the **Protect from Import** option.
8. Select the **Compress Movie** option if you want to get a lighter format. The movie may lose some quality, but the file will be lighter.
9. In the Disabled Effects section, select the effects you do **NOT** want to be rendered in the SWF movie.

Note that certain Harmony effects are not listed in this section as they are not compatible and therefore not available for SWF export. These effects will not appear in the SWF render.
10. Click **OK**.
11. Browse to the location on your computer where you saved your Flash Movie and double-click on it to view the export.

Exporting OpenGL Frames

You can export the OpenGL frames (fast display mode) if you need a quick render for your scene. Some heavier scenes containing 3D, multiple effects and camera moves can be fairly long to export.

Use the Export OpenGL Frames dialog box to select the frames you want to render from the OpenGL Camera view, then save the rendered frames as image files or as a QuickTime movie.

Frames saved from OpenGL view have neither antialiasing nor special effects. To render final frames with effects, export Images or a Movie.

How to export OpenGL Frames

1. From the top menu, select **File > Export > OpenGL Frames**.

The Export OpenGL Frames dialog box opens.

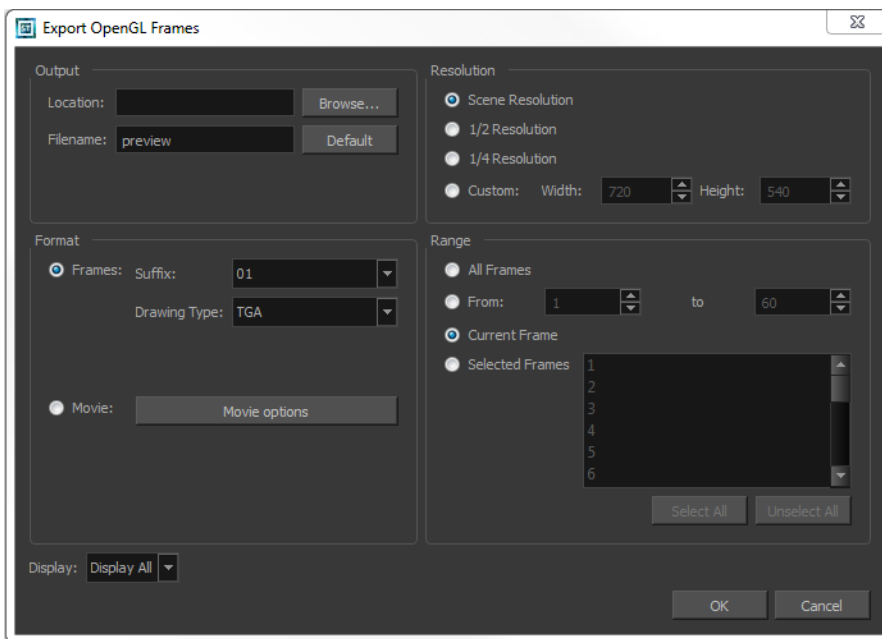

2. In the Output section, in the Location field, click **Browse** to select a folder for the frames.
3. In the Filename field, enter a name (prefix) for the frames or revert to the default name by clicking **Default**.
4. In the Format section, decide if you want to export individual image frames or a movie.
 - **Suffix:** Lets you select the desired suffix. If you intend to render only a few frames, use 1 or 01, whereas if you intend to render 1000 frames, you can select 0001.
 - **Drawing Type:** Lets you select the file type to render, such as TGA or SGI.
5. Click **Movie Options** to customize the Audio and Video settings for the *.mov export—see [Exporting a QuickTime Movie on page 590](#).
6. From the Resolution section, select a resolution for export. If you are running some quick tests, then you might want to reduce the resolution to save time and space. You also have the option to set a Custom width and height to produce smaller or larger frames.
7. In the Range section, decide whether you want to render all your frames, a range of frames, the current frame or selected frames.

8. Use the Display menu to select a Display module to use for rendering your OpenGL frames from. It is always recommended to render from the Display module located under the final Composite module, unless you want to render a specific section displayed by a particular Display module.
9. Click **OK**.

Exporting a Sound File

At some point during the production, you might need to export a sound file to use it in another application, such as an editing software. Harmony allows you to export sound files as a merged soundtrack or as a series of individual files. The exported soundtracks are generated as *.wav files.

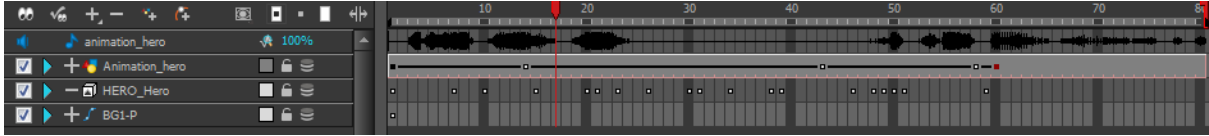

How to export a soundtrack

1. From the top menu, select **File > Export > Soundtrack**.

The Export Soundtracks dialog box opens.

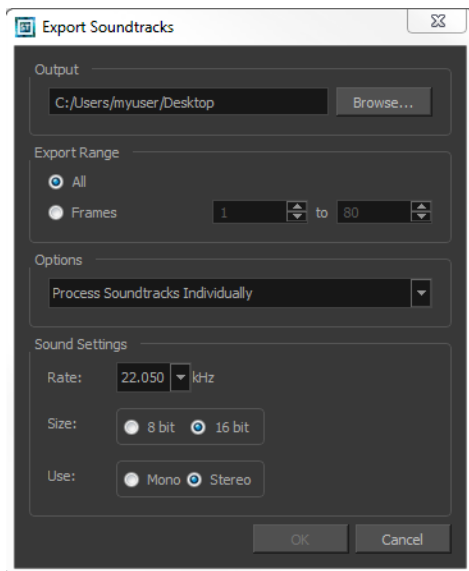

2. In the Output section, click **Browse** and specify where you want to save the exported sound file.
3. In the Export Range section, select one of the following options:
 - **All**: Exports the sound over all the frames of your scene.
 - **Frames**: Sets the start and end frames in the corresponding fields on the right.
4. From the Options menu, select one of the following:
 - **Process Soundtracks Individually**: Each soundtrack from all layers is exported as individual files.
 - **Merge all Soundtracks**: One single file is created, combining all the sound files you imported in your scene. Note that it will only use the sound files in the selected frame range set in the Export Range section. If you selected to export all the frames, all the sound files will be processed.
5. In the Sound Settings section, set the **Rate**, **Size** and **Use** parameters for the soundtracks to export. It is a good idea to verify what is required by the software or device that you may want to use next with the sound file.
6. Click **OK**.

The generated sound files appear in the selected directory and are named according to the scene name. Individual files keep their original name; only a prefix matching the scene name is added.

Advanced Export

The Network view allows you to make advanced connections and isolate certain portions of your project. It also allows you to perform multiple exports from the entire network or from specific sections.

For this kind of process, use the Write module in the Module Library view. The Write module lets you render and output the connected image information. Using the Write module, you can export a project as a QuickTime movie or as image sequences. You can export one format at a time or both simultaneously.

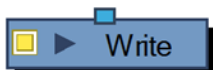

To export an image sequence, you need to adjust a few settings in the Write module's properties.

You can export image sequences as several different formats:

- TVG
TVG (Toon Boom Vector Graphic) is the Toon Boom vector proprietary format.
- TGA (TGA1, TGA3, TGA4)
Select TGA4 to export your sequence with an alpha channel (transparency).
- SGI (SGI1, SGI3, SGI4)
Select SGI4 to export your sequence with an alpha channel (transparency).
- SGIDP (SGIDP1, SGIDP3, SGIDP4)
Select SGIDP4 to export your sequence with an alpha channel (transparency).
- OMFJPEG
- PSD (PSD1, PSD3, PSD4)
Select PSD4 to export your sequence with an alpha channel (transparency).
- PSDDP (PSDDP1, PSDDP3, PSDDP4)
Select PSDDP4 to export your sequence with an alpha channel (transparency).
- YUV
- PAL
- SCAN
- PNG (PNG4)
Select PNG4 to export your sequence with an alpha channel (transparency).

PNG4 is the recommended format to export an image sequence with transparency.

- JPG
- BMP (BMP4)
Select BMP4 to export your sequence with an alpha channel (transparency).
- IFF (IFF_16)
- OPT (OPT1, OPT3, OPT4)
Select OPT4 to export your sequence with an alpha channel (transparency).
- VAR
- TIFF
- DPX (DPX3_8, DPX3_10, DPX3_12, DPX3_16, DPX3_10_INVERTED_CHANNELS, DPX3_12_INVERTED_CHANNELS)
- PDF

The formats used if you need to output a vector format are TVG and PDF. You can also export a SWF movie.

To export a QuickTime movie, you need to adjust few settings in the Write module's Properties.

How to add a Write module

1. In the Module Library, select the **IO** tab.
2. Select the **Write** module and drag it to the Network view.

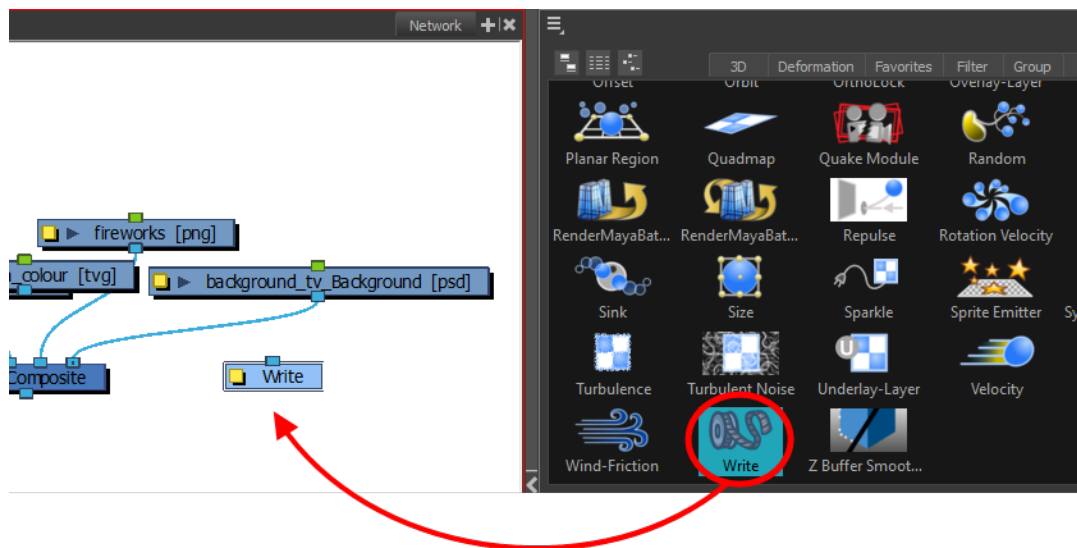

3. In the Network view, connect the final Composite module or any other module which outputs an image you want to render to the Write module.

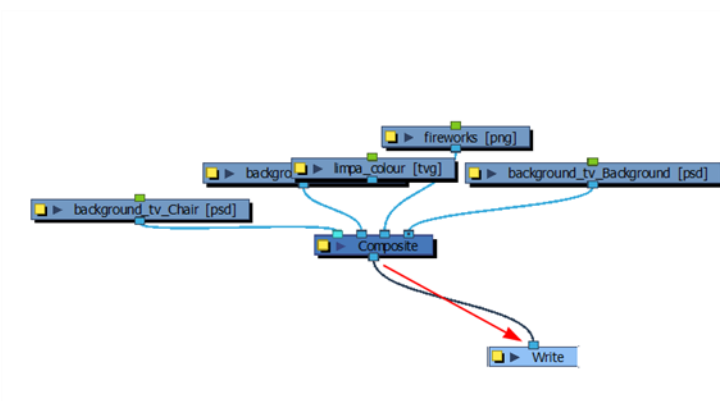

How to set the Write Module to export an image sequence

1. In the Network view, open the Write module's editor by clicking its yellow Properties button.

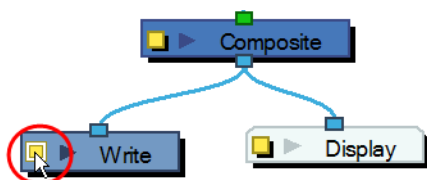

2. In the Output tab, select the **Drawing** option to create an image sequence.

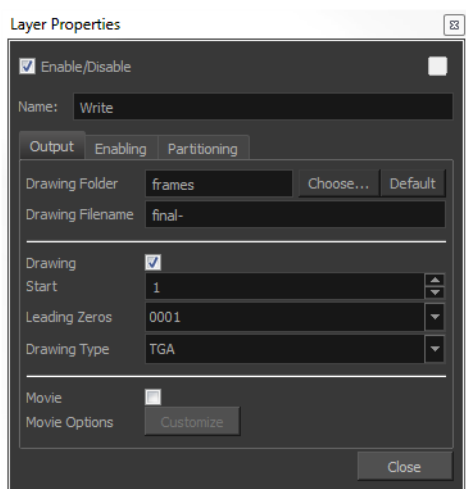

3. Click **Choose** and browse to the directory where you want to save the output. You can also use the default directory to save in the default **frames** folder included in the scene directory.
4. In the Drawing Filename field, type the image sequence's name prefix. It is recommended to leave the hyphen (-) at the end of the name to separate the image name from the image number.

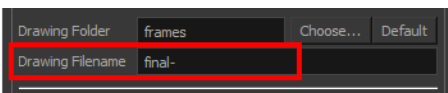

5. In the Start field, select the starting number for the image sequence.
6. In the Leading Zeros field, select the number of digits you want to see after the sequence prefix.



7. In the Drawing Type field, select the file format in which your project will output.

When the file format includes a "4" at the end of its name, it means that an alpha channel will be created.

8. Click **Close**.

The project will not start rendering yet, since these are only the settings. You can still modify your scene.

How to set the Write module to export a QuickTime movie

1. In the Network view, open the Write module's editor by clicking on its Properties button.

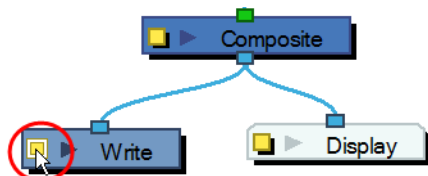

2. In the Output tab, select the **Movie** option to create a movie file.

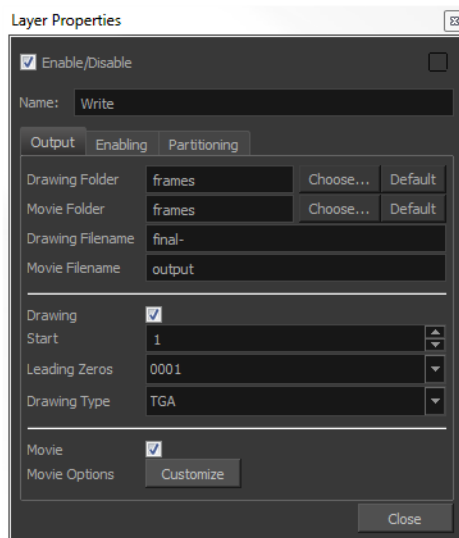

3. Click **Choose** and browse to the desired directory to save the output.
 - You can also use the default directory to save in the default Frames folder included in the scene folder.
4. In the File name field, name the output file. You do not need to write the file format extension.

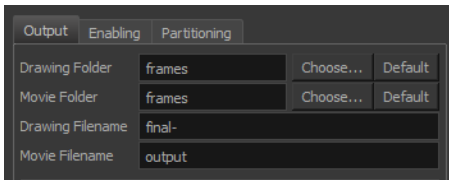

5. In the Movie Options field, click **Customize** to open the Movie Settings dialog box.

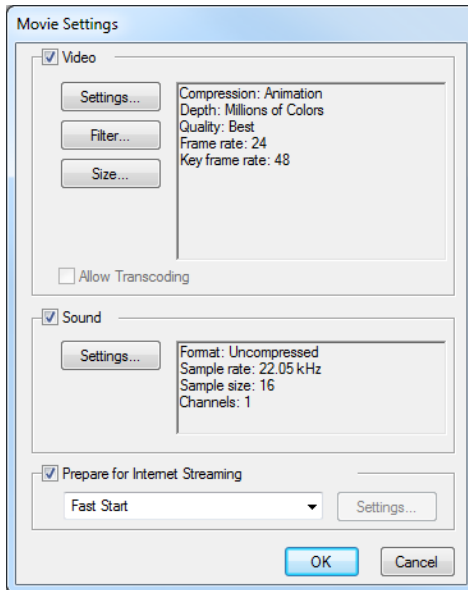

6. In the Movie Settings dialog box, in the Video section, click **Settings** to set your video options.

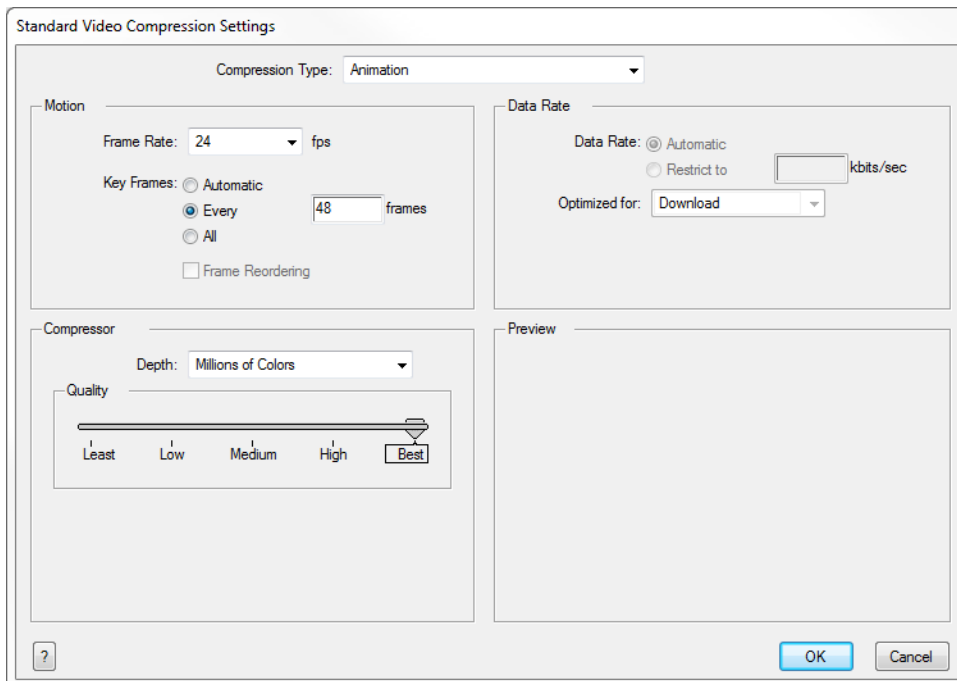

7. Click **OK**.
8. In the Movie Settings dialog box, in the Sound section, click **Settings** to set your audio options.

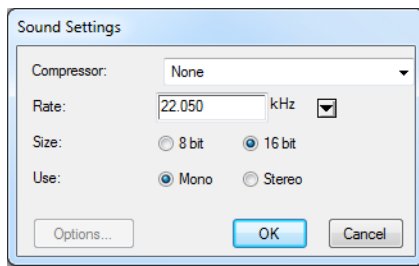

9. Click **OK** and **Close**.

The project will not start rendering yet. These are only the settings. You can still modify your scene.

Multiple Renders

Harmony lets you simultaneously render many formats and resolutions for a scene. This saves a lot of time as you do not have to return between each render to start a new one.

To use multiple renders, connect as many Write modules as needed to match the required number of exports. Then, adjust each Write module's settings to create image sequences or movies.

YOU MUST GIVE DIFFERENT NAMES TO EACH OUTPUT FILE. This is especially important if you save them all in the same folder, so they do not overwrite each other.

When you have multiple Write modules in a scene, it is useful to rename the modules according to their output settings such as: **low_resolution_movie** or **HDTV_sequence**.

To export different resolutions concurrently, you need to create a combination of the following:

- Write module—see [Advanced Export on page 601](#)

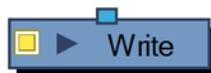

- Scale-Output module



- Crop module



Once your Write modules are connected, you need some Scale-Output modules to change the resolution output of the Write module. For example, if you export in a high resolution and a low resolution, you need one Scale-Output module.

Set the project's resolution to the highest resolution needed for this export and use the Scale-Output modules to scale down the other outputs.

DO NOT scale up the output size, that will not provide a good result. It is also better to use the Scale-Output module to scale down in a same aspect ratio so that it does not distort the image.

To output two files with different aspect ratios, such as 16:9 and 4:3, you can use the Crop module. This module is used to crop the final image in order to discard excess information without distorting the render.

If you start with a higher resolution and want to crop down to a lower resolution, such as HDTV to NTSC, you will need to combine the Crop module with a Scale module.

Once you know the type of render you want to do, you will need to retrieve your modules from the Module Library and connect them to the scene's network.

How to add a Scale-Output Module

1. In the Module Library view, select a **Scale-Output** module and drag it to the Network view.

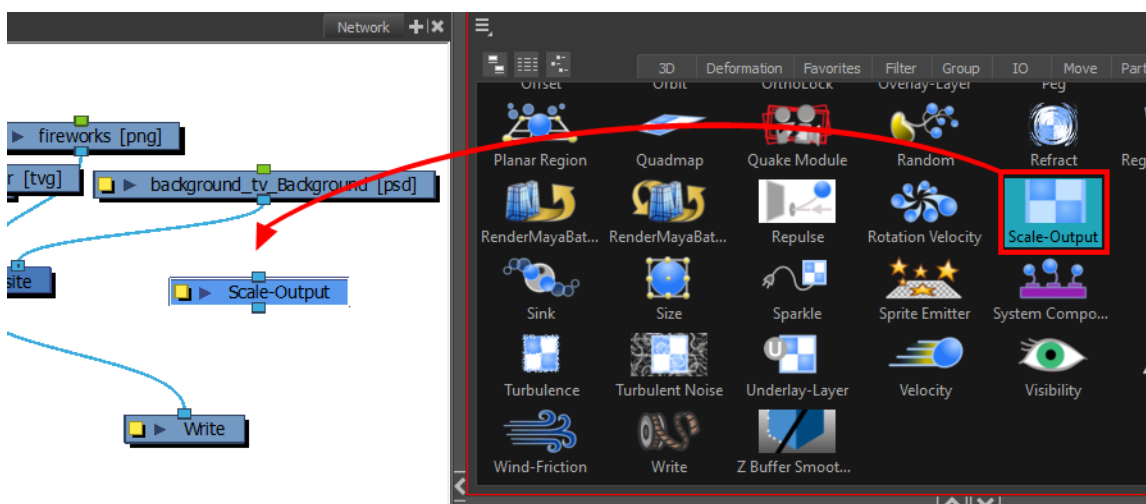

2. In the Network view, connect the Composite module to the Input port of the Scale-Output module.

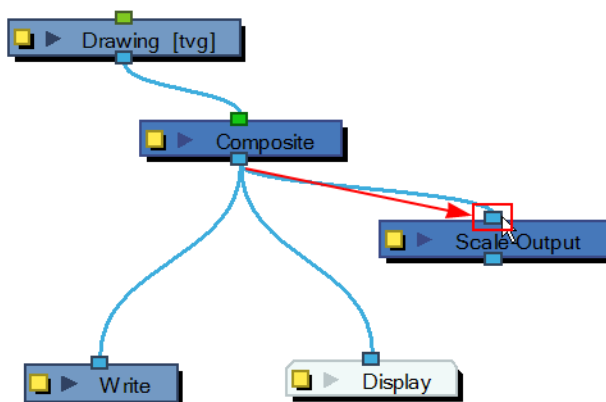

3. In the Network view, connect the Scale-Output module to the input ports of both the Display module and the Write module.

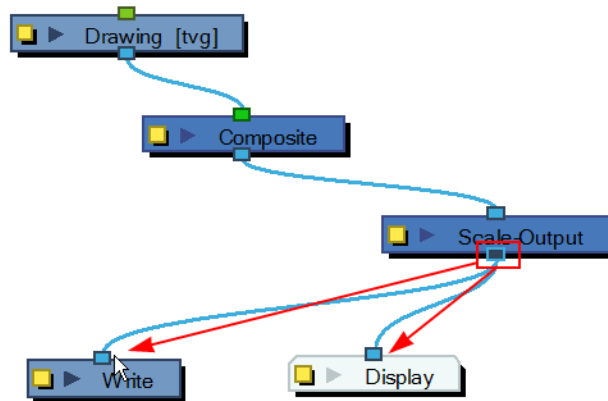

How to set the Scale-Output module

1. In the Network view, open the Scale-Output module's editor by clicking on its Properties button.



2. In the Layer Properties dialog box, select a resolution from the suggested Resolution Name list or type new resolution values to indicate the resolution to scale to.

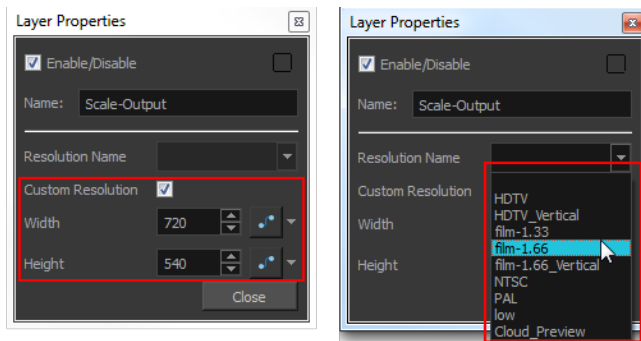

3. Click **Close**.

How to add a Crop Module

1. In the Module Library view, select a **Crop** module and drag it to the Network view.

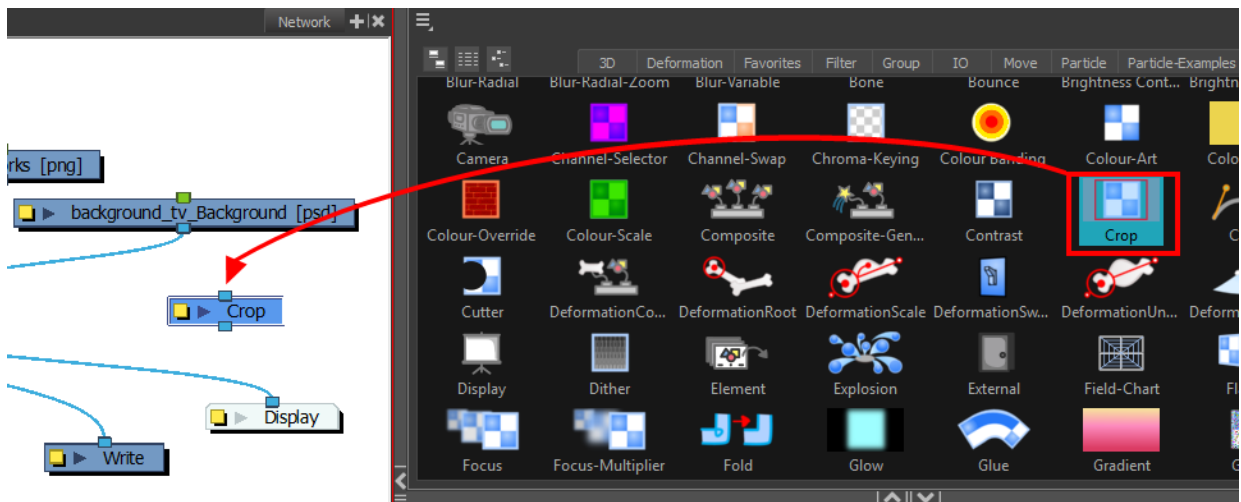

2. In the Network view, connect the Composite module to the Input port of the Crop module.

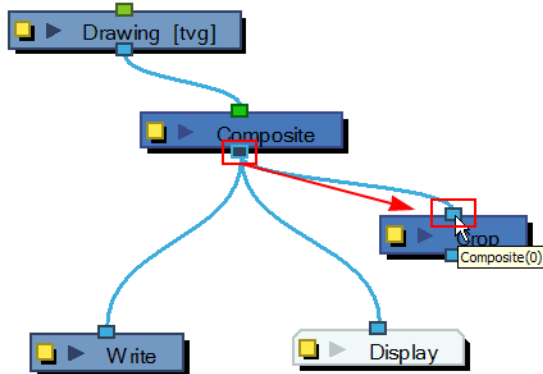

3. In the Network view, connect the Crop module to the input ports of both the Display module and the Write module.

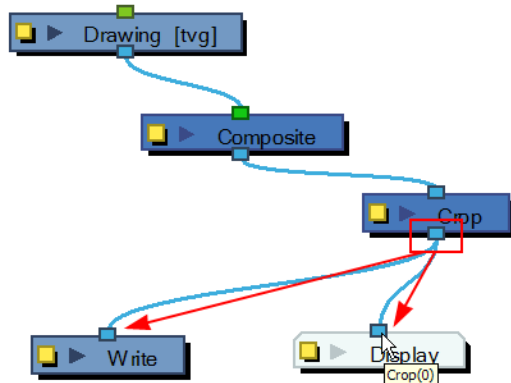





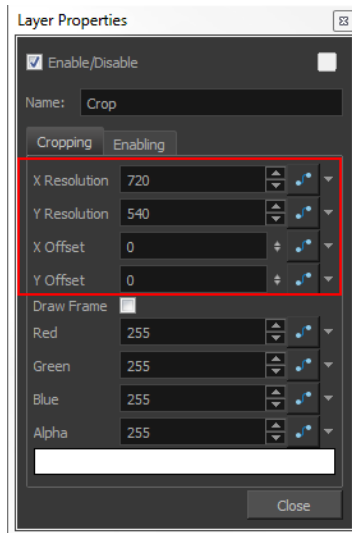

How to set the Crop module

1. In the Network view, open the Crop module's editor by clicking on the module's Properties button.



- In the Layer Properties dialog box, type new resolution values to indicate the resolution to crop to.



- You can manually enter the X-Y Offset, or move it in the Camera view. Select the right Display module in the Display toolbar. In the Advanced Animation toolbar, select the Translate  tool and with the middle mouse button, move the crop area. If the Animate  mode is enabled, the position of the crop area will be animated over time.
- If you want to create a Pan and Scan effect (panning the cropped selection over time to show more information), you can create a function to animate the cropped selection. Click on the Function  button beside the Local dialog box to create a Bezier or ease curve—see .
- If you created a function curve to animate the cropped selection, click again on the Function  button and edit the curve by adding keyframes and moving the selection box in the Camera view. If you created a function curve to animate the cropped selection, click again on the Function  button and edit the curve by adding keyframes and moving the selection box in the Camera view—see .

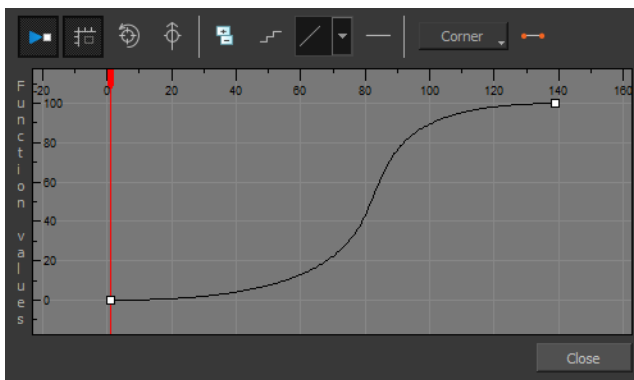

- Enable the Draw Frame option if, instead of cropping the images, you prefer to have Harmony draw the frame over the rendered scene.

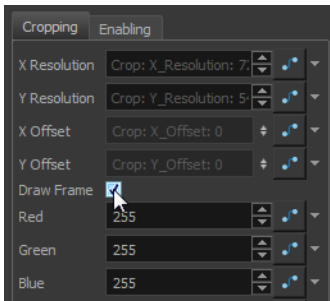

- Click in the colour rectangle to adjust the frame colour as desired if you have enabled the Draw Frame option.

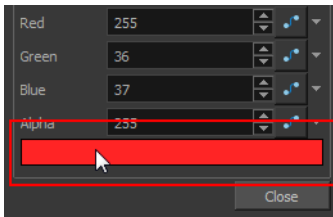

- Click **Close**.

The Crop module also has an advanced Enabling tab for determining when the Crop module should be activated.

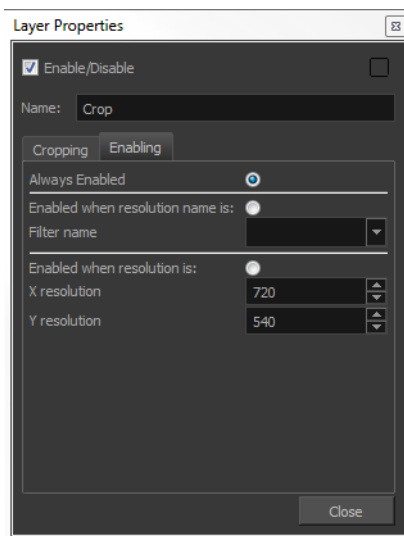

- ▶ **Always Enabled:** Makes the Crop module always produce output.
- ▶ **Enabled when resolution name is:** Activates the Crop module only when the resolution of the scene matches the value in the Filter Name menu. The listed resolutions come from the Resolution/Frame Rate dialog box.
- ▶ **Enabled when resolution is:** Activates the Crop module whenever the scene's resolution matches the values in the X and Y resolution fields.

How to connect modules to export multiple renders

- In the Module Library view, retrieve the necessary Write, Scale-Output and Crop modules.

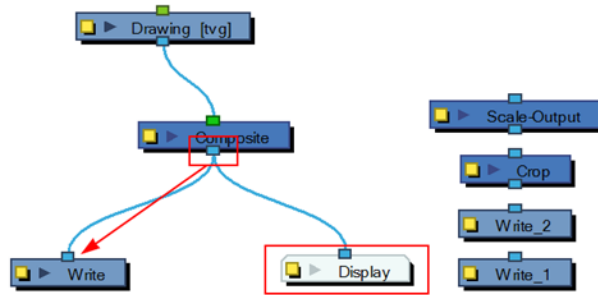

2. Connect the final Composite module to the first Write module. (Make sure you have a Display module reading the same information.)
3. Open the Write module's editor by clicking on its yellow Properties button.
4. Name the Write module according to the render type that you are planning to do.
5. Set the Write module parameters—see [How to set the Write Module to export an image sequence on page 603](#).

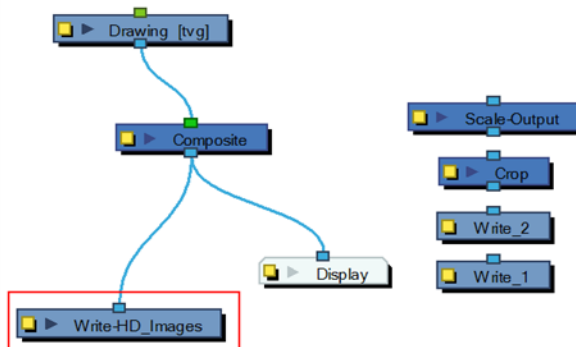

6. Connect the other Write modules and repeat steps 2 to 5.

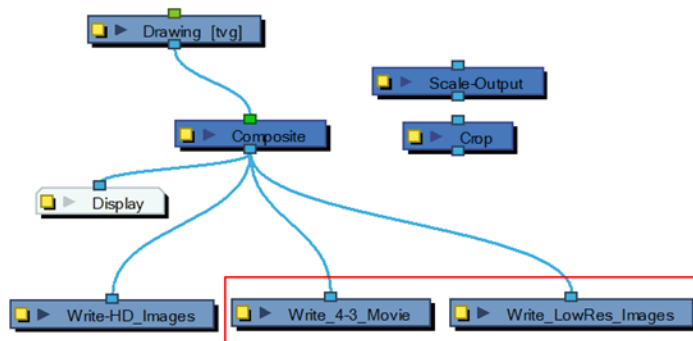

7. Using the Alt key, insert the Scale-Output modules between the final Composite module and their corresponding Write module.

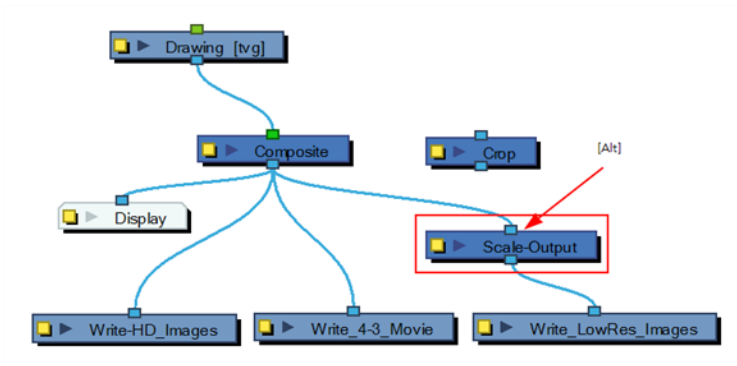

8. Using the Alt key, insert the Crop modules between the final Composite module and their corresponding Write or Scale module.

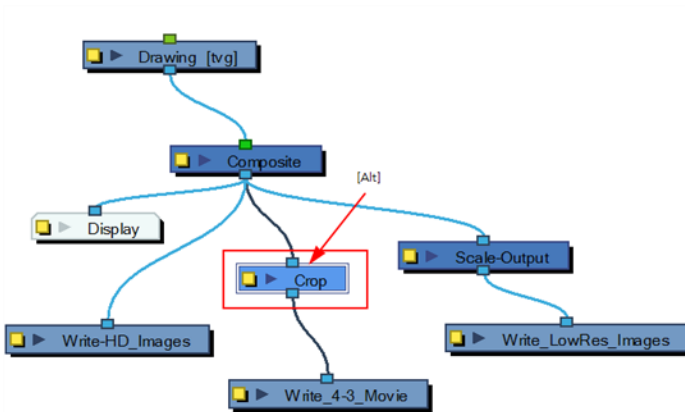

- If the output from the Crop module has to be scaled down, use a Scale-Output module.

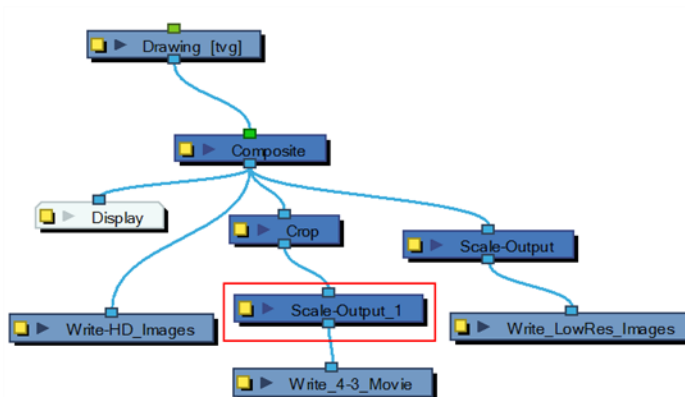

9. Connect a Display module to each Scale-Output or Crop module to see each final image in the Camera view.

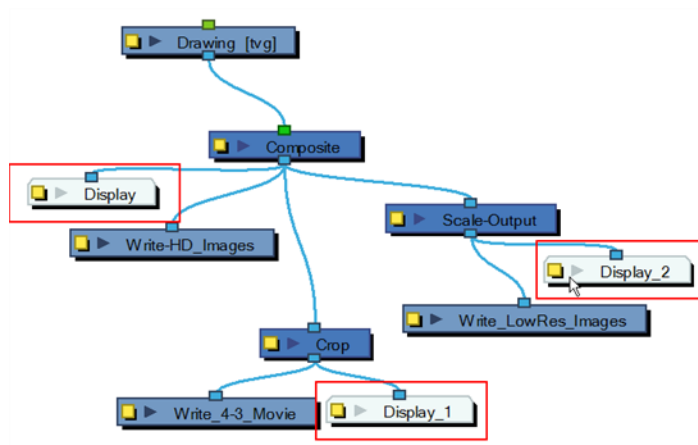

Rendering Images and Movies from the Network

If you want to render from your Write module, you will need to use the Render Network option found in the File menu.

How to render the network from the Write module

1. Select **File > Export > Render Network** or press **Ctrl + Shift + Y** (Windows/Linux) or **⌘ + Shift + Y** (Mac OS X).

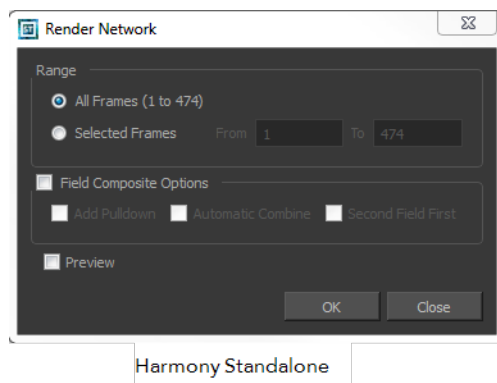

2. In the Range section, select the frame range to render.
3. Select the **Field Composite** option to render the final images as fields for display on interlaced monitors.
4. Select the **Preview** option to automatically see the image sequence result once the render is done. The preview will not show up for a QuickTime movie.
5. Click **OK**.

All renders start.

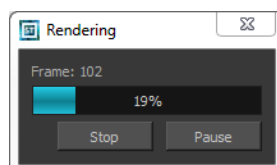

Partitioning Renders

By partitioning renders, you can separate the elements of a scene or character, and render them separately according to group and Z position. This is useful when you want to export part of a character or scene in Harmony, so you can add effects and create the final composite using a different software application.

Using the Write module, you can partition the rendering of images based on group and Z position. First, you determine which groups you want to render. Then you define the render by their Z position—see [Groups on page 143](#).

The Z position is based on fields. Each field is equal to one partition, which is centered on the absolute value of the range you define. Each partition yields a separate folder that contains your exported, rendered image.

How to export images based on group and Z position

1. In the Module Library, select the **IO** tab.
2. Select the **Write** module and drag it to the Network view.
3. In the Network view, attach the groups you want to render to a Composite module.

In the following example, there are three groups connected to one Composite module. They will be rendered simultaneously, producing three separate folders to hold the renders. If you have more groups, you can go ahead and connect those you want to render. Otherwise, disconnect the ones you don't want to render.

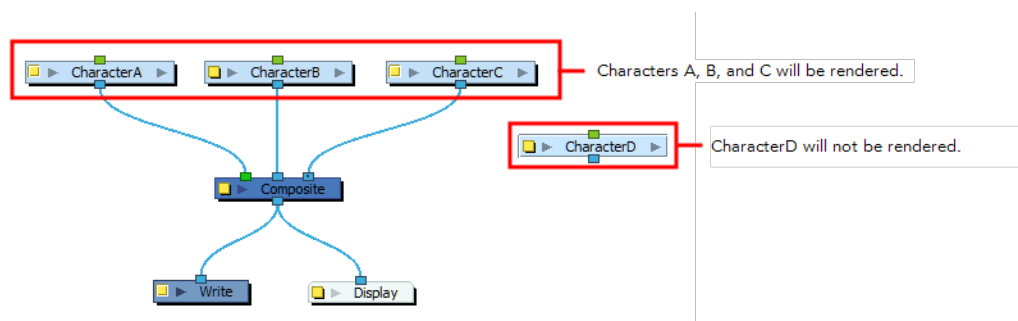

4. Display the Write module properties. Select the **Output** tab and set the following:
 - **Drawing Folder:** Type in a name for the folder that will hold the renders.
 - **Drawing Filename:** Type in a prefix for the names of the subfolders.

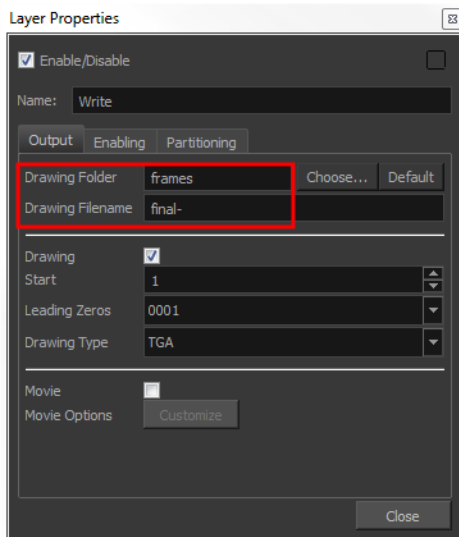

5. Select the **Partitioning** tab.

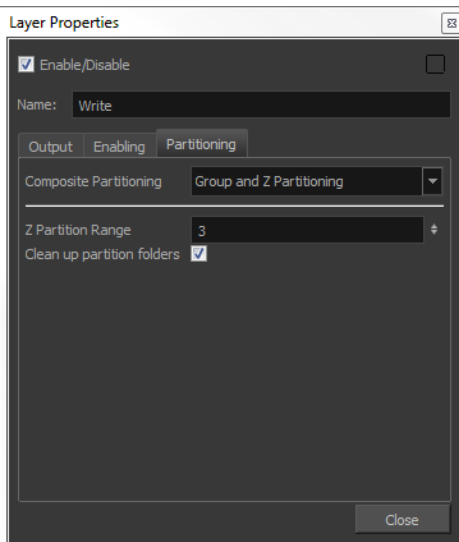

Parameter	Description
Composite Partitioning	<p>Off: Renders the entire network and places separate images of the composite in the Drawing Folder.</p> <p>Group and Z Partitioning: Creates multiple renders and places the folders that correspond to their group in the Network view.</p>
Z Partition Range	Based on the Z position, defines the range of the partition, centered on the absolute value.
Clean up partition folders	When selected, removes old folders from the Drawing Folder each time you perform an export.

	When deselected, each time you render, more folders are added to the existing ones.
--	---

6. Set the parameters in the Partitioning tab.
7. Start the render by selecting **File > Export > Render Network** or press **Ctrl + Shift + Y** (Windows/Linux) or **⌘ + Shift + Y** (Mac OS X).
8. To see your renders, navigate to the Drawing Folder you defined in step 4.

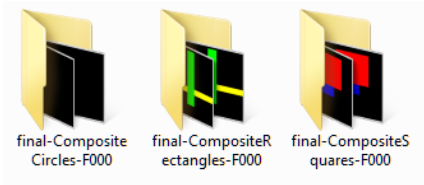

Glossary

alpha channel	The image's channel carrying the transparency information. An image already has three channels: red, green and blue (RGB). The alpha channel is the fourth channel (RGBA). The matte, or the transparency information, is stored in this fourth channel. An image without an alpha channel is always opaque.
animatic	A movie with sound that is developed from the storyboard. The storyboard panel is exposed for the duration of the scene and at times, the characters are placed on a trajectory to indicate motion. The camera moves are also animated. The animatic is used to determine the rhythm of a project and provides a good overview of the project before beginning production.
animation	A simulation of movement created by displaying a series of pictures or frames.
anime	An animation style known for its sinister and dark feel; popular in Japan.
arc	Action rarely occurs in a straight-forward manner; rather it typically unfolds in what storytellers refer to as an arc. The purpose of a story arc is to move a character or a situation from one state or scenario to the next.
aspect ratio	The relationship between the width and height dimensions for any scene, frame or film format. Television ratio is 4:3 and widescreen ratio is 16:9.
auto-feed	An automated method of feeding drawings into a scanner in which multiple drawings are stacked into a sheet feeder. When the scanner is activated, the drawings are scanned consecutively, without further user intervention.
automatic lip-sync detection	Automatically mapping drawings in an element to the mouth chart generated for a sound. This can save time when lip-syncing a voice track.
axis	<p>An imaginary line around which an object rotates.</p> <p>For 2D graphics, there are two axes:</p> <ul style="list-style-type: none"> • X: Horizontal • Y: Vertical <p>For 3D graphics, there are three axes:</p> <ul style="list-style-type: none"> • X: Horizontal • Y: Vertical • Z: Depth
background	The part of a scene that is farthest to the rear. The background is the artwork, or decor, against which the animation takes place.
Bézier	A method of defining curved lines invented by French

	<p>mathematician Pierre Bézier. A Bézier curve is a mathematical or parametric curve. Bézier curves use at least three points to define a curve.</p> <p>In Toon Boom, a function can be hooked to a Bézier curve and vary along with the curve value information. Bézier curves are also very useful in vector graphics. They are used to model smooth curves and can be scaled indefinitely.</p>
bitmap	An image composed of pixels with a single resolution (size). If it is enlarged too much, it will lose definition and pixels will begin to appear. This is known as <i>pixelation</i> .
breakdown	<p>In cut-out animation, breakdown is the action of breaking a character into pieces to create a puppet with articulations. To break down a character, the artist cuts part, such as hands and arms, from the character's model and pastes them in separate layers. Next, the joints are fixed and the pivots set.</p> <p>In traditional animation, a breakdown is an animation pose generally found between two key poses. The key poses are the main poses in an animation and the breakdowns are secondary poses, ones that help to describe the motion and the rotation curve.</p>
camera shake	Camera shake occurs in a scene when the camera moves slightly and quickly in several directions. This gives the impression of an impact, vibration or, for example, bumps on the road.
caption	In a storyboard, a caption is a text field containing dialogue, effects, sound, or slugging information.
cel	<p>In traditional animation, a cel, also known as a <i>celluloid</i>, is a transparent sheet on which the animation is inked and painted before being sent to the camera. The picture's outline is drawn on the front of the cel and then coloured along the back.</p> <p>In Toon Boom, a cel is an individual space encountered in an Xsheet's column, from which you can expose a drawing or a function's coordinate.</p>
character design	Each character in an animated film is drawn from multiple angles in poster-style format, called a <i>model sheet</i> , which serves as a reference for the animators.
clean up	After rough drawings have been tested and approved, all the noise in the image (excess lines, notes, etc) is removed to create final drawings which can be inked, painted and shot. The cleanup process refers to either tracing a clean line over a rough drawing to achieve the final version, or removing dirt and extra lines left by the scanning process.
CMYK	Cyan, Magenta, Yellow, Black. Refers to the process used by printers to define colour on the printed page.
colour card	A Colour Card is a solid colour card that is the same size as the camera. The Colour Card can be used to fill the background with a solid colour when there is no background image included.

colour model	In animation, a colour model is the official colour design that must be used to paint the animation. A model is the definitive character, prop, or location design that each artist must follow for the production.
colour wheel	A display of the colour spectrum in the form of a circle.
compositing	Compositing is the action of incorporating all of a scene's elements to create the final result prior to rendering. For example, the compositing artist will import all the animation sequences, background, overlays and underlays in the scene and position them correctly. The artist will then set the camera frame and animate it, if needed. Finally, the animator will create all the computer-generated effects for the project.
cross dissolve	An effect used to fade two scenes, one into the other.
cut	A direct transition between two scenes. When a cut is used, there are no transition effects inserted to pass from one scene to the next. The first scene ends and the second one starts immediately.
cut-out animation	The action of animating characters made of several pieces by moving them around frame by frame. Cut-out animation can either be computer generated or done traditionally using paper.
cycle	A group of images that together make up an action, such as walking. A cycle is an action repeated as a loop over a period of time. It can be a series of animated drawings or keyframes.
dialogue	The text spoken by a character in a movie or animation.
dope sheet	Used by animators, directors and other members of a crew to track the sequence and timing of images, dialogue, sound effects, sound tracks and camera moves. Also known as an <i>exposure sheet</i> or <i>Xsheet</i> .
doping	To assign a particular drawing to a range of frames.
DPI	Dots Per Inch is the standard measure of resolution for computerized printers. It is sometimes applied to screens, in which case it should more accurately be referred to as <i>pixels per inch</i> . Either way, the dot is the smallest discrete element making up the image.
ease/velocity	In animation, the ease, also known as <i>velocity</i> , is the acceleration and deceleration of a motion. It can be a motion created by a function curve, or a series of animated drawings. Other common terms for ease-in and ease-out are slow-in and slow-out.
ease-in	Gradual acceleration in the action. Another common term for ease-in is slow-in.
ease-out	Gradual deceleration in the action. Another common term for ease-out is slow-out.
establishing shot	A scene in which the viewer can see the whole area in which a sequence is happening. For example, if a child is playing on the ground in front of his house, the establishing shot would be a scene

	where the viewer can see the house, the ground, a part of the street and the buildings around the central point of action. This helps the viewer understand the story location and scene orientation.
exposure	In animation, an exposure is the number of cels on which a drawing appears in the scene. For a drawing to appear longer, the exposure must be extended over a greater number of cels.
exposure sheet (Xsheet)	<p>The exposure sheet or Xsheet, is a sheet with several vertical columns and horizontal frames used to indicate a scene's timing.</p> <p>Each column represents a scene's layer. In each column, the drawing's numbers are indicated and repeated over the particular amount of frames they need to appear.</p> <p>The exposure sheet is used by animators, directors and other members of a crew to track the sequence and timing of images, dialogue, sound effects, sound tracks and camera moves. Also known as a <i>dope sheet</i>.</p>
fade in/fade out	Fade in or fade out is a transition effect used to open or close a sequence. A fade in occurs when the first scene appears progressively, from complete transparency to its complete opacity. A fade out occurs when the last scene progressively disappears, going from complete opacity to complete transparency.
fast-in	Dramatic acceleration at the start of the action.
fast-out	Dramatic acceleration at the end of the action.
field	In animation, a field is a measurement unit used to calculate motion, registration and camera positioning. A standard animation scene will vary between 6 to 12 fields.
field chart	A guide containing all the field units that animation and layout artists use to determine a scene size or camera motion.
film-1.33	Use this resolution setting for the widescreen film format that conforms to the standard 4:3 pixel aspect ratio.
film-1.66	Use this resolution setting for the widescreen film format that conforms to the 16:9 pixel aspect ratio. (The pixels are wider than they are high).
flipping	In traditional animation, flipping is the action of going through the drawings of an animation sequence very quickly in order to see the animation in motion. Flipping can also be the action of creating a mirror transformation of an object.
follow-through	The follow-through is the secondary motion caused by the main action. For example, a character wearing a cloak is running. The main action is the body running. This will cause the cloak to follow the motion, although it will not move at the same time, but react a few frames later and follow the main motion curve.
forward kinematics	Forward kinematics is a feature used to animate principally 3D characters and cut-out puppets with hierarchy. It is used to animate

	<p>a puppet from one of parent parts, such as a shoulder, and make the rest of the arm move with it as a single piece.</p>
frame	<p>A frame is a single photographic image in a movie. In traditional animation, the North American standard generally contains 24 frames per second, while in Europe the standard is 25 frames per second.</p>
frame rate	<p>This is the measurement of the frequency (rate) at which an imaging device produces unique consecutive images, called frames. The term applies equally to computer graphics, video cameras, film cameras, and motion capture systems.</p> <p>Frame rate is most often expressed in frames per second (FPS) and in progressive-scan monitors as hertz (Hz).</p> <p>The frame rate is the speed at which the frames are played. They are generally calculated by frame per second. For example, a scene could be played back at 12, 24, 25, 30 or 60 frames per second or any other number</p>
functions	<p>A function is a computer generated motion, trajectory or path that elements, other trajectories and effects parameters can be attached to. The function can be controlled by adding keyframes and control points on the function curve.</p>
gamut	<p>The range of colours that a particular device can represent.</p>
HDTV	<p>High Definition Television delivers a higher quality image than standard television does because it has a greater number of lines of resolution. To take advantage of the superior quality and make full use of your resolution setting, your output device must be compatible with HDTV technology.</p>
hold	<p>This is a frame in the animation in which the character maintains its position without moving. A hold can be created between any two keyframes.</p>
HSV	<p>Hue, Saturation, Value. A method of defining colours in terms of hue (tint), saturation (shade) and value (tone or luminance).</p>
in-between	<p>The drawings that exist between the key poses. These are drawn to create fluid transitions between poses.</p>
ink and paint	<p>The ink and paint process is the action of painting the empty zones and colouring the lines on the final animation drawings, while following a colour model.</p>
interpolation	<p>In animation, the interpolation is the computer generated motion created between two keyframes. You have the choice to create interpolation, or not, between your keyframes.</p>
jump cut	<p>A jump cut is a jerky cut between two scenes. Typically, a jump cut is not visually pleasing. It is generally caused by one scene ending, and a second one starting, with similar a image. The lack of difference causes the eye to see a little jump between the two scenes.</p>

key pose	Important positions in the action defining the starting and ending points of any smooth transition. Keys, or key poses, are the main drawings in an animation sequence describing the motion. For example, if an arm is waving, the keys will be of the arm at one extremity of the wave motion and the other extremity. By flipping those drawings, the animator can see the skeleton of the motion without having all of the drawings.
keyboard shortcuts	<p>One or more keyboard keys which, when used, cause an operation to be performed. Keyboard shortcuts are used throughout the Toon Boom software and form an integral part of the workflow. It is, in most cases, possible to customize the shortcuts in the Preferences dialog of the software.</p> <p>The shortcuts are written as follows in the Toon Boom user documentation: Each key in a sequence is shown inside square brackets as in: [Ctrl]+[A]. The brackets "["]" separate the key from the plus sign (+). Neither the brackets, nor the plus sign are part of the sequence. To use a shortcut, press the key and the character simultaneously.</p>
keyframe	Important positions in the action defining the starting and ending points of any action. A keyframe is a computer generated position at a specific moment (frame) on a given trajectory.
layer	In animation, a layer is an individual column, level or character. A scene's layers are superposed to form the final image.
layout	The layout process is the communication step between the storyboard and the animation. The layout and posing process is the action of putting the storyboard on model, that is drawing the character following the design in the model pack, so that the animator can start his work. The layout artist will draw the background, create the camera and field guide matching the scene and the camera motion. Lastly, he will draw on model the main action poses.
layout and posing	The action of putting on model, that is, at the right scale, the storyboard for the animator to start his work.
library	A library is a storage area containing templates and assets that can be reused in any project or scenes.
light table	The Light Table feature allows you to see the other layers in transparency while you are working on a particular one in the Drawing view.
line of action	Direction that the action will follow. Also known as the Path of Action
lip-sync	The lip-sync is the character's mouth synchronization with the dialogue sound track. Frame by frame, the mouth will be adjusted to fit the sound to give the illusion of the character is speaking.
low resolution	This format is ideal for videos destined for the web, where size and fast download of a video file might take precedence over quality. A low-resolution image is one that lacks fine detail.

manual lip-sync detection	The manual swapping of mouth position drawings to match a voice track. For this process, both sound scrubbing (listening to a sound wave broken up frame-by-frame) and drawing substitutions from the Library view are used.
master palette	A master palette is a group of colours attributed to a character or a prop. The palette is used throughout the entire production to maintain consistency in the look and to ensure that the same colours are used throughout the production. Also known as palette.
model/colour model	In animation, a model is the definitive character, prop or location design that each artist must follow for the production. A colour model is the official colour design that must be used to paint the animation.
motion keyframe	In Toon Boom, the motion keyframe is a keyframe with computer-generated interpolation.
mouth chart	Adding a lip-sync to a project can really enhance its quality and storytelling. However, it can be difficult to shape a character's mouth so that it matches the sound at the precise frame. To solve this problem, Toon Boom provides a lip-sync feature which analyses the contents of a sound element and generates a mouth chart based on the eight animation phonemes (A, B, C, D, E, F, G, and X, which is used to represent silence).
multiplane	The effect of passing through multiple levels of drawings to create a sense of depth in a shot. A multiplane is a scene in which the layers are placed at different distances from the camera so that when the camera moves, a depth illusion occurs. With a multiplane, all the perspective and scale is calculated automatically.
NTSC	The standard analogue television broadcasting system used in North America. NTSC conforms to North American standards on how rectangular pixels are displayed for computer and television screens.
nudge	A small push (left, right, up, down, forward or backward) done with the keyboard arrow keys on a selected element. Nudging is used to move a selection very slightly and precisely.
onion skin	A feature that lets you see the previous and next drawings of a sequence.
overlay	A part of the scene environment, such as a chair or a bush, that is placed in front of the main animation.
PAL	A resolution that works best with the European format for television and computer screens, as the rectangular pixels are displayed at a different orientation.
palette/master palette	A palette or master palette is a group of colours attributed to a character or a prop. The palette is used throughout the entire project to maintain a consistency in the look and avoid the colour changing during the animation. Also referred to as a master palette.

palette style	A palette style is a second version of an existing palette with a slight change in the tint and value. A palette style can be used to create the night version of a palette. It may also be called a clone palette.
pan	To move the camera across the scene in any direction.
panel	In a storyboard, a panel is a frame in a shot. A shot can be composed of one or several panels.
paperless animation/tradigital	The paperless animation process is the action of animating digitally. The main paperless animation process is to draw, frame by frame, the animation directly in the software.
passing position	When drawing a walk sequence for a character, the passing position is the point at which one leg passes the other.
path of action	Direction that the action will follow. Also known as the Line of Action.
peg	In traditional animation, a tool used to ensure accurate registration of action as cel layers move. In digital animation, in which you are doing a more advanced puppet rigging, you can use peg layers. Peg layers are trajectory layers that do not contain drawings. They are motion paths that you can use to add path articulations. For the latter, you can also use the Inverse Kinematics tool.
phoneme	Unit of sound in a language.
pivot	A pivot is the point around which a peg or a drawing rotates.
pixel	Smallest element of an image displayed on a monitor or TV screen. Pixel, short for Picture Element, is a single point in a graphic image. It is a small sample of an image, a dot, a square, or a very small section made out of smooth filtering. If you zoom in close enough on a digital image, you will see the pixels, which look like small squares of different colours and intensity.
pose-to-pose animation	The pose-to-pose animation process is the action of creating all the main action poses, called key poses, and then placing the secondary poses between the keys. The secondary poses are called breakdown. Finally, the animator fills the gaps with the in-between drawings to achieve a smooth animation.
rendering	The final step when animating by computer. During rendering, the computer takes each pixel that appears on screen and processes all of the components as well as adding motion blur before it produces a final image. In animation, the rendering process is the action of calculating the final images after the compositing process.
resolution	The resolution is the size of a scene, generally calculated in pixel. For example, the NTSC resolution is 720 x 480. Resolution type should match your final output: HDTV, film-1.33, film-1.66, NTSC, PAL, low.
RGB	Red, Green, Blue: method of defining colour by specifying amounts

	of these three colour components.
rigging	The rigging process is the action of attaching the cut-out puppet parts one to the other.
rotary table	The Rotary Table is equivalent to the animation disk/table and allows one to rotate the workspace to be more comfortable while drawing.
rotoscoping	Is an animation technique in which animators trace over live-action film movement, frame by frame, for use in animated films. The act of sketching over live-action footage to create an animated sequence.
roughs	The roughs are the skeleton sketch of an animation or a design. Roughs mainly consist of sketch lines and shapes, though they can also contain design details.
safety area	In animation and movie parlance, the safety area is the zone at the centre of the scene's frame, one safe from being cropped by the TV frame. As a TV frame cuts a margin off the original frame size, maintaining a safety area ensures that the scene's main action will remain clearly visible once the film is screened on television.
scene	A scene is a shot in a movie or show. A sequence is composed of several scenes. A scene changes to another scene by a simple cut, or a transition.
script	The script is the original text containing all the movie or show information. In animation, the script contains all of the location descriptions, dialogues, time and more. A project starts with a script.
sequence	In animation, a sequence is a series of scenes or shots forming a distinct part of the story or movie, usually connected by unity of location or time.
shot	A shot is a scene in a movie or show. A sequence is composed of several shots. A shot changes to another shot by a simple cut, or a transition.
slow-in	Gradual acceleration in the action. Another common term for slow-in is ease-in.
slow-out	Gradual deceleration in the action. Another common term for slow-out is ease-out.
slugging	In Storyboard Pro, slugging refers to indicating the start and stop times of dialogue and relevant actions.
sound scrubbing	A process that lets you hear sound in real time while you move the playhead forward or backward. This is very useful for finely-tuned lip-syncing.
stop-motion keyframe	A stop-motion keyframe is a keyframe with no computer generated interpolation.
storyboard	A visual plan of all the scenes and shots in an animation. The storyboard indicates what will happen, when it will happen and

	how the objects in a scene are laid out.
straight-ahead	A technique in which an entire sequence is drawn from the first position to the last, in order. There is very little planning in this methodology, and where the character ends up and how it gets there can be a surprise for both the audience and the animator. While this approach is a lot more spontaneous and creative, it can create inaccurate results.
strokes	Strokes are invisible vector lines forming the drawing zones. They can be adjusted with Bézier handles.
tablet/pen	Device used in conjunction with, or instead of, a mouse to move a mouse pointer (sometimes referred to as the cursor) around the computer screen.
template	In Toon Boom, a template is an asset stored in the library, one that can be reused in any project. A template can be a drawing, a series of keyframes, a sound file, a panel, a cut-out character, an effect, a trajectory, an animation, or anything else used in the software.
thumbnails	A thumbnail is a very small image used as a reference or indicator.
timecode	Timecode is timing information printed on a movie clip to indicate what scene, hour, minute and second is currently displayed on the screen.
timeline	The timeline is a horizontal representation of the scene's elements, timing and keyframes.
trace and paint	After the rough animations have gone through cleanup and a final line or pencil test, each drawing is traced and painted for the final animation. In today's digital world, this may be done in a variety ways other than via the traditional celluloid or acetate methods.
track breakdown	The soundtrack for animated film is broken down into individual sounds documenting the precise frame-by-frame position of each sound.
traditional animation	The traditional animation process is the action of drawing on paper all of the animation sequences, before either scanning them or inking them on cels.
trajectory	A computer generated path or trajectory that elements can follow. The trajectory can be controlled by control points, keyframes and velocity.
transition	A transition is an effect placed between two scenes as they pass from one to the other. Common transition effects are cross-dissolve and wipe.
underlay	In animation, an underlay is a specific part of the decor placed behind the main animation.
aspect ratio	The aspect ratio describes the shape of the grid unit. A square grid unit would have the ratio 1:1, whereas a grid unit of aspect ratio 4:3 is a unit with one side 1.33 times as big as the other side.

vector	A vector-based image is composed of points and Bézier curves. The computer reads the points and traces the segments, linking them to reproduce the image shape. There is no fixed size or resolution in a vector image. The graphic can be enlarged and distorted as much as desired and the system will simply recalculate the segments and rebuild the shapes. Vector images are translated and displayed in pixels once the calculation is done.
velocity/ease	In animation, the velocity, also known as ease, is the acceleration or deceleration of a motion. This can be achieved by a function curve, or via a series of animated drawings. Other common terms for ease-in and ease-out are slow-in and slow-out.
walk cycle	To avoid making innumerable drawings, animators routinely make a walk cycle for their character. This comprises a series of drawings "on the spot" that describe the walk for that character. The illusion of movement is created via the use of background pans.
workspace	In Toon Boom, the workspace is made up of the views, toolbars, and menus.
Xsheet (exposure sheet)	<p>The Xsheet or exposure sheet, is a sheet with several vertical columns and horizontal frames used to indicate a scene's timing.</p> <p>Each column represents a scene's layer. In each column, the drawing numbers are indicated and spread over the specific amount of frames they need to appear.</p> <p>The exposure sheet is used by animators, directors and other members of a crew to track the sequence and timing of images, dialogue, sound effects, sound tracks and camera moves. Also known as a Dope Sheet.</p>
zone	An area which can be painted with colour.

Index

3D

 positioning layers 188

alpha channel

 _defined 618

animatic

 _defined 618

animating

 camera 223

animation

 _defined 618

anime

 _defined 618

arc

 _defined 618

aspect ratio

 _defined 618

 defined 627

auto-feed

 _defined 618

axis

 _defined 618

background

 _defined 618

Bezier

 _defined 618

bitmap images

 _defined 619

 importing in original format 19

breakdown

 _defined 619

camera

 adding and parenting to peg 222

 animating 223

camera shake

 _defined 619

caption

 _defined 619

cel

 _defined 619

celluloid

 See cel. 619

character design

 _defined 619

clean up

 _defined 619

CMYK

 _defined 619

colour card

 _defined 619

colour model

 _defined 624

 defined 620

colour wheel

 defined 620

Composite module 131, 339

compositing

 defined 620

cross dissolve

 defined 620

cut

 defined 620

cut-out animation

 defined 620

cycle

 defined 620

dialogue

 defined 620

Display modules 131, 339

dope sheet

 defined 620

doping

 defined 620

DPI

 defined 620

Drawing module 130, 338

ease

 defined 620

ease-in

 defined 620

ease-out

 defined 620

Effect module 132, 340

elements

 positioning in Top and Side views 165

establishing shot

 defined 620

exposure

 _defined 621

exposure sheet

 _defined 628, 621

fade-in

 _defined 621

fade-out

 _defined 621

field

 _defined 621

field chart

 _defined 621

film-1.33

 _defined 621

film-1.66
 _defined 621

flipping
 _defined 621

follow-through
 _defined 621

forward kinematics
 _defined 621

frame
 _defined 622

frame rate
 _defined 622

Function view 243
 displaying functions 239, 244

functions
 _defined 622
 displaying 239, 244

gamut
 _defined 622

group navigation 130, 338

HDTV
 _defined 622

Hold
 _defined 622

HSV
 _defined 622

importing
 bitmap image in original format 19
 sound file 280

in-between
 _defined 622

ink and paint
 _defined 622

interpolation

 _defined 622

jump cut

 _defined 622

key pose

 _defined 623

keyboard shortcuts

 _defined 623

keyframes

 _defined 623

layers

 _defined 623

 panning with Transform tool 99

 positioning in 3D space 188

 rotating with Transform tool 99

 skewing with Transform tool 100

layout

 _defined 623

layout and posing

 _defined 623

library

 _defined 623

light table

 _defined 623

line of action

 _defined 623

lip-sync

 _defined 623

 auto detection, defined 618

 mouth shapes 300

lip-sync detection

 manual, defined 624

low resolution

 _defined 623

- manual lip-sync detection
 - _defined 624
- master palette
 - _defined 624
- Matte Drawing module 132, 340
- model
 - _defined 624
- model sheet See character design
- Module Library view 341
 - toolbar 341
- Module Library view toolbar 341
- modules 130, 338
 - Composite 131, 339
 - Display 131, 339
 - Drawing 130, 338
 - Effect 132, 340
 - Matte Drawing 132, 340
 - Peg 132, 340
 - ports 132, 340
 - Write 131, 339
- motion keyframe
 - _defined 624
- mouth
 - chart 624
 - shapes 300
- multiplane
 - _defined 624
 - positioning elements 165
- Navigator view 129, 337
- Network view 128, 336
 - Composite module 131, 339
 - Drawing modules 130, 338
 - Effect module 132, 340
 - group navigation 130, 338

- Matte Drawing module 132, 340
- modules 130, 338
- Navigator view 129, 337
- Peg modules 132, 340
- position ports 132, 340
- Search toolbar 129, 337
- Symbol Stack 129, 337
- Write and Display modules 131, 339

node system 129, 337

NTSC

- _defined 624

nudge

- _defined 624

onion skinning

- _defined 624

overlay

- _defined 624

PAL

- _defined 624

palettes

- _defined 624
- style, defined 625

panel

- _defined 625

panning

- _defined 625
- layer using Transform tool 99

paperless animation

- _defined 625

passing position

- _defined 625

path of action

- _defined 625

Peg module 132, 340

pegs

 _defined 625

pen

 _defined 627

Perspective view 170

 rotating a scene 171

phoneme

 _defined 625

pivot

 _defined 625

 repositioning permanently 105

pixel

 _defined 625

pixelation See bitmap image

ports 132, 340

pose-to-pose

 _defined 625

rendering

 _defined 625

resolution

 _defined 625

RGB

 _defined 625

rigging

 _defined 626

rotary table

 _defined 626

rotating

 layer with Transform tool 99

rotoscoping

 _defined 626

roughs

 _defined 626

safe area

 _defined 626

scaling

 layer with Transform tool 100

scanning

 VectOptions.conf file 78

scene setup

 panning layer using Transform tool 99

 repositioning pivot permanently 105

 rotating layer with Transform tool 99

 scaling layer with Transform tool 100

 skewing layer with Transform tool 100

scenes

 _defined 626

 rotating in Perspective view 171

script

 _defined 626

scrubbing

 _defined 626

sequences

 _defined 626

shot

 _defined 626

Side view 169

 opening 222

 positioning elements 165

skewing

 layer with Transform tool 100

slow-in

 _defined 626

slow_out

 _defined 626

slugging

 _defined 626

sound

importing sound file 280

scrubbing

 _defined 626

stop-motion keyframe

 _defined 626

storyboard

 _defined 626

straight-ahead

 _defined 627

strokes

 _defined 627

Symbol Stack 129, 337

tablet

 _defined 627

templates

 _defined 627

thumbnails

 _defined 627

timecode

 _defined 627

timeline

 _defined 627

toolbars

 Module Library view 341

 Search, Network view 129, 337

Top view 167

 opening 222

 positioning elements 165

trace and paint

 _defined 627

track breakdown

 _defined 627

tradigital

 _defined 625

traditional animation

 _defined 627

trajectory

 _defined 627

Transform tool

 panning layer 99

 rotating layer 99

 scaling layer 100

 skewing layer 100

transition

 _defined 627

underlay

 _defined 627

VectOptions.conf file 78

 Linux 81

 Mac 79

 setting 79

 Windows 79

vector

 _defined 628

vectorization

 creating a style 77

 parameters, creating 77

 parameters, custom 69

 parameters, modifying 77

Vectorization Parameters dialog box

 Help tab 72

 opening 69

 Options tab 70

velocity

 defined 620, 628

views

Function 243

Module Library 341

Navigator 129, 337

Network 128, 336

Perspective 170

Side 169

Top 167

walk cycle

_defined 628

workspace

_defined 628

Write module 131, 339

Xsheet view

_defined 628

zone

_defined 628