



HARMONY

TOON BOOM HARMONY 12.1
- Advanced Edition -
Compositing and Effects Guide

Legal Notices

Toon Boom Animation Inc.
4200 Saint-Laurent, Suite 1020
Montreal, Quebec, Canada
H2W 2R2

Tel: +1 514 278 8666

Fax: +1 514 278 2666

toonboom.com

Disclaimer

The content of this guide is covered by a specific limited warranty and exclusions and limit of liability under the applicable License Agreement as supplemented by the special terms and conditions for Adobe®Flash® File Format (SWF). For details, refer to the License Agreement and to those special terms and conditions.

The content of this guide is the property of Toon Boom Animation Inc. and is copyrighted.

Any reproduction in whole or in part is strictly prohibited.

Trademarks

Harmony is a trademark of Toon Boom Animation Inc.

Publication Date

2015-08-07

Copyright © 2015 Toon Boom Animation Inc. All rights reserved.

Contents

Toon Boom Harmony 12.1- Advanced Edition -Compositing and Effects Guide	1
Contents	3
Chapter 1: Compositing - An Introduction	9
Chapter 2: Import	11
Importing Bitmap Images	12
Importing a Bitmap Image Without Vectorization	12
Adding Images to a Bitmap Layer	16
Bitmap Image Quality	20
Importing and Vectorizing Bitmap Images	20
Importing PSD Files as Separate Layers	23
Exporting and Reimporting a PSD Layout	29
Exporting a Layout	29
Importing a Photoshop Layout	33
Scanning Images	39
Importing AI and PDF Files	47
Importing Adobe Flash Files	49
Importing SWF Files	50
Redistributing Elements	52
Importing FLA Files	52
Preparing and Exporting Files from Flash	53
Importing Flash Files in Harmony	57
Your Flash Scene in Harmony	61
Guidelines for Creating a Flash File Before Exporting to Harmony	61
Scene Root	61
Timeline	62
Library View	62
Effects	62
Drawing Features	63
Mixed Layers	63
Understanding Drawing Objects	64
Mixed Layers	64
Importing QuickTime Movies	64
Custom Vectorization Parameters	65
Options Tab	66

Help Tab	68
File IO Options	69
Registration Options	69
Filtering Options	70
Options for bitmap that has no registration information	71
RGB Keying Options	72
Colour Vectorization Options	72
Bubble Usage (implemented only for colour vectorization's line art)	72
4 Colour Vectorization	73
Creating a Vectorization Style	73
Setting the VectOptions.conf File	75
Chapter 3: Library	81
Understanding the Library Concept	81
What is a Library?	82
What is a Template?	82
What is a Symbol?	82
Library View	83
Structuring the Library	85
Templates	89
Symbols	91
Importing Symbols and Templates	99
Importing Files Through the Library	103
Using Paste Special	103
Chapter 4: Scene Setup	109
Importing the Scene Components	109
Setting the Camera Frame	109
Positioning the Scene Components	114
Animate Mode	115
Selecting a Layer	115
Locking Layers in the Timeline View	117
Positioning an Element Using the Transform Tool	120
Transform Tool Properties	125
Positioning an Element Using the Advanced Animation Tools	127
Positioning an Element Using the Layer Properties View	131
Drawing Layer Properties Reference	133

Setting Properties for Many Layers	142
Auto Apply Option	143
Resetting a Transformation	144
Cloning and Duplicating Layers	145
Cloning Layers	145
Duplicating Layers	146
Working with Groups	147
Display Concepts	147
Timeline View Modes	148
Creating a Multiplane	150
Top View	153
Side View	155
Perspective View	156
Chapter 5: Animation Paths	159
Animating a Layer	159
Differences between Animated Layers and Pegs	161
Layer Parameters	165
Adding and Deleting Keyframes	168
Motion and Stop-motion Keyframes	169
Constant Z	173
Animating the Camera	173
Camera Truck-ins and Line Thickness	176
Modifying a Path in the Camera, Top and Side Views	177
Offsetting a Trajectory	182
Modifying a Path in the Timeline View	183
Modifying a Path in the Function View	185
Function View	190
Modifying a Path in the Xsheet View	192
Function Curves	194
Copying and Pasting a Motion	198
Paste Special Options	202
Adjusting the Velocity	205
Chapter 6: Sound	213
Importing a Sound File	213
Sound Layer Properties and Sound Element Editor	214

Sound Displays	215
Sound Playback	216
Sound Scrubbing	217
Analog Sound Scrubbing	218
Performing an Analog Sound Scrub in Harmony	219
Editing a Sound File	220
Changing the Start or End Frame of a Sound	221
Trimming the Start and End of a Sound File	223
Looping a Sound	224
Mixing the Sound Volume	225
Customizing the Playback Range	226
Adding an Empty Sound Layer	227
Lip-sync	228
Generating a Lip-sync Detection	230
Mapping the Lip-Sync Detection	232
Modifying the Lip-sync	233
Manual Lip-sync	235
Chapter 7: Effects	237
Adding Effects	237
Previewing Effects	240
Animating an Effect over Time	242
How Does an Effect Work?	244
Using Effects	244
Blending	245
Blending Properties	246
Blur - Gaussian	248
Blur - Gaussian Properties	249
Blur	250
Blur-Radial Properties	250
Brightness and Contrast	251
Brightness and Contrast Properties	251
Colour-Card	252
Colour Card Properties	252
Colour-Override	253
Colour-Override Editor Interface	254

Palettes	254
Colours	255
Whole Palette Overrides	255
Individual Colour Overrides	255
Overriding a Colour	256
Colour-Scale	257
Colour-Scale Properties	257
Cutter	258
Cutter Properties	259
Glow	259
Glow Properties	260
Highlight	261
Highlight Properties	262
Quadmap	264
Quadmap Properties	265
Shadow	266
Shadow Properties	266
Tone	267
Tone Effect Properties	269
Transparency	270
Transparency Properties	271
Chapter 8: Export	273
Exporting a QuickTime Movie	273
Exporting an SWF Movie	278
Exporting Image Sequences	280
Exporting OpenGL Frames	281
Glossary	282
Index	293

Chapter 1: Compositing - An Introduction

Once the ink and paint is done, the animation completed and the timing locked, you are ready to move on to compositing. This includes different components, such as the elements' positioning, scene resolution, trajectories, camera moves, effects and filters, and so on. During compositing, you are working with computer-generated effects done with Harmony's many effect nodes. You can create many types of interesting effects and then customize it to suit your animation style.

It is during the compositing phase that the three animation workflows merge together. Whatever your chosen path, they all end up in the same animation, together in the same scene. However, the cut-out compositing can be a bit more complex due to the advanced networking of the different puppets.

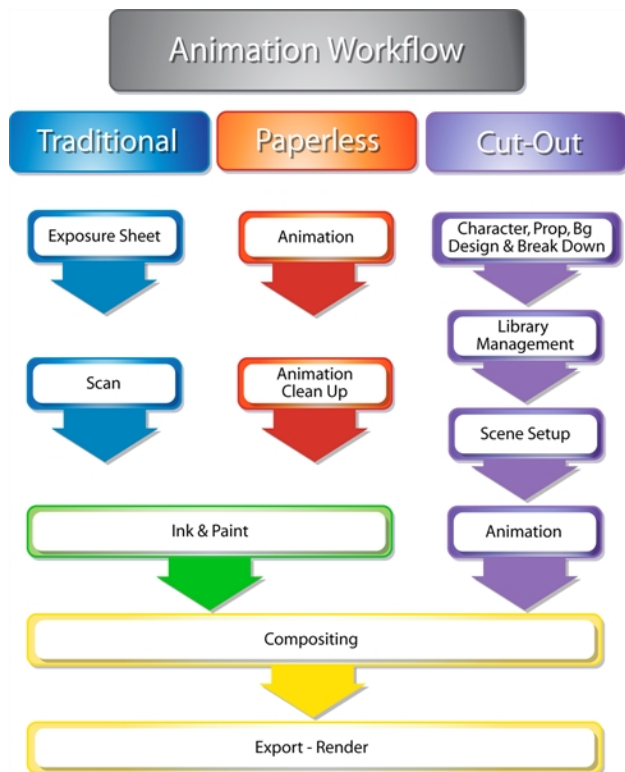

Topics in this section:

- [Import](#) on page 11
- [Library](#) on page 81
- [Scene Setup](#) on page 109
- [Animation Paths](#) on page 159
- [Sound](#) on page 213
- [Effects](#) on page 237
- [Export](#) on page 273

Chapter 2: Import

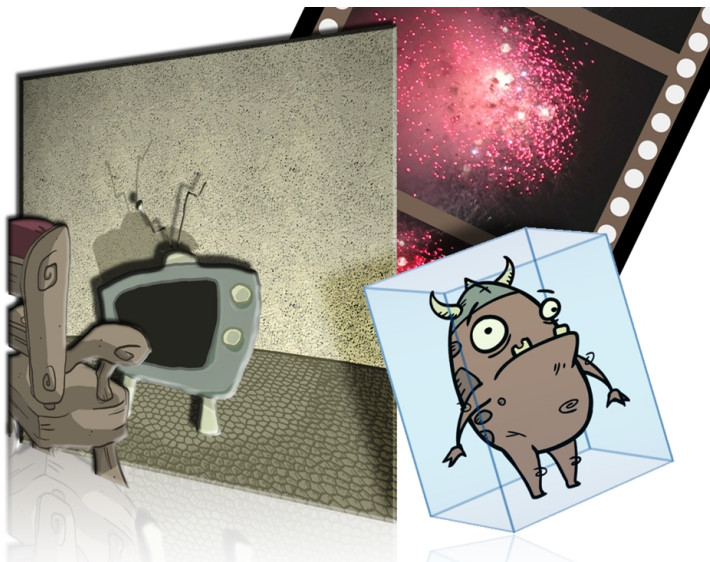

Toon Boom Harmony allows you to import external content as well as being able to draw directly in the software. This means that characters, backgrounds and videos created in other drawing, painting and multimedia programs can be brought in and animated. You can import QuickTime videos, pictures, multilayered .psd files, as well as .ai, .swf, .pdf, and .fla files. You can also scan images and import them as bitmap or vectorize them.

This chapter contains the following topics:

- [Importing Bitmap Images](#) on page 12
- [Importing PSD Files as Separate Layers](#) on page 23
- [Exporting and Reimporting a PSD Layout](#) on page 29
- [Scanning Images](#) on page 39
- [Importing AI and PDF Files](#) on page 47
- [Scanning Images](#) on page 39
- [Importing Adobe Flash Files](#) on page 49
- [Importing QuickTime Movies](#) on page 64
- [Custom Vectorization Parameters](#) on page 65

NOTE: For sound import, refer to [Importing a Sound File](#) on page 213.

Importing Bitmap Images



Images can come in many different file formats and are usually saved in a format that retains the original specifications set by the image creator. Some formats can preserve the transparency or transparent layers, while others are not resolution dependent due to their vector nature. Toon Boom Harmony supports the following formats: JPEG, BMP, PNG, TGA, PSD, TIFF, SGI, TVG, OMF, PAL, SCAN.

When importing images and 3D models and linking images, the settings are saved in your user settings.

In this section, you will cover the following topics:

- [Importing a Bitmap Image Without Vectorization on page 12](#)
- [Importing and Vectorizing Bitmap Images on page 20](#)

Importing a Bitmap Image Without Vectorization

How to open the Import Images dialog box

1. Do one of the following:
 - ▶ From the top menu, select **File > Import > Images**.
 - ▶ In the File toolbar, click the Import Images  button.
 - ▶ In the Xsheet view, right-click anywhere in the frame area and select **Import > Images**.

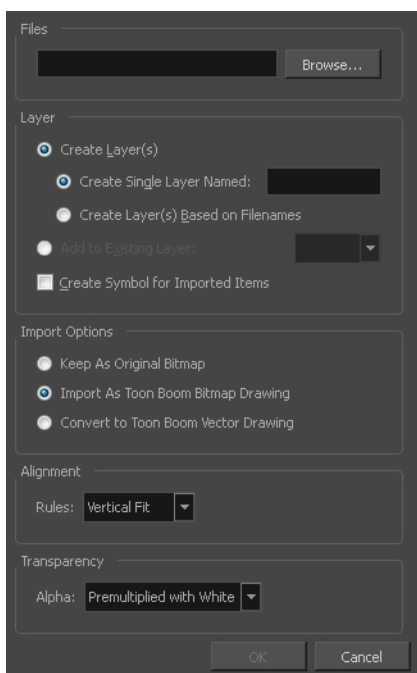

The Import Images dialog box opens.



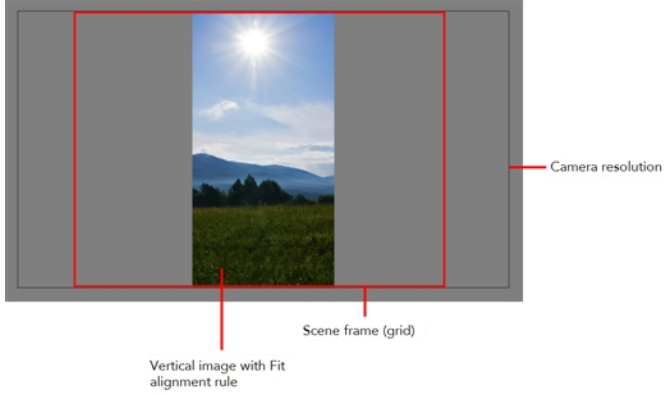

How to import a bitmap image in its original format

1. In the Files section of the Import Images dialog box, click **Browse** to find and select one or more images on your computer.
2. Decide if the bitmap image will go on a new layer or an existing layer. To add the bitmap image to a new layer, go to step 3. To add the bitmap image to an existing layer, go to step 4.
3. Add the bitmap image to a new layer by selecting the **Create Layer(s)** option and one of the following options and then proceed to step 5:
 - **Create Single Layer Named:** Creates a layer you can name.
 - **Create Layer(s) Based on Filenames:** Creates a layer based on each unique filename prefix. For example, the filenames a-1.tga, a-2.tga and b-1.tga will create layers name "a" and "b", where "a" has two drawings and "b" has one. When creating a single layer from these three filenames, all three drawings will be inserted in the new layers.
4. Select the **Add to Existing Layer** option to place the bitmap image on a layer you select from the list. If only vector layers are available in your scene, they will not be displayed in the list. You can choose to encapsulate the bitmap in a symbol by selecting the **Create Symbols for Imported Items** option.
5. In the Import Options section, select the **Keep As Original Bitmap** option. In the Alignment section, decide on the size and placement of your image within the camera frame. Depending on the Scene Settings (the height and width in pixels that you chose for your project), an image that you import may be scaled to the point where all its individual pixels become visible. There are three options available in the Alignment section:

Parameter	Description
Fit	Enlarges or shrinks (but not distorts) the image height to match

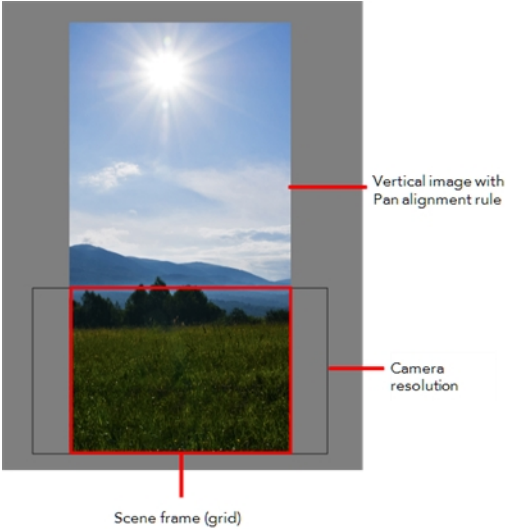
	<p>the full height of the scene grid.</p>  <p>If the image orientation is landscape, this will enlarge or shrink (but not distort) the image width to match that of the scene grid.</p>  <p>Note that the Fit alignment rule equals the Center Fit rule in the layer properties.</p>
<p>Pan</p>	<p>This is the opposite of the Fit parameter. If the image orientation is portrait, its width will be made to match the width of the scene grid. As a result, part of the image's height will extend beyond the height of the frame. This can be useful if you want to make your background move up and down, or from left to right to make it appear as if the camera is panning or to actually perform a camera pan.</p>

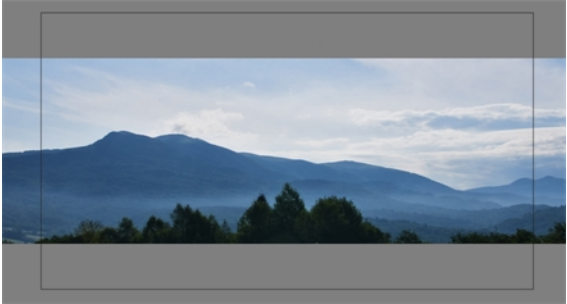
	 <p>Vertical image with Pan alignment rule</p> <p>Camera resolution</p> <p>Scene frame (grid)</p> <p>The opposite will apply to a landscape image. Its height will be fit to the scene grid, therefore it is possible that the image will extend beyond the scene grid's boundaries.</p>  <p>Scene frame Camera resolution Landscape image with Pan alignment rule</p> <p>Note that the Pan alignment rule equals the Center First Page rule in the layer properties.</p>
<p>Project Resolution</p>	<p>Scales the image in proportion to the scene's resolution. The system looks at the resolution of the bitmap image, for example 4000 x 2000, then compares it to the scene's resolution, for example 1920 x 1080, and adjusts the scale factor in proportion. So, in this example, the bitmap would appear at 208% (4000/1920). If you import a bitmap that is 960 x 540, it will be displayed at 50% (960/1920) of the size of the project resolution.</p>  <p>Note that the Project Resolution alignment rule is equal to the As</p>

	Is rule in the layer properties.
--	----------------------------------

6. In the Transparency section, select one of the following from the Alpha menu:

Parameter	Description
Premultiplied with White	Individual pixels at the edge of an image are blended with white.
Premultiplied with Black	Semitransparent pixels in the original image are blended with black.
Straight	Pixels at the edge of an image are blended with black, white and greys.
Clamp Colour to Alpha	Premultiplies the colour value with the alpha value. When the colour is clamped to the alpha, the colour value cannot be higher than the alpha value. It calculates the real colour value faster. When the RGB values are multiplied with the alpha value, that is, if you have a pixel of value R=247, G=188, B=29 and the alpha is 50% or the image has a 50% transparency, then the actual RGB values that are output would be half of the amounts listed above.

1. Click **OK**.

Adding Images to a Bitmap Layer

How to add more bitmap images to an existing bitmap layer

1. In the Timeline view, if the bitmap image is contained in a symbol, double-click on the bitmap symbol cell to edit the symbol. Otherwise, if the bitmap image is on a bitmap layer, leave it as is.

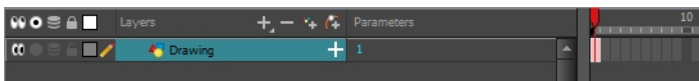

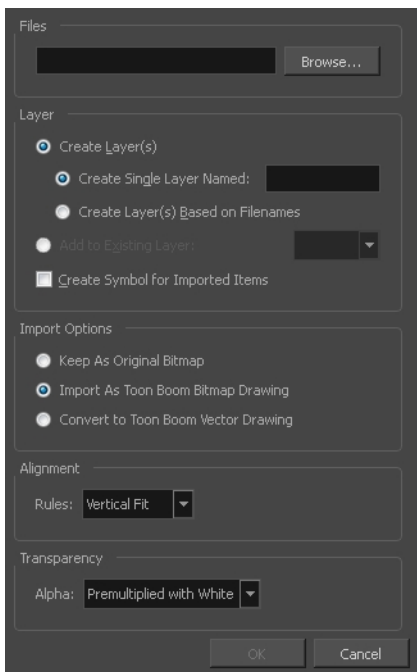

2. If necessary, in the Timeline view, pull on the red bracket to extend the exposure.
3. From the top menu, select **File > Import > Images** or click the Import Image  button.

The Import Images dialog box opens.

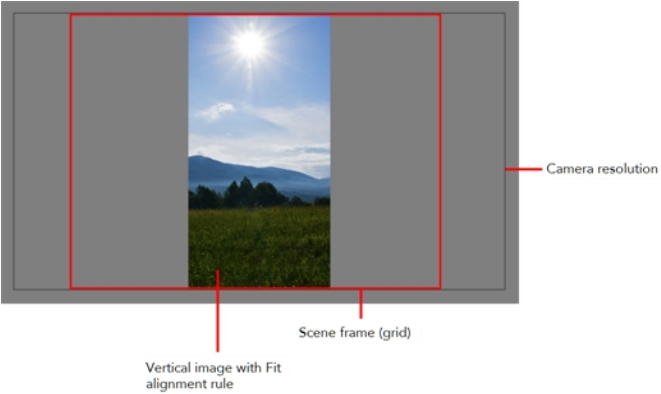

4. Click **Browse** to find and select one or several images on your computer.
5. In the Layer section, select the **Add to Existing Layer** option and select an existing bitmap layer from the menu.
6. Deselect the **Create Symbol for Imported Items** option.
7. In the Import Options section, select the **Keep As Original Bitmap** option. In the Alignment section, decide on the size and placement of your image within the camera frame. Depending on the Scene Settings (the height and width in pixels that you chose for your project), an image that you import may get scaled to the point where all its individual pixels become visible. There are three options available in the Alignment section:

Parameter	Description
Fit	<p>Enlarges or shrinks (but not distorts) the image height to match the full height of the scene grid.</p> 

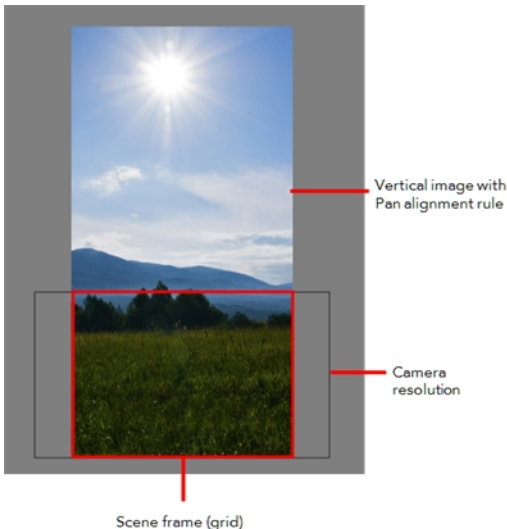
	<p>If the image orientation is landscape, this will enlarge or shrink (but not distort) the image width to match that of the scene grid.</p>  <p>Note that the Fit alignment rule equals the Center Fit rule in the layer properties.</p>
<p>Pan</p>	<p>This is the opposite of the Fit parameter. If the image orientation is portrait, its width will be made to match the width of the scene grid. As a result, part of the image's height will extend beyond the height of the frame. This can be useful if you want to make your background move up and down, or from left to right to make it appear as if the camera is panning or to actually perform a camera pan.</p>  <p>The opposite will apply to a landscape image. Its height will be fit to the scene grid, therefore it is possible that the image will extend beyond the scene grid's boundaries.</p>

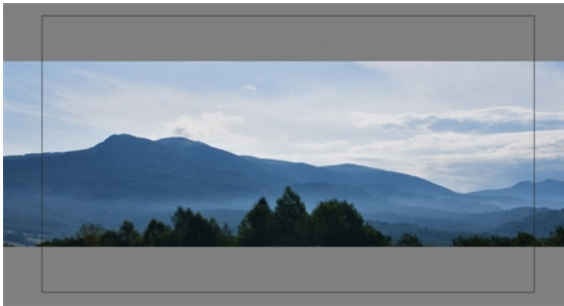
	 <p>Scene frame Camera resolution Landscape image with Pan alignment rule</p> <p>Note that the Pan alignment rule equals the Center First Page rule in the layer properties.</p>
<p>Project Resolution</p>	<p>Scales the image in proportion to the scene's resolution. The system looks at the resolution of the bitmap image, for example 4000 x 2000, then compares it to the scene's resolution, for example 1920 x 1080, and adjusts the scale factor in proportion. So, in this example, the bitmap would appear at 208% (4000/1920). If you import a bitmap that is 960 x 540, it will be displayed at 50% (960/1920) of the size of the project resolution.</p>  <p>Note that the Project Resolution alignment rule is equal to the As Is rule in the layer properties.</p>

8. In the Transparency section, select one of the following from the Alpha menu:

Parameter	Description
Premultiplied with White	Individual pixels at the edge of an image are blended with white.
Premultiplied with Black	Pixels at the edge of an image are blended with black.
Straight	Pixels at the edge of an image are blended with black, white and greys.
Clamp Colour to Alpha	Premultiplies the colour value with the alpha value. When the colour is clamped to the alpha, the colour value cannot be higher than the alpha value. It calculates the real colour value faster. When the RGB values are multiplied with the alpha value, that is to say, if you have a pixel of value R=247, G=188, B=29 and the alpha is 50% or the image has a 50% transparency, then the actual RGB values that are output would be half of the amounts listed above.

9. Click **OK**.

Bitmap Image Quality

If the bitmap images that you imported look blurry or slightly pixelated, you can clean up the image by changing the quality of the preview in the Camera view. It will not affect the final render.

How to change the bitmap image quality

1. In the Camera view, double-click on the bitmap image to enter its symbol if the image is encapsulated or simply select the bitmap image layer in the Timeline view if it's not.
2. Do one of the following:
 - ▶ From the top menu, select **View > Bitmap File Quality**.
 - ▶ From the Camera menu, select **View > Bitmap File Quality**.
 - ▶ Press **Ctrl + Q** (Windows/Linux) or **⌘ + Q** (Mac OS X).

The Bitmap Image Quality dialog box opens.

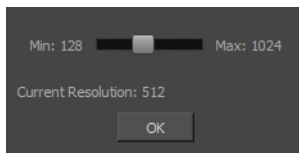

3. Drag the slider to the right to improve the quality.
4. Click **OK**.
5. If you are inside a symbol, go to the top of the Camera view and click **Top** to exit the symbol and return to your scene.

Importing and Vectorizing Bitmap Images

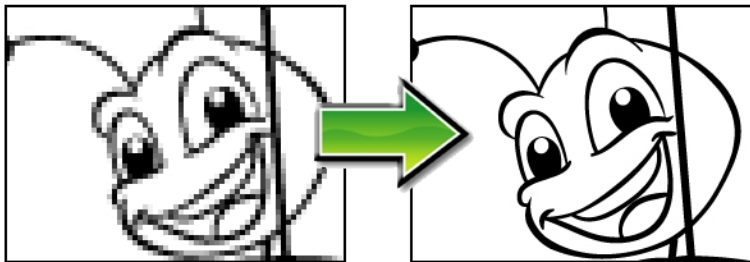

You can turn bitmap images into vector drawings, while maintaining the sketchiness of a pencil line or into vector images with a bitmap fill. Both options can add life to an animation, which straight vectorization with smoothing does not usually afford.

How to import and vectorize a bitmap image

1. Do one of the following:
 - ▶ From the top menu, select **File > Import > Images**.
 - ▶ In the File toolbar, click the Import Images  button.

The Import Images dialog box opens.

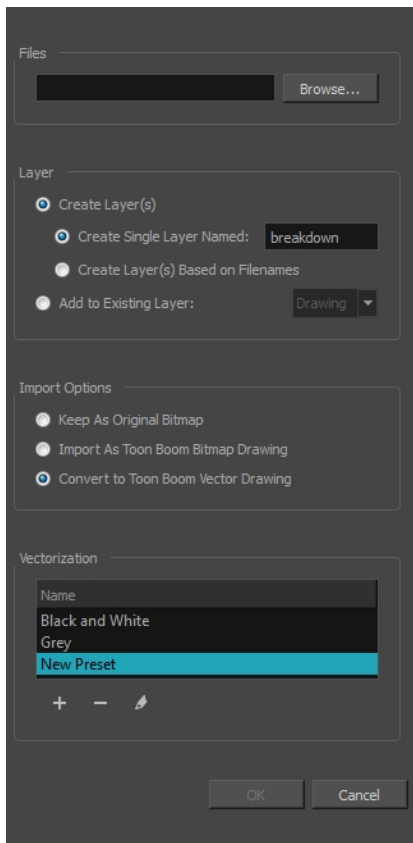

2. Click **Browse** to locate images.
3. In the Layer section, decide if the scanned or imported image will be placed on a new layer or existing layer.
 - ▶ **Create Layer:** Scans or imports the image into a new layer. Select one of the following options:

Parameter	Description
Create Single Layer Named	Creates a layer you can name.
Create Layer(s) Based on Filenames	Creates a layer based on each unique filename prefix. For example, the filenames a-1.tga, a-2.tga and b-1.tga will create layers named "a" and "b", where "a" has two drawings and "b" has one. When creating a single layer from these three filenames, all three drawings will be inserted in the new layers.

- ▶ **Add to Existing Layer:** Scans or imports the image into an existing layer. Select a layer from the Layer list. You must scan into the same layer type if you're using an existing layer.
- ▶ **Create Symbol for Acquired Items:** Encapsulates the bitmap image in a symbol. To mix bitmap images with vector drawings on the same layer, the bitmap image must be encapsulated in a symbol and vice versa. Symbols will also be automatically added to the Symbol folder in the Library view.

4. In the Import Options section, select the **Convert to Toon Boom Vector Drawing** option.

- In the Vectorization section, decide whether you want to import your image in colour, black and white, grey, or if you want to add a new preset.
 - ▶ **Black and White:** Vectorizes drawings as a solid black line; creates a 100% vector-based drawing.
 - ▶ **Grey:** Vectorizes your image as a mix of vector contour and greyscale bitmap filling. Lines keep the texture from the scan, and the white of the paper becomes transparent.
 - ▶ **New Preset:** The New Preset **+** button lets you create custom vectorization parameters via the Vectorization Parameters interface.

NOTE:

You can double-click on any of the presets at any time to open the Vectorization Parameters dialog box to customize your option.

NOTE: The vectorized images are painted with the Vectorize Line colour swatch from the colour palette.

- Click **OK**.

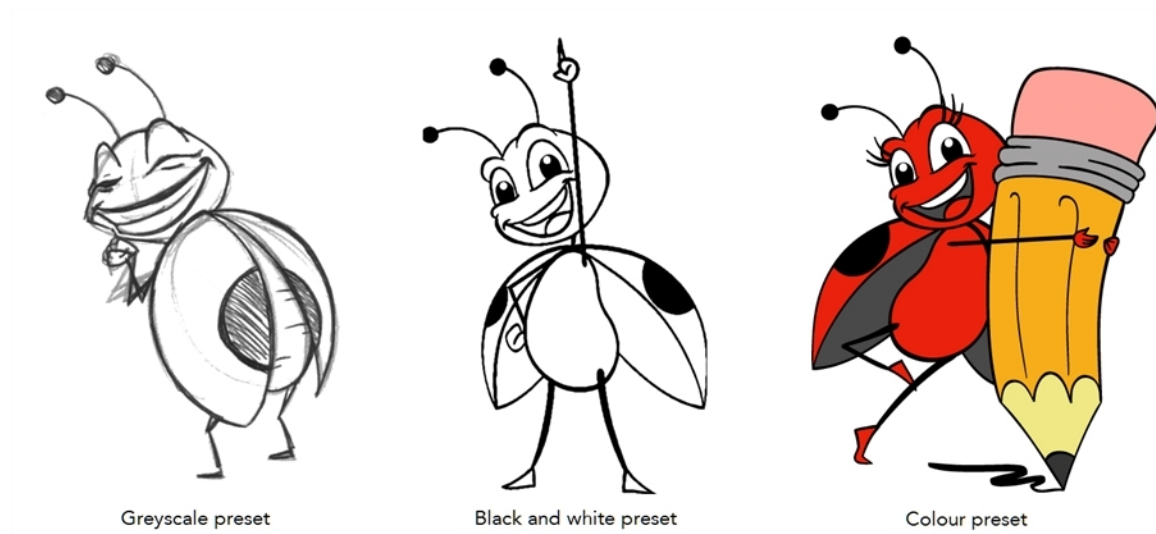

A symbol or new layer contains the vector drawing. For images contained in a symbol, double-click on the image's first cell in the Timeline view to enter the symbol so you can edit the image.

Importing PSD Files as Separate Layers

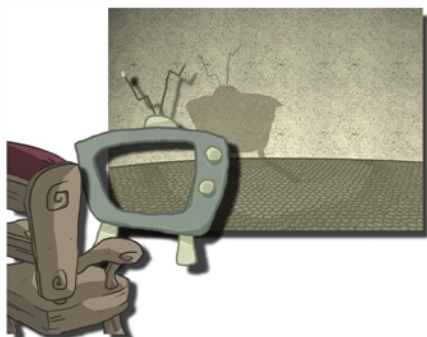



PSD files (a format exportable exclusively from Adobe Photoshop) are unique in that they are able to retain multiple layers. This is advantageous as the image remains fully editable in terms of any colour correction, effects, masking, transparency, or compositing that were made to the `.psd` file in Adobe Photoshop.

NOTE: Note that your `.psd` image file must be set to RGB mode within Adobe Photoshop prior to being imported into Harmony.

How to import the separated layers of a `.psd` file

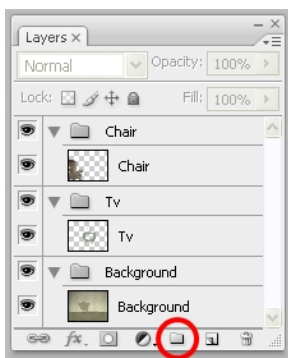
1. In Adobe Photoshop, organize your file so that all your layers are “grouped” into individual folders, or that all the elements you want to import as a single layer in Harmony are grouped together in their own folder. Any layer that is not in a folder group, by itself or otherwise, will not be imported.



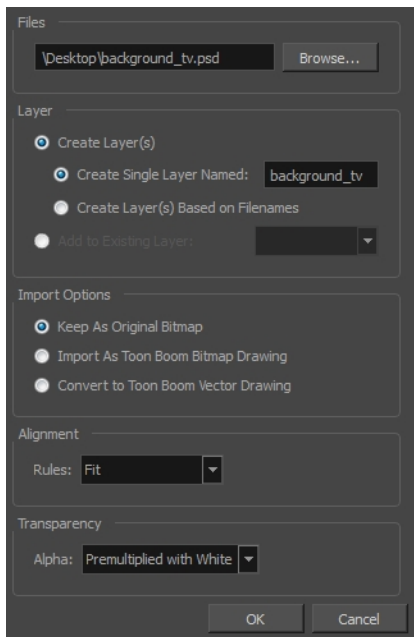
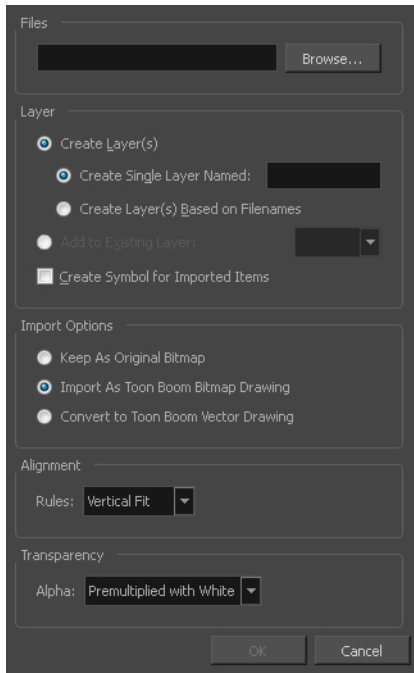

1. In Harmony, go to the top menu and select **File > Import > Images** or click the Import Images  button. The Import Images dialog box opens.





2. In the Files section, click **Browse** to find and select the **.psd** image on your computer.
3. In the Layer section, select the **Create Layer(s)** option, then select one of the following options:
 - ▶ **Create Single Layer Named:** Creates a layer you can name.
 - ▶ **Create Layer(s) Based on Filenames:** Creates a layer based on each unique filename prefix. For example, the filenames a-1.tga, a-2.tga and b-1.tga will create layers name "a" and "b", where "a" has two drawings and "b" has one. When creating a single layer from these three filenames, all three drawings will be inserted in the new layers.

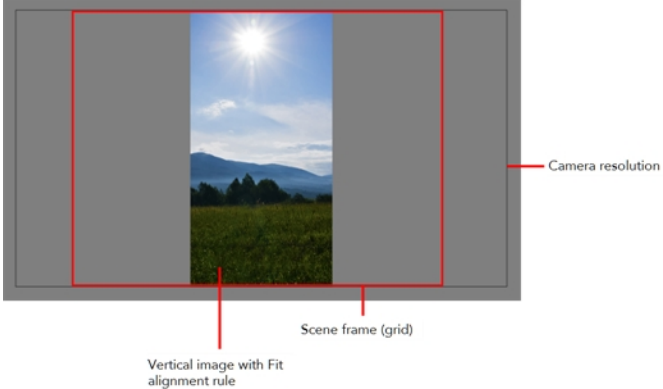

4. In the Import Options section, select one of the following:

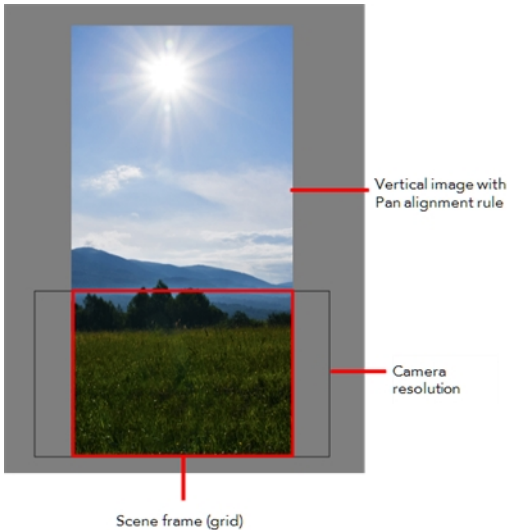
- **Keep As Original Bitmap:** Retains an imported image as a bitmap. In the Alignment section, decide on the size and placement of your image within the camera frame. Depending on the Scene Settings (the height and width in pixels that you chose for your project), an image that you import may get scaled to the point where all its individual pixels become visible. There are three options available in the Alignment section:

Parameter	Description
Fit	<p>Enlarges or shrinks (but not distorts) the image height to match the full height of the scene grid.</p>  <p>If the image orientation is landscape, this will enlarge or shrink (but not distort) the image width to match that of the scene grid.</p>  <p>Note that the Fit alignment rule equals the Center Fit rule in the layer properties.</p>
Pan	<p>This is the opposite of the Fit parameter. If the image orientation is portrait, its width will be made to match the width of the scene grid. As a result, part of the image's height will extend beyond the height of the frame. This can be useful if you want to make your background move up and down, or from left to right to make it appear as if the camera is panning or to actually perform a camera pan.</p>

	 <p>The diagram shows a vertical image of a landscape with a sun in the sky. A red box labeled 'Camera resolution' is overlaid on the bottom portion of the image. A red line labeled 'Vertical image with Pan alignment rule' is positioned to the right of the image. Below the image, a red box labeled 'Scene frame (grid)' is shown.</p> <p>The opposite will apply to a landscape image. Its height will be fit to the scene grid, therefore it is possible that the image will extend beyond the scene grid's boundaries.</p>  <p>The diagram shows a horizontal landscape image of mountains. A red box labeled 'Camera resolution' is overlaid on the left portion of the image. A red line labeled 'Landscape image with Pan alignment rule' is positioned below the image. Below the image, a red box labeled 'Scene frame' is shown.</p> <p>Note that the Pan alignment rule equals the Center First Page rule in the layer properties.</p>
<p>Project Resolution</p>	<p>Scales the image in proportion to the scene's resolution. The system looks at the resolution of the bitmap image, for example 4000 x 2000, then compares it to the scene's resolution, for example 1920 x 1080, and adjusts the scale factor in proportion. So, in this example, the bitmap would appear at 208% (4000/1920). If you import a bitmap that is 960 x 540, it will be displayed at 50% (960/1920) of the size of the project resolution.</p>  <p>The diagram shows a landscape image of mountains scaled to fit within a gray rectangular frame representing the scene's resolution.</p> <p>Note that the Project Resolution alignment rule is equal to the As Is rule in the layer properties.</p>

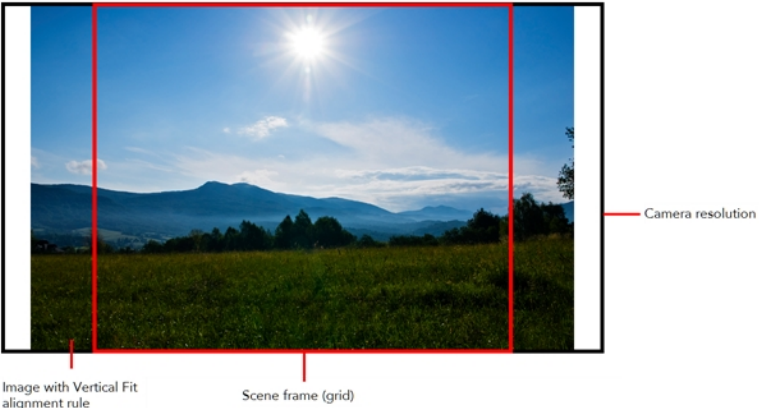
- ▶ **Import As Bitmap Drawing:** Imports a drawing into a vector layer where you can edit the image using the drawing tools. In the Alignment section, select one of the following:

Parameter	Description
Vertical Fit	<p>Enlarges or shrinks (but not distort) to your image height to match the full height of the scene frame (alignment grid).</p> 
Horizontal Fit	<p>Enlarges or shrinks (but not distort) to your image height to match the full width of the scene frame (alignment grid).</p> 
Actual Size	<p>Scales the image in proportion to the scene's resolution. The system looks at the resolution of the bitmap image, for example 4000 x 2000, then compares it to the scene's resolution, for example 1920 x 1080, and adjusts the scale factor in proportion. So, in this example, the bitmap would appear at 208% (4000/1920). If you import a bitmap that is 960 x 540, it will be displayed at 50% (960/1920) of the size of the project resolution.</p>

- ▶ **Convert to Toon Boom Vector Drawing:** Imports a drawing and converts it to a Toon Boom vector drawing. In the Vectorization section, select one of the following:

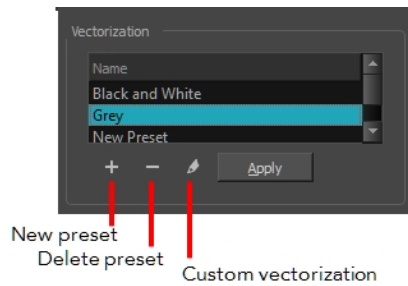

Black and White: Vectorizes drawings as a solid black line; creates a 100% vector-based drawing.

Grey: Vectorizes the image as a mix of vector contour and greyscale bitmap filling. Lines keep the texture from the scan, and the white of the paper becomes transparent.

New Preset: Lets you create a new preset.

Delete Preset: Lets you delete any preset in the list.

Custom vectorization: Lets you set custom vectorization parameters—see [Creating a Vectorization Style](#) on page 73.

- Decide whether to select **Vectorize Imported Items** option.

NOTE: If you decide to use the Vectorize Imported Items option, see [Importing and Vectorizing Bitmap Images](#) on page 20 to learn more about vectorization settings.

NOTE: If you disable the Vectorize Imported Items options, the Transparency and Alignment settings will appear in place of the Vectorization settings—see [Importing a Bitmap Image Without Vectorization](#) on page 12.

- Click **OK**.

The Multilayer Image Import Settings dialog box opens.

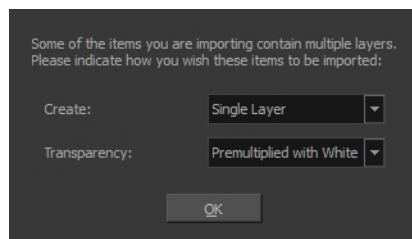

- From the Create menu, select one of the following:
 - ▶ **Single Layer:** To import the Camera and Layout layers merged together.
 - ▶ **Separated Layers:** To keep your Camera and Layout layers separated.
- From the Transparency menu, select one of the following if applicable:

Parameter	Description
-----------	-------------

Premultiplied with White	Individual pixels at the edge of an image are blended with white.
Premultiplied with Black	Pixels at the edge of an image are blended with black.
Straight	Pixels at the edge of an image are blended with black, white and greys.
Clamp Colour to Alpha	Premultiplies the colour value with the alpha value. When the colour is clamped to the alpha, the colour value cannot be higher than the alpha value. It calculates the real colour value faster. When the RGB values are multiplied with the alpha value, that is to say, if you have a pixel of value R=247, G=188, B=29 and the alpha is 50% or the image has a 50% transparency, then the actual RGB values that are output would be half of the amounts listed above.

9. Click **OK**.

Your image appears as separate layers in the Timeline view, corresponding to the PSD layer group folders.

NOTE: The artwork displayed in every one of your layers as a result of a multilayer PSD file import is linked to the same source image. This means that if you use the **Drawing > Delete Selected Drawings** command to physically delete the drawing from the project folder, the exposed drawing will be deleted in all layers at once. Once deleted from the project folder, the image cannot be retrieved unless you reimport your psd file.

Exporting and Reimporting a PSD Layout

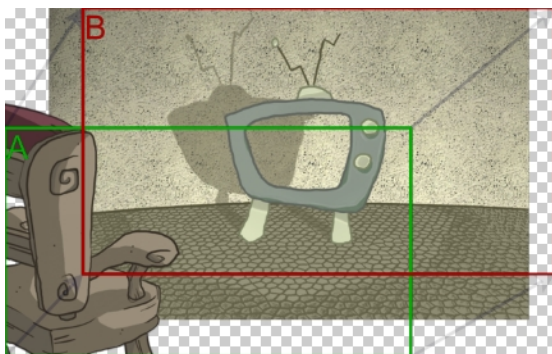

Harmony allows you to export the contents of your scene as a PSD layout. This can be helpful for scene setup, background art retakes, or even planning of animation.

Exporting a Layout

Before exporting a layout, all the elements must be well positioned. For example, if you plan to include a camera movement in this scene, you should also set this up, as you can export the camera keyframes to generate a clear and complete layout.

You can also create all the layouts for your production in the same Harmony project which can be imported later on when you start each scene's project. This will help set up the scene and begin its creation. You can use the layout .psd files to create the background art of each scene and make sure everything is correctly framed and at the right size. Finally, you can also have a layer with a drawing of the rough poses of the character or action and generate your layout posing from there.

NOTE: Because the layout image is one static .psd file, only the first frame of your drawing layers will be exported—see [Scene Setup on page 109](#) and [Animation Paths on page 159](#).

How to export your scene as a layout

Before exporting your scene as a layout, position your background elements, and everything you need as a reference in your scene, including a camera movement.

- From the top menu, select one of the following:
 - File > Export > Layout Image to export all the elements in your scene to the layout .psd file.
 - File > Export > Layout Image from Selection to export only the selected elements.

The Export Layout Image dialog box opens.

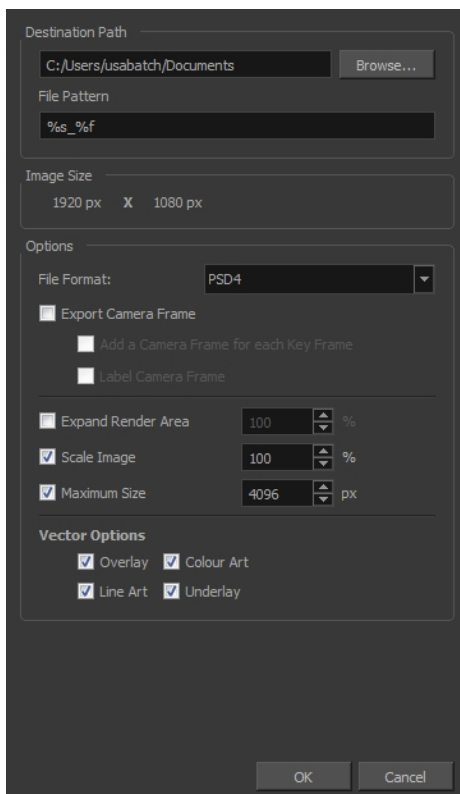

- In the Export Layout Image dialog box, set the export parameters:

Parameter	Description
Destination Path	Use the Browse button to select a location to save your layout and name the resulting .psd file.
	File Pattern: Automatically puts the name of the scene and/or the frame number in the name of the file you create.
Image Size	The size of the .psd image file that will be exported. The resulting image will be 72 dpi as the standard television resolution and its size in pixel will fit your scene resolution settings. i.e HDTV, NTSC, PAL, etc. Note that if you have a

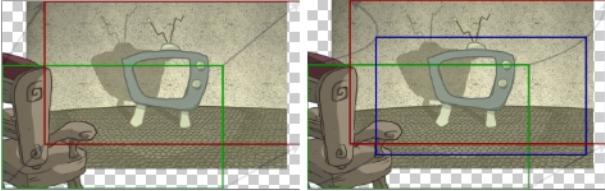
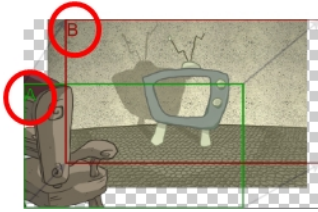
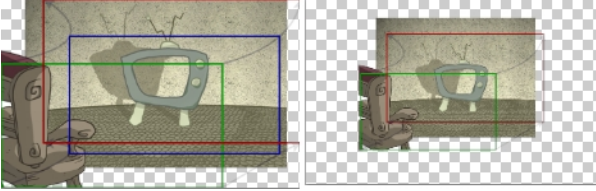
	<p>camera movement going over the normal camera frame limit, for example a pan, the image will be bigger.</p>
Options	<p>File Format: Lets you select the format to export your layout.</p> <p>Export Camera Frame: This option is disabled by default. You can enable it to export an additional layer to your .psd file displaying the camera frame on it.</p> <p>Add a Camera Frame for Each Keyframe: This option is disabled by default, meaning that if you have a camera movement with more than a starting and an ending point, only these positions of the camera frame will appear on the camera layer of the exported layout .psd file. You must enable this option if you need to the in-between keyframes to also be displayed.</p>  <p>Label Camera Frame: Adds the camera position label in the top corner of the camera frames. The camera label is a single alphabet letter determining the order of the camera frame position.</p> 
	<p>Expand Render Area: This option is disabled by default, meaning the layout image will take the complete PSD area, cropped at the very edge of the canvas. You can enable this option to add a transparent area all around the layout. You must setup the size of this area by using the Scale field lower. The resulting image will be larger.</p>  <p>Scale Image: Sets the size of the transparent border around the layout image. By default the value is set to 100% to export the image as is with no transparent area around it. Increase the percentage value to add the extra around the image to create the border.</p> <p>Maximum Size: This option is enabled by default, meaning that when you have a camera zoom movement, the size of the layout image will be adjusted accordingly. The resulting percentage will be calculated following the</p>

	<p>maximal camera zoom value appearing in the layout. This allows the image to be exported at an appropriate resolution, preventing the layout image from appearing pixelated or blurry when the camera zoom occurs. You can disable this option to export the image layout at the normal size.</p>
	<p>Vector Options</p> <p>If you export one or more vector-based drawing layers in your layout image, you have the option to export only the drawing layers you want. Enable or disable the following options to export or prevent the export of the corresponding art layers.</p> <p>Overlay: Exports the art in the Overlay layer of the drawings to be exported to the layout image.</p> <p>Line Art: Exports the art in the Line layer of the drawings to be exported to the layout image.</p> <p>Colour Art: Exports the art in the Colour layer of the drawings to be exported to the layout image.</p> <p>Underlay: Exports the art in the Underlay layer of the drawings to be exported to the layout image.</p>

3. Click **OK** to validate the settings and export a .psd file of your layout.

The resulting image is a .psd file with one or two layers, each of which is contained in a corresponding group. These groups make the layout .psd file ready for a multilayer .psd import.

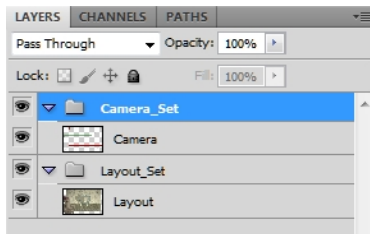

The Camera_Set group contains the camera drawing layer. If you selected the Export Camera option, this group and layer appear in your layout image.



The Layout_Set group contains a merged drawing layer of all the content of your scene's first frame when you exported the layout image.

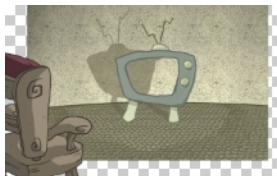

NOTE: An .xli file is exported along with your .psd file. This file contains all the necessary information for correctly importing and automatically positioning your layout image in a Harmony project. Do not delete the .xli file or rename it. Also, always keep it at the same location as the layout .psd file.

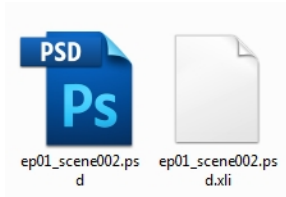

Importing a Photoshop Layout

If you exported a Photoshop layout image from a Harmony project, you can easily import it back into Harmony. Just be sure to import it at the beginning of the project for accurate scene planning.

How to import a PSD layout

1. In your Harmony project, select **File > Import > Images**.

The Import Images dialog box opens.

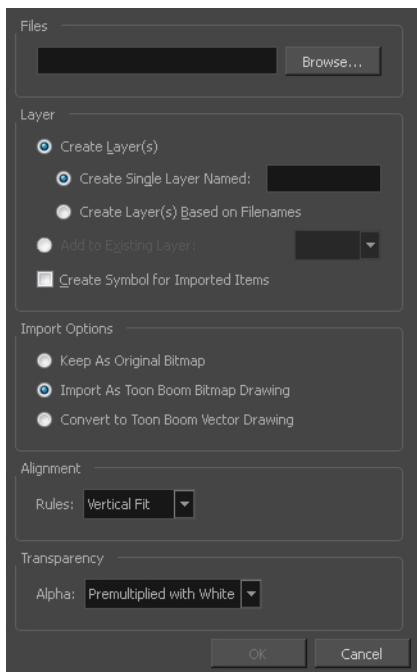

2. In the Files section, click **Browse** to find and select the .psd layout file on your computer. Note that this layout file must have its corresponding .xli file in the same folder.

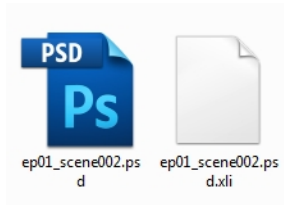



- Once you have selected the layout file, the Use Position Information Contained in XLI File option appears in the Layer section.

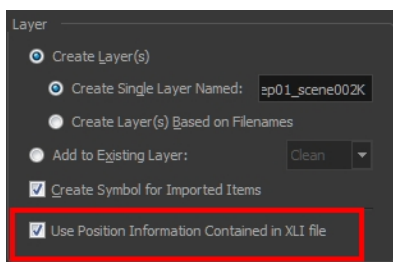

This option is enabled by default. When you import the layout image in your scene, it will be automatically positioned to fit the original layout scene creating an accurate layout guide. You can disable this option if you want the imported layout image to be imported according to the normal behaviour of the import process. The layout image will be incorrectly aligned as it was when it was first created.



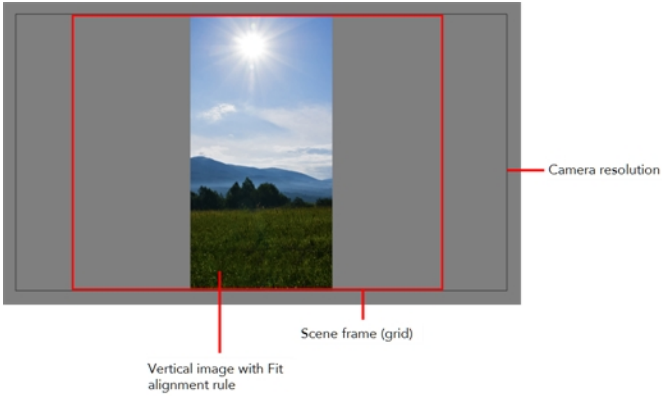

- In the Layer section, select the **Create Layer(s)** option, then select one of the following options:
 - **Create Single Layer Named:** Creates a layer you can name.
 - **Create Layer(s) Based on Filenames:** Creates a layer based on each unique filename prefix. For example, the filenames a-1.tga, a-2.tga and b-1.tga will create layers name "a" and "b", where "a" has two drawings and "b" has one. When creating a single layer from these three filenames, all three drawings will be inserted in the new layers.
- Select the **Create Symbol for Imported Items** option if you want the layers to be contained in symbols.
- In the Import Options section, select one of the following:
 - **Keep As Original Bitmap:** Retains an imported image as a bitmap. In the Alignment section, decide on the size and placement of your image within the camera frame. Depending on the Scene Settings (the height and width in pixels that you chose for your project), an image that you import may get scaled to the point where all its individual pixels become visible. There are three options available in the Alignment section:

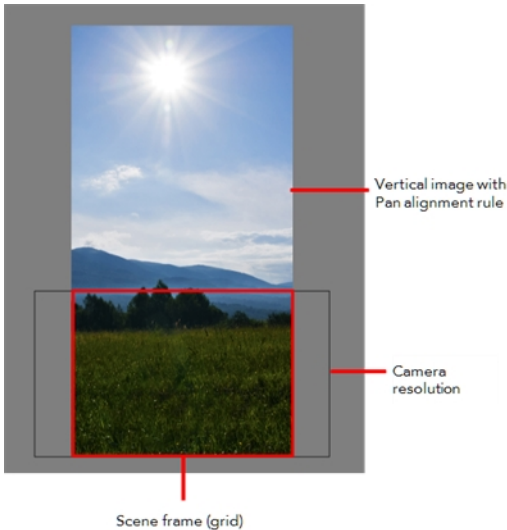
Parameter	Description
Fit	Enlarges or shrinks (but not distorts) the image height to match the full height of the scene grid.

	 <p>Camera resolution</p> <p>Scene frame (grid)</p> <p>Vertical image with Fit alignment rule</p> <p>If the image orientation is landscape, this will enlarge or shrink (but not distort) the image width to match that of the scene grid.</p>  <p>Camera resolution</p> <p>Scene Frame (Grid)</p> <p>Landscape image with Fit alignment rule</p> <p>Note that the Fit alignment rule equals the Center Fit rule in the layer properties.</p>
<p>Pan</p>	<p>This is the opposite of the Fit parameter. If the image orientation is portrait, its width will be made to match the width of the scene grid. As a result, part of the image's height will extend beyond the height of the frame. This can be useful if you want to make your background move up and down, or from left to right to make it appear as if the camera is panning or to actually perform a camera pan.</p>

	 <p>Vertical image with Pan alignment rule</p> <p>Camera resolution</p> <p>Scene frame (grid)</p> <p>The opposite will apply to a landscape image. Its height will be fit to the scene grid, therefore it is possible that the image will extend beyond the scene grid's boundaries.</p>  <p>Scene frame Camera resolution Landscape image with Pan alignment rule</p> <p>Note that the Pan alignment rule equals the Center First Page rule in the layer properties.</p>
<p>Project Resolution</p>	<p>Scales the image in proportion to the scene's resolution. The system looks at the resolution of the bitmap image, for example 4000 x 2000, then compares it to the scene's resolution, for example 1920 x 1080, and adjusts the scale factor in proportion. So, in this example, the bitmap would appear at 208% (4000/1920). If you import a bitmap that is 960 x 540, it will be displayed at 50% (960/1920) of the size of the project resolution.</p>  <p>Note that the Project Resolution alignment rule is equal to the As Is rule in the layer properties.</p>

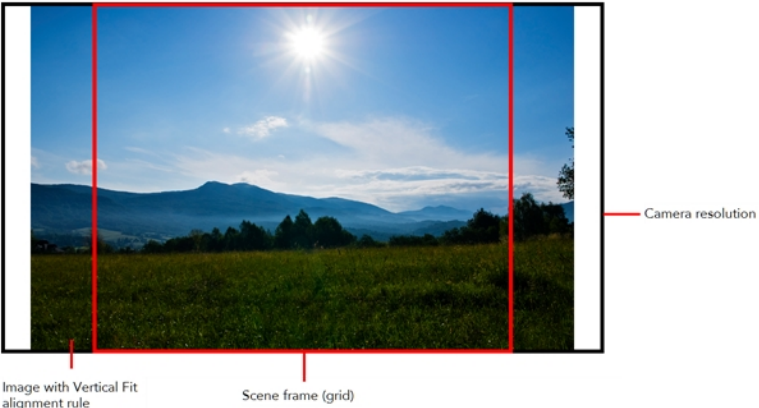
- ▶ **Import As Toon Boom Bitmap Drawing:** Imports a drawing into a vector layer where you can edit the image using the drawing tools. In the Alignment section, select one of the following:

Parameter	Description
Vertical Fit	<p>Enlarges or shrinks (but not distort) to your image height to match the full height of the scene frame (alignment grid).</p> 
Horizontal Fit	<p>Enlarges or shrinks (but not distort) to your image height to match the full width of the scene frame (alignment grid).</p> 
Actual Size	<p>Scales the image in proportion to the scene's resolution. The system looks at the resolution of the bitmap image, for example 4000 x 2000, then compares it to the scene's resolution, for example 1920 x 1080, and adjusts the scale factor in proportion. So, in this example, the bitmap would appear at 208% (4000/1920). If you import a bitmap that is 960 x 540, it will be displayed at 50% (960/1920) of the size of the project resolution.</p>

- ▶ **Convert to Toon Boom Vector Drawing:** Imports a drawing and converts it to a Toon Boom vector drawing. In the Vectorization section, select one of the following:

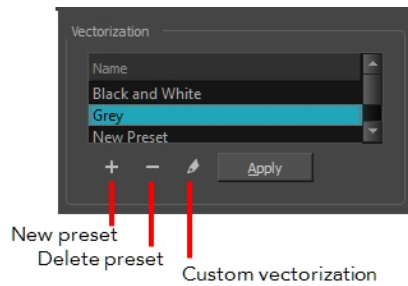

Black and White: Vectorizes drawings as a solid black line; creates a 100% vector-based drawing.

Grey: Vectorizes the image as a mix of vector contour and greyscale bitmap filling. Lines keep the texture from the scan, and the white of the paper becomes transparent.

New Preset: Lets you create a new preset.

Delete Preset: Lets you delete any preset in the list.

Custom vectorization: Lets you set custom vectorization parameters—see [Creating a Vectorization Style](#) on page 73.

7. Click **OK**.

The Multilayer Image Import Settings dialog box opens.

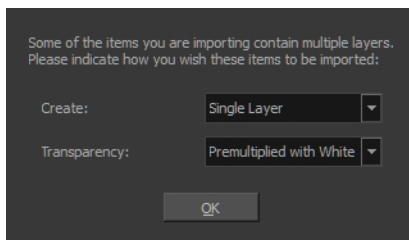

8. From the Create menu, select one of the following:
 - ▶ **Single Layer:** To import the Camera and Layout layers merged together.
 - ▶ **Separated Layers:** To keep your Camera and Layout layers separated.
9. From the Transparency menu, select one of the following if applicable:

Parameter	Description
Premultiplied with White	Individual pixels at the edge of an image are blended with white.
Premultiplied with Black	Pixels at the edge of an image are blended with black.
Straight	Pixels at the edge of an image are blended with black, white and greys.
Clamp Colour to Alpha	Premultiplies the colour value with the alpha value. When the colour is clamped to the alpha, the colour value cannot be higher than the alpha value. It calculates the real colour value faster. When the RGB values are multiplied with the alpha value, that is to say, if you have a pixel of value R=247, G=188, B=29 and the alpha is 50% or the image has a 50% transparency, then the actual RGB values that are output would be half of the amounts listed above.

10. Click **OK**.

Your image appears as separate layers in the Timeline view, corresponding to the .psd layer group folders **Camera_Set** and **Layout_Set**. You can now use this layout as a guide for scene settings.

NOTE: Refer to [Scene Setup on page 109](#) to learn more about the scene setup task.

Scanning Images



Toon Boom Harmony can receive images from any TWAIN device such as scanners and digital cameras. These images can either be loaded into your scene as bitmaps or converted into vector-based images that can be edited using Toon Boom Harmony.

If your operating system does not automatically recognize your device after it has been connected, you must install the correct TWAIN drivers in order to access its contents. You can usually download the drivers from the device manufacturer's website.

How to open the Scan Drawings window and set your scanner

1. From the top menu, select **File > Import > From Scanner**.

The Scan Drawings window opens.

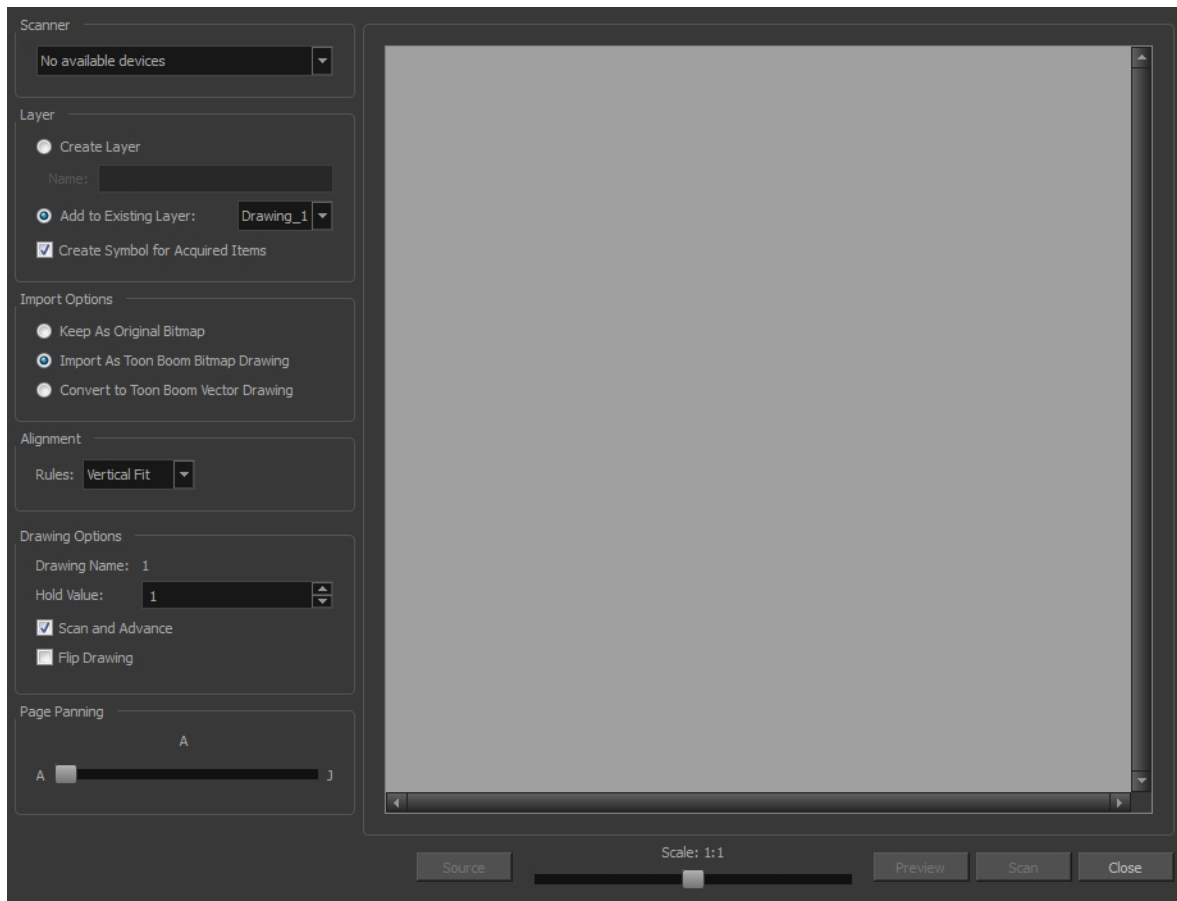

- In the Scan Drawings window, select your scanner or other supported TWAIN device from the Scanner menu. If none are available, check your device to ensure that it's properly connected to your computer. If your device still does not appear in the menu, you may have to shut down and restart the software.

How to scan an image in its original format



- In the Layer section, decide if the scanned or imported image will be placed on a new layer or existing layer.
 - ▶ **Create Layer:** Scans or imports the image into a new layer. Select one of the following options:



Parameter	Description
Create Single Layer Named	Creates a layer you can name.
Create Layer(s) Based on Filenames	Creates a layer based on each unique filename prefix. For example, the filenames a-1.tga, a-2.tga and b-1.tga will create layers named "a" and "b", where "a" has two drawings and "b" has one. When creating a single layer from these three filenames, all three drawings will be inserted in the new layers.

- ▶ **Add to Existing Layer:** Scans or imports the image into an existing layer. Select a layer from the Layer list. You must scan into the same layer type if you're using an existing layer.

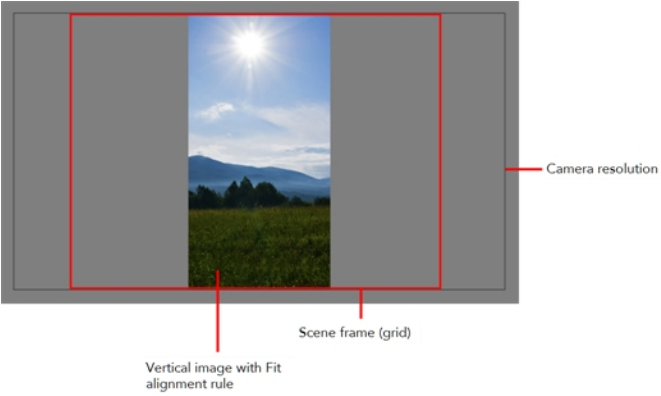
- ▶ **Create Symbol for Acquired Items:** Encapsulates the bitmap image in a symbol. To mix bitmap images with vector drawings on the same layer, the bitmap image must be encapsulated in a symbol and vice versa. Symbols will also be automatically added to the Symbol folder in the Library view.

2. In the Import Options section, select the **Keep As Original Bitmap** option.
3. In the Alignment section, decide on the size and placement of your scanned image within the camera frame. Depending on the scene settings (the height and width, in pixels, that you chose for your project), an image that you scan may be scaled to the point where all its individual pixels become visible.

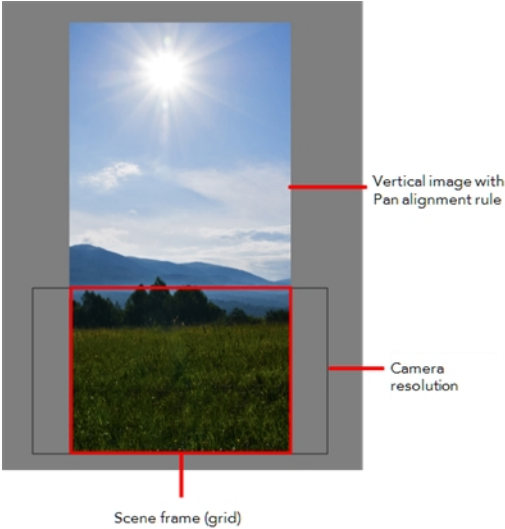
Parameter	Description
Fit	<p>Enlarges or shrinks (but not distorts) the image height to match the full height of the scene grid.</p>  <p>If the image orientation is landscape, this will enlarge or shrink (but not distort) the image width to match that of the scene grid.</p>  <p>Note that the Fit alignment rule equals the Center Fit rule in the layer properties.</p>
Pan	<p>This is the opposite of the Fit parameter. If the image orientation is portrait, its width will be made to match the width of the scene grid. As a result, part of the image's height will extend beyond the height of the frame. This can be useful if you want to make your background move up and down, or from left to right to make it appear as if the camera is panning or to actually perform a camera pan.</p>

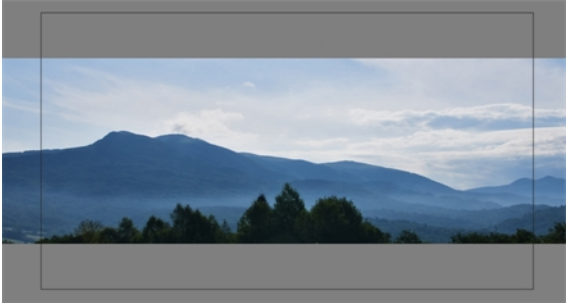
	 <p>The diagram shows a vertical image of a landscape with a sun in the sky. A red box labeled 'Camera resolution' is overlaid on the bottom portion of the image. A red line labeled 'Vertical image with Pan alignment rule' is positioned to the right of the image. Below the image, a red box labeled 'Scene frame (grid)' is shown.</p> <p>The opposite will apply to a landscape image. Its height will be fit to the scene grid, therefore it is possible that the image will extend beyond the scene grid's boundaries.</p>  <p>The diagram shows a horizontal landscape image. A red box labeled 'Camera resolution' is overlaid on the left portion of the image. A red line labeled 'Landscape image with Pan alignment rule' is positioned below the image. Below the image, a red box labeled 'Scene frame' is shown.</p> <p>Note that the Pan alignment rule equals the Center First Page rule in the layer properties.</p>
<p>Project Resolution</p>	<p>Scales the image in proportion to the scene's resolution. The system looks at the resolution of the bitmap image, for example 4000 x 2000, then compares it to the scene's resolution, for example 1920 x 1080, and adjusts the scale factor in proportion. So, in this example, the bitmap would appear at 208% (4000/1920). If you import a bitmap that is 960 x 540, it will be displayed at 50% (960/1920) of the size of the project resolution.</p>  <p>The diagram shows a landscape image scaled to fit within a scene frame grid. The image is smaller than the grid, leaving significant white space around it.</p> <p>Note that the Project Resolution alignment rule is equal to the As Is rule in the layer properties.</p>

4. In the Drawing Options section, set the following options if desired:

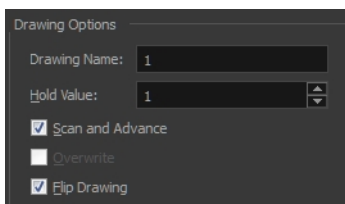

- ▶ **Drawing Name:** Name of the drawing to import.
 - ▶ **Hold Value:** Type the number of frames that the drawing will be exposed.
 - ▶ **Scan and Advance:** Lets you scan one drawing after another every time you click **Scan**.
 - ▶ **Flip Drawing:** Mirrors the drawings horizontally and scans it this way.
5. Adjust the **Scale** control and sliders in the Preview Image window until you are satisfied with the view.

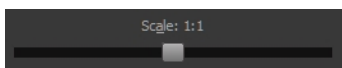

6. Click **Scan** to scan your drawing.
7. If you are scanning panoramic drawings, in the Page Panning section, move the slider to the next letter to capture your next frame.

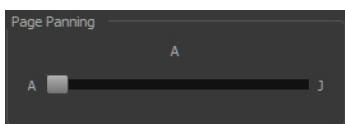

8. If you have more than one drawing, set the next drawing in place and click **Scan** again. Repeat until you have finished scanning all your drawings.

How to scan an image as a Toon Boom bitmap drawing

1. In the Import Options section, select the **Import as Toon Boom Bitmap Drawing** option.
2. In the Layer section, decide if the scanned or imported image will be placed on a new layer or existing layer.
 - ▶ **Create Layer:** Scans or imports the image into a new layer. Select one of the following options:



Parameter	Description
Create Single Layer Named	Creates a layer you can name.
Create Layer(s) Based on Filenames	Creates a layer based on each unique filename prefix. For example, the filenames a-1.tga, a-2.tga and b-1.tga will create layers named "a" and "b", where "a" has two drawings and "b" has one. When creating a single layer from these three filenames, all three drawings will be inserted in the new layers.

- ▶ **Add to Existing Layer:** Scans or imports the image into an existing layer. Select a layer from the Layer list. You must scan into the same layer type if you're using an existing layer.

- **Create Symbol for Acquired Items:** Encapsulates the bitmap image in a symbol. To mix bitmap images with vector drawings on the same layer, the bitmap image must be encapsulated in a symbol and vice versa. Symbols will also be automatically added to the Symbol folder in the Library view.
3. In the Alignment section, decide on the size and placement of your scanned image within the camera frame. Depending on the scene settings (the height and width, in pixels, that you chose for your project), an image that you scan may be scaled to the point where all its individual pixels become visible.

NOTE: Make sure you're in the Camera view's Render mode when judging an imported image, otherwise it may appear blurry.

The following three Alignment Rules options are available:

Parameter	Description
Vertical Fit	<p>Enlarges or shrinks (but not distort) to your image height to match the full height of the scene frame (alignment grid).</p> 
Horizontal Fit	<p>Enlarges or shrinks (but not distort) to your image height to match the full width of the scene frame (alignment grid).</p> 

Actual Size	Scales the image in proportion to the scene's resolution. The system looks at the resolution of the bitmap image, for example 4000 x 2000, then compares it to the scene's resolution, for example 1920 x 1080, and adjusts the scale factor in proportion. So, in this example, the bitmap would appear at 208% (4000/1920). If you import a bitmap that is 960 x 540, it will be displayed at 50% (960/1920) of the size of the project resolution.
-------------	---

4. In the Drawing Options section, set the following options if desired:

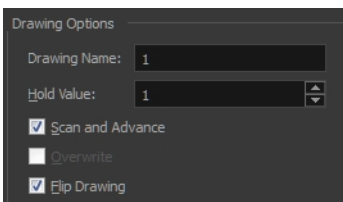

- ▶ **Drawing Name:** Name of the drawing to import.
- ▶ **Hold Value:** Type the number of frames that the drawing will be exposed.
- ▶ **Scan and Advance:** Lets you scan one drawing after another every time you click **Scan**.
- ▶ **Flip Drawing:** Mirrors the drawings horizontally and scans it this way.

5. Adjust the **Scale** control and sliders in the Preview Image window until you are satisfied with the view.

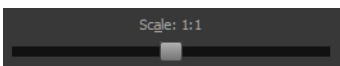

6. Click **Scan** to scan your drawing.
7. If you are scanning panoramic drawings, in the Page Panning section, move the slider to the next letter to capture your next frame.

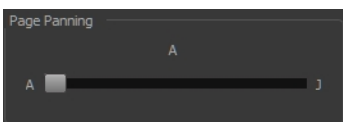

8. If you have more than one drawing, set the next drawing in place and click **Scan** again. Repeat until you have finished scanning all your drawings.

How to scan an image and convert it to a Toon Boom vector drawing

1. In the Import Options section, select the **Convert to Toon Boom Vector Drawing** option. You can choose to encapsulate the image in a symbol by selecting the **Create Symbols for Imported Items** option.
2. In the Layer section, decide if the scanned or imported image will be placed on a new layer or existing layer.
 - ▶ **Create Layer:** Scans or imports the image into a new layer. Select one of the following options:

Parameter	Description
Create Single Layer Named	Creates a layer you can name.

<p>Create Layer(s) Based on Filenames</p>	<p>Creates a layer based on each unique filename prefix. For example, the filenames a-1.tga, a-2.tga and b-1.tga will create layers named "a" and "b", where "a" has two drawings and "b" has one. When creating a single layer from these three filenames, all three drawings will be inserted in the new layers.</p>
---	--

- ▶ **Add to Existing Layer:** Scans or imports the image into an existing layer. Select a layer from the Layer list. You must scan into the same layer type if you're using an existing layer.
 - ▶ **Create Symbol for Acquired Items:** Encapsulates the bitmap image in a symbol. To mix bitmap images with vector drawings on the same layer, the bitmap image must be encapsulated in a symbol and vice versa. Symbols will also be automatically added to the Symbol folder in the Library view.
3. In the Vectorization section, decide whether you want to import your image in black and white or grey.

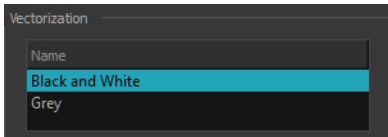

Parameter	Description
Black and White	Vectorizes drawings as a solid black line; creates a 100% vector-based drawing.
Grey	Vectorizes your image as a mix of vector contour and greyscale bitmap filling. Lines keep the texture from the scan, and the white of the paper becomes transparent.

1. In the Drawing Options section, set the following options if desired:

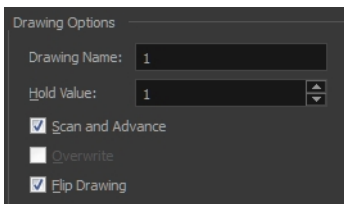

- ▶ **Drawing Name:** Name of the drawing to import.
 - ▶ **Hold Value:** Type the number of frames that the drawing will be exposed.
 - ▶ **Scan and Advance:** Lets you scan one drawing after another every time you click **Scan**.
 - ▶ **Flip Drawing:** Mirrors the drawings horizontally and scans it this way.
2. Adjust the **Scale** control and sliders in the Preview Image window until you are satisfied with the view.

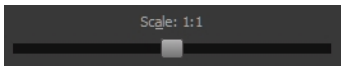

3. Click **Scan** to scan your drawing.
4. If you are scanning panoramic drawings, in the Page Panning section, move the slider to the next letter to capture your next frame.

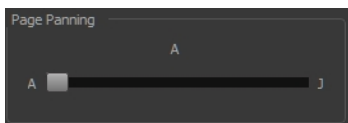

5. If you have more than one drawing, set the next drawing in place and click **Scan** again. Repeat until you have finished scanning all your drawings.

Importing AI and PDF Files

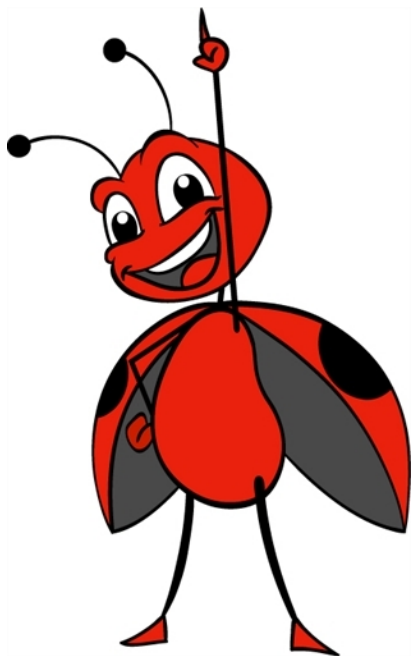

You can import AI (Adobe Illustrator) and PDF files into Toon Boom Harmony to convert your files to the Toon Boom format (TVG) and create a colour palette based on the colour settings of the original file.

When importing AI and PDF files:

- RGB is supported, CMYK is not.
- Gradients and textures are not supported.
- Only legacy versions of Adobe Illustrator are supported. Exported SWFs, including Actionscript 2 and Actionscript 3, cannot be imported.
- When importing an Illustrator or PDF file in Toon Boom Harmony, by default the file will be imported as separate layers. The import will use the Illustrator file's top level groups as separate layer names. However, you can change this behaviour by deselecting the PDF/Illustrator Import as Separate Layers option, to import your file as a single layer .

How to import an AI or PDF file

1. In the Library view, right-click on the Stage Advanced Library folder and select **Right to Modify** to unlock the library folder. Make sure the Lock icon disappears from the folder. If not, your library will remain locked and you will not be able to import files.

NOTE: For more information, refer to the Library chapter in the Cut-out Animation Guide.

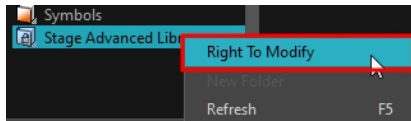

2. Do one of the following:

- ▶ In the top menu, select **File > Import > SWF, Illustrator Files to Library**.
- ▶ Right-click on any unlocked folder and select **Import Files**.

The browser window opens.

3. Find and select your AI or PDF file in the Import Files dialog box and click **Open**.

The Rename dialog box opens.

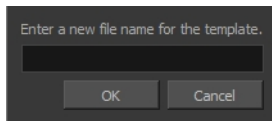

4. Type in a name for the new template or keep the name of the original AI or PDF file.

5. Click **OK**.

A new template folder is created in the Library view.

6. Drag the new template folder from the Library view to the left side of the Timeline view. Wait until the copy cursor  appears before releasing the folder.

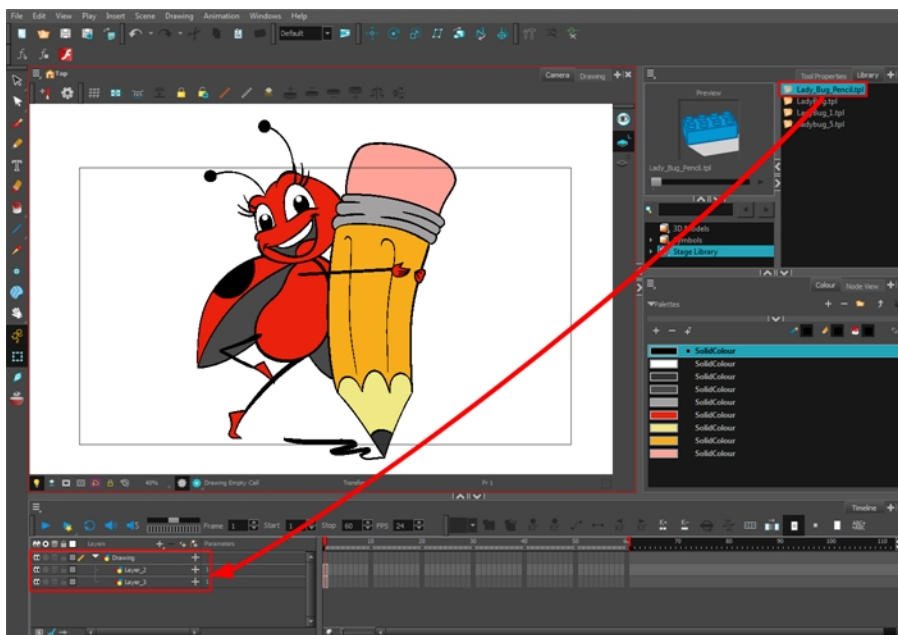

The message window opens.

7. The colour recovery dialog box appears, requesting that a colour recovery should occur. Before clicking the Yes button, you have the option of selecting the **Do Not Ask Again For This Session** option if you plan to import multiple .ai or .pdf files.

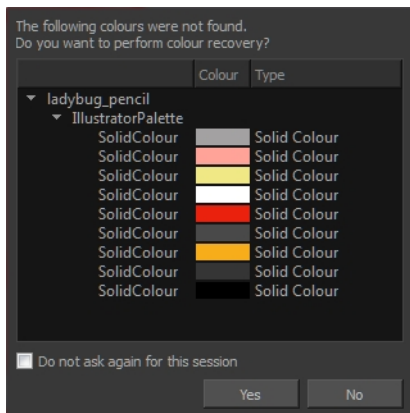

The colour palette used to create the .ai or .pdf file is imported and a new palette is created under the imported file's name.

NOTE:

To learn about the Support CMYK in PDF/Illustrator Import option, refer to the Preferences Guide.

Importing Adobe Flash Files



If a project was started in Adobe Flash and needs a more professional boost, such as camera movements or multiplaning, it can easily be imported into Harmony.

The actual *.fla file is not supported in Harmony, so you must export your project from Adobe Flash.

This chapter contains the following topics:

- [Importing SWF Files on page 50](#)
- [Importing FLA Files on page 52](#)

Importing SWF Files

You can import **.swf** files in Harmony that were published using any version of Flash Player, up to version 14. Note that some effects may not appear when imported in Harmony.

How to import a SWF file

1. In the Library view, right-click on the Stage Advanced Library folder and select **Right to Modify** to unlock the library folder. Make sure the Lock icon disappears from the folder. If not, your library will remain locked and you will not be able to import files.

NOTE: For more information, refer to the Library chapter in the Cut-out Animation Guide.

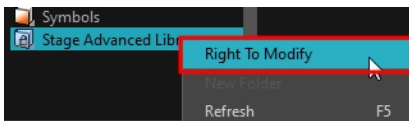

2. Do one of the following:
 - ▶ In the top menu, select **File > Import > SWF, Illustrator Files to Library**.
 - ▶ Right-click on any unlocked folder and select **Import Files**.
 The browser window opens.
3. Find and select your **.swf** file from the Import Files dialog box and click **Open**.

The Rename dialog box opens.

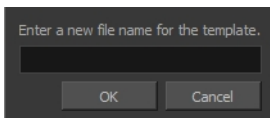

4. Type a name for the new template or keep the name of the original ***.swf** file.
5. Click **OK**.
A new template folder is created in the Library view.
6. Drag the new template folder from the Library view to the left side of the Timeline view. Wait until the copy cursor  appears before releasing the folder.

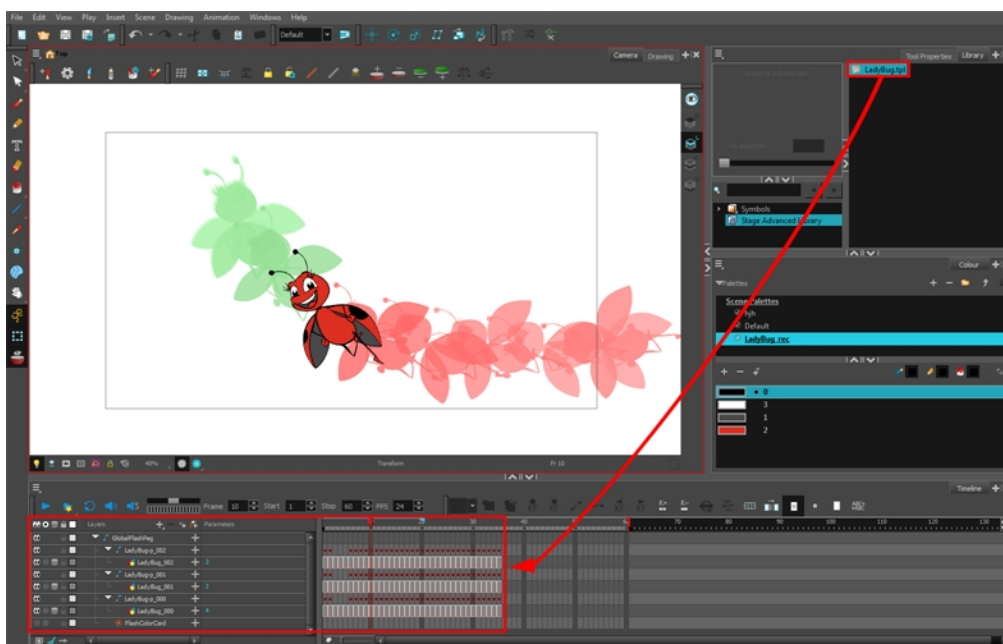

- The colour recovery dialog box appears, requesting that a colour recovery should occur. Before clicking the Yes button, you have the option of selecting the **Do Not Ask Again For This Session** option. This might be useful if you plan to import multiple *.swf files.

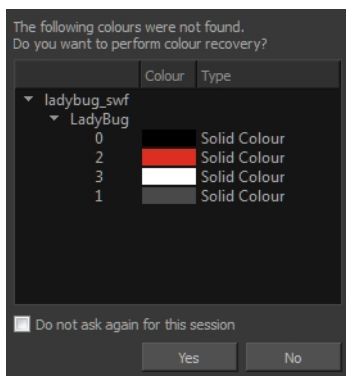

The colour palette used to create the .ai or .pdf file is imported and a new palette is created under the imported file's name.

NOTE: All the Flash layers are automatically attached to a parent peg called GlobalFlashPeg. DO NOT DELETE THIS PEG. To maintain the look of your movie, it's important not to delete this peg or detach its child layers.

The Adobe Flash file layers appear in the Timeline view. Symbols that were created in Flash become regular drawing layers, but can be reconverted into symbols in Harmony. Symbols within symbols or drawings within symbols collapse into their corresponding parent symbol.



NOTE: Some layers in your .swf movie may be combined in a single layer as a result of optimization enhancements in your movie file. You can easily move these elements back onto separate layers.

In addition, all drawing elements that are dynamically linked to the Toon Boom Harmony file are grouped together in one folder. In our example, this means that when you scroll through the Drawing Substitution preview in the Library view, the different hand, leg, tentacles, antennae, torso and facial positions are all organized together.

Redistributing Elements

In some instances, due to an optimization enhancement in the exported SWF file (CS4), some of the layers might be combined as a single layer. If so, you can quickly redistribute these elements onto individual layers again.

How to distribute to layers

1. In the Tools toolbar, click the Select  tool.
2. In the Camera view, select the drawing that contains elements you want to redistribute onto individual layers. To select the all the elements of the selected drawing layer, press Ctrl + A (Windows/Linux) or ⌘ + A (Mac OS X).
3. Do one of the following:
 - From the top menu, select **Drawing > Distribute to Layers**.
 - In the Tool Properties view of the Select tool, click the Distribute to Layers  button.

The number of drawing layers corresponding to the different grouped elements are created in the Timeline view. The selected elements in the original drawing layer are removed. Each element is distributed onto a new drawing layer.

4. Repeat the process for each drawing that contains elements to redistribute.

Importing FLA Files



© 2015 Crazy Chicken by Clémence Dufresne

You can export files from Flash and import them in Harmony to transfer character rigs, props and backgrounds.

Flash import is available on all three editions of Harmony on Windows and Mac OS X. It is not possible to do so on Linux versions.

On the Flash side, users can work with these versions: Adobe Flash CS5 to Adobe Flash CC. Exports from older versions of Flash are not possible.

Preparing and Exporting Files from Flash

At the scene level (top timeline), you must have a symbol, such as a movie clip or graphic. Colour shapes, shape lines, drawing objects, groups and bitmaps at the scene level won't be exported. If these elements are present, you will be prompted to perform a clean up of the scene level. For details on importing Flash files, see [Guidelines for Creating a Flash File Before Exporting to Harmony on page 61](#)

As part of preparing to import Flash files in Harmony, you must add an extension to Flash using Adobe Extension Manager. The extension is required in order for Flash to export files to Harmony. The extension is called **Export to Harmony .zxp** and is located here:

OS	Edition	Location
Windows	Premium	C:\Program Files (x86)\Toon Boom Animation\Toon Boom Harmony [version] Premium\resources\flash
	Advanced	C:\Program Files (x86)\Toon Boom Animation\Toon Boom Harmony [version] Advanced\resources\flash
	Essentials	C:\Program Files (x86)\Toon Boom Animation\Toon Boom Harmony [version] Essentials\resources\flash
Mac OS X	Premium	Applications > Toon Boom Harmony [version] Premium Network > tba > resources > flash
	Advanced	Applications > Toon Boom Harmony [version] Advanced Network > tba > resources > flash
	Essentials	Applications > Essentials > tba > resources > flash

NOTE: Before installing the extension, you must remove all Harmony offline and database preferences.

It is important to use the correct version of Adobe Extension Manager:

- If more than one version of Flash is installed on your computer, be careful where you install the extension. If it's added to Adobe Extension Manager of Flash CS6, the extension will only be added in this version and not the other.
- If you have a previous version of the extension, you must remove it first and install the latest extension—see [How to remove a previously installed Export to Harmony.zxp extension \(if applicable\) on page 55](#).

When you export your files, a folder will be created that contains the **stage.tp1** and **export.json** files, as well as all the **.swf** and **.txt** files in your scene. The **export.json** file is used by a Harmony script to organize and construct the hierarchy from your exported files.

How to install the Toon Boom Animation extension

1. To remove your Harmony offline preferences (if any), open the following folder:

Windows:

- Toon Boom Harmony Premium: C:\Users\[user_name]\AppData\Roaming\Toon Boom Animation\Toon Boom Harmony
- Toon Boom Harmony Advanced: C:\Users\[user_name]\AppData\Roaming\Toon Boom Animation\Toon Boom StageAdvanced
- Toon Boom Harmony Essentials: C:\Users\[user_name]\AppData\Roaming\Toon Boom Animation\Toon Boom StageEssentials

Mac OS X:

- Toon Boom Harmony Premium: /Users/[user_name]/Library/Preferences/Toon Boom Animation/Toon Boom Harmony
- Toon Boom Harmony Advanced: /Users/[user_name]/Library/Preferences/Toon Boom Animation/Toon Boom Stage Advanced
- Toon Boom Harmony Essentials: /Users/[user_name]/Library/Preferences/Toon Boom Animation/Toon Boom Stage Essentials

On Mac OS X, the Library folder is a hidden folder. To display the folder, hold down the Alt key.

- **Global:** [Server_Name] > USA_DB > scripts
- **Environment:** [Server_Name] > USA_DB > environments > [environment_name]
- **Job:** [Server_Name] > USA_DB > jobs > [job name]
- **User:** [Server_Name] > USA_DB > users > [user_name] > stage > 1200-scripts

2. Delete these folders:

- full-1200-pref
- 1200-scripts

3. In Adobe Extension Manager, click **Install**.

4. Locate and open the **Export to Harmony.zxp** file.

A message opens informing you that you're about to install the Export to Harmony extension.

5. Click **Accept**.

You may see the following message confirming that you want to install the extension. Click **Install**.

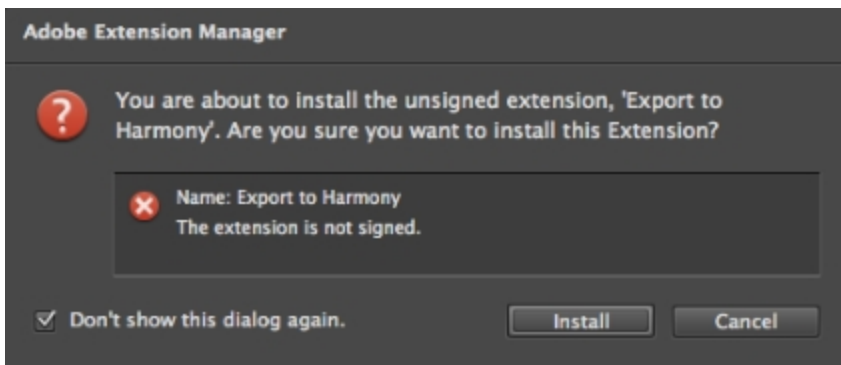

6. In order for the changes to take effect, you must close and restart Adobe Flash.
7. Click **OK**.

How to remove a previously installed Export to Harmony.zxp extension (if applicable)

1. If open, close Adobe Flash.
2. Start Adobe Extension Manager.
3. From the Products list, select **Adobe Flash**.

If you have a previous version of the **Export to Harmony.zxp** extension installed, it will be listed in the right pane.

4. Select the extension and click **Remove**.

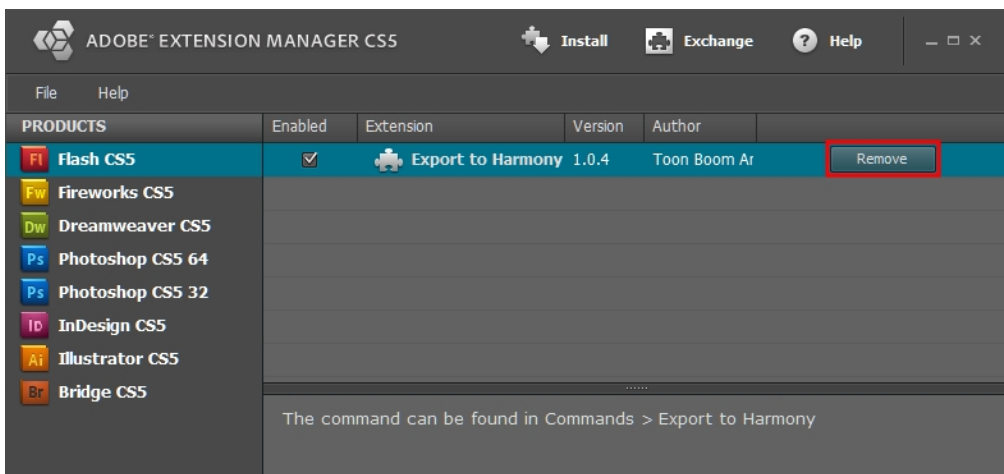

A message opens asking you to confirm the removal of the extension.

5. Click **Yes**.

How to export FLA files from Adobe Flash

1. Open your **.fla** file in Adobe Flash.

NOTE: In case of a new file, it needs to be saved before continuing the exportation process. If not, the export won't be completed.

2. Return to the scene level.

Before exporting to Harmony, it is assumed that you are at the scene level even if you're not.

3. Do one of the following:

- ▶ Older versions of Adobe Flash: Select **Window > Other Panels > Export to Harmony**.
- ▶ Adobe Flash CC: **Window > Extensions > Export to Harmony**.

NOTE: This window must be opened once after installing the extension in the extension manager because it creates a direct link to Harmony (even if the window is not used). Afterwards, you do not have to reopen it if there is no need to change the option.

The Export to Harmony window opens from which you can set the resolution of the files as it will appear in Harmony. The default resolution is set to 1920 x 1080, like the HD default resolution value of Harmony. If needed, you can change the compression: Photo (JPG) or Lossless (PNG).

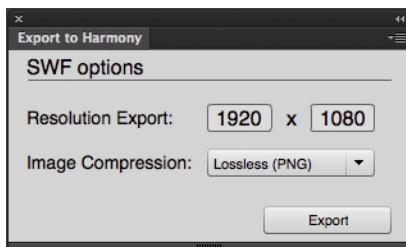

4. Do one of the following:

- ▶ In the Export to Harmony window, click **Export** button.
- ▶ Select **Commands > Export to Harmony**.

The Output tab displays information about the conversions necessary for the export including:

Distributing to layers, breaking apart, the presence of shapes at the scene level, ungrouping all groups to verify if any symbols are hidden inside, breaking drawing objects to transfer them as shapes, drawing substitutions, and so on. Problematic situations will also be mentioned. If nothing appears in the Output tab, then your **.fla** file is clean and does not need any conversions.

The **.txt** files contain the drawing substitution information and at which frame they are exposed. A **.swf** file is created for each symbol in Flash and a **.tp1** file is created of them. The corresponding **export.json** file is also created, which you will need when importing your Flash scene in Harmony. These files are in a folder located at the same location as the **.fla** file. The folder name is the same as the **.fla** file.

NOTE: If a folder with the same name as the `.fla` file already exists, you will be prompted to replace the folder. Be aware that saving Flash projects as `.xfl` files will automatically create a folder with the same name as the `.fla` file. In this case, the folder of the export will be created inside the folder of the `xfl`. If this not what you want, place a copy of the `.fla` in another path on your computer before the export.

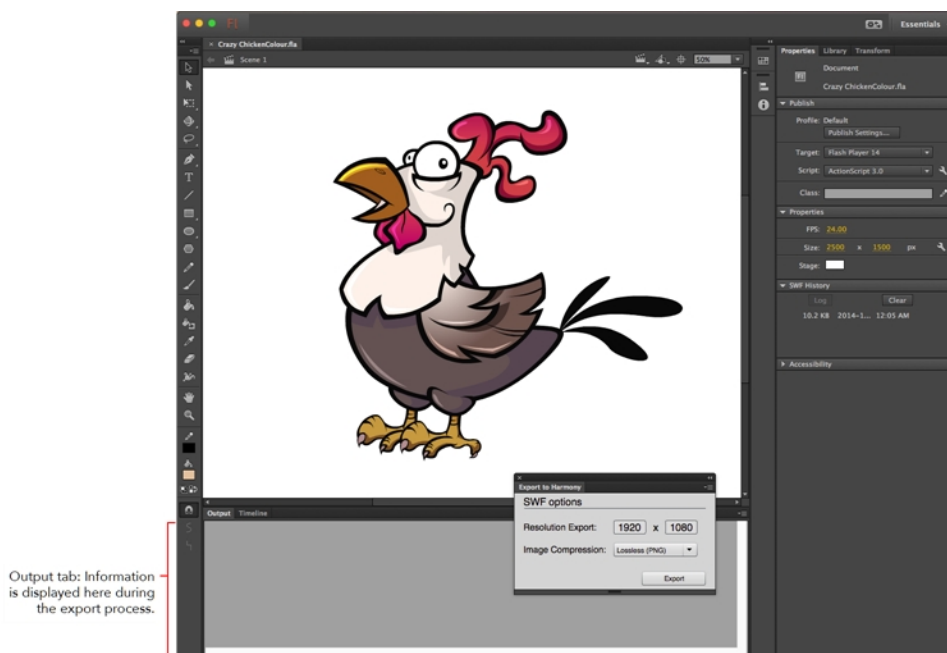

Importing Flash Files in Harmony

When importing Flash files, the Scripting toolbar must be displayed, which should contain the Import Flash Scene icon. If the icon does not appear in the toolbar, add it to the Scripting toolbar. Note that you will only have to do this once. After that, you can import Flash files whenever needed.

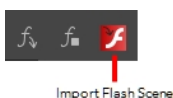

How to display the Flash icon

1. From the top menu, select **Windows > Toolbars > Scripting**.

The Scripting toolbar bars appears below the File toolbar in the upper-left of the Harmony interface.



2. Click the Manage Scripts  button.

The Scripts Manager opens.

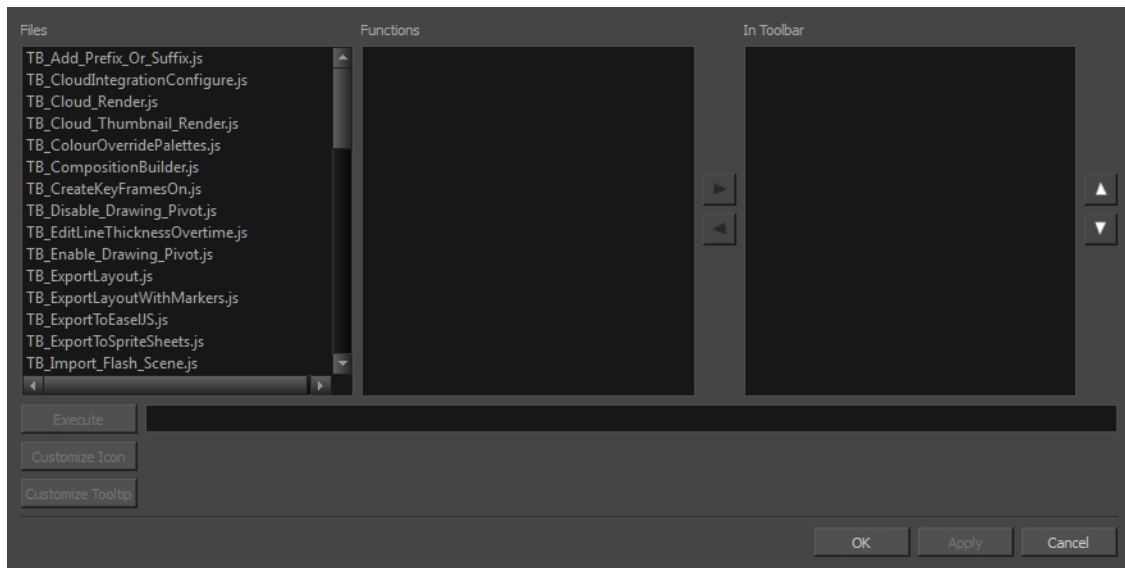

- From the Files section, select **TB_Import_Flash_Scene.js**.

On your computer, here is the location of the script file:

- **Windows:**

- **Toon Boom Harmony Premium:** C:\Users\[user_name]\AppData\Roaming\Toon Boom Animation\Toon Boom Harmony\1200-scripts
- **Toon Boom Harmony Advanced:** C:\Users\[user_name]\AppData\Roaming\Toon Boom Animation\Toon Boom StageAdvanced\1200-scripts
- **Toon Boom Harmony Essentials:** C:\Users\[user_name]\AppData\Roaming\Toon Boom Animation\Toon Boom StageEssentials\1200-scripts

- **Mac OS X:**

- **Toon Boom Harmony Premium:** /Users/[user_name]/Library/Preferences/Toon Boom Animation/Toon Boom Harmony/1200-scripts
- **Toon Boom Harmony Advanced:** /Users/[user_name]/Library/Preferences/Toon Boom Animation/Toon Boom Stage Advanced/1200-scripts
- **Toon Boom Harmony Essentials:** /Users/[user_name]/Library/Preferences/Toon Boom Animation/Toon Boom Stage Essentials/1200-scripts

On Mac OS X, the Library folder is a hidden folder. To display the folder, hold down the Alt key.

- From the Functions section, select **TB_Import_Flash_Scene** and click the arrow button to move it to the In Toolbar section.

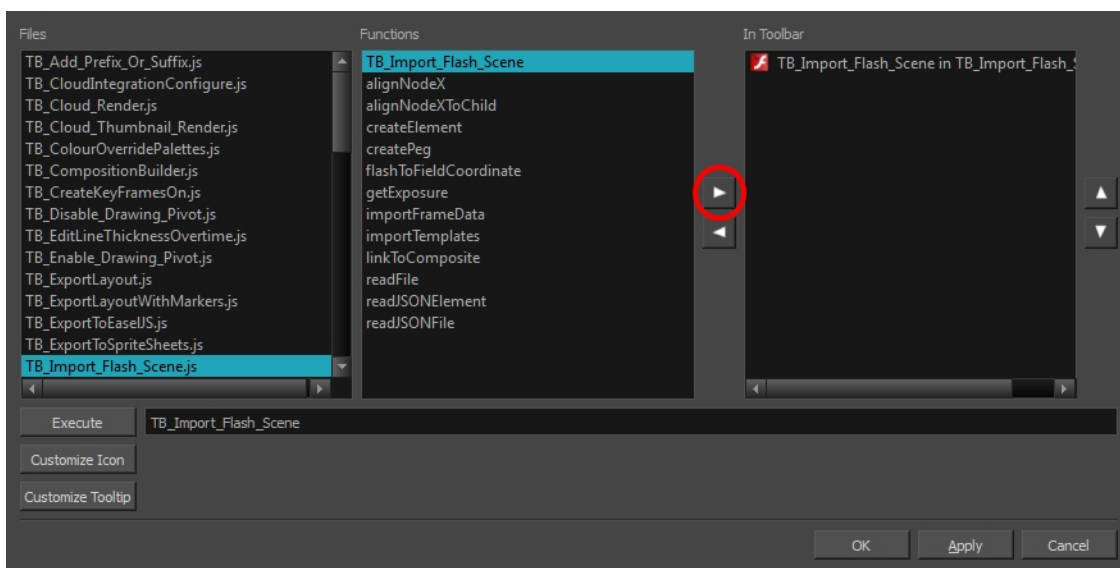

3. Click **OK**.

The Import Flash icon appears in the Scripting toolbar. Everything is now ready to import Flash scenes.

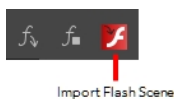

How to import FLA files

1. In the Scripting toolbar, click the Import Flash  button.
2. In the Import Files dialog box, locate the **export.json** file contained in the folder that was created when you exported your files from Flash.
3. Click **Open**.

In a few moments, the colour recovery dialog box appears, requesting a colour recovery.

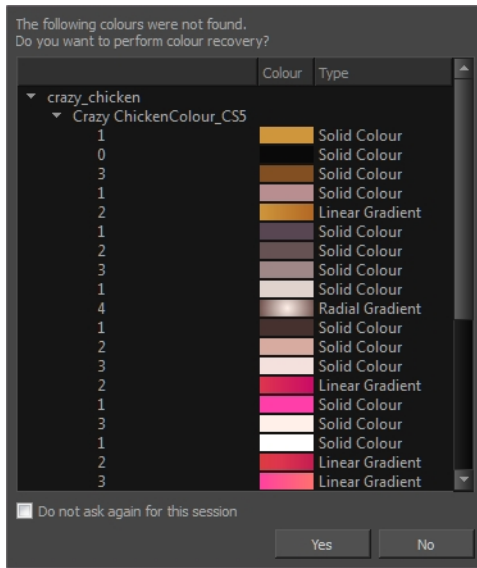

- Before clicking **Yes**, you have the option of selecting the **Do Not Ask Again For This Session** option.

In a few moments, the **.fla** files are imported in Harmony.

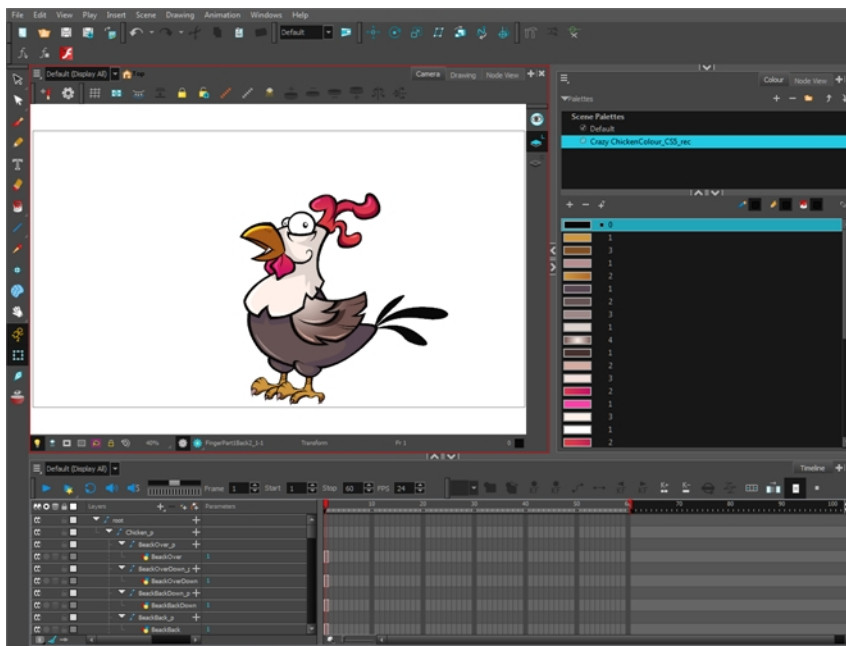

- In the Node view, press 1 to zoom out of the Node view and see the entire node system.

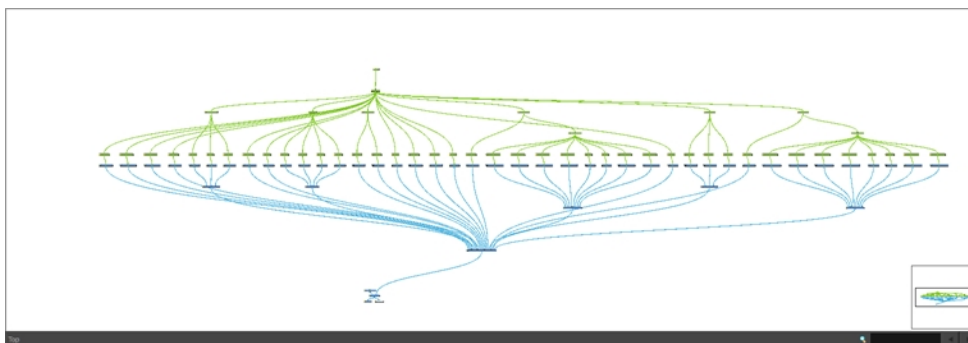

Your Flash Scene in Harmony

Once the Flash project is successfully imported into Harmony, here's how the hierarchy was constructed:

- Each symbol has its own peg in which all the transformation information is stored.
- The pivot information is stored in the peg's Layer Properties (Pivot fields). The pivot information came from the rotation point of the symbol in Flash.
- Registration point of the symbol in Flash represents the centre of the drawing space in Stage. Therefore, the position of the drawing inside a symbol will be exactly the same in Stage.

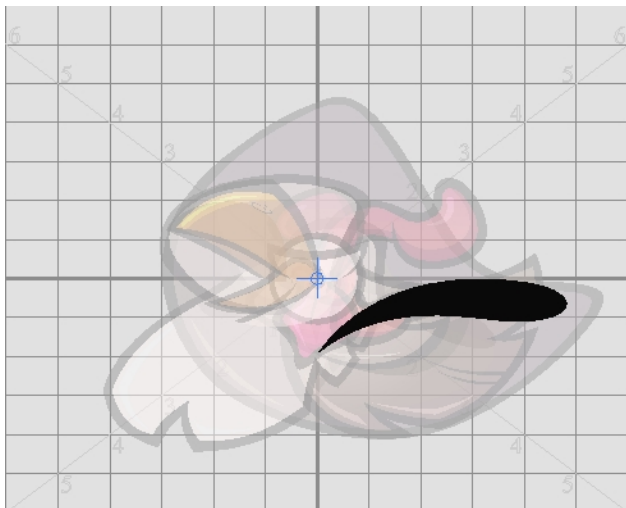

- One colour palette is created for each Flash import. One colour swatch is created per RGB value. If you have more than one zone using the same colour, they will be linked to the same colour swatch.
- If there are masks in your Flash project, they will be reconstructed in Harmony using Cutter effects. Stage Advanced is now able to understand when more than one symbol share the same mask in Flash. Each symbol sharing the same mask will be grouped by a composite and connected to the cutter.

Guidelines for Creating a Flash File Before Exporting to Harmony

Scene Root

What can be at the scene root:

- Only symbols. A minimum of one symbol is necessary. It could be a MovieClip or a graphic.

What cannot be used at the scene root:

- Shapes: Colour shapes and line shapes
- Bitmaps
- Drawing objects
- Groups: The group works differently at the scene level. They are understood as shapes at the scene level—see [Mixed Layers on page 63](#).

Timeline

These features can be used in the Flash file, but will not appear in Stage Advanced:

- Guide layers for references
- Locked layers
- Disabled layers
- Folders in the Timeline view
- Other: Several symbols on the same layer/keyframe. In this case, Stage Advanced will separate them, giving them a proper layer. In other words, a Distribute to Layers action performed in the process of exporting/importing.

Not recommended:

- Mixed layers—see [Mixed Layers on page 63](#)
- Symbols with shapes, bitmaps, or group on the same layer/keyframe
- Symbols with drawing objects

Library View

In the Library view, the following will not be exported:

- ActionScript Linkage
- Embedded fonts

Effects

The following effects will not be exported:

Filters	Adjust Colour Drop Shadow Blur Glow Gradient Bevel Gradient Glow
Colour Effects (other than None)	Alpha

	Advanced Brightness Tint
Display	Blending (other than Normal): <ul style="list-style-type: none"> • Layer • Darken • Multiply • Lighten • Screen • Overlay • Hard Light • Add • Subtract • Difference • Invert • Alpha • Erase
	Render: Cache as Bitmap
	Component parameters

Drawing Features

- Width tool: Any change on the thick and thin of a line
- Line:
 - Width
 - Cap: Any change of the line cap will be replaced by the round cap (None and Square)
 - Join: Any change of the line join will be replaced by the round join (Miter and Bevel)
- Gradient (Flow): Reflect colour, Repeat colour
- Import Bitmap: When importing .swf files, you can import files that have an image compression of Photo (JPG) or Lossless (PNG).

Mixed Layers

Mixed layers are something you must seriously consider before trying to export a Flash project to Harmony. Otherwise, there can be unexpected results or no export at all. In fact, it's best to avoid having mixed layers altogether.

A mixed layer is defined as a layer that has more than one instance of objects at the same keyframe. It could be a mix of symbols and groups; groups and drawing objects; symbols and shapes, and so on. Since Harmony understands symbols better than groups or drawing elements, some information can be lost along the way.

Understanding Drawing Objects

Drawing Objects

No matter what is inside a drawing object, it will always be understood as a shape. So if a drawing object shares the same layer with a shape, it won't be a real mixed layer, since they are all understood as shapes.

Mixed Layers

Symbols and Drawing Objects/Shapes on the Same Layer

If there are symbols and drawing objects/shapes sharing the same layer, the symbols will be separated from them and all the drawing objects/shapes will be kept together. Drawing objects and shapes cannot be separated. In Harmony, the symbols will have their own Drawing node and the drawing objects/shapes will share the same Drawing node. Since only symbols can have a name, its name is propagated to the Drawing node and peg.

Drawing objects and shapes, however, can't do this. Drawing objects and shapes will receive the name of the MovieClip followed by an underscore and an appropriate number. For example, if you have a group inside a symbol called *HEAD*, the group will be named *HEAD_1* if there is already a Drawing node that was created with the same name.

Mixed Instances at the Same Level as a Symbol

Mixed instances at the same level as a symbol can occur when, at the same level inside a symbol, there is more than one type of element sharing the same timeline at a specific frame. Those elements may be mixed layers.

Type of problems that can occur if mixed instances are kept:

- Order of appearance can be lost
- Some layers can merge together
- Transparency of shapes can cut other shapes

Importing QuickTime Movies

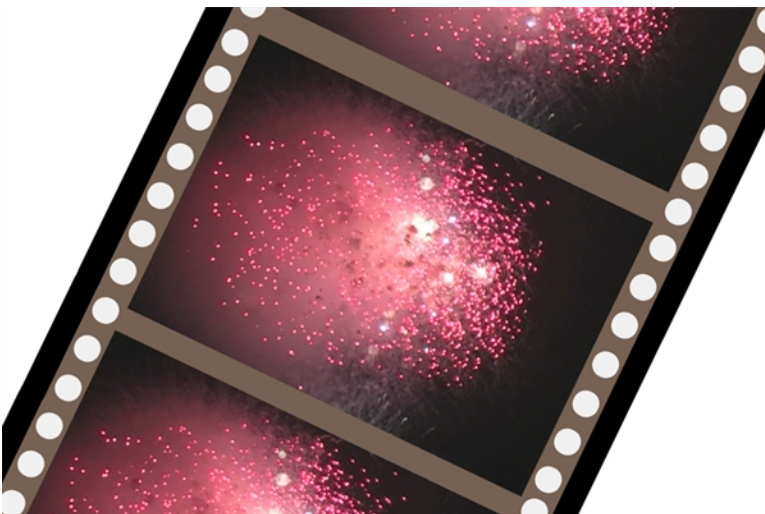

When creating an animation, it is not unusual to embed moving elements saved as videos within the animation. Toon Boom Harmony allows you to import QuickTime movies into your project.

How to import a QuickTime movie

1. From the top menu, select **File > Import > Movie**.
2. Browse for the QuickTime movie to import and click **Open**.

The Import Images dialog box opens.

NOTE: Do not browse for the movie file again. Leave the automatically generated field text as “many files selected”.

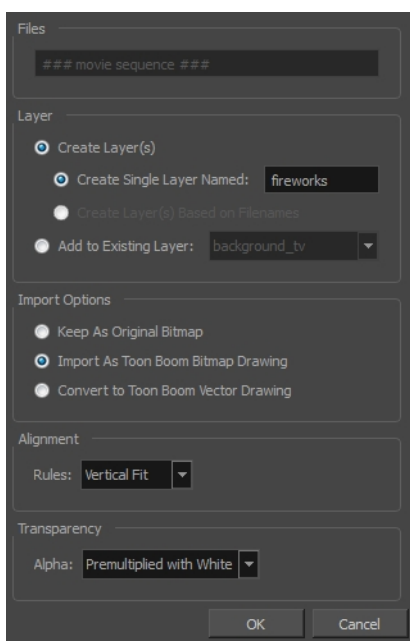

3. Make your decisions for the Layer, Alignment and Transparency sections of this dialog box—see [Importing a Bitmap Image Without Vectorization on page 12](#).
4. Click **OK**.

The QuickTime video appears in the Timeline view as an image sequence. You can scroll through the film frame-by-frame just as you would scroll through your animation drawing-by-drawing.

Custom Vectorization Parameters

You can create your own vectorization settings with Harmony. The vectorization parameters you create can be saved, shared and also inserted into the `vectorOptions.conf` file used by the Scan and Control Center modules when scanning or vectorizing a series of drawings.

You can use an interface to select and test the different options, as well as type in some advanced settings.

The Vectorization Parameters dialog box lets you vectorize pencil drawings, along with any red, blue or green pencil marks you may have used to indicate highlights and shadows. The drawing will be vectorized into pure red,

blue, green and black (RGB values), while creating colour art zones wherever lines connect. After painting in your tones and highlights, change your pure RGB colours to transparent (0 Alpha) in the Colour Picker window and watch the indicator colour zone lines disappear.

How to open the Vectorization Parameters dialog box

1. From the top menu, select **File > Import > From Scanner**.
You can also open it from any other import option that allows you to customize the vectorization parameters (i.e. from the scanner).
2. In the Scan Drawings window, do the following:
 - ▶ In the Layer section, decide on the layer options.
 - ▶ In the Import Options section, select the **Convert to Toon Boom Vector Drawing** option
 - ▶ Click **Preview**.
3. In the Vectorization section, click the Vectorization Parameters  button.

The Vectorization Parameters dialog box opens.

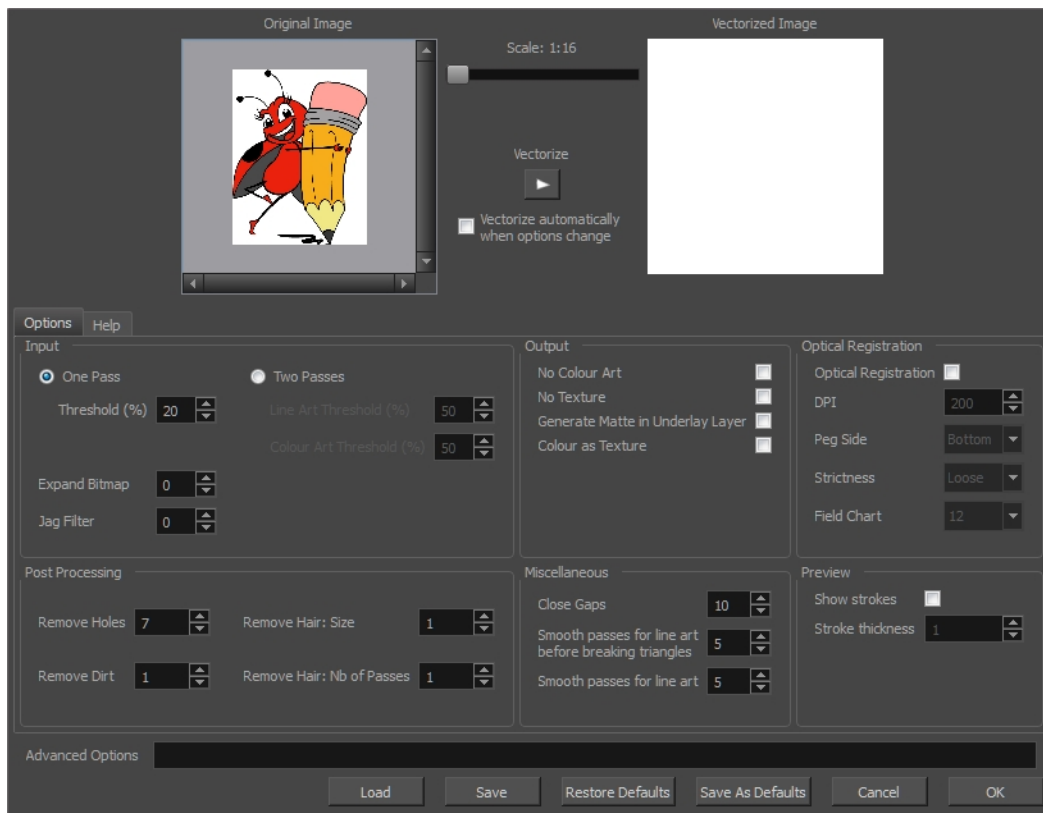

- [Options Tab](#) on page 66
- [Help Tab](#) on page 68

Options Tab

The Options tab contains the main vectorization settings. More settings are available in the Help tab.

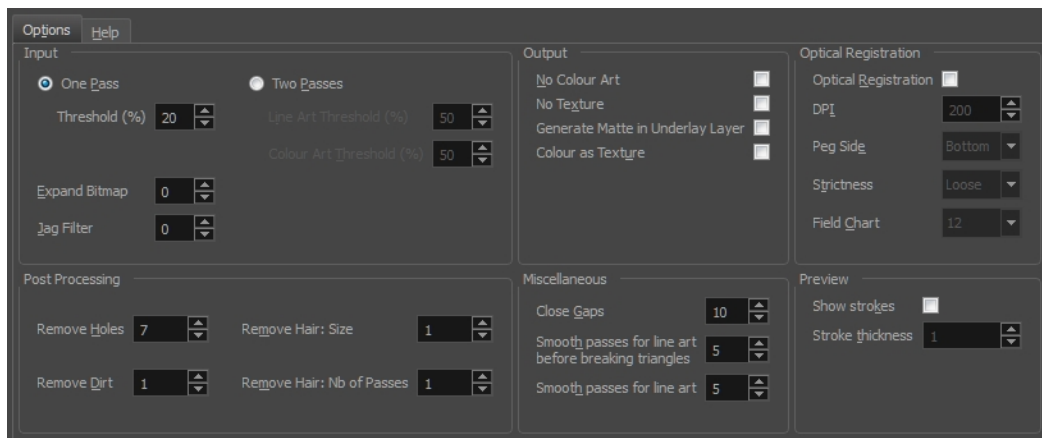

Parameter	Description
Input	The input filters are applied to the bitmap image before it is vectorized.
	One Pass: One threshold value is applied to both the Line and Colour Art. For drawings with distinct vector-style lines of mattes, you only need one pass.
	Two Passes: Applies a different threshold value to each layer. For greyscale drawings, you may want to perform the vectorization process twice to apply different threshold values to the Line and Colour Art layers.
	Threshold: Determines which values in the scanned image are considered part of the Line or Colour Art layer and what will be eliminated from the vectorized drawing; 0% is white and 100% is black. The threshold is between these two values.
	Expand Bitmap: Lets you enter a value to scale the bitmap to detect small variations in the line. Use this option if you scanned a greyscale image and want to preserve small variations in the texture to apply to the line art.
	Jag Filter: Lets you enter a value to scale back the bitmap to remove some of the line's roughness. This is useless when you have a drawing that appears quite rough; the Jag filter will eliminate excess strokes in the final drawing.
Output	The output filters are applied during the vectorization process.
	No Colour Art: Does not generate filling zones in the Colour Art layer.
	No Texture: Does not generate texture in the Line Art layer in the final images. Select this option to create solid lines in the final line art.
	Generate Matte in Underlay Layer: Creates an opaque zone behind your drawing's lines to avoid seeing through the layers.
Optical Registration	Colour as Texture: Converts colour values into a texture layer.
	The optical registration options are used to automatically align drawings based on the position of the peg holes on the animation paper. The peg holes must appear in the scanned drawings for the optical registration to work.
	DPI: Lets you enter the dots-per-inch value of your image. You must enter the same value as the DPI used to scan the image.

	Peg Side: Lets you select the position of the peg holes on your drawings. Identify whether they are on the top, bottom, left or right.
	Strictness: Determines how exact the location of the peg holes must be for the software to recognize them. There are two values to choose from: <ul style="list-style-type: none"> • Strict: The peg holes must be in a tightly defined area to be recognized. • Loose: The peg holes can be recognized somewhere in a larger area. This is the recommended setting.
	Field Chart: Lets you indicate the size of the animation paper, 12 or 16.
Post Processing	The Post Processing filters are applied to the final vector images.
	Remove Holes: Removes holes of a specified value that might make painting difficult.
	Remove Dirt: Removes stray marks and dirt of a specified value. Try a value around 500.
	Remove Hair Size: Removes small strokes that have no line art.
Miscellaneous	Remove Hair: Number of Passes: The number of times the drawing will be analyzed to identify hair marks.
	Close Gaps: Closes gaps in the Colour Art so you can paint it.
	Smooth Passes for Line Art Before Breaking Triangles: The number of times the smoothing operation runs before creating the triangles that break lines in the drawing. If unnecessary triangles are appearing in the drawing, increase this value.
Preview	Smooth Passes for Line Art: The number of times the smoothing operation is performed after the triangles have been created. This further smooths the line art.
	Show Strokes: Shows the strokes in the Vectorized Image panel.
	Stroke Thickness: Shows the size of the strokes.

Help Tab

The Help tab contains the most advanced vectorization settings which you type in the Advanced Option fields at the bottom of the Vectorization Parameters dialog box.

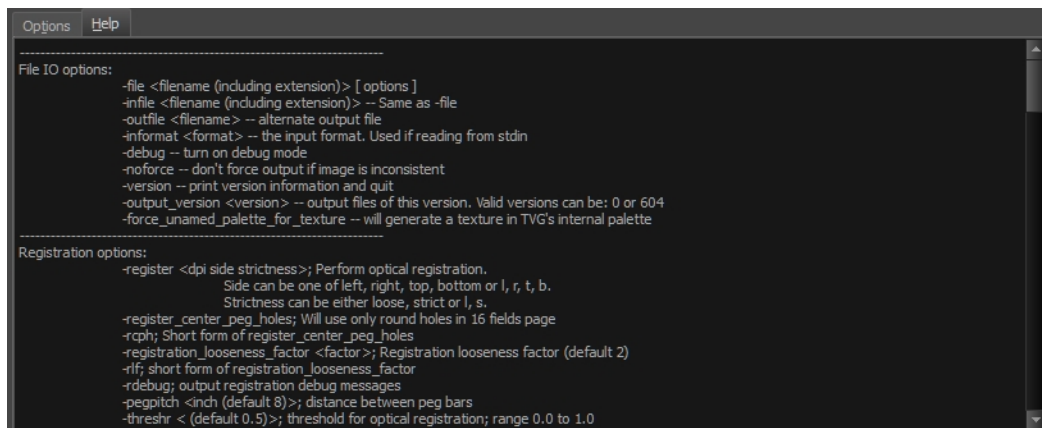

```

Options Help
-----
File IO options:
-file <filename (including extension)> [ options ]
-infile <filename (including extension)> -- Same as -file
-outfile <filename> -- alternate output file
-informat <format> -- the input format. Used if reading from stdin
-debug -- turn on debug mode
-noforce -- don't force output if image is inconsistent
-version -- print version information and quit
-output_version <version> -- output files of this version. Valid versions can be: 0 or 604
-force_unnamed_palette_for_texture -- will generate a texture in TVG's internal palette

Registration options:
-register <dpi side strictness>; Perform optical registration.
    Side can be one of left, right, top, bottom or l, r, t, b.
    Strictness can be either loose, strict or l, s.
-register_center_peg_holes; Will use only round holes in 16 fields page
-rcph; Short form of register_center_peg_holes
-registration_looseness_factor <factor>; Registration looseness factor (default 2)
-rlf; short form of registration_looseness_factor
-rdebug; output registration debug messages
-pegpitch <inch (default 8)>; distance between peg bars
-threshr <(default 0.5)>; threshold for optical registration; range 0.0 to 1.0

```

File IO Options

-file <filename (including extension)> [options]

-infile <filename (including extension)>; same as -file

-outfile <filename>; alternate output file

-informat <format>; the input format. Used if reading from stdin

-debug; turn on debug mode

-noforce; don't force output if image is inconsistent

-version; print version information and quit

-output_version <version>; output files of this version. Valid versions can be: 0 or 604

-force_unnamed_palette_for_texture; will generate a texture in TVG's internal palette

Registration Options

-register <dpi side strictness>; perform optical registration.

- Side can be one of left, right, top, bottom or l, r, t, b.
- Strictness can be either loose, strict or l, s.

-register_center_peg_holes; will use only round holes in 16 fields page

-rcph; short form of register_center_peg_holes

-registration_looseness_factor <factor>; registration looseness factor (default 2.000000)

-rlf; short form of registration_looseness_factor

-rdebug; output registration debug messages

-pegpitch <inch (default 8.000000)>; distance between peg bars

-threshr <(default 0.500000)>; threshold for optical registration; range 0.0 to 1.0

-rmargin <inch (default 1)>; region size where to look for peg bars

-peg_distance_from_center <inch (default 5.25)>; peg distance from centre of the image

-pdfc; short form of `-peg_distance_from_center`

-out_peg_position <side (default same)>; wanted position of the peg on the drawing.

- Can be one of right, left, top, bottom (or r, l, t, b) or same.
- A rotation will be performed if it is different from the side passed to `-register`.

-output_peg_matrix; output the peg transformation matrix on standard output.

-scanner_calibrate; < (default 1.0000 1.0000) > x and y scale factors to be applied to scanner image.

Filtering Options

-pixel <pixel_shape (default '4x3')>; Valid values: 4x3

-gap <worldUnits (default 10)>; close gaps up to this big

-pencil; generate line art only

-keep_dirt; don't filter out dirt

-thresh <threshold (default 0.2)>; range 0.0 to 1.0

-rmv_hairs <worldUnits (default 1)> <passes (default 1)>

- remove hairs of size smaller than "size" in "passes" passes

-rmv_holes <area (default 7)>; remove holes smaller than "area"

-rmv_dirt <area (default 1)>; remove dirt smaller than "area"

- try values between 100 and 500 for `rmv_holes` and `rmv_dirt`. The area is in world units squared

-rmv_triangles <worldUnits (default 30.000000)>; remove triangles at "pixels"

- distance from each other. Use `-no_break` to remove all triangles

-no_texture; don't generate textured strokes

-color_as_texture; will vectorize the alpha channel and put the RGB colour in a textured colour

-noclosegap; disable all gap closing algorithms

-no_break; disable the breaking of line art

-jag_filter <pixels (default 0)>; expand the pixels in the vectorization bitmap

-expand_bitmap <pixels (default 0)>; expand the pixels in the vectorization bitmap

-fit_errorrc <error (default 1.000000)>; fitting error for the colour art

-fit_errorrl <error (default 1.000000)>; fitting error for the line art

-smoothl <passes (default 1)>; number of smooth passes for line art

-smoothc <passes (default 1)>; number of smooth passes for colour art

-first_smooth <passes (default 0)>; number of smooth passes for line art before breaking triangles

-first_smoothl <passes (default 0)>; number of smooth passes for line art before breaking triangles

-first_smoothc <passes (default 0)>; number of smooth passes for line art in colour art pass (needs `-2pass`)

-2pass; specify two sets of parameters; one for line art "l", one for colour art "c"

(-thresh, -rmv_holes and -rmv_dirt will be overridden by -threshl, threshc, -rmv_holesl, -rmv_holesc, -rmv_dirtl and -rmv_dirtc)

-threshl <threshold for line art (default 0.5)>; range 0.0 to 1.0

-threshc <threshold for color art (default 0.5)>; range 0.0 to 1.0

-jag_filterl <pixels (default 0)>; expand the pixels in the vectorization bitmap for line art

-jag_filterc <pixels (default 0)>; expand the pixels in the vectorization bitmap for colour art

-expand_bitmapl <pixels (default 0)>; expand the pixels in the vectorization bitmap for line art

-expand_bitmapc <pixels (default 0)>; expand the pixels in the vectorization bitmap for colour art

-rmv_holesl <area (default 7)>; remove line art holes smaller than "area"

-rmv_holesc <area (default 7)>; remove colour art holes smaller than "area"

-rmv_dirtl <area (default 1)>; remove line art dirt smaller than "area"

-rmv_dirtc <area (default 1)>; remove colour art dirt smaller than "area"

try values between 100 and 500 for rmv_holesl, rmv_holesc, rmv_dirtl and rmv_dirtc. The values are in world units squared

-margins <inch (default 0.25)>; remove margin around bitmap

-top_margin <inch (default 0.25)>; remove margin at top of bitmap

-bottom_margin <inch (default 0.25)>; remove margin at bottom of bitmap

-left_margin <inch (default 0.25)>; remove margin at left of bitmap

-right_margin <inch (default 0.25)>; remove margin at right of bitmap

-remove_peg_bars; remove the peg bar holes

-field_size <fields (default 12 or use value in scan file)>; set the drawing to this field size

-fs; short hand for -field_size

-peg_bar_size <inch (default 1)>; the size of the peg bar region

-noframe; do not put a frame around the colour art

-frame_fields <default -1.000000>; put a frame of the specified dimension around the colour art

-downscale_input <default 1>; downscale the raw input by this integer factor

-downscale_texture <default 1>; downscale the output texture by this integer factor

-buildmatte; generate a matte on underlay for line test

-buildmatte_colourart; generate a matte on colour art for line test

Note: -buildmatte and -buildmatte_colourart are mutually exclusive

-copystrokes; copy original strokes when building matte.

Options for bitmap that has no registration information

-pixel_margins <inch (default 0)>; remove margin around bitmap

- top_pixel_margin** <inch (default 0)>; remove margin at top of bitmap
- bottom_pixel_margin** <inch (default 0)>; remove margin at bottom of bitmap
- left_pixel_margin** <inch (default 0)>; remove margin at left of bitmap
- right_pixel_margin** <inch (default 0)>; remove margin at right of bitmap
- dpi** <(default -1)>; dpi information of input bitmap

RGB Keying Options

- rgb**; generate separate zones for red, green and blue lines
- rgb_alpha** <value (default 255)>; generate red, green and blue colour with alpha of this value
- no_red**; ignore red colour in vectorization
- no_green**; ignore green colour in vectorization
- no_blue**; ignore blue colour in vectorization
- flatten**; flatten the drawing after generating colours
- rmv_rgb_dirt** <threshold area default 0.0>; remove red, green and blue regions smaller than area
- expand_bitmap_rgb** <pixels (default 0)>; expand the pixels in the vectorization bitmap for rgb
- threshrgb** <value> <threshold for rgb vectorization default 0.200000>;
- threshsv** <saturation threshold default 0.500000> <value threshold default 0.500000>; thresholds on saturation and value to consider a pixel to be grey

Colour Vectorization Options

- color_vectorize**; perform a colour vectorization
- file2** <colour art filename>; specify the colour art bitmap
- penstyle** <center alpha (0.0-20.0)> <edge alpha (0.0-20.0)> <gamma (0-10)><centre pressure effect (0.0-1.0)> <edge pressure effect (0.0-1.0)><texture bitmap downscaling (0.2-20)> <texture bitmap file (valid filename or " " if no file)>; generate brush texture for the line art
- pressure_variation** <strategy (0, 1 or 2)> <min pressure (0.0-1.0)> <max pressure (0.0-1.0)> <max variation (0.0-1.0)>; specify a pressure strategy for the centre line.
- blur_radius** <pixels (default 0)>; blur the penstyle texture generated
- color_contour_smooth_passes** <times (default 3)>; perform number of smooth passes on contour before computing texture
- ccsp** <times (default 3)>; short for -color_contour_smooth_passes
- color_rmv_holes1** <world units (default 0.000000)>; remove holes of this size when computing texture
- color_fill_holes1** <world units (default 0.000000)>; fill holes of this size for colour line art

Bubble Usage (implemented only for colour vectorization's line art)

- create_bubbles**; add bubbles into the LineArt. Implemented for colour vectorization only

-bubble_gap <value (default 3)>; max number of colour art points between 2 bubbles

-bubble_length <value (default 10)>; max number of circles in a bubble

-min_radius <value (default 1.5000)>; min radius of a circle in a bubble relative to the line thickness (must be >= 1.0)

-max_radius <value (default 3.5000)>; max radius of a circle in a bubble relative to the line thickness (must be >= 1.0)

-uniform_gap; the space between bubbles is constant

4 Colour Vectorization

-4colours [key:value] ... [key:value] ; The key value list can be empty. The list of keys is:

rgbdiff:value ; between [0.0-1.0] or [0-255]

dark:value ; between [0.0-1.0] or [0-255]

grey:value ; between [0.0-1.0] or [0-255]

white:value ; between [0.0-1.0] or [0-255]

dirt:value ; dirt area. 200 is a good value

rt:value ; between [0.0-1.0] or [0-255]

gt:value ; between [0.0-1.0] or [0-255]

bt:value ; between [0.0-1.0] or [0-255]

NOTE:

There must be no space between the colon and the key/value. For example: `-4colours rgbdiff:20 dark:20 grey:120 white:250 dirt:200 rt:240 gt:240 bt:240`

Creating a Vectorization Style

With Harmony, you can create custom vectorization parameters that can be saved, reused, shared, or used to set the Scan module vectorization style list.

You can vectorize drawings using one of the following methods:

- **Black and White:** All the lines become vector based and 100% black. The white areas become completely transparent.
- **Greyscale:** All the lines preserve their initial textured look in grey shades as a bitmap image contained inside a vector frame. The white areas become completely transparent.
- **Four Colours:** With the advanced parameters, you can isolate the red, green, blue, and black lines and turn them into 100% vector lines, preserving their original colours—see [Custom Vectorization Parameters on page 65](#).

How to create or modify the vectorization parameters

1. Set the different options available in the Vectorization Parameters dialog box.

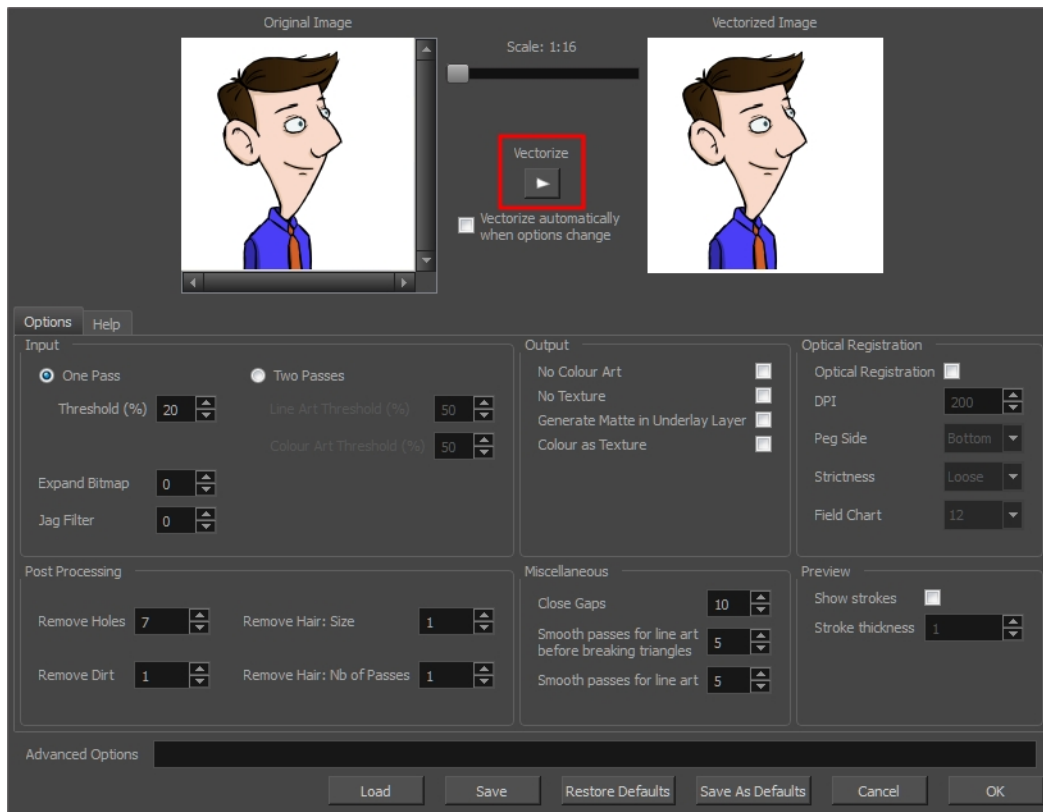

2. Click the **Vectorize** button to update the Vectorized Image preview.

The vectorized image is just a preview. The actual vectorization happens when you click **OK** in the Import Images dialog box. There are many options to try in the Vectorization Parameters dialog box. These are applied during the vectorization process.

3. To set advanced parameters, read the information on the Help tab, then type in the Advanced Options field at the bottom of the dialog box.
4. To save your vectorization parameters to reuse them later, share them, or use them to set the Scan module vectorization style list, click **Save**.
5. In the Browser window, name and save the file.

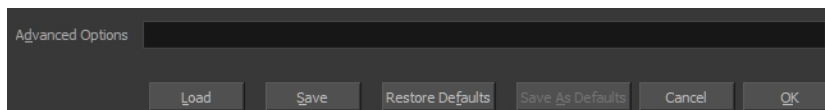

6. To save the current settings as your default settings, click **Save As Default**. To restore the default settings, click **Restore Defaults**.
7. To load a vectorization style, click **Load** and locate the existing *.vof file.

- Click **OK**.

Setting the VectOptions.conf File

Toon Boom Harmony Server uses a file called **VectOptions.conf** to get the vectorization style when batch vectorizing a series of drawings. A series of default styles is available in this file, but you will certainly want to create your own to fit your production style.

How to set the VectOptions.conf file on Windows or Mac OS X

- Open the **vectOptions.conf** file:
 - Windows: Select **Programs / All Programs > Harmony 12.1 > Tools > Configuration Editor**.
 - Mac OS X: Select **Applications > Harmony 12.1 > Tools > Configuration Editor**.

The Configuration Editor window opens.

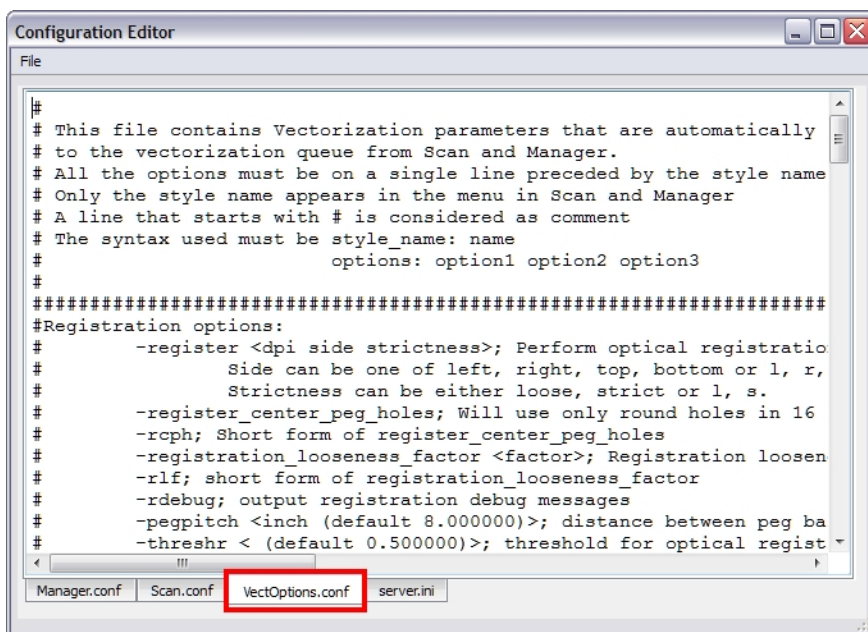

- In the bottom section of the window, select the **VectOptions.conf** tab.
- Scroll down the VectOptions.conf file to see all the different options available for creating your custom vectorization style. These options are the same as in the Vectorization Parameters dialog box. It is recommended that you create your vectorization style using Harmony and the Vectorization Parameters window and copy the result parameters in this file—see [Creating a Vectorization Style on page 73](#)
- Scroll down toward the bottom of the file to see the default styles. You can modify them or add new ones to the list using the parameters you got using the Vectorization Parameters window. Notice that some of the lines have a “#” sign at the beginning to indicate that the line is a comment and will not appear in the style list. The lines that have no sign at the beginning appear in the style list.

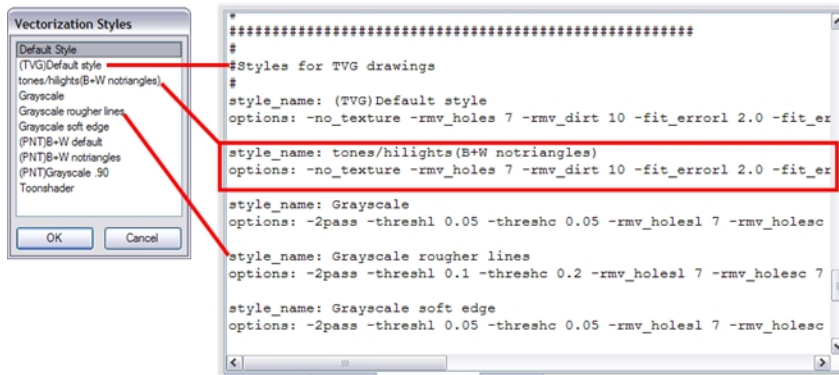

- To create a new style, type the following below the existing styles:

style_name:

This should be followed by the name of your new style. For example: **style_name: Black Lines.**

- Under the style name line, type the following:

options:

- Copy and paste the information in your *.vof style when saving your settings in the Vectorization Parameters window.

▶ To open the *.vof file, use any plain text editor application.

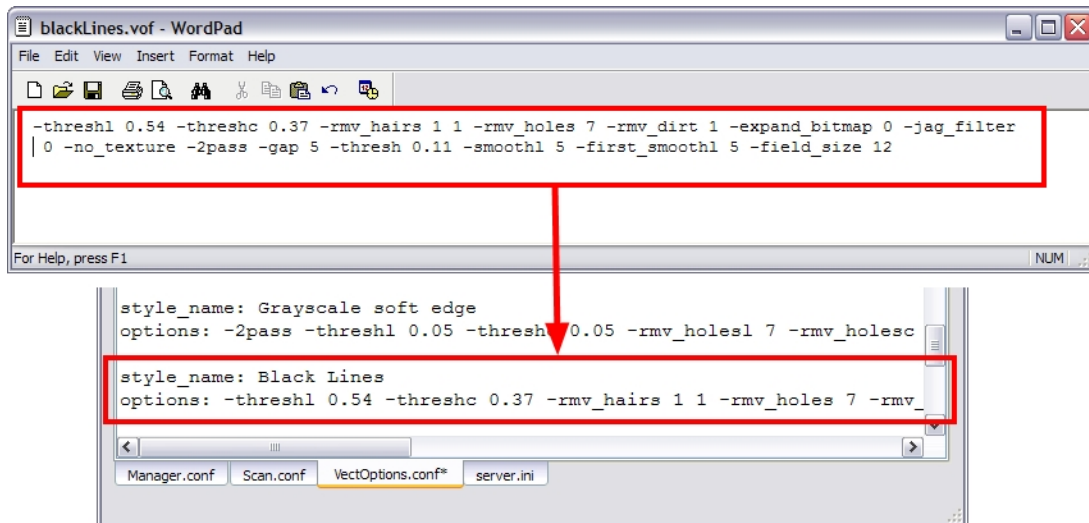

- In the Configuration Editor's top menu, select **File > Save**.
- If you have Toon Boom Harmony Scan on your computer, you can start the application and verify that the new style appears in the Vectorization Style list under **Edit > Vectorization Style**.

NOTE:

If you are using the batch processing method available with Toon Boom Harmony Server to scan and vectorize drawings, the selected style must be available on all the machines included in the batch processing list.

Refer to the Control Center Guide Guide to learn more about setting up and using batch processing.

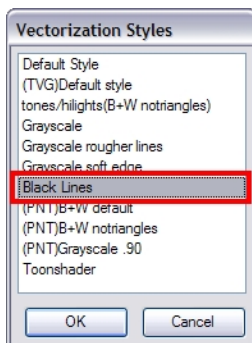

How to set the VectOptions.conf file on Linux using the vi text editor

1. Open a Terminal window:
Menu: **Applications > System Tools > Terminal**
2. Open the etc folder inside the installation directory:

```
$ cd /usr/local/ToonBoomAnimation/harmony_12.1/etc
```
3. Change your user to "root":

```
$ su
```

 - If your user is part of the sudoers list, enter the following command and go to step 5.

```
$ sudo vi VectOptions.conf
```
4. Enter the root password.
5. Open the VectOptions.conf file:

```
$ vi VectOptions.conf
```
6. To start editing, press **I** to enter Insert mode.
7. When you're finished editing the file, press **Esc** to exit Insert mode.
8. To save the changes made to the file, type the following and press Enter/Return:

```
$ :w!
```
9. To exit the vi editor and return to the Terminal, type the following and press Enter/Return:

```
$ :q
```

- If you have Toon Boom Harmony Scan module on your computer, start the application and verify that the new style appears in the Vectorization Style list under **Edit > Vectorization Style**.

NOTE:

If you are using the batch processing method available with Toon Boom Harmony Server to scan and vectorize drawings, the selected style must be available on all the machines included in the batch processing list.

Refer to the Control Center Guide Guide to learn more about setting up and using batch processing.



How to set the VectOptions.conf file on Linux using the gedit text editor

- Open a Terminal window:
Menu: **Applications > System Tools > Terminal**
- Open the `etc` folder inside the installation directory:

```
$ cd /usr/local/ToonBoomAnimation/harmony_12.1/etc
```
- Change your user to "root":

```
$ su
```

 - If your user is part of the sudoers list, enter the following command and go to step 5.

```
$ sudo gedit VectOptions.conf
```
- Enter the root password.
- Open the `VectorOptions.conf` file:

```
$ gedit VectOptions.conf
```
- Edit the parameters of the `VectOptions.conf` file as you would do in most text editor applications.
- Select **File > Save**.
- Select **File > Quit**.
- If you have Toon Boom Harmony Scan module on your computer, start the application and verify that the new style appears in the Vectorization Style list under **Edit > Vectorization Style**.

NOTE:

If you are using the batch processing method available with Toon Boom Harmony Server to scan and vectorize drawings, the selected style must be available on all the machines included in the batch processing list.

Refer to the Control Center Guide Guide to learn more about setting up and using batch processing.

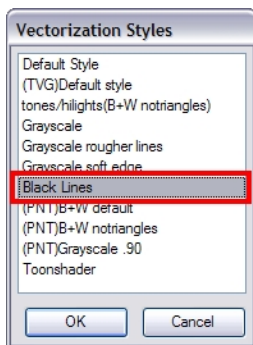

Chapter 3: Library

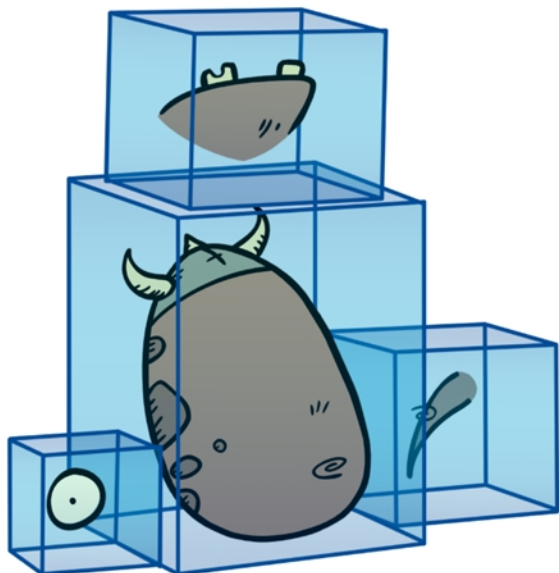

Using templates and symbols, you can share and reuse any elements you create in Harmony. The Harmony library lets you store several different elements such as puppets, backgrounds, animations and key poses. In fact, anything you create in Harmony can be stored in the library.

This chapter contains the following topics:

- [Understanding the Library Concept](#) on page 81
- [Library View](#) on page 83
- [Structuring the Library](#) on page 85
- [Templates](#) on page 89
- [Symbols](#) on page 91
- [Importing Symbols and Templates](#) on page 99
- [Importing Files Through the Library](#) on page 103
- [Using Paste Special](#) on page 103

Understanding the Library Concept

The Library view is where you can store and reuse your artwork and animation in other scenes or build props and puppets.

- [What is a Library?](#) on page 82
- [Understanding the Library Concept](#) on page 81
- [What is a Symbol?](#) on page 82
- [Understanding the Library Concept](#) on page 81

What is a Library?

The library is a storage centre for all production assets; the elements stored in the library are called *templates*. Although it is mainly used for cut-out animation, the library is also useful for paperless and traditional animation processes. The library can contain any asset used in a Toon Boom Harmony production.

Using the library is as simple as dragging the content into the library to store your artwork and then dragging it to the Timeline or Camera view when you want to reuse it.

You can organize your library using several different subfolders and store them on your hard drive or network.

What is a Template?

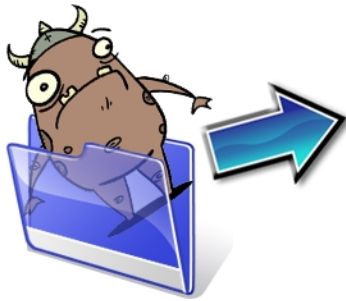

A template is an individual copy of the artwork stored in the library which you can reuse in different scenes. Once a template is stored in the library, you can access it from any project.

Dragging a template into your scene copies the content in your Timeline and does not link it to the original. You can modify this individual copy at any time.

What is a Symbol?



A symbol is a container used to build your props, puppets and looping clips. You can use symbols to contain artwork and animation and manipulate them as a single object. You can also use symbols as a placeholder in which you place a series of different drawings for each body part of your puppets or when you have a repeating cycle. However, symbols are not necessary for creating characters.

To create a symbol, drag your artwork to the Symbol library. When you drag a symbol from the Symbol library into your scene, it will be linked to the original symbol. If you drag a symbol into your scene several times in the Timeline view, they will all be linked to the original symbol. If you modify one, they will all be modified.

A symbol is local to the project and cannot be accessed directly from other scenes. To reuse a symbol's content in another scene, you must create a template out of it.

When a symbol is exposed in the Timeline view, the symbol's cells are represented as a movie strip.

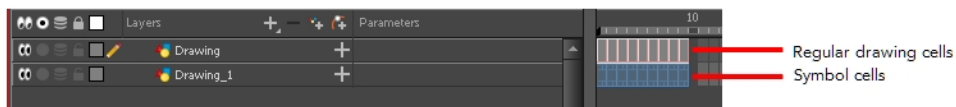

Library View

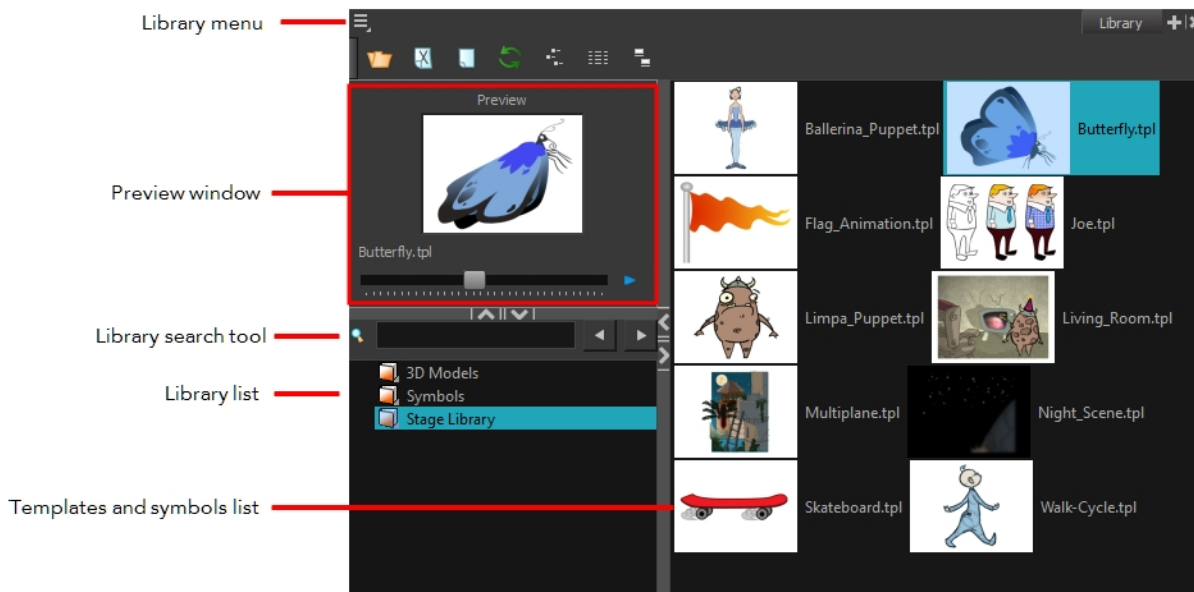

You use the Library view to create and manage your symbols and templates, display the folders and manage and all of the content.

Library View Menu

The Library menu lets you access commands specific to the Library view, such as opening a Library or getting the rights to modify a library folder.

Preview Window



The Preview window lets you preview the content of a symbol or template, and swap between drawings and symbol cells in the Timeline view. This window is also used as the Drawing Substitution window.

How to preview a template or symbol's content

1. In the Library view's right side, click or double-click on the symbol or template to preview.
2. In the Preview window, click the Play ► button or drag the slider to scrub through the frames.

Library Search Tool

When working on a movie or series, you will probably end up with many templates and symbols in your library. Using the Search tool, you can quickly find the templates and symbols in your folders.

How to use the Library Search tool

1. From the left side of the Library view, select the library in which you want to search.

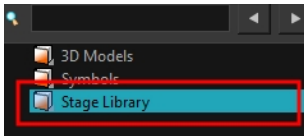

2. In the Search field, type the name or partial name of the symbol or template you are looking for.

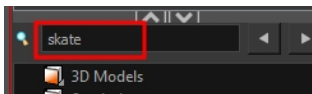

3. Click the left ◀ and right ▶ arrows to see the previous and next results. The Search engine will look for results within the library master folder and its subfolders. It will not look in other libraries.

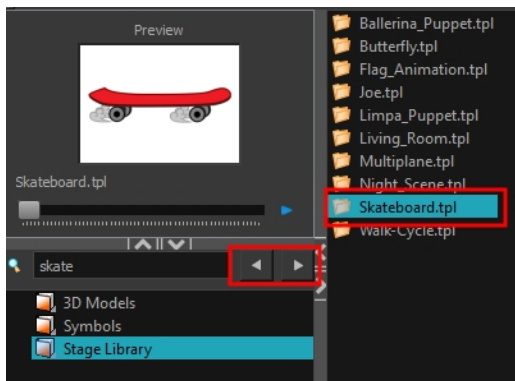

Library List

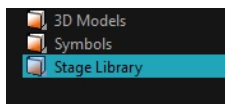

The Library list lets you navigate through the different libraries and subfolders. You can also open, close and create new libraries from here.

The Library folders have these default libraries:

- **Symbols:** The only library folder containing symbols for your project. You can organize the symbols library folder using subfolders, but you cannot create a second library for your symbols. This library is local to your project.
- **Harmony Library:** This folder contains templates and is stored on your hard drive. You can organize the Harmony library folder using subfolders. This folder does not contain symbols.

Templates and Symbols List

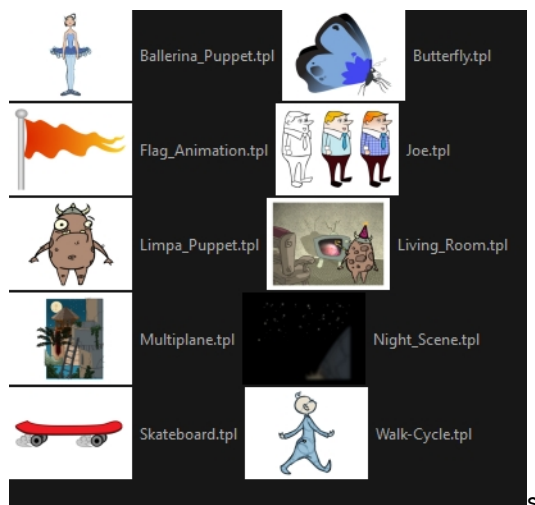

The symbols and templates contained in the selected Library list can be displayed on the right side of the Library view as thumbnails, in a list or as details.

How to access the templates and symbols list display options

- ▶ In the Library view's right side, right-click and select **View > List, Thumbnails** or **Details**.
- ▶ In the Library View toolbar, you can click the following buttons:

 Thumbnails

 List

 Details

Structuring the Library

As you will probably create a large number of symbols and templates, you will soon realize they need to be organized. You can create different libraries and subfolders to easily access your assets. For example, you can create a different library for each project and divide it into several categories, such as:

- Characters
- Props
- Backgrounds

Although you can only have one symbol library folder, you can organize it by creating subfolders.

There are two ways to create library folders.

- Directly through your operating system
- Using Harmony's interface

Folders can be opened in Harmony when you require it. You can open any folder on your hard drive or network as a library. Opening a library means linking the folder to your Library view. You only need to open the library once. The library folder is available every time you open the application until you decide to close the library and unlink it.

You may not always require all the library folders in the Library List. If so, you can close the ones you do not need. Closing a folder does not delete it; it only unlinks it from the Library view. If you want to reopen it, locate it on your hard drive or network and open it in the Library view.

Symbol and template libraries need to be organized. You can create different subfolders on your hard drive or in the Harmony Library view, so you can easily access assets. By default, any new library you link to your Library view is locked to prevent accidental deletion or modification of symbols and templates. You must obtain the right to modify it before being able to add a new folder to it.

You can delete a folder from the library if its contents are no longer needed.

NOTE: Warning: All templates and symbols in the folder will be deleted from your hard drive. Once deleted, the data cannot be retrieved.

Once you add a folder, you can rename it. This also renames the folder on your hard drive.

If you update the content of your libraries through your operating system, you will need to refresh your library folders in the Library view.

When you display thumbnails in the Library view, the system generates a series of small images (thumbnails) for you. You can generate template thumbnails yourself, if they do not display or if the process has been stopped.

You can also delete thumbnails if you want to send a template to another user or studio and keep your packages small.

How to create a library folder through your operating system

1. On your computer, create a new folder with a relevant name in the location where you want the library to be stored.

How to create a library folder in Harmony

1. In the Library View menu, select **Folders > Open Library**.
The Browser window opens.
2. Browse for the location where you want to store your new library folder.
3. Click the New Folder button.

A new folder appears.

4. Name the new library folder with a relevant name and click **OK**.

The new library appears in the Library List section.

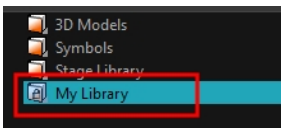

How to open a library

1. In the Library View menu, select **Folders > Open Library**.

The Browser window opens.

2. Browse to the location of the library folder.
3. Select the folder and click **OK**.

The new library appears in the Library Folders section.

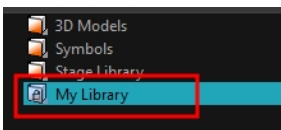

How to close a library

1. On the right side of the Library view, select the library folder to close.
2. In the Library View menu, select **Folders > Close Library**.

The library closes.

How to create a folder

1. On the left side of the Library view, select the library folder to which you want to add a subfolder.
2. In the Library View menu, select **Edit > Right to Modify**.
3. In the Library View menu, select **Folders > New Folder**.

The new folder appears in the Library. Click on the library containing the new folder and click the plus [+] sign to expand it.

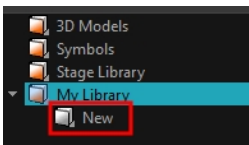

How to delete a folder

1. In the Library view's left side, select the folder to delete.
2. In the Library View menu, select **Edit > Right to Modify** or right-click on the selected library and select **Right to Modify**.
3. In the Library View menu, select **Folders > Delete Folder** or press Delete.

How to rename a folder

1. In the Library view's left side, select the folder to rename.
2. In the Library View menu, select **Edit > Right to Modify** or right-click on the selected library and select **Right to Modify**.
3. In the Library View menu, select **Folders > Rename Folder**.
4. Rename the selected folder.

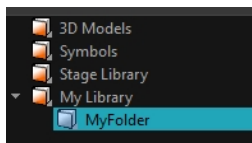

5. Press Enter/Return to validate the operation.

How to refresh a library

1. In the Library view's left side, select the folder to refresh.
2. In the Library View menu, select **Folders > Refresh** or press F5.
The library displays the new content.

How to generate thumbnails

1. In the Library view's right side, select the template in which you want to generate thumbnails.

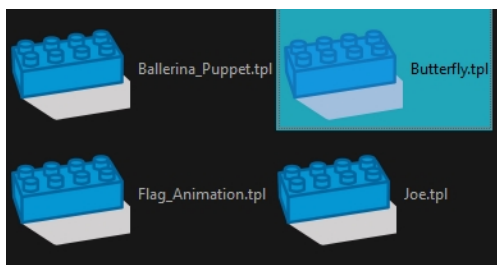

2. In the Library View menu, select **View > Generate Thumbnails**.
The progress bar appears.

How to delete thumbnails

1. In the Library View menu, select **Edit > Delete Thumbnails**.

All the thumbnails contained in the library are removed.

Templates

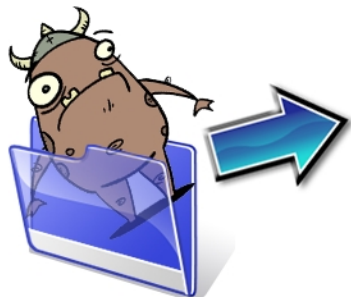

When you want to reuse artwork and animation from your project in other scenes, you must create a template from it. A template can be seen as a portable scene or package that you can drag inside your project. You can open a template and edit it just like any other project. If you want modify your templates, you can edit them using the Edit Template command.

You can create a template using the Timeline view.

To delete templates from your library, use the Library view. Harmony lets you undo the action if necessary.

How to create a template from the Timeline view

1. In the Timeline view, select some cells or layers.
2. In the Library view, select a folder to store the template.
3. If a library folder is locked, right-click and select **Right to Modify**.
4. Drag the selection to the Stage Library folder or any other library folder.

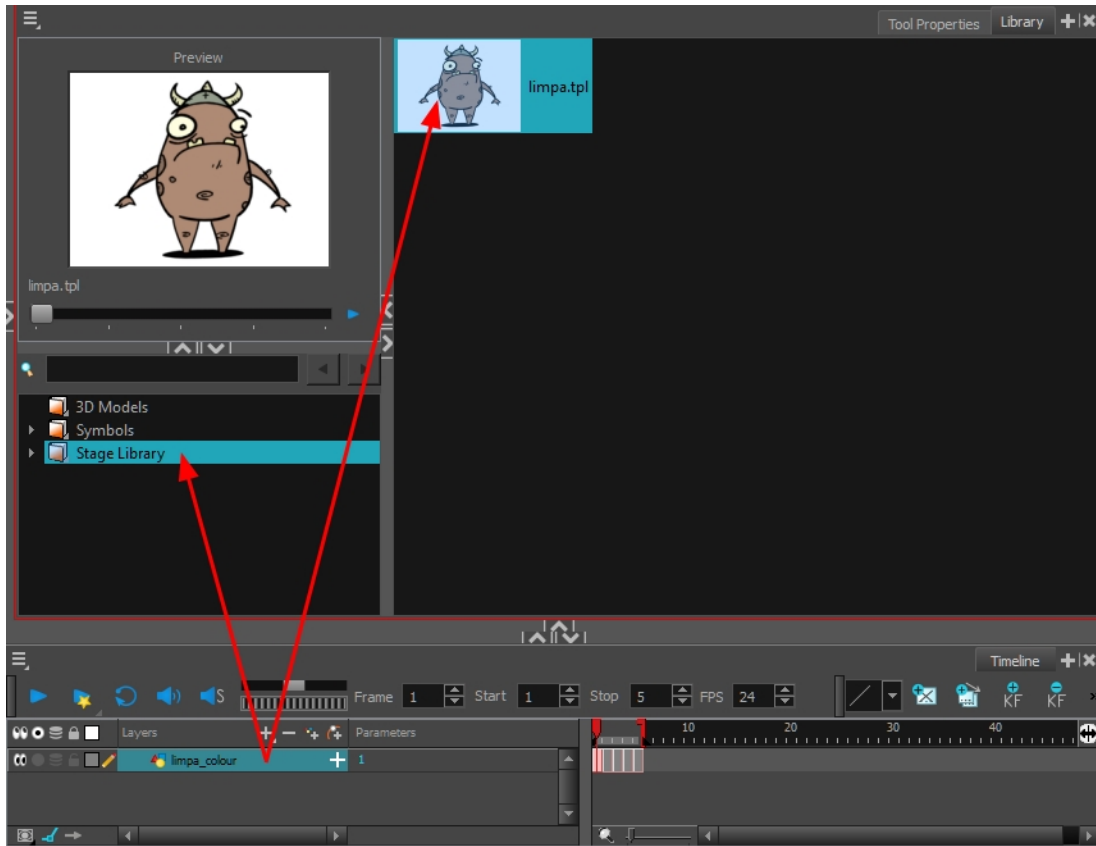

5. In the Rename dialog box, give the new template a name.
To rename a template once it is created, right-click on the symbol and select **Rename**.
6. Click **OK**.

How to delete a template

1. In the Library view, select the folder containing the template to delete.

NOTE: If the library folder is locked, right-click on the folder and select **Right to Modify**.

2. Right-click on the selection and select **Delete** or press Delete.

How to edit a template

1. In the Library view, select the folder containing the template to edit.

NOTE: If the library folder is locked, right-click on the folder and select **Right to Modify**.

2. Right-click on the selection and select **Edit Template**.

A new Harmony application opens.

3. Edit the template.
4. From the top menu, select **File > Save**.
5. In the top menu, select **File > Quit** (Windows/Linux) or **Stage Advanced > Quit** (Mac OS X).

Symbols



A symbol combines animation, artwork or layers into a single object that you can control in one layer. You can also create symbols out of each body part in your cut-out puppets.

You do not need to create symbols in order to create drawings or characters in Toon Boom Harmony.

When you delete a symbol, it will be deleted from your hard drive. You can use the Undo function to retrieve the data. The symbol cannot be retrieved once you close the application.

When you import a symbol from the library to the Timeline view it is linked to the original symbol in the library. If you import a symbol into your scene several times in the Timeline view, they will all be linked to the original symbol. If you modify one, they will all be modified.

If you want to edit a symbol without modifying the other instances, you must duplicate the symbol first. If other symbols are nested inside the new symbol, they are not duplicated. If you modify them, the original and other instances will also be modified.

You can either edit a symbol from the Timeline view or from the Library view.



When you edit a symbol, the drawings contained in it are not placed at the centre of the stage, but are located in the position where they were created. The pivot is translated at the centre of the symbol.





When you enter a symbol to edit it, you are entering another scene with an independent timeline. You can nest many symbols one inside the other. To help you follow the hierarchy of your nested symbol, take note of the Editing stack at the top of the Camera view which displays the path to your symbol's location. You can click on the symbol's name to move up the chain.

You can share a symbol and use its contents (the drawings) in another scene. To do this, you must first convert your symbol into a template. This conversion breaks the drawing's link with both the original scene and symbol. It then becomes a separate entity that you can import into other projects.

How to create a symbol from a drawing selection

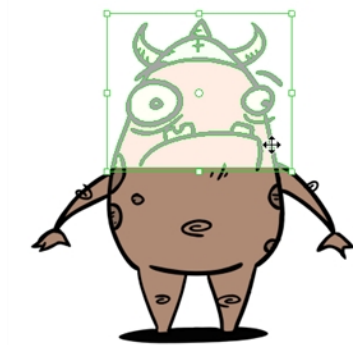
1. In the Tools toolbar, select the Select  or Cutter  tool.
2. In the Camera view, select the drawing elements to create a symbol.



3. From the top menu, select **Edit > Create Symbol** or press F8.
 - Clicking the Create Symbol  button in the Edit toolbar will create a symbol from the entire layer. The Create Symbol from Drawing Selection dialog box opens.

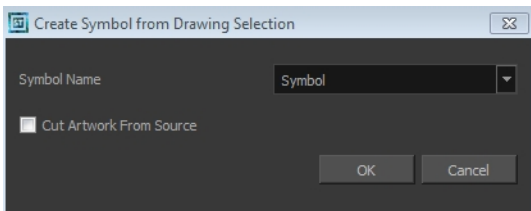

4. In the Symbol Name field, type the name of the symbol.
 - ▶ You can also select an existing layer from the Symbol Name drop-down menu. It will add your symbol on the layer's current cell. If there is already an exposure on that cell, the symbol will be added to a new layer.
5. You can choose to place the current selected artwork in the drawing or remove it:
 - ▶ To remove currently selected artwork from the drawing and place it in the new symbol, select the **Cut Artwork From Source Drawing** option.
 - ▶ To keep currently selected artwork in both the drawing and in the new symbol, deselect the **Cut Artwork From Source Drawing** option.
6. Click **OK**.

The new symbol appears in the Library view's symbol folder and in the Timeline view as a new layer.

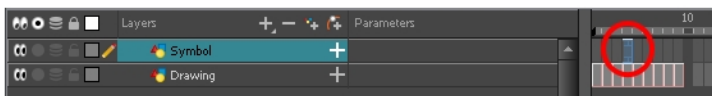

How to create a symbol from the Timeline view

1. In the Timeline view, select the layer or cells from which you want to create a symbol.
2. Do one of the following:
 - ▶ From the top menu, select **Edit > Create Symbol**.
 - ▶ In the Edit toolbar, click the Create Symbol  button.
 - ▶ Press F8.
 - ▶ Drag your selection to the Symbol folder in the Library view.

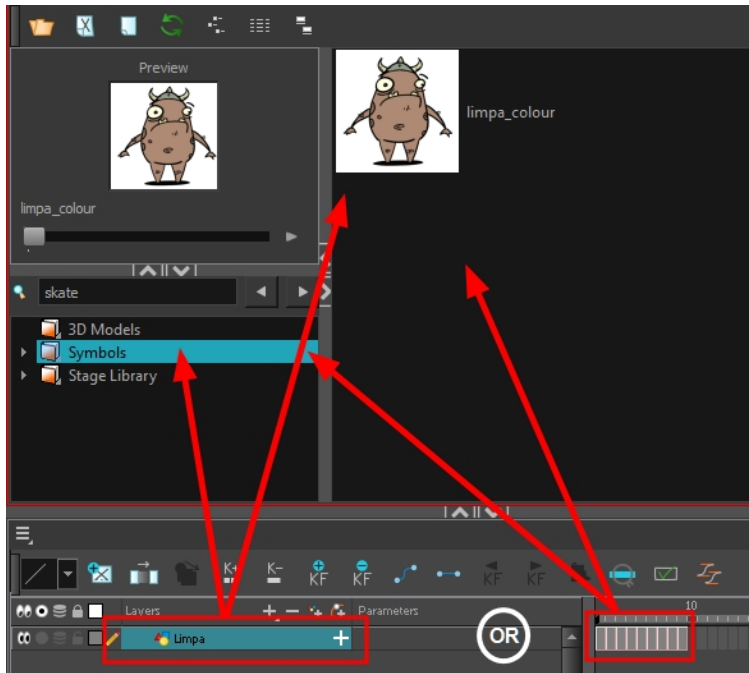

The Create Symbol dialog box opens

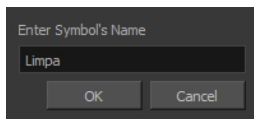

3. In the Enter Symbol's Name field, type the new symbol's name.

To rename a symbol once it is created, right-click on the symbol and select **Rename**.

4. Click **OK**.

The new symbol appears in the Library view's Symbol folder. The current selection is not replaced by the new symbol. The new symbol only appears in the library. You must drag it into your scene to use it.

How to create an empty symbol

1. In the Library view, select the **Symbol** folder.
2. Do one of the following:
 - ▶ In the Library view's right side, right-click and select **New Symbol**.
 - ▶ From the top menu, select **Insert > Create Empty Symbol in Library**.

The new empty symbol appears in the Library view.

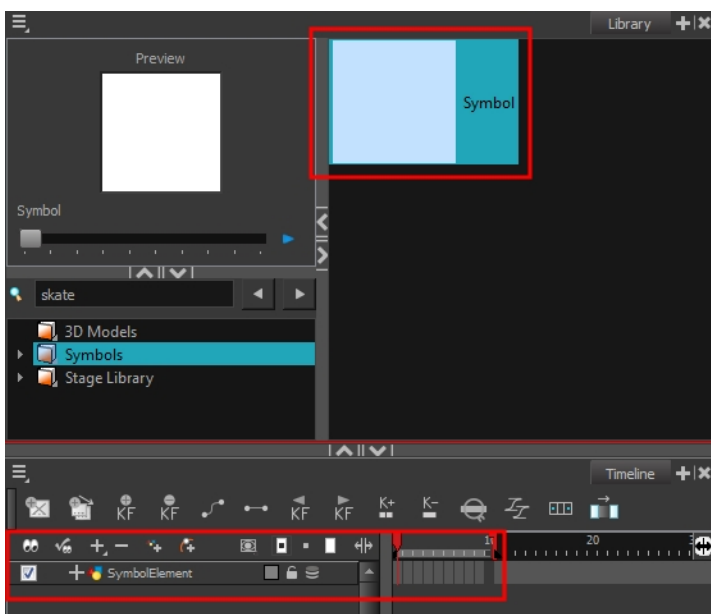

The symbol is ready for you to edit (add content to). To go back to the root timeline, click the Top 🏠 button in the Camera view.

To rename a symbol once it is created, right-click on the symbol and select **Rename**.

How to delete a symbol

1. In the Library view, select the symbol to delete.
2. Right-click and select **Delete** or press Delete.
 - ▶ If the symbol is currently in use in the scene, a warning message displays. Click **OK** to delete the symbol from the library and scene.

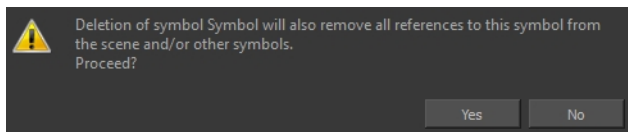

How to edit a symbol from the Timeline view

1. Do one of the following:
 - ▶ In the Timeline view, double-click on the symbol's cell to edit the symbol.
 - ▶ In the Camera view, double-click on the symbol or press Ctrl + E (Windows/Linux) or ⌘ + E (Mac OS X)).
 - ▶ Click the Edit Selected Symbol 🖱️ button in the Camera View toolbar's extra buttons.

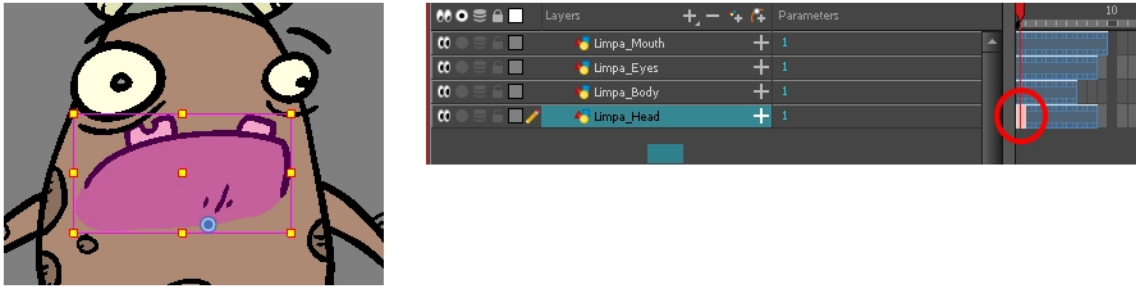

You are now inside the symbol and you are able to edit it.



2. Do one of the following:

To return to the project's timeline, click the Top  button in the Camera view's top-left corner, press Ctrl + Shift + E (Windows/Linux) or  + Shift + E (Mac OS X).

- In the Timeline view's right side, right-click and select **Symbols > Leave Current Symbol**.

How to edit a symbol from the Library view

1. In the Library view, select the symbol to edit.
2. Right-click and select **Edit > Edit Symbol** or double-click on the symbol.

You are now inside the symbol and you are able to edit it.



To return to the project's timeline, click the Top 🏠 button in the Camera view's top-left corner, press **Ctrl + Shift + E** (Windows/Linux) or **⌘ + Shift + E** (Mac OS X).

How to duplicate a symbol

1. In the Timeline view, go to the frame where you want to duplicate the symbol.
2. Select the symbol's cell.



3. From the top menu, select **Edit > Duplicate Selected Symbol**.

In the Library view, the symbol is duplicated and in the Timeline view, the current cell and its held exposure is replaced with the new symbol. You can now modify the symbol's content.

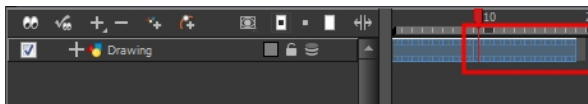

How to convert a symbol into a template

1. From the Library view, select the symbol to convert into a template and drag it to the Camera or Timeline view. If you drop your symbol into the Camera view instead of the Timeline view, it will not be placed in the centre of your camera frame, but rather wherever your cursor drops it within the camera frame.

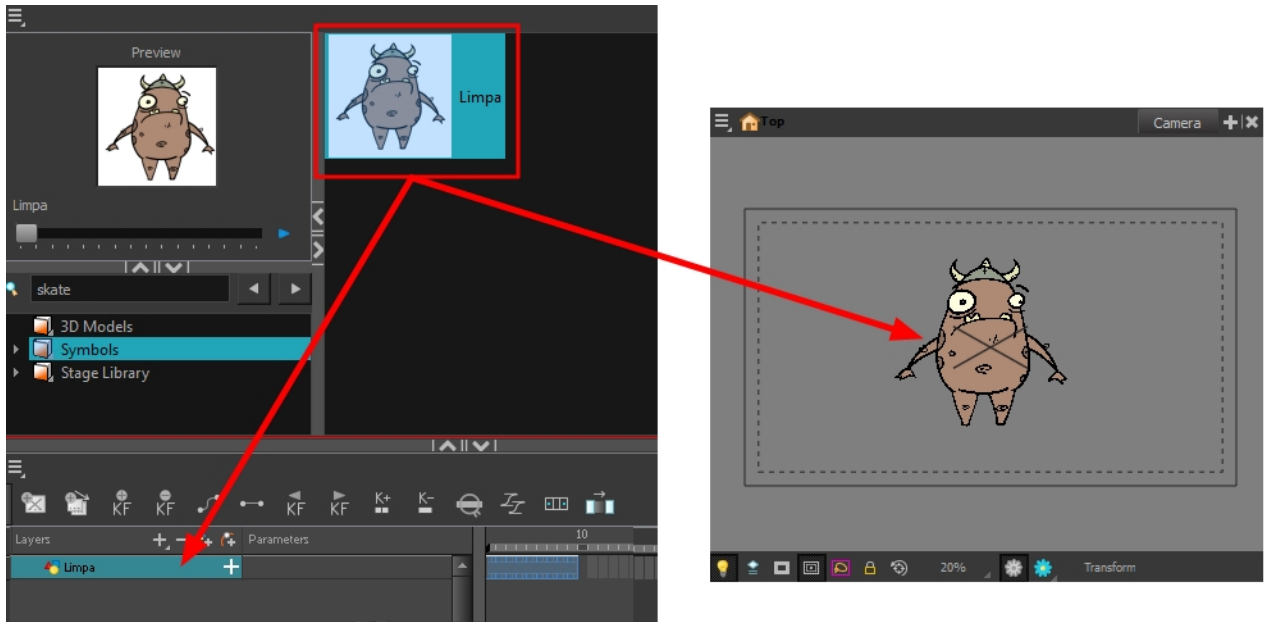

2. In the Timeline view, select the symbol's cells or layer and drag it to the Stage Library folder or to any other library folder. Make sure you have the right to modify the library folder.

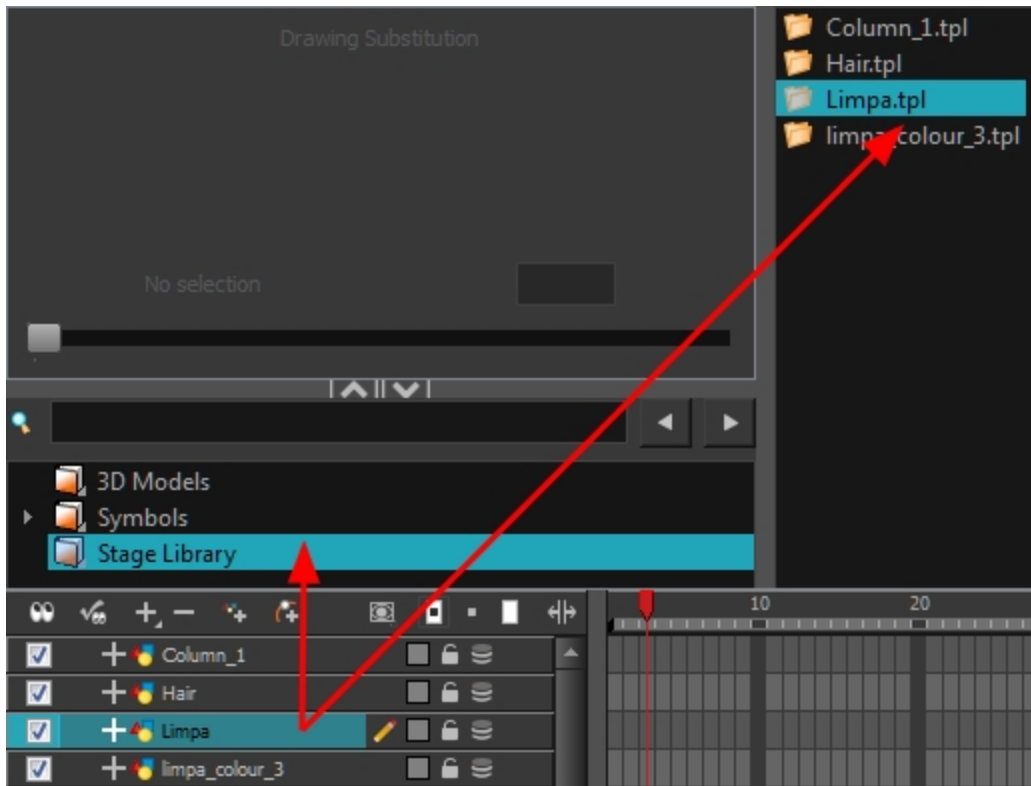

3. In the Rename dialog box, rename the new template.

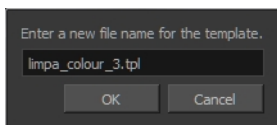

4. Click **OK**.

Importing Symbols and Templates

There are several ways you can import symbols and templates in your scene.

Sometimes a character rig is not a straightforward matter. Rigs, which are usually saved as templates, can contain symbols such as a leg that was made with a patch. However, a symbol does not work in the same way as an action template. In the Timeline view, you can add an action template into another template of the same structure. When working on a layer on the right side of the Timeline view and you place a symbol into a symbol of the same structure, instead of being added to the previous symbol, the new symbol becomes a copy.

For greater control over how the action template behaves when brought into the Timeline view, you can use the Paste Special feature—see [Using Paste Special on page 103](#).

Since a template is like a scene, you can open the template's folder and select elements inside it such as drawings.

Instead of importing the entire contents of a template, you may only want to import a few drawings or a palette. In this case, use the Open As Folder command to import the items you want.

If you want to import a palette, simply drag the palette file into the Palette list section of the Colour view.

You can use the Expand Symbol command to extract a symbol's contents and place it on the root timeline. The symbol will not be removed from the Timeline view. Its contents will be copied and inserted into the root timeline. The symbol's layers will be parented to it in case you created motions and transformations on the drawing layer that contains the symbol. Breaking the hierarchy could result in the loss of any scaling and animation you may have created.

You can also expand a symbol within a group to avoid crowding the timeline with a series of layers. When you expand the symbols, the layers will be contained in a group node that you can expand to see the content.

How to import a template into the Timeline or Camera view

1. In the Library view, select the template you want to import.
2. Drag the selected template to the Camera view or to the left side of the Timeline view.

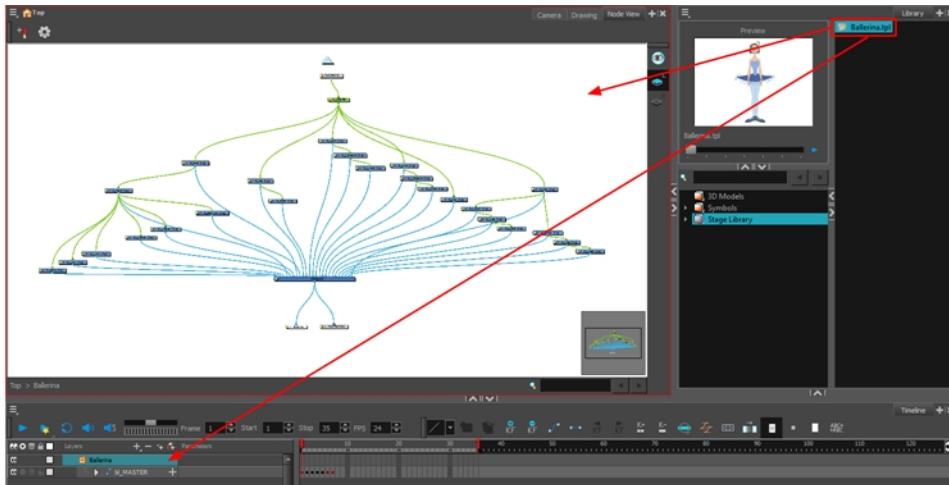

3. You can also drag a template to the right side of the Timeline view and into existing layers if the layer structure is the same as the existing one.



How to import a symbol in the Timeline view

1. In the Library view, select the symbol you want to import.
2. Drag the selected symbol to one of the following:
 - ▶ The Timeline view's left side to import it into the centre of the camera frame.
 - ▶ The Camera view to place it at the location where you release your cursor.

NOTE: This may be useful if you saved a character's body parts as separate symbols. If you dropped them into the Timeline view, then they would all appear in the centre, haphazardly one on top of the other. It would be more efficient to arrange them into their correct places as you bring them into the scene.

How to import a template with symbols

1. From the right side of the Library view, select the action template that contains symbols.
2. Hold down Alt (Windows/Linux) or ⌘ (Mac OS X) as you drag it from the Library view to the right side of the Timeline view and drop it next to a template with the exact same rig.

The Paste Special window opens.

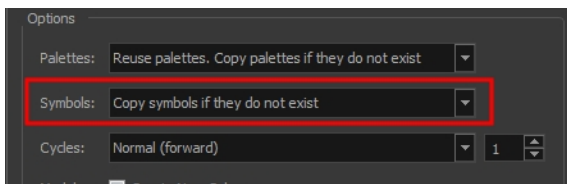

3. Select the **Advanced** tab.
4. Select one of the following options from the Symbols menu:

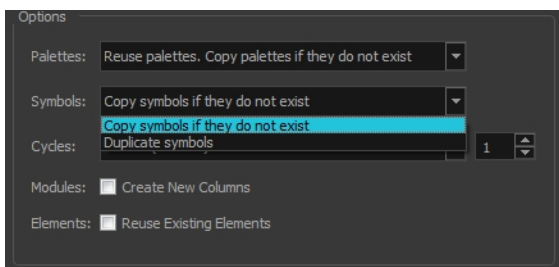

- ▶ **Copy symbols if they do not exist:** This is the default setting for this operation and will prevent symbols in an action template from being copied.
- ▶ **Duplicate symbols:** Makes copies of the symbols in your template.

How to open a template as a folder

1. In the Library view, select the folder that contains the template to open. If the library folder is locked, right-click on the folder and select **Right to Modify**.
2. Right-click on the selection and select **Open As Folder**.
3. In the library list section, click on the template's folder to display its content.

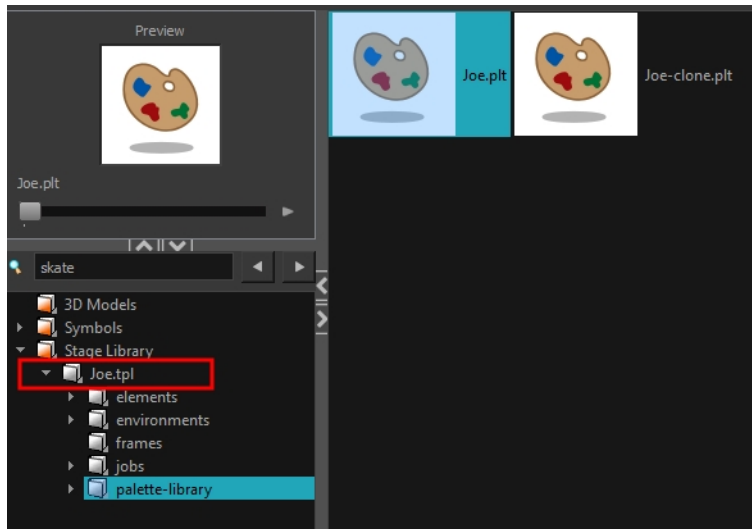

4. Drag the content to the Timeline or Colour view.

How to expand a symbol

1. In the Timeline view, select the symbol to expand.

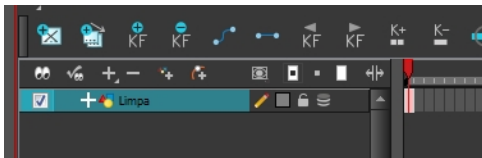

2. From the top menu, select **Edit > Expand Symbol** or press Shift + F8.

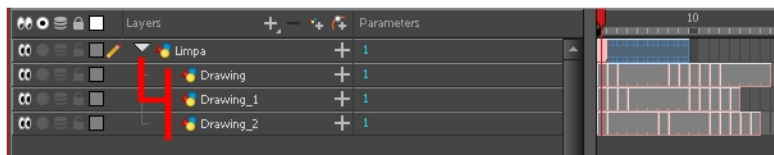

How to expand a symbol in a group

1. In the Timeline or Node view, select the symbol cell or symbol node you want to expand.

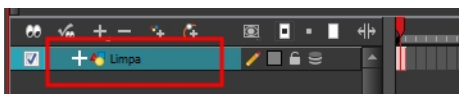

2. From the top menu, select **Edit > Expand Selected Symbol in a Group**.
3. In the Timeline view, click the plus sign (+) to see the group content. In the Node view, click the **Expand Arrow** to enter the group.

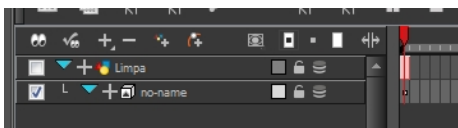

Importing Files Through the Library

Harmony lets you import sound files and images directly through the library. Simply open the folder containing your files in the Library view and drag them directly from there.

How to open a file through the Library

1. In the Library View menu, select **Folders > Open Library**.
2. Browse for the folder containing the files you want to import.
3. Click **Open**.
4. From the Library's template list, drag the file you want to import in the Timeline or Camera view.

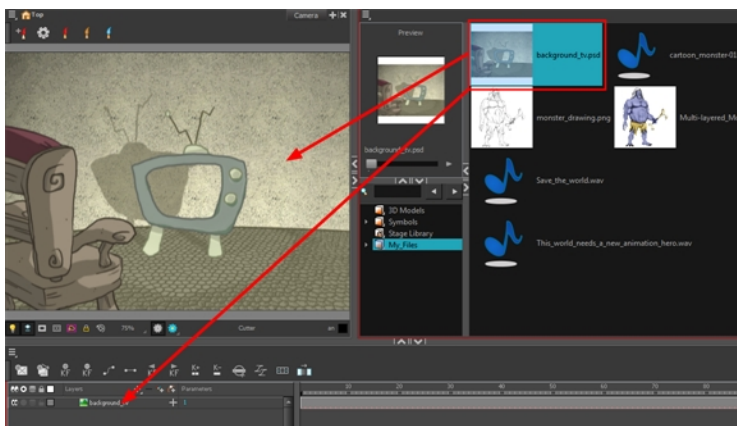

Using Paste Special

When you import a template in the Timeline view, all layers are created as well as drawings and keyframes. You can choose to import only the keyframes without the drawings or import only the drawings that are not already in your layers. You can adjust the behaviour using the Paste Special dialog box.

When you import a symbol in your scene, its full length is exposed by default. If you import a symbol in the Timeline view's left side, all the frames will be exposed. However, if you import it into an existing layer, you can use the Paste Special dialog box to adjust the import behaviour to fit your requirements.

Once you set the parameters, Harmony will reuse them each time you import a symbol in the Timeline view's right side until you set new parameters.

How to open the Paste Special dialog box

1. In the Library view, select the symbol or template to import.
2. Hold down Alt (Windows/Linux) or ⌘ (Mac OS X) and drag the selection to the Timeline view.

NOTE: Drop the selection in the Timeline view before releasing the keyboard shortcut key.

The Paste Special dialog box opens.

3. Set the parameters and click **OK**.

Basic Tab

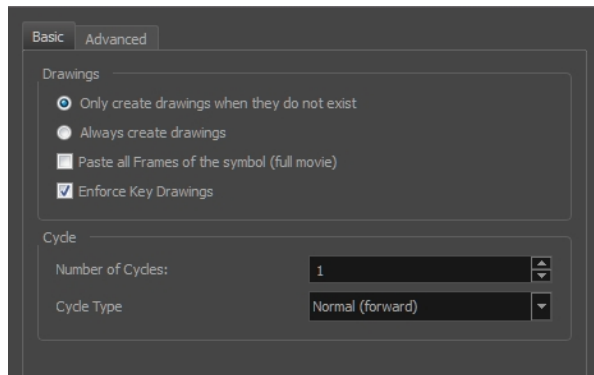

Parameter	Description
Drawings	
Only create drawing files when they do not exist	When adding exposures to a drawing layer, new drawings will be created only when drawings with the same name do not already exist in the destination.
Always create drawing files	When adding exposures to a drawing layer, new drawings will always be created. If drawing files with the same name already exist, Harmony will create a new name for the drawing.
Paste all Frames of the Symbols (full movie)	When enabled, the Paste Special command exposes all the symbol's frames instead of only the first one.
Enforce Key Drawings	Creates a key exposure on the same drawing.
Cycle	
Number of Cycles	Lets you set the number of cycles.
Cycle Type	Normal (forward): Pastes your selection as is, starting with the first cell and ending with the last.
	Reverse: Pastes your selection in reverse, starting with the last cell and ending with the first.
	Forward > Reverse: Pastes your selection as a yo-yo, starting with the first cell, going to the last one and ending with the first cell.
	Reverse > Forward: Pastes your selection as a reverse yo-yo, starting with the last cell, going to the first one and ending with the last cell.

Advanced Tab

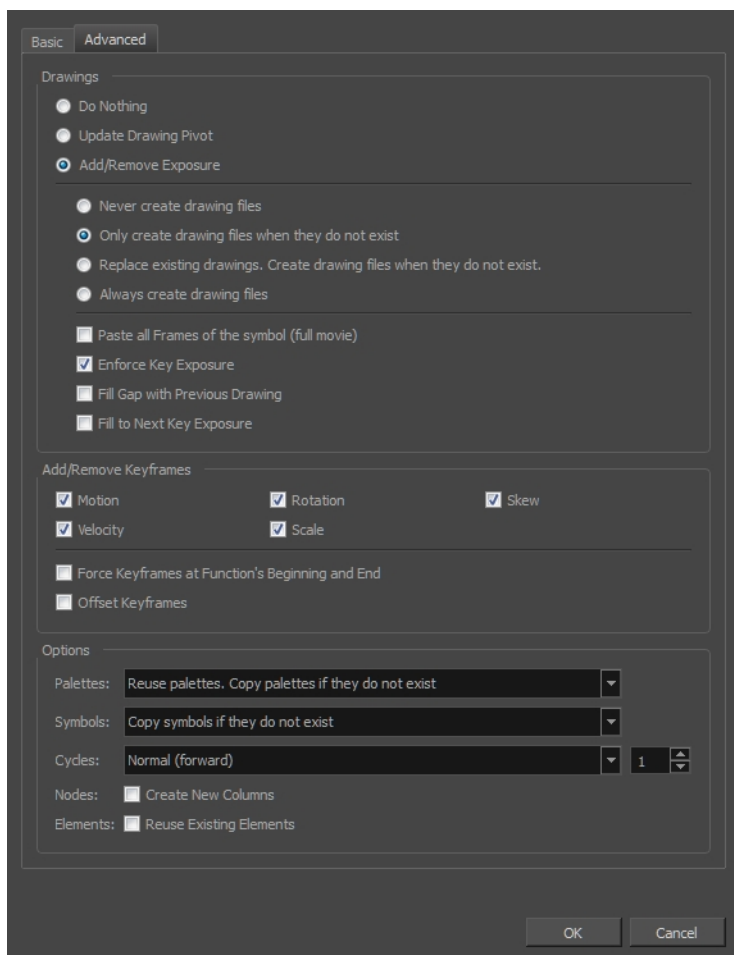

Parameter	Description
Drawings	
Do Nothing	Does not create or overwrite drawings.
Update Drawing Pivot	Revises the drawing pivot in the destination to use the same drawing pivot as the first drawing in the template. If you have a range of drawings selected in the destination, the pivot points of all selected drawings will be updated.
Add/Remove Exposure	Never create drawing files: When adding exposures to a drawing layer, drawing files will not be created.
	Only create drawing files when they do not exist: When adding exposures to a drawing layer, new drawings will be created only when drawings with the same name do not already exist in the destination.
	Replace existing drawings. Create drawing files when they do not exist: Replace drawings with the same names to update a scene with new modified drawings and preserve the animation.

	<p>Tip: If you don't want to lose the existing animation when pasting a template, such as when placing new drawings after the animation, then delete the template's animation. It will still have updated the drawings but not override the existing animation.</p>
	<p>Always create drawing files: When adding exposures to a drawing layer, new drawings will always be created. If drawing files with the same name already exist, Harmony will create a new name for the drawing.</p>
	<p>Paste all frames of the symbol (full movie): When enabled, the Paste Special command exposes all the symbol's frames instead of only the first one.</p>
	<p>Enforce Key Exposure: If there are key exposures that exist on copied drawings, they are preserved when pasting. No key exposures are added. This is the default behavior when pasting.</p>
	<p>Fill Gap with Previous Drawing: Fills selected area in the Xsheet or Timeline view with the previous drawing.</p>
	<p>Fill to Next Key Exposure: Fills selected area till the next key exposure.</p>
Add Remove/Keyframes	
Motion	Copies the properties of the selected motion keyframe to the new frame.
Velocity	Copies the properties of the selected velocity keyframe to the new frame.
Rotation	Copies the properties of the selected rotation keyframe to the new frame.
Scale	Copies the properties of the selected scale keyframe to the new frame.
Skew	Copies the properties of the selected skew keyframe to the new frame.
Force Keyframes at Function's Beginning and End	Adds a keyframe to the beginning and end of the pasted function, reproducing the source function.
Offset Keyframes	When pasting functions, offsets keyframes from the function's last frame value by the values in the pasted function. This will continue the progression of a function instead of repeating the values.
Options	
Palettes	<p>Do nothing: Does not create, overwrite, merge or link palettes.</p> <p>Reuse palettes. Copy palettes if they do not exist: Palettes in the destination drawings are left as they are.</p> <p>Copy and overwrite existing palettes: Overwrites destination palettes with the palettes from the source drawings.</p> <p>Copy and create new palette files: Creates new palette files, placing them at the same relative environment and scene level as the source. If the palettes in the templates were stored at the environment level of the source scene, the paste operation will place the palettes in the environment level of the destination scene.</p> <p>Copy and create new palette files in element folder: Creates new palette files in the element folders of the destination scene, rather than in the same</p>

	<p>relative job or environment.</p> <p>Copy palette and merge colours. Add new colours only: Adds new colours to the destination palettes and ignores colours that are the same in the two palettes.</p> <p>Copy palettes and update existing colours: Adds new colours to the destination palette and updates duplicate colours in the destination with colour values from the source.</p> <p>Link to original palettes (colour model): Links the colour palettes in the destination scene to the palettes in the source. Use this to link drawings to the palettes in a colour model.</p> <p>Copy scene palettes and merge colours. Add new colours only: Adds new colours to the destination scene palettes and ignores colours that are the same in the two palettes.</p> <p>Copy scene palettes and update existing colours: Adds new colours to the destination scene palette and updates duplicate colours in the destination with the colour values from the source.</p>
Symbols	<p>Copy symbols if they do not exist: This is the default setting for this operation and will prevent Symbols in an Action template from being copied.</p> <p>Duplicate symbols: Creates a duplicate of the symbol instead of linking the Symbol instance to the original one. The new Symbol is created in the Library.</p>
Cycles	<p>Normal (forward): Pastes your selection as is, starting with the first cell and ending with the last.</p> <p>Reverse: Pastes your selection in reverse, starting with the last cell and ending with the first.</p> <p>Forward > Reverse: Pastes your selection as a yo-yo, starting with the first cell, going to the last one and ending with the first cell.</p> <p>Reverse > Forward: Pastes your selection as a reverse yo-yo, starting with the last cell, going to the first one and ending with the last cell.</p>
Nodes	<p>Create New Columns: A new column is created when you copy and paste nodes from the layer in the Timeline view. If the layers are linked to function curves, the function curves, drawings and timing will be duplicated.</p>
Elements	<p>Reuse existing elements: Lets you paste existing elements without creating new ones. This should be used only when pasting within versions of the same scene.</p>

Chapter 4: Scene Setup



Setting up your scene can be compared to building a set for a television show. This is the point when you position each scene element such as the camera frame, the background elements and the characters.

This chapter contains the following topics:

- [Importing the Scene Components](#) on page 109
- [Setting the Camera Frame](#) on page 109
- [Positioning the Scene Components](#) on page 114
- [Cloning and Duplicating Layers](#) on page 145
- [Working with Groups](#) on page 147
- [Display Concepts](#) on page 147
- [Timeline View Modes](#) on page 148
- [Creating a Multiplane](#) on page 150

Importing the Scene Components

The first step in the scene setup task is gathering the scene's different components and then importing them into your project. You might need to import some backgrounds, sound files or movie clips to complete your scene. You can refer to the following topics to learn how to bring those elements in.

- [Importing Bitmap Images](#) on page 12
- [Importing QuickTime Movies](#) on page 64
- [Importing a Sound File](#) on page 213



Setting the Camera Frame

The scene action occurs inside the camera frame, so it's really important to set it up correctly. You can adjust the camera resolution and other parameters in the Scene Settings window. Refer to the Fundamentals Guide, *Starting Harmony* chapter to learn more.

The Camera layer is static which means that if you need to animate it, you must add a peg.

You need to add a camera layer to your scene, so you can edit the camera frame. You can only see one camera at a time. If you add several cameras to your scene, you can use the Camera list to select the active one. You could use this feature if you are still working on your scene composition and have different camera framing to try out.

You can reposition your camera frame directly in the Camera view, using the advanced animation tools. Another way to set up your camera frame is to type the coordinates directly in the camera's properties. Doing this positions the camera precisely where you want it to be rather than gauging it visually.

You can easily reset the camera to its original position. Using the Reset command, you can reset the value of the selected element to the initial value of the active tool. For example, if the Rotate  tool is active, the transformation angle will be reset to 0 and if the Transform  tool is active, then all parameters values will be reset.

You can change the near and far clipping planes of the camera. The near plane is the point on the camera cone where the camera is located. The far clipping plane is the far end of the camera cone. Nothing outside that range is visible. This is useful when dealing with 3D elements and 3D sets. For example, the camera can be looking inside a 3D box or room and you might want the foreground wall to not obstruct the view of the interior. By default, the near clipping plane is set to 1 field and the far clipping plane is set to 1000 fields.

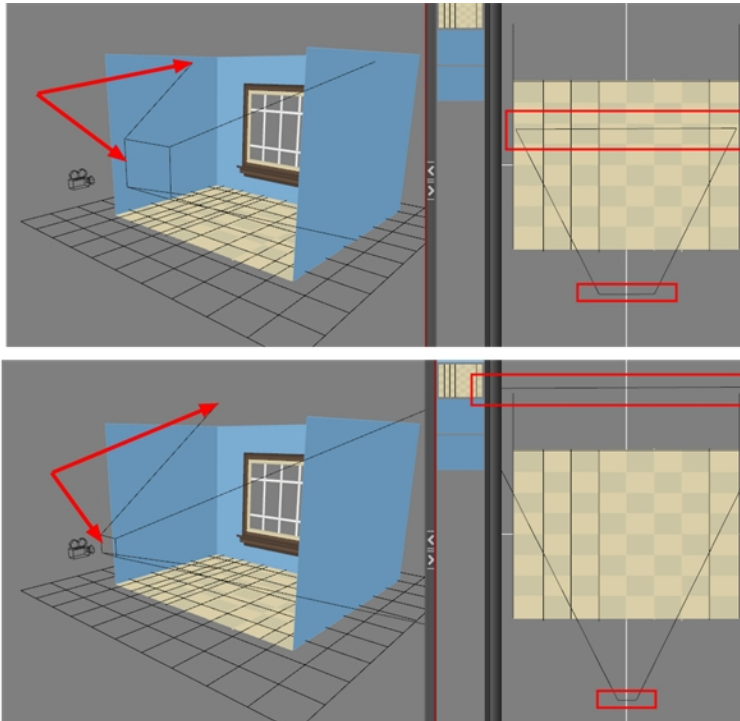

How to add a camera in the Timeline view

1. Do one of the following:
 - ▶ In the Timeline view, click the Add Layer  button and select **Camera**.
 - ▶ From the top menu, select **Insert > Camera**.

A new camera layer is added to the scene and appears in the Timeline view.

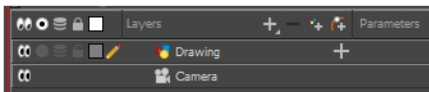



NOTE: You cannot add a camera inside a symbol.

How to select a camera from the Camera list (set the active camera)

1. From the top menu, select **Scene > Camera > the desired camera**.

If you only add one camera to your scene, you will only see Default Camera in your list.

How to reposition the camera frame directly in the Camera view

1. In the Tools toolbar, disable the Animate  mode.
2. Do one of the following:
 - ▶ From the top menu, select **Animation > Tools > Translate**.
 - ▶ In the Advanced Animation toolbar, click the Translate  tool.
 - ▶ Press Alt + 2.
3. In the Camera view, click on the camera frame (thin rectangle) to select it. You can also select the camera layer from the Timeline view.

The selected camera frame is highlighted.

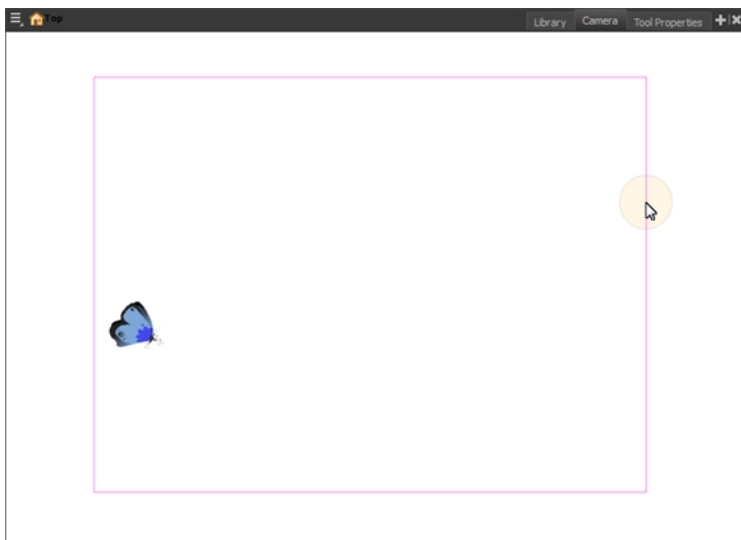

4. Drag the camera frame to a new position.

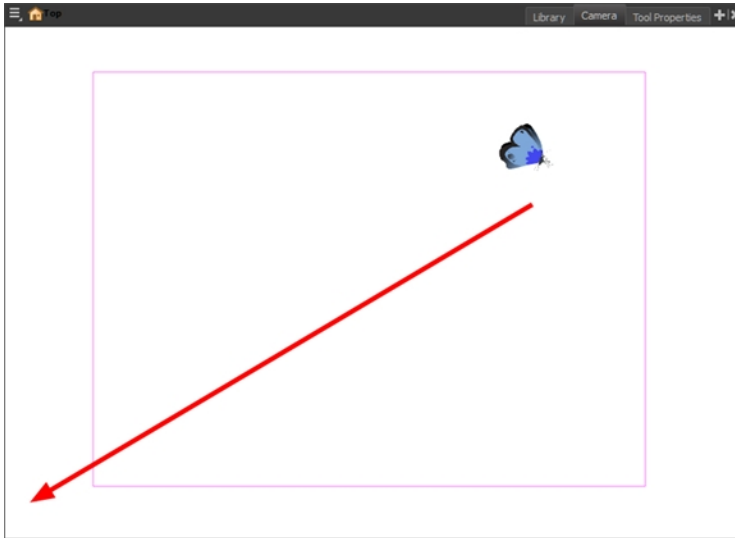

5. To tilt the camera frame, do one of the following to select the Rotate tool:
 - ▶ From the top menu, select **Animation > Tools > Rotate**.
 - ▶ In the Advanced Animation toolbar, select the Rotate  tool.
 - ▶ Pres Alt + 3.
6. In the Camera view, drag to rotate the camera frame until it reaches the desired rotation angle.

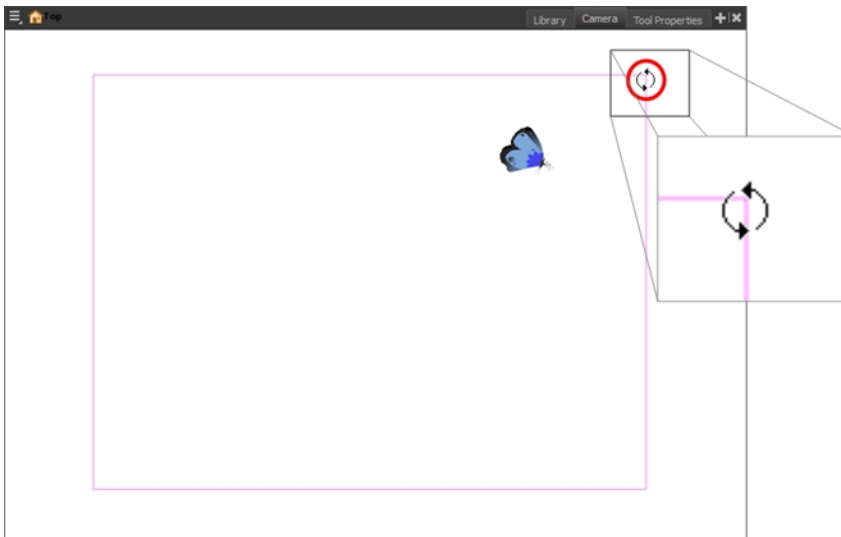

How to modify the camera clipping plane

1. In the Timeline or Node view, select the Camera node.
2. In the Layer Properties view, go to the **Clipping Planes** section.

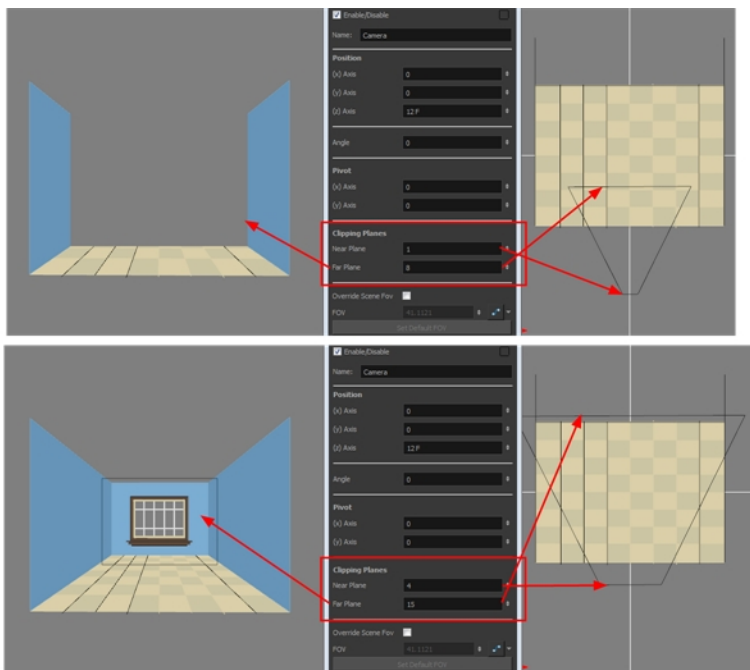

3. Modify the value of the Near Plane to pull or push the clipping area closer to the camera. Anything behind this plane will no longer be visible.
4. Modify the value of the Far Plane to pull or push the clipping area closer to the camera. Anything beyond this plane will no longer be visible.

How to set up the camera frame using the Layer Properties view

1. In the Timeline view, select the camera layer.
2. In the Layer Properties view, adjust the camera's properties.

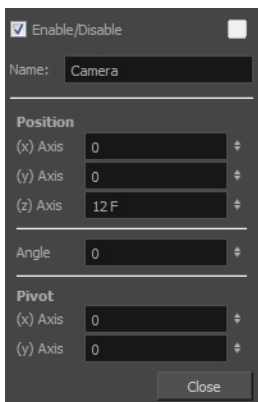

Parameter	Description
Enable/Disable	Turns the camera layer on or off.
Change Track Colour	The Change Track Colour <input type="checkbox"/> button lets you change the colour of the exposed frames; this helps you to quickly locate a layer in the Timeline view. Click the

	Change Track Colour <input type="checkbox"/> button to open the Select Colour window and choose a new colour. You can modify the colour for any type of layer, such as group, peg, drawing, and effects.
Name	Displays the current layer name. You can rename the layer by typing in a new layer name.
Position	Displays the current position of the camera layer using X-axis (East/West), Y-axis (North/South) and Z-axis (Forward/Backward) coordinates. To reposition your camera frame, type in the new values corresponding to the desired position coordinates. You can also use the up and down arrows to set the value of each field—see Positioning an Element Using the Layer Properties View on page 131 .
Angle	Displays the current rotation value. To set a new rotation position, type in a new angle value. You can also use the up and down arrows to set the new angle value.
Pivot	Displays the current position of the rotation pivot of the camera layer. The camera will perform a rotation taking the position of the pivot as its angle centre. By default, the pivot is set at the centre of the camera frame. To reposition the pivot point, type in new X and Y coordinates values in the appropriate field. You can also use the up and down arrows to set the position values. In order to see the pivot's position you will need to have the Rotate tool selected.

How to reset the camera position

1. In the Tools toolbar, select the Transform  tool or press Shift + T.
2. In the Timeline or Camera view, select the camera layer.
3. From the top menu, select **Animation > Reset** or press Shift + R.

The camera automatically returns to its original position.

Positioning the Scene Components



Setting up the scene also involves positioning the different scene elements within the camera frame.

Here are the main features and topics you need to know about to position your elements:

- [Animate Mode](#) on page 115
- [Selecting a Layer](#) on page 115
- [Positioning an Element Using the Transform Tool](#) on page 120
- [Positioning an Element Using the Advanced Animation Tools](#) on page 127
- [Positioning an Element Using the Layer Properties View](#) on page 131
- [Drawing Layer Properties Reference](#) on page 133
- [Setting Properties for Many Layers](#) on page 142
- [Auto Apply Option](#) on page 143
- [Resetting a Transformation](#) on page 144

Animate Mode

When positioning elements, make sure the Animate Mode is turned off, or it will create a keyframe on your drawing layer. The animate mode is used to animate layers over time.



Animate mode is on.
(Pushed in) Animate mode is off.

How to turn off the Animate mode

- ▶ In the Tools toolbar, click the Animate Mode  button. Make sure the button is depressed.
- ▶ In the top menu, disable **Animation > Animate**.

Selecting a Layer

There are different ways to select the layers you want to reposition.



You can select your elements directly in the Camera view using the Transform tool. When using this tool, its properties and options appear in the Tool Properties view. Always make sure that the Peg Selection Mode option in the Tool Properties view is disabled or it will limit the selection to pegs only.

When you have several layers in the Timeline view, you may find it hard to locate which one is selected. You can use the Centre on Selection feature to display the selected layer in the Timeline view.

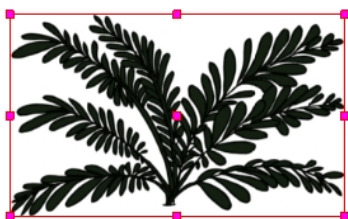
You can change the display style of selected elements to a bounding box style. This removes the default overlay highlight and leaves only the bounding box around the selected element.



How to select a layer in the Camera view

1. In the Tools toolbar, select the Transform  tool or press Shift + T.
1. In the Tool Properties view, make sure that the Peg Selection Mode  is deselected.
2. In the Camera view, click on the element to be repositioned. You can select more than one element at a time. Hold down Shift while clicking on the elements to be selected.

The corresponding layers and columns are highlighted in the Timeline and Xsheet views.

How to set the bounding box selection style

1. In the Camera View bottom toolbar, click the BBox Selection Style  button.

How to center on the selected layer in the Timeline view

1. In the Camera view, select a layer.
2. Do one of the following:
 - ▶ From the Timeline View menu, select **View > Centre on Selection** or press O.
 - ▶ In the Timeline View toolbar, click the Centre on Selection  button.

How to select from the Timeline or Xsheet view

- ▶ In the Timeline view, click the layer corresponding to the element you want to reposition.
- ▶ In the Xsheet view, click the column header corresponding to the element you want to reposition.

The selected element is highlighted in the Camera view.

How to select all elements within a group in the Timeline view

1. With a group collapsed or expanded, hold down Alt and click on the group in the Timeline view.

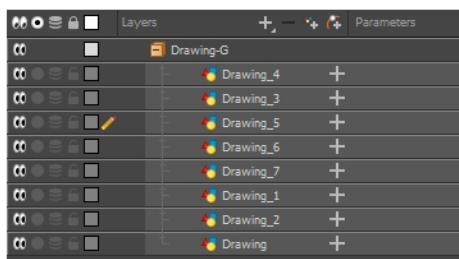



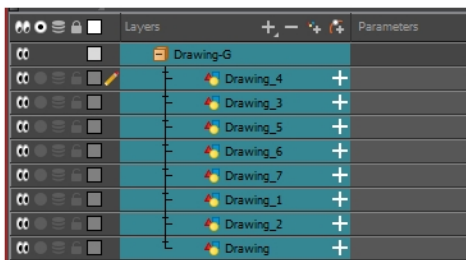

All elements contained within the group are selected.



Locking Layers in the Timeline View

You can prevent correctly positioned layers from being selected in the Camera view by locking them in the Timeline view. This is useful for making a multiple selection inside the Camera view while avoiding to select them. Once a layer has been locked, its locked state will be remembered the next time you open a saved project.

You can perform five types of locking actions on your layers:

- The Lock  option lets you lock one or a multiple selection of layers.
- The Unlock  button lets you unlock one or a multiple selection of locked layers.
- The Lock All  option lets you lock all the layers in the Timeline view.
- The Unlock All  button lets you unlock all the layers in the Timeline view.
- The Lock All Others  button lets you lock every layer except the selected ones.

How to lock a layer or a selection of layers

1. In the Timeline view, select one or more layers.

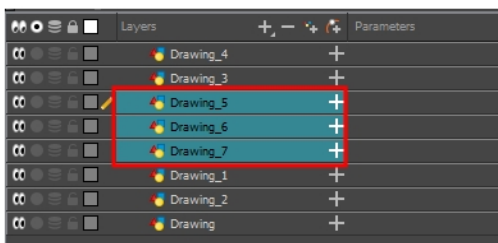



2. Do one of the following:
 - From the top menu, select **Animation > Lock > Lock**.
 - Click one of the selected layer's Lock  icon.
 - Press Ctrl + Alt + L (Windows/Linux) or ⌘ + Alt + L (Mac OS X).
 All selected layers are locked.

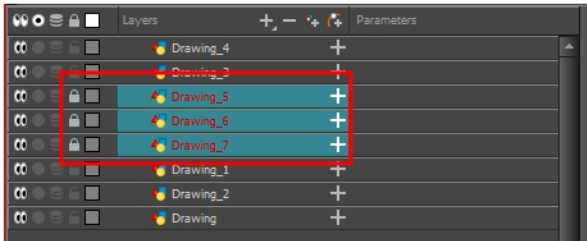

How to unlock a locked layer or a selection of locked layers

1. In the Timeline view, select one or more locked layers.



2. Do one of the following:
 - ▶ From the top menu, select **Animation > Lock > Unlock**.
 - ▶ Click a selected layer's Lock  icon.
 - ▶ Press Ctrl + Shift + K (Windows/Linux) or ⌘ + Shift + K (Mac OS X).

All selected layers are unlocked.

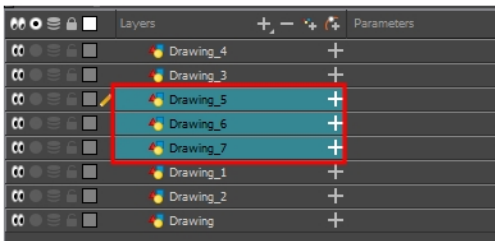

How to lock all layers

1. Do one of the following:
 - ▶ From the top menu, select **Animation > Lock > Lock All**.
 - ▶ In the Timeline view, select all layers and click Lock  icon of a selected layer.
 - ▶ Press Ctrl + Shift + L (Windows/Linux) or ⌘ + Shift + L (Mac OS X).

All layers are locked.

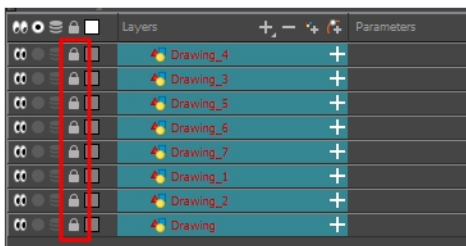

How to unlock all layers

- Do one of the following:
 - From the top menu, select **Animation > Lock > Unlock All**.
 - In the Timeline view, select all layers (locked) and click Lock  icon of a selected layer.
 - Press **Ctrl + Alt + Shift + L** (Windows/Linux) or **⌘ + Alt + Shift + L** (Mac OS X).

All layers are unlocked.

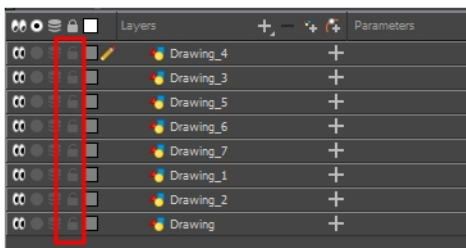

How to lock all other layers

- In the Timeline view, select the layers you do not want to lock.

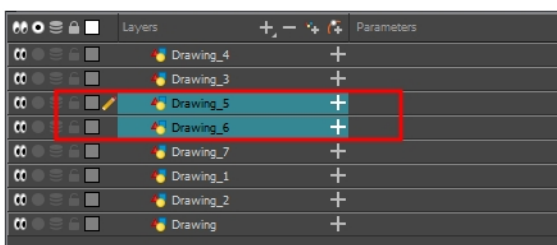

- Do one of the following:
 - From the top menu, select **Animation > Lock > Lock All Others**.
 - Press **Ctrl + Alt + Shift + O** (Windows/Linux) or **⌘ + Alt + Shift + O** (Mac OS X).
- All layers are locked except the selected ones.

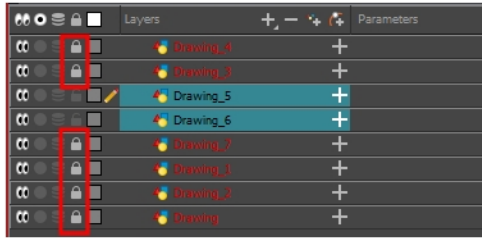

Positioning an Element Using the Transform Tool

Using the Transform tool, you can easily reposition, scale, rotate and even skew layers directly in the Camera view.

When positioning a drawing layer using the Transform tool, always make sure the Peg Selection Mode  is deselected in the Tool Properties view. Otherwise, it will limit the selection to pegs in the Camera view.

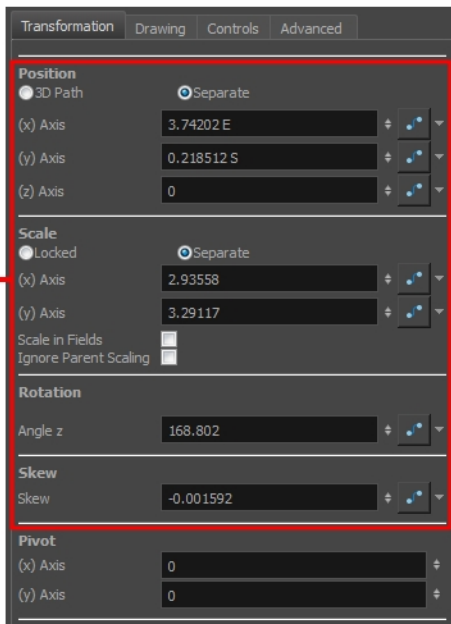

The Transform tool can affect the Position, Scale, Rotation, and Skew parameters, but not the Pivot parameter.

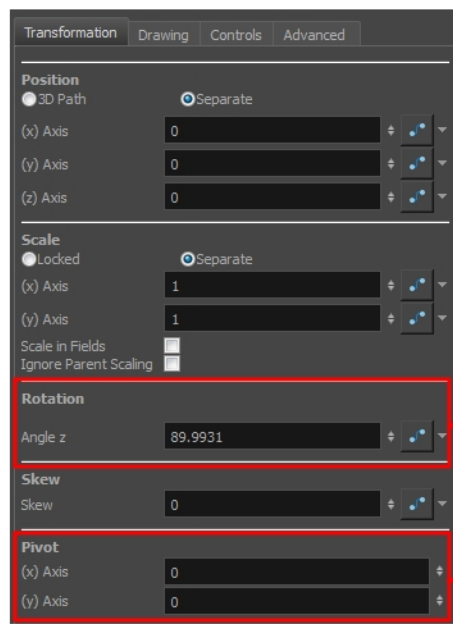

The Rotation tool only affects the Rotation and Pivot parameters.

There are two different options you can use when you want to flip your element.

The Flip Horizontal and Flip Vertical options let you flip a drawing layer along the Camera view's horizontal and vertical axis.

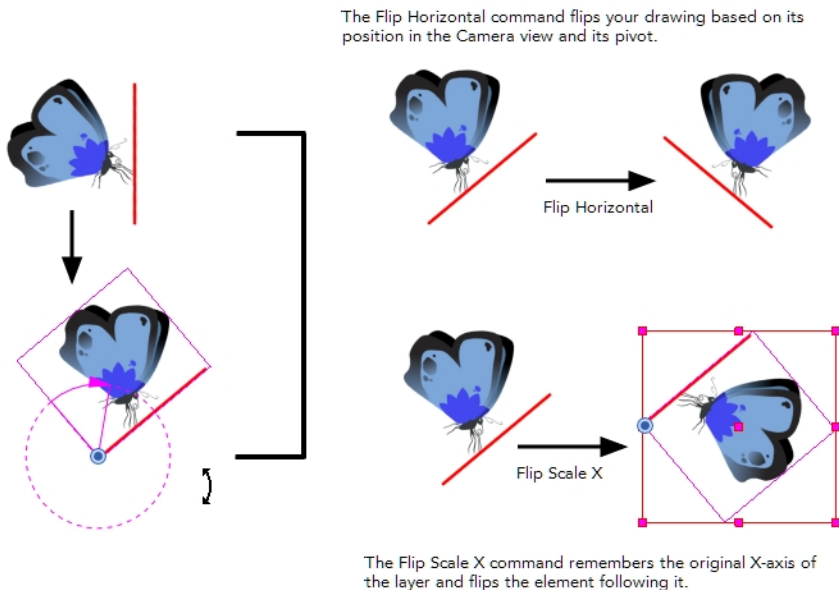

Once your drawing layer is rotated, the original horizontal and vertical axes change. The Flip Scale X and Flip Scale Y will perform a flip on your drawing layer following its original axis.

- The Flip Horizontal command flips the layer following the Camera view X-axis.
- The Flip Scale X command uses the original X-axis of the layer and flips the element following it.



Transformations, such as rotation, scale, skew and flip are made relative to the pivot point position. You can temporarily reposition the pivot point for each transformation using the Transform tool. Note that the pivot is only moved temporarily. When animating the position, the interpolation is calculated from the permanent pivot position—see [Positioning an Element Using the Advanced Animation Tools](#) on page 127.

How to temporarily reposition the pivot point

1. In the Tools toolbar, select the Transform  tool.
2. In the Tool Properties view, make sure the Peg Selection Mode  is disabled.
3. In the Camera view, select your element.

The pivot point appears at the center of the scene space (coordinates 0, 0, 0), unless previously repositioned.

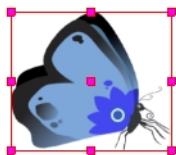



4. Click on the pivot point and drag it to a new position.

This will be the new position of the pivot point for the current transformation. It will remain in this position as long as you do not deselect the drawing. Using the Transform tool to reposition your pivot will temporarily override the existing pivot point position until you complete the current transformation. Then it returns automatically to its original position.

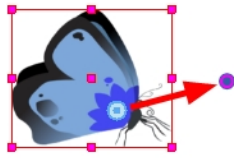
When you translate the pivot point using the Transform tool, the permanent pivot will appear as a ghost so you know where it is and also from where the animation will be interpolated when you create motion paths. The animation is always interpolated from the original pivot and not the temporary pivot.



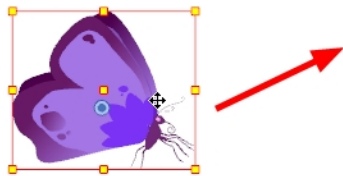

How to pan a layer using the Transform tool

1. In the Tools toolbar, disable the Animate  mode.
2. In the Tools toolbar, select the Transform  tool or press Shift + T.
3. In the Tool Properties view, make sure the Peg Selection Mode  is deselected.
4. In the Camera view, select a drawing layer and drag the selection to a new area. You can select multiple layers to reposition them at the same time. Hold down Shift and select the different layers.



How to rotate a layer using the Transform tool

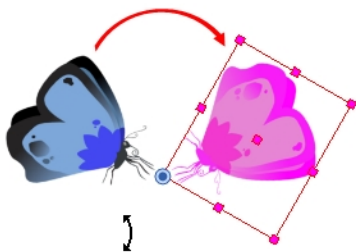

1. In the Tools toolbar, disable the Animate  mode.
2. In the Tools toolbar, select the Transform  tool or press Shift + T.
3. In the Tool Properties view, make sure the Peg Selection Mode  is deselected.
4. In the Camera view, select a drawing layer.
5. Place the pointer outside of a corner of the bounding box and drag to rotate.

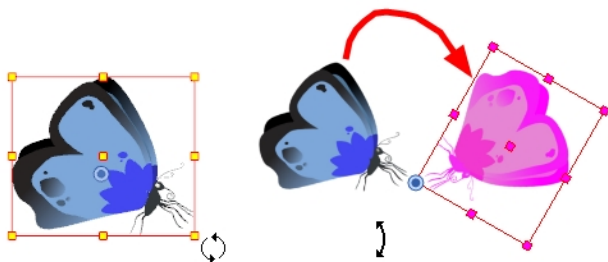

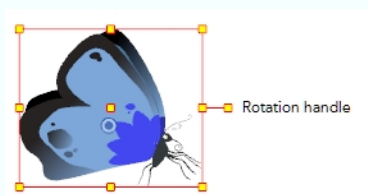

**NOTE:**

You can display a rotation handle on the bounding box when transforming a layer. In the Preferences dialog box, select the Camera tab and then select the **Use Rotation Lever with Transformation Tools** option. This preference is off by default.

**How to scale a layer using the Transform tool**

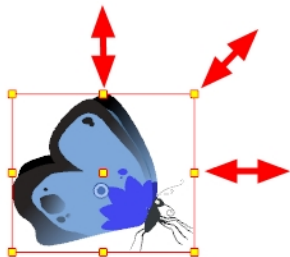
1. In the Tools toolbar, disable the Animate  mode.
2. In the Tools toolbar, select the Transform  tool or press Shift + T.
3. In the Tool Properties view, make sure the Peg Selection Mode  is deselected.
4. In the Camera view, select a drawing layer and push or pull on the size, top, or corner control point. Hold down Shift to lock the selection's aspect ratio.





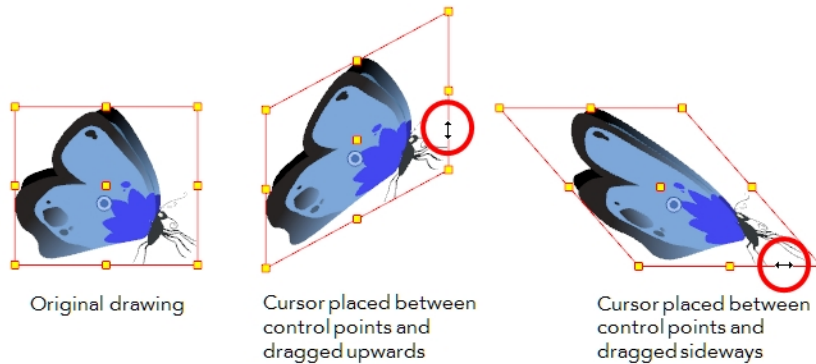

**How to skew a layer using the Transform tool**

1. In the Tools toolbar, disable the Animate  mode.
2. In the Tools toolbar, select the Transform  tool or press Shift + T.

3. In the Tool Properties view, make sure the Peg Selection Mode  is deselected.
4. In the Camera view, select a drawing layer.
5. Place the pointer between two controls points and drag sideways or up and down.



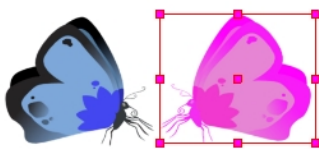

How to flip a layer

1. In the Tools toolbar, disable the Animate  mode.
2. In the Tools toolbar, select the Transform  tool or press Shift + T.
3. In the Tool Properties view, make sure the Peg Selection Mode  is deselected.
4. In the Camera view, use the Transform  tool to select a drawing layer to flip.
5. Do one of the following:
 - ▶ From the top menu, select **Animation > Flip > Flip Horizontal** or **Flip Vertical**.
 - ▶ In the Tool Properties view, click the Flip Horizontal  and the Flip Vertical  buttons.
 - ▶ Press 4 or 5.









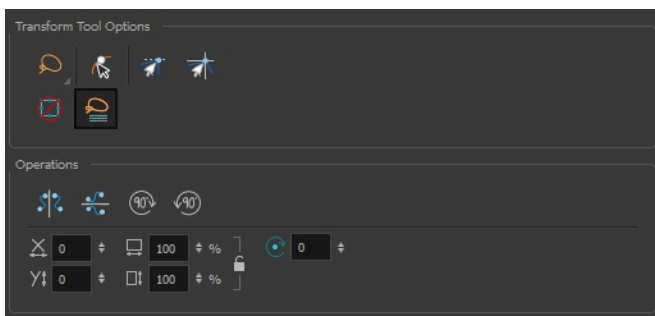

How to flip an element following its original axis

1. In the Tools toolbar, disable the Animate  mode.
2. In the Tool Properties view, make sure the Peg Selection Mode  is deselected.
3. In the Camera view, use the Transform  tool to select an element that has already been transformed.
4. From the top menu, select **Animation > Flip > Flip Scale X** or **Flip Scale Y**.



Transform Tool Properties



Icon	Tool Name
	Lasso and Marquee on page 125
	Peg Selection Mode on page 126
	Snap Options on page 126
	Hide Manipulator Controls on page 126
	Flip Horizontal and Flip Vertical on page 126
	Rotate 90 Degrees CW and CCW on page 126
	Width and Height on page 126
	Offset X and Y on page 127
	Angle on page 127

Lasso and Marquee

The Lasso and Marquee options let you choose the type of selection the current tool will perform. The default selection mode is Marquee.

- Lasso  lets you draw a custom selection box around zones.
- Marquee  makes a rectangle selection box.

NOTE:

Hold down the Alt key to switch to toggle between the selection modes.



Peg Selection Mode

In the Camera view, the Peg Selection Mode  limits the selection to peg layers instead of drawing layers. This mode is useful when you have created a character rig using peg layers for each drawing. That way, you do not accidentally select the drawing layer when you want to animate on the peg.

When disabled, the Transform tool selects the drawing layers.

Snap Options



When transforming or repositioning a layer using the Transform tool, you can enable different snap options to help you.

-  **Snap and Align:** Snaps the selected layer to any existing object, while automatically displaying temporary rulers that guide you and that you can also snap your object to.
-  **Snap to Grid:** Snaps your selection according to the currently enabled grid.

Hide Manipulator Controls

The Hide Manipulator Controls  button lets you hide the bounding box and manipulator controls from the Camera view when an element is selected.

Flip Horizontal and Flip Vertical

The Flip Horizontal  and Flip Vertical  buttons let you flip the selected element horizontally or vertically. You can also select **Animation > Flip > Flip Horizontal** and **Flip Vertical** from the top menu or press 4 or 5.

Rotate 90 Degrees CW and CCW

The Rotate 90 Degrees CW  and Rotate 90 Degrees CCW  operations rotate the current selection 90 degrees clockwise or counter-clockwise.

Width and Height

The Width

 and Height  fields allow you to enter specific values for accurately resizing a selected layer.

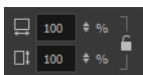

- **Width:** Enter a width value in this field to resize the width of your selection.
- **Height:** Enter a height value in this field to resize the height of your selection.
- **Lock:** Click the Lock icon to lock or unlock the ratio between the width and height values.

Offset X and Y

Use the Offset X  and Offset Y  fields to enter specific values to reposition the selected layer accurately.



- **X:** Enter an offset value in this field to reposition the selected layer along the X-axis.
- **Y:** Enter an offset value in this field to reposition the selected layer along the Y-axis.

Angle

The Angle  field lets you enter specific values to rotate the selected layer accurately. A positive value rotates the layer counterclockwise and a negative value rotates the layer clockwise.

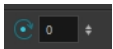

- **Angle:** Enter a degree value in this field to rotate the selected layer.

Positioning an Element Using the Advanced Animation Tools

You can also use the advanced animation tools to position your layers. The difference between these tools and the Transform tool is that they modify only one parameter of the position such as the rotation or the scale as the Transform tool adjusts all parameters together.

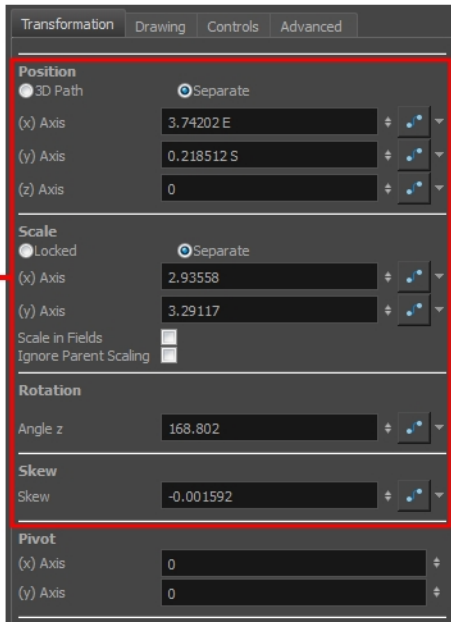



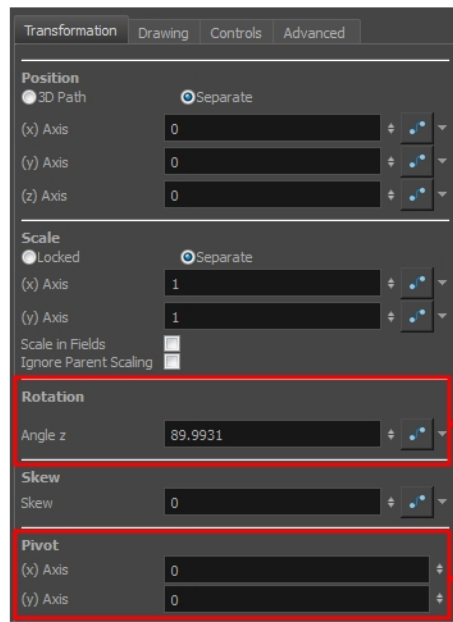

The Transform tool can affect the Position, Scale, Rotation, and Skew parameters, but not the Pivot parameter.



The Rotation tool only affects the Rotation and Pivot parameters.

Transformations, such as rotation, scale, skew and flip, are made relative to the pivot point position. You can reposition this pivot point anywhere using the advanced animation tools.

How to permanently reposition the pivot point

1. In the Advanced Animation toolbar, select the Translate , Rotate , Scale , or Skew  tool.
2. In the Camera view, Ctrl + click (Windows/Linux) or ⌘ + click (Mac OS X) to select your element.

The pivot point appears in the Camera view.

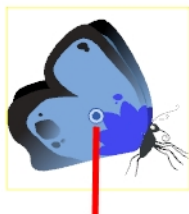

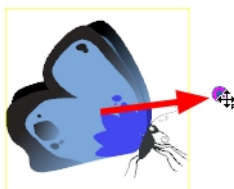

Pivot point

3. Drag the pivot point to a new position.



All transformations, including existing ones will be recalculated from this new pivot position.

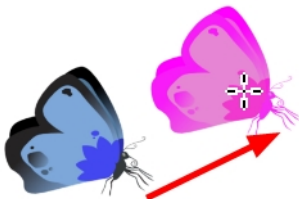

How to pan a layer using the Translate tool

1. In the Tools toolbar, disable the Animate  mode.
2. Do one of the following:
 - ▶ From the top menu, select **Animation > Tools > Translate**.
 - ▶ In the Advanced Animation toolbar, click the Translate  tool.
 - ▶ Press Alt + 2.
3. In the Camera view, Ctrl + click (Windows/Linux) or ⌘ + click (Mac OS X) to select your element.
4. Drag the selection to a new area.



- ▶ You can select multiple layers at the same time. Press Ctrl + Shift + click (Windows/Linux) or ⌘ + Shift + click (Mac OS X) on each element to select them.

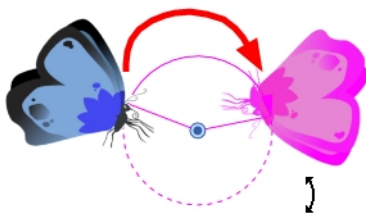

How to rotate a layer using the Rotate tool

1. In the Tools toolbar, disable the Animate  mode.
2. Do one of the following:
 - ▶ From the top menu, select **Animation > Tools > Rotate**.
 - ▶ In the Advanced Animation toolbar, click the Rotate  tool.
 - ▶ Press the Alt + 3.
3. In the Camera view, Ctrl + click (Windows/Linux) or ⌘ + click (Mac OS X) to select your element.
4. Rotate the layer.



- ▶ You can select multiple layers at the same time. Press Ctrl + Shift + click (Windows/Linux) or ⌘ + Shift + click (Mac OS X) on each element to select them.

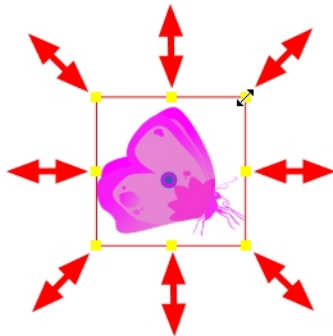

How to scale a layer using the Scale tool

1. In the Tools toolbar, disable the Animate  mode.
2. Do one of the following:
 - From the top menu, select **Animation > Tools > Scale**.
 - In the Advanced Animation toolbar, click the Scale  tool.
 - Press Alt + 4.
1. In the Camera view, Ctrl + click (Windows/Linux) or  + click (Mac OS X) to select your element.
3. Pull or push either on the side, top or corner control point. Hold down Shift to lock the selection's ratio when using the corner control points.



- You can select multiple layers at the same time. Press Ctrl + Shift + click (Windows/Linux) or  + Shift + click (Mac OS X) on each element to select them.

How to scale a layer using the Skew tool

1. In the Tools toolbar, disable the Animate  mode.
2. Do one of the following:
 - Select **Animation > Tools > Skew**.
 - In the Advanced Animation toolbar, click the Skew  tool.
 - Press Alt + 5.
3. In the Camera view, Ctrl + click (Windows/Linux) or  + click (Mac OS X) on the element to select it and drag a side of the bounding box up, down or sideways.

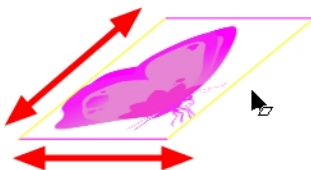

- You can select multiple layers at the same time. Press Ctrl + Shift + click (Windows/Linux) or  + Shift + click (Mac OS X) on each element to select them.

Positioning an Element Using the Layer Properties View

Each layer has a series of parameters that you can modify to adjust an element's position. You can access these parameters in the Layer Properties view. In this view, you can type in a value instead of moving the object in the Camera view. These values can also be animated over time. See [Drawing Layer Properties Reference](#) on page 133 for additional details.

You can also access a layer's parameters in the Timeline view. Click on the Expand Parameters  button.

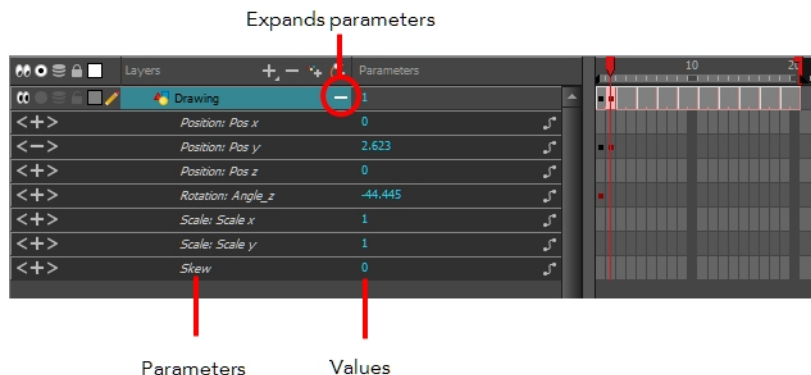

It is important to understand the coordinate values in Harmony. Harmony's core is based on the origins of animation. In traditional animation, a scene's size and camera motion are calculated in fields. A field has a 4:3 ratio and measures 0.5 inches (12.7 mm) in width. A specific grid has been created for this purpose known as a *field chart*. Harmony uses this unit of measurement as its coordinate system.

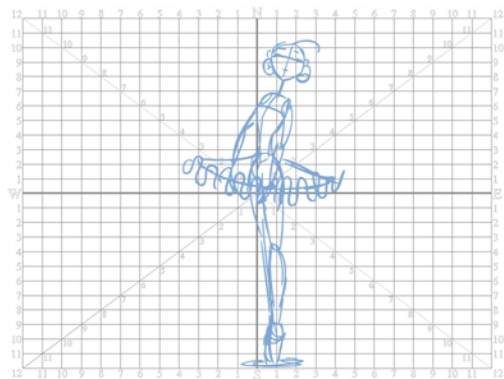

A field chart uses the cardinal directions. The X axis is the east-west (left-right) direction, the Y axis is the north-south (up-down) direction and the Z axis is the forward-backward direction.

In Harmony, a drawing's pivot is located at the centre of the field chart, regardless where your drawing has been drawn on the page. Your drawing is the entire sheet of paper, not only the drawing strokes you have drawn on the page. This allows scanned drawings, imported images and paperless drawings to be properly registered together.

If you want to move your drawing in the upper-left region of the camera frame, you would type in something like the following:

- X Axis: -4 or 4W (4 West)
- Y Axis: 5 or 5N (5 North)

If you want to move your drawing in the lower-right region of the camera frame, you would type in something like the following:

- X Axis: 3 or 3E (3 East)
- Y Axis: -2 or 2S (2 South)

How to display layer parameters

1. Do one of the following:
 - ▶ In the Layer Properties view is not part of your workspace, from the top menu, select **Windows > Layer Properties**. In the Timeline view, select a layer
 - ▶ In the Timeline view, double-click on a layer.
 - ▶ Press Shift + E.

The properties display.

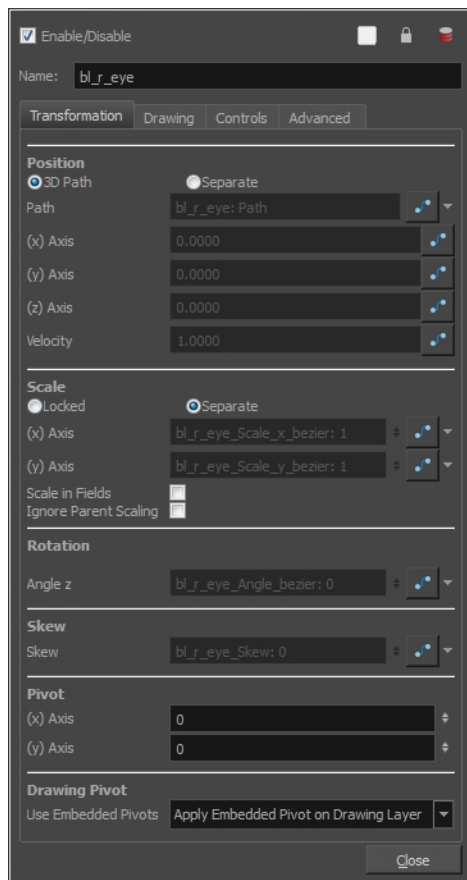

How to position an element

1. In the Timeline view, select a layer.
2. In the Position section, select one of the following options:
 - ▶ **Separate** to independently edit the different coordinate fields. Continue to step 3.
 - ▶ **3D Path** to use a 3D path function when animating your element. Continue to step 4.

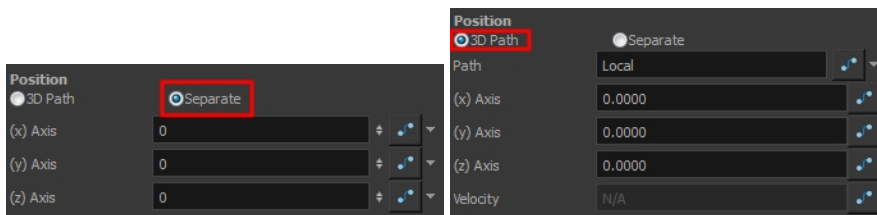

3. In the (x), (y) and (z) Axis fields, type in a new coordinates corresponding to the desired position—see [Creating a Multiplane on page 150](#).

As you type in values, the element's position is updated in the Camera view.

1. Use the Function  buttons to create function curves and add keyframes to animate the parameter.
4. In the Scale section, select one of the following options:
 - ▶ **Locked** to resizes the element uniformly in three directions.
 - ▶ **Separate** to resize the element in any direction without affecting the others.

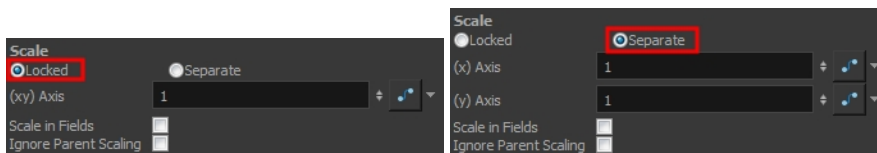

5. In the (x) and (y) Axis fields, type in a new coordinates corresponding to the desired position
2. Use the Function  buttons to create function curves and add keyframes to animate the parameter.
6. In the Rotation section, Angle z field, type in a degree value for the rotation angle. Note that you can enter values greater than 360 and -360 degrees. If you enter 720, the object will rotate twice.



7. In the Skew field, type in a degree value between -90 to 90 for the skew angle.



8. In the Pivot section, type in the desired coordinate value to reposition the transformation pivot. This will change the permanent position of the pivot.

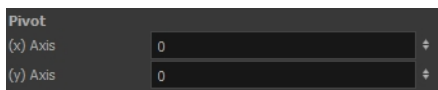

For detailed information on the Layer Properties parameters, see [Drawing Layer Properties Reference on page 133](#).

Drawing Layer Properties Reference

The drawing layer's properties is composed of the following tabs:

- [Transformation Tab on page 134](#)
- [Drawing Tab on page 136](#)

- [Controls Tab](#) on page 138
- [Advanced Tab](#) on page 139

Transformation Tab

The Transformation tab contains parameters for adjusting the position, scale, rotation, skew and pivots of an element.

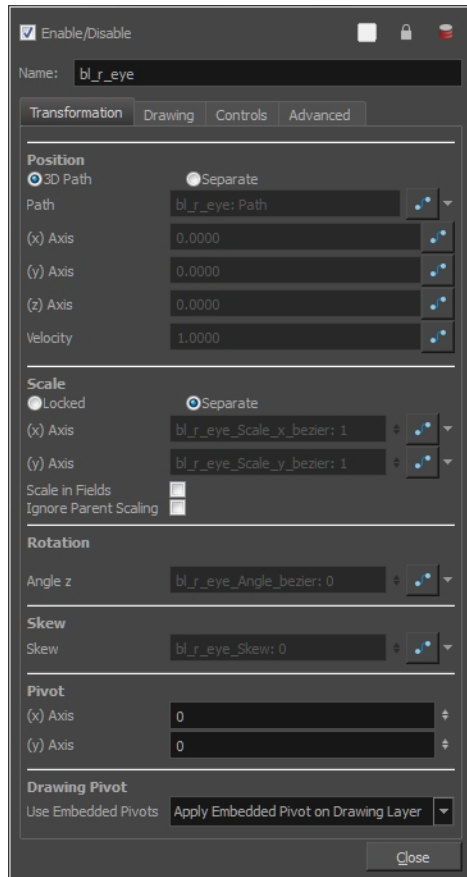

Parameter	Description
Position	<p>3D Path: Lets you use a 3D path function to animate an element.</p> <p>Separate: Lets you independently edit the different coordinate fields.</p> <p>Path (x) Axis: Lets you type in a new East/West coordinate corresponding to the desired position.</p> <p>Path (y) Axis: Lets you type in a new North/South coordinate corresponding to the desired position.</p> <p>Path (z) Axis: Lets you type in a new Forward/Backward coordinate corresponding to the desired position.</p> <p>Velocity: When the 3D Path option is selected, lets you set the speed at which</p>
Scale	<p>Locked: Resizes the element while keeping its ratio. The X and Y axes scale</p>

	<p>proportionally</p> <p>Separate: Resizes the element allowing to modify the ratio (squash and stretch).</p> <p>(x) Axis: Lets you type in the horizontal scale value.</p> <p>(y) Axis: Lets you type in the vertical scale value.</p> <p>Scale in Fields: Instead of using the standard scaling units, when this option is enabled, images are scaled using field units, based on the traditional animation field chart.</p> <p>Ignore Parent Scaling: When this option is enabled, any scaling value applied to a parent layer is ignored in the current layer. This can be handy in cut-out rigs when you need to scale an arm without affecting the forearm.</p>
Rotation	<p>Angle z: Lets you type in a degree value for the rotation angle. Note that you can enter values greater than 360 and -360 degrees. If you enter 720, the object will rotate twice.</p>
Skew	<p>Skew: Lets you type in a degree value between -90 to 90 for the skew angle.</p>
Pivot	<p>(x) Axis: Lets you type in a new East/West coordinate corresponding to the desired position.</p> <p>(y) Axis: Lets you type in a new North/South coordinate corresponding to the desired position.</p>
Drawing Pivot	<p>Use Embedded Pivots:</p> <p>Harmony has three types of pivots:</p> <ul style="list-style-type: none"> <p>Permanent Pivot</p> <p>This is a permanent pivot, sometime referred to as peg pivot, that is applied to the entire drawing or peg layer. If you modify its position, it will be changed for the entire layer, modifying the animation, scale and rotation interpolation. The permanent pivot is set using the Rotate, Translate or Scale tool. The Transform tool will only move that pivot temporarily for positioning purposes, but the animation interpolation will be done from the original permanent pivot's position. The Transform tool is designed to move the pivot temporarily during the animation process. It also permits you to select multiple pegs and apply a common temporary pivot.</p> <p>To permanently move a peg pivot, use the Rotate or Scale tool. You can also directly type the values in the Layer Properties window in the Pivot section's (x) Axis and (y) Axis fields.</p> <p>In the Layer Properties window, in the Drawing Pivot section, select the Don't Use Embedded Pivot option to use the permanent pivot.</p> <p>Drawing Pivot</p> <p>The Drawing pivot is contained within each drawing. In one layer, each drawing can have its own pivot. If you have many different views of a character within one layer, the pivot can be different and the animation will adjust to the pivot. The Drawing pivot can also be</p>

referred to as *embedded pivot*. If you are not mixing different views within the same layers or are using pegs to animate your layers, it is recommended to use the permanent pivot.

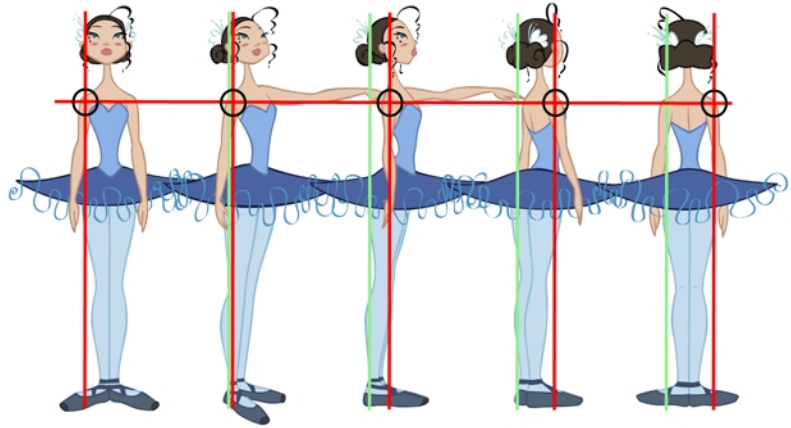

You can set a different pivot for each one of your drawings. For example, if you have a series of drawings from different views, they are not likely to rotate from the same location. In that case, you can set a different pivot for these drawings by using the Drawing Pivot  tool.

In the Layer Properties window, in the Drawing Pivot section, select the **Apply Embedded Pivot on Drawing Layer** option to use the drawing pivot directly on the drawing layer. If you want to apply the drawing pivot to a parent peg to force the peg to follow the drawing pivot variations, enable the **Apply Embedded Pivot on Parent Peg** option.

- **Symbol Pivot**

The Symbol pivot is similar to the Drawing pivot. Each symbol cell can have its own pivot and act the same as the Drawing pivot. The Symbol pivot can also be referred to as *embedded pivot*. Inside a symbol, each drawing can have its own pivot. If you are not mixing different views within the same layers or are using pegs to animate your layers, it is recommended to use the Peg pivot.

For a simple character rig, it is recommended to set the Peg pivot (even on drawing layers) using the Rotate  tool.

Drawing Tab

The Drawing tab contains parameters for the element columns, designating art layers, and setting bitmap options.

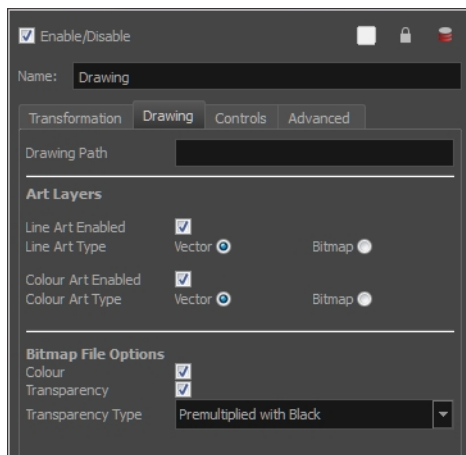

Parameter	Description
Art Layers	<p>Overlay Art Enabled: Enables the Overlay Art display.</p> <p>Line Art Enabled: Enables the Line Art display.</p> <p>Colour Art Enabled: Enables the Colour Art display.</p> <p>Underlay Art Enabled: Enables the Underlay Art display.</p> <p>Overlay Art Type: Allows you to set the Overlay Art as Vector or Bitmap type.</p> <p>Line Art Type: Allows you to set the Line Art as Vector or Bitmap type.</p> <p>Colour Art Type: Allows you to set the Colour Art as Vector or Bitmap type.</p> <p>Underlay Art Type: Allows you to set the Underlay Art as Vector or Bitmap type.</p>
Bitmap File Options	<p>When an image is created with an external software and that image has some transparency, there are several formats the software can use when writing the RGB channels. The purpose of the four import options for the transparency is for the user to tell Harmony how to interpret the RGB channels of the imported image. The correct option has to match the output format of the software that was used to create the image in the first place. For instance, if you used Adobe Photoshop and exported an image as Straight, then it should be imported in Harmony as Straight in order to get the correct result.</p> <p>Note that if the image has no alpha channel or if it does have an alpha channel and all the pixels are 100% opaque, it does not make any difference which option is selected.</p> <p>Colour: Controls the production of colour information from bitmap images. If this module reads 3 or 4-channel bitmaps, this selection determines whether the colour should be read or ignored. If this module reads 1-channel bitmaps, this selection determines whether the channel should be read as colour. When this option is selected with 1-channel images, the resulting image will be a greyscale image.</p> <p>Transparency: Controls the production of alpha information from bitmap</p>

	<p>images. If this module reads a 1 or 3-channel image, this option will create a matte from the colour values in the image. If the module reads a 4-channel image and this option is not selected, the alpha information in the image will be ignored.</p>
	<p>Transparency Type</p> <p>Premultiplied with Black: Semi-transparent pixels in the original image are blended with black.</p> <p>Premultiplied with White: Semi-transparent pixels in the original image are blended with white.</p> <p>Straight: Semi-transparent pixels in the original image are left as is (unmatted).</p> <p>Clamp Colour to Alpha: Semi-transparent pixels in the original image are blended with black. On import, each of the RGB channels is clamped so that a color value never exceed the alpha value for a given pixel. When the RGB values are multiplied with the alpha value, that is to say, if you have a pixel of value R=247, G=188, B=29 and the alpha is 50% or the image has a 50% transparency, then the actual RGB values output would be half of the amounts listed above.</p>

Controls Tab

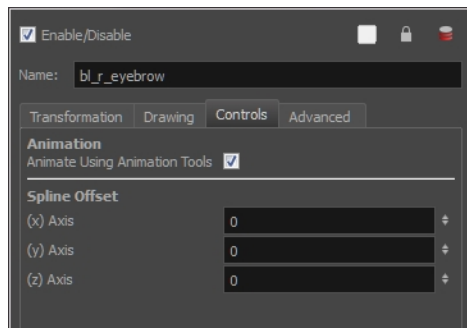

The Controls tab contains animation control options.

Parameter	Description
Animation	<p>Animate Using Animation Tools: By default, a drawing layer can be animated using the same parameters as a peg, but you can disable this feature. Being able to switch your drawing layers so they can no longer be animated without a peg has certain advantages. In cut-out animation, it is easier to separate your drawing exposure and keyframes to change timing easier and rearrange keyframe position in the Timeline view. This feature is also available for backward compatibility when bringing in templates created in older versions of the software, so as not to lose their offset keyframes or drawing substitution keyframes.</p>
Spline Offset	<p>In the X, Y and Z axis fields, type the coordinates of where you want to offset the visual trajectory. By default, the trajectory is displayed at the centre drawing, using the layer's pivot position. If you want to move it so it corresponds better with your drawing, either type new coordinates or use</p>

the Spline Offset tool available in the Advanced Animation toolbar.

To display the trajectory in the Camera view, select your drawing and select **View > Show > Control**. You can also press Shift + F11 (Windows/Linux) or ⌘ + F11 (Mac OS X).

Advanced Tab

The Advanced tab contains options for setting the alignment of drawings, line thickness, vector render options, and more.

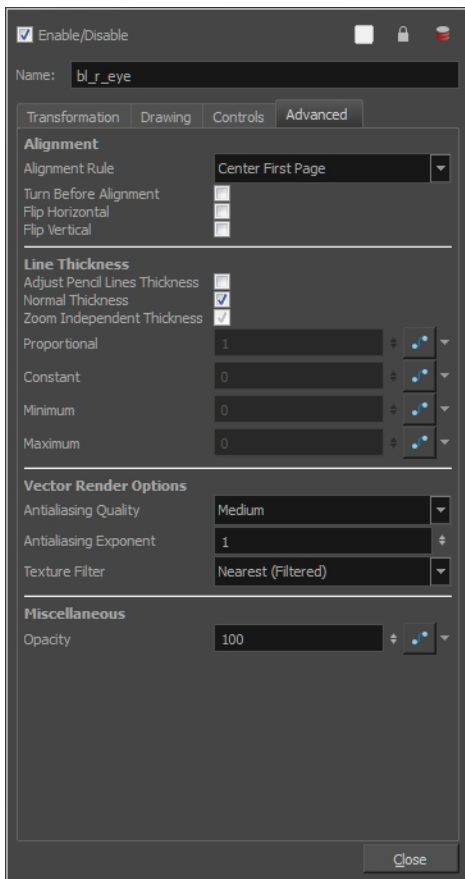

Parameter	Description
Alignment	<p>Alignment Rule: The alignment rule selections are intended to deal with drawings that were created on paper of a different size or orientation from the default alignment rule (set up in the Scene Settings dialog box) or imported bitmap images. The drawings are then scaled to match the Harmony alignment rectangle. Note that alignment rules are not based on the camera frame, but on the scene frame. Refer to the Fundamentals Guide to learn more about scene alignment and scene settings.</p> <ul style="list-style-type: none"> • Left: The default alignment for drawings; aligns the drawings to the left side of the scene's alignment rectangle. Harmony scales the drawings to match their height to the alignment rectangle of the scene.

	<ul style="list-style-type: none"> • Right: Aligns the drawings to the right side of the alignment rectangle. Harmony scales the drawings to match their height to the height of the alignment rectangle of the scene. • Top: Aligns the drawings to the top of the alignment rectangle. Harmony scales the drawings to match their widths to the width of the alignment rectangle of the scene. • Bottom: Aligns the drawings to the bottom of the alignment rectangle. Harmony scales the drawings to match their widths to the width of the alignment rectangle of the scene. • Centre Fit: Centers the drawings. • Centre Fill: Centers the drawings and then scales them so the width or height fills the available space. • Centre LR: Aligns the drawings in the left-right centre of the alignment rectangle. Harmony scales the drawings to match their height to the height of the alignment rectangle of the scene. • Centre TB: Aligns the drawings in the top-bottom centre of the alignment rectangle. Harmony scales the drawings to match their widths to the width of the alignment rectangle of the scene. • Stretch: Scales the drawings so they fit within the alignment rectangle of the scene. This is particularly useful for images that you will manipulate with a Quadmap node. If the drawings in the Quadmap node do not have the same aspect ratio as the alignment rectangle of the scene (from the Scene Settings dialog box), the handles on the quadmap will not appear on the corners of the image, making it difficult to manipulate the quadmap. In this case, you would set the drawing layer of the quadmap images to Stretch to make the handles appear on the corner of the image. This can have the effect of distorting the images, but it is not an issue with images that will be distorted through the Quadmap node anyways. • As Is: Leaves the drawings aligned as they are. • Centre First Page: Aligns the centre of the first part of a standard panel with the centre of the field chart.
	<p>Turn Before Alignment: Rotates the drawings in the selected element 90 degrees to the left before scaling and aligning them according to the alignment rule, and before performing any offset, rotation or scaling for the element or peg. This and the Alignment Rule are intended for drawings that were created on paper of a different size or orientation than the other paper in the scene, and requires alignment so they are treated accurately.</p>
	<p>Flip Horizontal: Flips the drawing on the X-axis.</p>
	<p>Flip Vertical: Flips the drawing on the Y-axis.</p>
Line Thickness	As you move the camera in your scene along the Z-axis, notice that, logically, the lines of the elements become thicker the closer the camera gets to the

	<p>drawing. If you prefer the lines to remain the same size or become thicker at a different speed, you can use the thickness feature to adjust your brush stroke and pencil line thickness. You can modify the size of the lines even if the camera is not animated.</p> <p>To learn how to use this feature, see Camera Truck-ins and Line Thickness on page 176.</p> <p>Adjust Pencil Lines Thickness: Lets you work with pencil lines and adjust their thickness. You will not see any changes to lines in the Camera view OpenGL mode. You must switch to the Render mode.</p> <p>Normal Thickness: Disables all overrides on the brush stroke line thickness. This option must be enabled in order for the pencil line thickness parameter and pencil lines to appear. If you want to modify the brush stroke thickness, deselect this option. To enable brush strokes to work with the line thickness feature, you must first create central strokes in the Colour Art layer. The central strokes control the line variation of your brush strokes in the Line Art layer. Select Drawing > Create Colour Art from Line Art.</p> <p>Zoom Independent Thickness: Select this if you want your line thickness to remain constant independently from the camera move. Everything else will increase in size, but the line thickness will stay the same.</p> <p>Proportional: Enter a multiple by which you want to increase the line thickness base on its original thickness. A value of 1 will result in no change; a value of 0 (zero) will hide the lines.</p> <p>Constant: Enter a value in pixels (based on a 720x540 screen resolution) to indicate the amount of pixels you want to add around the existing line.</p> <p>Minimum: Enter a value in pixels (based on a 720x540 screen resolution) for the minimum line thickness allowed.</p> <p>Maximum: Enter a value in pixels (based on a 720x540 screen resolution) for the maximum line thickness allowed.</p>
Vector Render Options	<ul style="list-style-type: none"> • Antialiasing Quality: A smoothness (antialiasing) setting applied to the final rendered image. <ul style="list-style-type: none"> • Low: No antialiasing • Medium Low: Basic antialiasing • Medium: Improved antialiasing (blurs the textures) • High: High quality antialiasing (does not blur the textures) <p>Higher quality images require more time to render and more system memory. Choose a lower quality if you are rendering a pencil test.</p> • Antialiasing Exponent: Controls the size of the area around the final image edges used in the antialiasing process. A higher value uses less area, resulting in sharper edges, while a lower value uses more area, resulting in softer edges. If the Antialiasing Quality value is set to Low (no antialiasing) or Medium Low, this value is ignored. Values: Between 0 and 1. • Texture Filter: This option changes the way coloured pixels of TVG

	<p>textures are calculated when rendered for different degrees of accuracy.</p> <ul style="list-style-type: none"> • Bilinear: This option takes the four pixels around each point and makes a bilinear interpolation between them. (Medium Quality) • Nearest: This option chooses the colour of the closest pixel to a point. (Lower Quality) • Nearest (Filtered): This option is an improved version of Bilinear and improves the quality when zooming on a texture. (Best Quality)
Miscellaneous	<ul style="list-style-type: none"> • Opacity: Lets you quickly change the transparency of the selected element. Opacity settings here will be reflected in both OpenGL preview, and full render.

Setting Properties for Many Layers

When working with several nodes, you may frequently want to modify a series of settings. Instead of opening the properties for each individual layer, you can set the properties for many layers so you can change a common setting in a single click.

This allows you to modify the following settings:

- 3D Path or Separate mode
- Use Embedded Pivot
- Overlay
- Line Art
- Colour Art
- Underlay
- Animate Using Animation Tools

NOTE: You can add the button to the Timeline View toolbar through the Toolbar Manager. In the Toolbar Manager, you will find the feature in the script section under the name Script: TB_Set_Properties_on_manu_layers in TB_Set_Properties_on_many_layers.js.

How to set properties for many layers

1. In the Timeline view, select all the layers you want to modify at the same time.
2. In the Timeline View toolbar, click the Set Properties for Many Layers  button. This option is not available by default in the Timeline View toolbar. You must add it through the Customize option. Right-click on the toolbar and select Customize. In the Available Tools list, select Script: TB_Set_Properties_on_many_layers and move it to the Toolbar list.

The Set Properties for Many Layers dialog box opens.

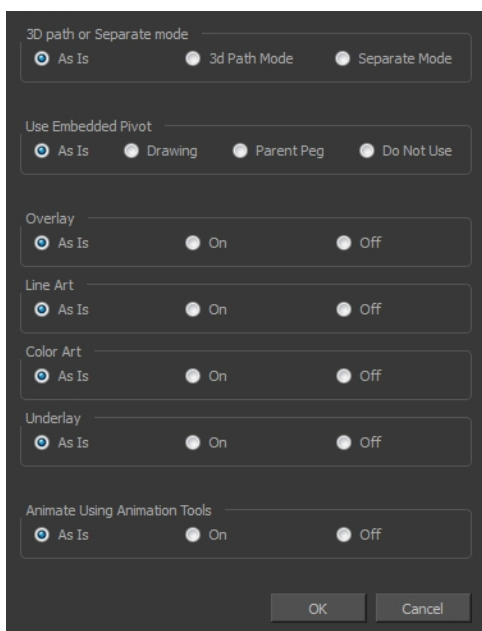

3. Modify the properties. If your nodes have different parameters enabled for a certain setting, leave the **As Is** option selected to avoid modifying it. Each node will keep its original setting. Select any other options for all nodes to change to this parameter regardless of their original setting.
4. Click **OK**.

Auto Apply Option

When you modify a parameter in a property dialog box, Harmony applies the modification automatically and displays the result immediately in the Camera view. If you do not want to immediately display every change made to your scene, turn off this default setting by deselecting the Auto Apply option. This is useful when you are working on a very heavy scene.

When you disable this function, Apply and OK buttons are added at the bottom of the Layer Properties view and any other parameter dialog boxes.

- Click **Apply** to apply the current change.
- Click **OK** to apply the current change and close the Layer Properties.

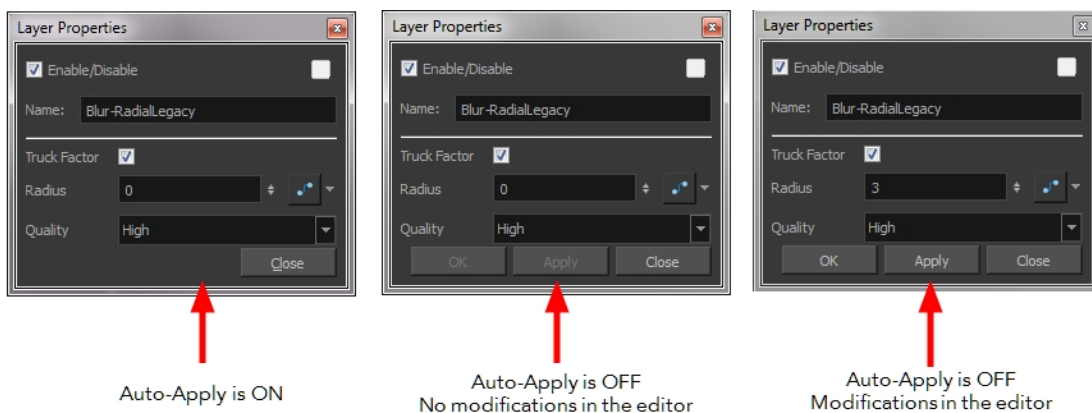

NOTE: If you want to always work in Auto-Apply mode, you can deselect the Auto-Apply option in the Preferences dialog box. Then, each time you start Harmony, the Auto-Apply mode will be off. You must click the Apply button to see any modifications.



How to enable or disable the Auto Apply option

- ▶ From the top menu, select **Edit > Auto-Apply**.

How to enable or disable the Auto-Apply preference

1. In the top menu, select **Edit > Preferences** (Windows/Linux) or **Stage Advanced > Preferences** (Mac OS X).
The Preferences dialog box opens.
2. In the Preferences dialog box, select the **General** tab.
3. In the Options section, select or deselect the **Auto Apply** option.

Resetting a Transformation

You can easily reset layers to their original position. With the Reset command, you can return the value of a selected element to the initial value of the active tool. For example, if the Rotate  tool is active, the transformation angle will be reset to 0 and if the Transform  tool is active, the all transformation parameters values will be reset.





When selecting elements in the Camera view using the Transform tool, always make sure that the Peg Selection Mode  is deselected in the Tool Properties view. Otherwise, it will limit the selection to pegs only.

How to completely reset the layers' parameters

1. In the Tools toolbar, select the Transform  tool or press Shift + T.
2. In the Timeline or Camera view, select one or more drawing layers to reset.
3. Do one of the following:
 - ▶ From the top menu, select **Animation > Reset** or press R. This will reset the current frame if keyframes were created.
 - ▶ Right-click the selected layers and select **Clear All Values**. This will remove all keyframes and reset all values for the entire layer.
 - ▶ In the Timeline view menu, select **Layers > Clear All Values**. This will remove all keyframes and reset all values for the entire layer.

The selected layers return to their original position.

How to reset an individual parameter

1. In the Advanced Tools toolbar, select the Translate , Rotate , Scale , or Skew  tool based on the parameter to reset.
2. In the Timeline or Camera view, select the layer to reset.
3. From the top menu, select **Animation > Reset** or press R. This will reset the current frame if keyframes were created.

The selected parameter returns to its original position.

How to reset all transformation values except Z

1. In the Tools toolbar, select the Transform  tool or press Shift + T.
2. In the Timeline or Camera view, select one or more drawing layers to reset.
3. From the top menu, select **Animation > Reset All Except Z**.

All values except for those set on the Z axis are reset.

Cloning and Duplicating Layers

At times, you will need to create a large group of characters such as a crowd, school of fish or flock of birds. You can do this by cloning or duplicating a layer. The difference between cloning and duplicating is that a clone uses the same drawings for all layers. A duplicated layer is simply an independent copy.

If you want to maintain the ability to modify drawings and propagate the changes through all layers, you should clone your layer. If you simply want to copy your layers and be able to modify your drawings without affecting the original layer, use the duplicate option.

Cloning Layers

A cloned layer is linked to the original element directory. If a drawing is modified in the original or cloned layer, both will be updated. However, cloned layers can have different timings.



Cloned layer - Changes to the original layer propagate to the cloned layer.

When cloning layers, you have the ability to clone the drawings and the corresponding columns (timing) or only the drawings. If you choose to clone the drawings and timing, your node will be linked to the same element folder, as well as the same drawing and function columns. Therefore, if you change the drawing exposure or keyframe on one layer, all cloned layers will be updated.

You may want to create a large group of characters reusing the same animation, but want to slightly offset the timing so they're not dancing or walking quite on the same beat. For example, if you create a walk-cycle for a soldier and want to use it for an entire army, you may want to have 50 layers with 50 different drawing exposures to produce a slight difference in the timing. If you copy your layers and drawings 50 times over, it will create a heavier scene. It is better to clone the 50 layers with only their drawings without linking to the same timing (function and exposure columns).

How to clone a layer

1. In the Timeline, Xsheet view, select a layer to clone. You can select multiple layers.
2. Do one of the following:
 - ▶ From the Xsheet menu, select **Columns > Clone Selected Columns: Drawings Only** or **Columns > Clone Selected Columns: Drawings and Timing**.
 - ▶ From the top menu, select **Edit > Clone Drawings Only** or **Edit > Clone Drawings and Timing**.
 - ▶ From the Timeline menu, select **Layers > Clone Selected Layers: Drawings Only** or **Layers > Clone Selected Layers: Drawings and Timing**.
 - ▶ In the Timeline view, right-click on the layers and select **Clone Selected Layers: Drawings Only** or **Clone Selected Layers: Drawings and Timing**.

The cloned layer appears.

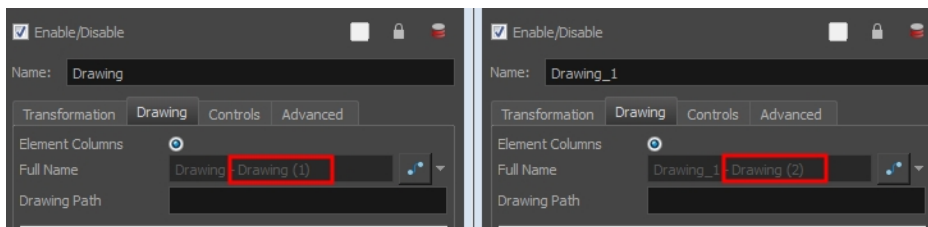

Duplicating Layers

You can duplicate a layer to have a copy of the drawings that are independent from the original ones, as well as an independent timing (exposure). When you need the drawings to be modified independently, you will want to duplicate the layer instead of cloning it.



Duplicated layer - Changes to the original layer do not propagate to the duplicated layer.

How to duplicate a layer

1. In the Timeline, Xsheet view, select a layer to clone. You can select multiple layers.
2. Do one of the following:
 - In the Timeline menu, select **Layers > Duplicate Selected Layers**.
 - In the Timeline view, right-click on the layers and select **Duplicate Selected Layers**.
 - From the Xsheet menu, select **Columns > Duplicate Selected Layers**.
 - From the top menu, select **Edit > Duplicate**.

The duplicated layer appears.

Working with Groups

With so many connections and nodes possible, the Timeline view can quickly become crowded. Keep things organized by grouping your nodes.

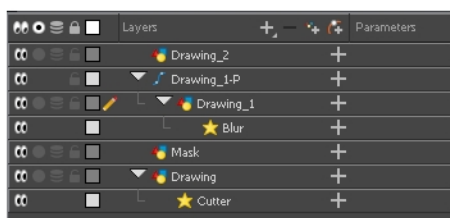

Ungrouped layers

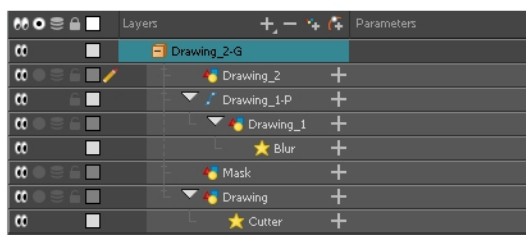

Grouped layers
Expanded group

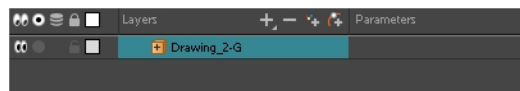

Grouped layers
Collapsed group

How to group elements in the Timeline view

1. In the Timeline view, select the elements you want to group.

Any layers between the selected layers will be automatically grouped as well, so if the stacking order does not matter, move extra layers above or below the layers want to group.
2. Do one of the followings:
 - Right-click on the highlighted layers and select **Group Selection**.

The layers appear indented under a new Group layer in the Timeline view.

Display Concepts

When you open a scene coming from Harmony Premium, it may contain multiple Display nodes allowing you to see isolated portions of the scene.

The Display node is an important node; it is used by the export and views to display your scene, primarily the Camera and Timeline views. By default, a scene's node system always has a Display node which can be used to show your entire scene, a single node or a group of nodes through a Composite or Group node. You might use it

to see one single character as you animate it, debug your node system as you create complex effects or export your complete scene or a portion of it.



Harmony Advanced doesn't allow you to add Display nodes. The display selection feature is only available for the possible scenario that you need to use a specific Display node created by a Harmony Premium user.

How to set a different Display node as a global display

- ▶ From the top menu, select **Scene > Default Display > *desired display***.

Each view is updated if set to the Default display option.

Timeline View Modes

The View Modes  button lets you streamline the process of working with elements in the Timeline view. There are three different view modes you can choose to work in. With each mode you select, certain elements may or may not be visible in the Timeline view. Depending on your workflow, this can be useful for quickly hiding elements when you want to focus on specific ones. To select a view mode, use the drop-down menu in the bottom-left corner of the Timeline view.

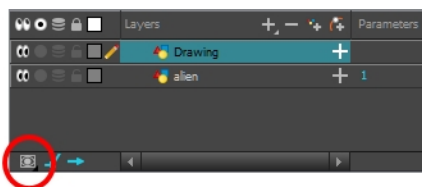

Normal View Mode

Normal View  mode is the default Timeline view mode. It shows everything connected to the chosen display. In this mode, anything not connected to the currently set default display will not be shown in the Timeline view. This also means that you cannot add certain elements to the Timeline view, as by default, when added they are not connected to any display or composite node. An example of such an element is a peg.

NOTE: If you prefer to work as you did before, where you see everything in the Timeline whether it is connected to a Display or not, you can change the Always Display Unconnected Nodes setting in the Preferences dialog box, Timeline tab.

Selection Only Mode

When working in Selection Only  mode, only elements currently selected in the Camera or Node view will be visible in the Timeline. This makes it easier to concentrate on one or a few elements at a time.

View Tagged Nodes

The View Tagged Nodes  mode lets you see only elements which have been assigned a Tagged status. An item that has been tagged will appear in the Timeline view with a small asterisk beside its name.

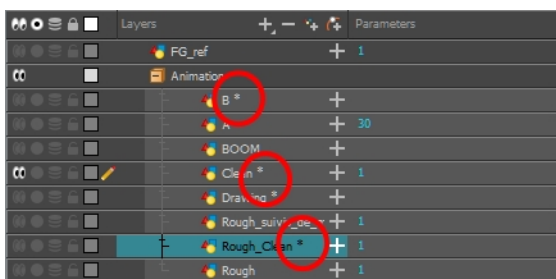

Once your elements are tagged and you have switched over to View Tagged Layers mode, the Timeline view will display only tagged elements. The red bar on the left of the layers indicates you are in this view mode.

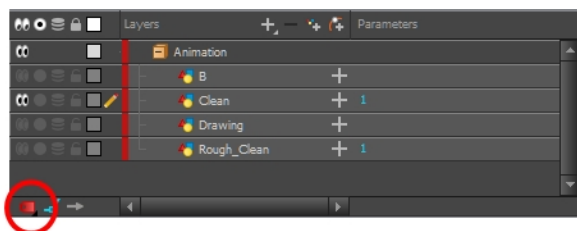

Viewing tagged layers in the Timeline view

While in this mode, the asterisks are not displayed beside the tagged elements.

How to tag or untag elements in the Timeline or Node view

1. In the Timeline or Node view, select one or more elements.
2. Do one of the following:
 - Right-click and select **Tag** and one of the following:
 - **Timeline Tag**
 - **Timeline Untag**
 - **Timeline Untag All**

- **Timeline Untag All Others**
- In the Timeline or Node view menu, select **Edit > Tag** and one of the following:
 - **Timeline Tag**
 - **Timeline Untag**
 - **Timeline Untag All**
 - **Timeline Untag All Others**

Creating a Multiplane



One of the most exciting features in Harmony is the multiplane or Z-depth. In the multiplane, you can create backgrounds in several layers, spread them on the Z-axis to add depth, and then move the camera through this environment to create an impressive perspective illusion.

To construct a multiplane, you must imagine what a real environment is like. Take a look at your background picture and imagine a camera moving through the space. Notice that objects in the picture move at different speeds depending on where they are in relation to the camera lens.

Building a multiplane requires an understanding of the scene's background, as well as the positioning of the elements on different layers.



For example, in the background illustrated above, the main objects to be separated are:

1. Fern
2. Front tower
3. Second tower
4. Moon
5. Stars
6. Sky

Although the bottom of the tower is hidden behind the plant and the ladder, each of the multiplane layers should be a complete drawing. This is because hidden portions may show up during a camera move later on in the scene.

You can position layers on the Z-axis using the Side and Top view.

Positioning your element closer to the camera makes them appear bigger. You can also move elements towards the camera or away from the camera while keeping the same size aspect ratio in the Camera view.

It is a good idea to keep a Camera view open to see what your scene looks like while positioning elements in the Top and Side views—see [Top View on page 153](#), [Side View on page 155](#) and [Perspective View on page 156](#).

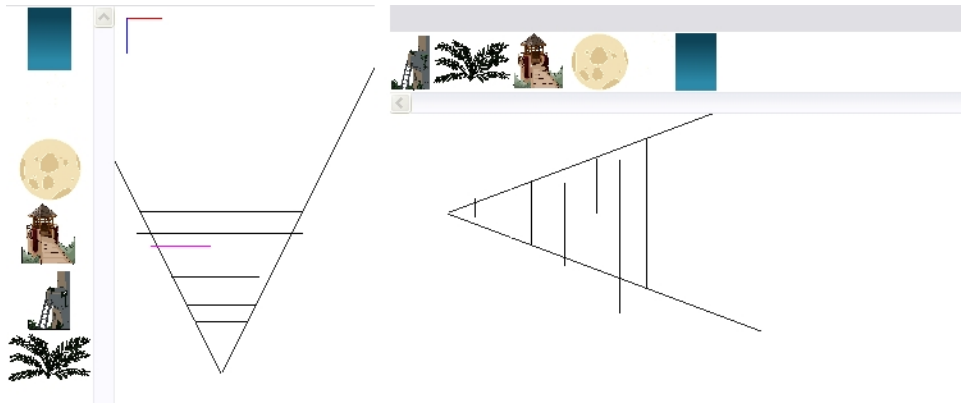

How to position an element in the Top and Side views

NOTE: Before distributing layers along the Z-axis using the Top and Side views, deselect the No Z Dragging option by selecting **Animation > No Z Dragging**. This option is disabled by default.

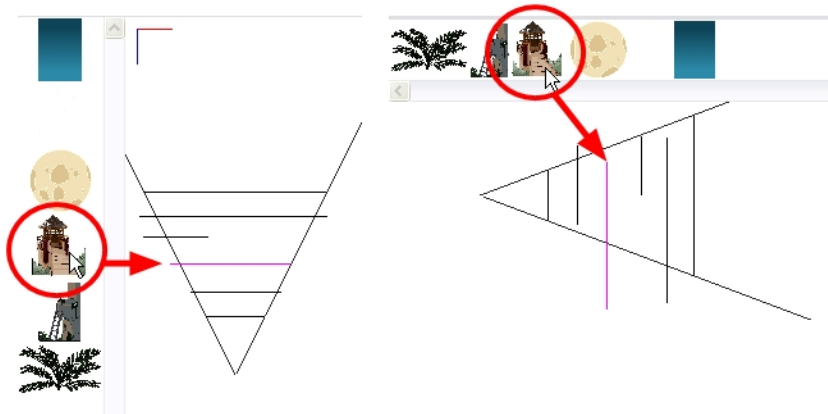

- To maintain the visual scale in the Camera view as you move your element, do one of the following:
 - ▶ In the Advanced Animation toolbar, select the Maintain Size  tool.
 - ▶ From the top menu, select **Animation > Tools > Maintain Size**.
 - ▶ Press Alt + 6.
- In the Side or Top view, select one of the layers in the thumbnails section. You can also select a layer from the Timeline view.

The selected layer is highlighted in the Top, Side and Camera views.

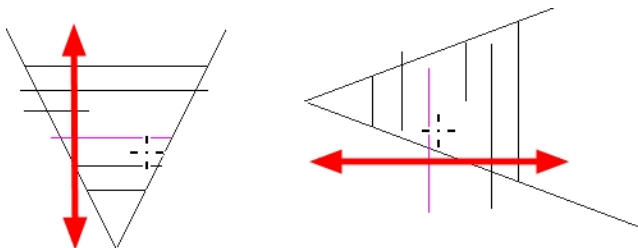

- Drag the layer to the correct depth position in the camera cone. Your element aspect will remain the same in the Camera view.



4. For your element to scale up or down in relation to their distance to the camera, do one of the following:
- ▶ In the Tools toolbar, select the Transform  tool. Make sure the Peg Selection Mode  option is disabled in the Tool Properties view.
 - ▶ In the Advanced Animation toolbar, select the Translate  tool and select a layer from the thumbnails section of the Top or Side view.
 - ▶ Select a layer from the Timeline view.
The selected layer is highlighted in the camera cone.

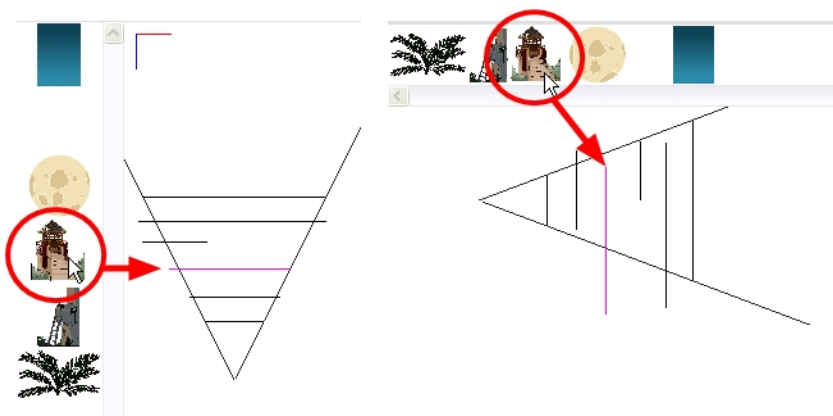



5. In the Top view, drag the element sideways to position it horizontally. Hold Shift while dragging the element to make sure it only moves along the X-axis.
6. In the Side view, drag the selected element up or down to position it vertically. Hold Shift while dragging the element to make sure it only moves along the Y-axis.

Top View

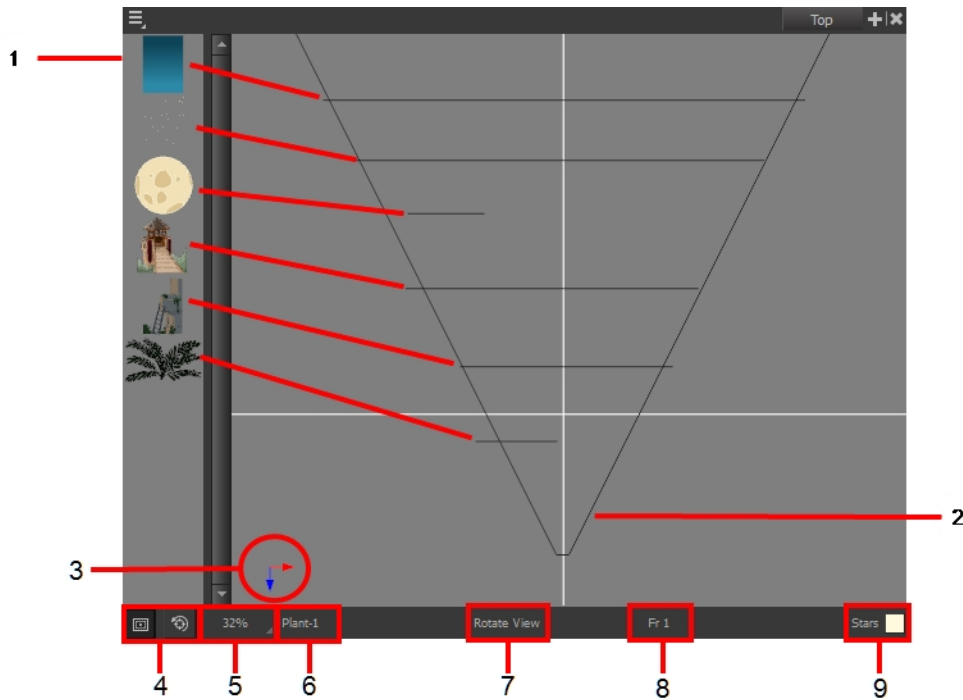
The Top view is used mainly for multiplane scenes and to position elements in 3D space. It allows you to see the scene's stage from above. This lets the camera cone and the spacing between the elements be seen.



1. A thumbnail of each drawing layer in the scene. The order of the thumbnail images is based on each element's FB position in the scene space. You can see a representation of the FB position of each layer in the camera cone.
2. The camera cone represents the camera's position and field-of-view (FOV).
3. The axis reference arrows let you maintain your orientation when navigating in the Perspective view.
4. There are two view option buttons displayed in the lower-left corner of the view.
 - ▶  **Show/Hide Camera:** Shows or hides the camera frame in the Perspective view.
 - ▶  **Reset View:** Resets the pan, rotation and zoom of the Perspective view.
5. This field displays the current zoom level in the Perspective view. You can use the Zoom menu to select a zoom level from 2.5% to 6400%. You can also select Fit To View to automatically use a zoom level that lets you see all of the scene layers and information in the Perspective view at once.

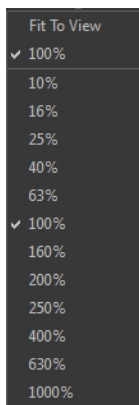



6. Displays the currently selected layer and drawing name.

7. Displays the currently selected tool.
8. Displays the currently selected frame of your animation.
9. Displays the currently selected colour in the palette.

Side View

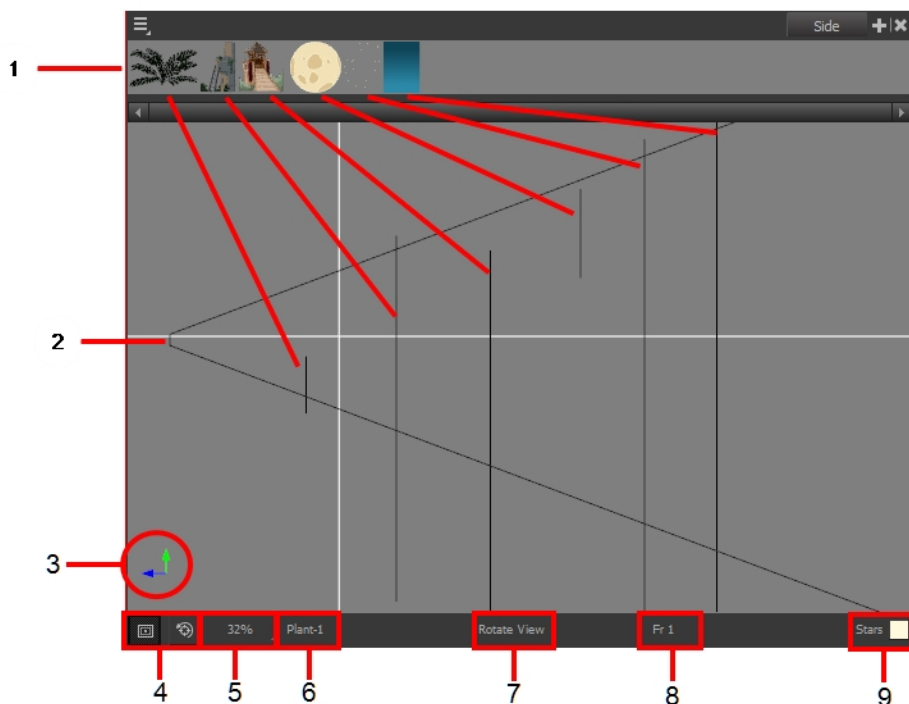
The Side view is used mainly for multiplane scenes and to position elements in 3D space. It allows you to see a scene's stage from the side. This lets the camera cone and spacing between the elements to be seen.



1. A thumbnail of each drawing layer in the scene. The order of the thumbnail images is based on each element's FB position in the scene space. You can see a representation of the FB position of each layer in the camera cone.
2. The camera cone represents the camera's position and field-of-view (FOV).
3. The axis reference arrows let you maintain your orientation when navigating in the Perspective view.
4. There are two view option buttons displayed in the lower-left corner of the view.
 - ▶  **Show/Hide Camera:** Shows or hides the camera frame in the Perspective view.
 - ▶  **Reset View:** Resets the pan, rotation and zoom of the Perspective view.
5. This field displays the current zoom level in the Perspective view. You can use the Zoom menu to select a zoom level from 2.5% to 6400%. You can also select Fit To View to automatically use a zoom level that lets you see all of the scene layers and information in the Perspective view at once.

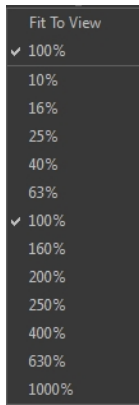



6. Displays the currently selected layer and drawing name.
7. Displays the currently selected tool.
8. Displays the currently selected frame of your animation.
9. Displays the currently selected colour in the palette.

Perspective View

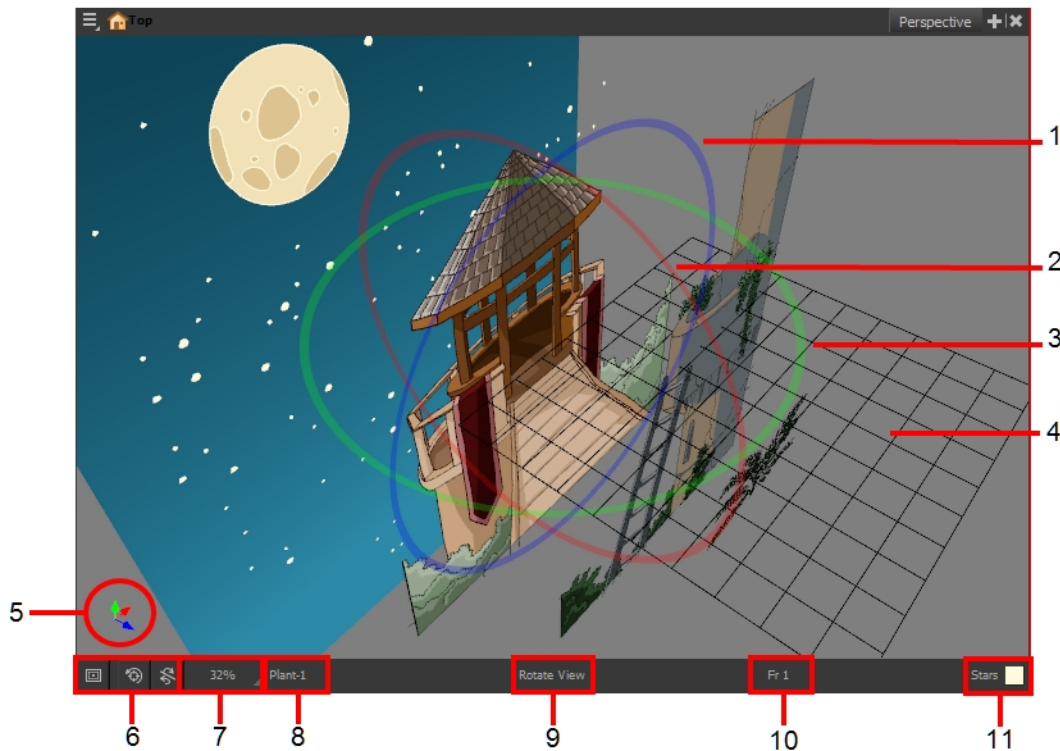
The Perspective view is used during scene setup. It allows you to see a multiplane scene's orientation. The Perspective view is similar to a 3D display, as it lets you rotate the scene through all possible angles to understand the spacing between the elements. You can also position and rotate your layers and the camera inside the 3D display to achieve some 3D setup and camera moves.



1. The red circle rotates the view on its X axis.

2. The green circle rotates the view on its Y axis.
3. The blue circle rotates the view on its Z axis.
4. This is a perspective grid reference.
5. The axis reference arrows let you maintain your orientation when navigating in the Perspective view.
6. There are three view option buttons displayed in the lower-left corner of the view.
 - ▶  **Show/Hide Camera:** Shows or hides camera frame in the Perspective view.
 - ▶  **Reset View:** Resets the pan, rotation, and zoom of the Perspective view.
 - ▶  **Reset Rotation:** Resets the rotation of the Perspective view.
7. This field displays the current zoom level in the Perspective view. You can use the Zoom level drop-down menu to select a specific zoom level from the list. Zoom levels from 2.5% to 6400% are available; you can also select Fit To View to automatically use a zoom level that lets you see all your scene layers and information in the Perspective view at once.

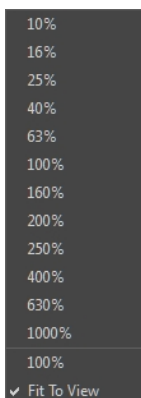

8. This field displays the currently selected layer and drawing name.
9. This field displays the currently selected tool.
10. This field displays the currently selected frame of your animation.
11. This field displays the currently selected colour in the palette.

How to rotate a scene in the Perspective view

1. In the Tools toolbar, select the Rotate View  tool.
 - ▶ Click in the view, and drag the cursor around to rotate the view.
 - ▶ Press and hold Ctrl + Alt (Windows/Linux) or ⌘ + Alt (Mac OS X) and click and drag to rotate the view one axis at a time.

Chapter 5: Animation Paths

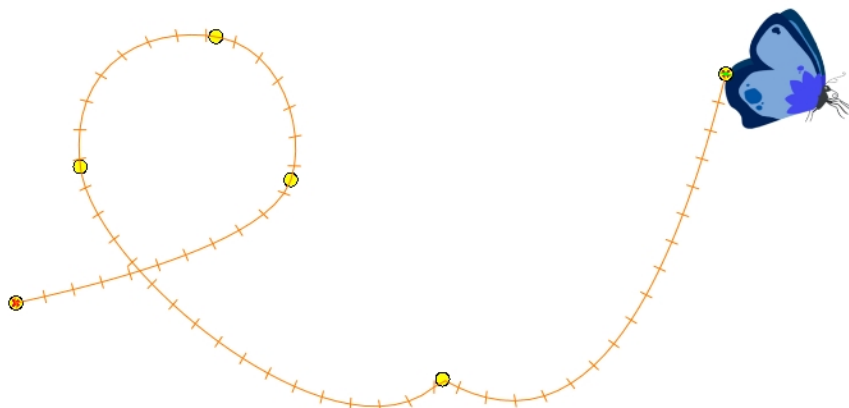

With Harmony, you can animate layers using computer-generated trajectories, create multiplane camera moves and camera shakes, adjust the easing, shape your paths with control points and much more.

This chapter contains the following topics:

- [Animating a Layer](#) on page 159
- [Differences between Animated Layers and Pegs](#) on page 161
- [Layer Parameters](#) on page 165
- [Adding and Deleting Keyframes](#) on page 168
- [Motion and Stop-motion Keyframes](#) on page 169
- [Animating the Camera](#) on page 173
- [Modifying a Path in the Camera, Top and Side Views](#) on page 177
- [Modifying a Path in the Timeline View](#) on page 183
- [Modifying a Path in the Function View](#) on page 185
- [Modifying a Path in the Xsheet View](#) on page 192
- [Function Curves](#) on page 194
- [Copying and Pasting a Motion](#) on page 198
- [Adjusting the Velocity](#) on page 205

Animating a Layer

Before animating the position of drawing layers, you need to create motion paths which are trajectories on which you can attach drawing objects. Using keyframes, you can then record key positions along the trajectory.



Harmony's wide range of features let you produce simple and advanced motions and trajectories. By creating a simple motion, you will learn the basics of animating a layer.

The Animate mode lets you keyframe drawing layers to create computer-generated animation. When working in the Animate mode, you can animate a layer's position and then turn off the mode to reposition a layer for the entire scene. When the Animate mode is disabled, keyframes are created on selected layers at the current frame. Depending on what transformations were performed (rotation, translation, skew), the new keyframes are added on the corresponding parameters (function curves).

How to turn the Animate mode on or off

1. In the Tools toolbar, click the Animate  button or select **Animation > Animate**.

How to animate a layer

1. In the Tools toolbar, select the Transform  tool or press Shift + T.
 2. In the Tool Properties view, make sure the Peg Selection Mode  is deselected.
 3. In the Tools toolbar, enable the Animate  mode. This will create keyframes at the current frame when moving objects.
1. In the Timeline view, go to the first frame.



2. In the Camera view, select the element to animate and move it to its first position.

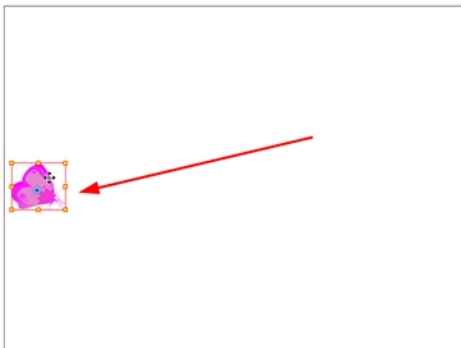

A keyframe is created on the first frame of the Timeline view.

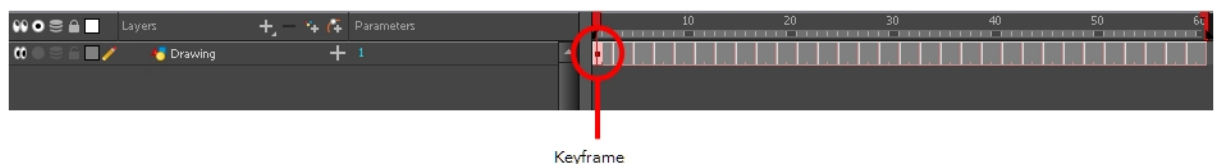

3. In the Timeline view, go to the frame on which you want to set the second position.

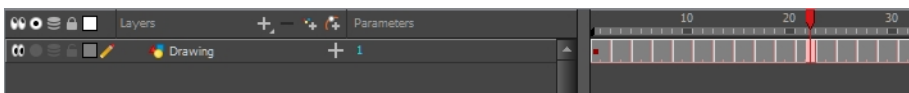

4. In the Camera view, move the element to its second position.

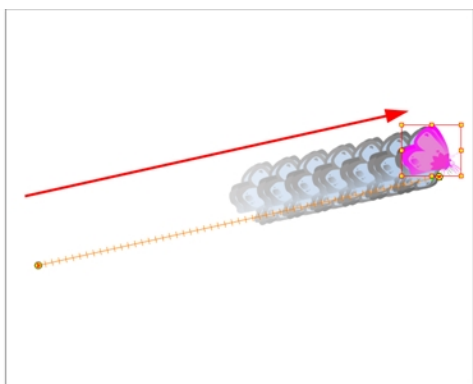

A second keyframe is created on the Timeline view.

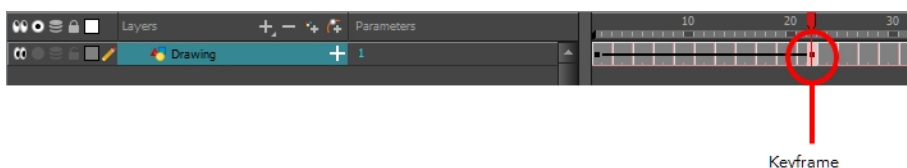

5. Play back  your animation.

To see your motion animations in the Top, Side or Perspective views while you play back, you must turn on the Playback option. From the top menu, select **Play > Enable Playback > Top View** or **Side View** or **Perspective View**.

Differences between Animated Layers and Pegs

There are two ways to create motion paths: animated drawing layers and pegs. They each have different purposes.

You can create a motion path directly on layers (animated layers).

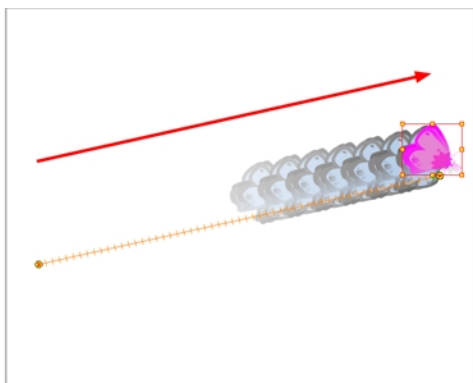

You can control and define a trajectory using several different parameters, including:

- X, Y and Z positions (3D Path or Separate Positions)
- Angle (rotation)
- Skew
- X and Y Scales

Each parameter has its own function curve where you can add keyframes and control the easing. If you're not familiar with graphs and function curves, these are easy-to-use tools for visually controlling trajectories in the Camera and Timeline views.

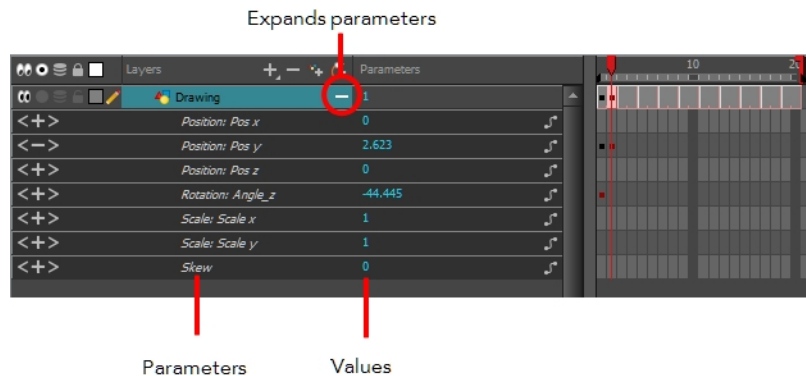

By default, you can animate a drawing layer using the same parameters as a peg, but you can choose not to do so by turning off this feature. This allows you to switch your drawing layers so they can no longer be animated without a peg, which has certain advantages. In cut-out animation, it's easier to separate drawing exposure and keyframes to change the timing and rearrange keyframe position in the Timeline view. This also works for backward compatibility when bringing in templates created in older versions of Harmony so as not to lose their offset keyframes or drawing substitution keyframes.

If you do not want to animate a drawing layer, you can turn off its animation parameter. To do so, simply select the layer and in the Layer Properties view, deselect the **Animate Using Animation Tools** option on the Controls tab. If your layer was already animated, then your keyframes will appear dimmed so you can easily identify them as ones that cannot be modified. To modify keyframes, select the Animate Using Animation Tools options.



A Peg layer is a trajectory that contains no drawings on which you can hook your drawings.



Pegs have been used for a long time in the traditional animation process, mainly for registration purposes. Peg holes at the bottom or top of the animation paper are used to keep all the sheets even and at the same registration.

There are three peg holes in regular animation paper. The centre peg hole is round while the left and right ones are oval shaped. The oval peg holes are located on each side of the page, four inches away from the centre peg hole.

To keep the drawings together, the animator uses a peg bar. This peg bar has three pins that correspond to the shape and location of the peg holes. Peg bars are normally found at the bottom and top of animation discs.

Before digital compositing, the peg bars were also used to move layers on the camera stand to create pans and camera moves. They were the equivalent of digital trajectories. Harmony makes use of these concepts to create animation and camera motion.

A peg is composed of many customizable parameters. These parameters are:

- X, Y and Z positions (3D Path or Separate Positions)
- Angle (rotation)
- Skew
- X and Y Scales

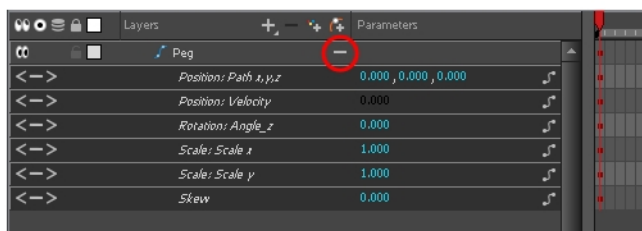

You can control a peg's trajectory the same way as the animated drawing layer.

A peg layer is mainly used to control a series of drawing layers, such as clouds, a school of fish or a flock of birds. You can attach them to a peg layer and make them follow a trajectory as a single unit. This makes trajectory modifications much easier and faster. When building a puppet, most of the time you will add a master peg to control your puppet as one object.

In the Tool Properties view, the Peg Selection Mode  lets you automatically select the peg layers in the Camera view instead of the drawing layers. If you animate with pegs instead of animating the drawing layers directly, enable the **Peg Selection Mode** to avoid having to select in the Timeline view or use the Select Parent Skipping Effects command.

How to disable the animation feature on a layer

1. In the Timeline view, double-click the layer on which you want to set the parameter.
The Layer Properties editor opens.
2. In the Controls tab, deselect the **Animate Using Animation Tools** option.

How to add a peg in the Timeline view

1. In the Timeline view, select the layer on which you want to attach a peg.



2. Do one of the following:

- ▶ From the Timeline View layers toolbar, click the Add Peg  button.
- ▶ From the Timeline view menu, select **Insert > Peg**.
- ▶ From the top menu, select **Insert > Peg**.

The layer that was originally selected becomes a child of the new parent Peg layer. The new Peg layer automatically takes the name of its child layer, with the addition of the suffix -P.

The indentation of the layer, along with the "L" indicates hierarchy and that the layer is attached to the Peg layer. This relationship is called a parent-child relationship.

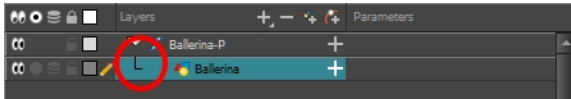

3. If you intend to add multiple pegs or if the layer name that was added to the peg does not accurately represent the content of the Peg layer, you can rename it. Click the layer name and type in a new name. Or double-click the layer and type a new name into the dialog box.

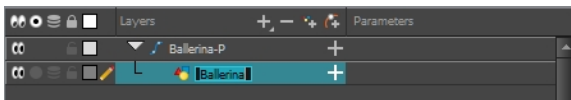

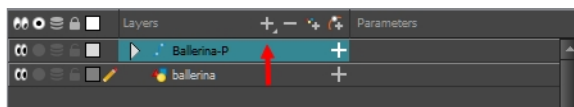

4. If you did not create your peg layer directly above the layer you intended on parenting it to, then drag the layer you want to attach to the peg and drop it directly below the Peg layer. The indentation of the layer below the Peg layer indicates whether it was correctly attached or not.



- ▶ You can unparent layers by holding down Shift and dragging the selected parents away from the child layer. Drop your selected between other layers.

How to enable the Peg Selection Mode

1. In the Tools toolbar, select the Transform  tool or press Shift + T.
1. In the Tool Properties view, click the Peg Selection Mode  button.
2. In the Camera view, select an element parented to a peg.

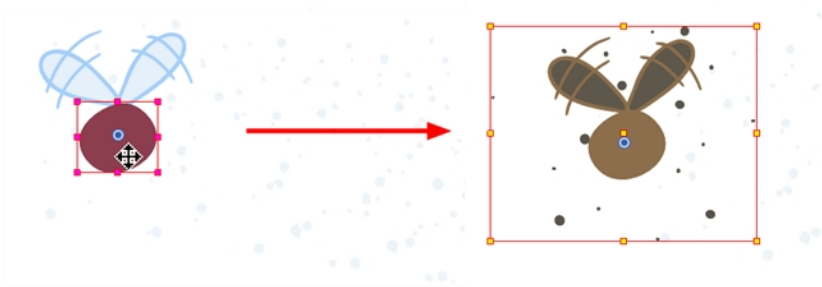

Layer Parameters

A layer is composed of many customizable parameters, such as the X, Y and Z positions, angle (rotation), skew and scales. Each parameter has its own function which is a mathematical formula expressing the relationship between position values. You can view each function on a graph as a simple curve, such as the one below.

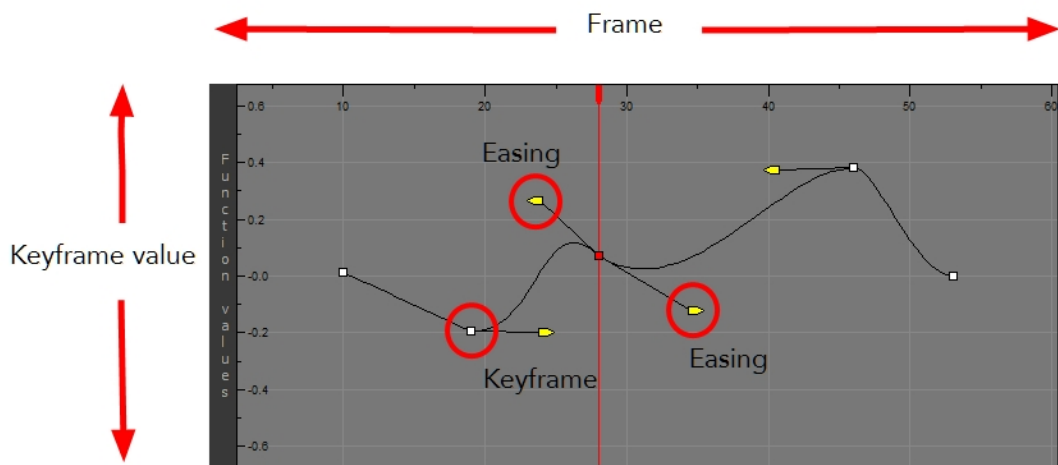

There are six options available for setting up function parameters:

- ▶ Locked Positions (3D Path)
- ▶ Separate Positions
- ▶ Locked Scales
- ▶ Separate Scales



Locked Positions



Separate Positions



Locked Scale

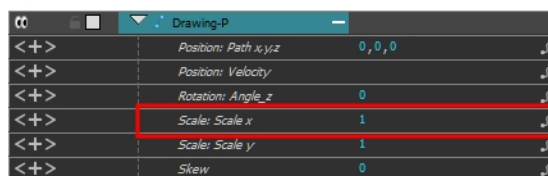

Separate Scale

You must select 3D Path, Separate Positions, Separate Scale, or Locked Scale before starting the animation. When you lock or unlock parameters, this does not convert the functions from one to the other, but creates new ones.

In a 3D Path, the X, Y and Z curves are locked together and controlled by a single velocity function. When you add a keyframe, it is added on all three trajectories at once, as is the velocity. This is very useful for long, smooth trajectories.

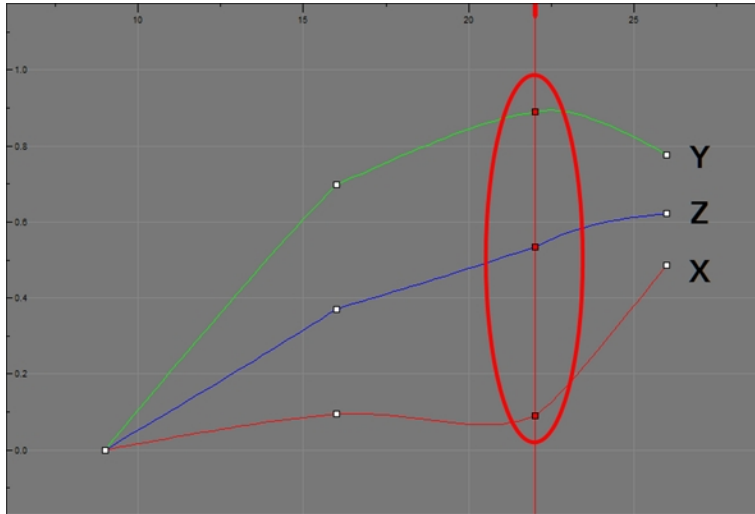

When the Separate Positions option is used, the X, Y and Z curves are independent and have velocity controls directly on their function curve. This is useful when you want to set keyframes on one of the curves without affecting the others.

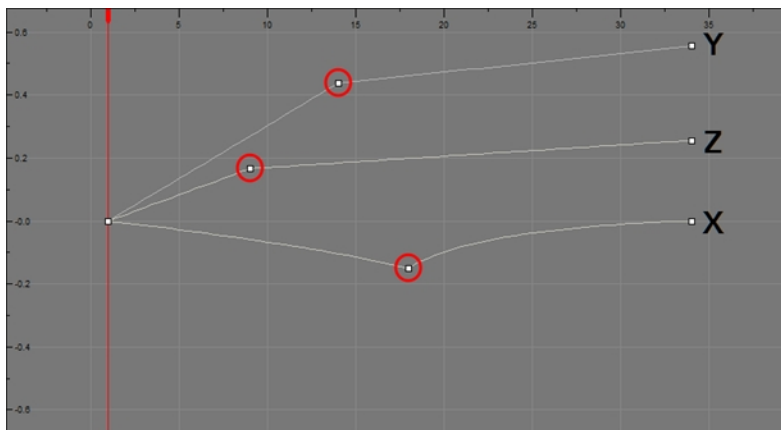

When using the Scale parameter, you can use a single function curve to control both the vertical and horizontal scale, or two separate scales. When using a single function curve, the values are the same for the X (horizontal) and Y (vertical) axes for uniform size changes without distortion. However, if you separate the scale functions, you can squash, stretch and skew your elements.

How to display the layer parameters in the Timeline view

- Do one of the following:
 - In the Timeline's left side, click a layer's Expand **+** button.
 - In the Timeline view menu, select **View > Show Functions**.

- ▶ Press Alt + F.

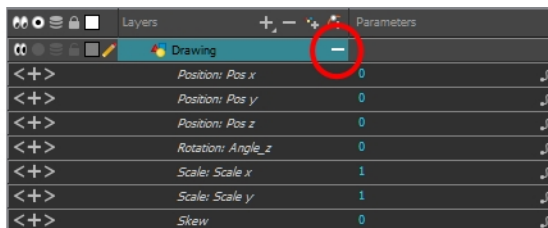
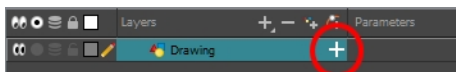

Layer parameters are displayed

How to set the layer parameters

1. In the Timeline view, double-click on the layer on which you want to set the parameter. You can also see the parameters in the Layer Properties window when you select the layer in the Timeline view.

The Layer Properties window opens.

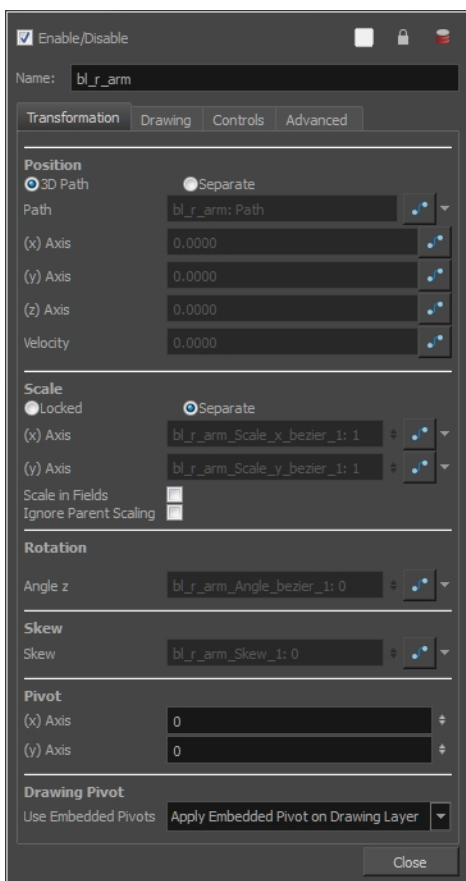

2. Select the **Transformation** tab.
3. In the Position section, select the **3D Path** or **Separate** option.
4. In the Scale section, select the **Locked** or **Separate** option.
5. Click **Close**.

Adding and Deleting Keyframes

There are several different ways you can create keyframes. You can add a coordinate keyframe, position keyframe or a keyframe along with your drawing duplication.

You can create a keyframe without a drawing. This adds new coordinate points but the drawing in the layer stays the same. At the same time, you may also want to duplicate your drawing if you need to modify it and do not want to modify the original.

You can also add a position keyframe instead of a regular keyframe. When you do this, keyframes will only be added on the X, Y and Z parameters of the selected layer. Keyframes are not added on the Angle, Scale and Skew parameters.

NOTE: If you select a keyframe in the Timeline view and press the Delete key, you will also delete the drawing exposure. To only delete the keyframe, you must use the Delete Keyframe command—see [Adding and Deleting Keyframes](#) on page 168.

How to create keyframes

1. In the Timeline view, select the cell on which you want to add a keyframe.

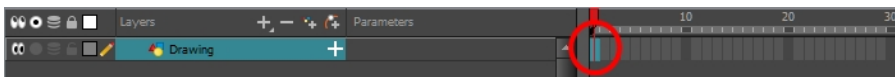

2. Add a keyframe by doing one of the following:
 - ▶ From the top menu, select **Insert > Keyframe**.
 - ▶ Right-click on the selection and select **Insert Keyframe**.
 - ▶ Press F6.
 - ▶ In the Timeline View toolbar, click the Add Keyframe  button.

If the Animate mode is enabled in the Camera view, a keyframe is automatically created on the current frame.

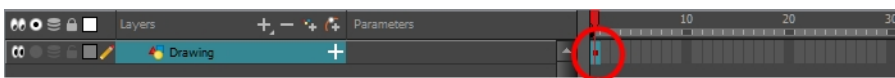

How to create a keyframe and duplicate the drawing at the same time

1. In the Timeline view, select the cell containing the drawing you want to duplicate and add a keyframe.

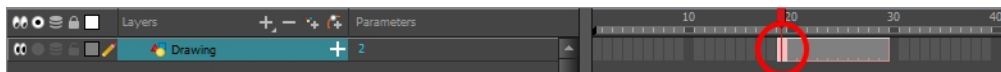

2. Do one of the following:
 - ▶ From the top menu, select **Insert > Keyframe and Duplicate Drawing**.
 - ▶ Right-click on the selection and select **Insert Keyframe and Duplicate Drawing**.
 - ▶ Press F6.

A keyframe and a duplicate of the drawing is created. The duplicated drawing sits on top of the original drawing.



How to add a Position keyframe

1. In the Timeline view, select the cell on which you want to add a position keyframe.

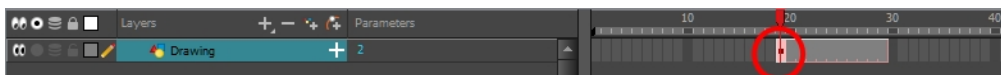

2. From the top menu, select **Insert > Position Keyframe**.

How to delete a keyframe

- ▶ In the Timeline view, select a keyframe and do one of the following:
 - Right-click and select **Delete Keyframes**.
 - In the Timeline view menu, select **Motion > Delete Keyframes**.
 - From the top menu, select **Animation > Delete Keyframe**.
 - Press F7.
- ▶ Use the Transform  tool to select a keyframe to delete from the trajectory in the Camera view and press Delete.

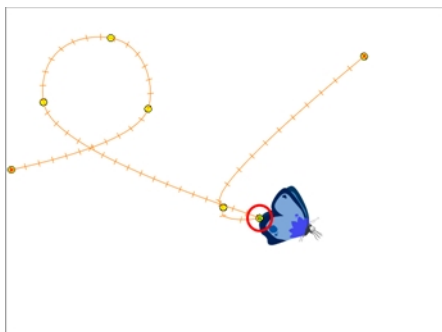

Motion and Stop-motion Keyframes

Interpolation is the computer-generated motion between two keyframes. Some animators and compositors like to create their own in-betweens, while others like to have the computer do it. Harmony has stop-motion (no interpolation) and motion keyframes (computer-generated interpolation).

A stop-motion keyframe means there is no computer-generated motion between two keyframes. The segment is constant or flat. The drawing remains still until the playback reaches the next keyframe, then the drawing pops to its new location.

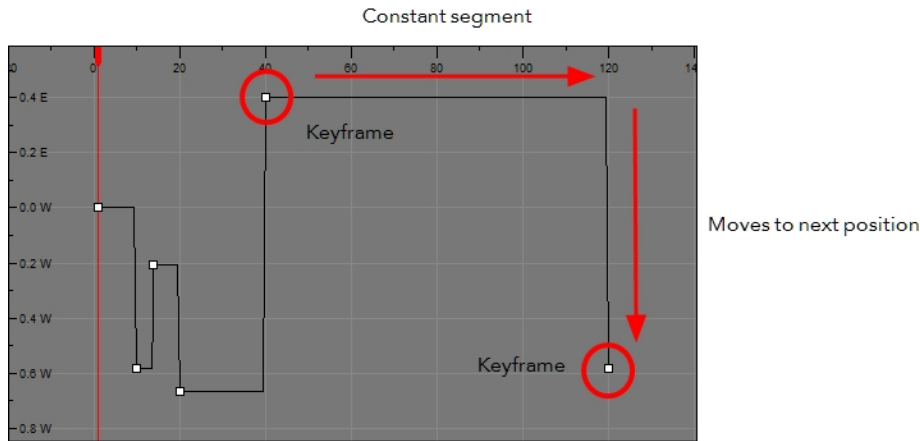

A motion keyframe This means there is no automatic interpolation created between the selected point and the next one. The layer will maintain its position until the animation reaches the frame of the next point and will then jump to the new position. Deselect this option to generate interpolation and get the layer to progressively move to the next position.

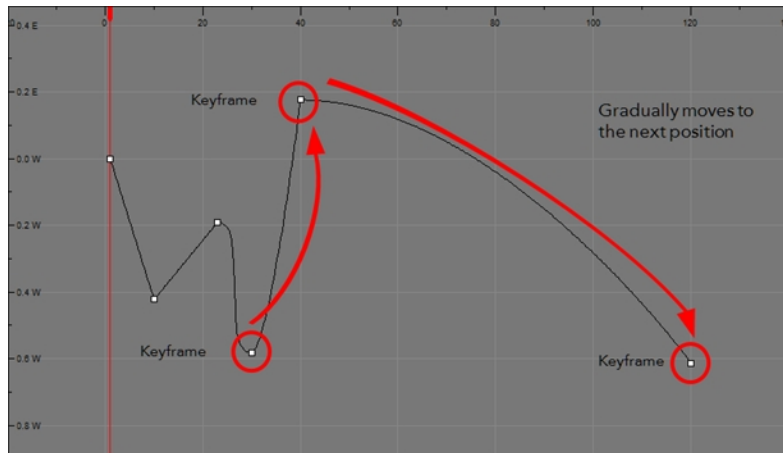

You can switch a keyframe from stop-motion to motion at any time in the Timeline view and Function Editor.

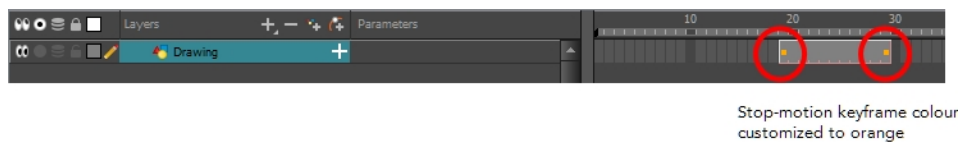

To easily identify stop-motion keyframes in the Timeline view, you can customize the colour In the Preferences dialog box.

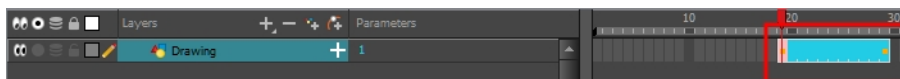

How to switch between motion and stop-motion in the Timeline view

1. On the right side of the Timeline view, select one or more keyframes to modify.





- Switch between motion and stop-motion by doing one of the following:
 - Right-click on the selected keyframes and select **Set Motion Keyframes** or **Set Stop-Motion Keyframes**.
 - Press Ctrl + K (Windows/Linux) or ⌘ + K (Mac OS X) for motion keyframes and Ctrl + L (Windows/Linux) or ⌘ + L (Mac OS X) for stop-motion keyframes.
 - In the Timeline View toolbar, click the Motion Keyframe  or Stop-Motion Keyframe  button.

How to switch between motion and stop-motion keyframes in the Function view

- Open the Function view.
- In the Timeline view, double-click on the layer that contains the keyframes you want to convert.

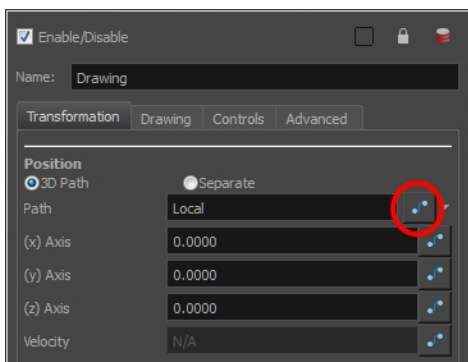
The Layer Properties window opens.



- Do one of the following:
 - In the Transformation tab, click the Function Editor  button.
 - In the Timeline view, click the Expand Function  button or press Alt + F and double-click on the function to edit.

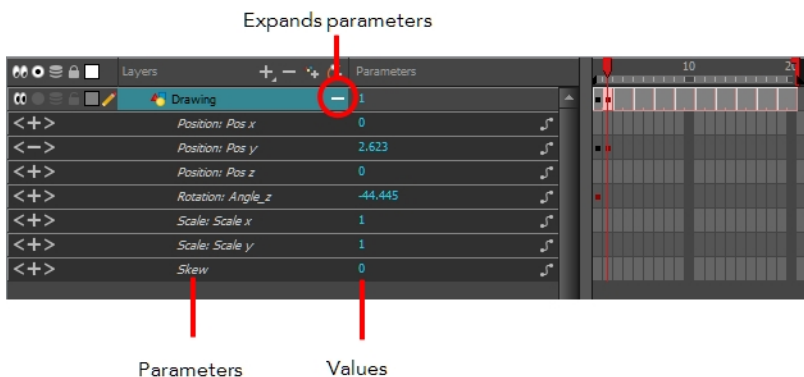

- On the function curve, select one or more keyframes to modify.

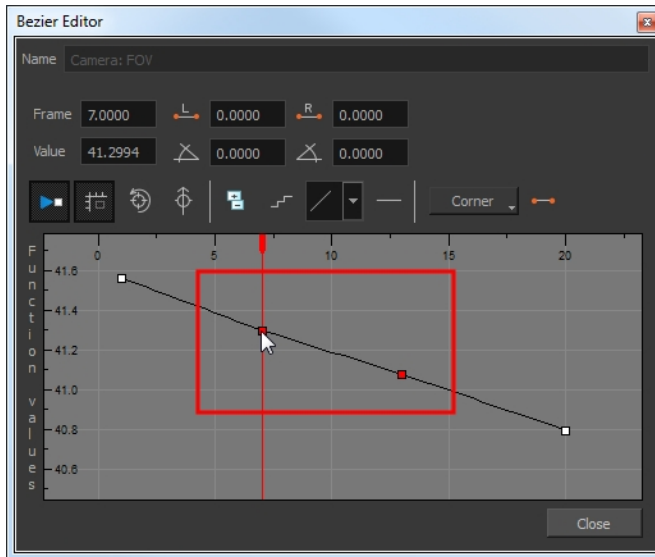

5. Select or deselect the Stop-motion Keyframe  button to set a stop-motion or motion keyframe.

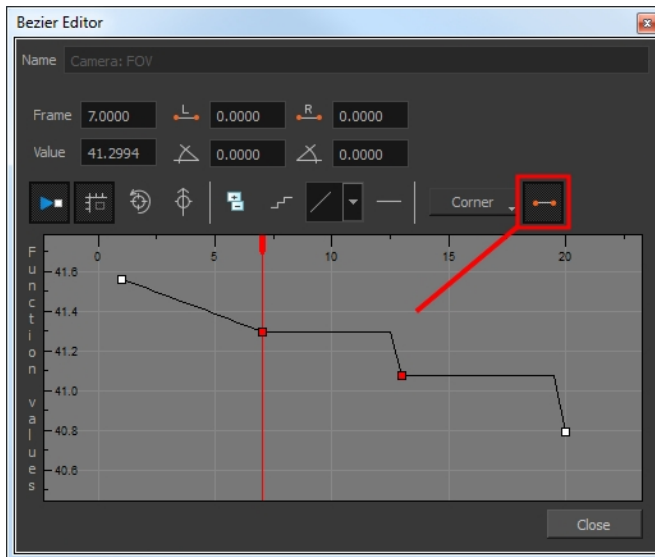

How to set the stop-motion keyframe colour

1. Open the Preferences dialog box by pressing Ctrl + U (Windows/Linux) or ⌘ + U (Mac OS X).
2. Select the **General** tab.
3. In the Colours section, click **Edit Colours**.
4. In the Colours dialog box, select the **Xsheet and Timeline** tab.
5. In the Timeline section, click the **Stop Motion Keyframe** swatch.
6. In the Select Colour window, select a new colour and close the windows.

Constant Z

When using a 3D path, the X, Y and Z functions work together using the same keyframes. This allows for the velocity to control the curve and create a smooth trajectory. Even if a function does not have any variation on its curve (for example, all keyframes are at zero), the velocity might add a slight motion to ensure a smooth trajectory. This can cause elements that are very close to each other on the Z-axis to pop in front of one another. This is why in cut-out animation it is recommended to use separate position settings. But if you work with 3D path, you can use the Constant Z feature to avoid this from happening.

The Constant Z feature is used when creating motion keyframes. The Z function will use stop-motion keyframes and will not be interpolated, which can be very useful for cut-out animation. The Constant Z feature only works with 3D paths.

You can also enable the Constant Z option directly in the Function view for specific functions.

How to enable the Constant Z option

1. In the Timeline view, expand the layer on which you want to set the Constant Z feature. Note that you must select the **3D Path** option for the layer.
2. Double-click on one of the position functions to open the Function editor.
3. In the Function editor, select the Constant Z  button.

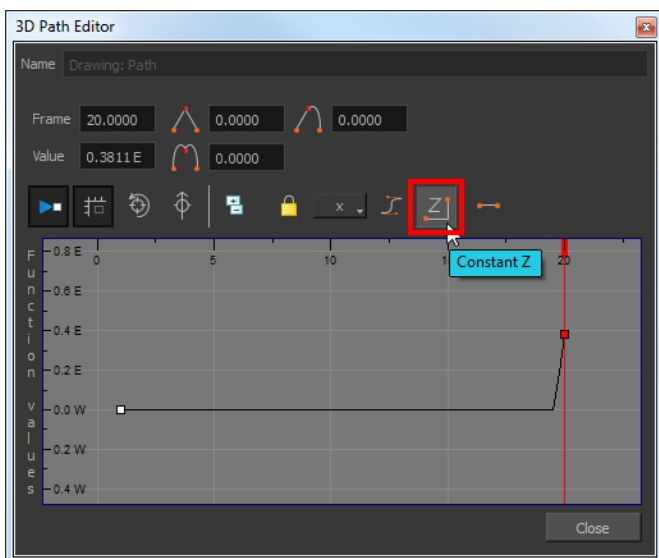

Animating the Camera

In Harmony is a camera that can move along the X, Y, and Z axes. Having the camera move on the Z-axis offers the possibility to create truck in and truck outs, as well as multiplane camera moves. The default camera position is centred and backed up to 12 fields.

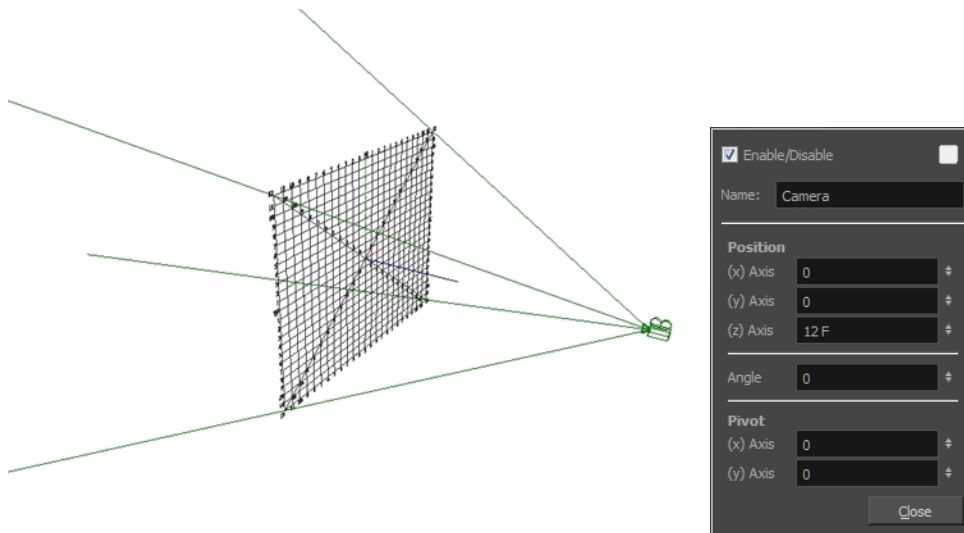

It is important to understand the coordinate values in Harmony. Harmony's core is based on the origins of animation. In traditional animation, a scene's size and camera motion are calculated in fields. A field has a 4:3 ratio and measures 0.5 inches (12.7 mm) in width. A specific grid has been created for this purpose known as a *field chart*. Harmony uses this unit of measurement as its coordinate system.

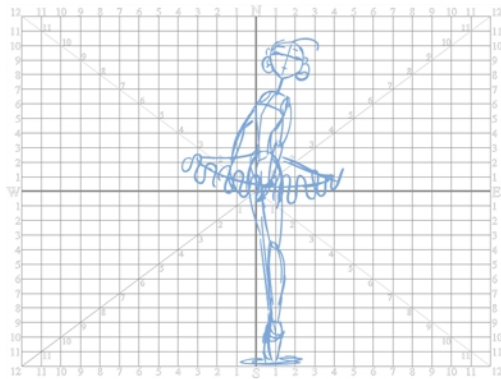

A field chart uses the cardinal directions. The X axis is the east-west (left-right) direction, the Y axis is the north-south (up-down) direction and the Z axis is the forward-backward direction.

The camera is treated the same way as any other element. You can use the same tools and selection modes to offset or animate it, but the camera is a static object. To animate the camera, you need to connect it to a peg layer. A peg is a trajectory layer.

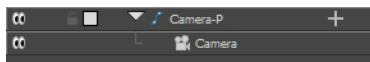

While making camera moves, you can use the Top, Side, and Camera views.

How to open the Top and Side views

1. Do one of the following:
 - ▶ From the top menu, select **Windows > Top** or **Side**.
 - ▶ From any view already open, click the Add View **+** button at the top-right corner and select **Top** or **Side**.

How to add a camera and parent it to a peg

1. If you don't already have a camera layer, do one of the following:
 - ▶ From the top menu, select **Insert > Camera**.
 - ▶ From the Layers toolbar, click the Add Layers **+** button and select **Camera**.

A new camera layer is added to the scene and appears in the Timeline view.

2. In the Timeline view, select the Camera layer.

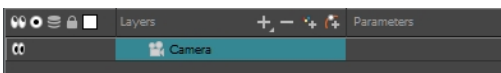

3. From the Layers toolbar, click the Add Peg **+** button.

A Peg layer appears directly above the Camera layer, which is automatically attached to it.

The Peg layer automatically takes the name of the camera and adds the suffix **-P** to indicate that it is a Peg layer, for example **Camera-P**.

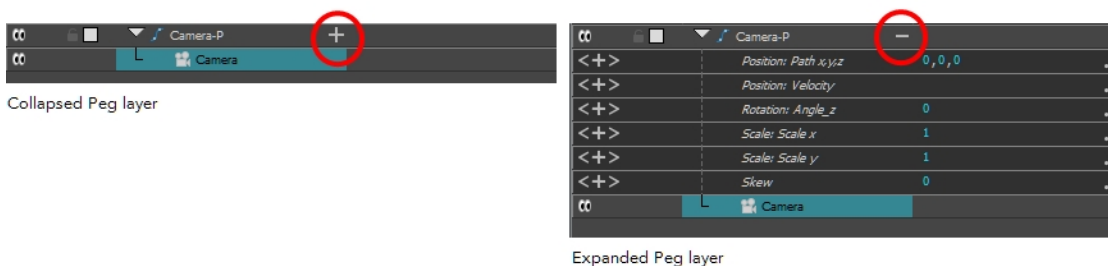

If the new Peg layer did not appear directly above the camera, you may have clicked elsewhere in the scene, which deactivated the layer on which you want to add the Peg layer. To fix this:

- ▶ Select the Camera layer and drag and drop it under the new Peg layer. Or delete the misplaced Peg layer, select the Camera layer and click the Add Peg **+** button again.
- ▶ You can unparent layers by holding down Shift and dragging the selected parents away from the child layer. Drop your selected between other layers.

How to animate the camera

1. In the Tools toolbar, enable the Animate **🌀** mode.
1. In the Tools toolbar, select the Transform **📏** tool or press Shift + T.
2. On the right side of the Timeline view, on the Camera Peg layer, select the frame at which you want the camera move to start.
3. Do one of the following:
 - ▶ In the Timeline toolbar, click the Add Keyframe **KF** button.

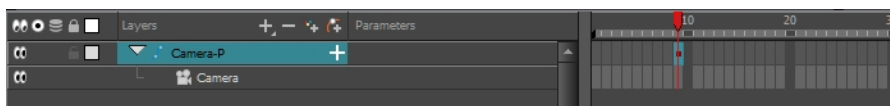

- ▶ Right-click and select **Insert Keyframe**.
- ▶ Press F6.

A keyframe appears in that cell. Any frames preceding this keyframe cell will hold the same camera position as this keyframe.

4. In the Top, Side or Camera view, select the camera (the large V-shaped cone) and move it to the desired position. In the Camera view, the camera is represented by a thin frame. You need to click directly on one of the edges.

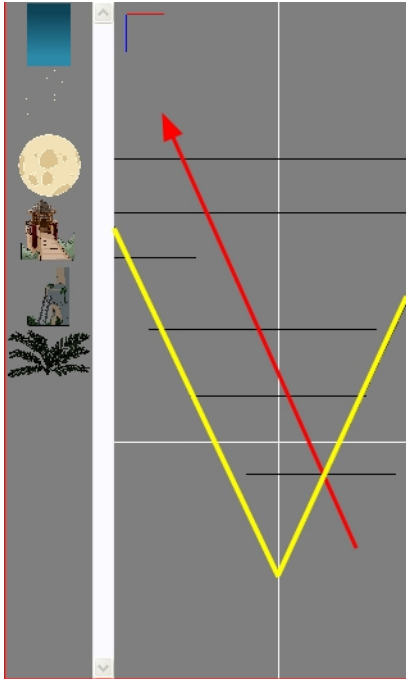

5. On the Timeline view, click on another cell a bit further down in time to indicate where the camera move will end.
6. Select the camera in the Camera, Top or Side view and move it to the desired position.

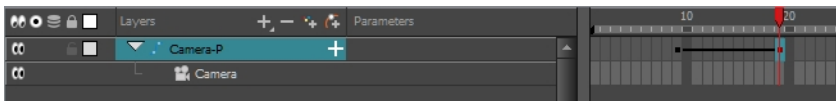

A second keyframe appears and a line is created between the two frames to indicate that the subsequent motion between the frames will be calculated and rendered by the program.

7. Play back ▶ your animation.

Camera Truck-ins and Line Thickness

As you move the camera in your scene along the Z-axis, notice that, logically, the lines of the elements become thicker the closer the camera gets to the drawing. If you prefer the lines to remain the same size or become thicker at a different speed, you can use the thickness feature to adjust your brush stroke and pencil line thickness. You can modify the size of the lines even if the camera is not animated.

NOTE: This feature can only be viewed in the Camera view's render mode.

How to adjust the pencil line thickness of a drawing layer in the Camera view

1. In the Timeline view, double-click on a drawing layer to display the Layer Properties window.
2. Select the **Advanced** tab.
3. In the Line Thickness section, adjust some of the following parameters until you achieve the desired effect.

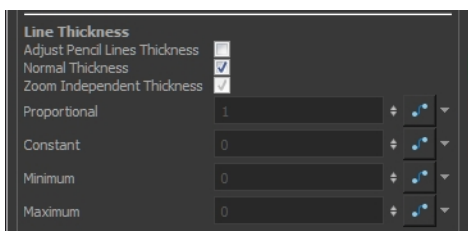

Adjust Pencil Lines Thickness: Lets you work with pencil lines and adjust their thickness. You will not see any changes to lines in the Camera view OpenGL mode. You must switch to the Render mode.

Normal Thickness: Disables all overrides on the brush stroke line thickness. This option must be enabled in order for the pencil line thickness parameter and pencil lines to appear. If you want to modify the brush stroke thickness, deselect this option. To enable brush strokes to work with the line thickness feature, you must first create central strokes in the Colour Art layer. The central strokes control the line variation of your brush strokes in the Line Art layer. Select **Drawing > Create Colour Art from Line Art**.

Zoom Independent Thickness: Select this if you want your line thickness to remain constant independently from the camera move. Everything else will increase in size, but the line thickness will stay the same.

Proportional: Enter a multiple by which you want to increase the line thickness base on its original thickness. A value of 1 will result in no change; a value of 0 (zero) will hide the lines.

Constant: Enter a value in pixels (based on a 720x540 screen resolution) to indicate the amount of pixels you want to add around the existing line.

Minimum: Enter a value in pixels (based on a 720x540 screen resolution) for the minimum line thickness allowed.

Maximum: Enter a value in pixels (based on a 720x540 screen resolution) for the maximum line thickness allowed.

Modifying a Path in the Camera, Top and Side Views

Camera moves and motion paths can become quite advanced, especially with moves through 3D space. Harmony provides tools to view your camera's path and make adjustments to it from both a 2D and 3D perspective.

You can display the trajectory of a motion path when you select an object in the Timeline or Camera view.

A motion path is easy to manipulate. One important concept to understand is that a trajectory contains both keyframes and control points. Both can be used to shape a path; each have their own significance and behaviour, however only keyframes appear in the Timeline view.

- **Keyframes** have a transformation value and a position in space at a given frame. Keyframes are locked in time.
- **Control points** have a position but no fixed frame or timing. It is mainly used to deform a trajectory. There are no velocity handles available on a control point. The velocity segments are set between keyframes only, making curves and trajectories much smoother. Control points can only be added on a 3D path.

You can set the default Continuity, Bias and Tension parameters in the Preferences panel.

- **Continuity** controls the smoothness of a transition between the segments joined by a point.

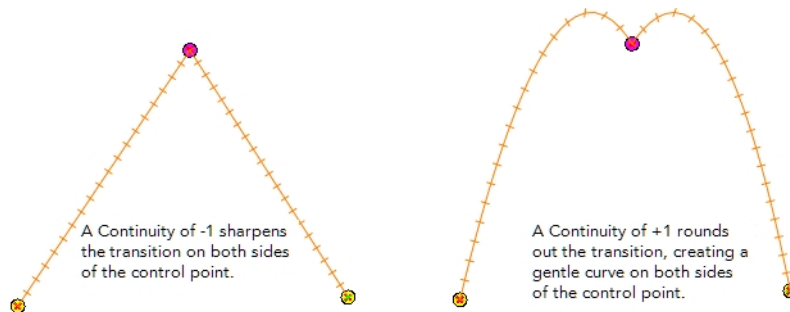

- **Tension** controls how sharply the path bends as it passes through a control point or keyframe.

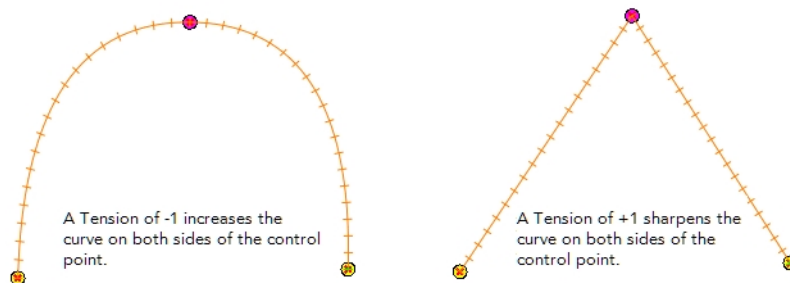

- **Bias** controls the slope of the path so it flows towards one side of the motion point or the other.

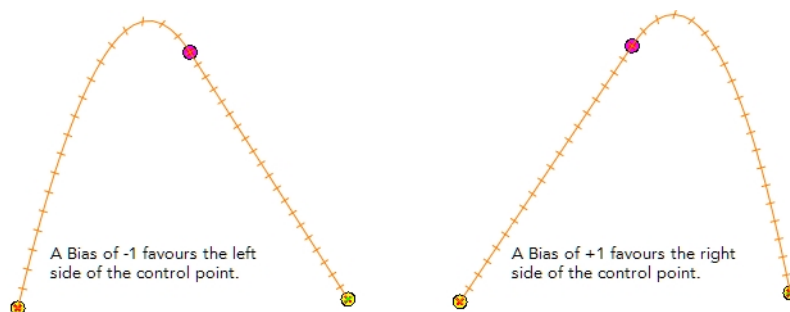

When you select a control point on a path, you can switch between a rounded or square corner by using the Linear/Curve command.

How to view the layer's trajectory using the Control command

1. Verify that the Camera view (click its tab) is selected and that the layer whose trajectory you want to display is selected in the Timeline view.

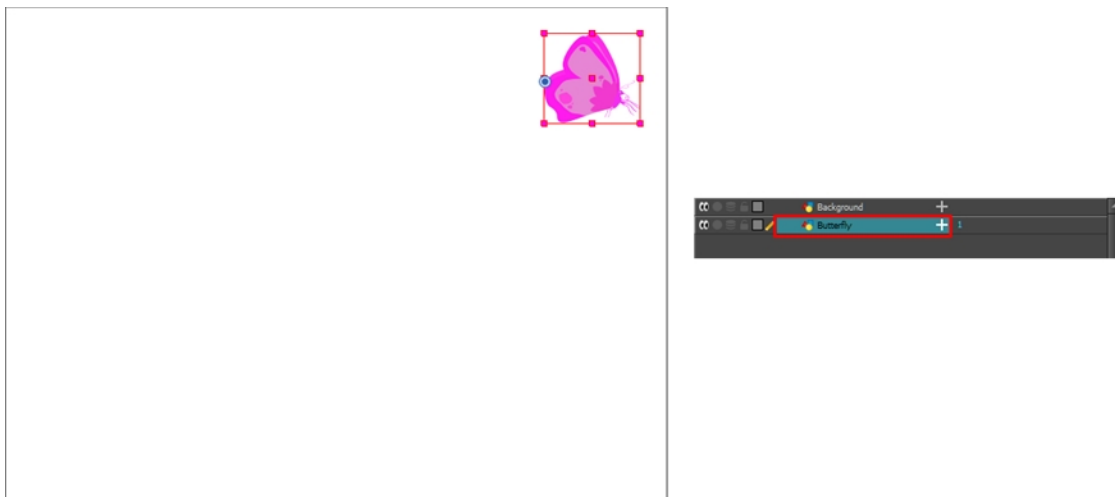

2. From the top menu, select **View > Show > Control** or press Shift + F11.



NOTE: If nothing appears in the Camera view, you may not have animated or selected the layer.

How to add a control point on a trajectory

1. In the Timeline or Camera view, select the peg or layer on which you want to add a control point.
2. If the selected element's trajectory is not displayed, select **View > Show > Control** from the top menu or press Shift + F11.

The trajectory appears in the Camera, Top, Side and Perspective views.

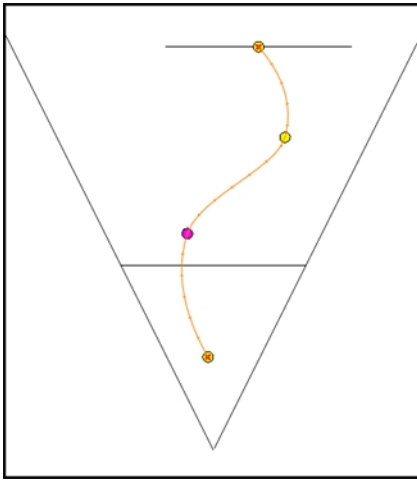

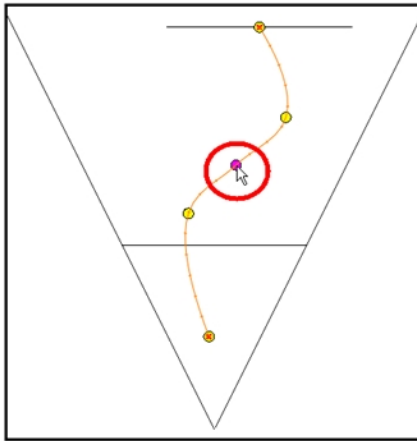

3. Add control points on a 3D path trajectory by placing the cursor where you want to add the point and press P once. If you hold the key down, control points will be added continuously until you release the key.



A control point is added to the trajectory

How to switch between keyframe and control point

1. In the Camera view, use the Transform  tool select a point to convert.
2. To convert the point:
 - ▶ From the top menu, select **Animation > Lock in Time**.
 - ▶ In the Function view or Function Editor, select the keyframe to convert and click the Lock in Time  button.

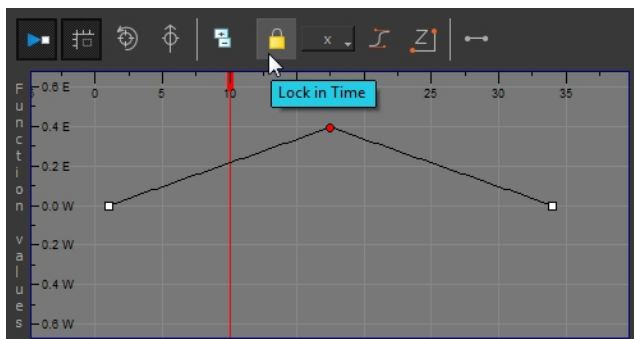

- ▶ Press Alt+L.

How to adjust the control point preferences

1. From the top menu, select **Edit > Preferences (Windows)** or **Stage Advanced > Preferences (Mac OS X)**.
The Preferences dialog box opens.
2. Select the **Camera** tab and adjust the parameters in the Control Points section.

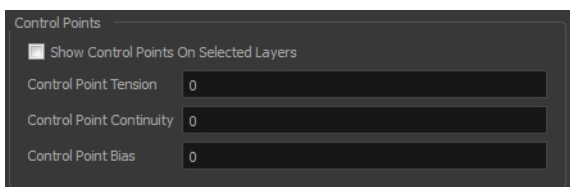

How to toggle between a linear and curved corner

1. In the Timeline view, double-click the layer that contains the point you want to convert.
The Layer Properties window opens.
2. On the Transformation tab, select the **3D Path** option.
3. In the Tools toolbar, select the Transform  tool or press Shift + T.
4. In the Camera view, select the point to convert.
5. From the top menu, select **Animation > Linear Motion**.

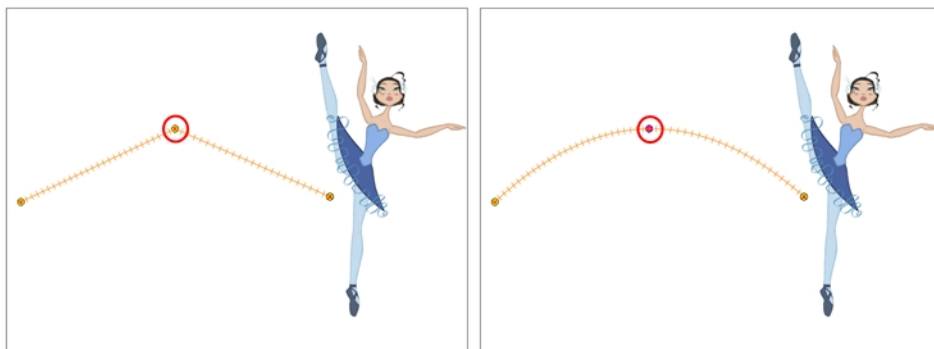

Offsetting a Trajectory

By offsetting a trajectory, you reposition the visual trajectory without offsetting or modifying your animation. By default, the trajectory is located at 0,0,0 fields. If your elements were drawn in a different location than the centre of the drawing area, it will look like the trajectory is not aligned with your drawing. Also, if you have several elements attached to one trajectory, you might want your trajectory to be at a different location to represent the group's motion better.

How to offset a trajectory

1. In the Animation Tools toolbar, select the Spline Offset  tool or press Alt + 8.
2. In the Camera, Top, Side or Timeline view, select the layer whose trajectory you want to offset.
3. From the top menu, select **View > Show > Control** to display the trajectory. If you do not display the trajectory, any transformation done using the Spline Offset tool will be ignored.

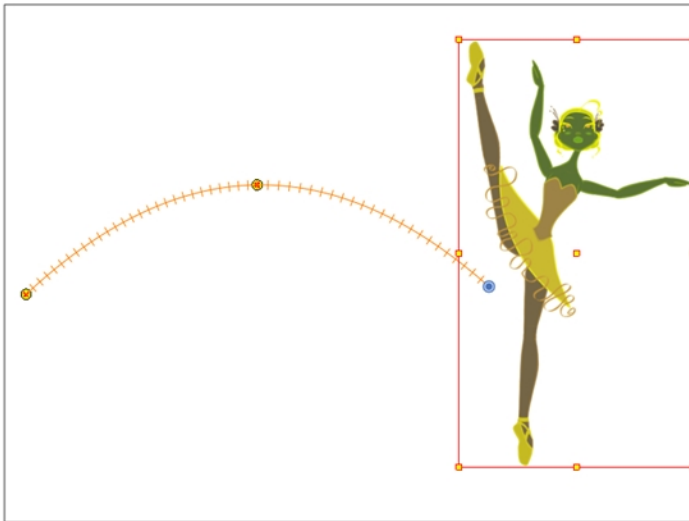

4. In the Camera view, drag the trajectory to the proper position. You can move it on the X and Y axes, but also on the Z-axis using the Top and Side views.

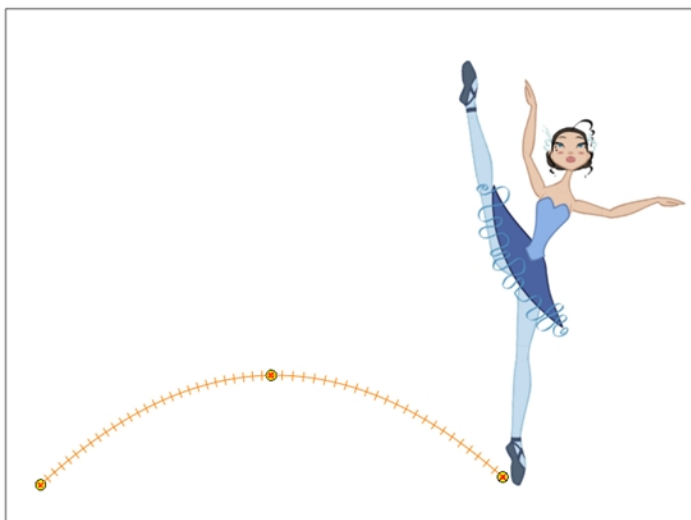

Trajectory is moved downwards

Modifying a Path in the Timeline View

When you select a peg or drawing layer in the Camera view and move it around, Harmony will automatically create keyframes on the corresponding function curves. If you want to modify these curves, you can do it through the peg or drawing layer parameters in the Timeline view.

Harmony lets you also flip between the selected layer's keyframes in the Timeline view.

How to create the function curve in the Timeline view

1. In the Timeline view, expand the layer's parameters.
2. Click the Function button and, in the drop-down menu, select **Create Bezier**.

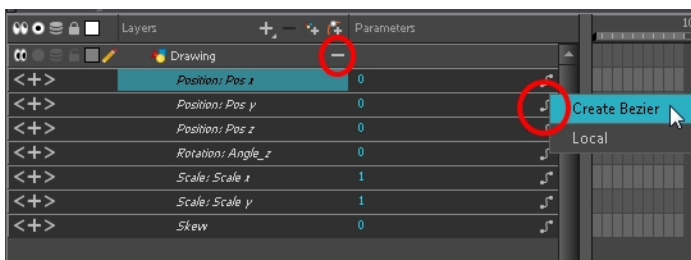

How to add a keyframe in the Timeline view

1. On the right side of the Timeline view, select a cell on the layer's function that you want to animate.

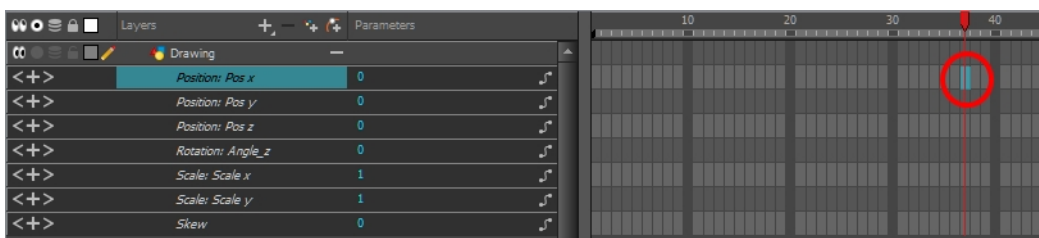

2. Do one of the following:
 - Right-click the selected cell and select **Insert Keyframe**.
 - Press F6.
 - In the Timeline View menu, select **Motion > Insert Keyframe**.
 - In the Timeline View toolbar, click the Add Keyframe  button.

How to delete a keyframe in the Timeline view

1. On the right side of the Timeline, select a keyframe to delete. You can [Shift]+click several keyframes to select a group before deleting the keyframes.
2. Do one of the following:
 - Right-click on the selected keyframe and select **Delete Keyframes**.
 - Press F7.
 - In the Timeline View menu, select **Motion > Delete Keyframes**.
 - In the Timeline View toolbar, click on the Delete Keyframes  button.

NOTE: If you select a keyframe or group of keyframes and press Delete, the corresponding drawings on that cell are also deleted.

How to change the keyframe values in the Timeline view

1. In the Timeline view, open the drawing or layer's parameters by clicking the Expand  button or press Alt + F.

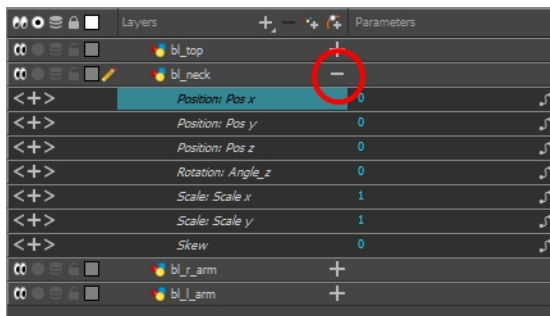

2. Select the parameter for which you want to create a function curve.
 1. Place the cursor over the blue number value of the parameter and do one of the following:
 - Wait until the cursor changes to a white hand with a two-way arrow and then drag the hand left to decrease the value or right to increase the value.



- ▶ Double-click on the blue number and enter a value in the field.

How to flip through keyframes

1. In the Camera or Timeline view, select the layer that contains the keyframes you want to flip through.



2. From the top menu, select **Animation > Go to Previous Keyframe** or **Go to Next Keyframe** or press semicolon (;) and single quote (').

Modifying a Path in the Function View

If you are accustomed to using graphs and function curves, you can use the Function view to define trajectories.

The graph in the Function view displays the motion over the first and last keyframes set in the scene, as well as any keyframes created between. If the scene is 60 frames, but the character's motion ends at frame 40, then the editor will only display up to frame 40.

The Function view lets you edit function curves and parameters. It is a visual graph for adding, removing, and editing keyframes, as well as adjusting the velocity. The Function view allows you to display multiple functions in the background as a reference.

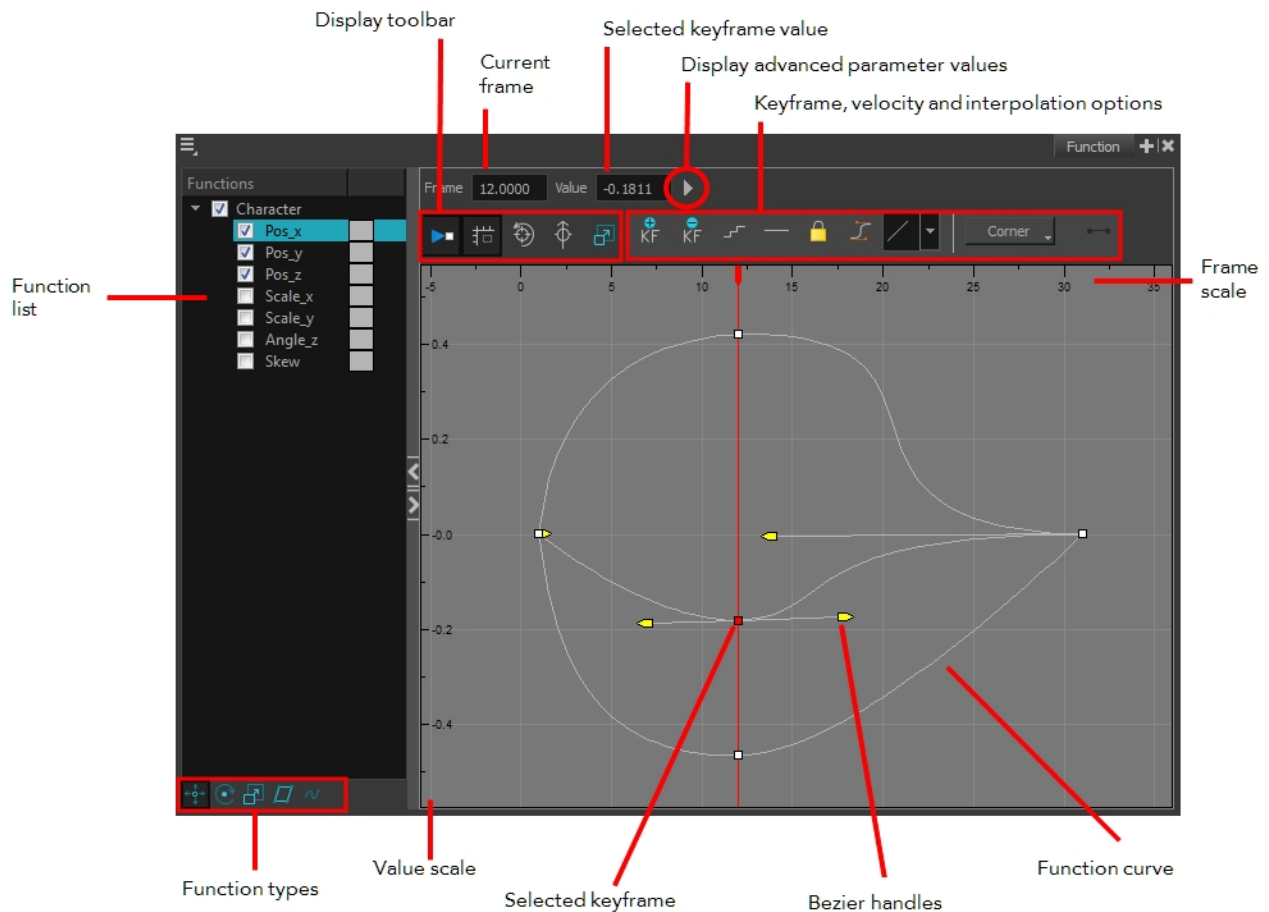

How to display functions in the Function view

1. Open the Function view.
The Function view is blank until you select the layer containing the functions you want to display.
2. To display a function in the Function view, click on the layer containing the functions to adjust in the Timeline view.
3. To select the functions you want to edit, select them in the Function list.

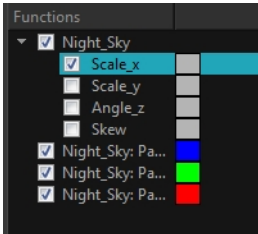
Parameter	Description
Function List	 <p>When selecting a layer in the Timeline view, all the corresponding functions are displayed. Select all the functions you want to see and edit; hide the ones</p>

	you don't.
Display Toolbar	The Display toolbar allows you to modify how the editing area is displayed. You can hide the grid, disable the synchronization with the current frame, reset the zoom level and normalize the function display by stacking them one over the other to compare them regardless of their value range.
Current Frame	Displays the current scene frame.
Selected Keyframe Value	Displays the value of the selected keyframe.
Display Advanced Parameter Values	 <p>Displays the Projection, Bias, Tension and Continuity parameters to adjust the curve around the selected keyframe.</p>
Keyframe, Velocity and Interpolation Options	This toolbar lets you add and delete keyframes, adjust the velocity curve, adjust the segments to motion or stop-motion keyframes and set the velocity to create steps instead of a constant progression.
Function Types	This toolbar lets you click on the different function types to enable or disable all the listed functions of that type.
Value Scale	Displays the value range for the displayed editing area. It can be referenced to know the value of a keyframe.
Selected Keyframe	The selected keyframe is displayed in red. When selected, the keyframe values are displayed in the corresponding fields.
Bezier Handles	The Bezier handles let you adjust the ease in and ease out of each keyframe. The more the handle is pulled out horizontally, the slower the animation will be. The more the handle is pulled out vertically, the faster the animation will be.
Function Curve	The thin line going from keyframe to keyframe is the actual curve. The section of a curve located between two keyframes is called a segment.
Frame Scale	The Frame Scale displays the frame range for the displayed editing area. It can be referenced to know the current frame of a keyframe.

How to edit a function in the Function view

- In the graph of the Function editor, select a white keyframe.
The keyframe turns red and displays a pointed yellow handle.
- Drag the point up or down, or click and pull one of the handles to adjust the curve of the graph.

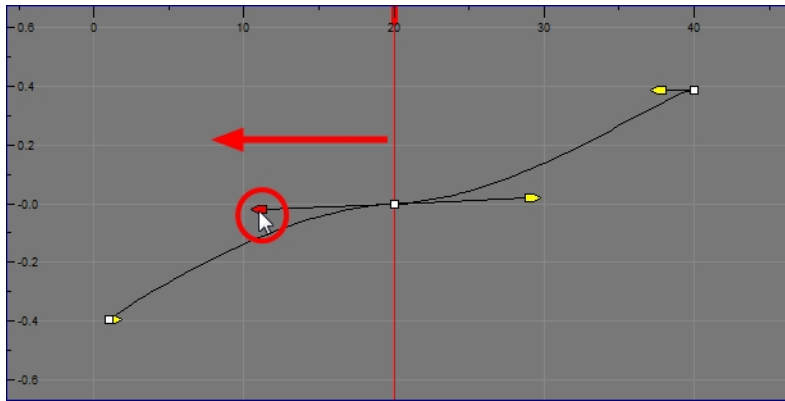

In the example above, changing the velocity from a straight line (constant velocity) to a curved one changes the ease-in (where the curve shoots up and then flattens out) and ease-out (where the curve flattens out and then shoots up) values.

The centre keyframe cannot be dragged up or down because the velocity is set. Theoretically, dragging it downwards towards zero would put it back to a place of nonmovement.

3. Press the Enter/Return key with the editor still open to watch the result of your curve adjustment in the Camera view.

How to add or delete keyframes in the Function editor

1. In the Timeline view, open the drawing or layer's parameters by clicking the Expand **+** button or press Alt + F.

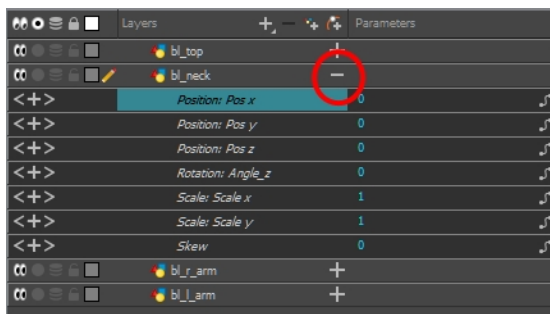

1. Double-click on the parameter layer name to open the Function editor window or click once on the parameter layer to display it in the Function view.

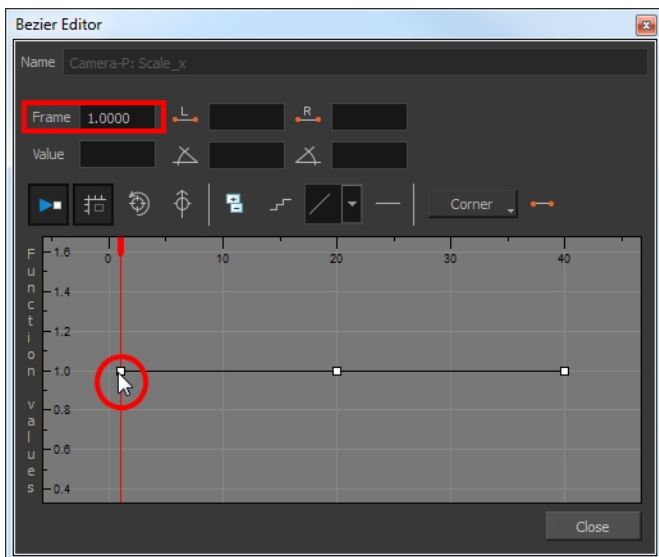

2. Do one of the following:

- ▶ In the graph section, click on the frame number where you want to make changes.
- ▶ In the Frame field, enter the frame number.

In the graph, the vertical red line moves to the frame number.

3. Do one of the following:

- ▶ In the Function editor, click the Add/Remove Keyframes  button.



- ▶ In the Function view, click the Add Keyframe  and Delete keyframe  buttons.

4. Click on the newly created keyframe and drag it up (to decrease the width of the object) or down (to increase the width of the object) or pull on the handles to create a smooth fluctuation of the drawing object's width.

5. If you do not like the changes you just made, select and delete the new keyframe by pressing Delete or clicking the Add/Remove Keyframes  button.

You can delete an existing keyframe by using the same process.

How to change a keyframe value in the Function view

1. In the Timeline view, open the peg element's parameters by clicking the Plus  sign next the peg layer's name.

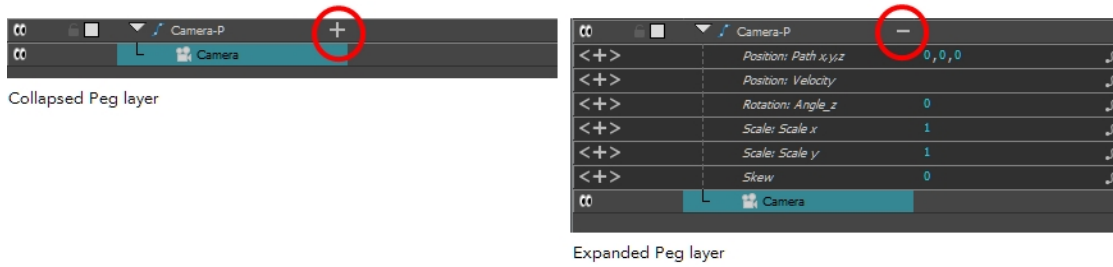

2. Double-click on the parameter layer name to open the Editor window or click once on the parameter layer to display it in the Function view.

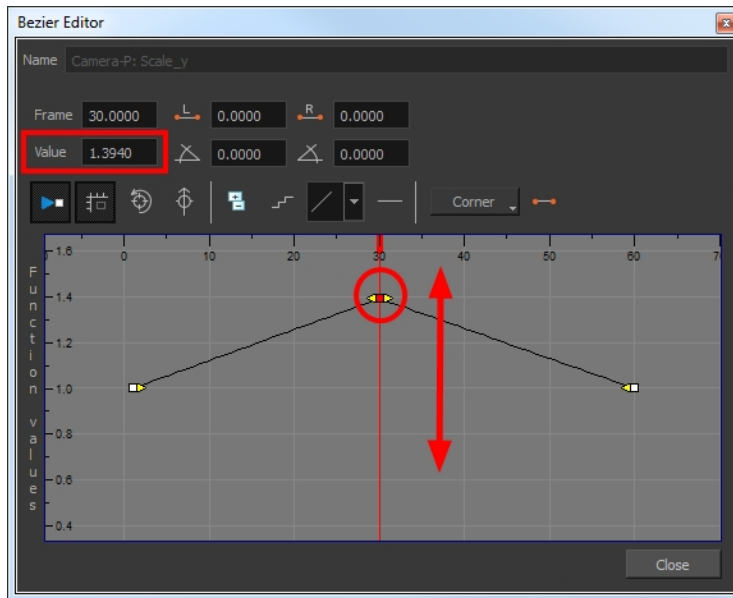

3. In the Value field, enter a value. You can also drag the keyframe up or down in the graph.
4. Press Enter/Return or click the Play  button to view the changes made in the Camera view.
5. Keep adjusting the values until you're satisfied with the results.
6. Click **Close**.

Function View

The Function view lets you edit function curves and parameters. It is a visual graph for adding, removing, and editing keyframes, as well as adjusting the velocity. The Function view allows you to display multiple functions in the background as a reference.

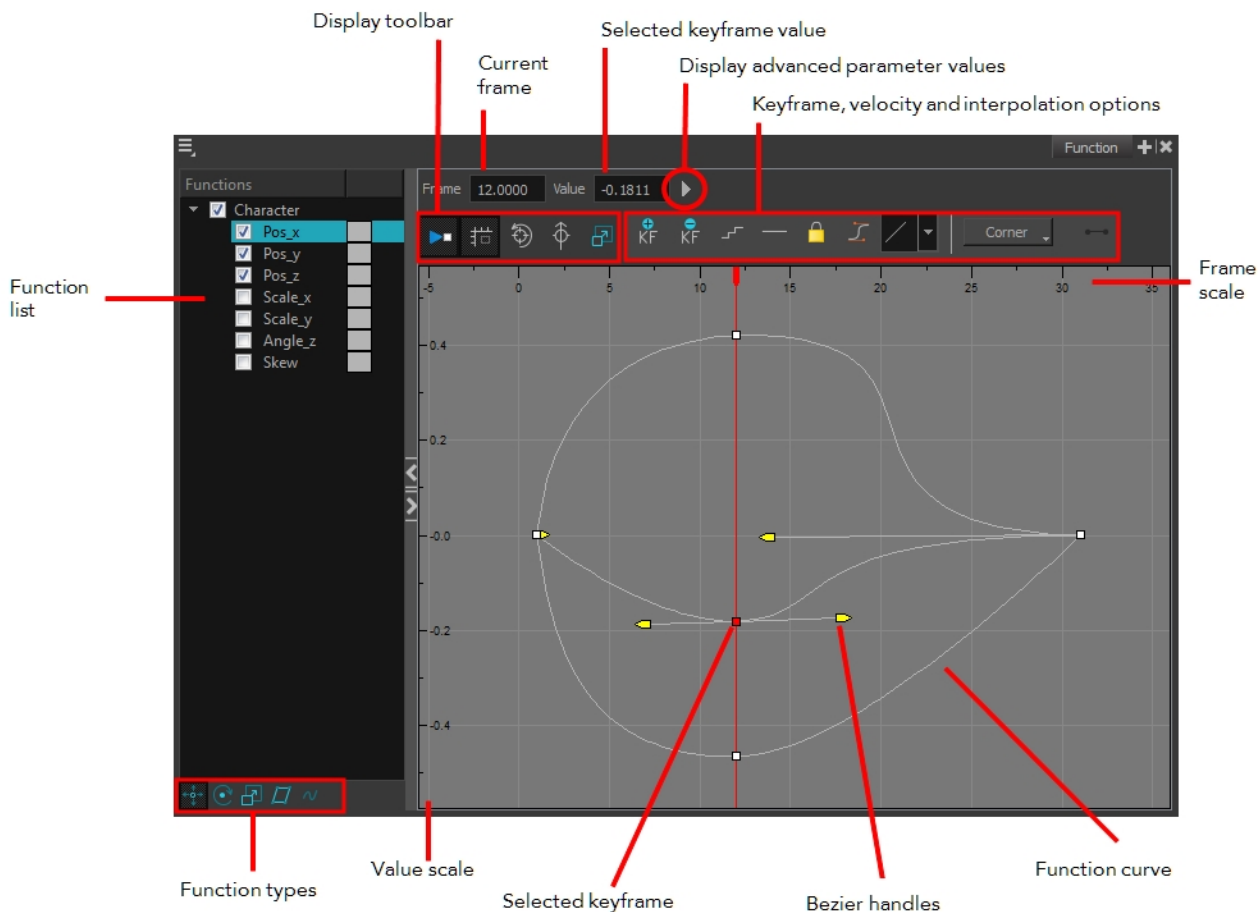

How to display functions in the Function view

1. Open the Function view.
The Function view is blank until you select the layer containing the functions you want to display.
2. To display a function in the Function view, click on the layer containing the functions to adjust in the Timeline view.
3. To select the functions you want to edit, select them in the Function list.

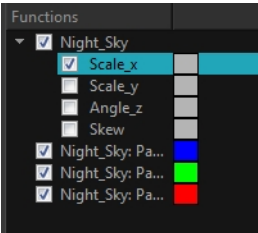
Parameter	Description
Function List	 <p>When selecting a layer in the Timeline view, all the corresponding functions are displayed. Select all the functions you want to see and edit; hide the ones you</p>

	don't.
Display Toolbar	The Display toolbar allows you to modify how the editing area is displayed. You can hide the grid, disable the synchronization with the current frame, reset the zoom level and normalize the function display by stacking them one over the other to compare them regardless of their value range.
Current Frame	Displays the current scene frame.
Selected Keyframe Value	Displays the value of the selected keyframe.
Display Advanced Parameter Values	 <p>Displays the Projection, Bias, Tension and Continuity parameters to adjust the curve around the selected keyframe.</p>
Keyframe, Velocity and Interpolation Options	This toolbar lets you add and delete keyframes, adjust the velocity curve, adjust the segments to motion or stop-motion keyframes and set the velocity to create steps instead of a constant progression.
Function Types	This toolbar lets you click on the different function types to enable or disable all the listed functions of that type.
Value Scale	Displays the value range for the displayed editing area. It can be referenced to know the value of a keyframe.
Selected Keyframe	The selected keyframe is displayed in red. When selected, the keyframe values are displayed in the corresponding fields.
Bezier Handles	The Bezier handles let you adjust the ease in and ease out of each keyframe. The more the handle is pulled out horizontally, the slower the animation will be. The more the handle is pulled out vertically, the faster the animation will be.
Function Curve	The thin line going from keyframe to keyframe is the actual curve. The section of a curve located between two keyframes is called a segment.
Frame Scale	The Frame Scale displays the frame range for the displayed editing area. It can be referenced to know the current frame of a keyframe.

Modifying a Path in the Xsheet View

If you are prefer working with the Xsheet view, you can also create keyframes and type values in the Xsheet view.

You cannot create function curves directly in the Xsheet view. You must do this in the Layer Properties window or the Timeline view.

To edit a function column in the Xsheet view, you must first display the Functions section of the Xsheet view and then select the layer you want to modify. If you double-click on a function column's header, you will display the corresponding function curve in the Function editor.

How to display the function columns in the Xsheet view

1. In the Xsheet view, click the Expand button located on the right side of the main section to show the Functions section.



1. In the Timeline view, select the layer that contains the parameters to modify.

The columns appear in the Xsheet view if function curves were previously created by adding keyframes in the Xsheet view or Layer Properties window. Otherwise, the columns do not appear.

	Drawing		Drawing Pos_x	Drawing Pos_y	Drawing Pos_z	Drawing Scale_x	Drawing Scale_y	Drawing Angle
1	1		0.000	0.000	0.000	1.000	1.000	
2								
3								
4								
5								
6								
7								
8								
9								
10								
11								
12								
13								
14								
15								
16								

How to add a keyframe in the Xsheet view

1. In the Xsheet view, go to the function column on which you want to add a keyframe.
2. Double-click on the cell on which you want to add a keyframe and type a numeric value.

	Drawing Pos_x	Drawing Pos_y	Drawing Pos_z
1	0.000	0.000	0.000
2			
3	0.000		
4			
5			
6			
7			
8			
9			

3. Press Enter/Return to continue to the next cell.
4. Press Esc to exit the typing mode.

	Drawing Pos_x	Drawing Pos_y	Drawing Pos_z
1	0.000	0.000	0.000
2	2.500		
3	5.000		
4	5.000		
5			
6			
7			
8			
9			

How to convert a cell into a keyframe

1. In the Xsheet view, go to the function column on which you want to add a keyframe.
2. Select the cell to convert.

	Drawing Path x	Drawing Path y
1	0.000	0.000
2	1.000 E	
3	2.000 E	
4	3.000 E	
5	4.000 E	
6	5.000 E	0.000
7	6.000 E	
8	7.000 E	
9	8.000 E	
10	9.000 E	0.000

3. Right-click on the cell and select **Set Selection As Keyframe** or press F6.

	Drawing Path x	Drawing Path y
1	0.000	0.000
2	1.000 E	
3	2.000 E	
4	3.000 E	
5	4.000 E	
6	5.000 E	0.000
7	6.000 E	
8	7.000 E	
9	8.000 E	
10	9.000 E	0.000

4. To remove a keyframe, select the keyframe, right-click on the cell and select **Clear Keyframe in Selection** or press F7.

Function Curves

By default, when a drawing layer or peg is added to a scene, no function curves are created. You will generally create the ones needed to avoid being overloaded with too many functions you might not use.

When you select an element in the Camera view and move it around, it will automatically create the corresponding function curves. If you need to create certain functions manually, you can always do it through the Layer Properties view or editor. You can then share it with other layer parameters or set your keyframes directly on the function curve instead of the Timeline or Camera view.

You can also link a layer's parameter to an existing function curve or attach several parameters to the same function curve. For example, if you have an aircraft performing loops between clouds, you may want the camera to follow the aircraft's motion path. If you attach the camera to the aircraft's layer, the camera will also loop, but this may produce undesirable results and even induce a feeling of motion sickness as you watch the final animation. Instead, you can share the X, Y and Z positions of the aircraft with the camera's peg layer, but ignore the angle, scale and skew.

By default, all the function curves you create are private. This means that the function curves can only be used and modified using their original parameter. If you want another layer or parameter to use the same function curve, you must make the function public by sharing it.

There are two ways to share a function:

- Share Functions command
- Layer Properties editor

When you create a function curve in the Layer Properties view or editor, there are several choices available:

Parameter	Description
Create 3D Path	Creates a new 3D Path Column set
Create Bezier	Creates a new Bezier curve
Local	Disconnects the parameter from any function and turns it public
3D Path	Displays the list of every public 3D Path function available
Bezier	Displays the list of every public Bezier curve available
Velobased	Displays the list of every public velocity based curve available
3D Rotation	Displays the list of every public 3D Rotation function available
Connected	Displays the list of every public connected function curve
Unconnected	Displays the list of every public unconnected function curve
All	Displays the list of every public function curve

You have the choice of creating a new function curve or linking it to an existing public one. This way, you can have two or more parameters following the same function.

Depending on your favourite working method, you can create different types of function curves to suit your needs, including:

- Bezier function
- Velobased function

When you create a function to control a parameter over time (Scale, X, Y, Z, Rotate), you can use a Bezier function.

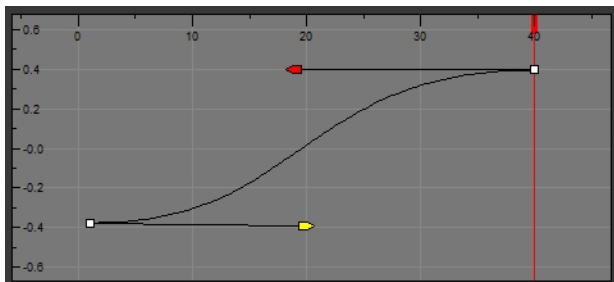

Bezier function

These function editors present different ways of editing the values over time. The shape of the created graph indicates the velocity of the function, regardless of the chosen editor. The type of function that you choose is largely based on your working preference.

You can also create Velobased functions for certain effects, like changes in rotation or size over time. When you do this, the Velobased functions are linked to the velocity of a 3D path. You cannot change the shape of a Velobased function to control its velocity.

With Velobased functions, you can link changes in rotation or scaling to the velocity of a 3D path. This makes it possible for changes in rotation or scaling to progress at the same speed as changes to the position of an element.

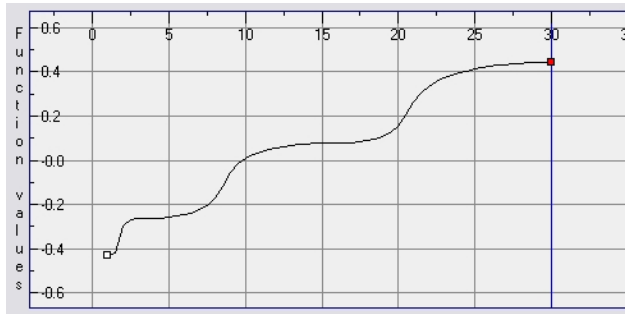

You can convert a Bezier functions so you can edit it using the controls offered by that type of function.

How to create function curves

1. In the Timeline view, double-click on a layer.

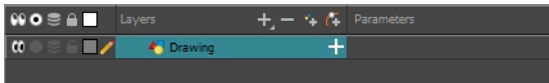

The Layer Properties Editor opens.

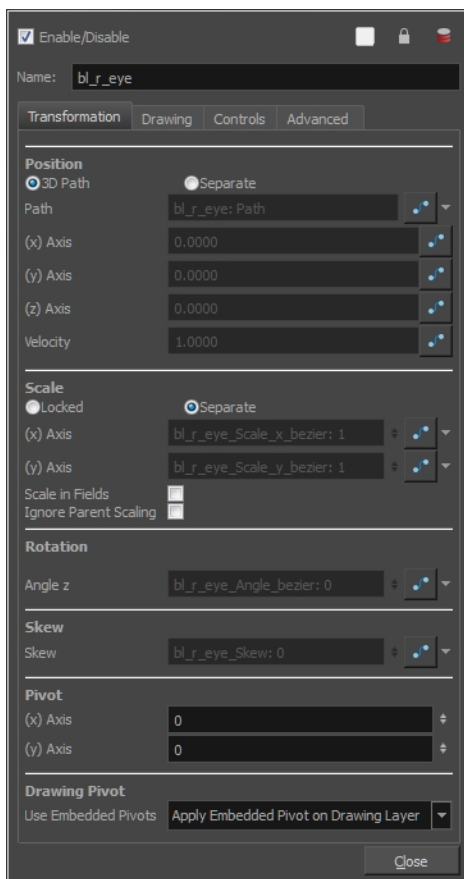

2. In the Transformation tab, click the Function Arrow button beside the local function information.
3. Create a 3D Path, Bezier, or Velobased curve.

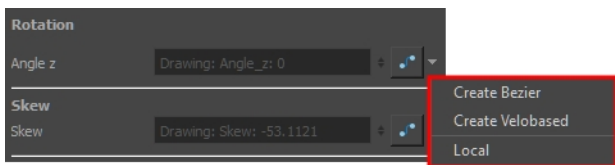

You can click the Function  button to open the Function editor.

How to share function curves

1. In the Timeline view, double-click on the layer that contains the function to share.

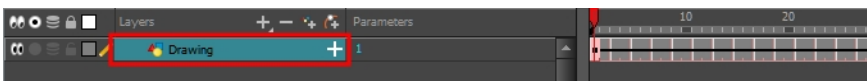

The Layer Properties window displays.

2. In the Transformation tab, click the Arrow button beside the function you want to share and select **Local**.

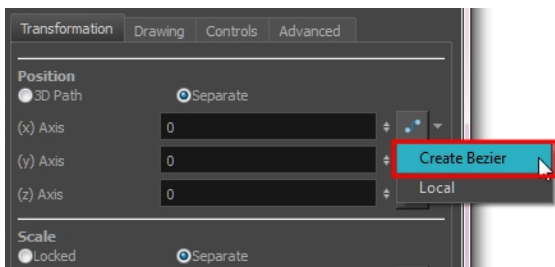

The function becomes public to the other layers and parameters, and can be shared.

Public functions are visible in the main section of the Xsheet view.

	Drawing_Pos_x	Drawing_Pos_y	Drawing_Pos_z	Drawing_Angle_	Drawing
1	0.000	0.000	0.000		1
2	-0.021		0.072		
3	-0.050		0.148		
4	-0.092		0.225		
5	-0.156		0.303		
6	-0.248		0.381		
7	-0.375		0.370		
8	-0.284		0.359		
9	-0.195		0.347		
10	-0.110		0.336		
11	-0.032		0.325		
12	0.038		0.314		
13	0.098		0.303		
14	0.146		0.291		
15	0.187		0.280		
16	0.177		0.269		
17	0.166		0.258		
18	0.156		0.247		
19	0.145		0.235		
20	0.135		0.224		
21	0.125		0.213		
22	0.114		0.202		
23	0.104		0.191		
24	0.093		0.179		
25	0.083		0.168		
26	0.072	0.000	0.157		1
27	0.062	0.000	0.146		1

3. From the same menu in which you chose the Bezier option (in our example), select the function you just made public and attach it to your parameter.

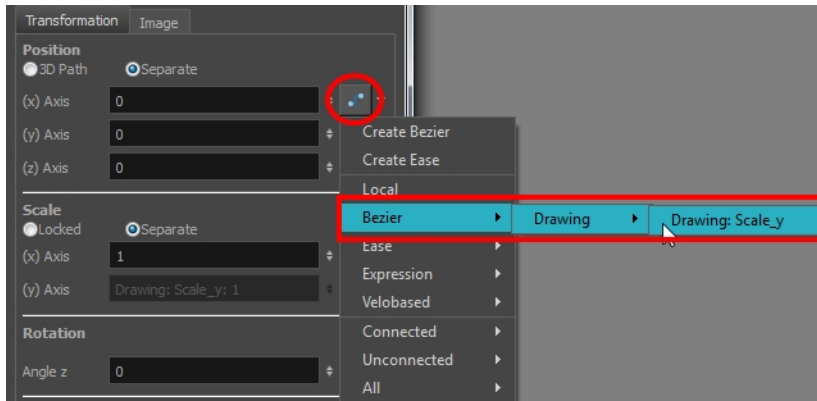

4. In the Timeline view, open the Layer Properties editor of the other layer that contains the parameters you want to link to the public function.
5. In the Layer Properties editor or view, attach the parameter to the public function the same way you did for the first layer.

The two parameters are both linked to the same function curve and follow the same path. If you modify the curve, both parameters will update.

Copying and Pasting a Motion

In the Timeline view, you can easily drag keyframes to change the animation timing, delete them, cycle them and even copy them.

As you animate, you will find that you reuse many positions, drawings, and keys. However, you may only want to paste the drawings or just the keys or maybe everything. There are different paste options available in the Timeline view which give you maximum flexibility when reusing and pasting.

Note that these modes also apply when you drag instead of copying and pasting.

There are three different modes for pasting your selection:

- **Paste Mode: All Drawing Attributes:** Pastes the drawing exposure and keyframes.
- **Paste Mode: Keyframes Only:** Pastes only the keyframes.
- **Paste Mode: Exposures Only:** Pastes only the drawing exposure.

When you have position keyframes set in your drawing layer and you want to move them around when moving your drawing's timing, you can use the Paste Special feature to only move selected keyframes.

You can also use the Paste Cycle and Paste Reverse feature to cycle your selection including keyframes and drawings.

If you want to cycle a portion of your animation, you can use the Paste Cycle command. You can also use the Paste Reverse command to completely reverse the flow of your animation.

How to copy and paste a motion using Paste Special

1. In the Timeline view, select the keyframes to copy and paste. If you want to move the keyframes, go to step 3.



2. From the top menu, select **Edit > Copy Cells from the Timeline** or press **Ctrl + C** (Windows/Linux) or **⌘ + C** (Mac OS X).
3. Edit your selection by doing the following:
 - ▶ To paste the selection, in the Timeline view, select the first cell on which you want to paste your keyframes and from the top menu, select **Edit > Paste Special** or press **Ctrl + B** (Windows/Linux) or **⌘ + B** (Mac OS X).
 - ▶ To move the selection, in the Timeline view, drag the selection and hold down **Alt** (Windows/Linux) or **⌘** (Mac OS X). Drop the selection where you need it and release the hot key.



The Paste Special window opens.

4. Set the Drawing, Pegs and Functions, and Cycles parameters.
5. Click **OK**.

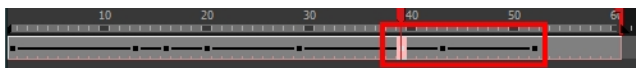

How to open the Paste Special dialog box

1. In the Library view, select the symbol or template to import.
2. While dragging the selection to the Timeline view, hold down the **Alt** (Windows/Linux) or **⌘** (Mac OS X). Drop the selection in the Timeline view before releasing the hot key.

The Paste Special window opens.

3. Set the parameters.

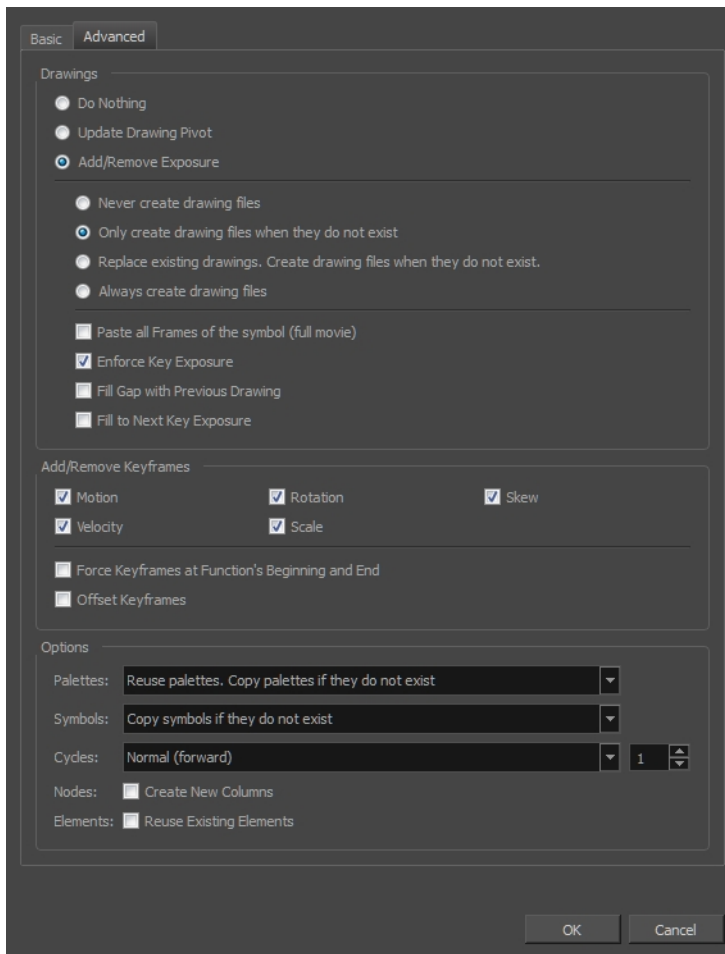

How to cycle a portion of an animation

1. In the Xsheet or Timeline view, select the cell range and keyframes to loop.
2. From the top menu, select **Edit > Copy Cells from the Xsheet/Timeline**.
3. In the Xsheet or Timeline view, select the cell on which you want the cycles to start.

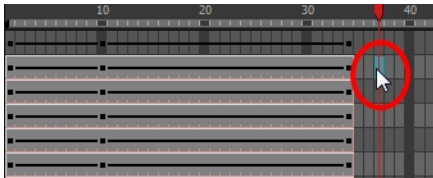

4. From the top menu, select **Edit > Paste Cycle** or press **Ctrl + /** (Windows/Linux) or **⌘ + /** (Mac OS X).
The Paste Cycle dialog box opens.

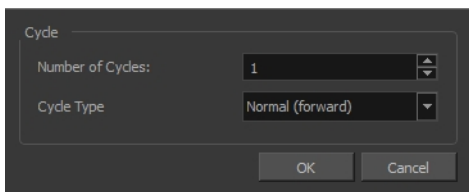

5. In the Number of Cycles field, increase or decrease the number of cycles you want to paste.
6. In the Cycle Type, select the type of cycle to paste.



- **Normal (forward)**: Pastes your selection as it is, starting with the first cell and ending with the last.
- **Reverse**: Pastes your selection reversed, starting with the last cell and ending with the first.
- **Forward > Reverse**: Pastes your selection as a yo-yo, starting with the first cell, going to the last one and ending with the first cell.
- **Reverse > Forward**: Pastes your selection as a reversed yo-yo, starting with the last cell, going to the first one and ending with the last cell.

How to reverse the animation flow

1. In the Xsheet or Timeline view, select the cell range and keyframes to paste inverted.



2. From the top menu, select **Edit > Copy**.
3. In the Xsheet or Timeline view, select the cell on which you want the cycles to start.
4. From the top menu, select **Edit > Paste Reverse** or press **Ctrl + .** (Windows/Linux) or **⌘ + .** (Mac OS X).

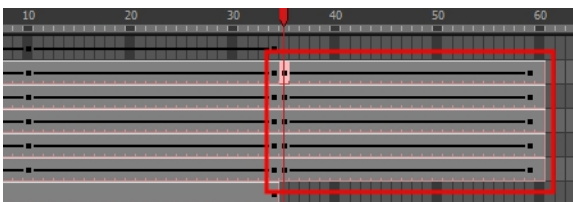

Paste Special Options

Basic Tab

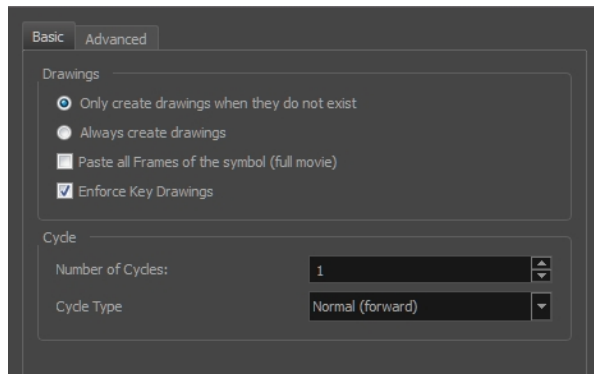

Parameter	Description
Drawings	
Only create drawing files when they do not exist	When adding exposures to a drawing layer, new drawings will be created only when drawings with the same name do not already exist in the destination.
Always create drawing files	When adding exposures to a drawing layer, new drawings will always be created. If drawing files with the same name already exist, Harmony will create a new name for the drawing.
Paste all Frames of the Symbols (full movie)	When enabled, the Paste Special command exposes all the symbol's frames instead of only the first one.
Enforce Key Drawings	Creates a key exposure on the same drawing.
Cycle	
Number of Cycles	Lets you set the number of cycles.
Cycle Type	Normal (forward): Pastes your selection as is, starting with the first cell and ending with the last.
	Reverse: Pastes your selection in reverse, starting with the last cell and ending with the first.
	Forward > Reverse: Pastes your selection as a yo-yo, starting with the first cell, going to the last one and ending with the first cell.
	Reverse > Forward: Pastes your selection as a reverse yo-yo, starting with the last cell, going to the first one and ending with the last cell.

Advanced Tab

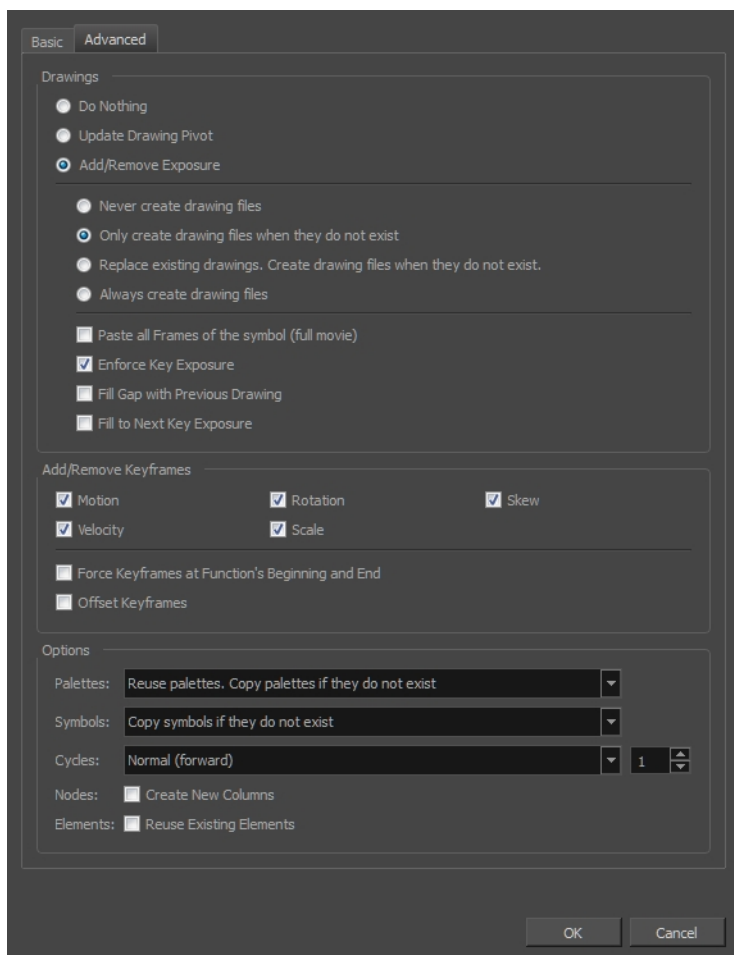

Parameter	Description
Drawings	
Do Nothing	Does not create or overwrite drawings.
Update Drawing Pivot	Revises the drawing pivot in the destination to use the same drawing pivot as the first drawing in the template. If you have a range of drawings selected in the destination, the pivot points of all selected drawings will be updated.
Add/Remove Exposure	Never create drawing files: When adding exposures to a drawing layer, drawing files will not be created.
	Only create drawing files when they do not exist: When adding exposures to a drawing layer, new drawings will be created only when drawings with the same name do not already exist in the destination.
	Replace existing drawings. Create drawing files when they do not exist: Replace drawings with the same names to update a scene with new modified drawings and preserve the animation.

	<p>Tip: If you don't want to lose the existing animation when pasting a template, such as when placing new drawings after the animation, then delete the template's animation. It will still have updated the drawings but not override the existing animation.</p>
	<p>Always create drawing files: When adding exposures to a drawing layer, new drawings will always be created. If drawing files with the same name already exist, Harmony will create a new name for the drawing.</p>
	<p>Paste all frames of the symbol (full movie): When enabled, the Paste Special command exposes all the symbol's frames instead of only the first one.</p>
	<p>Enforce Key Exposure: If there are key exposures that exist on copied drawings, they are preserved when pasting. No key exposures are added. This is the default behavior when pasting.</p>
	<p>Fill Gap with Previous Drawing: Fills selected area in the Xsheet or Timeline view with the previous drawing.</p>
	<p>Fill to Next Key Exposure: Fills selected area till the next key exposure.</p>
Add Remove/Keyframes	
Motion	Copies the properties of the selected motion keyframe to the new frame.
Velocity	Copies the properties of the selected velocity keyframe to the new frame.
Rotation	Copies the properties of the selected rotation keyframe to the new frame.
Scale	Copies the properties of the selected scale keyframe to the new frame.
Skew	Copies the properties of the selected skew keyframe to the new frame.
Force Keyframes at Function's Beginning and End	Adds a keyframe to the beginning and end of the pasted function, reproducing the source function.
Offset Keyframes	When pasting functions, offsets keyframes from the function's last frame value by the values in the pasted function. This will continue the progression of a function instead of repeating the values.
Options	
Palettes	<p>Do nothing: Does not create, overwrite, merge or link palettes.</p> <p>Reuse palettes. Copy palettes if they do not exist: Palettes in the destination drawings are left as they are.</p> <p>Copy and overwrite existing palettes: Overwrites destination palettes with the palettes from the source drawings.</p> <p>Copy and create new palette files: Creates new palette files, placing them at the same relative environment and scene level as the source. If the palettes in the templates were stored at the environment level of the source scene, the paste operation will place the palettes in the environment level of the destination scene.</p> <p>Copy and create new palette files in element folder: Creates new palette files in the element folders of the destination scene, rather than in the same</p>

	<p>relative job or environment.</p> <p>Copy palette and merge colours. Add new colours only: Adds new colours to the destination palettes and ignores colours that are the same in the two palettes.</p> <p>Copy palettes and update existing colours: Adds new colours to the destination palette and updates duplicate colours in the destination with colour values from the source.</p> <p>Link to original palettes (colour model): Links the colour palettes in the destination scene to the palettes in the source. Use this to link drawings to the palettes in a colour model.</p> <p>Copy scene palettes and merge colours. Add new colours only: Adds new colours to the destination scene palettes and ignores colours that are the same in the two palettes.</p> <p>Copy scene palettes and update existing colours: Adds new colours to the destination scene palette and updates duplicate colours in the destination with the colour values from the source.</p>
Symbols	<p>Copy symbols if they do not exist: This is the default setting for this operation and will prevent Symbols in an Action template from being copied.</p> <p>Duplicate symbols: Creates a duplicate of the symbol instead of linking the Symbol instance to the original one. The new Symbol is created in the Library.</p>
Cycles	<p>Normal (forward): Pastes your selection as is, starting with the first cell and ending with the last.</p> <p>Reverse: Pastes your selection in reverse, starting with the last cell and ending with the first.</p> <p>Forward > Reverse: Pastes your selection as a yo-yo, starting with the first cell, going to the last one and ending with the first cell.</p> <p>Reverse > Forward: Pastes your selection as a reverse yo-yo, starting with the last cell, going to the first one and ending with the last cell.</p>
Nodes	<p>Create New Columns: A new column is created when you copy and paste nodes from the layer in the Timeline view. If the layers are linked to function curves, the function curves, drawings and timing will be duplicated.</p>
Elements	<p>Reuse existing elements: Lets you paste existing elements without creating new ones. This should be used only when pasting within versions of the same scene.</p>

Adjusting the Velocity

To add ease in and ease out on motion paths, you can display the function curve and modify the Bezier or Ease curve. To apply ease to multiple functions and keyframes, you can use the Set Ease For Multiple Parameters script and set the amount.

The Velocity, or ease, is used on motion keyframes. The Velocity must be adjusted directly on the function curve in the Function view or Function editor. When a keyframe is selected, easing values appear in the right handle and

left handle fields, as well as Bezier handle or Ease wheel controls on each selected keyframe. Pull on them to adjust the ease in and ease out, or type values in the fields.

You can reshape the velocity function using Bezier controls.

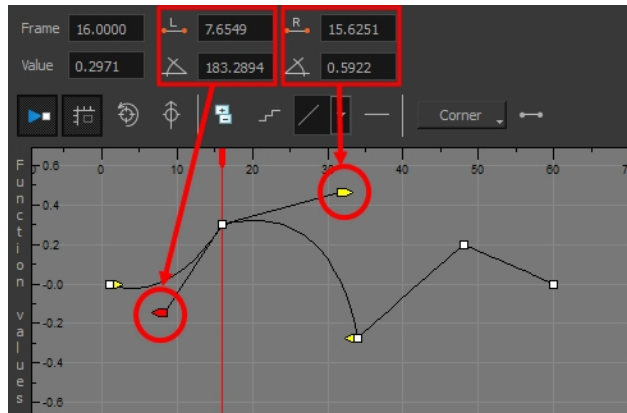

You can create a stepped curve to hold the same value over a selected number of frames. This works well when you are animating drawings on 2s, for example, and you want to hold the same value for a function over those two frames.

If you have several functions whose velocity you want to adjust at the same time, you can use the Set Ease for Multiple Parameters dialog box. It allows you to apply the same velocity parameters to all the selected keyframes in the same frame.

How to display the velocity curve

1. In the Timeline view, click the Expand **+** button on a layer or press Alt + F.

The layer's functions are displayed.

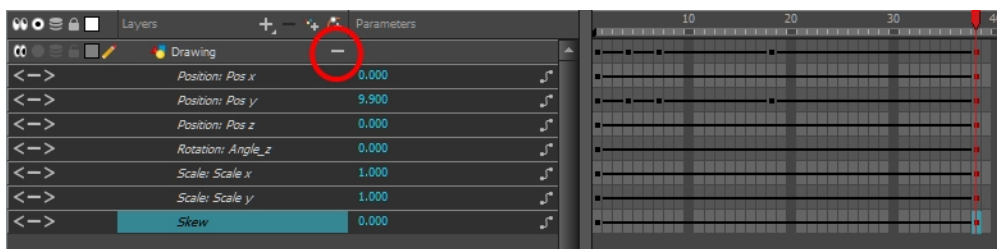

2. Double-click the desired function.

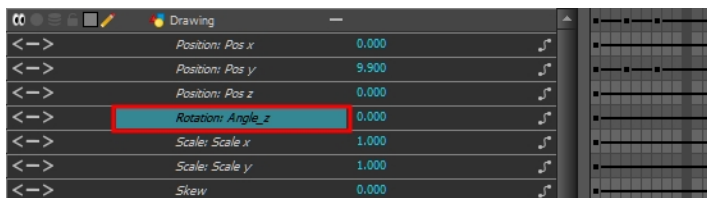

The Function Editor opens as the Bezier Editor.

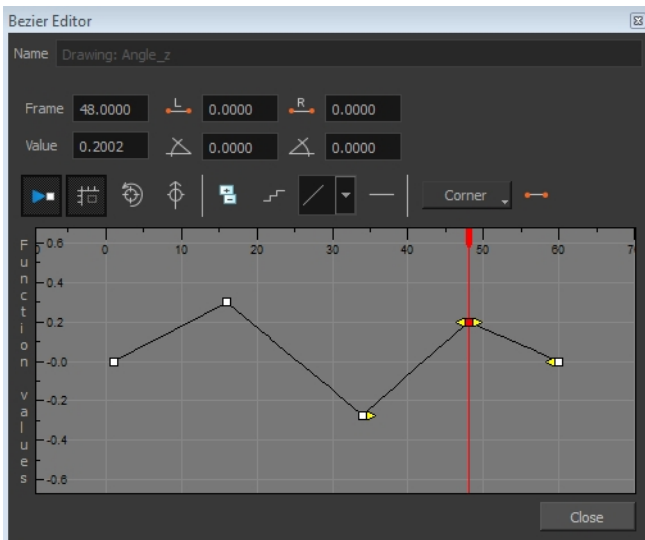

The editor will not be displayed if the function does not already exist. You can reshape the function using the Bézier controls.

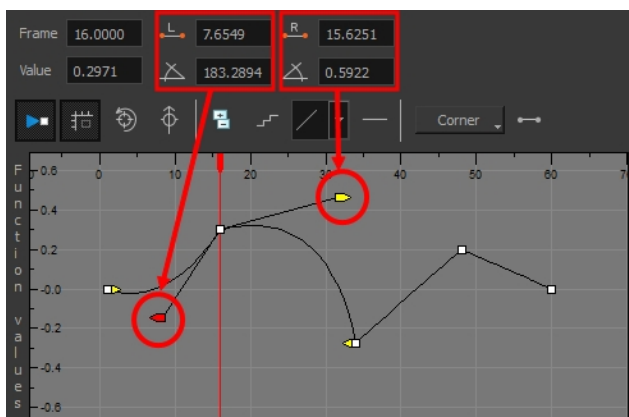

How to reshape a function using Bézier controls

1. Select a keyframe.
2. Drag the handles to modify the shape of the curve.
3. The Continuity options influence how you can move the handles:
 - ▶ **Straight:** Lets you move the handles together, maintaining the same angle to the point.
 - ▶ **Corner:** Lets you move the handles independently.
 - ▶ **Smooth:** Lets you move the handles together, maintaining the same distance and angle to the point.

How to reshape the function using Ease controls

1. Select a keyframe.
2. To set the number of frames in the ease-in, press Alt, click to the right of the keyframe and drag the green line. The ease in slope is indicated in blue.

As you change the values visually, the value in the Ease In field is updated. This value represents the number of frames in the ease-in.

- To set the number of frames in the ease-out, press Alt, click to the left of the keyframe and drag the green line. The ease-out slope is indicated in red.

As you change the values visually, the value in the Ease Out field is updated. This value represents the number of frames in the ease-out.

- To adjust the ease-in or ease-out, drag the handles around the keyframe.

The Continuity options, Corner and Straight, influence how you can move the handles:

- ▶ **Straight:** Lets you move the handles together, maintaining the same angle to the point.
- ▶ **Corner:** Lets you move the handles independently.

How to hold the same value over several frames

- Click the Hold Value Editor  button.

The Hold Value editor opens.

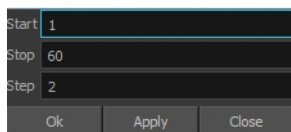

- In the Hold Value Editor, enter the following values:

- ▶ **Start:** The starting frame for the effect.
- ▶ **Stop:** The last frame for the effect.
- ▶ **Step:** The number of frames to hold the value.

The function curve is updated based on the values you entered.

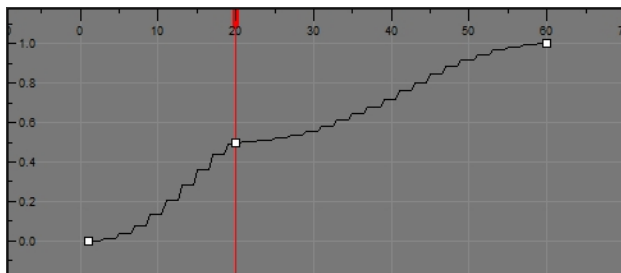

You can reshape the curve to create a linear velocity, so the values are interpolated (tweened) consistently between keyframes. That is, there is no acceleration in the effect.

How to set the ease on multiple parameters

- In the Timeline view, select a keyframe on one or more layers.

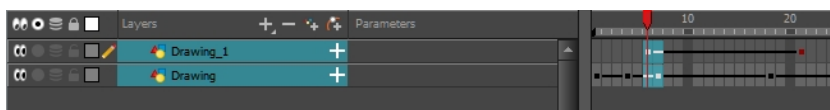

NOTE: Only the first selected keyframe will be considered when using the Set Ease For Multiple Parameter function. If many keyframes are selected on the same layer, the ease values will be applied only on the first keyframe and the rest will be ignored.

2. Do one of the following:

- ▶ In the Timeline view, right-click and select **Set Ease For Multiple Parameters**.
- ▶ In the Timeline toolbar, click the Set Ease For Multiple Parameters  button.

The Set Ease For Multiple Parameters dialog box opens.

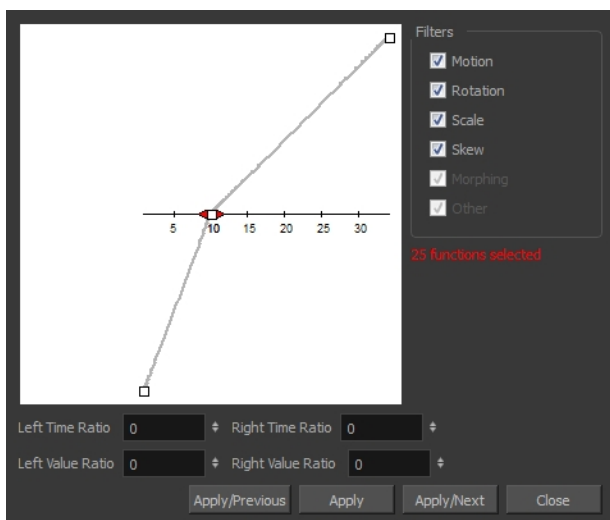

3. In the graph, adjust the Bezier handles to change the velocity for all the selected functions.

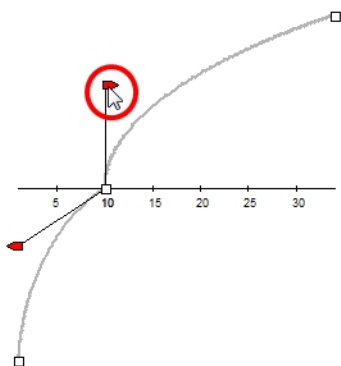

4. In the Filters section, you can apply the easing parameters to a specific type of function only, such as Rotation or Scale. Deselect the function types you do not want to affect.

- ▶ **Motion:** Applies the easing parameters to the selected Position X, Position Y, Position Z and 3D Path functions.
- ▶ **Rotation:** Applies the easing parameters to the selected Angle functions.
- ▶ **Scale:** Applies the easing parameters to the selected Scale functions.
- ▶ **Skew:** Applies the easing parameters to the selected Skew functions.

- ▶ **Morphing:** Applies the easing parameters to the selected Morphing Velocity functions. Note that it applies to the Morphing velocity function found in the Layer Properties window, not the basic morphing ease in the Tool Properties view.
 - ▶ **Other:** Applies the easing parameters to all the other the selected functions, such as all functions created to animate effect parameters.
5. You can also adjust the easing by typing values in the Time and Value Ratio fields. The values are calculated in percentage.
 - ▶ In the Left Time Ratio and Right Time Ratio fields, type the percentage value corresponding to the length of time you want the easing to last. Stay between 0% and 100%. If you go beyond 100%, your motion will overshoot.
 - ▶ In the Left Value Ratio and Right Value Ratio fields, type the percentage value of how strong you want the easing out to be. Stay between 0% and 100%. If you go beyond 100%, your motion will overshoot.
 - ▶ If your Time Ratio and Value Ratio values are equal, you will have a linear motion.
 6. Once done, click one of the following:
 - ▶ **Apply/Previous:** Applies the easing parameters to the selected keyframes and then selects the previous keyframe in the timeline.
 - ▶ **Apply:** Applies the easing parameters to the selected keyframes.
 - ▶ **Apply/Next:** Applies the easing parameters to the selected keyframes and then selects the next keyframe in the timeline.
 - ▶ **Close:** Close the dialog box. If you did not apply the modifications, they will be cancelled.

How to set the ease in the Timeline view

1. In the Timeline view, select a keyframe on one or more layers.

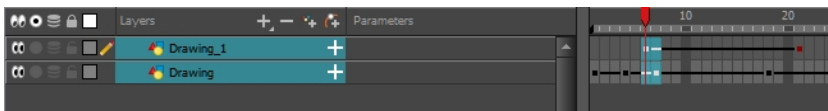

NOTE: Only the first selected keyframe will be considered when using the Set Ease For Multiple Parameter function. If many keyframes are selected on the same layer, the ease values will be applied only on the first keyframe and the rest will be ignored.

2. In the Timeline toolbar, select an option from the Set Ease Type menu.

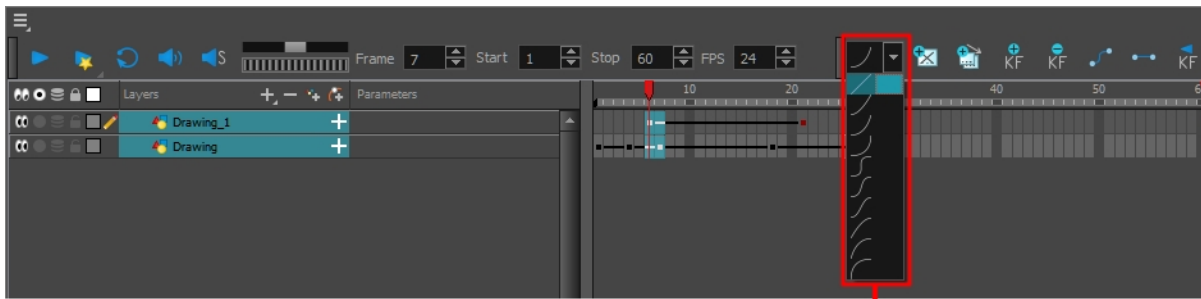

Set Ease Type menu

NOTE: TIP: Optimize your workflow by adding the Apply Ease to Selection  button to the Timeline toolbar. This lets you quickly reapply the ease type without going through the Set Ease Type menu each time. To add the button to the toolbar, right-click on the toolbar area of the Timeline view and select **Customize**.

Chapter 6: Sound

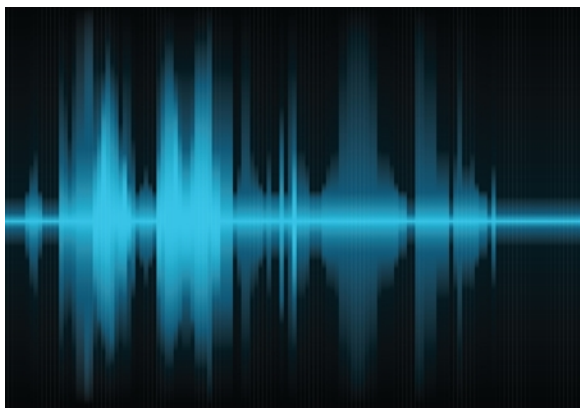

With Harmony, you can import soundtracks and dialogue into your animation. There are several sound editing features you can use to synchronize sounds to individual frames or moments in time. You can also edit them to trim unwanted seconds from the beginning and end of your sound files, as well as loop sounds that you want to continue throughout your animation.

Your ability to add dialogue to animation is greatly enhanced with the Harmony automatic lip-sync detection. Harmony can analyze voice tracks to determine which of the eight animation phonemes (lip positions) would best apply to each frame of sound. With the mouth chart that is generated, you can easily draw lip positions for your character. Furthermore, Harmony can automatically apply drawings of lip positions to each frame of your animation based on the mouth chart.

This chapter contains the following topics:

- [Importing a Sound File on page 213](#)
- [Sound Layer Properties and Sound Element Editor on page 214](#)
- [Sound Displays on page 215](#)
- [Sound Playback on page 216](#)
- [Sound Scrubbing on page 217](#)
- [Editing a Sound File on page 220](#)
- [Adding an Empty Sound Layer on page 227](#)

Importing a Sound File

If you decide to add sound to your animation, you must first prepare the sound outside of Harmony. Once this is done, you must add a sound element in Harmony to organize the sound files in your animation. Sound will play in the movie until it reaches the end of the file or a stop frame that you created in the Sound Element Editor.

If you first create your project in Toon Boom Storyboard Pro, the sound will be cut up into the different scenes for you automatically.

You can import .wav, .aiff or .mp3 sound files.

How to import a sound file

1. Do one of the following:

- ▶ From the top menu, select **File > Import > Sound**.
- ▶ In the Xsheet view, right-click anywhere in the frame area and select **Import > Sounds**.
- ▶ From the Xsheet menu, select **File > Import > Sounds**.
- ▶ From the Timeline menu, select **Import > Sounds**.

The Select Sound File dialog box opens.

1. From the Select Sound File dialog box, find and select a sound file.

The sound file appears as a layer in the Timeline and Xsheet views.

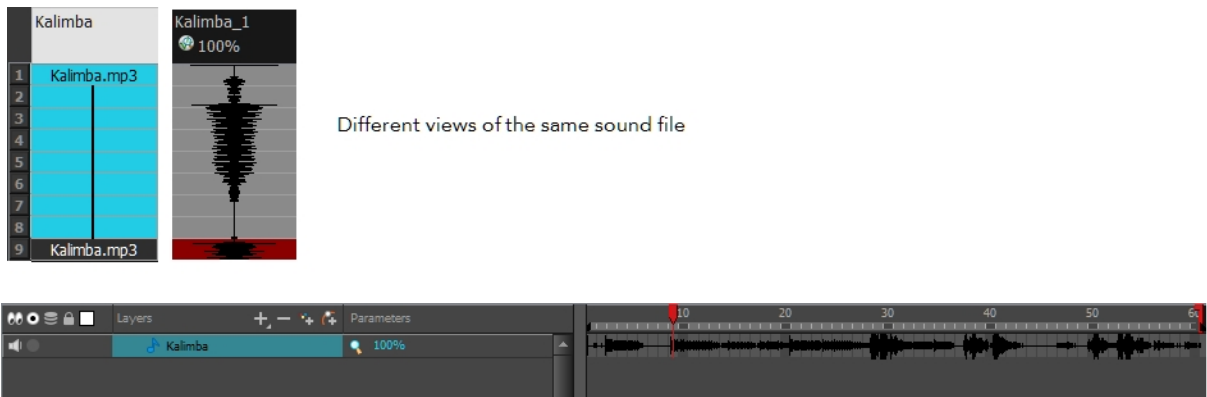

Sound Layer Properties and Sound Element Editor

When you select a sound layer in the Timeline view, the options related to that layer appear in the Layer Properties view and in the Sound Element editor when you double click on the layer.

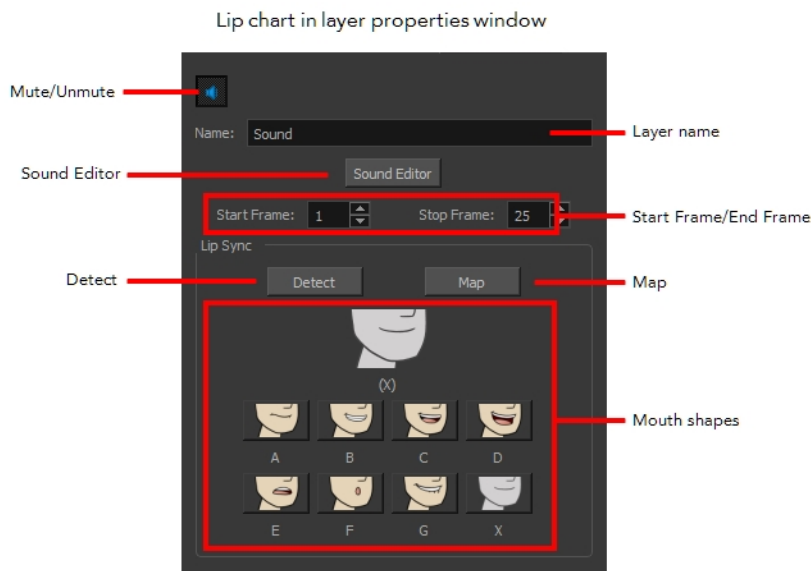

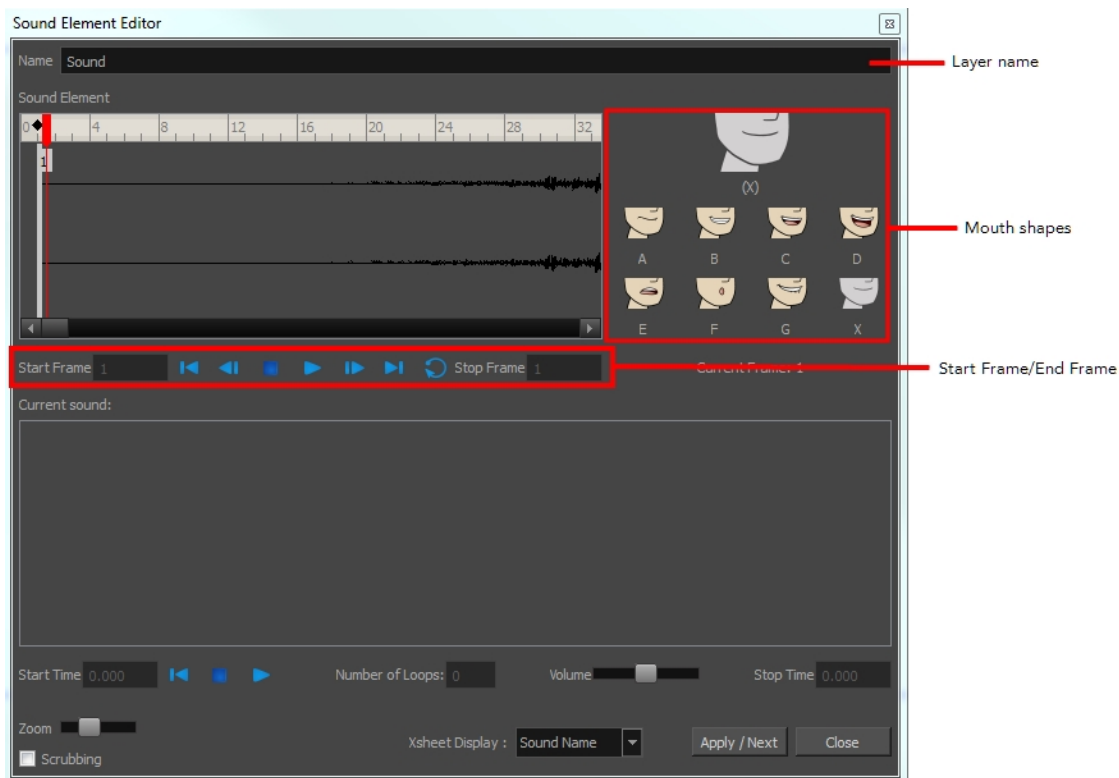

- **Mute/Unmute:** This button mutes and unmutes the sound layer during the scene play back.
- **Layer Name:** This field displays the layer's name.
- **Sound Editor:** This button opens the Sound editor.
- **Start Frame/End Frame:** These fields determine the start and end frame of the sound file.
- **Detect:** This button launches the automated lip-sync detection.
- **Map:** This button opens the Map Lip-sync dialog box.
- **Mouth Shapes:** This section shows the automated lip-sync detection during the scene play back. Click on the thumbnail image of each mouth to change the phoneme assigned to the current frame.

Sound Displays

Within the Xsheet view, you can display the sound file in different ways, depending on your sound editing needs.

You can show or hide the waveform in the Timeline view by selecting the Waveform  button in the Timeline View toolbar. You must customize the toolbar to display this button because it is not included in this toolbar by default.

How to change the sound display in the Timeline view

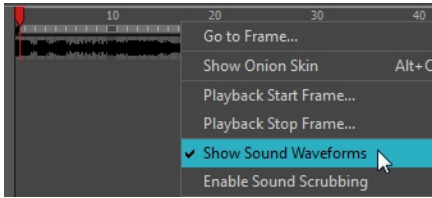

1. In the Timeline view's right area, right-click in the frame section and select **Show Sound Waveforms** or in the Timeline View menu, select **View > Show > Show Sound Waveforms**.

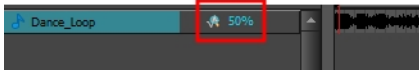

- ▶ You can change the waveform scale using the Zoom Waveform  icon on individual sound layers in the Timeline view's left side.



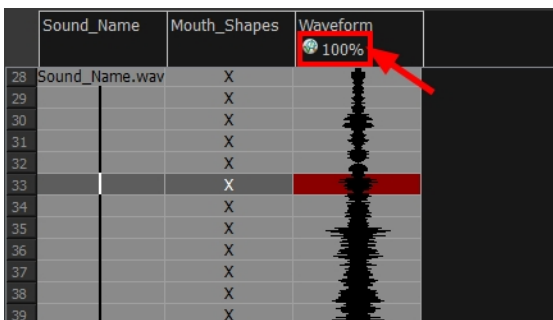

How to change the sound display in the Xsheet view

1. Right-click in the sound column or on the sound column header, and select **Sound Display** and one of the following:
 - ▶ **Sound Name:** Shows the name of the sound file, as well as the file format. The line running vertically through the column frames between the same file name indicates a continuity of the same sound file in these frames.
 - ▶ **Mouth Shapes:** Shows the letter (or name depending on the way you named your character's different mouth positions) in the column's frames. There is only one mouth position allotted per frame and this position should correspond to the sound file after performing a lip-sync.
 - ▶ **Waveform:** Shows a vertical display of the sound file's actual waveform. In the column header, in the field under the column name, you can type in a percentage to zoom in or zoom out on the waveform, or pass the scroll cursor  over the Zoom Waveform  icon.



Sound Playback

Before playing back any sound, click the Enable Sound  button in the Playback toolbar or enable it through the Play menu (in the top menu). This will ensure that you can hear the sound layers in your scene, even the ones included within symbols.

If there are two or more sound layers and you want to listen to them independently, you can disable the unwanted sound by clicking the Disable Layer  button on the sound name layer in the Timeline view.





If you are trying to do a playback with sound and the frame rate doesn't reach 24 fps (frame per second), you can do one of the following to troubleshoot the issue:

- Shrink down the Camera view size to reduce the cached image size.
- Playback your scene without sound first, then add the sound. If you do not cache the images first without sound, the playback will try to follow the sound by skipping images that will never get cached.
- In the Preferences panel, in the OpenGL tab, reduce the size of the Playback Cache Size (in mb) preference.

How to play back sound

1. To select a starting point:
 - In the Xsheet view, click on a cell in the sound column.
 - In the Timeline view, click on a cell in the sound layer. You can also slide the red playhead to the correct cell.



2. In the Playback toolbar, activate the Enable Sound  button.
3. Do one of the following:
 - Click the Play  button in the Playback toolbar.
 - From the top menu, select **Play > Play** or click on the Enter/Return key.
4. To hear the sound played back again and again, do one of the following:
 - Click the Loop  button in the Playback toolbar
 - From the top menu, select **Play > Loop**.
5. To mute soundtrack, on the left side of the sound layer, click the Disable Layer  button.

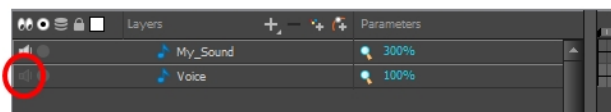

Sound Scrubbing

Harmony uses a process known as Sound Scrubbing to let you hear sound in real-time while you move the playback pointer forward or backward. This is very useful for finely-tuned lip-synching. You can scrub sounds from the Timeline view.

How to scrub a sound from the Timeline view

1. Do one of the following:
 - From the top menu, select **Play > Enable Sound Scrubbing**.
 - Right-click in the frame bar of the Timeline view and select **Play > Enable Sound Scrubbing**.
 - In the Playback toolbar, enable the Sound Scrubbing  button.

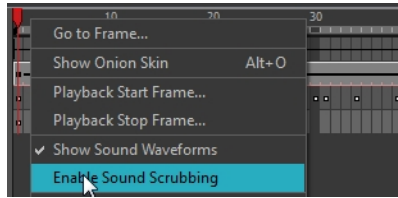

- At the top of the Timeline view, drag the red playhead to hear the sound at each frame.



- In the Playback toolbar, you can use the jog slider to playback forward and backward subsequent sound frames. This allows you to do a more fluid scrubbing.



Analog Sound Scrubbing

Harmony is set to the digital sound scrubbing mode by default. This means that all sounds are played in real time. It also means that as you scrub over a frame, you will hear the section of your sound file that is allotted to that frame. As you are scrubbing, although it is accurate, the sound can sound clipped. It can also be difficult to hear nuances in pitch and tone.

Harmony has an analog sound scrubbing option. When sound scrubbing in this mode, the sound is played back according to the speed that the playhead or jog is manually adjusted. Harmony's interface offers shuttle and jog sliders to perform analog sound scrubbing, however, external hardware and their corresponding software can be used in conjunction with Harmony for improved analog sound scrubbing results.



Contour Shuttle Pro, an example of an external sound scrubbing controller.

NOTE: Refer to the device's manual to configure its functionality with Harmony.

Performing an Analog Sound Scrub in Harmony

Before you can perform an analog sound scrub in Harmony, you have to learn about the Shuttle and Jog controls.



- **Shuttle:** Pull the Shuttle control backward or forward to make the red playhead in the Timeline view jump by large increments in the direction you are moving the shuttle.
- **Jog:** Drag the Jog control to make the "dial" rotate. The Jog controls finer incremental movements along the soundwave. Use the Frame field to see the frame number which you are on. As you rotate the dial, your speed in fps appears directly after the FPS field.

How to perform an analog sound scrub

1. Do one of the following:
 - ▶ From the top menu, select **Play > Enable Sound Scrubbing**.
 - ▶ Right-click in the frame bar of the Timeline view and select **Play > Enable Sound Scrubbing**.
 - ▶ In the Playback toolbar, enable the Sound Scrubbing  button.

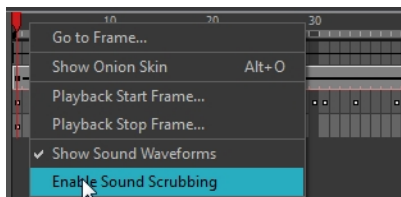

2. In the top menu, select **Edit > Preferences** (Windows) or **Stage Advanced > Preferences** (Mac OS X).
3. In the Sound tab, select the **Analog Sound Scrubbing** option.
4. Click **OK**.
5. Do one of the following:
 - ▶ In the Playback toolbar, use the Shuttle to find the general location of where you want to start your sound scrub.
 - ▶ In the Timeline view, drag the red playhead to the desired location.
6. In the Playback toolbar, use the Jog to fine-tune your scrub to just a few frames.

Editing a Sound File

Now that you have successfully imported a sound file into Harmony, it is time to familiarize yourself with the sound editing interface. The Sound Element editor makes it possible to edit sounds that were created outside of Harmony and imported into your scene.

How to open the Sound Element editor

1. Double-click on the sound layer name in the Timeline view or the sound column header in the Xsheet view.

The Sound Element Editor dialog box opens.

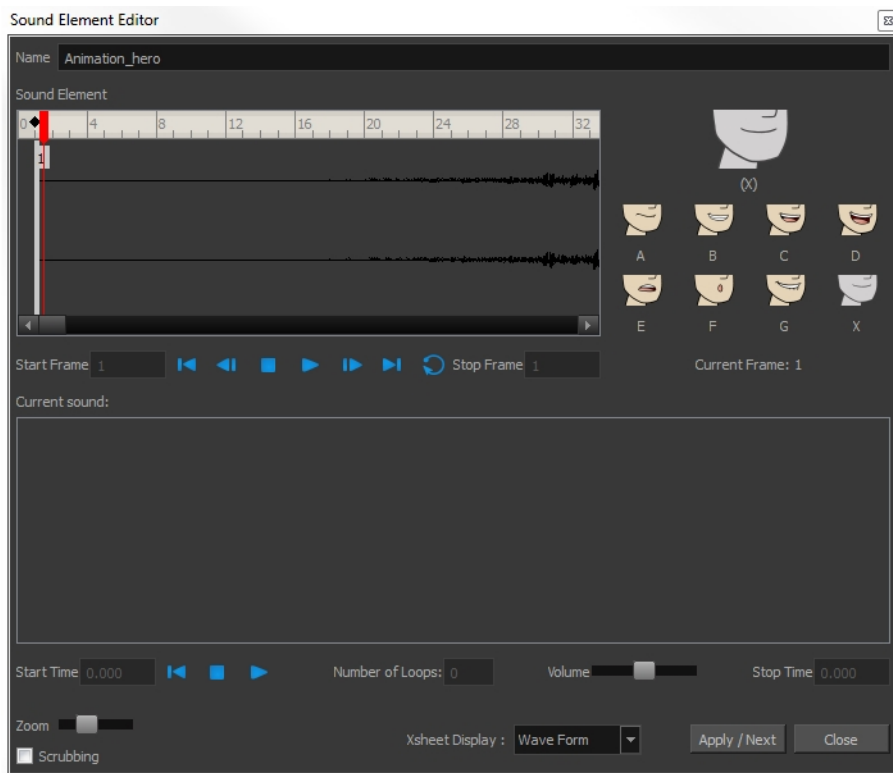

The Sound Element editor consists of three main parts.

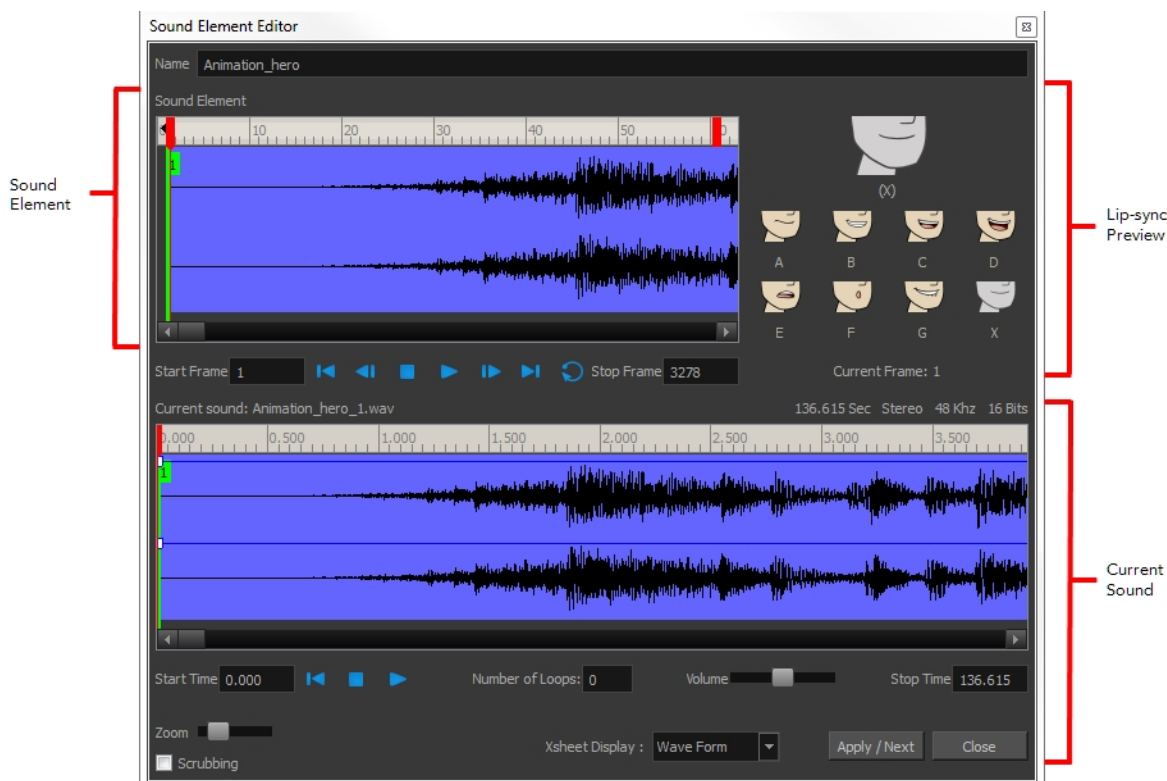

- ▶ **Sound Element:** The waveform in the Sound Element Editor is the actual sample that will be heard when the final movie is rendered. It may be shorter than the original sound sample due to the length of the scene. If any edits are made to the sound sample, they can be heard here. In the Sound Element panel, notice the coloured tabs that indicate the start and end frames of a sound segment. The frame number is displayed in the tab.
- ▶ **Current Sound:** Displays the original sound file in its entirety and is where you can edit its properties. This window remains empty until you click inside the Sound Element Editor.
- ▶ **Lip-sync Preview:** Lets you preview the automated detection and to manually insert different mouth positions to correspond with the sound sample.

You can accomplish the following tasks in the Sound Element Editor:

- [Changing the Start or End Frame of a Sound on page 221](#)
- [Trimming the Start and End of a Sound File on page 223](#)
- [Looping a Sound on page 224](#)
- [Mixing the Sound Volume on page 225](#)
- [Customizing the Playback Range on page 226](#)

Changing the Start or End Frame of a Sound

To synchronize the sound with specific images in your scene, you must set a start frame for your sound. To make sure the sound ends by a certain frame, you must set an end frame.

In the Sound Element panel you will see some coloured tabs, these tabs represent the frames. The frame number is shown inside the tab flag marker. These tabs indicate the start and end frames of a sound segment.

How to change start or end frame of a sound

1. Double-click on the sound layer name in the Timeline view or the sound column header in the Xsheet view.
2. In the Sound Element editor, select a sound sample from the Sound Element section. To distinguish one sound section from another on the same sound layer, check the frame numbers that appear on tabs flanking the start and stop lines of each waveform section.

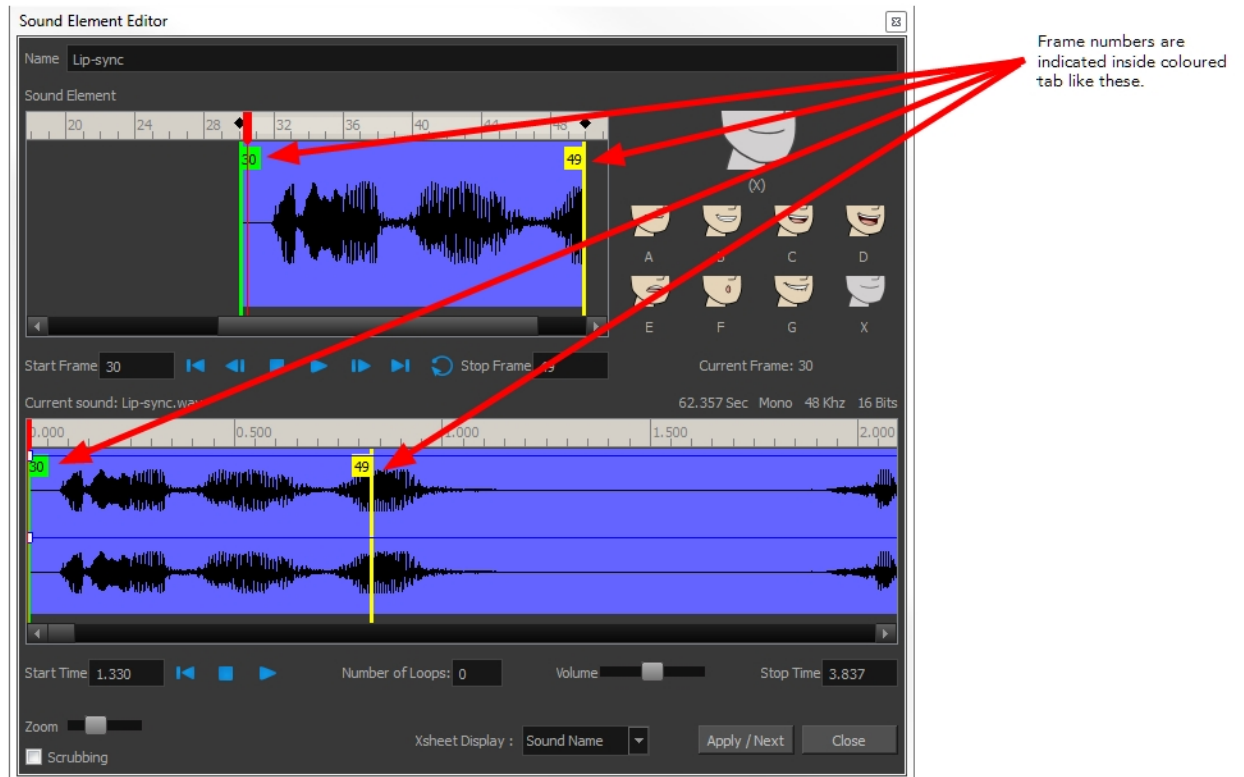

Click the Play ► button in the Current Sound section (only the selected sound plays).

1. Within the Sound Element panel, drag the selected clip to the frame number where you want it to start playing.



You can only move the clip to a section that does not already contain a clip; you cannot overlap two clips in the same element.

2. To change the end frame, drag the yellow marker at the end of the waveform to the frame position.



- To hear how all the clips fit together in the element, click the Play ► button in the Sound Element section.

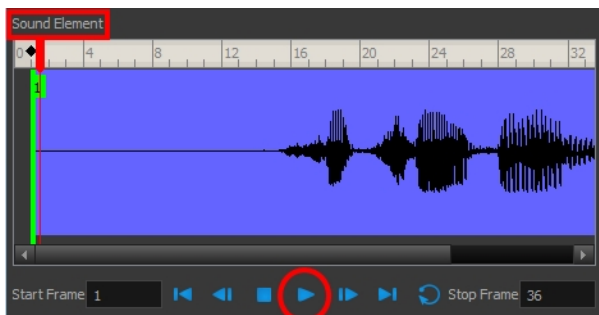

If you only want to hear the selected clip, click the Play ► button in the Current Sound section.

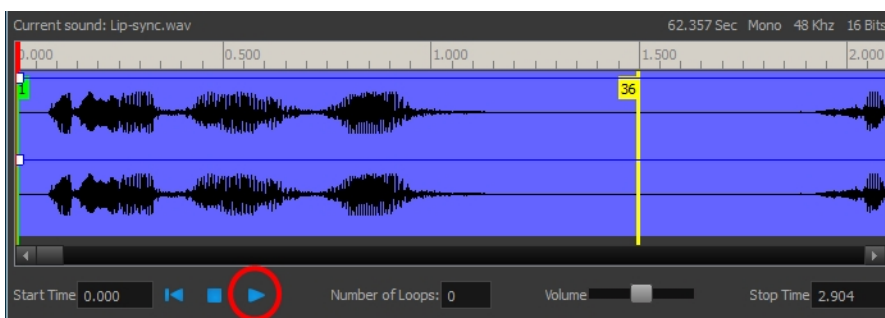

- Click **Apply/Next**.

The Xsheet and Timeline views display the sound clip at the start frame you selected.

Trimming the Start and End of a Sound File

To play only a section of a sound file, use the Sound Element editor to select the exact part you want to use. For example, if there is a bit of noise at the start of the sound, use the Sound Element editor to cut the noise.

The Sound Element Editor does not change the original sound file; it only plays a section of it, ignoring the rest. This means that the entire sound file is included on export. If you need to be mindful of file size, it is better to edit sound files completely in a sound editor before bringing them into Harmony.

How to trim the start and end of a sound file

- Double-click on the sound layer name in the Timeline view or the sound column header in the Xsheet view.
- In the Sound Element editor, select a sound sample from the Sound Element section. To distinguish one sound section from another on the same sound layer, check the frame numbers that appear on tabs

flanking the start and stop lines of each waveform section. Or select a soundwave and click the Play ► button in the Current Sound panel (only the selected sound plays).

- Using the Current Sound section, decide on the part of the file you want to play by dragging the left and right boundaries of the selection area.

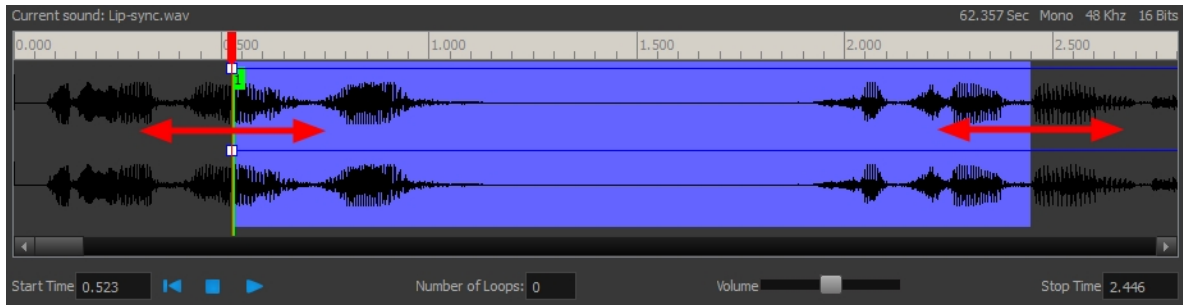

- Click the Play ► button in the Current Sound section to check that you have trimmed the desired sections. Use the Zoom slider at the bottom of the panel to zoom in on the waveform so you can trim it more accurately.

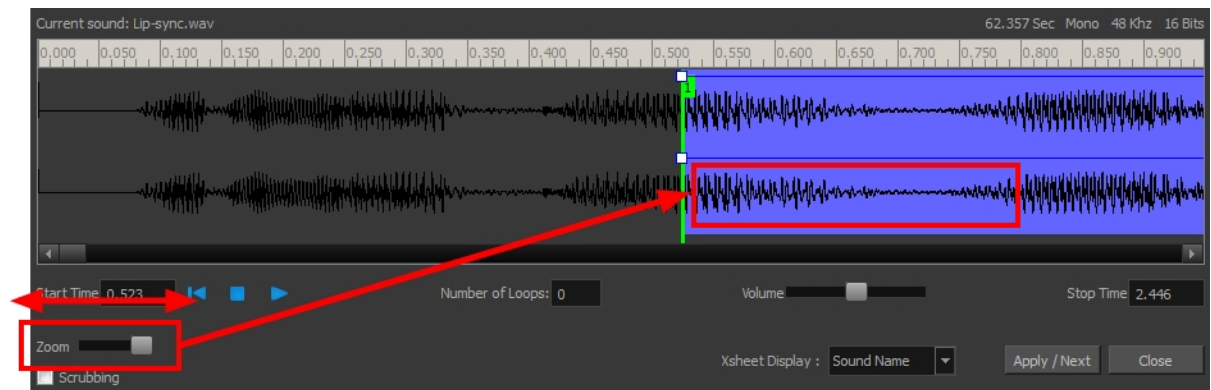

- Click **Apply/Next**.

The trimmed sound sample appears in both the Timeline and Xsheet views at the start and end positions you selected.

Looping a Sound

To repeat a sound, specify the number of times that you want it to loop in the Sound Element editor.

How to loop a sound sample

- Double-click on the sound layer name in the Timeline view or the sound column header in the Xsheet view.
- From the Sound Element section, select the sound section you want to loop.
- In the Current Sound section, type the number of times you want the sound to play in the Number of Loops field.

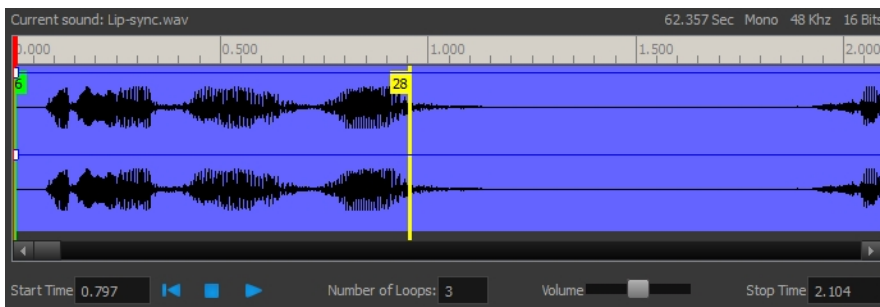

3. Press the Enter/Return key.

The looped sound appears after the current sound. They are indicated by their grey waveforms, as opposed to black.

When you loop a sound, the looped sections fill the cells in the sound element (column or layer) until the next sound sample starts or until the scene ends. This means that the looping could be cut if the next sound sample starts too soon or if the scene ends too quickly.

Mixing the Sound Volume

You can adjust the volume of an entire sound clip or modify the volume in increments by adjusting the fade-in and fade-out times, otherwise known as sound envelopes. The fade edit only affects the playback; the original sound file is not affected.

How to adjust the overall volume of the entire sound clip

1. Double-click on the sound layer name in the Timeline view or the sound column header in the Xsheet view.

1. In the Sound Element section, select the sound you want to work on.

A more detailed version of the selected sound appears in the Current Sound section.

2. In the Current Sound section, use the Volume slider to adjust the volume.

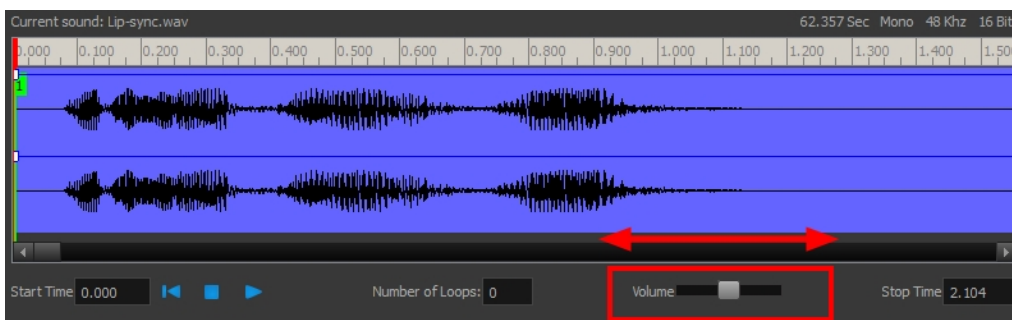

3. Click the Play button in the Current Sound panel to verify the volume.

How to create the fade in/out effect on a sound clip

1. Double-click on the sound layer name in the Timeline view or the sound column header in the Xsheet view.

1. In the Sound Element section, select the sound you want to work on.

2. In the Current Sound section, click on the thin blue line above the waveform to add an envelope marker.



3. Drag the envelope markers to adjust the volume at that frame and to create the time of the transition. The line from the edge of the clip to the envelope marker identifies how the volume increases (fades-in) or decreases (fades-out) over time.

Dragging the marker to the bottom of the channel mutes the volume, while dragging it upwards increases the volume.

NOTE: To create an even effect, be sure to adjust the envelope markers uniformly in both the left and right (bottom and top) channels.

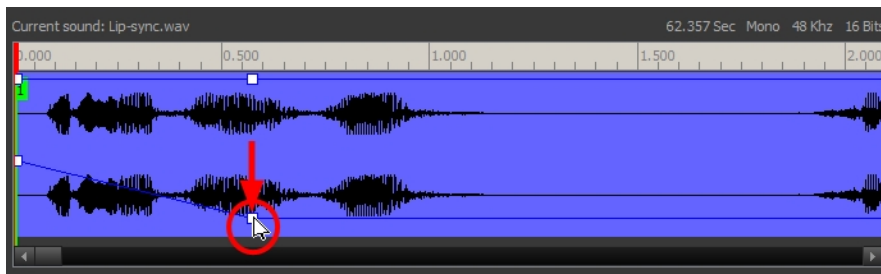

4. Click the Play button in the Current Sound panel to check the fade envelopes.

Customizing the Playback Range

To hear a specific section of the sound element, adjust the playback range in the Sound Element editor to start or stop at specific frames. This customized playback range does not affect the actual sound in the Sound element.

How to change the playback range in the Sound Element editor

1. Drag the start or end range markers in the Sound Element section to the boundary frames you want.



- When you click the Play button to play back your sound in the Sound Element editor, it only plays the sound which exists between the two markers.

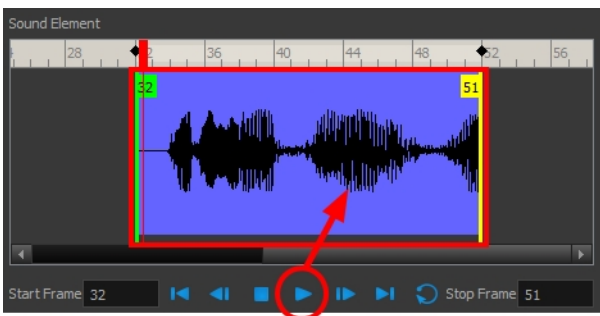

Adding an Empty Sound Layer

When performing sound editing tasks, it can be useful to chop up a sound sample into different layers. For example, when performing a lip-sync, only a single view of the various mouth positions for a character can exist on one layer. Therefore, if you want to have a character turn its head from a profile view to a three-quarter view and have mouth position changes to fit with the sound sample from these two different views, you would need to cut up the sound samples needed for the profile view mouth positions on one layer and the sound samples needed for the three-quarter view on another.

For this task, you will need an empty sound layer.

How to add an empty sound layer

- In the Timeline Layer toolbar, click the Add Layer button.
- From the drop-down menu, select **Sound**.

An empty (silent) sound layer appears in both the Timeline and Xsheet views.



- Rename the layers accordingly by double-clicking on the layer name and renaming it in the Sound Element editor. Click **Apply/Next** to accept the change.

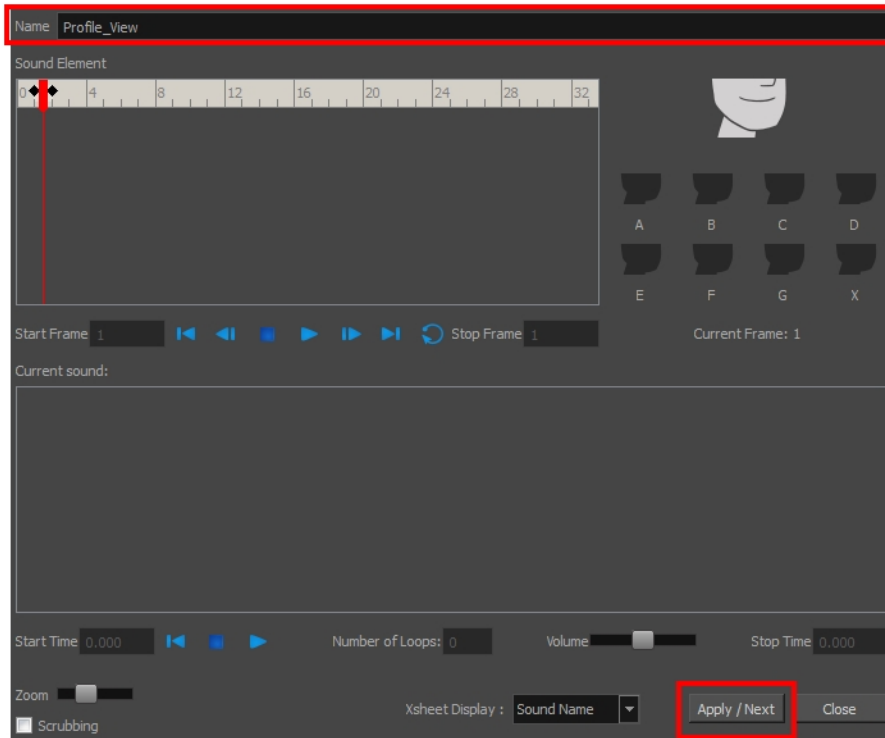

1. In the sound file you want to grab sound frames from, click the cell where you want to start the cut and Shift + click on the final cell of the cut. The sample to be cut becomes highlighted.

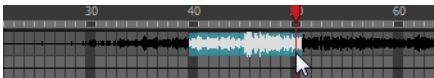

2. Drag the selection into the empty sound layer below.

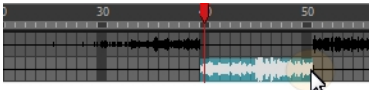

4. You can now continue to cut-up and distribute the sound sample between the two layers or carry on to the lip-syncing process for each layer and its corresponding facial view.

NOTE: If you need to duplicate your sound layer to keep an unedited copy for safety, select the Duplicate Selected Layers button in the Timeline View toolbar. You must customize the toolbar to display this button because it is not included in this toolbar by default.

Lip-sync



Adding a lip-sync to a project can really enhance its quality and storytelling. However, it can be difficult to shape a character's mouth to match the sound at a precise frame.

To solve this problem, Harmony provides a lip-sync feature which analyzes the contents of a sound element and generates a mouth chart (see below) based on the eight animation phonemes (A, B, C, D, E, F, G, and X for silence).

The mouth shapes used by Harmony are based on the conventional mouth chart used in the animation industry.

NOTE: The letters used to represent the shapes do **NOT** correspond to an actual sound.

NOTE: If you are doing cut-out animation, refer to the Cut-out Animation Guide, Character Building chapter, "Adding Extra Drawings" topic to learn how to add extra drawings to your character.

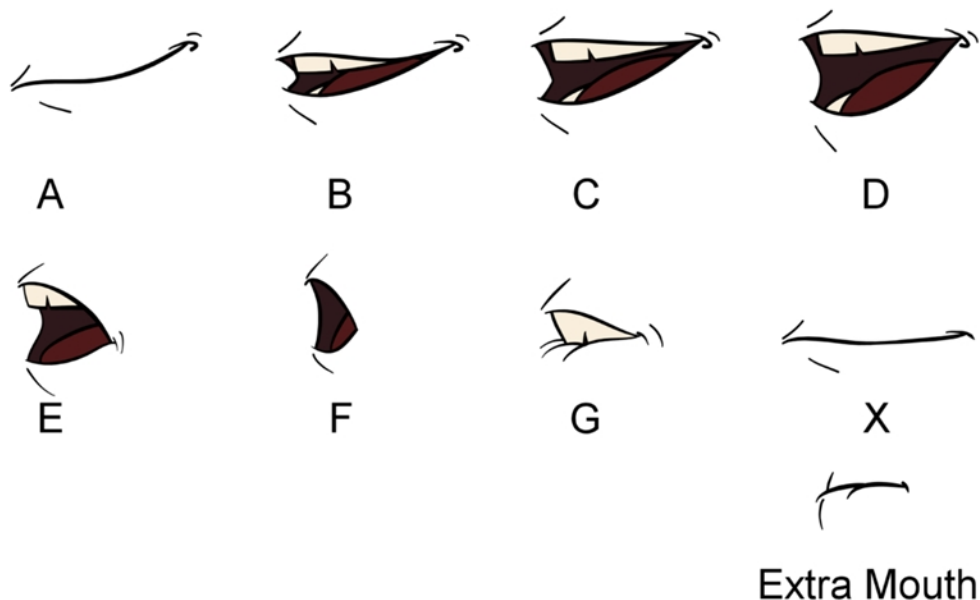

Here is an approximation of the sound each mouth shape can produce:

- **A:** m, b, p, h
- **B:** s, d, j, i, k, t
- **C:** e, a
- **D:** A, E
- **E:** o
- **F:** u, oo
- **G:** f, ph
- **X:** Silence, undetermined sound

You can lip-sync the traditional way or let the system automatically create the basic detection.

You can refer to the mouth chart positions as you draw the shape of the character's mouth.

Generating a Lip-sync Detection

There are several places where you can perform a lip-sync detection: Layer Properties view, Timeline view, Xsheet view and Sound Element editor.

How to generate a sound detection for lip-sync using the Layer Properties view

1. In the Timeline or Xsheet view, select the sound layer.
The options for that layer will appear in the Layer Properties view.
2. In the Layer Properties, click **Detect**.

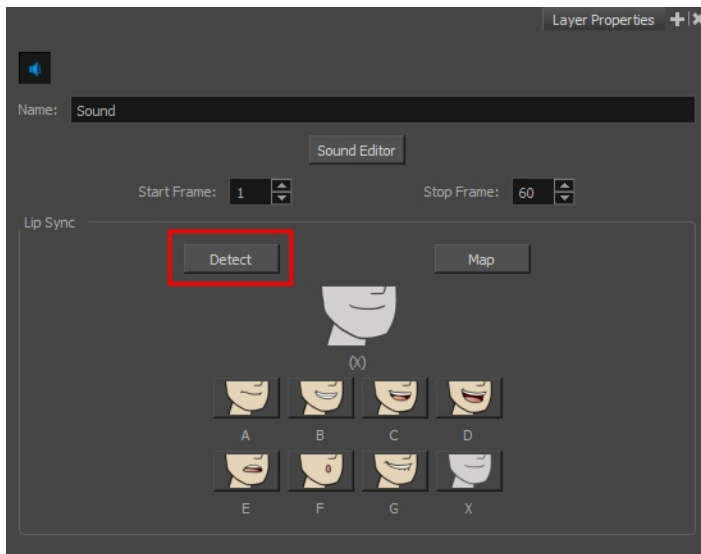

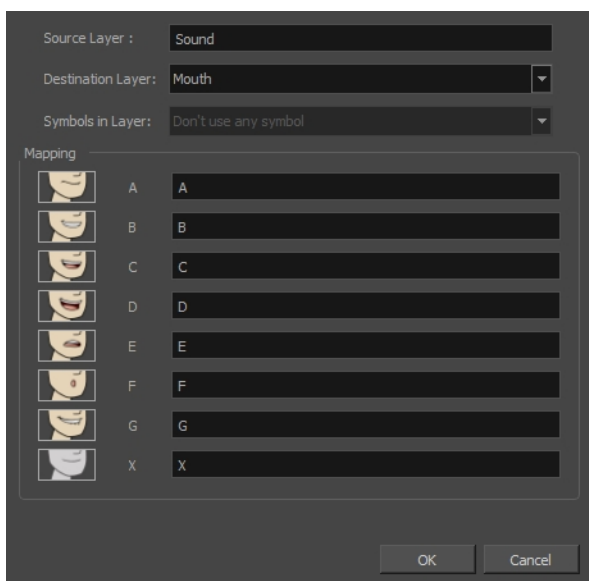

A progress bar appears while Harmony analyzes the selected sound clips and assigns a lip-sync letter to each sound cell.

3. Click the **Map** button to open the Lip-Sync Mapping dialog box.

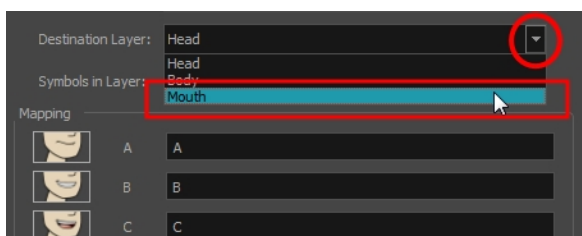

- From the Destination Layer menu, select the layer that contains the mouth positions for the character's voice track.



- If the selected layer contains symbols, you can map the lip-sync using drawings located directly on the layer or use the symbol's frames. In the Symbol Layer field select **Don't Use Any Symbol** if you want to use the drawings or select the desired symbol from the drop-down menu.
- In the Mapping section, type the drawing name or Symbol frames in the field to the right of the phoneme it represents. If your drawings are already named with the phoneme letters, you do not have to do anything.
- Click **OK**.
- Press the Play  button in the Playback toolbar to see and hear the results in the Camera view. To play back your scene with sound, enable the Sound  button in the Playback toolbar.

How to generate a sound detection for lip-sync in the Xsheet or Timeline view

- Do one of the following:
 - In the Xsheet or Timeline view, right-click on the sound layer's cells and select **Lip-Sync > Auto Lip-Sync Detection**.
 - From the top menu, select **Animation > Lip-Sync > Auto Lip-Sync Detection**.

NOTE: To show the mouth chart letters, if they're not already present in the Xsheet view, right-click on the sound column and select **Lip-Sync > Sound Display > Mouth Shapes**.

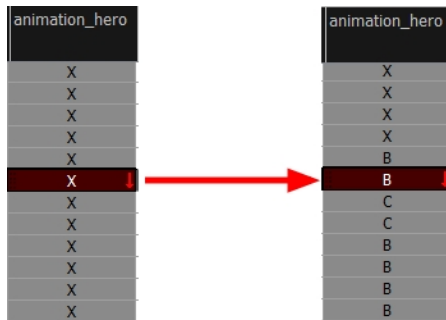

Harmony analyzes the selected sound clips and assigns a lip-sync letter to each frame. The X markers in the frame are replaced by these designated letters.

How to generate a sound detection for lip-sync using the Sound Element editor

1. Do one of the following:
 - In the Timeline view, double-click on the sound layer.
 - In the Xsheet view, double-click on the sound column header.
 The Sound Element editor opens.
2. In Sound Element section, select the waveform for which you want to generate a mouth chart.
3. Right-click on the sound file and select **Auto Lip-Sync Detection**.

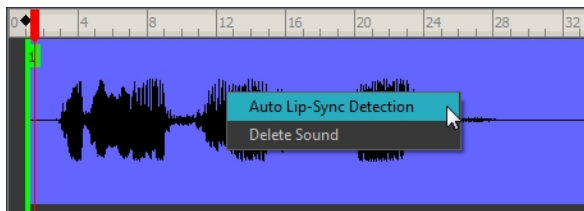

A progress bar appears while Harmony analyzes the selected sound clips and assigns a lip-sync letter to each sound cell.

Mapping the Lip-Sync Detection

Harmony can automatically map drawings in an element to the mouth chart you have generated for a sound. This can save time when you are lip-synching a voice track.

In the Layer Properties view, you can identify each lip drawing of a character. Harmony then automatically labels all of the cells in the character's element with the appropriate name.

How to automatically map lip-sync drawings to a mouth layer

- To open the Lip-Sync Mapping dialog box, do one of the following:
 - In the Layer Properties view, click on the Map button.
 - In the Timeline view, right-click on any cell in the sound sample layer and select **Lip-Sync > Map Lip-Sync**.
 - From the top menu, select **Animation > Lip-Sync > Map Lip-Sync**.

The Lip-Sync Mapping dialog box opens.

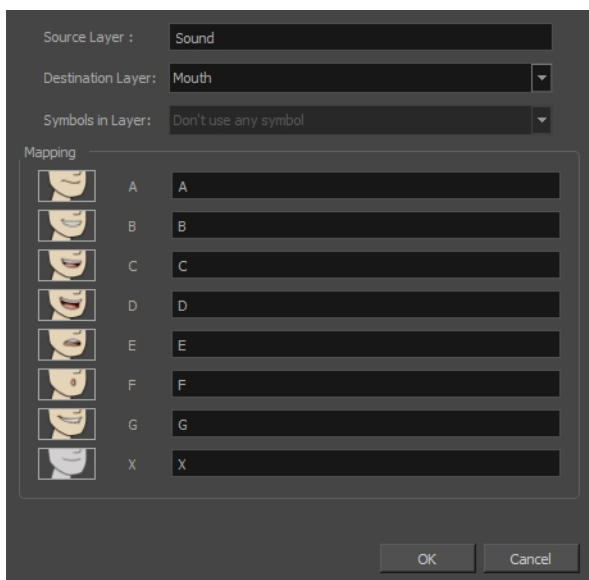

- From the Destination Layer menu, select the layer that contains the mouth positions for the character's voice track.

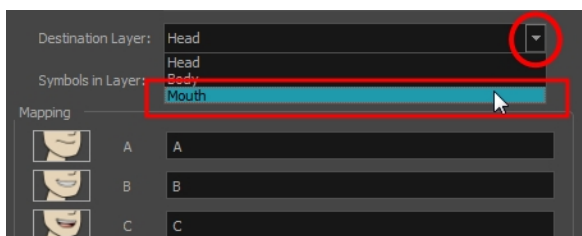

- If the selected layer contains symbols, you can map the lip-sync using drawings located directly on the layer or use the symbol's frames. In the Symbol Layer field select **Don't Use Any Symbol** if you want to use the drawings or select the desired symbol from the drop-down menu.
- In the Mapping section, type the drawing name or Symbol frames in the field to the right of the phoneme it represents. If your drawings are already named with the phoneme letters, you do not have to do anything.

Modifying the Lip-sync

You can change the mouth position assigned to a frame if you think another position is more appropriate.

For example, you may have a character who says nothing for 10 frames between two speeches. Harmony would normally assign an X image for the silent period. However, if you want your character's mouth to hang open in astonishment for these 10 frames, you can change the lip assignment for these frames from an X to an F.

If you modify the sound detection, you will need to remap the lip-sync to your animation—see [Mapping the Lip-Sync Detection on page 232](#).

How to change the mouth position assignment of a sound from the Sound Element editor and Layer Properties view

1. Double-click the sound layer name in the Timeline view or the sound column header in the Xsheet view to open the Sound Element editor.
2. In the Sound Element section, drag the frame slider to the frame you want to change the mouth position assignment on.

In the Lip-sync image area, the image on top represents the lip position assigned to the current frame.

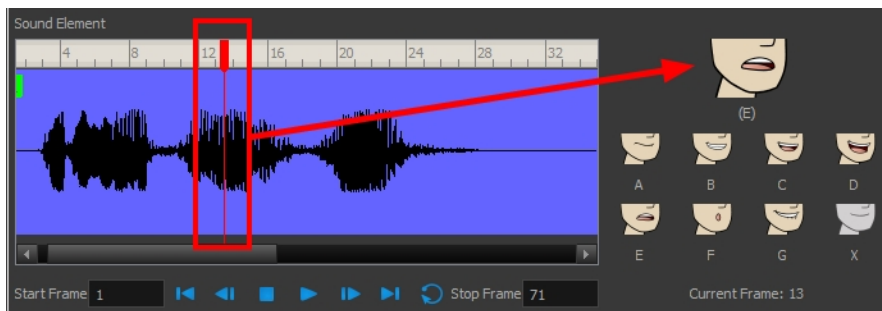

1. To change the image assigned to the frame, click on the image of the mouth position you want from below the preview image. The preview image changes to the mouth position image you select. You can perform the same operation in the Layer Properties view.

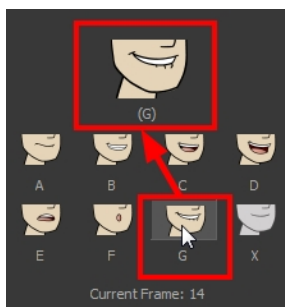

The position is updated in the Timeline and Xsheet views.

How to change the lip assignment of a sound in the Xsheet or Timeline view



1. Right-click in the cell that contains the mouth position you want to change.
2. From the pop-up menu, select **Lip-Sync > Change Mouth Shape to** and choose the letter that reflects the mouth position you want to use for that sound. You can also select **Animation > Lip-Sync > Change Mouth Shape > the desired mouth shape** from the top menu.

NOTE: Note that if you modify the lip-sync detection you must remap the detection to your mouth layer.

Manual Lip-sync

Harmony allows for the manual swapping of mouth position drawings to match a voice track. For this process, both sound scrubbing (listening to a sound wave broken up frame-by-frame) and drawing substitutions are used.

How to animate lip-sync using the Timeline view

1. In the Playback toolbar, enable the **Sound Scrubbing**  button.
2. In the Timeline view, drag the red playhead along the sound layer waveform.
3. When you reach a frame where a mouth position should go, for example, an open mouth with rounded lips for an "oh" sound, click on that frame on your mouth shapes layer.
4. In the Parameters section, staying on your mouth shapes layer, place your cursor on top of the drawing name (often a letter) until it changes to the swapping  pointer.
5. Pull the cursor to see the list of mouth shape names and choose the one you want. The current drawing automatically changes to the new selection.



How to animate lip-sync using the Library view

1. In the Playback toolbar, click the Sound Scrubbing  button.
2. In the Timeline view, drag the red playhead along the waveform of your sound layer.
3. When you reach a frame where a mouth position should go, for example, an open mouth with rounded lips for an "oh" sound, click on that frame on your mouth shapes layer.
4. In the Drawing Substitution window of the Library view, drag the slider to choose a mouth shape. The current drawing is swapped for the one in the preview window.

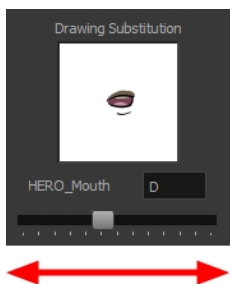

Chapter 7: Effects



Once your animation is completed, you can add effects such as blurs and glows to make your project look even better! Harmony provides you with a series of essential effects that you can add to your layers.

This chapter contains the following topics:

- [Adding Effects](#) on page 237
- [Animating an Effect over Time](#) on page 242
- [How Does an Effect Work?](#) on page 244
- [Using Effects](#) on page 244

Adding Effects

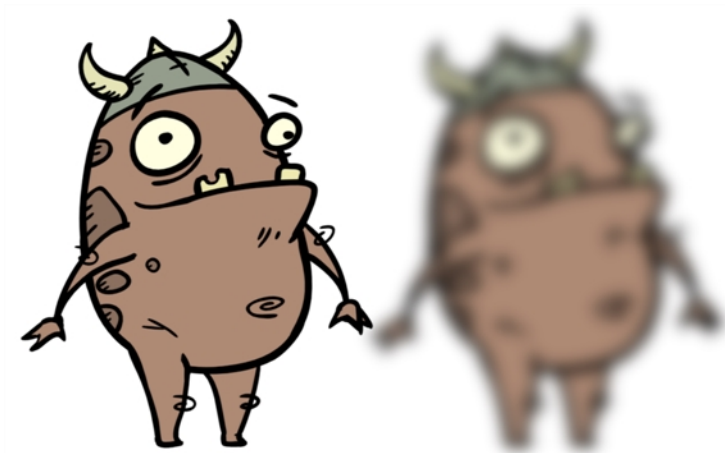



In Harmony, you can add effects through the Timeline view, connecting them to your drawing layers and then adjusting the parameters until you achieve the look you want.

How to add effects in the Timeline view

1. In the Timeline view, select the layer on which you want to add an effect.
2. Do one of the following:
 - ▶ From the top menu, select **Insert > Effects > *desired effect***.
 - ▶ In the Layers toolbar, click the Add Layers  button and select **Effects > *desired effect***.
 - ▶ From the Timeline menu, select **Insert > Effects > *desired effect***.

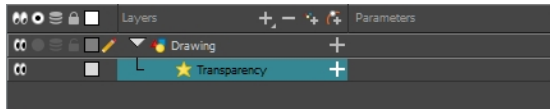
The effect appears in the Timeline view.





3. In the Camera view, click the Render View  button to see the scene's rendered current frame and effect. Note that most effects cannot be played back in real time. You need to use the Render and Play  option in the Playback toolbar.

NOTE: If your background appears all in black, it's because you need to add a Colour Card. To do this, follow step 2.

1. In the Timeline view, double-click on the effect layer to open the Layer Properties window. You can also select the effect layer and see its properties in the Layer Properties view.

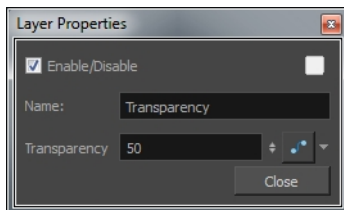
The Layer Properties view opens, displaying the parameters available for the selected effect.



2. In the Layer Properties view, adjust the effect's parameters—see [Using Effects](#) on page 244.
3. To play back your scene with the final effects, in the Playback toolbar, click the Render and Play  button.

NOTE:

Once you have set the parameters for the effect, you can store it in the Library view as a template, so you can quickly reuse it without resetting the parameters again—see *Templates* in Chapter 7: Library of the Cut-out Animation Guide.

How to use effects with more than one port

1. Select a drawing layer.

- Click the Add Layers  button and select **Effects > Highlight**.

The Highlight effect is parented to the selected layer.

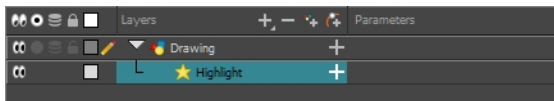

- In the Drawing or Camera view, create a drawing on a new layer that will act as the matte.
- In the Timeline view, click the Collapse/Expand  button on the effect layer.

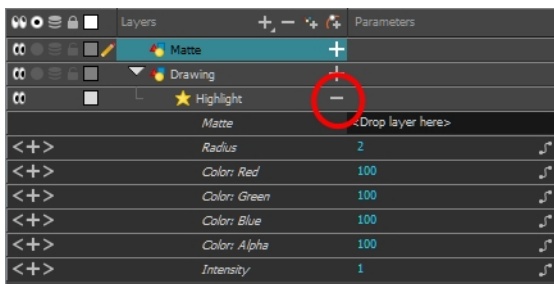

- Drag and drop the matte layer beside the Matte field.

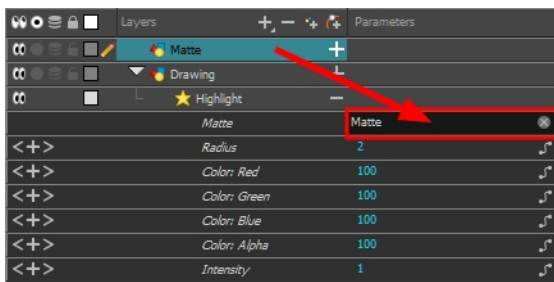

- Display the effect properties and adjust them until you achieve the desired effect.

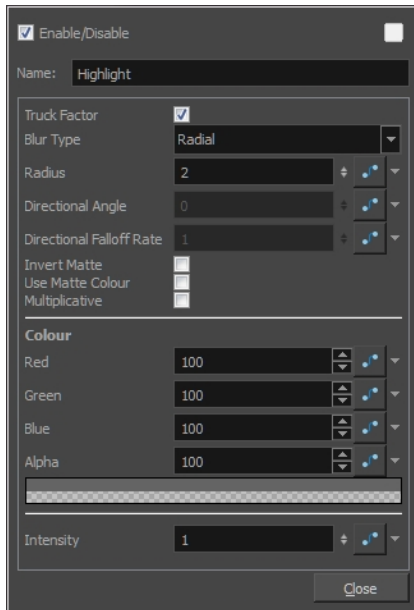

Previewing Effects

Most effects must be rendered so you can preview them properly. Some effects can be displayed in the OpenGL view, but most of them must be rendered and previewed in the Render Mode of the Camera view.

Once you preview your effect, you may want to adjust it. By default, as soon as you modify a parameter, Harmony will recalculate the preview image. If your scene is heavy and you do not want the preview rendered automatically, you can deselect the Auto-Render option and do the preview update yourself.

You cannot play back your animation in Render mode. You must perform a render or a preview render to see your animation with the final effects. Effects must be calculated before they can be viewed in real time.

To make your previews calculate faster, you may want to render them at a smaller resolution. You can use the Preview Resolution command so you will not have to modify the resolution of your scene every time you make a check preview.

The Preview Resolution command allows you to quickly get a preview at three-quarter, half, one-third, or one-quarter of the scene resolution. You can even customize the preview resolution size.

How to preview effects

1. In the Camera view status bar, click the Render Mode  button.

In the bottom-right corner of the Camera view, the progress bar indicates the status of the render. Depending on the size of the frame to render, it may take several seconds.

How to disable the Auto-Render option

1. In the Camera view status bar, click the Auto-Render  button. In the top menu, you can enable and disable **Scene > Render > Auto-Render**.

Once the Auto-Render option is disabled, you must request the preview update by clicking the Auto-Render  button.

How to manually update the rendering preview

1. In the Camera view status bar, click the Render  button.

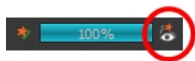

How to play back effects

1. In the Playback toolbar, click the Render and Play  button.

The Play node opens and loads the frames.

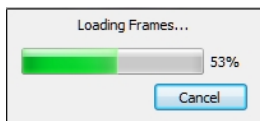

2. Once the frames are loaded, click the Play  button in the Play window.
3. Select **Scene > Render > Cancel Preview Render** to cancel the rendering.

NOTE: While previewing effects, you can press the Spacebar to stop and start playback.

How to use the Preview Resolution command

1. From the top menu, select **View > Preview Resolution** and one of the following:
 - ▶ Same as Scene Resolution
 - ▶ 3/4 of Scene Resolution
 - ▶ 1/2 of Scene Resolution
 - ▶ 1/3 of Scene Resolution
 - ▶ 1/4 of Scene Resolution
 - ▶ Custom

If you selected the Custom option, the Custom Preview Resolution dialog box opens.

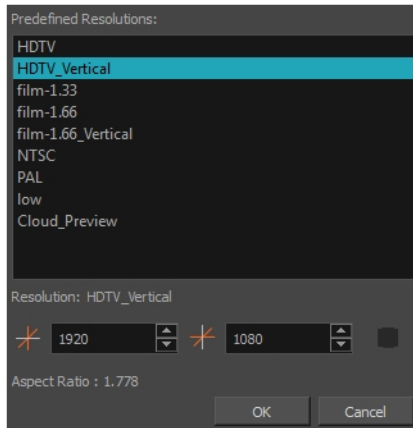

2. In the dialog box, select a resolution from the presets or type a new X-Y value.
3. Click **OK**.
4. Preview your effects animation.

Animating an Effect over Time

When compositing your scene, you will often want to animate the parameters of an effect over time. For example, you may want an object to fade in or out by changing the transparency level over time or by increasing the colour contrast on one of your drawings over a certain frame range.

To animate an effect over time, create a function curve by adding keyframes to the parameters you want to animate. To do this, you will use these views: Layer Properties and Timeline. You can fine tune your animation using the Function view.

How to animate an effect over time

1. In the Timeline view, select a layer and add an effect to it by doing one of the following:
 - Click the Add Layer **+** button and select **Effects > desired effect**.
 - Right-click and select **Insert > Effects > desired effect**.
 - From the top menu, select **Insert > Effects > desired effect**.

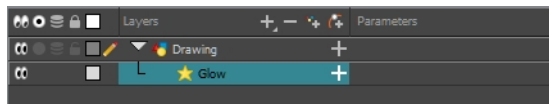

2. Create the function curve by doing one of the following:
 - Double-click on the effect layer to display the effect properties. Click the Function  button of the parameter you want to animate and create a function curve.

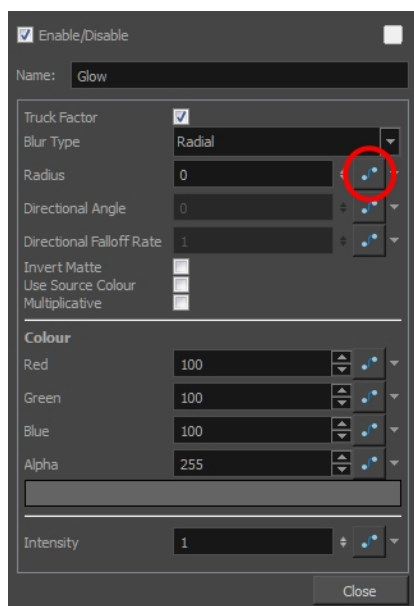

- ▶ In the Timeline view, expand the effect layer's parameters by clicking the Collapse/Expand \pm button. Then click the Function  button of the parameter you want to animate and create a function curve.

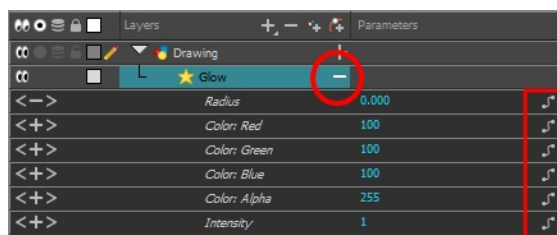

3. In the Timeline view, go to the frame on which you want to start animating the effect.
4. In the Timeline toolbar, click the Add Keyframe  button.
5. In the Value field of the parameter you want to animation, enter the keyframe value. If your keyframes are stop-motion keyframes, in the Timeline view, select the new keyframes. Right-click and select **Set Motion Keyframe**.

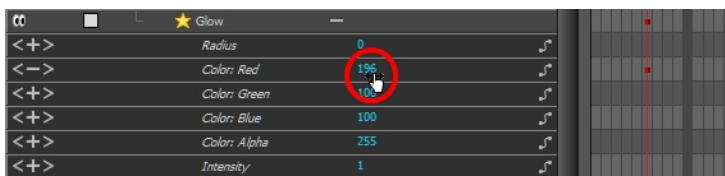

6. Repeat this process for each keyframe to be added.

NOTE: Refer to [Previewing Effects on page 240](#) to learn how to preview animated effects.

How Does an Effect Work?

An effect always needs a drawing connection and sometimes a matte or shape connection. A matte provides drawing information that determines the area on which the effect will be applied on the drawing. The details and colours within the matte drawing don't matter, as only the shape and transparencies are used. A matte is also known as *mask*.

The matte principle can be demonstrated with the Cutter effect.

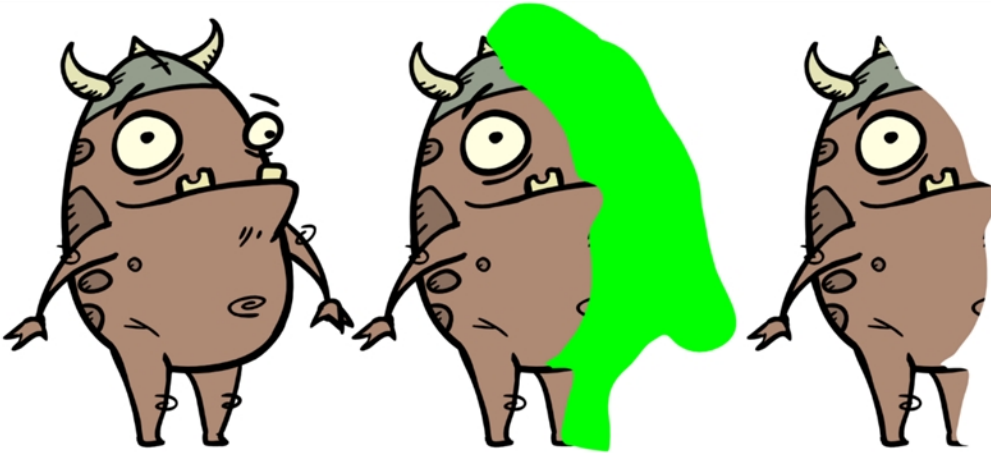

The Cutter effect cuts out a portion of an image using a matte drawing. You can use the Cutter effect to allow a character to disappear behind a background element or to cut a virtual hole into the layer itself. The Cutter requires a matte input.

Adjust the Cutter properties to invert the effect of the matte on an image. Instead of the object being hidden by the mask, it will only be visible where it intersects with the matte shape area.

You can adjust the effect parameters in the Layer Properties view and link any of them to a function column to be animated over time. This means that all of the effects can be customized.

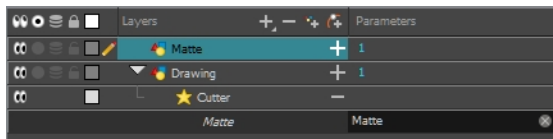

Using Effects

Here is the list of the main effects available in Harmony. Each effect and how to use it is described in the corresponding section.

<ul style="list-style-type: none"> • Blur - Gaussian on page 248 • Blur on page 250 Blur on page 250 • Brightness and Contrast on page 251 • Colour-Override on page 253 • Colour-Scale on page 257 	<ul style="list-style-type: none"> • Cutter on page 258 • Glow on page 259 • Highlight on page 261 	<ul style="list-style-type: none"> • Shadow on page 266 • Tone on page 267 • Transparency on page 270
--	---	--

Blending



Effects nodes, like the Tone node and Highlight node, can control the colour and alpha composite operations for you. These nodes were created with preset colour and alpha composite operations to fit the most frequently used, composite operations.

You might, however, still want to control the colour and alpha composite operation between two images using the Blending node, to create a multiplicity of lighting, shadow, filter or ambient effects. The Blending node combines two images into one output image, following the parameters you choose for your movie and images sequence or SWF movie exports.

The drawing node connected to the Blending effect will act as the blending image and will be applied to all the drawing layers situated under them in the Timeline view order.

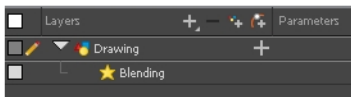

S

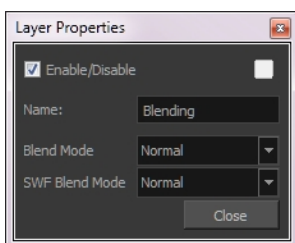

Blending Properties

Parameter	Description
Name	Lets you rename the node.
Blend Mode and SWF Blend Mode	<p>Choose the blending effect mode you wish to apply to your layer. The Blend Mode type will only be visible when the Camera view is set to Render  mode and will only export to a bitmap movie file or sequence of images.</p> <p>Both the Blending node and Composite-Generic node have regular blending modes and legacy blending modes. The regular blending modes will take the source images and unmultiply them before blending the two inputs together. The images will be remultiplied when being output from the node. The legacy blending modes use the pre-multiplied source images as is in order to apply the effect. Unmultiplying the images before processing them will give a final result closer to what can be found in software such as Adobe Photoshop.</p>
	<ul style="list-style-type: none"> • Normal: The layer attached to the effect acts as a normal layer and will not create any blending mode effect.
	<ul style="list-style-type: none"> • Multiply: This operation multiplies the blending element colour with the output image. This will darken the colour of the overlapping area.
	<ul style="list-style-type: none"> • Screen: This operation multiplies the inverted colour of the blending element with the image. This will lighten the colour of the overlapping area.
	<ul style="list-style-type: none"> • Lighten (Lighten Legacy): This operation lightens the area of the output image which, is darker than the blending element's colours. The lighter colours will remain unchanged.
	<ul style="list-style-type: none"> • Darken: This operation darkens the area of the output image, which is lighter than the blending element's colours. The darker colours will remain unchanged.
	<ul style="list-style-type: none"> • Difference (Difference Legacy): This operation subtracts the blending elements colour from the output image colours or vice-versa, depending on which of them has more bright colours. The final result will be colours that are more vibrant.
	<ul style="list-style-type: none"> • Add (Add Legacy): This operation lightens the output image using the blending element.
	<ul style="list-style-type: none"> • Subtract (Subtract Legacy): This operation darkens the output image using the blending element.
	<ul style="list-style-type: none"> • Invert: This operation inverts the output image colours on the area overlapping the blending layer colours.
<ul style="list-style-type: none"> • Overlay (Overlay Legacy): This operation multiplies or screens the colours from the blending image, with those of the output image, depending on the base colour. Colours from the blending element overlay the colours of the drawing elements, while preserving the highlights and shadows of the base colour. The base colour is not replaced, but mixed with the blend colour to reflect the lightness, or darkness, of the original colour. 	

	<ul style="list-style-type: none"> • Hardlight(Hardlight Legacy): This operation multiplies, or screens, the colours of the blending layer with those of the output image, depending on the blend colour. If the blend colour is lighter than 50% grey, the image is lightened, as if it were screened. This is useful for adding highlights to an image. If the blend colour is darker than 50% grey, the image is darkened, as if it were multiplied. This is useful for adding shadows to an image. Painting with pure black or white results in pure black or white. Play with the Opacity value to create a subtler look.
	<ul style="list-style-type: none"> • Alpha: This operation will blend the alpha value of the blending layer with the output image. This effect is not available for SWF Blend Mode.
	<ul style="list-style-type: none"> • Erase: This operation produces a cutter effect using the blending element. This effect is not available for SWF Blend Mode.
	<ul style="list-style-type: none"> • Divide (Divide Legacy): This operation divides the output image colour values by the blending layer colour values. The blending image colour values are inverted, creating a negative image. The negative image's colour values are then multiplied by the right image colour values. This effect is not available for SWF Blend Mode.
	<ul style="list-style-type: none"> • Replace: This operation replaces the output image by the blending layer. This effect is not available for SWF Blend Mode.
	<ul style="list-style-type: none"> • Softlight: This operation darkens or lightens the colours in a soft and diffuse way, depending on the blend colour (image in left port). If the blend colour is lighter than 50% grey, the image is lightened. If the blend colour is darker than 50% grey, the image is darkened. Painting with pure black or white produces a distinctly darker or lighter area, but does not result in pure black or white.
	<ul style="list-style-type: none"> • Linear Light: This operation burns or dodges the colours by decreasing or increasing the brightness depending on the colour of the underlying colour. If the blend colour is lighter than 50% grey, the colour is lightened because the brightness is increased. If the blend colour is darker than 50% grey, the colour is darkened because the brightness is decreased.
	<ul style="list-style-type: none"> • Pin Light: This operation will replace the colours, depending on the underlying colour . If the blend colour is lighter than 50% grey, pixels darker than the underlying colour are replaced, and pixels lighter than the underlying colour do not change. If the blend colour is darker than 50% grey, pixels lighter than the underlying colour are replaced, and pixels darker than the underlying colour do not change.
	<ul style="list-style-type: none"> • Vivid Light: This operation burns or dodges the colours by decreasing or increasing the brightness depending on the colour of the underlying colour. If the colour is lighter than 50% grey, the blend colour is lightened because the contrast is decreased. If the colour is darker than 50% grey, the blend colour is darkened because the contrast is increased.
	<ul style="list-style-type: none"> • Exclusion: This operation produces a similar result to the Difference mode, but with a lower contrast.

	<ul style="list-style-type: none"> • Dodge: This operation will lighten the colour.
	<ul style="list-style-type: none"> • Burn: This operation will darken the colour.
	<ul style="list-style-type: none"> • Hue: This operation will result in a colour that will take the luminosity and saturation of the underlying colour, and the hue of the source colour.
	<ul style="list-style-type: none"> • Saturation: This operation will result in a colour that will have the same luminosity and hue of the underlying colour, and the saturation of the source colour.
	<ul style="list-style-type: none"> • Colour: This operation will result in a colour that will have the luminosity of the underlying colour, and the hue and saturation of the source colour.
	<ul style="list-style-type: none"> • Luminosity: This operation will result in a colour which has the hue and saturation of the underlying colour, and the luminosity of the source colour. This mode is opposite to the Colour mode.

NOTE: It is possible to select two different blending modes in the same Blending effect layer, in the event that you want to export your project to both a Bitmap and an SWF movie file with different results.

Blur - Gaussian

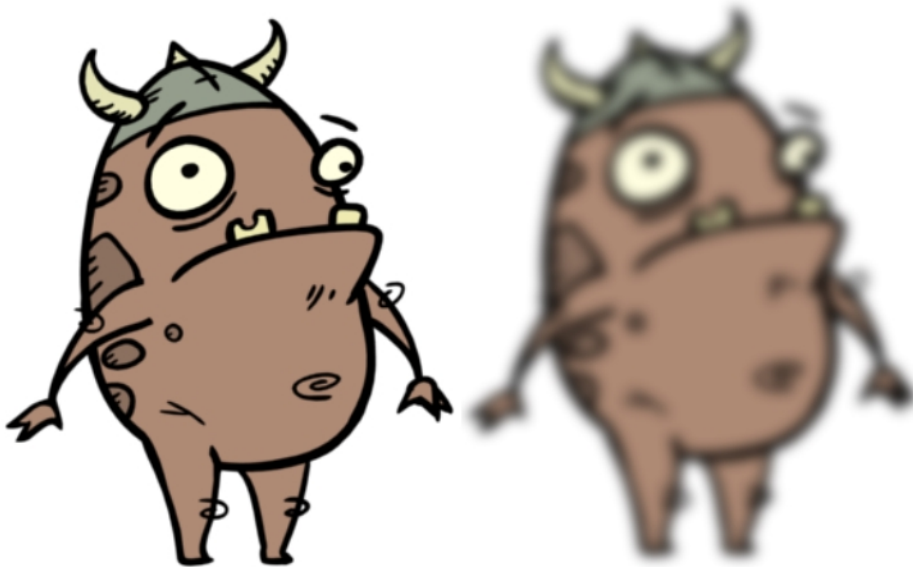

The Blur - Gaussian effect softens the image, reducing the amount of noise and detail. The look of the Gaussian blur is smooth, but does take some rendering time. This effect is useful when rendering time is less important, and quality is more important. Also, you can use a matte with this effect to isolate areas of the image.

For detailed video tutorials and sample scenes by Adam Phillips, see toonboom.com/resources/video-tutorials/chapter/adam-phillips-harmony-effects.

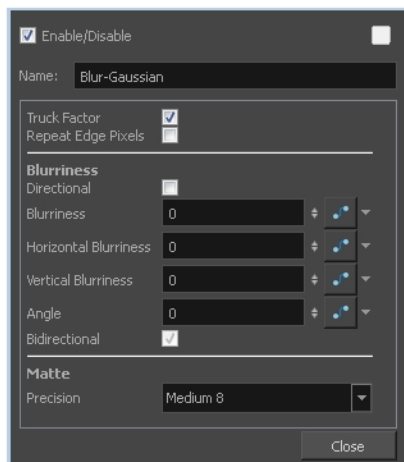
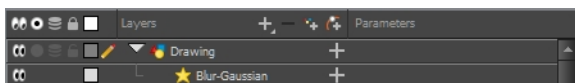

Blur - Gaussian Properties

Parameter	Description
Truck Factor	Activated by default, this option readjusts the blur when the elements undergo a change of depth or scale. When this option is deselected, the effect's values remain unchanged regardless of any depth or scale changes. This option should be deselected when multiple drawings are composited and attached to this effect.
Repeat Edge Pixels	Makes the blur algorithm operate as if the pixel values beyond the edge of the layer are the same as the values of the edge pixels. This keeps edges sharp, preventing them from darkening and becoming more transparent.
Blurriness	
Directional	Blurs according to the length, width, and angle you specify. For example, if a character is walking east, the blur may fall to the west.
Blurriness	Amount of blur applied to the layer.
Horizontal Blurriness	Length of the blur.
Vertical Blurriness	Thickness of the blur.
Angle	The direction in which the blur is applied: sideways, up, down, 90 degrees, 45 degrees, and so on.
Bidirectional	Blurs in both horizontal and vertical directions.
Matte	Precision: Blurs the image the number of times the precision indicates at different radius (between 0 and the specified radius).

Blur



The Blur-Radial effect creates an effect that softens, fogs or obscures the image evenly in all directions. This effect is useful when you want to make cloudy images not realistically seen in detail, such as a drawing object that is farther back or in the background of your scene, usually blurry due to the laws of atmospheric perspective. Other uses include the general softening of objects such as snow, stars and shadows that do not naturally have a hard outline.

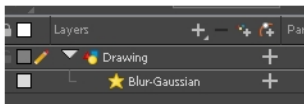

Use the Blur-Radial editor to change the values of the Blur effect.

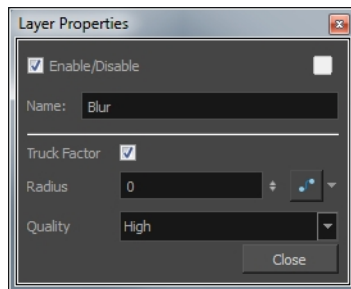

Blur-Radial Properties

Parameter	Description
Truck Factor	Activated by default, this option readjusts the blur when the elements undergo a change of depth or scale. When this option is deselected, the effect's values remain unchanged regardless of any depth or scale changes. This option should be deselected when multiple drawings are composited and attached to this effect.
Radius	Size of the blur. The larger the value, the greater the strength or reach of the blur. The blur radius is affected by the drawing scale and camera position. Click the Edit Curve button to change these values over time by adjusting the function curve.

Quality	Select High for a slow and accurate operation or Low for a faster operation with a more raw look.
---------	---

Brightness and Contrast

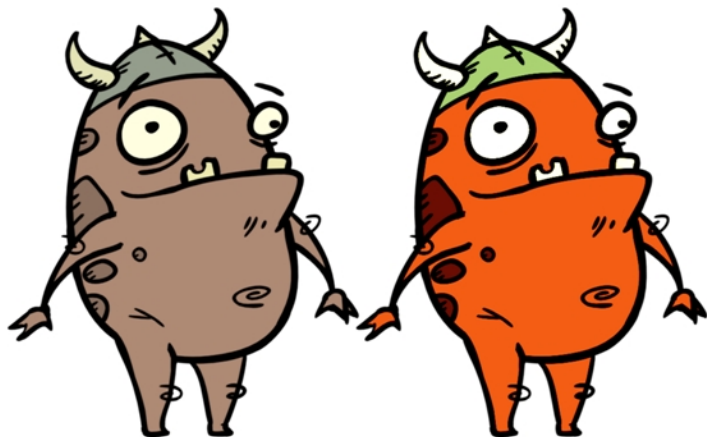

The Brightness and Contrast effect lets you modify the brilliance or dullness of an image or to create a greater difference between the lights and darks of an image by increasing their respective intensities. This effect can be used when an image appears too flat. Increasing the brightness or contrast can give a drawing a more attractive and 3D quality. This can be useful if you want to push your background to the rear by making it look dull and flat and pulling your foreground elements to the front by giving them a higher contrast.

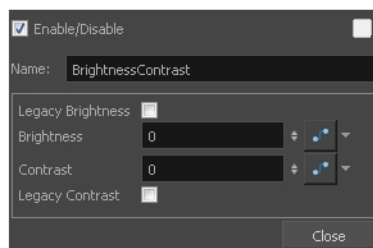
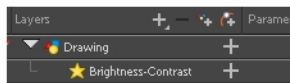

Brightness and Contrast standard node

Brightness and Contrast Properties

Parameter	Description
Brightness	A value less than 0 will darken the image; a value greater than 0 will brighten it. Attach a Bezier or Ease function to change the brightness over time.
Contrast	A value less than 0 will reduce contrast; a value greater than 0 will increase contrast. Attach a Bezier or Ease function to change the contrast over time.
Legacy Brightness/Contrast	If you are using an older version of this effect, the Legacy Brightness and Legacy

Contrast options are automatically selected. This ensures that the resulting effect looks the same as in older versions.

Colour-Card



The Colour Card is a solid background the same size as the camera. The Colour Card lets you fill the scene's background with a solid colour when there is no background image. If no background or colour card is added to the scene, the resulting export will appear with a black background.

By default, the Colour Card has a Z ordering value of **12 Backward**. This puts the Colour card behind all elements that have a value lower than **12 Backward**. Most of the time, the Colour card will appear automatically behind all the scene's elements as they are all set to **0 Backward**, unless you have changed the Z ordering of the scene components. If so, the Colour Card will be in front of the elements that are pushed back to more than 12 fields backward.

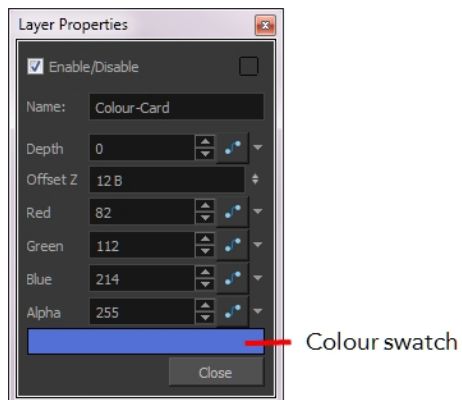

Colour Card Properties

Parameter	Description
Depth	The value used to determine composition order when the Z value of two elements is the same.
Offset Z	The front-back position of the Colour Card layer in 3D space. This value can be verified in the Top view.

Red/Green/Blue/Alpha	The colour and transparency of the Colour Card. You can also attach these parameters to function columns to change their values over time. Click the colour swatch to open the Colour Picker window and select a colour.
Colour Swatch	Opens the Colour Picker window in which you can specify the colour.

Colour-Override

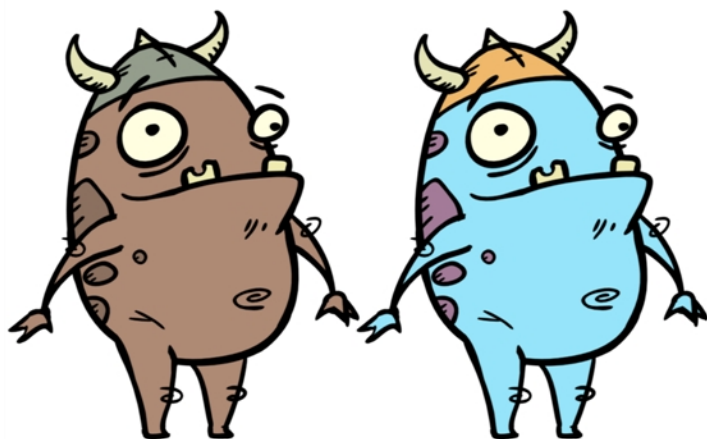

The Colour-Override effect processes the colours in a drawing layer. Using this effect, you can change colours from the palette without affecting the actual palette, swap clone palettes, or even replace a specific colour zone. The drawings in this layer must be .tvg files as the Colour-Override uses the colour palettes linked to them.

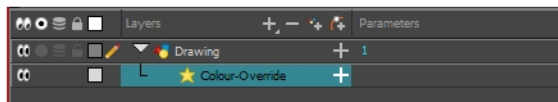

The Colour-Override effect lets you:

- Change colour values in drawings during the compositing process.
- Use colour values from a specific colour palette in the palette list.
- Establish the priority of override palettes in the palette list. For example, you may have different clones of the same palette, such as a daytime and nighttime version.
- Isolate specific areas of a drawing by selecting certain colours. For example, using specific colours to generate a matte for a glow effect.
- Hide certain colours.

This topic is divided as follows:

Colour-Override Editor Interface

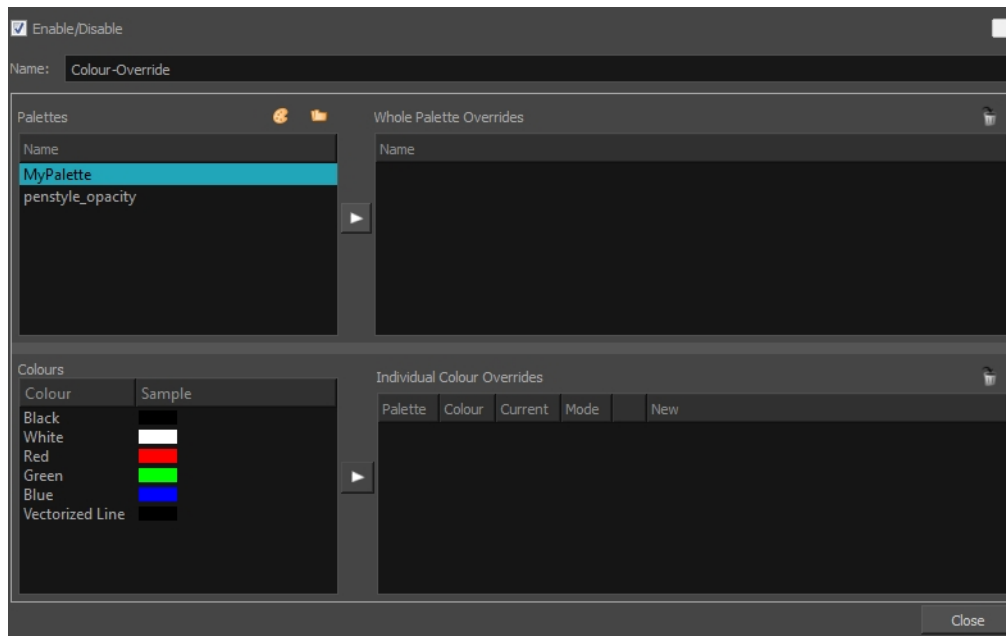

The Colour-Override editor interface is comprised of the following sections:

- [Palettes on page 254](#)
- [Colours on page 255](#)
- [Whole Palette Overrides on page 255](#)
- [Individual Colour Overrides on page 255](#)

Palettes

The Palettes section displays the palettes in the palette list of the selected layer. You can move these palettes into the Whole Palette Overrides section to reorder them. If you have cloned palettes, the higher one in the list will override the others. This is useful for overriding the clone palette ordering set in the scene through the Colour view.

You can load additional palettes in the palette list from either your project, by clicking on The Palette 🎨 button, or your computer by clicking on the Browse 📁 button.

- The Palette 🎨 button allows you to load a palette contained within the project hierarchy (Environment, Job, Scene and Elements).
- The Browse 📁 button allows you to load a palette located outside the project hierarchy, anywhere on your system or server. If you link to a palette outside of your project, you will be prompted with the following warning message:

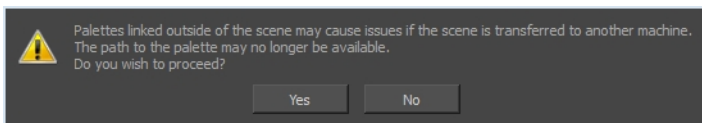

Colours

The Colours section displays the colour swatches of the selected palette. Move a swatch into the Colour-Overrides section to change its value.

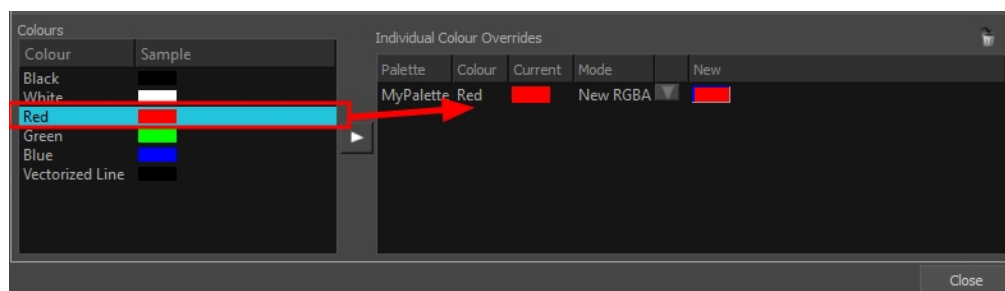

Whole Palette Overrides

The Whole Palette Overrides section forces the use of a particular palette (clone palette) or palette list ordering during the compositing process. You must drag palettes from the Palettes section to change their order. Harmony uses the palettes in the order they appear in the palette list to find the colour values associated with the colour IDs of each colour zone. To apply a different version of a colour palette to, for example, switch from a day to a night palette, use the Override section to change the order of the colour palettes (you must be working with cloned palettes).

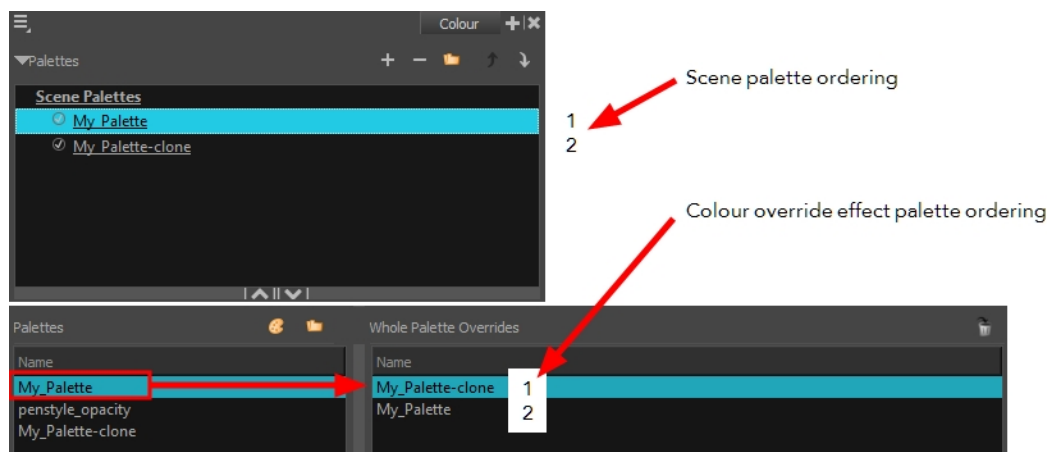

Individual Colour Overrides

When you drag a swatch from the Colours section to this section, you can override its value. The default override mode is set to New RGBA so you can override the RGB value as well as the transparency value.

The Current column always displays the colours from the currently active palette. Selecting a clone palette in the Palettes area will not change the colours if you haven't changed the active palette in the Whole Palette Overrides section. The update will be done once you close and reopen the Colour Override Layer Properties window.

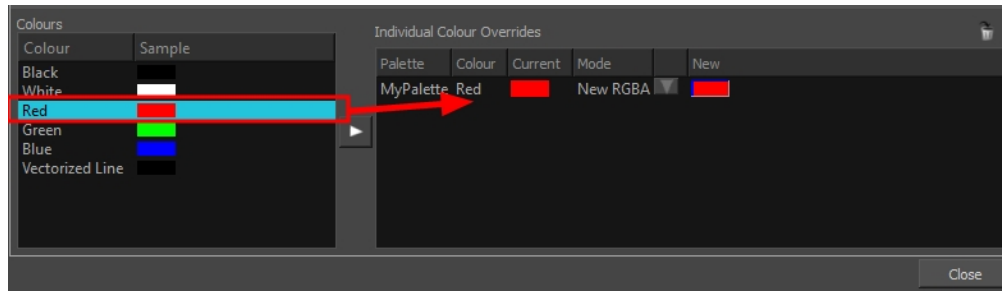

Overriding a Colour

With the Colour-Override node, you can change the colour of some swatches.

How to override colours

1. From the Colours section, select the colour swatch to modify and move it to the Individual Colour Overrides section. Several options are available to modify your colours.

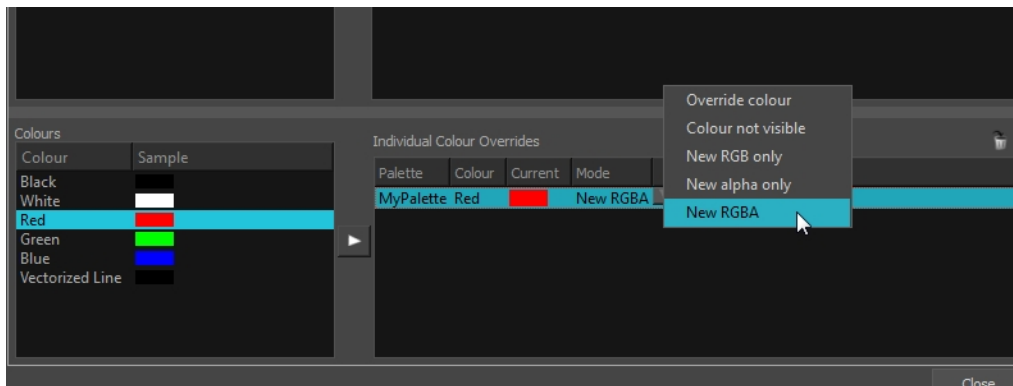

2. Once the swatch appears in the Colour-Overrides section, click the drop-down arrow and select one of the following options from the Mode menu:
 - ▶ **Override colour:** When selecting a colour swatch from a clone palette (not set as the current palette), use this option to override the current colour and use the swatch from the clone palette over the corresponding one in the current palette.
 - ▶ **Colour Not Visible:** Renders the selected colour invisible in the Camera view.
 - ▶ **New RGB Only:** Overrides the colour swatch RGB value while maintaining its original alpha value. You can select a new colour by clicking on the colour swatch and choosing a new colour from the Colour Picker window.
 - ▶ **New Alpha Only:** Overrides the swatch's alpha channel while maintaining its original RGB values. You can select a new alpha value by clicking on the colour swatch and choosing an alpha value from the Colour Picker window.
 - ▶ **New RGBA:** Overrides the swatch's colour and alpha values. You can select a new colour by clicking on the colour swatch and choosing an alpha value from the Colour Picker window.

Colour-Scale

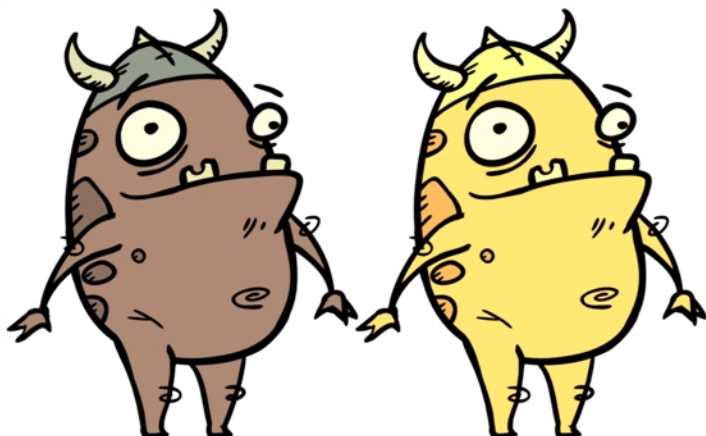

The Colour-Scale effect offsets an image's colours. This effect is useful in creating ambient transitions, such as from daytime to nighttime.

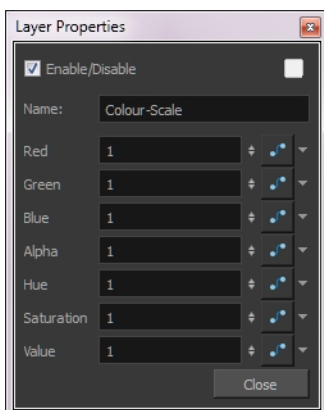
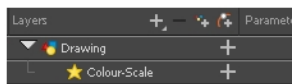

Colour-Scale Properties

Parameter	Description
Red, Green, Blue, Alpha	The red, green, blue and alpha used to offset the image.
Hue	The colour or hue to offset the image.
Saturation	The amount of colour to offset the image.
Value	Enter the value for the colour to offset the image. The actual colour values of the image are not changed; instead, the channels are multiplied by a selected amount. For example: <ul style="list-style-type: none"> • A value of 1 does not change the colour values. • A value greater than 1 brings the colour channel value closer to 255 (or white).

- A value less than 1 brings the colour channel value closer to zero (0 or black).

Cutter

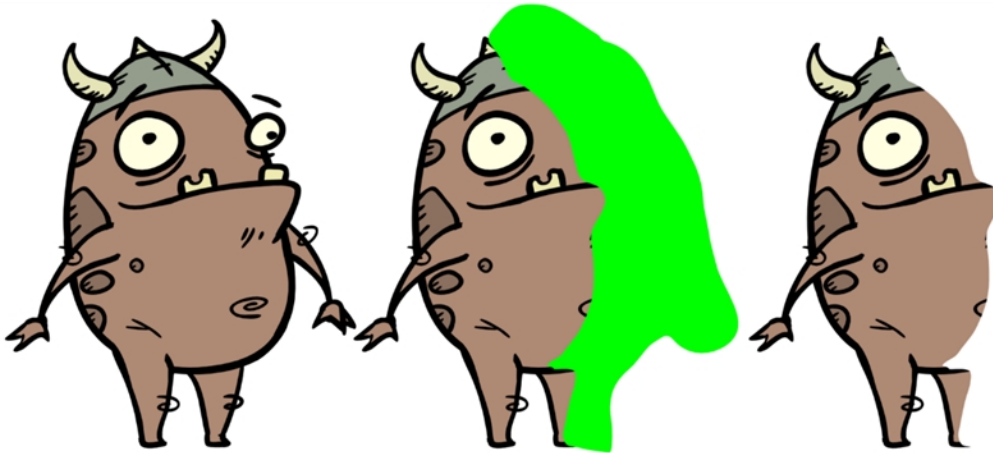

The Cutter effect cuts out a portion of an image using a matte drawing. You can use the Cutter effect to allow a character to disappear behind a background element or to cut a virtual hole into the layer itself. The Cutter requires a matte input.

Adjust the Cutter properties to invert the effect of the matte on an image. Instead of the object being hidden by the mask, it will only be visible where it intersects with the matte shape area.

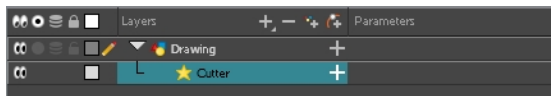

How to use the Cutter effect

1. Select a drawing layer.
2. Click the Add Layers **+** button and select **Effects > Cutter**.

The Highlight effect is parented to the selected layer.

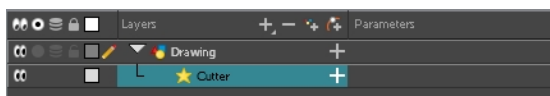

3. In the Drawing or Camera view, create a drawing on a new layer that will act as the matte.
4. In the Timeline view, click the Collapse/Expand **+** button on the effect layer.

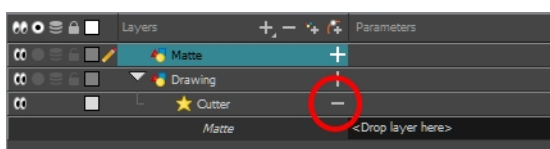

1. Drag and drop the matte layer beside the Matte field.

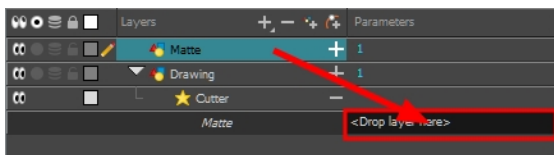

5. Display the Cutter properties and adjust the properties to control the type and amount of blur and the colour of the Cutter effect.

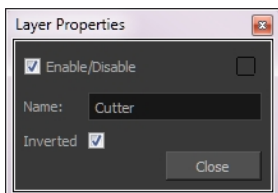

Cutter Properties

Parameter	Description
Name	Allows you to change the node's name.
Inverted	When this option is enabled, the Cutter node will invert the matte shape to cut the drawing. Instead of cutting the image intersecting with the matte, it will cut any artwork outside of the matte shape.

Glow



The Glow effect adds a bright soft-edged light or diffuse light region around an image. The Glow effect is useful for creating a shining rim around objects, such as the sun or stars.

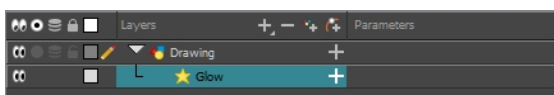

Use the Glow editor to control the direction of the blur that creates the glow, as well as its colour.

Glow Properties

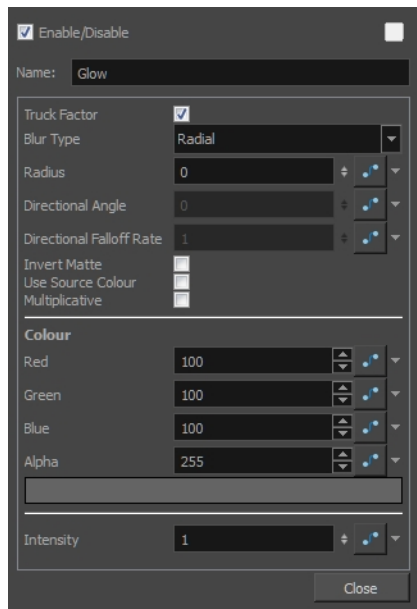

Parameter	Description
Truck Factor	Activated by default, this option readjusts the blur when the elements undergo a change of depth or scale. When disabled, the effect's values will remain unchanged regardless of depth or scale changes. It is recommended that this option be disabled when multiple drawings are composited and attached this effect.
Blur Type	Radial: The edges of the matte are blurred evenly around points that make up the edge of the matte. Directional: The matte is blurred in the direction you select.
Radius	Enter a value for the size of the blur. The larger the value, the greater the blur effect. The blur radius is affected by the drawing scale and camera position.
Directional Angle	If you selected the Directional Blur type, you can set the direction of the blur by entering a value from 0 to 360 in this field. 0: Blurs the image to the west. 90: Blurs the image to the south. 180: Blurs the image to the east. 270: Blurs the image to the north.
Directional Falloff Rate	The distance where the blur fades from the edge of the image. Select a value between 0 and 1. 0: Makes the blur fade out slowly, distributing the blur evenly from the edge of the character to the farthest edge of the blur. 1: Makes the blur fade out quickly. The blur is heaviest closer to the edge of the image.

Invert Matte	Inverts the matte used to create the tone, shadow, or highlight.
Use Matte/Source Colour	Creates the shadow or tone using the matte shape's colour. Be sure that you are in render mode  to see this effect and that your background is NOT white and that you do NOT have a white colour card node attached to the composite. As the matte only gives colour information, but no alpha, the matte is automatically multiplied with the background colours. If there is no colour card attached and the background appears black, you will see the matte colour at full opacity. If it is multiplied with a white background, the colours disappear into the full 255.
Multiplicative	Multiplies the tone or shadow colours with the background.
Colour	
RGBA	Enter a value to add or subtract from the colour channels in the drawings or attach these values to function curves.
Colour Swatch	Opens the Colour Picker where you can specify the colour.
Intensity	Lets you set a value to determine the strength of the effect or attach a function to animate the effect.

Highlight



The Highlight effect lets you to turn a drawing's area lighter to simulate a light source. For this effect, you will need to create a matte to determine the shape and position of the highlight on another element and so you can blur the edges to create a softer effect. By adjusting the Highlight properties, you can control the type and amount of blur, as well as the colour of the highlight effect.

How to use the Highlight effect

1. Select a drawing layer.
2. Click the Add Layers  button and select **Effects > Highlight**.

The Highlight effect is parented to the selected layer.

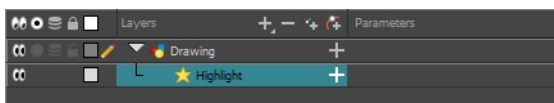

3. In the Drawing or Camera view, create a drawing on a new layer that will act as the matte.

- In the Timeline view, click the Collapse/Expand  button on the effect layer.

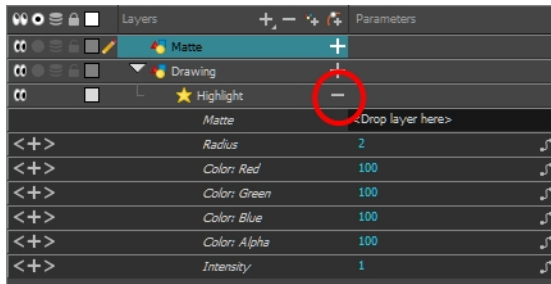

- Drag and drop the matte layer beside the Matte field.

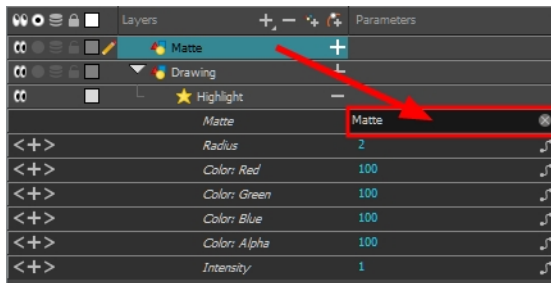

- Display the Highlight properties and adjust the properties to control the type and amount of blur and the colour of the highlight effect.

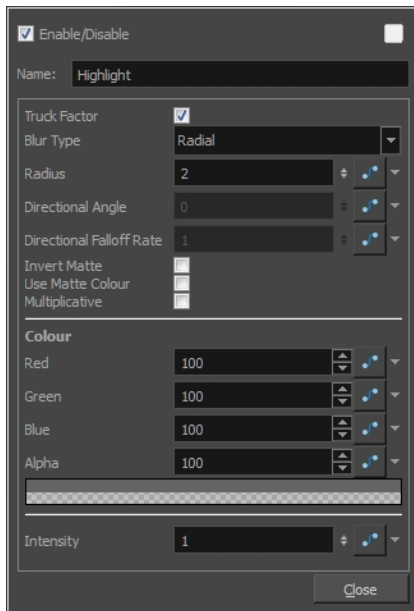

Highlight Properties

Parameter	Description
Truck Factor	Activated by default, this option readjusts the blur when the elements undergo a change of depth or scale. When disabled, the effect's values will remain unchanged regardless of depth or scale changes. It is recommended that this option be disabled when multiple drawings are composited and

	attached this effect.
Blur Type	<p>Radial: The edges of the matte are blurred evenly around points that make up the edge of the matte.</p> <p>Directional: The matte is blurred in the direction you select.</p>
Radius	Enter a value for the size of the blur. The larger the value, the greater the blur effect. The blur radius is affected by the drawing scale and camera position.
Directional Angle	<p>If you selected the Directional Blur type, you can set the direction of the blur by entering a value from 0 to 360 in this field.</p> <p>0: Blurs the image to the west.</p> <p>90: Blurs the image to the south.</p> <p>180: Blurs the image to the east.</p> <p>270: Blurs the image to the north.</p>
Directional Falloff Rate	<p>The distance where the blur fades from the edge of the image. Select a value between 0 and 1.</p> <p>0: Makes the blur fade out slowly, distributing the blur evenly from the edge of the character to the farthest edge of the blur.</p> <p>1: Makes the blur fade out quickly. The blur is heaviest closer to the edge of the image.</p>
Invert Matte	Inverts the matte used to create the tone, shadow, or highlight.
Use Matte/Source Colour	Creates the shadow or tone using the matte shape's colour. Be sure that you are in render mode  to see this effect and that your background is NOT white and that you do NOT have a white colour card node attached to the composite. As the matte only gives colour information, but no alpha, the matte is automatically multiplied with the background colours. If there is no colour card attached and the background appears black, you will see the matte colour at full opacity. If it is multiplied with a white background, the colours disappear into the full 255.
Multiplicative	Multiplies the tone or shadow colours with the background.
Colour	
RGBA	Enter a value to add or subtract from the colour channels in the drawings or attach these values to function curves.
Colour Swatch	Opens the Colour Picker where you can specify the colour.
Intensity	Lets you set a value to determine the strength of the effect or attach a function to animate the effect.

Quadmap



The Quadmap transformation layer lets you deform the shape of an element. For example, you can use it to create a drop-shadow effect on an element.

You can edit the Quadmap visually in the Camera view.

How to edit the Quadmap in the Camera view

1. In the Timeline view, click the Add Layer  button and select **Quadmap**.
2. Connect the drawing you want to deform to the Quadmap.

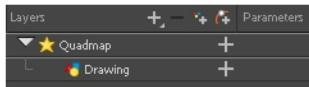

3. In the Tools toolbar, disable the Animate mode to change the value for the Quadmap over the entire duration of the element.
4. In the Timeline view, click on the Quadmap layer to select it.
5. From the top menu, select **View > Show > Control** or press Shift + F11.

The quadmap handles appear around the element in the window. There is also a pivot point at the centre of the quadmap frame that you can reposition.

6. In the Camera view window, use the Transform tool to move the points on the quadmap. Shift + click to select multiple points.

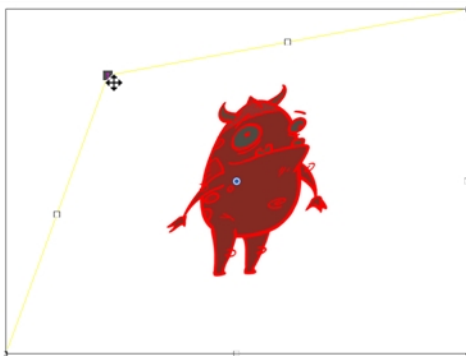

The value of each point on the quadmap can be changed gradually. To do this, use the Quadmap node Layer Properties to attach the points to function curves.

Only the X and Y values of each point in the quadmap can be changed.

Quadmap Properties

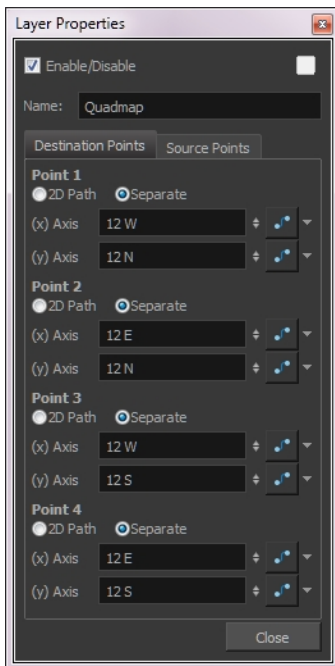

Parameter	Description
Name	Lets you rename the node.
2D Path	Changes the X and Y values simultaneously and control the velocity of the change.
Separate	Changes the X and Y values separately. Each one can be attached to separate function curves.

Shadow



With the Shadow effect, you can turn a drawing into a shadow. It doesn't matter if the drawing layer is a fully coloured character. The Shadow effect will render it into a grey, semitransparent, slightly blurry silhouette.

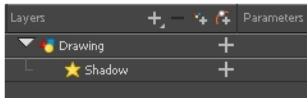

To add a shadow stretched out on the ground, simply add a Quadmap node to flip, stretch and skew the matte. Attach the entire effect to the same trajectory as your drawing layer and watch the shadow move along with your character.

Use the Shadow editor to modify the way the Shadow effect is created.

The Shadow effect uses the shape of the drawing connected to create the shadow behind another element and can blur the edges to create a softer effect. You can control the type and amount of blur, as well as the colour of the shadow.

Shadow Properties

Parameter	Description
Truck Factor	Activated by default, this option readjusts the blur when the elements undergo a change of depth or scale. When disabled, the effect's values will remain unchanged regardless of depth or scale changes. It is recommended that this option be disabled when multiple drawings are composited and attached this effect.
Blur Type	Radial: The edges of the matte are blurred evenly around points that make up the edge of the matte. Directional: The matte is blurred in the direction you select.
Radius	Enter a value for the size of the blur. The larger the value, the greater the blur effect. The blur radius is affected by the drawing scale and camera position.
Directional Angle	If you selected the Directional Blur type, you can set the direction of the blur by entering a value from 0 to 360 in this field.

	<p>0: Blurs the image to the west.</p> <p>90: Blurs the image to the south.</p> <p>180: Blurs the image to the east.</p> <p>270: Blurs the image to the north.</p>
Directional Falloff Rate	<p>The distance where the blur fades from the edge of the image. Select a value between 0 and 1.</p> <p>0: Makes the blur fade out slowly, distributing the blur evenly from the edge of the character to the farthest edge of the blur.</p> <p>1: Makes the blur fade out quickly. The blur is heaviest closer to the edge of the image.</p>
Invert Matte	Inverts the matte used to create the tone, shadow, or highlight.
Use Matte/Source Colour	Creates the shadow or tone using the matte shape's colour. Be sure that you are in render mode  to see this effect and that your background is NOT white and that you do NOT have a white colour card node attached to the composite. As the matte only gives colour information, but no alpha, the matte is automatically multiplied with the background colours. If there is no colour card attached and the background appears black, you will see the matte colour at full opacity. If it is multiplied with a white background, the colours disappear into the full 255.
Multiplicative	Multiplies the tone or shadow colours with the background.
Colour	
RGBA	Enter a value to add or subtract from the colour channels in the drawings or attach these values to function curves.
Colour Swatch	Opens the Colour Picker where you can specify the colour.
Intensity	Lets you set a value to determine the strength of the effect or attach a function to animate the effect.

Tone



The Tone effect lets you add a dark-coloured region to your drawing and simulate the shaded area away from a light source. To produce the tone effect, create a drawing to control where the tone will appear. The Tone effect uses a matte to determine the shape and position of the tone on your drawing and can be blurred at the edges to create a softer effect.

How to use the Tone effect

1. Select a drawing layer.
2. Click the Add Layers **+** button and select **Effects > Tone**.

The Tone effect is parented to the selected layer.

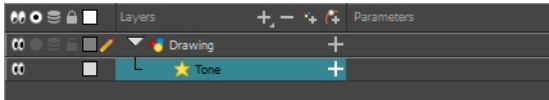

3. In the Drawing or Camera view, create a drawing on a new layer that will act as the matte.
4. In the Timeline view, click the Collapse/Expand **+** button on the effect layer.

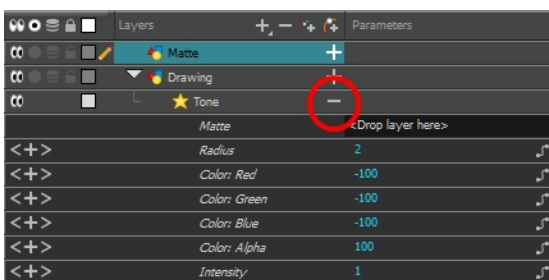

1. Drag and drop the matte layer beside the Matte field.

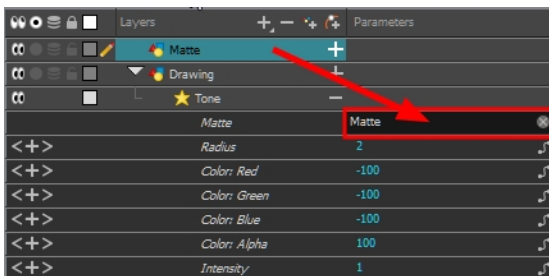

5. Display the Tone properties and adjust the properties to control the type and amount of blur and the colour of the tone effect.

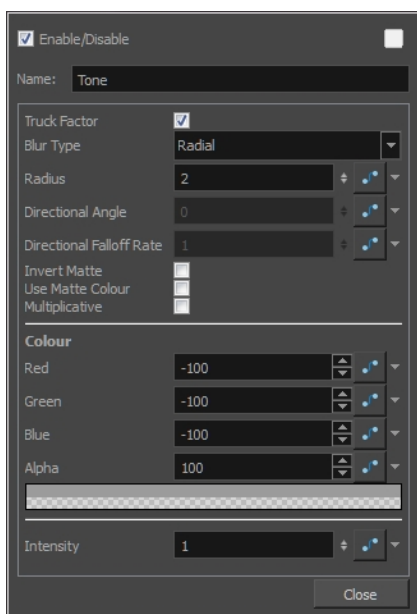

Tone Effect Properties

Parameter	Description
Truck Factor	Activated by default, this option readjusts the blur when the elements undergo a change of depth or scale. When disabled, the effect's values will remain unchanged regardless of depth or scale changes. It is recommended that this option be disabled when multiple drawings are composited and attached this effect.
Blur Type	Radial: The edges of the matte are blurred evenly around points that make up the edge of the matte. Directional: The matte is blurred in the direction you select.
Radius	Enter a value for the size of the blur. The larger the value, the greater the blur effect. The blur radius is affected by the drawing scale and camera position.
Directional Angle	If you selected the Directional Blur type, you can set the direction of the blur by entering a value from 0 to 360 in this field. 0: Blurs the image to the west. 90: Blurs the image to the south. 180: Blurs the image to the east. 270: Blurs the image to the north.
Directional Falloff Rate	The distance where the blur fades from the edge of the image. Select a value between 0 and 1. 0: Makes the blur fade out slowly, distributing the blur evenly from the edge of the character to the farthest edge of the blur. 1: Makes the blur fade out quickly. The blur is heaviest closer to the edge of the image.

Invert Matte	Inverts the matte used to create the tone, shadow, or highlight.
Use Matte/Source Colour	Creates the shadow or tone using the matte shape's colour. Be sure that you are in render mode  to see this effect and that your background is NOT white and that you do NOT have a white colour card node attached to the composite. As the matte only gives colour information, but no alpha, the matte is automatically multiplied with the background colours. If there is no colour card attached and the background appears black, you will see the matte colour at full opacity. If it is multiplied with a white background, the colours disappear into the full 255.
Multiplicative	Multiplies the tone or shadow colours with the background.
Colour	
RGBA	Enter a value to add or subtract from the colour channels in the drawings or attach these values to function curves.
Colour Swatch	Opens the Colour Picker where you can specify the colour.
Intensity	Lets you set a value to determine the strength of the effect or attach a function to animate the effect.

Transparency

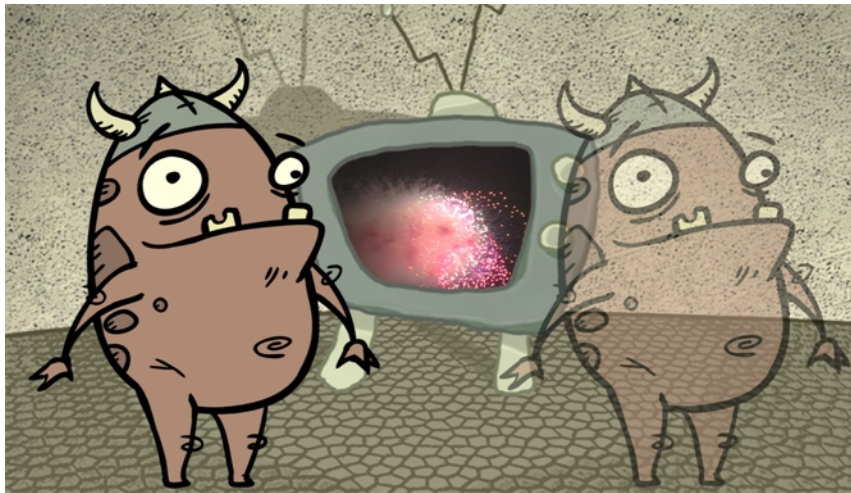

The Transparency effect is used to make an image partially transparent. The Transparency effect is useful when fading images in and out, such as a phantom or to make something partially see-through, such as a window.

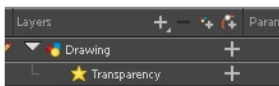

You can enter a value in the Transparency field or change the transparency value over time by linking it to a function curve. Entering a value of 100 in the Transparency field will make the element 100% transparent, in other words, invisible. Entering a value of 0 will render the element completely opaque.

It is also possible to adjust a layer/node's transparency directly in the Layer Properties window without using the Transparency node. In the layer's properties, go to the Drawing tab and adjust the Opacity parameter. This parameter is visible in OpenGL mode.

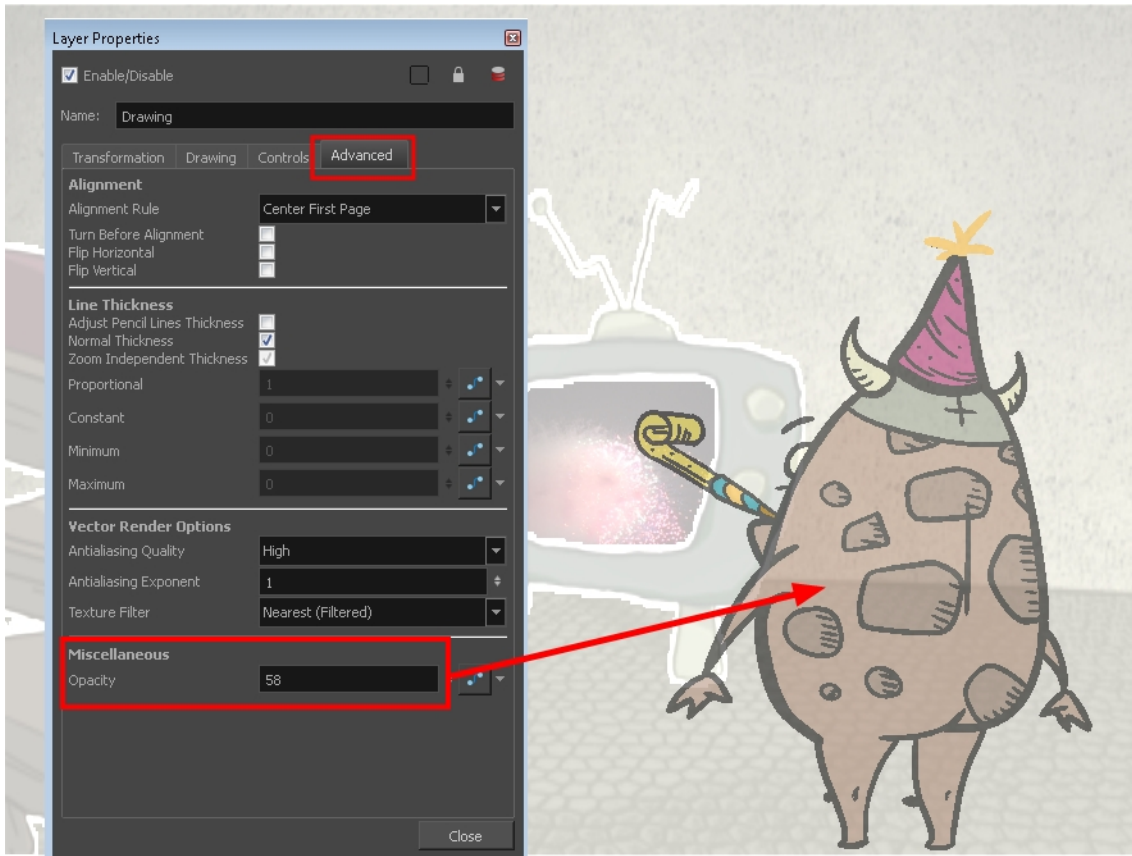

Use the Transparency editor to control how translucent the element should be.

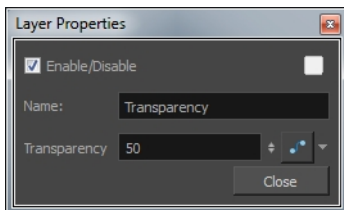

Transparency Properties

Parameter	Description
Name	Allows you to change the node's name.
Transparency	Lets you set the opacity of an element. Values range from 0 to 100. A value of 100 will make the element 100% transparent and a value of 0 will render the element completely opaque.

Chapter 8: Export

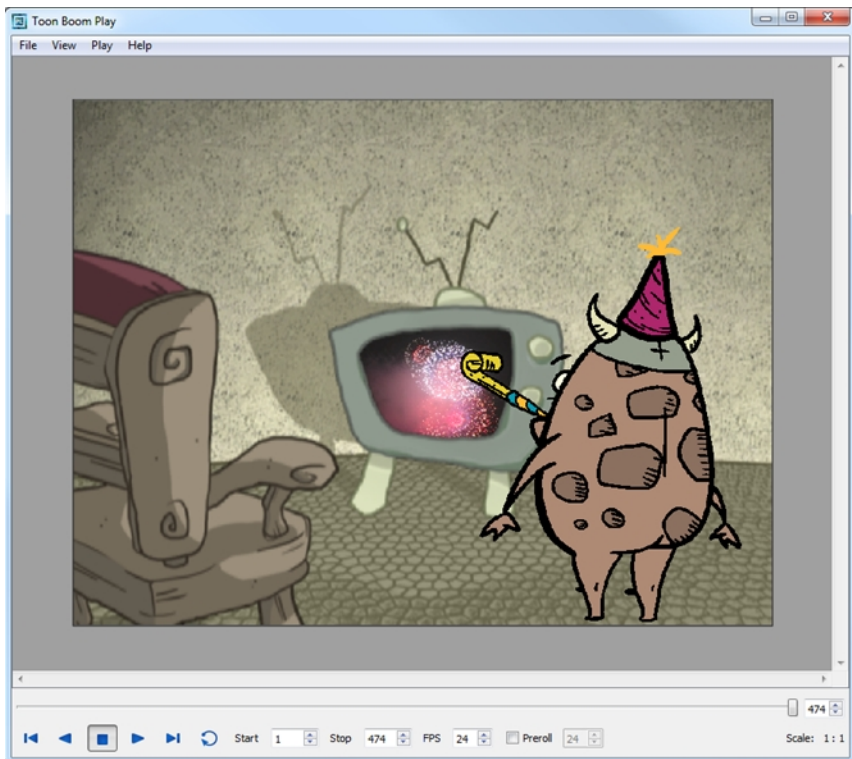

Now that you've finished your animation, it's time to render your movie. Depending on whether you plan to further edit your movie using a third party software, composite the movie in a larger body of work or put it up directly on the web, Harmony supports several formats for all your rendering needs.

The render resolution for the various editions of Harmony are:

- Harmony Essentials: 2K (2048x1556)
- Harmony Advanced: 4K (4096x3112)
- Harmony Premium: Unlimited

This chapter contains the following topics:

- [Exporting a QuickTime Movie on page 273](#)
- [Exporting an SWF Movie on page 278](#)
- [Exporting Image Sequences on page 280](#)
- [Exporting OpenGL Frames on page 281](#)

Exporting a QuickTime Movie

If you require a video file, you can export your animation as a QuickTime movie. To render a QuickTime movie with transparency, you need to set the Depth to Millions of Colours +. You can set this when exporting a QuickTime movie.

If your exported video is too small or too large, you can change the project size from the top menu in **Scene > Scene Settings**. This will change the size of the video output.

How to export a QuickTime Movie

1. From the top menu, select **File > Export > Movie**.

The Export to QuickTime Movie dialog box opens.

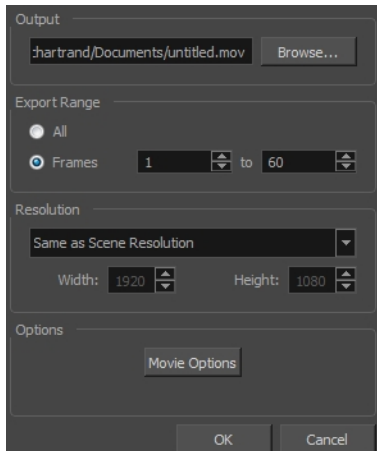

2. Click **Browse** and select a folder in which to save your movie and give it a file name for the export.
3. Click **OK**.

1. In the Display Source section, select the Display node to use for rendering your project.
2. From the Export Range section, decide whether you want to export the entire scene (All) or a specific frame range. If you decide on the latter, enter the frame range.

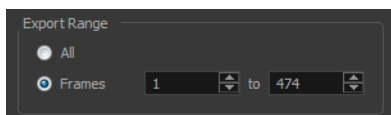

3. In the Resolution section, select one of the following from the menu:
 - ▶ A preferred resolution ratio.
 - ▶ **Custom**: Enables the Width and Height fields so you can enter a specific size.

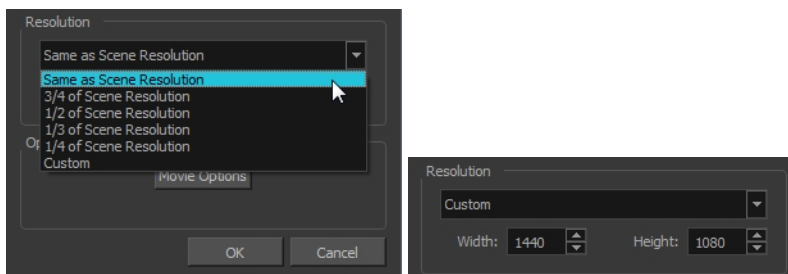

4. In the Options section, click **Movie Options**.

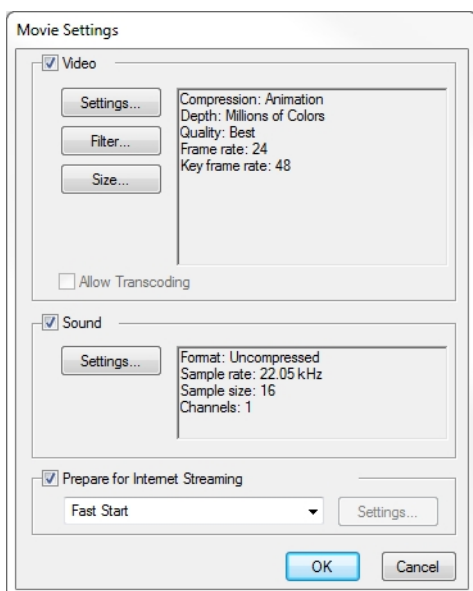

Parameter	Description
Video	Enables the customization of the video settings, filters and size.
	Settings: Opens the Standard Video Compression Settings dialog box (see below).
	Filter: Opens the Choose Video Filter dialog box, where you can select from a range of filters to apply to your video export.
	Size: Opens the Export Size Settings dialog box. The size settings are overridden by the Harmony's scene settings.
Sound	Enables the customization of the sound settings.
	Settings: Opens the Sound Settings dialog box (see below).
Prepare for Internet Streaming	Enables the customization of the Internet streaming options.

- In the Video section, click **Settings**.

The Standard Video Compression Settings dialog box opens.

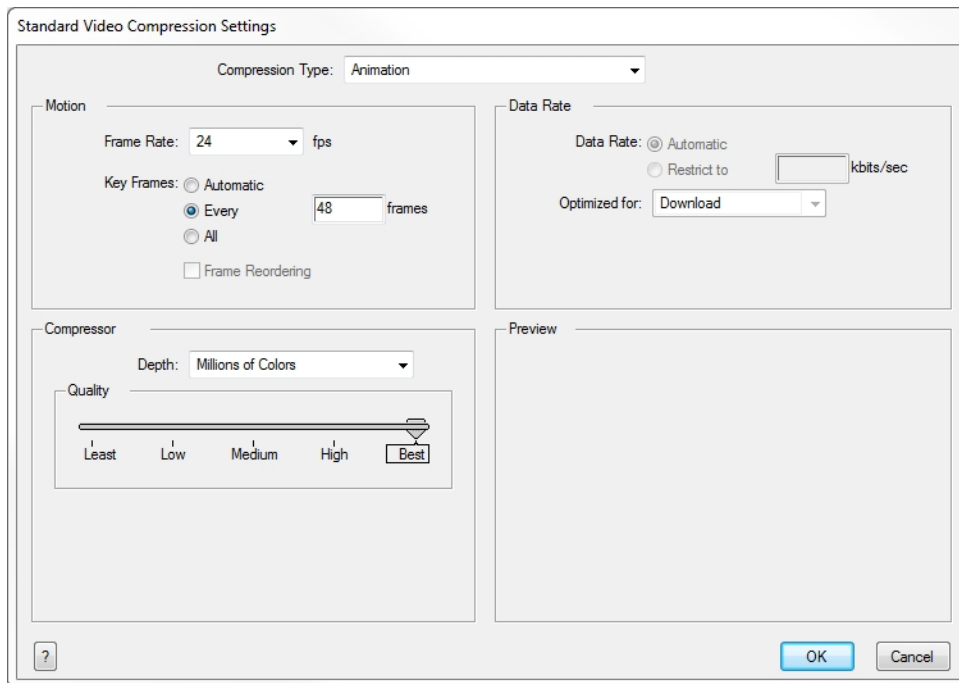

6. From the Compression Type menu, select a codec. The availability of certain compression settings depends on the Compression Type selected. For example, Animation is the default compression type and as a result the Data Rate option is greyed out.
7. In the Motion section, choose a **Frame Rate** from the list.
By default, it is set to match the frames-per-second (fps) of your Harmony project. If you choose a lower frame rate, your export playback will be faster than your actual project. The reverse is also true for a higher frame rate.
8. If you want keyframes inserted, select the **Every** option and set the number per frame.
This is the option is recommended by QuickTime. For further details, refer to the QuickTime documentation.
9. In the Compressor section, select a **Depth** based on your movie's needs. For example, Millions of Colours+ houses an alpha channel.
10. In the Quality section, use the slider to choose a quality setting. Remember that the better the quality of the export, the larger the file.

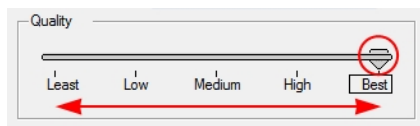

11. From the Data Rate section, either choose to allow the program to automatically select the most optimal bit rate, or enter a Restricted rate to save space and allow for faster downloading at a cost to the quality of the export.
12. In the same section, from the Optimized For menu, select the intended viewing method for the export.
13. Click **OK**.

- From the Movie Settings dialog box, click **Sound Settings**.

The Sound Settings dialog box opens.

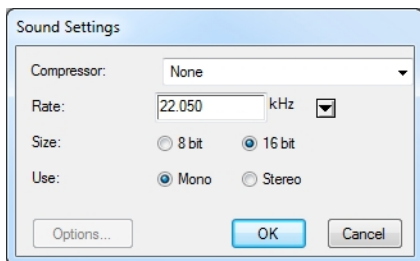

- From the Compressor menu, select a compression type.

The default setting is None. This will preserve your original sound file without the loss of information. However, an uncompressed sound file will inevitably add “weight” to the overall size of your video export.

- From the Rate menu, select a rate.

It is best to check and match the original properties of your sound file. For example, if your file has an audio sample rate of 48 kHz and you choose a conversion rate of 22.05 kHz, the sound will play at the same speed, but with higher frequencies missing.

For a standard film sound quality, choose **44.1 kHz**, or **48 kHz** for DVD quality. Anything less will make the sound “dull” or less bright. For things like recorded voice, this doesn't matter so much, but for music it can make an audible difference.

If file size is a consideration, such as with videos for the Internet, then a lower rate might be more practical.

- Select the **Size** and **Use**, which are related. Once again, it is advisable to check your original sound file properties. If the file was recorded in one channel (mono), there is no point in choosing the two channel (stereo) option. Although Mono can support a 16-bit channel, the extra information is unnecessary. Mono is generally paired with 8-bit and Stereo with 16-bit.
- Click **OK**.
- In the Export to QuickTime Movie dialog box, click **OK**.

A progress bar appears.

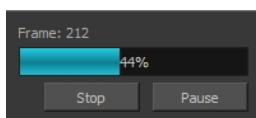

- Browse to the location on your computer where you saved your QuickTime video and double-click on it to view the export.

How to set the depth to Millions of Colours + to export a QuickTime movie with transparency

- In the Standard Video Compression Settings dialog box, select **Millions of Colors+** from the Depth menu—see [Exporting a QuickTime Movie on page 273](#).

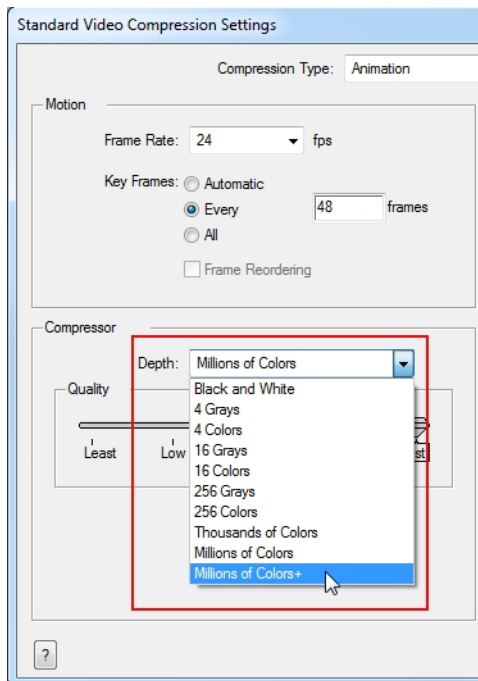

Exporting an SWF Movie

The SWF export supports some bitmap effects (which can be previewed in Render View mode) and SWF Blend Modes (vector effects which can be previewed in OpenGL View mode).

The following are also supported:

- Pencil line thickness: They are converted to brush strokes in the .swf file.
- Auto Patch node for creating joint patches.

If you have not already done so, you should preview the .swf by using the SWF preview  button to see what the two types of effects look like when blended together. Once you are satisfied with the results, go ahead and export your movie.

How to export a .swf movie

1. From the top menu, select **File > Export > SWF**.

The Export to Flash Movie (.swf) dialog box opens.

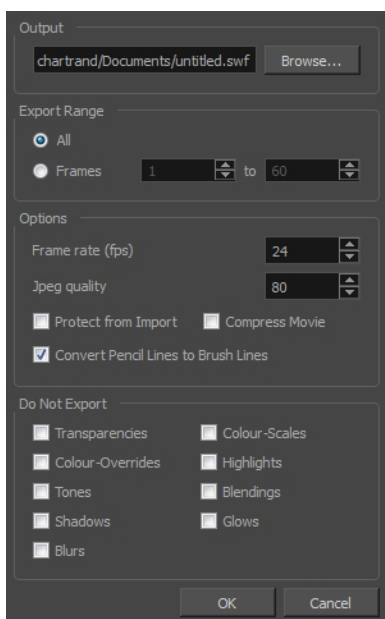

2. Click **Browse** and select a file name and destination path for your movie.
3. In the Export Range section, select one of the following options:
 - ▶ **All:** To export all the frames of your movie.
 - ▶ **Frames:** To export a frame range. Enter the frame range in the fields.

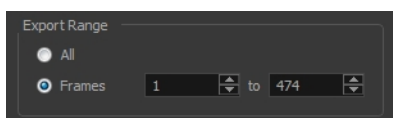

4. In the Options section, enter your Frame rate (fps). By default, it will be set to match the fps of your Harmony project. If you choose a lower frame rate, your export playback will be faster than your actual project. The reverse is also true for a higher frame rate.
5. In the same section, select the JPEG quality:
 - ▶ 100 = Full quality
 - ▶ 50 = Average quality at about 1/5th of the size.
 - ▶ 25 = Medium quality where loss of high image resolution starts to occur.
 - ▶ 10 = Low quality where "macro-blocking" or large pixelation become obvious.
 - ▶ 1 = Lowest quality where there is extreme loss of colour and detail and the image becomes nearly unrecognizable.
6. To prevent your movie from being imported in another application, select the **Protect from Import** option.
7. For a lighter format, select the **Compress Movie** option. The movie may lose some quality, but the file will be lighter.
8. To retain the thickness of pencil lines, select the **Convert Pencil Lines to Brush Lines** option.

- In the Do Not Export section, select the effects you do **NOT** want to be rendered in the SWF movie.

Note that certain Harmony effects are not listed in this section as they are not compatible and therefore not available for SWF export. These effects will not appear in the SWF render.

- Click **OK**.
- Browse to the location on your computer where you saved your Flash Movie and double-click on it to view the export.

Exporting Image Sequences

In Harmony, you can export a scene as a bitmap image sequence. If there is sound in your scene, it will not be exported with the images.

If you want to export images with transparency, you need to select the file type that supports this option, such as .tga, .psd or .png. The Colour Mode menu changes according to the File Type selected. For example, selecting .tif will result in only having "Colour" as a Colour Mode option, whereas .png will have "Colour" and "Colour with Transparency".

How to render an image sequence

- From the top menu, select **File > Export > Images** or press Ctrl + Shift + Y (Windows/Linux) or ⌘ + Shift + Y (Mac OS X).
The Export Images dialog box opens.

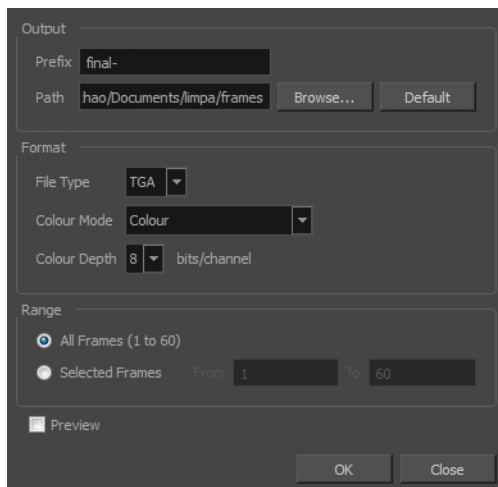

- In the Output section, choose a prefix. The prefix is the file name. Each image in the sequence will have this name, plus a sequence number and file format extension. For example: final-0001.jpg.
- Click **Browse** and specify the location in which your movie will be saved. The default location is the file directory's frames folder.
- In the Format section, choose the File Type, Colour Mode and Colour Depth from their respective menus.
- In the Range section, select the Frame Range to render.
 - **All Frames:** Exports export the entire scene.

- ▶ **Selected Frames:** Lets you specify the first and last frame of the frame range to export.

6. Select the Preview option to see the images being rendered.
7. Click **OK**.

If you selected the Preview option, a generic player opens so you can watch the image sequence strung together as a video. The image sequence is now available in the scene's frames directory. You should be able to preview each frame as an individual image.

How to render an image sequence with transparency

1. Open the Export Images dialog box.
2. In the Format section, select **Colour with Transparency** from the Colour Mode menu.

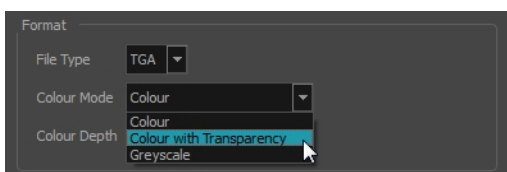

Exporting OpenGL Frames

You can export the OpenGL frames (fast display mode) if you need a quick render for your scene. Heavier scenes containing 3D, multiple effects and camera moves can be fairly long to export.

Use the Export OpenGL Frames dialog box to select the frames you want to render from the OpenGL Camera view, then save the rendered frames as image files or as a QuickTime movie.

Frames saved from OpenGL view have neither antialiasing nor special effects. To render final frames with effects, export as images or a movie.

How to export OpenGL Frames

1. From the top menu, select **File > Export > OpenGL Frames**.

The Export OpenGL Frames dialog box opens.

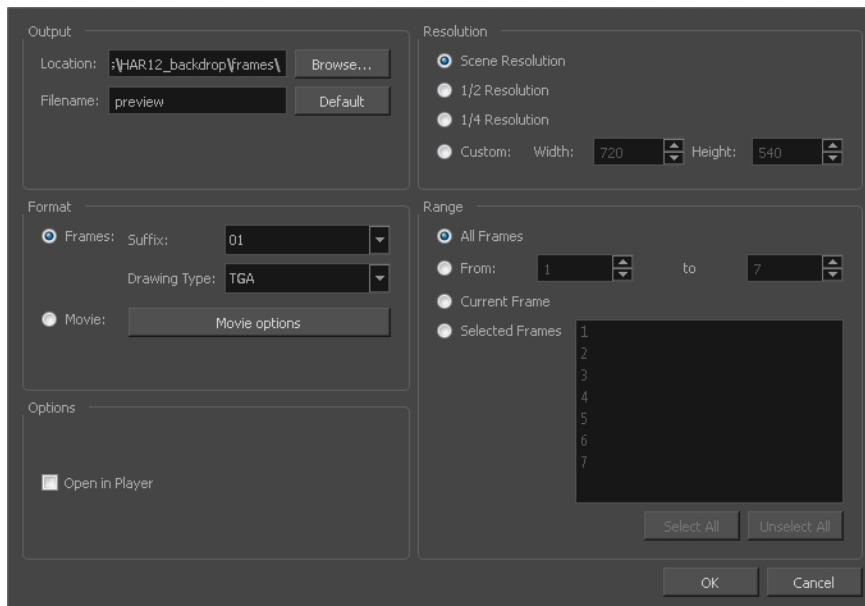

2. In the Output section, click **Browse** and select a folder for the frames.
3. In the Filename field, enter a name (prefix) for the frames or revert to the default name by clicking **Default**.
4. In the Format section, decide if you want to export individual image frames or a movie.
 - **Suffix:** Lets you select the desired suffix. If you intend to render only a few frames, use 1 or 01, whereas if you intend to render 1000 frames, you can select 0001.
 - **Drawing Type:** Lets you select the file type to render, such as .tga or .sgi.
5. Click **Movie Options** to customize the Audio and Video settings for the *.mov export—see [Exporting a QuickTime Movie on page 273](#).
6. From the Resolution section, select a resolution for export. If you are running some quick tests, then you might want to reduce the resolution to save time and space. You also have the option to set a Custom width and height to produce smaller or larger frames.
7. In the Range section, decide whether you want to render all your frames, a range of frames, the current frame or selected frames.
8. In the Options section, select the **Open in Player** option to view the rendered frames.
9. Click **OK**.

Glossary

alpha channel	An image channel that carries transparency information. An image already has three channels: red, green and blue (RGB). The alpha channel is the fourth channel (RGBA). The matte, or the transparency information, is stored in this fourth channel. An image without an alpha channel is always opaque.
animatic	A movie with sound that is developed from the storyboard. The storyboard

	panel is exposed for the duration of the scene and at times, the characters are placed on a trajectory to indicate motion. The camera moves are also animated. The animatic is used to determine the rhythm of a project and provides a good overview of the project before beginning production.
animation	A simulation of movement created by displaying a series of pictures or frames.
anime	An animation style known for its sinister and dark feel; popular in Japan.
arc	Action rarely occurs in a straight-forward manner; rather it typically unfolds in what storytellers refer to as an arc. The purpose of a story arc is to move a character or situation from one state or scenario to the next.
aspect ratio	The relationship between the width and height dimensions for any scene, frame or film format. Television ratio is 4:3 and widescreen ratio is 16:9.
auto-feed	An automated method of feeding drawings into a scanner in which multiple drawings are stacked into a sheet feeder. When the scanner is activated, the drawings are scanned consecutively, without further user intervention.
automatic lip-sync detection	Automatically mapping drawings in an element to the mouth chart generated for a sound. This can save time when lip-syncing a voice track.
axis	An imaginary line around which an object rotates. For 2D graphics, there are two axes: X (horizontal) and Y (vertical). For 3D graphics, there are three axes: X (horizontal), Y (vertical) and Z (depth).
background	The part of a scene that is farthest to the rear. The background is the artwork, or decor, against which the animation takes place.
Bézier	A method of defining curved lines invented by French mathematician Pierre Bézier. A Bézier curve is a mathematical or parametric curve. Bézier curves use at least three points to define a curve.
bitmap	An image composed of pixels with a single resolution (size). If it is enlarged too much, it will lose definition and pixels will begin to appear. This is known as <i>pixelation</i> .
breakdown	In cut-out animation, breakdown is the action of breaking a character into pieces to create a puppet with articulations. To break down a character, the artist cuts parts, such as the hands and arms, from the character's model and pastes them in separate layers. Next, the joints are fixed and the pivots set. In traditional animation, a breakdown is an animation pose generally found between two key poses. The key poses are the main poses in an animation and the breakdowns are secondary poses, ones that help describe the motion and the rotation curve (usually referred to as an <i>arc</i>).
camera shake	Camera shake occurs in a scene when the camera moves slightly and quickly in several directions. This gives the impression of an impact, vibration or, for example, bumps on the road.
caption	A text field containing dialogue, effects, sound, or slugging information in a storyboard.

cel	<p>In traditional animation, a cel (also known as <i>celluloid</i>) is a transparent sheet on which the animation is inked and painted before being sent to the camera. The picture's outline is drawn on the front of the cel and then coloured along the back.</p> <p>In Harmony, a cel is an individual space in an Xsheet column from which you can expose a drawing or a function's coordinate.</p>
character design	Each character in an animated film is drawn from multiple angles in poster-style format, called a <i>model sheet</i> , which serves as a reference for the animators.
clean up	After rough drawings have been tested and approved, all the noise in the image (excess lines, notes, etc) is removed to create final drawings which can be inked, painted and shot. The cleanup process refers to either tracing a clean line over a rough drawing to achieve the final version, or removing dirt and extra lines left by the scanning process.
CMYK	Cyan, Magenta, Yellow, Black. Refers to the process used by printers to define colour on the printed page.
colour card	A colour card is a solid colour card that is the same size as the camera. The colour card can be used to fill the background with a solid colour when there is no background image included.
colour model	The official colour design that must be used to paint the animation. A model is the definitive character, prop, or location design that each artist must follow for the production.
colour wheel	A display of the colour spectrum in the form of a circle.
compositing	Compositing is the action of incorporating all of a scene's elements to create the final result prior to rendering. For example, the compositing artist will import all the animation sequences, background, overlays and underlays in the scene and position them correctly. The artist will then set the camera frame and animate it, if needed. Finally, the animator will create all the computer-generated effects for the project.
cross dissolve	An effect used to fade two scenes, one into the other.
cut	A direct transition between two scenes. When a cut is used, there are no transition effects inserted to pass from one scene to the next. The first scene ends and the second one starts immediately.
cut-out animation	The action of animating characters made of several pieces by moving them around frame by frame. Cut-out animation can either be computer generated or done traditionally using paper.
cycle	A group of images that together make up an action, such as walking. A cycle is an action repeated as a loop over a period of time. It can be a series of animated drawings or keyframes.
dialogue	The text spoken by a character in a movie or animation.
dope sheet	Used by animators, directors and other members of a crew to track the sequence and timing of images, dialogue, sound effects, sound tracks and camera moves. Also known as an <i>exposure sheet</i> or <i>Xsheet</i> .

doping	To assign a particular drawing to a range of frames.
DPI	Dots per inch is the standard measure of resolution for computerized printers. It is sometimes applied to screens, in which case it should more accurately be referred to as <i>pixels per inch</i> . Either way, the dot is the smallest discrete element making up the image.
ease/velocity	In animation, the ease, also known as <i>velocity</i> , is the acceleration and deceleration of a motion. It can be a motion created by a function curve, or a series of animated drawings. Other common terms for ease-in and ease-out are slow-in and slow-out.
ease-in	Gradual acceleration in the action. Also known as <i>slow-in</i> .
ease-out	Gradual deceleration in the action. Also known as <i>slow-out</i> .
establishing shot	A scene in which the viewer can see the whole area in which a sequence is happening. For example, if a child is playing on the ground in front of his house, the establishing shot would be a scene where the viewer can see the house, the ground, a part of the street and the buildings around the central point of action. This helps the viewer understand the story location and scene orientation.
exposure	In animation, an exposure is the number of cels on which a drawing appears in the scene. For a drawing to appear longer, the exposure must be extended over a greater number of cels.
exposure sheet	<p>A sheet with several vertical columns and horizontal frames used to indicate a scene's timing. Each column represents a scene layer. The drawing numbers in each column are indicated and repeated over the particular amount of frames they need to appear.</p> <p>The exposure sheet is used by animators, directors and other members of a crew to track the sequence and timing of images, dialogue, sound effects, sound tracks and camera moves. Also known as a <i>dope sheet</i>.</p>
fade in/fade out	Fade in or fade out is a transition effect used to open or close a sequence. A fade in occurs when the first scene appears progressively, from complete transparency to its complete opacity. A fade out occurs when the last scene progressively disappears, going from complete opacity to complete transparency.
fast-in	Dramatic acceleration at the start of the action.
fast-out	Dramatic acceleration at the end of the action.
field	In animation, a field is a measurement unit used to calculate motion, registration and camera positioning. A standard animation scene will vary between 6 to 12 fields.
field chart	A guide containing all the field units that animation and layout artists use to determine a scene size or camera motion.
film-1.33	A resolution that is ideal for the widescreen film format that conforms to the standard 4:3 pixel aspect ratio.
film-1.66	A resolution that is ideal for the widescreen film format that conforms to the 16:9 pixel aspect ratio. (The pixels are wider than they are high).

flipping	In traditional animation, flipping is the action of going through the drawings of an animation sequence very quickly in order to see the animation in motion. Flipping can also be the action of creating a mirror transformation of an object.
follow-through	The secondary motion caused by the main action. For example, a character wearing a cloak is running. The main action is the body running. This will cause the cloak to follow the motion, although it will not move at the same time, but react a few frames later and follow the main motion curve.
forward kinematics	Forward kinematics is a feature used to animate principally 3D characters and cut-out puppets with hierarchy. It is used to animate a puppet from one of parent parts, such as a shoulder, and make the rest of the arm move with it as a single piece.
frame	A single photographic image in a movie. In traditional animation, the North American standard generally contains 24 frames per second, while in Europe the standard is 25 frames per second.
frame rate	<p>The frame rate is the speed at which the frames are played. They are generally calculated by frame per second. For example, a scene could be played back at 12, 24, 25, 30 or 60 frames per second or any other number.</p> <p>This is the measurement of the frequency (rate) at which an imaging device produces unique consecutive images, called <i>frames</i>. The term applies equally to computer graphics, video cameras, film cameras, and motion capture systems.</p> <p>Frame rate is most often expressed in frames per second (fps) and in progressive-scan monitors as hertz (Hz).</p>
functions	A computer-generated motion, trajectory or path on which elements, other trajectories and effects parameters can be attached. The function can be controlled by adding keyframes and control points on the function curve.
gamut	The range of colours that a particular device can represent.
HDTV	High Definition Television delivers a higher quality image than standard television does because it has a greater number of lines of resolution. To take advantage of the superior quality and make full use of your resolution setting, the output device must be compatible with HDTV technology.
hold	A frame in the animation in which the character maintains its position without moving. A hold can be created between any two keyframes.
HSV	Hue, Saturation, Value. A method of defining colours in terms of hue (tint), saturation (shade) and value (tone or luminance).
in-between	The drawings that exist between the key poses. These are drawn to create fluid transitions between poses.
ink and paint	The ink and paint process is the action of painting the empty zones and colouring the lines on the final animation drawings, while following a colour model.
interpolation	The computer-generated motion created between two keyframes. You have the choice to create interpolation, or not, between your keyframes.

jump cut	A jerky cut between two scenes. Typically, a jump cut is not visually pleasing. It is generally caused by one scene ending, and a second one starting, with a similar image. The lack of difference causes the eye to see a little jump between the two scenes.
key pose	Important positions in the action defining the starting and ending points of any smooth transition. Keys, or key poses, are the main drawings in an animation sequence describing the motion. For example, if an arm is waving, the keys will be of the arm at one extremity of the wave motion and the other extremity. By flipping those drawings, the animator can see the skeleton of the motion without having all the drawings.
keyboard shortcuts	One or more keyboard keys which, when used, cause an operation to be performed.
keyframe	Important positions in the action defining the starting and ending points of any action. A keyframe is a computer-generated position at a specific moment (frame) on a given trajectory.
layers	In animation, a layer is an individual column, level or character. A scene's layers are superimposed to form the final image.
layout	<p>The communication step between the storyboard and the animation. It is the action of putting the storyboard on model. That is, drawing the character by following the design in the model pack, so the animator can start working.</p> <p>The layout artist draws the background, creates the camera and field guide matching the scene and camera motion. Lastly, the animator draws on model the main action poses.</p>
layout and posing	The action of putting on model. That is, at the right scale, the storyboard for the animator to start working.
library	A storage area containing templates and assets that can be reused in any project or scene.
light table	A device that allows you to see other layers in transparency while you are working on a particular layer.
line of action	The direction that the action will follow. Also known as <i>path of action</i> .
lip-sync	The character's mouth synchronization with the dialogue sound track. Frame by frame, the mouth will be adjusted to fit the sound to give the illusion of the character is speaking.
low resolution	A format that is ideal for videos destined for the web, where size and fast download of a video file take precedence over quality. A low-resolution image is one that lacks fine detail.
manual lip-sync detection	The manual swapping of mouth position drawings to match a voice track. For this process, both sound scrubbing (listening to a sound wave broken up frame-by-frame) and drawing substitutions are used.
master palette	A group of colours attributed to a character or prop. The palette is used throughout the entire production to maintain consistency in the look and to ensure that the same colours are used throughout the production. Also known as <i>palette</i> .

model/colour model	The definitive character, prop or location design each artist must follow for a production. A colour model is the official colour design that must be used to paint the animation.
motion keyframe	A keyframe with computer-generated interpolation.
mouth chart	A chart based on the eight animation phonemes (A, B, C, D, E, F, G, and X, which is used to represent silence) used for lip-sync.
multiplane	The effect of passing through multiple levels of drawings to create a sense of depth in a shot. A multiplane is a scene in which the layers are placed at different distances from the camera so that when the camera moves, a depth illusion occurs. With a multiplane, all the perspective and scale is calculated automatically.
NTSC	The standard analogue television broadcasting system used in North America. NTSC conforms to North American standards on how rectangular pixels are displayed for computer and television screens.
nudge	A small push (left, right, up, down, forward or backward) done with the keyboard arrow keys on a selected element. Nudging is used to move a selection very slightly and precisely.
onion skin	A feature that lets you see the previous and next drawings of a sequence.
overlay	A part of the scene environment, such as a chair or a bush, that is placed in front of the main animation.
PAL	A resolution that works best with the European format for television and computer screens, as the rectangular pixels are displayed at a different orientation.
palette/master palette	A palette or master palette is a group of colours attributed to a character or a prop. The palette is used throughout the entire project to maintain a consistency in the look and avoid the colour changing during the animation. Also referred to as a master palette.
palette style	A palette style is a second version of an existing palette with a slight change in the tint and value. A palette style can be used to create the night version of a palette. It may also be called a clone palette.
pan	To move the camera across the scene in any direction.
panel	In a storyboard, a panel is a frame in a shot. A shot can be composed of one or several panels.
paperless animation/tradigital	The paperless animation process is the action of animating digitally. The main paperless animation process is to draw, frame by frame, the animation directly in the software.
passing position	When drawing a walk sequence for a character, the passing position is the point at which one leg passes the other.
path of action	Direction that the action will follow. Also known as <i>line of action</i> .
peg	In traditional animation, a tool used to ensure accurate registration of action as cel layers move. In digital animation, in which you are doing a more advanced puppet rigging, you can use peg layers. Peg layers are trajectory layers that do not contain drawings. They are motion paths that

	you can use to add path articulations. For the latter, you can also use the Inverse Kinematics tool.
phoneme	A unit of sound in a language.
pivot	The point around which a peg or drawing rotates.
pixel	The smallest element of an image displayed on a monitor or TV screen. Pixel, short for <i>picture element</i> , is a single point in a graphic image. It is a small sample of an image, a dot, a square, or a very small section made out of smooth filtering. If you zoom in close enough on a digital image, you will see the pixels, which look like small squares of different colours and intensity.
pose-to-pose animation	The pose-to-pose animation process is the action of creating all the main action poses, called <i>key poses</i> , and then placing the secondary poses between the keys. The secondary poses are called <i>breakdown</i> . Finally, the animator fills the gaps with the in-between drawings to achieve a smooth animation.
rendering	The final step when animating by computer. During rendering, the computer takes each pixel that appears on screen and processes all of the components, as well as adding motion blur before it produces a final image. The process of calculating the final images after the compositing process.
resolution	The size of a scene, generally calculated in pixels. For example, the NTSC resolution is 720 x 480. The resolution should match the final output: HDTV, film-1.33, film-1.66, NTSC, PAL, low.
RGB	Red, Green, Blue. A method of defining colour by specifying amounts of these three colour components.
rigging	The process of attaching the various parts of a cut-out puppet.
rotary table	Equivalent to the animation disk/table, a device that allows you to rotate the workspace for greater comfort while drawing.
rotoscoping	An animation technique in which animators trace over live-action film movement, frame by frame, for use in animated films. The act of sketching over live-action footage to create an animated sequence.
roughs	The skeleton sketch of an animation or design. Roughs mainly consist of sketch lines and shapes, though they can also contain design details.
safe area	The zone at the center of a scene's frame that is safe from being cropped by the TV frame. As a TV frame cuts a margin off the original frame size, maintaining a safe area ensures that the scene's main action will remain clearly visible once the film is screened on television.
scene	A shot in a movie or show. A sequence is composed of several scenes. A scene changes to another scene by a simple cut or transition.
script	The original text containing all the movie or show information. In animation, the script contains all of the location descriptions, dialogue, time and more. A project starts with a script.
sequence	A series of scenes or shots forming a distinct part of the story or movie,

	usually connected by unity of location or time.
shot	A scene in a movie or show. A sequence is composed of several shots. A shot changes to another shot by a simple cut or transition.
slow-in	The gradual acceleration in the action. Also known as <i>ease-in</i> .
slow-out	The gradual deceleration in the action. Also known as <i>ease-out</i> .
slugging	To indicate the start and stop times of dialogue and relevant actions.
sound scrubbing	A process that lets you hear sound in real time while you move the playhead forward or backward. This is very useful for finely-tuning a lip-sync.
stop-motion keyframe	A keyframe with no computer-generated interpolation.
storyboard	A visual plan of all the scenes and shots in an animation. The storyboard indicates what will happen, when it will happen and how the objects in a scene are laid out.
straight-ahead	A technique in which an entire sequence is drawn from the first position to the last, in order. There is very little planning in this methodology. Where the character ends up and how it gets there can be a surprise for both the audience and the animator. While this approach is spontaneous and creative, it can create inaccurate results.
strokes	Invisible vector lines forming the drawing zones. They can be adjusted with Bézier handles.
tablet/pen	A device used in conjunction with, or instead of, a mouse to move a mouse pointer (sometimes referred to as the <i>cursor</i>) around the computer screen.
template	An asset stored in the library that can be reused in any project. A template can be a drawing, a series of keyframes, a sound file, a panel, a cut-out character, an effect, a trajectory, an animation, or anything else used in the animation.
thumbnails	A very small image used as a reference or indicator.
timecode	The timing information printed on a movie clip to indicate the scene, hour, minute and second that is currently displayed on the screen.
timeline	A horizontal representation of a scene's elements, timing and keyframes.
trace and paint	After the rough animations have gone through cleanup and a final line or pencil test, each drawing is traced and painted for the final animation. In today's digital world, this may be done in a variety ways other than the traditional celluloid or acetate methods.
track breakdown	The break down of an animated film's soundtrack into individual sounds to produce the precise frame-by-frame position of each sound.
traditional animation	A type of animation process whereby all the animation sequences are drawn by hand on paper before scanning or inking them on cels.
trajectory	A computer-generated path or trajectory that elements can follow. The trajectory can be controlled by control points, keyframes and velocity.
transition	An effect placed between two scenes as they pass from one to the other. Common transition effects are cross-dissolve and wipe.

underlay	In animation, an underlay is a specific part of the decor placed behind the main animation.
aspect ratio	The aspect ratio describes the shape of the grid unit. A square grid unit would have a 1:1 ratio, whereas a grid unit of aspect ratio 4:3 is a unit with one side 1.33 times as big as the other side.
vector	A vector-based image is composed of points and Bézier curves. The computer reads the points and traces the segments, linking them to reproduce the image shape. There is no fixed size or resolution in a vector image. The graphic can be enlarged and distorted as much as desired and the system will simply recalculate the segments and rebuild the shapes. Vector images are translated and displayed in pixels once the calculation is done.
velocity	In animation, the velocity, also known as <i>ease</i> , is the acceleration or deceleration of a motion. This can be achieved by a function curve, or via a series of animated drawings. Other common terms for ease-in and ease-out are <i>slow-in</i> and <i>slow-out</i> .
walk cycle	A series of drawings "on the spot" that describe the walk for a character. The illusion of movement is created by the use of background pans. To avoid making innumerable drawings, animators routinely make a walk cycle for a character.
Xsheet (exposure sheet)	<p>The Xsheet or exposure sheet, is a sheet with several vertical columns and horizontal frames used to indicate a scene's timing.</p> <p>Each column represents a scene's layer. In each column, the drawing numbers are indicated and spread over the specific number of frames in which they appear.</p> <p>The exposure sheet is used by animators, directors and other members of the crew to track the sequence and timing of images, dialogue, sound effects, sound tracks and camera moves. Also known as <i>dope sheet</i>.</p>
zone	An area which can be painted with colour.

Index

- alpha channel 282
- animatic 282
- animating
 - camera 175
- animation 283
- anime 283
- arc 283
- aspect ratio 283, 291
- auto-feed 283
- axis 283
- background 283
- Bezier 283
- bitmap images 283
 - importing in original format 13
- breakdown 283
- camera
 - adding and parenting to peg 175
 - animating 175
- camera shake 283
- caption 283
- cel 284
- celluloid
 - See cel. 284
- character design 284
- clean up 284
- CMYK 284
- colour card 284
- colour model 284, 288
- colour wheel 284
- compositing 284
- cross dissolve 284
- cut 284
- cut-out animation 284
- cycle 284
- dialogue 284
- dope sheet 284
- doping 285
- DPI 285
- ease 285
- ease-in 285
- ease-out 285
- establishing shot 285
- exposure 285
- exposure sheet 285, 291
- fade-in 285
- fade-out 285
- field 285
- field chart 285
- film-1.33 285
- film-1.66 285
- flipping 286
- follow-through 286
- forward kinematics 286
- frame 286
- frame rate 286
- Function view 190
 - displaying functions 186, 191
- functions 286
 - displaying 186, 191
- gamut 286
- HDTV 286
- Hold 286
- HSV 286
- importing
 - bitmap image in original format 13
 - sound file 213
 - templates 99
- in-between 286
- ink and paint 286
- interpolation 286
- jump cut 287
- key pose 287
- keyboard shortcuts 287
- keyframes 287
- Layer Properties editor
 - displaying 132
- layers 287
 - panning with Transform tool 122
 - rotating with Transform tool 122
 - skewing with Transform tool 123
- layout 287
- layout and posing 287
- library 287
- Library view
 - importing templates 99
- light table 287
- line of action 287
- lip-sync 287
 - auto detection 283
- lip-sync detection
 - manual 287
- low resolution 287
- manual lip-sync detection 287
- master palette 287-288
- model 288
- model sheet See character design
- motion keyframe 288
- mouth
 - chart 288
- multiplane 288
- NTSC 288
- nudge 288
- onion skinning 288
- overlay 288

- PAL 288
- palettes 288
 - style 288
- panel 288
- panning 288
 - layer using Transform tool 122
- paperless animation 288
- passing position 288
- path of action 288
- pegs 288
- pen 290
- Perspective view 156
 - rotating a scene 157
- phoneme 289
- pivot 289
 - repositioning permanently 128
- pixel 289
- pixelation See bitmap image
- pose-to-pose 289
- rendering 289
- resolution 289
- RGB 289
- rigging 289
- rotary table 289
- rotating
 - layer with Transform tool 122
- rotoscoping 289
- roughs 289
- safe area 289
- scaling
 - layer with Transform tool 123
- scanning
 - VectOptions.conf file 75
- scene setup
 - panning layer using Transform tool 122
 - repositioning pivot permanently 128
 - rotating layer with Transform tool 122
 - scaling layer with Transform tool 123
 - skewing layer with Transform tool 123
- scenes 289
 - rotating in Perspective view 157
- script 289
- scrubbing 290
- sequences 289
- shot 290
- Side view 155
 - opening 174
 - positioning elements 152
- skewing
 - layer with Transform tool 123
- slow-in 290
- slow-out 290
- slugging 290
- sound
 - importing sound file 213
 - scrubbing 290
- stop-motion keyframe 290
- storyboard 290
- straight-ahead 290
- strokes 290
- tablet 290
- templates 290
 - creating 89
 - importing 99
- thumbnails 290
- timecode 290
- timeline 290
- Top view 153
 - opening 174
- positioning elements 152
- trace and paint 290
- track breakdown 290
- tradigital 288
- traditional animation 290
- trajectory 290
- Transform tool
 - panning layer 122
 - rotating layer 122
 - scaling layer 123
 - skewing layer 123
- transition 290
- underlay 291
- VectOptions.conf file 75
 - Mac 75
 - Windows 75
- vector 291
- vectorization
 - creating a style 73
 - parameters, creating 74
 - parameters, custom 65
 - parameters, modifying 74
- Vectorization Parameters dialog box
 - Help tab 68
 - opening 66
 - Options tab 66
- velocity 285, 291
- views
 - Function 190
 - Perspective 156
 - Side 155
 - Top 153
- walk cycle 291
- Xsheet view 291
- zone 291