



# HARMONY

TOON BOOM HARMONY 12.1  
- Advanced Edition -  
**Fundamentals Guide**

---

## **Legal Notices**

Toon Boom Animation Inc.  
4200 Saint-Laurent, Suite 1020  
Montreal, Quebec, Canada  
H2W 2R2

Tel: +1 514 278 8666

Fax: +1 514 278 2666

[toonboom.com](http://toonboom.com)

### **Disclaimer**

The content of this guide is covered by a specific limited warranty and exclusions and limit of liability under the applicable License Agreement as supplemented by the special terms and conditions for Adobe®Flash® File Format (SWF). For details, refer to the License Agreement and to those special terms and conditions.

The content of this guide is the property of Toon Boom Animation Inc. and is copyrighted.

Any reproduction in whole or in part is strictly prohibited.

### **Trademarks**

Harmony is a trademark of Toon Boom Animation Inc.

### **Publication Date**

2015-08-07

Copyright © 2015 Toon Boom Animation Inc. All rights reserved.

# Contents

Toon Boom Harmony 12.1- Advanced Edition -Fundamentals Guide .....	1
<b>Contents .....</b>	<b>3</b>
<b>Chapter 2: Toon Boom Harmony - About this Help System .....</b>	<b>7</b>
Help Structure .....	7
Tutorials and Other Help Tools .....	8
System Requirements .....	9
Harmony .....	9
<b>Chapter 3: About Toon Boom Harmony .....</b>	<b>11</b>
Top Features .....	11
Toon Boom Pipeline .....	11
Render Resolution .....	11
Modules .....	11
<b>Chapter 4: Animation Workflow .....</b>	<b>15</b>
Pre-production .....	15
Production .....	19
Post-production .....	19
About the Animation Types .....	21
Traditional Animation .....	21
Paperless Animation .....	22
Cut-out Animation .....	23
Production Steps .....	25
Traditional Animation Workflow .....	25
Paperless Animation Workflow .....	28
Cut-out Animation Workflow .....	30
<b>Chapter 5: Animation Principles .....</b>	<b>33</b>
<b>Chapter 6: Concepts .....</b>	<b>39</b>
Bitmap and Vector Graphics .....	39
Bitmap Image Types .....	39
Vector Image Types .....	40
Advantages and Disadvantages of Bitmap and Vector Images .....	40
Line and Colour Layers .....	40
Colour Palettes .....	41
Exposure Sheet, Timeline and Timing .....	42
Broadcast Standards .....	43

Exposure Sheet .....	43
Timeline .....	44
Xsheet and Timeline Usage .....	44
Pegs .....	45
Multiplane .....	46
Network .....	46
Frame Rate and Format .....	47
Scenes .....	48
<b>Chapter 7: Project Organization and File Structure .....</b>	<b>51</b>
File Structure .....	51
Scene File Structure .....	51
Root Directory and Content Building Scenes .....	52
Drawings and Layers .....	54
Libraries and Templates .....	56
Library Structure Tips .....	57
Personal Libraries .....	58
Naming Convention .....	58
Scene Naming Convention .....	58
Layer Naming Convention .....	58
Renaming a Series of Nodes .....	59
Puppet Drawing Naming Convention .....	60
<b>Chapter 8: Starting Toon Boom Harmony .....</b>	<b>61</b>
Starting .....	61
Welcome Screen .....	61
Accessing the Documentation .....	62
Creating and Opening Scenes .....	62
Saving a Scene .....	65
Setting the Scene Length .....	66
New Scene Startup Script .....	67
Adding a Drawing Layer .....	67
Scene Settings .....	68
Verifying the Project Integrity .....	74
Check Files .....	74
Check Colours .....	74
Basic Commands .....	75

---

Preferences .....	78
<b>Chapter 9: Interface .....</b>	<b>81</b>
Menus .....	82
Managing the Views .....	84
Managing the Toolbars .....	88
Managing the Workspace .....	93
View References .....	98
Camera View .....	99
Colour View .....	104
Drawing View .....	109
Function View .....	110
Layer Properties Editor .....	112
Library View .....	113
Message Log View .....	115
Model View .....	115
Perspective View .....	116
Script Editor View .....	118
Side View .....	119
Timeline View .....	120
Tool Properties View .....	128
Top View .....	128
Xsheet View .....	129
Toolbar References .....	136
Top Toolbars .....	136
View Toolbars .....	140
Interface Navigation .....	140
Using the Play Menu to Navigate .....	142
Zoom Tool .....	142
Glossary .....	143
Index .....	153



## Chapter 2: Toon Boom Harmony - About this Help System

Toon Boom Harmony is an animation and digital content creation tool that offers you a wide array of features and options. Harmony is packaged in several different modules and allows you to create animation using the technique of your choice—see [About Toon Boom Harmony on page 11](#).

This help system is built to guide you through the different workflows possible and explains which tool and module to use in a production context.

Help Structure .....	7
Tutorials and Other Help Tools .....	8
System Requirements .....	9

### Help Structure

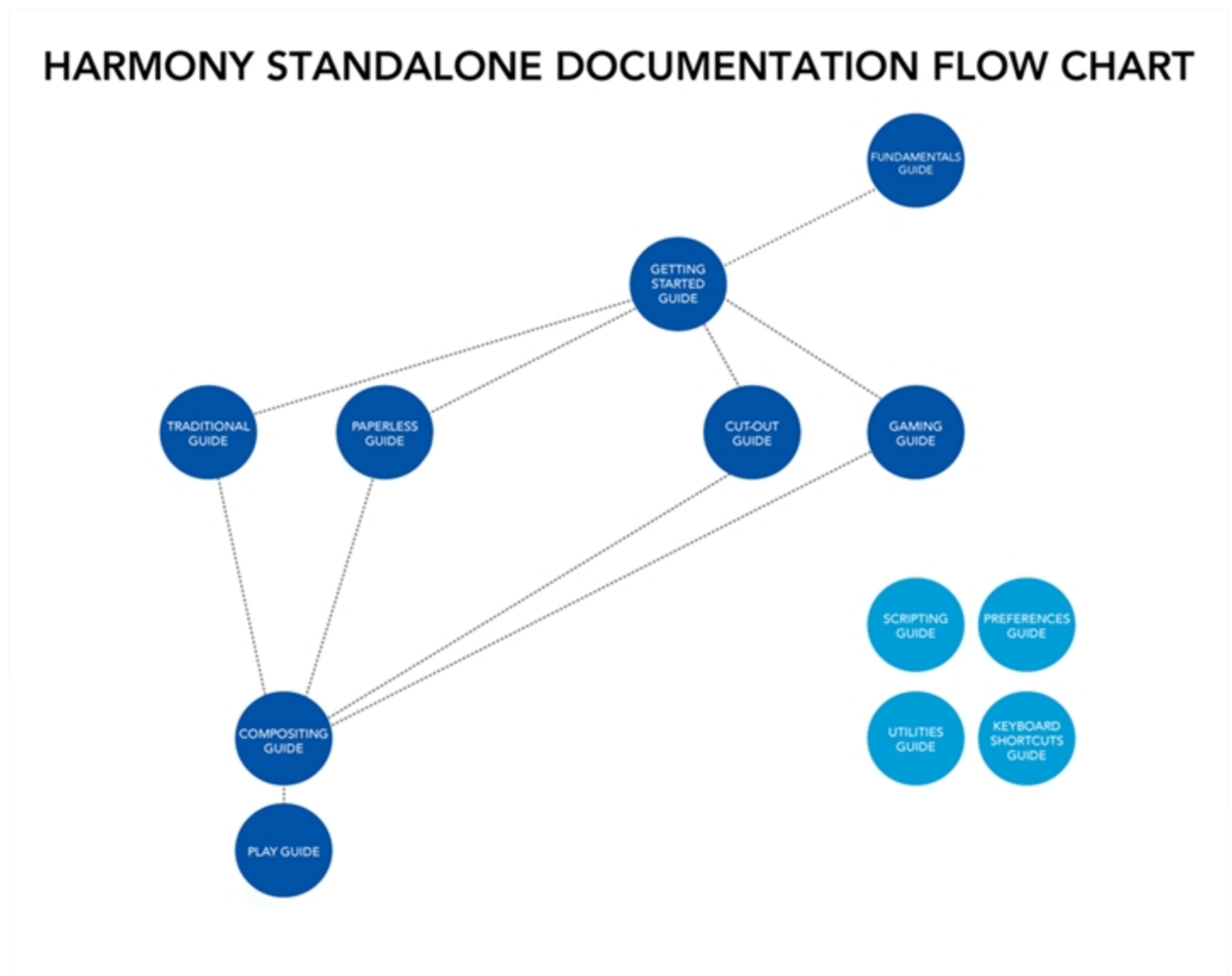

The fundamental concepts of animation and Harmony are explained in this guide. It covers the essentials of various animation workflows, basic animation principles, as well as Harmony's interface. Depending on what you want to do, you can either start with this Fundamentals Guide to get immersed into the world of Harmony and animation or go right to the Getting Started Guide, which covers the main functions and tasks. All conceptual and reference topics are omitted to get you up and running in a very short amount of time.

The core of this help system revolves around the main features and techniques you can use in Harmony to create animation:

- Traditional Animation
- Paperless Animation
- Cut-out Animation
- Gaming Animation

All workflows join in the compositing step of the process. All the information on compositing in Harmony can be found in the Compositing Guide. Finally, you can watch the rendered animations in the Play module. To learn how to use the Play module, refer to the Play guide.

If you are focusing on a single part of the workflow such as ink and paint or scanning, you can simply read the Fundamentals Guide and one of the corresponding module guides:

- Paint Guide
- Scan Guide

Other satellite guides are also available to learn about additional information such as the preferences and keyboard shortcuts.

- Keyboard Shortcuts Guide
- Preferences Guide
- Scripting Guide
- Utilities Guide

If you are already a Harmony user and want to know more about the new features that were added to this latest version, refer to:

- What's New (Release Notes)

## Tutorials and Other Help Tools

Aside from the main product documentation, you can find supplementary material to learn more about Harmony. The [Toon Boom website's online resources](#) section offers a variety of videos and samples that can further your knowledge of Harmony.

- Video Tutorials: [toonboom.com/resources/video-tutorials/harmony-network](http://toonboom.com/resources/video-tutorials/harmony-network)
- Templates and Sample Scenes: [toonboom.com/resources/templates/harmony-network](http://toonboom.com/resources/templates/harmony-network)
- Tips and Tricks: [toonboom.com/resources/tips-and-tricks/harmony-network](http://toonboom.com/resources/tips-and-tricks/harmony-network)
- White Papers: [toonboom.com/solutions/white-papers](http://toonboom.com/solutions/white-papers)



## System Requirements

Here are the technical specifications for Harmony 12.1.

### Harmony

Here are the specifications to install Harmony. Note that this does not encompass the network and server specifications for Harmony Server.

Requirements	Windows	Mac OS X
Operating System	Windows 7 64-bit Windows 8 64-bit	Mac OS X 10.9.5 Mac OS X 10.10.2 or later
Processor	Intel Core i7, 3.4 GHz Intel Core i5, 3 GHz Intel Core 2 Duo	
Monitor	Optimized for 1920 x 1080 or higher Minimum requirement is 1280 x 800	
Memory	16 GB 8 GB 4 GB	
Video Card	<p><b>Fast</b></p> <ul style="list-style-type: none"> <li>• NVIDIA GeForce GTX 780</li> </ul> <p><b>Medium</b></p> <ul style="list-style-type: none"> <li>• NVIDIA GeForce GTX 560, 650</li> </ul> <p><b>Slow</b></p> <ul style="list-style-type: none"> <li>• Intel HD Graphics 4000, 5000</li> <li>• Intel Iris Graphics</li> <li>• NVIDIA GeForce GT 520, 620, 720</li> </ul>	<p><b>Fast</b></p> <ul style="list-style-type: none"> <li>• AMD FirePro D500</li> <li>• NVIDIA GeForce GTX 775M</li> </ul> <p><b>Medium</b></p> <ul style="list-style-type: none"> <li>• AMD Radeon HD 6770</li> <li>• NVIDIA GeForce 750M</li> </ul> <p><b>Slow</b></p> <ul style="list-style-type: none"> <li>• Intel HD Graphics 4000, 5000</li> <li>• Intel Iris Graphics</li> <li>• NVIDIA GeForce 320M</li> <li>• Radeon HD 6630</li> </ul>
Drawing Tablet	<p><b>Best</b></p> <ul style="list-style-type: none"> <li>▸ Wacom Intuos Pro</li> <li>▸ Wacom Cintiq</li> </ul> <p><b>Basic</b></p> <ul style="list-style-type: none"> <li>▸ Wacom Intuos</li> </ul>	
Media Player	Apple QuickTime Player (free)	



## Chapter 3: About Toon Boom Harmony

Toon Boom Harmony is the most advanced professional animation software on the market. Bringing together an impressive 2D drawing toolset with the ability to work in a real 3D space, and import 3D models,

### Top Features

- **Advanced Drawing Tools:** Texture brushes, and thick and thin pencil lines
- **Smart Colour Palettes:** Colour you can adjust on the fly
- **Character Rigging:** Hierarchy, deform, and effects for creating sophisticated rigs
- **Special Effects:** An array of effects including highlights and shadows, glows, blurs, and a full particle effects engine
- **Real 3D Camera:** A camera you can reposition in a full 3D space
- **3D Integration:** Allowing you to import 3D models, position and animate them in 3D space
- **Production Pipeline Integration:** Seamlessly integrate content from pre-production via Toon Boom Storyboard Pro

### Toon Boom Pipeline

Toon Boom Harmony has been recognized for its excellence by winning many awards, including a Primetime Emmy® Engineering Award and the prestigious Ub Iwerks Annie Award for the integrated pipeline with Toon Boom Storyboard Pro.

Harmony works perfectly with Toon Boom Storyboard Pro for all pre-production phases. Therefore, animatics created in Toon Boom Storyboard Pro can be imported seamlessly in Harmony for animation and scene setup guidance.

### Render Resolution

The render resolution for the various editions of Harmony are:

- Harmony Essentials: 2K (2048x1556)
- Harmony Advanced: 4K (4096x3112)
- Harmony Premium: Unlimited

### Modules



Harmony Stand Alone is composed of the following modules:

- [Stage Advanced](#) on page 12
- [Play](#) on page 12
- [Web Control Center](#) on page 13

These modules are all accessible from:

- Windows: **Start > Programs > Harmony 12.1 Advanced**
- Mac OS X: **Applications > Toon Boom Harmony 12.1 Advanced**

## Stage Advanced



The Stage Advanced module is the core of Harmony. It comprises all the major drawing, animation and compositing features. It is used to work in the scene: design, character breakdown, cut-out animation, traditional animation, ink and paint, exposure sheet, timeline, effects, compositing, camera moves, colour styling, and so on.

**NOTE:** You cannot create scenes in Stage with Harmony Server, you require the Control Center module. You create them directly in Stage with Harmony Stand Alone.

To learn more about Stage Advanced, refer to the following guides:

- Fundamentals Guide
- Getting Started Guide
- Traditional Animation Guide
- Paperless Animation Guide
- Cut-out Animation Guide
- Gaming Guide
- Compositing and Effects Guide
- Play Guide
- Preferences Guide
- Keyboard Shortcuts Guide
- Scripting Guide
- Utilities Guide

## Play



The Play module is used to play back the rendered image sequences enabling the user to view the final scenes and compositing results.

To learn more about the Play module, refer to the following guides:

- Fundamentals Guide
- Play Guide

## Web Control Center



You can access your database via Web Control Center. When you're running a studio, you will most likely have a database set up. This enables all the artists working on your production to share the same scenes and assets.

Web Control Center lets you host this database on the Internet. This way, freelancers can log in from anywhere with an Internet connection. Then they can download a scene from the database, work on it, and upload it again.

You no longer to spend time copying files to an FTP or have an admin exporting and importing files from the database. You can do it all directly through Web Control Center.

To learn more about Web Control Center, refer to the following guides:

- Installation Guide
- Control Center Guide



## Chapter 4: Animation Workflow

In this chapter, you will become familiar with the different animation workflows and how they end up merging together. There is also an overview of how they work with Harmony.

To begin with, let's determine what an animation workflow is. No matter which method you choose to create your project, it will always be divided in three segments. Then you will have to choose your animation method.

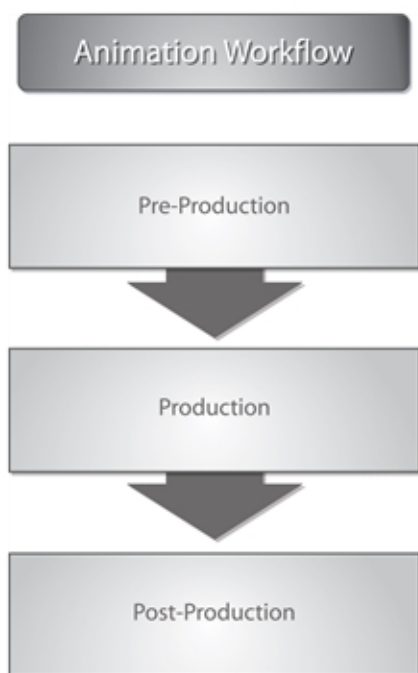

Harmony is designed to handle part of the pre-production and all of the production. Post-production is managed in an external application. The three workflow segments are each broken down in different steps.

### Pre-production

The first segment is the pre-production.

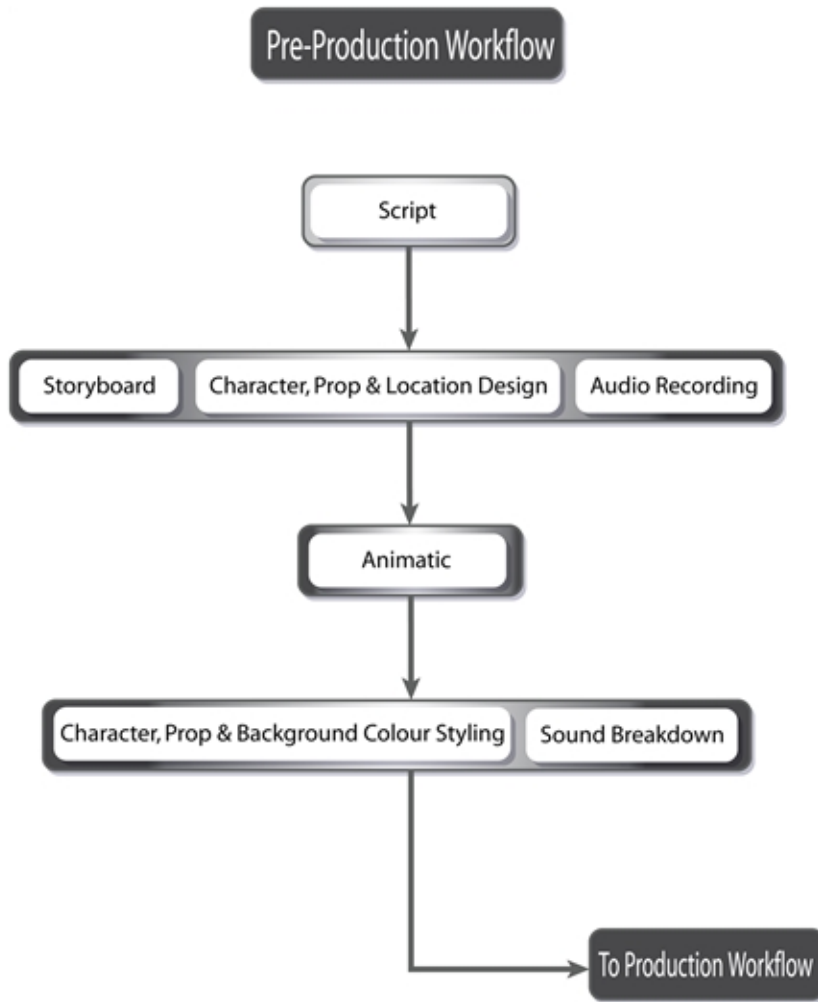

Pre-production almost always follows these steps:

### Script

Every project starts with a script or a synopsis. You will also see the term *screenplay*. A script is the written version of a project done by a screenwriter. You will encounter a script in many different types of projects such as movies, television series, video games and advertisements. It is the source for all the upcoming steps. A script usually contains the storyline, location descriptions, actions, dialogue, sound effects, etc. It contains all the information necessary for the artists to illustrate and animate the movie or series.



```

FADE IN

EXT. LOFT/GRAMP'S - DAY

Slow push in on entrance of loft. The glow of morning light
is fading across the giant window door that opens to a busy
cityway.

The title "The Key" fades in and off the screen.

INT. LOFT/GRAMP'S - DAY

We do a slow push in on a YOUNG MAN silhouetted in a door.
He's leaning on a sword hanging out of his mouth.

We cut in tight as he slowly looks past camera and we see a
winked grin appear.

CUTWISE POP to see a BIRDIE HIT CAR on a circular lift,
suspended by chains 8-10 feet in the air. A beam of light
from the upper window glides off it as we see dust particles
floating in the air in the soft glow reflecting off the car.

As we look past the car up at the second floor left railing,
an OLD MAN leans a strap up to the rail with his large staff.

Cut in close on the old man as he looks down and grins.

CUT past the old man down at the car. We see the same dust
and glow.

The camera pans right to the outside, snap zoom to CUT of a KEY
hanging on a loop on the outside.

BUT of old man's lower face, grin slowly grows.

Medium shot of the young man grin out the weed, turn and
move out of frame towards the key on the outside.

We see the key in extreme foreground as the forced
perspective of the young man's hand reaches for it.

As his fingers are about to touch the key, in the background
we see a blurred figure drop to the ground and out of frame.
Then the end of a long staff hangs his head away.

OLD MAN/GRAMP'S
Not today, buddy boy. I got me eyes
on that honey.
    
```

The script is needed in order to transform the project into a storyboard. This same script is used as a dialogue for the audio recording. Finally, characters, props and locations will be designed from all of the descriptions contained in the script.

## Storyboard

The storyboard, which is created by the storyboard artist from the script, is also common to all types of projects. A storyboard is a visual representation of all the scenes and actions contained in the script. The dialogue, backgrounds, action notes, and characters are included.



The storyboard is often created at the same time as the characters, props, location design and audio recording. The first storyboard is not always exact, as the designs are subject to many changes during the beginning of a production.

The storyboard is essential to the layout and posing, and the animatic.

This step is not done with Harmony. Traditionally, the storyboard is created on paper. This step can also be achieved with [Toon Boom Storyboard Pro](#), software developed specifically for this use. Toon Boom Storyboard Pro projects can be imported into Harmony.

## Character, Prop and Location Design

Once the script is completed, the designer can start work. Before any animation, background or colouration can

be done, the design needs to be addressed. The artist has to decide on the production style, the character's look, the location's complexity, and so on. Once these designs are done and approved, the model pack is produced, containing all of the models for all these aspects.



The designs and models will be used by the colour stylist and layout artist, and finally by the animator.

### Audio Recording

The audio recording is also called *voice recording*. The script is needed for dialogue and extra sound effects. The actors will read the lines from the script and record their dialogue. These voices will be used later on for the animatic, the animation and the final production compositing.

### Animatic

The animatic, also known as *leica*, comes directly from the storyboard. The animatic is the first movie of a project and is used to help the animators and compositors. The storyboard is scanned in and mounted with the sounds and dialogue. There is no animation yet. It is simply the storyboard frames changing over time to help evaluate the rhythm and the look of the show. This will help avoid mistakes that would have been found only at the end of a show.

This step is unnecessary if you are absolutely sure of your storyboard and timing, but an animatic is always recommended.

This step is not done with Harmony. Generally, an external software is used to do the storyboard editing to create the animatic. This step can be achieved with Toon Boom Storyboard Pro software which was developed specifically for this purpose.

### Character, Prop and Background Colour Styling

Once the black and white designs are done, they are sent to colour styling. The colour stylist chooses the colours and ambiance for the production and balances the characters, props and effects with the location palettes. This contributes to an even feeling or an emotional contrast where needed in the show. When the colours are approved, colour models are produced and backgrounds are painted. Colour models will often be added to the model pack.

The colour models will be used by the colourists and the coloured background will be sent for compositing.

## Sound Breakdown

For the dialogue, a sound breakdown can be done. This means that the sound will be broken down in small pieces and written on the traditional exposure sheet for the animator to use. Each frame will have its own bit of sound information which tells the animator what mouth phoneme to place on the character on a particular image.

For digital cut-out and paperless animation, the traditional sound breakdown is not necessary as there are different tools inside Harmony to help the animator achieve the same result.

## Production

The production segment can vary greatly depending on the user and the technique. There are three main techniques or animation types that you will discover on the following pages: traditional, paperless and cut-out. For more information about production steps, see [About the Animation Types on page 21](#)

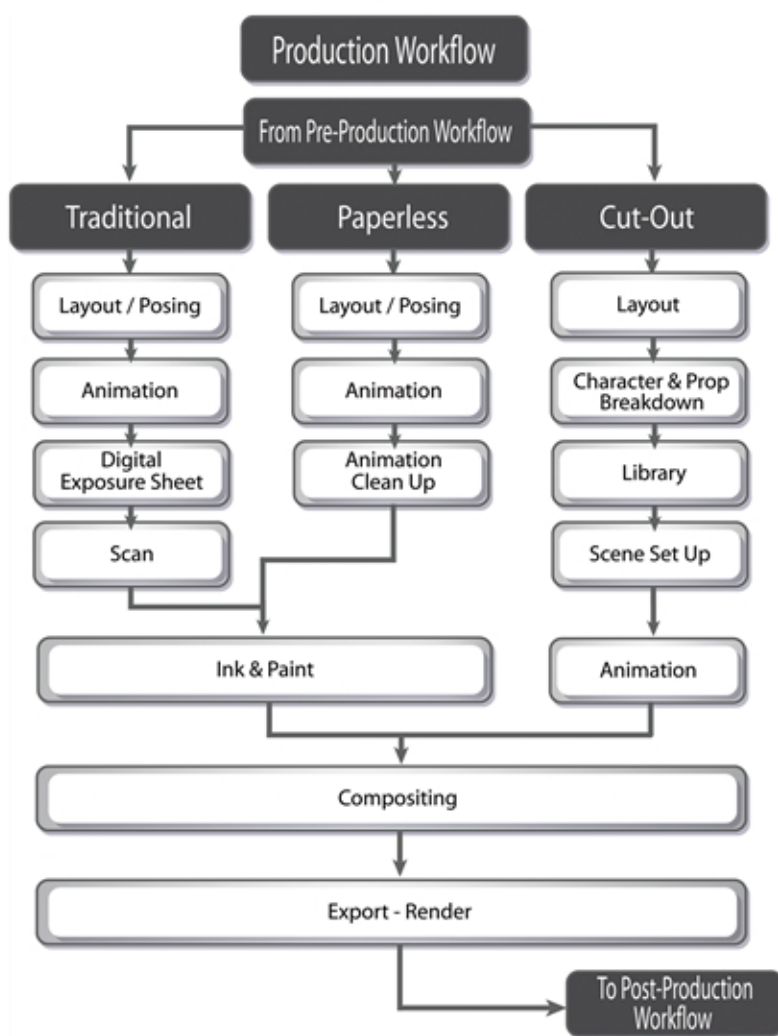

## Post-production

Post-production is the final step in which video and audio editing and calibrations are done. Some effects and colour grading can also be performed at this stage.



### Final Editing

The final editing comes after the rendering of the production scene. Harmony does not handle the editing, so the renders are exported to an external application. There, the different scenes are assembled and adjusted. If need be, users can add extra filters and effects, such as transitions between the scenes, during this step.

Once the editing is completed, the audio will be added.

### Audio Editing

The audio editing is also done in an external application. It can be done directly in the editing software or in an audio application and then transferred to the editing software. The dialogue, sound effects and soundtracks will be adjusted and placed with the project's final editing. The tracks will be matched to the images and volumes and effects will be added.

### Dubbing

Once the final images and sounds are assembled, the project is ready for dubbing. Actors will come in and record voices over the movie. This process is called *post-syncho*. At this point in the process, multiple languages can be added to the soundtrack.

The project is complete, and is ready to be output to the final master copy.

## Master Distribution

All of the data is transferred to the master copy and the user or studio is ready to distribute the project to the clients, festivals, television, cinema, and other venues.

## About the Animation Types

Harmony is an animation and digital content creation software. Animation can be divided into three main categories: traditional, paperless, and cut-out animation.

These techniques can be used independently or together. Harmony is optimized to handle all three animation types, one of the software's great benefits.

Each animation technique has its own advantages and disadvantages. Combining different techniques allows you to incorporate the best elements while eliminating the weakness of an individual technique that may not be exactly what you need.

Before going any further, review each animation type:

## Traditional Animation

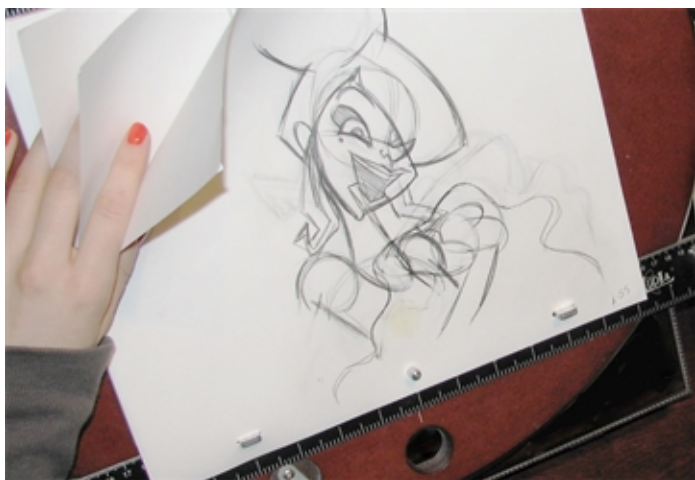

Traditional animation is the original method of animation, as well as the most popular. It is also called *cel* or *classical animation*. It consists of drawing every image of an animation on paper, normally 12 to 30 drawings per second per character or layer. The number of drawings per second is determined by the format (NTSC or PAL) or purpose. The human brain is able to process an animation with a minimum of 12 drawings per second. The number of drawings per second will be between 12 and 30. The standard is 24 or 25 frames per second.



Melosa, Di-Gata Defenders © Nelvana Limited, Corus® Entertainment Inc.

From the end of the 19th century to the late 1980s, the workflow was entirely done manually. Only with the introduction of computers to the general public did some of the steps become automated. Now, with all the technology available, the colouring and compositing are achieved digitally. However, the drawing part is still done by hand on paper.

## Paperless Animation

Paperless animation is the most recent 2D animation process. It consists of digitally drawing all of the images of an animation. It is similar to the traditional animation technique.



This method is entirely digital; it does not involve any materials other than virtual tools. However, the animator still must draw each frame individually.



Paperless animation requires the user to be familiar with digital graphic applications and be able to convert this traditional knowledge to a digital medium. This method of animation allows significant control over the drawings, a possibility for greater quality and an infinite number of complex poses and rotations for the animated characters and objects. It also eliminates the paper used in traditional animation and gives you the opportunity to instantly see a line test. Paperless animation allows you to easily cut and paste parts of a drawing, undo actions in case of mistakes, and zoom in and out of drawings.

## Cut-out Animation



Nikki Wong, 6Teen © Nelvana Limited, Corus® Entertainment Inc.

Cut-out animation consists of breaking down a puppet into pieces that are moved frame by frame to animate the character. It can be divided into two categories: classical and digital. When working in the classical cut-out style, the animator manually moves the parts under a camera and shoots each frame before moving on to the next pose. When working in the digital style, the parts are moved in a similar way as the classical cut-out style and then keyframed in the computer software, which means that it is fixed and recorded digitally. Since the characters and

objects are composed of many parts, the animator does not need to redraw them on each frame, but can just move or distort the parts to create the animation.



Abigail Archer, Grossology © Nelvana Limited, Corus® Entertainment Inc.

Harmony allows you to do digital cut-out animation, which has become increasingly popular in recent years.

Cut-out animation requires you to be familiar with digital graphics applications. Cut-out animation is very useful in cutting down the time it takes to complete a project. There is no need to redraw characters and the computer can handle a large part of the in-betweening. It also eliminates the paper used in traditional animation and allows you to instantly see a line test. The team for a cut-out project is much smaller than that of a traditional production, allowing the whole production to be kept within the same studio. This also means that you have a great deal of control over quality.



## Production Steps

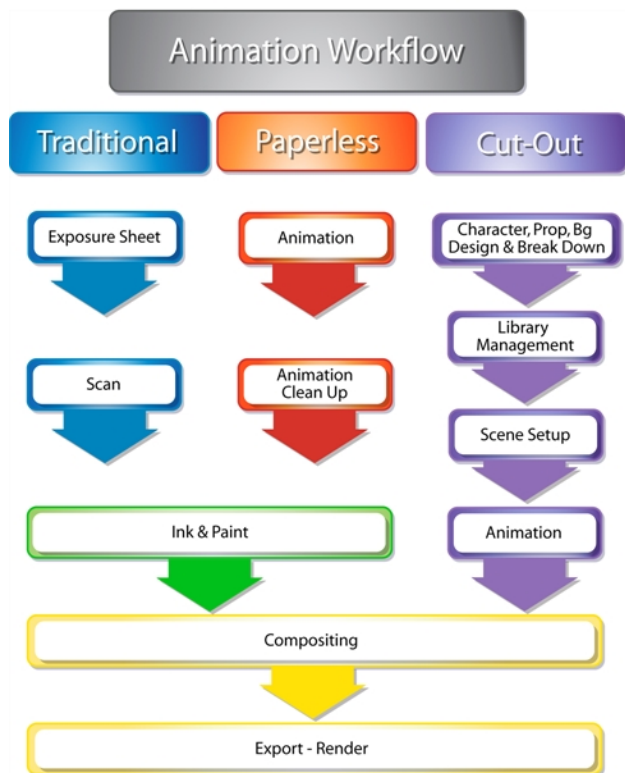

Now that you know the differences between the traditional, paperless and cut-out animation types, you can move on to the basic organization of their workflow. The following illustrations show the animation pipelines that represent the most popular workflows. The tasks can be divided or the order can be rearranged to suit the specific needs of the studio or user.

After familiarizing yourself with the basic workflow pipelines, you should read about the various examples of the workflows and how the individual and the studio are organized according to their size.

### Traditional Animation Workflow

In a traditional workflow, many steps are done manually. Harmony is used for the digital portion. We will focus mainly on these steps.

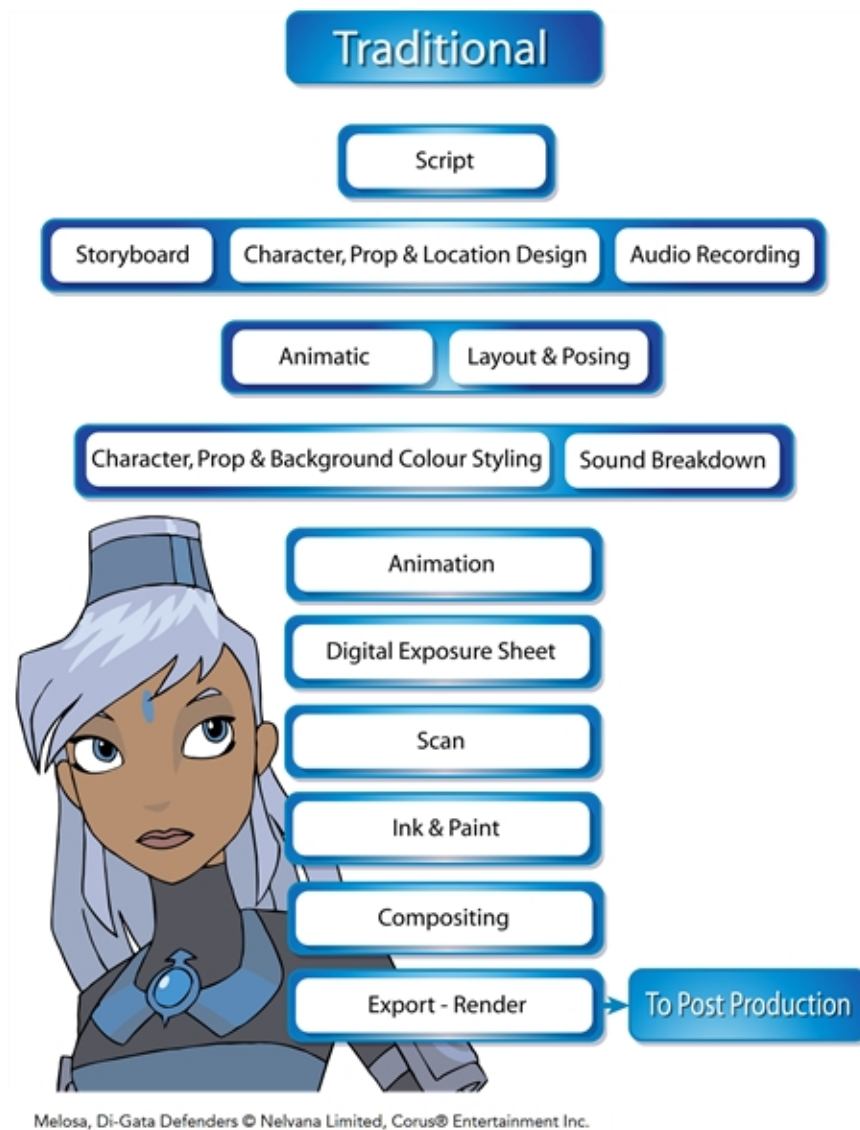

The following is a list of the steps done using Harmony in a traditional animation workflow. This will help you understand how the work is divided and give you a base to start building your own traditional pipeline.

### Layout and Posing

The layout and posing process links the storyboard artist and the animator. The layout artist uses the storyboard and prepares an organized folder for the animator. This folder contains a field guide that shows the proper camera move and the right size of the scene. It also includes the character's main poses from the storyboard following the official design, and the effects, backgrounds and all the other information necessary to the animator.

The backgrounds are done directly out of the storyboard and location design. A background is a section or an angle of a location. The background artist refers to the storyboard and draws the background for each scene. Once the background is completed, it is added to the layout folder.

In a cut-out or paperless animation process, this step can be done digitally or traditionally. This will depend on the user's preferences. This step is mainly applied to larger productions. An individual user can move directly from the storyboard to the animation.

This step can be done with Harmony, but Toon Boom also has another software developed for this. [Toon Boom Storyboard Pro](#) has optimized tools to create the layout and posing.

## Animation

Traditional animation is done on paper. The animator receives the layout folder and uses the references to animate the scene. The animator will draw each frame of the animation or each pose of the character. If there is dialogue in the scene, the animator will follow the breakdown and animate the mouths and expressions.

Depending on the studio size, the animation can be divided in different ways. Sometimes the animator will do all of the work, from the key poses to the in-betweens and then the clean up. Bigger studios will have the animator doing only the key poses and then send the scene to the in-between department and finally to the clean up department.

Once the animation is completed, it is sent to the digital part of the process. This applies only to modern processes. In the traditional, old-fashioned pipeline, the animation was sent for hand-inking and painting. The animation was traced with ink on transparent cels and the colours are painted with brushes on the other side of the cel to fill the zones. Today, using Harmony, you can still use this technique by utilizing the digital Line Art and Colour Art feature.

## Digital Exposure Sheet

The digital exposure sheet is the first step done in Harmony. This controls the timing of the animation. The traditional animator creates a paper exposure sheet in order to create the timing. The person in charge of the digital exposure sheet reads the paper version and recreates it in Harmony. Once the drawings are all in place on the exposure sheet, the scene is ready for the scan.

Note that a single user will scan the drawings first and then set the timing in the exposure sheet. The digital exposure sheet is only created first in a larger animation studio using the advanced scan features available in Harmony.

## Scanning

Scanning is the second step in Harmony. The cleaned-up drawings are scanned and imported in the software in a simple step that incorporates all of the drawings in the scene. When all the drawings are scanned, they are ready to be inked and painted (coloured in).

## Inking and Painting

At this point in the process, the colour models are ready and the drawings are scanned in and properly exposed. Using Harmony's optimized tools, the colourist can clean the scanned artwork and start applying colour to the different drawings. When the drawings are cleaned, as well as inked and painted, they are ready for compositing.

## Compositing

The compositor imports the coloured background, animatic reference and sound as required. Referring to the exposure sheet, animatic and animation, the compositor assembles all these elements and creates the camera

moves and other necessary motions. Finally, the compositor adds any digital effects required by the scene. These can include tones, highlights and shadows. When the compositing is completed, the final step is the rendering.

### Export - Render

Once the compositing is completed, the last step is to render the scene as a movie or an image sequence. Generally, the compositor will be the same person doing the render.

## Paperless Animation Workflow

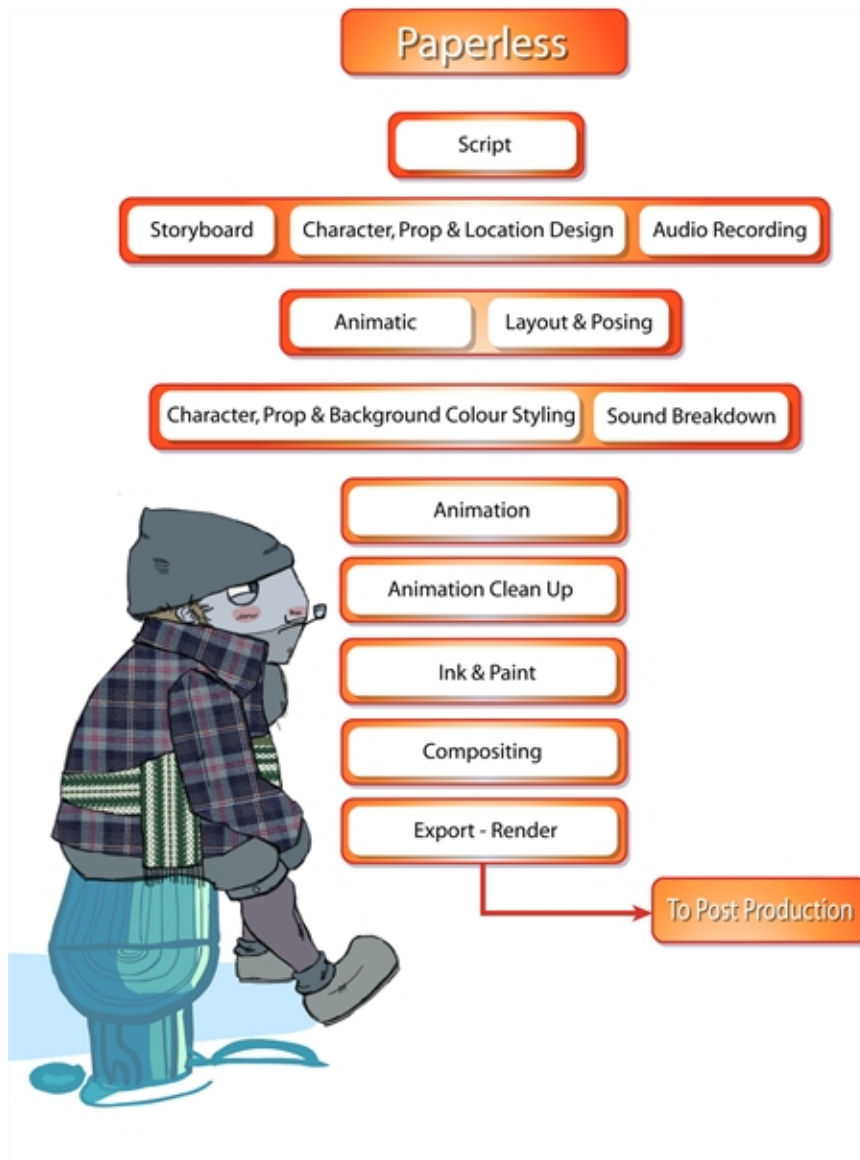

The following is a list of the steps done using Harmony in a paperless animation workflow. This will help you understand how the work is divided and give you a base to start building your own paperless pipeline.

## Layout and Posing

The layout and posing process links the storyboard artist and the animator. The layout artist uses the storyboard and prepares an organized folder for the animator. This folder contains a field guide that shows the proper camera move and the right size of the scene. It also includes the character's main poses from the storyboard following the official design, and the effects, backgrounds and all the other information necessary to the animator.

The backgrounds are done directly out of the storyboard and location design. A background is a section or an angle of a location. The background artist refers to the storyboard and draws the background for each scene. Once the background is completed, it is added to the layout folder.

In a cut-out or paperless animation process, this step can be done digitally or traditionally. This will depend on the user's preferences. This step is mainly applied to larger productions. An individual user can move directly from the storyboard to the animation.

This step can be done with Harmony, but Toon Boom also has another software developed for this. [Toon Boom Storyboard Pro](#) has optimized tools to create the layout and posing.

## Animation

Paperless animation is usually one of the first steps done in Harmony. All of the drawings are created digitally, using a pen tablet to optimize work and drawing ability. Other than the digital aspect, the animation principles are not very different from classical animation. The animator will use the same animation styles and methods as would be used on paper—only the medium is changed.

When all of the animation is done and the drawing timing is completed through the exposure sheet or the Timeline view, the scene can proceed to the animation clean-up process.

## Animation Clean-Up

The animation clean-up consists of transforming the rough paperless animation into cleaned, tied down and inked drawings. On a new layer, the clean-up artist will trace the animation following the official model pack (document containing all the official character, location/props design and colours). This step must be done very accurately.

When the clean-up is over, the scene is passed along to the colourist for the ink and paint step.

## Inking and Painting

At this point in the process, the colour models are ready and the drawings are properly exposed. Using Harmony's optimized tools, the colourist can start applying colour to the different drawings. When the drawings are inked and painted, they are ready for compositing.

## Compositing

The compositor imports the coloured background, animatic reference and sound as required. Referring to the exposure sheet, animatic and animation, the compositor assembles all these elements and creates the camera moves and other necessary motions. Finally, the compositor adds any digital effects required by the scene. These can include tones, highlights and shadows. When the compositing is completed, the final step is the rendering.

## Export - Render

Once the compositing is completed, the last step is to render the scene as a movie or an image sequence. Generally, the compositor will be the same person doing the render.

## Cut-out Animation Workflow

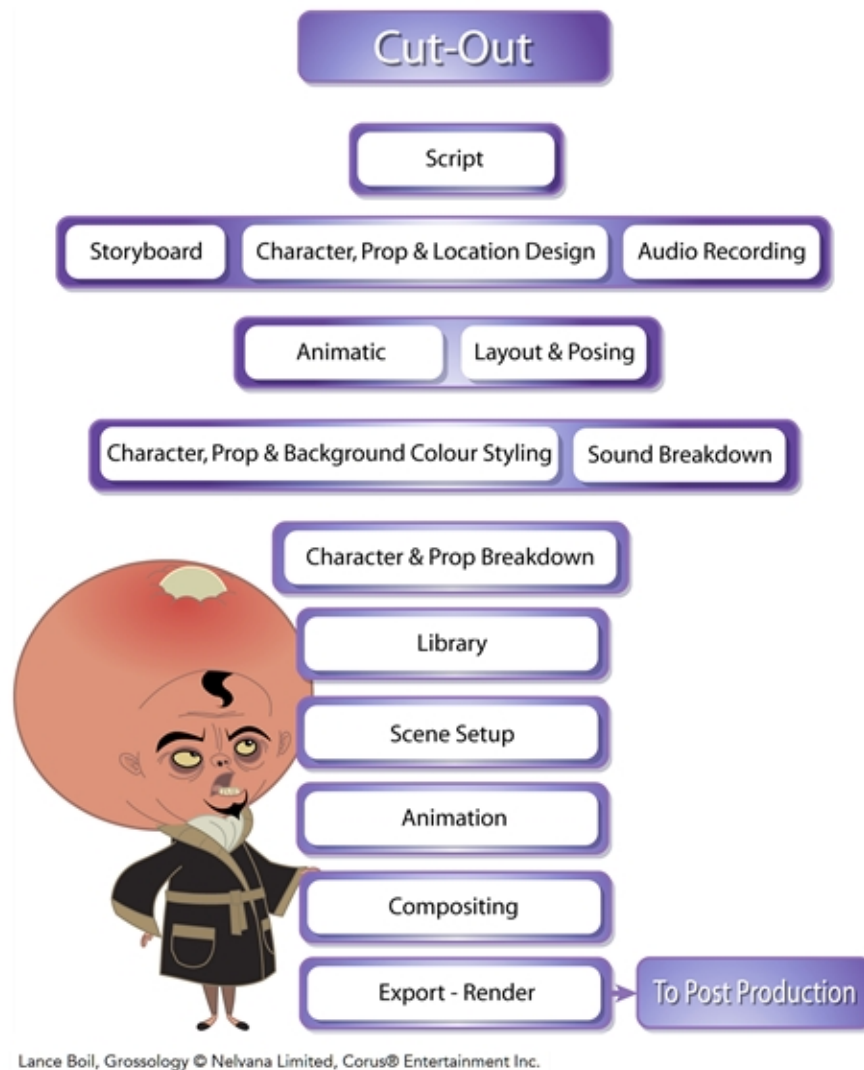

The following is a list of the steps done using Harmony in a cut-out animation workflow. This will help you understand how the work is divided and give you a base to start building your own cut-out pipeline.

## Layout and Posing

The layout and posing process links the storyboard artist and the animator. The layout artist uses the storyboard and prepares an organized folder for the animator. This folder contains a field guide that shows the proper camera move and the right size of the scene. It also includes the character's main poses from the storyboard following the official design, and the effects, backgrounds and all the other information necessary to the animator.

The backgrounds are done directly out of the storyboard and location design. A background is a section or an angle of a location. The background artist refers to the storyboard and draws the background for each scene. Once the background is completed, it is added to the layout folder.

In a cut-out or paperless animation process, this step can be done digitally or traditionally. This will depend on the user's preferences. This step is mainly applied to larger productions. An individual user can move directly from the storyboard to the animation.

This step can be done with Harmony, but Toon Boom also has another software developed for this. [Toon Boom Storyboard Pro](#) has optimized tools to create the layout and posing.

### Character and Prop breakdown

The breakdown step is really important in the cut-out workflow. The person doing the breakdown has to take the final character or prop model and start building the puppet. This means deciding which parts will be separated and preparing all of the joints and views for the animators.

Once the parts are broken down, the character or prop must be rigged. This means attaching the parts (hierarchy) and assigning the appropriate pivot points. This step must be done with care because these puppets will be distributed among all the animators later and you do not want to duplicate mistakes throughout the project.

When the character and prop rigs are ready, the breakdown artist stores them in the library as templates to be shared with the rest of the team.

### Library

The library is a central element of a digital cut-out production. It contains all the assets for the animation and scene set up.

The library is a central location where all these templates are stored, organized and made available to the animators and scene setup team. The library should be structured so that everyone using it can easily find the assets they require. Someone should be assigned to manage the library so that it remains well organized. This person is often the breakdown artist, but it depends on each studio's structure.

When the library is built, the scene setup person and the animators will start using the assets.

### Scene Setup

The scene setup consists of preparing the scenes for the animators and is similar to the traditional layout and posing. Following the storyboard and the animatic, the person working on the scene setup will import the assets needed for the scene animation, as well as import the animatic reference and often position the camera.

When the scene setup is completed, the scene can be passed on to the animator who can start animating without having to mount the scene.

### Animation

Cut-out animation is a vast subject. There are many techniques employed by different studios and animators. Basically, the animator moves the parts frame by frame to animate the puppet. The animator may even start their own pre-compositing, camera moves, and trajectories. This depends on the user's workflow. Once the animation is completed and approved, the scene goes to the final compositing and effects.

## Compositing

The compositor imports the coloured background, animatic reference and sound as required. Referring to the exposure sheet, animatic and animation, the compositor assembles all these elements and creates the camera moves and other necessary motions. Finally, the compositor adds any digital effects required by the scene. These can include tones, highlights and shadows. When the compositing is completed, the final step is the rendering.

## Export - Render

Once the compositing is completed, the last step is to render the scene as a movie or an image sequence. Generally, the compositor will be the same person doing the render.



## Chapter 5: Animation Principles

Animation can be used for several different purposes such as movies, advertisements, video games, corporate presentations, medical concept demonstrations and much more. Not all of these require the same animation quality level. To illustrate a concept, simple and linear animation is often more than sufficient to convey the message. For a feature length animation movie, the animation needs to be convincing and carry some weight and elasticity.

You will notice when you watch different movies that the animation style will differ quite a bit from film to film. Some have a very fluid and smooth flow in their animation while others have a very bouncy, cartoony feel. People without animation experience may watch a movie and find the animation very bad, unconvincing or too slow. They might not know why exactly, but they know that something isn't right. Most of the time, it happens because the animators missed a few of the fundamental animation principles.

If you already are an experienced animator, you can skip this topic and continue along.

Here are the main principles that create the backbone of a good animation. You will no doubt encounter variations of these principles when reading articles online or reading different books.

### Squash and Stretch



Squash and stretch is at the core of the animation principles. It is what gives some elasticity and flexibility to your animation. When an object hits the ground, the impact drawing will be really squashed. As it bounces off the ground, it will stretch in the opposite direction. The stronger the squash and stretch is, the smoother and bouncier the animation will look. Also, hard objects such as a bowling ball require less squashing or stretching so that the heavy and solid illusion remains. As you squash and stretch an object, it is really important to maintain the volume of the object. When you squash something down, you need to proportionally stretch it sideways, otherwise, the object will look like it is getting smaller.

### Timing

Animation is all about the timing. The timing comprises many things in animation. It is the duration of an action. It is the speed and velocity of an action. It is the way actions overlap and secondary objects follow the main action. If the timing is off, too slow, too long, too fast, or too linear, the animation will not look realistic. It will be stiff, even boring. The nature of the character, personality or weight of an object will influence the timing of the animation.

## Anticipation

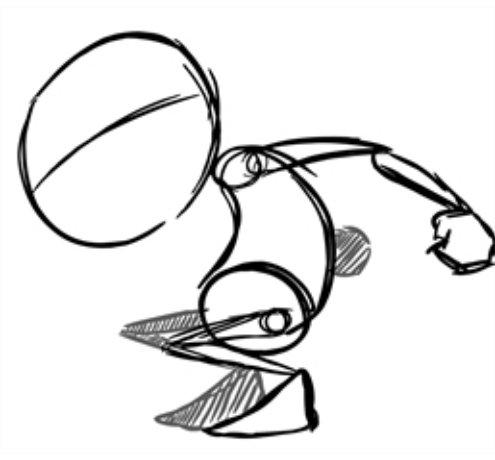

Anticipation is the preparation for an action such as a jump or a punch. For example, a character will squat down before pushing his body and legs up into a jump. The stronger the anticipation motion, the more cartoony and fluid the animation will be. The smaller the anticipation, the more stiff the animation will be.

## Straight-ahead and Pose-to-pose



These are two different ways to animate an action. The straight-ahead technique means to animate your action from drawing 1 to the end in sequence order. The pose-to-pose technique is a bit more intricate as it means to draw the key poses first (often the beginning and end drawing of the action and some other key moment between). Once the key poses are done, the breakdown and inbetween drawings are added to fill the rest of the animation. Smoke, water and other fluid elements are often animated using the straight-ahead technique. Actions that require tight timing and structure are often animated with the pose-to-pose technique. This method helps maintain a solid structure and preserve the volume. Sometimes, when using the straight-ahead technique, it may be difficult to calculate where the action will end up and the final drawing may be out of proportion and not where it should be.

## Follow-Through

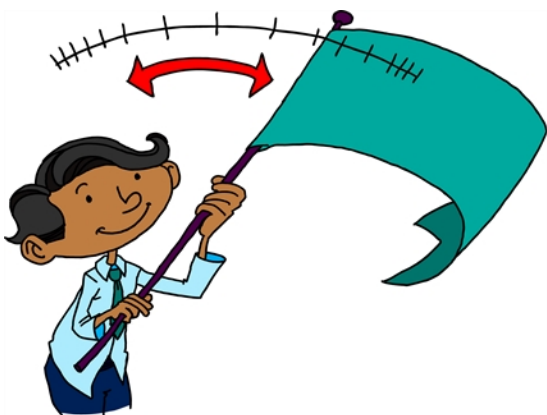

The Follow-Through principle is very important for increasing the quality of your animation. All the secondary parts of your character such as hair, clothes or a cloak will continue moving after the character stopped moving. Also if you observe closely, when a character walks, its body moves and down, and its long hair or cloak follow behind on the same path but with a slight delay. Therefore, your character might be at the lowest point in a crouching action but his cloak will be all the way up in the air. Also, notice that when the cloak floats behind the character, it will move along an "S" curve. The part of the cloak that is attached to the body will not always curve in the same direction as the tip of the cloak.

## Arcs of Rotation

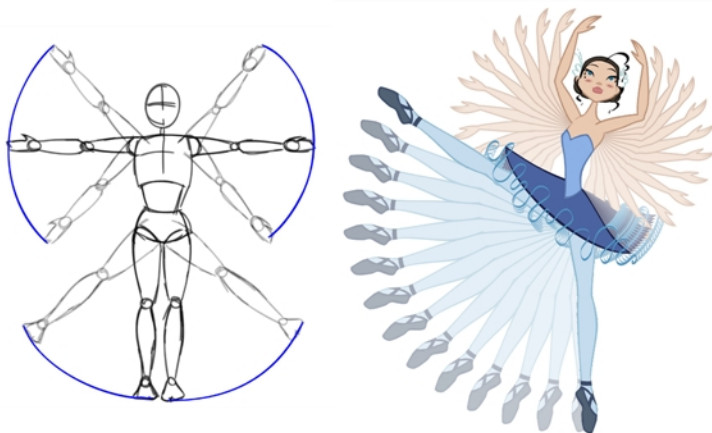

The human body moves from its articulations such as the shoulders, knees, hips and elbows. Therefore, all limbs move by rotating on their pivot (articulation). When animating an arm going up or down, the hand will not reach its end point on a straight trajectory. It will follow an arc until it reaches its end point.

### Slow-in and Slow-out



Most characters and objects accelerate and decelerate when moving. Most movements are not linear, therefore to reproduce the slow-in and slow-out effects, we add more drawings closer together at the beginning of the action and same at the end of the movement. The closer the drawings are, the slower the animation will be. The farther apart they are, the faster the animation will be.

### Secondary Actions



Secondary actions add another layer of realism and quality to an animation. The secondary actions are the other limbs or objects moving along with the main action. They are not the follow-through actions, which are inanimate objects reacting to the main actions. They are the limbs that move, such as the character's arms swinging rhythmically back and forth when walking. He could nod in time to music while taking a stroll or blink or chew gum.

## Exaggeration



The principle of exaggeration is another important way of adding life in animation. Sticking exactly to reality will make for a very stiff animation. Changing the direction of the main body curve from backward to forward in a dramatic way, using squash and stretch, snappy timing and good slow-in and slow out help exaggerate the movements and add life to your animation.

## Solidity

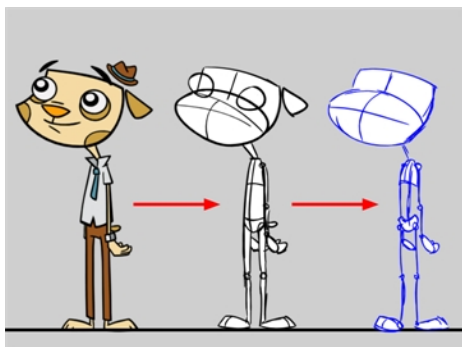

In animation it is paramount for drawings to have a strong underlying structure. The animator must understand the anatomy and skeleton of the characters and props to be animated. Without a good structure, the drawings will deform, bend in the wrong places, and progressively become off model.

The animator should always know what is under the skin of his character.



## Chapter 6: Concepts

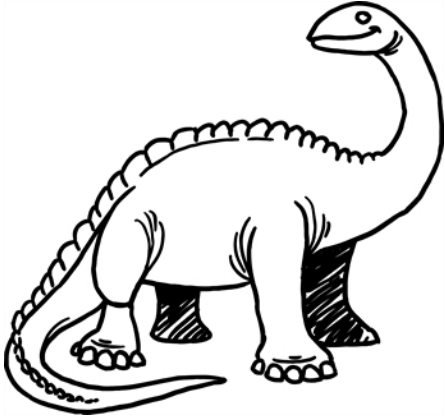

Harmony was designed using traditional animation concepts. This lets you use familiar tools and work practices. Whether you are new to animation or an experienced animator who wants to understand Harmony, the concepts covered in this section will be interesting and useful.

Bitmap and Vector Graphics .....	39
Line and Colour Layers .....	40
Colour Palettes .....	41
Exposure Sheet, Timeline and Timing .....	42
Pegs .....	45
Multiplane .....	46
Network .....	46
Frame Rate and Format .....	47
Scenes .....	48

### Bitmap and Vector Graphics

There are two types of digital images: bitmap and vector. Discover their main differences so you can make the optimal choice for your project.

#### Bitmap Image Types



A bitmap image consists of pixels and has a fixed size. A pixel, short for picture element, a single point in a graphic image. It is a small sample of an image, a dot, a square or a very small section made out of smooth filtering. If you zoom in close enough on a digital image, you will see the pixels. They look like small squares of

different colours and intensity. Since a bitmap image is composed of pixels and has a single resolution (size), if it is enlarged too much, it will start losing definition and pixels will start to appear. This is known as *pixelation*.

## Vector Image Types



A vector-based image is composed of points and Bezier curves. The computer reads the points and traces the segments linking them to reproduce the image shape. There is no fixed size or resolution in a vector image. You can enlarge the graphic and distort it as much as you want, and the system will simply recalculate the segments and rebuild the shapes. The segment's shape can be controlled with Bezier handles to curve and smooth it. Vector images are translated and displayed in pixels once the calculation is done.

## Advantages and Disadvantages of Bitmap and Vector Images

Bitmap images allow a more organic style. Since everything has a fixed size and is already made out of pixels, more effects are possible, such as blur, texturing, shading, a painted look and so on. The bitmap format is excellent for creating backgrounds and overlay elements. However, because of the precise resolution, in order to zoom in on or to work in high resolution such as HDTV, the created file must be a large size.

Vector-based graphics can be very useful when creating large illustrations, as these graphics are resolution independent. The images can be significantly enlarged without losing definition. A vector-based image is generally a smaller file size than a bitmap, as it is a set of mathematical points. However, if there are many vectors composing the graphic, the result can be larger than a bitmap file. A vector shape can always be modified. It also creates very crisp images.

## Line and Colour Layers

Before the advent of computers, animation was done manually. There was no process of scanning and painting digitally. Once the animation was completed and cleaned on paper, the drawings were traced with a brush or a quill onto cels. The cel transparency permitted many layers to be superimposed, composing the scene elements together.





Melosa, Di-Gata Defenders © Nelvana Limited, Corus® Entertainment Inc.

The first step in the cel process is to ink the lines on the front side of the cel, either in black or with different colours. In the late 1950s, this step was changed to photocopying the drawings on the cels, called the Xerox process. Once the lines are inked, it is time to fill in the colours, usually painted with a brush. Painting on the same level as the lines makes it all too easy to accidentally go over the line or not apply the colour densely enough, so light is passed through the drawing. To remedy this, colours are painted on a second level onto the back of the cel. This protects the lines from any colour stains and the colour filling can go under the lines covering the entire zone.

Working digitally produces a similar process. Once you have scanned drawings into the system, you can colour the lines without ruining the colour filling, or you can paint complete zones without staining the lines. If there is some transparency (alpha) or texture in the line, the colour filling is allowed to go under the lines to create the correct look.

## Colour Palettes



In animation, precise colours are used to paint each particular character and prop. In order to maintain absolute consistency, a colour palette is created for each character, prop and effect throughout the production. These are referred to as *master palettes*.

Before computers, painters used real colour pots (often big glass jars) mixed by a colour palette artist. The colour palette artists had to make sure to use the exact same amount of paint from each tint every time they would mix a new batch to make sure the colours would remain consistent throughout the entire movie. Now, using a computer process, a digital colour palette is created. This allows absolute colour accuracy by always having the same group of colours associated with each character.

Master palettes contain a colour pot for each zone to colour with a precise RGBA colour value.

- Red
- Blue
- Green
- Alpha (contains transparency information)

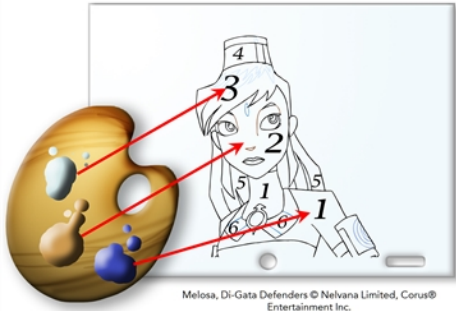

Painting animation using a master palette is very similar to the paint-by-number concept.

Using a master colour palette has many benefits, including:

- Each character consistently retains their dedicated colours.
- You cannot accidentally use a colour which is not in the master palette.
- Standardization and colour consistency throughout the production.
- Multiple artists can use the same colour palette and produce the same results.

## Exposure Sheet, Timeline and Timing

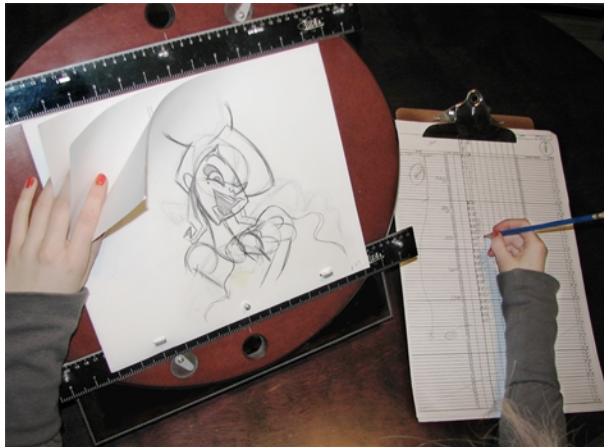

Animation is about movement and in order to have the illusion of movement, you need different drawings to progressively change over time. For your eyes to perceive a smooth motion and not just a series of drawings changing, you need several drawings per second. To be more precise, you need a minimum of 12 drawings per second. If you have less than 12 drawings per second, the motion will be jerky and you will not see a smooth motion.

It is important to know that the number of drawings per second will be based on the final output: television, cinema, web, DVD, etc., as those outputs have different frame per second rates. This parameter will influence the number of drawings per second as well as their exposure.

The exposure of a drawing is the length of time that it stays on the screen. A second can be divided as follows: 24, 25 or 30 images depending on the format. They are also called *frames*, so there are 24, 25 or 30 frames per second.

## Broadcast Standards

There are two main broadcast standards used; the one selected will determine the frame rate.

In North America, Japan and other parts of Asia, the NTSC (National Television System Committee) format is used. This format is 30 images (frames) per second.

In most of Europe, PAL (Phase Alternating Line) format is the broadcast standard. This format is 25 frames per second.

Film format is 24 images per second.

The human brain is able to process an animation as slow as 12 drawings per second. Therefore, the number of frames per second should be between 12 and 30. The general standard is 24 or 25 frames per second, so these 12 drawings are set on double exposure. This means that each drawing stays on the screen for two frames. If a drawing is exposed for 24 frames, it means that it will appear to the eye for one second.

The timing is a drawing's exposure.

## Exposure Sheet



The exposure sheet, also known as the *Xsheet* or *dope sheet*, is used when an animator is planning a scene. The animator enters data in the different columns (layers), the name of the drawings and their exposure into the Xsheet. The Xsheet allows you to see the animation timing in detail.

The Xsheet is composed of columns corresponding to the different layers. Each column is split into rows representing the frames (images) in the scene. A paper Xsheet usually has 80 rows and ten columns. This enables the animator to associate a layer with a certain element (character, prop, mouth, etc.) and make a record of the frame at which each drawing appears.

The traditional paper Xsheet was mainly created for the animator to communicate with the cameraman regarding the scene's timing, the camera moves and element trajectories. It is still used today to express the same information to the composers and the person working on the digital Xsheet.

## Timeline

A traditional timeline is a horizontal and chronological representation of key events occurring within a particular historical period.



In the digital process, the timeline is quite similar. The timeline is read from left to right to help you understand the scene and its timing. The frames or timecodes are placed at the top and the elements or layers on the left. There is no drawing name or value information. The timeline displays the timing and elements in a simplified and systematic manner, making it easy to read globally. The timeline can be considered to be a quick overview of the whole scene.

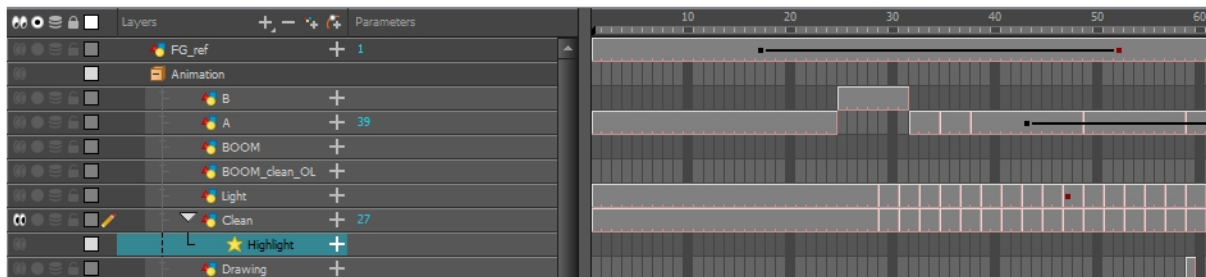

## Xsheet and Timeline Usage

Xsheets and timelines are used for different tasks. When a scene is done in a traditional animation workflow, the Xsheet is useful in keeping track of the drawings' ordering, names and timing. The Xsheet is used to reproduce the animator's work in the digital software or the camera. The colourists can then follow the Xsheet to paint the drawing sequences. Finally, the compositors can read the information that is necessary to their work from the Xsheet.

For digital animation, computer generated trajectories, hierarchies and distortions, there is a lot of extra information involved, including keyframes, velocities, function curves, and more. A keyframe is a computer-generated key position that contains values and coordinates for the element's onscreen positioning; keyframes can be displayed in the exposure sheet as values. If there are too many keyframes, modifying one can be difficult due to all of the values present. This is why there are digital timelines. Their simplified version of the timing is quite useful in these situations. The Timeline view does not display drawing names or keyframe values, but instead represents them as symbols, making it much easier for the eye to detect the desired element for modification. Although the name and value information is not directly displayed, the Xsheet is still very valuable when retrieving this type of information.

## Pegs

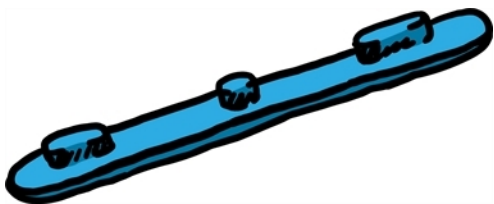

Pegs have been used for a long time in the animation process, mainly for registration purposes. Peg holes at the bottom (or top) of animation paper are used to keep all of the sheets even and at the same registration.

There are three peg holes in regular animation paper. The centre one is circular and the left and right ones are rectangular and situated at 4 inches from the centre one.



To keep the drawings together, traditional animations use a peg bar. This bar has three pins shaped exactly like the peg holes. Peg bars are normally found at the bottom and top of animation discs.

Before digital compositing, the peg bars were also used to move layers under the camera stand. All layer translations were calculated based on the distance the pegs were moved frame by frame. They were the equivalent of the digital trajectories. Harmony makes use of these concepts to create animation and camera moves.

## Multipane

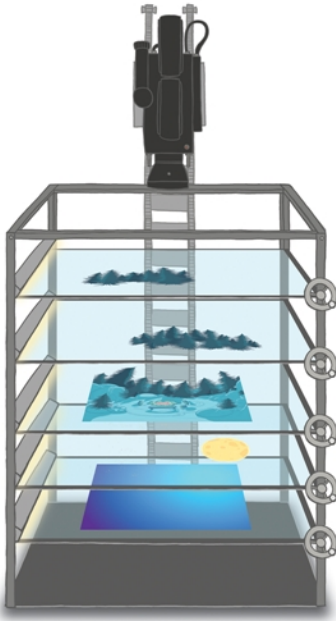

In the animation context, multiplaning is used to create a scene with many planes placed at different distances from the camera to recreate a perspective illusion. A plane is a layer or an element. In regular flat 2D scenes, all the elements are at the same distance superposed one on top of another. So, when the camera moves, all the elements are moving at the same speed. In real life, all objects and elements are placed at different distances from our eyes so when we walk or drive past, the closest objects appear to be moving away faster. The farthest ones, like mountains, are barely moving. In animation, that perspective effect has to be reproduced manually.

In 1933, the Walt Disney Company invented the multiplane camera. They got the idea from looking at methods used in the theatre to introduce perspective into a space with limited depth. In the theatre, cut-outs and flat pieces were placed in a variety of layers in front of a backdrop which allowed actors to move through the various sets while giving the illusion of depth. Walt Disney's final design for the multiplane camera used this same concept. The multiplane camera which was set up vertically, much like a photographic enlarger, would shoot down through as many as five planes attached to vertical posts that allowed four of the planes to move independently of one another. The first two planes were used for animation, the next two were for backgrounds, and the fifth was fixed and used for sky backgrounds. The finished result produced a depth of perspective which had not previously been seen in animated film.

Multipane camera effects can be created digitally. There is no longer a need to use the big multiplane camera. Multipane shots are normally used to add depth to a scene to reproduce perspective effect more easily. They can also be used on a smaller scale to make elements pass in front of and behind certain objects like trees or chairs.

## Network

A network can be described as an interconnected group or system of elements leading to a central point. It is widely known as a *node system*.

A network can be useful in animation because many components enter the process. A visual network can help represent many things like scenes, effects, composition and textures.

the Xsheet and timeline enhance the element display, but they may not be the most efficient for some production aspects. The Xsheet provides traditional animation details, displaying drawing names, values, exposures and timing. The timeline displays all of the timing, drawing exposures, keyframes and trajectories in a schematic view to provide a quick overview of the whole scene, enabling you to easily detect different elements. When it is time for advanced hierarchy, compositing, effects filters, grouping, and cutters, a timeline can get overloaded and may not have the capacity to represent the reality of things.

For greater efficiency, a network is brought in to visually represent all of the parenting, hierarchy, effects and element compositing. There is no timing representation or drawing name, but a visual set of links or cables between the elements that are represented as boxes or nodes. It helps the eye follow very quickly to what is happening in the scene. Also, because of the linking power available, a network allows more advanced connections and parenting than a timeline.

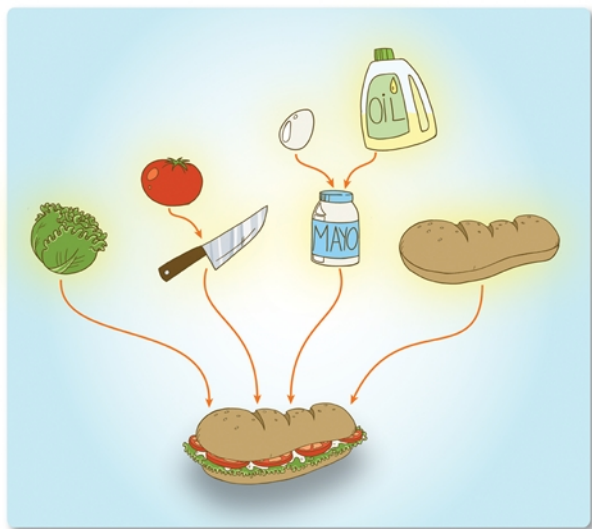

Elements can be combined using effect nodes or composite nodes and turned into something new. Elements can cut others or control other ones. In the end, all elements are brought into a composite node to turn all drawings, layers, parameters and effects into the final animation output.

## Frame Rate and Format



Old 4:3 North American NTSC Format



16:9 HDTV Format (Widescreen High Definition)

When you create an animation, the images you animate must move fluidly to produce the correct effect. If they don't, you will have a jumpy animation which won't look good. To get a fluid movement between the drawings,

you need several images per second. You need a minimum of 12 images per second, any slower than that and the animation becomes jumpy. An image can also be called a *frame*, therefore the frame rate is the number of frames you play per second in your animation.

The format of your project is the size of your camera frame in pixels. You may not be familiar with the term *pixel*, but you have probably seen it when you magnify a digital photograph. A pixel is the smallest element of an image displayed on a monitor or TV screen. Pixel, which is short for *picture element*, is a single point in a graphic image. It is a small sample of an image, a dot, a square or a very small section made out of smooth filtering. If you zoom in close enough on a digital image, you will see the pixels; they look like small squares of different colours and intensity.

Depending on the type of project you want to create, you will need a different image size. For example, if you want to put your project on the web, you will probably export your movie as a small size so that it is light to play back once it is on the web. The larger the images are, the heavier the project is, but also, the better the quality. If you want to export your project for the theatre, you will need to create your project in a large format so the image is of a high quality and looks good on the big screen.

Also, some display media such as iPad, TV or theatre have an exact format requirement. For example, one TV format that has been a standard for decades is the 4:3 size ratio, meaning that the width of your scene has the equivalent of 4 units compared to 3 units for the height.

In recent years, a new TV standard has been defined with the advent of Blu-ray and high-definition technologies. It is the 16:9 format, which is often referred to as HDTV (High Definition Television). The most common 16:9 format in pixel is 1920 x 1080.

You can find most of the formats in the presets list provided in the Harmony Welcome screen.

To recap, the format is the size of your camera frame in pixels, and it matches the width and height required for the medium in which you want to show your final movie.

## Scenes



Planning is an important step in creating an animation project. This involves listing the scenes that need to be animated, the characters to design and the different backgrounds to incorporate.

In animation, a scene is the action happening in front of the camera while the camera does not change angle. As long as the camera does not stop "filming", you are in the same scene. A good example would be two characters talking. When the camera is facing the first character, this is one scene. When the camera cuts and films the second character, you have a second scene. When the camera returns to the first character, you have a third scene, and so on.



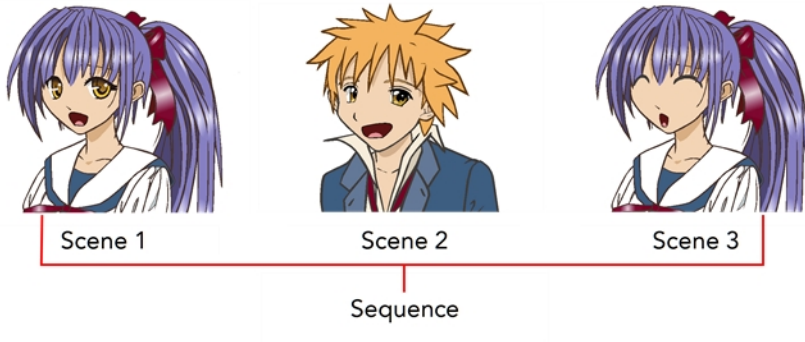

A group of scenes occurring in the same location about the same action or event is called a *sequence*. When there is a change of location or subject, it becomes a second sequence.



# Chapter 7: Project Organization and File Structure

When working in production, it is important to keep your work organized. It is important to create a naming convention chart and establish a file storage structure before starting the project. It is not only extremely important that everyone follows the criteria laid out in the naming convention chart and the file storage structure, but also that they understand the organization and where to find the files.

A well thought-out and logical naming convention will help keep your production structured and allow it to run smoothly by preventing the loss of files due to chaotic organization.

In this chapter, you will learn how to organize and name the different components in your animation project.

File Structure .....	51
Root Directory and Content Building Scenes .....	52
Drawings and Layers .....	54
Libraries and Templates .....	56
Naming Convention .....	58

## File Structure

A Harmony project is composed of several files. The drawings and colour palettes are not embedded in the project. They are separate linked files. Therefore, if you want to archive or share a project, you require all the files contained in the folder structure.

### Scene File Structure

Here is an example of the file structure contained in a scene. As you work and use more features, different folders may appear in your structure.

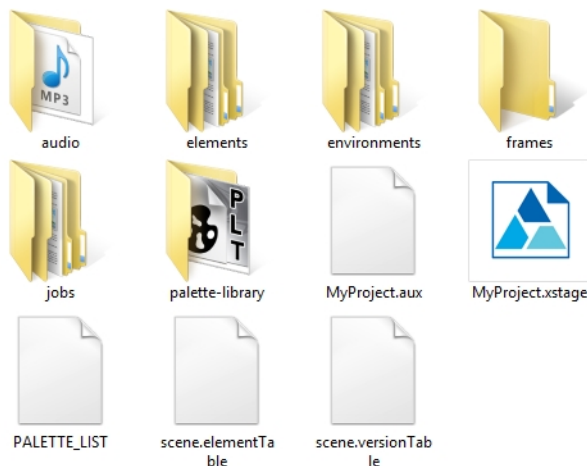

The Harmony scene folder contains the following folders: frames, audio, elements, etc.

Folder	Contents
annotation	Contains the images and thumbnails created while drawing in an Annotation column in the Xsheet view.

audio	Contains all imported audio files.
elements	Contains all the drawing files. The drawings are organized by folders named like the layers they are associated with.
environments	Contains the exported palette files that were originally stored at the environment level in the Harmony Server database structure or the palettes in a Harmony Stand Alone scene that will be imported later at the environment level in Harmony Server.
frames	Contains the final frames after a render if you are using the default settings of the Write node in the Node view.
jobs	Contains the exported palette files that were originally stored at the environment level in the Harmony Server database structure or the palettes in a Harmony Stand Alone scene that will be imported later at the environment level in Harmony Server.
palette-library	Contains scene palettes and scene palette list files.
timings	This folder is used when a user links external images to a scene and wants to store a backup copy in case the link breaks.

## Root Directory and Content Building Scenes

A production is not only composed of the series or movie's scenes, there are also animatics, backgrounds, character builds, colour models, references, storyboards, and so on. These elements must be stored somewhere.

Even if you have a structure integrated in Harmony, it is recommended that a root directory be created for your external elements such as audio clips, bitmap backgrounds, references, and so on. This directory should be stored on the server or be regularly backed up if you are a single user working on a standalone machine.

The Root directory contains subdirectories which hold such elements as animatics, backgrounds and audio files. You must create these subdirectories and name them accordingly. For example, store the backgrounds used in your production in a subdirectory called **backgrounds** or **adventure\_backgrounds**.

Keeping an organized work structure will give you greater control and ease. You can further improve the organization by grouping similar elements into categories.

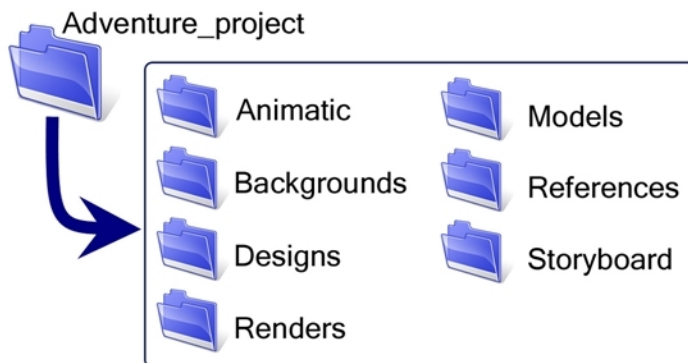

Here is a list of typical subdirectories:

## Animatic

Animatic project and movie files can be stored and organized in this folder.

## Backgrounds

Backgrounds can be stored by sequence or episode in the same way that animation scenes are. Create a subdirectory named **Backgrounds** and then place a sequence or episode subdirectory inside it. Categorize each background by episode or sequence.

## Designs

Create a Designs subdirectory and split the designs into three categories:

- Characters
- Props
- Effects

Categories for locations and backgrounds can also be added if you are creating the designs using Harmony.

## Final Editing

Final Editing projects and renders can be stored and organized in this folder.

## Library

The items contained in the library require a high level of organizational structure. The more structured the library, the faster you will be able to retrieve the items. Categorize the elements using subdirectories, which can be further subdivided. Categories could include:

- Characters
- Props
- Effects
- Audio
- Models

The Library folder should always be stored on the server, even if it is not included in the root directory. A library is generally shared between all the users working on the production as they will link this library to their Template Library and reuse its contents.

## Models

Create a Models subdirectory and divide it into three categories:

- Characters
- Props
- Effects

You may also need to add categories for the backgrounds and model pack. Note that you only need to create a Models subdirectory if you are not designing the models in Harmony.

## References

Create a References subdirectory and then categorize according to type:

- **Images:** These may be any subject from which you can gain ideas and inspiration to help develop your project. For example, if you are producing an 18th-century adventure series, you may have images of period costumes, buildings, and sailing ships.
- **Pictures:** You can also use photographs of items which may help you produce an accurate account of the time period in which your production is set.

## Render

Create a Render subdirectory and categorize the exported image sequences or clips by scene. For example, you would have a subdirectory named **Render** and categories named **Scene\_001**, **Scene\_002** and so on.

It is also possible to do the following:

- Create a subdirectory called Render and store your scene's render in a subdirectory named **sequence**.
- Create a subdirectory called Render and store your scene's render in a subdirectory named **episode**.

## Storyboard

Toon Boom Storyboard Pro projects or storyboard scans can be stored and organized in this folder.

## Textures

You can create a bitmap texture bank for pen styles and colour palettes and store all of the files in this folder.

## Drawings and Layers

A very important concept to understand in Harmony are drawings, drawing elements, and layers. Layers are also referred to as columns in traditional animation, but in Harmony, there is a difference between a column and a layer. A drawing element is a directory containing multiple drawings and is linked to a column in the Xsheet view and the column is linked to a layer in the Timeline view. The layer and column are generally named the same way as the drawing element (folder). A layer may also be an effect layer, a peg (motion) layer, etc. It is not always a drawing layer. A drawing element is the directory containing the drawings that the corresponding layer is linking to. Many layers can be linked to the same drawing element (folder) so that the same drawings are reused.

In traditional and paperless animation, a drawing element or layer can be a character, for example, level B. In cut-out animation, a drawing element can be the hand layer.

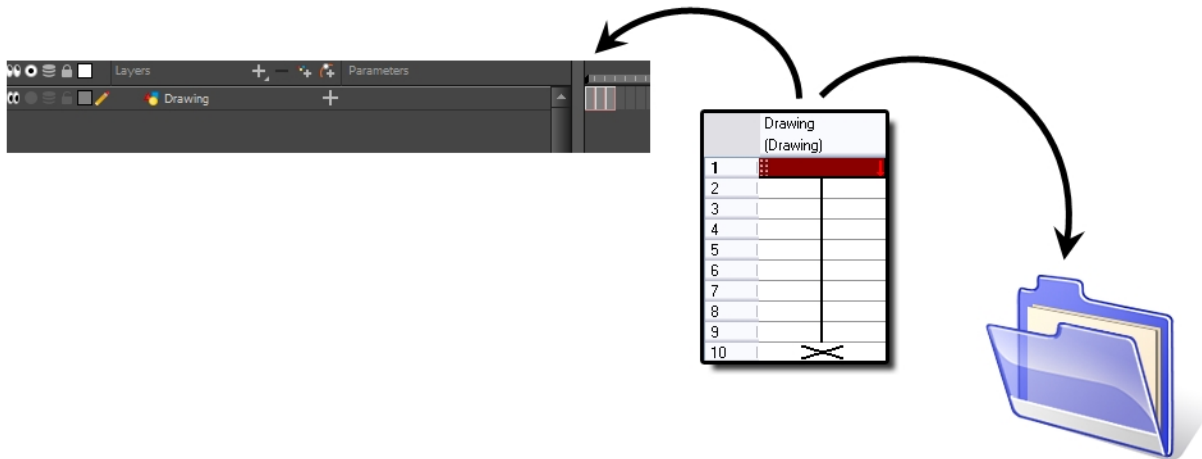

When you add a column or layer to your scene, a node and a folder (element folder) are also added. By default, the element folder and layer are named the same way as the column. As explained above, the element folder's purpose is to contain all the drawings related to this column. For example, in cut-out animation, a character can have many mouths available. All these mouth drawings will be contained in this folder, even if they are not currently exposed in the scene. In other words, there is always a drawing container hooked to a layer or column, unless that layer is linked to another drawing element (clone).

You can find the drawing element folders in your scene's subdirectory called **elements**.

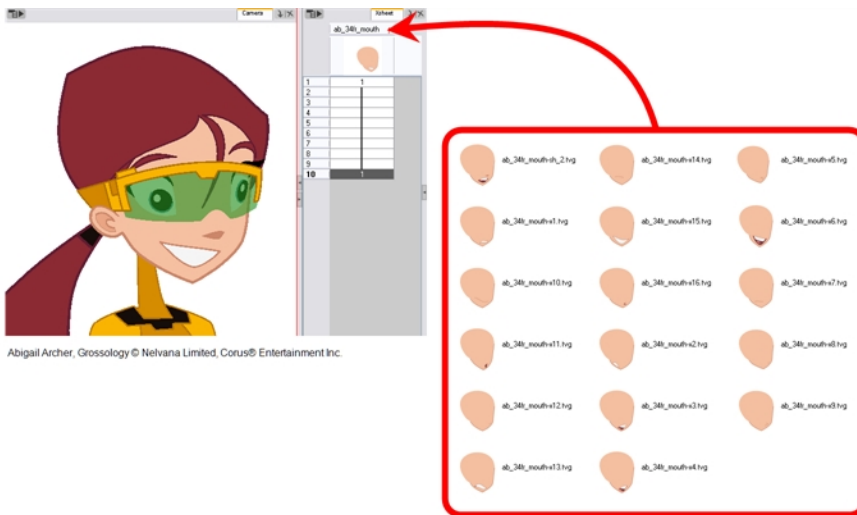

You can add drawing layers from the Timeline view, Xsheet view and the top menu .

In order to understand what happens when you duplicate a drawing, extend an exposure, create cycles or delete a drawing, it is important to know how a layer works.

Each layer is linked to a column and that column is linked to a directory in which all of its drawings are saved. This directory has the same name as the layer and column. When a value or drawing name is typed in a layer's cell, Harmony looks in the layer's directory for the corresponding drawing to display. If there is no corresponding drawing, a new one is created.

New vector drawings are created as \*.tvg (Toon Boom Vector Graphic) files.

The layer's cells are not used for storage, but are linked to the drawings contained in the layer's directory. If you remove a drawing from the layer exposure, it is not deleted; it is simply not displayed.

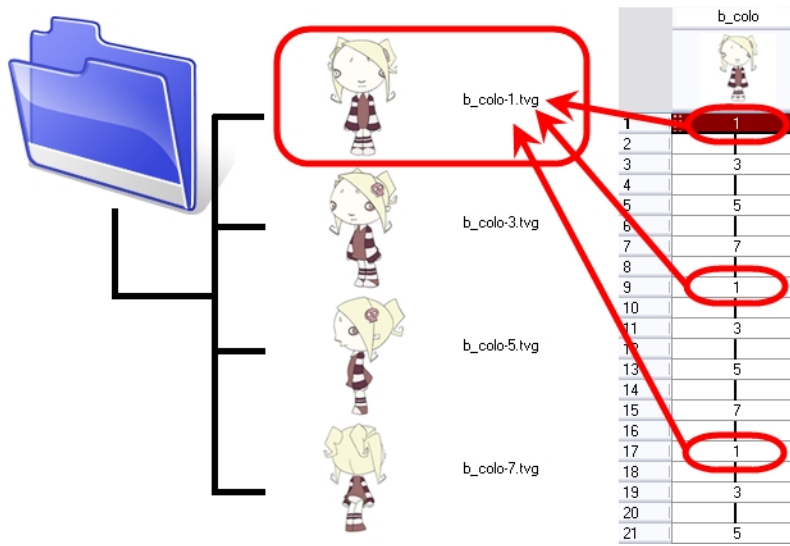

When you create a drawing cycle, all of the repeated drawings are linked to the same original files. This means that when you modify, repaint or correct a drawing named "1", all drawings named "1" are updated simultaneously. In order to modify a drawing independently from its other exposures, you must duplicate the drawing.

## Libraries and Templates

Harmony allows you to use a library to store and reuse elements such as animation cycles, network effects and filters, trajectories, cut-out puppets, etc. We call these elements *assets* or *templates*. These libraries can be placed and used on different levels.

Harmony provides some library folders, to which you can add your own libraries. Harmony's library can be accessed from any scene opened on the machine.

To store your assets somewhere other than the default location, you can create your own folder on your hard drive. If you are connected to a network, you can create a folder on the server to be shared with other network users.

We recommend that you name your library with a relevant project name, such as **adventure\_library**.

The library folders and their templates are completely external to Harmony and can be archived and moved independently from the production. They can also be sent to other Harmony users.

It is always a good idea to be descriptive when naming your templates (assets). Although not mandatory, it is highly recommended to use alphanumeric characters:

- a to z, 0 to 9 and underscore ( \_ )

This will avoid technical issues when working on different platforms such as Mac OS X or Linux.



## Library Structure Tips

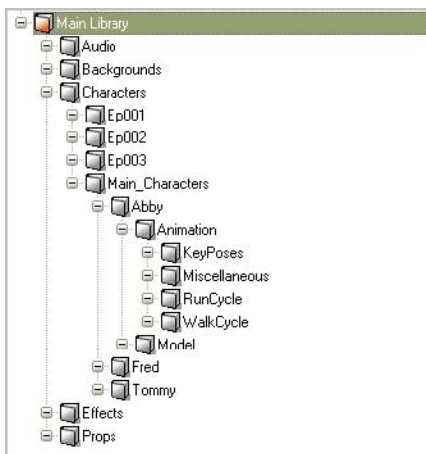

The following recommendations may be useful as you structure your work. The main library can be divided into categories to match different template types:

- Character
- Background
- Audio
- Prop
- Effect

The character section is often altered the most. It is recommended that you divide this folder between:

- Main Characters
- Episode Characters

Within the Main Characters folder, you can create a folder for each individual character. Episode characters are generally less numerous and can be stored in folders corresponding to their episode. Each character's folder can be further divided into subfolders, such as:

- Model
- Animation
- Keyposes
- Reuse Parts

The Animation section can be organized by actions, such as:

- Run Cycle
- Walk Cycle
- Jumps
- Miscellaneous

Some users may divide their animation folder by angle or view:

- Front
- Three-quarter
- Side
- Three-quarter back
- Back

## Personal Libraries

During the animation process, an animator will often reuse certain templates. Some animators have their own personal libraries to store their favourite templates. If a template has been updated in the master library, the Library manager should send a note to the animators and the scene setup team to ensure that they update their personal libraries.

## Naming Convention

When working on large or even small projects, it is best practice to create a naming convention for everyone to follow. This will help keep the work organized and consistent.

## Scene Naming Convention

For improved consistency and ease of use, incorporate naming conventions for your scenes and other project elements.

- We recommend that you name your scene using alphanumeric characters: a to z, 0 to 9 and underscore ( \_ ).
- Avoid capital letters or spaces in the file names.
- Try to provide the maximum amount of information for future identification, which helps ensure that you do not mix up elements and lose information.

For example, you could name a scene `adventure_sc001`, `adventure_scene_01`, `adventure_character_models` or `adventure_seq01_sc002`.

## Layer Naming Convention

When you create drawing layers, it is recommended to name them instead of keeping the default name. This way, your work will be organized and it will be easier for another person to work with your data later on.

It is always a good idea to be descriptive when naming a layer. Although not mandatory, it is highly recommended to use alphanumeric characters:

- a to z, 0 to 9 and underscore ( \_ )

This will avoid technical issues when working on different platforms such as Mac OS X or Linux.

It is highly recommended that you incorporate a naming convention for the layers when building cut-out puppets. This will be very useful later on.



We suggest that you:

- Add one or two letters for the character/prop name before the part name and an “r” for right or an “l” for left to identify the corresponding character/prop:
  - Character Abby’s right arm = **ab\_r\_arm**
- If you plan to work with different angles for your characters (front, side, three-quarter, back), you can add one or two letters to identify the angle:
  - Character Abby’s right arm, front view = **ab\_r\_arm\_f**
- Instead of using the “r” and “l” markers for the different right and left body pieces, you can use “1” to indicate if a limb is closer to or farther away from the character. For example instead of r\_arm and l\_arm, you could have arm and arm1. The reasoning is that when the character is flipped, it is less confusing to have “1” as an indicator for a close limb instead of right or left:
  - Character Abby’s closer arm = **ab\_arm**
  - Character Abby’s farthest arm = **ab\_arm\_1**

## Renaming a Series of Nodes

When you use a blank rigging template, all of the nodes’ names are generic. You will need to add naming information, such as the character’s name and the angle.

Harmony provides you with a script called Add Prefix or Suffix that allows you to add a prefix or a suffix to a series of selected nodes at the same time.

### How to add a prefix to a series of nodes

1. In the Network or Timeline view, select all of the nodes or press Ctrl + A (Windows/Linux) or ⌘ + A (Mac OS X).
2. In the Scripting toolbar, click the Add Prefix or Suffix script button.  
The Add Prefix or Suffix dialog box opens.
3. Select the **Prefix** or **Suffix** option, depending on what you want to add to the element’s name.
4. Type the prefix or suffix information to be added to the node name.

## Puppet Drawing Naming Convention

We recommend that you use a naming convention for your drawings. If you combine all of the angles of a character in the same breakdown scene, it is a good idea to identify each angle used.

Before drawing the parts in the drawing elements (layers), we recommend that you create a drawing name that represents the angle used. This will be quite useful during animation and drawing substitution. For example, use "f" for front, "s" for side, "q" for three-quarter so that the drawing name looks like this:

- f1, f2, f3, s1, s2, etc.

In the facial feature drawings' name, you can also add "h" for happy, "s" for sad or any other letter symbolizing an expression to help regroup the same theme of drawings. For example:

- Happy Mouths:
  - f\_h\_a,
  - f\_h\_b,
  - f\_h\_c,
  - f\_h\_d,
  - f\_h\_e,
  - f\_h\_f,
  - f\_h\_g,
  - f\_h\_x
- Sad Mouths:
  - f\_s\_a,
  - f\_s\_b,
  - f\_s\_c,
  - f\_s\_d,
  - f\_s\_e,
  - f\_s\_f,
  - f\_s\_g,
  - f\_s\_x

## Chapter 8: Starting Toon Boom Harmony

Once Harmony is installed, you are ready to start the application and animate! In this chapter, you will learn about starting the application, creating scenes, setting the resolution and opening the scenes.

### Starting

You can run Harmony on Mac OS X or Windows operating systems.

#### How to start Harmony

- Do one of the following:
  - Windows:** Start > Programs > Harmony 12.1 Advanced > Stage Advanced
  - Mac OS X:** Applications > Toon Boom Harmony 12.1 Advanced > Stage Advanced
  - Linux:** /usr/local/ToonBoomAnimation/harmony\_12/lnx86\_64/bin/StageAdvanced

Toon Boom Harmony opens.

### Welcome Screen

When you start Toon Boom Harmony, the Welcome Screen appears. If a scene is already open, you can display the Welcome screen by selecting **Help > Show Welcome Screen**.

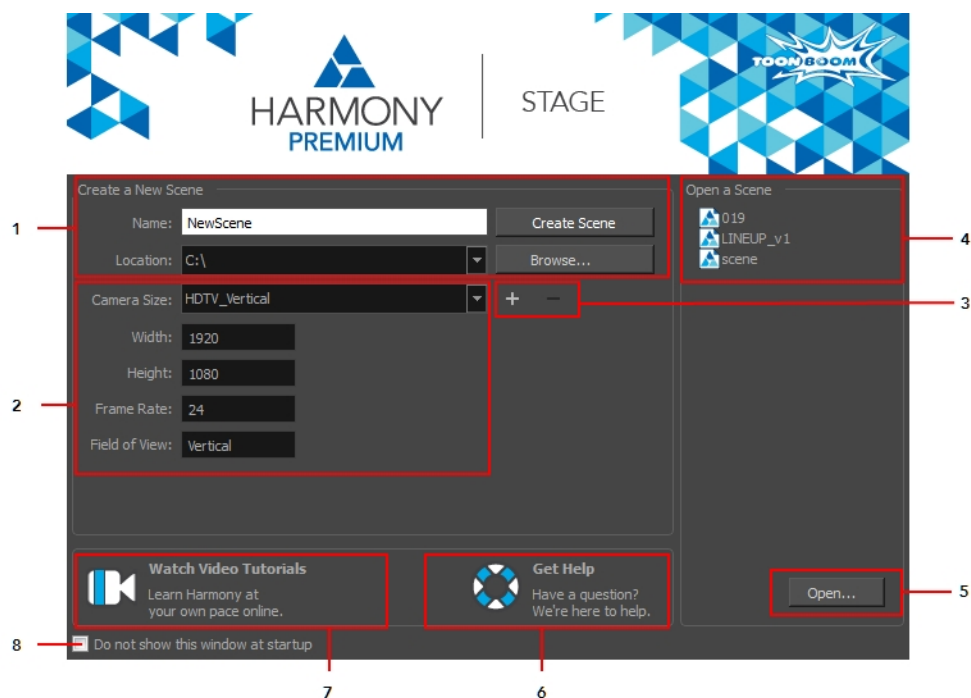

The Welcome Screen allows you to:

- Create scenes
- Choose the scene resolution

3. Add or delete a custom scene resolution
4. Open recent scenes from a list
5. Open scenes by browsing
6. Open the online support page
7. Open Harmony video tutorials
8. Open Harmony directly without opening the Welcome screen first.

To display the Welcome screen later on, go to the top menu and select **Help > Show Welcome Screen**.

## Accessing the Documentation

### How to access the Harmony documentation

1. In the Support section, click on the Get Help  button.  
Your default web browser opens to the Toon Boom Support page.
2. From the Support page, under the Learn Toon Boom Software section, click on the Documentation button.  
The Toon Boom Help page opens.
3. From the Toon Boom Help page, click on the Harmony icon.  
The Harmony 12.1 Help page opens.

All the Harmony guides can also be opened directly in the software. From the top menu, select **Help > Online Help** or press F1.

## Creating and Opening Scenes

All scenes created via Harmony Stand Alone are independent and local to the computer. You can create or open a scene using the Welcome screen or the File menu.

### How to create a scene from the Welcome screen

1. In the Name field, type the scene's name.



2. To select the scene's location, in the Location section, click on the Browse button.



**NOTE:** The scene name **cannot** exceed 23 characters and cannot contain special characters, such as \* & ^ % !.

- From the Camera Size drop-down menu, select the scene's resolution and click **Create Scene**.

A new scene is created.

### How to create a new scene from the File menu

- Do one of the following:
  - From the top menu, select **File > New**.
  - In the File toolbar, click the New  button.
  - Press Ctrl + N (Windows/Linux) or ⌘ + N (Mac OS X).

The New Scene dialog box opens.

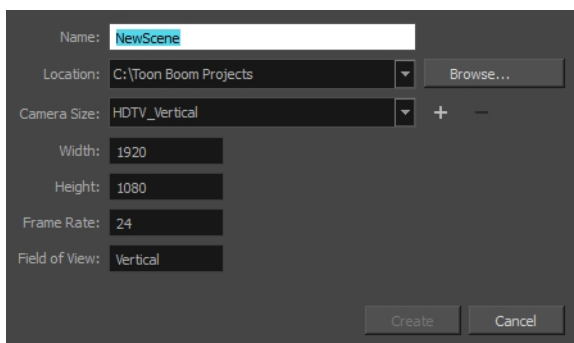

- In the Project Name field, type the scene's name.



- Select a scene directory by clicking the Browse button.



**NOTE:** The scene name **cannot** exceed 23 characters and cannot contain special characters, such as \* & ^ % !.

- In the Resolution window, select the scene's resolution and click **Create**.

A new scene is created.

### How to create a scene with a custom resolution

1. Create a new scene from the Welcome screen or from the File menu in Harmony.
2. Set the scene resolution by doing one of the following:
  - ▶ Select a scene resolution from the Camera sizes drop-down menu.
  - ▶ Set a custom resolution by changing the values in the Width and Height fields. This preset will not be saved.
  - ▶ Add a new resolution to the list by clicking the Add **+** button. You can delete a custom resolution from the Resolution list by selecting it, and clicking the Delete **-** button.
3. In the New Resolution dialog box, fill in the following fields and click **Create**.

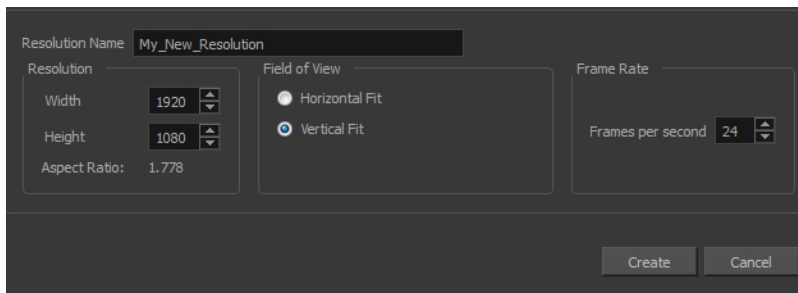

- ▶ **Resolution Name:** Name your new resolution.
- ▶ **Resolution:** Set the width, height and aspect ratio of the resolution.
- ▶ **Field of View:** Set the horizontal fit and vertical fit.
- ▶ **Frame Rate:** Type the scene's frame rate per second.

### How to open a scene from the File menu

1. Do one of the following:
  - ▶ From the top menu, select **File > Open**.
  - ▶ In the File toolbar, click the Browse  button.
  - ▶ Press Ctrl + O (Windows/Linux) or ⌘ + O (Mac OS X).
 The Open Scene browser opens.
2. Browse and select the desired \*.xstage file.
3. Click **Open**.

### How to open a scene from the Welcome screen

1. In the Recent Scenes section, click **Open**.  
The Open Scene browser opens.
2. Browse and select the desired \*.xstage file.



3. Click **Open**.

### How to open a recent scene from the Welcome screen

1. In the Open a Scene section, select a scene from the list.

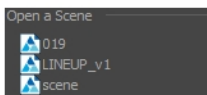

### How to open a recent scene from the File menu

1. From the top menu, select **File > Open Recent**.
2. Select a scene from the displayed list.

## Saving a Scene

It is important to regularly save your scene. As you make changes to a scene, an asterisk (\*) appears in the title bar beside the scene name to indicate that the scene contains unsaved changes.

To save the current state of a scene as another scene, you can use the Save As command. The Save As window prompts you to give a new name and choose a different location to this scene before saving it. This will create a complete scene directory for the new scene.

It is quite frequent, when working on a scene, to try out different timings, effects, camera motions or parameters to see which one will work best. Harmony allows you to save a new version of your scene. It is really important to note that the drawings and palettes are the same between ALL the scene versions. You can modify the timing, effects, parameters and camera motion, but if you modify the drawings, they will be changed everywhere.

You can also automatically save your work. Refer to the Preferences guide to learn more about this function.

### How to save a scene

- From the top menu, select **File > Save**.
- Press **Ctrl + S** (Windows/Linux) or **⌘ + S** (Mac OS X).

### How to save a scene as a new copy

1. From the top menu, select **File > Save As**.
2. In the Save As dialog box, browse to the location of the new archive and give the copy of the scene a new name. The name cannot exceed 23 characters.
3. Click **Save**.

### How to save a new version of a scene

1. From the top menu, select **File > Save As New Version**.

The Save Version dialog box opens.

2. In the Save Version dialog box, type the new version name.
3. Click **OK**.

## Auto-Save

### How to open the Preferences dialog box

1. Do one of the following:
  - ▶ Windows/Linux: From the top menu, select **Edit > Preferences**.
  - ▶ Mac OS X: Select **Stage Advanced > Preferences**.
  - ▶ Press Ctrl + U (Windows/Linux) or ⌘ + U (Mac OS X).
1. Select the **General** tab.
2. In the Save section, select the **Auto-save** option.
  - **Interval (minutes)**: This is the frequency at which the auto-save takes place.
  - **Inactivity Interval (seconds)**: When Auto-save is about to take place, it verifies if you are drawing or doing anything in the application. If so, Auto-save waits this number of seconds before attempting another save.
  - **Ask Before Saving**: Before performing an auto-save, you are prompted with a message to confirm if you want to save or not. You can choose to turn off this option.
  - **Enabled**: This enables the Auto-save feature. If you do not want the system to automatically save your work, deselect this option. The auto-save is off by default.

## Setting the Scene Length

Once you have opened your scene, you can set its length.

### How to set the scene length

1. From the top menu, select **Scene > Scene Length**.

The Set Scene Length dialog box opens.

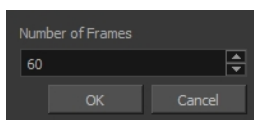

2. In the Number of Frames field, enter the number of frames needed.

## New Scene Startup Script

When you create a new scene, the `TB_sceneCreated` script automatically sets the scene length to 60 frames and adds one of each of the following nodes: drawing element, composite, display and write.

You can find the script in the Script Editor window.

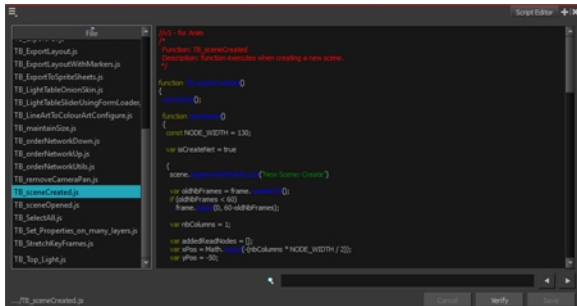

You can customize this script to fit your current project needs. This way, you can set the default scene length to any number of frames you want, or even decide which types of elements and nodes you want to be in your scene when you create it.

Refer to the Toon Boom Harmony Scripting Guide to learn more about using, creating and customizing scripts.

## Adding a Drawing Layer

Now that your scene is set up, you can start adding drawing layers.

### How to add a drawing layer from the Timeline view

1. In the Timeline view, click the Add Drawing Layer  button or press Ctrl + R (Windows/Linux) or ⌘ + R (Mac OS X).

The Add Drawing Layer window opens.

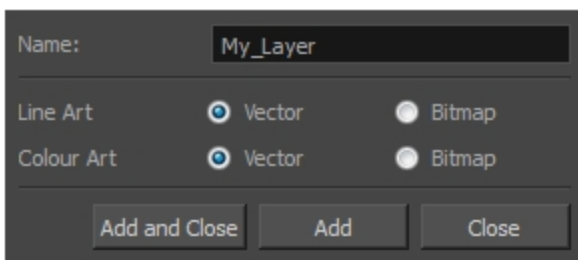

2. In the Name field, name your new layer.
3. Set the Line Art and Colour Art options to **Vector** to get a vector layer or to **Bitmap** to have a bitmap layer.
4. Do one of the following:
  - ▶ Click **Add** to add a first layer and keep the window open to add more layers.
  - ▶ Click **Add and Close** to add a new layer and close the window.

A new drawing layer is added to the Timeline view.

## Scene Settings

When you created your new scene, you set up the resolution and the alignment. However, if you want to change these initial settings later, you can do it using the Scene Settings dialog box. The different Scene Settings options are separated into four tabs.

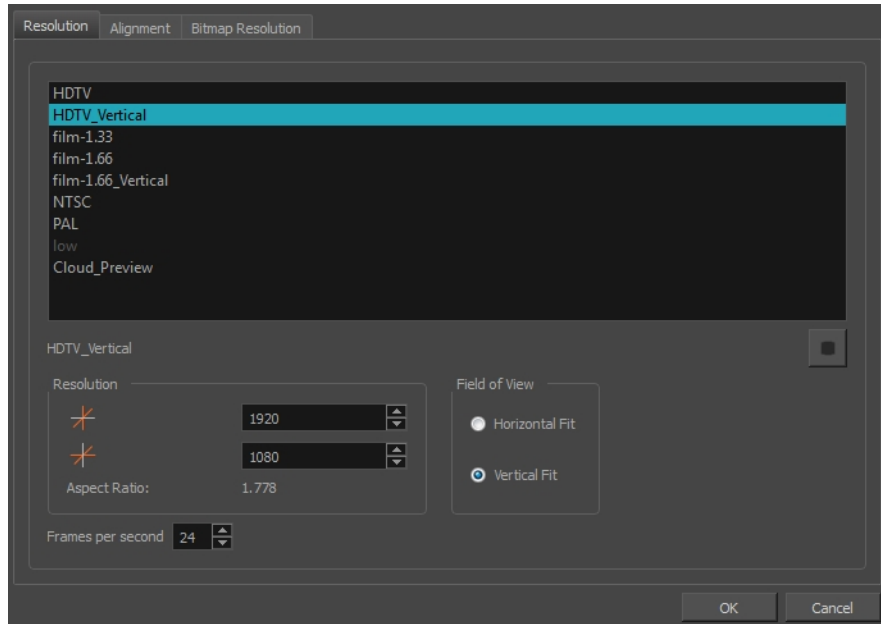

### How to open the Scene Settings dialog box

1. From the top menu, select **Scene > Scene Settings**.

The Scene Settings dialog box opens.

### Resolution Tab

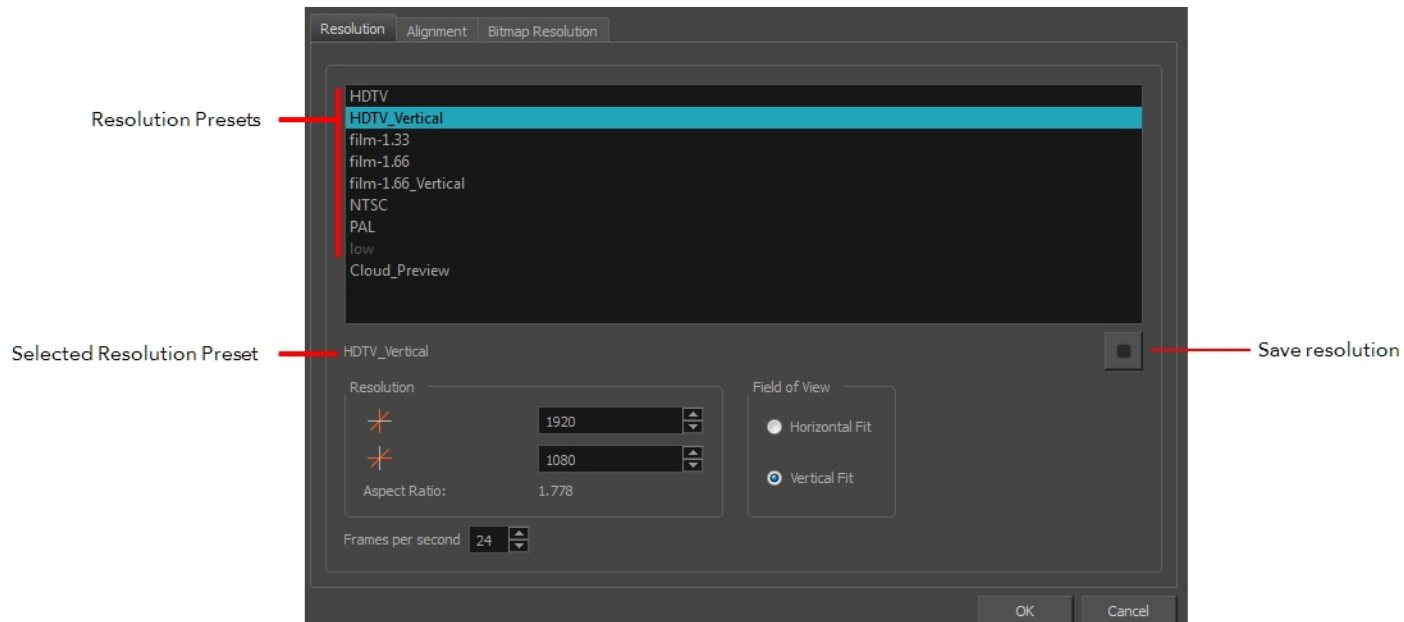

Parameter	Description
Resolution Presets	<p>You can select your project's resolution (camera frame size) from this preset list.</p> <ul style="list-style-type: none"> <li>▶ <b>HDTV:</b> High definition television delivers a higher quality image than standard television (4:3) does, because it has a greater number of lines of resolution. To take advantage of the superior quality your output device must be compatible with HDTV technology to make this resolution setting useful.</li> <li>▶ <b>HDTV_Vertical:</b> The "vertical resolution" of HDTV_Vertical refers to how the images will be aligned in relation to the actual scene frame (default 4:3 grid). Note that the camera resolution and the scene frame are not the same. When working with 12 or 16 field drawing grids, the grid is a different aspect ratio from the camera frame. When you fit vertically, you fit the images with the top and bottom of the scene grid.</li> <li>▶ <b>film-1.33:</b> Use this resolution setting for the academy film format that conforms to the standard 4:3 aspect ratio.</li> <li>▶ <b>film-1.66:</b> Use this resolution setting for the widescreen film format that conforms to the 16:9 aspect ratio.</li> <li>▶ <b>film-1.66_Vertical:</b> This is essentially the same as film-1.66. Refers to how the drawing is fit into the scene frame. When working with 12 or 16 field drawing grids, the grid is a different aspect ratio from the camera frame. When you fit vertically, you fit the images with the top and bottom of the scene frame.</li> <li>▶ <b>NTSC:</b> This is the standard analogue television broadcasting system used in North America and conforms to the North American standards on how rectangular pixels are displayed for computer and television screens.</li> <li>▶ <b>PAL:</b> This resolution works best with the European format for television and computer screens, as the rectangular pixels are displayed at a different orientation.</li> <li>▶ <b>Low:</b> This format is ideal for videos destined for the web, where size and fast download of a video file might take precedence over quality.</li> <li>▶ <b>Cloud Preview:</b> This is the resolution used by Web Control Center to create its preview.</li> </ul>
Selected Resolution Preset	Displays the selected resolution preset.
Save Resolution Setting	Click the Save Resolution button after you define your new resolution to save it as a preset.
Pixel Dimensions	<p>Displays the pixel dimensions for your project resolution.</p> <p>If you decide to type in the pixel dimensions, or use the up and down arrows to change the pixel increments, you will have to save your custom selection in order to save it as a new preset. It will then appear in the resolution selection list. It doesn't modify the current resolution preset.</p>

<p>Aspect Ratio</p>	<p>Displays the ratio between the horizontal and vertical dimensions of the camera framing. Each resolution setting has a preset aspect ratio that cannot be changed.</p>
<p>Frame per second</p>	<p>Sets the frame rate for your project. The higher the frame rate, for example 30 fps, the faster the animation will play. The lower the frame rate, for example 12 fps, the slower your animation will play. Avoid going under 12 frames per second as your animation will have a choppy playback. The human eye requires a minimum of 12 frames per second to perceive a fluid animation.</p>
<p>Field of View</p>	<p>Use these options to define the FOV (field of view) of the camera (angle of the camera cone) and how the drawing elements (and drawing grid) align to the scene grid. The drawing grid is always scaled proportionally to a 4:3 ratio (unless you change the scene alignment), therefore changing the Field of View setting may not show a visible difference if your project resolution is also 4:3, such as NTSC.</p> <ul style="list-style-type: none"> <li>▶ <b>Horizontal Fit:</b> The camera resolution is set to fit the left and right edges of the scene grid.</li> </ul> <div data-bbox="683 804 1442 1224" style="text-align: center;"> </div> <ul style="list-style-type: none"> <li>▶ <b>Vertical Fit:</b> The camera resolution is set to fit the top and bottom edges of the scene grid.</li> </ul> <div data-bbox="683 1367 1442 1770" style="text-align: center;"> </div>

## Alignment Tab

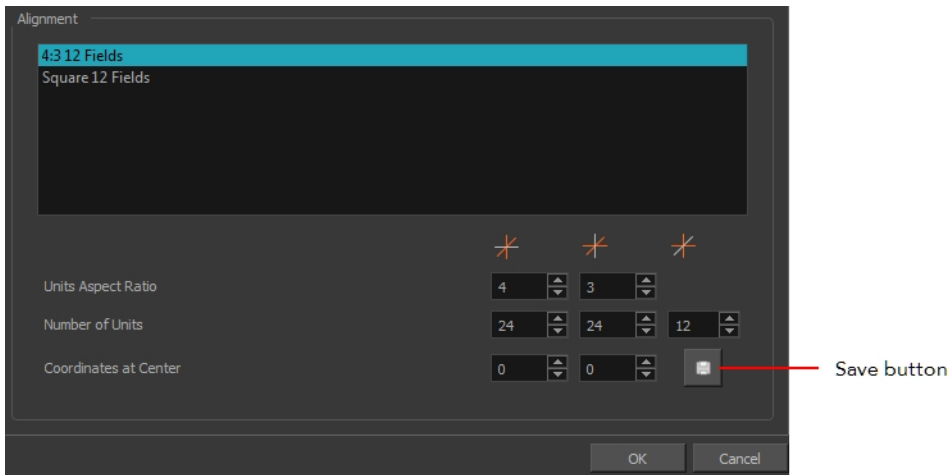

Parameter	Description
Alignment	<p>The Alignment presets give you two preset options:</p> <ul style="list-style-type: none"> <li>▶ <b>4:3 12 Fields:</b> Defines the units of your project to have a 4:3 ratio and sets up 12 of these units to run both vertically and horizontally in four cardinal quarters (NW, NE, SW, SE). This Alignment preset is visible in the FOV and drawing grids.</li> <li>▶ <b>Square 12 Fields:</b> Defines the units of your project to have a 1:1 or square ratio and sets up 12 units to run both vertically and horizontally in four cardinal quarters (NW, NE, SW, SE). This Alignment preset is NOT visible in the FOV and drawing grids.</li> </ul>
Units Aspect Ratio	<p>In the Units Aspect Ratio fields, enter the aspect ratio of the grid you will use. The aspect ratio describes the shape of the grid unit. A square grid unit would have the ratio 1:1, whereas a grid unit of aspect ratio 4:3 is a unit with one side 1.33 times as big as the other side.</p>

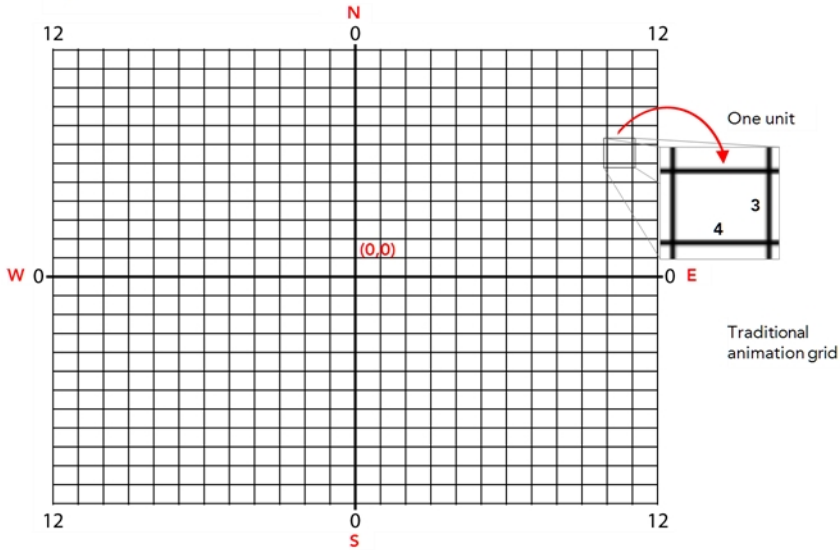
	<p>Alignment Presets</p>  <p>If the aspect ratio you want to use is 1:1, enter 1 in the Left/Right field (X-axis) and 1 in the Up/Down field (Y-axis). The default Aspect Ratio is set to 4:3 as it is the one used by traditional animators, who are accustomed to working with the grid system described above.</p>
<p>Number of Units</p>	<p>In the Number of Units fields, enter the number of horizontal, vertical and depth units for your scene's grid.</p> <p>Animators who prefer to work traditionally will understand the default setting of 24 units horizontal by 24 units vertical as it, once again, corresponds to the grid above. Twelve is a common setting for the field depth.</p> <p>Those who prefer to work in pixels should enter the pixel dimensions (3) of their project. This way if you want to move something over 600 pixels you just need to type in 600 units.</p>
<p>Coordinates at Centre</p>	<p>In the Coordinates at Centre, you can enter a new coordinate for the centre of your scene.</p> <p>By default, the (0,0) centre is set in the middle of the grid as shown in the grid above. If you want to change the centre of your grid, for example to the upper left corner, you would enter (-12, 12), -12 units across and 12 units up. That is of course unless you changed the number of units to match the pixel dimensions of your scene. Then you would enter negative half the width and positive half the height.</p>
<p>Save</p>	<p>Saves your current Alignment settings and be able to select them later from the list.</p>



**NOTE:** If you change your scene's alignment from 4:3 12 Fields to Square 12 Fields part way through your project, you may find that the animation grid becomes offset. To correct this, choose the following setting from the Layer Properties panel's Advanced tab: **Alignment > Alignment Rule > Centre First Page**.

## Bitmap Resolution Tab

The bitmap resolution settings at the scene level affects newly created bitmap art layers.

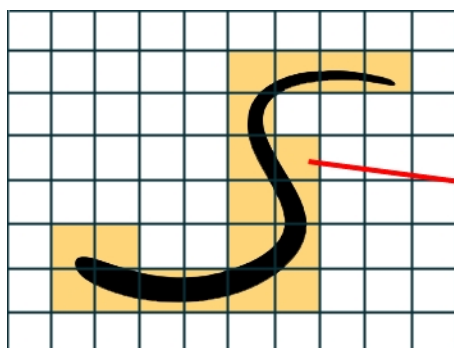
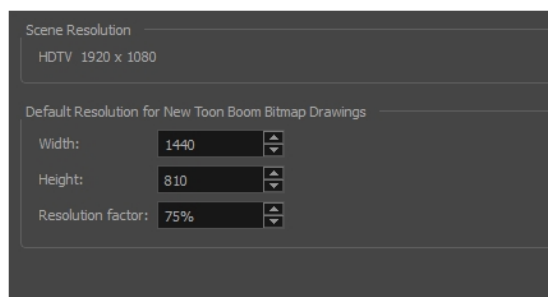

The yellow tiles are the spaces containing artwork. The white tiles are empty spaces, making the bitmap image much lighter.

The bitmap resolution (width and height) is the resolution of the tiles in relation to the project resolution.

Parameter	Description
Scene Resolution	This is the scene resolution preset name and size in pixels.
Width	This is the width of the resolution for the bitmap that will be created. This is not the actual size of the bitmap. TVG drawings (Toon Boom drawing native format) have an infinite size. Bitmap TVGs are composed of small tiles. Therefore it does not mean that because you have artwork at the four corners of your camera frame or even quite far outside of your drawing that your bitmap image will be very large and heavy. By default, it is set to the same width as the scene resolution.
Height	This is the height of the resolution for the bitmap that will be created. By default, it is set to the same height as the scene resolution.
Resolution Factor	This is the size of the bitmap resolution in relation to the scene resolution. If you increase the percentage, the width and height fields will increase accordingly. If you plan to animate the camera and zoom into your background, you will need to set a higher resolution so that the smaller area in which you will zoom will be 100% of the scene resolution.



## Basic Commands

This table lists the most common commands used in Harmony.

Command	Action	Access Methods
New	Creates a new scene while closing any scene already open. The New Scene dialog box opens, asking for directory, name, and resolution information.	<b>File &gt; New</b> Press Ctrl + N (Windows/Linux) or ⌘ + N (Mac OS X).
Open	Displays the Open Scene dialog box. Browse your file system for a scene file.  The Open command is not disabled when a scene is opened. You can open a new scene from the current one and the previous scene will be closed.	<b>File &gt; Open</b> Press Ctrl + O (Windows/Linux) or ⌘ + O (Mac OS X).
Open Recent	Displays a quick access list to view and open recently used Harmony files.	<b>File &gt; Open Recent</b>
Open Recent > Clear	Clears the recently opened Harmony files list.	<b>File &gt; Open Recent &gt; Clear</b>
Close	Closes the currently opened scene, but does not close the Harmony application.	<b>File &gt; Close</b>
Save	Saves all changes made to the opened scene, drawings, palettes, and palette lists.	<b>File &gt; Save</b> Press Ctrl + S (Windows/Linux) or ⌘ + S (Mac OS X).
Save As	Saves the current state of a scene as another scene. The Save As window prompts you to give a new name and choose a different location to this scene before saving it. This will create a complete scene directory for the new scene.  The scene name <b>cannot</b> exceed 23 characters.	<b>File &gt; Save As</b>
Save As New Version	Saves the current scene as another version. The Save Version dialog box prompts you to give a name for this new version. This will create a new	<b>File &gt; Save As New Version</b>

Command	Action	Access Methods
	.xstage file in your current project directory.	
Quit	Closes the application.	Windows/Linux: <b>File &gt; Quit</b> Mac OS X: <b>Stage Advanced &gt; Quit</b>
Show Scan Information	Displays a status bar showing the scanning information at the bottom of the Drawing and Camera view.	<b>Drawing View Menu &gt; View &gt; Show &gt; Show Scan Information</b>
Cut	Removes selected objects. You can then paste the object or its properties to another object.	<b>Edit &gt; Cut</b> Press Ctrl + X (Windows/Linux) or ⌘ + X (Mac OS X).
Copy	Copies selected objects and properties.	<b>Edit &gt; Copy</b> Press Ctrl + C (Windows/Linux) or ⌘ + C (Mac OS X).
Paste	Places an object you cut or copied into the location you select in the Camera, Drawing and Timeline views.	<b>Edit &gt; Paste</b> Press Ctrl + V (Windows/Linux) or ⌘ + V (Mac OS X).
Delete	Removes selected objects.	<b>Edit &gt; Delete</b> Delete
Select All	Selects all drawing objects in the current drawing window in the Drawing, Timeline and Camera views. This helps you manage multiple objects as one when moving them.	<b>Edit &gt; Select All</b> Press Ctrl + A (Windows/Linux) or ⌘ + A (Mac OS X).
Deselect All	Deselects all selected objects in the Drawing and Camera views.	<b>Edit &gt; Deselect All</b> Esc
Undo	Removes the last change made to your project. Harmony supports multiple undo, so you can undo changes you made in the order you made them.	<b>Edit &gt; Undo</b> Press Ctrl + Z (Windows/Linux) or ⌘ + Z (Mac OS X).
Redo	Redoes an operation you have undone. This command is active only after you use the Undo command.	<b>Edit &gt; Redo</b> Press Ctrl + Shift + Z.
Select Children	Lets you select all elements	<b>Animation &gt; Select Children</b>

Command	Action	Access Methods
	parented to the selected peg element in the Timeline view.	
Select Child	Lets you select the first element parented to the selected peg element in the Timeline view..	<b>Animation &gt; Select Child</b> Press Shift + B.
Select Parent	Lets you select the parent of the selected element in the Timeline view.	<b>Animation &gt; Select Parent</b> Press B.
Select Previous Sibling	Lets you select the previous element (above current element) in the Timeline view.	<b>Animation &gt; Select Previous Sibling</b> Press /.
Select Next Sibling	Lets you select the next element (below current element) in the Timeline view.	<b>Animation &gt; Select Next Sibling</b> Press ?.
Debug Mode	Enables the Debug mode for gathering and displaying precise information about each rendering frame, such as the nodes encountered and action taken.	<b>Help &gt; Debug Mode</b>
Help	Launches the Toon Boom Harmony Online Help system, complete with instructions on how to use the system. This requires an internet connection.	<b>Help &gt; Help</b>
Toon Boom Harmony on the Web	Launches the Toon Boom Harmony website, which features a Support and Community > Forum section.	<b>Help &gt; Toon Boom Harmony on the Web</b>
About	Use the About command to access general information about the software.	Windows/Linux: <b>Help &gt; About</b> Mac OS X: <b>Stage Advanced &gt; About</b>
Show Welcome Screen	Brings back the Welcome screen	<b>Help &gt; Show Welcome Screen</b>
Customer Experience Improvement Program	Harmony includes an optional customer experience feature whereby usage information is collected and sent to Toon Boom. The data does not contain any personally identifiable information and cannot be used to identify you. The data will	<b>Help &gt; Customer Experience Improvement Program</b>

Command	Action	Access Methods
	<p>consist of a basic hardware description, a project summary and usage information. This information will only be used for software improvement purposes, as well as sharing the information with third parties for the same reason.</p> <p>The customer experience feature is enabled by default but is voluntary. If you prefer not to participate, you can opt out when you first launch the software, by using a global preference, or by a command line argument.</p>	

## Preferences

An important feature of Toon Boom Harmony is the Preferences dialog box. From here you can customize your interface, tool behaviour and shortcuts. Throughout this guide, you are often required to go to the Preferences dialog box to set parameters and options.

To learn about the different preferences available, refer to the Preferences Guide.

### How to open the Preferences dialog box

1. Do one of the following:
  - ▶ Windows/Linux: From the top menu, select **Edit > Preferences**.
  - ▶ Mac OS X: Select **Stage Advanced > Preferences**.
  - ▶ Press **Ctrl + U** (Windows/Linux) or **⌘ + U** (Mac OS X).

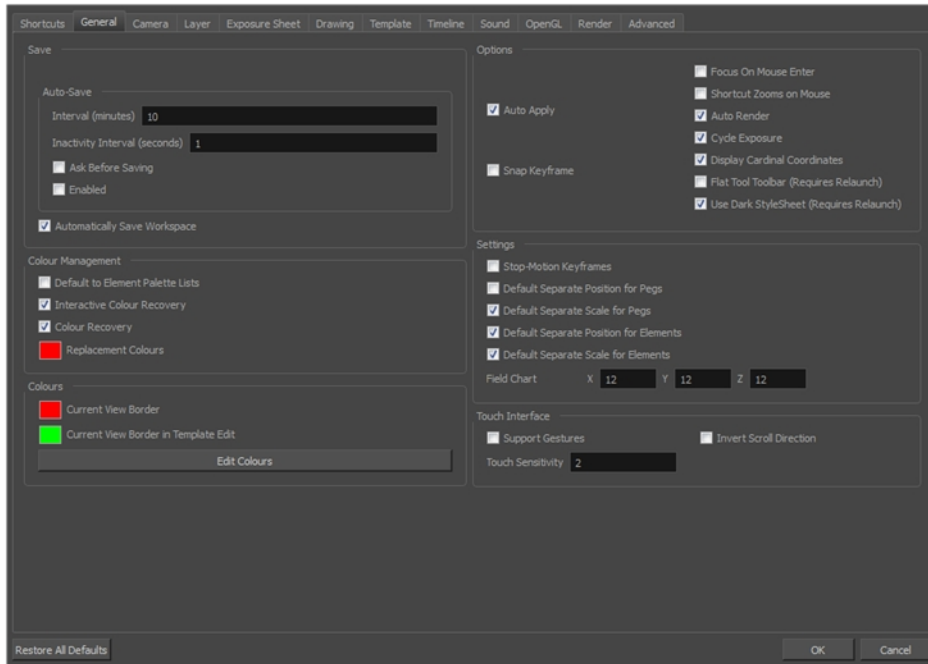





## Chapter 9: Interface

Knowing how to manage the Toon Boom Harmony interface helps you to work efficiently and organize your workspace conveniently. There are a series of views and toolbars you can use as you perform different operations. Usually, each person has a specific way of working in the interface and prefer particular views and toolbars. In this chapter, you will learn about the main elements of the interface and how to manage them.

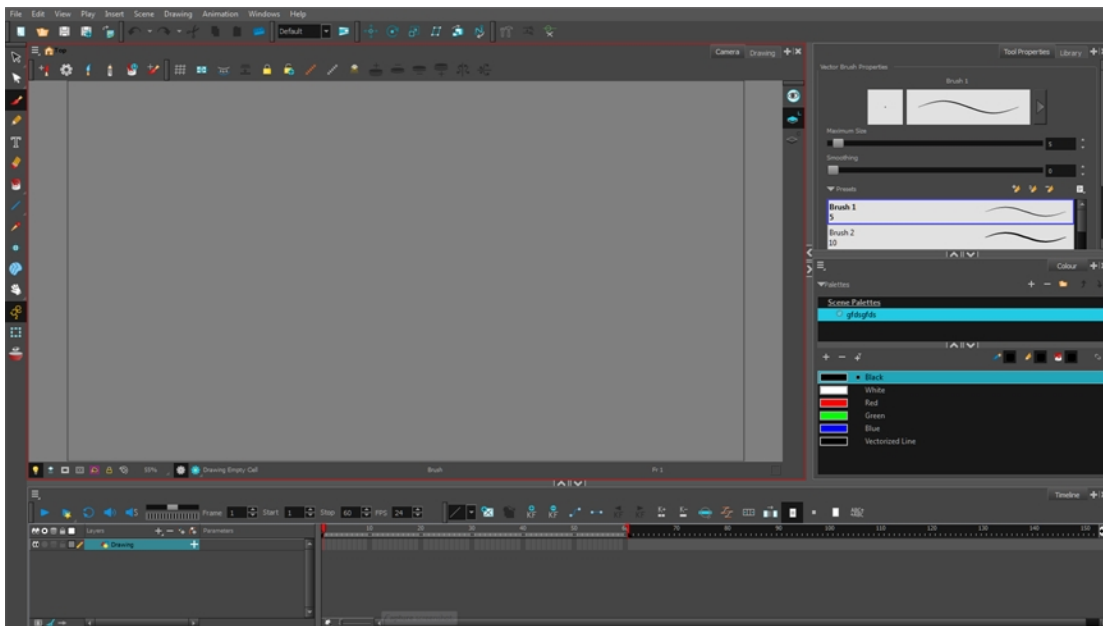

The Harmony interface is set to a dark theme by default. You have the option of switching to a light theme.

### How to change the interface theme

1. From the top menu, select **Edit > Preferences** (Windows/Linux) or **Stage Advanced > Preferences** (Mac OS X).  
The Preferences dialog box opens.
2. Select the **General** tab.
3. In the Options section, deselect the **Use Dark StyleSheet** option to use the light theme.
4. Restart Harmony.

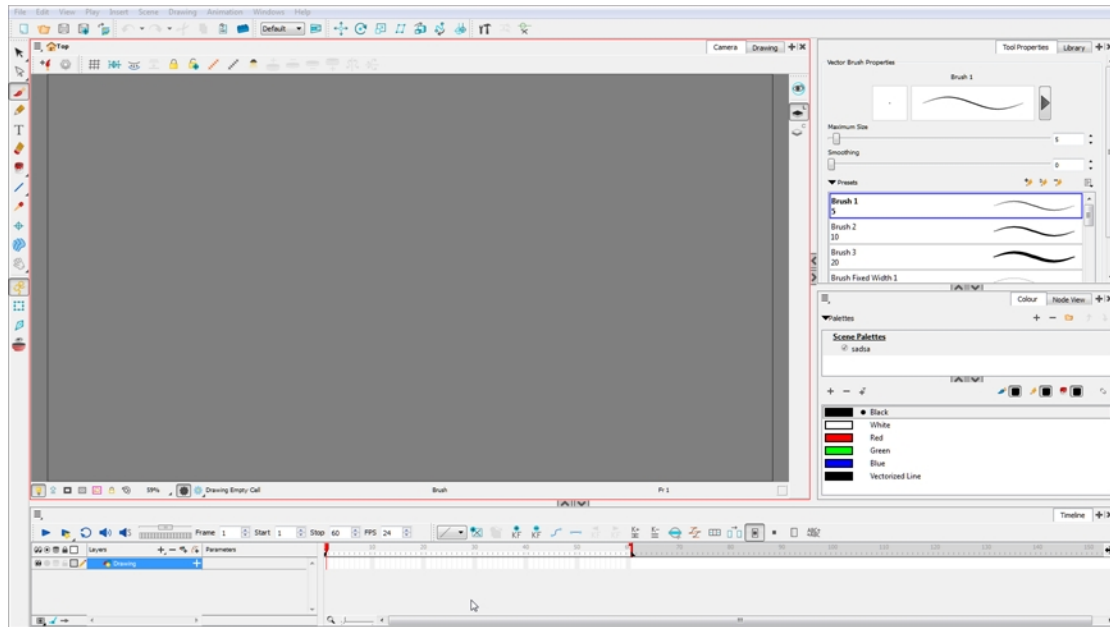

This chapter is divided as follows:

## Menus

Harmony contains three types of menus from which you can access many commands and options:

### Top Menu

The top menu contains most of the commands. Depending on the view you're working in and the element, some commands are available and others are not. The top menu is always located at the very top of the interface.

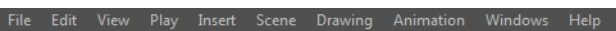
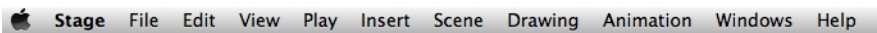

The top menu contains the following categories:

- File
- Edit
- View
- Play
- Insert
- Scene
- Drawing
- Animation
- Windows
- Help

On Mac OS X, there is also a Stage Advanced category that contains the following commands:

- Preferences
- About
- Quit

## View Menu

A view menu contains commands specifically related to that view.

To access a view menu, click the Menu  button in the top-left corner of a view.

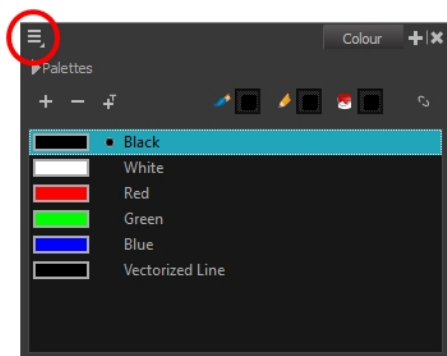

A view menu is available in the following views:

- Camera
- Colour
- Drawing
- Function
- Library
- Model
- Perspective
- Script Editor
- Side
- Timeline
- Top
- Xsheet

## Quick Access Menu

A quick access menu lets you open a list of the commands you will use most often.

To access this menu, right-click anywhere in a view.

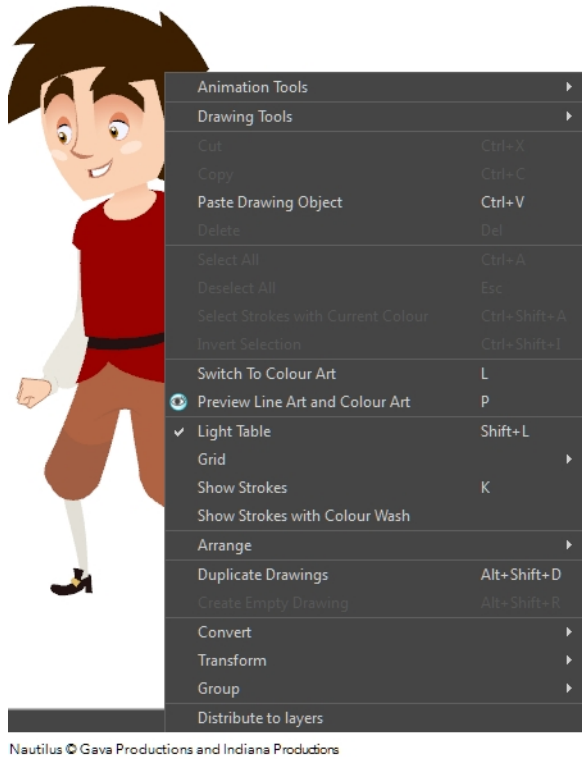

## Managing the Views

The Harmony interface is composed of different views, each one designed for a specific purpose. You can modify the location of the views by adding a new view as a tab or as a window. You can also swap the location of a view.

When a view is active, a red rectangle appears around the view. Keyboard shortcuts and top menu options are associated with the active view. If a menu option is greyed out, it means it does not apply to the layer, drawing or other type of selection or the option does not apply to the active view.

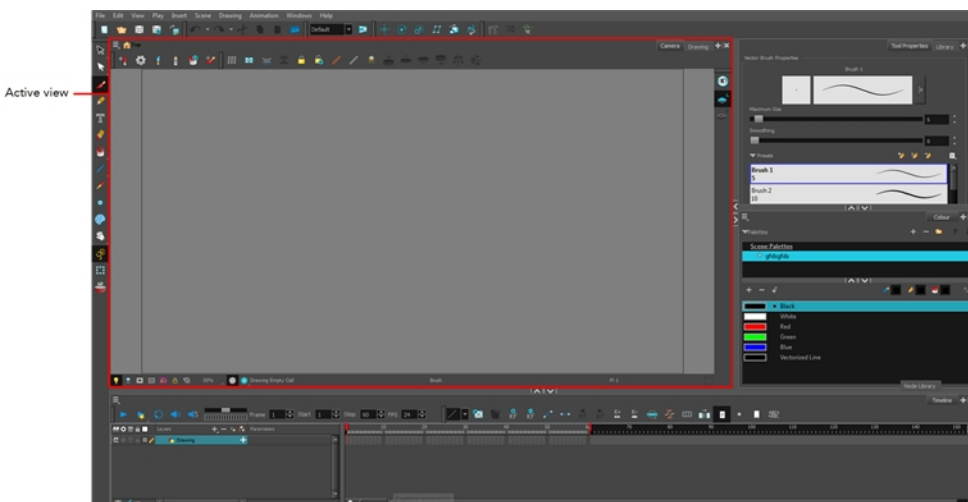

Workspace modifications are automatically saved when you exit the application unless you deselected the Automatically Save Workspace option in the Preferences dialog box.

## How to add a view

- Do one of the following:
  - Select the view you want to add from **Windows > desired view**.
  - In the top-right corner of a view, click the Add View **+** button and select a view from the list. You can open several instances of the same view except for the Timeline, Tool Properties, Colour, and Drawing views.

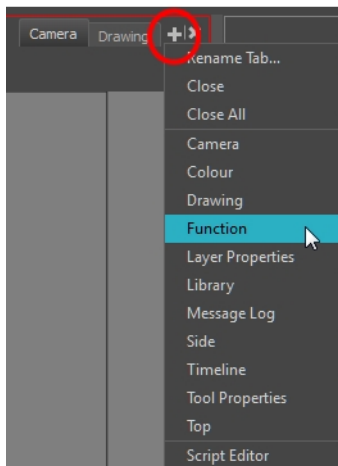

By default, the view appears as a tab.

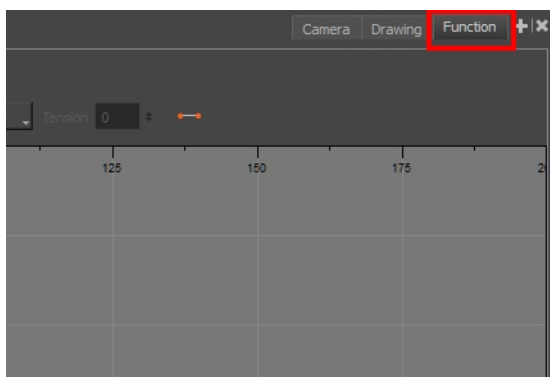

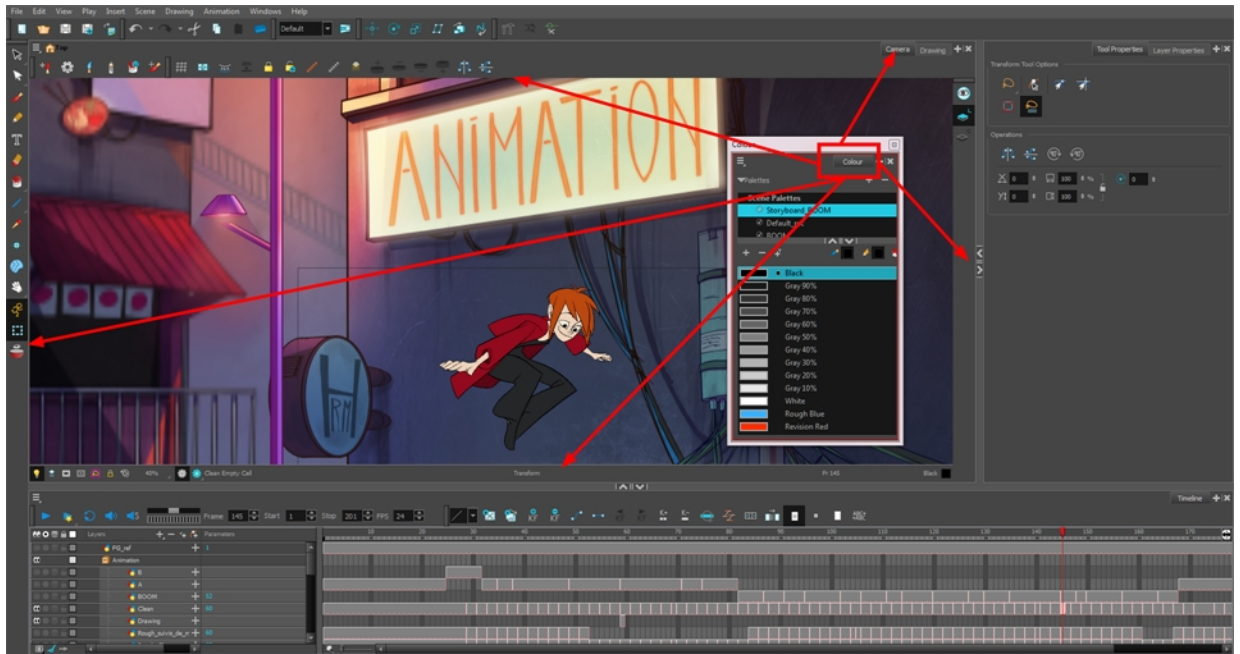

## How to dock a window

- Drag a window by its tab and do one of the following:
  - Drop the window onto other existing tabs to add it to the others.
  - Drop the window above, below or beside an existing view. When you get close to the edge of a view, a black rectangle with a blue background appears, indicating where the view will be inserted.



Window is dragged by its tab onto other tabs or above/below/beside other views.

### How to close a view

1. Click the Close View  button.
  - ▶ If there are several tabs in the same view, press Shift and click the Close View  button to close all tabs at the same time.

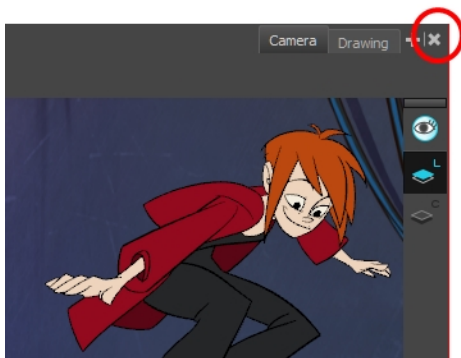

### How to swap views

1. Select the view's tab and drag it onto one of the view's separators, top area or onto another view's tab.
2. When a blue rectangle outline appears showing an available location for the view, release the tab to drop the view into position. One of three things will happen:

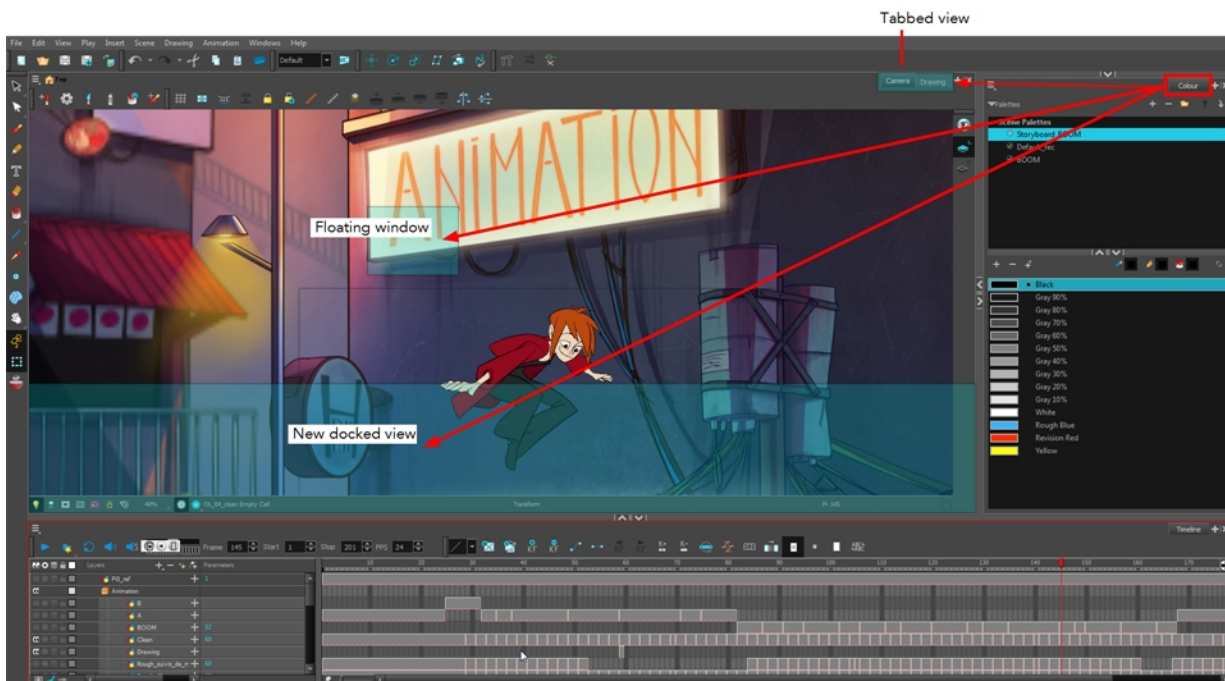

- The view becomes a tabbed view.
- The view becomes a floating window.
- The view becomes a new docked view.

### How to resize a view

1. Place the pointer on the edge of the view to resize.
2. When you see the Resizing  $\leftarrow\rightarrow$  icon, drag the side of the view to the desired size.

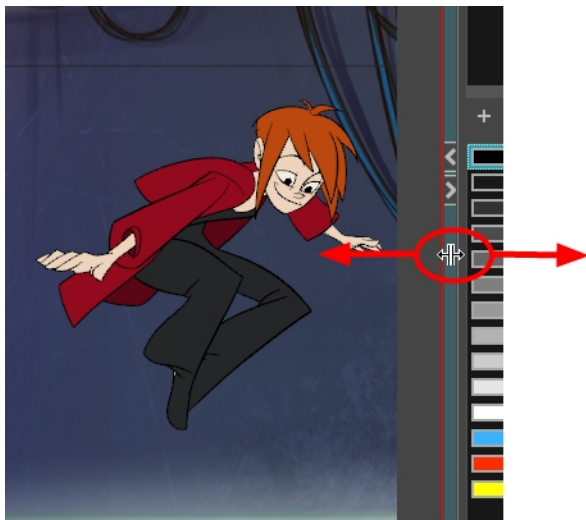

### How to temporarily hide a view

1. On the edge of the window you want to hide, click the **Collapse/Expand** button.  
The view is compressed and only the Collapse/Expand button is visible.
2. Click the **Collapse/Expand** button again to redisplay the view.

## Managing the Toolbars

Harmony contains toolbars which, by default, are located at the top of the interface. Some of the views also have their own toolbars which you can move around. You can reposition the toolbars to suit your work style or hide unused ones.

**NOTE:** Throughout this section, there may be slight differences between your interface and the illustrations in this guide. This is because the images are taken from Harmony Premium.

You can display or hide toolbars using the menus. The Toolbar menu only contains the View toolbars of the views that are displayed in the workspace. As you show or hide views in your workspace, the Toolbar menu updates.

The top toolbars can also be displayed directly in a view. Only one instance of each toolbar can be displayed. If a toolbar is already displayed in the top area and you decide to display it in a view, the selected toolbar will move from the top area to the view.

The View toolbars can be customized to contain your favourite tools and options. Using the Toolbar Manager window, you can organize different toolbars to suit your working style.

If you prefer to have all your tools visible in the Tools toolbar, the Flat Tool Toolbar option allows you to expand the toolbar so there are no nested toolsets in the toolbar. When you set this option, you will need to close Harmony and restart it for the new interface to be displayed. A default set of tools will appear in the toolbar. However, you can customize which tool icons appear in the toolbar to fit your work pattern.

The default Tools toolbar



These arrows denote nested toolsets.



The Flat Tool Toolbar option expands the toolbar so there are no nested toolsets.

If the default toolbar does not contain the tools you require, you can customize the toolbar.

Once you are displaying the flat toolbars, you can customize the tools which appear in the toolbar. This means that you can change the default set of tools and replace the tools you use less frequently with ones use more often. This customizing is done through the Toolbar Manager.



## How to show and hide a toolbar

- From the top menu, select **Windows > Toolbars > the desired toolbar**.
  - You can right-click anywhere in the toolbar area to access Harmony toolbars. View toolbars, however, are not available by right-clicking the toolbar area. You can access the toolbar of any open and active view by right-clicking in the view's top area or the Windows menu.

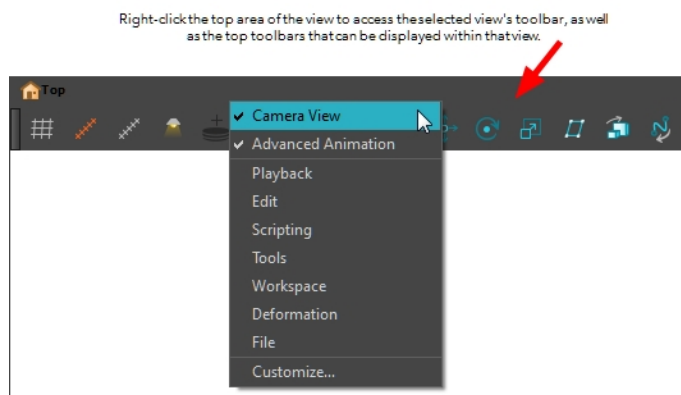
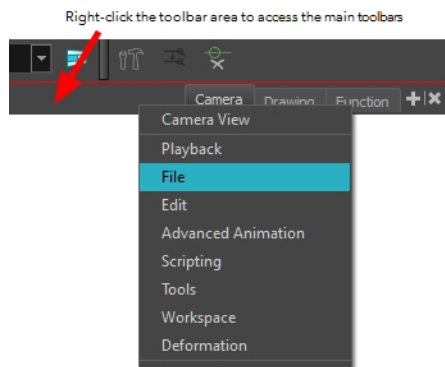

## How to resize a toolbar

- Hide a portion of a toolbar by dragging another open toolbar over its tail-end.
- Click on the arrows appearing at the end of the collapsed toolbar to expand it.

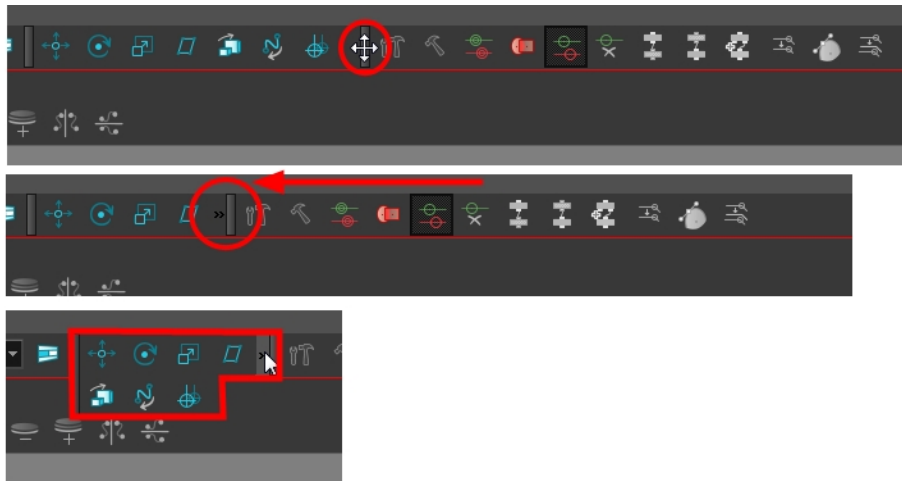

### How to move a toolbar

1. Select the toolbar you want to move by clicking its anchor point and dragging it into a view toolbar area or another position in the top or side interface toolbar area.

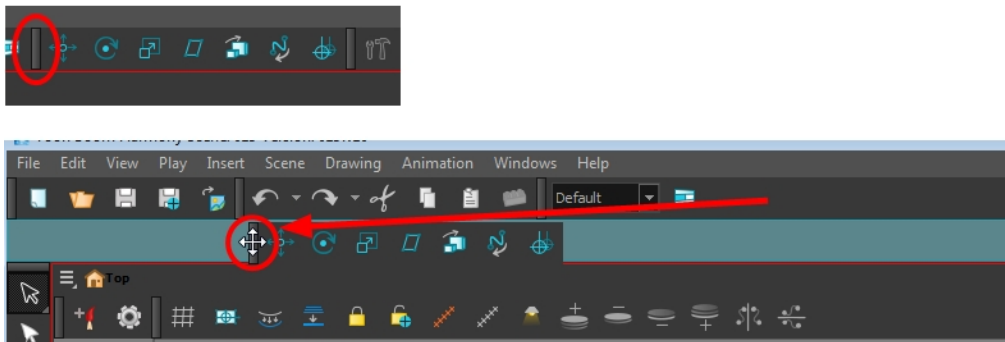

2. When a highlighted zone appears showing an available location for the toolbar, release the mouse button and drop the toolbar into position.

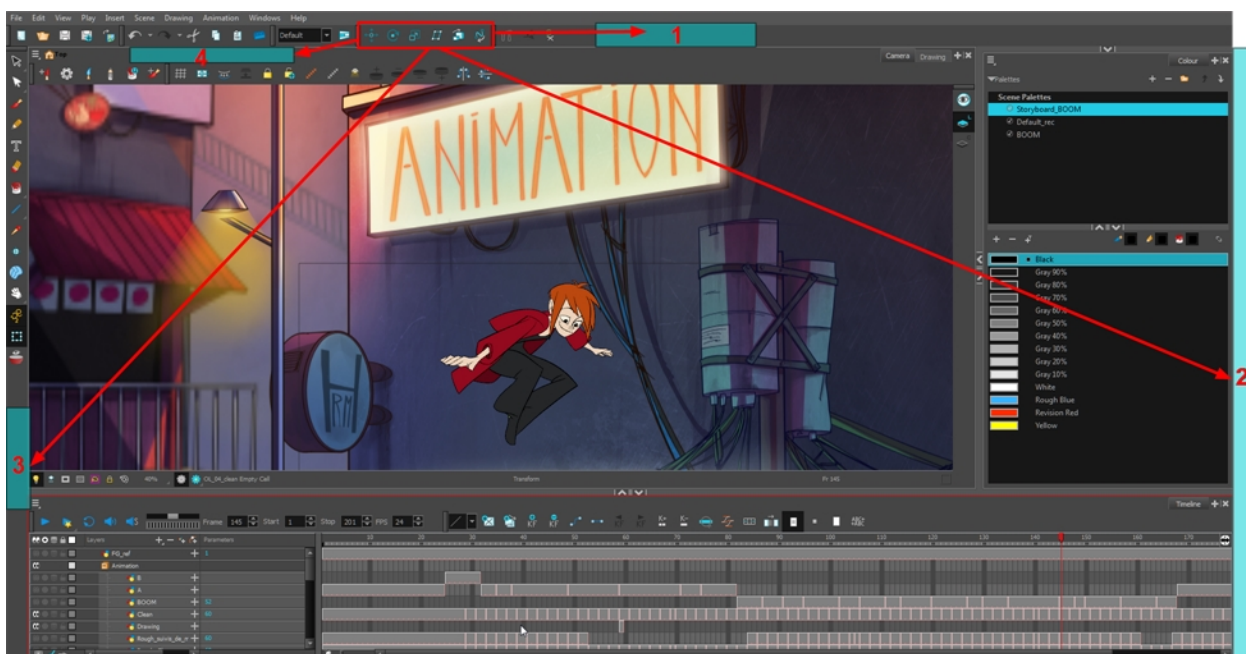

## How to customize a view toolbar

1. In the chosen view, right-click on any button in the toolbar where you want to add or subtract a new button. You can also reorder the buttons. Make sure the button you right-click on is active.
2. From the menu, select **Customize**.

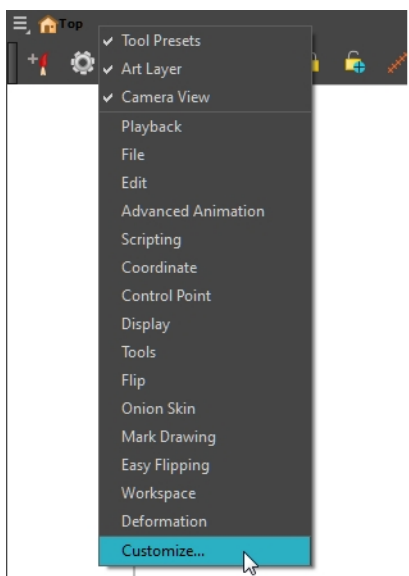

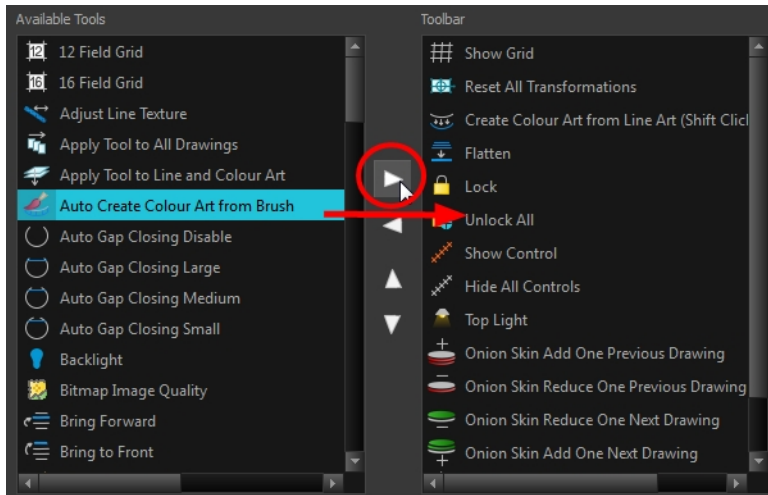

The Toolbar Manager window opens.

3. To add a new icon to your toolbar, select the tool or command from the Available Tools list and click the Right Arrow  button to switch it to the Toolbar list.

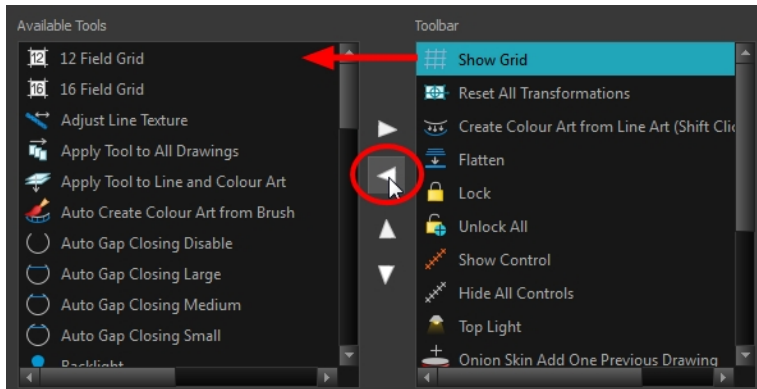

- To remove an icon from your toolbar, select the tool or command in the Toolbar list and click the Left Arrow  button to switch to the Available Tools list.



- To reorder the icons in your toolbar, select the command to be moved from the Toolbar list and click the Up  or Down  buttons to move it to the correct location.

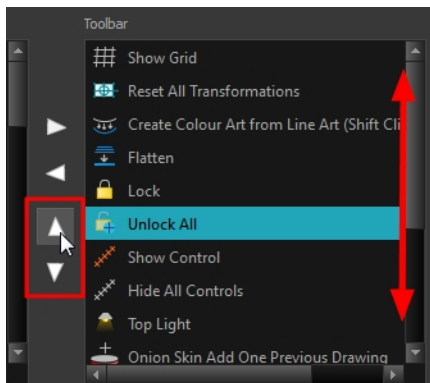

- Click **OK** when you are finished.

### How to use enable the Flat Tool Toolbar preference

1. From the top menu, select **Edit > Preferences** (Windows/Linux) or **Stage Advanced > Preferences** (Mac OS X).
2. In the Preferences dialog box, select the **General** tab.
3. Select the **Flat Tool Toolbar** option.
4. Click **OK**.
5. Save your work and close Harmony.
6. Restart Harmony.

The Tools toolbar no longer contains nested tools.

## Managing the Workspace

The Harmony interface is composed of several views. You can customize your workspace to suit your working style, save it as a new workspace, and load it from the Workspace toolbar.

The first time you open Harmony, the default workspace is loaded. Other workspaces are available such as the Hand-Drawn Animation and Compositing workspaces. These display different views and toolbars. You can access these workspaces, and any others you create, from the Windows menu and the Workspace toolbar.

By default, when you modify the look of a workspace, it is automatically saved. If you prefer to keep your workspaces as they are and only save the modifications when you really want to, you must disable the Automatically Save Workspace option.

The Workspace Manager allows you to modify, create, delete, rename and reorder you workspaces. You can save your workspace as a new version to avoid over-writing the current one. If you do not want to modify the current workspace, use the Workspace Manager to create another one and then modify that one.

You can also restore modified workspaces to their original default layout if you do not like the current modifications or inadvertently closed some windows.

### How to load a workspace

1. Do one of the following:
  - ▶ From the top menu, select **Windows > Workspace > Workspace**.
  - ▶ Select a workspace from the Workspace toolbar.

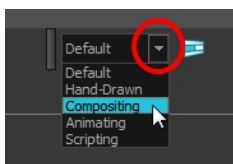

## How to open the Workspace Manager

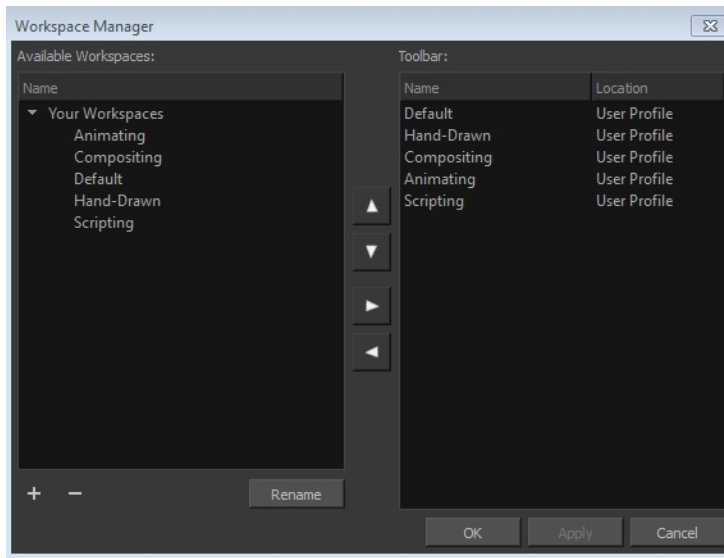

1. Do one of the following:
  - In the Workspace toolbar, click the  button.
  - From the top menu, select **Windows > Workspace > Workspace Manager**.

## How to create a new workspace

1. Open the Workspace Manager.
2. In the Available Workspaces list, select an existing workspace.

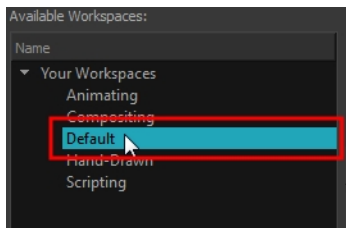

3. At the bottom of the Available Workspaces list, click the Add  button to add a workspace.

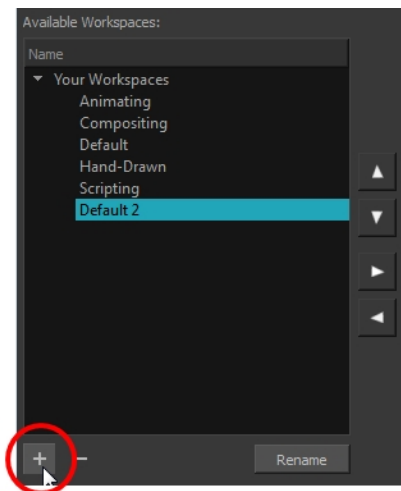

4. Select the new workspace that was created. Click **Rename** and give it a new name.

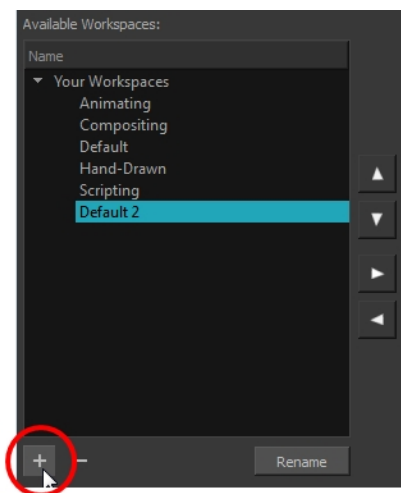

5. Select the new workspace and click the Right Arrow  button to move it to the Workspace toolbar.

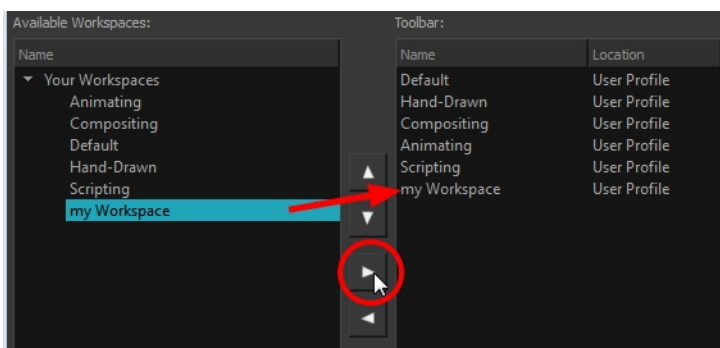

6. Click **OK**.

### How to rename a workspace

1. Open the Workspace Manager.
2. Choose the workspace to be renamed from the list.
3. Double-click on the workspace to be renamed or click the **Rename** button. This allows you to edit the name.

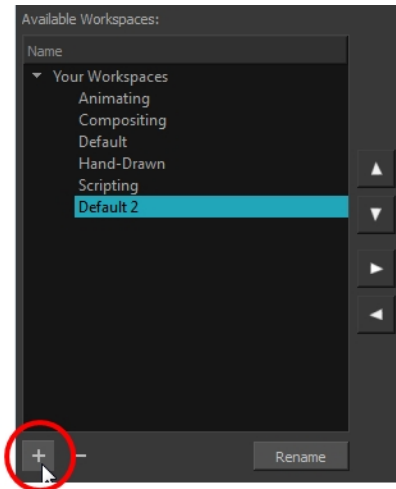

4. Type in the new name of the workspace.
5. Press the Enter/Return key to validate the name.
6. Click **OK**.

### How to disable the Automatically Save Workspace preference

1. From the top menu, select **Edit > Preferences** (Windows/Linux) or **Stage Advanced > Preferences** (Mac OS X) to open the Preferences dialog box.
2. Select the **General** tab.
3. In the Options section, deselect the **Automatically Save Workspace** option.
4. Click **OK**.

The Save Workspace  button appears in the Workspace toolbar.

### How to save a workspace manually

1. Do one of the following:
  - In the Workspace toolbar, click the Save Workspace  button.
  - You can also select **Windows > Workspace > Save Workspace**.



### How to save your workspace as a new version

1. From the top menu, select **Windows > Workspace > Save Workspace As**.

The Save Workspace As dialog box opens.

2. Type in a workspace name and click **OK**.

### How to delete a workspace

1. Open the Workspace Manager.
2. In the Workspace Manager, select the workspace to be deleted and click the Left Arrow  button to move it to the Available Workspaces list.

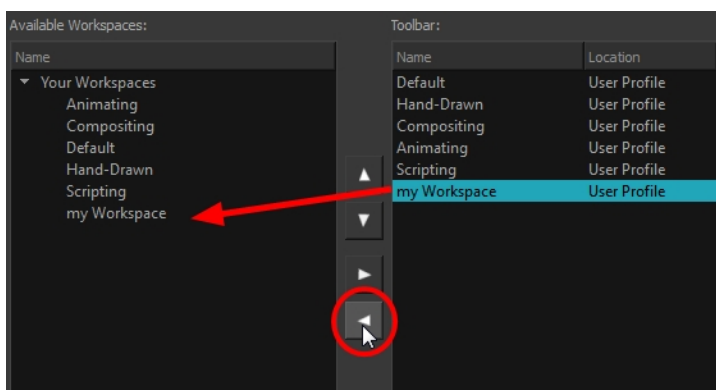

3. Select the workspace from the Available Workspaces list, then click the Delete  button to delete the workspace.
4. Click **OK**.



### How to show a workspace

1. Open the Workspace Manager.
2. In the Available Workspaces list, select the workspace to be displayed and click the Right Arrow  button to move it to the Workspace toolbar.
3. Click **OK**.

### How to hide a workspace

1. Open the Workspace Manager.
2. In the Workspace Manager, select the workspace to be hidden and click the Left Arrow  button to move it to the Available Workspaces list.
3. Click **OK**.

### How to reorder workspaces

1. Open the Workspace Manager.
2. In the Workspace toolbar, select the workspace to be reordered and on the Up  or Down  buttons to move it up or down.

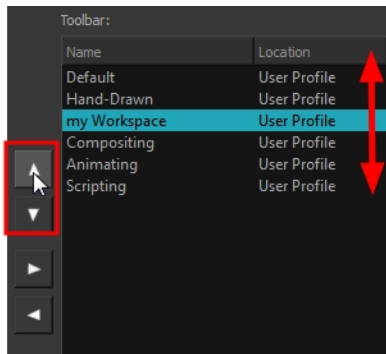

3. Click OK.

### How to restore the default workspaces

- ▶ From the top menu select **Windows > Restore Default Workspace**.

## View References

Harmony contains a series of views that are each focused on a specific set of tasks. Here are the views available:

- Camera view
- Colour view
- Drawing view
- Function view
- Layer Properties view
- Library view
- Message Log view
- Model view
- Perspective view
- Script Editor views
- Side view
- Timeline view
- Tool Properties view
- Top view
- Xsheet view

## Camera View

The Camera view is the centre of operations in Harmony. In this view, you will draw, paint, animate, create animation paths and see your results. You can also move through your symbol's hierarchy.

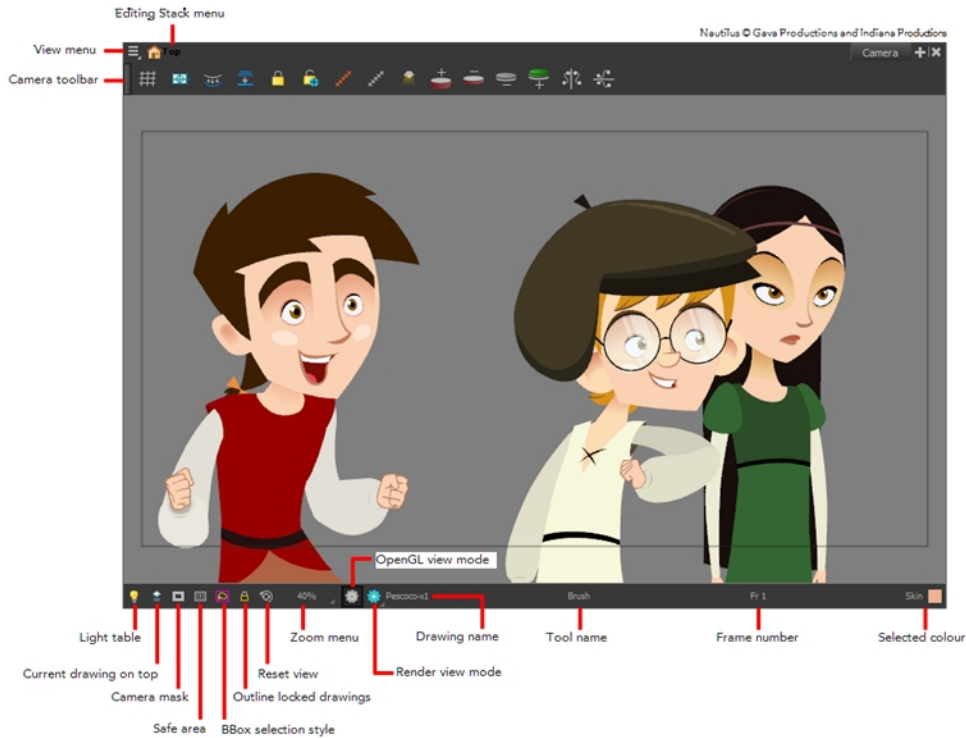

The Camera view has a top and bottom toolbar that you can use to navigate in the view, change the display mode, or go back up your symbols hierarchy.

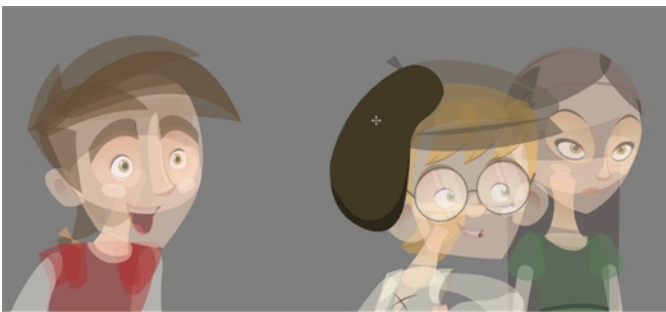

## Light Table



Nautilus © Gava Productions and Indiana Productions

When you have a drawing layer or drawing selected, the Light Table button  button allows you to fade the colours of the other layers so you can see the current artwork better as you edit with a drawing tool. Note that the light table does not work when using a layer editing tool, such as the Transform  tool.

### Current Drawing on Top



Nautilus © Gava Productions and Indiana Productions

When this button is enabled, the drawing that you are currently editing with a drawing tool is temporarily displayed in front of all the other elements. The actual scene is not modified.

### Camera Mask



Nautilus © Gava Productions and Indiana Productions

The Camera Mask  button shows or hides a black mask around the scene's frame to avoid seeing the unnecessary artwork. This option is handy when you're animating and setting up the scene. It allows you to see your scene's composition better.

You can also access this from the top menu by selecting **View > Show > Camera Mask**.

### Safe Area



Nautilus © Gava Productions and Indiana Productions

The Safe Area  button shows or hides the TV safety zone and the centre of the camera frame. The safe area adapts to the scene resolution, as well as the safety zone and frame's centre.

You can also access this feature from the top menu by selecting **View > Show > Safe Area**.

## BBox Selection Style

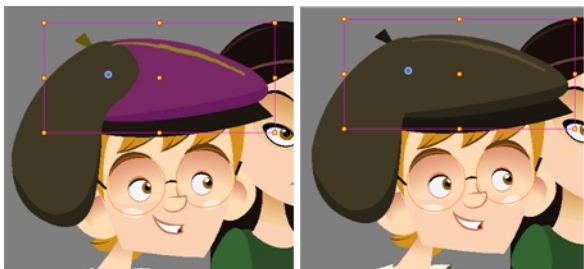

Neotilus © Geva Productions and Indiana Productions

When you select an object in the Camera view with the Transform tool, a bounding box always appears around the object and the artwork is tinted in fuchsia, red or yellow. Enabling this option will only keep the bounding box and remove the colour tint.

## Outline Locked Drawings



Neotilus © Geva Productions and Indiana Productions

Drawings that are locked in the Timeline view (cannot be selected in the Camera view) are displayed as wireframes.

## Reset View

The Reset View  button resets any panning, zooming or rotation done in the Camera view and returns the display to the initial settings. You can also press Shift + M.

## Zoom Menu

The Zoom menu lets you enlarge or reduce the Camera or Drawing view display.

To make the camera frame size always match the size of your view, select the **Fit to View** option. Click the drop-down arrow and select a zoom level or press 1 and 2.

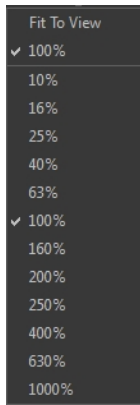



### OpenGL View Mode



The OpenGL View Mode  button switches the Camera view to fast display, letting you see your animation play in real time. The OpenGL display requires less memory. The final look of your effects is not shown in the OpenGL View Mode. You must switch to the Render View Mode to see your effects.

### Render View Mode



The Render View Mode  button switches the Camera view to a fully rendered display showing the final image of the current frame. If a modification is done to your current frame or if you move to a different frame, click the **Update Preview** button to update the display if your preview does not update automatically. The Render View Mode display lets you see the final look of your frames including effects and antialiasing. You cannot play back your scene in Render View Mode. To see your scene fully rendered and to play it back, you must press the Render and Play  button in the Playback toolbar.

### Matte View Mode

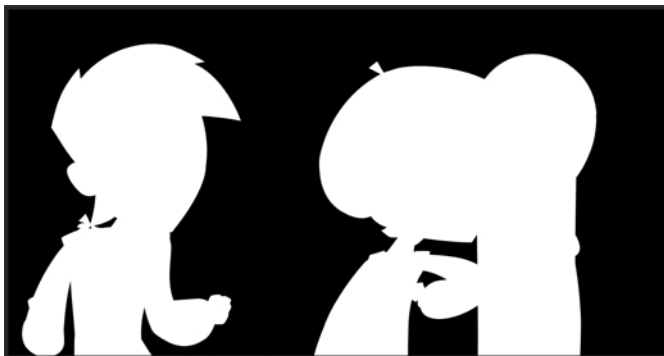

Neutilus © Gava Productions and Indiana Productions

The Matte View Mode  button switches the Camera view to a matte display showing the alpha channel of the elements in your scene. The transparency level ranges from 0 to 100 percent. Zero percent is completely transparent and represented by black and 100 percent is completely opaque and represented by white. Everything in between these extremes has a transparency level somewhere between 1 and 99 percent and is represented in various shades of grey.

- ▶ To access the Matte View mode, click on the Render View  button and select Matte View  from the drop-down menu.

### Drawing Name

The Drawing Name field displays the name of the selected drawing, as well as the layer containing it. If the cell does not contain any drawing, an **Empty Cell** text is shown in the field.

### Tool Name

The Tool Name field displays the name of the selected tool. If you temporarily override a drawing tool using a keyboard shortcut, the tool's name will be highlighted in red. You can temporarily override a tool by holding its keyboard shortcut without the [Alt] key. For example, the Select tool shortcut is Alt + S. If you hold down the S key, you will switch to the Select tool. When you release the key, you will return to the tool you were using.

### Frame Number

The Frame Number field displays the number of the current frame.

### Selected Colour

The colour swatch displays the currently selected colour in the Colour view.

## Camera Toolbar

The Camera View toolbar contains all the tools and options you can use in the Camera view to draw, animate or set up the scene. The toolbar can be displayed or hidden by right-clicking on it and selecting or deselecting the Camera View toolbar.

## View Menu

The View menu contains all the tools and options that you can use in the Camera view to draw, animate or set up the scene.

## Editing Stack Menu

The Editing Stack menu displays the names of the symbols and their hierarchy when you are editing a symbol. You can click on the different names to go back up to the different parent symbols or the top/current project.

## Colour View

The Colour view is where you create colours and palettes and import existing palettes into your project. The Colour view is also necessary for drawing, painting and creating colour styling.

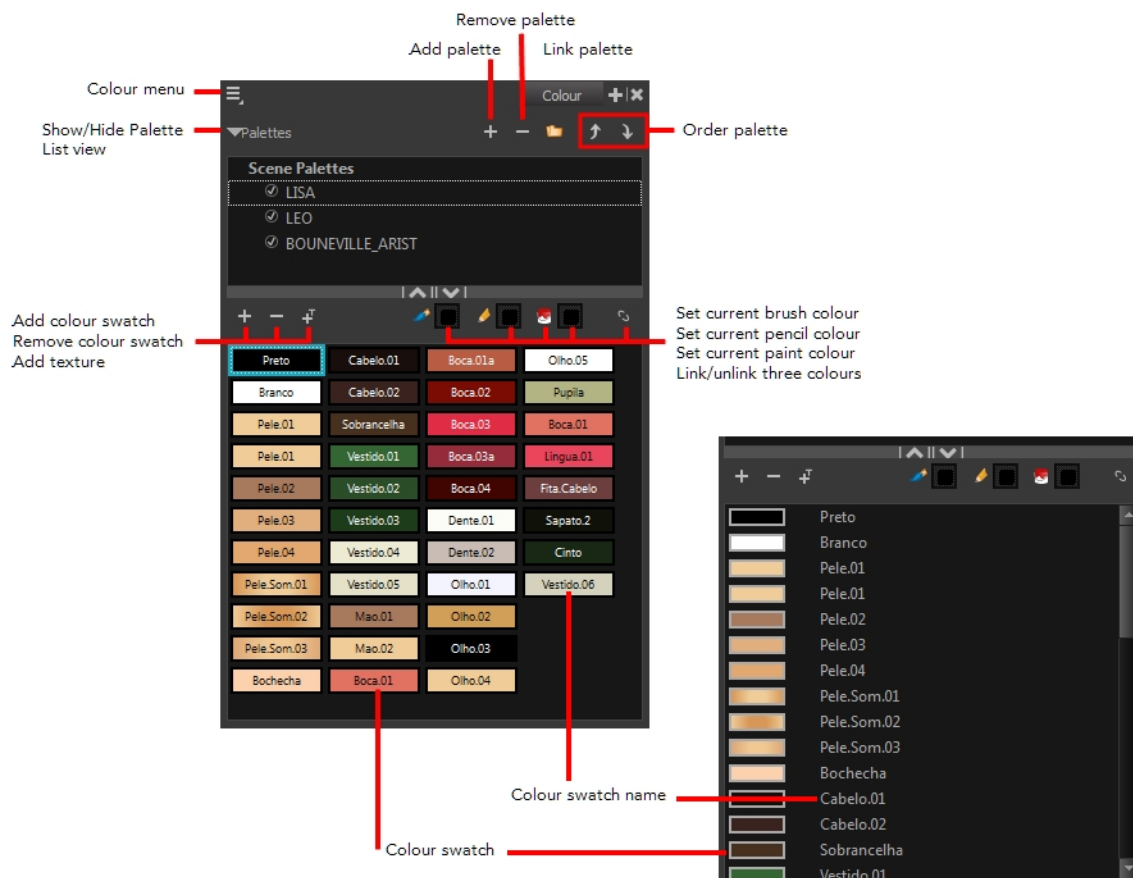

The Colour view has two display modes:

- List mode



- Swatch mode

## How to switch between the display modes

1. From the Colour menu, select **Colours > Swatch Mode** and do one of the following:

- Select the option to display the swatches.
- Deselect the option to display the colour list.

When you are painting on bitmap layers, the Colour view will look like the following. It contains a subset of the tools available when working with vector layers.

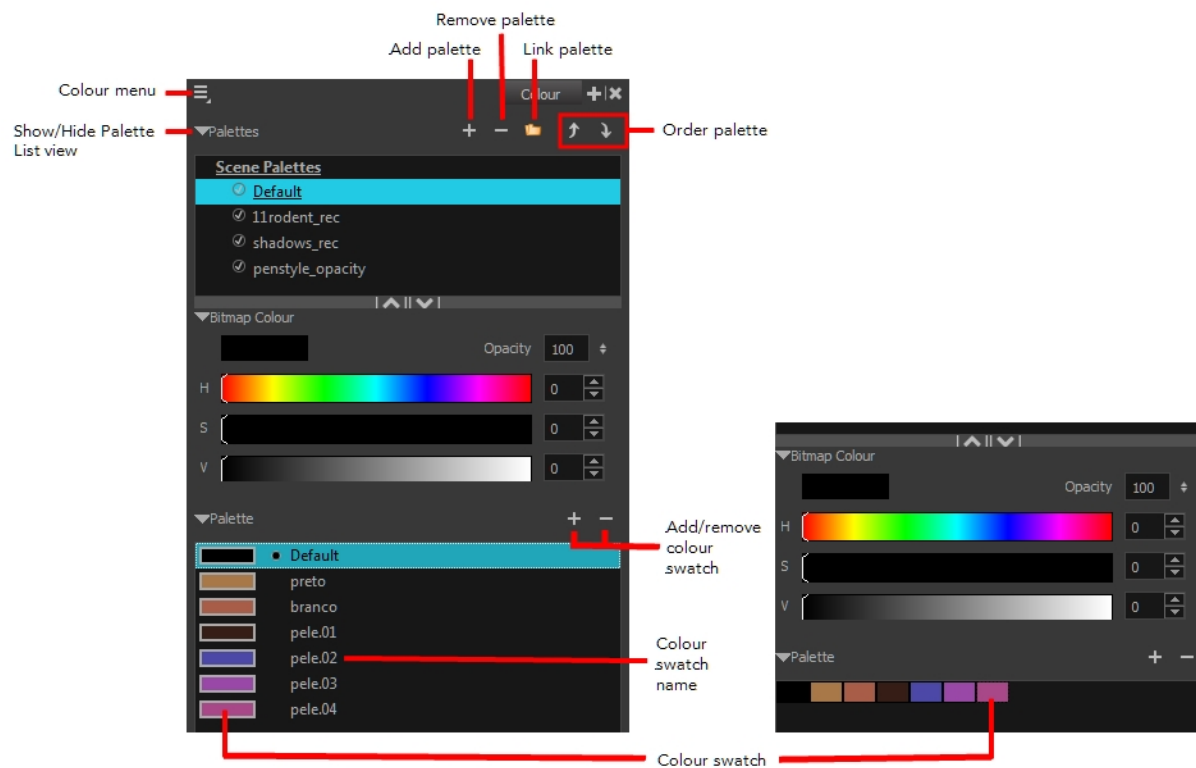

## Add Colour

The Add Colour **+** button lets you add a new colour swatch to the bottom of your colour list.

## Remove Colour

The Remove Colour **-** button lets you delete the currently selected colour swatches. If the colour swatch is used in your project, the Delete Colour dialog box will appear asking you to confirm the operation.

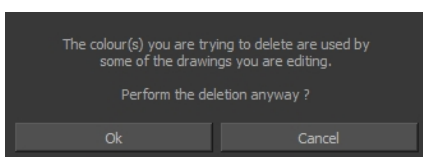

- Click **OK** to confirm the operation or **Cancel** to cancel it.

Zones painted with colour swatches which have been deleted will turn red, easily identifying them so you can repaint them with another colour swatch.



Nautilus © Gava Productions and Indiana Productions



### Add Texture









Nautilus © Gava Productions and Indiana Productions

The Add Texture  button lets you add a bitmap colour swatch to your palette. You can load photos and textures and paint your drawings with it. The bitmap image must be a .tga or .psd file format.



### Set Current Brush Colour

The Set Current Brush Colour  button let you set the currently selected colour swatch as the colour used by the Brush  tool. If you select a new colour in the Colour view while using the Brush tool, the Set Current Brush Colour swatch will be updated.

### Set Current Pencil Colour

The Set Current Pencil Colour  button lets you set the currently selected colour swatch as the colour used by the Pencil , Polyline , Ellipse , Rectangle  and Line  tools. If you select a new colour in the Colour view while using any of these tools, the Set Current Pencil Colour swatch will be updated.

### Set Current Paint Colour

The Set Current Paint Colour  button lets you set the currently selected colour swatch as the colour used by the Brush  tool. If you select a new colour in the Colour view while using the Paint tool, the Set Current Paint

Colour swatch will be updated.

### Link/Unlink Three Colours

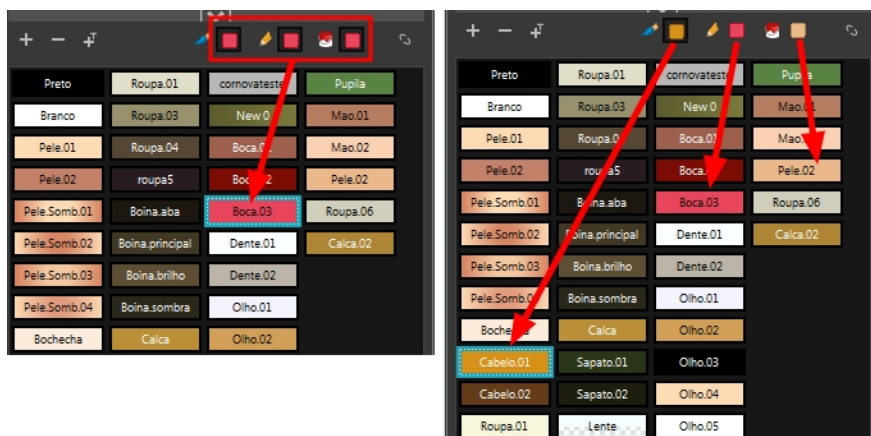

The Link/Unlink Three Colours  button lets you link the Set Current Brush Colour, Set Current Pencil Colour and Set Current Paint Colour swatches to the currently selected colour swatches in the Colour view.

### Show/Hide Palette List View

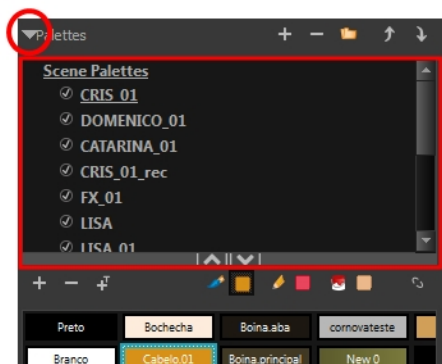

The Show/Hide Palette List View button lets you display the Palette List view in the Colour view. This option is for the advanced user who wants to create colour palettes for their props and characters.

### Colour Swatch Name

	Skin
	Teeth
	Horns
	Helmet

Each colour swatch available in the Colour view can have its own name, making it easy to identify which colour is used to paint what part of your character or background.

Two colours can have the same name.

## Colour Swatch



A colour swatch is a specific colour used to paint a certain zone of a character or background. Colour palettes are composed of colour swatches. They can also be called *colour pots*. When you paint a zone with a colour swatch, the zone is linked to the swatch. So if you update the swatch's tint, the zone will be updated along with it. This allows you to modify your animation colours even after it is completely painted.

## Colour Menu

The Colour menu lets you access commands related to the Colour view such as creating new palettes, adding new colour swatches, and displaying the Tint panel.

## Add Palette

The Add Palette  button lets you add a new palette to the bottom of your palette list.

## Remove Palette

The Remove Palette  button lets you delete the currently selected palette. If the colour swatch is used in your project, zones painted with colour swatches which have been deleted will turn red, easily identifying them so you can repaint them with another colour swatch.



Nautilus © Gave Productions and Indiana Productions

## Link Palette

The Link Palette  button lets you access other palettes created in the project and link them to your scene.

## Order Palette List

The Up and Down arrows let you reorder the selected palette. When using clone palettes (colour styles), the highest palette in the list will override its clone located lower in the list.

## Drawing View

In Harmony, you can draw in the Drawing or Camera view. Although the two views are similar, when it comes to drawing, there are some differences.

Only the selected drawing is displayed by default in the Drawing view. You can use features, such as the light table to display the current drawing of all the enabled layers of your scene in washed-out colours, or the Onion Skin to display the previous and next drawings of the currently selected drawing layer.

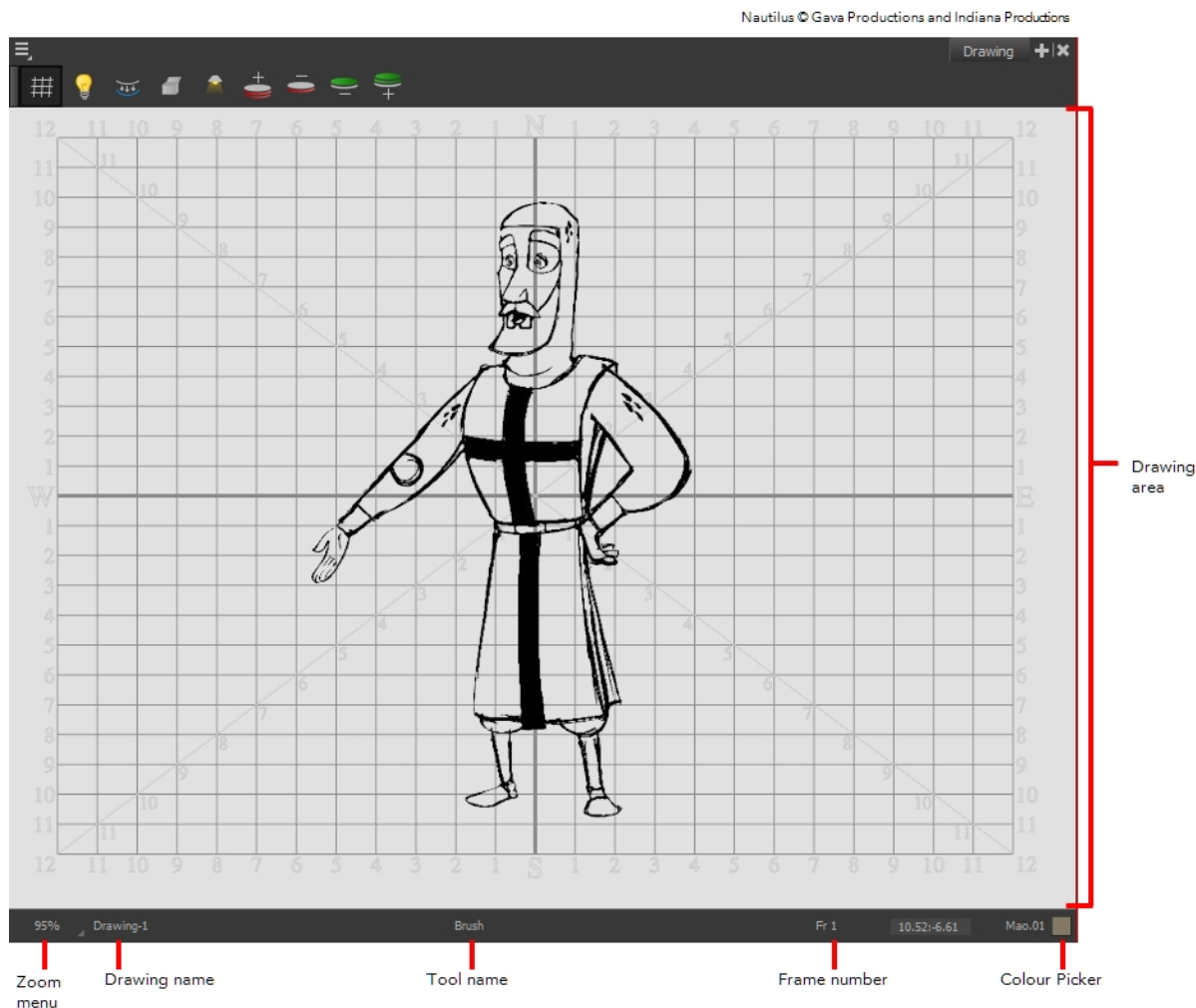

### Drawing Area

This is the main space in the Drawing view. It is where you draw and where the drawings are displayed.

### Zoom Menu

The Zoom menu lets you enlarge or reduce the Camera or Drawing view display.

To make the camera frame size always match the size of your view, select the **Fit to View** option. Click the drop-down arrow and select a zoom level or press 1 and 2.

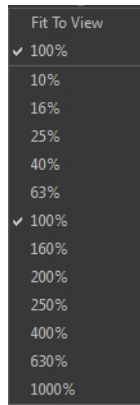

### Drawing Name

The Drawing Name field displays the name of the selected drawing, as well as the layer containing it. If the cell does not contain any drawing, an **Empty Cell** text is shown in the field.

### Tool Name

The Tool Name field displays the name of the selected tool. If you temporarily override a drawing tool using a keyboard shortcut, the tool's name will be highlighted in red. You can temporarily override a tool by holding its keyboard shortcut without the [Alt] key. For example, the Select tool shortcut is Alt + S. If you hold down the S key, you will switch to the Select tool. When you release the key, you will return to the tool you were using.

### Frame Number

This field displays the current frame of the animation you are working on.

### Cursor Coordinates

This indicates the position of the your pointer in the drawing area.

### Colour Picker

The Colour Picker allows you to select a colour for drawing.

## Function View

The Function view lets you edit function curves and parameters. It is a visual graph for adding, removing, and editing keyframes, as well as adjusting the velocity. The Function view allows you to display multiple functions in the background as a reference.

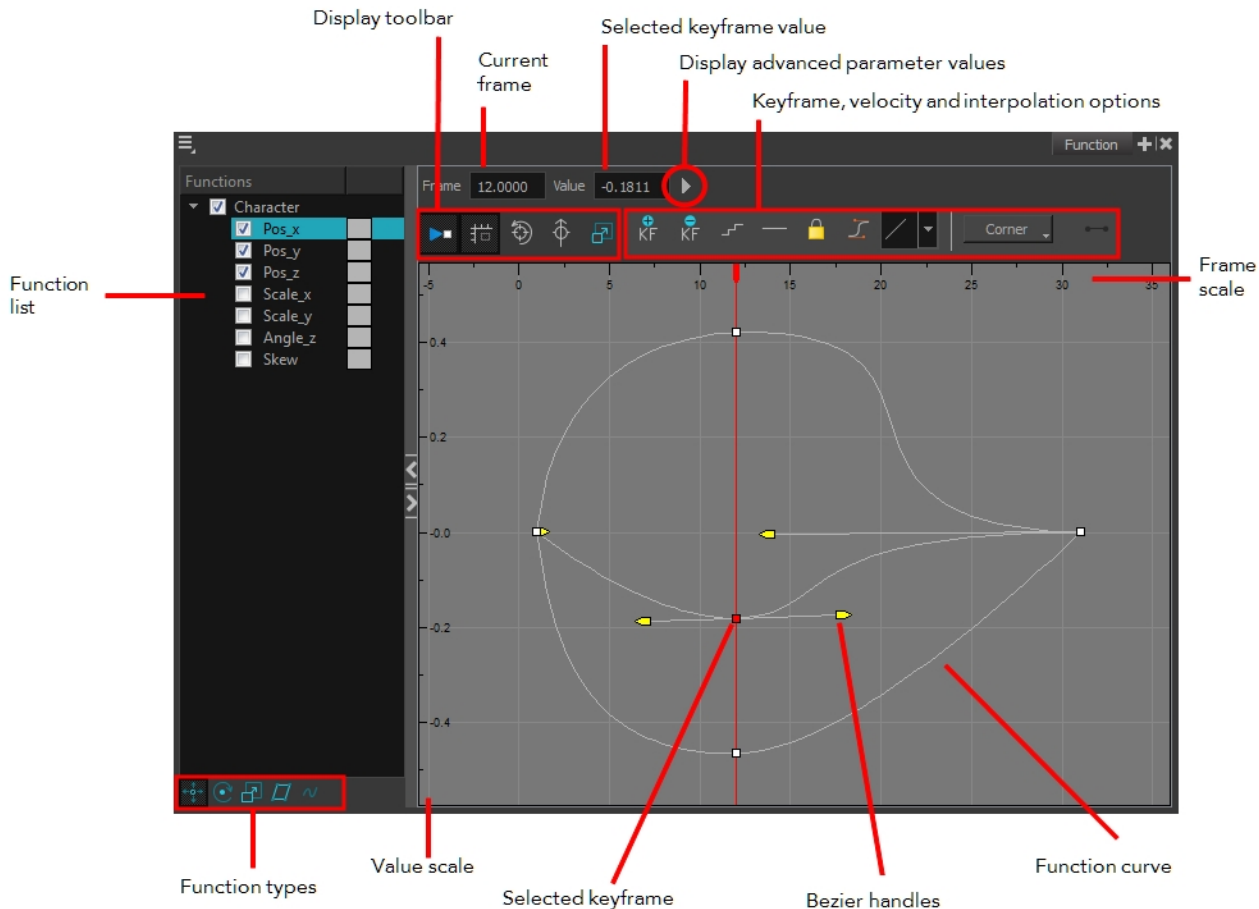

### How to display functions in the Function view

1. Open the Function view.  
The Function view is blank until you select the layer containing the functions you want to display.
2. To display a function in the Function view, click on the layer containing the functions to adjust in the Timeline view.
3. To select the functions you want to edit, select them in the Function list.

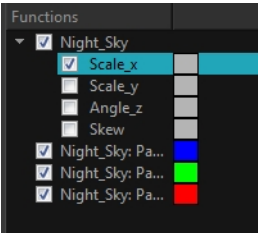
Parameter	Description
Function List	 <p>When selecting a layer in the Timeline view, all the corresponding functions are displayed. Select all the functions you want to see and edit; hide the ones you</p>

	don't.
Display Toolbar	The Display toolbar allows you to modify how the editing area is displayed. You can hide the grid, disable the synchronization with the current frame, reset the zoom level and normalize the function display by stacking them one over the other to compare them regardless of their value range.
Current Frame	Displays the current scene frame.
Selected Keyframe Value	Displays the value of the selected keyframe.
Display Advanced Parameter Values	 <p>Displays the Projection, Bias, Tension and Continuity parameters to adjust the curve around the selected keyframe.</p>
Keyframe, Velocity and Interpolation Options	This toolbar lets you add and delete keyframes, adjust the velocity curve, adjust the segments to motion or stop-motion keyframes and set the velocity to create steps instead of a constant progression.
Function Types	This toolbar lets you click on the different function types to enable or disable all the listed functions of that type.
Value Scale	Displays the value range for the displayed editing area. It can be referenced to know the value of a keyframe.
Selected Keyframe	The selected keyframe is displayed in red. When selected, the keyframe values are displayed in the corresponding fields.
Bezier Handles	The Bezier handles let you adjust the ease in and ease out of each keyframe. The more the handle is pulled out horizontally, the slower the animation will be. The more the handle is pulled out vertically, the faster the animation will be.
Function Curve	The thin line going from keyframe to keyframe is the actual curve. The section of a curve located between two keyframes is called a segment.
Frame Scale	The Frame Scale displays the frame range for the displayed editing area. It can be referenced to know the current frame of a keyframe.

## Layer Properties Editor

Each layer has its own set of properties that can be modified, including effect and peg layers. Display the Layer Properties editor if you want to modify some of the layer's properties such as the name or the antialiasing quality. You can display the editor by double-clicking a layer in the Timeline view.



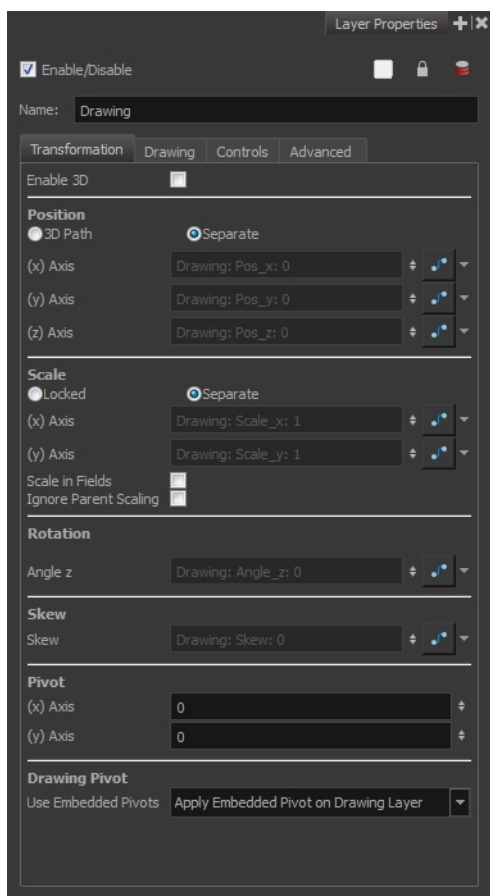

## Library View

The Library view is used to store elements such as animation, drawings, backgrounds and puppets to reuse in different projects. You can also use the Library view to create and store symbols.

To reuse an element from another project, you must create a template from your drawings. A template is a mini scene that you import in other projects. A template has no link to the original scene. When you create a template, the full content of your selection is copied in the template.

You also have the possibility to create symbols. These can be used as drawing containers when you are creating puppets so you can store different mouth shapes or hands to use while animating. Note that drawing layers already have this capability without being a symbol. You can also use symbols when you are building props, such as a skateboard that has a wheel you want to reuse for the four skateboard wheels.

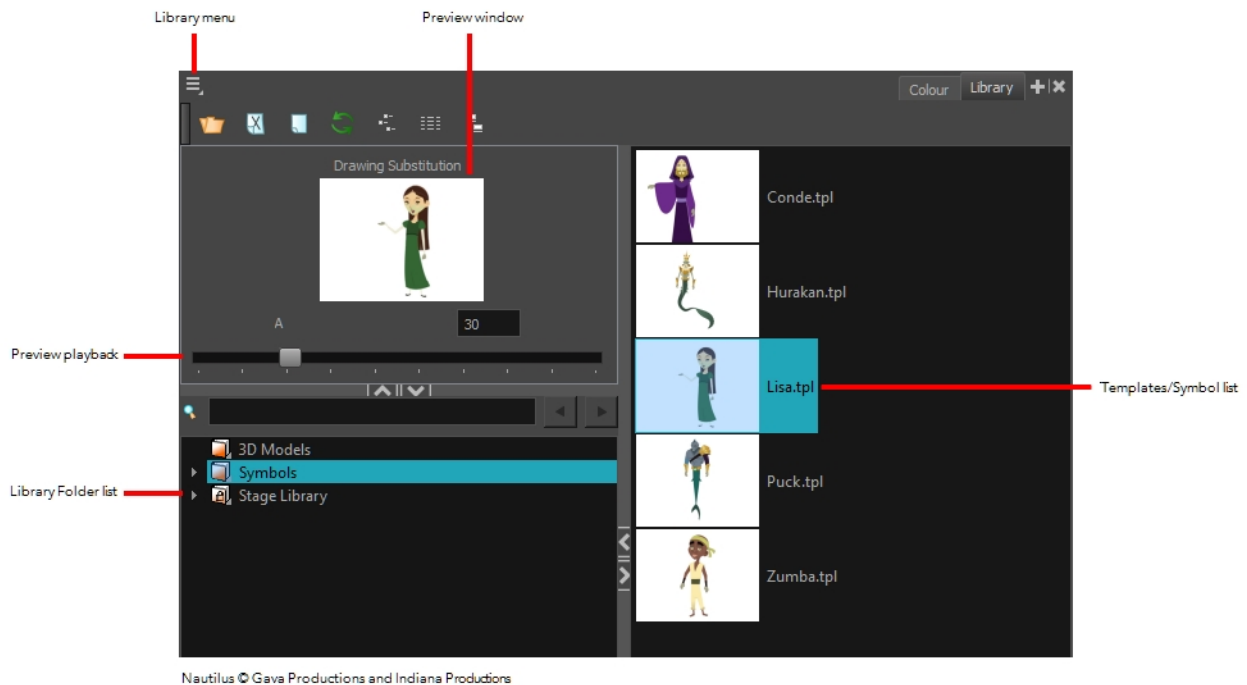

### Library Menu

The Library menu lets you access commands related to the Library view, importing .swf movies and Illustrator files, add a new folder, and refresh the library's content.

### Preview Window

The Preview window lets you see the content of the currently selected template or symbol in the Template/Symbol list.

### Preview Playback

The Preview Playback button lets you play back the content of the selected template or symbol if it contains more than one frame. Press the Play ► button to play back the preview.

### Library Folder List

The Library Folder List displays all the folders linked to the Library view. There are two default folders:

- **Symbols:** This folder is the only folder containing symbols. You can organize it by adding subfolders inside.
- **Stage Advanced Library:** This is a default folder found on the hard drive in your user documents. This folder can contain templates, but no symbols.

You can link new library folders to the Library view and organize them with subfolders.

## Template/Symbol List

The Template/Symbol list displays the templates or symbols contained in the selected library folder. You can display the templates by right-clicking the symbols' thumbnails and selecting **View > Thumbnails**.

## Message Log View

The Message log view displays information gathered during a render task, such as which frames and at what time they were each rendered. The view also contains a list of the colour recovery operations.

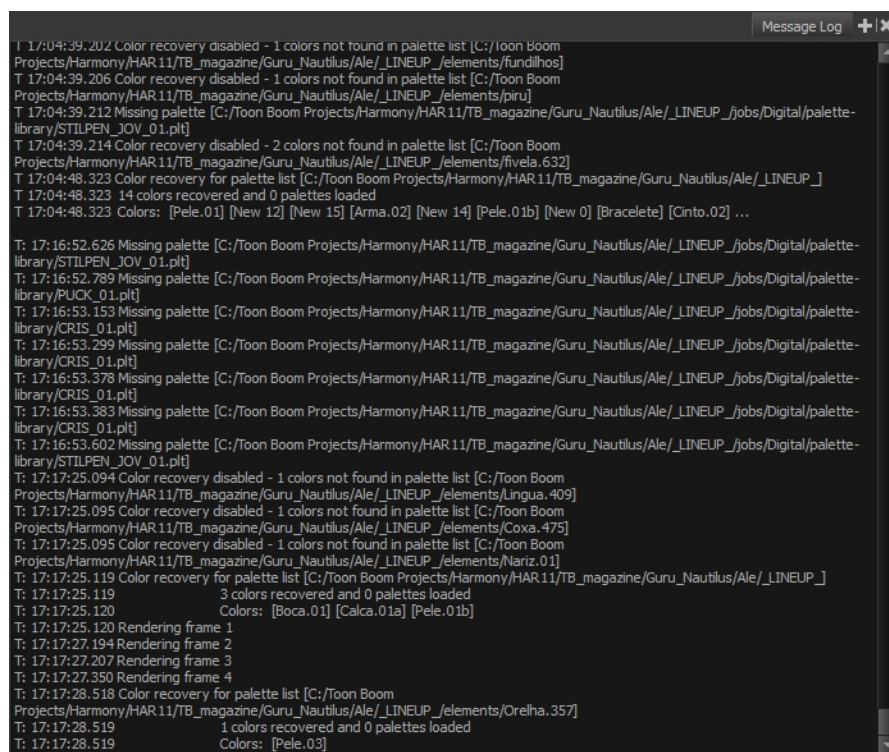

```

Message Log + X
T 17:04:39.202 Color recovery disabled - 1 colors not found in palette list [C:/Toon Boom
Projects/Harmony/HAR11/TB_magazine/Guru_Nautilus/Ale/_LINEUP_/elements/fundilhos]
T 17:04:39.206 Color recovery disabled - 1 colors not found in palette list [C:/Toon Boom
Projects/Harmony/HAR11/TB_magazine/Guru_Nautilus/Ale/_LINEUP_/elements/piru]
T 17:04:39.212 Missing palette [C:/Toon Boom Projects/Harmony/HAR11/TB_magazine/Guru_Nautilus/Ale/_LINEUP_/jobs/Digital/palette-
library/STILPEN_JOV_01.plt]
T 17:04:39.214 Color recovery disabled - 2 colors not found in palette list [C:/Toon Boom
Projects/Harmony/HAR11/TB_magazine/Guru_Nautilus/Ale/_LINEUP_/elements/fivela.632]
T 17:04:48.323 Color recovery for palette list [C:/Toon Boom Projects/Harmony/HAR11/TB_magazine/Guru_Nautilus/Ale/_LINEUP_]
T 17:04:48.323 14 colors recovered and 0 palettes loaded
T 17:04:48.323 Colors: [Pele.01] [New 12] [New 15] [Arma.02] [New 14] [Pele.01b] [New 0] [Bracelete] [Cinto.02] ...

T: 17:16:52.626 Missing palette [C:/Toon Boom Projects/Harmony/HAR11/TB_magazine/Guru_Nautilus/Ale/_LINEUP_/jobs/Digital/palette-
library/STILPEN_JOV_01.plt]
T: 17:16:52.789 Missing palette [C:/Toon Boom Projects/Harmony/HAR11/TB_magazine/Guru_Nautilus/Ale/_LINEUP_/jobs/Digital/palette-
library/PUCK_01.plt]
T: 17:16:53.153 Missing palette [C:/Toon Boom Projects/Harmony/HAR11/TB_magazine/Guru_Nautilus/Ale/_LINEUP_/jobs/Digital/palette-
library/CRIS_01.plt]
T: 17:16:53.299 Missing palette [C:/Toon Boom Projects/Harmony/HAR11/TB_magazine/Guru_Nautilus/Ale/_LINEUP_/jobs/Digital/palette-
library/CRIS_01.plt]
T: 17:16:53.378 Missing palette [C:/Toon Boom Projects/Harmony/HAR11/TB_magazine/Guru_Nautilus/Ale/_LINEUP_/jobs/Digital/palette-
library/CRIS_01.plt]
T: 17:16:53.383 Missing palette [C:/Toon Boom Projects/Harmony/HAR11/TB_magazine/Guru_Nautilus/Ale/_LINEUP_/jobs/Digital/palette-
library/CRIS_01.plt]
T: 17:16:53.602 Missing palette [C:/Toon Boom Projects/Harmony/HAR11/TB_magazine/Guru_Nautilus/Ale/_LINEUP_/jobs/Digital/palette-
library/STILPEN_JOV_01.plt]
T: 17:17:25.094 Color recovery disabled - 1 colors not found in palette list [C:/Toon Boom
Projects/Harmony/HAR11/TB_magazine/Guru_Nautilus/Ale/_LINEUP_/elements/Lingua.409]
T: 17:17:25.095 Color recovery disabled - 1 colors not found in palette list [C:/Toon Boom
Projects/Harmony/HAR11/TB_magazine/Guru_Nautilus/Ale/_LINEUP_/elements/Coxa.475]
T: 17:17:25.095 Color recovery disabled - 1 colors not found in palette list [C:/Toon Boom
Projects/Harmony/HAR11/TB_magazine/Guru_Nautilus/Ale/_LINEUP_/elements/Nariz.01]
T: 17:17:25.119 Color recovery for palette list [C:/Toon Boom Projects/Harmony/HAR11/TB_magazine/Guru_Nautilus/Ale/_LINEUP_]
T: 17:17:25.119 3 colors recovered and 0 palettes loaded
T: 17:17:25.120 Colors: [Boca.01] [Calca.01a] [Pele.01b]
T: 17:17:25.120 Rendering frame 1
T: 17:17:27.194 Rendering frame 2
T: 17:17:27.207 Rendering frame 3
T: 17:17:27.350 Rendering frame 4
T: 17:17:28.518 Color recovery for palette list [C:/Toon Boom
Projects/Harmony/HAR11/TB_magazine/Guru_Nautilus/Ale/_LINEUP_/elements/Orelha.357]
T: 17:17:28.519 1 colors recovered and 0 palettes loaded
T: 17:17:28.519 Colors: [Pele.03]

```

## Model View

Once you have a fully painted drawing, you can use it as a colour model and load it in the Model view. This drawing can be used and loaded in any of your Harmony scenes.

Once a drawing is loaded in the Model view, you can use the Dropper  tool to select a colour from the model and use it to paint in the Camera or Drawing view without having to pick the colour from the colour palette.





Erik, Di-Gata Defenders © Nelvana Limited, Corus® Entertainment Inc.

## Perspective View

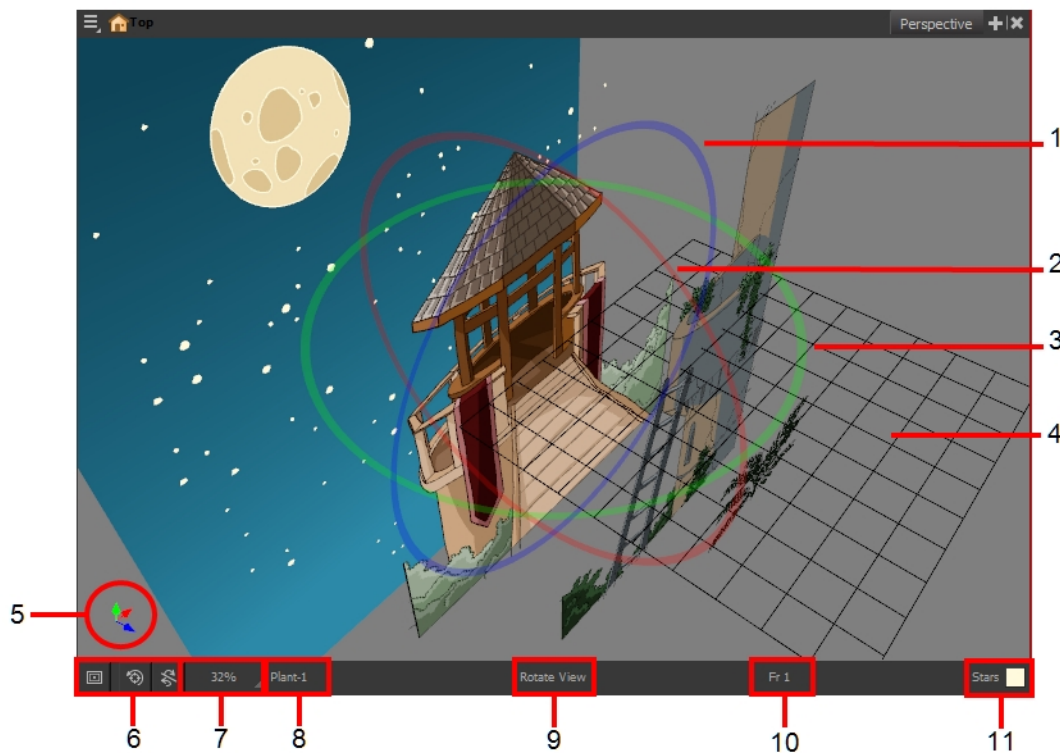
The Perspective view is used during scene setup. It allows you to see a multiplane scene's orientation. The Perspective view is similar to a 3D display, as it lets you rotate the scene through all possible angles to understand the spacing between the elements. You can also position and rotate your layers and the camera inside the 3D display to achieve some 3D setup and camera moves.



1. The red circle rotates the view on its X axis.
2. The green circle rotates the view on its Y axis.
3. The blue circle rotates the view on its Z axis.
4. This is a perspective grid reference.
5. The axis reference arrows let you maintain your orientation when navigating in the Perspective view.
6. There are three view option buttons displayed in the lower-left corner of the view.
  - ▶  **Show/Hide Camera:** Shows or hides camera frame in the Perspective view.
  - ▶  **Reset View:** Resets the pan, rotation, and zoom of the Perspective view.
  - ▶  **Reset Rotation:** Resets the rotation of the Perspective view.
7. This field displays the current zoom level in the Perspective view. You can use the Zoom level drop-down menu to select a specific zoom level from the list. Zoom levels from 2.5% to 6400% are available; you can also select Fit To View to automatically use a zoom level that lets you see all your scene layers and information in the Perspective view at once.

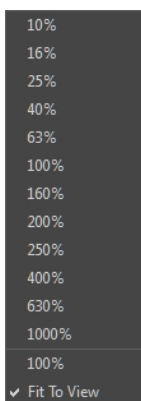

8. This field displays the currently selected layer and drawing name.
9. This field displays the currently selected tool.
10. This field displays the currently selected frame of your animation.
11. This field displays the currently selected colour in the palette.

### How to rotate a scene in the Perspective view

1. In the Tools toolbar, select the Rotate View  tool.
  - ▶ Click in the view, and drag the cursor around to rotate the view.
  - ▶ Press and hold Ctrl + Alt (Windows/Linux) or ⌘ + Alt (Mac OS X) and click and drag to rotate the view one axis at a time.

## Script Editor View

Qt Script provides access to many of the functions supported in the interface. With Qt Script, you can automate a number of Harmony functions to speed the completion of various repetitive tasks. The Script Editor view allows you to edit existing scripts and create new ones. Refer to the Scripting guide to learn more about scripting with Harmony.

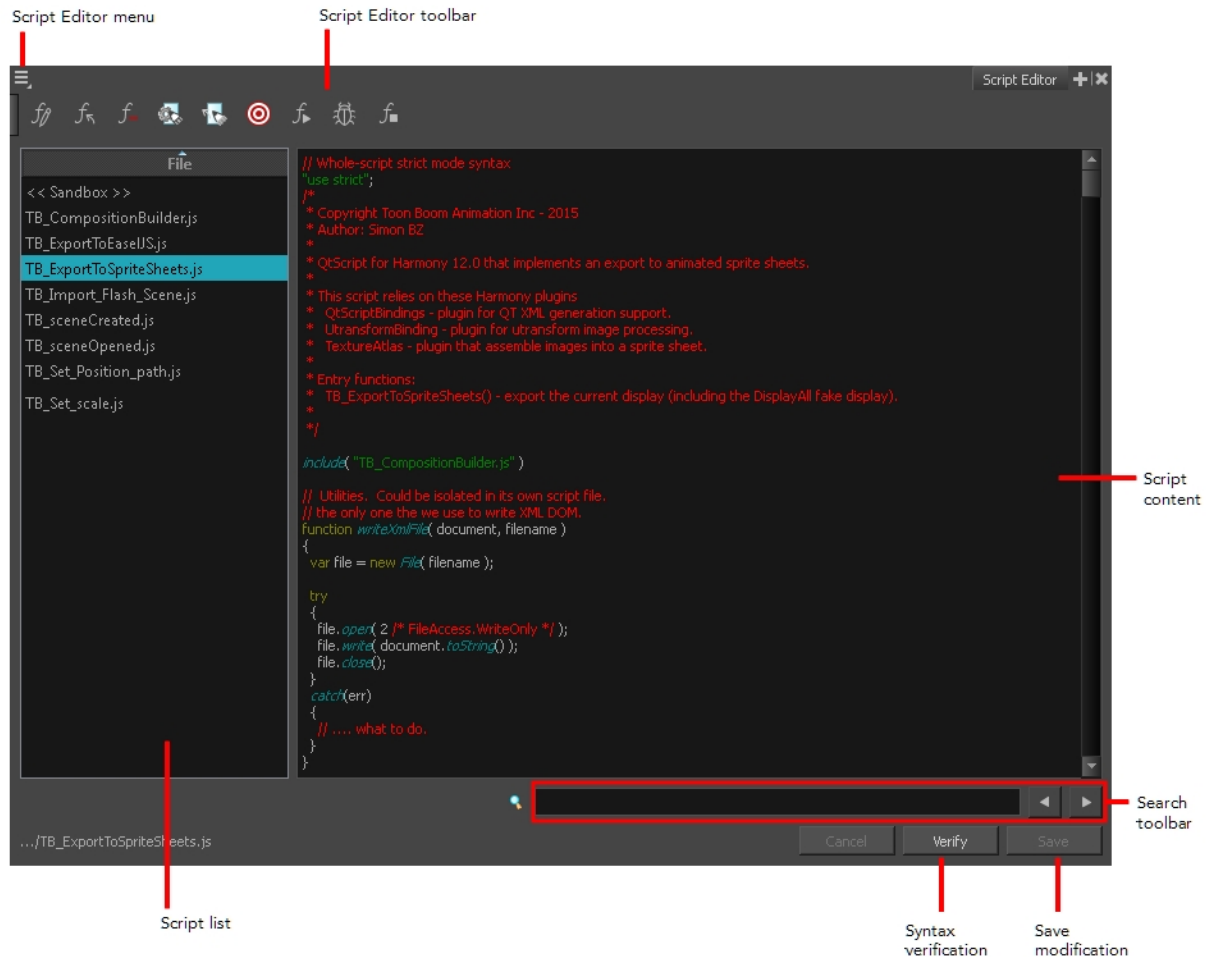

### Script List

On the left side of the Script Editor view, all existing script files are listed and can be modified in this view. The script format is JavaScript. Click on a file to display its content in the Script Content window of the view.

### Script Content

On the right side of the Script Editor view, the contents of the selected script are displayed and can be edited.

### Search Toolbar

The Search toolbar allows you to search a string within the selected script content. You can use the Previous and Next buttons to navigate through the results.

## Verify

This function verifies the syntax of the currently displayed script and lists any error found.



## Save

Once you are satisfied with the modifications made to the script, click **Save Changes** to save the modifications.

## Side View

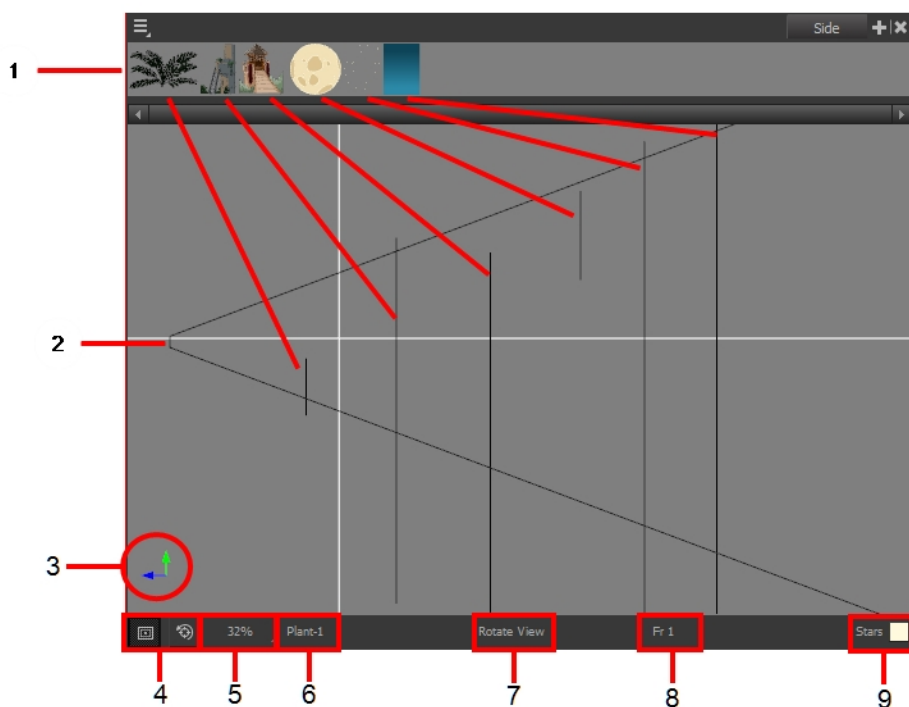
The Side view is used mainly for multiplane scenes and to position elements in 3D space. It allows you to see a scene's stage from the side. This lets the camera cone and spacing between the elements to be seen.



1. A thumbnail of each drawing layer in the scene. The order of the thumbnail images is based on each element's FB position in the scene space. You can see a representation of the FB position of each layer in the camera cone.
2. The camera cone represents the camera's position and field-of-view (FOV).
3. The axis reference arrows let you maintain your orientation when navigating in the Perspective view.
4. There are two view option buttons displayed in the lower-left corner of the view.
  - ▶  **Show/Hide Camera:** Shows or hides the camera frame in the Perspective view.
  - ▶  **Reset View:** Resets the pan, rotation and zoom of the Perspective view.
5. This field displays the current zoom level in the Perspective view. You can use the Zoom menu to select a zoom level from 2.5% to 6400%. You can also select Fit To View to automatically use a zoom level that lets you see all of the scene layers and information in the Perspective view at once.

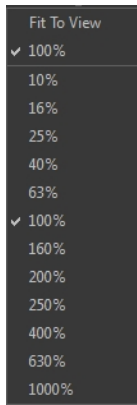

6. Displays the currently selected layer and drawing name.
7. Displays the currently selected tool.
8. Displays the currently selected frame of your animation.
9. Displays the currently selected colour in the palette.

## Timeline View

To set your animation timing, you will mostly work with the Timeline and Xsheet views. It's extremely useful to become familiar with the Timeline view, how it works, and its interface.

The Timeline view is the main view used when adjusting the timing of drawings, adding keyframes and ordering layers. The Timeline view displays layers, effects, sounds, keyframe values, scene length, layer names, drawings, keyframes, timing, and frames.

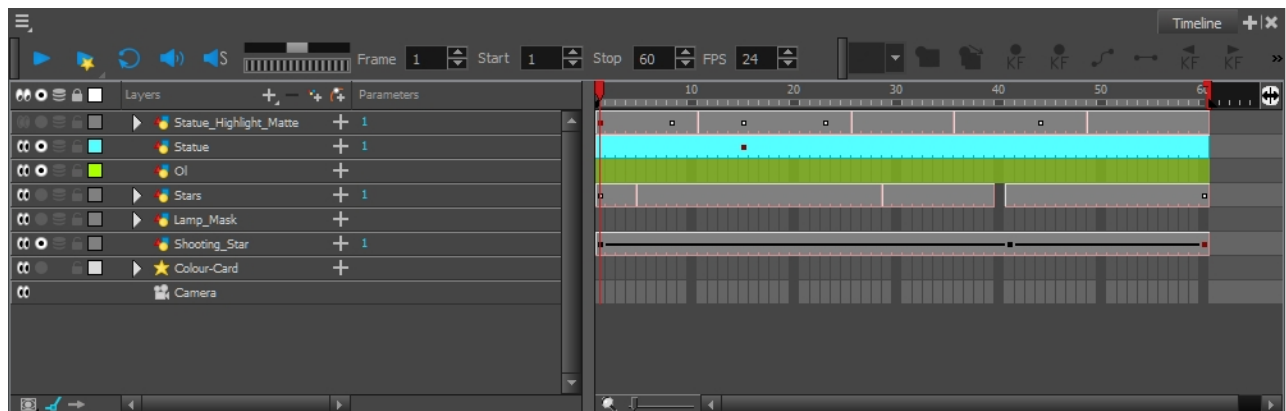

The Timeline view allows you to read your timing from left to right. It represents the scene's elements in their simplest form. You can also see the layers and their names, as well as the drawing's exposure. The drawing name is displayed when you place your pointer over the drawing's exposure.

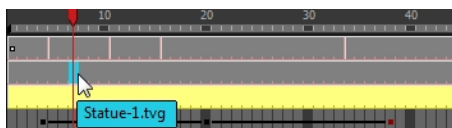



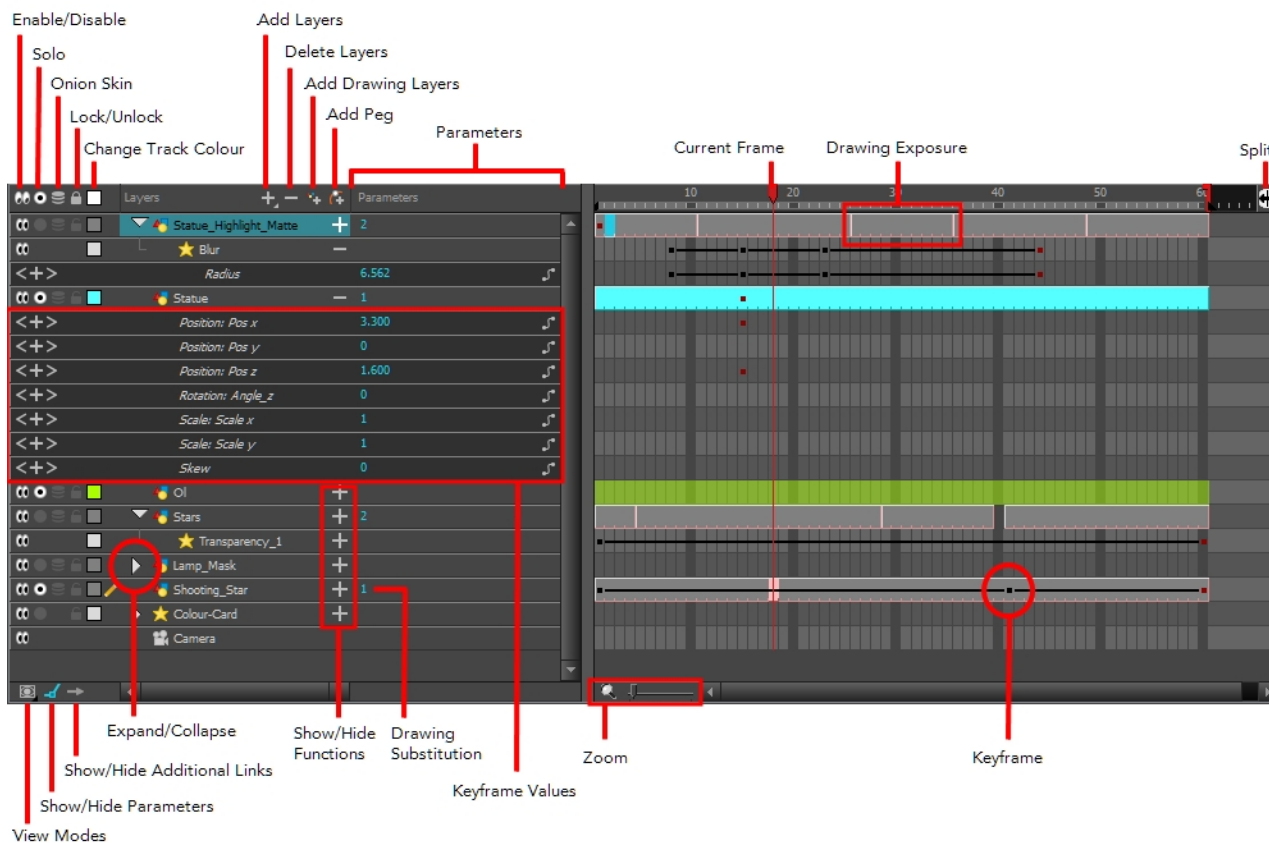



## Enable/Disable All

The Enable/Disable All  button lets you show or hide layers.

When you deselect a layer in the Timeline view, the corresponding column is hidden in the Xsheet view. When a column is hidden in the Xsheet view, the corresponding layer is disabled in the Timeline view.

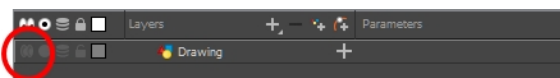
To disable a layer, click the layer's Enable/Disable All  button or press D.



To enable a layer, click the layer's Enable/Disable All  button or press A.

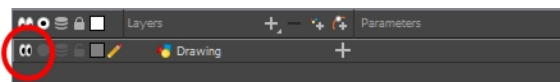

## Solo

The Solo  button lets you view drawing or sound layers in the Camera view. You can enable this mode on multiple layers. When the Solo mode button is deselected, everything is visible in the Camera view. When one or more layers are soloed, only those layers appear in the Camera view.

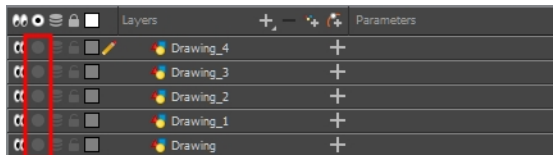

All layers are visible in the Camera view

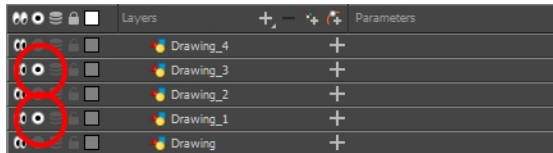

Only soloed layers are visible in the Camera view



## Onion Skin



The Onion Skin  button enables the Onion Skin option on a particular layer. If you want to see the previous and next frames of a specific layer, go to the Timeline view and click the Onion Skin button for that particular layer. Blue arrows appear on both sides of the play head. Drag the blue arrows to add more frames to the onion skin display.

To activate the general Onion Skin preview, in the Tools toolbar, click the Onion Skin  button.

## Lock/Unlock Layer

The Lock/Unlock Layer   button lets you prevent the selection or editing of a layer in the Camera view. To select some of the layers without selecting others, in the Timeline view, lock the layers you do not want to select. When a layer is locked, its name is displayed in red.

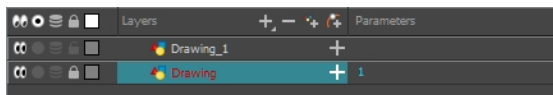

In the top menu, there is a series of locking options. Select **Animation > Lock > select one of the following:**

- **Lock:** Locks the currently selected element.
- **Unlock:** Unlocks the currently selected element.
- **Lock All:** Locks all the elements in the Camera view.
- **Unlock All:** Unlocks all the elements in the Camera view.
- **Lock All Others:** Locks all the elements in the Camera view except the currently selected one.

You can display the locked drawings as outlines in the Camera view to quickly find out which drawings are locked.

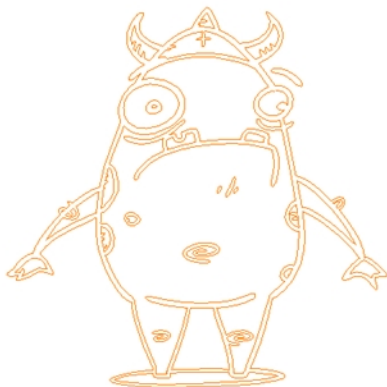

### How to display locked drawings as outline

1. In the Camera View bottom toolbar, enabled the Outline Locked Drawings  option.
2. You can also set this option as a permanent preference. From the top menu, select **Edit > Preferences** (Windows/Linux) or **Stage Advanced > Preferences (Mac OS X)**.
3. In the Preferences dialog box, select the **Camera** tab.
4. In the Tools section, select the **Show Locked Drawings As Outlines** option.





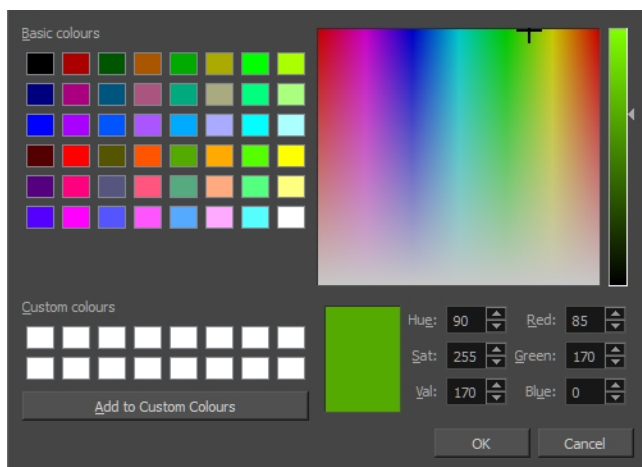



### Change Track Colour

The Change Track Colour  button lets you change the colour of the exposed frames; this helps you to quickly locate a layer in the Timeline view. Click the Change Track Colour  button to open the Select Colour window and choose a new colour. You can modify the colour for any type of layer, such as group, peg, drawing, and effects.



## Add Layers

The Add Layers  button lets you add new layers to the Timeline view. When you click the Add Layers button, a menu appears displaying the layer types available. You can add several different types of layers:

-  Camera
-  Deformation
-  Drawing
-  Generator
-  Group
-  Transformation
-  Effects
-  Sound

## Delete Layers

The Delete Layers  button lets you delete the currently selected layers in the Timeline view.

## Add Drawing Layer

The Add Drawing Layer  button lets you automatically add a new drawing layer to the Timeline view. By default, the layer is named **Drawing**.

## Add Peg

The Add Peg  button lets you add a peg layer to the timeline. If several layers are selected, a peg is added and parented to each layer.

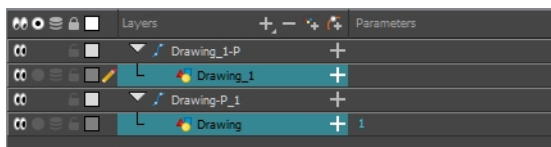

## Expand/Collapse



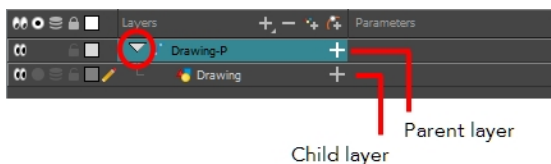



The Expand/Collapse  button is used to display the children layers of a parent layer. Once a layer is parented to another layer, it is indented to the right and the Collapse/Expand Children button appears on the parent layer allowing you to show or hide the child layer.

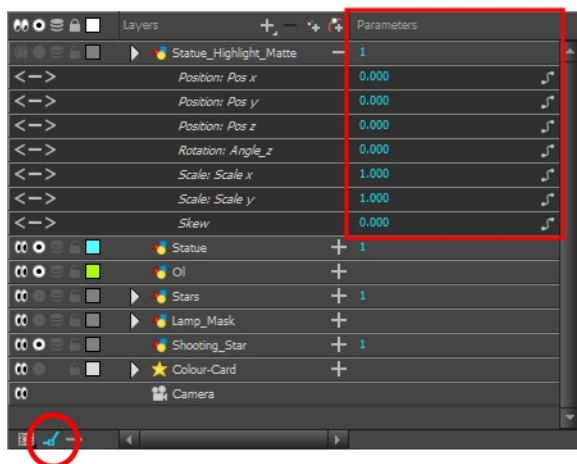

## Parameters

The Parameters section lets you add, remove or modify a keyframe at the current frame. You can show or hide the Parameters section by clicking the Show/Hide Parameters  button.



Icon	Tool Name	Tool
	Add Keyframe	Adds a keyframe at the current frame.
	Delete Keyframe	Removes an existing keyframe at the current frame.
	Hand Cursor	Lets you change the current keyframe or drawing exposure. When you hover the cursor over the value, the hand cursor appears. Drag left or right to change the value. Or double-click on the keyframe value and enter a new value.
	Previous Keyframe	Lets you navigate through existing keyframes.
	Next Keyframe	
	Show Function Menu	Displays the Function menu where you can link a layer to an existing function or create a new function—see <a href="#">Function Curves on page 1</a> .

## Current Drawing and Frame

The highlighted drawing represents the drawing currently displayed. The red play head represents the current frame displayed and marked in the Playback toolbar. You can move the play head to the left or right to scrub through frames and update the Camera view.

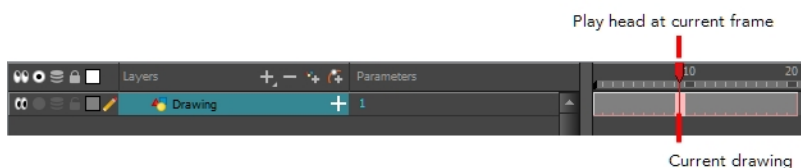

## Keyframe

A black or red square is displayed in the Timeline view when a keyframe exists. You can select these keyframes and drag them wherever you want on the timeline. You can also copy, cut, and delete them.

**NOTE:** To delete a keyframe without deleting the drawing exposure, go to the Timeline view and select the keyframe to be deleted and then select **Animation > Delete Keyframe** from the top menu or press F7.

When a parent layer is collapsed and a child layer contains a keyframe, a white square will be displayed.

## Split

The Split  button lets you split the Timeline view in two sections, allowing you to see two different portions of the Timeline view. This way, if your scene length is very long, you can see the beginning and the end at the same time.

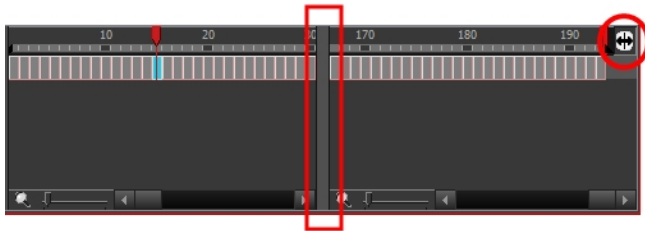

## Drawing Exposure

In the Timeline view, when a drawing is exposed, it is represented as a grey block. If the drawing is exposed for several frames, the block is extended. When a second drawing is exposed, a new grey block is displayed.



The exposure's colour can be changed. To pick a new colour, click the Change Track Colour  button in the corresponding layer.

## View Modes

The View Modes  button lets you streamline the process of working with elements in the Timeline view. There are three different view modes you can choose to work in. With each mode you select, certain elements may or may not be visible in the Timeline view. Depending on your workflow, this can be useful for quickly hiding elements when you want to focus on specific ones. To select a view mode, use the drop-down menu in the bottom-left corner of the Timeline view.

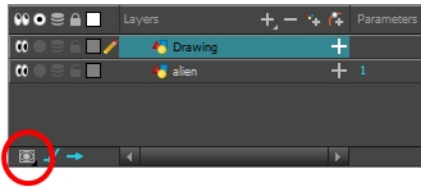

## Show/Hide Additional Links

The Show/Hide Additional Links  button lets you display links associated with a layer. For example, if you connect a mask to more than one effect such as a Tone and a Highlight, you can see these connections in the Additional Links section.

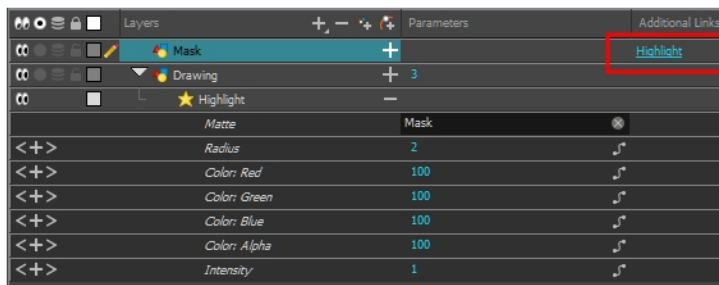

The Mask layer is associated with the Highlight effect.

## Zoom

The Zoom tool increases or reduces the width of the frames in the Timeline view. Move the slider right to increase the width or left to reduce it. You can also press 1 and 2. Reset the zoom by click the Reset Zoom button.



## Show/Hide Functions

The Show/Hide Functions  button lets you display the functions embedded in each layer. The functions are the different coordinates and values used to record a layer's parameters at each frame. This information is stored on the function curves using keyframes.

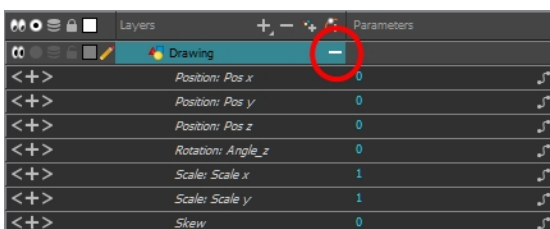

## Tool Properties View

The Tool Properties view contains the most common options and operations related to the currently selected tool. When you select a tool from the Tools toolbar, the Tool Properties view updates.

For example, if you choose the Select tool, the Tool Properties view will display the options and operations related to it, such as Snap to Contour, Apply to All Drawings, Flip Horizontal, and Flatten.

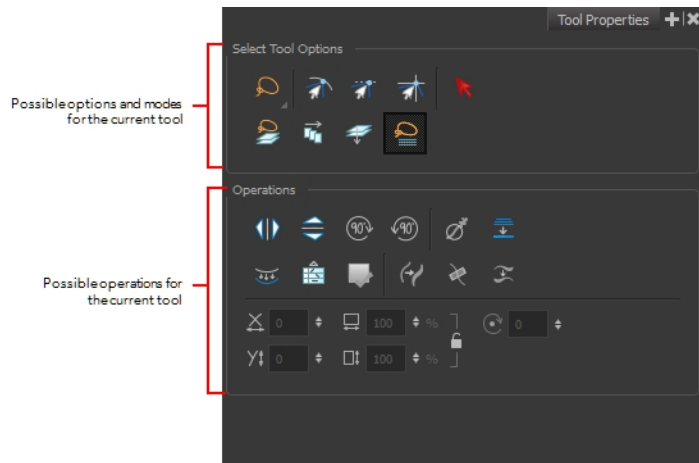

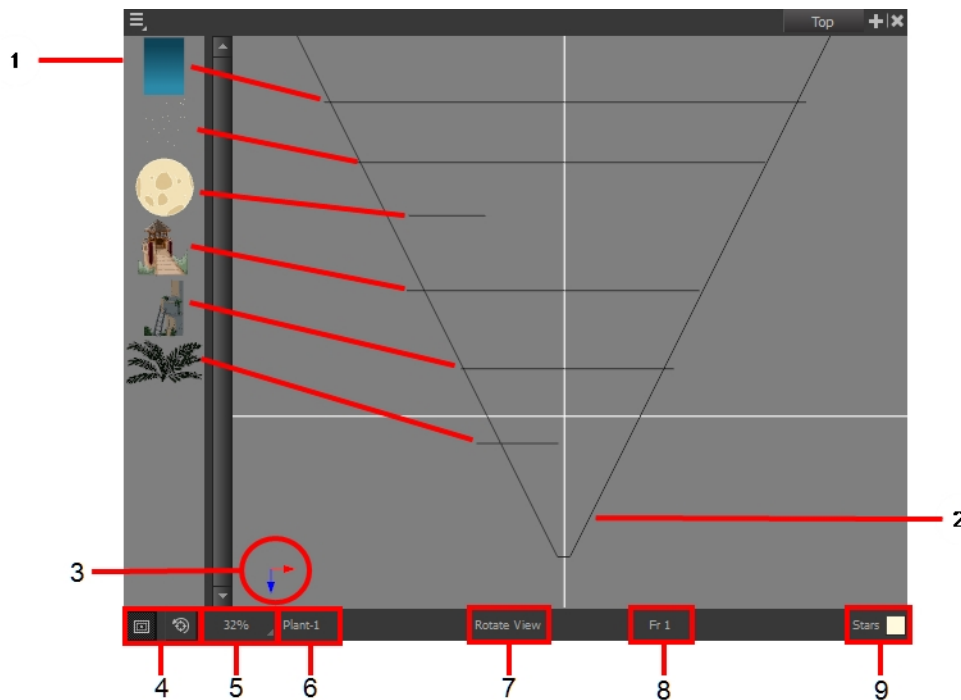

## Top View

The Top view is used mainly for multiplane scenes and to position elements in 3D space. It allows you to see the scene's stage from above. This lets the camera cone and the spacing between the elements be seen.



1. A thumbnail of each drawing layer in the scene. The order of the thumbnail images is based on each element's FB position in the scene space. You can see a representation of the FB position of each layer in the camera cone.



2. The camera cone represents the camera's position and field-of-view (FOV).
3. The axis reference arrows let you maintain your orientation when navigating in the Perspective view.
4. There are two view option buttons displayed in the lower-left corner of the view.
  -  **Show/Hide Camera:** Shows or hides the camera frame in the Perspective view.
  -  **Reset View:** Resets the pan, rotation and zoom of the Perspective view.
5. This field displays the current zoom level in the Perspective view. You can use the Zoom menu to select a zoom level from 2.5% to 6400%. You can also select Fit To View to automatically use a zoom level that lets you see all of the scene layers and information in the Perspective view at once.

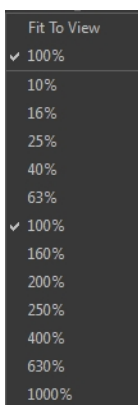

6. Displays the currently selected layer and drawing name.
7. Displays the currently selected tool.
8. Displays the currently selected frame of your animation.
9. Displays the currently selected colour in the palette.

## Xsheet View

The Xsheet view lets you read the timing vertically, displays the drawing layers as columns, and shows the drawing's name. You can also see the functions and keyframes of the motion paths in the Xsheet's function columns. The value of each keyframe is shown in the Xsheet view; these are displayed as black squares in the Timeline view. The Xsheet view contains more detail than the Timeline view, and is faster and easier to read.

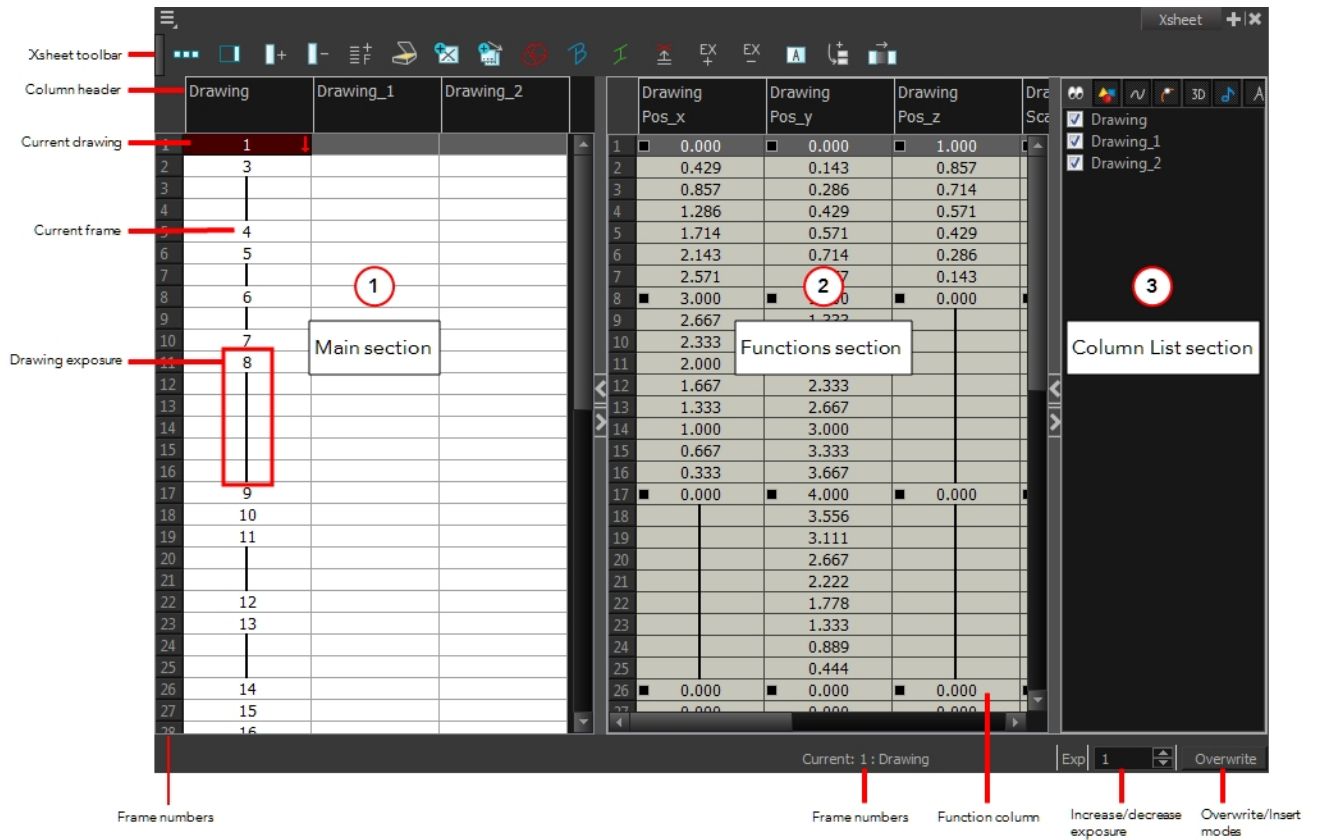

## 1. Xsheet Main Section

The Xsheet view has three sections. By default, only the main section is visible. It displays the drawing layers, also known as *drawing columns*.

	Drawing	Drawing_1	Drawing_2
1	1	1	1
2	3	1	1
3		2	1
4		3	1
5	4	4	1
6	5	5	1
7		6	1
8	6	7	1
9		8	1
10	7	9	1
11	8	10	1
12		11	1
13		12	1
14		13	1
15		14	1
16		15	1
17	9	16	1
18	10	17	1
19		18	1
20		19	1
21		20	1
22	12	21	1
23	13	22	1
24		23	1
25		24	1
26	14	25	1
27	15		1
28	16		1

When using advanced compositing and animation techniques, unconnected functions (motion paths) also appear in the main section. Unconnected functions mean that some motion paths are not attached to any particular layer.

When you reconnect functions to a layer, they are still visible in the main section.

	Drawing_1	Drawing_2	Drawing	Drawing_Pos_x	Drawing_Pos_y	Drawing_Pos_z
1	1	1	1	0.000	0.000	1.000
2			3	0.429	0.143	0.857
3	2			0.857	0.286	0.714
4	3			1.286	0.429	0.571
5	4		4	1.714	0.571	0.429
6	5		5	2.143	0.714	0.286
7	6			2.571	0.857	0.143
8	7		6	3.000	1.000	0.000
9	8			2.667	1.333	
10	9		7	2.333	1.667	
11	10		8	2.000	2.000	
12	11			1.667	2.333	
13	12			1.333	2.667	
14	13			1.000	3.000	
15	14			0.667	3.333	
16	15			0.333	3.667	
17	16		9	0.000	4.000	0.000
18	17				3.556	
19	18		11		3.111	
20	19				2.667	
21	20	1			2.222	
22	21	1	12	0.000	1.778	0.000

## 2. Functions Section

The Functions section is used for more advanced techniques. This section displays the functions (paths) related to the selected layer in the Timeline view. By default, the Functions section is hidden.

	Drawing Scale_x	Drawing Scale_y	Drawing Angle_z	Drawing Skew
1	1.000	1.000	0.000	0.000
2				
3				
4				
5				
6				
7				
8	1.000	1.000	0.000	0.000
9				
10				
11				
12				
13				
14				
15				
16				
17	1.000	1.000	0.000	0.000
18				
19				
20				
21				
22	1.000	1.000	0.000	0.000

Current: 14 : Drawing

### How to display the Functions section

1. In the Xsheet view, click the Expand button located on the right side of the main section. Click on the same button to collapse it. You can also use the Show Column List

 button in the Xsheet View toolbar. If you select a drawing column in the main section of the Xsheet view, the function columns will not be displayed. You must select the layer from the Timeline view.

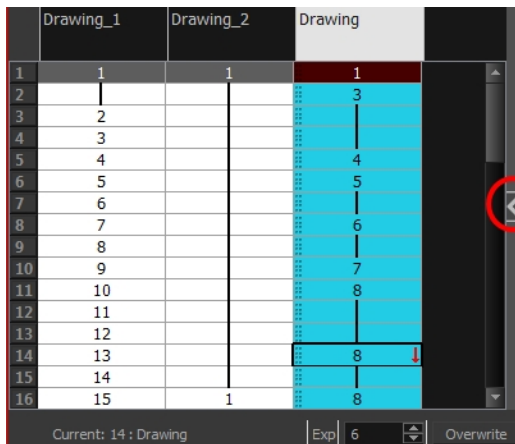

## . Column List Section

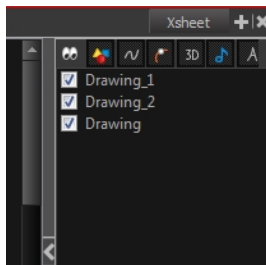

The Column List section allows you to show and hide columns in the Xsheet view. When you hide a layer in the Xsheet view, it is also disabled in the Timeline view.

You can use the Column List to hide individual columns or hide an entire column type (drawing or function) from the Xsheet view. By default, the Functions section is hidden.

## How to display the Column List section

1. In the Xsheet view, click the Expand button on the right side of the main section to show the Functions section. Click on the same button to collapse it. You can also use the Show Column List  button in the Xsheet toolbar.
  - ▶ In Harmony, you can also go to the Xsheet view menu and select **View > Show Column List**.

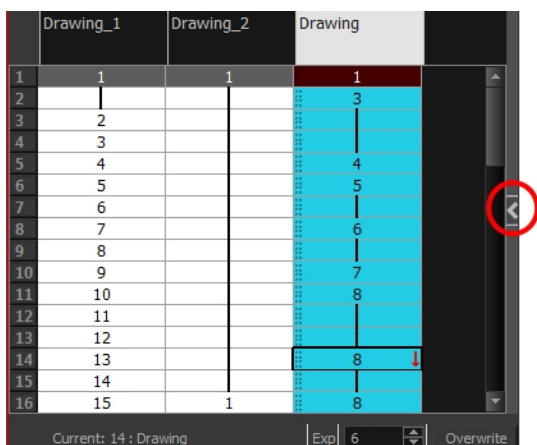

- Click the Expand button on the right side of the Functions section to display the Column List section.

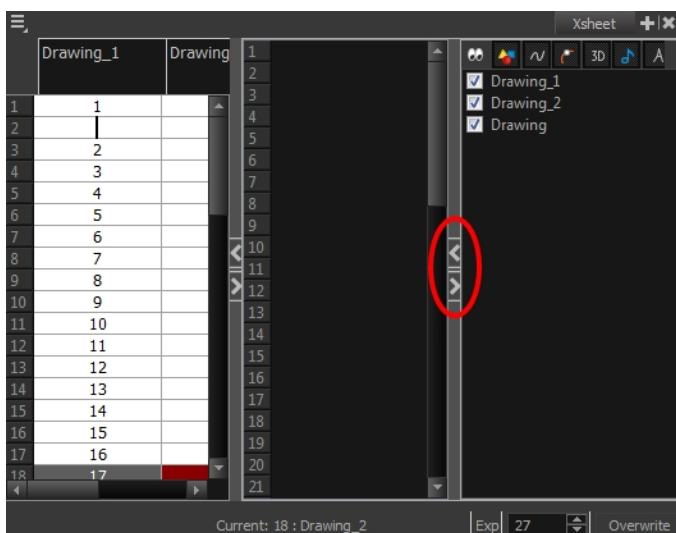

## Xsheet Toolbar

The Xsheet view has its own toolbar where you can find the most common features. This toolbar is displayed by default. If you do not see it, select **Windows > Toolbars > Xsheet View**.

The Xsheet view must be part of your workspace in order to display its toolbar.

## Column Header

Each column available in the Xsheet view has a header displaying the column's name. The column's name is the same as the corresponding timeline layer. If you rename one or the other, they will both be renamed.

A quick access menu is available when you right-click. This menu contains the command affecting an entire column such as renaming, changing the default colour, or deleting a column.

The tooltip that appears when you hover at the top of each Xsheet column shows the folder path to the source drawings for that column.

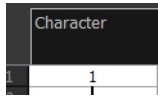

In Harmony, the column header shows the layer’s name and the name of the drawing folder to which it is linked. If the name of the layer is the same as the drawing folder, the drawing folder’s name will not be displayed. To modify the name of the element folder independently from the column and layer name, you must select the Advanced Element Mode option preference in the Advanced tab of the Preferences dialog box.

Column name

	Character	Night_Sky Background	Drawing
1	1	1	1
2	1		3
3	2		
4	3		
5	4		4
6	5		5
7	6		6
8	7		6

Drawing folder name

### Current Drawing

A drawing selected in dark red indicates that the drawing is currently displayed in the Drawing and Camera views. The current drawing selection is not linked to the drawing displayed in the Camera view since drawings from each visible layer are displayed at once.

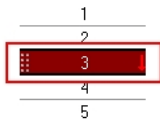

### Current Frame

The darker frame appearing in the Xsheet view represents the current frame.



### Drawing Exposure

In the drawing columns, you can see the drawing names and their exposure. You can use any alphanumeric symbol to name your drawing. When a drawing is exposed over more than one cell, a vertical black line is displayed to indicate the continuity of the exposure. When there is no drawing in a cell, the cell will be blank.

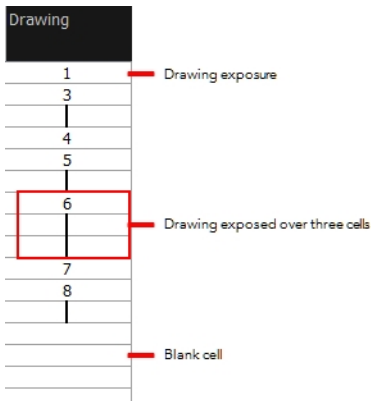

## Frame Numbers

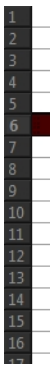

On the left side of the Xsheet view, the frame numbers are shown indicating where you are. These read vertically instead of being displayed horizontally as they are in the Timeline view.

- To go to a particular frame, click the frame number.

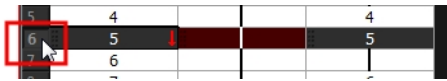

- To select an entire range of frames, click and drag a selection downwards.

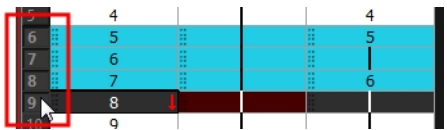

## Current Frame Display

At the bottom-right of the Xsheet view, you can see the current frame number, as well as the column containing the drawing currently displayed in the Drawing view.

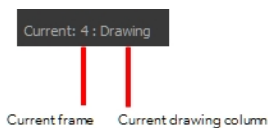

## Functions Column

The functions columns are displayed in the Functions section of the Xsheet view. They represent the motion and rotation you applied to a drawing layer.

A function column can also be related to an effect. Selecting the effect layer shows you the corresponding function column in the Xsheet view.

The function columns display the position value or effect value on each cell. If there is a keyframe on a cell, a black square is displayed. Holding the same value for several frames displays a vertical black line.

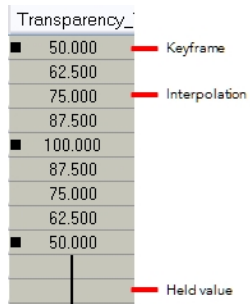

## Increase/Decrease Exposure

You can quickly increase or decrease the exposure of the selected cell by clicking on the up and down arrows in the Increase/Decrease Exposure field.



## Overwrite/Insert Modes

The Overwrite/Insert button allows you to decide the way the values are inserted into the Xsheet.

## Toolbar References

Harmony has several toolbars. There are two types of toolbars: the top toolbars available at the top of the interface and the view toolbars in individual windows. View toolbars are only shown if the particular view is displayed in the workspace. This is a complete list of the toolbars available in Harmony.

## Top Toolbars

### Advanced Animation Toolbar

The Advanced Animation toolbar contains tools to position and animate layers. The Scale, Translate and Rotate tools can be used to reposition the permanent pivot position of a layer. Unlike the Transform tool, each tool in the Advanced Animation toolbar performs a single operation, either rotate, scale, translate or scale in relation to the camera distance.





## Art Layer

A drawing is composed of two layers, a line layer and a colour layer. The colour layer is always placed under the line layer. These layers are accessible in the Drawing or Camera view (using drawing tools). When you view the final drawing, you will see the final composition of the lines and colours, not two separate layers.

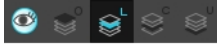
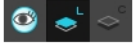

You can draw and paint in all layers. If you prefer to work in a single view layer, everything can be done in the Line Art layer.

You can change your preferences to enable the advanced use of layers and have access to four layers instead of two:

- Overlay
- Line Art
- Colour Art
- Underlay

## How to enable the Support Overlay and Underlay Arts option

1. From the top menu, select **Edit > Preferences** ( Windows/Linux ) or **Stage Advanced > Preferences** ( Mac OS X ).
2. In the Preferences panel, select the **Advanced** tab.
3. In the Advanced Options section, select the **Support Overlay and Underlay Arts** option.
4. Click **OK**.

## Art Layer

### Deformation Toolbar

A drawing is composed of two layers, a line layer and a colour layer. The colour layer is always placed under the line layer. These layers are accessible in the Drawing or Camera view (using drawing tools). When you view the final drawing, you will see the final composition of the lines and colours, not two separate layers.

By default, the Deformation toolbar only contains the essential options. If you right-click on the toolbar and select **Customize**, you can add additional buttons.

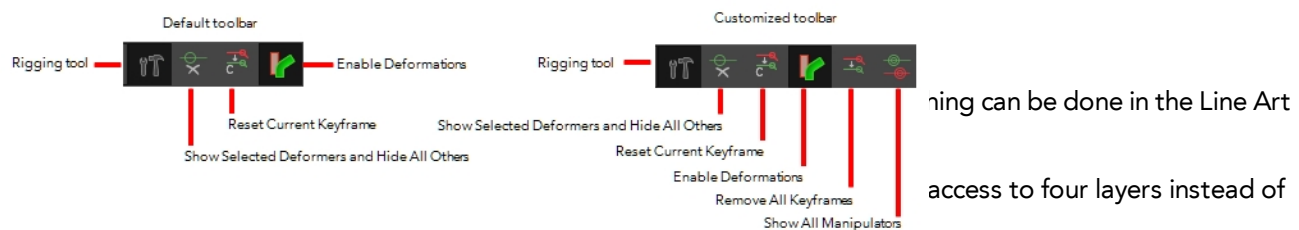

- Overlay

## Easy Flipping Toolbar

The Easy Flipping toolbar lets you rapidly flip through drawings in the Drawing view as is done with paper

- Underlay

## How to enable the Support Overlay and Underlay Arts option

drawings.



### Edit Toolbar

The Edit toolbar contains common operations such as Copy, Paste, Cut, Undo and Redo. These options can also be found in the Edit menu.



### File Toolbar

The File toolbar contains the common file operations such as New, Save and Open. These options can also be found in the File menu.



### Xsheet Toolbar

The Xsheet toolbar contains the common timing operations such as Add Column, Delete Column, Clone Column, and so on. These options can also be found in the top menu.



### Flip Toolbar

The Flip toolbar lets you determine the type of drawing to include in your flipping selection. You can flip through the key, breakdown or in-between drawings individually, or view a combination.



### Mark Drawing Toolbar

The Mark Drawing toolbar lets you identify drawings such as Key, Breakdown and In-between. The drawing Identification feature can help the animator stay well organized and save time when identifying key, breakdown or in-between drawings in the Xsheet and Timeline views.



### Onion Skin Toolbar

When designing or animating, it is useful to be able to see your previous drawings. The Onion Skin tool is used to preview the previous and subsequent drawings. By default, the previous drawings will appear with a shade of red and the next drawings will be displayed with a shade of green, but you can change the display options in the Preferences dialog box. In the Onion Skin toolbar, you can select what type of drawing you want to display in your onion skin display.



## Playback Toolbar

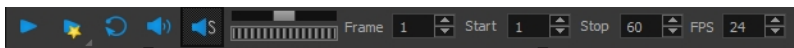

The Playback toolbar lets you play back animation and sound. Use it to scrub the sound to create your lip-sync, loop the playback, navigate through frames, and change the playback range and speed.

Name	Button	Description
Play		Plays and stops the animation. You can also select <b>Play &gt; Play Scene Forward</b> or <b>Stop</b> .
Render and Play		Creates a render of your scene to play back the final result including the effects.
Loop		Repeatedly plays back your animation indefinitely. You can also select <b>Play &gt; Loop</b> .
Sound		Enables sound in the playback. You can also select <b>Play &gt; Enable Sound</b> .
Sound Scrubbing		Enables sound scrubbing in the playback. You can also select <b>Play &gt; Enable Sound Scrubbing</b> .
Jog Frames		Lets you scroll through the playback's frames.
		Lets you change the playback frame range by entering new values in the Start and Stop fields. You can also click on the Start and Stop words to set the start or end frame at the current frame.
FPS		Lets you enter a new value to change the speed of the playback.

## Scripting Toolbar

The Scripting toolbar lets you import and access the scripts created to automate actions and operations.



## Tools Toolbar



The Tools toolbar contains all of the main tools you will use while working in Harmony. In the default workspace, you will find this toolbar on the left-most side of the interface.

### Tool Presets Toolbar

The Tool Presets toolbar lets you create new tool presets and manage them.



### Workspace Toolbar

The first time you open Harmony, the default workspace is loaded. Other workspaces are available such as the Hand-Drawn Animation and Compositing workspaces; these display different views and toolbars. You can access these workspaces and any you create, from the Windows menu and the Workspace toolbar.

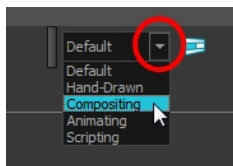

## View Toolbars

Here is a list of the toolbars available in the Harmony views:

- Camera Toolbar
- Drawing Toolbar
- Layer Toolbar
- Library Toolbar
- Model Toolbar
- Script Editor Toolbar
- Timeline Toolbar
- Xsheet Toolbar

## Interface Navigation

Toon Boom Harmony lets you zoom in, zoom out, rotate, pan and reset views for easy navigation of the interface.

Command	Action	Access Methods
Zoom In	Zooms in the view.	<b>View &gt; Zoom In</b> Press 2 or roll the mouse wheel up. In the Timeline view, roll the mouse wheel up.
Zoom Out	Zooms out the view.	<b>View &gt; Zoom Out</b> Press 1 or roll the mouse

		wheel down. In the Timeline view, roll the mouse wheel down
Zoom In or Out	Zooms in or out of the view.	Roll the middle mouse button up or down.
Pan	Moves parallel to the view.	Hold down the Spacebar and drag n in the direction in which you want to pan the view.
Recenter view	Recenters the view on the pointer.	Press N
Reset Pan	Resets the view's pan to its default position.	<b>View &gt; Reset Pan</b> Press Shift + N
Reset View	Resets the view to its default position.	<b>View &gt; Reset View</b> Press Shift + M
Reset Rotation	Resets the view's rotation to its default position.	<b>View &gt; Reset Rotation</b> Press Shift + X
Reset Zoom	Resets the view's zoom to its default position.	<b>View &gt; Reset Zoom</b>
Toggle Full Screen	Enlarges the selected view to full screen which is done in three stages.  First, the selected view enlarges to the maximum width or height, but keeps the tool views such as Colour or Tool Properties view.  Second, the view enlarges to full screen.  Third, the view returns to its original size.	<b>View &gt; Toggle Full Screen</b> Press Ctrl + F (Windows/Linux) or ⌘ + F (Mac OS X)
Rotate 30 CW	Rotates the Camera view 30 degrees clockwise, like an animation table.	<b>View &gt; Rotate View CW</b>
Rotate 30 CCW	Rotates the Camera view 30 degrees counter-clockwise, like an animation table.	<b>View &gt; Rotate View CCW</b>
Toggle Quick Close-up	Use the Magnifier tool to quickly center on the mouse position and zoom in to a pre-defined value such as 4X. Then you can zoom out again. Hold the Shift key and press Z to zoom in and back out again. Replace the Reset Zoom by pressing Shift +.	

	The area where you zoom in or out is dependent on the pointer location in the Camera view. If you zoom in and then move the pointer to a different location when you zoom out the mouse will be centered on that location.	
--	----------------------------------------------------------------------------------------------------------------------------------------------------------------------------------------------------------------------------	--

## Using the Play Menu to Navigate

From the top menu, you can select any of the following commands from the Play menu to navigate around the interface.

Command	Description
Start Frame	Lets you set the frame on which playback will start.
End Frame	Lets you set the frame on which playback will end.
First Frame	Jump to the first frame. You can also press <.
Previous Frame	Jumps to the frame before the frame currently selected in the Timeline view. You can also press the comma (,) key.
Next Frame	Jumps to the frame after the currently selected frame in the Timeline view. You can also press the period (.) key.
Last Frame	Jumps to the last frame. You can also press >.
Go to Frame	Opens the Go to Frame window in which you can enter the number of the frame you want to display.  You can also use the Go button, which you can add to the Timeline toolbar through the Toolbar Manager. Open the Go to Frame dialog box and enter the frame number to jump to.
Enable Playback	Plays back your animation from the Top, Side, or Perspective views.





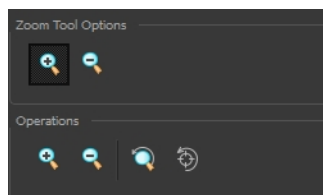

## Zoom Tool

The Zoom  tool in the Tools toolbar lets you zoom in and zoom out of the Camera or Drawing view.

- The keyboard shortcuts are 1 and 2.
- When you're in Zoom In mode, hold Alt as you click to zoom out.

When you select the Zoom tool, its properties are displayed in the Tool Properties view.



Parameter		Button	Description
Zoom Tool Options	Zoom In		Zooms in
	Zoom Out		Zooms out
Operations	Perform Zoom In		Zoom in the Camera or Drawing view. The keyboard shortcut is 2.
	Perform Zoom Out		Zoom out the Camera or Drawing view. The keyboard shortcut is 1.
	Reset Zoom		Restores the current zoom level to 100%.
	Reset View		Restores the original display by resetting any pan, rotation or zoom actions.

## Glossary

<b>alpha channel</b>	An image channel that carries transparency information. An image already has three channels: red, green and blue (RGB). The alpha channel is the fourth channel (RGBA). The matte, or the transparency information, is stored in this fourth channel. An image without an alpha channel is always opaque.
<b>animatic</b>	A movie with sound that is developed from the storyboard. The storyboard panel is exposed for the duration of the scene and at times, the characters are placed on a trajectory to indicate motion. The camera moves are also animated. The animatic is used to determine the rhythm of a project and provides a good overview of the project before beginning production.
<b>animation</b>	A simulation of movement created by displaying a series of pictures or frames.
<b>anime</b>	An animation style known for its sinister and dark feel; popular in Japan.
<b>arc</b>	Action rarely occurs in a straight-forward manner; rather it typically unfolds in what storytellers refer to as an arc. The purpose of a story arc is to move a character or situation from one state or scenario to the next.
<b>aspect ratio</b>	The relationship between the width and height dimensions for any scene, frame or film format. Television ratio is 4:3 and widescreen ratio is 16:9.
<b>auto-feed</b>	An automated method of feeding drawings into a scanner in which multiple drawings are stacked into a sheet feeder. When the scanner is activated, the drawings are scanned consecutively, without further user intervention.
<b>automatic lip-sync detection</b>	Automatically mapping drawings in an element to the mouth chart generated for a sound. This can save time when lip-syncing a voice track.
<b>axis</b>	An imaginary line around which an object rotates. For 2D graphics, there are two axes: X (horizontal) and Y (vertical). For 3D graphics, there are three axes: X (horizontal), Y (vertical) and Z (depth).
<b>background</b>	The part of a scene that is farthest to the rear. The background is the artwork, or decor, against which the animation takes place.

<b>Bézier</b>	A method of defining curved lines invented by French mathematician Pierre Bézier. A Bézier curve is a mathematical or parametric curve. Bézier curves use at least three points to define a curve.
<b>bitmap</b>	An image composed of pixels with a single resolution (size). If it is enlarged too much, it will lose definition and pixels will begin to appear. This is known as <i>pixelation</i> .
<b>breakdown</b>	In cut-out animation, breakdown is the action of breaking a character into pieces to create a puppet with articulations. To break down a character, the artist cuts parts, such as the hands and arms, from the character's model and pastes them in separate layers. Next, the joints are fixed and the pivots set.  In traditional animation, a breakdown is an animation pose generally found between two key poses. The key poses are the main poses in an animation and the breakdowns are secondary poses, ones that help describe the motion and the rotation curve (usually referred to as an <i>arc</i> ).
<b>camera shake</b>	Camera shake occurs in a scene when the camera moves slightly and quickly in several directions. This gives the impression of an impact, vibration or, for example, bumps on the road.
<b>caption</b>	A text field containing dialogue, effects, sound, or slugging information in a storyboard.
<b>cel</b>	In traditional animation, a cel (also known as <i>celluloid</i> ) is a transparent sheet on which the animation is inked and painted before being sent to the camera. The picture's outline is drawn on the front of the cel and then coloured along the back.  In Harmony, a cel is an individual space in an Xsheet column from which you can expose a drawing or a function's coordinate.
<b>character design</b>	Each character in an animated film is drawn from multiple angles in poster-style format, called a <i>model sheet</i> , which serves as a reference for the animators.
<b>clean up</b>	After rough drawings have been tested and approved, all the noise in the image (excess lines, notes, etc) is removed to create final drawings which can be inked, painted and shot. The cleanup process refers to either tracing a clean line over a rough drawing to achieve the final version, or removing dirt and extra lines left by the scanning process.
<b>CMYK</b>	Cyan, Magenta, Yellow, Black. Refers to the process used by printers to define colour on the printed page.
<b>colour card</b>	A colour card is a solid colour card that is the same size as the camera. The colour card can be used to fill the background with a solid colour when there is no background image included.
<b>colour model</b>	The official colour design that must be used to paint the animation. A model is the definitive character, prop, or location design that each artist must follow for the production.
<b>colour wheel</b>	A display of the colour spectrum in the form of a circle.
<b>compositing</b>	Compositing is the action of incorporating all of a scene's elements to create the final result prior to rendering. For example, the compositing artist will



	import all the animation sequences, background, overlays and underlays in the scene and position them correctly. The artist will then set the camera frame and animate it, if needed. Finally, the animator will create all the computer-generated effects for the project.
<b>cross dissolve</b>	An effect used to fade two scenes, one into the other.
<b>cut</b>	A direct transition between two scenes. When a cut is used, there are no transition effects inserted to pass from one scene to the next. The first scene ends and the second one starts immediately.
<b>cut-out animation</b>	The action of animating characters made of several pieces by moving them around frame by frame. Cut-out animation can either be computer generated or done traditionally using paper.
<b>cycle</b>	A group of images that together make up an action, such as walking. A cycle is an action repeated as a loop over a period of time. It can be a series of animated drawings or keyframes.
<b>dialogue</b>	The text spoken by a character in a movie or animation.
<b>dope sheet</b>	Used by animators, directors and other members of a crew to track the sequence and timing of images, dialogue, sound effects, sound tracks and camera moves. Also known as an <i>exposure sheet</i> or <i>Xsheet</i> .
<b>doping</b>	To assign a particular drawing to a range of frames.
<b>DPI</b>	Dots per inch is the standard measure of resolution for computerized printers. It is sometimes applied to screens, in which case it should more accurately be referred to as <i>pixels per inch</i> . Either way, the dot is the smallest discrete element making up the image.
<b>ease/velocity</b>	In animation, the ease, also known as <i>velocity</i> , is the acceleration and deceleration of a motion. It can be a motion created by a function curve, or a series of animated drawings. Other common terms for ease-in and ease-out are slow-in and slow-out.
<b>ease-in</b>	Gradual acceleration in the action. Also known as <i>slow-in</i> .
<b>ease-out</b>	Gradual deceleration in the action. Also known as <i>slow-out</i> .
<b>establishing shot</b>	A scene in which the viewer can see the whole area in which a sequence is happening. For example, if a child is playing on the ground in front of his house, the establishing shot would be a scene where the viewer can see the house, the ground, a part of the street and the buildings around the central point of action. This helps the viewer understand the story location and scene orientation.
<b>exposure</b>	In animation, an exposure is the number of cels on which a drawing appears in the scene. For a drawing to appear longer, the exposure must be extended over a greater number of cels.
<b>exposure sheet</b>	A sheet with several vertical columns and horizontal frames used to indicate a scene's timing. Each column represents a scene layer. The drawing numbers in each column are indicated and repeated over the particular amount of frames they need to appear.  The exposure sheet is used by animators, directors and other members of a

	crew to track the sequence and timing of images, dialogue, sound effects, sound tracks and camera moves. Also known as a <i>dope sheet</i> .
<b>fade in/fade out</b>	Fade in or fade out is a transition effect used to open or close a sequence. A fade in occurs when the first scene appears progressively, from complete transparency to its complete opacity. A fade out occurs when the last scene progressively disappears, going from complete opacity to complete transparency.
<b>fast-in</b>	Dramatic acceleration at the start of the action.
<b>fast-out</b>	Dramatic acceleration at the end of the action.
<b>field</b>	In animation, a field is a measurement unit used to calculate motion, registration and camera positioning. A standard animation scene will vary between 6 to 12 fields.
<b>field chart</b>	A guide containing all the field units that animation and layout artists use to determine a scene size or camera motion.
<b>film-1.33</b>	A resolution that is ideal for the widescreen film format that conforms to the standard 4:3 pixel aspect ratio.
<b>film-1.66</b>	A resolution that is ideal for the widescreen film format that conforms to the 16:9 pixel aspect ratio. (The pixels are wider than they are high).
<b>flipping</b>	In traditional animation, flipping is the action of going through the drawings of an animation sequence very quickly in order to see the animation in motion. Flipping can also be the action of creating a mirror transformation of an object.
<b>follow-through</b>	The secondary motion caused by the main action. For example, a character wearing a cloak is running. The main action is the body running. This will cause the cloak to follow the motion, although it will not move at the same time, but react a few frames later and follow the main motion curve.
<b>forward kinematics</b>	Forward kinematics is a feature used to animate principally 3D characters and cut-out puppets with hierarchy. It is used to animate a puppet from one of parent parts, such as a shoulder, and make the rest of the arm move with it as a single piece.
<b>frame</b>	A single photographic image in a movie. In traditional animation, the North American standard generally contains 24 frames per second, while in Europe the standard is 25 frames per second.
<b>frame rate</b>	<p>The frame rate is the speed at which the frames are played. They are generally calculated by frame per second. For example, a scene could be played back at 12, 24, 25, 30 or 60 frames per second or any other number.</p> <p>This is the measurement of the frequency (rate) at which an imaging device produces unique consecutive images, called <i>frames</i>. The term applies equally to computer graphics, video cameras, film cameras, and motion capture systems.</p> <p>Frame rate is most often expressed in frames per second (fps) and in progressive-scan monitors as hertz (Hz).</p>
<b>functions</b>	A computer-generated motion, trajectory or path on which elements, other

	trajectories and effects parameters can be attached. The function can be controlled by adding keyframes and control points on the function curve.
<b>gamut</b>	The range of colours that a particular device can represent.
<b>HDTV</b>	High Definition Television delivers a higher quality image than standard television does because it has a greater number of lines of resolution. To take advantage of the superior quality and make full use of your resolution setting, the output device must be compatible with HDTV technology.
<b>hold</b>	A frame in the animation in which the character maintains its position without moving. A hold can be created between any two keyframes.
<b>HSV</b>	Hue, Saturation, Value. A method of defining colours in terms of hue (tint), saturation (shade) and value (tone or luminance).
<b>in-between</b>	The drawings that exist between the key poses. These are drawn to create fluid transitions between poses.
<b>ink and paint</b>	The ink and paint process is the action of painting the empty zones and colouring the lines on the final animation drawings, while following a colour model.
<b>interpolation</b>	The computer-generated motion created between two keyframes. You have the choice to create interpolation, or not, between your keyframes.
<b>jump cut</b>	A jerky cut between two scenes. Typically, a jump cut is not visually pleasing. It is generally caused by one scene ending, and a second one starting, with a similar image. The lack of difference causes the eye to see a little jump between the two scenes.
<b>key pose</b>	Important positions in the action defining the starting and ending points of any smooth transition. Keys, or key poses, are the main drawings in an animation sequence describing the motion. For example, if an arm is waving, the keys will be of the arm at one extremity of the wave motion and the other extremity. By flipping those drawings, the animator can see the skeleton of the motion without having all the drawings.
<b>keyboard shortcuts</b>	One or more keyboard keys which, when used, cause an operation to be performed.
<b>keyframe</b>	Important positions in the action defining the starting and ending points of any action. A keyframe is a computer-generated position at a specific moment (frame) on a given trajectory.
<b>layers</b>	In animation, a layer is an individual column, level or character. A scene's layers are superimposed to form the final image.
<b>layout</b>	<p>The communication step between the storyboard and the animation. It is the action of putting the storyboard on model. That is, drawing the character by following the design in the model pack, so the animator can start working.</p> <p>The layout artist draws the background, creates the camera and field guide matching the scene and camera motion. Lastly, the animator draws on model the main action poses.</p>
<b>layout and posing</b>	The action of putting on model. That is, at the right scale, the storyboard for the animator to start working.

<b>library</b>	A storage area containing templates and assets that can be reused in any project or scene.
<b>light table</b>	A device that allows you to see other layers in transparency while you are working on a particular layer.
<b>line of action</b>	The direction that the action will follow. Also known as <i>path of action</i> .
<b>lip-sync</b>	The character's mouth synchronization with the dialogue sound track. Frame by frame, the mouth will be adjusted to fit the sound to give the illusion of the character is speaking.
<b>low resolution</b>	A format that is ideal for videos destined for the web, where size and fast download of a video file take precedence over quality. A low-resolution image is one that lacks fine detail.
<b>manual lip-sync detection</b>	The manual swapping of mouth position drawings to match a voice track. For this process, both sound scrubbing (listening to a sound wave broken up frame-by-frame) and drawing substitutions are used.
<b>master palette</b>	A group of colours attributed to a character or prop. The palette is used throughout the entire production to maintain consistency in the look and to ensure that the same colours are used throughout the production. Also known as <i>palette</i> .
<b>model/colour model</b>	The definitive character, prop or location design each artist must follow for a production. A colour model is the official colour design that must be used to paint the animation.
<b>motion keyframe</b>	A keyframe with computer-generated interpolation.
<b>mouth chart</b>	A chart based on the eight animation phonemes (A, B, C, D, E, F, G, and X, which is used to represent silence) used for lip-sync.
<b>multiplane</b>	The effect of passing through multiple levels of drawings to create a sense of depth in a shot. A multiplane is a scene in which the layers are placed at different distances from the camera so that when the camera moves, a depth illusion occurs. With a multiplane, all the perspective and scale is calculated automatically.
<b>NTSC</b>	The standard analogue television broadcasting system used in North America. NTSC conforms to North American standards on how rectangular pixels are displayed for computer and television screens.
<b>nudge</b>	A small push (left, right, up, down, forward or backward) done with the keyboard arrow keys on a selected element. Nudging is used to move a selection very slightly and precisely.
<b>onion skin</b>	A feature that lets you see the previous and next drawings of a sequence.
<b>overlay</b>	A part of the scene environment, such as a chair or a bush, that is placed in front of the main animation.
<b>PAL</b>	A resolution that works best with the European format for television and computer screens, as the rectangular pixels are displayed at a different orientation.
<b>palette/master palette</b>	A palette or master palette is a group of colours attributed to a character or a

	prop. The palette is used throughout the entire project to maintain a consistency in the look and avoid the colour changing during the animation. Also referred to as a master palette.
<b>palette style</b>	A palette style is a second version of an existing palette with a slight change in the tint and value. A palette style can be used to create the night version of a palette. It may also be called a clone palette.
<b>pan</b>	To move the camera across the scene in any direction.
<b>panel</b>	In a storyboard, a panel is a frame in a shot. A shot can be composed of one or several panels.
<b>paperless animation/tradigital</b>	The paperless animation process is the action of animating digitally. The main paperless animation process is to draw, frame by frame, the animation directly in the software.
<b>passing position</b>	When drawing a walk sequence for a character, the passing position is the point at which one leg passes the other.
<b>path of action</b>	Direction that the action will follow. Also known as <i>line of action</i> .
<b>peg</b>	In traditional animation, a tool used to ensure accurate registration of action as cel layers move. In digital animation, in which you are doing a more advanced puppet rigging, you can use peg layers. Peg layers are trajectory layers that do not contain drawings. They are motion paths that you can use to add path articulations. For the latter, you can also use the Inverse Kinematics tool.
<b>phoneme</b>	A unit of sound in a language.
<b>pivot</b>	The point around which a peg or drawing rotates.
<b>pixel</b>	The smallest element of an image displayed on a monitor or TV screen.  Pixel, short for <i>picture element</i> , is a single point in a graphic image. It is a small sample of an image, a dot, a square, or a very small section made out of smooth filtering. If you zoom in close enough on a digital image, you will see the pixels, which look like small squares of different colours and intensity.
<b>pose-to-pose animation</b>	The pose-to-pose animation process is the action of creating all the main action poses, called <i>key poses</i> , and then placing the secondary poses between the keys. The secondary poses are called <i>breakdown</i> . Finally, the animator fills the gaps with the in-between drawings to achieve a smooth animation.
<b>rendering</b>	The final step when animating by computer. During rendering, the computer takes each pixel that appears on screen and processes all of the components, as well as adding motion blur before it produces a final image. The process of calculating the final images after the compositing process.
<b>resolution</b>	The size of a scene, generally calculated in pixels. For example, the NTSC resolution is 720 x 480. The resolution should match the final output: HDTV, film-1.33, film-1.66, NTSC, PAL, low.
<b>RGB</b>	Red, Green, Blue. A method of defining colour by specifying amounts of these three colour components.
<b>rigging</b>	The process of attaching the various parts of a cut-out puppet.

<b>rotary table</b>	Equivalent to the animation disk/table, a device that allows you to rotate the workspace for greater comfort while drawing.
<b>rotoscoping</b>	An animation technique in which animators trace over live-action film movement, frame by frame, for use in animated films. The act of sketching over live-action footage to create an animated sequence.
<b>roughs</b>	The skeleton sketch of an animation or design. Roughs mainly consist of sketch lines and shapes, though they can also contain design details.
<b>safe area</b>	The zone at the center of a scene's frame that is safe from being cropped by the TV frame. As a TV frame cuts a margin off the original frame size, maintaining a safe area ensures that the scene's main action will remain clearly visible once the film is screened on television.
<b>scene</b>	A shot in a movie or show. A sequence is composed of several scenes. A scene changes to another scene by a simple cut or transition.
<b>script</b>	The original text containing all the movie or show information. In animation, the script contains all of the location descriptions, dialogue, time and more. A project starts with a script.
<b>sequence</b>	A series of scenes or shots forming a distinct part of the story or movie, usually connected by unity of location or time.
<b>shot</b>	A scene in a movie or show. A sequence is composed of several shots. A shot changes to another shot by a simple cut or transition.
<b>slow-in</b>	The gradual acceleration in the action. Also known as <i>ease-in</i> .
<b>slow-out</b>	The gradual deceleration in the action. Also known as <i>ease-out</i> .
<b>slugging</b>	To indicate the start and stop times of dialogue and relevant actions.
<b>sound scrubbing</b>	A process that lets you hear sound in real time while you move the playhead forward or backward. This is very useful for finely-tuning a lip-sync.
<b>stop-motion keyframe</b>	A keyframe with no computer-generated interpolation.
<b>storyboard</b>	A visual plan of all the scenes and shots in an animation. The storyboard indicates what will happen, when it will happen and how the objects in a scene are laid out.
<b>straight-ahead</b>	A technique in which an entire sequence is drawn from the first position to the last, in order. There is very little planning in this methodology. Where the character ends up and how it gets there can be a surprise for both the audience and the animator. While this approach is spontaneous and creative, it can create inaccurate results.
<b>strokes</b>	Invisible vector lines forming the drawing zones. They can be adjusted with Bézier handles.
<b>tablet/pen</b>	A device used in conjunction with, or instead of, a mouse to move a mouse pointer (sometimes referred to as the <i>cursor</i> ) around the computer screen.
<b>template</b>	An asset stored in the library that can be reused in any project. A template can be a drawing, a series of keyframes, a sound file, a panel, a cut-out character, an effect, a trajectory, an animation, or anything else used in the animation.

<b>thumbnails</b>	A very small image used as a reference or indicator.
<b>timecode</b>	The timing information printed on a movie clip to indicate the scene, hour, minute and second that is currently displayed on the screen.
<b>timeline</b>	A horizontal representation of a scene's elements, timing and keyframes.
<b>trace and paint</b>	After the rough animations have gone through cleanup and a final line or pencil test, each drawing is traced and painted for the final animation. In today's digital world, this may be done in a variety ways other than the traditional celluloid or acetate methods.
<b>track breakdown</b>	The break down of an animated film's soundtrack into individual sounds to produce the precise frame-by-frame position of each sound.
<b>traditional animation</b>	A type of animation process whereby all the animation sequences are drawn by hand on paper before scanning or inking them on cels.
<b>trajectory</b>	A computer-generated path or trajectory that elements can follow. The trajectory can be controlled by control points, keyframes and velocity.
<b>transition</b>	An effect placed between two scenes as they pass from one to the other. Common transition effects are cross-dissolve and wipe.
<b>underlay</b>	In animation, an underlay is a specific part of the decor placed behind the main animation.
<b>aspect ratio</b>	The aspect ratio describes the shape of the grid unit. A square grid unit would have a 1:1 ratio , whereas a grid unit of aspect ratio 4:3 is a unit with one side 1.33 times as big as the other side.
<b>vector</b>	A vector-based image is composed of points and Bézier curves. The computer reads the points and traces the segments, linking them to reproduce the image shape. There is no fixed size or resolution in a vector image. The graphic can be enlarged and distorted as much as desired and the system will simply recalculate the segments and rebuild the shapes. Vector images are translated and displayed in pixels once the calculation is done.
<b>velocity</b>	In animation, the velocity, also known as <i>ease</i> , is the acceleration or deceleration of a motion. This can be achieved by a function curve, or via a series of animated drawings. Other common terms for ease-in and ease-out are <i>slow-in</i> and <i>slow-out</i> .
<b>walk cycle</b>	A series of drawings "on the spot" that describe the walk for a character. The illusion of movement is created by the use of background pans. To avoid making innumerable drawings, animators routinely make a walk cycle for a character.
<b>Xsheet (exposure sheet)</b>	<p>The Xsheet or exposure sheet, is a sheet with several vertical columns and horizontal frames used to indicate a scene's timing.</p> <p>Each column represents a scene's layer. In each column, the drawing numbers are indicated and spread over the specific number of frames in which they appear.</p> <p>The exposure sheet is used by animators, directors and other members of the crew to track the sequence and timing of images, dialogue, sound effects, sound tracks and camera moves. Also known as <i>dope sheet</i>.</p>

<b>zone</b>	An area which can be painted with colour.
-------------	-------------------------------------------



---

# Index

---

- 4:3
  - 12 fields 71
- about
  - Cloud module 13
  - Harmony 11
  - Play module 12
  - Stage 12
- adding
  - views 85
- Advanced Animation toolbar 136
- alignment 71
  - 4:3 12 Fields 71
  - Square 12 Fields 71
- alpha channel 143
- animatic 18, 143
- animation 143
  - principles 33
- animation principles 33
  - anticipation 34
  - arcs of rotation 35
  - concepts, traditional 39
  - exaggeration 37
  - follow-through 35
  - pose-to-pose 34
  - secondary actions 36
  - slow-in, slow-out 36
  - solidity 37
  - squash and stretch 33
  - straight-ahead 34
  - timing 33
- animation types 21
  - cut-out 23
  - paperless 22
  - traditional 21
- animation workflows 15
  - post-production 19
  - pre-production 15
  - production 19
- anime 143
- anticipation 34
- arc 143
- arcs of rotation 35
- area, safe 100
- Art Layer toolbar 137
  - enabling art layers 137
- art layers
  - enabling 137
- aspect ratio 70, 143, 151
  - grid 71
- audio
  - dubbing 20
  - editing 20
  - recording 18
- auto-feed 143
- auto-save
  - disabling on workspaces 96
- axis 143
- background 143
- background styling 18
- Bezier 144
- bitmap graphics 39
  - advantages, disadvantages 40
  - image types 39
- bitmap images 144
- bitmap resolution
  - height 73
  - resolution factor 73
  - settings 73
  - width 73
- bounding box
  - selection style 101
- breakdown 144
  - sound 19
- broadcast standards 43
- camera mask 100
- camera shake 144
- Camera toolbar 104
- Camera view 99
  - bounding box selection style 101
  - camera mask 100
  - Camera View toolbar 104
  - current drawing on top 100
  - Editing Stack menu 104
  - light table 99
  - Matte View mode 103
  - OpenGL view mode 102
  - outline locked drawings 101
  - Render View mode 102
  - resetting view 101
  - safe area 100
  - View menu 104
  - Zoom menu 101
- caption 144
- cel 144
- celluloid
  - See cel. 144
- center coordinates, setting 72
- character
  - design 17
  - styling 18
- character design 144
- checking
  - colours 74
  - files, project 74

- project files 74
- clean up 144
- clockwise
  - rotating 141
- closing
  - views 86
- CMYK 144
- colour card 144
- colour layers 40
- colour model 144, 148
- colour palettes 41
  - switching display modes 105
- Colour view 104
  - switching palette display modes 105
- colour wheel 144
- colours
  - checking 74
- commands
  - basic 75
- compositing 144
- conventions, naming 58
  - layer 58
  - puppet drawings 60
  - renaming modules 59
  - scene 58
- counterclockwise
  - rotating 141
- creating
  - scenes 62
  - scenes from File menu 63
  - scenes from Welcome scene 62
  - scenes with custom resolution 64
  - workspace, new 94
- cross dissolve 145
- current drawing on top, Camera view 100
- custom resolution
  - creating scenes 64
- customizing
  - toolbars 91
- cut 145
- cut-out animation 23, 145
  - workflow 30
- cycle 145
- dark style interface 81
- Deformation toolbar 137
- deleting
  - workspace 97
- dialogue 145
- display
  - workspace 97
- distribution, master 21
- documentation
  - accessing 62
- dope sheet 145
- doping 145
- DPI 145
- drawing layers
  - adding 67
- Drawing view 109
- drawings
  - current drawing on top 100
  - flipping through 137
  - outline locked drawings 101
- dubbing 20
- ease 145
- ease-in 145
- ease-out 145
- Easy Flipping toolbar 137
- editing
  - audio 20
  - final 20
- Editing Stack menu 104
- editors
  - Layer Properties 112
- establishing shot 145
- exaggeration 37
- exposure 145
- exposure sheet 145, 151
  - traditional 43
- fade-in 146
- fade-out 146
- field 146
- field chart 146
- field of view 70
  - custom 70
  - horizontal fit 70
  - vertical fit 70
- file structure 51
  - drawings and layers 54
- File toolbar 138
- files
  - checking project files 74
  - film-1.33 69, 146
  - film-1.66 69, 146
  - film-1.66\_Vertical 69
  - final editing 20
  - flat toolbars 88, 93
  - Flip toolbar 138
  - flipping 146
  - follow-through 35, 146
  - format 47
  - forward kinematics 146
  - FOV (field of view) 70
    - custom 70
    - horizontal fit 70

---

- vertical fit 70
- fps 70
- frame 146
- frame rate 47, 146
- frames per second 70
- full screen 141
- Function view 110
  - displaying functions 111
- functions 146
  - displaying 111
- gamut 147
- graphics, bitmap and vector 39
  - advantages, disadvantages 40
  - bitmap image types 39
  - vector image types 40
- grid
  - aspect ratio, setting 71
  - centre coordinates, setting 72
  - number of units, setting 72
- Harmony
  - dark style 81
  - file structure 51
  - interface 81
  - modules 11
  - starting 61
- Harmony Server
  - dark style 81
  - interface 81
  - starting 61
- HDTV 69, 147
- HDTV\_Vertical 69
- Help
  - Harmony 7
  - structure 7
- hiding
  - views temporarily 88
  - workspace 97
- Hold 147
- HSV 147
- in-between 147
- ink and paint 147
- integrity
  - project, checking 74
- interface 81
  - dark style 81
- interpolation 147
- jump cut 147
- key pose 147
- keyboard shortcuts 147
- keyframes 147
- Layer Properties editor 112
- layers 147
  - adding drawing layer 67
  - line and colour layers 40
  - naming convention 58
- layout 147
- layout and posing 147
- library 56, 148
  - personal 58
- Library view 113
- light table 148
  - Camera view 99
- line layers 40
- line of action 148
- lip-sync 148
  - auto detection 143
- lip-sync detection
  - manual 148
- loading
  - workspace 93
- location design 17
- looping
  - playback 139
- low resolution 69, 148
- manual lip-sync detection 148
- Mark Drawing toolbar 138
- mask
  - camera 100
- master distribution 21
- master palette 148
- Matte View mode 103
- menus 82
  - Editing Stack 104
  - View 104
  - Zoom 101
- Message Log view 115
- model 148
- model sheet See character design
- Model view 115
- motion keyframe 148
- mouth
  - chart 148
- moving
  - toolbars 90
- multiplane 148
  - traditional animation 46
- multiplane camera 46
- naming convention 58
  - layer naming 58
  - puppet drawings 60
  - renaming modules 59
  - scene naming 58

- navigating
  - centering screen on mouse 141
  - full screen 141
  - panning 141
  - Play menu 142
  - recentering view 141
  - resetting pan 141
  - resetting rotation 141
  - resetting views 141
  - resetting zoom 141
  - rotating clockwise 141
  - rotating counterclockwise 141
  - zooming in 140
  - zooming in or out 141
  - zooming out 140
- network 46
- node system 46
- nodes
  - Cloud 13
  - Harmony 11
  - Play 12
  - renaming 59
  - Stage 12
- NTSC 69, 148
- nudge 148
- Onion Skin toolbar 138
- onion skinning 148
  - toolbar 138
- OpenGL
  - view mode 102
- opening
  - scenes 62
  - scenes from File menu 64
  - scenes from Windows screen 64
  - Workspace Manager 94
- organizing
  - drawings and layers 54
  - files 51
  - projects 51-52
  - outline locked drawings 101
  - overlay 148
  - PAL 69, 148
  - palettes 148
    - colour 41
    - style 149
    - switching display modes 105
  - panel 149
  - panning 141, 149
    - resetting 141
  - paperless animation 22, 149
    - workflow 28
  - passing position 149
  - path of action 149
  - pegs 149
    - traditional animation 45
  - pen 150
  - Perspective view 116
    - rotating a scene 117
  - phoneme 149
  - picture element 48
  - pipeline
    - Toon Boom 11
  - pivot 149
  - pixel 48, 149
    - dimensions 69
  - pixelation See bitmap image
  - Play menu 142
  - Play module
    - about 12
- Playback toolbar 139
  - FPS button 139
  - Jog Frames button 139
  - Loop button 139
  - Play button 139
  - Render and Play button 139
  - Sound button 139
  - Sound Scrubbing button 139
- playing back 139
  - fps 139
  - jogging frames 139
  - looping 139
  - rendering and playing 139
  - sound 139
  - sound scrubbing 139
- pose-to-pose 149
- post-production workflow 19
- pre-production
  - workflow 15
- preferences 78
  - disabling auto-save workspace 96
  - flat toolbars 93
- Preferences dialog box 78
- principles, animation 33
  - anticipation 34
  - arcs of rotation 35
  - exaggeration 37
  - follow-through 35
  - pose-to-pose 34
  - secondary actions 36
  - slow-in, slow-out 36
  - solidity 37
  - squash and stretch 33
  - straight-ahead 34
  - timing 33

---

product requirements  
 Harmony 9

production steps 25

projects  
 checking colours 74  
 checking files 74  
 colours, checking 74  
 content building scenes,  
 organizing 52  
 drawings and layers, organizing 54  
 files, checking 74  
 organizing 51  
 resolution 69  
 root directory, organizing 52  
 verifying integrity 74

prop  
 design 17  
 styling 18

puppets  
 naming convention 60

recentering  
 view 141

renaming  
 nodes 59  
 workspace 96

Render View mode 102

rendering 149

reordering  
 workspace 98

resetting  
 Camera view 101  
 pan 141  
 rotation 141  
 views 141  
 zoom 141

resizing  
 toolbars 89  
 views 87

resolution 149  
 bitmap 73  
 factor, bitmap 73  
 film-1.33 69  
 film-1.66 69  
 film-1.66\_Vertical 69  
 HDTV 69  
 HDTV\_Vertical 69  
 height, bitmap 73  
 Low 69  
 NTSC 69  
 PAL 69  
 presets 69  
 scene 73  
 width, bitmap 73

restoring  
 workspace, default 98

RGB 149

rigging 149

root directory 52

rotary table 150

rotating  
 resetting rotation 141  
 rotating clockwise 141  
 rotating counterclockwise 141

rotoscoping 150

roughs 150

safe area 100, 150

saving  
 auto-saving scenes 66  
 scenes 65  
 workspace manually 96

scene resolution 73

Scene Settings dialog box 68

scenes 48, 150  
 auto-saving 66  
 creating 62  
 creating from File menu 63  
 creating from Welcome scene 62  
 creating with custom resolution 64  
 file structure 51  
 naming convention 58  
 new scene startup script 67  
 opening 62  
 opening from File menu 64  
 opening from Welcome screen 64  
 rotating in Perspective view 117  
 saving 65  
 scene length, setting 66  
 setting length 66  
 settings 68

script 150

Script Editor view 118

scripting  
 toolbar 139

Scripting toolbar 139

scripts 16  
 new scene startup 67

scrubbing 150

secondary actions 36

selection style  
 bounding box 101

sequences 150

settings  
 scene 68

shot 150

Side view 119

- slow-in 36, 150
- slow-out 36, 150
- slugging 150
- solidity 37
- sound
  - breakdown 19
  - scrubbing 150
- squash and stretch 33
- Stage 12
  - about 12
- standards
  - broadcast 43
- starting
  - Harmony 61
  - ToonBoomProductName 61
- stop-motion keyframe 150
- storyboard 17, 150
- straight-ahead 34, 150
- strokes 150
- swapping
  - views 86
- switching
  - workspace 93
- system requirements
  - Harmony 9
- tablet 150
- technical specifications
  - Harmony 9
- templates 56, 150
- thumbnails 151
- timecode 151
- timeline 151
  - traditional 44
  - usage 44
- Timeline view 120
- timing 33
  - scene length 66
- tool presets 140
- Tool Presets toolbar 140
- Tool Properties view 128
- toolbars 136
  - Advanced Animation 136
  - Art Layer 137
  - Camera View 104
  - customizing 91
  - Deformation 137
  - Easy Flipping 137
  - Edit 138
  - File 138
  - flat 88
  - Flip 138
  - hiding 89
  - managing 88
  - Mark Drawing 138
  - moving 90
  - Onion Skin 138
  - Playback 139
  - resizing 89
  - Scripting 139
  - showing and hiding 89
  - Tool Presets 140
  - Tools 139
  - top 136
  - view 140
  - Workspace 140
  - Xsheet View 138
- tools
  - Zoom 142
- Tools toolbar 139
- Top view 128
- trace and paint 151
- track breakdown 151
- tradigital 149
- traditional animation 21, 151
  - colour layers 40
  - colour palettes 41
  - concepts 39
  - exposure sheet 42-43
  - file structure 51
  - frame rate and format 47
  - line and colour layers 40
  - line layers 40
  - multiplane 46
  - network 46
  - pegs 45
  - project organization and file structure 51
  - scenes 48
  - timeline 42
  - timeline usage 44
  - timeline, traditional 44
  - timing 42
  - workflow 25
  - Xsheet usage 44
- trajectory 151
- transition 151
- underlay 151
- vector 151
- vector graphics 39
  - advantages, disadvantages 40
  - images types 40
- velocity 145, 151
- View menu 104
- view modes
  - Matte 103
  - OpenGL 102

---

Render view 102  
views 84  
  adding 84-85  
  Camera 99  
  closing 86  
  Colour 104  
  Drawing 109  
  Function 110  
  hiding temporarily 88  
  Library 113  
  managing 84  
  Message Log 115  
  Model 115  
  Perspective 116  
  recentering 141  
  resetting 141  
  resizing 87  
  Script Editor 118  
  Side 119  
  swapping 86  
  Timeline 120  
  Tool Properties 128  
  Top 128  
  Xsheet 129  
walk cycle 151  
Web Control Center  
  about 13  
Welcome screen 61  
workflows  
  animation 15  
  cut-out animation 30  
  paperless animation 28  
  post-production 19  
  pre-production 15  
  production 19  
  traditional animation 25  
workspace  
  creating new 94  
  deleting 97  
  disabling auto-save 96  
  displaying 97  
  hiding 97  
  loading 93  
  managing 93  
  renaming 96  
  reordering 98  
  restoring default 98  
  saving as new version 97  
  saving manually 96  
  showing 97  
  toolbar 140  
Workspace Manager  
  opening 94  
Workspace toolbar 140  
Xerox process 41  
Xsheet toolbar 138  
Xsheet view 129, 151  
  usage 44  
zone 152  
Zoom menu 101  
Zoom tool 142  
zooming  
  in 140  
  in or out 141  
  out 140  
  resetting zoom 141  
Zoom tool 142

