



Harmony
Essentials

Toon Boom Harmony Essentials V15.0 User Guide



TOON BOOM ANIMATION INC.
4200 Saint-Laurent, Suite 1020
Montreal, Quebec, Canada
H2W 2R2

+1 514 278 8666
contact@toonboom.com
toonboom.com

Legal Notices

Toon Boom Animation Inc.
4200 Saint-Laurent, Suite 1020
Montreal, Quebec, Canada
H2W 2R2

Tel: +1 514 278 8666

Fax: +1 514 278 2666

toonboom.com

Disclaimer

The content of this guide is covered by a specific limited warranty and exclusions and limit of liability under the applicable License Agreement as supplemented by the special terms and conditions for Adobe® Flash® File Format (SWF). For details, refer to the License Agreement and to those special terms and conditions.

The content of this guide is the property of Toon Boom Animation Inc. and is copyrighted.

Any reproduction in whole or in part is strictly prohibited.

Trademarks

Harmony is a trademark of Toon Boom Animation Inc.

Publication Date

01-15-2020

Copyright © 2018 Toon Boom Animation Inc., a Corus Entertainment Inc. company. All rights reserved.

Table of Contents

Table of Contents	3
User Guide	23
Chapter 1: Project Creation	25
Starting Harmony	26
About the Welcome Screen	27
About Scenes	28
Creating Scenes	29
Creating Custom Resolutions	31
Opening Scenes	33
Setting the Scene Length	34
About Scene Settings	35
Saving Scenes	36
Saving Scenes as Copies	37
Saving Scenes as New Versions	38
Enabling Auto-Save	39
About the File Structure	40
Chapter 2: Interface	43
Changing the Theme Colours	44
Changing the User Interface Language	45
About Menus	47
About Toolbars	50
Adding Toolbars	51
Moving Toolbars	52
Resizing Toolbars	53
Customizing View Toolbars	54
About Views	56
Adding Views	57
Closing Views	60

Showing and Hiding Views	61
Moving Views	62
Resizing Views	63
About Preferences	64
About Workspaces	66
Loading Workspaces	67
Creating Workspaces	68
Renaming Workspaces	70
Saving Workspaces	71
Deleting Workspaces	72
Showing and Hiding Workspaces	73
Reordering Workspaces	74
Restoring the Default Workspace	75
About Interface Navigation	76
About Documentation	79
Accessing the Documentation	80
Using the Integrated Help	81
Chapter 3: Drawing	85
About Drawing Tools	86
About the Brush Tool	88
Drawing with the Brush Tool	89
Creating a Brush	90
About Brush Presets	92
Creating a Brush Preset	93
Selecting a Brush Preset	94
Updating a Brush Preset	95
Renaming a Brush Preset	96
Deleting a Brush Preset	97
Exporting Brush Presets	98

Importing Brush Presets	100
Changing the Brush Preset Display	102
About the Pencil Tool	103
Drawing with the Pencil Tool	104
Changing Pencil Settings	105
Disabling Pencil Line Textures	106
About Pencil Presets	108
Creating Pencil Presets	109
Selecting a Pencil Preset	110
Renaming Pencil Presets	111
Deleting Pencil Presets	112
Exporting Pencil Presets	113
Importing Pencil Presets	115
Changing the Pencil Preset Display	117
About Shape Tools	118
Creating Rectangles, Circles and Lines with the Shape Drawing Tools	119
Creating Vector Shapes with the Polyline Tool	121
About the Stroke Tool	122
Creating Invisible Lines with the Stroke Tool	123
About the Eraser Tool	125
Erasing	126
Creating an Eraser	127
About Eraser Presets	129
Creating an Eraser Preset	130
Selecting an Eraser Preset	131
Updating a Brush Preset	132
Renaming an Eraser Preset	133
Deleting a Brush Preset	134
Exporting Eraser Presets	135

Importing Eraser Presets	137
Changing the Brush Preset Display	139
About the Select Tool	140
Selecting	141
Inverting a Selection	143
Repositioning the Selection Pivot	144
Arranging and Reordering Drawing Strokes	145
Grouping Drawing Strokes	146
Working on a Single Drawing with the Select Tool	147
About the Repositioning All Drawings Tool	148
Repositioning All Drawings in a Layer	149
About the Cutter Tool	151
Cutting Artwork	152
About the Contour Editor Tool	153
Reshaping a Shape, Pencil Line or Stroke with the Contour Editor Tool	154
About the Centerline Editor	158
Reshaping Brush Strokes Using the Centerline Editor	160
About the Smooth Editor Tool	164
Smoothing Artwork Using the Smooth Editor	165
About the Perspective Tool	166
Deforming a Drawing with the Perspective Tool	167
About the Envelope Tool	168
Warping a Drawing with the Envelope Tool	169
About the Text Tool	171
Adding Text to Drawings	172
Breaking Text Into Letters or Vector Shapes	174
About Drawing Space Management	175
About the Zoom Tool	176
About the Hand Tool	177

About the Rotate View Tool	178
Rotating the Workspace	179
Displaying the Current Drawing on Top	180
About the Grid	181
Displaying the Grid	182
Modifying the Grid	183
About OpenGL Antialiasing	184
Setting the Full Scene Antialiasing Preference	185
About Drawing Guides	186
Adding Drawing Guides	189
Renaming Drawing Guides	190
Deleting Drawing Guides	191
Selecting the Active Drawing Guide	192
Cutting Drawing Guides	193
Copying Drawing Guides	194
Reordering Drawing Guide Lists	195
Editing Drawing Guides	196
Drawing with Drawing Guides	198
Locking Drawing Strokes to a Specific Axis	200
Drawing Freehand Perspective with Drawing Guides	201
Erasing Using Drawing Guides	202
Viewing Drawing Guide Reference Lines	203
Minimizing Guide Cursor Axes Display	204
Preventing the Editing of Drawing Guides	205
Enabling and Disabling Drawing Guides	206
Importing and Exporting Drawing Guide Lists	207
About Drawing Optimization	208
Flattening Drawings	209
Smoothing Drawings	210

Optimizing Drawings	211
Reducing the Drawing Texture Resolution	212
About Strokes Conversion	213
Converting Brush Strokes to Pencil Lines	214
Converting Pencil Lines to Brush Strokes	215
Converting Strokes to Pencil Lines	216
Chapter 4: Colours	217
About Colour Swatches	219
Adding a Colour Swatch	220
Adding a Gradient Colour Swatch	222
Adding a Texture Colour Swatch	224
Copying and Pasting Colours	225
Deleting a Colour Swatch	227
Modifying a Texture Colour Swatch	228
Replacing Colours and Textures in Drawings	229
Changing the Colour Display Mode	231
About Palettes	232
About Scene and Element Palette Lists	234
About the Palette List	235
Showing and Hiding the Palette List	236
Creating a Palette	237
Importing a Colour Palette	238
Renaming a Palette	239
Removing a Palette	240
Duplicating a Palette	241
Cloning a Palette	242
Tinting a Palette's Colour Swatches	244
Reordering Palettes in the Palette List	246
About Painting	247

Flipping Between Models	248
Copying Colour Models	249
Painting Drawings	251
Repainting	254
Selecting Strokes with the Current Colour	255
Closing Gaps	256
Picking a Colour with the Dropper Tool	258
About the Edit Gradient and Texture Tool	259
Using the Edit Gradient and Texture Tool	260
Chapter 5: Paperless Animation	263
Creating a Rough Animation	264
Creating the Tie Down Animation	268
Cleaning Animation	272
Paperless Animation Tools	275
Displaying Drawing Thumbnails in the Timeline View	276
About the Onion Skin	279
Enabling the Onion Skin	280
Generating a Matte	281
Chapter 6: Timing	283
About Scene Length	284
Setting the Scene Length	285
Adding Frames in the Middle of a Scene	286
Adding Frames at the Beginning of a Scene	288
Adding Frames at the End of a Scene	289
Removing Frames from a Scene	290
About Layers and Columns	292
Layer and Column Types	293
Adding Layers and Columns	296
Adding Layers in the Timeline View	297

Adding Layers from the Top Menu	298
Adding Columns from the Xsheet View	299
Using the Advanced Add Column Dialog Box	300
Deleting Layers and Columns	301
Renaming Layers and Columns	303
About Layer and Column Display	304
Expanding and Collapsing Layers and Columns	305
Showing and Hiding Layers and Columns	307
Showing and Hiding Layers	308
Showing and Hiding Columns	310
Showing Hidden Columns	311
Showing and Hiding Column Types	312
Displaying Xsheet Thumbnails	313
Changing Layer and Column Colours	314
Reordering Layers and Columns	316
Navigating Layers and Columns	317
Duplicating Layers and Columns	319
Cloning Layers and Columns	320
Displaying Layer and Column Properties	321
About Exposure	323
About Creating Exposure	324
Typing Exposures	325
Setting the Exposure Hold	327
Toggling Between Inserting and Overwriting Exposure	328
Filling a Selection with a Specific Exposure	329
Creating an Exposure Sequence	331
Creating an Exposure Cycle	333
Inserting Blank Cells	334
Filling Empty Cells	336

Toggling Extending Previous Drawing Exposure	337
About Adjusting Exposure	339
Increasing Exposures	340
Decreasing Exposures	341
Extending Single Exposures	343
Setting the Exposure	345
Deleting Exposures	347
Moving Cells	348
About Rippling and Overwriting the Exposure in the Timeline View	351
Changing Exposure and Rippling Drawings in the Timeline View	352
Changing Exposure and Overwriting Drawings in the Timeline View	354
About Key Exposures	356
Adding Key Exposures	357
Removing Key Exposures	359
Removing Duplicate Key Exposures	360
About Drawings	361
Creating Empty Drawings	362
Renaming Drawings	363
Deleting Drawings	364
Duplicating a Drawing	365
Copying and Pasting Drawings	366
Chapter 7: Rigging	369
About Rig Types	370
About Simple Rigs	371
About Drawing Hierarchy Rigs	372
About Peg Hierarchy Rigs	374
About Scene Setup for Rigging	375
About Models	376
About Size Relation	378

Setting Preferences for Rigging	380
About Naming Conventions	381
Naming Drawing Layers	382
About Character Breakdown	383
Tracing the Model	386
Breaking Down the Main Parts	389
Breaking Down Secondary Parts	392
Breaking Down Other Views	396
Completing Parts and Articulations	399
About Articulations	402
Creating Classical Articulations	403
About Ordering Layers	405
Ordering Layers in the Timeline View	406
About Z Nudging	407
Nudging Layers	408
About Pivots	409
About Permanent Pivots	410
Setting Permanent Pivots	411
Setting Multiple Permanent Pivots	412
Adding Pegs	413
Creating Hierarchies	415
Adding the Master Peg	418
Invert-Cutting	420
Grouping Rigs	423
Creating Keyframes	425
Creating a Master Controller Through Scripting	426
Chapter 8: Cut-out Animation	427
About Animating with the Transform Tool	428
Animating with the Transform Tool	430

Resetting Transformations	431
About Hierarchy Navigation	433
Navigating Layers	434
Selecting Parent and Children	435
Centering on Selections	436
About Keyframes	437
Creating Motion Keyframes	438
Creating Stop-motion Keyframes	440
About Swapping Drawings	442
Swapping Drawings in the Timeline View	443
Swapping Drawings in the Library View	444
Adding Key Exposures	446
Removing Key Exposures	448
About Eases	449
Setting Eases for Multiple Parameters	450
Using the Onion Skin in Cut-out Animation	453
Using the Outline Mode	456
Flipping Through Poses	460
Flipping Parts	461
Animating Lip-Sync	462
Ordering in Z-Depth	466
Creating Cycles	468
Chapter 9: Motion Paths	471
About Pegs	472
Adding Pegs	474
Enabling Peg Selection Mode	476
About Drawing Layers	477
About Layer Parameters	479
Displaying Layer Parameters	481

Setting Layer Parameters	482
Enabling Constant Z	483
About Keyframes	484
Enabling the Animate Mode	485
About Keyframe Creation	486
Creating Keyframes in the Timeline View	487
Creating Keyframes in the Function View	489
Creating Keyframes in the Xsheet View	491
Deleting Keyframes	493
Animating with Keyframes	494
Changing Keyframe Values	497
Switching Keyframe Types	499
Jumping to Keyframes	502
About Controls	503
Displaying Controls	505
Adding Control Points	506
Toggling Point Types	507
Adjusting Tension, Bias, and Continuity	508
Offsetting Trajectories	509
About Functions	511
Creating Functions	514
About Copying Motions	516
Using Timeline Paste Modes	517
Using Paste Special	519
About Velocity	520
Displaying Velocity Curves	521
Adjusting Bezier Curve Velocity	523
Creating Stepped Velocity	524
Adjusting Velocity in the Timeline View	529

Setting Ease on Multiple Parameters	530
Chapter 10: Deformations	533
About Deformation Types	534
About Bone Deformations	535
About Game Bone Deformations	536
About Chain Creation	537
Selecting Elements for Deformation	538
Creating Bone Deformation Chains	539
Creating Game Bone Deformation Chains	541
Creating a Split Deformation Chain	543
Setting Rest Positions for Bone and Game Bones	545
Selecting Region of Influence Types	549
Setting Up Elliptic Regions of Influence	550
Setting Up Shaped Regions of Influence	553
Converting Elliptic Regions of Influence into Shapes	555
About Assembly	556
Assembling in the Timeline View	558
Displaying Selected Deformation Controls	560
Hiding Deformation Controls	561
About Deformation Animation	562
Animating Bone and Game Bone Deformers	563
Resetting a Deformer to its Resting Position	567
Disabling Deformation Preview	568
Transferring Curve Positions of Legacy Deformations	569
Converting Legacy Deformation Chains	571
Chapter 11: Staging	573
About Layer Position	574
About the Animate Mode	575
Selecting Layers	576

Centering on Selections	578
About the Transform Tool	579
Repositioning Temporary Pivots with the Transform Tool	581
Panning with the Transform Tool	582
Rotating with the Transform Tool	583
Scaling with the Transform Tool	584
Skewing with the Transform Tool	585
Flipping with the Transform Tool	586
About Advanced Animation Tools	587
Repositioning Permanent Pivots	588
Using the Translate Tool	589
Using the Rotate Tool	590
Using the Scale Tool	591
Using the Skew Tool	592
About the Layer Properties View	593
Displaying the Layer Properties View	595
Positioning Elements with the Layer Properties View	596
About Selection Locking	598
Locking Layers	599
Setting the Auto-Apply Option	603
Resetting Transformations	604
About Opacity and Transparency	605
Setting the Layer Opacity	606
About Multiplane	608
Setting Up Multiplanes	611
About Clone and Duplicate Layers	613
About Clone Layers	614
Cloning Layers	615
About Duplicate Layers	616

Duplicating Layers	617
Displaying Port Tooltips	618
About Peg Nodes	619
Connecting and Disconnecting Nodes	620
About Groups	622
Grouping Layers	623
Chapter 12: Cameras	625
Adding a Camera	627
Selecting the Active Camera	628
Positioning the Camera Frame	629
Resetting the Camera Position	632
Animating the Camera	633
Chapter 13: Import	637
About Importing Bitmap Images	638
Importing Bitmap Images As Original Bitmap	639
Adjusting the Bitmap Image Display Quality	641
Vectorizing Images on Import	642
Importing Multi-layer PSD Files	644
About Importing Vector Files	647
Importing Adobe Illustrator (.ai) files and Portable Document Files (.pdf)	648
Importing Flash Movies (.swf)	650
Distributing SWFs to Layers	653
About FLA Import	654
Installing the Export to Harmony Option	656
Exporting FLA Files	665
Displaying the Import Flash Scene Icon	667
Importing FLA Files	670
Flash Export and Import Guidelines	672
Importing QuickTime Movies	675

About Scanning	676
Scanning Images	677
Vectorizing Scanned Drawings	679
About Custom Vectorization Parameters	681
Creating Vectorization Styles	682
Configuring the VectOptions.conf File	684
Chapter 14: Effects	687
Adding Effects Layers	689
Connecting Effects	690
Adding a Matte Drawing to an Effect	691
Configuring an Effect	694
Animating an Effect	697
About Effects Preview	707
Previewing Effects in Render Mode	708
Playing Back Effects	709
Changing the Preview Resolution	710
About Masking and Cutting Parts of Elements in your Scenes	711
Using the Matte Port of a Drawing Layer	712
Using the Cutter Node	715
Examples of Effect Usage	718
Creating a Drop Shadow	719
Chapter 15: Sound	723
About the Sound Editor	724
Sound Layer	725
Importing Sound	726
Playing Sound	728
Changing the Sound Display	729
Sound Scrubbing	731
Editing Sound	732

Cropping Sound	734
Trimming Sound	737
Looping Sound	738
Mixing the Sound Volume	739
Setting the Playback Range	741
Adding an Empty Sound Layer	742
About Lip-sync	744
Generating a Lip-sync Detection	746
Mapping the Lip-Sync Detection	749
Modifying the Lip-sync Detection	751
Manual Lip-syncing	753
Chapter 16: Export	755
Exporting Image Sequences	756
Exporting a Movie File	758
Configuring Movie Settings for Windows Media Video	761
Configuring Movie Settings for QuickTime Movies on Windows and macOS	762
Exporting a QuickTime Movie with Lossless Compression and Transparency	765
Exporting Flash (SWF) Movies	766
Batch Rendering	767
Chapter 17: Library	769
About Structure	770
Creating Libraries	771
Opening Libraries	772
Closing Libraries	773
Creating Folders	774
Deleting Folders	775
Renaming Folders	776
Refreshing Libraries	777
Generating Thumbnails	778

Deleting Thumbnails	779
Searching in Libraries	780
About Templates	781
Creating Templates	782
Deleting Templates	784
Editing Templates	785
Importing Templates	786
Opening Templates as Folders	789
About Symbols	790
Creating Symbols	791
Creating a Symbol from a Drawing	793
Creating Empty Symbols	795
Deleting Symbols	796
Editing Symbols	797
Importing Symbols	799
Expanding Symbols	800
Converting Symbols to Templates	801
Importing Files in the Library	803
Using Paste Special	804
Chapter 18: Gaming	805
Rigging Guidelines	806
Exporting Rigged Sprite Sheets or Rendered Sprite Sheets	807
Scene Set-Up Guidelines	809
Guidelines for Rigging Game Characters in Harmony	810
Guidelines for using the Cutter Effect for Game Assets in Harmony	813
Guidelines and Tips for Animating Game Assets in Harmony	814
Guidelines for Adding Audio to your Game Assets	815
Creating Multiple Clips for a Game Object in Harmony	816
About Anchors and Props	817

Creating an Anchor for a Game Character	818
Creating Props for Game Characters	823
Adding Metadata Notes to Game Props	827
Using the Harmony Game Previewer	829
About Exporting to Unity	831
Installing the Scripts for Exporting Game Sprite Sheets	832
Exporting a Game Character as a Rigged Sprite Sheets	835
Exporting Game Assets to Easel JS	838
Converting Exported Game Assets from XML to Binary	841
About Working in Unity	842
About the Sample Unity Project	843
About the Unity Interface	844
Importing Harmony Files into Unity	846
About Game Objects	847
Using Empty Game Objects	848
Attaching Props to Anchors in Unity	851
Attaching Props to Anchors in Unity	853
Troubleshooting	856

User Guide

The Harmony core functionality are explained in this User guide. All the steps required to create and complete a project are covered in the following chapters with concept descriptions and detailed step-by-step procedures focused on the task at hand.

Detailed parameter descriptions for all buttons, commands, and functions are covered in the Reference guide and Preference guide. Some of them are explained here where necessary to the understanding of a given concept or procedure.

Chapter 1: Project Creation

Once Harmony Essentials is installed, you are ready to start the application and animate! In this chapter, you will learn about starting the application, as well as creating, opening and saving scenes

Starting Harmony

T-HFND-001-002

You can run Harmony Essentials from your operating system's desktop.

**WARNING**

On macOS, Harmony and its other applications will not run on the first time unless you right-click on the application, then select **Open**. You will be prompted to confirm a security exception, which will require administrative privileges.

How to start Harmony

1. Do one of the following:
 - **Windows:** Start > Programs > Harmony 15.0 Essentials > Harmony Essentials
 - **macOS:** Applications > Toon Boom Harmony 15.0 Essentials > Harmony Essentials

The Harmony Essentials application launches and displays a splash screen. After the splash screen, the Welcome Screen will appear —see [About the Welcome Screen on page 27](#).

About the Welcome Screen

T-HFND-001-003

When you start Toon Boom Harmony, the Welcome screen appears. If a scene is already open, you can display the Welcome screen by selecting **Help > Show Welcome Screen**.

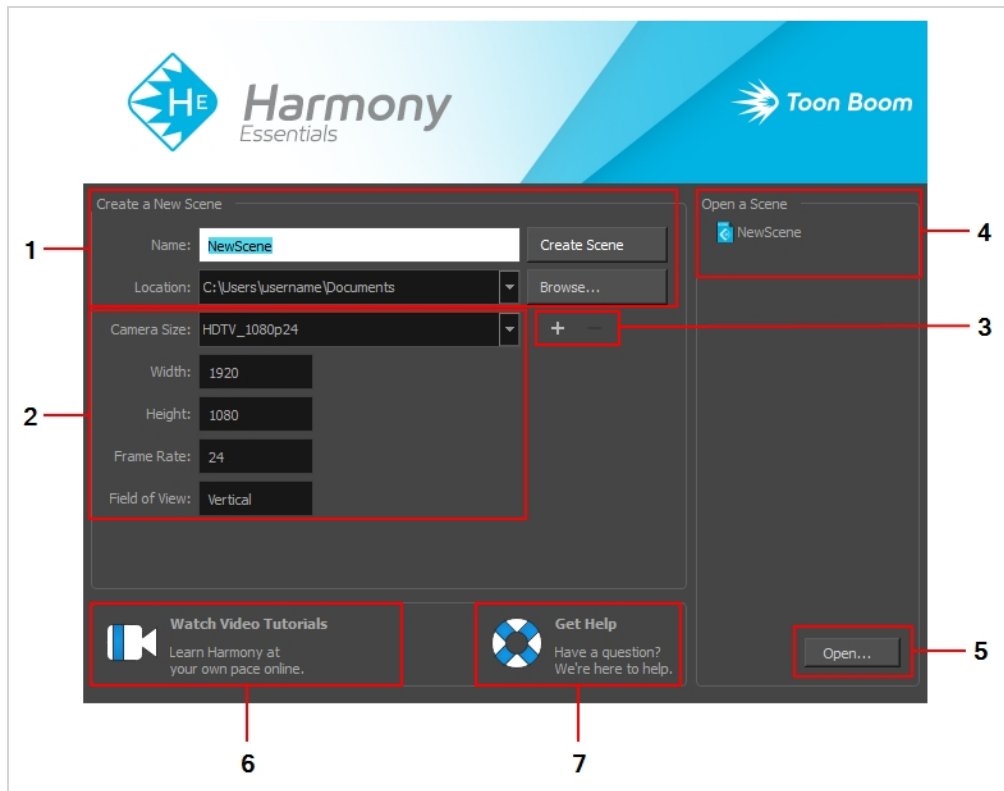

The Welcome screen allows you to:

1. Create scenes
2. Choose your scene resolution
3. Manage your scene resolution presets
4. Quickly open recently opened scenes
5. Browse for and open a scene from your documents
6. Watch Harmony video tutorials
7. Open the online support page

About Scenes

When working in production, it is important to keep your work organized. It is important to create a naming convention chart and establish a file storage structure before starting the project. It is not only extremely important that everyone follows the criteria laid out in the naming convention chart and the file storage structure, but also that they understand the organization and where to find the files.

A well thought-out and logical naming convention will help keep your production structured and allow it to run smoothly by preventing the loss of files due to chaotic organization.

In this section, you will learn how to create, open, organize, and name the different components in your animation project.

Creating Scenes

T-HFND-001-005

All scenes created via Harmony Stand Alone are independent and local to the computer. You can create or open a scene using the Welcome screen or the File menu.

How to create a scene from the Welcome screen

1. In the **Name** field, type the scene's name.

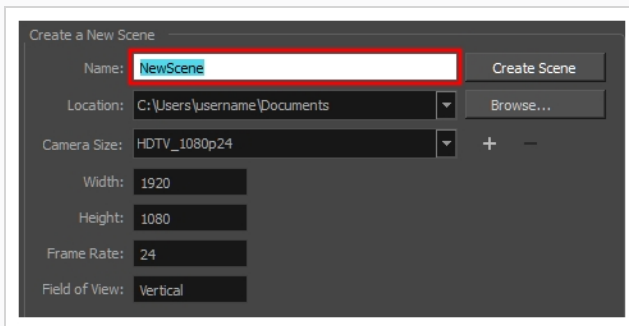

NOTE

The scene name should **not** exceed 23 characters and cannot contain special characters, such as *&^%!

2. To decide in which directory the scene will be created, click the **Browse** button next to the Location field.

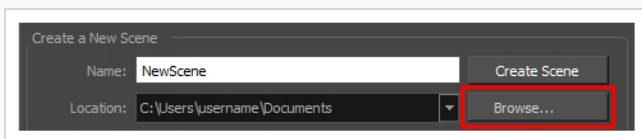

3. From the Camera Size menu, select a scene resolution.

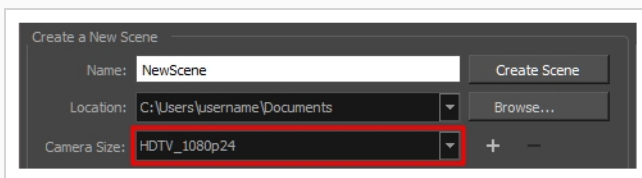

4. Click on **Create Scene**.

A new scene is created.

How to create a new scene from the File menu

1. Do one of the following:

- From the top menu, select **File > New**.
- In the File toolbar, click the New  button.
- Press Ctrl + N (Windows/Linux) or ⌘ + N (macOS).

The New Scene dialog box opens.

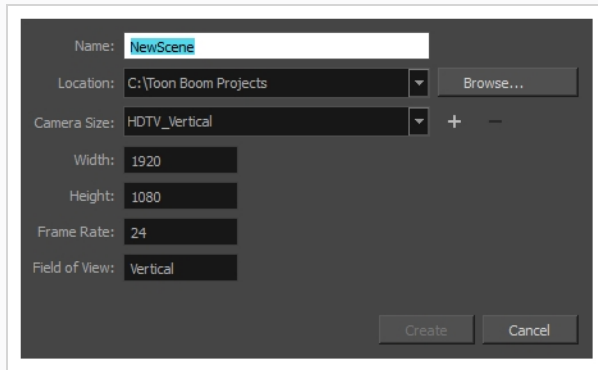

2. In the Project Name field, type the scene's name.



3. Select a scene directory by clicking the Browse button.

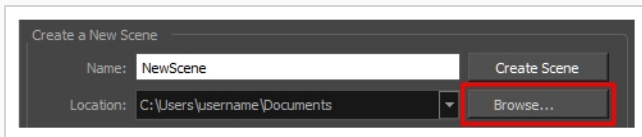

NOTE

The scene name **cannot** exceed 23 characters and cannot contain special characters, such as * & ^ % !.

4. In the Resolution window, select the scene's resolution and click **Create**.

A new scene is created.

Creating Custom Resolutions

T-HFND-001-006

You can create your own custom resolution presets for your projects.

How to create a custom resolution

1. Create a new scene from the Welcome screen or from the File menu in Harmony.
2. Set the scene resolution by doing one of the following:
 - Select a scene resolution from the Camera sizes drop-down menu.
 - Set a custom resolution by changing the values in the Width and Height fields. This preset will not be saved.



NOTE

The different editions of Harmony support the following maximum render resolutions:

- Harmony Essentials: 2K (2048x1556)
 - Harmony Advanced: 4K (4096x3112)
 - Harmony Premium: Unlimited
- Add a new resolution to the list by clicking the Add **+** button. You can delete a custom resolution from the Resolution list by selecting it, and clicking the Delete **—** button.
3. In the New Resolution dialog box, fill in the following fields and click **Create**.

Resolution Name: HDTV_1080p24

Resolution

Width: 1920

Height: 1080

Aspect Ratio: 1.778

Field of View

Horizontal Fit

Vertical Fit

Frame Rate

Frames per second: 24

Create Cancel

- **Resolution Name:** Name your new resolution.
- **Resolution:** Set the width and height of the scene, in pixels.

- **Field of View:** Select how the angle of the field of view should be determined.
 - **Horizontal Fit:** The angle of the field of view is adjusted to the width of the scene.
 - **Vertical Fit:** The angle of the field of view is adjusted to the height of the scene.
 - **Custom Fov:** Set the angle of the field of view to a custom value.
- **Frame Rate:** Type in the amount of animation frames to play each second.

Opening Scenes

T-HFND-001-007

You can open scenes from the Welcome Screen and the File menu. You can also open your recent scenes.

How to open a scene from the Welcome screen

1. In the Recent Scenes section, click **Open**.

The Open Scene browser opens.

2. Browse and select an **.xstage** file.
3. Click **Open**.

How to open a scene from the File menu

1. Do one of the following:
 - From the top menu, select **File > Open**.
 - In the File toolbar, click the Browse 📁 button.
 - Press Ctrl + O (Windows/Linux) or ⌘ + O (macOS).

The Open Scene browser opens.

2. Browse and select the desired **.xstage** file.
3. Click **Open**.

How to open a recent scene from the Welcome screen

1. In the Open a Scene section, select a scene from the list.

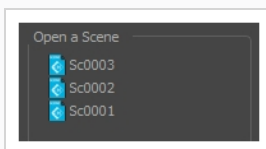

How to open a recent scene from the File menu

1. From the top menu, select **File > Open Recent**.
2. Select a scene from the displayed list.

Setting the Scene Length

T-HFND-001-009

Once you have opened your scene, you can set its length.

How to set the scene length

1. Select **Scene > Scene Length**.

The Set Scene Length dialog box opens.

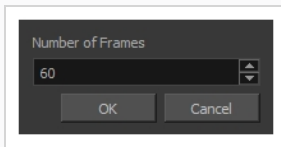

2. In the Number of Frames field, enter the number of frames needed.

About Scene Settings

T-HFND-001-010

When you created your scene, you set up the resolution and the alignment. However, if you want to change these settings later, you can do it using the Scene Settings dialog box. The different Scene Settings options are separated into four tabs.



NOTE

Refer to the Scene Setting dialog box in the Reference guide to learn more about the individual parameters of the Scene Settings dialog box.

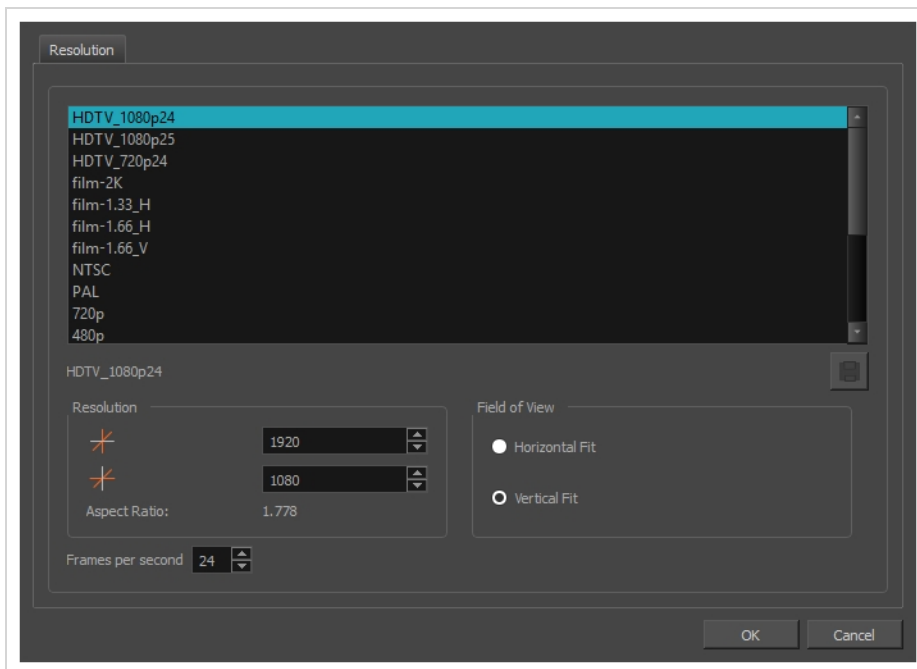

How to access the Scene Settings dialog box

1. In the top menu, select **Scene > Scene Settings**.

The Scene Settings dialog box opens.

Saving Scenes

T-HFND-001-011

You can save your scene, save a new copy or save a new version. Don't forget that saving a new version uses the same drawings in all versions.

How to save a scene

1. Do one of the following
 - In the top menu, select **File > Save**.
 - Press **Ctrl + S** (Windows/Linux) or **⌘ + S** (macOS).

Saving Scenes as Copies

Saving a copy of your scene allows you to choose a new file name and location for your scene.

How to save a scene as a copy

1. Select **File > Save As**.
2. In the Save As dialog box, browse to the location of the new archive and give the copy of the scene a new name. The name cannot exceed 23 characters.
3. Click **Save**.

Saving Scenes as New Versions

Saving a new version of your scene allows you to save your scene at its current location, under a new file name.

How to save a new version of a scene

1. Select **File > Save As New Version**.

The Save Version dialog box opens.

2. In the Save Version dialog box, type the new version name.

3. Click **OK**.

Enabling Auto-Save

T-ANIMPA-001-001

You can allow the software to automatically save your scene, as well as decide on the interval of time between auto-saves.

How to auto-save a scene

1. Do one of the following:
 - Windows/Linux: Select **Edit > Preferences**.
 - macOS: Select **Harmony Essentials > Preferences**.
 - Press Ctrl + U (Windows/Linux) or ⌘ + U (macOS).
2. Select the **General** tab.
3. In the **Save** section, set the Auto-Save parameters:
 - **Interval (minutes):** The frequency at which auto-save happens.
 - **Inactivity Interval (seconds):** When Auto-save is about to take place, it verifies if you are drawing or doing anything in the application. Auto-save will not happen until you have stopped using the application for this amount of seconds.
 - **Ask Before Saving:** Before performing an auto-save, you are prompted with a message to confirm if you want to save or not.
 - **Enabled:** This enables the Auto-save feature. If you do not want the system to automatically save your work, uncheck this option. Auto-save is off by default.

About the File Structure

T-HFND-001-008

A Harmony project is composed of several files. The drawings and colour palettes are not embedded in the project. They are separate linked files. Therefore, if you want to archive or share a project, you require all the files contained in the folder structure.

Here is an example of the file structure contained in a scene. As you work and use more features, different folders may appear in your structure.

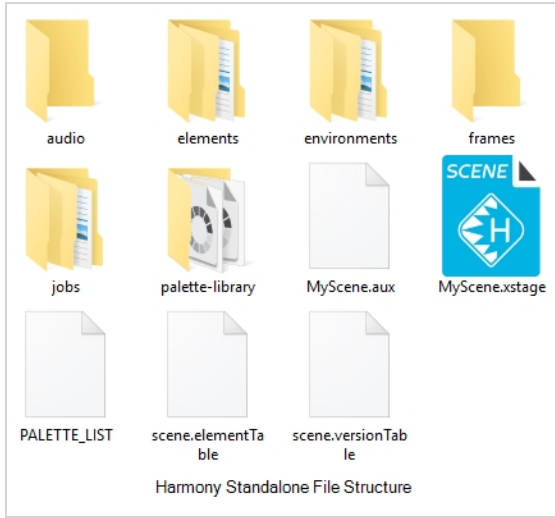

The Harmony scene folder contains the following folders:

Folder	Contents
annotation	Contains the images and thumbnails created while drawing in an Annotation column in the Xsheet view.
audio	Contains all imported audio files.
elements	Contains all the drawing files. The drawings are organized by folders named like the layers they are associated with.
environments	If the scene was exported from a Harmony Server database, this directory will contain the palettes and templates that were stored in the scene's environment. Otherwise, it is empty.
frames	Contains the final frames after a render if you are using the default settings of the Write node in the Node view.

jobs	If the scene was exported from a Harmony Server database, this directory will contain the palettes and templates that were stored in the scene's job. Otherwise, it is empty.
palette-library	Contains scene palettes and scene palette list files.
timings	This folder is used when a user links external images to a scene and wants to store a backup copy in case the link breaks.

Chapter 2: Interface

T-HFND-003-001

Knowing how to manage the Toon Boom Harmony interface helps you to work efficiently and organize your workspace conveniently. There are a series of views and toolbars you can use as you perform different operations. Usually, each person has a specific way of working in the interface and prefer particular views and toolbars. In this chapter, you will learn about the main elements of the interface and how to manage them.



NOTE

To learn more about each view's properties, see the Reference guide.

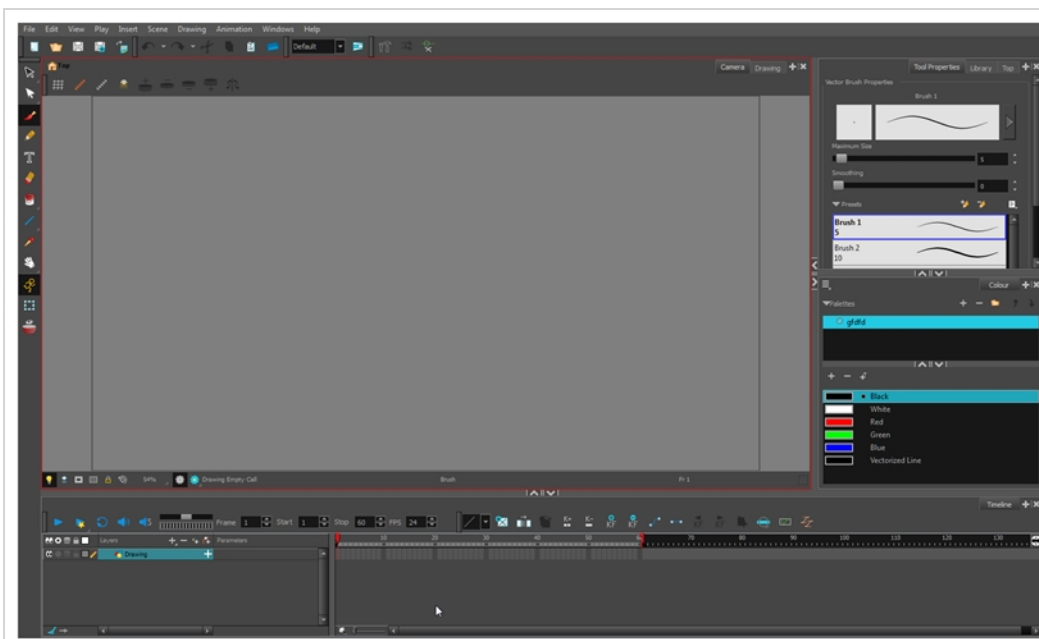

Changing the Theme Colours

The Harmony interface is set to a dark theme by default. You have the option of switching to a light theme.

How to change the interface theme

1. From the top menu, select **Edit > Preferences** (Windows/Linux) or **Harmony Essentials > Preferences** (macOS) .

The Preferences dialog box opens.

2. Select the **General** tab.
3. In the Options section, deselect the **Use Dark StyleSheet** option to use the light theme.
4. Restart Harmony.

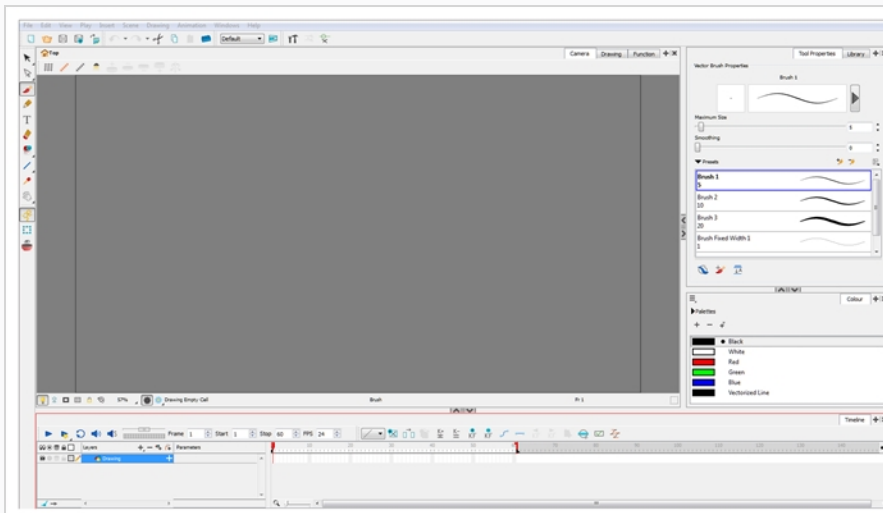

Changing the User Interface Language

Harmony is available in English, Spanish, Japanese, and Chinese. Harmony will automatically change to your OS language if it corresponds to one of these four languages. If you would like to start Harmony in one of those language independently from your OS, you can do so by launching it from a command prompt terminal with a parameter that specifies the desired language.

How to start Harmony using a specific user interface language

1. Start a terminal, command prompt, or shell on your OS.
2. Using the change drive command (`cd`), navigate to the Harmony executable file location:
 - Windows: `cd "C:\Program Files (x86)\Toon Boom Animation\Toon Boom Harmony 15.0 Essentials\win64\bin"`
 - macOS: `cd "/Applications/Toon Boom Harmony 15.0 Essentials/tba/macosx/bin"`
 - GNU/Linux: `cd /usr/local/ToonBoomAnimation/harmonyEssentials_15.0/lnx86_64/bin`
3. To start Harmony in a specific language, type in the name of the Harmony application including the language argument (`-lang`) and language code (two letters):
 - Windows:
 - English: `HarmonyPremium.exe -lang en`
 - Chinese: `HarmonyPremium.exe -lang zh`
 - Japanese: `HarmonyPremium.exe -lang ja`
 - Spanish: `HarmonyPremium.exe -lang es`
 - macOS:
 - English: `./Harmony\ Premium -lang en`
 - Chinese: `./Harmony\ Premium -lang zh`
 - Japanese: `./Harmony\ Premium -lang ja`
 - Spanish: `./Harmony\ Premium -lang es`
4. Press Enter/Return to validate and launch Harmony in the desired language.

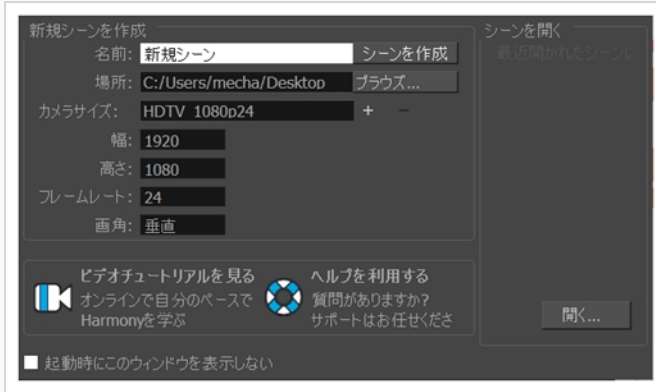

About Menus

T-HFND-003-002

Harmony contains three types of menus from which you can access many commands and options:

Top Menu

The top menu contains most of the commands. Depending on the view you're working in and the element, some commands are available and others are not. The top menu is always located at the very top of the interface.

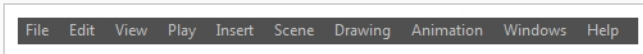
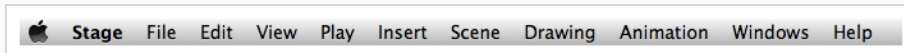

The top menu contains the following categories:

- File
- Edit
- View
- Play
- Insert
- Scene
- Drawing
- Animation
- Windows
- Help

On macOS, there is also a Harmony Essentials category that contains the following commands:

- Preferences
- About
- Quit

View Menu

A view menu contains commands specifically related to that view.

To access a view menu, click the Menu  button in the top-left corner of a view.

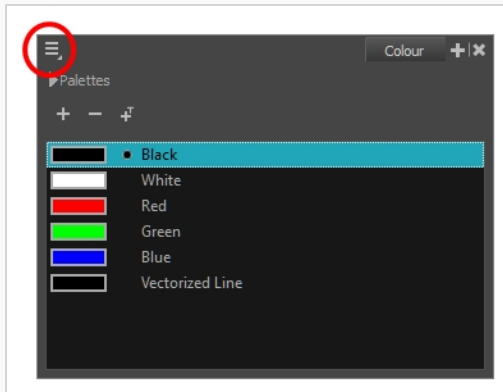

A view menu is available in the following views:

- Colour
- Function
- Library
- Script Editor

Quick Access Menu

A quick access menu lets you open a list of the commands you will use most often.

To access this menu, right-click anywhere in a view.

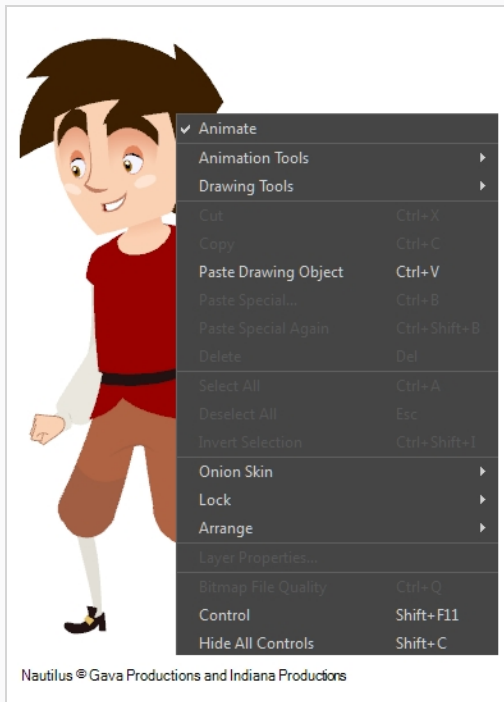

About Toolbars

T-HFND-003-003

Harmony contains toolbars which, by default, are located at the top of the interface. Some of the views also have their own toolbars which you can move around. You can reposition the toolbars to suit your work style or hide unused ones.



NOTE

Throughout this section, there may be slight differences between your interface and the illustrations in this guide. This is because the images are taken from Harmony Premium.

You can display or hide toolbars using the menus. The Toolbar menu only contains the View toolbars of the views that are displayed in the workspace. As you show or hide views in your workspace, the Toolbar menu updates.

The top toolbars can also be displayed directly in a view. Only one instance of each toolbar can be displayed. If a toolbar is already displayed in the top area and you decide to display it in a view, the selected toolbar will move from the top area to the view.

The toolbars in any of the views can be customized with your favourite tools. Using the Toolbar Manager dialog box, you can organize different toolbars to suit your working style.

If the default toolbar does not contain the tools you require, you can customize the toolbar.

If you prefer to have all your tools visible in the Tools toolbar, the Flat Tool Toolbar option allows you to expand the toolbar so there are no nested toolsets in the toolbar. When you set this option, you will need to close Harmony and restart it for the new interface to be displayed. A default set of tools will appear in the toolbar. However, you can customize the toolbar with the tools that more closely fit your work pattern.

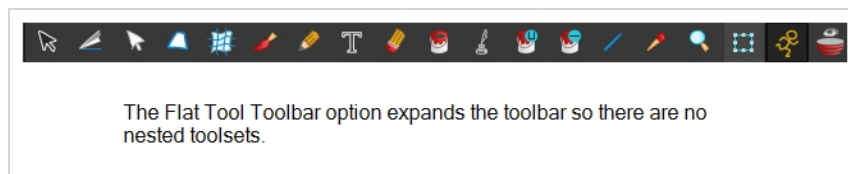
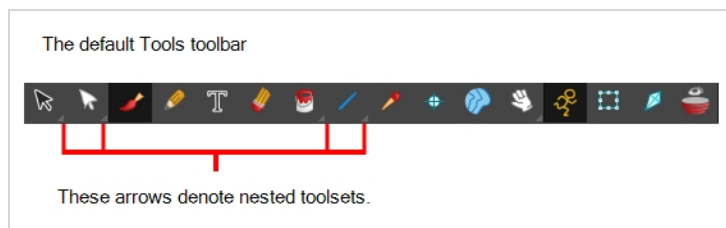

Once you are displaying the flat toolbars, you can customize the tools which appear in the toolbar. This means that you can change the default set of tools and replace the tools you use less frequently with ones use more often. This customizing is done through the Toolbar Manager.

Adding Toolbars

T-HFND-003-004

You can add toolbars simply by using menus.

How to add or close a toolbar

1. Select **Windows > Toolbars > toolbar**.
 - You can right-click anywhere in the toolbar area to access Harmony toolbars. View toolbars, however, are not available by right-clicking the toolbar area. You can access the toolbar of any open and active view by right-clicking in the view's top area or the Windows menu.

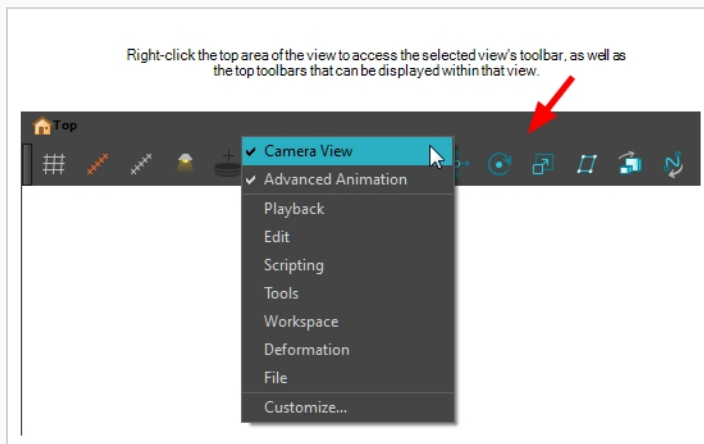
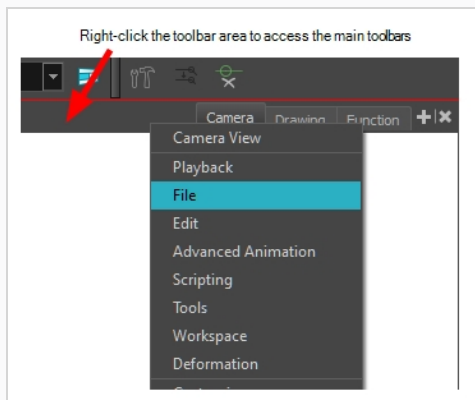

Moving Toolbars

T-HFND-003-005

You can move toolbars simply by dragging them to a new location.

How to move a toolbar

1. Select the toolbar you want to move by clicking its anchor point and dragging it into a view toolbar area or another position in the top or side interface toolbar area.

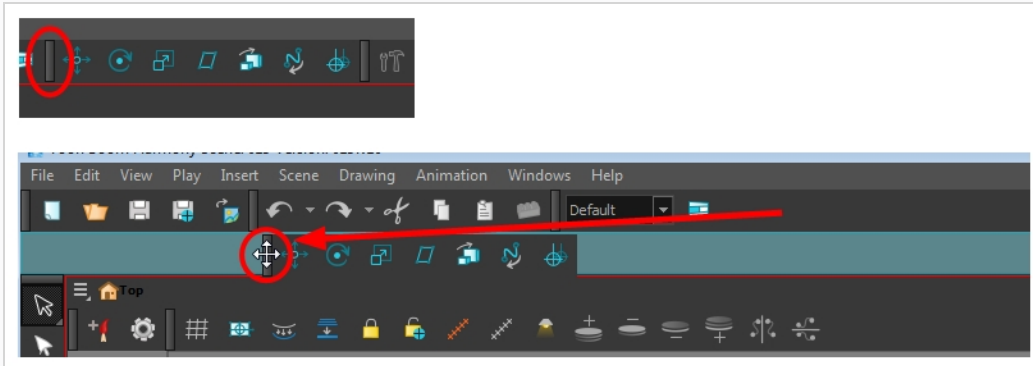

2. When a highlighted zone appears showing an available location for the toolbar, release the mouse button and drop the toolbar into position.

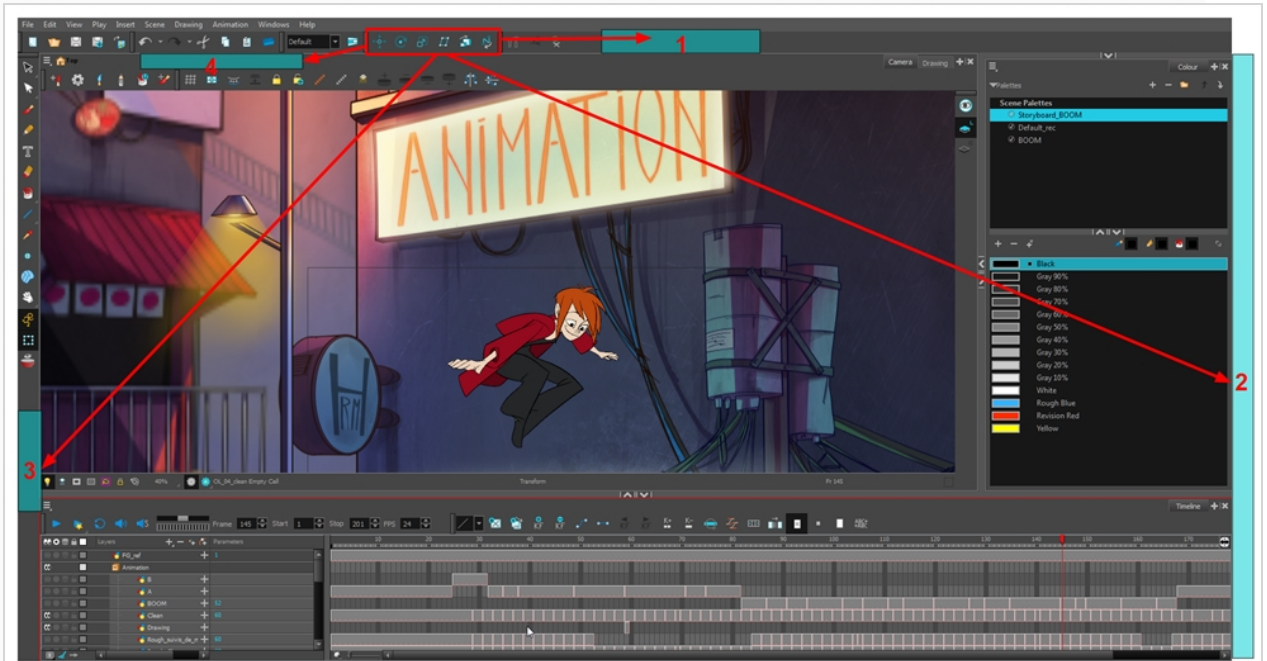

Resizing Toolbars

T-HFND-003-006

You can resize a toolbar by sliding its tail-end.

How to resize a toolbar

1. Hide a portion of a toolbar by dragging another open toolbar over its tail-end.
2. Click on the arrows appearing at the end of the collapsed toolbar to expand it.

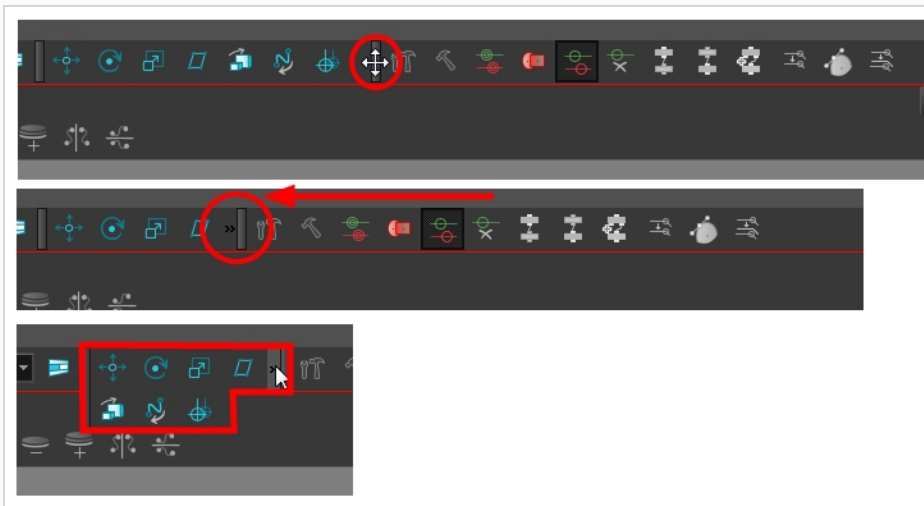

Customizing View Toolbars

T-HFND-003-007

You can customize a view toolbar to add, remove, and reorder icons.

How to customize a view toolbar

1. In the chosen view, right-click on any button in the toolbar where you want to add or subtract a new button. You can also reorder the buttons. Make sure the button you right-click on is active.
2. From the menu, select **Customize**.

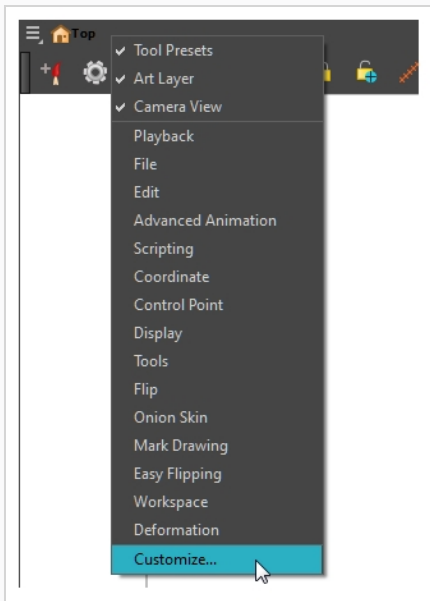

The Toolbar Manager window opens.

3. To add a new icon to your toolbar, select the tool or command from the Available Tools list and click the Right Arrow  button to switch it to the Toolbar list.

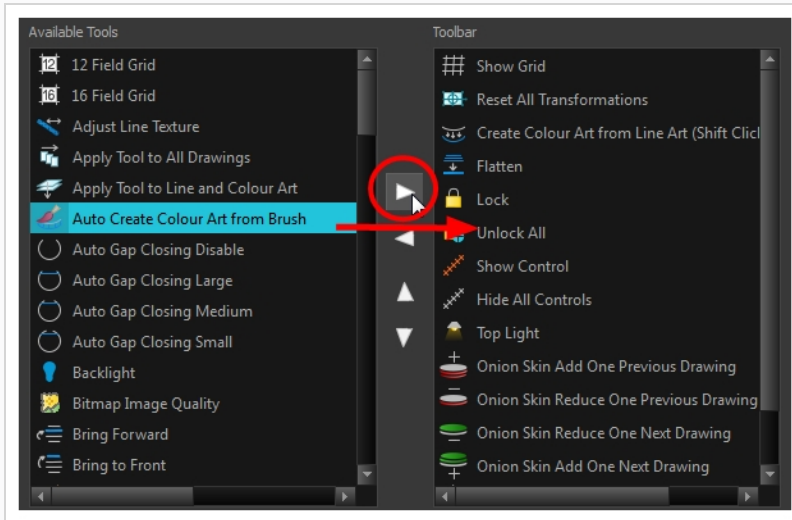

4. To remove an icon from your toolbar, select the tool or command in the Toolbar list and click the Left Arrow \triangleleft button to switch to the Available Tools list.

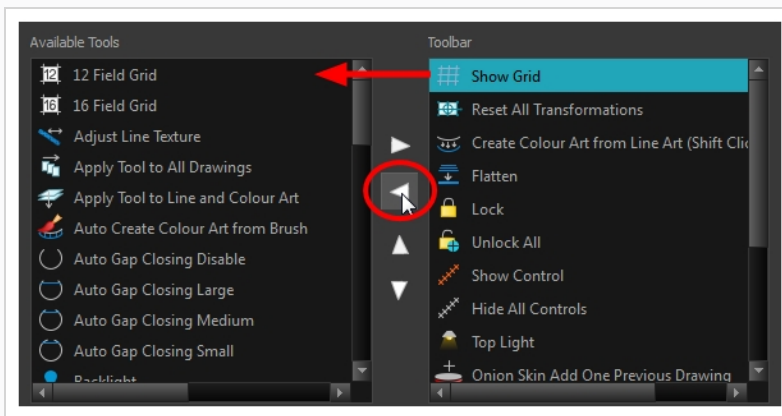

5. To reorder the icons in your toolbar, select the command to be moved from the Toolbar list and click the Up \triangle or Down ∇ buttons to move it to the correct location.

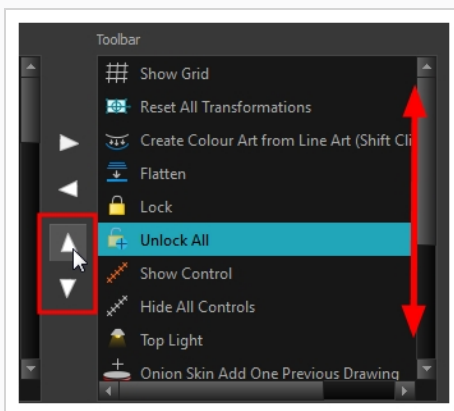

6. Click **OK** when you are finished.

About Views

T-HFND-003-008

The Harmony interface is composed of different views, each one designed for a specific purpose. You can modify the location of the views by adding a new view as a tab or as a window. You can also swap the location of a view.

When a view is active, a red rectangle appears around the view. Keyboard shortcuts and top menu options are associated with the active view. If a menu option is greyed out, it means it does not apply to the layer, drawing or other type of selection or the option does not apply to the active view.

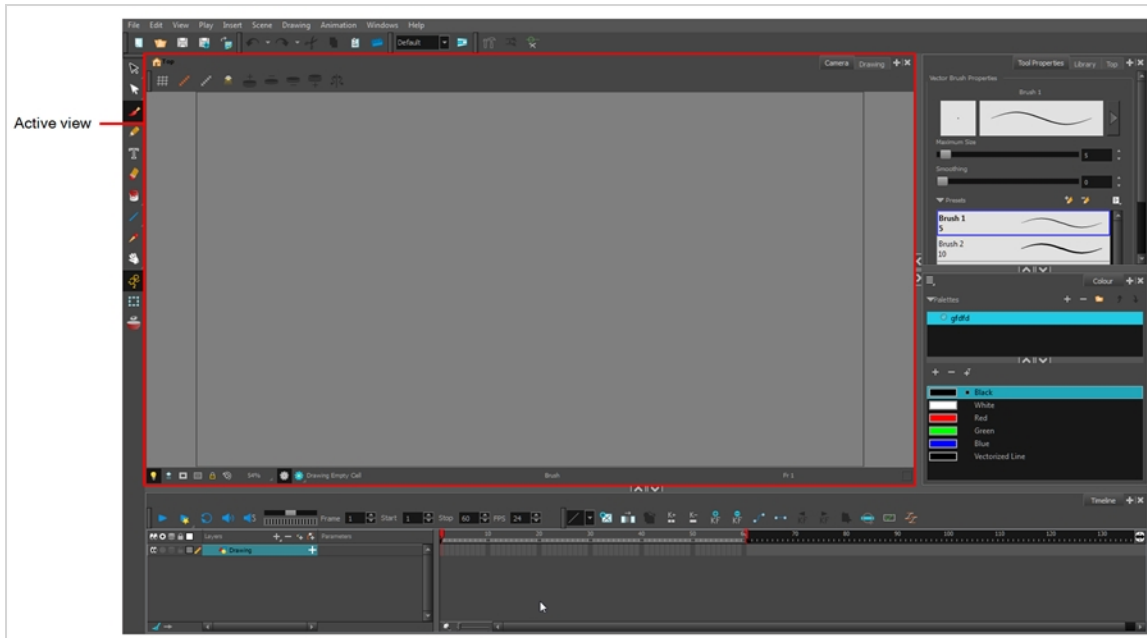

Workspace modifications are automatically saved when you exit the application, unless you disable the Automatically Save Workspace option in the Preferences dialog box.

Adding Views

T-HFND-003-009

You can easily add views through the top menu or each view.

How to add a view to your workspace as a tab

1. In the top-right corner of an existing view, click the Add View **+** button

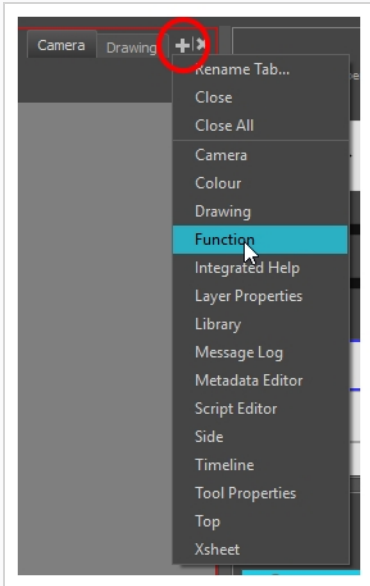

2. Select the desired view from the list.

The view appears as a new tab in the same section of your workspace:

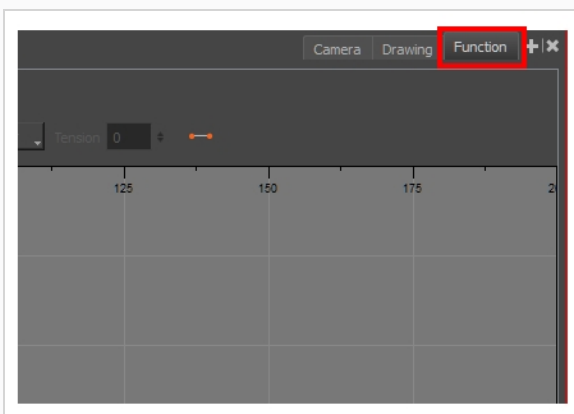

**NOTE**

Some views, such as the Camera view, can be opened in multiple instances. For example, this can be useful if you want to have two instances of the Camera views open, each focused on different areas of your scene, to quickly switch between working on these two areas.

How to add a view to your workspace as a window

1. Open the **Windows** menu.
2. Select the view you wish to add.

The view will appear as a new window over Harmony's main application window.

How to dock a view window to your workspace

1. Drag a window by its tab and do one of the following:
 - Drop the window onto other existing tabs to add it to that set of tabs.
 - Drop the window above, below or beside an existing view. When you get close to the edge of a view, a black rectangle with a blue background appears, indicating where the view will be inserted.

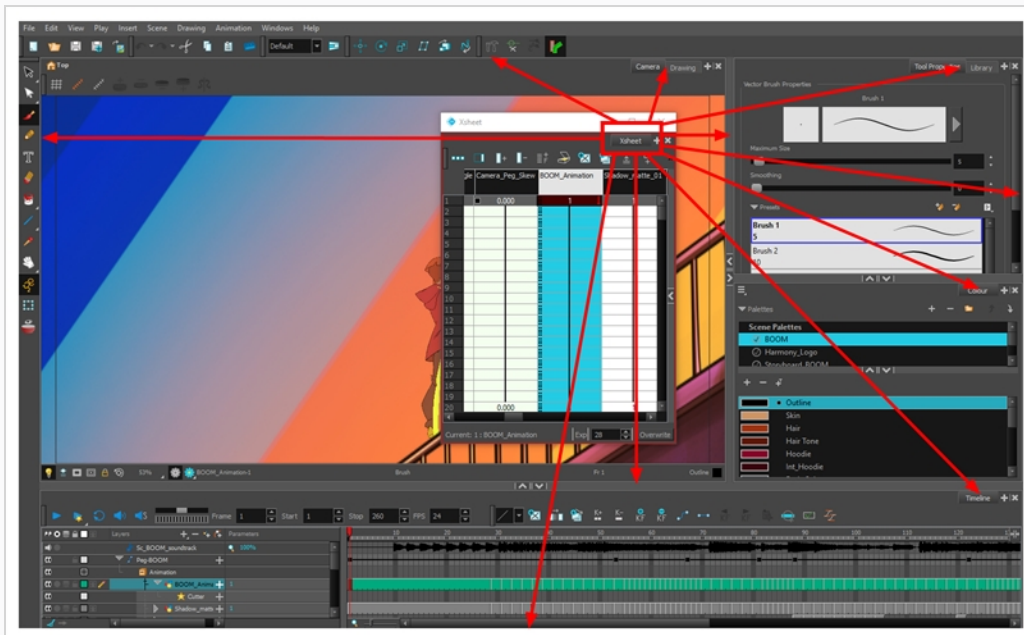

**NOTE**

The view in which you are currently working will have a red square surrounding it, marking it as your active view.

Closing Views

T-HFND-003-010

You can close one or multiple views by using their closing button.

How to close a view

1. Click the Close View | ✕ button.

If there are several tabs in the same view, press Shift and click the Close View | ✕ button to close all tabs at the same time.

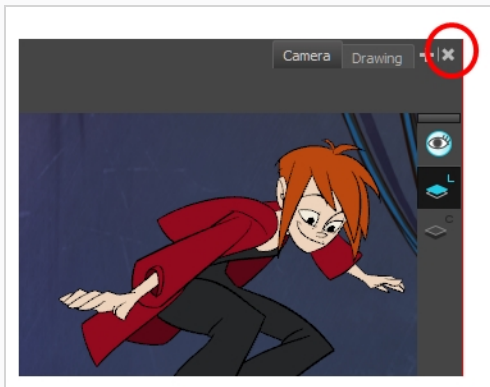

Showing and Hiding Views

T-HFND-003-012

You can temporarily show and hide views using the collapsing buttons.

How to temporarily hide a view

1. On the edge of the window you want to hide, click the **Collapse/Expand** button.
The view is compressed and only the Collapse/Expand button is visible.
2. Click the **Collapse/Expand** button again to redisplay the view.

Moving Views

T-HFND-003-011

You can move views by dragging their name tab to a new location.

How to move views

1. Select the view's tab and drag it onto one of the view's separators, top area or onto another view's tab.
2. When a blue rectangle outline appears showing an available location for the view, release the tab to drop the view into position. One of three things will happen:

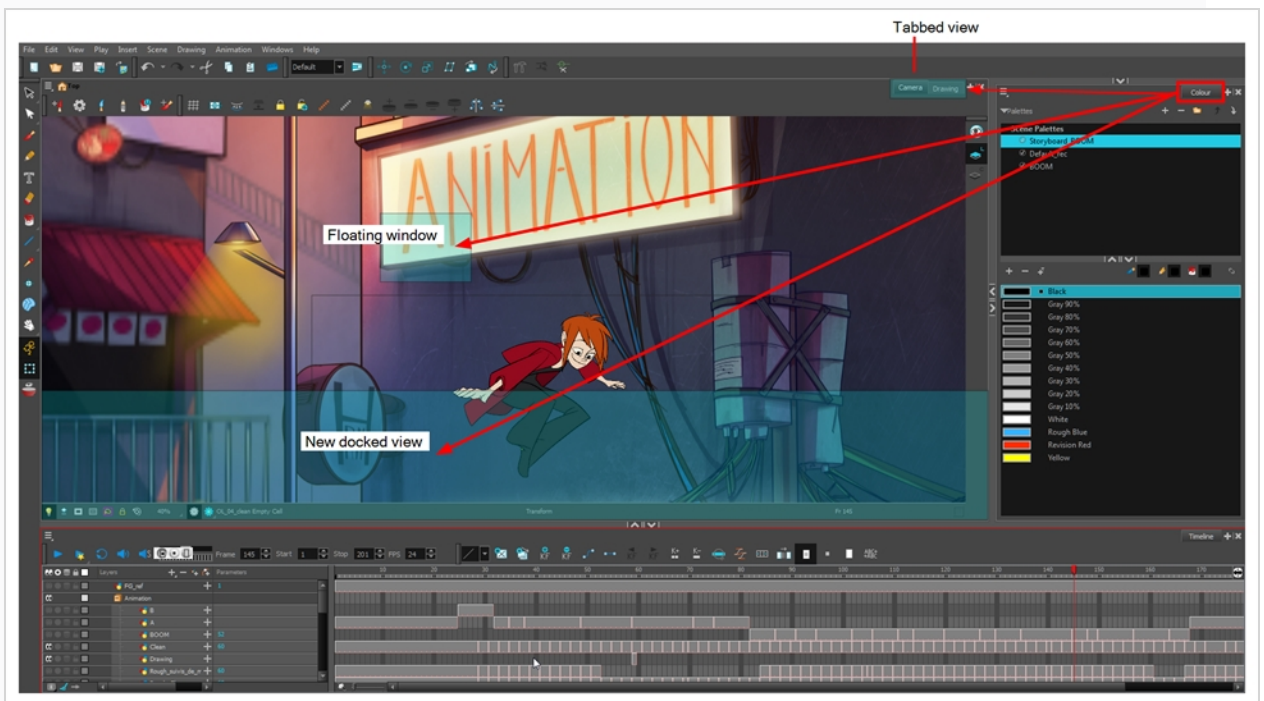

- The view becomes a tabbed view.
- The view becomes a floating window.
- The view becomes a new docked view.

Resizing Views

T-HFND-003-013

You can resize a view by sliding its edges.

How to resize a view

1. Place the pointer on the edge of the view to resize.
2. When you see the Resizing  icon, drag the side of the view to the desired size.

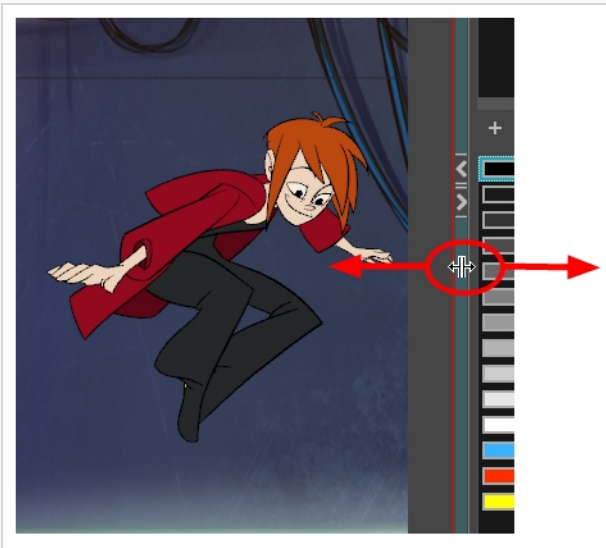

About Preferences

An important feature of Toon Boom Harmony is the Preferences dialog box. From here you can customize your interface, tool behaviour and shortcuts. Throughout this guide, you are often required to go to the Preferences dialog box to set parameters and options.



NOTE

To learn about the different preferences available, refer to the Preferences Guide.

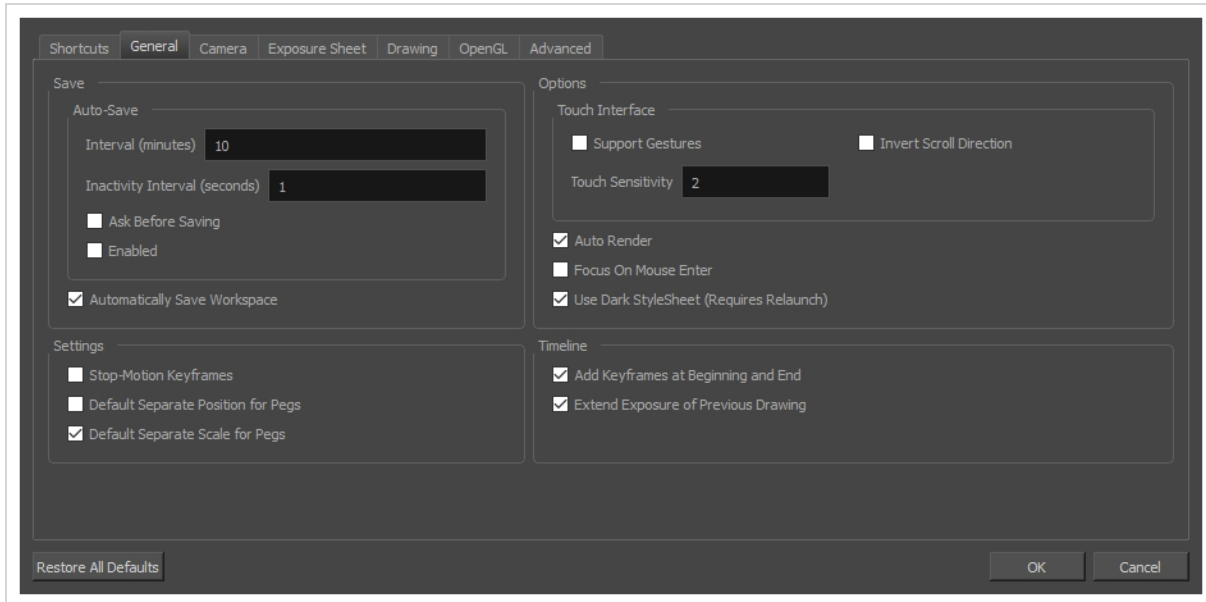

After you've launched Harmony for the first time, your custom preferences are stored in the following location, depending on your operating system:

- **Windows:** C:\Users\[user_name]\AppData\Roaming\Toon Boom Animation\Toon Boom [Harmony Essentials\full-1500-pref



NOTE

On Windows, the AppData folder is hidden. To display it in Explorer, in the top menu, open the **View** pane and check the **Hidden Items** checkbox.

- **macOS:** /Users/[user_name]/Library/Preferences/Toon Boom Animation/Toon Boom [Harmony Essentials/full-1500-pref



NOTE

On macOS, the Library folder is hidden. To display it in Finder, hold down the Alt key.

How to open the Preferences dialog box

1. Do one of the following:
 - Windows: In the top menu, select **Edit > Preferences**.
 - macOS: In the top menu, select **Harmony Essentials > Preferences**.
 - Press Ctrl + U (Windows/Linux) or ⌘ + U (macOS).

About Workspaces

T-HFND-003-014

The Harmony interface is composed of several views. You can customize your workspace to suit your working style, save it as a new workspace, and load it from the Workspace toolbar.

The first time you open Harmony, the default workspace is loaded. Other workspaces are available such as the Hand-Drawn Animation and Compositing workspaces. These display different views and toolbars. You can access these workspaces, and any others you create, from the Windows menu and the Workspace toolbar.

By default, when you modify the look of a workspace, it is automatically saved. If you prefer to keep your workspaces as they are and only save the modifications when you really want to, you must disable the Automatically Save Workspace option.

The Workspace Manager allows you to modify, create, delete, rename and reorder your workspaces. You can save your workspace as a new version to avoid over-writing the current one. If you do not want to modify the current workspace, use the Workspace Manager to create another one and then modify that one.

Your customized preferences are stored in the following location and you can save them to either share with someone else, copy to a second computer or simply back them up.

Your workspaces are stored in the following location:

- **Windows:** `C:\Users\[username]\AppData\Preferences\Toon Boom Animation\Toon Boom Harmony Essentials\1500-layouts-xml`
- **macOS:** `/Users/[username]/Library/Preferences/Toon Boom Animation/Toon Boom Harmony Essentials/1500-layouts-xml`

Loading Workspaces

T-HFND-003-015

You can load an existing workspace from the drop-down menu.

How to load a workspace

1. Do one of the following:
 - Select **Windows > Workspace > Workspace**.
 - Select a workspace from the Workspace toolbar.

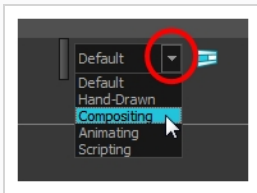

Creating Workspaces

T-HFND-003-016

You can create new workspaces through the Workspace Manager dialog box.

How to create a new workspace

1. Do one of the following:
 - In the Workspace toolbar, click the  button.
 - From the top menu, select **Windows > Workspace > Workspace Manager**.
2. In the Available Workspaces list, select an existing workspace.

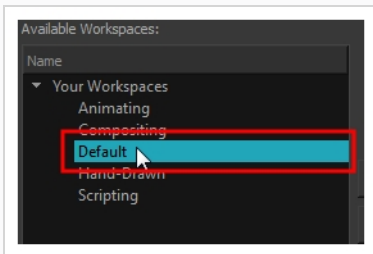

3. At the bottom of the Available Workspaces list, click the Add  button to add a workspace.

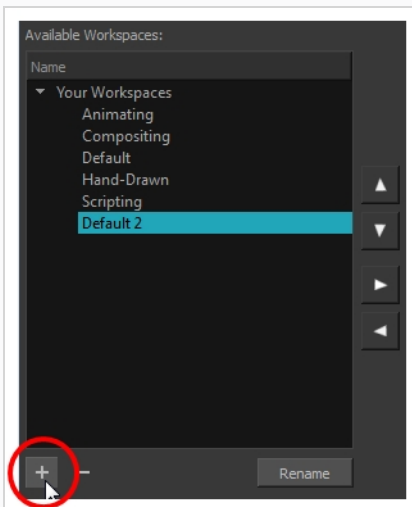

4. Select the new workspace that was created. Click **Rename** and give it a new name.

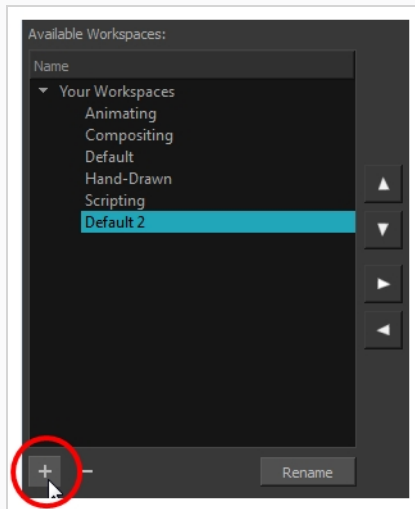

5. Select the new workspace and click the Right Arrow \triangleright button to move it to the Workspace toolbar.

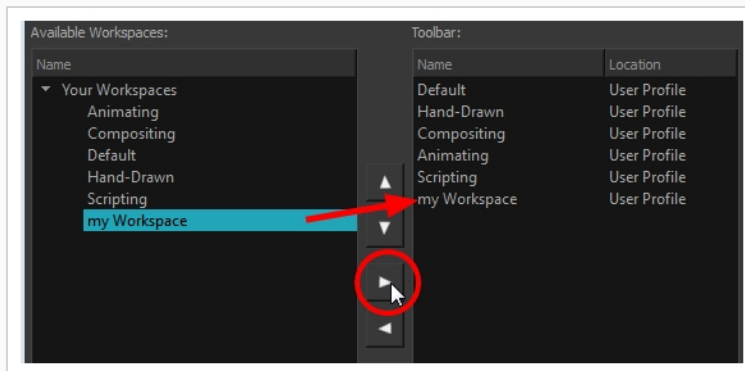

6. Click **OK**.

Renaming Workspaces

You can rename a workspace through the Workspace Manager dialog box.

How to rename a workspace

1. Do one of the following:
 - In the Workspace toolbar, click the  button.
 - From the top menu, select **Windows > Workspace > Workspace Manager**.
2. Choose the workspace to be renamed from the list.
3. Double-click on the workspace to be renamed or click the **Rename** button. This allows you to edit the name.

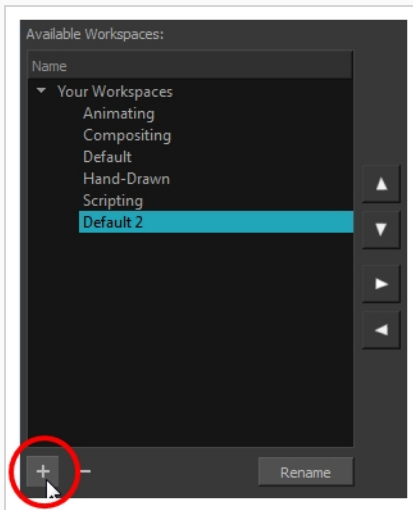

4. Type in the new name of the workspace.
5. Press the Enter/Return key to validate the name.
6. Click **OK**.

Saving Workspaces

T-HFND-003-017

You can either save your workspaces automatically or manually.

How to save your workspace as a new version

1. From the top menu, select **Windows > Workspace > Save Workspace As**.

The Save Workspace As dialog box opens.

2. Type in a workspace name and click **OK**.

How to disable the Automatically Save Workspace preference

1. From the top menu, select **Edit > Preferences** (Windows/Linux) or **Harmony Essentials > Preferences** (macOS) to open the Preferences dialog box.
2. Select the **General** tab.
3. In the Options section, deselect the **Automatically Save Workspace** option.
4. Click **OK**.

The Save Workspace  button appears in the Workspace toolbar.



How to save a workspace manually

1. Do one of the following:
 - In the Workspace toolbar, click the Save Workspace  button.
 - You can also select **Windows > Workspace > Save Workspace**.

Deleting Workspaces

You can delete a workspace through the Workspace Manager dialog box.

How to delete a workspace

1. Do one of the following:
 - In the Workspace toolbar, click the  button.
 - From the top menu, select **Windows > Workspace > Workspace Manager**.
2. In the Workspace Manager, select the workspace to be deleted and click the Left Arrow  button to move it to the Available Workspaces list.

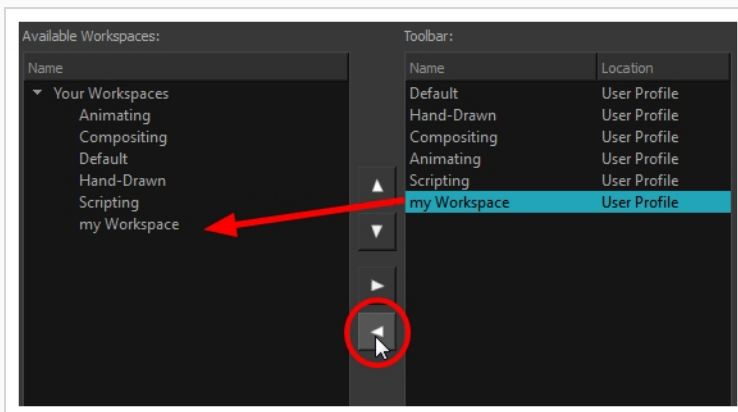



3. Select the workspace from the Available Workspaces list, then click the Delete  button to delete the workspace.
4. Click **OK**.



Showing and Hiding Workspaces

You can show and hide workspaces from your drop-down list through the Workspace Manager dialog box.

How to show a workspace

1. Do one of the following:
 - In the Workspace toolbar, click the  button.
 - From the top menu, select **Windows > Workspace > Workspace Manager**.
2. In the Available Workspaces list, select the workspace to be displayed and click the Right Arrow  button to move it to the Workspace toolbar.
3. Click **OK**.



How to hide a workspace

1. Do one of the following:
 - In the Workspace toolbar, click the  button.
 - From the top menu, select **Windows > Workspace > Workspace Manager**.
2. In the Workspace Manager, select the workspace to be hidden and click the Left Arrow  button to move it to the Available Workspaces list.
3. Click **OK**.

Reordering Workspaces

You can reorder workspaces in your drop-down list through the Workspace Manager dialog box.

How to reorder workspaces

1. Do one of the following:
 - In the Workspace toolbar, click the  button.
 - From the top menu, select **Windows > Workspace > Workspace Manager**.
2. In the Workspace toolbar, select the workspace to be reordered and on the Up  or Down  buttons to move it up or down.

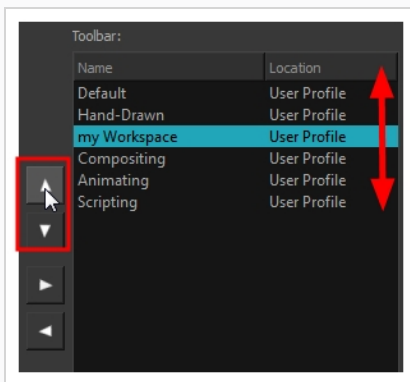

3. Click **OK**.

Restoring the Default Workspace

T-HFND-003-018

You can restore modified workspaces to their original layout.

How to restore the default workspaces

- Select **Windows > Restore Default Workspace**.

About Interface Navigation

Toon Boom Harmony lets you zoom in, zoom out, rotate, pan and reset views for easy navigation of the interface.

The navigation commands in the table below can be used in the following views, with some exceptions:

- Camera
- Drawing
- Timeline
- Xsheet
- Function
- Side and Top

Command	Action	Access Methods
Zoom In	Zooms in the view.	View > Zoom In Press 2 Roll the mouse wheel up (except in the Timeline and Xsheet views)
Zoom Out	Zooms out the view.	View > Zoom Out Press 1 Roll the mouse wheel down (except in the Timeline and Xsheet views)
Zoom In or Out	Zooms in or out of the view.	Roll the middle mouse button up or down. Hold down the Spacebar and the middle mouse button while dragging the mouse up or down.
Pan	Moves the view horizontally or vertically.	Hold down the Spacebar and drag in the direction you want to pan the view.
Reset Pan	Resets the view's pan to its default position.	View > Reset Pan Press Shift + N

Reset View	Resets the view to its default position.	View > Reset View Press Shift + M
Reset Rotation	Resets the view's rotation to its default position.	View > Reset Rotation Press Shift + X
Reset Zoom	Resets the view's zoom to its default position.	View > Reset Zoom
Rotate View	Rotates the view.	Press Ctrl + Alt (Windows/Linux) or Ctrl + ⌘ (macOS) and drag in the direction you want to rotate the view.
Rotate 30 CW	Rotates the Camera view 30 degrees clockwise, like an animation table.	View > Rotate View CW
Rotate 30 CCW	Rotates the Camera view 30 degrees counter-clockwise, like an animation table.	View > Rotate View CCW
Toggle Quick Close-up	Instantly multiplies the view's Zoom Factor by 4. For example, if the Camera View's Zoom Factor is at 100%, this will make it toggle between 400% and 100%.	Shift + Z
Toggle Full Screen	Cycles through the following display modes: <ul style="list-style-type: none"> • Normal Full-Screen: The main application window becomes full screen. • View Full-Screen: The selected view becomes full screen and all other views are collapsed. • Normal: The main application window is restored to its original size and collapsed views are expanded. 	View > Toggle Full Screen Press Ctrl + F (Windows/Linux) or ⌘ + F (macOS)

Using the Play Menu to Navigate

From the top menu, you can select any of the following commands from the Play menu to navigate around the interface.

Command	Description
---------	-------------

Start Frame	Lets you set the frame on which playback will start.
End Frame	Lets you set the frame on which playback will end.
First Frame	Jump to the first frame. You can also press <.
Previous Frame	Jumps to the frame before the frame currently selected in the Timeline view. You can also press the comma (,) key.
Next Frame	Jumps to the frame after the currently selected frame in the Timeline view. You can also press the period (.) key.
Last Frame	Jumps to the last frame. You can also press >.
Go to Frame	<p>Opens the Go to Frame window in which you can enter the number of the frame you want to display.</p> <p>You can also use the Go button, which you can add to the Timeline toolbar through the Toolbar Manager. Open the Go to Frame dialog box and enter the frame number to jump to.</p>
Enable Playback	Plays back your animation from the Top or Side views.

About Documentation

The documentation is a way to help you find answers to your questions about how things work in Harmony. The documentation of features and procedures exists online, but you can access it through the software.

A simple, but fast way to find a description of certain menu items and preferences is through the Integrated Help.

Accessing the Documentation

T-HFND-001-004

The Harmony documentation can be accessed from the Help menu.

How to access the Harmony Essentials documentation

1. From the top menu, select Help > Online Help.

Using the Integrated Help

If you are unsure about what a certain menu item is in the Top menu or the function of a specific preference in the Preferences panel, use the Integrated Help.

If you keep the Integrated Help window open for the entire duration of your work session, then you can use the forward and backward arrows to scroll through a history of the help information that you called up during your session.

How to use the Integrated Help with Menu Items

1. In the top menu, go to **Help > Show What's This** or press F1 on Windows/Linux or ⌘ + / on macOS.

The Integrated Help window appears.

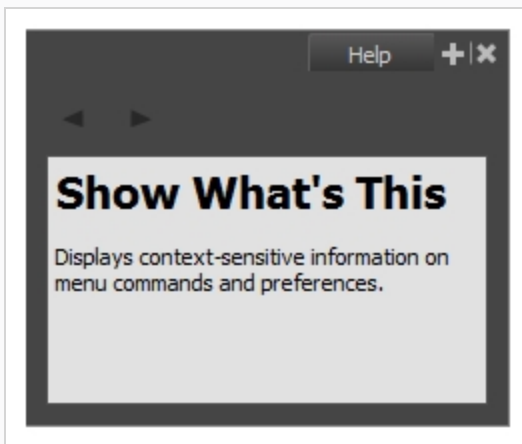

2. In the top menu, click on a menu heading to display its contents.
3. Use your mouse to hover over a menu item.

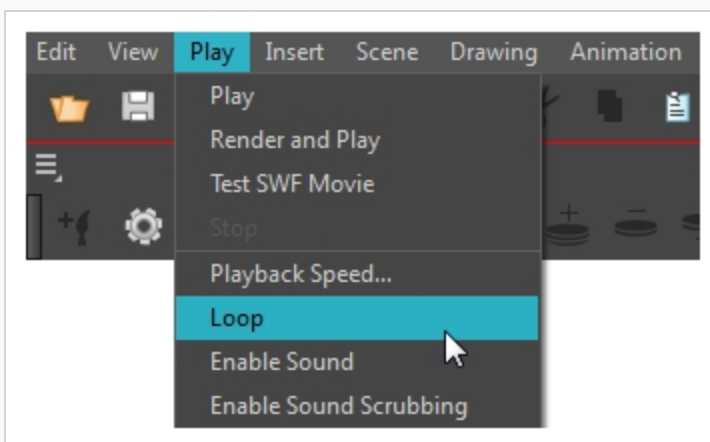

4. Press F1 on Windows/Linux or ⌘ + / on macOS.

In the Integrated Help window, a description of the menu item appears.

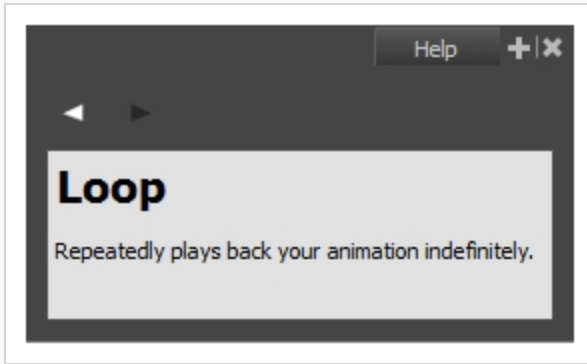

How to use the Integrated Help with Preferences

1. In the top menu, go to **Help > Show What's This** or press F1 on Windows/Linux or $\text{⌘} + /$ on macOS.

The Integrated Help window appears.

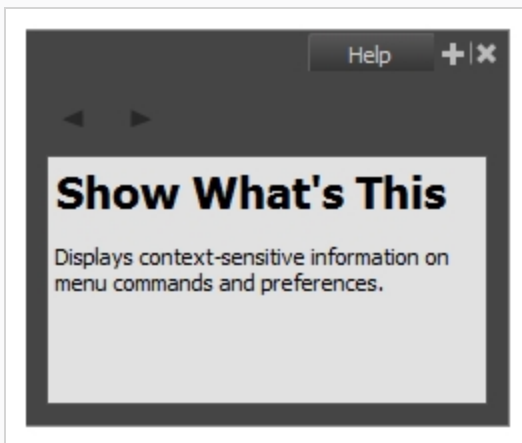

2. In the top menu, go to **Edit > Preferences** (Windows/Linux) or **Harmony > Preferences** (macOS).

The Preferences window appears.

3. In the Preferences window, use your mouse to hover over a preference.

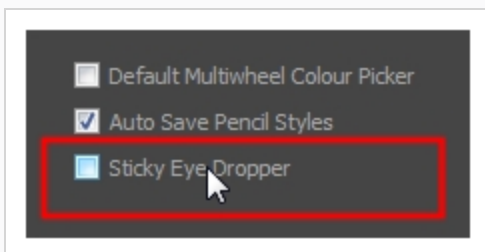

4. Press F1 on Windows/Linux or $\text{⌘} + /$ on macOS.

In the Integrated Help window, a description of the preference appears.

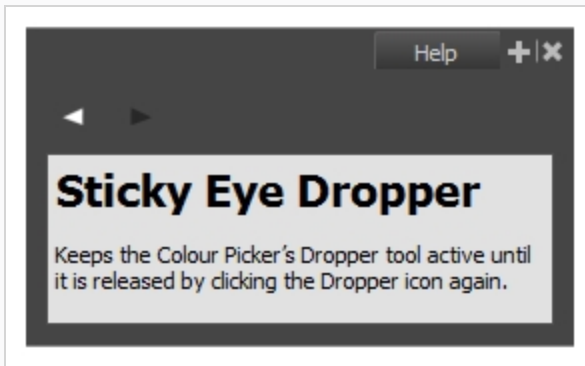

How to scroll through the bank of searched items

- In the **Integrated Help** window, click on the forward or backward arrow buttons.



NOTE

The moment you close the Integrated Help window all searched items will be erased from the memory bank. In order to keep an on-going record of all the search requests made, you must keep the window open.













Chapter 3: Drawing











Harmony has many powerful tools, views, and features for sketching, drawing and animating with ease. This chapter describes the main assets needed when drawing , as well as tips on how to start and use these tools efficiently.

About Drawing Tools

Harmony has a wide array of drawing tools and drawing features to allow flexible design, work methods and styles.

Here are the drawing tools available in Harmony.

Icon	Tool Name
	Select
	Cutter
	Reposition All Drawings
	Contour Editor
	Centerline Editor
	Smooth Editor
	Perspective
	Envelope
	Edit Gradient/Texture
	Brush
	Pencil
	Text

	Eraser
	Paint
	Paint Unpainted
	Unpaint
	Stroke
	Close Gap
	Line
	Rectangle
	Ellipse
	Polyline
	Dropper

Each drawing tool has a series of options to customize its behaviour and drawing style. When you select a tool, the Tool Properties view displays the properties of the currently selected tool, where you can configure your drawing tool's behavior and style, if applicable.

About the Brush Tool

T-HFND-004-003

The Brush tool is pressure sensitive and lets you create a contour shape with a thick and thin line effect, as if it was created with a paint brush.

When drawing with the Brush tool, you can use the Select Tool, Contour Editor, Smooth Editor, Perspective and Envelope tool to scale your brush strokes or to tweak their shape.

Drawing with the Brush Tool

T-HFND-004-003A

In the Camera or Drawing view, you can draw on any drawing layer type with the Brush tool.

How to draw with the Brush tool

1. In the Timeline view, select the cell on which you want to draw.
2. In the Tools toolbar, select the Brush  tool or press Alt + B.
3. In the Tool Properties view, set the Maximum Size to the desired brush size.



NOTE

If you are drawing with a mouse, your strokes will always be at their maximum size. If you are using a pressure-sensitive tablet, your strokes will vary in size depending on the pressure of your pen, ranging between 25% to 100% of the maximum size.

4. In the Colour view, click a colour swatch to select a colour.

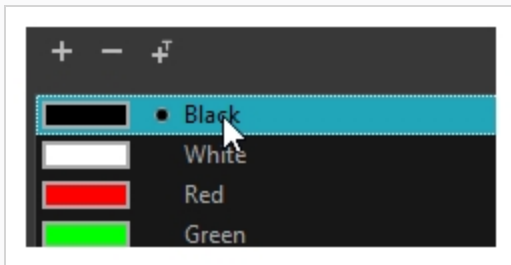

5. In the Drawing or Camera view, start drawing.



NOTE

You can hold Ctrl (Windows/Linux) or ⌘ (macOS) while drawing to force your stroke to be a closed shape. This will automatically draw a straight line between the beginning and the end of your stroke.

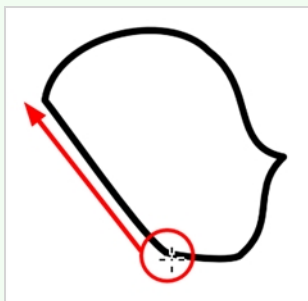



Creating a Brush

T-ANIMPA-002-001

Drawing a stroke with the Brush tool creates a vector shape and simply fills it with the selected colour.

A brush's tip can be shaped like a circle, a diamond or a square, and can be configured to have a specific size, aspect ratio and angle. Also, your brush strokes can be automatically smoothed by Harmony as you draw.

How to create a brush

1. In the Tools toolbar, select the Brush  or Eraser  tool.
2. In the Tool Properties view, click the arrow button to open the Brush/Eraser Properties dialog.



The Brush Properties dialog opens.

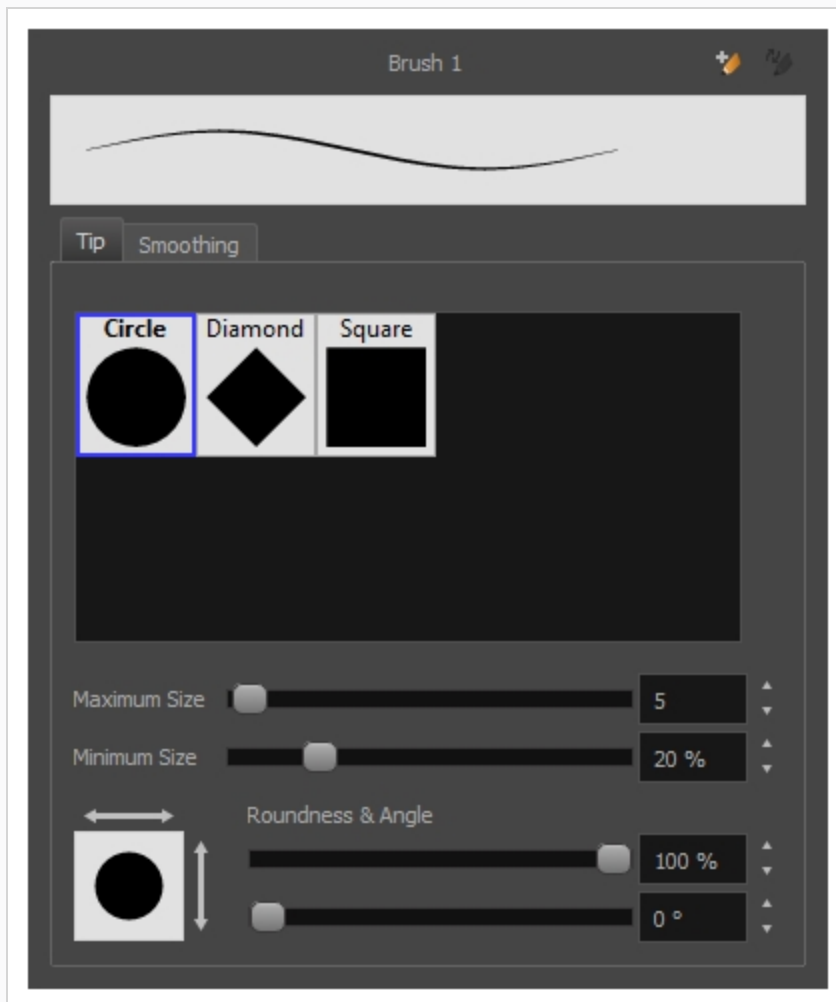

1. In the brush tip list, select either **Circle**, **Diamond** or **Square**.
2. Use the **Maximum Size** slider to set the maximum size of your brush tip.

**NOTE**

When drawing with a mouse, your brush is always at its maximum size. When drawing with a pressure-sensitive pen tablet, your brush's size will range between its minimum and maximum size, depending on the amount of pressure you put on the pen when drawing.

3. If you are using a pressure-sensitive pen tablet, use the **Minimum Size** slider to set the size of your brush when using your pen with very little pressure. The minimum size is set to a percentage of your brush tip's maximum size, which is 25% by default. If you don't want the pressure on your pen to affect the brush size, set this parameter to 100%.
4. If you want your brush tip to have uneven dimensions, use the **Roundness** slider to shrink the brush tip vertically all the while preserving its horizontal size.
5. If you want your brush tip to be at an angle, use the **Angle** slider to rotate your brush tip.
6. Click on the **Smoothing** tab.

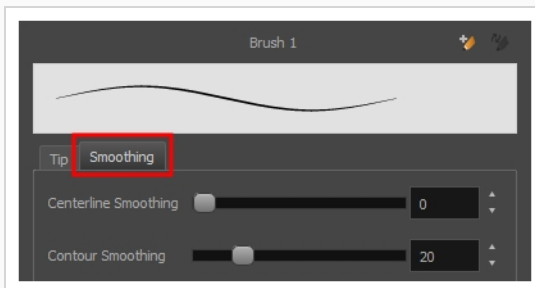

7. Use the **Centerline Smoothing** slider to set the amount of smoothing Harmony should perform on your stroke's direction, curves and corners. A higher setting will prevent your line from being shaky, but is liable to reduce your drawing precision and to round sharp corners into curves.
8. Use the **Contour Smoothing** slider to set the amount of smoothing Harmony should perform on your stroke's contour. A higher setting will round sharp corners and reduce the amount of control points for the resulting vector shape.
9. Either close or set aside the Brush Properties dialog.
10. In the Camera or Drawing view, start drawing to test your brush settings.

About Brush Presets

Setting up your brush to perfectly reproduce the desired art style can require a lot of tweaking as well as trial and error. Once you have found the correct settings for your brush, you will want to reuse it throughout your project for consistency. You can do that by creating and using brush presets.

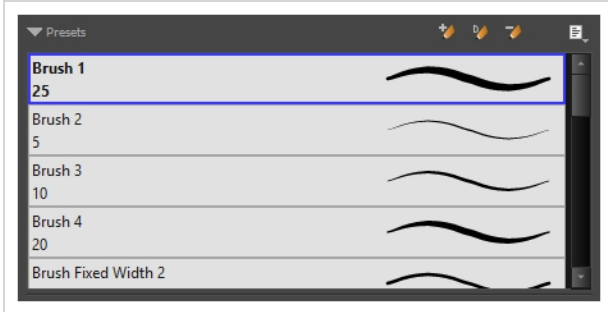

Harmony comes preloaded with many brush presets which you can select from the Tool Properties view. It is also possible to create your own brush presets by configuring your brush, then saving it as a preset.

Brush presets are saved in your preferences. You can also export your brush presets into an `.xml` file, and import them on a different workstation, allowing you to share your brush presets between the different people collaborating on your project.



Creating a Brush Preset

You can create your own custom brush presets by configuring your brush, then adding it as a preset.

How to create a brush preset

1. In the Tools toolbar, select the Brush  tool or press Alt + B.
2. Click on the Arrow button to open the Brush Properties dialog.



3. Configure your brush to be exactly how you wish to use it in the future—see [Creating a Brush](#).
4. Do one of the following:
 - From the Brush Properties dialog, click on the New Brush Preset  button in the top-right corner.
 - In the Tool Properties view, click the New Brush Preset  button.
 - In the Tool Properties view, open the Brush Presets menu  and select **New Brush Preset**.
5. In the New Preset window, type a name for your new brush preset.

Your new brush preset is added to the end of the list of brush presets.

Selecting a Brush Preset

Harmony provides you with default brush presets available in the Tool Properties view.

How to select a brush preset

1. In the Tools toolbar, select the Brush  tool or press Alt + B.
2. In the Tool Properties view, select a brush preset from the Presets list.

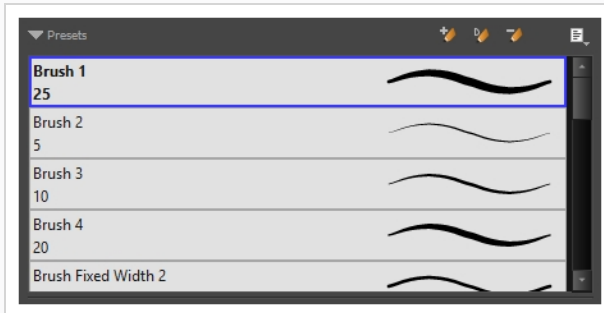

Updating a Brush Preset

If you want to modify the settings of an existing custom preset, you can do so by adjusting the parameters in the Tool Properties view, then updating your preset with your brush current's parameters.

How to update a brush preset

1. In the Tools toolbar, select the Brush 🖌️ tool or press Alt + B.
1. In the Tool Properties view, select the Brush Preset you wish to update.
2. Click on the Arrow button to open the Brush Properties view.





3. Configure your brush to be exactly how you wish to use it in the future—see [Creating a Brush](#).
4. Click on the Update Brush Preset 🔄🖌️ button in the upper-right corner of the Brush Properties dialog.

Renaming a Brush Preset

To keep your list comprehensive and organized, you can name your custom brush presets.

How to rename a brush preset

1. In the Tools toolbar, select the Brush  tool or press Alt + B.
2. In the Tool Properties view, select a brush preset to rename.
3. Open the Brush Preset menu  and select **Rename Brush**.

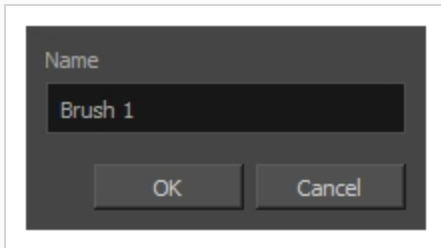



4. Type in a new name for the brush and click **OK**.

Deleting a Brush Preset

You can keep your preset list clean by deleting unwanted custom presets.





How to delete a brush preset

1. In the Tools toolbar, select the Brush  tool or press Alt + B.
2. In the Tool Properties view, select the brush preset you want to delete.
3. Do one of the following:
 - Click the Delete Brush  button.
 - Open the Brush Preset menu  and select **Delete Brush**.

Exporting Brush Presets

You can export brush presets into an **.xml** file which will contain all of your brush's settings. This can be useful if you wish to back up or share your brush presets.

How to export pencils, brushes and erasers

1. In the Tools toolbar, select either the Brush , Pencil  or Eraser  tool.
2. Open the Brush Preset menu  and select **Export Brushes**.

The Export Tips and Textures dialog opens. This dialog allows you to export brush presets for the Brush, Pencil and Eraser tools.

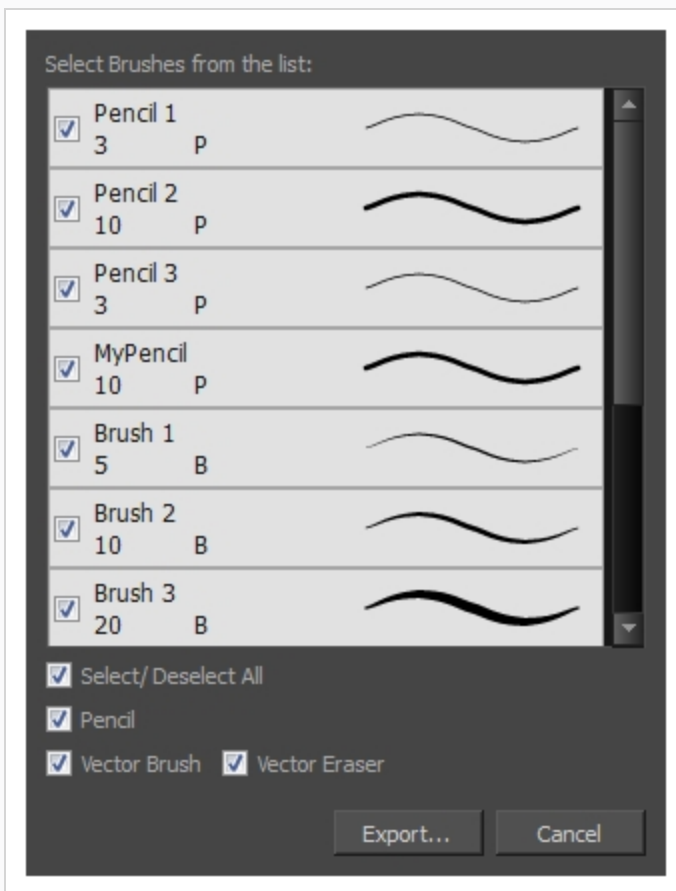





3. By default, the presets for all your tools will be selected for export. If you only wish to export presets for specific tools, uncheck **Select/Deselect All** and select the tools for which you want to export the presets.
4. Click **Export**.

5. In the Export Presets dialog that appears, browse to the location where you want to save the **.xml** file and enter its file name.
6. Click **Save**.

Importing Brush Presets

You can import brush presets that you previously exported from Harmony.

How to import pencils, brushes and erasers

1. In the Tools toolbar, select either the Brush , Pencil  or Eraser  tool.
2. Open the Brush Preset menu  and select **Import Brushes**.
3. In the browser window that appears, navigate to and select the **.xml** file in which you exported your brush presets.
4. Click **Open**.

The Import Brushes dialog box opens.

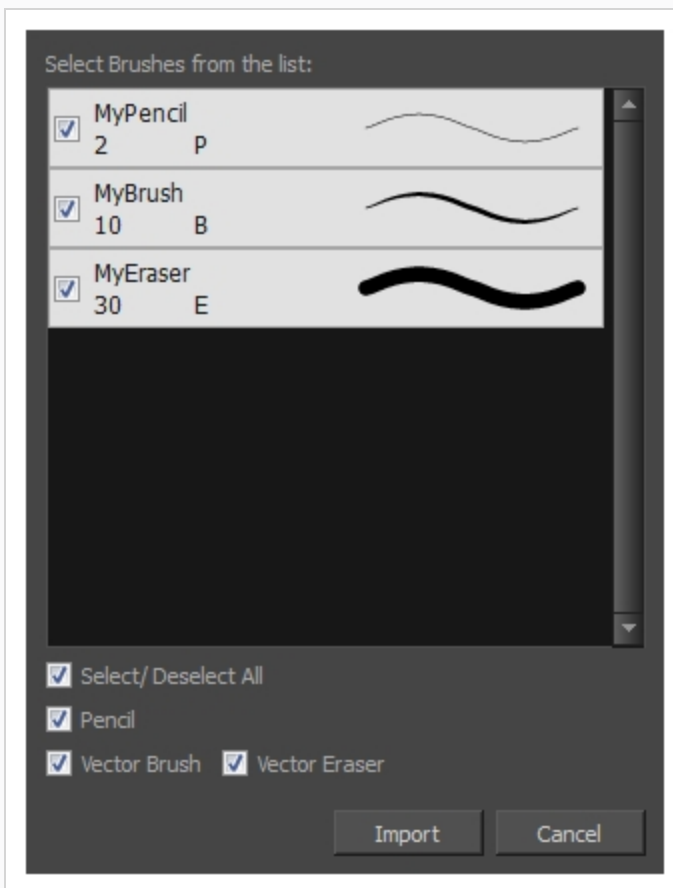

5. By default, the presets for any tools included in the file will be selected for import. If you only wish to import presets for specific tools, uncheck **Select/Deselect All** and select the tools for which you want to export the presets
6. Click **Import**.

The imported brush, eraser and pencil styles will appear in the Presets list.

Changing the Brush Preset Display

You can display your preset list as thumbnails or a list.

How to change the Brush Presets display

1. In the Tool Properties view, click on the Brush Presets menu button  .
2. Select one of the following options:
 - **Small Thumbnail:** Displays presets in a grid of small thumbnails with a preview of their tip.
 - **Large Thumbnail:** Displays presets in a grid of big thumbnails, with their name and a preview of their tip.
 - **Stroke View:** Displays presets in a list, with their name and a preview of a stroke done with each preset. This is the default setting.

About the Pencil Tool

T-HFND-004-004

The Pencil tool is for drawing the final images, such as character nodes, cut-out puppet and clean animation. The pencil creates a central vector shape.

The Brush tool takes account of pressure sensitivity, allowing you to create lines with variable thicknesses when using a pen tablet, creating a contour vector shape. You can set different parameters, such as the size and smoothness of the Brush tool in the Tool Properties view. If you draw with the Brush tool and want to modify the thickness variation, use the Contour Editor tool.

The Pencil, Polyline and Shape tools let you create a central vector line of uniform thickness. Pressure sensitivity is not supported with pencil lines. You can set different parameters, such as the size and smoothness of the Pencil tool in the Tool Properties view.

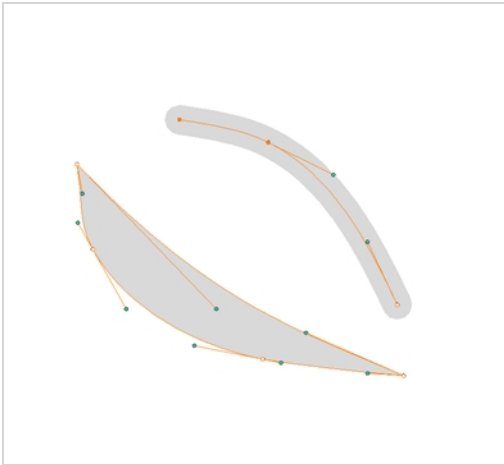

Drawing with the Pencil Tool

T-HFND-004-004A

Using the Pencil tool, you can draw vector pencil lines which can be easily tweaked and reshaped as needed.

How to draw with the Pencil tool

1. In the Timeline view, select the cell on which you want to draw.
2. In the Tools toolbar, select the Pencil  tool or press Alt + /.
3. In the Colour view, click a colour swatch to select a colour.

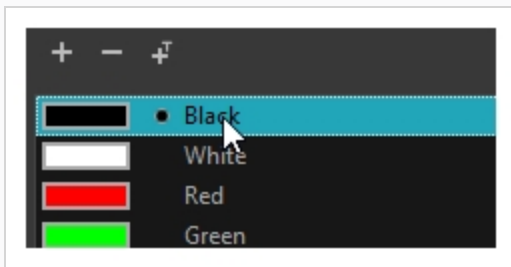

4. In the Drawing or Camera view, start drawing.



NOTE

You can press Shift + Alt as you draw to draw straight lines.



NOTE

Pencil lines are central vector lines. Sometimes, two pencil lines may look connected because their edges overlap, but if their centerline is not connected, they will be considered an open shape. To make sure the end of your stroke connects to the beginning of your stroke, hold the Alt key when you start or finish drawing a pencil line.

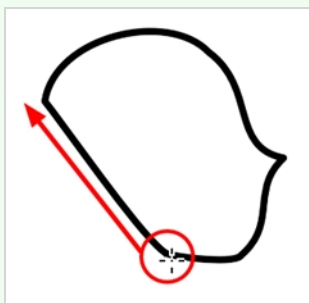

Changing Pencil Settings

T-LAY-001-001

You can configure a pencil's size as well as how much Harmony should automatically smooth your pencil lines when drawing.

How to modify the pencil settings

1. In the Tools toolbar, select the Pencil  tool or press Alt + /.

The Pencil tool properties appear in the **Tool Properties** view.

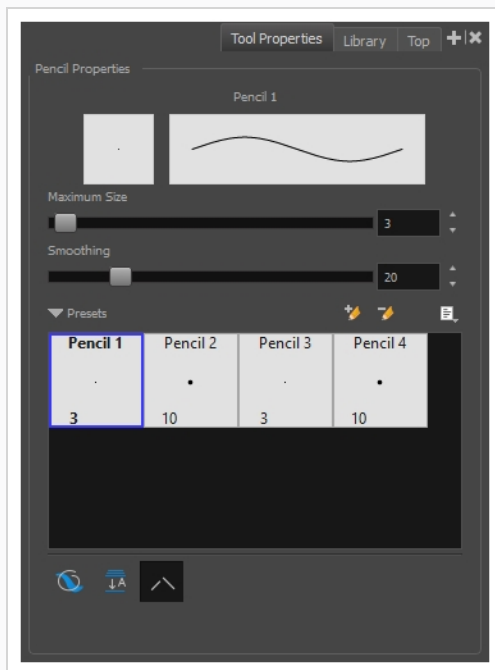

2. Use the **Size** slider to set the size of your pencil line.
3. Use the **Smoothing** slider to set the amount of smoothing Harmony should perform on your pencil lines. A higher setting will prevent your line from being shaky, but is liable to reduce your drawing precision and to round sharp corners into curves.
4. In the Camera or Drawing view, start drawing to test your pencil settings.

Disabling Pencil Line Textures

After you selected a pencil line texture, if you wish to resume drawing solid pencil lines again, you can do so using either the Colour view or the Pencil Properties dialog.

How to resume drawing with a solid pencil line using the Colour view

1. Click on the Show Pencil Texture Palettes  button to display your pencil texture palettes.

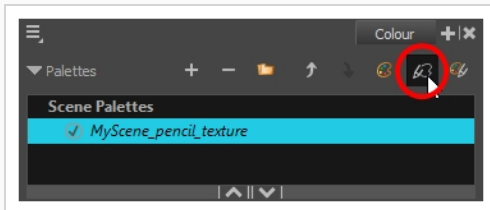

2. Over the swatch list, click on the **No Texture** button.

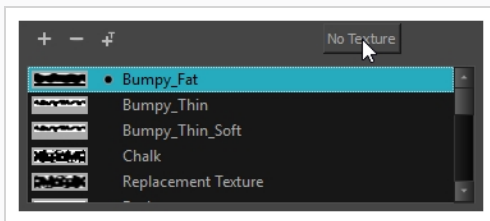

From now on, the pencil lines you draw will not have a texture.

How to resume drawing with a solid pencil line Pencil Properties dialog

1. In the Colour view, select the colour with which you wish to draw.
2. In the Tools toolbar, select the Pencil  tool or press Alt + /.
3. In the Tool Properties view, click on the arrow button next to the stroke preview area to open the Pencil Properties dialog.

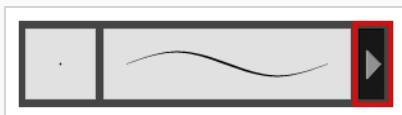

4. In the Pencil Properties dialog, click on the **Texture** tab.
5. In the pencil textures library, select **None**.

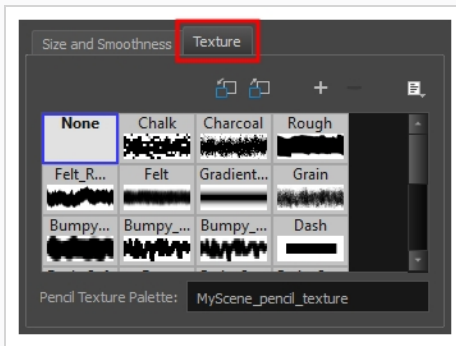

From now on, the pencil lines you draw will not have a texture.

About Pencil Presets

Setting up your pencil to perfectly reproduce the desired art style can require a lot of tweaking as well as trial and error. Once you have found the correct settings for your pencil, you will want to reuse it throughout your project for consistency. You can do that by creating and using pencil presets.

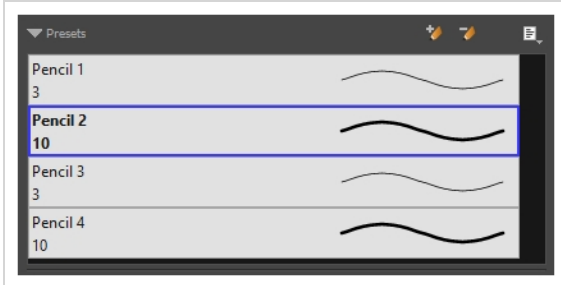

Harmony comes preloaded with a few pencil presets which you can select from the Tool Properties view. It is also possible to create your own pencil presets by configuring your pencil, then saving it as a preset.

Pencil presets are saved in your preferences. You can also export your brush presets into an **.xml** file, and import them on a different workstation, allowing you to share your brush presets between the different people collaborating on your project.

Creating Pencil Presets





T-LAY-002-002

You can create your own custom pencil presets.

**NOTE**

To learn more about the Pencil tool options, see the Reference guide .

How to create a pencil preset

1. In the Tools toolbar, select the Pencil , Line , Ellipse , or Rectangle  tool.
2. Configure your brush to be exactly how you wish to use it in the future—see [Changing Pencil Settings on page 105](#).
3. In the Tool Properties view, click the New Brush  button.

The New Preset dialog box opens.

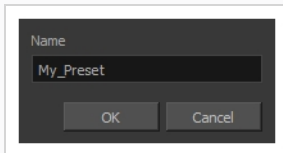

4. Type in a name for your new pencil thickness stencil and click **OK**.
5. Start drawing in the Drawing or Camera view.





Selecting a Pencil Preset

T-ANIMPA-010-001

A pencil preset is a pencil with specific properties.

Regular pencil presets allow you to set the size and smoothing of a pencil line, or the size of a shape.

How to select a pencil preset

1. In the Tools toolbar, select the Pencil , Line , Ellipse , or Rectangle  tool.
2. In the Tool Properties view, use the Presets menu to select a pencil preset.

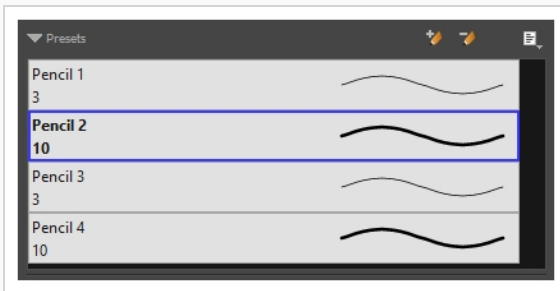



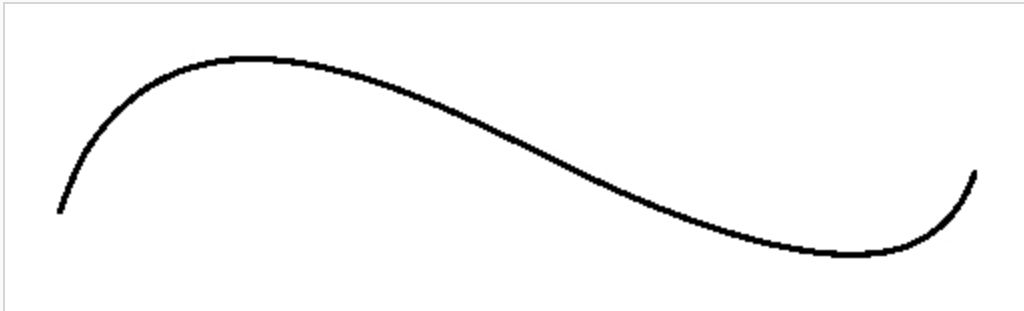

3. In the Drawing or Camera view, draw your pencil line or shape.



Renaming Pencil Presets

You can rename your pencil presets to keep your list organized.

How to rename a pencil preset

1. In the Tools toolbar, select the Pencil , Line , Ellipse , or Rectangle  tool.
2. In the Presets menu, select the preset you want to rename.
3. From the Brush menu , select **Rename Brush**.

The Rename Preset dialog box opens.

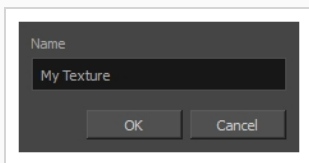



4. In the Name field, type in the new name.
5. Click **OK**.

Deleting Pencil Presets

You can delete unnecessary presets from your list.

How to delete a thickness stencil or pencil preset





1. In the Tools toolbar, select the Pencil  tool.
2. In the Presets menu, select the thickness stencil or preset to delete.
3. Click the Delete Preset  button.

Exporting Pencil Presets

T-ANIMPA-010-005

You can export your pencil presets to either backup, share or install on a different computer.

How to export pencils, brushes and erasers

1. In the Tools toolbar, select either the Brush , Pencil  or Eraser  tool.
2. Open the Brush Preset menu  and select **Export Brushes**.

The Export Tips and Textures dialog opens. This dialog allows you to export brush presets for the Brush, Pencil and Eraser tools.

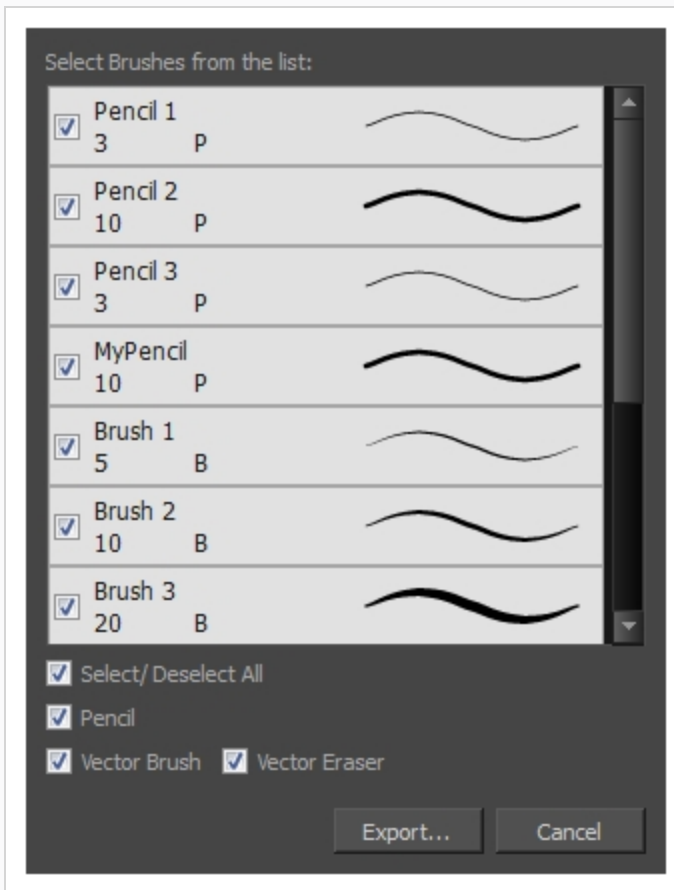

3. By default, the presets for all your tools will be selected for export. If you only wish to export presets for specific tools, uncheck **Select/Deselect All** and select the tools for which you want to export the presets.
4. Click **Export**.





5. In the Export Presets dialog that appears, browse to the location where you want to save the **.xml** file and enter its file name.
6. Click **Save**.

Importing Pencil Presets

T-ANIMPA-010-006

You can import Harmony pencil presets that you previously exported.

How to import pencils, brushes and erasers

1. In the Tools toolbar, select either the Brush , Pencil  or Eraser  tool.
2. Open the Brush Preset menu  and select **Import Brushes**.
3. In the browser window that appears, navigate to and select the **.xml** file in which you exported your brush presets.
4. Click **Open**.

The Import Brushes dialog box opens.

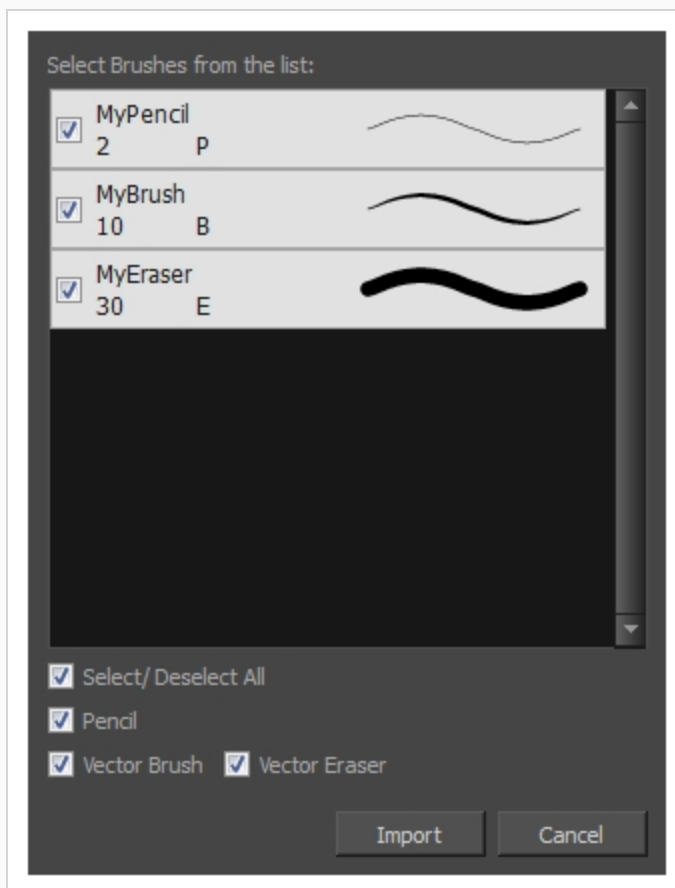

5. By default, the presets for any tools included in the file will be selected for import. If you only wish to import presets for specific tools, uncheck **Select/Deselect All** and select the tools for which you want to export the presets

6. Click **Import**.

The imported brush, eraser and pencil styles will appear in the Presets list.

Changing the Pencil Preset Display

You can display your preset list as thumbnails or a list.

How to change the Brush Presets display

1. In the Tool Properties view, click on the Brush Presets menu button  .
2. Select one of the following options:
 - **Small Thumbnail:** Displays presets in a grid of small thumbnails with a preview of their tip.
 - **Large Thumbnail:** Displays presets in a grid of big thumbnails, with their name and a preview of their tip.
 - **Stroke View:** Displays presets in a list, with their name and a preview of a stroke done with each preset. This is the default setting.

About Shape Tools

T-HFND-004-006

In Harmony, you can use the shape tools to draw circles, lines and rectangles. You can also easily reshape a square or circle into a much more complex drawing—see [About the Contour Editor Tool on page 153](#) .

The available shape tools are:

- Line tool
- Rectangle tool
- Ellipse tool
- Polyline tool

The shape tools use the same pencil presets as the Pencil tool. To learn how to create, delete, rename, import and export presets, see [About the Pencil Tool on page 103](#).

To learn more about the shape tool parameters, see the Reference guide .

Creating Rectangles, Circles and Lines with the Shape Drawing Tools

T-HFND-004-006A





You can use the Line, Rectangle, or Ellipse tool to draw shape without having to trace them. You can also draw perfect circles and squares.





NOTE

To learn more about the shape tool parameters, see the Reference guide .

How to draw with a shape tool

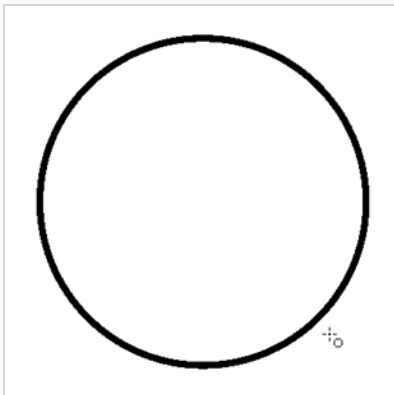
1. In the Timeline or Xsheet view, select the cell on which you want to draw.
2. In the Tools toolbar, select the Rectangle , Ellipse , or Line  tool.
3. To automatically fill the shape, in the Tool Properties view, select the Auto Fill  option.
4. In the Camera view, click and drag to draw the shape.



- Hold down Shift to lock the rectangle or the ellipse ratio to 1:1.
 - Hold down Alt to draw the rectangle or ellipse from its centre.
 - Hold down Shift to snap the line every 15 degrees.
 - Hold down Alt to snap the start or end of the line to a nearby stroke.
5. Use the Contour Editor  tool to deform the shape and create your drawing.

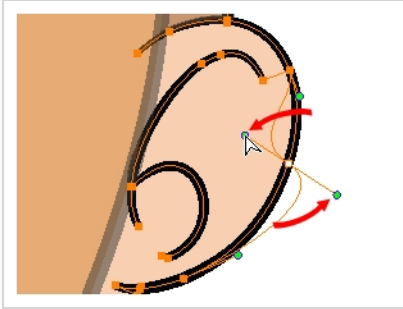

Creating Vector Shapes with the Polyline Tool

You can use the Polyline tool to draw long and curvy lines.





NOTE

To learn more about the Polyline tool options, see the Reference guide .

How to draw with the Polyline tool

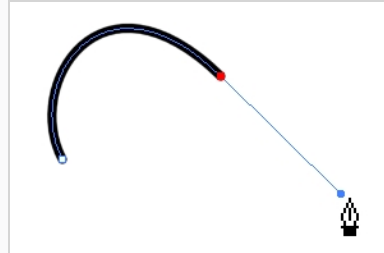
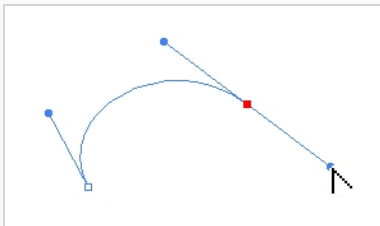
1. In the Timeline view, select the cell on which you want to draw.
2. In the Tools toolbar, select the Polyline  tool or press Alt + _.
3. In the Camera or Drawing view, click and drag to create a point and a Bezier handle to shape your line.
4. Click a new area and drag to create a second point and Bezier handle.
 - Press Alt to pull only one handle, instead of two.
 - Press Shift to snap the handles to 45, 90, or 180 degrees.



5. Repeat the previous step until your shape is completed.
6. Press Ctrl (Windows/Linux) or ⌘ (macOS) and click to release the Polyline tool from the current path or shape that it is creating. Continue to use the tool to make multiple, independent paths or shapes.
7. If necessary, reshape the lines using the Contour Editor  tool—see [Reshaping a Shape, Pencil Line or Stroke with the Contour Editor Tool](#) on page 154.

About the Stroke Tool

T-HFND-004-013

There are two different ways to draw invisible lines, using the Pencil tool or Stroke tool.

Using the Pencil tool, you can draw as strokes only, meaning that the line will be invisible. This can be useful for drawing tones and highlights directly on the character.

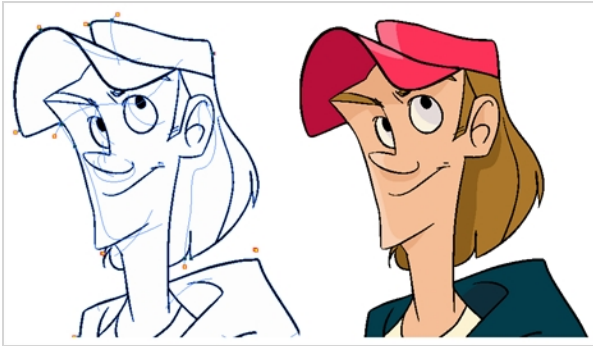

The Stroke tool draws invisible lines only. You cannot add thickness to the line. Unlike the Close Gap tool that creates a short, straight line between two points, the stroke line will stay exactly where you draw it. This tool can be useful for closing a zone in a particular way or creating some hard shadows or highlight areas.

Sometimes, it may be difficult to see strokes, especially if your colours are similar to the blue stroke colour. In Harmony, you can display the strokes in washed-out colours so the invisible lines stand out.



NOTE

To learn more about the Stroke tool parameters, see the Reference guide

Authors

Marie-Eve Chartrand

Christopher Diaz

chrisdiazart.com

Creating Invisible Lines with the Stroke Tool

T-HFND-004-013A



You can draw invisible lines with the Stroke tool as well as with the Pencil tool.



NOTE

To learn more about the Stroke tool parameters, see the Reference guide

How to draw invisible lines with the Stroke tool

1. In the Timeline or Xsheet view, select the cell on which you want to draw.
2. In the Tools toolbar from the Paint drop-down menu, select the Stroke  tool or press Alt + V.
3. From the top menu, select **View > Show Drawing > Show Strokes**  or press K.
4. In the Tool Properties view, you can adjust the smoothness.
5. In the Camera or Drawing view, start drawing.

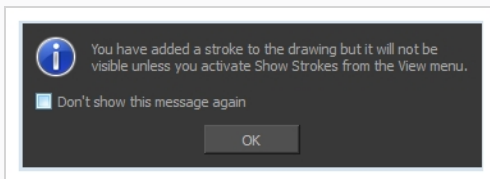

If you forgot to enable the Show Strokes option before drawing, as soon as you draw a first stroke, a Message dialog box opens.



Select the **Don't Show This Message Again** option if you do not want the dialog box to notify you about the Show Strokes option.

6. Click **OK**.
7. You can modify the stroke shape with the Contour Editor  tool.

How to draw invisible lines with the Pencil tool

1. In the Timeline or Xsheet view, select the cell on which you want to draw.
2. In the Tools toolbar, select the Pencil  tool or press Alt + /.
3. From the top menu, select **View > Drawing > Show Strokes**  or press K.
4. In the Tool Properties view, set the Pen Style size to **0**. You can also adjust the smoothness.
5. In the Camera or Drawing view, start drawing.

If you forgot to enable the Show Strokes option before drawing, as soon as you draw a first stroke, a Message dialog box opens.

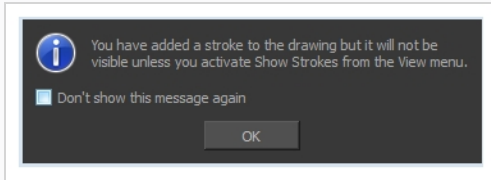

Select the **Don't Show This Message Again** option if you do not want the dialog box to notify you about the Show Strokes option.

6. Click **OK**.
7. You can modify the stroke shape with the Contour Editor  tool.

Authors

Marie-Eve Chartrand
Christopher Diaz
chrisdiazart.com

About the Eraser Tool

T-HFND-004-010

Using the Eraser tool, you can remove parts of your drawing.

It is a good idea to create and save erasers with precise sizes and parameters in order to save time when drawing and designing. Harmony provides you with a variety of default eraser styles and allows you to create and save your own eraser presets.

The Eraser tool has as many options as the Brush tool.

Erasing

T-HFND-004-010A

You can erase portion of your artwork using the Eraser tool.

How to erase with the Eraser tool

1. In the Timeline or Xsheet view, select the cell that contains objects you want to erase.
2. In the Tools toolbar, select the Eraser  tool or press Alt + E.
3. In the Tool Properties view, set the Maximum Size to the desired Eraser size.



NOTE

If you are drawing with a mouse, your strokes will always be at their maximum size. If you are using a pressure-sensitive tablet, your strokes will vary in size depending on the pressure of your pen, ranging between 25% to 100% of the maximum size.

4. In the Camera or Drawing view, start erasing.

Creating an Eraser

Drawing a stroke with the Eraser tool cuts out the stroke from your artwork.

An eraser's tip can be shaped like a circle, a diamond or a square, and can be configured to have a specific size, aspect ratio and angle. Also, your eraser strokes can be automatically smoothed by Harmony as you erase.

How to create an eraser

1. In the Tools toolbar, select the Eraser  tool or press Alt + B.
2. In the Tool Properties view, click the arrow button to open the Eraser Properties view.



The Eraser Properties dialog opens.

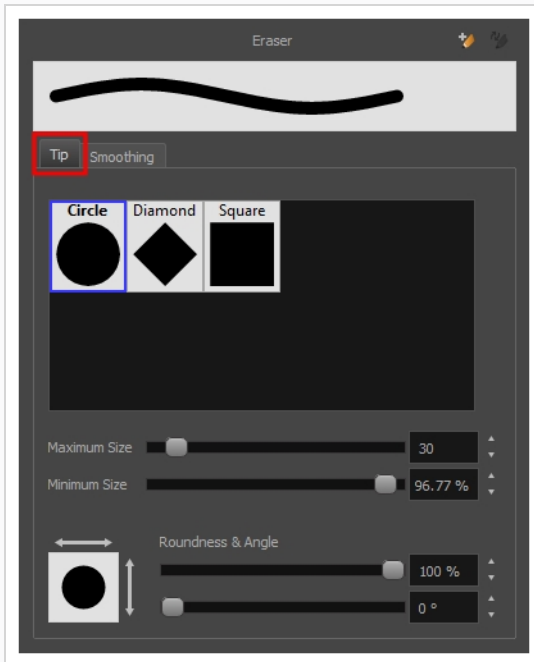

3. In the brush tip list, select either **Circle**, **Diamond** or **Square**.

4. Use the **Maximum Size** slider to set the maximum size of your eraser tip, in pixels.

**NOTE**

When drawing with a mouse, your eraser is always at its maximum size. When drawing with a pressure-sensitive pen tablet, your eraser's size will range between its minimum and maximum size, depending on the amount of pressure you put on the pen when drawing.

5. If you are using a pressure-sensitive pen tablet, use the **Minimum Size** slider to set the percentage of your eraser tip's maximum size your eraser should be when you use your pen with very little pressure. If you don't want the pressure on your pen to affect the eraser size, set this parameter to 100%.
6. If you want your eraser tip to have uneven dimensions, use the **Roundness** slider to shrink the eraser tip vertically all the while preserving its horizontal size.
7. If you want your eraser tip to be at an angle, use the **Angle** slider to rotate your brush tip.
8. Click on the **Smoothing** tab.

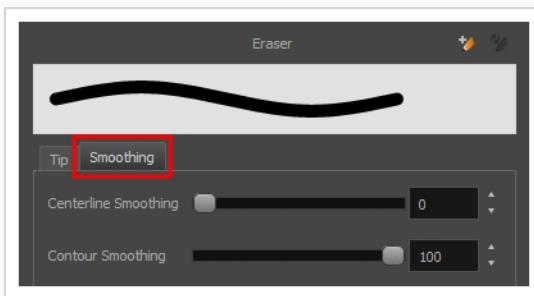

9. Use the **Centerline Smoothing** slider to set the amount of smoothing Harmony should perform on your stroke's direction, curves and corners. A higher setting will prevent your line from being shaky, but is liable to reduce your drawing precision and to round sharp corners into curves.
10. Use the **Contour Smoothing** slider to set the amount of smoothing Harmony should perform on your stroke's contour. A higher setting will round sharp corners and reduce the amount of control points for the resulting vector shape.
11. Either close or set aside the Eraser Properties dialog.
12. In the Camera or Drawing view, start erasing to test your eraser settings.

About Eraser Presets

Once you have found the correct settings for your eraser, you might want to reuse it throughout your project for consistency. You can do that by creating and using eraser presets.

Harmony comes preloaded with a few eraser presets which you can select from the Tool Properties view. It is also possible to create your own eraser presets by configuring your eraser then saving it as a preset.

Eraser presets are saved in your preferences. You can also export your eraser presets into an **.xml** file, and import them on a different workstation, allowing you to share your eraser presets between the different people collaborating on your project.



Creating an Eraser Preset

You can create your own custom eraser preset by configuring your eraser, then adding it as a preset.

How to create an eraser preset

1. In the Tools toolbar, select the Eraser  tool or press Alt + E.
2. Click on the Arrow button to open the Eraser Properties dialog.



3. Configure your brush to be exactly how you wish to use it in the future—see [Creating an Eraser](#).
4. Do one of the following:
 - From the Eraser Properties dialog, click on the New Brush Preset  button in the top-right corner.
 - In the Tool Properties view, click the New Brush Preset  button.
 - In the Tool Properties view, open the Brush Presets menu  and select **New Brush Preset**.
5. In the New Preset window, type a name for your new eraser preset.

Your new eraser preset is added to the end of the list of eraser presets.

Selecting an Eraser Preset

Harmony provides you with default eraser presets available in the Tool Properties view.

How to select a brush preset

1. In the Tools toolbar, select the Eraser  tool or press Alt + E.
2. In the Tool Properties view, select an eraser preset from the Presets list.

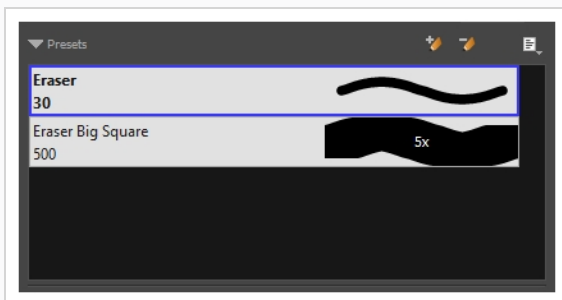

Updating a Brush Preset

If you want to modify the settings of an existing custom preset, you can do so by adjusting the parameters in the Tool Properties view, then updating your preset with your brush current's parameters.

How to update a brush preset

1. In the Tools toolbar, select the Brush 🖌️ tool or press Alt + B.
1. In the Tool Properties view, select the Brush Preset you wish to update.
2. Click on the Arrow button to open the Brush Properties view.





3. Configure your brush to be exactly how you wish to use it in the future—see [Creating a Brush](#).
4. Click on the Update Brush Preset 🔄🖌️ button in the upper-right corner of the Brush Properties dialog.

Renaming an Eraser Preset

To keep your list comprehensive and organized, you can name your custom brush presets.

How to rename a brush preset

1. In the Tools toolbar, select the Eraser  tool or press Alt + E.
2. In the Tool Properties view, select an eraser preset to rename.
3. Open the Brush Preset menu  and select **Rename Brush**.

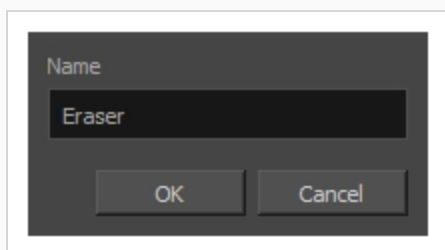



4. Type in a new name for the brush and click **OK**.

Deleting a Brush Preset

You can keep your preset list clean by deleting unwanted custom presets.

How to delete a brush preset

1. In the Tools toolbar, select the Eraser  tool or press Alt + E.
2. In the Tool Properties view, select the eraser preset you want to delete.
3. Do one of the following:
 - Click the Delete Brush  button.
 - Open the Brush Preset menu  and select **Delete Brush**.

Exporting Eraser Presets

You can export eraser presets into an **.xml** file which will contain all of your eraser's settings. This can be useful if you wish to back up or share your eraser presets.

How to export pencils, brushes and erasers

1. In the Tools toolbar, select either the Brush 🖌️, Pencil 🖊️ or Eraser 🧽 tool.
2. Open the Brush Preset menu ☰ and select **Export Brushes**.

The Export Tips and Textures dialog opens. This dialog allows you to export brush presets for the Brush, Pencil and Eraser tools.

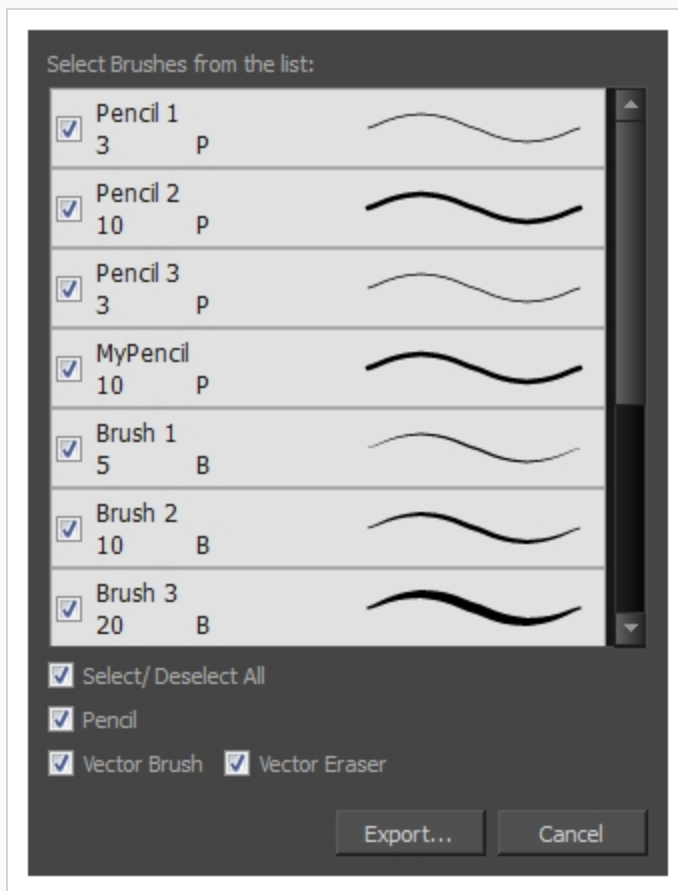





3. By default, the presets for all your tools will be selected for export. If you only wish to export presets for specific tools, uncheck **Select/Deselect All** and select the tools for which you want to export the presets.
4. Click **Export**.

5. In the Export Presets dialog that appears, browse to the location where you want to save the **.xml** file and enter its file name.
6. Click **Save**.

Importing Eraser Presets

You can import eraser presets that you previously exported from Harmony.

How to import pencils, brushes and erasers

1. In the Tools toolbar, select either the Brush , Pencil  or Eraser  tool.
2. Open the Brush Preset menu  and select **Import Brushes**.
3. In the browser window that appears, navigate to and select the **.xml** file in which you exported your brush presets.
4. Click **Open**.

The Import Brushes dialog box opens.

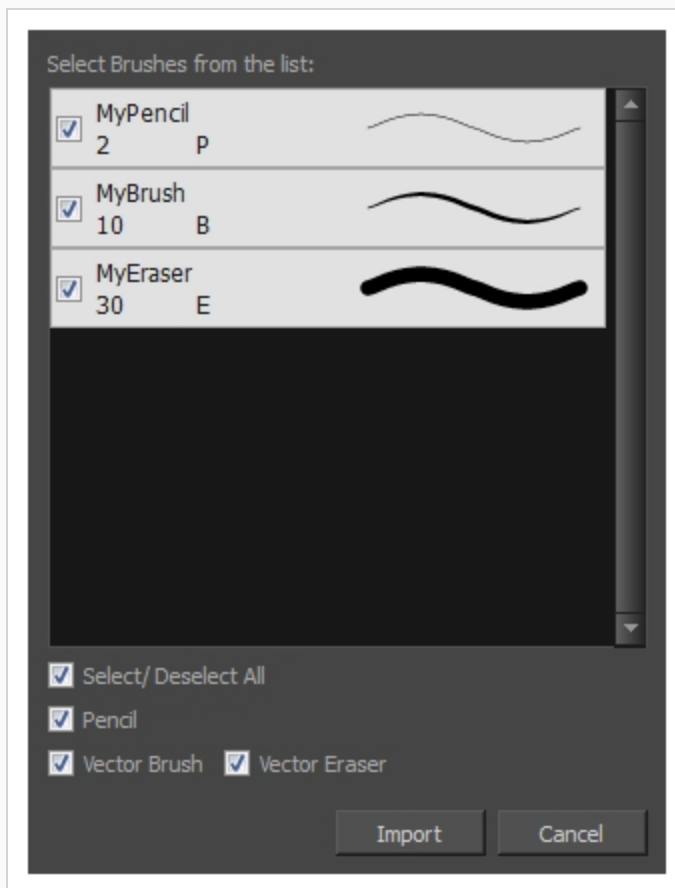

5. By default, the presets for any tools included in the file will be selected for import. If you only wish to import presets for specific tools, uncheck **Select/Deselect All** and select the tools for which you want to export the presets
6. Click **Import**.

The imported brush, eraser and pencil styles will appear in the Presets list.

Changing the Brush Preset Display

You can display your preset list as thumbnails or a list.

How to change the Brush Presets display

1. In the Tool Properties view, click on the Brush Presets menu button  .
2. Select one of the following options:
 - **Small Thumbnail:** Displays presets in a grid of small thumbnails with a preview of their tip.
 - **Large Thumbnail:** Displays presets in a grid of big thumbnails, with their name and a preview of their tip.
 - **Stroke View:** Displays presets in a list, with their name and a preview of a stroke done with each preset. This is the default setting.

About the Select Tool

T-HFND-004-005

The Select tool allows you to select drawing strokes and drawing objects. When selected, you can use the Select tool to scale, translate, rotate, resize, flip and delete them.



NOTE

To learn more about the Select tool options, see the Reference guide .

Authors

Marie-Eve Chartrand

Christopher Diaz

chrisdiazart.com

Selecting

T-HFND-004-005A

Using the Select tool, you can select drawing strokes and groups.



NOTE

To learn more about the Select tool options, see the Reference guide .

How to select objects

1. In the Timeline view, select the cell on which you want to select drawing objects.
2. In the Tools toolbar, select the Select  tool or press Alt + S.
3. In the Camera view, select strokes or drawing object you want to edit by doing one of the following:
 - Click on a stroke or drawing object to select it.
 - Shift + Click on a stroke or drawing object to add it to a multiple selection.
 - Draw a lasso around drawing strokes or objects to select them simultaneously.
 - From the top menu, select **Edit > Select All** or press Ctrl + A (Windows/Linux) or ⌘ + A (macOS) to select all the strokes and drawing objects in the drawing.
4. Do one of the following to edit your selection:
 - To reposition, click the selected drawing object and drag the selection to a new area.

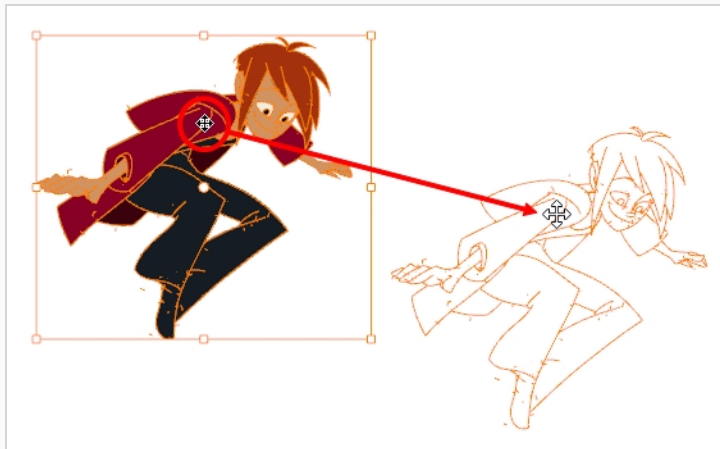

NOTE

You can also nudge your selection using the arrow keys, and fast-nudge



your selection by holding Shift and pressing the arrow keys.

- To rotate, grab the selection box handle and rotate it.

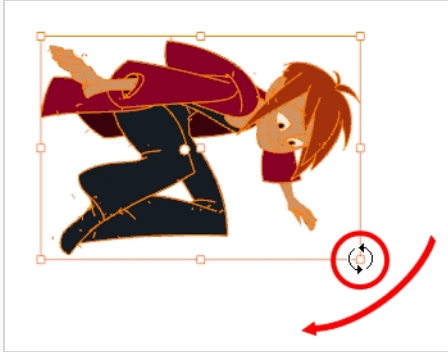

- To scale, pull or push on the top, side, bottom or corner control point. Hold down Shift to lock the selection's ratio.

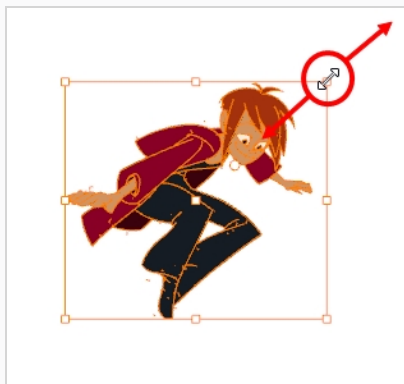

- To skew, drag sideways or up and down the sides or top and bottom segments, between the control points.

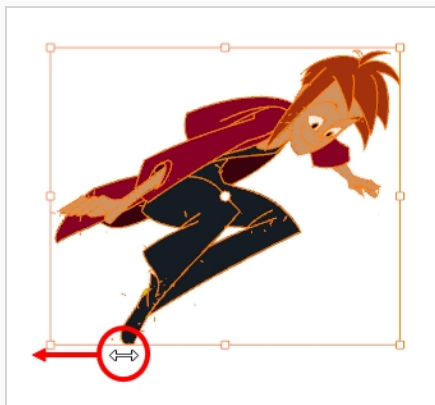

- To delete, press Del (Windows/Linux) or Backspace (macOS).

Inverting a Selection

You can invert your selection to select everything else in your drawing that was not previously selected.

How to invert a selection

1. From the top menu, select **Edit > Invert Selection** or press Ctrl + Shift + I (Windows/Linux) or Shift + ⌘ + I (macOS).

Repositioning the Selection Pivot

You can temporarily reposition the selection's pivot position to rotate, scale, or skew from a different point.

How to temporarily reposition the pivot point

1. In the Camera or Drawing view, select the drawing object you want to transform.

The pivot point appears in the middle of your selection.



2. Click the pivot point and drag it to a new position.



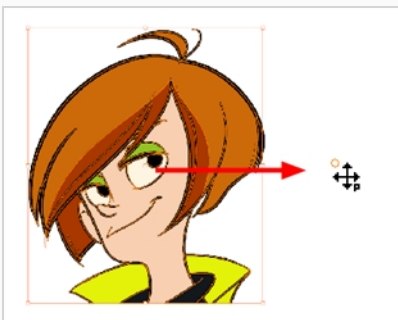

This becomes the new position of the pivot point for the current transformation and will remain there until you make a new selection.



Arranging and Reordering Drawing Strokes

The different Arrange options let you reorder drawing objects and strokes inside a single layer in the Drawing or Camera view.

How to arrange drawing strokes

1. In the Tools toolbar, select the Select tool.
2. In the Camera or Drawing view, select the strokes to be reordered.
3. Do one of the following:
 - From the top menu, select **Drawing > Arrange > Bring to Front**—Moves the selected art to the front (on top). Press Ctrl + Shift + PgUp (Windows/Linux) or ⌘ + Shift + PgUp (macOS).
 - From the top menu, select **Drawing > Arrange > Bring Forward**—Moves the selected art one level forward (closer to the front). Press Ctrl + PgUp (Windows/Linux) or ⌘ + PgUp (macOS).
 - From the top menu, select **Drawing > Arrange > Send Backward**—Moves the selected art one level lower (behind). Press Ctrl + PgDown (Windows/Linux) or ⌘ + PgDown (macOS).
 - From the top menu, select **Drawing > Arrange > Send to Back**—Moves the selected art behind everything (bottom / back). Press Ctrl + Shift + PgDown (Windows/Linux) or ⌘ + Shift + PgDown (macOS).
4. In the Drawing View and Camera View toolbars, you can also add the following buttons—see [Customizing View Toolbars](#) on page 54.
 - Bring to Front  button
 - Bring Forward  button
 - Send Backward  button
 - Send to Back  button

Grouping Drawing Strokes

Use the grouping options to group and ungroup selected drawing objects and strokes. This can help in the selection, repositioning, re-scaling and other transformations to be applied to multiple objects of a drawing. Grouping does not flatten your objects. You can ungroup your selection at any time. You can also group groups.

How to group strokes

1. In the Tools toolbar, select the Select tool.
2. In the Camera or Drawing view, select the strokes to be grouped.
3. Do one of the following:
 - From the top menu, select **Edit > Group > Group**.
 - From the Camera or Drawing view menu, select **Edit > Group > Group**.
 - Press Ctrl + G (Windows/Linux) or ⌘ + G (macOS).

How to ungroup strokes

1. In the Tools toolbar, select the Select tool.
2. In the Camera or Drawing view, select the groups to be ungrouped.
3. Do one of the following:
 - From the top menu, select **Edit > Group > Ungroup**.
 - From the Camera or Drawing view menu, select **Edit > Group > Ungroup**.
 - Press Ctrl + Shift + G (Windows/Linux) or ⌘ + Shift + G (macOS).

Working on a Single Drawing with the Select Tool



In the Drawing view, the select tool will always work on the selected layer only. In the Camera view, you can set the Select tool to either work on all visible layers or on the selected layers only.



NOTE

To learn more about the Select tool options, see the Reference guide .

How to enable the Select Tool Works on Single Drawing preference

1. In the Tools toolbar, select the Select  tool or press Alt + S.
2. Do one of the followings:
 - In the Tool Properties view, click the Single Drawing Mode  button.
 - Select **Edit > Preferences** (Windows/Linux) or **Harmony Essentials > Preferences** (macOS). In the Camera tab, go to the Tools section and select the **Select Tool Works on Single Drawing** option and click **OK**.
3. In the Camera view, make your selection. Note that you may need to restart Harmony depending on your system.



About the Repositioning All Drawings Tool

T-ANIMPA-010-008

The Reposition All Drawings tool is used to reposition, scale, rotate or skew all drawing strokes on every drawing included in a layer.

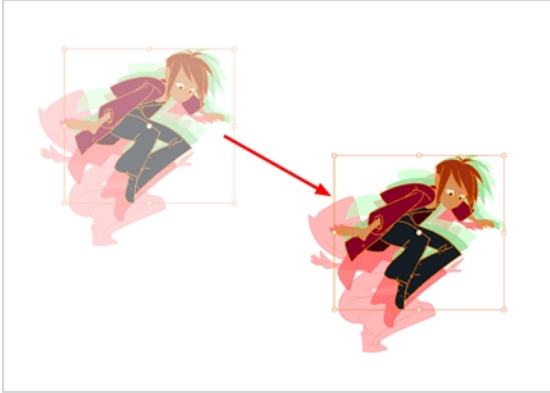

If your hand-drawn animation requires to be repositioned in the grid, as soon as you select the Reposition All Drawings tool, all the strokes in all the drawings exposed on the current layer are selected. You can use the controls the same way as the Select tool—see [About the Select Tool on page 140](#).



NOTE

To learn more about the Reposition All Drawings tool options, see the Reference guide .

Repositioning All Drawings in a Layer

T-ANIMPA-010-009

Use the Reposition All Drawings tool to reposition all the drawing strokes on all drawings exposed in the current layer.



NOTE

To learn more about the Reposition All Drawings tool options, see the Reference guide .

How to reposition all drawings

1. From the Tools toolbar, select the Reposition All Drawings  tool. This also automatically selects every stroke in your drawing in the Drawing and Camera view.
2. Do any of the following:
 - To reposition, click and drag your selection to a new area.

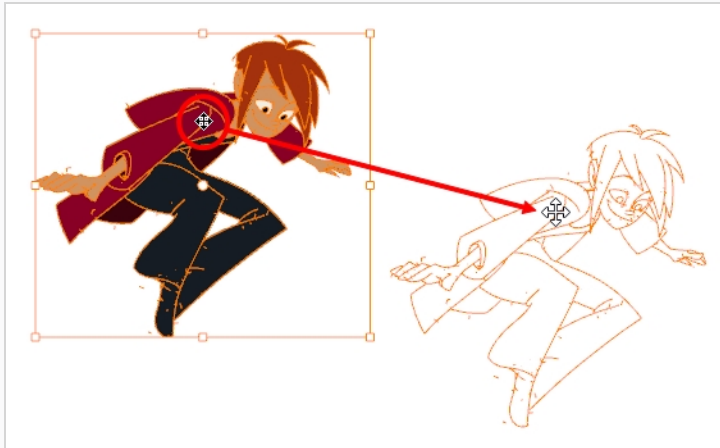

- To rotate, rotate the selection box handle.

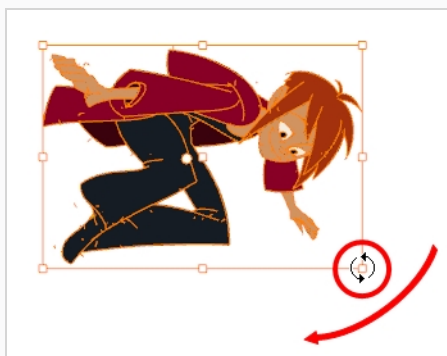

- To scale, pull or push on the top, side, bottom or corner control points. Hold down Shift to maintain the selection's ratio.

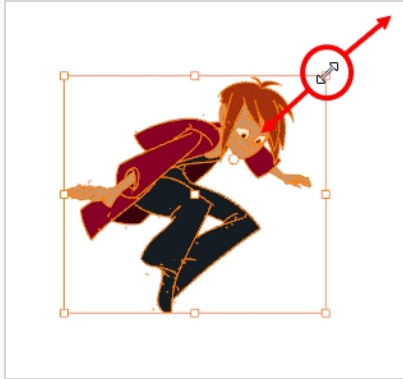

- To skew, drag the sides or top and bottom segments, between the control points.

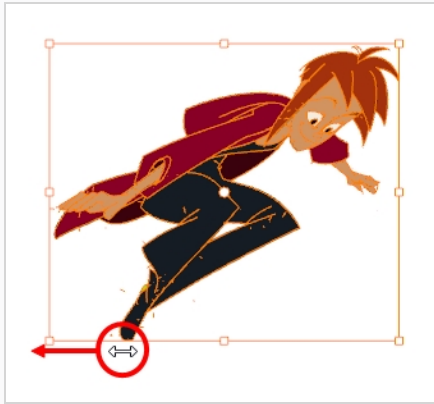

3. When you release your cursor, every drawing in the drawing layer you repositioned, scaled, rotated or skewed will follow the same transformation.
4. You can also adjust the position by modifying the settings and using the operation buttons in the Tool Properties view.

About the Cutter Tool

T-HFND-004-007

The Cutter tool lets you cut a drawing to move, copy, or delete it. You can use it to scale or reposition the portion of a flattened drawing. You can also use it to trim strokes using a single gesture.

**NOTE**

To learn more about the Cutter tool options, see the Reference guide .

Authors

Marie-Eve Chartrand

Christopher Diaz

chrisdiazart.com

Cutting Artwork

T-HFND-004-007A

Use the Cutter tool to trim and cut your artwork.



NOTE

To learn more about the Cutter tool options, see the Reference guide .

How to cut drawings

1. In the Tools toolbar, select the Cutter  tool or press Alt + T.
2. In the Camera or Drawing view, select an area to cut away.



- To delete the selected area, press Del.
- To move the selection, drag it to a new area.
- Use the bounding box controls to scale, skew, or rotate the cut piece.

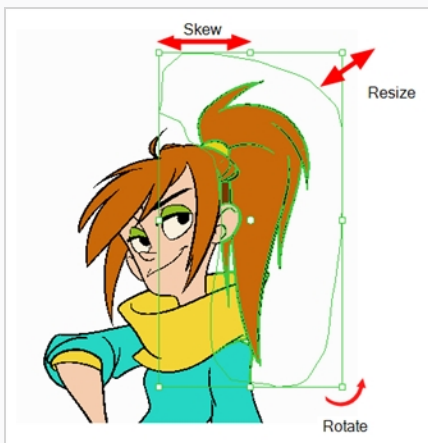

About the Contour Editor Tool

T-HFND-004-008

The Contour Editor lets you reshape vector shapes, brush strokes and lines in your drawings.

Artwork in Harmony is made of vector shapes. Vector shapes are defined by points, the lines joining the points together (contours) and the curve vectors, represented by Bezier handles, which make the curve of said lines.

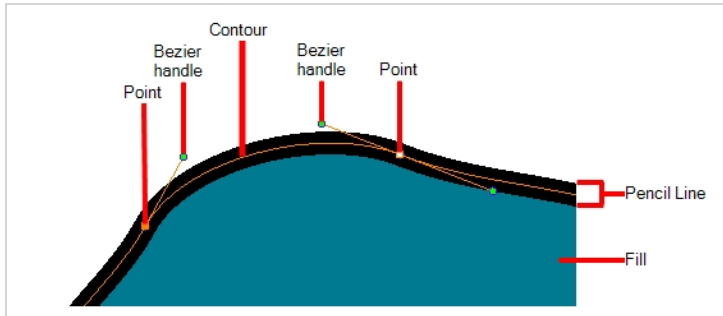

The Contour Editor tool allows you to select a contour or point, and change the position of points, add and remove points from the shape, rotate, lengthen and shorten curve handles to influence the curve of contours between those points, or drag contours between points to change their curve directly.

Since pencil lines are defined by a single line with a line width, you can use the Contour Editor to easily modify the shape of pencil lines. In contrast, brush strokes are full vector shapes, so the Contour Editor can be used to modify their shape.

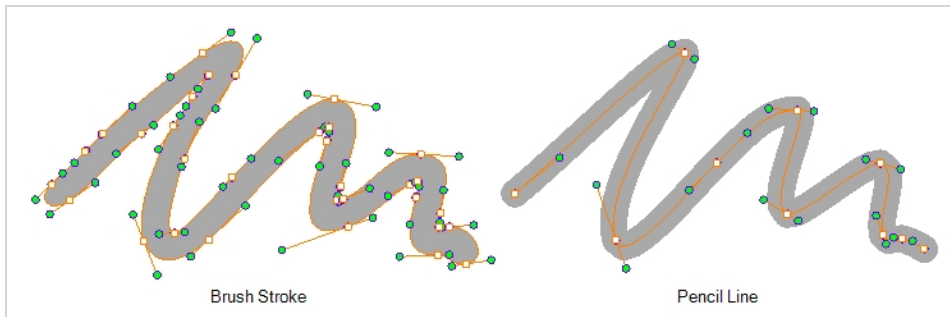

The Contour Editor can be used to tweak vector artwork in all sorts of ways. It can be used to perfect a pencil line, correct shapes, or create complex shapes out of a basic ellipse or rectangle.

Reshaping a Shape, Pencil Line or Stroke with the Contour Editor Tool

T-HFND-004-008A

You can use the Contour Editor tool to tweak the contours of vector shapes and brush strokes in your drawings, as well as reshape pencil lines and strokes.

How to reshape drawings

1. In the Tools toolbar, select the Contour Editor  tool or press Alt + Q.
2. In the Drawing or Camera view, click the shape, contour or pencil line you want to edit near the area you wish to change.

The shape or line's control points appear.

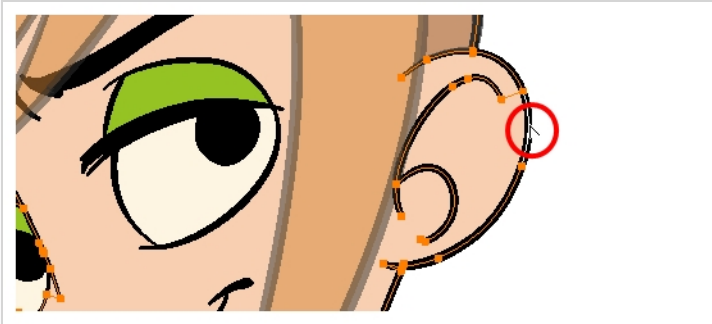

3. Click on one of the points to select it.

The point's Bezier handles appears, as well as Bezier handles for the surrounding points.

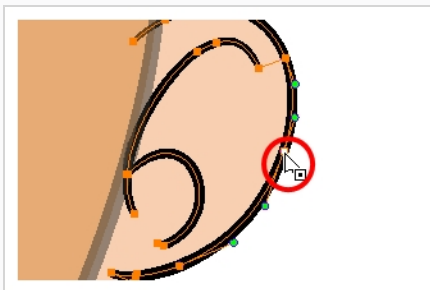

TIP

You can select several points by drawing a lasso around the points, or by holding Shift while clicking on points to add them to your selection. You can use the Contour Editor to scale and rotate a selection of multiple points by enabling the Show Contour Editor Control  option in the Tool Properties view.

4. Do one of the following:

- To move a point or a selection of multiple points, click and drag it.

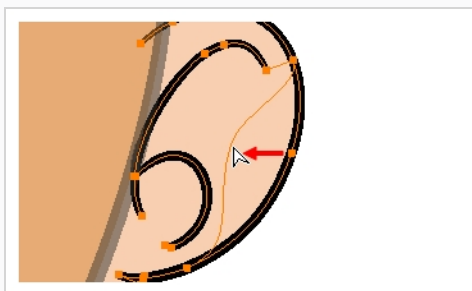

- To change the curve on both sides of a point, drag one of its Bezier handles.

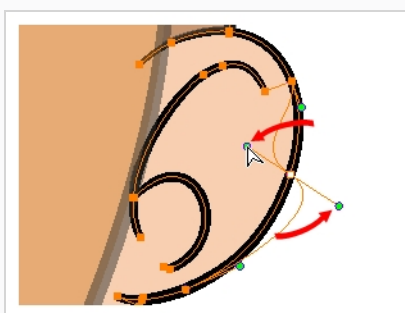

- To change the curve on only one side of a point, press and hold the Alt key, then drag one of its Bezier handles.

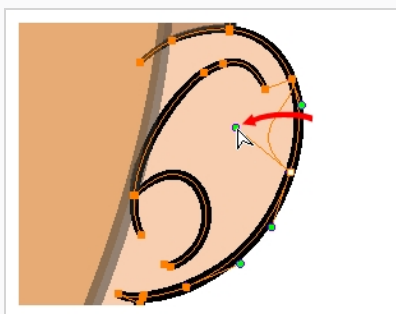

- To deform the contour, drag a part of the contour between two points.

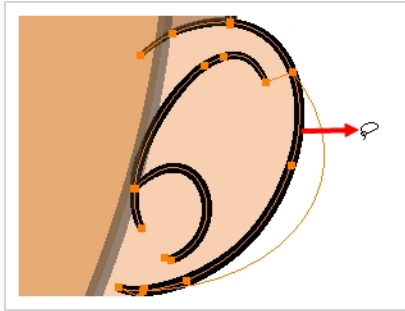

- To deform the curve between two points, hold the Shift key and drag the contour between two points.

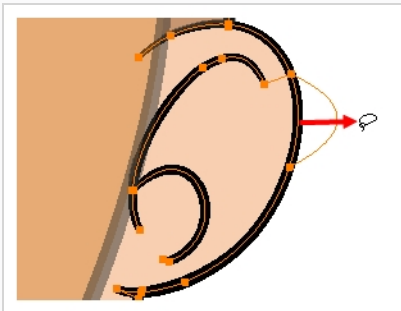

- To remove a point's Bezier handles and make the lines it is connected to straight, press and hold the Alt key and click on the point.

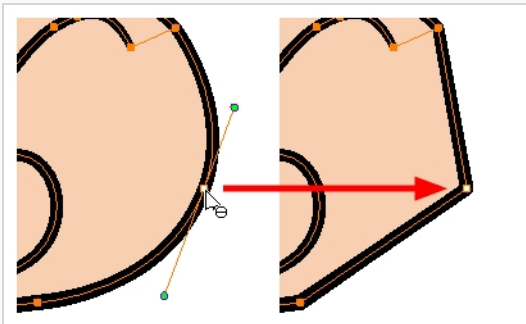

- Straight lines have no Bezier handles at their points by default. To create Bezier handles for these points and make their lines curved, press and hold the Alt key, then click and hold the point and drag the mouse cursor away from it. A new Bezier handle will follow your mouse cursor until you release the mouse button.

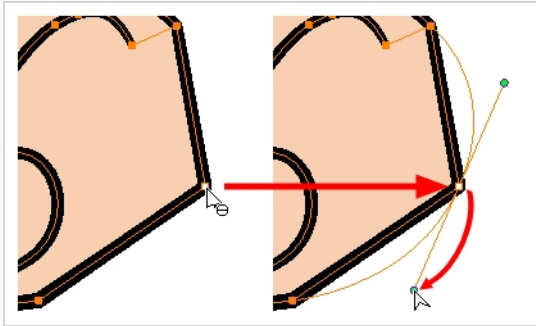

- To add a control point, press Ctrl (Windows/Linux) or ⌘ (macOS) and click on the contour where you want the new point to be created.

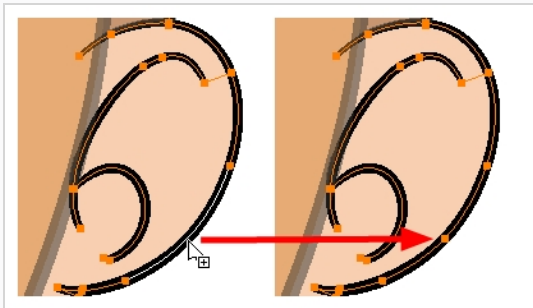

- To remove a control point, select the control point and press Del (Windows/Linux) or Backspace (macOS).

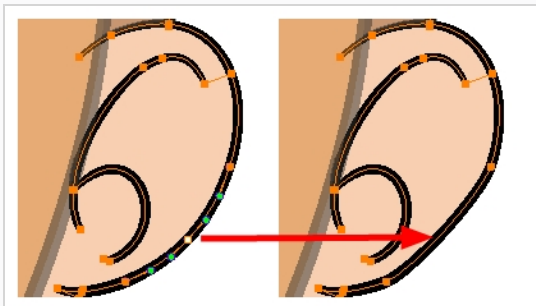

About the Centerline Editor

T-HFND-004-009B

The Centerline Editor allows you to tweak and reshape brush strokes by manipulating their center line rather than their contour. This gives you a flexibility that is similar to the one you have when using the Contour Editor tool to manipulate pencil lines.

In Harmony, pencil lines are vector information calculated by their center line and the width of the line. This makes it easy to edit pencil lines with the Contour Editor. Brush strokes, however, are stored as shapes. Therefore, using the Contour Editor on a brush stroke does not allow you to edit the center line of the stroke, but rather, its contour.

The Centerline Editor tool creates a center line for a brush stroke, and gives you access to control points and Bezier handles for this center line, allowing you to deform the brush stroke the same way you can deform a pencil line using the Contour Editor.

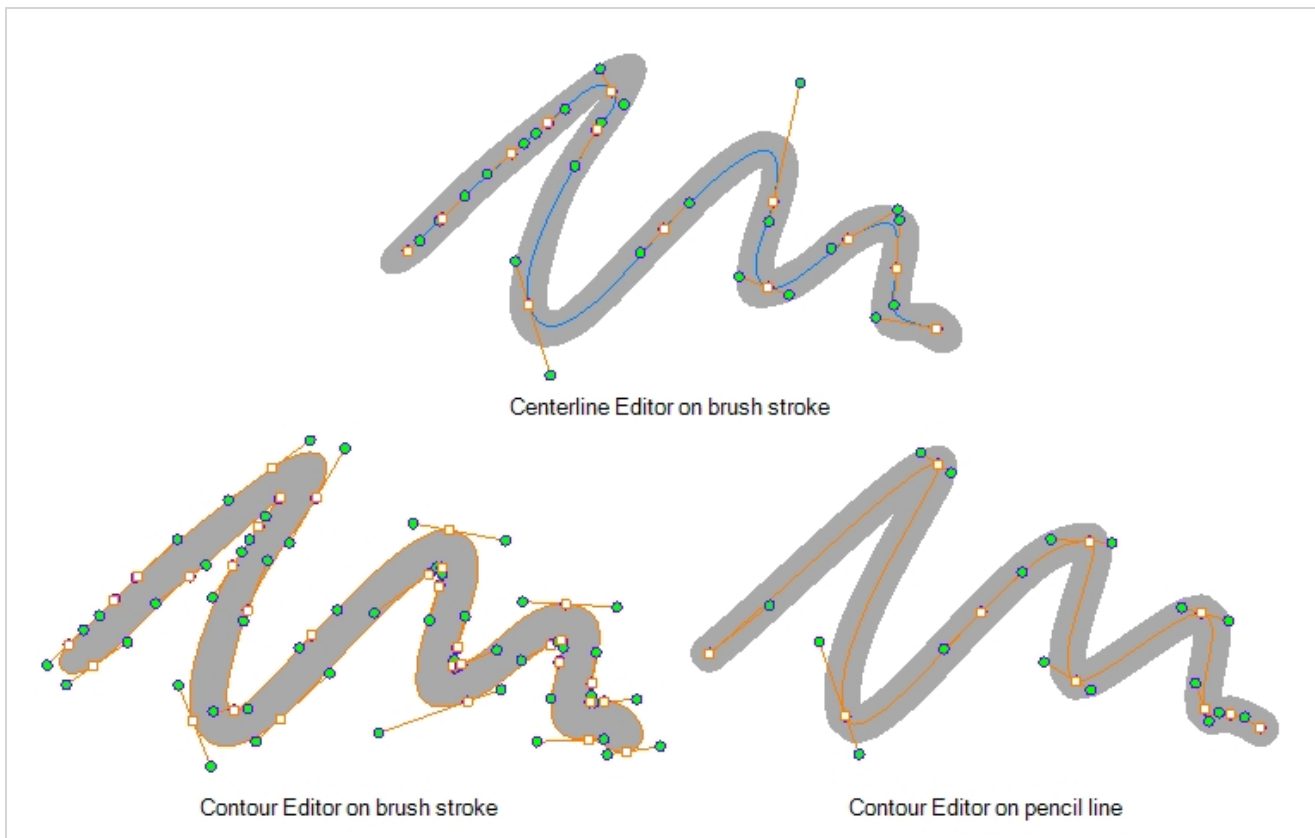

Keep in mind that brush strokes are vector shapes with a fill. As such, the Centerline Editor must do guess work to figure out the center line of your brush strokes, and apply deformations on its shape as you tweak its control points. The Centerline Editor will not be able to make a clear center line out of brush strokes that merge together, that look scrambled or that do not have a clear direction.

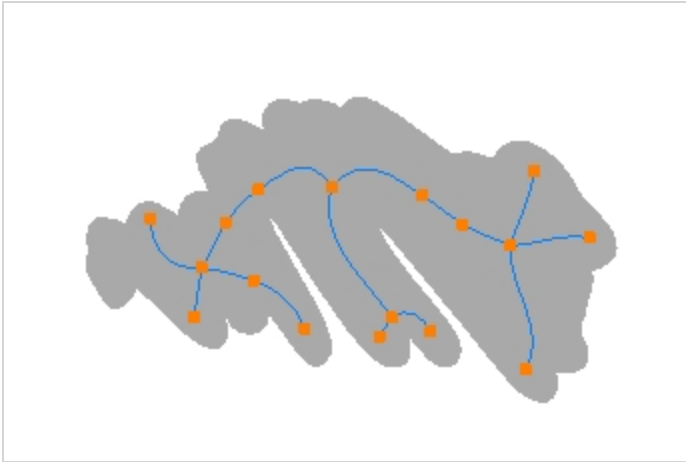
**NOTE**

If you use the Centerline Editor to deform a closed brush stroke with a fill inside it, the fill will not be reshaped to fit the new shape of the brush stroke.

Reshaping Brush Strokes Using the Centerline Editor

T-HFND-004-009C



You can use the Centerline Editor tool to reshape brush strokes from their center line rather than their contour, like you would reshape pencil lines using the Contour Editor.



NOTE

If you use the Centerline Editor to deform a closed brush stroke with a fill inside it, the fill will not be reshaped to fit the new shape of the brush stroke.

How to reshape brush strokes

1. In the Tools toolbar, double-click on the Contour Editor  button and select the Centerline Editor  tool, or press Alt + W.
2. In the Drawing or Camera view, click the contour or pencil line you want to edit near the area you wish to change.

The Centerline Editor creates a center line manipulator based on the outline's shape, with control points.



3. Click on one of the points to select it.

The point's Bezier handles appears, as well as Bezier handles for the surrounding points.

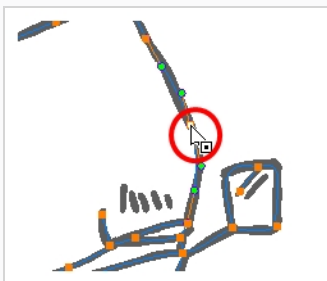

**TIP**

You can select several points by drawing a lasso around the points, or by holding Shift while clicking on points to add them to your selection. You can use the Contour Editor to scale and rotate a selection of multiple points by enabling the Show Centerline Editor Control  option in the Tool Properties view.

4. Do one of the following:

- To move a point or a selection of multiple points, click and drag it.

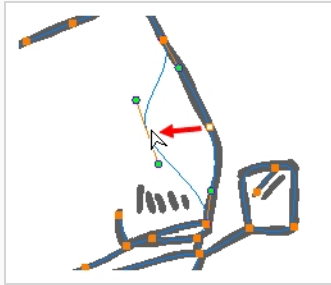

- To change the curve on both sides of a point, drag one of its Bezier handles.

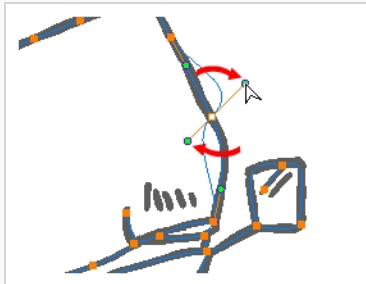

- To change the curve on only one side of a point, press and hold the Alt key, then drag one of its Bezier handles.



- To deform the contour, drag a part of the contour between two points.

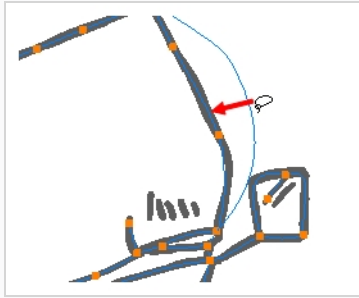

- To deform the curve between two points, hold the Shift key and drag the contour between two points.

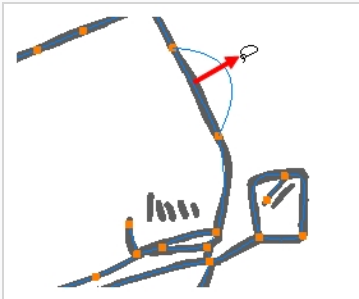

- To remove a point's Bezier handles and make the lines it is connected to straight, press and hold the Alt key and click on the point.

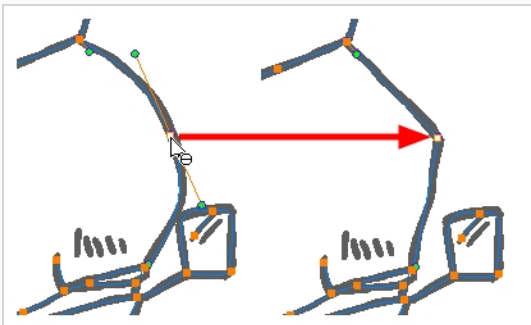

- Straight lines have no Bezier handles at their points by default. To create Bezier handles for these points and make their lines curved, press and hold the Alt key, then click and hold the point and drag the mouse cursor away from it. A new Bezier handle will follow your mouse cursor until you release the mouse button.

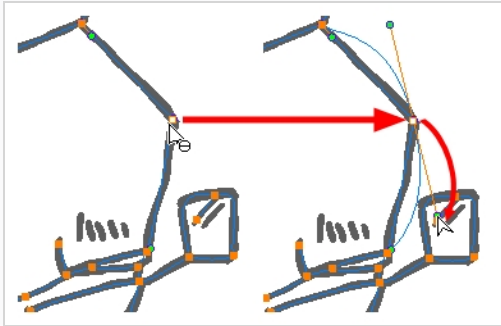

- To add a control point, press Ctrl (Windows/Linux) or ⌘ (macOS) and click on the contour where you want the new point to be created.

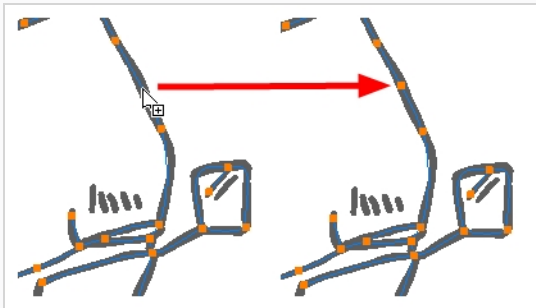

About the Smooth Editor Tool

T-ANIMPA-010-010

When drawing in a digital application, it is not like drawing on a sheet of paper. Sometimes the lines you draw may look as if they were drawn with an unsteady hand. When this occurs, you may need to correct the look of your lines.

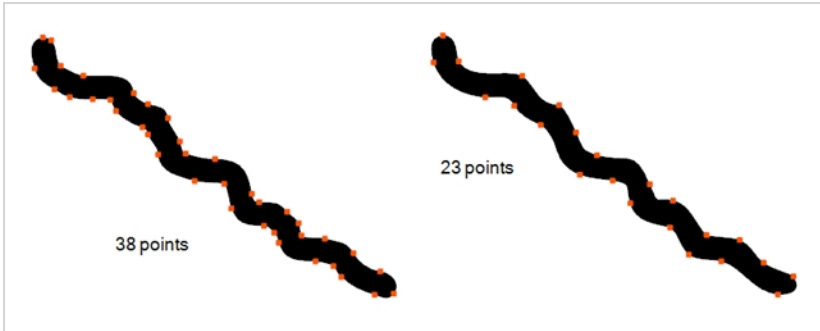

Harmony has a very powerful tool you can use to optimize contours and reduce the number of points on the lines, the Smooth Editor tool.

**NOTE**

To learn more about the Smooth Editor tool options, see the Reference guide .

Smoothing Artwork Using the Smooth Editor

T-ANIMPA-010-011

You can use the Smooth Editor to smooth out specific areas of your drawing strokes.

How to optimize lines with the Smooth Editor tool

1. In the Tools toolbar, select the Smooth Editor  tool or select **Drawing > Tools > Smooth Editor**.
2. In the Camera or Drawing view, place your pointer over the lines to smooth. You may need to pass over the same line several times to remove more points and make the line smoother. Note that by default, the Smooth Editor tool colour is yellow, it was changed to orange for screen grab clarity—see the Reference guide to learn about the various settings available.

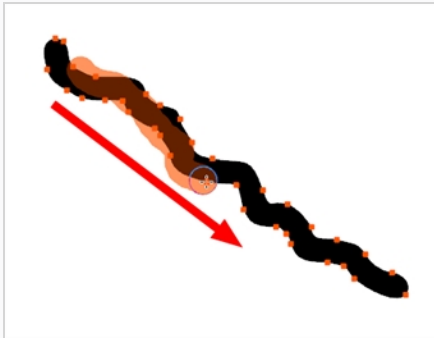

About the Perspective Tool

The Perspective tool lets you deform a drawing selection and alter its perspective. You can use the corner and edge anchor points to warp the shape.

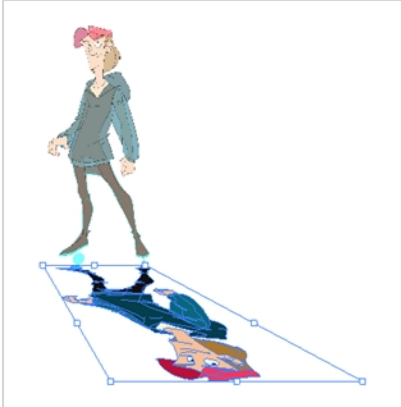

NOTE

To learn more about the Perspective tool options, see the Reference guide .

Deforming a Drawing with the Perspective Tool

Use the Perspective tool to distort a drawing's bounding box and simulate a perspective effect.



NOTE

To learn more about the Perspective tool options, see the Reference guide .

How to deform a drawing with the Perspective tool

1. In the Tools toolbar, select the Perspective  tool from the Contour Editor drop-down menu or press Alt + 0.
2. In the Camera or Drawing view, select a drawing to deform.
3. Click and drag the different anchor points to deform the shape.

About the Envelope Tool

The Envelope tool lets you deform and warp part of a drawing using a grid envelope and Bezier handles. You can warp images to make them look like they are reflected in water or in a deformable mirror.



NOTE

To learn more about the Envelope tool options, see the Reference guide .

Warping a Drawing with the Envelope Tool

You can warp your drawings using the Envelope tool.



NOTE

To learn more about the Envelope tool options, see the Reference guide .

How to warp a drawing with the Envelope tool

1. In the Tools toolbar, select the Envelope  tool from the Contour Editor drop-down menu.
2. In the Timeline view, select a drawing to deform.
3. In the Camera or Drawing view, select the region you want to deform

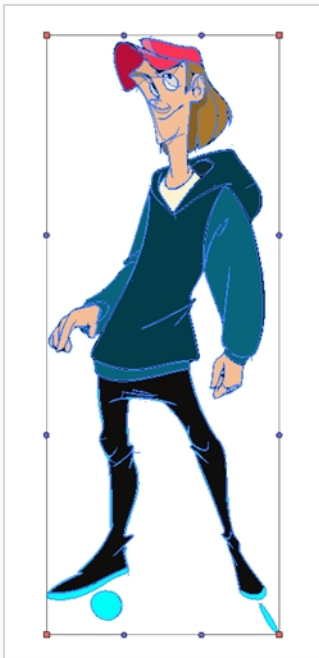

4. Click and drag the different anchor points and handles to deform the image.

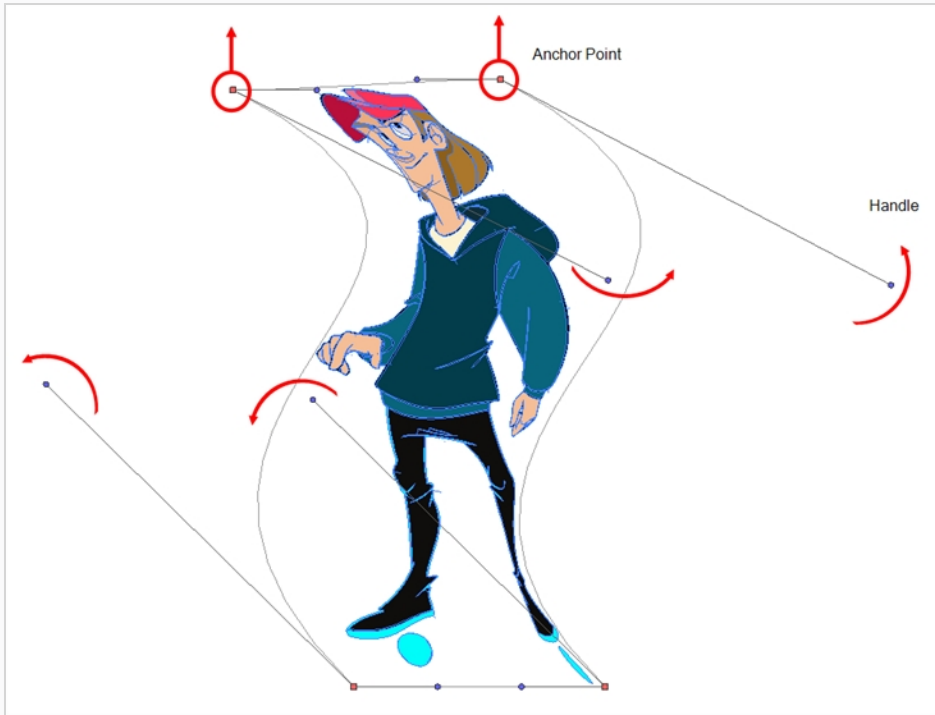

5. To display more controls, in the Tool Properties view, click the Show Advanced Controls  button.

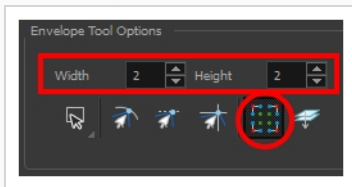

6. Increase the height and width of the grid to get more control points to deform your image.

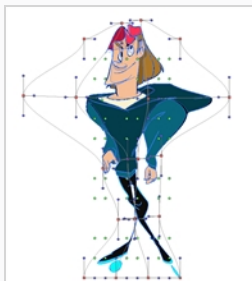

About the Text Tool

With the Text tool, you can add text in your project using various fonts and text attributes.



Text objects are drawing objects in the same way as brush strokes and drawing groups are, so they can be manipulated with the select tool. After you have written and formatted your text, you can break the string apart to convert the letters into drawing objects that can then be individually modified with tools such as Select, Perspective, Contour Editor, Smooth Editor.



NOTE

To learn more about the Text tool options, see the Reference guide .

Adding Text to Drawings

You can use the Text tool to add text to your drawings.



NOTE

To learn more about the Text tool options, see the Reference guide .

How to add text to drawings



1. Do one of the following:
 - In the Tools toolbar, select the Text  tool.
 - From the top menu, select **Drawing > Tools > Text**.
 - Press Alt + 9.
2. In the Timeline view, select the cell containing the drawing on which you want to add text.
3. In the Drawing or Camera view, click on the location you want the text to begin.



4. You can use the Tool Properties view to select the font, font size and format of the text you will type—see the Reference guide .
5. Type in the desired text.



6. Click outside the text box to exit the typing mode.

If you want to create another text object, click outside the currently active text box. You can always return to edit the text by selecting the Text  tool and clicking in the text.
7. You can resize the text box by selecting your text box with the Text  tool and moving the anchor point right or left. Using the Select tool will distort and scale your text itself rather than changing the width and height of your text box.

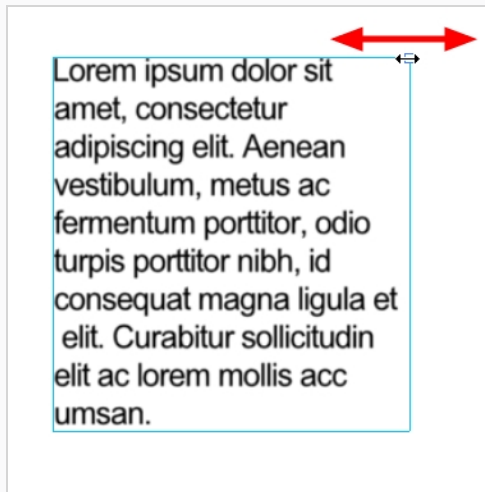

Breaking Text Into Letters or Vector Shapes

Text contained in a text field is treated as a single drawing object. You can easily separate the text so each character becomes an individual drawing object that you can select and modify independently.

How to break a text object

1. In the Tools toolbar, click the Select  tool or press Alt + S.
2. In the Drawing or Camera view, select the text object you want to break.

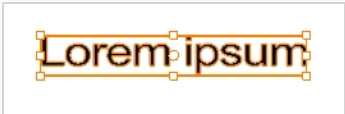

3. From the top menu, select **Drawing > Convert > Break Apart Text Layers**.
 - From the Drawing or Camera view menu, select **Drawing > Convert > Break Apart Text Layers**.

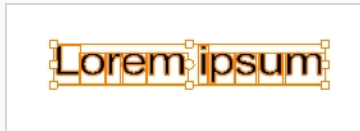

Each character is surrounded by a bounding box that you can modify; they remain text objects that you can edit.

4. If you want to convert your independent letter to a complete vector object that you can deform, use the Select tool to select the letters to convert.
5. From the top menu, select **Drawing > Convert > Break Apart Text Layers** to break the selection into a regular drawing object, with no more text attributes.
 - From the Drawing or Camera view menu, select **Drawing > Convert > Break Apart Text Layers** to break the selection into a regular drawing object, with no more text attributes.



About Drawing Space Management

When you are drawing in the Camera or Drawing view, you can zoom, pan and rotate the view to make it easier to determine where to place objects, determine the scale of objects, and when zooming out, get an overall view of the panel and its contents. You can also use the grid to help you determine the size and placement of objects as you draw.

If you like drawing in the Camera view, but don't want overlays to cover the drawing you're working on, you can enable the Current Drawing on Top option.

About the Zoom Tool





The Zoom tool in the Tools toolbar lets you zoom in and zoom out of the Camera or Drawing view.



NOTE

To learn more about the Zoom tool options, see the Reference guide .

How to use the Zoom tool

1. In the Tools toolbar, select the Zoom  tool available in the Hand tool drop-down menu.
2. Click in the Camera or Drawing view.
3. In the Tools Properties view, do the following:
 - Enable the Zoom In  mode to zoom in mode when you click in the Camera or Drawing view. When you're in Zoom In mode, hold as you click to zoom out.
 - Enable the Zoom Out  mode to zoom out when you click in the Camera or Drawing view.
 - Click on the Zoom In  button to immediately zoom in. You can also press 2.
 - Click on the Zoom Out  button to immediately zoom out. You can also press 1.

About the Hand Tool

You can use the Hand tool to pan through the Drawing or Camera view. When you are zoomed in your workspace, you may need to pan to a different area of your image. You can do so with the Hand tool or the Spacebar keyboard shortcut.

The Hand tool has no options in the Tool Properties view.

How to use the Hand tool

1. Do one of the following:
 - In the Tools toolbar, select the Hand  tool, click in the Drawing or Camera view and drag.
 - You can also Hold down the Spacebar, click in the Drawing or Camera view and move your mouse in the direction you want to pan the view.

About the Rotate View Tool

T-LAY-001-005

The Rotate View tool lets you rotate the Drawing or Camera view, the same way as you would do with a real animation disc for increased flexibility. This tool can also be used in the Perspective view.



The rotation angles for the Camera and Drawing views are independent; if you rotate the Drawing view 25 degrees, if you switch to the Camera view, you can use the rotary table in that view and rotate it to a different angle without affecting the settings in the other view.

When using the Rotate View tool, you are only rotating your workspace. You can not changing the actual rotation angle of your drawings. Exporting your project will completely ignore the Rotate View angle.

The Rotate View tool has no options in the Tool Properties view.

Rotating the Workspace

T-LAY-001-006

You can use the Rotate View tool to rotate your drawing workspace.

How to use the Rotate View tool

1. Do one of the following:
 - From the top menu, select **Drawing > Tools > Rotate View**.
 - In the Tools toolbar, select the Rotate View tool in the Hand tool menu.
 - In the Drawing or Camera view, right-click and select **Drawing Tools > Rotate View**.
 - Hold down Ctrl + Alt (Windows/Linux) or ⌘ + Alt (macOS).

The rotary table appears.

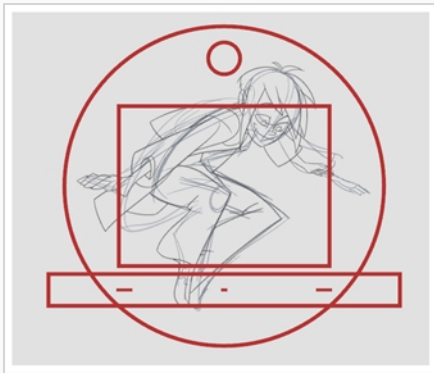

2. In the Drawing or Camera view, click and drag to rotate the space.



3. Release the keyboard shortcut or switch to a new drawing tool.
4. Reset the view rotation using **View > Reset Rotation** or press Shift + X to reset the rotation.

Displaying the Current Drawing on Top

T-ANIMPA-010-020

In the Camera view, when you draw on a layer, the artwork is displayed in the correct order. For example, if the layer on which you are drawing is located behind an object on another layer, the lines you draw will be hidden behind that object.

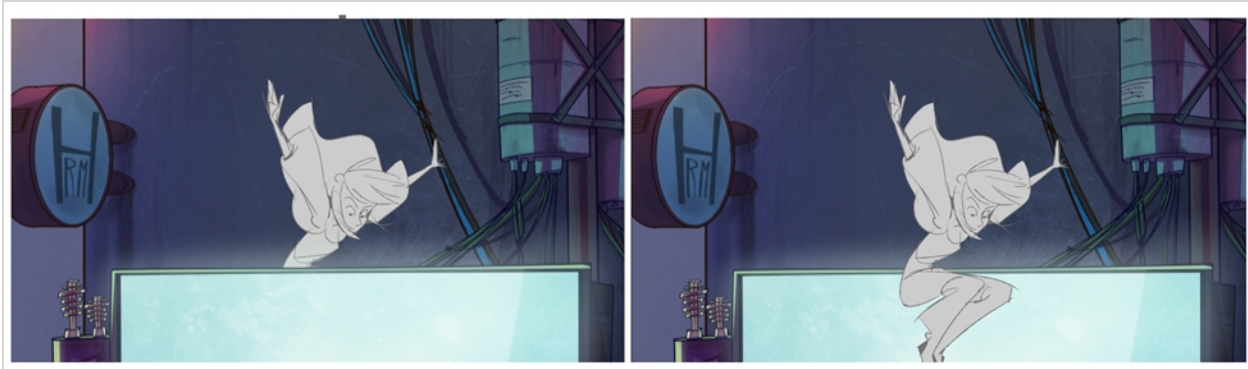

You can display a selected drawing on top of everything while you draw. Then, each time you select a drawing tool, the drawing is displayed in front of everything in the Camera view. The Timeline view ordering remain unchanged.

How to display the drawing on top

1. Do one of the following:
 - From the top menu, select **View > Show > Current Drawing on Top**.
 - In the Camera bottom toolbar, click the Current Drawing on Top  button.



NOTE

The Current Drawing on Top status is retained when you exit Harmony. When you restart the application, the last status will be used.

2. In the Tools toolbar, select a drawing tool. You only need to enable this option once, it is not necessary to do it each time you select a drawing tool.
3. In the Camera view, start drawing.

About the Grid

Harmony is equipped with a traditional animation grid. You can use it as a reference while drawing to fit a given layout field chart, align elements, or simply see the center of your drawing. You can draw beyond the grid boundaries as it is only a visual reference.

In the Camera view, the Grid is visible when you select a drawing tool.

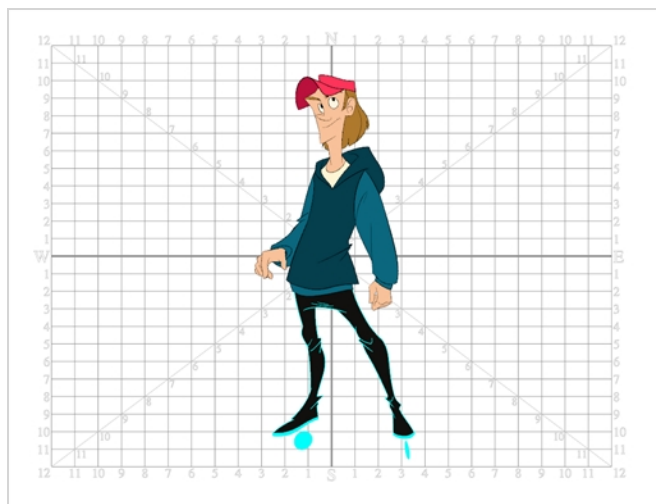



Displaying the Grid

You can display the grid and it will be visible in the Drawing view. It will be visible in the Camera view when you select a drawing tool.

Use the Show Grid option to display a grid in the Drawing or Camera views.







How to display the grid

1. Do one of the following:
 - In the Drawing View toolbar, press the Show Grid  button.
 - In the Camera View toolbar, press the Show Grid  button.
 - Select **View > Grid > Show Grid**.
 - Press Ctrl + ' (Windows/Linux) or ⌘ + ' (macOS).

Modifying the Grid

You can modify the look of the grid to be either square, 12-field, 16-field, outline, and so on.

How to modify the grid display

1. Select **View > Grid > Show Grid** to display the grid.
2. To modify the grid, select one of the following:
 - **View > Grid > Grid Outline Only**—Displays the outline of the grid only.
 - **View > Grid > Square**—Displays a standard square grid.
 - **View > Grid > 12 Field Grid**—Displays a 12-field size grid.
 - **View > Grid > 16 Field Grid**—Displays a 16-field size grid.
 - **View > Grid > Underlay**—Displays the grid under the drawing elements.
 - **View > Grid > Overlay**—Displays the grid over the drawing elements.
3. In the Drawing View and Camera View toolbars, you can also add the following buttons—see [Customizing View Toolbars on page 54](#).
 - Grid Outline Only  button
 - Square  button
 - 12 Field Grid  button
 - 16 Field Grid  button
 - Underlay  button
 - Overlay  button

About OpenGL Antialiasing

T-ANIMPA-010-016

Everything you draw in Harmony is vector-based, unless you purposely elected to draw as bitmap. When you draw in the Drawing or Camera view, notice that your lines may appear jagged. This is caused by the fast real-time display called OpenGL. If you prefer to see smooth lines as you draw, you can enable the antialiasing preference.



Full scene antialiasing is generated by your computer's graphics card. This antialiasing will not only antialias your drawings, but all your different views in the interface. Full scene antialiasing is an option you can turn on or off; by default, it is disabled.

There is no need to modify your graphic card settings.



NOTE

Full Scene Antialiasing parameters are only valid while you work in your scene. The scene will be rendered to 100% of its resolution regardless of your preference settings or graphic card panel.

Setting the Full Scene Antialiasing Preference

T-ANIMPA-010-017

You can enable the Full Scene Antialiasing preference to smooth out the OpenGL artwork.



NOTE

You must restart Harmony after you change the parameters.

How to customize the full scene antialiasing parameters

1. Do one of the following:
 - Select **Edit > Preferences** (Windows/Linux) or **Harmony Essentials > Preferences** (macOS).
 - Press **Ctrl + U** (Windows/Linux) or **⌘ + U** (macOS).

The Preferences dialog box opens.

2. In the OpenGL tab, select the **Enable** option in the Full Scene Antialiasing section.

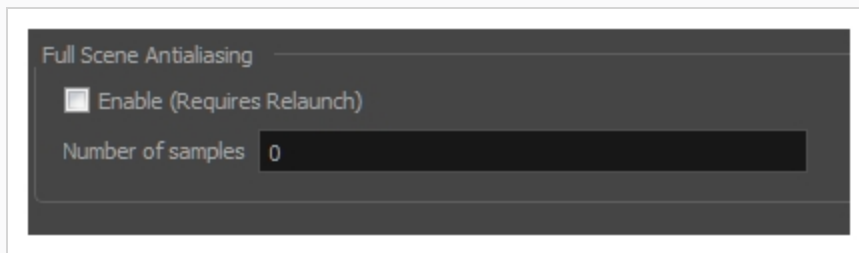

3. **Number or samples:** Enter the number of samples you want to be used for the antialiasing process. The number of samples is basically equivalent to the amount of times a pixel will be enlarged to calculate the antialiasing. This technique is called *supersampling*. The higher the number of samples, the better the antialiasing quality will be, but the longer it will take to calculate.
4. Restart Harmony.

About Drawing Guides

T-LAY-001A-001

Drawing guides can assist you in drawing background and objects that require straight lines, square angles and, more importantly, perspective. In traditional art, this is usually done using rulers, set squares, and vanishing points to draw lines from. Guides are meant to reproduce the usage of such tools in combination with Harmony's drawing tools.

When a guide is in use, it adds a horizon line and vanishing points to your drawing space, which can be moved to fit your scene's needs, and it locks your drawing tools so that they draw straight lines, either going from one of your vanishing points, or parallel to your guide's horizontal or vertical axis. This makes the process of drawing structures with volume and perspective streamlined. Also, guides display dotted lines going through your mouse cursor going from your vanishing points or parallel to your guide's horizontal and vertical axes to help you visualize the axes your drawing strokes will follow.

Harmony supports the following types of drawing guides:

- The **Square Grid** guide simply helps you draw on the horizontal and vertical axes, which are relative to the horizon line.

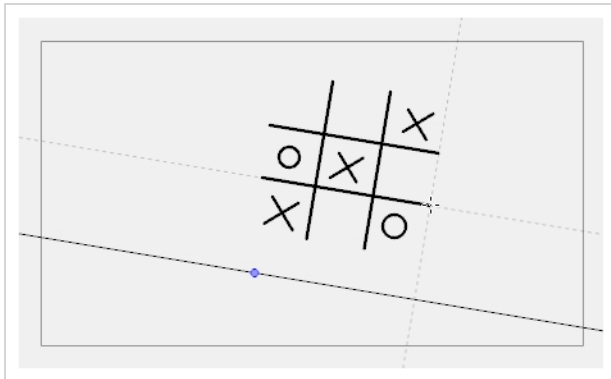

- The **1-Point Perspective** guide helps you draw lines coming from a single vanishing point, which is in the middle of the horizon by default. It also helps you draw along the horizontal and vertical axes. This can help create realistic-looking backgrounds with buildings, walls and objects that are facing your camera.

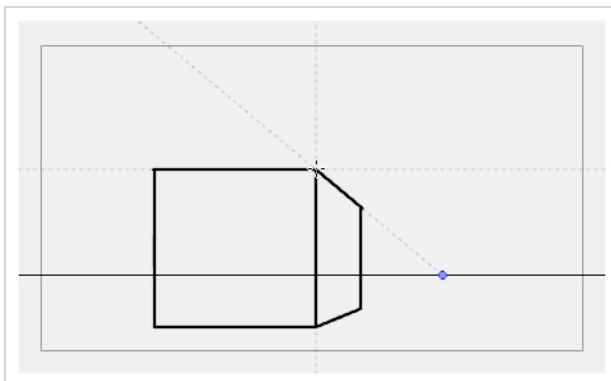

- The **2-Point Perspective** guide helps you draw lines going from one of two vanishing points, which are positioned left and right of your drawing space. This can help create realistic-looking backgrounds with buildings, walls and objects that are at an angle from your camera.

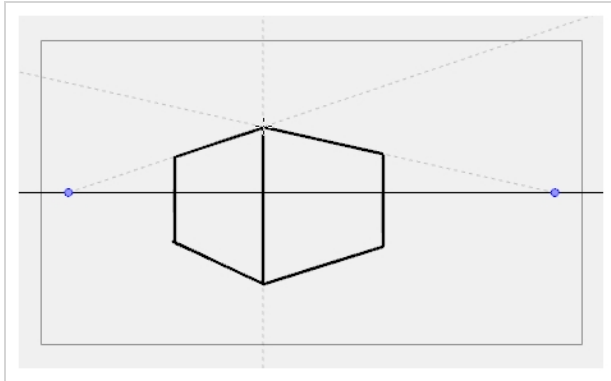

- The **3-Point Perspective** guide helps you draw lines going from one of 3 vanishing points: Two horizontal vanishing points positioned left and right of your drawing space, and one vertical vanishing point positioned below or above your drawing space. This can help you draw realistic looking backgrounds from a low or high angle. The 3-Point Perspective guide has two presets: Bird's Eye View preset and the Worm's-Eye View, which can be used for high angle and low angle perspectives, respectively.

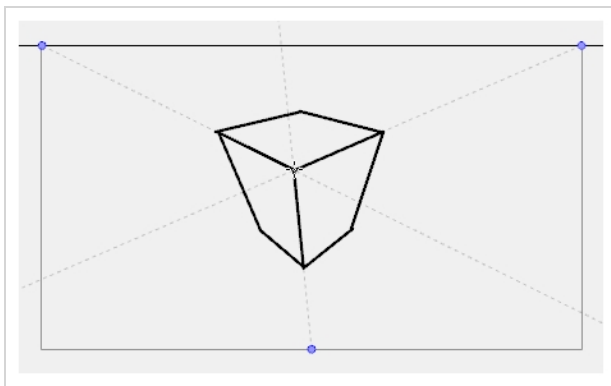

Guides are made to work with the following tools. They are only visible in your drawing space when one of these tools is selected:

- Brush
- Pencil
- Stroke
- Line

Before you can use a guide, you must use the Guide view to add the guide you wish to use to your scene's guides list. A new guide will have its horizon line and vanishing points in preset positions, which can be adjusted to fit your scene's needs. Using the Guides view, you can add, select, rename, delete, cut, copy, paste and reorder guides as needed. Your guides list can also be exported to a file and re-imported into a different scene. When a guide is selected, you can use it, but you can also adjust its horizon line and vanishing points.



NOTE





Your guide list and its guides are part of your scene's data. They are saved with your scene. Changes done to your guides list or to a guide can be undone with the Undo command.

Adding Drawing Guides

T-LAY-001A-002

The first step in using drawing guides is to create a guide in the Guides view.

How to Add a Drawing Guide to your Scene

1. From the top menu, select **Windows > Guides** to add the Guides view to the current workspace.
2. In the Guides view, select the **+** New Guide button and choose one of the following types of guides:
 -  Square Grid
 -  1-Point Perspective
 -  2-Point Perspective
 -  3-Point Perspective (Bird's-eye View)
 -  3-Point Perspective (Worm's-eye View)

The new guide appears in the Guides view list.

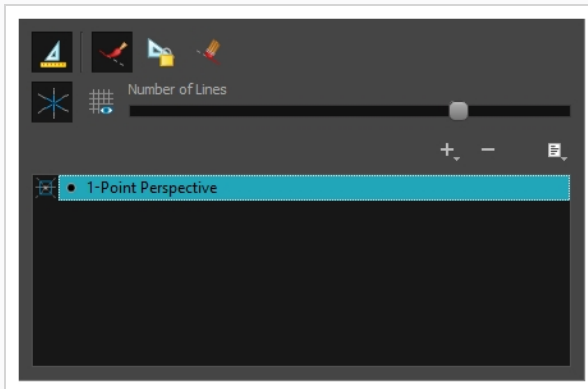

3. To add another guide, repeat the previous step.

Renaming Drawing Guides

Since guides can be customized, you may want to give them specific name to help you identify them

How to rename a guide using the Guide Menu

1. In the Guides view, select a guide from the list.
2. In the Guide Menu, select **Rename Guide**.
The Rename Guide dialog box opens.
3. In the Rename Guide dialog box, enter the new guide name.
4. Press **OK**.

How to rename a guide using the Guide List

1. In the Guides view, double-click on a guide displayed in the list.
The guide's name becomes editable.
2. In the editable name field, enter a new name for the guide.
3. Press Enter/Return.



NOTE

It is not required to give a unique name to each guide in a guides list.

Deleting Drawing Guides

T-LAY-001A-003

You can delete a drawing guide from your list.

How to delete a Drawing Guide

1. In the Guides view, select one or multiple guides from the list.
2. In the Guides view, select the Delete Guide  button or press Del (Windows/Linux) or Backspace (macOS).

The selected guides are deleted from the list.

Selecting the Active Drawing Guide

A Harmony scene can have as many guides as needed, but you can only use one guide at a time. You can decide which guide you're using by selecting it from the guides list. The selected guide will display in your drawing space.

Although you can select the active guide at any time, a guide will only behave as active if one of the following drawing tools is selected:

- Brush
- Pencil
- Stroke
- Line

Once a guide is active, it will display its horizon line and vanishing points in your drawing space. There will also be two or three dotted lines following your mouse cursor in the drawing area: One line for each horizontal or vertical axis in your guide, and one line going from each vanishing point in your guide through your mouse cursor.

How to select the active guide from the guides list

1. In the Guide view, click on the desired guide in the guides list

The selected guide will become active.

**NOTE**

If Guides are disabled, clicking on a guide in the guides list will enable them.

How to quickly switch between guides

1. Set the focus on your Camera or Drawing view, for example, by clicking on the view's tab.
2. Press the Up Arrow or Down Arrow key to select the previous or next guide in the list.

**NOTE**

Using the Up Arrow or Down Arrow to select a guide will only work if guides are already enabled.

Cutting Drawing Guides

You can cut a drawing guide from your guides list. This will remove the guide from the list allow you to paste it into another scene.

How to cut a Drawing Guide

1. In the Guides view, select one or multiple guides from the list.
2. In the Guides view menu, select **Cut** or press Ctrl + X (Windows/Linux) or ⌘ + X (macOS).
The selected guides are deleted from the list and stored in the clipboard.
3. In the top menu, select **File > Open** and open a different Harmony scene.
4. In the Guides view, click on the guides list to set the focus on it. If the guides list already contains guide, select a guide that will act as an insertion point.
5. In the Guides View menu, select **Paste** or press Ctrl + V (Windows/Linux) or ⌘ + V (macOS).

Drawing Guides that were copied from the previous guides list are pasted in the current guides list, under the selected guide, if any.



NOTE

If you want to use the Cut, Copy and Paste keyboard shortcuts on guides, make sure the focus is on the Guides view.

Copying Drawing Guides

T-LAY-001A-004

You can copy drawing guides and paste them into other scenes.

How to copy a Drawing Guide

1. In the Guides view, select one or multiple guides from the list.
2. In the Guides View menu, select **Copy** or press Ctrl + C (Windows/Linux) or ⌘ + C (macOS).
3. In the top menu, select **File > Open** and open a different Harmony scene.
4. In the Guides view, click on the guides list to set the focus on it. If the guides list already contains guide, select a guide that will act as an insertion point.
5. In the Guides View menu, select **Paste** or press Ctrl + V (Windows/Linux) or ⌘ + V (macOS).

Drawing Guides that were copied from the previous guides list are pasted in the current guides list, under the selected guide, if any.



NOTE

If you want to use the Cut, Copy and Paste keyboard shortcuts on guides, make sure the focus is on the Guides view.

Reordering Drawing Guide Lists

The drawing guides in your guides list can be reordered.

How to reorder a Drawing Guide list

1. In the Guides view, select one or multiple guides from the list.
2. Drag and drop the selected guides to their desired position in the list.





Editing Drawing Guides

T-LAY-001A-005

When a new guide is created, it comes with a preset horizon line and, if applicable, preset vanishing points. The position and angle of the horizon line as well as the position of any vanishing point in the selected guide can be adjusted visually from within your drawing space.

Guides can only be edited with the Brush, Pencil, Stroke or Line tool. The selected guide will only be visible when one of these tools is selected.

How to edit a drawing guide

1. In the Timeline or Xsheet view, select a drawing, or select an empty cell and create a new drawing by doing one of the following:
 - Right-click on the cell and select **Drawing > Create Empty Drawing**.
 - Press Alt + Shift + R
2. In the Tools toolbar, select the Brush , Pencil , Stroke  or Line  tool.
3. In the Guides view, select a guide to make it the active guide.

Once a guide is active, its horizon line and vanishing point(s) appear in the drawing area.

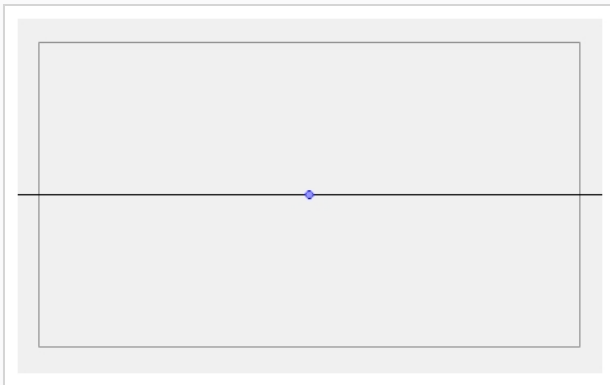

4. In the Guides view, make sure the Lock Guide  option is disabled. This ensures you're able to edit the active guide.
5. In the drawing area, zoom out until all vanishing points are visible (if necessary).
6. In the drawing area, grab either the horizon or a vanishing point and move it to its desired location.

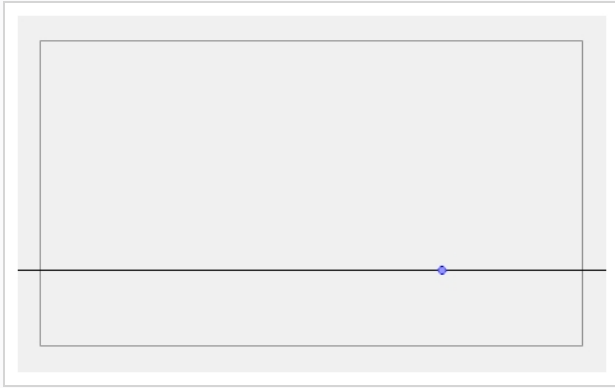

When using the square grid or 1-point perspective guides, the angle of the horizon can be modified by manipulating the horizon line itself.

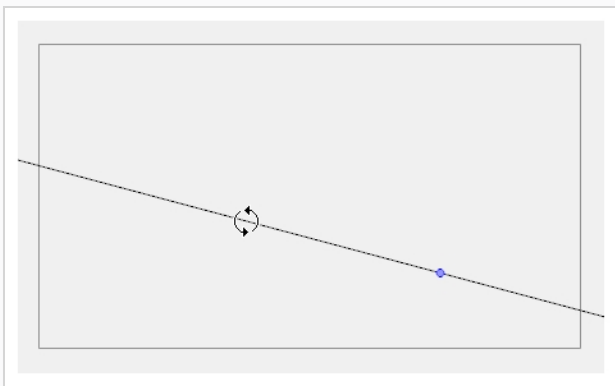

When using the 2-point or 3-point perspective guides, the angle of the horizon can be modified by manipulating one of the two vanishing points on the horizon.

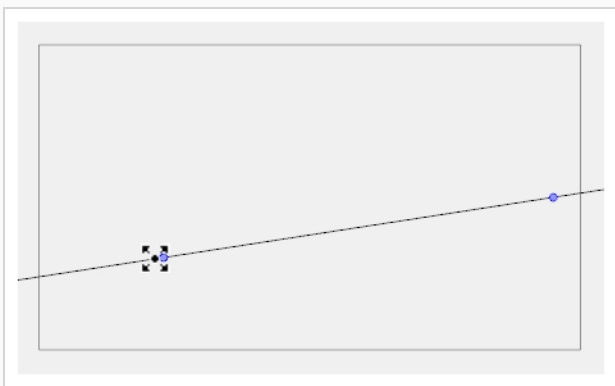

When adjusting the horizon line, you can hold down Shift to snap the horizon line at every 15 degrees. This makes it easy to maintain a perfectly horizontal horizon.

**NOTE**

Each modification to a guide can be undone with the Undo command.





Drawing with Drawing Guides

T-LAY-001A-006

Once a guide is active and properly set up, you can use it to assist you in creating a drawing with perspective. The guide will display its axes going through your mouse cursor as you move it inside your drawing space. When you start drawing a stroke, your drawing tool will become locked to the axis that most closely matches the angle of your stroke, forcing you to draw a straight line along that axis, as if you were using a ruler or a set square.

Guides can only be used with the Brush, Pencil, Stroke or Line tool. The selected guide will only be visible when one of these tools is selected.

How to draw using guides

1. In the Timeline or Xsheet view, select a drawing, or select an empty cell and create a new drawing by doing one of the following:
 - Right-click on the cell and select **Drawing > Create Empty Drawing**.
 - Press Alt + Shift + R
2. In the Tools toolbar, select the Brush , Pencil , Stroke  or Line  tool.
3. In the Guides view, select the guide you wish to use.

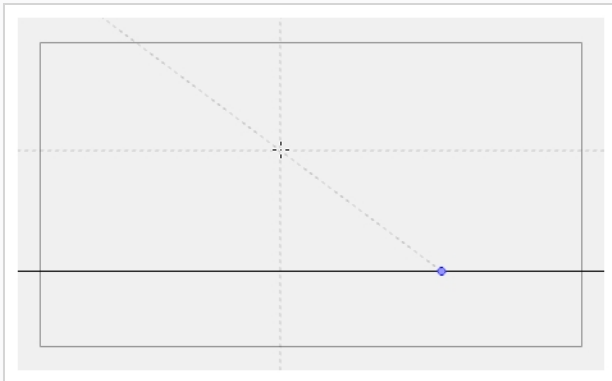

4. In the drawing area, draw a stroke with the current drawing tool. From the initial gesture, the tool locks on one of the guide's axes, forcing it to draw a straight line that follows the axis.

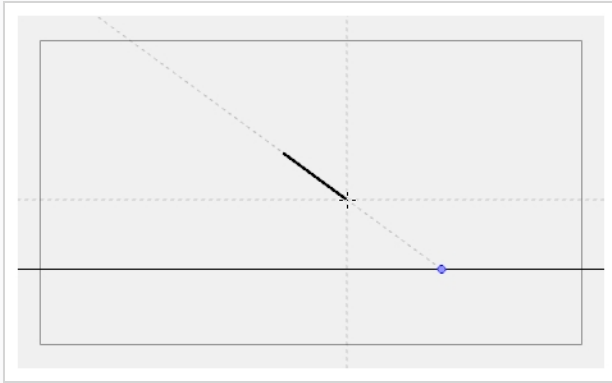
**NOTE**

Some guides do not lock onto a horizontal or vertical axis line by design. At any time, when drawing with the Brush or Pencil tool, you can hold down Shift + Alt before starting the stroke; this will force the tool to draw a straight line that locks at every 15 degrees. You can also achieve the same effect with the Line tool by holding down Shift before drawing a stroke.

Locking Drawing Strokes to a Specific Axis

T-LAY-001A-010

When using a drawing guide, your drawing tool will lock onto one of its axes based on the initial direction of your drawing stroke. In some situations, it may be hard for the tool to lock onto the expected guide axis. To remedy this, it is possible to manually select which axis you want to lock your drawing strokes to.

How to lock your drawing tool to a specific axis

1. Set the focus to the Camera or Drawing view, for example, by clicking on the view's tab.
2. Press the Left Arrow or Right Arrow key repeatedly to cycle through your guide's axes. The selected axis will be displayed in bold across your mouse cursor.

All your drawing strokes will lock onto the selected axis.

How to re-enable using all axes

1. Press the Left Arrow or Right Arrow key repeatedly to cycle through your guide's axes, until none of them are displayed in bold across your mouse cursor.

Drawing Freehand Perspective with Drawing Guides

By default, all strokes drawn with an active drawing guide are straight lines that follow one of the guide's axes. To achieve a different style, you might want to draw with freehand perspective instead, where you use the guides as references, but without forcing your strokes to be straight and aligned with their axes. This can be done by disabling the Align with Guide option, which is enabled by default.

When the Align with Guide option is disabled:

- The Brush, Pencil, Line and Eraser tools will no longer lock to your guide's axes, allowing you to draw strokes in any direction.
- The guide will still be visible, but will only serve as a visual aid.
- The initial angle of your stroke will still determine which axis you're using, but instead of locking your stroke on the axis, it will simply make the reference line for that axis bolder, to help you draw along it.

How to draw freehand perspective

1. In the Guides view, activate the Align with Guide  button.

You can now draw freely and use the guide as a visual aid.

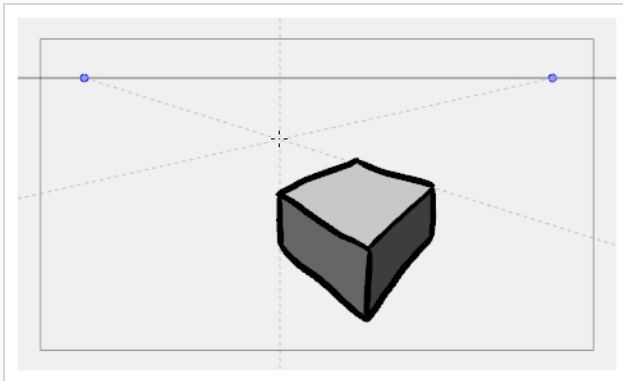







2. Start drawing.

Erasing Using Drawing Guides

By default, drawing guides have no effect when using the Eraser tool. However, if needed, you can make the Eraser tool use your selected guide.

How to erase using a Drawing Guide

1. In the Guides view, activate the Enable Guide with Eraser  button.

The Eraser  tool will now work with the currently selected guide, just like the Brush , Pencil , Stroke  and Line  tools.

2. Start erasing.



NOTE

With the Enable Guide with Eraser option, you can also edit your guide's horizon line and vanishing points using the Eraser tool.

Viewing Drawing Guide Reference Lines

T-LAY-001A-007

By default, a guide will only display its horizon line, its vanishing point, and its axes relative to your mouse cursor's position. To help you lay out the objects in your drawing, you can also enable reference lines. Reference lines are multiple semi-transparent lines that are drawn in parallel to your axes and from your vanishing points, at an equal distance or angle from each other, to cover your entire drawing space with visual guides.

When using reference lines, you can decide the amount of lines that display in your drawing space. If you have too many reference lines, they will be very close to each other and your drawing space might feel cluttered, but if you have too few, you might not always have a reference line close enough to the stroke you wish to draw to help serve as a reference.

How to view Drawing Guide Reference Lines

1. In the Guides view, activate the Show Reference Lines  button.

The reference lines appear as a semi-transparent overlay.

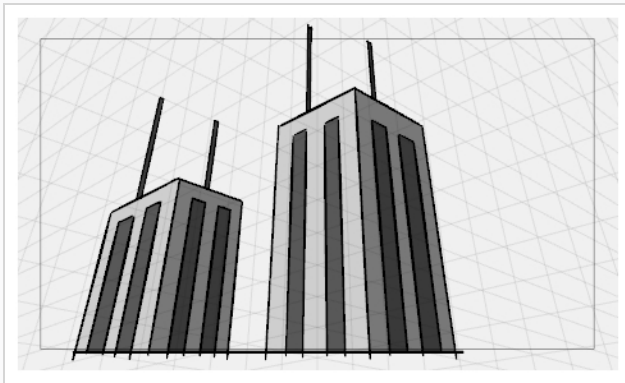

2. In the Guides view, use the Number of Lines slider to adjust the line density.

Minimizing Guide Cursor Axes Display

By default, the guide axes that are drawn across your mouse cursor extend throughout your entire drawing space. You may want those axes to only extend to a short distance around your cursor, so that they can still serve as guides without obstructing your drawing space or drawing your eye away from your mouse cursor. You can do this by disabling the Full Cursor Display option, which is enabled by default.

When the Full Cursor Display option is disabled:

- The guide axes displaying across your mouse cursor only span on a short distance from your mouse cursor.
- When drawing a stroke, all guide axes disappear until you finish drawing the stroke. By default, only the axis you are drawing on disappears.
- The actual axes used to lock your drawing tool still extend across the entire drawing space. Only the axes displayed in your drawing space are shortened.

How to minimize the Drawing Guide's cursor axes display

1. In the Guides view, toggle the Full Cursor Display  button off.

The guide axes now only span over a short distance from your mouse cursor.

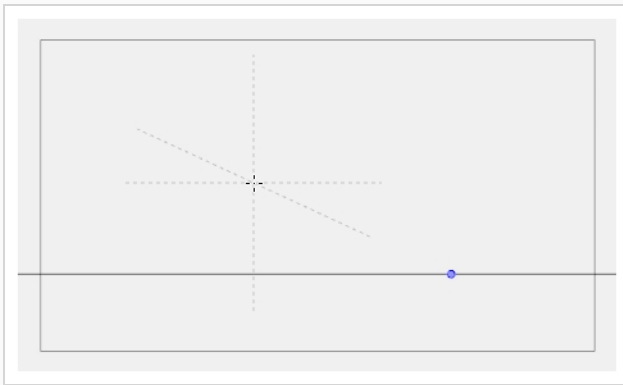

Preventing the Editing of Drawing Guides

T-LAY-001A-008

When using a drawing tool with a guide, you are also able to edit the guide's horizon line and vanishing points. This may be a problem if you need to draw close to the horizon line or to your vanishing points, as you may accidentally displace them instead. Once you're sure that your guide is properly set up, it is recommended to lock your guides before you start drawing, so you don't have to worry about editing them by accident.

How to prevent editing of Drawing Guides while drawing

1. In the Guides view, activate the Lock Guide  button.

**NOTE**

The Lock Guide option locks the editing of all guides, not just the selected one. When creating a new guide, the Lock Guide option is automatically disabled to allow the new guide to be edited immediately.

Enabling and Disabling Drawing Guides

T-LAY-001A-009

When you want to stop working with guides, you must disable them. When drawing guides are disabled:

- The Brush, Pencil, Line and Eraser tools have their normal, non-constrained behavior.
- The horizon, vanishing points, guide axes and reference lines are not displayed.

How to enable and disable a Drawing Guide

1. To enable or disable Drawing Guides, do one of the following:

- In the Guides view, enable or disable the Enable Guide  button.
- Press Shift + G.

**NOTE**

The guide that was selected when you disable guides will be restored when you enable them again.

**NOTE**

Drawing guides only work with the Brush, Pencil, Stroke and Line tools. They will behave as if they were disabled when any other tool is selected.

Importing and Exporting Drawing Guide Lists

How to export Drawing Guides to a file

1. In the Guides view, select one or multiple guides from the list.
2. In the Guides View menu, select **Export Selected Guides**.
3. In the Export Guides dialog box that displays, choose a destination filename and folder and click **Save**.

The selected guides are written into the destination file. A message displays to confirm the amount of guides that were exported.

How to import Drawing Guides from a file

1. In the Timeline or Thumbnail view, select the destination panel.
2. In the Guides View menu, select **Import Guides**.
3. In the Import Guides dialog box that displays, choose a file from a previous export and click **Open**.

The Drawing Guides from the imported file are inserted at the bottom of the Drawing Guide list. A message displays to confirm the amount of guides that were added.



NOTE

When importing a list of guides, duplicate guides are filtered out to avoid cluttering the list. The import confirmation will indicate if duplicates were detected and filtered out.

About Drawing Optimization

As you work, your drawing can get complex and contain multiple strokes. You may want to optimize those drawings to reduce the number of brush strokes, pencil lines, and invisible strokes. You may also want to flatten your artwork or optimize your brush stroke textures.

The Optimize command reduces the number of layers, such as overlapping brush strokes, in the selected drawing objects. Drawing objects will only be flattened and optimized if the selected objects do not change the appearance of the final image when they are merged.

For example, if you have selected a number of partially transparent objects, which you layered to create an additive colour effect, the selected transparent drawing objects will not be merged. This is because merging the transparent drawing objects will cause them to lose the effect of the layered transparent colours.

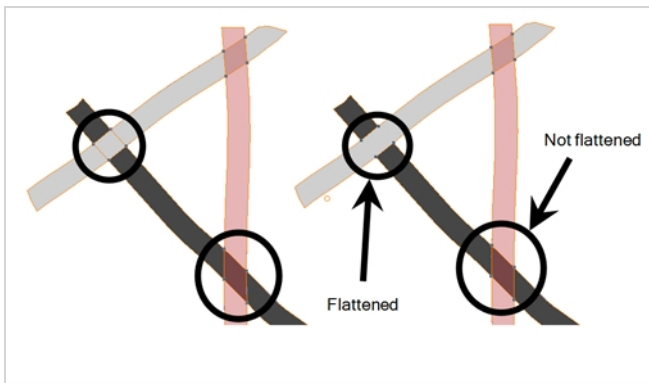

You could also want to add invisible contour strokes so that if you unpaint lines, the vector container remains to be repainted later.

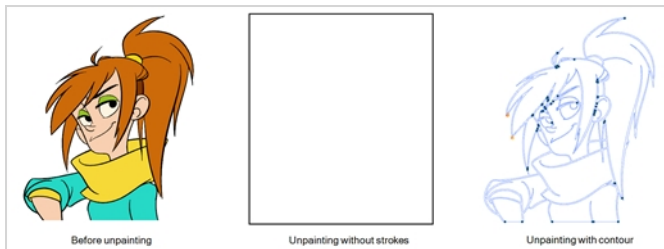

Flattening Drawings

T-ANIMPA-002-006

The Flatten operation is used to merge drawing objects and brush strokes into a single layer. If you draw new lines to fix a drawing or line with many brush strokes, it can be useful to flatten them all into a single shape. By default, lines are drawn one on top of each other. If you intend to repaint the lines or modify their shape, it will be easier if they are flattened.

How to flatten drawings

1. In the Tools toolbar, select the Select tool.
2. In the Camera or Drawing view, select the drawing strokes you want to flatten.
3. Select **Drawing > Optimize > Flatten** or press Alt + Shift + F. You can also press the Flatten  button in the Tool Properties view.

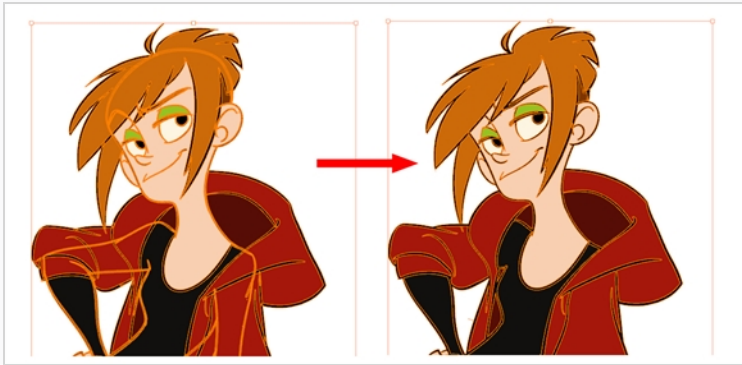

Smoothing Drawings

The Smooth operation is used to reduce the number of contour points on a brush stroke and center points on a pencil line. It also smooths out the shape.

How to smooth drawings

1. In the Tools toolbar, select the Select tool.
2. In the Camera or Drawing view, select the drawing strokes you want to smooth out.
3. Select **Drawing > Optimize > Smooth** or press Alt + Shift + S. You can also press the Smooth  button in the Tool Properties view.

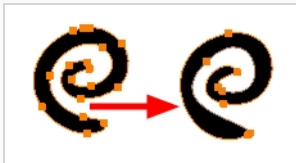

Optimizing Drawings

You can use the Optimize feature to flatten your drawing strokes without changing the aspect of your drawings. This mainly means that transparencies will not be flattened.

How to optimize a drawing

1. In the Tools toolbar, select the Select tool.
2. In the Camera or Drawing view, select the drawing strokes you want to optimize.
3. Do one of the following:
 - From the top menu, select **Drawing > Optimize > Optimize**.
 - From the Camera or Drawing view menu, select **Drawing > Optimize > Optimize**.

Reducing the Drawing Texture Resolution

How to reduce the drawing texture resolution

1. In the Tools toolbar, select the Select tool.
2. In the Camera or Drawing view, use the Select tool to select the drawing objects whose texture resolution you want to reduce.
3. From the top menu, select **Drawing > Optimize > Reduce Drawing Texture Resolution**.
 - From the Camera or Drawing view menu, select **Drawing > Optimize > Reduce Drawing Texture Resolution**.

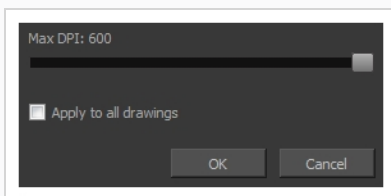

4. In the dialog box, drag the slider toward the left to reduce the texture resolution.
5. Enable the **Apply to All Drawings** option if you want the modification to be applied to all the drawings in your layer.
6. Click **OK**.

About Strokes Conversion

You may have drawing stroke using the Pencil tool when you wanted to use the Brush tool. You may also have drawing your image using the Polyline tool and now you want to convert your strokes to brush strokes. For many reasons, you may want to switch your stroke types to another type to use the various advantage set they offer.

There are three types of strokes:

- Brush strokes (contour vector)
- Pencil strokes (central vector)
- Invisible strokes (central vector with a thickness value of 0)



Harmony lets you convert pencil lines to brush strokes, brush strokes to pencil lines, and invisible strokes (strokes) to pencil lines.

You can also break text objects apart—see [Breaking Text Into Letters or Vector Shapes on page 174](#).

Converting Brush Strokes to Pencil Lines

The Brushes Strokes to Pencil Lines operation converts selected contour strokes into centreline pencil strokes. The brush stroke thickness will be lost.



How to convert brush strokes to pencil lines

1. In the Tools toolbar, select the Select tool.
2. In the Camera or Drawing view, select the strokes you want to convert.
3. Do one of the following:
 - From the top menu, select **Drawing > Convert > Brush Strokes to Pencil Lines** or press **^**.
 - Right-click on the selection, select **Convert > Brush Strokes to Pencil Lines** or press **^**

Converting Pencil Lines to Brush Strokes

The Pencil Lines to Brush Strokes operation converts the selected centreline pencil strokes into contour strokes brush lines.



How to convert pencil lines to brush strokes

1. In the Tools toolbar, select the Select tool.
2. In the Camera or Drawing view, select the strokes you want to convert.
3. Do one of the following:
 - From the top menu, select **Drawing > Convert > Pencil Lines to Brush Strokes** or press &.
 - Right-click on the selection, select **Convert > Pencil Lines to Brush Strokes** or press &.
 - In the Tool Properties view, press the Pencil Lines to Brush Strokes  button.

Converting Strokes to Pencil Lines

The Strokes to Pencil Lines operation converts the selected invisible line to a pencil line.



How to convert strokes to pencil lines

1. In the Tools toolbar, select the Select tool.
2. In the Camera or Drawing view, select the strokes you want to convert.
3. Do one of the following:
 - Select **Drawing > Convert > Strokes to Pencil Lines** or press Shift + F12 (Windows/Linux only).
 - Right-click on the selection, select **Convert > Strokes to Pencil Lines** or press Shift + F12 (Windows/Linux only)

Chapter 4: Colours

T-ANIMFX-003-001

Toon Boom Harmony has some very powerful painting features to add colour to your drawings. Whereas some other software only allow users to work with one colour swatch at a time, painting in Harmony is done by using palettes containing multiple colour swatches that can be saved and reused as needed.

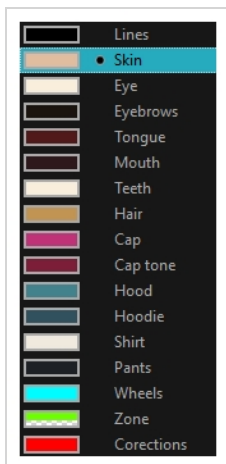

In the Colour view, you choose a different colour swatch for each colour you want to paint in your drawing. You can add as many swatches as you want. You can also rename them and modify existing ones.

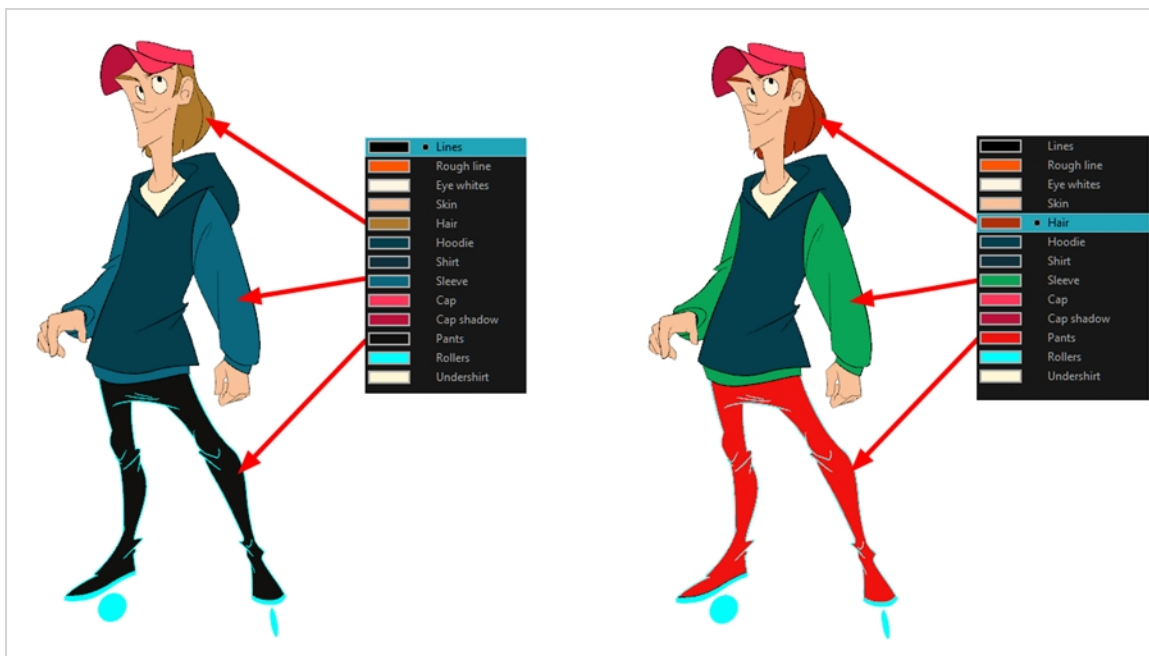

When you modify the colour of an existing swatch, it automatically updates all the zones painted with this swatch throughout the entire scene. The colour swatch has a unique ID number that associates it with the painted zones. This way, you can change the look of your character at any time without having to repaint it!

Another advantage of this system is that you can create complete palettes for different lighting situations. For instance, in addition to the regular palette for a character, you could have one for that character in the rain using colours that are duller and less vibrant than the dry daytime colours, or yet another for using in a night scene. Using palettes linked to your character in this way allows you to instantly change its colouring to suit the mood and atmosphere of the scene without having to repaint each element.

About Colour Swatches

T-HFND-006-017

You can use several different types of colour swatches, including solid colour, gradient colour and bitmap texture swatches.

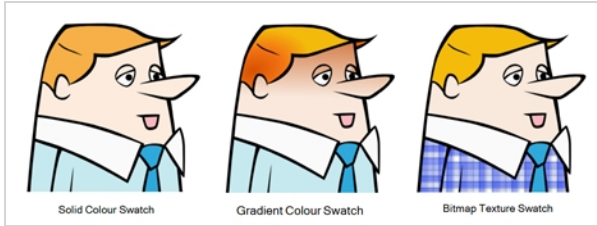

A colour palette is an actual file on the hard drive.

Adding a Colour Swatch

T-HFND-006-017A

You can add as many colour swatches as you want in your palette.

How to add a solid colour swatch

1. In the Colour view, click the Add Colour **+** button.
2. Do one of the following to edit the colour swatch:
 - From the Colour view menu, select **Colours > Edit**.
 - Double-click on the colour swatch.

The Colour Picker window opens.

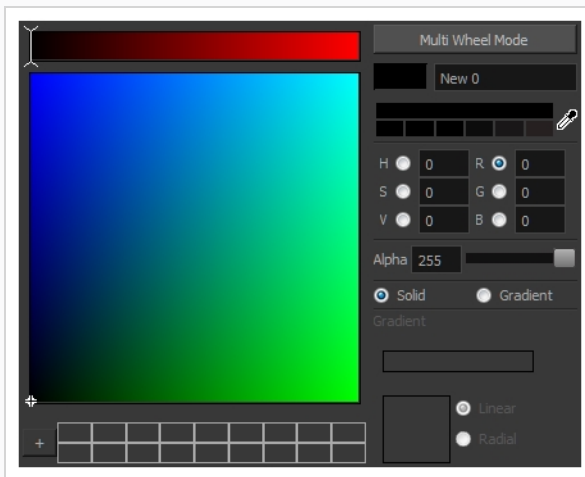

3. To set your colour, do one of the following:
 - Select either **Red, Green, Blue, Hue, Saturation** or **Value** to change the colour wheel's spectrum, then click on the desired colour in the colour wheel.
 - Enter the hue, saturation, value, red, green and blue values manually into their corresponding fields. All values range from 0 to 255.

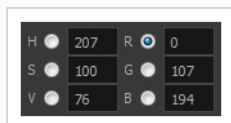

- Click the Dropper  button to select any colour on your screen. It can be from the Harmony interface, your operating system or any other open application.

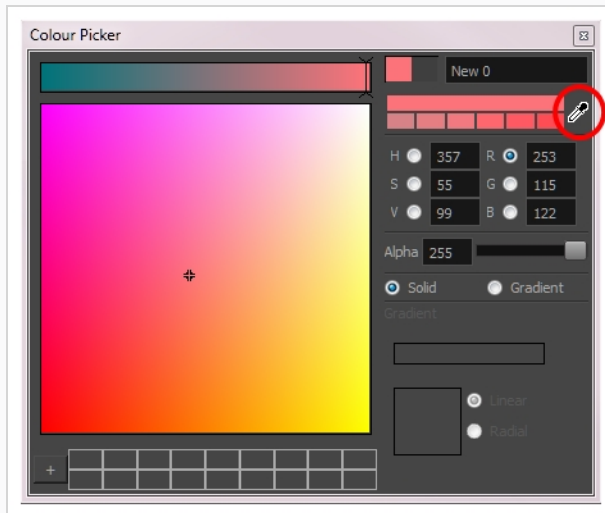

- Click on the Shade Scale switches to modify the shade of the selected colour.

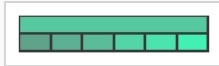

- Adjust the transparency with the Alpha slider or type the value directly in the Alpha field.

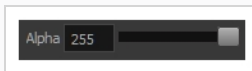

- Click the **Add** button to add the current selected colour to the Colour Storage Library, so you can quickly access it later.



- Rename the colour swatch in the Colour Picker window or directly in the colour list by double-clicking on its name.

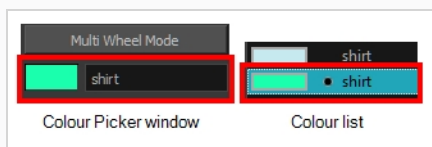

By default, when you create a new colour swatch, its colour will be the same as the currently selected colour swatch, or black if no colour swatch is selected. You can make Harmony create new colour swatches with a specific default colour instead.

Adding a Gradient Colour Swatch

T-HFND-006-017B

You can transform any colour swatch into a linear or radial gradient.

How to create a gradient colour swatch

1. In the Colour view, select a colour to modify .
2. Do one of the following:
 - Click the new colour and from the Colour View menu, select **Colours > New**.
 - Double-click on the colour swatch.



The Colour Picker window opens.

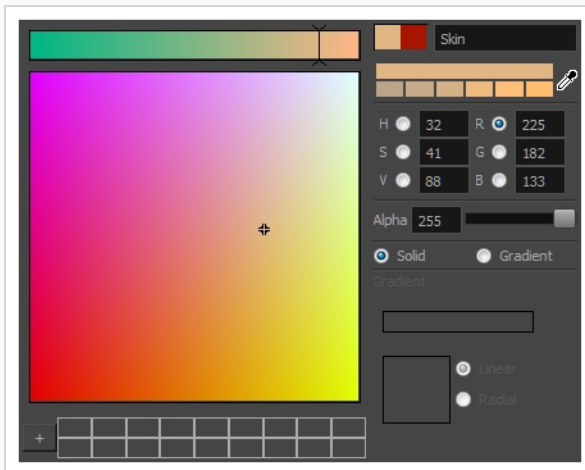

3. Select the **Gradient** option.
4. Select the **Linear** or **Radial** option.
5. In the Gradient slider, create your gradient:
 - To change one of the colours of your gradient, select a key colour from the gradient slider, then pick its colour in the colour picker.

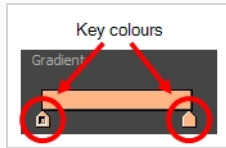

- To add a key colours to your gradient, click anywhere on the colour slider, between the existing key colour.

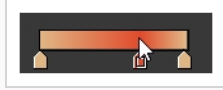

- To delete a key colour, use the mouse to pull down on it.



- To move a key colour's position in the gradient, use the mouse to drag it left or right.

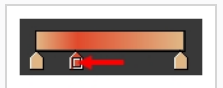

NOTE

To learn how to reposition the gradient zones in your drawings, see [About the Edit Gradient and Texture Tool](#) on page 259.

Adding a Texture Colour Swatch

T-HFND-006-017C

You can add bitmap texture colour swatches to your palette. This allows you to fill zones in your artwork with custom patterns and textures.

How to create a texture colour

1. From the Colour menu, select **Colours > New Texture** or click the New Texture  button.

The Browser window opens.

2. Browse for a PSD or TGA bitmap file created with a third party software and click **Open**.

The texture is added to the colour list.

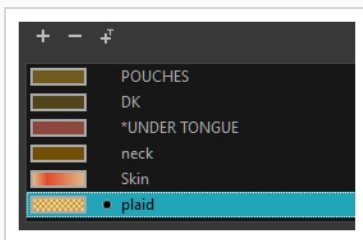

You can also replace a texture once it is painted. If you decide to make the character's shirt wool instead of plaid, just update the texture file in the swatch and the entire project updates. Any transformation previously applied to the texture's position in your drawings will be kept.

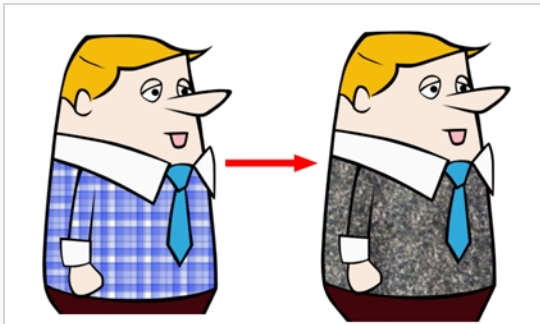

NOTE

To learn how to reposition the textured zones in your drawings, see [About the Edit Gradient and Texture Tool](#) on page 259.

Copying and Pasting Colours

When you're creating palettes, you may want to copy colour swatches or their values and paste them in other palettes to save time. You can also quickly copy a colour value from a palette in your scene to a selected colour swatch in a different palette.

You can copy a selected colour swatch and paste it as a clone. Since it produces a clone colour swatch, it is impossible to use the Paste as Clone command in the same palette as you copied the original colour swatch from.

If you would like to keep a reference file of some colour IDs or use them with custom plug-ins, you can copy the colour swatch IDs. Here is an example of colour ID: **075cf5b552401130**.

```
ToonBoomAnimationInc PaletteFile 2
Solid Black 0x075cf5b15fe006a1 0 0 0 255
Solid White 0x075cf5b15fe006a3 255 255 255 255
Solid Red 0x075cf5b15fe006a5 255 0 0 255
Solid Green 0x075cf5b15fe006a7 0 255 0 255
Solid Blue 0x075cf5b15fe006a9 0 0 255 255
Solid Custom 0x075cf5b15fe006a8 0 0 150 255
Solid "Vectorized Line" 0x0000000000000003 0 0 0 255
```

How to copy and paste colours

1. In the Colour view, select one or more colours to copy.

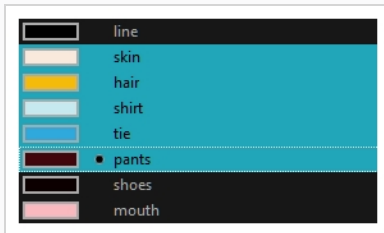

2. In the Colour View menu, select **Colours > Copy** or press Ctrl + C (Windows/Linux) or ⌘ + C (macOS).
3. In the Palette list, select the palette in which you want to paste the colours.

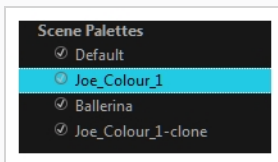

4. From the Colour View menu, select **Colours > Paste as New Colours** or press Ctrl + V (Windows/Linux) or ⌘ + V (macOS).
 - To paste the colour values of the copied swatch over an existing colour swatch, select **Colours > Paste Colour Values**.

How to clone a colour swatch

1. In the Colour view, select the colour swatch you want to clone.
2. From the Colour View menu, select **Colours > Copy** or press Ctrl + C (Windows/Linux) or ⌘ + C (macOS).
3. In the Colour view, select the colour palette you want to paste the clone into or create a new palette.
4. From the Colour View menu, select **Colours > Paste as Clone**.

The cloned colour swatch appears in the palette.

How to copy a colour ID

1. In the Colour view, select the colour swatch you want to get the ID from.
2. From the Colour View menu, select **Colours > Copy Colour ID** or press Ctrl + C (Windows/Linux) or ⌘ + C (macOS).
3. Paste the copied value as plain text in the desired document.

Deleting a Colour Swatch

T-ANIMPA-003-007

You can delete unnecessary colour swatches from your palette. If painted zones are using this colour, they will be displayed in red and the system will try to recover them the next time you load the scene.

How to delete a colour swatch

1. In the Colour view, select the colour swatches to delete.

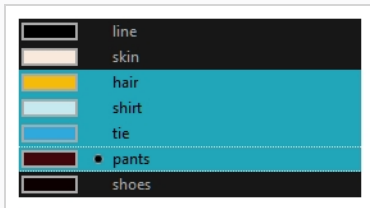

2. Do one of the following:
 - From the Colour View menu, select **Colours > Delete**.
 - Click the Delete Colour  button.
 - Right-click and select **Delete**.
 - Press Del.

If the colour swatch is used in a drawing, the Delete Colour dialog box opens.

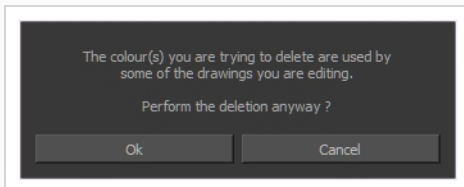

3. Click **OK** to delete the colours or click **Cancel** to abort the operation.

If you delete colour swatches already in use, the zones painted with them turn red so you can easily identify them.



Modifying a Texture Colour Swatch

You can replace a texture colour swatch and all zones already painted with it will update.

How to replace a texture swatch

1. In the Colour view, select the texture swatch that contains the bitmap texture you want to replace.

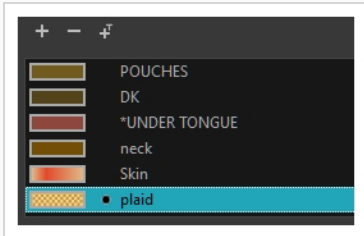

2. From the Colour View menu, select **Colours > Edit Texture** or double-click on the swatch.

The Browser window opens.

3. Browse for the new PSD or TGA bitmap file created in a third party software.



4. Click **Open** to update the colour swatch.

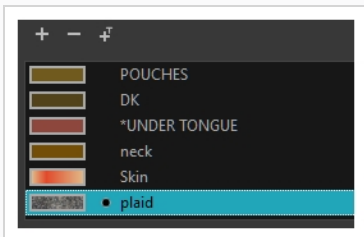

Replacing Colours and Textures in Drawings

T-H15NEW-004-001

Although it is always possible to change colours and textures in existing drawings by updating the swatch in the palette, there may be situations where you want to replace a colour or texture in your drawings with a different colour or texture swatch, without updating the existing swatch. For example, you may want to only replace a colour with a different colour in specific drawings, but not in all the drawings that use the original colour, or you may want to replace a colour with a colour from a different palette without changing your palettes.

Using the Recolour Drawing dialog, you can replace all instances of a colour or texture used in your drawings with a different colour or texture swatch. This will actually change the colours or textures from within the drawings, without making any changes to your palette. You can perform this operation on the currently selected drawing, on all drawings in the current layer or in all drawings in your scene.

How to recolour drawings

1. First, make sure one of the palettes in your scene already has a swatch containing the colour or texture you want to replace the original colour with—see [About Colour Swatches on page 219](#), [About the Edit Gradient and Texture Tool](#) and [Adding a Texture Colour Swatch on page 224](#).
2. In the Timeline or Xsheet view, select the drawing or drawing layers you wish to recolour.







NOTE

You can select multiple layers if needed.



NOTE

You can skip this step if you intend to recolour all the drawings in your scene.

3. In the Colour view, click on Show Colour Palettes  if you want to replace a colour, gradient or texture, or on Show Pencil Texture Palettes  if you want to replace a pencil texture. You can also click on Show All Palettes .
4. In the Colour view, select the colour or texture swatch you want to replace by doing one of the following:
 - Select the palette in which the colour or texture swatch is located, then select the swatch you wish to replace.
 - If the drawing in the Camera or Drawing view contains the colour or texture you want to replace, select the Dropper  tool in the Tools toolbar, then click on that colour or texture in the drawing. The Colour view will automatically select that colour or texture's palette as well as that colour or texture's swatch.

5. Do one of the following:

- Right-click on the swatches list, then select **Recolour Drawings**.
- Open the Colour view menu , then select **Colours > Recolour Drawings**.

The Recolour Drawings dialog appears.

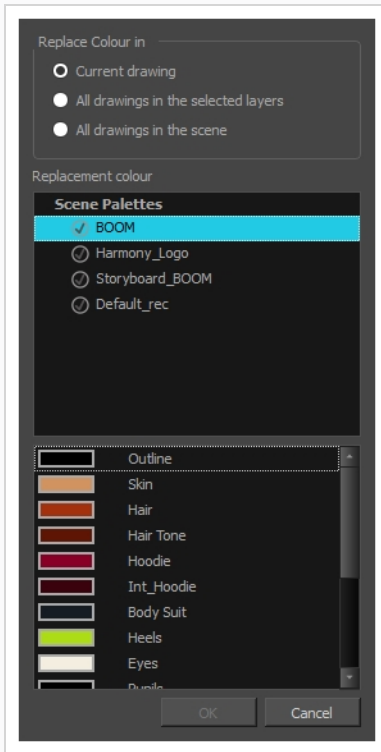

6. In the Replace Colour In panel, select whether you want to replace the selected colour in the **Current Drawing**, in **All drawings in the selected layers** or in **All drawings in the scene**.
7. In the palette list in the Replacement Colour panel, select the palette that contains the colour or texture swatch you want to replace the original colour or texture with.
8. In the swatches list, select the colour or texture swatch you want to replace the original colour or texture with.
9. Click OK.

A dialog displays showing the progress of the recolour operation. When finished, the original colour or texture is replaced with the replacement colour or texture in your drawing.

Changing the Colour Display Mode

The Colour view has two display modes:

- List
- Swatch

You can also display the RGB values and names of your solid colour swatches instead of only the name. This option is not available when displaying the colours in Swatch mode.

How to switch between the display modes

1. From the Colour View menu, and do one of the following:
 - Select **Colours > Swatch Mode** to display the swatches.
 - Deselect **Colours > Swatch Mode** to display the colour list.

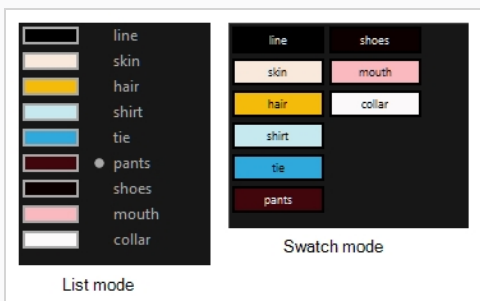

How to display the swatch colour values

- From the Colour View menu, select **Palettes > Display Colour Values**.

The solid colour swatches' RGB values are displayed between the colour swatch and its name. The gradient colour swatches will be identified as (gradient).

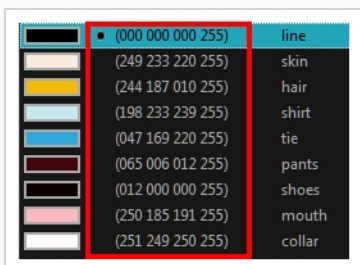

About Palettes

T-ANIMPA-003-001

In animation, specific colours are used to paint each part of each character. In order to maintain absolute consistency, a base colour palette should be created for each character, prop and effect in the production. This is referred to as a *master palette*.

Master palettes contain a colour swatch for each area to colour. Each swatch stores a colour in precise levels of red, green, blue and opacity (the latter which is referred to as *alpha*).

Using a master colour palette has many benefits, including:

- Each character consistently retains their dedicated colours.
- You cannot accidentally use a colour which is not in the master palette.
- Standardization and colour consistency throughout the production.
- Multiple artists can use the same colour palette and produce the same results.

Harmony uses palettes to hold all the colours needed to paint your elements, allowing complete control and consistency in the painting process.

A palette is created by assigning a set of colours to each character, prop or effect. You will create a new palette and add a new colour, known as a *colour swatch*, for each zone of the character, such as the skin, hair, tongue, shirt, pants, and so on.

When you modify the colour of an existing swatch, it automatically updates all the zones painted with this swatch throughout the entire scene. The colour swatch has a unique ID number that associates it with the painted zones. This way, you can change the look of your character at any time without having to repaint it!

Another advantage of this system is that you can create complete palettes for different lighting situations. For instance, in addition to the regular palette for a character, you could have one for that character in the rain using colours that are duller and less vibrant than the dry daytime colours, or yet another for using in a night scene. Using palettes linked to your character in this way allows you to instantly change its colouring to suit the mood and atmosphere of the scene without having to repaint each element.

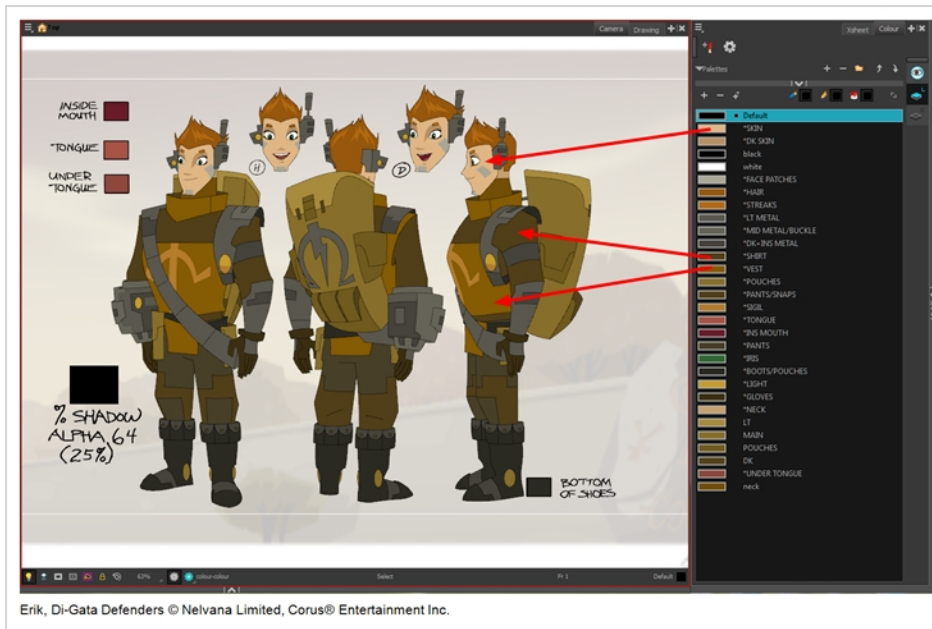

In Harmony, colour palettes are individual *.plt files that are stored in each scene's **palette-library** folder and which can be copied, transferred and imported as needed.

About Scene and Element Palette Lists

By default, you can only add palettes to a scene's palette list. With the Advanced Palette Lists preference enabled, you can choose to store add palettes to the palette list of individual elements if you choose. Here is an explanation of the two different levels of palette lists:

- **Scene palette list:** This palette list and its palettes are available for and can be used in all of the scene's elements. Hence, it is the most simple and least restrictive approach, and is the type of palette used by Harmony when Advanced Palette Lists mode is disabled. It is most recommended to add your palettes to your scene's palette list if you are doing digital animation, where character models can be made of many different elements that must use the same palette.
- **Element palette list:** A palette list associated with a single element in your scene. An element is the container for the drawings used by a drawing layer. Hence, when an element has a palette list with its own palettes, only the drawings in that element can use the colours in these palettes, and the palettes in this element's palette list will only be shown in the Colour view when a drawing from this element is selected.

Using element palette lists as certain advantages, depending on your type of production:

- In paperless and traditional animation projects, characters are usually drawn on single elements. Hence, you can use this to associate characters in a scene to their colour palette.
- If a scene requires a lot of palettes, linking those palettes only to elements that need them rather than to the whole scene can help declutter your palette list.
- When a palette and its clone are in the scene's palette list, Harmony will only use whichever palette is highest in the list. If you want one element to use the original palette and another element to use the cloned palette, you can do so by adding the right palette to each element's palette list.

About the Palette List

T-ANIMPA-003-006

A palette list is a file containing all of the links to the palette files. Each scene created has its own palette list, and every element in your scene can use colours from any palette in your scene's palette list.

Showing and Hiding the Palette List

By default, the palette list is enabled. If you want to only use one palette for all of your scenes, you can disable the palette list simply by collapsing it, which will give more vertical space to your colour swatch list:

How to show or hide the palette list

1. In the Colour view, right over the palettes list, click on the expand/collapse arrow to expand or collapse the palettes list.

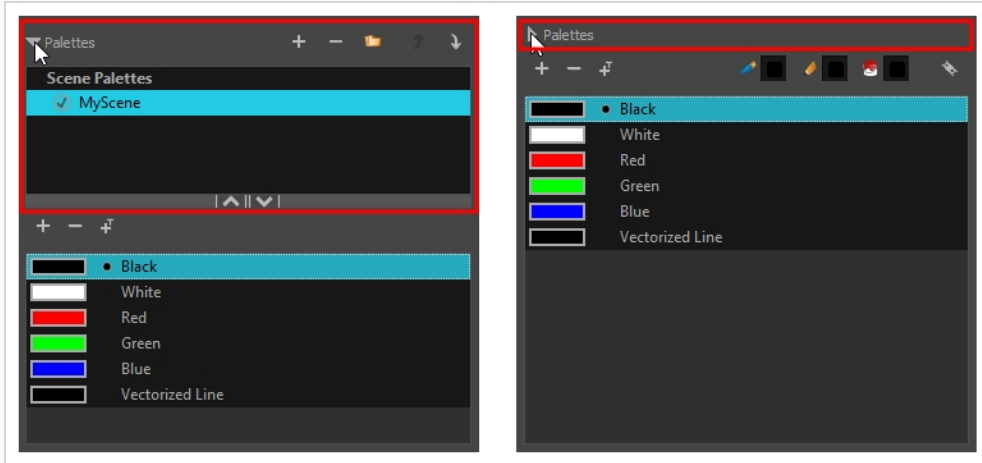

Creating a Palette

T-ANIMPA-003-002

You can create a palette in either Basic or Advanced mode.

How to create a new palette

1. Do one of the following:

- In the Colour View, click the New Palette **+** button over the palette list.
- From the Colour view menu, select **Palettes > New**

The Create Palette dialog box opens.

2. In the Create Palette dialog, enter the new palette's name. Make sure your palette name contains information to be easy to identify, such as the name of the character and information about the type of setting for this palette, if any.

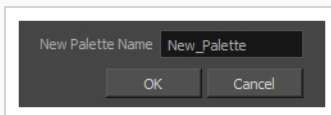

3. Click **OK**.

The palette appears in the drawing element's palette list.

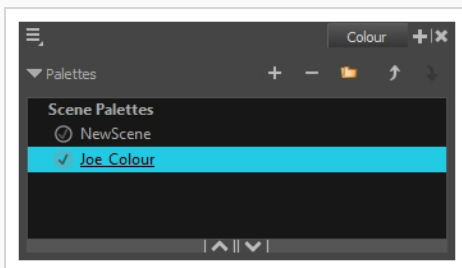



Importing a Colour Palette

T-ANIMPA-003-005

You can import an existing palette from your file system or network into your scene. This will create a copy of the palette file and add it to your palette list.

How to import a palette into your project

1. Do one of the following:
 - In the Colour view, click on the Import  button.
 - From the Colour menu , select **Palettes > Import**.
 - Right-click on the palette list and select **Import**.

The Browser window opens.

2. Browse for a palette file located (***.plt**) on your hard drive. You can usually find a scene's palettes by browsing to the **palette-library** sub-folder of the scene's folder.
3. Click **Open**.

The palette is copied to your project and added to your scene's palette list.

Renaming a Palette

T-ANIMPA-003-003

You can rename a colour palette to keep your list organized.

How to rename a palette

1. In the Colour view, select the palette to rename.



2. Do one of the following:
 - Right-click and select **Rename**.
 - From the Colour View menu, select **Palettes > Rename**.
3. In the Rename dialog box, give the palette a new name and click **OK**.

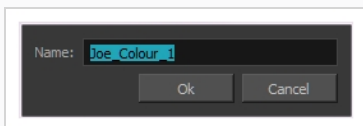

Removing a Palette

You can remove palettes from your Palette list if they're not needed in your scene. The actual palette file will not be deleted, so you can add it back to your palette list later if you need it.

How to remove a palette

1. In the Colour view, select the palette to remove.

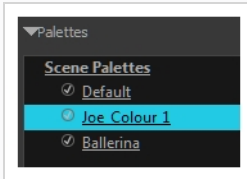

2. Do one of the following:
 - From the Colour View menu, select **Palettes > Remove**.
 - Right-click on the selected palette and select **Remove**.
 - Click the Remove Palette — button located above the Palette list.

If the palette was used in your scene, the zones painted with its colours turn red.





Duplicating a Palette

A duplicated palette is a simple copy of the original palette. When you duplicate a palette, the duplicated palette will have the same colour names and values, but will have different colour IDs so that Harmony does not mix it up with its original palette. This is useful when you want to create different palettes for similar models, but want to avoid having to create the palette and its colours all over again. You can just start with your duplicate palette, tweak the colours and add and remove colours as needed.

How to duplicate a palette

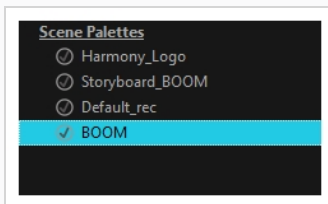
1. In the Colour view, select a palette to duplicate.



2. Do one of the following: From the Colour menu, select **Palettes > Duplicate** or right-click and select **Duplicate**.
 - Right-click on the palette and select **Duplicate**.
 - Open the Colour menu , then select **Palettes > Duplicate**.

The Duplicate palette dialog box opens

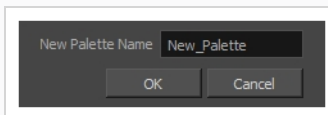

3. In the **New Palette Name** field, enter the name for the new palette. By default, the palette's name is based on the original palette name followed by "-copy". The palette list above this field lists the palettes that already exist in the selected location. Make sure you enter a name that is not already used by another palette.
4. Click **OK**.

The duplicated palette appears in the palette list.

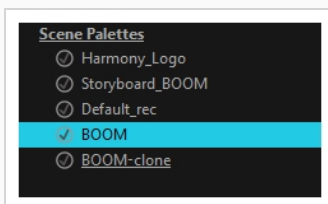

Cloning a Palette

Cloning a palette creates an exact copy of the palette, where each colour swatch has the same colour ID as in the original palette, but which you can modify independently afterward. Since painted zones in drawings are associated to their colour by their colour ID, this means that any drawing colored with the original palette can have its colours replaced with the cloned palette's colours just by switching the palette in the scene with the cloned palette.

A good example of how this can be useful is when you want to make variants of a character's palette. A character usually has only one master palette, although there are times when the characters are placed in different lighting conditions and require a different colour shading. The night palette is a popular choice when a scene or sequence changes from day to night. Instead of creating a different palette for the character and repainting all of its zones with the night palette, you can just clone the character's master palette, tweak its colours, and the character will have its original colours or its night colours depending on which one of the palettes is in the palette list, without having to repaint your drawings.

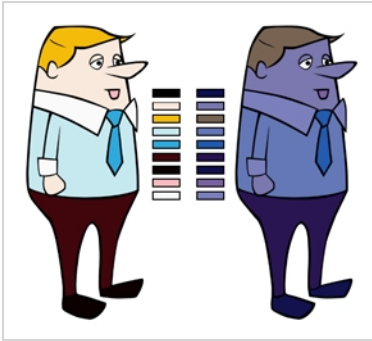

When a palette and its clone are present in the same scene, Harmony uses the palette that is highest in the list. If one palette clone is present in the scene's palette list and another clone is present in the element's palette list, the element will use the palette in its own palette list.

How to clone a palette

1. In the Colour view, select a palette to clone.

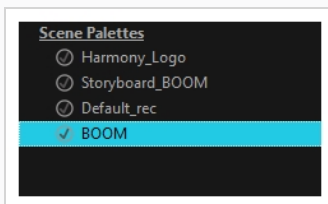

2. Do one of the following: From the Colour menu, select **Palettes > Clone** or right-click and select **Clone**.
 - Right-click on the palette and select **Clone**.
 - Open the Colour menu , then select **Palettes > Clone**.

The Clone palette dialog box opens

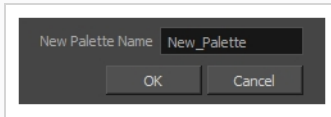

3. In the **New Palette Name** field, enter the name for the new palette. By default, the palette's name is based on the original palette name followed by "-clone". The palette list above this field lists the palettes that already exist in the selected location. Make sure you enter a name that is not already used by another palette.
4. Click **OK**.

The cloned palette appears in the palette list.

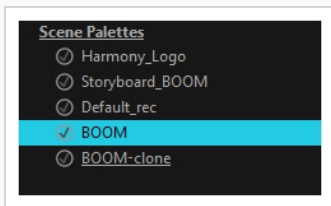

NOTE

You can modify your cloned palette by changing its colour swatches individually, or you can use the Tint Panel to change all of the palette's colour swatches simultaneously—see [Tinting a Palette's Colour Swatches](#) on page 244.

Tinting a Palette's Colour Swatches

You can use the Tint Panel dialog to offset, blend or mix all the different colour swatches in a palette simultaneously. This can be useful if you want to give a cloned palette a different tint, for example to make a night-themed version of a character's master palette.

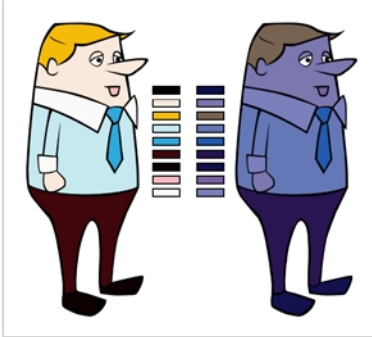

How to tint a palette

1. In the Palette list, select the palette you want to tint.
2. From the Colour View menu, select **Palettes > Tint Panel** or right-click and select **Tint Panel**.

The Blend/Offset Tint panel opens.

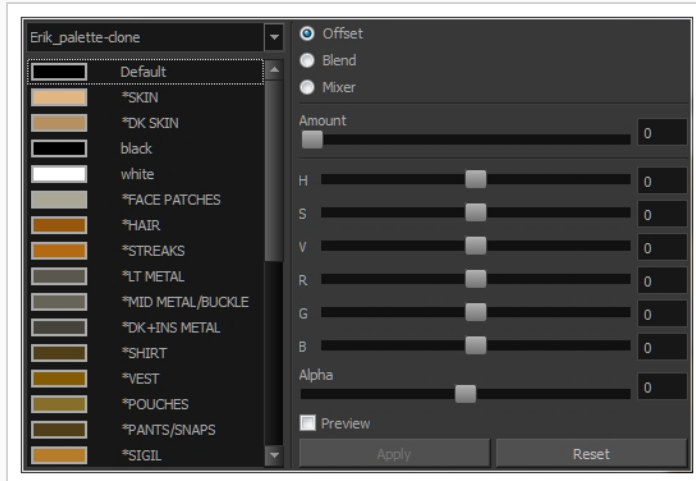

3. Select one or more colours to modify. You can select all your colours by pressing **Ctrl + A** (Windows/Linux) or **⌘ + A** (macOS).
4. Offset, blend, or mix the colours using the sliders and increasing the Amount value.

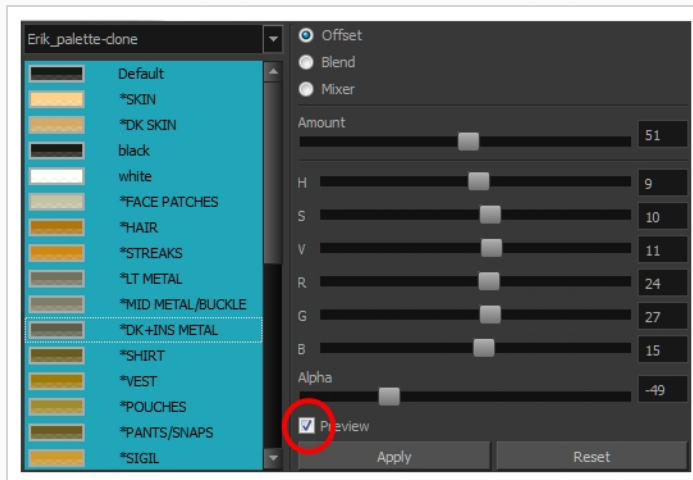

5. Select the **Preview** option to see a preview of the colours while you adjust them.

Reordering Palettes in the Palette List

You may want your palettes to be listed in a specific order. In a lot of cases, this is strictly a matter of convenience. However, if your palette list contains palettes that have been cloned off each other, Harmony will use the palette that is located the highest in the list to determine the colours to use in the drawings. Hence, if you are using cloned palettes, you must mind the order of your palettes in the palette list. For more information, see [Cloning a Palette](#) on page 242.

How to reorder palettes in the palette list

1. Select the palette you wish to reorder.
2. Do one of the following:
 - In the Palette list toolbar, click the Up ↑ or Down ↓ buttons.
 - From the Colour View menu, select **Palettes > Move Up** or **Move Down**.

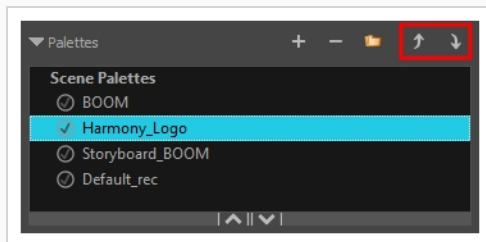

About Painting

Harmony is optimized to ink and paint drawings efficiently. Since most of the drawings are vector-based, the colour zones are completely filled and there are no scattered spots left blank. Also, there are some actions that can be applied on an entire animation sequence at once, like dirt removal, some colour filling, line repainting, and so on.

When traditional animation is traced, cleaned up, scanned in and properly exposed, it's time for the ink and paint process. This consists of cleaning all dirt and hair (for example, dust that was in the scanner, dots that do not belong in the drawing, extra floating artwork around the drawing that must be removed), painting the lines and filling the colours in the empty zones on an entire animation sequence.



For paperless animation, the drawings are cleaned up directly in Harmony, so there is generally no dirt to clean, only painting and inking.

Harmony uses palettes to hold all the colours you need to paint your elements. A palette is created by assigning a set of colours to each character, prop or effect. The colour styling artist will create a new palette and add a new colour for each zone of the character, such as the skin, hair, tongue, shirt, pants, and so on. Each colour is known as a colour swatch—see [About Palettes on page 232](#).

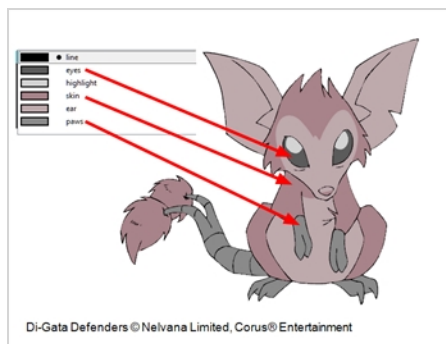

Flipping Between Models

T-LAY-002-001

Once your models are loaded in the Model view, you can flip through them using a keyboard shortcut or toolbar buttons.

How to flip between models

1. Do one of the following:
 - In the Model View toolbar, click the Next Model ► or Previous Model ◀ buttons.
 - From the Model View menu, select **Next Model** or **Previous Model**.
 - Press F and G.

The previous or next model appears in the Model view.

Copying Colour Models

You can copy pieces or the entire colour model to paste in your scene,

How to copy the entire model from the Model view

1. In the Model View toolbar, select the Select  tool.
2. In the Model view, select your model.

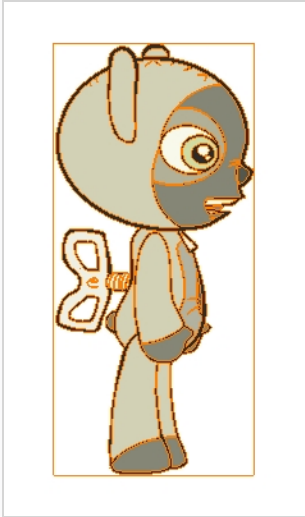

3. From the top menu, select **Edit > Copy Drawing Object** or press **Ctrl + C** (Windows/Linux) or **⌘ + C** (macOS).
4. In the Timeline view, make sure you have the correct layer and frame selected.
5. Select the Drawing or Camera view, then go to the top menu and select **Edit > Paste Drawing Object**, or select the Timeline view and from the top menu, select **Edit > Paste cells in the Timeline** or press **Ctrl + V** (Windows/Linux) or **⌘ + V** (macOS).

The model appears in the selected view.

How to copy part of the model from the Model view

1. In the Model View toolbar, select the Cutter  tool or press **Alt + T**.
2. In the Model view, use the Cutter tool to create a selection around the part of your model that you want to copy.

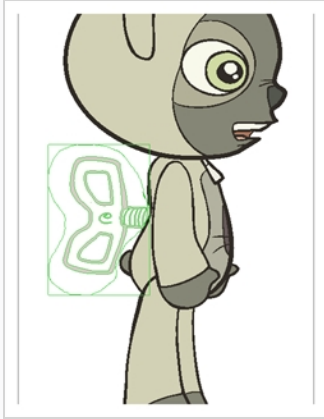

3. From the top menu, select **Edit > Copy Drawing Object** or press **Ctrl + C** (Windows/Linux) or **⌘ + C** (macOS).
4. In the Timeline view, make sure you have the correct layer and frame selected.
5. Do one of the following:
 - Select the Drawing or Camera view and select **Edit > Paste Drawing Object**.
 - Select the Timeline view and select **Edit > Paste cells in the Timeline** or press **Ctrl + V** (Windows/Linux) or **⌘ + V** (macOS).

The model appears in the selected view.

Painting Drawings

T-HFND-004-011

The main tool you will use to paint your drawings with is the Paint tool. The Paint tool can be used in several different modes, which can be customized in the Tool Properties view.

The Paint tool paints closed zones, including brush strokes and pencil lines. If there are gaps in the lines defining a zone, you must close them using the Brush, Pencil, or Close Gap tools or the Automatic Close Gap option.





NOTE

To learn more about the Paint tool options, see the Reference guide .

How to paint drawings

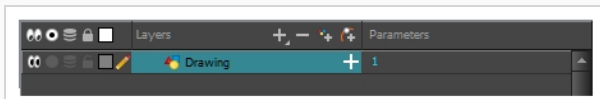
1. In the Timeline or Xsheet view, select the cell on which you want to paint.



2. Do one of the following:
 - In the Tools toolbar, click the Paint  tool.
 - Press Alt + I.

In the Tool Properties view or Tools toolbar, you can select additional painting modes.

- The Paint  mode paints everything it touches, including empty and filled zones.



- The Paint Unpainted  mode paints only empty zones. Any line or filled zone will remain unchanged.

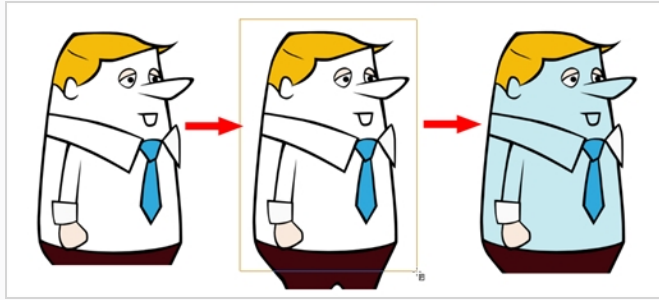

- The Unpaint  mode unpaints everything it touches, including empty and filled zones.

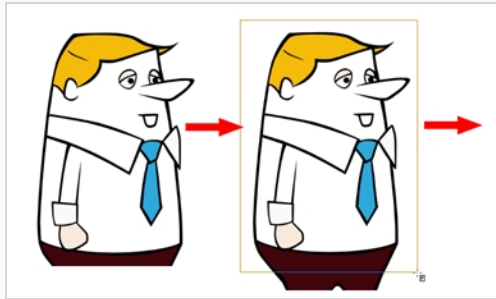

3. In the Colour view, select a colour.

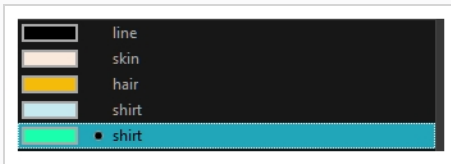

4. In the Drawing or Camera view, start painting. Click on a zone or pencil line to paint it, or trace a lasso or marquee selection to paint several zones or pencil lines at the same time.

 **NOTE**
The last colour you select while using the Paint tool will be used the next time you select the Paint tool if you're using the unlocked painting tools in the Colour view.

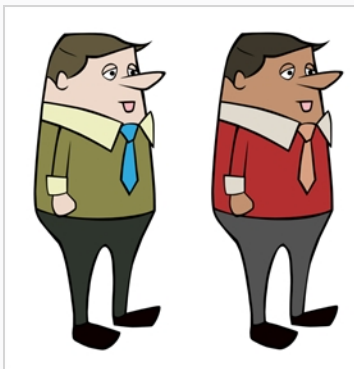

Authors

Marie-Eve Chartrand

Christopher Diaz

chrisdiazart.com

Repainting



T-ANIMPA-011-004

You can use the Paint tool to click on the zones to repaint. If you click in an empty zone, it will fill the area.

The Brush tool can be used to repaint specific segments. The Brush tool's Repaint Brush mode is used to paint a section by manually painting over the lines. This is useful when the vectorization triangles are not placed as you would like or you simply need to repaint a section of a segment. It is also useful for paperless animation, where there are no triangles. So, the Repaint Brush is used to paint a certain area. It acts like the Brush tool, but will only show on painted areas that are already painted.

Unlike the Brush tool's regular mode, the Repaint Brush mode flattens automatically. The brush strokes are not added one on top of each other.

How to enable the Repaint Brush mode

1. In the Tools toolbar, select the Brush  tool.
2. In the Tool Properties view, click the Repaint Brush  button.
3. In the Camera or Drawing view, draw on the zones to repaint.

Selecting Strokes with the Current Colour

You can select zones painted with a specific colour swatch.

How to select the zones painted with the current colour

1. In the Colour view, select the colour from which you want to select the corresponding zones.

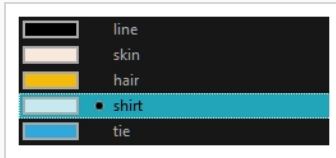

2. Do one of the following:
 - Select **Drawing > Select Strokes With Current Colour**.
 - Press **Ctrl + Shift + A** (Windows/Linux) or **⌘ + Shift + A** (macOS).

Closing Gaps



T-HFND-004-014

When painting, you may notice that some drawing areas are not closed. To close the zone, you can draw the missing line with the Brush or Pencil tool, or close the gap with an invisible line using the Close Gap tool.

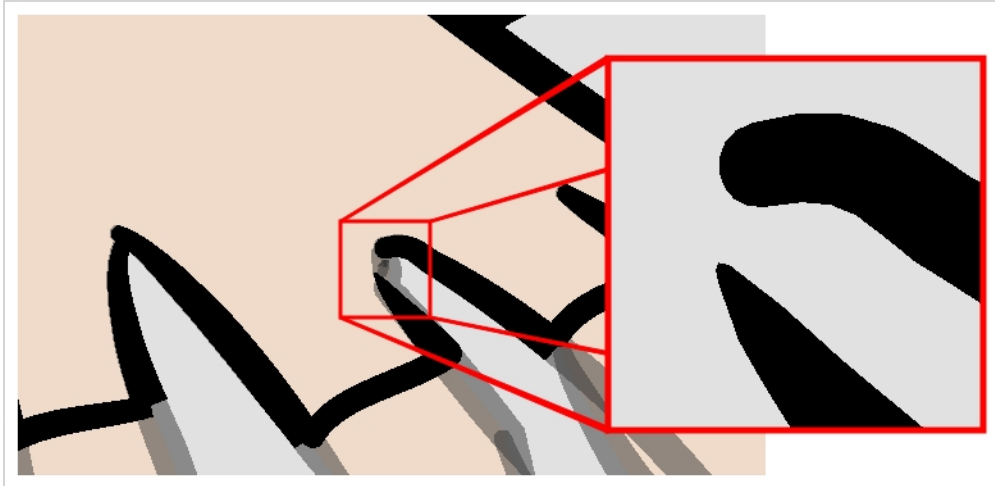
The Close Gap tool lets you close small gaps in a drawing by creating small, invisible strokes between the two closest points to close the colour zone. You do not need to trace directly over the gap. You can draw it a few millimeters away. The two closest points automatically close the gap.



How to close gaps

1. Select **View > Show > Show Strokes** or press K to see a preview of the result.
2. In the Tools toolbar, select the Close Gaps  tool.
3. In the Camera or Drawing view, trace a line near the gap to be closed. Your strokes will be invisible.
4. Enable the Auto-Flatten  option in the Tool Properties view if you want your strokes to be flattened with your artwork. They will cut overlapping drawing strokes in two pieces.

The gap automatically closes.

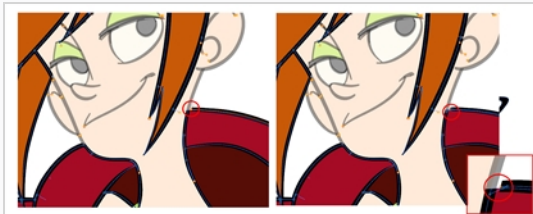

Authors

Marie-Eve Chartrand
Christopher Diaz
chrisdiazart.com

Picking a Colour with the Dropper Tool

T-ANIMPA-011-002

While working in the Camera or Drawing view, you can use the Dropper tool to pick a colour from your drawing without going to the Colour view.



How to use the Dropper tool

1. Do one of the following:
 - In the Tools toolbar, select the Dropper  tool.
 - From the top menu, select **Drawing > Drawing Tools > Dropper**.
 - Press Alt + D.
2. In the Camera or Drawing view, click on the desired colour.
 - If you're using another drawing tool such as the Paint tool, you can temporarily hold down the D key and click in your drawing before releasing the key to pick your colour. When you release the key, you will return to your previous tool. You may also want to select the zones painted with the colour currently selected in the Colour view. This can be useful for removing rough lines from a clean drawing.

About the Edit Gradient and Texture Tool

T-HFND-006-019

If you paint a zone with a gradient or texture colour, you can use the Edit Gradient/Texture tool to modify its position in the zone. You can move, scale, rotate and skew. If you want to match the colour to the animation, set the first texture position and copy the Edit Gradient/Texture position. When moving to the next drawing, you can select the next texture and paste the previous position to continue the modifications.

If you are painting a hand-drawn animation or if you want the Brush and Paint tool to use your gradient's position, angle and scale settings instead of the default ones, you can store your own settings and reuse them afterward.

This way of editing a texture using the Edit Gradient/Texture tool also works with pencil lines drawn with textured "brushes". If you then paint your textured pencil line with a gradient, you can do so and then edit both elements independently at the same time.



Using the Edit Gradient and Texture Tool

T-HFND-006-019A

You can use the Edit Gradient/Texture tool to reposition a texture or gradient within a painted zone.

How to use Edit Gradient/Texture tool

1. Do one of the following:
 - In the Tools toolbar, click the Edit Texture  tool.
 - Press Shift + F3.
2. Click the gradient or texture colour to modify.



A blue selection frame surrounds the selected gradient or texture.

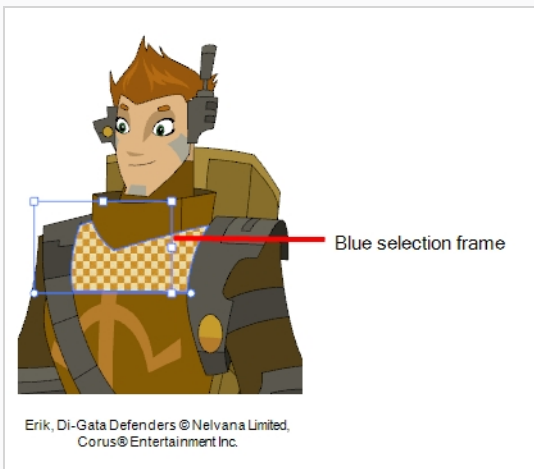

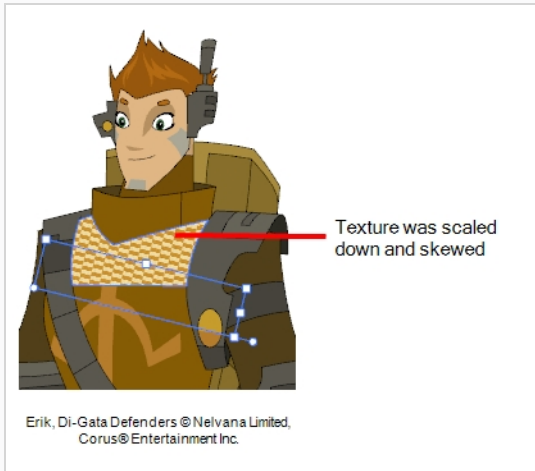

3. Edit the gradient or texture by adjusting the control handles around the selection frame.

Chapter 5: Paperless Animation

T-HFND-006-001

Toon Boom Harmony is a powerful paperless animation software that incorporates animation and drawing tools to make your work easier and more efficient.

Although it is a digital process, paperless animation is still hand-drawn and the fundamental principles of animation still apply.



One of the advantages of working with paperless animation is that you do not lose time scanning elements in and testing them because everything is already digital. You can simply draw your animation and play back your line test right away. This also saves the substantial amount of paper required by traditional animation. Another practical advantage is the ability to undo and redo some actions that are often difficult on paper, such as erasing brush strokes.



NOTE

When you draw on an empty cell, Harmony automatically creates a drawing that spans over a single frame in that cell. You can adjust that drawing's timing as needed afterward. However, it is possible to create, name and set the timing of each drawing before creating your animation, which can help organize your workflow. For more information, see [Timing on page 283](#).

Creating a Rough Animation

T-LAY-003-005

The first step to create paperless animation is the rough construction, which is the skeleton of your animation. You would usually start by animating the most important part of a character's action. For example, to animate a walk cycle, you will start with the torso motion and the legs. Secondary animation such as the head, arms and clothes can be added afterward.

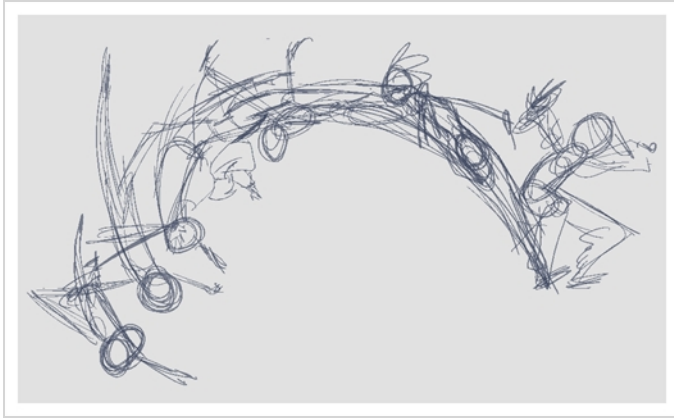

For a satisfactory animation, start by animating the main action with quick, rough sketches, then add the details when you're satisfied with the movement. If you start animating all the details right away, you will lose a lot of time if you have to make corrections, and your animation is likely to look rigid.

How to create a rough animation

1. In the top row of the Timeline view, click on Show All Thumbnails  to enable Thumbnail mode.

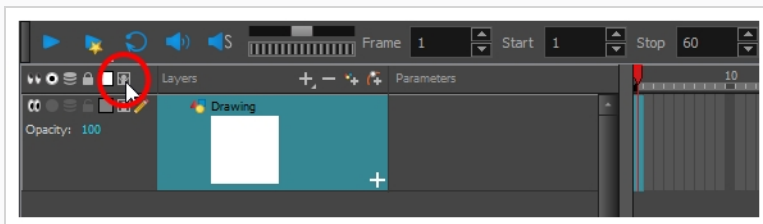

2. In the Tools toolbar, select the Brush  tool or press Alt + B.
3. In the Colour view, select a colour for the brush. It is a good idea to choose a light colour for your rough animation. This will make the clean up process easier as your clean dark lines will contrast with your light sketch lines.

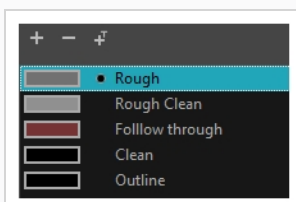

4. In the Timeline or Xsheet view, select the cell where you want your first drawing to appear.
5. In the Camera or Drawing view, draw the first key drawing.

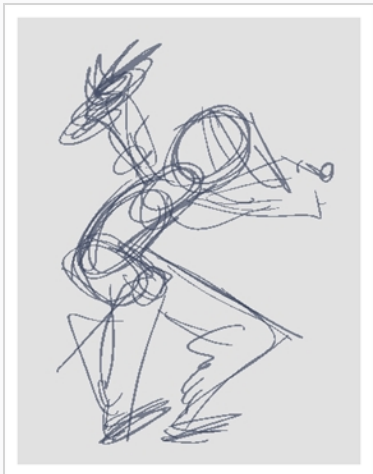

As soon as you draw your first stroke, a drawing is automatically created in the cell you selected.

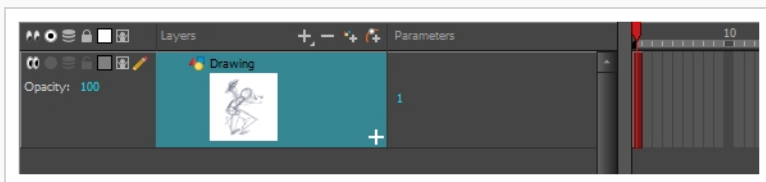

6. Increase the Timeline view's zoom level until you see the thumbnails inside the cells by doing one of the following:
 - Drag the Timeline Zoom  slider to the right.
 - Click on the Timeline view's tab, then press 2 repeatedly.
 - Move the mouse cursor in the Timeline view, then hold Ctrl (Windows/Linux) or ⌘ (macOS) and roll the mouse wheel up.

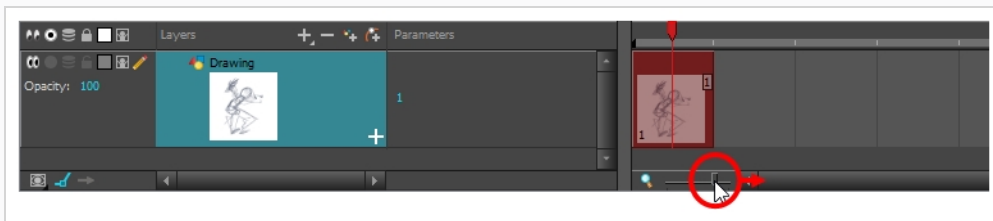





7. In the Timeline or Xsheet view, select the cell where your next key drawing will appear.



8. In the Tools toolbar, click the Onion Skin  button. This will display the previous and next drawings in a light colour in the Camera or Drawing view, behind your current drawing, so that you can use them as references to draw new drawings with accuracy. This can be useful to draw breakdown poses between two key poses, or to add an in-between drawing between two other drawings.
9. Ensure the onion skin displays your first key drawing, so that you can base your second key drawing on it. To do this, do one of the following:
 - In the Timeline view, drag the blue onion skin markers to extend the number of past and future drawings to display as onion skin.



- In the Camera View or Drawing View toolbar, use the Onion Skin Add One Previous Drawing , Onion Skin Reduce One Previous Drawing , Onion Skin Reduce One Next Drawing  and Onion Skin Add One Next Drawing  buttons to adjust the span of the onion skin frame by frame.
10. Create a new empty drawing by doing one of the following:
 - In the Timeline or Xsheet toolbar, click on the Create Empty Drawing  button.
 - Press Alt + Shift + R.

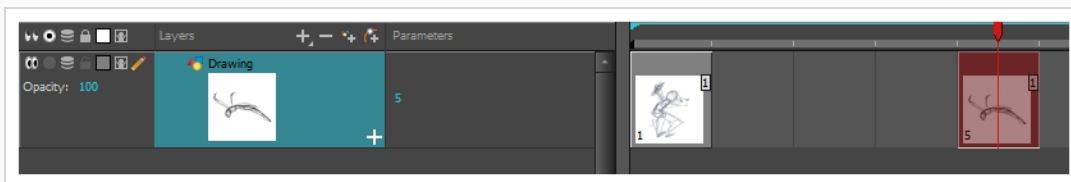

12. In the Timeline or Xsheet view, select a cell between the two key drawings. Using the onion skin markers, ensure the onion skin covers both your first and last drawings.

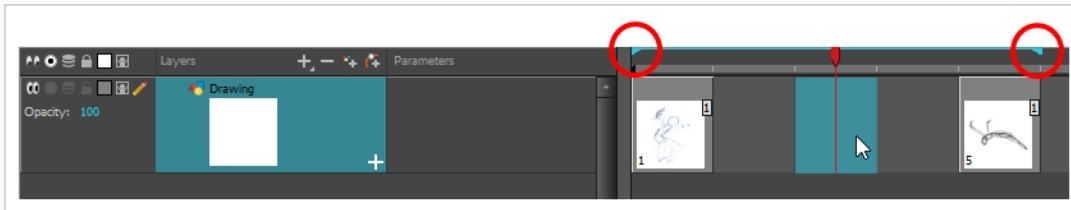

13. Create a new empty drawing by doing one of the following:
- In the Timeline or Xsheet toolbar, click on the Create Empty Drawing  button.
 - Press Alt + Shift + R.
14. In the Camera or Drawing view, draw your new pose.

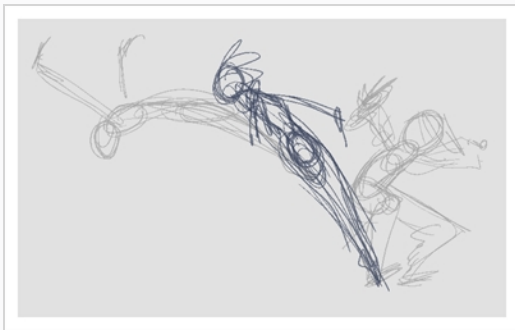

15. In the Timeline or Xsheet view, select a new cell and repeat the previous steps for each new drawing.



NOTE

When working with overlay layers in the Camera view, you can enable the Current Drawing on Top  option to make the layer you're working on appear over other layers.

Creating the Tie Down Animation

Once your rough animation is correct, you can start adding extra details, such as arms, clothes or hair. You can add the extra details on the same layer with the same colour or you can also create a new colour so that you can always see your original sketch.

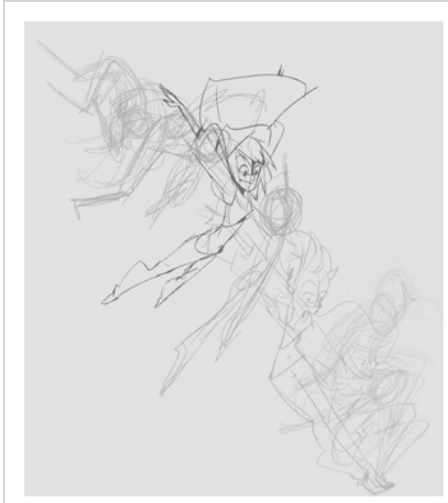

If your primary and secondary animation were done as a rough drawing, it is now time to put your drawing on model, also known as tie down. This means that you have to review your animation and ensure that every single detail is on model and there is no volume distortion. You can do this directly on the original sketch layer or on a new layer.



If you want to keep your rough animation as it is to avoid any mistakes, you can add an extra drawing element and use the Light Table feature to draw over the first drawing element. This technique can also be used if you want to reuse your rough animation for other characters. For example, if you have a rough walk-cycle, you can reuse it for another character and add its personal features in a new layer. This way, you only need to animate the secondary animation instead of the whole body again.

How to create secondary animation on the same layer

1. In the Xsheet or Timeline view, select the cell in which you want to add new details.
2. In the Colour view, create a new colour (give it the same name and add the prefix `_2` or `_sec`, for example) or select the same rough colour as before.
3. In the Drawing Tools toolbar, select your drawing tool.
4. In the Camera or Drawing view, draw the secondary animation.

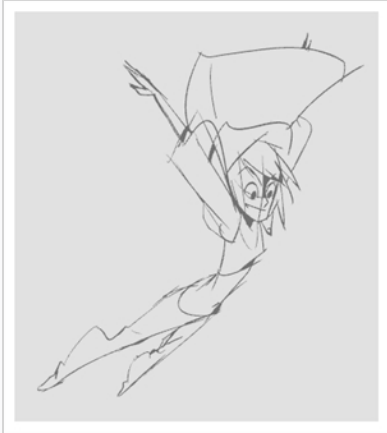

5. Do one of the following:
 - In the Xsheet or Timeline view, select the next cell in which you want to draw.
 - Press F and G to navigate between your drawings.
6. Do one of the following:
 - Select **View > Onion Skin > Show Onion Skin**.
 - In the Timeline view menu, select **Onion Skin > Show Onion Skin**.
 - Press Alt + O.
7. Extend the onion skin.
8. In the Camera or Drawing view, draw the secondary animation.

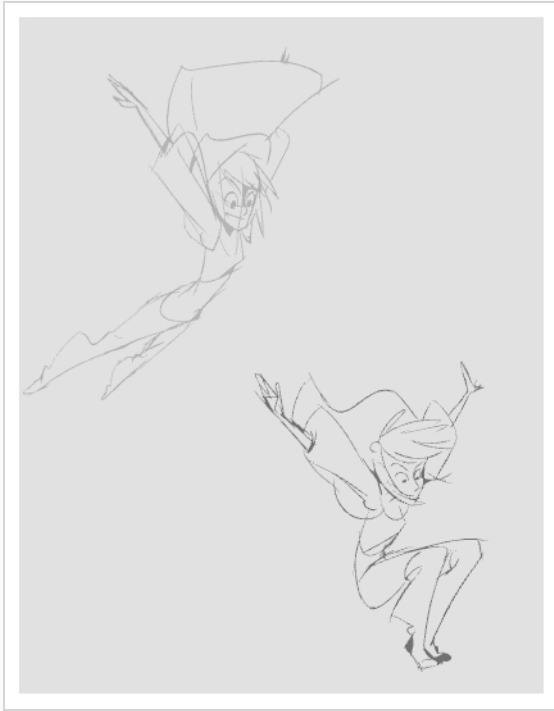

9. You can also use the Playback toolbar to play the animation in real time.

How to create your secondary animation on an extra layer

1. Add a new drawing layer and name it **secondary_animation**.
2. In the Timeline or Xsheet view, select the rough layer's timing.
3. Copy the timing and in the top menu, select **Edit > Paste Special** or Ctrl + B (Windows/Linux) or ⌘ + B (macOS).
4. Choose **Never create drawing files** from the options to paste the timing but not the drawing files.

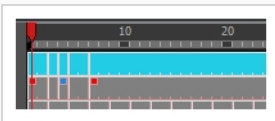

5. If you are working in the Drawing view, in the Drawing View toolbar, enable the Light Table.
6. In the Xsheet or Timeline view, select the cell where you want to add the new details.

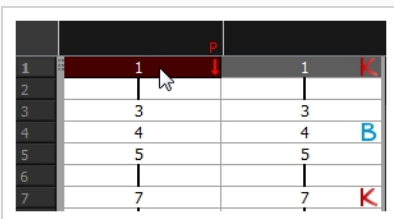

7. In the Colour view, create a new colour (give it the same name and add the prefix _2 or _sec, for example) or select the same rough colour as before.
8. In the Tools toolbar, select your drawing tool.
9. In the Drawing or Camera view, draw the secondary animation on top of your rough drawing.

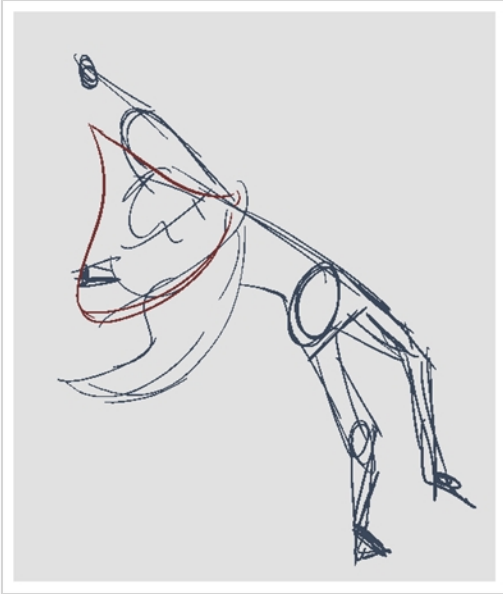

10. Do one of the following:
 - In the Xsheet View, select the next cell in which you want to draw.
 - In the Camera, Drawing or Xsheet view, press F and G to navigate between your drawings.

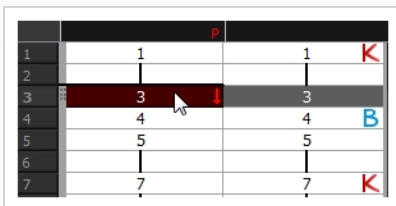

11. Do one of the following:
 - In the top, Drawing View or Camera View menu, select **View > Onion Skin > Show Onion Skin**.
 - In the Timeline view menu, select **Onion Skin > Show Onion Skin**.
 - Press Alt + O.
12. Extend the onion skin.
13. In the Camera or Drawing view, draw the next secondary animation.
14. You can also use the Playback toolbar to play the animation in real time.

Cleaning Animation

T-HFND-006-010



When your rough animation is ready, it is time to clean it up and ink it. The clean-up is also called *tracing*. It consists of tracing solid and clean lines over the rough animation to get closed zones. This is the final paperless animation step before the ink and paint step.





You will need to add a new drawing layer to create your clean drawing. This is the equivalent of adding a sheet of paper and tracing the rough using the animation disk. This allows you to keep the roughs and the cleans intact. You only need to lock the rough layer to prevent it from appearing in the scene.

If you plan on tracing your animation in the Drawing view, use the light table to display all the layers in your project.



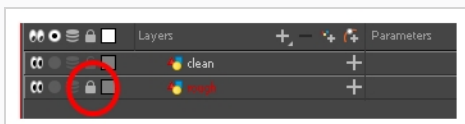

How to trace animation in a new layer

1. In the Layer toolbar, click the Add Drawing Layer  button and add a new layer.
2. In the Timeline view, click the Lock  button of the layer containing your rough animation to avoid selecting the layer in the Camera view.



3. In the Timeline or Xsheet view, in the new layer, select the cell corresponding to the first key drawing of your rough animation.
4. In the Tools toolbar, select the drawing tool of your choice. The Pencil  tool is recommended.
5. In the Colour view, select a colour for tracing your animation. A dark bold colour, such as black, would ensure that it contrasts well with the light colour of your rough animation.
6. In the Camera or Drawing view, start tracing the first key drawing.



7. If you have some other layers in the way, you can disable them temporarily from the Timeline view so that only the rough animation and clean-up layer are displayed in the Camera view.
8. In the Tools toolbar, click the Onion Skin  button and pull on the blue onion skin handles in the Timeline view to extend the number of frames you can see.
9. In the Camera View or Drawing View toolbar, use the Onion Skin Add One Previous Drawing , Onion Skin Reduce One Previous Drawing , Onion Skin Reduce One Next Drawing  and Onion Skin Add One Next Drawing  buttons to adjust the span of the onion skin frame by frame.
10. In the Timeline or Xsheet view, select the next cell corresponding to a rough drawing.
11. In the Drawing or Camera view, trace your next drawing.



12. Repeat the previous steps for each drawing.

Paperless Animation Tools

To understand paperless animation, you must first discover the tools available. There are, of course, drawing tools, but also practical features such as setting a drawing as a key, breakdown or in-between.

When you create hand-drawn animation digitally, there are certain tools you require in order to work efficiently, as you would with an animation table, paper and pencils.

The onion skin and light table are used to preview previous and next drawings, cells, elements and frames. When designing or animating, it is very useful to see your previous drawings. Just as if you were building a cut-out puppet, you want to view other drawing elements to know where to draw the new element.

Harmony has many useful advanced features such as the Flipping toolbar, enhanced onion skin, extra drawing layers, and automated matte generation.

Displaying Drawing Thumbnails in the Timeline View

T-ANIMPA-006-003

In the Timeline view, it is possible to preview the drawings in your scene by enabling the display of thumbnails for your drawing layers. You can display the thumbnail for all drawing layers or for individual drawing layers. This allows you to preview the drawing in the current frame as well as drawings exposed in every frame of your scene, which can be useful for managing your drawings and for adjusting their timing.

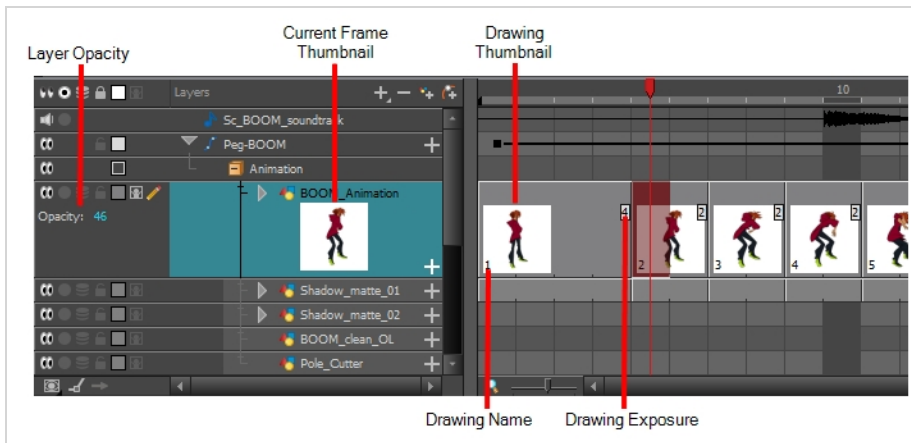

You can enable Thumbnails for all drawing layers simultaneously or for individual drawing layers. When thumbnails are displayed for a layer, the Timeline view also displays the name of each drawing as well as the amount of frames on which each drawing is exposed for that layer. Enabling thumbnails on a layer also gives access to that layer's Opacity parameter in the left panel of the Timeline view.

How to display or hide thumbnails for all drawing layers

1. In the Layers toolbar of the Timeline view, click on the Show/Hide All Thumbnails  button

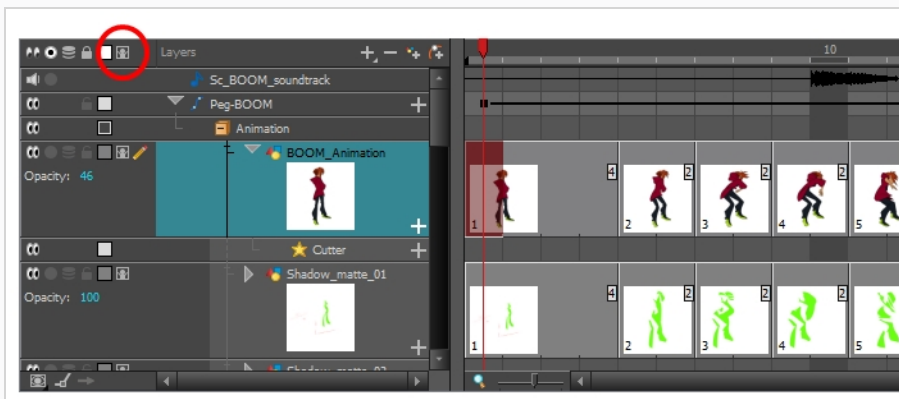

How to display or hide thumbnails for a specific drawing layer

1. Do one of the following:
 - In the Timeline view, left of the layer's name, click on the Show/Hide Thumbnails  button.
 - In the Timeline view, select the layer and press T.

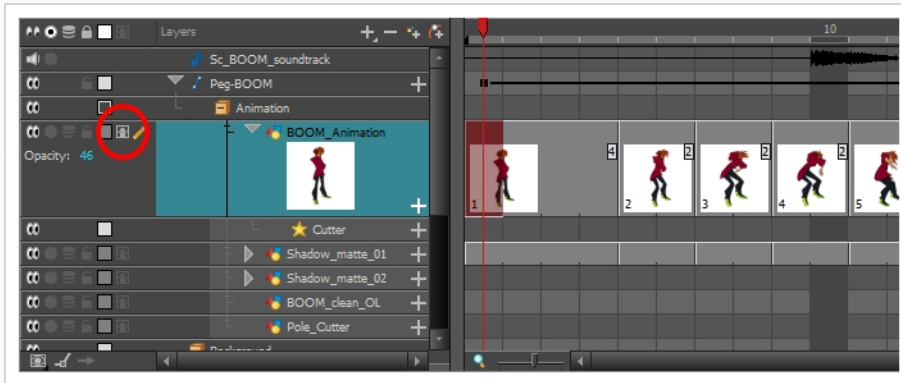

Even when thumbnails are displayed for a layer, it is likely that you won't be able to see the full thumbnails for individual drawings that are exposed over 1 or 2 frames because, by default, frames are not large enough to display their thumbnails. To make the frames larger so that thumbnails have enough horizontal space to be displayed, you must zoom in on the Timeline view.

How to zoom in on the Timeline view.

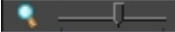
1. Set the focus on the Timeline view, for example by clicking on the Timeline view tab.
2. Do one of the following:
 - Drag the Timeline Zoom  slider to the right.
 - Click on the Timeline view's tab, then press 2 repeatedly.
 - Move the mouse cursor in the Timeline view, then hold Ctrl (Windows/Linux) or ⌘ (macOS) and roll the mouse wheel up.

**TIP**

If you animate mostly on twos or threes, you can adjust the Timeline zoom to fully display the thumbnails of drawings exposed over two or three frames, or you can zoom in enough to display the thumbnails of drawings exposed over a single frame, depending on your preference.

**TIP**

To reset the Timeline Zoom to its default zoom level, click on the Reset Zoom  icon left of the Timeline Zoom slider.

**NOTE**

When zoomed in on the Timeline view, you can tweak the exposure of your drawing by dragging the edges of the drawings with your mouse cursor. This is especially useful when displaying thumbnails as you can visually adjust the timing of your animation. For more information, see [About Rippling and Overwriting the Exposure in the Timeline View](#).

About the Onion Skin

The Onion Skin tool lets you preview the previous and next drawings. By default, the previous drawings appear in a shade of red and the next drawings are displayed with a shade of green. You can change these colours in the Preferences dialog box.

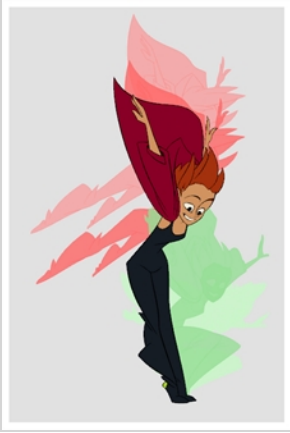

Enabling the Onion Skin

T-ANIMPA-006-008

You can enable the onion skin to see your previous and next drawings as reference,



NOTE

You can modify the onion skin display in the Preferences panel.

How to enable the onion skin

1. Do one of the following:

- From the top menu, select **View > Onion Skin > Show Onion Skin**.
- In the Timeline view, click the Onion Skin  button on a layer.

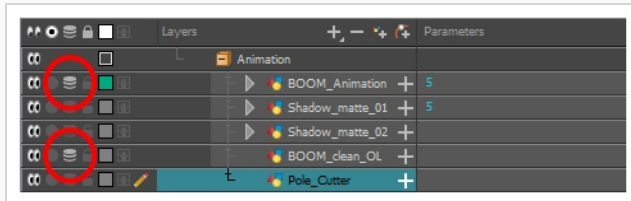

- In the Tools toolbar, click the Onion Skin  button.
- Press Alt + O.

Blue arrows appear on both sides of the play head.

2. Drag the blue arrows to add more frames to the onion skin display.

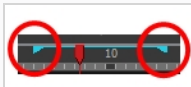

Generating a Matte

T-ANIMPA-006-013

You can quickly generate a matte to be displayed behind your rough animation so you don't see the background through the drawings. It can be generated in any art layer.

How to generate a matte

1. Do one of the following:
 - In the Tools toolbar, select the Select  tool.
 - Press Alt + S.
2. In the Camera or Drawing view, select the drawing you want to create a matte for.



NOTE

You can also apply the operation to all the drawings in the layer at the same time.

3. Do one of the following:
 - In the Camera or Drawing menu, select **Drawing > Generate Auto-Matte**.

The Auto-Matte dialog box opens.

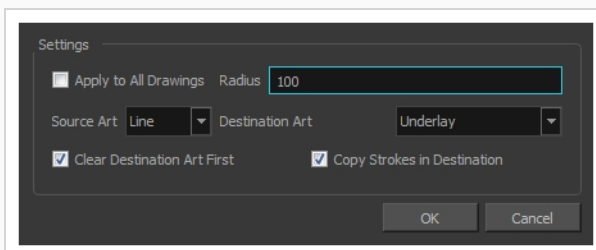

4. If you want to create a matte for all the drawings included in your layer, select the **Apply to All Drawings** option.
5. Depending on how precise or rough your line is, increase or decrease the radius value. Use a lower value, the closer to your lines' contours the matte will be shaped. The higher the value, the looser the matte will be shaped.

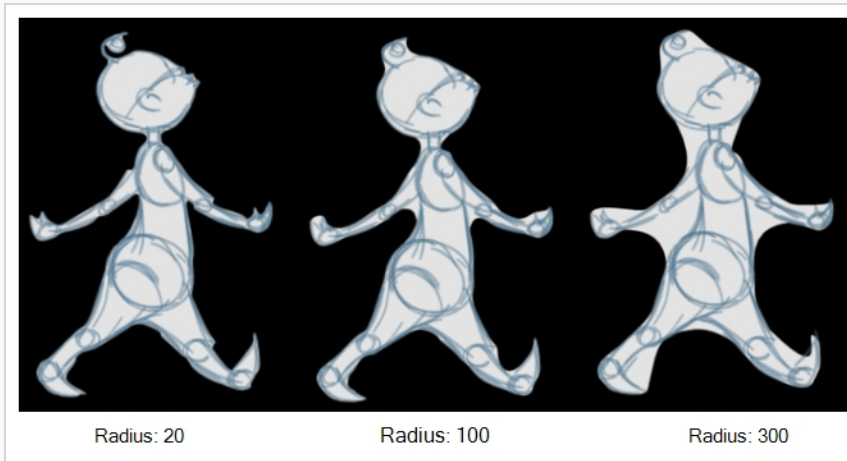

6. In the Source Art menu, select the layer from which you want the matte created: **Line ArtColour Art**.
7. In the Destination Art menu, select the layer on which you want the matte to be created: **Line ArtColour Art**.
8. If you already have artwork on the destination layer and you want the content to be deleted before the matte is added into it, select the **Clear Destination Art First** option.
9. If you want the contour of your lines to be copied as invisible lines in your matte drawing (in case you ever need to keep them for later), select the **Copy Stroke in Destination** option.
10. Click **OK**.

Chapter 6: Timing

When you create hand-drawn animation traditionally or in a paperless environment, it's important to know how to set and modify the timing of your drawings.

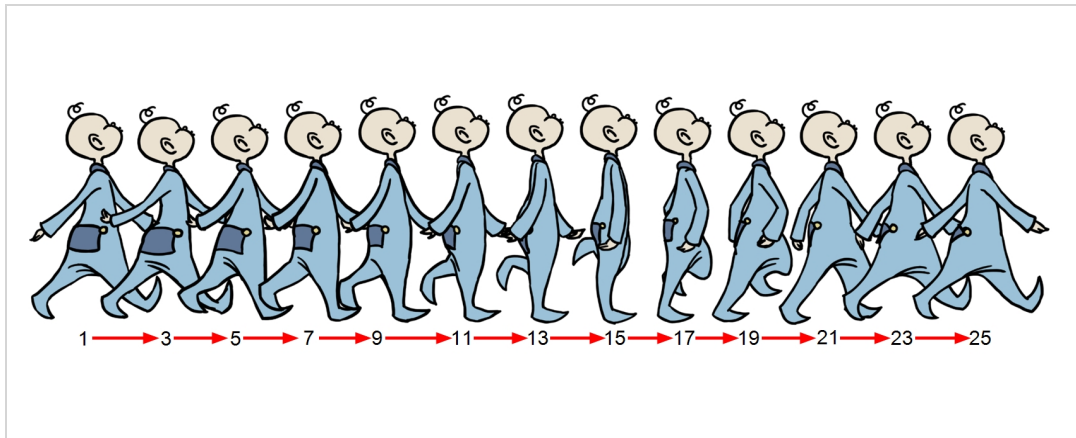

In a traditional workflow, the person in charge of the digital exposure sheet reproduces the paper exposure sheet created by the animator. In a paperless workflow, the animator creates and manages their own exposure sheet directly in Harmony without the need for reproduction.

If you're more of a traditional animator, you will probably work with an exposure sheet. If you're a digital animator, you may prefer to work with a timeline to visualize your timing. Harmony offers both.

The Xsheet view displays the digital reproduction of a traditional paper exposure sheet used in hand-drawn animation. You can set the animation sequence's exposure and name the drawings.

The Timeline view is also used to visualize timing, and represents elements and groups of elements as layers.

You can adjust timing in both views; your choice depends on which technique you're accustomed to using. Depending on your working style, some actions may seem preferable to do in one view instead of another. Many of the actions you perform in the Xsheet can also be accomplished in the Timeline. This chapter will often show both techniques. You can choose which one you prefer.

In this chapter, you will learn how to work on your drawing's exposure and length. The exposure and animation paths for symbols are covered in separate chapters.



NOTE

The exposure sheet is not mandatory for cut-out animation. It can be useful for creating characters and parts, but is not really needed for animation and timing. If you plan to work with cut-out animation, you can still learn useful tips by reviewing the section on exposure sheets.

About Scene Length

In Harmony, the length of each scene is determined by the amount of frames it contains. You can calculate the amount of frames your scene requires based on the amount of time it should span over with the formula, in which **l** is the scene's length, **s** is the amount of seconds your scene requires, and **fps** is the scene's frame rate.

$$l = s \times fps$$

Likewise, a scene's length in seconds can be calculated with the reverse formula:

$$s = l \div fps$$

By default, scenes created in Harmony are 60 frames in length. At 24 frames per second, this makes a scene of 2½ seconds in length. You should set your scene's length based on how much time you plan for it to require after creating your scene so you can plan your animation based on the scene's length. However, it is possible to adjust your scene's length at any time. You can also insert or remove frames at any point in your scene.

Setting the Scene Length

T-HFND-007-007

You can set the scene length by entering its exact amount of frames or by adjusting its length using the scene length bracket in the Timeline view.

How to set the scene's length in frames

1. Select **Scene > Scene Length**.

The Set Scene Length dialog box opens.

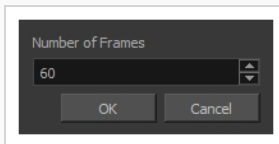

2. In the Number of Frames field, enter the number of frames needed.

How to modify the scene length in the Timeline view

1. In the ruler of the Timeline view, click and drag the red scene length bracket **1** and move it to the left to shorten the scene or to the right to extend the scene.

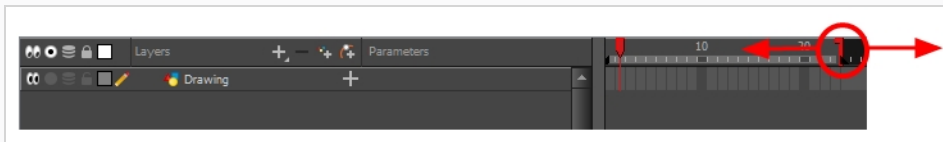

Adding Frames in the Middle of a Scene

You can add frames to your scene before or after the currently selected frame(s). All of your scene's animation before or after the selection will be offset by the amount of frames you added.

How to add frames to the middle of a scene

1. In the Timeline or Xsheet view, select a frame or a range of frames.

	Drawing_3	Drawing_2	Drawing_1	Drawing
1	13	15	1	1
2	14		2	
3	1		3	
4			4	
5		1	5	1
6		2	6	
7		3		
8	2	4		

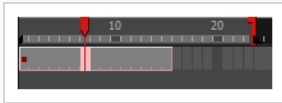

2. Do one of the following:

- From the top menu, select **Scene > Frame > Add Frames Before Selection** or **Add Frames After Selection**.
- In the Xsheet view, right-click and select **Frames > Add Frames Before Selection** or **Add Frames After Selection**.
- In the Xsheet toolbar, click the Add Frames  button to add frame after your selection.
- Press Ctrl + G (Windows/Linux) or ⌘ + G (macOS) to add frames before the selection, or Ctrl + H to add frames after the selection.

The Add Frames dialog box opens.

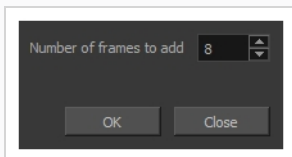

3. In the **Number of Frames to Add** field, enter the amount of frames to add to the scene.
4. Click **OK**.



Adding Frames at the Beginning of a Scene

You can add frames at the beginning of your scene using the Add Frames at Start dialog. All of your scene's animation will be offset by the amount of frames you added.

How to add frames at the start or end of a scene

1. In the top menu, select **Scene > Frames > Add Frames at Start**.

The Add Frames dialog box opens.

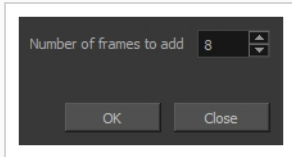

2. In the Number of Frames to Add field, enter the number of frames needed in the scene.
3. Click OK.

Adding Frames at the End of a Scene

You can add a set amount of frames at the end of your scene using the Add Frames at End dialog.



NOTE

You can also extend your scene's length by entering its total length or by manipulating the scene length bracket in the Timeline view—see [Setting the Scene Length on page 285](#).

How to add frames at the start or end of a scene

1. In the top menu, select **Scene > Frames > Add Frames at End**.

The Add Frames dialog box opens.

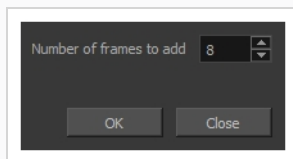

2. In the **Number of Frames to Add** field, enter the number of frames to add to the scene.
3. Click OK.

Removing Frames from a Scene

It is possible to remove frames from your scene. Your scene will be shortened by the amount of selected frames, and all the animation after the selection will move back to close the gap.

How to remove a frame or a range of frames in the Xsheet view

In the Xsheet view, you can remove any selected frame range, such as the last frame.

- In the Xsheet view, do one of the following:
 - Select a frame in a given column.
 - Select a frame range by clicking the first frame's number and then dragging the selection highlight down to the last frame to delete.

	Drawing_3	Drawing_2	Drawing_1	Drawing
1	13	15	1	1
2	14		2	
3	1		3	
4			4	
5		1	5	
6		2	6	
7		3		
8	2	4		
9	3	5		2
10	4	6		3
11	5	7		4
12	6	8		
13	6	9		
14	7	10		5
15	8	11		6
16	9	12	7	7
17	10	13		8
18	11	14		
19	12			
20				
21				

- To delete the selected frames, do one of the following:
 - From the top menu, select **Scene > Frame > Remove Selected Frames**.
 - Press Del to delete the selection.
 - Click the Remove Frames  button. To remove several frame selections, click the button repeatedly.

If you selected a range of frames, the Warning dialog box may open.

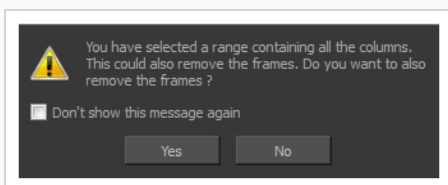

3. To complete the operation:

- Click **Yes** to delete the selection.
- Click **No** to delete only the exposure in the cell and not the frames.
- Select the **Don't Show This Message Again** option to prevent the warning message from being displayed each time you delete a frame range.

About Layers and Columns

T-RIG-009-003

Before filling in any values or setting any timing or exposure, you need to create drawing elements. Each drawing element is represented as a vertical column in the Xsheet view and a horizontal layer in the Timeline view.

In Harmony, whether you work in the Timeline or Xsheet view, any modification you do to one view will be applied to both.

When you add a drawing element to your scene, a folder is added to the scene directory. This folder is named the same way as the drawing element and is in fact, linked to the drawing element. Its purpose is to contain all the drawings related to this element (layer, column). For example, in cut-out animation, a character can have many heads available. All of the head drawings will be contained in this folder, even if they are not exposed in the Timeline or the Xsheet view.

Drawings are exposed in cells/frames and linked to the drawings saved in the layer's directory. When you remove a drawing from a cell/frame, it is not displayed, but still exists in the directory.

When you create a drawing cycle, all of the repeated drawings are linked to the original files. This means that when you modify, repaint, or correct a drawing named "1," all exposures of drawing "1" are updated simultaneously. In order to modify a drawing independently from its other exposures, you must duplicate the drawing.

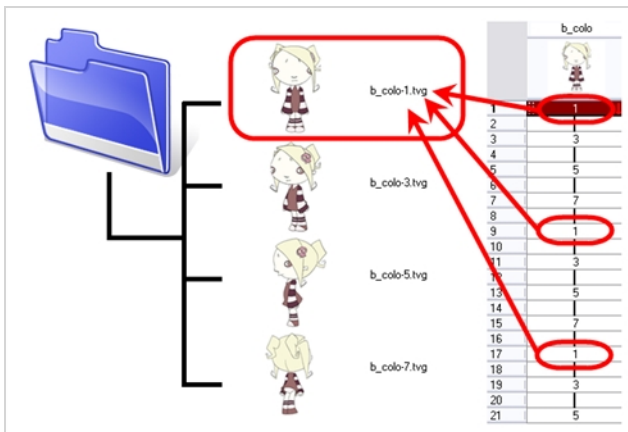

NOTE

There are different element types available, such as sound and expression. A sound element contains sound files. Expressions, Beziers, 3D path, Quadmaps and Pegs are for motion purposes during the compositing step. It's not necessary to create these types to create your exposure sheet.

You can add drawing elements from the Timeline view, Xsheet view, and the Scene menu.

Layer and Column Types

A column is also known as a layer. There are several types of layers you can add in the Timeline and Xsheet view. Each layer is indicated by an icon to help you differentiate them. Some layers are represented differently in the Xsheet view.

Drawing Layer

The most common layer type is the drawing layer.



Any time you need to create a vector drawing or import a symbol or image, you can use a drawing layer. You can also create bitmap artwork on a drawing layer.

Bitmap Layer

If you import a bitmap images (as original bitmap) in your project, they are inserted in a Bitmap layer. If you choose to vectorize your image when you import, the vectorized object will be placed on a Drawing layer.



When importing a bitmap image, you have the option of encapsulating the image in a symbol. If you place a bitmap into a symbol, you will be able to mix vector drawings with it on the same layer.

Camera Layer

You can only have one Camera layer at a time in the Timeline view. By default, there is no Camera layer when you create a scene. You need to add a Camera layer when you want to create a camera motion.



The Camera layer is not visible in the Xsheet view.



NOTE

If you want to have several cameras with different settings, you can keep adding Camera layers in your Timeline view (however, only one will ever be visible at a time as you can only have one camera at a time in your timeline). To switch to a different camera, select **Scene > Camera** and select another camera layer.

Effect Layer

To enhance the look of your scene, you can add effect layers and attach your drawings to them.



When you select the Effect layer in the Timeline view, the effect's parameter columns are displayed in the Functions section of the Xsheet view.

Colour-Card Layer

The Colour-Card layer is used to add a plain colour background to a scene. By default, your scene has no background colour and if you render it as a QuickTime movie or image sequence, it will have a black background.



This layer is not visible in the Xsheet view.

Group Layer

A Group layer can be used to organize the Timeline view.



You can drag and drop other layers onto a Group layer and then collapse the Group layer to hide these other layers from view.

Peg Layer

A Peg layer is a trajectory or motion path layer that does not contain drawings. It can be attached to any drawing layer, cut-out puppet, or other peg layers; they will all follow the trajectory you set in the Peg layer.



When you select the Peg layer in the Timeline view, the peg's function columns are displayed in the Functions section of the Xsheet view.

Quadmap Layer

A Quadmap layer can be described as a deformation transformation layer that does not contain drawings. This can be attached to any drawing layer, cut-out puppet, or even other Peg layers. They will all follow the deformation you set in the Quadmap layer.



When you select the Quadmap layer in the Timeline view, the Quadmap's function columns are displayed in the Functions section of the Xsheet view.

Sound Layer

You can import sound files to add dialog and sound effects to your project. The sound layer will be added to your Timeline and Xsheet view when you import a sound file in your scene.



In the Xsheet view, the Sound layer is a dark grey colour.

Advanced Column Types

In the Xsheet view, you can add several advanced column types to create particular animation paths. When you create these columns, they are not linked automatically to any particular drawing layer. You can create a motion path using these columns and then link or unlink several drawing or peg layers to it.

Advanced column types include:

- Timing
- 3D Path
- 3D Rotation
- Bezier Curve
- Ease Curve
- Expression
- Annotation

Adding Layers and Columns

T-HFND-005-002

There are different ways to add a drawing elements (layers and columns) to your project. By default, when you create a new scene there is one Drawing column in the Xsheet view and one corresponding Drawing layer in the Timeline view.

When you add an element, it will appear as a column in the Xsheet view, a layer in the Timeline view.

Adding Layers in the Timeline View

T-LAY-001-007

Drawing elements are more commonly known as layers in the Timeline view. Create them using the following procedure:

How to add a drawing element from the Timeline view

1. In the Timeline view, click the Add Drawing Layer  button or press Ctrl + R (Windows/Linux) or ⌘ + R (macOS).

The Add Drawing Layer window opens.

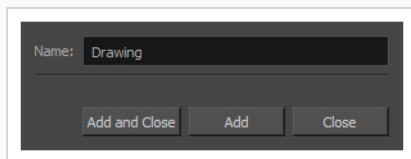

2. In the Name field, name your new layer.
3. Do one of the following:
 - Click **Add** to add a first layer and keep the window open to add more layers.
 - Click **Add and Close** to add a new layer and close the window.

A new drawing layer is added to the Timeline view.

Adding Layers from the Top Menu

Another way to add layers to the Timeline view is through the top menu.

How to add a drawing element from the top menu

1. From the top menu, select **Insert > Drawing**.

The Add Drawing Layer dialog box opens.

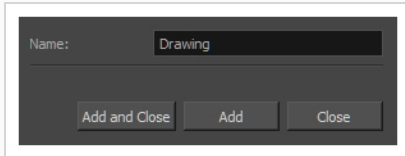

2. In the Name field, type a relevant element name and click **OK**.

The new drawing element appears in your scene.

Adding Columns from the Xsheet View

Drawing elements in the Xsheet view are more commonly known as columns. You can add columns using the following procedure:

How to add a drawing element from the Xsheet view

1. Do one of the following:
 - In the Xsheet menu, select **Columns > Add Columns**.
 - Click the Add Columns + button.
 - Press Shift + C.

The Add Column dialog box opens.

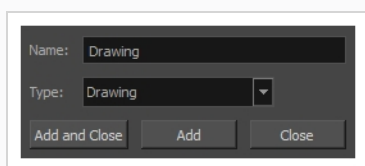

2. In the Name field, type a relevant element name.

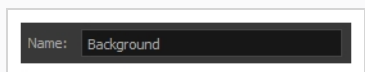

3. In the Type field, select **Drawing**.

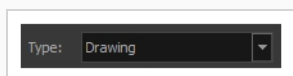

4. To complete the operation:
 - Click **Add and Close** to add your new layers and close the dialog box.
 - Click **Add** to add your new layers and keep the dialog box open to add column.
 - Click **Close** to cancel the operation.

The new drawing element appears in the Timeline, Xsheet and Node views—see [Layer and Column Types on page 293](#).

Using the Advanced Add Column Dialog Box

Deleting Layers and Columns

T-HFND-005-004

You can delete an element in the Timeline view or Xsheet view.

How to delete layers in the Timeline view

1. In the Timeline view, select the layers to delete.

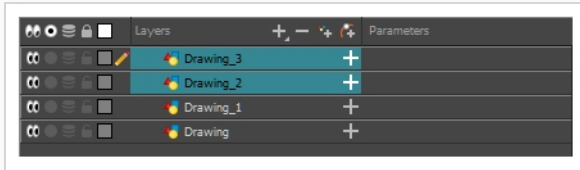

2. Do one of the following:
 - In the Timeline's Layer toolbar, click the Delete Layers button.
 - Right-click on the selection and select **Delete**.

How to delete columns in the Xsheet view

1. In the Xsheet view, select the columns to be deleted by clicking on their header.

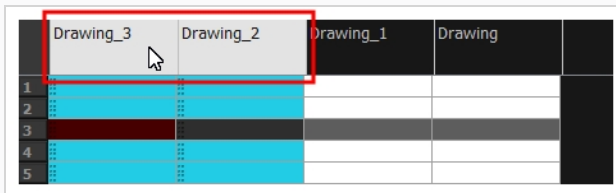

2. Do one of the following
 - Right-click on the selection and select **Delete Columns**.
 - In the Xsheet toolbar, click the Delete Columns button.
 - Press Del.

The Confirm Delete dialog box opens.

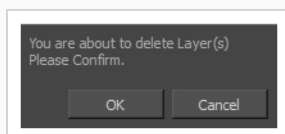

3. To complete the operation:

- Click **OK** to delete the selected layers.
- Click **Cancel** to cancel the operation.

Renaming Layers and Columns

T-LAY-001-008

Once you add layers and columns to your project, you can modify their names.

How to rename a layer in the Timeline view

1. In the Timeline view, double-click on the name of the layer to rename.
2. In the Name field, rename the layer and press Enter/Return.



How to rename a layer in the Layer Properties editor

1. In the Timeline view, double-click anywhere on the layer except the layer name to rename.
The Layer Properties editor opens.
2. In the Name field, rename the layer.

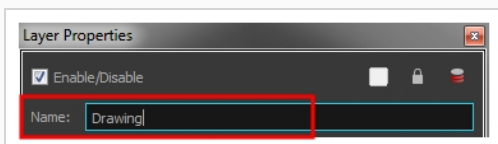

3. Click **Close**.



About Layer and Column Display

You can change the way a column in the Xsheet view displays. You can change the way a layer in the Timeline view or a column in the Xsheet view displays. You can stay organized without changing the content of elements or your animation output.

Expanding and Collapsing Layers and Columns



To simplify the look of the Timeline or Xsheet view, you can expand and collapse some of the layers and columns. If layers are parented to other ones, you can collapse the parent layer to hide its children.

How to collapse or expand selected layers in the Timeline view

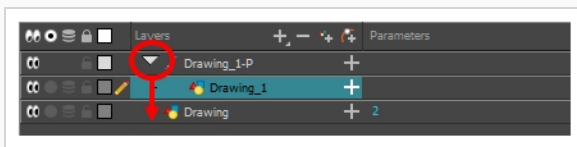
1. In the Timeline view, select the layer(s) to collapse or expand.
2. Do one of the following:
 - Right-click on the selection and select **Collapse/Expand > Collapse/Expand**.
 - Click the Expand Children Arrow  button on the parent layer.
 - Click the Collapse/Expand  button (you may have to customize the toolbar to display it).
 - Press Ctrl + I (Windows/Linux) or ⌘ + I (macOS).



How to collapse or expand all layers in the Timeline view

1. Do one of the following:
 - Right-click on the layers and select **Collapse/Expand > Expand All** or **Collapse All**.
 - In the Timeline toolbar, click the Collapse All  or Expand All  buttons (you may have to customize the toolbar to display them).
 - Press 0 and 9.

How to collapse and expand 3D path or rotation columns in the Xsheet view

1. In the Xsheet toolbar, click the Show Column List  button to display the Functions list.
2. In the Xsheet view, select the column header of the 3D path or 3D rotation column to collapse or expand.
3. Do one of the following:
 - Right-click on the column's header and select **Expand/Collapse > Collapse Selection**

or **Expand Selection**.

How to collapse or expand all 3D path and 3D rotation columns in the Xsheet view

Do one of the following:

- Right-click on any column's header and select **Expand/Collapse > Collapse All** or **Expand All**.
- Press 0 and 9.

Showing and Hiding Layers and Columns

As you work in the Drawing, Camera or Xsheet view, some layers or columns may be in the way, such as those that were used as references. You can hide these layers to make your work area less cluttered and easier to navigate.

Showing and Hiding Layers

T-HFND-005-010

You can show and hide layers in the Timeline view in several different ways.

When using the Solo mode to show or hide layers, here's how it works:

- If you have anything selected, it is not affected.
- When multiple layers are selected and you enable/disable the Solo mode on any of those layers, it is applied to all the selected layers.
- When multiple layers are selected and you enable/disable the Solo mode on layers that are not part of the selection, it is applied only to those particular layers.

When exporting or rendering a scene, the Solo mode setting of layers is ignored.





NOTE

When a layer is affected by an inverted cutter, enabling the Solo mode for this layer will not show it unless the mask is also enabled.

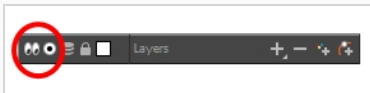

How to show or hide all layers

1. Click one of the following in the Layers toolbar:



- Enable/Disable All  button to show or hide all layers.
Any hidden layers are unhidden, so you can view all layers.
- Solo Mode  button to view disable your current Solo mode selection. Any soloed drawing or sound layers are disabled, so you can view all layers. When you click again on the Solo Mode button, you last Solo selection is displayed.

How to show or hide individual layers

1. Do one of the following:
 - In the Layer toolbar, click the Solo Mode  button.
 - Click the layer's Enable/Disable All  button to show or hide that layer.

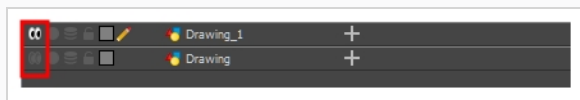

- Press A to show a layer or D to hide selected layers.
- In the Timeline toolbar, click the Enable/Disable button (you may have to customize the toolbar to display it).

When you deselect a layer in the Timeline view, the corresponding column is hidden in the Xsheet view.

How to enable the selected layer and disable all others

1. Do one of the following:
 - Hold down Alt and click the Solo Mode button of the layer you want to solo and hide all other layers.
 - In the Timeline toolbar, click the Disable All Others button (you may have to customize the toolbar to display it).

In the Timeline view, you can hide or show certain types of layers such as Effect.



Showing and Hiding Columns

The Xsheet view has a Column List section that displays all the columns contained in the exposure sheet. It can be used to hide individual columns.

If you need to see a column after it has been hidden, you can display it directly from the Xsheet view without using the Column List section.

You can also hide a column type, such as Drawing or Sound. When you do this, its corresponding layer is disabled in the Timeline view.

How to show and hide columns in the Xsheet view

1. In the Xsheet toolbar, click the Show Column List  button.
2. On the right side of the Functions section, click the Expand  button to display the Column List section.
3. Do one of the following:
 - In the Column List section, select the columns to display and deselect the columns to hide.
 - In the Xsheet toolbar, click the Hide Selected Column  button (you may have to customize the toolbar to display it).

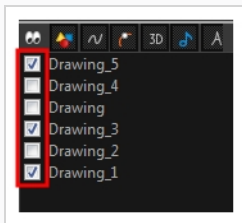

Showing Hidden Columns

In order to save visual space in the Xsheet view, columns can be hidden from view. The hidden layer's presence is indicated by a thicker grey line between columns.

How to show hidden columns in the Xsheet view

1. In the Xsheet view, do one of the following:

- Click the thick grey line that represents a hidden column.
- Right-click on the column header and select **Show Hidden Columns**.
- Press Alt + Shift + H.

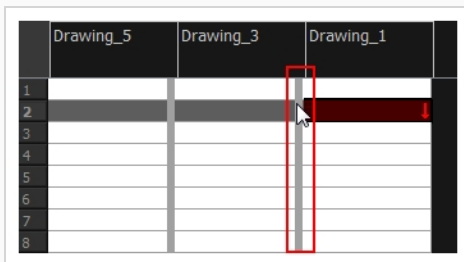

The Show Hidden Columns dialog box opens.

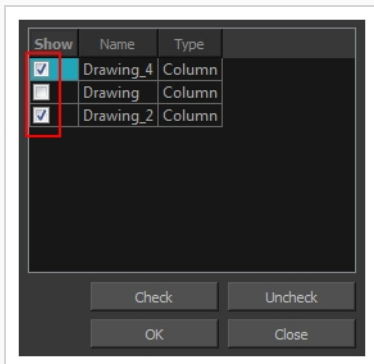

2. In the Show column, select the hidden columns you want to display in the Xsheet view.

- Click **Check** to select all the selected columns.
- Click **Uncheck** to deselect all selected columns.





Showing and Hiding Column Types

You can hide specific column types from view, in order to work more easily with one aspect of your project. For example, you could hide all the Drawing columns in the Xsheet, so that you could work more easily with your 3D Path Columns.

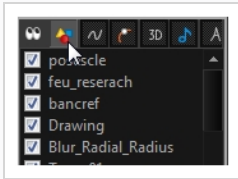
How to show and hide column types using the Column List

1. In the Column List section, click the button corresponding to the column type you want to show or hide.



Column Type	Action
	Show/Hide All Columns
	Show/Hide Drawing Columns
	Show/Hide Function Columns
	Show/Hide 3D Path Columns
3D	Show/Hide 3D Rotation Columns
	Show/Hide Sound Columns
A	Show/Hide Annotation Columns







Displaying Xsheet Thumbnails

When there are a large number of columns in the exposure sheet, it's not easy to quickly identify a particular column. Displaying the column thumbnails makes this easier. This option displays a small thumbnail picture of the current frame below the column header.

How to display the thumbnails

1. In the Xsheet toolbar, click the Show Thumbnails  button.

The thumbnails appear.

	Bg_Camp	Moon Scene_3	Stars Scene_2	Sky Scene	Fire_Colo	Lumberjack_D_H Lumberjack_D_C
1						
2	Camp	Moon	Stars	Sky	1	1
3					2	2

Changing Layer and Column Colours

To easily identify elements in the Timeline or Xsheet view, you can change the colour of layers and columns.

How to change the layer's colour in the Timeline view

1. In the Timeline view, click the Change Track Colour  button of the layer you want to modify.

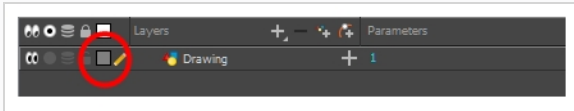

2. In the Select Colour dialog box, select a new colour for your layer.

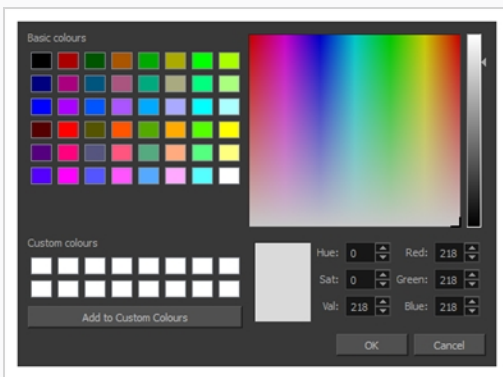

3. Click OK.

The layer's background colour is updated. In a Drawing layer, exposed cells are the brighter, selected colour for easy identification. The corresponding column colour is also updated in the Xsheet.

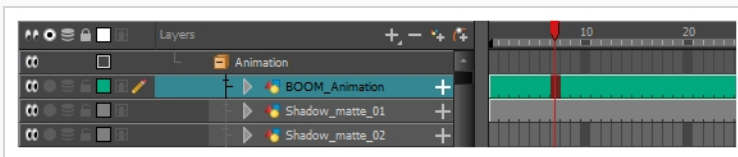

How to reset a layer's colour in the Timeline view

1. In the Timeline view, select the layers to reset.
2. In the Timeline toolbar, click the Default Track Colour  button (you may have to customize the toolbar to display it).

How to change a column's colour in the Xsheet view

1. In the Xsheet view, select one or more columns to modify.
2. Right-click on the column's header and select **Colour > Change Columns Colour**.
3. In the Select Colour dialog box, select a new colour for your columns.

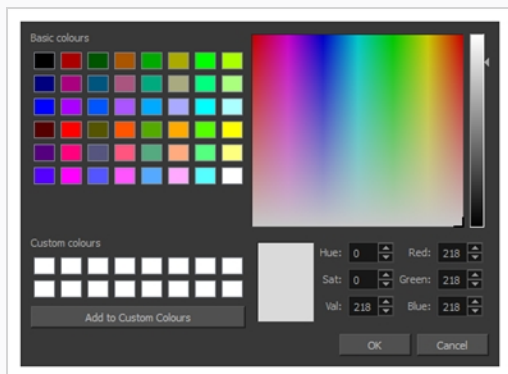

4. Click **OK**.

The column's colour is updated. The corresponding column colour is also updated.

	Plant_000	Tower_000	Tower2_000	Moon
1	1	1	1	1
2				
3				
4				
5				
6				
7				
8				
9				

How to reset the column's colour in the Xsheet view

1. In the Xsheet view, select the columns to reset.
2. Right-click on the column's header and select **Colour > Default Columns Colour**.

Reordering Layers and Columns

You can change the order of your elements in the Timeline view and Xsheet view. When you change the order of your elements in one view, the other one is updated.

How to reorder layers in the Timeline view

1. In the Timeline view, select the layers to move.
2. Drag the selection to the new location.
3. Do one of the following:
 - Drop the selection on an existing layer to make it a child of another element layer.
 - Drop it between the existing layers. Timeline layers that are located above the selection are displayed in front it. Layers located under it in the Timeline View are displayed behind it.

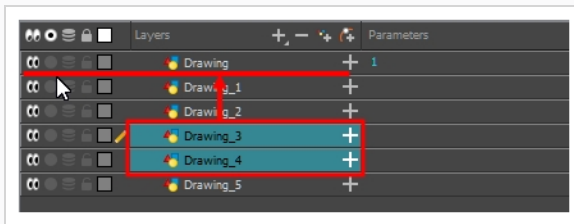

How to reorder columns in the Xsheet view

1. In the Xsheet view, click on the column's header with the middle mouse button.
2. Drag the column to its new position.

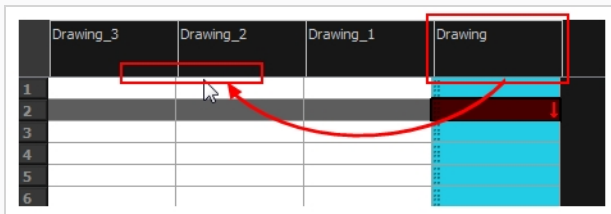

Navigating Layers and Columns

Once a cell is selected in the Timeline or Xsheet view, you can navigate between the drawings, frames, and layers. Displays the previous drawing, next drawing, previous layer or next layer. using keyboard shortcuts that work in the Camera, Drawing, Xsheet and Timeline views.

You can navigate through:

- Drawings
- Frames
- Columns

How to navigate through drawings, and frames and columns

1. In the Timeline or Xsheet view, select a cell.

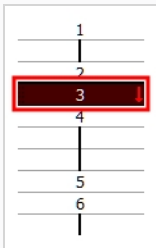
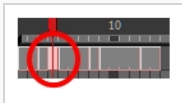

2. Once the cell is selected, you can navigate between:

- **Previous and next layers:** From the top menu, select **Drawing > Previous Layer** and **Next Layer** or press H and J.

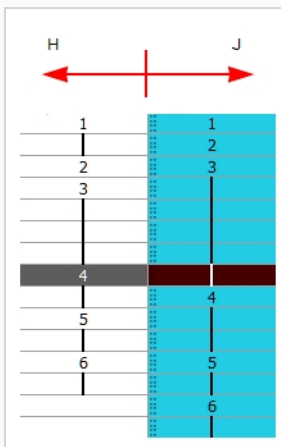

- **Previous and next drawings:** From the top menu, select **Drawing > Previous Drawing**

and **Next Drawing** or press F and G..

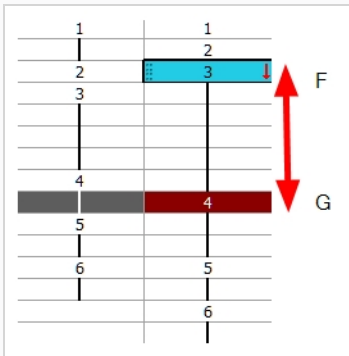

- **Previous and next frames:** From the top menu, select **Play > Previous Frame** and **Next Frame** or press comma (,) and period (.).

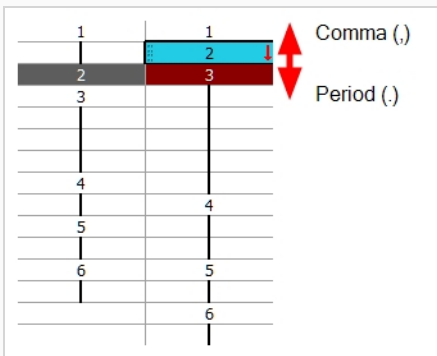

Duplicating Layers and Columns

Duplicating an element provides you with a copy of the drawings and their exposure. You can modify anything you want in the duplicated element without affecting the original one.

How to duplicate an element

1. In the Timeline or Xsheet view, click the layer or column to duplicate.

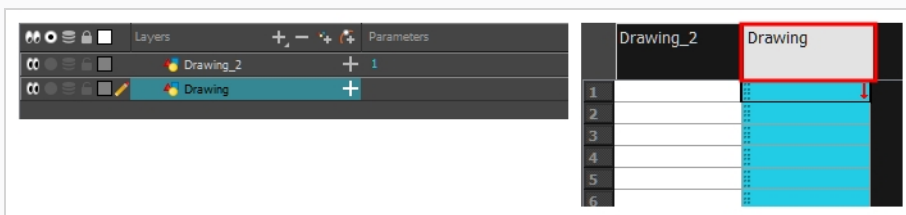

2. Do one of the following:
 - (Xsheet) Right-click on the column and select **Duplicate Selected Columns**.
 - (Timeline) Right-click on the layer and select **Duplicate Selected Layers**.

The new duplicated layer or column appears.

Cloning Layers and Columns

Cloning a layer or column provides you with a copy of the selected element that uses the same drawings as the original. For example, if you modify a drawing in the cloned or original column, it is updated in both columns.

You can choose whether or not to copy the column timing to the cloned columns.

- You can modify the column timing independently from each other, but the drawings remain linked.
- You can copy the columns timing, so drawings and timings remain linked.

You can clone selected nodes from the Node view in the same way.

This is useful when you want to reuse a hand-drawn animation but have different timings.

How to clone an element

1. In the Timeline or Xsheet view, select the layer or column to clone.

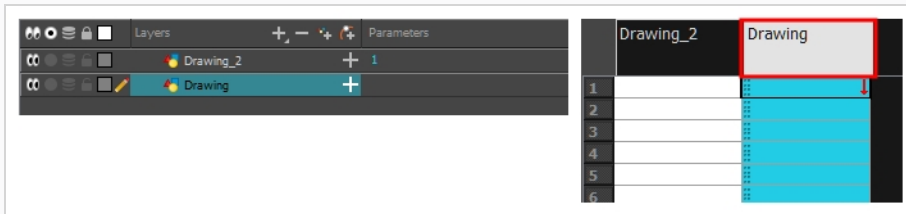

2. Do one of the following:
 - From the top menu, select **Edit > Clone: Drawings Only** to clone only the layer or column drawings.

The new cloned layer or column appears.

Displaying Layer and Column Properties

Each element has its own set of properties that you can modify, including effect and peg layers.

If you want to modify an element's properties, you can display the properties of a selected layer in the Timeline view. If you're working with the Xsheet, you can display its properties as well. You can display a layer's properties as a window or as a view of its own.

The Layer Properties editor allows you to:

- Rename the layer
- Enable or disable the layer
- Lock the layer
- Change the track colour

The Column Properties editor allows you to:

- Rename the layer
- Enable or disable the layer

How to display a layer's properties

1. Do one of the following:
 - In the Layer Properties view is not part of your workspace, from the top menu, select **Windows > Layer Properties**. In the Timeline view, select a layer
 - In the Timeline view, double-click on a layer.
 - Press Shift + E.

The properties display—see Element/Drawing Node in the Reference guide .



About Exposure

T-HFND-006-006

In Harmony, exposure is the term used for the link between a cell, which is a single frame in a drawing layer, and a drawing.

This concept comes from traditional animation. When drawings were finished and ready to be added to the animation, they would be placed under a camera, and taking one snapshot of the drawing would equate to one exposure. Hence, exposure is an important concept for planning out the drawings required for your action, as well as the timing in which they will be displayed as your scene plays out. It is especially important when drawings are used several times in a scene, which is a common practice to save on production time and costs, as you can re-use a drawing by exposing it over multiple frames.

In traditional animation, it is typical to plan a scene by filling the exposure sheet with the exposure before creating the animation. An exposure sheet is made of cells, which represent frames, spread across columns, representing drawing layers, and the exposure is planned by filling each cell with the identification numbers for the drawings you plan your scene's action to require. This allows animators to figure out the timing of their scene's actions and to allocate the amount of drawings each action will require before they start drawing, removing decision making from the animation process.

In Harmony, you can achieve this process by using the Xsheet view, which is very similar to a traditional animation exposure sheet. You can fill each cell in your scene's drawing layers with the number of the drawings you plan to create, at the frames at which you intend to expose them, and set the exposure of each drawing to the amount of frames you intend them to take.

Filling a cell with a drawing identifier allows Harmony to keep track of which frames should display which drawings. For example, if you fill cell 1 and 2 of the drawing layer A with the number 5, then start drawing in cell 1 or 2, Harmony will create the drawing A-5, which will display in layer A when at frame 1 or 2 of your scene. Otherwise, if you start drawing inside an empty cell, Harmony will automatically create a drawing and assign it an available drawing number.

About Creating Exposure

In traditional and paperless animation, it is useful to plan your scene by creating its exposure before creating the drawings. The most basic method of creating a scene's exposure is by manually entering the name (typically a number) of each drawing in each cell of each column in your scene using the Xsheet view. However, Harmony has many tools allowing you to streamline the exposure filling process. If you plan to animate on twos or threes, Harmony can automatically expose each drawing added to your exposure sheet over the preferred amount of frames. You can also fill a range of cells with the same drawing, a number sequence, or a cycle.

Typing Exposures

T-HFND-006-007

To fill in your exposure, you can type the values directly in the Xsheet view.

If you want to type an exact drawing name or value in the Timeline view, you must use the Parameters section of the Timeline.



NOTE

You can only use alphanumeric values (0 to 9, a to z) and the underscore (`_`) and dash (`-`).

How to type a value in the Timeline view

1. In the Drawing Substitution field, double-click to edit the field and type the name of the drawing you want to create.

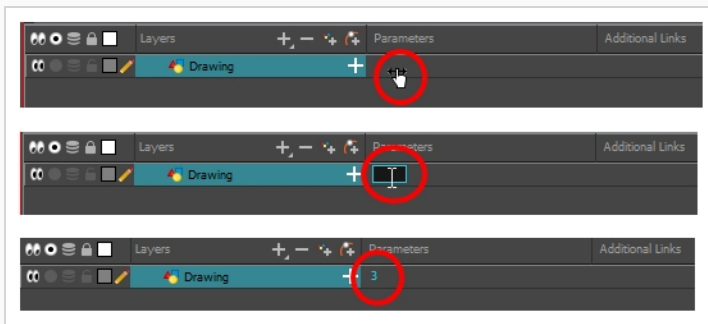

2. Press Enter/Return to validate the value.

How to type a value in the Xsheet view

1. In an Xsheet column, double-click on a cell.

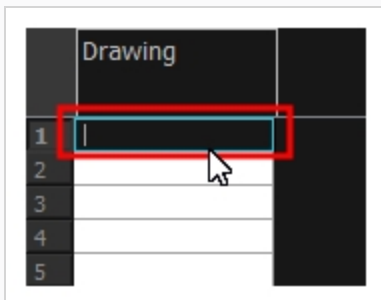

2. Type a value or drawing name in the cell.

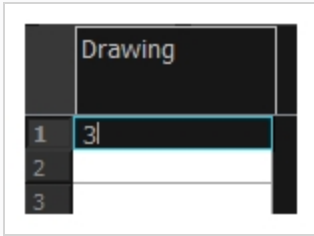

3. Press Enter/Return to move to the next cell.

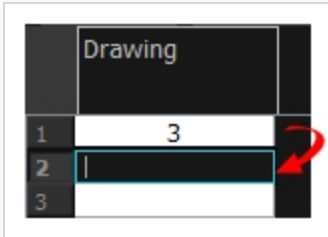

4. Press Esc to exit the typing mode.

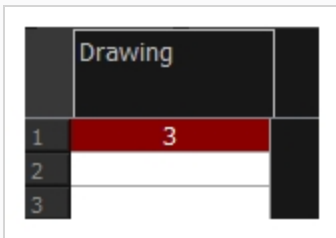

Setting the Exposure Hold

Drawings in an animation project are often exposed for more than one frame to save on production costs. In western animation, each drawing is usually exposed on two frames, and in Japanese animation, each drawing is usually exposed on three frames. In both cases, exceptions can be made for quick or detailed actions that require precise timing.

In the industry, this type of exposure is known as *animation in double* or *triple frames*, or *animation on twos* or *on threes*.

To save time when creating your scene's exposure, you can configure the Xsheet to *hold* the exposure. This will make every new exposure you type into the Xsheet exposed for the preferred amount of frames. After you enter the exposure for a cell, the selected cell will be after this exposure's hold, allowing you to quickly fill a column with exposure while respecting the selected hold.

How to hold an exposure

1. Do one of the following:
 - From the top menu, select **Animation > Cell > Hold Exposure > Hold the desired amount of cells**.
 - Right-click on the Xsheet and select **Exposure > Hold Exposure > Hold the desired amount of cells**.
2. Type a value or drawing name in the cell.
3. Type a value or drawing name in the cell.
 - Press Enter/Return to move on to the next cell.
 - Press Esc to quit the typing mode.

	Drawing
1	3
2	
3	
4	
5	4
6	
7	
8	
9	
10	

Toggle Between Inserting and Overwriting Exposure

T-HFND-006-007

In the Xsheet view, you can fill columns using two different filling modes: Overwrite or Insert. These modes control the filling behaviour. The Timeline view only uses the Overwrite mode.

By default, the Xsheet view is set to Overwrite mode. Adding a new value or a new value sequence overwrites existing ones. The existing timing sequence remains in the same place and is not pushed down the column.

	Original	After Overwrite
1	1	1
2	2	2
3	3	3
4	4	7
5	5	8
6	6	9
7	7	10
8	8	11
9	9	12
10	10	
11		
12		

The Insert mode is the opposite of the Overwrite mode. When you add a new value or a new value sequence over existing ones, the new values are inserted between the old ones. The existing timing sequence is pushed down the column.

	Original	After Insert
1	1	1
2	2	2
3	3	3
4	4	100
5	5	4
6	6	5
7	7	6
8	8	7
9	9	8
10	10	9
11		10
12		
13		
14		
15		

How to switch between the Overwrite and Insert modes

- Do one of the following:
 - In the bottom-right corner of the Xsheet view, click **Overwrite/Insert**.
 - Press **I**.

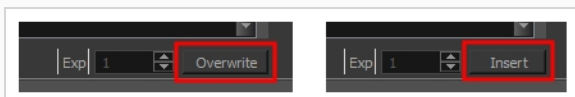

Filling a Selection with a Specific Exposure

You can fill a selection with the same drawing using the Fill Selection dialog box. You can fill a selection of a single drawing, several drawings or even several columns.

How to fill a selection with a specific exposure

1. In the Timeline or Xsheet view, select a cell range.

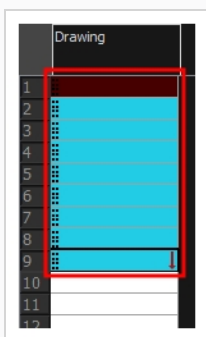

2. Do one of the following:
 - From the top menu, select **Animation > Cell > Fill Selection**.
 - Press **Ctrl + T** (Windows/Linux) or **⌘ + T** (macOS).

The Fill Selection dialog box opens.

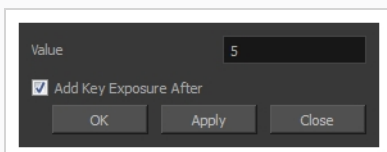

3. In the Value field, type the desired value.
4. To insert a key exposure in the frame following the last cell in the selection, select the **Add Key Exposure After** option. Otherwise, leave it deselected.
5. Click **OK**.



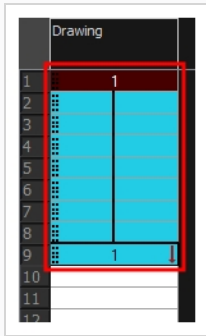



Creating an Exposure Sequence

You can quickly create a sequence with a gesture by holding the Shift key while extending an exposure, or use the Sequence Fill dialog box to create a custom sequence within your selection. While the former is faster, the latter allows you to determine your sequence's hold and increment, to create a backward sequence or to configure it in multiple other ways.

How to extend an exposure to create a sequence

1. In the Xsheet view, select a cell containing a number.
2. In the selected cell, click the red arrow  on the cell's right side. Make sure to see the drag down  cursor.

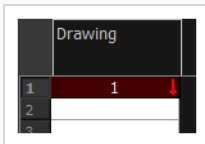

3. Hold down the Shift key. Make sure a plus sign (+) appears.
4. Pull down the selection box to the desired frame.

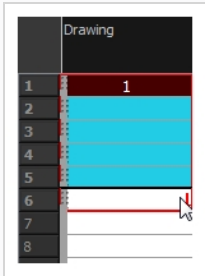

NOTE

The red selection box must be visible when releasing the cursor. If not, the action is considered cancelled.

5. First release the Shift key, then release the mouse button.

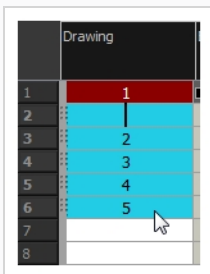

How to fill a selection with a sequence

1. In the Timeline or Xsheet view, select a cell range.

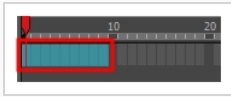

2. Do one of the following:
 - From the top menu, select **Animation > Cell > Sequence Fill**.
 - In the Timeline view, right-click and select **Exposure > Sequence Fill**.
 - Press Ctrl + M (Windows/Linux) or ⌘ + M (macOS).

The Sequence Fill dialog box opens.

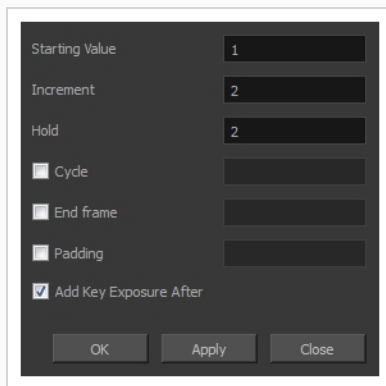

3. In the Starting Value field, type the first number in the sequence.
4. In the Increment field, type the number by which the drawing number will increase from frame to frame. For example, an increment of 1 gives you: **1-2-3-4**; an increment of 2 gives you: **1-3-5-7**; and -2 gives you this: **8-6-4-2**.

Creating an Exposure Cycle

T-HFND-006-008

Once you have entered a series of drawings and exposures, you can create cycles out of them in several ways. This can be useful for example if you want to make or use a looping character's walking animation, referred to as a *walk cycle*.

When you create cycle, each instance of each cycled drawing is linked to the same drawing file. This means that if you change a drawing for the first instance of the cycle, it will update for every other instance of the cycle.

How to create a cycle

1. In the Timeline view, select the cell range to loop.



2. In the Timeline toolbar, click the Create Cycle  button (you may have to customize the toolbar to display it).

The Create Cycle dialog box opens.

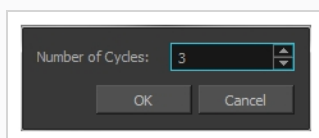

3. Enter the number of cycles you want, including the current selection.

Inserting Blank Cells

You can place an empty cell between other cells.



NOTE

Inserting a blank cell never overwrites existing cells, even if the Xsheet view is set to Overwrite mode. This is because overwriting existing cells with blank cells would replicate the behavior of deleting exposure.

How to insert a blank cell

1. In the Timeline or Xsheet view, select the cell in which you want to insert a blank cell.

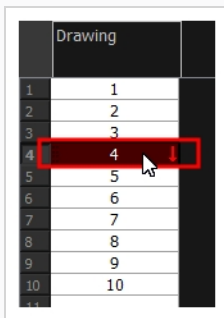
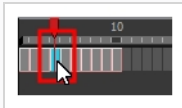

2. Do one of the following:

- In the top menu, select **Animation > Cell > Insert Blank Cell**.
- Right-click and select **Exposure > Insert Blank Cell**.
- In the Timeline or Xsheet toolbar, click the Insert Blank Cell  button. Note that you may have to add this button to your toolbar by right-clicking on it and selecting **Customize**.
- Press Shift + J.

A blank cell is inserted.



Drawing	
1	1
2	2
3	3
4	
5	4
6	5
7	6
8	7
9	8
10	9
11	10
12	
13	

Filling Empty Cells

T-LAY-002-005

You can automatically fill gaps between exposures using the Fill Empty Cells command. This will extend the exposure of cell exposed right before the gap until the end of the gap.

How to fill empty cells

1. In the Timeline or Xsheet view, select a cell range.

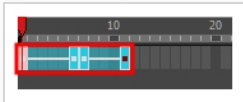

2. Do one of the following:
 - Right-click and select **Exposure > Fill Empty Cells**.
 - From the top menu, select **Animation > Cell > Fill Empty Cells**.
 - In the Timeline toolbar, click the Fill Empty Cells  button.

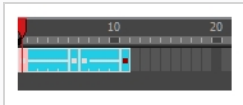

Each drawing in the selection is exposed in the range of empty cells that follow it.

Toggling Extending Previous Drawing Exposure

T-HFND-006-005

With the Extend Exposure of Previous Drawing preference enabled, you can configure Harmony to automatically extend a previous drawing's exposure when creating a new drawing, automatically filling the gaps as you create drawings.

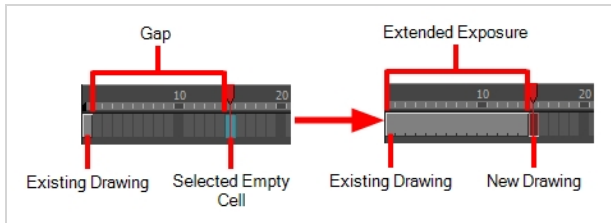

This preference is enabled by default. If you disable it, gaps between previous drawings and new drawing will not be automatically filled:

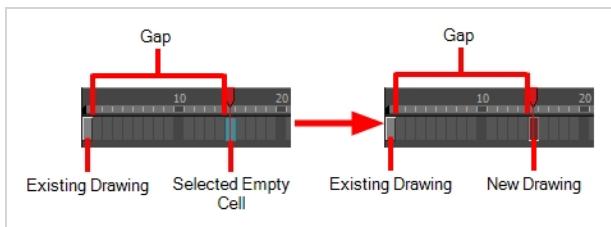

How to enable or disable the Extend Exposure of Previous Drawing preference

1. Open the Preferences dialog box by doing one of the following:
 - Select **Edit > Preferences**.
 - Press **Ctrl + U** (Windows/Linux) or **⌘ + U** (macOS).

The Preferences dialog box opens.

2. Select the **General** tab.

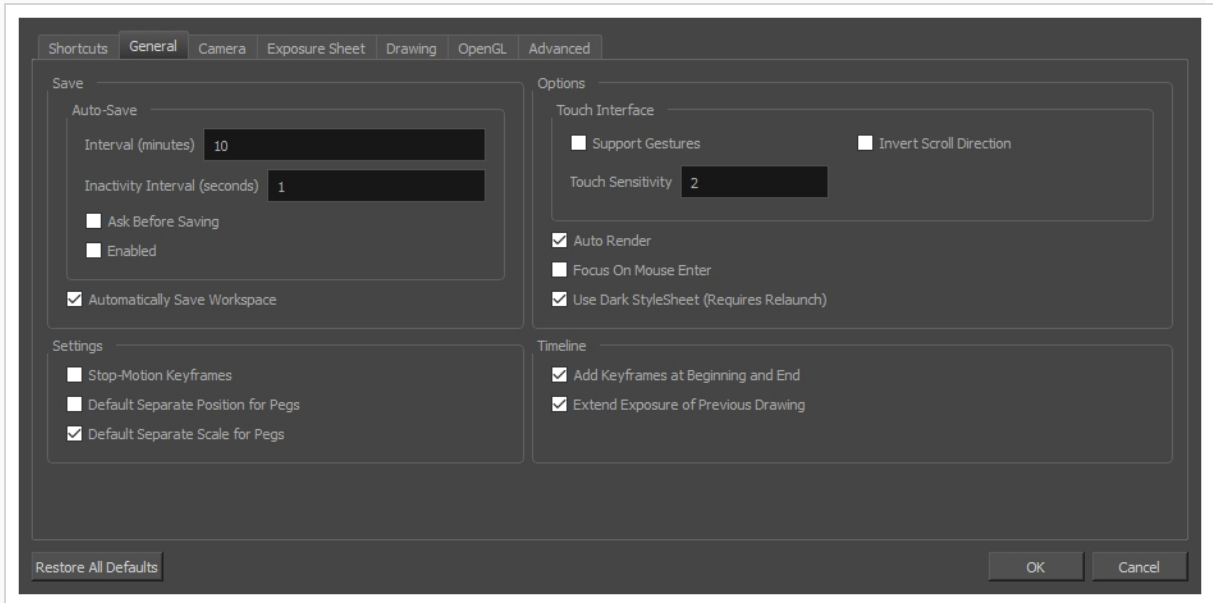

3. In the Timeline section, check or uncheck the **Extend Exposure of Previous Drawing** option.

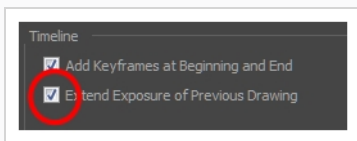

4. Click **OK**.

About Adjusting Exposure

The exposure of drawings in a scene often needs to be adjusted as you flesh out your animation and your scene's action starts taking form. Your scene's action may require more or less drawings than initially planned, or some drawings may need to be exposed for longer or shorter times than expected. There are many ways to adjust your scene's exposure, giving you the flexibility to quickly make changes and test them so you can fine-tune your animation.

Increasing Exposures

T-ANIMPA-006-005

Increasing the exposure Adds one more exposure to a selected cell; repeating this action adds an extra cell each time. This is an efficient way to extend a drawing's exposure and is always set in Insert mode. Increasing an exposure pushes the existing exposure forward.

How to increase exposure

1. In the Timeline or Xsheet view, select a cell.

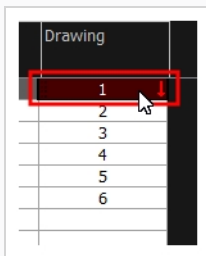
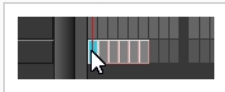

2. Do one of the following:

- Press +.
- At the bottom-right corner of the Xsheet view, set the number of cells over which the drawing will be exposed.



- In the Xsheet toolbar, click the Increase Exposure $\text{EX} \begin{smallmatrix} + \\ - \end{smallmatrix}$ button.
- Right-click and select **Exposure > Increase Exposure**.
- From the top menu, select **Animation > Cell > Increase Exposure**.

Decreasing Exposures

T-ANIMPA-006-006

Decreasing the exposure removes one exposure from a selected cell and pulls any cells following it to the beginning of selection. You can do this for one cell or a range.

How to decrease a single exposure

1. In the Timeline or Xsheet view, select a cell.

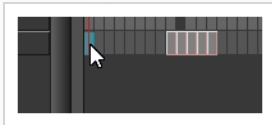

	Drawing_2	Drawing_1	Drawing
1			1
2			
3			
4			
5			
6			
7			
8			
9			2
10			3
11			4
12			5
13			6

2. Do one of the following:

- Press -.
- At the bottom-right corner of the Xsheet view, set the number of cells over which the drawing will be exposed.



- In the Xsheet toolbar, click the Decrease Exposure  button.
- Right-click and select **Exposure > Decrease Exposure**.
- From the top menu, select **Animation > Cell > Decrease Exposure**.

How to decrease a range of exposures

1. In the Timeline or Xsheet view, select a range of cells.



	Drawing_2	Drawing_1	Drawing
1			1
2			
3			
4			
5			
6			
7			
8			
9			2
10			3
11			4
12			5
13			6

2. Do one of the following:

- From the top menu, select **Animation > Cell > Clear Exposure and Pull**.
- Right-click and select **Exposure > Clear Exposure and Pull**.
- In the Xsheet toolbar, click the Clear Exposure and Pull  button.

The exposure is reduced by the selected number of cells.

Extending Single Exposures

T-HFND-007-008

Extending the exposure lets you select a cell and extend it to the desired frame.

How to extend an exposure in the Timeline view

1. In the Timeline view, select the cell you want to extend.
2. Do one of the following:
 - Right-click and select **Extend Exposure**.
 - In the Timeline View menu, select **Exposure > Extend Exposure**.
 - Select **Animation > Cell > Extend Exposure**.
 - Press **F5**.
3. In the Extend Exposure dialog box, enter the frame number to extend your cell to.
4. Indicate if you want to insert the new frames before the following exposure or overwrite it. If you select insert, any following exposure will be moved down. If you select Overwrite, the following exposure will be erased and replaced by the drawing being extended.

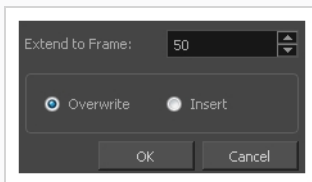

NOTE

You can also select the last cell where you want to extend your drawing to (such as the last cell of the layer), right-click and select **Extend Exposure**. You will not be prompted the dialog box.

How to extend an exposure gesturally

1. In the Xsheet view, select the red arrow  in the cell's right side. Make sure you see the drag down cursor.

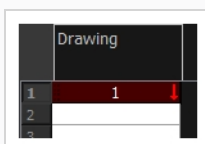

2. Pull down the selected cell to the desired frame.



NOTE

The red selection box must be visible when releasing the cursor. If not, the action is considered cancelled.

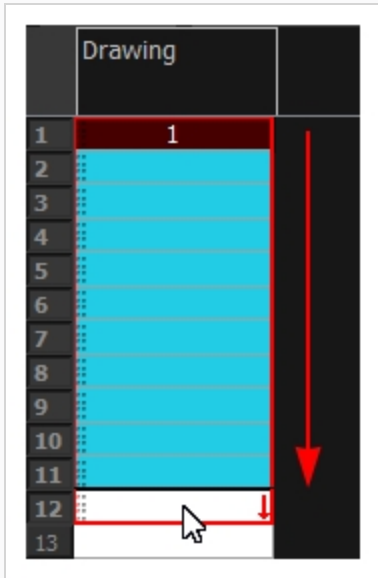

How to extend an exposure from the top menu

1. Select a cell and do one of the following:
 - From the top menu, select **Animation > Cell > Extend Exposure**.
 - Press F5.

The Extend Exposure dialog box opens.

2. Enter the frame number you want to extend the cell to.

Setting the Exposure

T-HFND-006-009

You can easily increase or decrease the exposure for a selected cell range.

How to set the exposure

1. In the Timeline or Xsheet view, select the cell range on which you want to set the exposure.

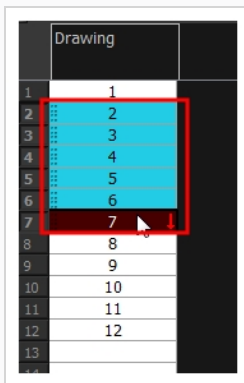
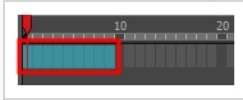

2. Do one of the following:
 - Select **Animation > Cell > Set Exposure to > Set Exposure to 1, 2, 3, or Set Exposure.**
 - In the Timeline toolbar, click one of the Set Exposure EX_1 EX_2 EX_3 $EX_{...}$ buttons. Note that you may have to add this button to your toolbar by right-clicking on it and selecting **Customize**.
 - In the Xsheet view, right-click and select **Exposure > Set Exposure to > Set Exposure to 1, 2, or 3, or Set Exposure.**
3. If you chose the Set Exposure option, the Set Exposure dialog box opens. Enter the number of frames you want the drawings to display and click **OK**.

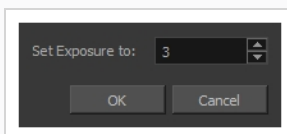

The new timing is displayed in the Xsheet view.

Drawing	
1	1
2	2
3	
4	
5	3
6	
7	3
8	4
9	
10	
11	5
12	
13	
14	6
15	
16	
17	7
18	
19	
20	8
21	9
22	10

Deleting Exposures

You can delete a drawing's exposure in several ways. When you delete a drawing's exposure from the Timeline or Xsheet view, you are not deleting the actual drawing file. You can always retrieve it by typing its name again in a cell.

You can delete the exposure in a selected cell range or delete the entire exposure of a drawing exposed over several cells. Note that you can also delete the exposure for drawings inside a collapsed group.

How to delete selected exposures

1. In the Timeline or Xsheet view, select the exposure you want to delete.
2. Do one of the following:
 - Press Del.
 - Right-click and select **Delete**.

How to clear the entire exposure of a drawing

1. In the Timeline or Xsheet view, select a cell of a drawing exposed over several cells.
2. Do one of the following:
 - From the top menu, select **Animation > Cell > Clear Exposure**.
 - In the Timeline view, right-click and select **Exposure > Clear Exposure**.

Moving Cells

T-ANIMPA-006-007

To readjust your timing, you can drag one or more cells to a new location. You can drag a cell to any other frame in the same column or into another column.

You can turn off the Gestural Drag mode for the Xsheet view to prevent drawings from being dragged from one location to another. This feature does not apply to Annotation columns.

How to drag a cell to another location in the Timeline view

1. In the Timeline view, select one or more cells to move.

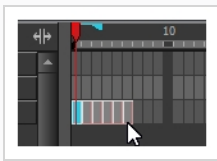

2. Drag the cells to the new location.

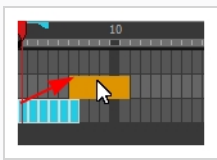

3. Drop the selection by doing one of the following:

- Drop by simply releasing the mouse or pen.

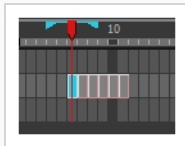

- Hold Ctrl (Windows/Linux) or ⌘ (macOS) while dropping the selection to copy the cells. The original cells will not be moved.

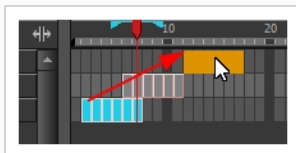

- Press Shift while dropping the selection to insert them between existing frames.

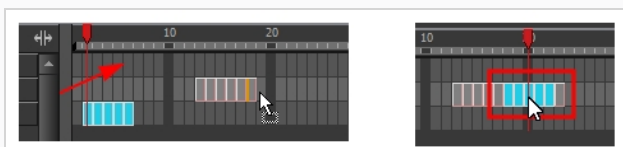

How to drag a cell to another location in the Xsheet view

1. In the Xsheet view, select one or more cells.

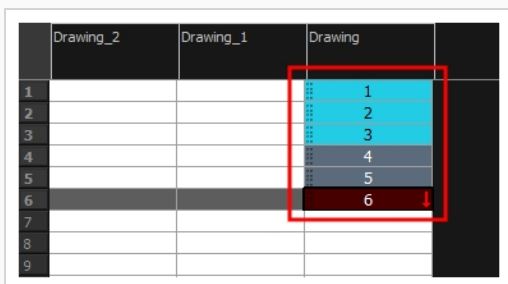

2. In the Xsheet view, position the pointer over the small dotted area on the left side of the selected cells.

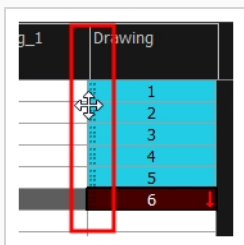

3. Drag the selection to any other cell in the same column or in another column.



4. Do one of the following:
 - Drop the selection to overwrite the existing cells.

	Drawing_2	Drawing_1	Drawing
1		1	
2		2	
3		3	
4		4	
5		1	
6		2	
7		3	
8		4	
9		5	
10		6	
11		11	
12		12	
13		13	
14			

- Hold down Ctrl (Windows/Linux) or ⌘ (macOS) while dropping the selection to copy the cells. The original selection will not be moved.

		1
		2
		3
		4
		5
		6

1		
2		
3		
4		
5		
6		

- Press Shift while dropping the selection to insert it between existing frames.

	Drawing_2	Drawing_1	Drawing
1		1	
2		2	
3		3	
4		4	
5		5	
6		6	
7		7	
8		1	
9		2	
10		3	
11		4	
12		5	
13		6	
14		8	
15		9	
16		10	
17		11	
18		12	
19		13	

About Rippling and Overwriting the Exposure in the Timeline View

T-ANIMPA-006-004

By default, you can only use your mouse to drag and drop frames in the Timeline view. However, if you zoom in sufficiently, you are able to tweak the exposure of each drawing by clicking and dragging the junction between two drawings.

Just like in some video editing software, when tweaking the duration of a drawing by dragging its side, you can decide whether to *ripple* or *overwrite* subsequent frames. This is determined by whether you grab the edge of the drawing by the left or the right side of said edge.

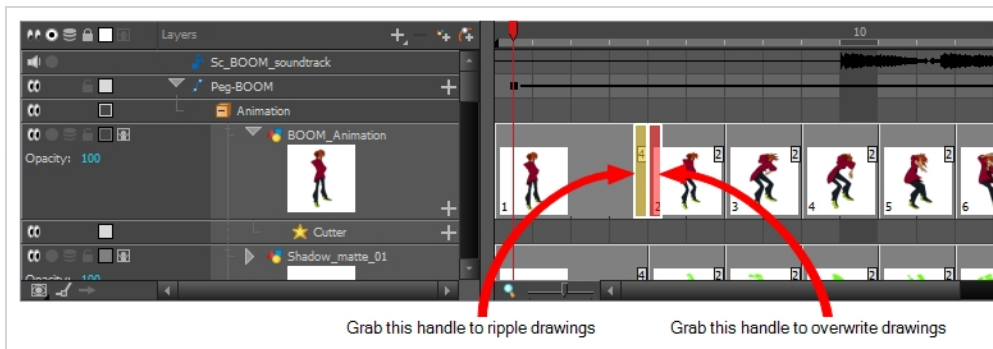



Although not required, this functionality is especially useful when displaying thumbnails in the Timeline view, as you can preview the exposed drawings as you modify their exposure. As a reference, tweaking exposure in the timeline is only possible when you zoom in on the timeline at least close enough to fully view the thumbnails of drawings exposed on two frames. For more information, see [Displaying Drawing Thumbnails in the Timeline View on page 276](#).

Changing Exposure and Rippling Drawings in the Timeline View

If you zoom in on the Timeline view, you can change the exposure of individual drawings by grabbing their right edge with the mouse cursor. If your mouse cursor is just left of the drawing's right edge, a yellow highlight will appear. This means dragging the drawing's edge will adjust its exposure and ripple the ensuing drawings.

How to extend a drawing's exposure and ripple ensuing drawings in the Timeline view

- In the Timeline view, enable thumbnails display for your drawing layer by doing one of the following:
 - Left of the layer's name in the Layers list, click on the Show Thumbnails  icon.
 - Select the drawing layer and press T.
 - Left of the Layers list header, click on the Show All Thumbnails  icon.



NOTE

Displaying thumbnails is not required for tweaking exposure in the Timeline view, but it is very useful.

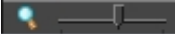
- Zoom in on the Timeline view at least enough to fully display the thumbnails of drawings exposed on twos, by doing one of the following:
 - Drag the Timeline Zoom  slider to the right.
 - Click on the Timeline view's tab, then press 2 repeatedly.
 - Move the mouse cursor in the Timeline view, then hold Ctrl (Windows/Linux) or ⌘ (macOS) and roll the mouse wheel up.

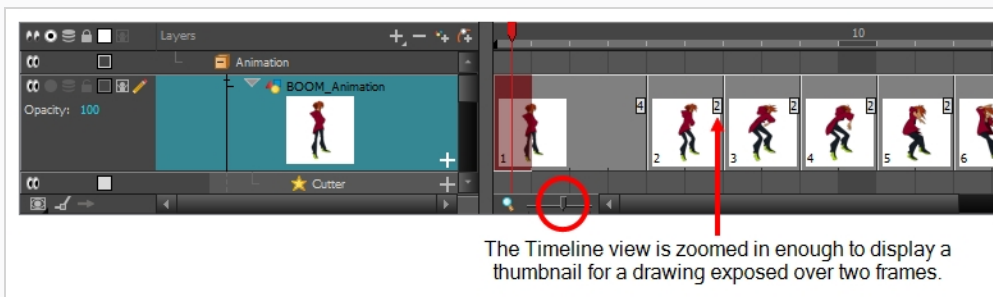

- Move the mouse cursor just left of the right edge of the drawing of which you want to change the exposure.

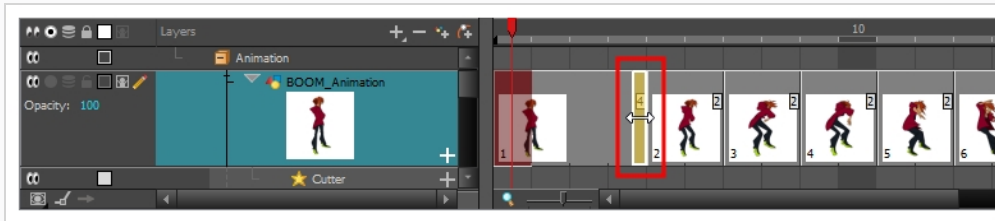

4. Click and drag the right edge of the drawing to change its exposure.

If you move the edge to the right, the drawing's exposure is extended, and all the drawings exposed after this drawing are moved forward.

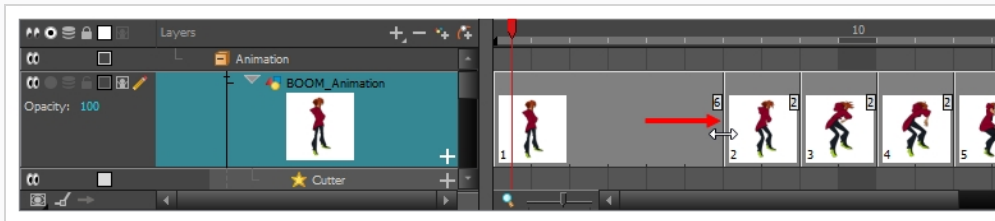

If you move the edge to the left, the drawing's exposure is reduced, and all the drawings exposed after this drawing are moved backward.

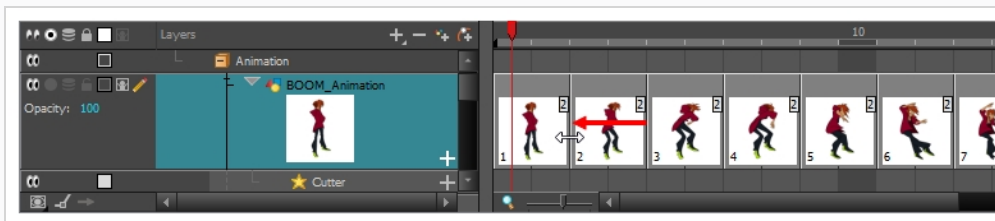

NOTE



You can drag the edge further left and completely remove the drawing, making subsequent drawings overwrite it.



Changing Exposure and Overwriting Drawings in the Timeline View

If you zoom in on the Timeline view, you can change the exposure of individual drawings by grabbing their right edge with the mouse cursor. If your mouse cursor is just right of the drawing's right edge, a red highlight will appear. This means dragging the drawing's edge will adjust its exposure and overwrite ensuing drawings.

How to extend a drawing's exposure and ripple ensuing drawings in the Timeline view

- In the Timeline view, enable thumbnails display for your drawing layer by doing one of the following:
 - Left of the layer's name in the Layers list, click on the Show Thumbnails  icon.
 - Select the drawing layer and press T.
 - Left of the Layers list header, click on the Show All Thumbnails  icon.



NOTE

Displaying thumbnails is not required for tweaking exposure in the Timeline view, but it is very useful.

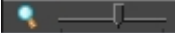
- Zoom in on the Timeline view at least enough to fully display the thumbnails of drawings exposed on twos, by doing one of the following:
 - Drag the Timeline Zoom  slider to the right.
 - Click on the Timeline view's tab, then press 2 repeatedly.
 - Move the mouse cursor in the Timeline view, then hold Ctrl (Windows/Linux) or ⌘ (macOS) and roll the mouse wheel up.



- Move the mouse cursor just left of the right edge of the drawing of which you want to change the exposure.



- Click and drag the right edge of the drawing to change its exposure.

If you move the edge to the right, the drawing's exposure is extended, and all the drawing right after is overwritten.

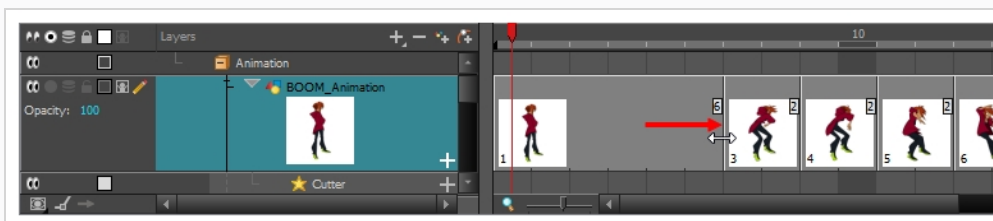

If you move the edge to the left, the drawing's exposure is reduced, and all the drawing right after is exposed over it.

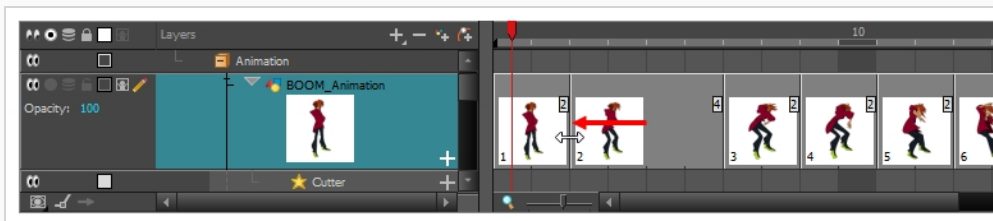

NOTE

You can drag the edge further left and completely remove the drawing, making the drawing right after overwrite it.

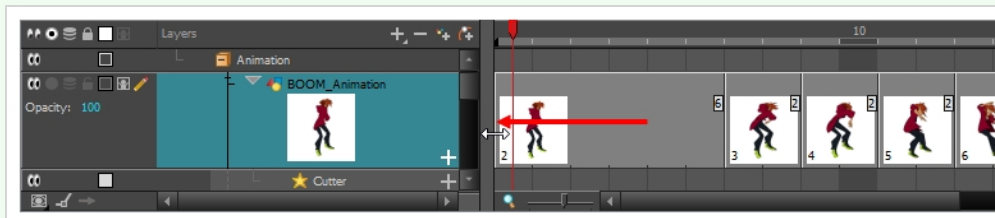

About Key Exposures

Before working with key exposures, it's important to understand how keyframes, exposure and key exposure work in Harmony:

- **Keyframe:** A keyframe is a point in time where a change to the properties of the object or character occurs. In Harmony, keyframes consist of the coordinates that determine how an entire layer and its contents are moved. Keyframes include these parameters: XYZ position, skew, scale, angle and pivot.
- **Exposure:** Exposure is a property; it is the length of time that a drawing is visible over a series of frames. In Harmony, exposure is independent of keyframes. That is, keyframes are not linked to drawings. Keyframes can be moved independently from the drawing exposure.
- **Key Exposure:** A key exposure in Harmony is a type of exposure that forces a drawing to remain exposed on a specific frame. If a drawing is exposed before a key exposure and you swap out that drawing for another one, then the original drawing is retained. This preserves the key drawing. Note that Harmony automatically sets a key exposure when you perform a drawing swap.

Adding Key Exposures

Key exposures are mainly used for swapping drawings in cut-out animation where you will have numerous drawings for the various positions of the mouth or eyes of a character for example.

If there is a particular drawing you want to keep on a specific frame, you can set it as a key exposure. This prevents it from being overwritten by a drawing swap on a preceding frame. A key exposure is simply a property of an exposure that forces it to be exposed on a certain frame regardless of whether the previous exposure is the same drawing or not.



NOTE

Keep in mind that if you modify the artwork in a drawing, all instances of that drawing will be automatically updated even if set as a key exposure. This keeps your existing animation key poses intact. It is frequently used on a mouth or eyes layer.

Example: Swapping a drawing with no key exposure

In the following example, drawing 3 (DR 3) is selected on the timeline and it contains no key exposure.



When it is swapped for drawing 4 (DR 4), the entire duration of drawing 3 substituted for drawing 4.



Example: Swapping a drawing with a key exposure

Here's what happens when swapping a drawing with a key exposure. In the following example, the playhead is positioned in the middle of drawing 5 (DR 5) to set the position for the new key exposure. When the new key exposure is added, drawing 5 is split in two; both halves contain drawing 5. Now if you swap the first drawing 5 for drawing 1, the second drawing 5 retains its exposure.

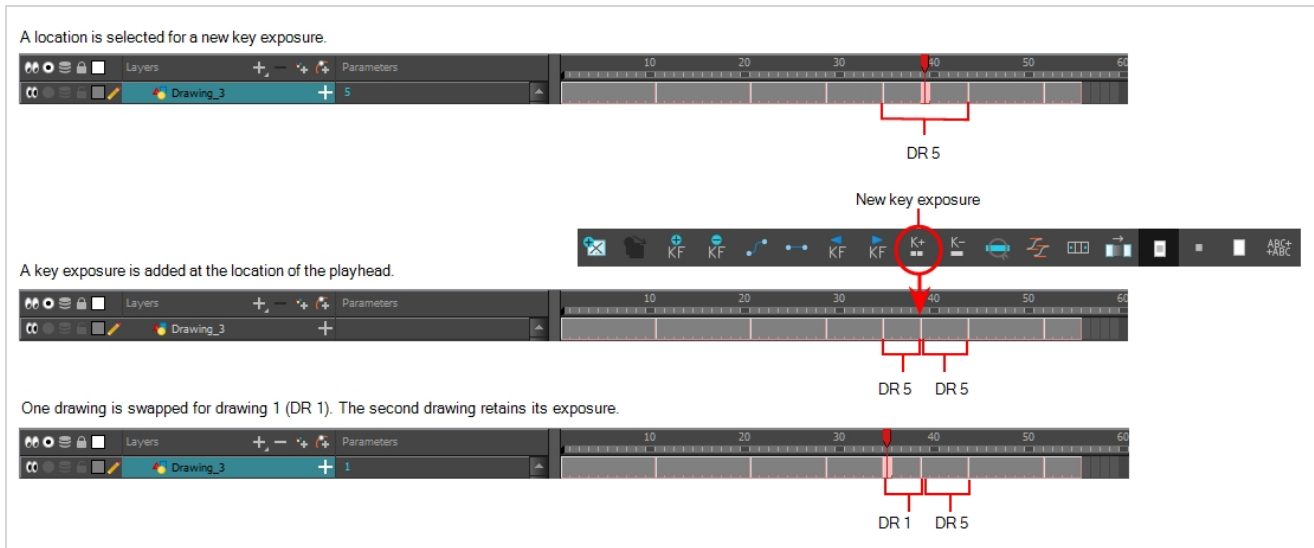

How to add a key exposure

1. In the Timeline view, select the drawing cell to set as the key exposure.
2. Do one of the following:
 - In the Timeline toolbar, click the Add Key Exposure K^+ button.
 - Right-click and select **Exposure > Add Key Exposure**.

A new key exposure is added.

If you added a key exposure at the beginning of the drawing, the entire exposure is filled with that same drawing. If you added a key exposure anywhere other than the beginning of the drawing, then the drawing is split in two and both parts contain the same drawing.

Removing Key Exposures

When you no longer need a key exposure, you can remove it. When you do this, the existing key exposure is replaced by the preceding exposure. In the following example, a key exposure is set to drawing 1 (DR 1). When the key exposure is removed, the exposure is replaced by the preceding exposure, drawing 4 (DR 4).



How to remove a key exposure

1. In the Timeline view, select a key exposure to remove.
2. Do one of the following:
 - In the Timeline toolbar, click the Remove Key Exposure **K-** button.
 - Right-click and select **Exposure > Remove Key Exposure**.

The key exposure is removed and replaced by the preceding exposure.

Removing Duplicate Key Exposures

When working with drawings to adjust the timing of a mouth in a lipsync, for example, and forcing the use of specific key exposures, unnecessary key exposures will be created. You can delete these duplicates without affecting the rest of the drawing. The first drawing of the selection will be used for the range.



NOTE

Duplicate key exposures may occur when pasting with the Enforce Key Exposure option selected.

How to remove duplicate key exposures

1. In the Timeline view, select the layer that contains duplicate key exposures.
2. In the Timeline toolbar, click the Remove Duplicate Key Exposure  button (you may have to customize the toolbar to display it).

About Drawings

Drawings that are created in Toon Boom Harmony are not stored in their cells. They are actual files stored in the project's folder. If you want to rename a drawing or delete a drawing from your project, you need to edit the file and not the cells.

Creating Empty Drawings

T-LAY-003-003

The Create Empty Drawing command automatically Creates a drawing in the selected cell, replacing any drawing that may already be exposed in that cell and the following ones until it meets another drawing, key exposure or a blank cell.

How to create an empty drawing

1. In the Timeline or Xsheet view, select the cell in which you want to create an empty drawing.
2. Do one of the following:
 - In the top menu, select **Drawing > Create Empty Drawing**.
 - In the Timeline view toolbar, click the Create Empty Drawing  button.
 - Press Alt + Shift + R.

The new drawing is created in the Xsheet and Timeline view.

Renaming Drawings

T-HFND-005-003

To rename a drawing, you need to select the drawing cell and use the Rename Drawing command.

You can also rename a series of drawings relative to their frame position, which is useful in hand-drawn animation.

How to rename a drawing

1. In the Timeline or Xsheet view, select the drawing to rename.

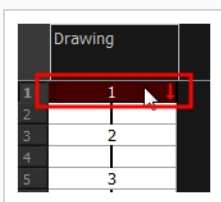

2. Do one of the following:
 - Right-click and select **Drawings > Rename Drawing**.
 - In the Timeline toolbar, click the Rename Drawing  button (you may have to customize the toolbar to display it).
 - Press Ctrl + D (Windows/Linux) or ⌘ + D (macOS).

The Rename Drawing dialog box opens.

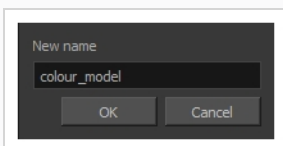

3. In the New Name field, type in the new drawing name.

Deleting Drawings

You can permanently delete a drawing file from a project's folder.



NOTE

Deleting a drawing file is an operation that cannot be undone.

How to delete a drawing

1. In the Timeline or Xsheet view, select the drawings to delete.

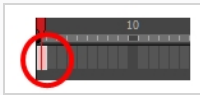

2. Do one of the following:
 - ▶ From the top menu, select **Drawing > Delete Selected Drawings**.
 - ▶ Right-click and select **Drawings > Delete Selected Drawings**.

Duplicating a Drawing

T-LAY-003-004

If you want to modify a drawing that already exists, but keep the original drawing intact, you can duplicate the drawing and work on the copy. When duplicating a drawing, the selected cell is replaced with the new drawing. The exposure of the original drawing that was on the current cell is removed. The original drawing is not deleted from the project folder or other cells in which it is exposed.

With Toon Boom Harmony, you can create a keyframe at the same time as you duplicate your drawing. This way, you can modify and reposition drawings without affecting the original drawing.

How to duplicate a drawing

1. In the Timeline or Xsheet view, select the drawing to duplicate.

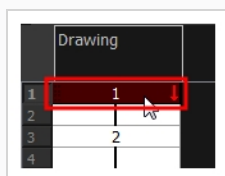

2. Do one of the following:
 - From the top menu, select **Drawing > Duplicate Drawings**.
 - Right-click and select **Drawings > Duplicate Drawings**.
 - In the Xsheet toolbar, click the Duplicate Drawing  button.
 - Press Alt + Shift + D.

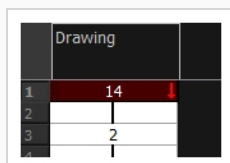

Copying and Pasting Drawings

When you copy and paste a selection in the Timeline or Xsheet view, you are not copying and pasting the actual drawings, you are pasting the exposure. Exposure is a property; it is the length of time that a drawing is visible over a series of frames. In Harmony, exposure is independent of keyframes. That is, keyframes are not linked to drawings. Keyframes can be moved independently from the drawing exposure.

If you want to copy and paste selected drawings into a different layer or paste the selection in the same layer to duplicate the drawings, you must use the Paste Special feature.

There are four different ways to paste your selected drawings with the Paste Special dialog box:

When adding exposures to a drawing layer, drawing files will not be created.

Only create drawing files when they do not exist: When adding exposures to a drawing layer, new drawings will be created only when drawings with the same name do not already exist in the destination.

Replace existing drawings. Create drawing files when they do not exist: Replace drawings with the same names to update a scene with new modified drawings and preserve the animation.

Tip: If you don't want to lose the existing animation when pasting a template, such as when placing new drawings after the animation, then delete the template's animation. It will still have updated the drawings but not override the existing animation.

Always create drawing files: When adding exposures to a drawing layer, new drawings will always be created. If drawing files with the same name already exist, Harmony will create a new name for the drawing.

If you want to perform another Paste Special operation using the same settings you used previously, you can use the Paste Special Again command instead. You can paste your selection using the same settings as in the most recent Paste Special operation, without opening the Paste Special dialog box.

How to paste drawings with the Paste Special command

1. In the Timeline or Xsheet view, select the drawings to copy and press Ctrl + C (Windows/Linux) or ⌘ + C (macOS).

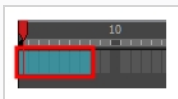

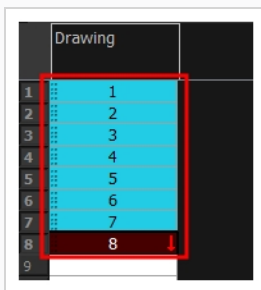

- In the Timeline or Xsheet view, select the cell where you want your pasted selection to start.



- Do one of the following:
 - Right-click and select **Paste Special**.
 - From the top menu, select **Edit > Paste Special**.
 - In the Xsheet or Timeline toolbar, click the Paste Special  button (you may need to customize the toolbar to display it).
 - Press **Ctrl + B** (Windows/Linux) or **⌘ + B** (macOS).

The Paste Special dialog box opens.

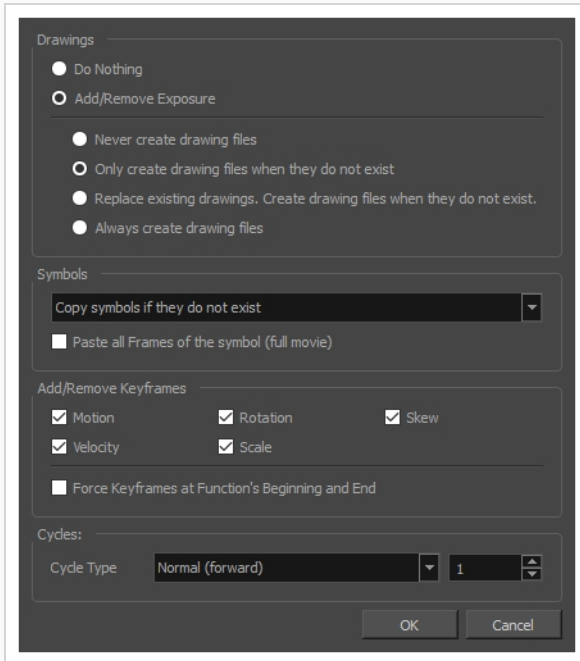

4. In the Drawings section, select the **Always Create Drawings** or **Only Create Drawings When They Do Not Exist** option.

How to paste new drawings with the previous Paste Special settings

1. Do one of the following:
 - From the top menu, select **Edit > Paste Special Again**.
 - Right-click and select **Paste Special Again**
 - In the Timeline or Xsheet toolbar, click the Paste Special Again  button (you may have to customize the toolbar to display it).
 - Press Ctrl + Shift + B (Windows/Linux) or  + Shift + B (macOS).

Chapter 7: Rigging

Harmony is a great tool for building characters. You can use different techniques and features to break down your puppets.

This chapter will guide you through all the steps to create a complete simple rig. Harmony allows you to create very advanced puppets using deformations, hierarchies and z ordering. As you practice and get familiar with those concepts, you will be able to develop more complex rigs and combine various advanced features.

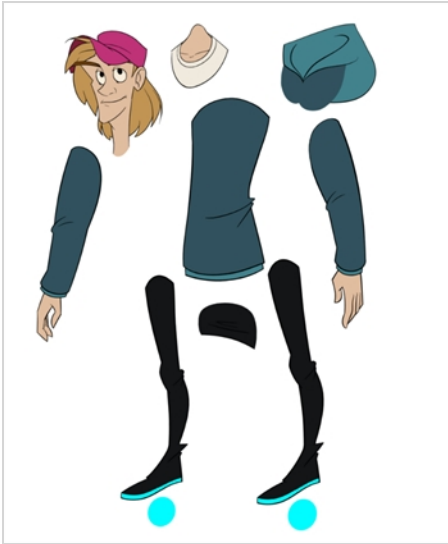

For more great options and features to create powerful rigs, refer to [Deformations on page 533](#).

About Rig Types

T-RIG-001-001

A rig is the process in which you will take apart the multiple pieces of your character and then reattach them together to get them to move individually. Harmony provides you with a multitude of tools to help you build characters. From the simplest of rigs, to a fully rotating character. There are about as many ways to rig a character as there are individuals who make them. The complexity of the rig is often determined by the level of animation to be achieved.

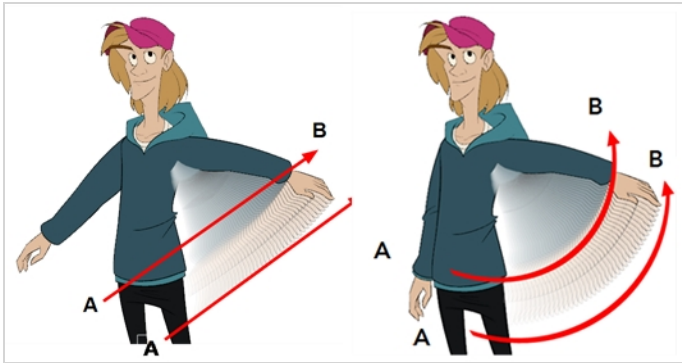

About Simple Rigs

T-RIG-001-002

Simple rigging is very fast and easy to do. It is built as follows:

- All the body parts are independent
- All the timeline layers are attached to a master peg layer (trajectory layer)

The advantage of using this technique is that you are free to move any part around without being influenced by a parent layer.



However, since the parts are not parented to each other, the parts will move from point A to point B along a straight trajectory. The hand will not follow the arm's rotation. You will have to set more keyframes for the hand to move along a curved path.

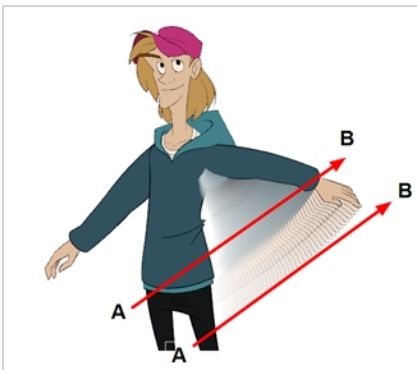

About Drawing Hierarchy Rigs

T-RIG-001-003

When you want one part to follow another part, such as the forearm following the arm, you can attach the layers one to the other. For example, you can attach the forearm layer to the arm layer without having to encapsulate the forearm into the arm layer. They will still be parented, but you can access the forearm directly without having to enter the arm layer.

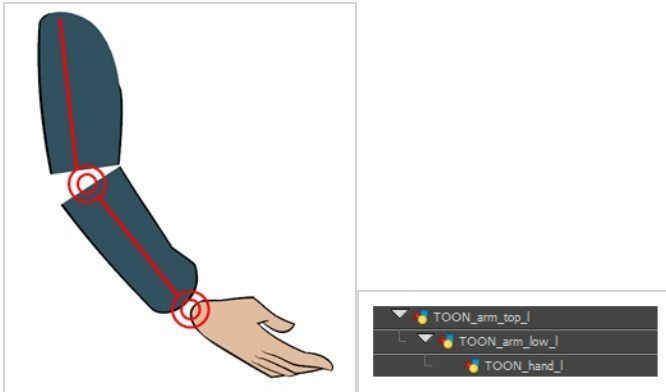

The advantage of parenting layers is that the child layers will follow the parent smoothly without having to select them or create a series of keyframes.

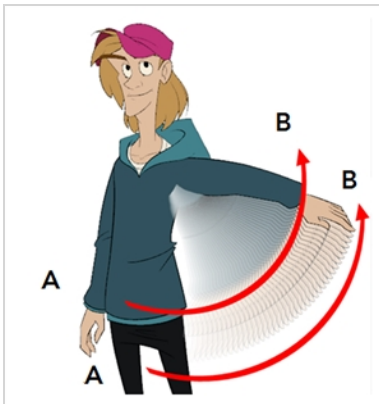

The disadvantage of parenting layers is that you are not able to move the parent independently of its children, since the child layers receive all the transformation information from their parent.

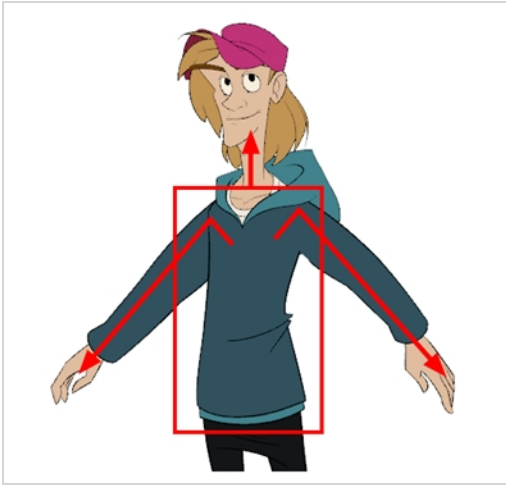

Parenting layers, such as the arms and legs, and allowing the torso and hips to be independent from them is often a good solution.

**NOTE**

To attach one layer to another, you must drag the desired layer onto the other one in the Timeline view.

Harmony offers powerful techniques to create hierarchies between your layers without having to encapsulate layers into each other. These techniques are a great improvement over the less efficient and time consuming method of creating parenting between your layers by inserting symbols into other symbols. Therefore, rigging with symbols inside symbols is **NOT** recommended.

About Peg Hierarchy Rigs

T-RIG-001-004

Peg layers are useful when you are doing more advanced puppet rigging. Peg layers are trajectory layers that do not contain drawings. They are motion paths that you can use to control your entire puppet or advanced hierarchies.

Parenting a drawing layer to a peg layer allows you to divide your motions on two separate levels. You can scale a body part up the chain of pegs directly on the drawing layer. This way, you do not affect any child layers that could be attached to that part.

Then, you can perform your translation and rotation on the peg layer so all the parts attached to that peg layer follow the same trajectory.

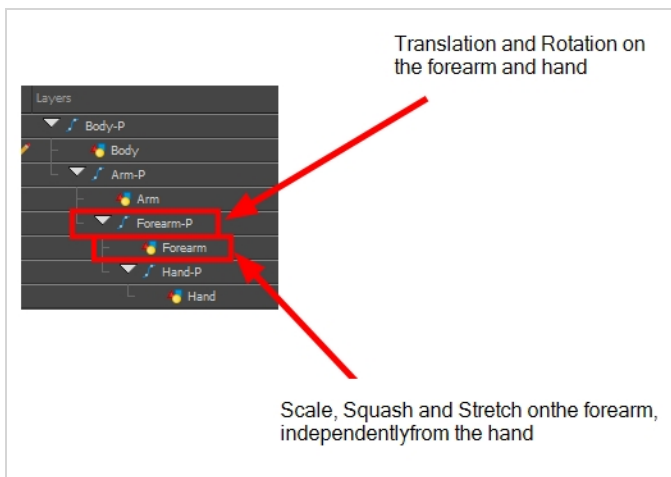

About Scene Setup for Rigging

Planning your rig is an essential step in avoiding missteps at later stages. Once a rig has moved on to the animation level, it becomes more difficult to fix potential blunders, since updating the rig scene doesn't have repercussions on rigs outside of that scene. These different topics will help you avoid such mistakes.

About Models

To begin breaking down your puppet, you must first import your character into a new project. You can also draw your character directly in the scene.



You can import your character in several different formats:

- Library template—see [Library](#)
- External vector format

Model Alignment

When setting the character model in your scene, we recommend that you to center it in the Camera view and scale it to fit inside the safe area frame.

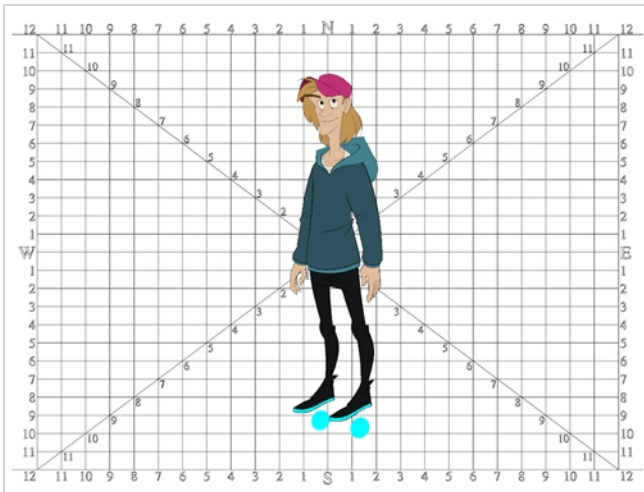

If you have several views of your character, place each view in a separate cell and center them one on top of another. This will facilitate the break down process and ensure that all of your puppets are aligned and the same size.

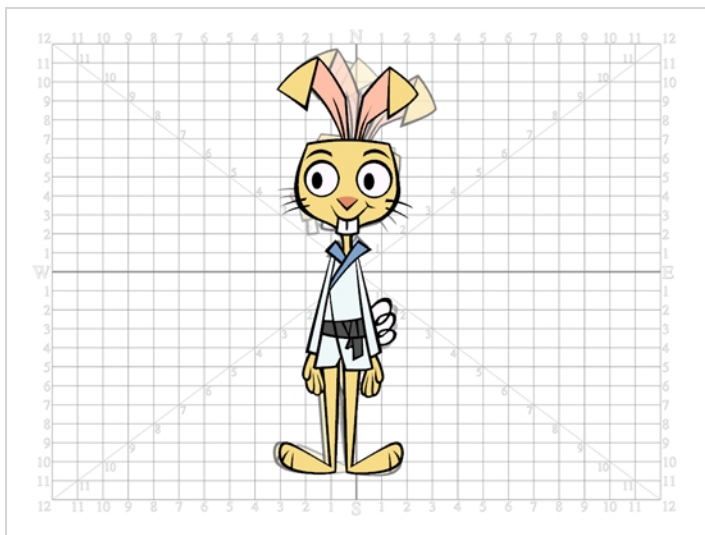
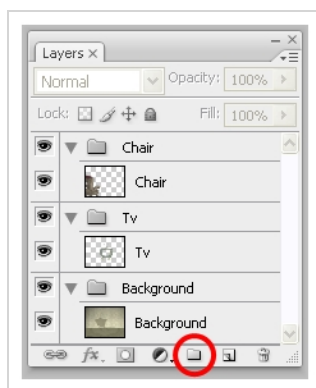

Photo Puppets

If you are creating a cut-out puppet out of photos, break down the different parts in a bitmap editing software. Then, import your parts and vectorize them as textured images.

A good way to set and import your bitmap parts is to organize them in a multilayered PSD file.

In Adobe Photoshop, organize your file so that all your layers are “grouped” into individual folders, or that all the elements you want to import as a single layer in Harmony are grouped together in their own folder. Any layer that is not in a folder group, by itself or otherwise, will not be imported.



About Size Relation

Understanding the relative size of every character and prop is important for maintaining consistency and structure throughout your project.

A production may contain many characters and props. It is not unusual for these to have been created by different people. If there is no size control implemented, the characters and elements created by different artists can vary greatly in size. When this occurs, the characters that are put together in a scene will be out of proportion. The animator or person doing the scene setup will then have to scale them to the correct size.

When a character or a prop is scaled down, the outline will get increasingly thinner. By the time the element is scaled to its proper size, the outline may be so thin that the difference between one character's outline and another's will not look very good.

Line Up

A line up consists of copying and pasting all of your character designs into the same drawing and then scaling them so they are in proportion with each other. This line up is very important and should be handed to any animator, layout and posing artist, or scene setup person working on the project.



For the prop design, it is recommended that you paste one of the main character's hands or even the full body beside the prop. This enables the animator to know what size to draw or set the prop.

In your character design scene, it is a good idea to create a layer for the character line up. The line up is usually done during the character design step. When the character builder imports the model to the break down scene, the size relation should be correct.

Field Chart

The field chart in Harmony is a tool that is very useful when setting the height of characters and props. You can display the field chart using the Show Grid option in the Camera and Drawing views.

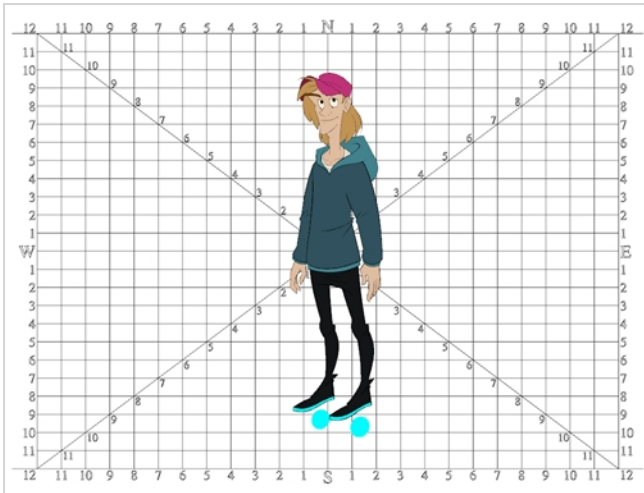

How to display the field chart

1. Do one of the following:
 - ▶ From the top menu, select **View > Grid > Show Grid**.
 - ▶ Press **Ctrl + '** (Windows/Linux) or **⌘ + '** (macOS).
 - ▶ Click the Show Grid  button in the Camera View and Drawing View toolbars.

Brush Size

There are a variety of pens and brushes in Harmony and you can also create and save your own. It is a good idea to create and save pens with precise sizes and parameters to trace and design your models and break downs—see [About the Brush Tool on page 88](#).

Setting Preferences for Rigging

Before you start adding layers to your puppets, make sure the **Default Separate Position** is enabled.

With the **Default Separate Position** preference selected, when you create new peg layers, their X, Y and Z axes are independent from each other.

For cut-out animation, you want to have three independent axes so you can control them individually.

When you lock the three positions together, each time you add a keyframe, it is added on all three positions at the same time.

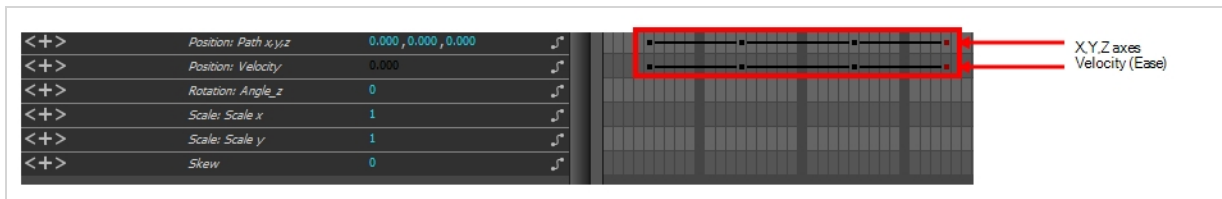

When you separate the three positions and add a keyframe on one axis, it is not added on the other two. This gives you more freedom when animating with motion keyframes and nudging parts forward and backward over time.

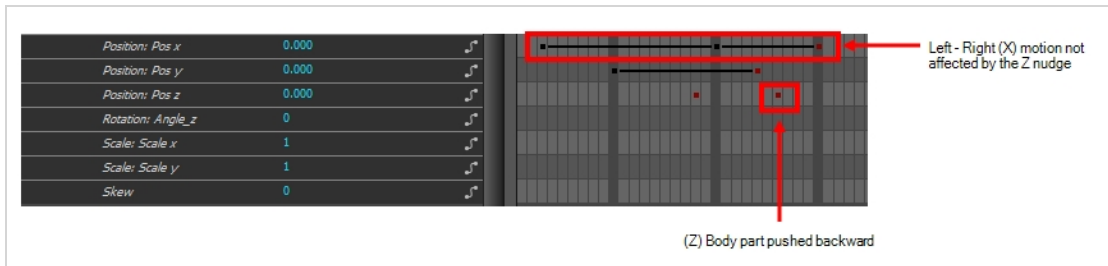

How to set the Default Separate Position option

1. Do one of the following:
 - Windows/Linux: Select **Edit > Preferences**.
 - macOS: Select **Harmony Essentials > Preferences**.
 - Press **Ctrl + U** (Windows/Linux) or **⌘ + U** (macOS).
2. In the Preferences dialog box, select the **General** tab.
3. In the Settings section, select the **Default Separate Position for Pegs** option.
4. Click **OK**.

About Naming Conventions

When working on a production, it is critical to keep work well organized with a naming convention chart before starting the project. When dealing with thousands of characters, pieces and puppets, it is easy to get lost. Proper naming of both drawing layers and drawing substitutions is essential to keeping your workflow consistent throughout your project.

Naming Drawing Layers

It is highly recommended that you incorporate a naming convention for the layers. This will be very convenient in later steps.

One common practice is to add one or two letters for the character/prop name, so that we don't make it too long. You can then add the name of the part that you've separated. It is recommended to add an indicator of the position of your character's symmetrical pieces to keep track of which part you are selecting. Common practice is to add either "F" or "B" (for front and back view) or "R" or "L" (for right or left). Avoid using spaces in between the words and opt for an underscore instead.

- Character Orcus's right arm =

OR_arm_F

or

OR_arm_R.



Pink: Front or Right

Blue: Back or Left

About Character Breakdown

T-RIG-001-006

Now that you have imported or designed your model, the next step is to analyze it. This is to determine what parts will be broken apart and how they will be divided. Will the hair be separated into one, two or three sections? Will the hand be separated from the sleeve? To determine what is best for your character, observe the model in the Camera or Drawing view.

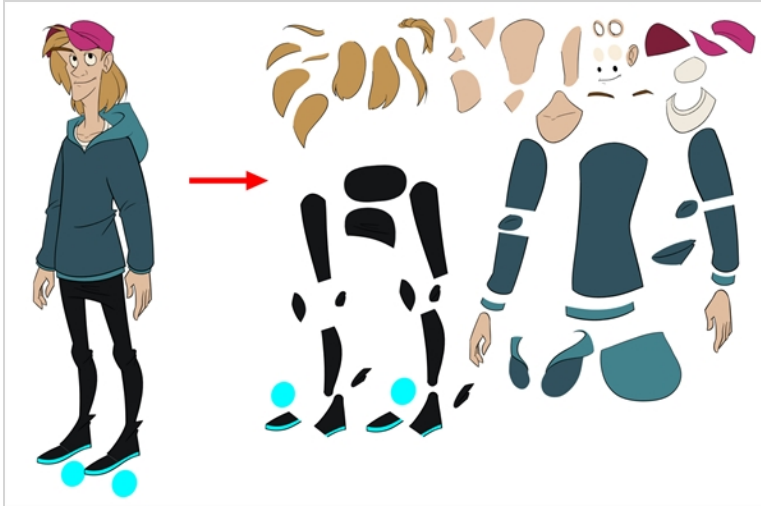

Eyelids and Pupils

For increased flexibility when animating the eyes, you can split them into three layers: the eyeball, the pupil and the eyelid. The eyelid layer is used for the blink and to cut the pupil when it gets too close to the side of the eyeball. For a more advanced break down, the two eyes are separated on their own individual three-layer sets.

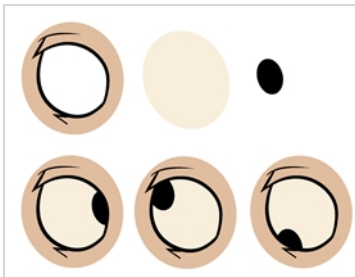

Separating the Mouth Elements and Jaw

To get a greater level of flexibility, you can separate the jaw from the head. You can also separate the mouth shape, teeth, tongue and interior one from another.

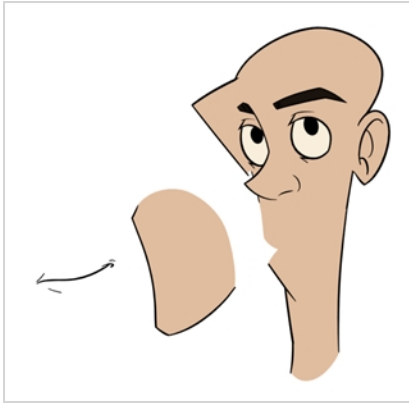

Keeping Fingers Attached to the Hand

To avoid needlessly complicating the break down, the fingers are not usually separated from the hand. The full hand is a single layer with a bank of different hands stored inside. This technique is easy to work with and produces a less mechanical effect.

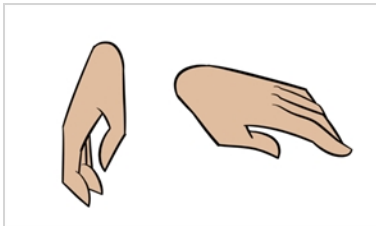

Flipping Logos

You can separate logos and letters that appear on a character or a prop. This allows you to flip and reuse a character's puppet.

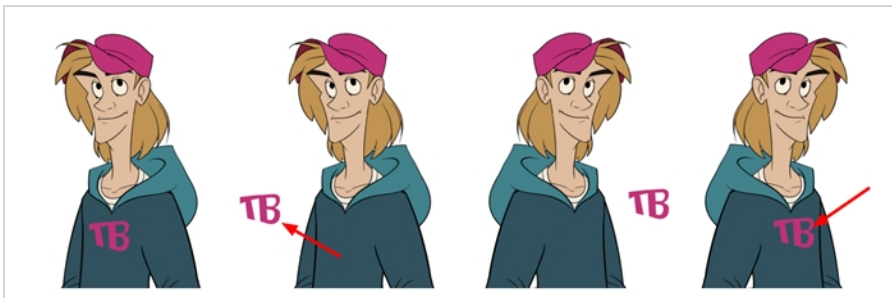

Complete and Overlapping Pieces

For a better result with animated parts, it is important to understand that they must be properly overlapping and complete. A common mistake is to trace the part just as it appears on the model.

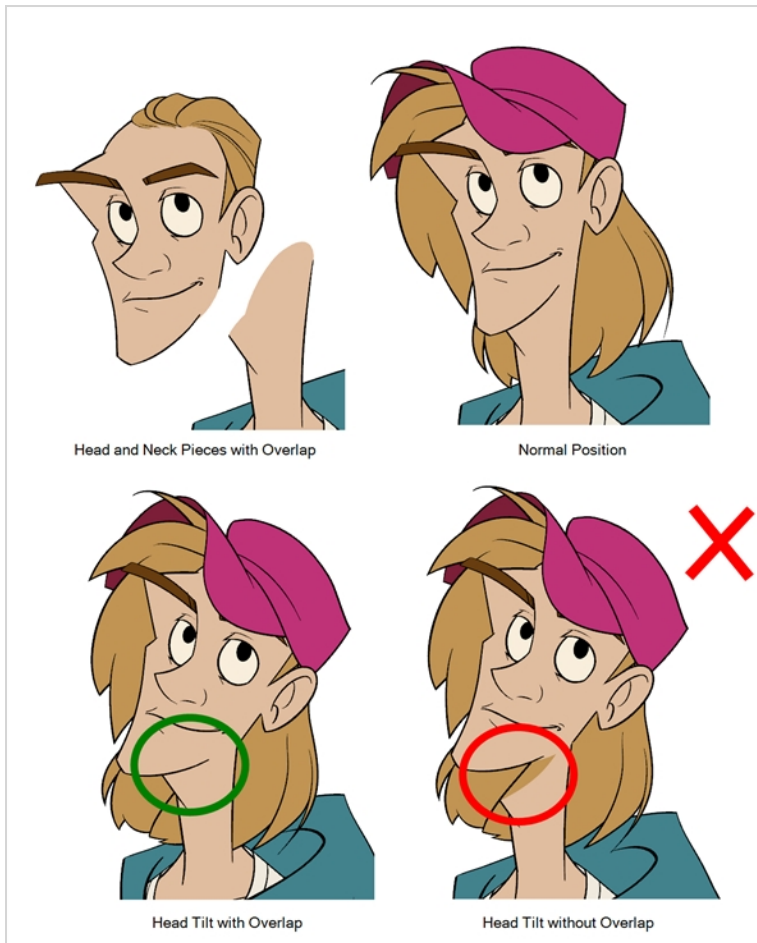

Tracing the Model

The main breakdown technique shown here is to trace your model.

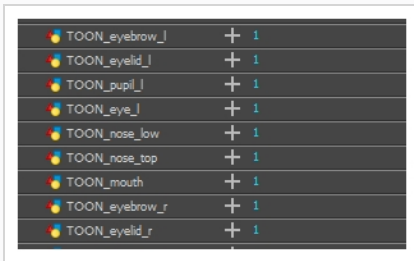

How to break down a character by tracing

1. In the Timeline view, add a new drawing layer for each body part to separate. You can press Ctrl + R (Windows/Linux) or ⌘ + R (macOS)—see .

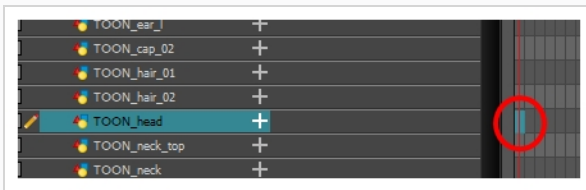

2. In the Timeline view, select the layer's first cell in which you want to draw the part.



3. In the Tools toolbar, select the drawing tool of your choice. There are two commonly used methods to drawing the parts of a cut-out character model:
 - Using the Pencil  tool, then smoothing your lines with the Smooth Editor  tool
 - Using the Polyline  tool. This method allows you to draw with great precision, but may take more time.

These methods ensure each part is made with as few points as possible, so that they are easy to manipulate, modify or redraw.

4. In the Colour view, select a colour swatch. If you haven't created a palette for your character yet, see .
5. If you prefer working in the Drawing view, do one of the following to display the other layers in washed out colours:
 - In the Drawing view toolbar, lick the Light Table  button.
 - Press Shift + L.
6. In the Camera or Drawing view, draw the new part.

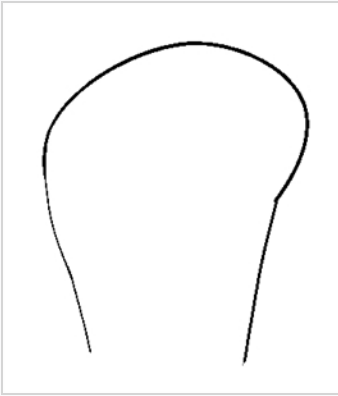

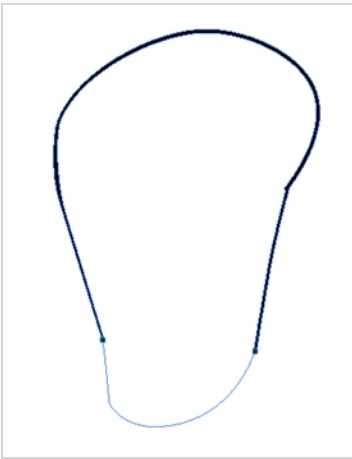

7. If you want to close an open shape without drawing a visible outline, you can draw an invisible line using the Stroke  tool.





NOTE

By default, your strokes are not visible. To see the strokes in your drawing, select **View > Show > Show Strokes** from the top menu or press K.

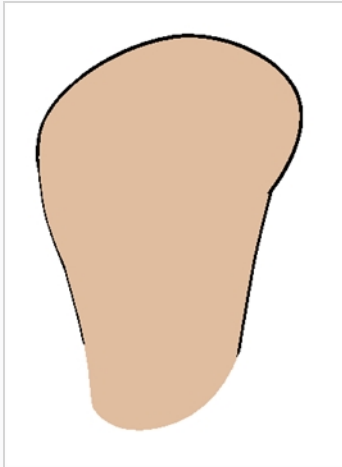
8. In the Tools toolbar, select the Paint  or Paint Unpainted  tool to colour your drawing.
9. In the Colour view, create the desired fill colour if it's not already in your palette, then select it.
10. In the Camera or Drawing view, paint your drawing.



11. In the Tools toolbar, select the Select  tool. Select your drawing and flatten the lines by clicking the Flatten  button in the Tool Properties view.
12. Repeat the entire process for every body part that you wish to make animatable.

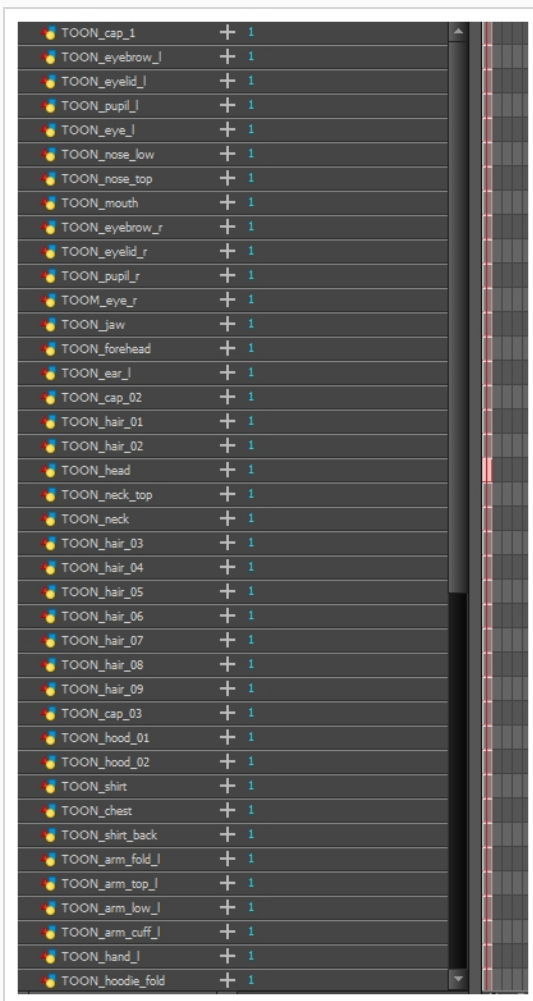

Breaking Down the Main Parts

To break down the main body parts, you will use the Create Drawing From Drawing Selection feature.

Breaks a character into its main body parts. There is no need to create any layers prior to this process. Make sure your model is well centered and sized in the Camera view.



You do not need to make clean cuts around your parts; a rough one is sufficient as long as it includes all the artwork of the part you want to break down. You will clean the extra bits and pieces later.

Using the Cutter tool, you can roughly cut the main sections, and then use the Select tool to select precise lines and colour zones.

How to break down the main parts

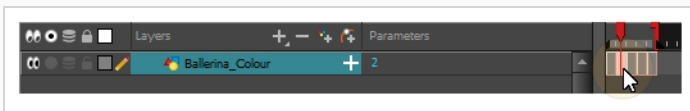
1. In the Timeline view, select the cell of the model that corresponds to the first view to break down.



2. In the Tools toolbar, select the Cutter  tool.
 - If you prefer to use the Select tool, choose the Select  tool from the Tools toolbar or press Alt + S.
 - In the Tool Properties view, you can switch to the Lasso  selection mode.
3. In the Camera view, create a selection around the first part to break down. If you click on a zone, the Cutter tool will select the zone. It will end the selection at the first point of intersection that it meets.

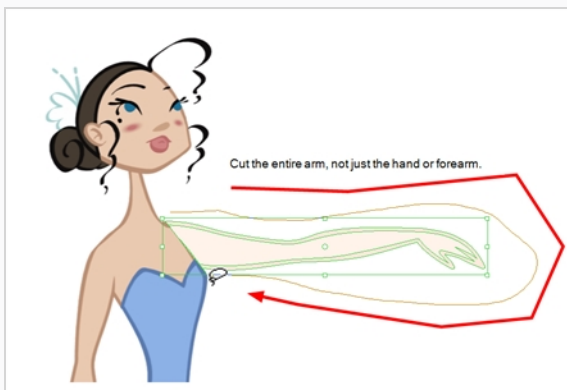

- Hold down Shift to create a new lasso selection around another zone and add it to your previous selection.

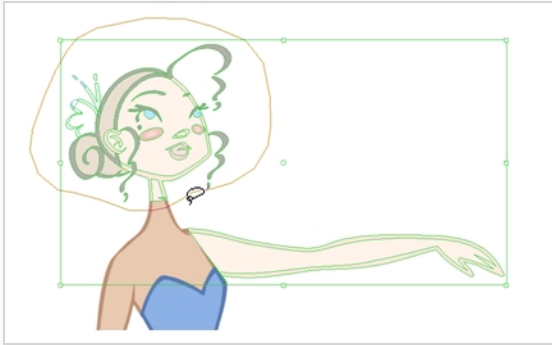

- From the top menu, select **Edit > Create Drawing From Drawing Selection** or press F9 (Windows/Linux) or ⌘ + F9 (macOS).

The Create Drawing From Drawing Selection dialog box opens.

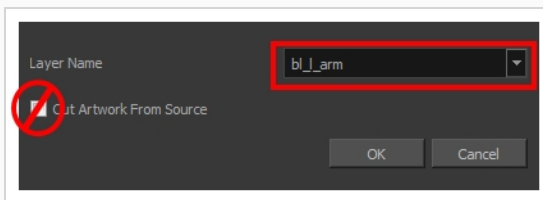

- In the Layer Name field, type the name of the layer you want to create following the naming convention you established previously.
- Deselect the **Cut Artwork From Source** option to keep the selected artwork on your original drawing. You do not want to cut the artwork from the colour model.
- Click **OK**.

The new layer is created and your selection is copied in it. The drawing is created in the same frame number as the cell it was taken from.

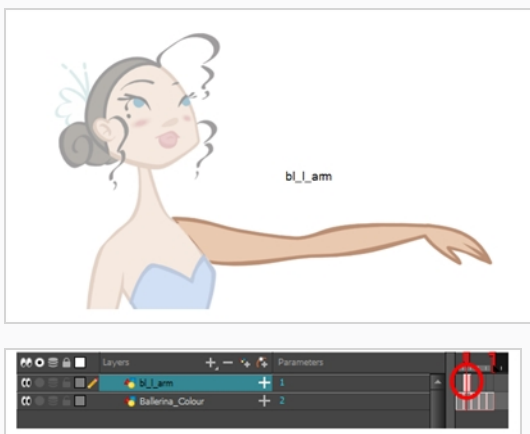

- Repeat the previous steps for each main body part.

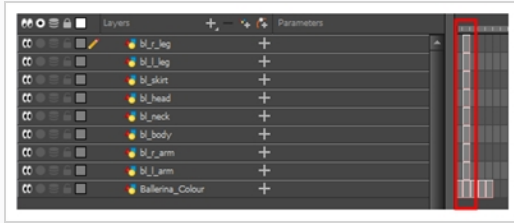

Breaking Down Secondary Parts

You should now have a layer for each main part of the character for the first view to break down. You are now ready to break down those main pieces into smaller ones.

Breaking down the secondary parts is similar to the main part break down process except that this time you will cut away the artwork from the layer it has been selected from.

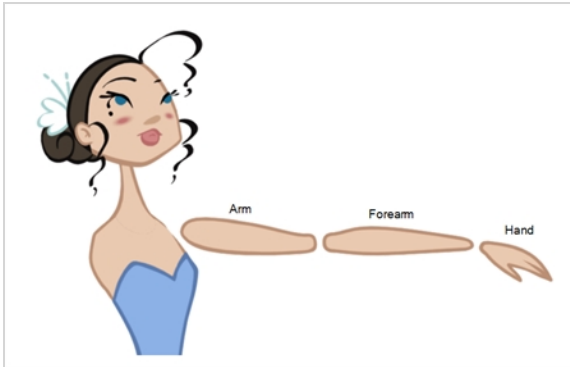

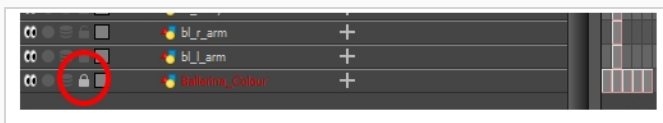

How to break down the secondary parts

1. In the Timeline view, lock your model layer by clicking its Lock  button.

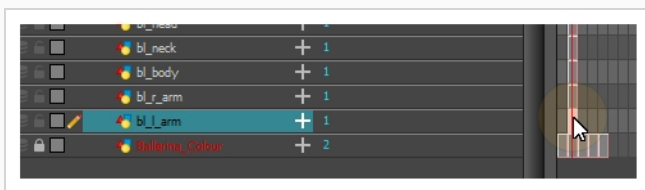

2. In the Timeline view, select the cell that corresponds to the main part you want to break down.



3. In the Tools toolbar, select the Cutter  tool.
 - If you prefer to use the Select tool, choose the Select  tool from the Tools toolbar or press Alt + S.
4. In the Camera view, create a selection around the part to break down.

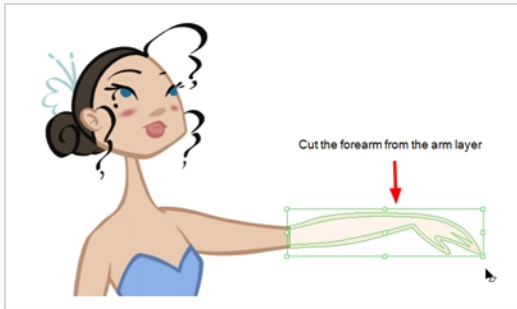

- ▶ If you click on a zone, the Cutter  tool will select the zone and end the selection at the first point of intersection that it meets. Click on the line with the Cutter tool to select it up to the next intersection.

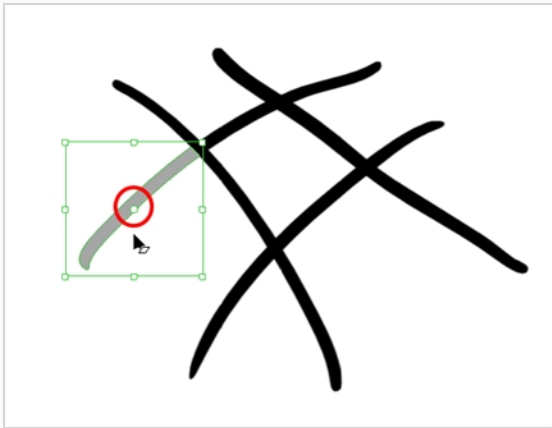

5. From the top menu, select **Edit > Create Drawing From Drawing Selection** or press F9 (Windows/Linux) or $\text{⌘} + \text{F9}$ (macOS).

The Create Drawing From Drawing Selection dialog box opens.

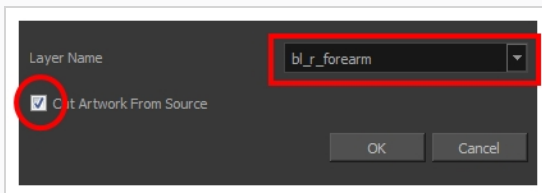

6. In the Layer Name field, type the name of the layer you want to create following the naming convention you established previously.
7. Select the **Cut Artwork From Source** option to remove the selected artwork from your original drawing. In this case, you want to cut the artwork from the colour model.
8. Click **OK**.

The new layer is created and your selection is copied in it. The drawing is created in the same frame number as the cell it was taken from.

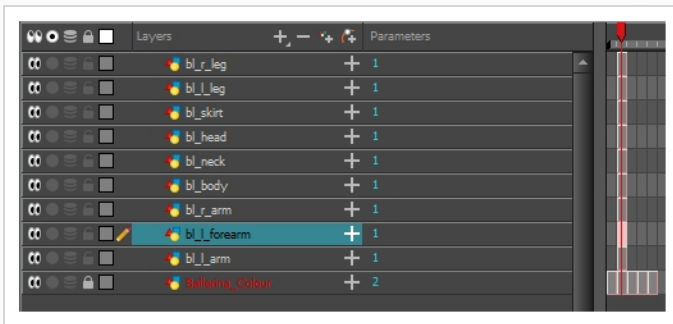

9. Repeat the previous steps for each body part.

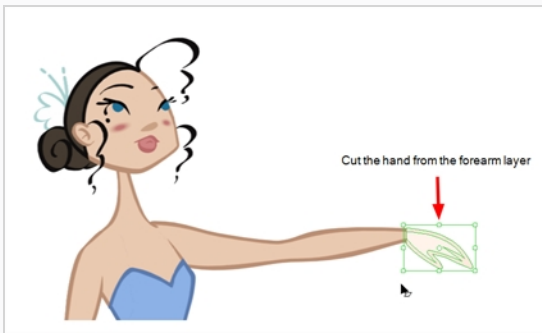

**NOTE**

If you forgot to add some artwork to a layer you previously created, you can always add it later.

In the Camera view, select the artwork to send to the existing layer. Open the Create Drawing from Drawing Selection dialog box by pressing F9 (Windows/Linux) or $\text{⌘} + \text{F9}$ (macOS). In the dialog box, select an existing layer from the list instead of typing a new name. Click **OK** to add the artwork to the existing drawing in the layer you selected.

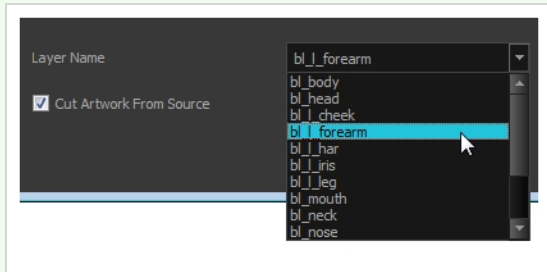

Breaking Down Other Views

If your character model has more than one view, now is the time to break them down.

The process is very similar to breaking down the first view. You have two choices:

- Breaking down the new view in a new set of layers
- Breaking down the new views in the same existing layers
 - If your layers are not in the correct order, you can reorder them later. Simply add the part that you are breaking down to the layer you previously created for the same body part.



Start by breaking down the main pieces, as you did before. The secondary parts will be broken down later on.

Repeat the following steps for each extra view you need to break down.

How to break down the other views

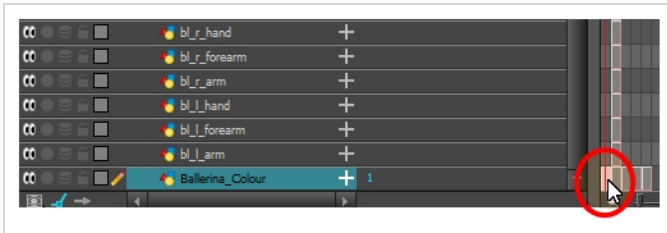
1. In the Timeline view, selected the model's cell corresponding to the view to break down. Don't forget to unlock the layer.



2. In the Tools toolbar, select the Cutter  tool.
 - If you prefer to use the Select tool, in the Tools toolbar select the Select  tool or press Alt + S.
2. In the Camera view, create a selection around the first part to break down.

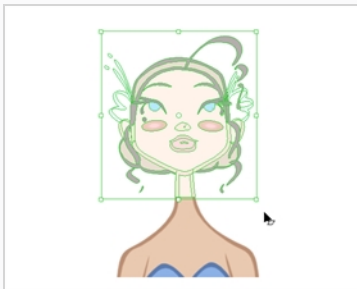

3. From the top menu, select **Edit > Create Drawing From Drawing Selection** or press F9 (Windows/Linux) or  + F9 (macOS).

The Create Drawing From Drawing Selection dialog box opens.

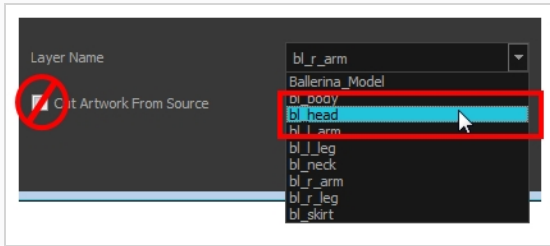

4. In the Layer Name field, select the corresponding layer from the list if you want to use the same layers or type a new name if you want to create a new layer.
5. Deselect the **Cut Artwork From Source** option to keep the selected artwork on your original drawing. You do not want to cut the artwork from the colour model.
6. Click **OK**.

The artwork is inserted into the existing layer. The drawing is created in the same frame number as the cell it was taken from. It is not incorporated in the other view's drawings.

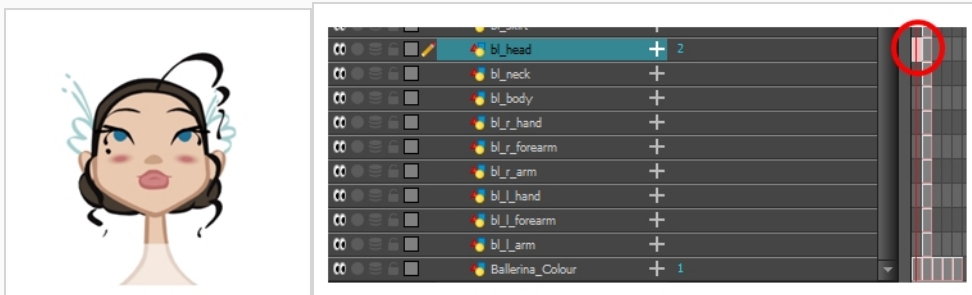

7. Repeat step 1 to 7 for each main body part.

Breaking Down Secondary Parts in the Extra Views

To break down the secondary parts for your extra views, follow the exact same process as you did for the first view you broke down, but you will incorporate the new parts in the existing layers—see [Breaking Down Other Views on page 396](#).

Each view can have its own set of layers in the Timeline view, therefore each view does not necessarily need to have the same layer structure.

Here is an example of how your timeline should look at this stage:







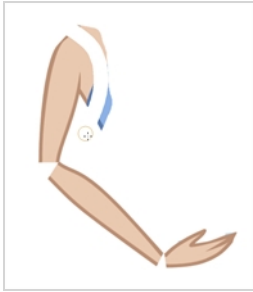

Completing Parts and Articulations

Now that all the layers are created and the parts are basically broken down, it is time to clean up the parts and complete the articulation.



Cleaning the Parts



You will need to use a series of drawing tools to clean the parts:

-  Brush tool
-  Eraser tool
-  Select tool
-  Cutter tool
-  Contour Editor tool
-  Paint tool
-  Close Gap tool

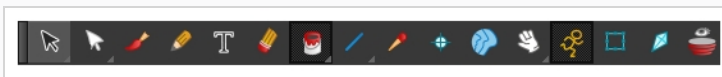

How to clean your drawings

1. In the Tools toolbar, select the drawing tool you need to fix your drawings.



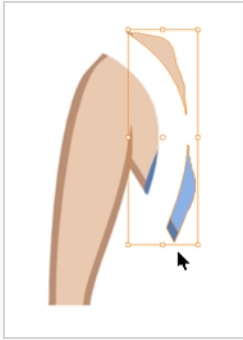

2. In the Timeline view, select the cell containing the drawing to fix.
3. In the Camera view, delete the extra bits using the Select  or Cutter  tool. You can also use the Eraser  tool.

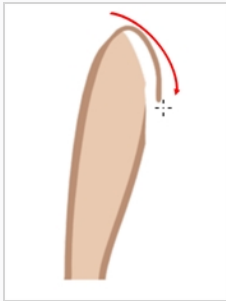

4. Draw the missing lines using the Brush  tool. If you use the Brush tool, it is recommended that you enable the Auto-Flatten  option in the Tool Properties view.



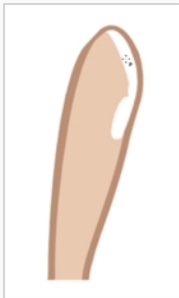

5. Using the Paint  tool, paint the gaps. You can close some gaps with invisible lines using the Close Gap  tool or press Alt + C.

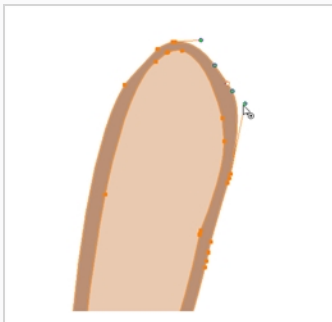

6. Reshape your lines using the Contour Editor  tool or press Alt + Q.



7. Using the Select  tool, select the entire drawing and click the Flatten  button in the Tool Properties view to flatten your drawings.
8. From the top menu, select **View > Show > Show Strokes** to display the invisible lines that could be present in your drawing or press K.

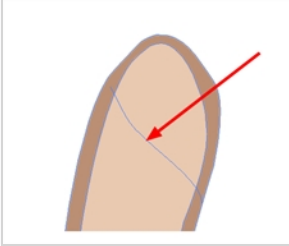

9. From the top menu, select **Drawing > Optimize > Remove Extra Strokes** to remove any unnecessary invisible lines in the drawing.
10. Repeat this entire process for each drawing to fix.

About Articulations

Once your pieces are traced, you can go ahead and complete the articulations.

Articulations are an important aspect of any cut-out break down because without them, a puppet cannot move properly and will not look good.

If you are using deformations to animate the limbs, your articulations don't need to overlap. The deformer effect will create the joint for you.

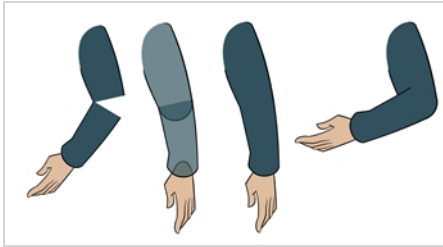

Creating Classical Articulations





Classical articulation is the most popular technique for basic characters. It is quite simple and produces excellent results, but it's not the most efficient method. In many instances, it causes limitations and extra drawing corrections. For example, there may be a gap in the articulation if the part is bent too far. Joint design is usually a circle; the overlapping part cannot be sent behind without showing the joint.

Classical articulation is done by erasing a part of the line from the overlay layer, leaving the colour overlapping the bottom layer. You can use this technique for all the articulations on your puppet.

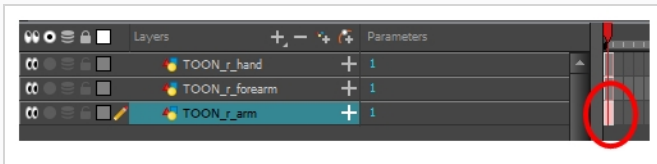
How to create a classical articulation

1. In the Timeline view, select the cell containing the part to modify (piece located behind), such as the upper arm.



2. In the Tools toolbar, select the Pencil , Polyline , Ellipse , Cutter , or Contour Editor  tool.
3. In the Colour view, select an outline colour.
4. In the Drawing or Camera view, use your drawing tool to make sure the joint overlaps the other part in a half-circle shape.



If you are working in the Drawing view, click the Light Table  button in the Drawing toolbar or press Shift + L.

5. From the top menu, select **View > Show > Show Strokes** or press K to display the invisible lines that may be present in your drawing.
6. In the Drawing or Camera view, select all the strokes in your drawing.
7. In the Tools Properties view, click the Flatten  button.
8. In the Drawing or Camera view, select all the strokes in your drawing.
9. Repeat the previous steps for the other articulations.

10. In the Timeline view, select the cell of the part that will be on top of the joint.

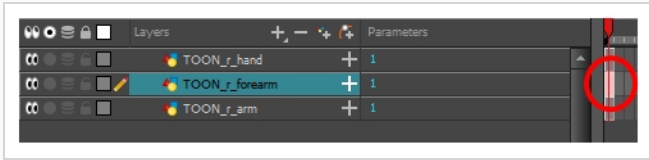

NOTE

When placing rotation pivots later on, make sure they are positioned at the centre of the articulation.

About Ordering Layers

T-HFND-005-005

At this point, it is possible that your character's pieces may show up in the wrong order.

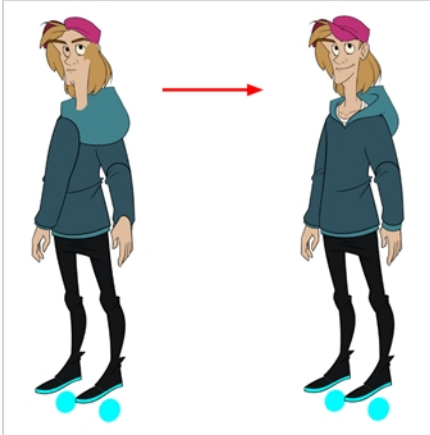

There are several ways to fix this. First, you can reorder your layers by dragging them to a higher or lower level in the Timeline view. The top layer is displayed in front of the others and the bottom one is displayed behind. Second, you can use the Z-axis nudging (forward and backward) if you have extra views included in the same layers (front, three-quarter, back, etc.).

Ordering Layers in the Timeline View

T-HFND-005-006

In the Timeline view, the layer positioned at the top will be displayed in front and the ones below will be displayed behind. If you have multiple views, you should order your layers based on the most common view, which is generally the three-quarter front.

How to order layers

1. In the Timeline view, drag a layer to reorder it and drop it between other layers.

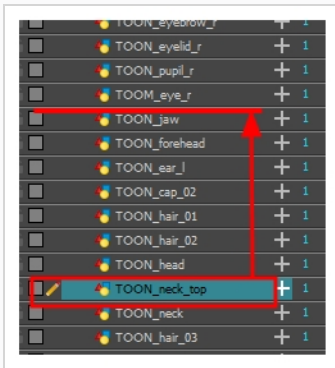

If you drop it on a layer, it will create a parent hierarchy, so make sure to drop it between layers.



About Z Nudging

T-HFND-005-008

If you created a hierarchy on your arms, legs or other body parts, it is possible that you will want a part, such as the hand, to appear in front of its parent. Yet, if you move the hand layer above the arm layer, you will break the hierarchy. To reorder a layer rigged in a hierarchy, nudge it backwards or forwards on the z-axis.

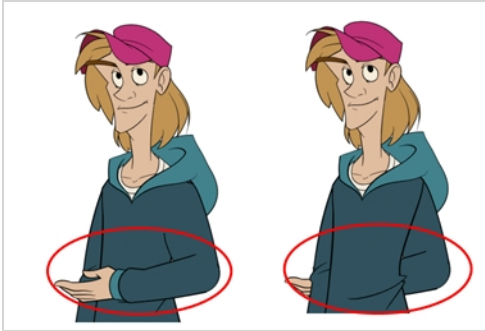

NOTE

You will do the same for the layers that are not in the right order on the extra views. Do not place the drawing on another layer. You want to keep all your drawings of the body parts in the same layers like a box containing all of the hands or all of the shoes.

Harmony allows you to move your elements in three dimensions:



- Up and down (Y-axis)
- Left and right (X-axis)
- Backwards and forwards (Z-axis)

Nudging Layers

T-HFND-005-009

In the same way you create multiplane backgrounds (depth), you can perform a micro nudge of the part to be reordered and see it in front of the other elements, even if its layer is actually behind the other ones in the Timeline view. The forward-backward position can also be animated over time.

How to nudge layers backwards and forwards

1. In the Tools toolbar, select the Transform  tool. Make sure to enable the Animate  mode.
2. In the Camera view, select the element you want to reorder. Make sure the focus (red outline) is around the Camera view before selecting the element.
3. To move the element forward, press Alt + Up Arrow and to move the element backward, press Alt + Down Arrow.

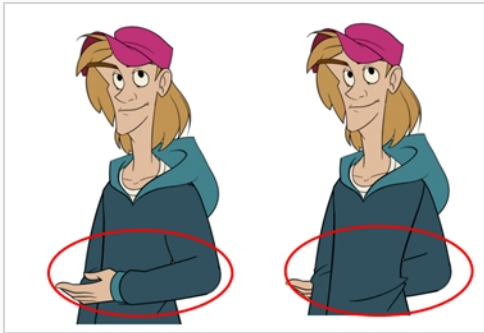

About Pivots

T-RIG-006-001

Even with a complex hierarchy, a rig is useless without positioning the proper pivot points. This will allow the puppet's pieces to rotate correctly. The arm needs to rotate from the shoulder and stay attached to the torso, so its pivot point needs to be positioned accordingly. A good way to achieve this is to position the pivot point exactly in the center of the articulation.

The initial position of the pivot point is always at the center of the scene. Sometimes there will not be an obvious place of rotation to place the pivot point, but it's a good idea to reposition the pivot to the best transformation point. For instance, the master peg, which generally controls the entire rig, is often best positioned between the character's feet.



About Permanent Pivots

T-RIG-006-002

For a simple character rig, it is recommended to set the Peg pivot (even on drawing layers) using the Rotate  tool.

Setting Permanent Pivots

T-RIG-006-004

In this section, we'll take a look at one of the options we have for setting pivots. The permanent pivot allows you to push your rigs to great lengths without having to worry about repositioning your pivot once it is set.

How to set the pivots with the Rotate tool

1. In the Advanced Animation toolbar, select the Rotate  tool.
2. In the Camera or Timeline view, select the layer whose pivot you want to set. In the Camera view, you can also hold down Ctrl (Windows/Linux) or ⌘ (macOS) and click on the piece whose pivot you want to set.
3. In the Camera view, drag the blue pivot to reposition it.



4. Repeat the previous steps for all the pieces, including the eyes, nose and mouth. If you are unsure as where to place the pivot, put it in the center of the selected piece or group of pieces.

**NOTE**

If you added other pegs to your rig, you must set their pivot using the same method.

Setting Multiple Permanent Pivots

You can simultaneously set the position of pivots for several drawing layers or pegs that you would like to rotate and scale from the same point of origin,

How to set pivots on multiple pegs

1. Select the multiple pegs or drawing layers from either the node view or timeline view.
2. Select any Advanced Animation tool, such as the  Rotate tool.
3. Reposition your pivot using the Advanced Animation tool



NOTE

Never use the Transform tool to permanently position pivots. The Transform tool only temporarily repositions it to accommodate your transformation, usually during the animation process.

Adding Pegs

Pegs are a special type of layer that do not contain any drawing. They are used strictly to offset and transform drawings that are under their hierarchy, without transforming the drawings directly.

When rigging or setting up a scene, it is recommended to add parent pegs for each of your drawing layers. This allows you to keep animation keyframes and drawings on separate layers, making it easier to work on the position and exposure of your drawing layers independently in the Timeline view. It also makes it easier to create a hierarchy of which body parts can be animated together and independently.

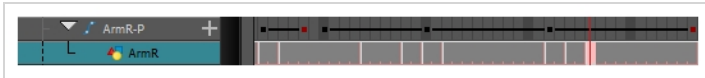

If you want to animate only on pegs, you can activate the Peg selection mode of the Transform tool in the Tool Properties view. You can also disable animating drawing layers, so that only pegs can be animated.



NOTE

It is also possible to make a drawing layer the parent of another drawing layer. Just like the way animating a peg animates its children layers, animating a drawing layer with children will also animate its children layers. Both layers will still appear in the animation.

How to create parent pegs for your layers in the Timeline view

1. In the Timeline view, select all the layers.

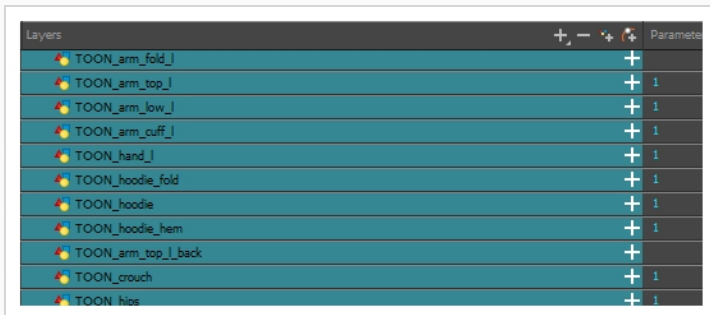

2. In the Timeline Layer toolbar, click the Add Peg  button to add a parent peg to all selected layers.

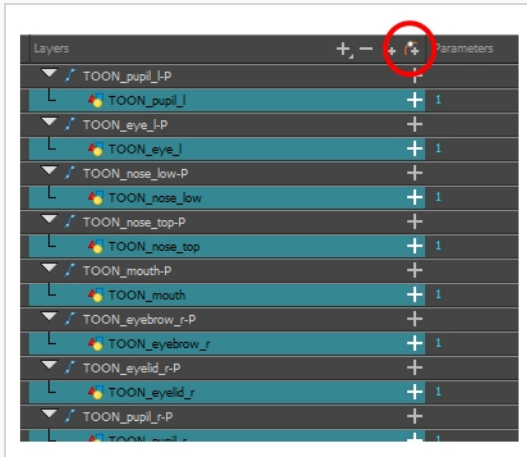

Creating Hierarchies

Harmony lets you build your rig in an elaborate hierarchy, allowing you to set which parts of your rig should influence other limbs, and how they can move independently. For example, when rigging a simple character's arm, you can make the forearm layer a child of the arm layer, and the hand layer a child of the forearm layer. This way, if the character moves their forearm, the hand will follow, and if they move their arm, the forearm and hand will follow.

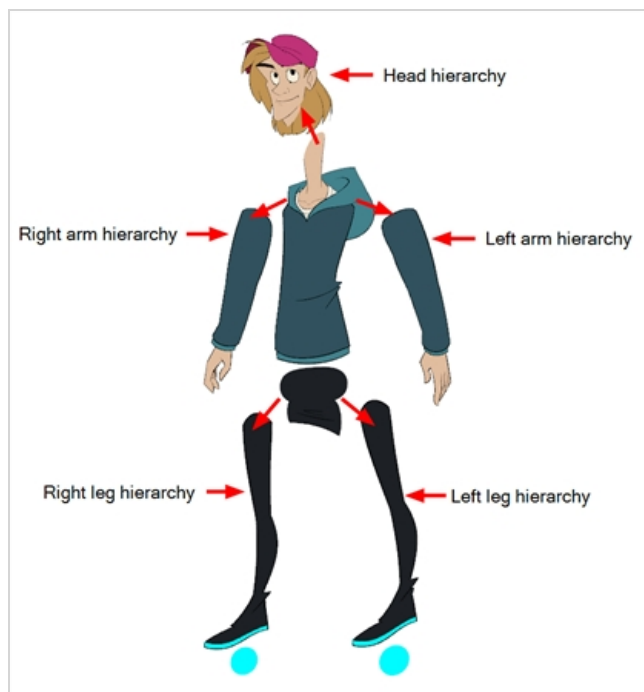

When building a basic character rig, you should at least have a hierarchy for each arm and each leg. You can make a hierarchy going from the torso, the neck and the head, and rig the arms to the torso, and you can rig the legs to the hips. This would make a hierarchy like this:

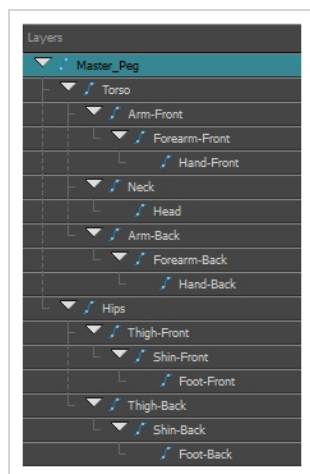

How to create a hierarchy in the Timeline view

1. In the left area of the Timeline view, select the layer which you want to make a child layer.
2. Drag the child and drop it over the layer which you want to make the parent layer. Make sure you are not dropping the child layer between two layers.
3. Repeat until you've created a hierarchy that rigs all of your character's parts, with a master peg at the root. While rigging, if you want several layers to have a common parent, but no existing part of your rig can serve as that parent, create a new peg and nest those layers under that peg.

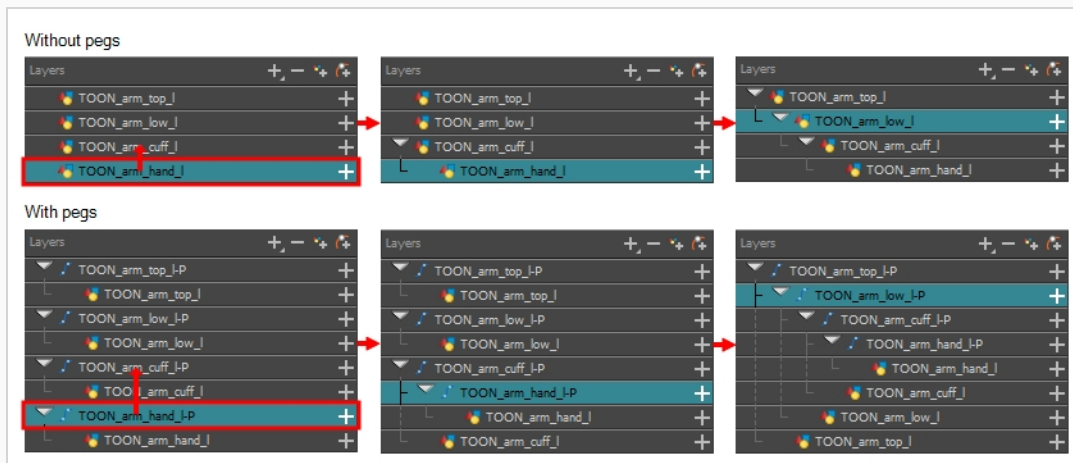

NOTE

In the Timeline view, you can unparent layers by holding down Shift, dragging the selected parent away from the child layer and dropping it somewhere else in the list.

When rigging, keep in mind that the order of the layers in the Timeline view affects the order in which they are rendered. Layers on top of the list will be rendered over layers at the bottom of the list. Should you need to change a layer's order while animating, you can nudge this layer's position on the Z-axis to override the layer order and force it to appear beneath or over other layers.

How to nudge a layer on the Z-axis

1. In the Tools toolbar, select the Transform  tool.
2. In the Timeline, Node or Camera view, select the layer you want to nudge.
3. If you selected the layer from the Timeline or Node view, click on the Camera view tab to set the focus on the Camera view.
4. Do one of the following:

- To nudge the layer forward, press Alt + Down Arrow.
- To nudge the layer backward, press Alt + Up Arrow.

Adding the Master Peg

Your character rig should always have a master peg which connects to all of its parts. The master peg allows you to manipulate the entire rig from a single layer, without having to manipulate each individual part. This is useful for positioning and scaling your character relative to the scene, as well as to animate your character's trajectory when it has to move between areas of the scene.

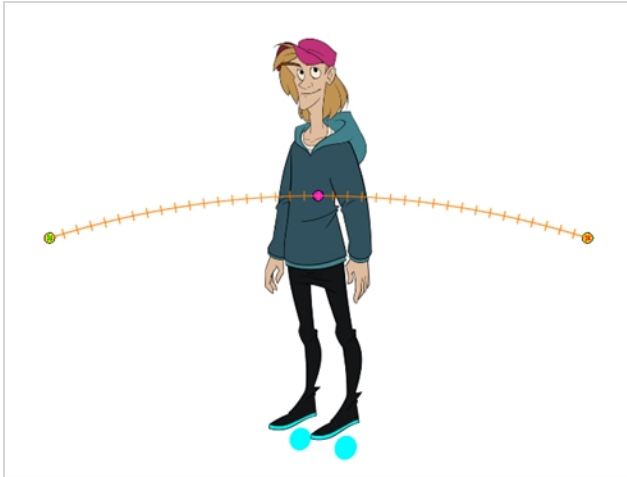

How to add a master peg in the Timeline view

1. In the Timeline view, select the top layer.
2. In the Timeline view, click on the Add Peg  button.
A new peg is added to the timeline as a parent of the selected layer.
3. Name the new peg **Master** plus the character's name.
4. In the Timeline view, select all the layers you want to attach to your new peg. Remember that your top layer is already a child of the peg, so don't include it in your selection.
5. Drag your selection **ON** to the peg layer to parent all your character's pieces to the peg. If your layers are added above the already parented layers, move that parented layer back on top of the layer stack.

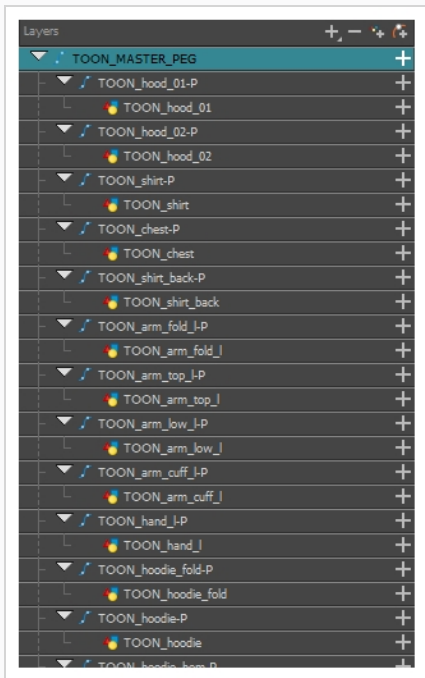

Invert-Cutting

When rigging a character, there may be instances when you want to have the ability to move a particular piece to give the illusion of a rotation or move the pupil within the white of an eye without having the extra bit of the drawing sticking out of the character or eyeball. To do so, you can use masks to cut anything you don't want to be visible.

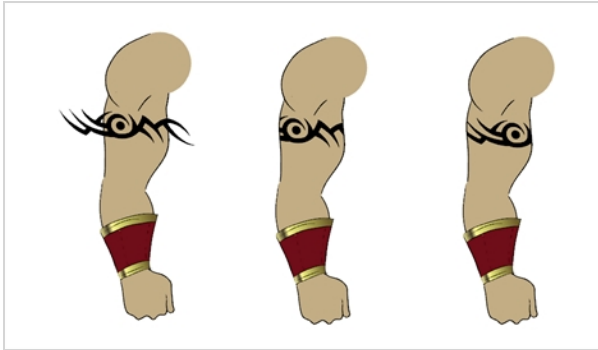

How to mask an object in the Timeline view

1. In the Timeline view, make sure the keyframe is added on the object that will be masking the piece to cut.

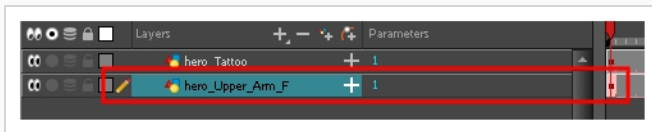

2. Select the layer that will act as the mask.
3. In the Timeline view, right-click on the layer and select **Clone Selected Layers: Drawings and Timing**.

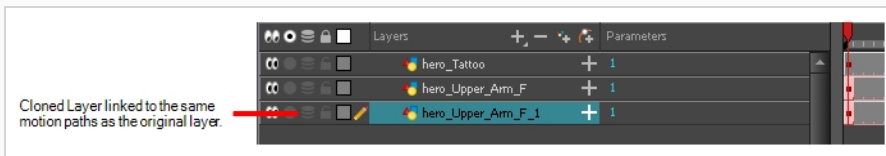

4. Select the layer to be masked.
5. In the Layer toolbar, click the Add Layer button and select **Effects > Cutter**.

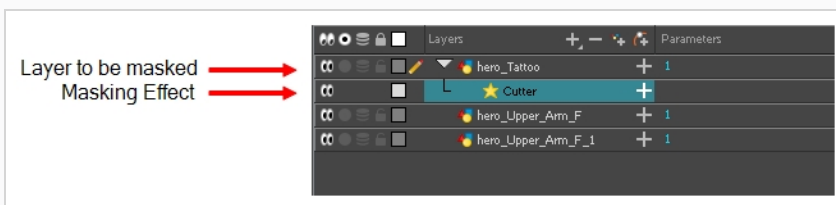

6. Click the Expand Parameters \oplus button to display the Cutter properties.

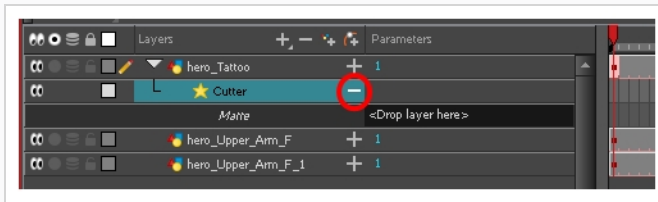

7. Drag the cloned layer **ONTO** the Matte parameter connection area.

The masking layer name appears in the Matte parameter area and the masking layer is repositioned above the effect.



The masking layer is no longer visible in the Camera view. You can see that the masking layer is connected to the Cutter effect by clicking the Show/Hide Additional Links \rightarrow button to display the Additional Links section.

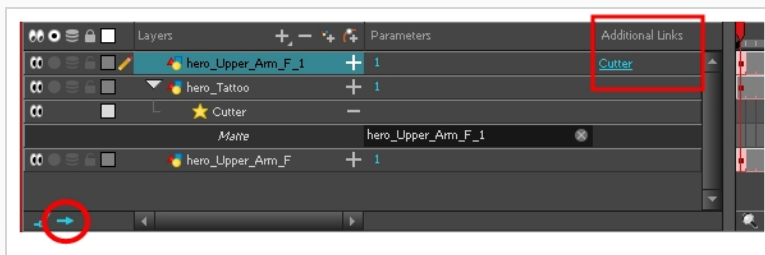

8. Your masking effect is most likely inverted and what you want to cut is probably showing. Double-click on the Mask layer to open the Layer Properties window. In the Layer Properties window, enable the **Inverted** option.

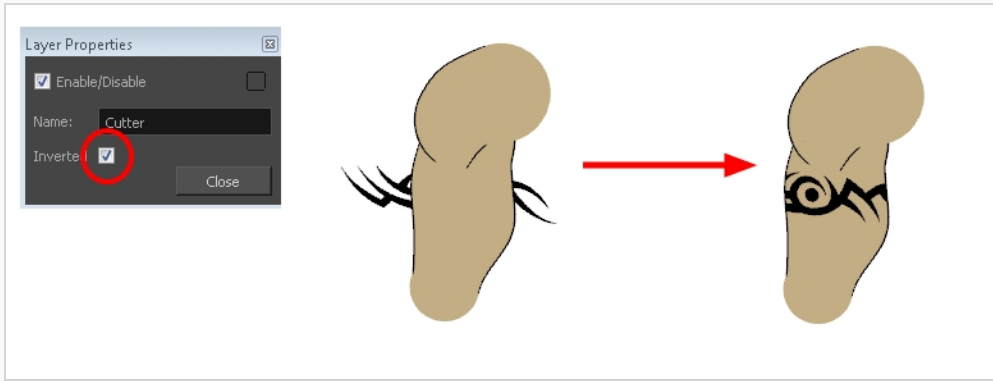

9. In the Tools toolbar, select the Transform  tool and move the cut object within the masking zone.

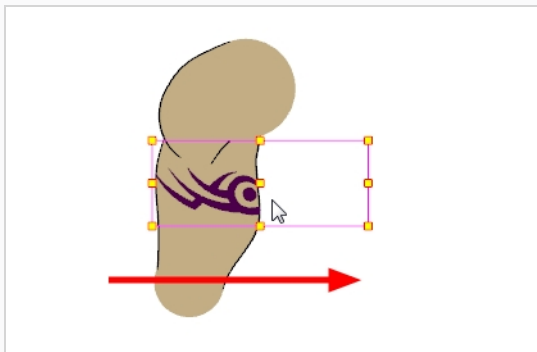

Grouping Rigs

Once your rigging is completed, you must group the puppet's skeleton to help organize the often large and complex networks. This way, once you have imported two or three characters into the scene, three Group nodes will be displayed instead of all the rigging connections of three puppets.

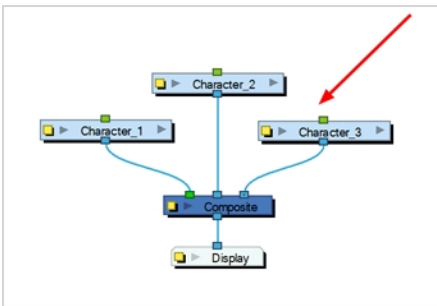
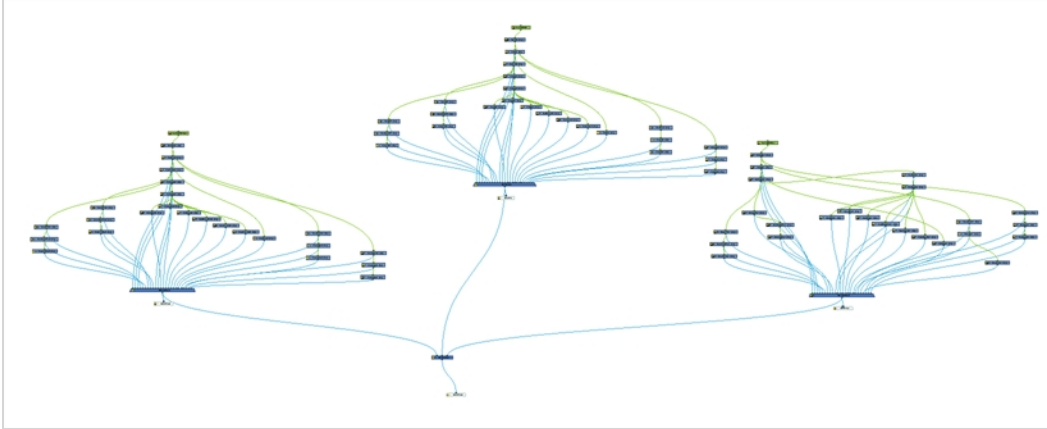

How to group nodes

1. In the Node view, select all your nodes.
2. In the top menu, select **Edit > Group > Group Selected Layers** or press Ctrl + G (Windows/Linux) or ⌘ + G (macOS).

Your nodes are grouped.

3. Click on the Group node's right arrow to enter the group.

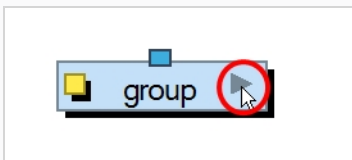

4. If you do not have a Multi-Port Out node inside your group, in the Node Library view, select the **Group** category and select a **Multi-Port Out** node.

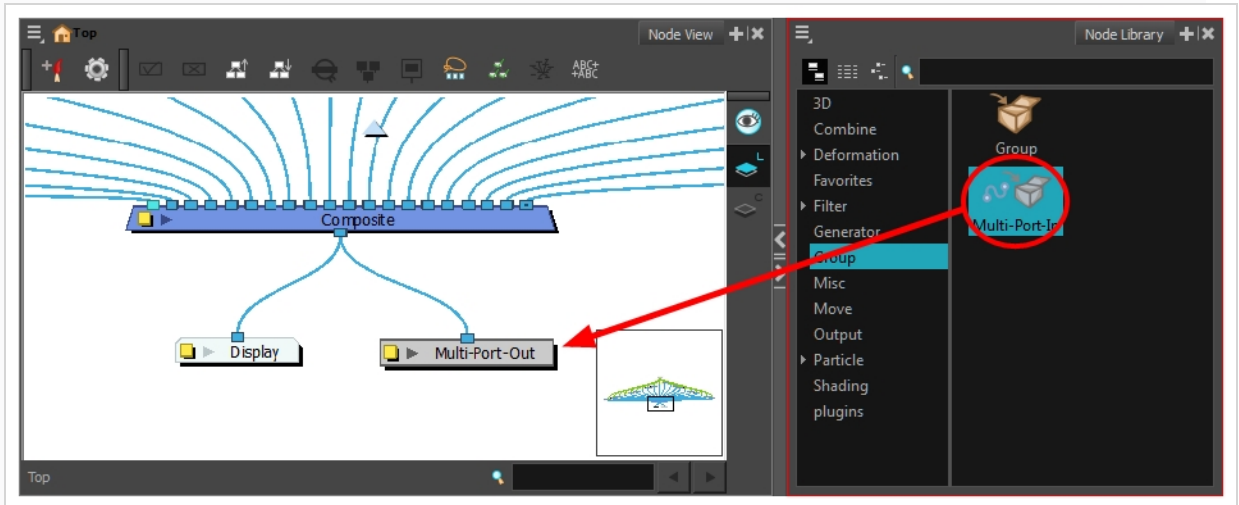

5. Drag the Multi-Port-Out node to the Node view.
6. Connect the Composite node's output port into the Multi-Port Out node.

An output port is created on your Group node.

7. In the bottom-left corner of the Node view, click **Top** to return to the network's root. You should now see an output port on your Group node.

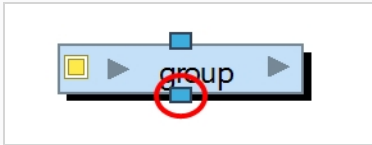

8. Click on the Group's Properties button to open the Layer Properties window.

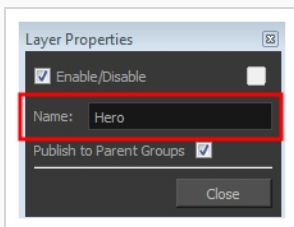

9. In the Layer Properties window, rename the Group node with your character's name.
10. Click **Close**.

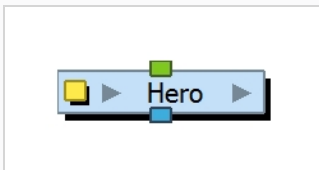

Creating Keyframes

Once all your drawings are ordered and your master peg is added, you need to insert keyframes on each cell to create all of the function curves and block your pose in place.

How to create the keyframes

1. In the Timeline view, collapse the master peg by clicking the Expand  arrow.

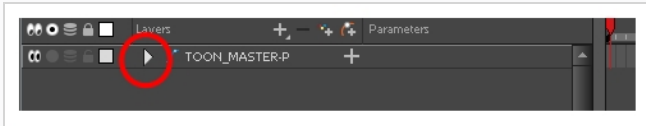

2. In the Timeline view, select the first cell.

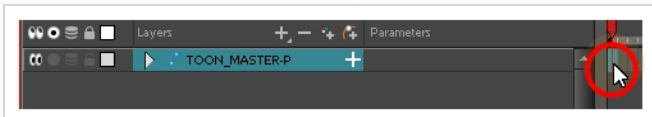

3. Do one of the following:
 - From the top menu, select **Insert > Keyframe**.
 - In the Timeline View toolbar, click the Add Keyframe  button.
 - Press F6.



NOTE

If you use the F6 shortcut when working Flash keyboard shortcuts flavour, this not only creates a keyframe but also duplicates a drawing.

Creating a Master Controller Through Scripting

The following topics will introduce you to scripting for a Master Controller and provide examples of how to handle basic use cases. However, before going through this section, you should know that:

- This documentation alone is not enough to be able to create a Master Controller through scripting. Such a task should only be taken by someone with sufficient experience in scripting or programming.
- This is an introduction guide, not a reference. To obtain a list of all the modules, properties and methods related to the Master Controller, you must refer to the Master Controller Node section of the Harmony scripting API reference.

Chapter 8: Cut-out Animation

Harmony provides some great tools for rigging and animating cut-out character models. You can make simple rigs or give your characters flexible capabilities using peg hierarchies, groups, cutters, and deformers, among other things. You can create basic animations with the Transform tool, or more advanced animation with Deformers. Harmony also supports onion skin and image swapping features to help you animate efficiently and quickly.



About Animating with the Transform Tool

The Transform tool is the main tool to use when working with a cut-out character. The Transform tool has many useful functions:

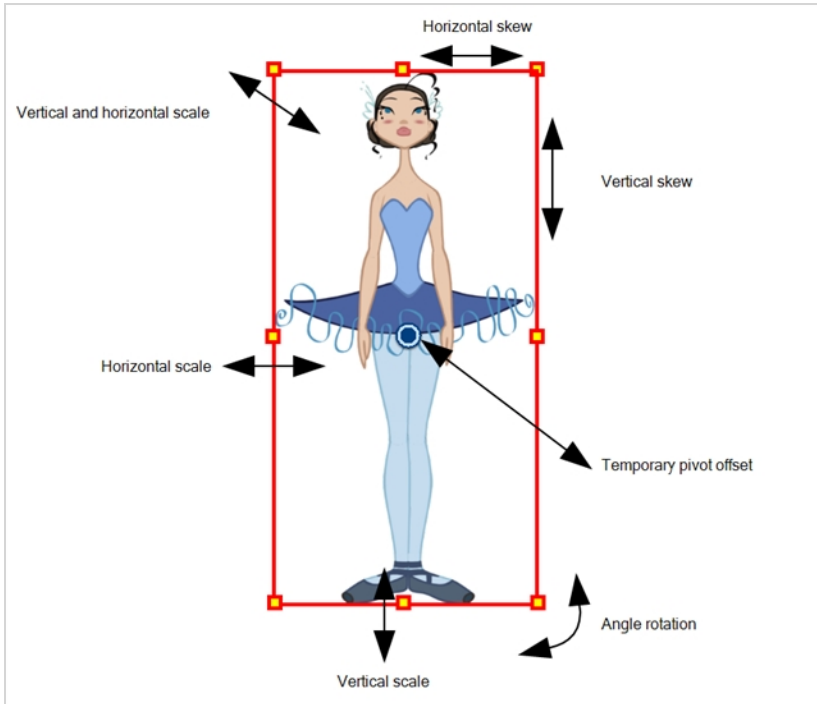

Using the individual Rotate, Translate, Scale and Skew tools is not recommended, as they move each piece from their own pivot point. They are compositing tools. The Transform tool creates a global selection, so when many parts are selected, you can move them as one unit. The Transform tool is highly recommended for cut-out animation.

When animating with the Transform tool, make sure to select the right selection mode. In this example, make sure that the Peg Selection  Mode is disabled in the Tool Properties view or it will limit the selection in the Camera view to pegs only.

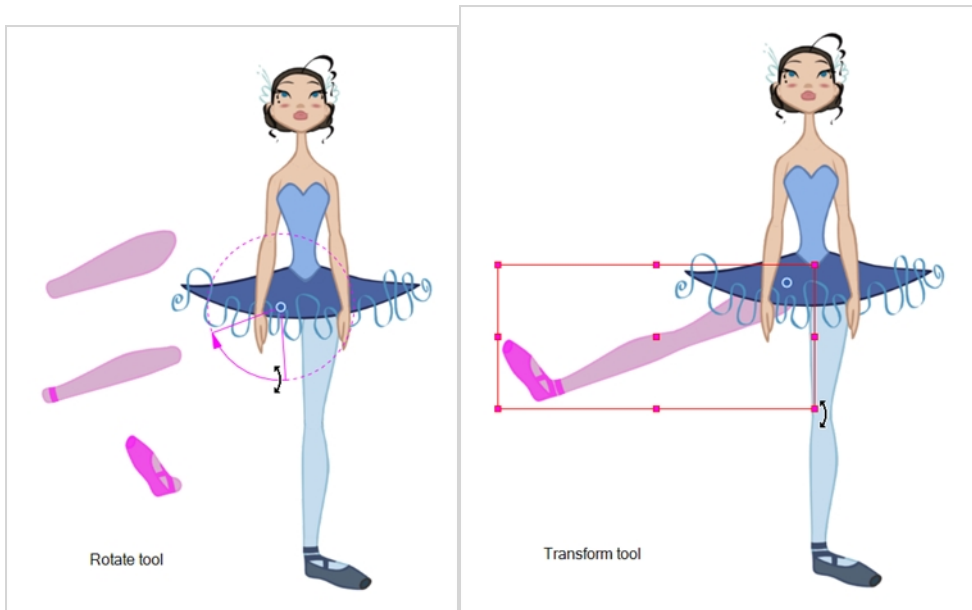

If there are hierarchy connections in the cut-out character, the Transform tool will also be used as the Forward Kinematics equivalent.

The Transform tool can be used on any kind of rigging.

When many parts are selected with the Transform tool, the first selected part's pivot will be used as the global selection's pivot. This pivot can be moved temporarily for the animation. When you offset the pivot, the permanent pivot is displayed as a ghost.





NOTE

The interpolation of the animation poses is always calculated from each individual part's permanent pivot. If there's a parent peg on a limb, make sure to select it instead of making a selection of each part to avoid setting individual keyframes.

Animating with the Transform Tool

The Transform tool allows you to move, rotate, scale and skew a selection or multi-selection.

How to animate using the Transform tool

1. In the Tools toolbar, click the Transform  tool or press Shift + T.
2. In the Transform Tool Properties view, make sure the Peg Selection  mode is deselected.
3. In the Timeline view, go to the frame on which you want to set the first position.
4. In the Timeline toolbar, click the Add Keyframe  button or press F6. It is recommended to add a keyframe before moving the character. Moving a character's part without setting a keyframe will create keyframes only on certain parameters of the animation. You could run into issues later on when setting poses between existing ones. Creating a keyframe on all layers and parameters will ensure your pose is set and will not be modified by other poses later on.
5. In the Camera view, select the element to animate and move it.

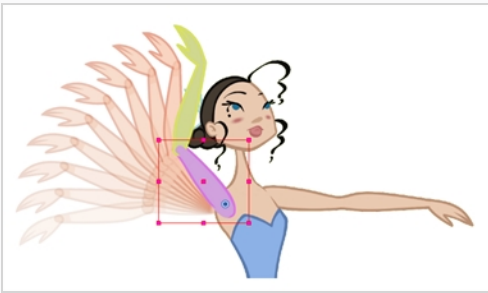

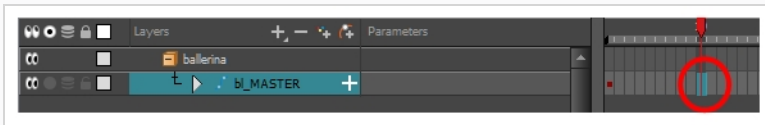

6. In the Timeline view, go to the frame where you want to set the next position.



7. In the Timeline toolbar, click the Add Keyframe  button or press F6.
8. In the Camera view, animate the character.

Resetting Transformations

With the Reset command, you can return a selected element to its initial position and scale values, depending on which tool is active. For example, if the Rotate  tool is active, the transformation angle will be reset to 0 and if the Transform  tool is active, then all transformation values will be reset.

The Reset All option Resets all transformations on the current frame in a selected layer. Your keyframe will remain, but all the values will return to the starting value. All transformations are reset regardless of the tool you're using.



The Reset All Except Z option resets Resets all transformations on the current frame except the Z position. This is useful when doing cut-out animation. Cut-out puppets often have a particular Z ordering for the different views of a character. You might want to reset the transformation, but not necessarily the Z position.



NOTE



When using the Transform tool to select elements in the Camera view, always make sure the Peg Selection Mode option in the Tool Properties view is disabled or it will limit the selection to peg only.

How to reset the transformation on the current frame

1. In the Tools toolbar, select the Transform  tool or any Advanced Animation  tool.
2. In the Timeline view or directly in the Camera view, select the drawing layer(s) to reset.
3. From the top menu, select **Animation > Reset** or press R. This will reset the current frame if keyframes were created.

The selected layer(s) return to their original position.

How to reset all transformations on the current frame

1. In the Tools toolbar, select the Transform  tool or any Advanced Animation  tool.
2. In the Timeline view or directly in the Camera view, select the drawing layer(s) to reset.
3. From the top menu, select **Animation > Reset All** or press Shift + R.

The selected layer(s) return to their original position.

How to completely reset the layers' parameters

1. In the Tools toolbar, select the Transform  tool or press Shift + T.
2. In the Timeline or Camera view, select one or more drawing layers to reset.

3. Do one of the following:

- Right-click the selected layers and select **Clear All Values**. This will remove all keyframes and reset all values for the entire layer.
- In the Timeline View menu, select **Layers > Clear All Values**. This will remove all keyframes and reset all values for the entire layer.

The selected layers return to their original position.

About Hierarchy Navigation

If there is a layer hierarchy in the puppet you built, use the keyboard shortcuts to travel up and down the parent-child chain. You can navigate between the children of the same parent. You can also easily center on your selection in the Timeline view.

Navigating Layers

Navigate between the layers in the Timeline view, using keyboard shortcuts or the Animation menu. This way of navigating only works for unparented layers or the children of a parent layer. If you are navigating between unparented layers, parent layers can be selected, but their children will be skipped. If you start on a parented layer (child), only the other children of the same parent will be available for selection.

How move up and down the layer stack

1. In the Tools toolbar, select the Transform  tool.
2. In the Camera or Timeline view, select an unparented layer or child layer of a parent with several children.



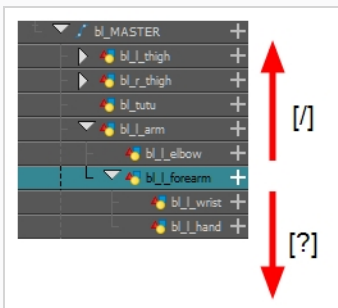

3. From the top menu, select:
 - **Animation > Select Previous Sibling** or press `/` to select the previous child layer.
 - **Animation Select Next Sibling** or press `?` to select the next child layer.



Selecting Parent and Children

When animating, large movements that are made at the root (parent) of a chain cause secondary movements throughout the rest (children) of the chain. For example, when you rotate the arm of a character from the shoulder, the forearm and hand will follow. However, in order to make the movement appear natural and graceful, the forearm and hand should not move at the same speed or angle. As a result, animators often need to move up and down a chain, intermittently selecting parent and children, in order to make both large and fine movements.

How to select the parent or child of the selected layer

1. In the Tools toolbar, select the Transform  tool.
2. In the Transform Tool Properties view, make sure the Peg Selection  mode is deselected.
3. In the Camera or Timeline view, select a layer or object attached to a hierarchy.



4. Do one of the following:
 - Select **Animation > Select Parent** or press B to select the parent layer.
 - Select **Animation > Select Child** or press Shift + B to select the child layer.

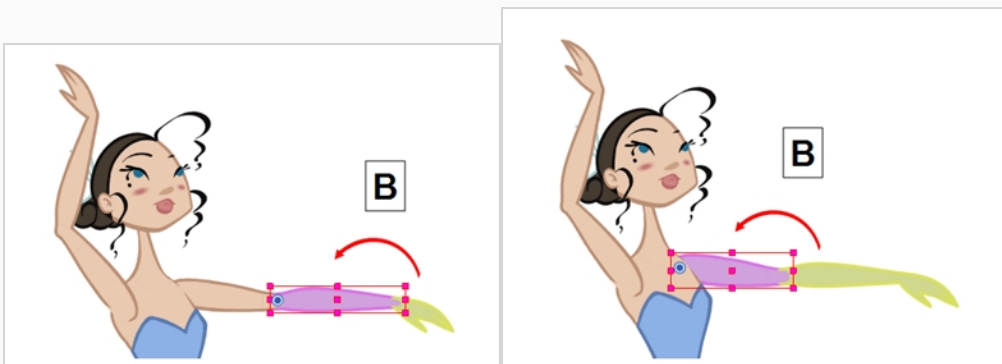

Centering on Selections

When you have many layers in the Timeline view, you may find it hard to locate which one is selected. You can use the Centre on Selection feature to display the selected object's layer in the Timeline view.

How to center on the selected layer in the Timeline view

1. In the Camera view, select a layer.
2. In the Timeline view toolbar, click the Centre on Selection  button or press O.

About Keyframes

Keyframes are the building blocks of Cut-out animation. Unlike Traditional animation, where every pose is drawn, Cut-out animation uses keyframes to mark major poses (key poses) and lets the software create all the poses in between.

In Harmony, you can create two kinds of keyframes: Motion and Stop-Motion. Motion keyframes behave like the description above; they allow for the automatic creation of drawings between two keyframed poses. Stop-Motion keyframes do not allow for interpolation between keyframes. They are often used to block poses, somewhat similar to what you would see in Traditional Animation.

Creating Motion Keyframes

T-LAY-004-001

After you have created the key poses, you can animate the in-between poses yourself or let Harmony do it using motion keyframes. When you use motion keyframes, the drawings gradually move to the next position instead of staying on the spot until the next keyframe.

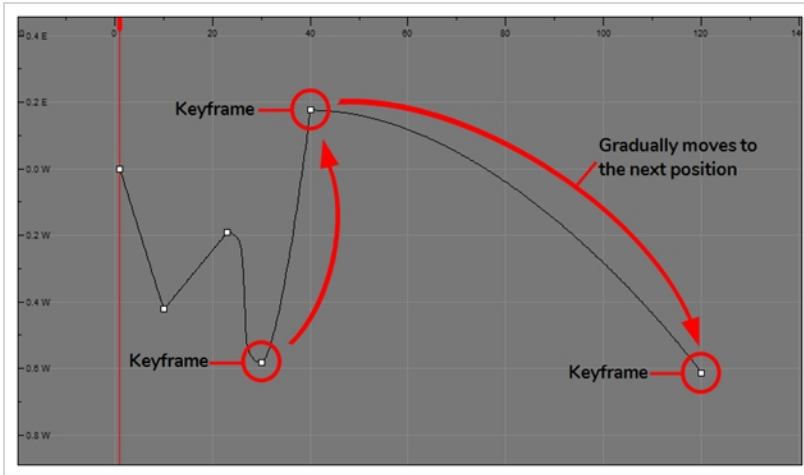

How to create motion keyframes

1. In the top menu, make sure the **Animation > Stop-Motion Keyframe** option is disabled.
2. In the Timeline view, select the cell on which you want to add a keyframe.

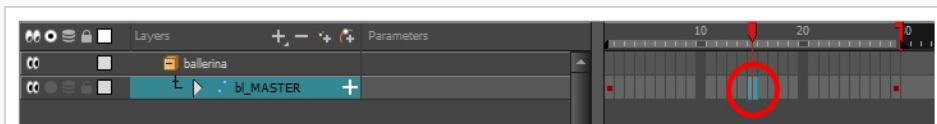

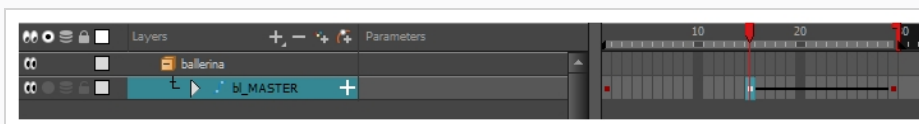

3. Do one of the following:
 - Right-click on the selection and select **Insert Keyframe**.
 - Click the Add Keyframe **KF** button in the Timeline toolbar.
 - Press F6.
 - In the Camera view, if the Animate mode is enabled, as soon as you move the selected element, a keyframe will be automatically created on the current frame.

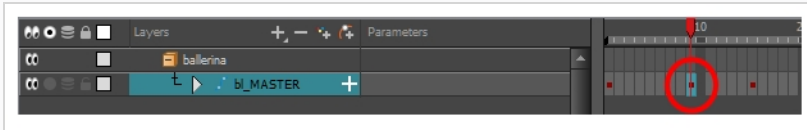

How to convert a stop-motion keyframe into a motion keyframe

1. In the Timeline view, select the stop-motion keyframes to convert into motion keyframes.



2. Do one of the following:
 - Right-click on the selection and select **Set Motion Keyframe**.
 - Click the Motion Keyframe  button in the Timeline View toolbar.
 - Press Ctrl + K (Windows/Linux) or ⌘ + K (macOS).

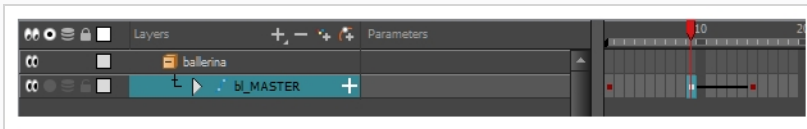

Creating Stop-motion Keyframes

To start animating your character, start by doing your key poses. In fact, most of your time will be spent doing key poses. It is better to work with stop-motion keyframes so Harmony does not automatically create the interpolation between your keyframes.

When using stop-motion keyframes, also known as *step keyframes*, the segment between two keyframes is constant. There is no animation generated by the computer between the poses. The drawing remains in position until the next keyframe, then moves to its new position.

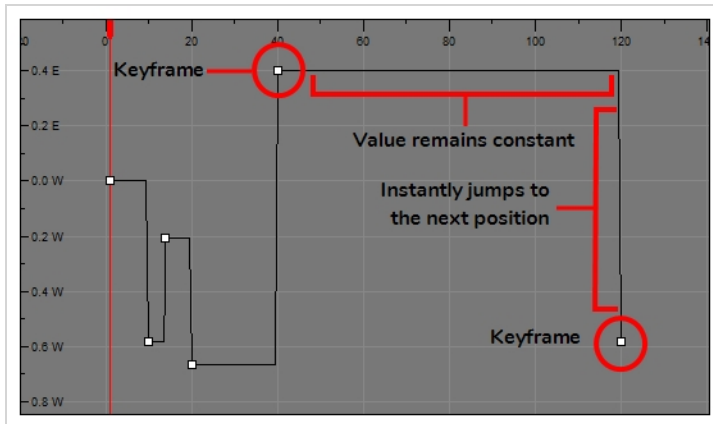

How to create stop-motion keyframes

1. In the top menu, make sure the **Animation > Stop-motion Keyframe** option is selected.
2. In the Timeline view, select the cell on which you want to add a keyframe.

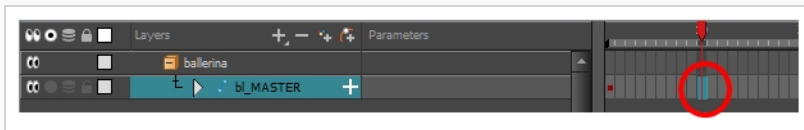

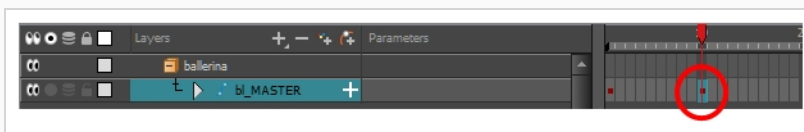

3. Do one of the following:
 - Right-click and select **Insert Keyframe**.
 - In the Timeline toolbar, click the Add Keyframe  button.
 - Press F6.
 - In the Camera view, if the Animate mode is enabled, as soon as you move the selected element, a keyframe is automatically created on the current frame.

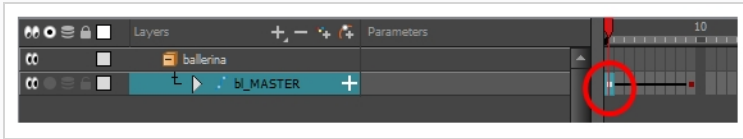

How to convert a motion keyframe into a stop-motion keyframe

1. In the Timeline view, select the motion keyframes to convert into stop-motion keyframes or press S.



2. Do one of the following:
 - Right-click and select **Set Stop-Motion Keyframes**.
 - In the Timeline toolbar, click the Stop-Motion Keyframe  button.
 - Press Ctrl + L (Windows/Linux) or ⌘ + L (macOS).

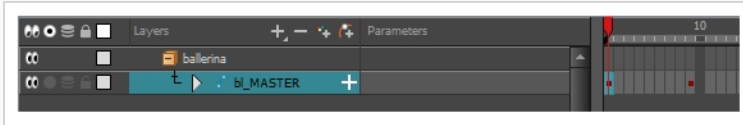

About Swapping Drawings

T-RIG-004-001

Cut-out animation is not only about moving parts around. It's also about swapping drawings to give the animation a more traditional animation look. You can add as many new drawings as you want in your scene and use them in your current animation. You can also add new drawings to the library and use them in other scenes. But before starting to swap drawings, it's important to understand how keyframes, exposure and key exposure work in Harmony:



- **Keyframe:** A keyframe is a point in time where a change to the properties of the object or character occurs. In Harmony, keyframes consist of the coordinates that determine how an entire layer and its contents are moved. Keyframes include these parameters: XYZ position, skew, scale, angle and pivot.
- **Exposure:** Exposure is a property; it is the length of time that a drawing is visible over a series of frames. In Harmony, exposure is independent of keyframes. That is, keyframes are not linked to drawings. Keyframes can be moved independently from the drawing exposure.
- **Key Exposure:** A key exposure in Harmony is a type of exposure that forces a drawing to remain exposed on a specific frame. If a drawing is exposed before a key exposure and you swap out that drawing for another one, then the original drawing is retained. This preserves the key drawing. Note that Harmony automatically sets a key exposure when you perform a drawing swap.

When you want to swap drawings, you can do so in the Timeline or Library view. In the Timeline view, the Parameters area is where you can select a drawing to swap. In the Library view, the Drawing Substitution window lets you see the drawings before selecting one for swapping. In this view, you are actually selecting drawings in your scene layers, not drawings in the Library.



NOTE

Keep in mind that when you swap a drawing, its entire exposure is replaced up to the next drawing exposure.

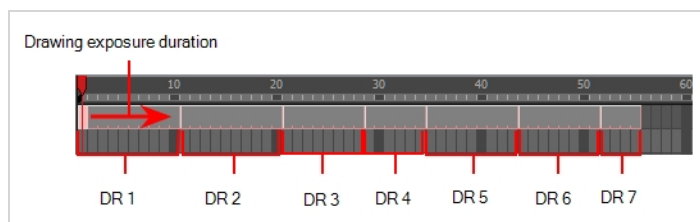

Swapping Drawings in the Timeline View

T-LAY-003-001

When selecting a certain frame range to be swapped, the behaviour of the Timeline and Library views is different. If you are using the Parameters area of the Timeline view to select a drawing to replace a selected frame range, the new drawing will replace the frame range and continue until the next key exposure. In the following example, drawing 2 (DR2) is replaced by a new drawing, starting at the beginning of the selected frame range and ending at the next key exposure.

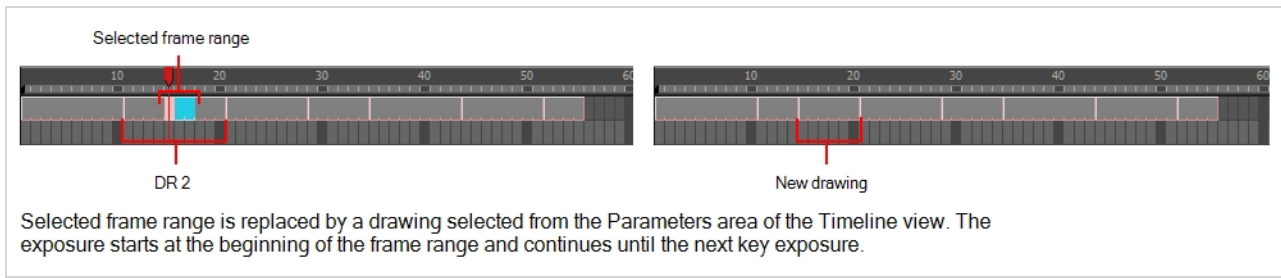

How to swap a drawing in the Timeline view

1. In the Timeline view's right side, select the cell containing the drawing or symbol cell to swap.

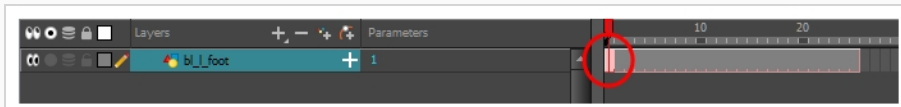

2. In the Drawing Substitution field, position the pointer over the value and drag left or right to change the cell or drawing exposed for another one. You can also type in the drawing name or symbol's cell number if you know it.

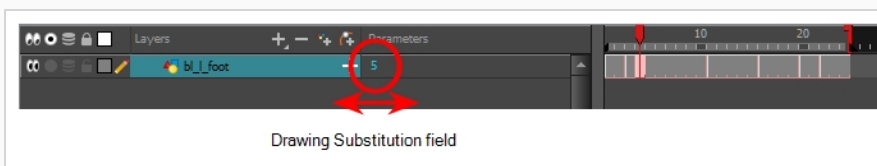



Swapping Drawings in the Library View

T-LAY-003-002

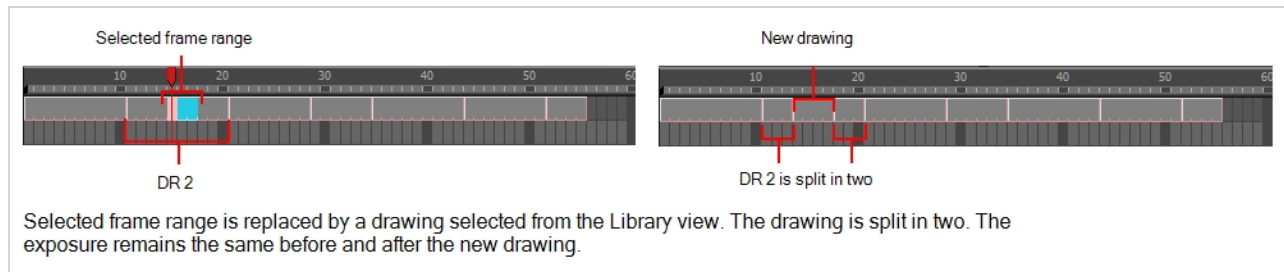
When selecting a certain frame range to be swapped, the behaviour of the Timeline and Library views is different. If you use the Drawing Substitution window in the Library view to select a drawing, the drawing is split in two and the exposure before and after the frame range remain the same. In the following example, drawing 2 (DR 2) is split in two and the selected frame range is filled with a new drawing.



How to swap images in the Library view

1. In the Tools toolbar, select the Transform  tool.
2. In the Transform Tool Properties view, make sure the Peg Selection  button is deselected.
3. In the Camera view, use the Transform  tool to select a part of the drawing to swap.



NOTE

You can swap the frames in symbols or the drawings in a layer. However, you cannot swap one symbol for another.

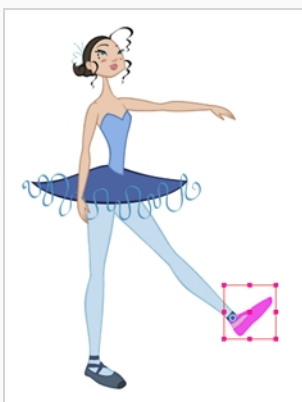

4. In the Timeline view, select the cell range in which you want to swap the drawing.

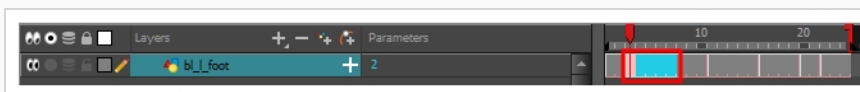

5. In the Library view, go to the Drawing Substitution window.



6. Scroll through the symbol's frames or drawings by doing one of the following:
- ▶ From the top menu, select **Animation > Substitute Drawing Previous** or **Substitute Drawing Next**.
 - ▶ Drag the slider left or right.
 - ▶ Press +.

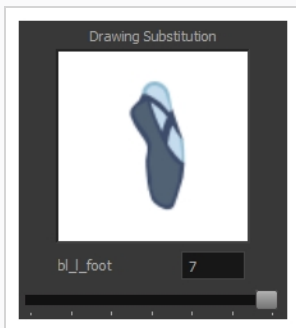

The drawing or symbol's cell on the current frame is replaced.



Adding Key Exposures

If there is a particular drawing you want to keep on a specific frame, you can set it as a key exposure. This prevents it from being overwritten by a drawing swap on a preceding frame. A key exposure is simply a property of an exposure that forces it to be exposed on a certain frame regardless of whether the previous exposure is the same drawing or not.



NOTE

Keep in mind that if you modify the artwork in a drawing, all instances of that drawing will be automatically updated even if set as a key exposure. This keeps your existing animation key poses intact. It is frequently used on a mouth or eyes layer.

Example: Swapping a drawing with no key exposure

In the following example, drawing 3 (DR 3) is selected on the timeline and it contains no key exposure.



When it is swapped for drawing 4 (DR 4), the entire duration of drawing 3 substituted for drawing 4.



Example: Swapping a drawing with a key exposure

Here's what happens when swapping a drawing with a key exposure. In the following example, the playhead is positioned in the middle of drawing 5 (DR 5) to set the position for the new key exposure. When the new key exposure is added, drawing 5 is split in two; both halves contain drawing 5. Now if you swap the first drawing 5 for drawing 1, the second drawing 5 retains its exposure.

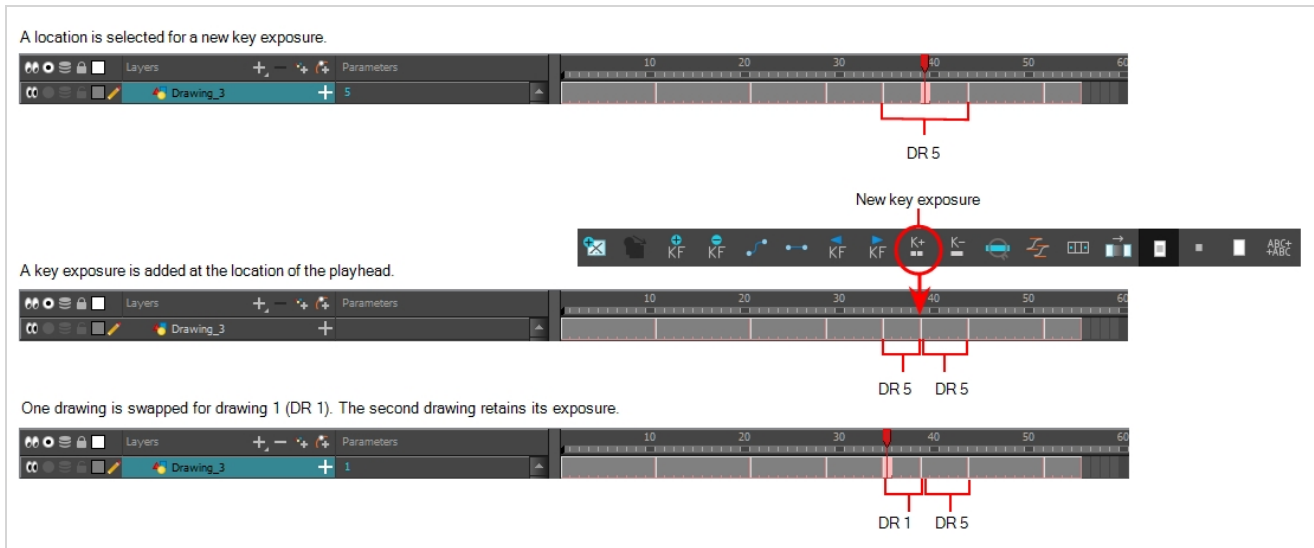

How to add a key exposure

1. In the Timeline view, select the drawing cell to set as the key exposure.
2. Do one of the following:
 - In the Timeline toolbar, click the Add Key Exposure $\underline{K+}$ button.
 - Right-click and select **Exposure > Add Key Exposure**.

A new key exposure is added.

If you added a key exposure at the beginning of the drawing, the entire exposure is filled with that same drawing. If you added a key exposure anywhere other than the beginning of the drawing, then the drawing is split in two and both parts contain the same drawing.

Removing Key Exposures

When you no longer need a key exposure, you can remove it. When you do this, the existing key exposure is replaced by the preceding exposure. In the following example, a key exposure is set to drawing 1 (DR 1). When the key exposure is removed, the exposure is replaced by the preceding exposure, drawing 4 (DR 4).

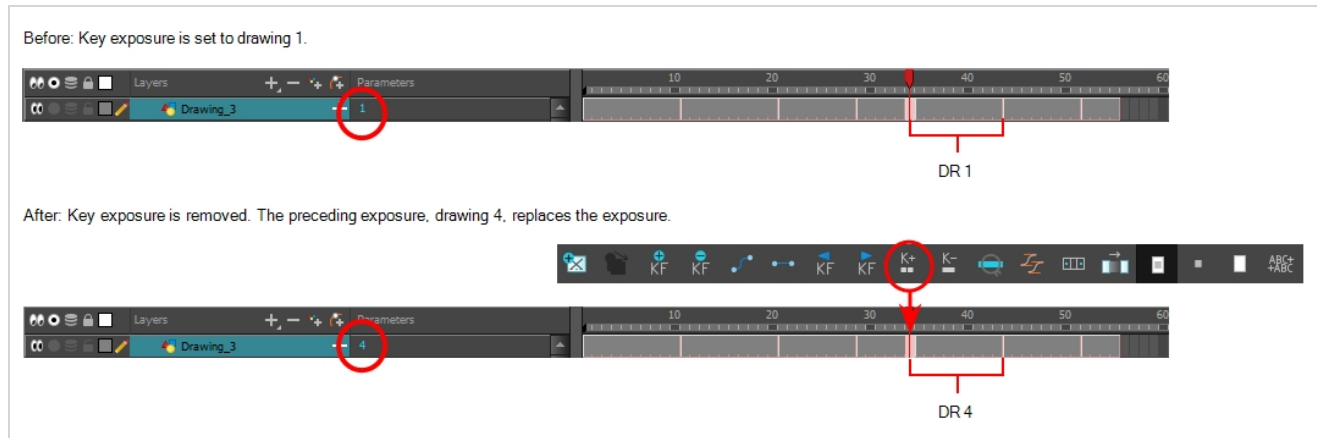

How to remove a key exposure

1. In the Timeline view, select a key exposure to remove.
2. Do one of the following:
 - In the Timeline toolbar, click the Remove Key Exposure  button.
 - Right-click and select **Exposure > Remove Key Exposure**.

The key exposure is removed and replaced by the preceding exposure.

About Eases

To add ease in and ease out on motion paths, you can display the function curve and modify the Bezier or Ease curve. To apply an ease to multiple functions and keyframes, use the Set Ease for Multiple Parameters feature and set the amount desired.



The velocity, or ease, is used on motion keyframes. The velocity must be adjusted directly on the function curve in the Function view or Function editor. When a keyframe is selected, easing values appear in the right handle and left handle fields, as well as the Bezier handle or Ease wheel controls on each selected keyframe. You can pull on them to adjust the ease in and ease out, or type values in the fields.

If there are several functions whose velocity you want to adjust at the same time, such as the hand, forearm and arm of a cut-out character, you can apply the same velocity parameters to all the selected keyframes in one frame.

Setting Eases for Multiple Parameters

You can adjust eases for multiple parameters at once.

How to set ease on multiple parameters

1. In the Timeline view, collapse your character model's hierarchy.
2. Select one of your animation keyframes. Since your model's hierarchy is collapsed, this selects the keyframe on every layer simultaneously.

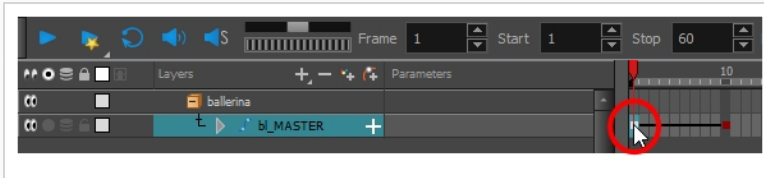

3. Do one of the following:
 - In the Timeline view, right-click and select **Set Ease For Multiple Parameters**.
 - In the Timeline toolbar, you can click the Set Ease For Multiple Parameters  button.

The Set Ease For Multiple Parameters dialog box opens.

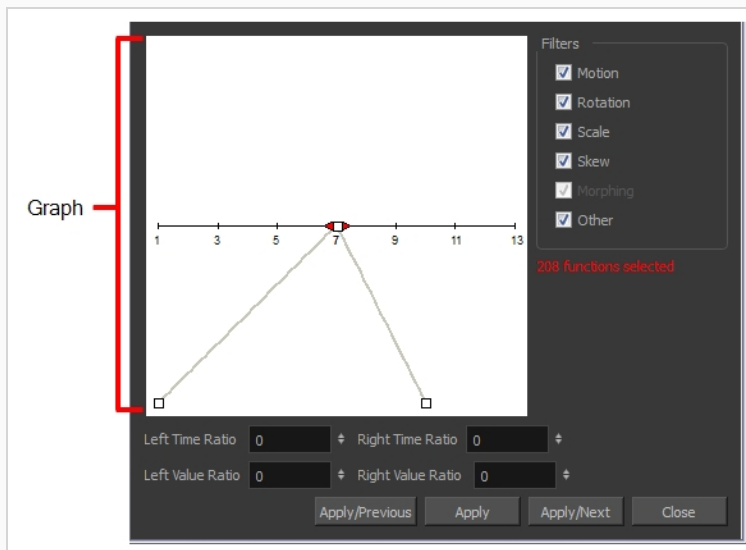

4. In the graph, pull on the Bezier handle to adjust the velocity for all the selected functions.

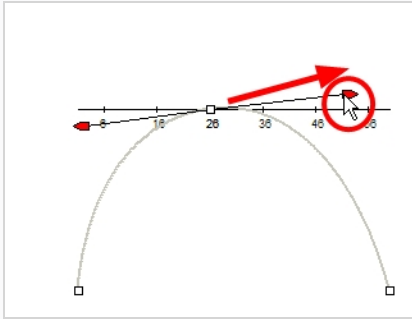

5. To apply these easing parameters to a certain type of function only, such as Rotation or Scale, in the Filters section, deselect the function types you do not want to affect.
 - **Motion:** Applies the easing parameters to the selected Position X, Position Y, Position Z and 3D Path functions
 - **Rotation:** Applies the easing parameters to the selected Angle functions.
 - **Scale:** Applies the easing parameters to the selected Scale functions.
 - **Skew:** Applies the easing parameters to the selected Skew functions.
 - **Morphing:** Applies the easing parameters to the selected Morphing Velocity functions. Note that Morphing is only available in Harmony Advanced and Harmony Premium.
 - **Other:** Applies the easing parameters to all the other selected functions, such as all functions created to animate effect parameters.

6. You can also adjust the easing by typing values in the Time Ratio and Value Ratio fields. The values are calculated in percentage.
 - In the Left Time Ratio and Right Time Ratio fields, type the percentage value corresponding to the length of time you want the easing to last. The value must be between 0% and 100%.
 - In the Left Value Ratio and Right Value Ratio fields, type the percentage value of how strong you want the easing out. The value must be between 0% and 100%.
 - If your Time Ratio and Value Ratio values are equal, you will have a linear motion.

7. Click one of the following buttons:
 - **Apply/Previous:** Applies the easing parameters to the selected keyframes and then selects the previous keyframe in the timeline.
 - **Apply:** Applies the easing parameters to the selected keyframes.
 - **Apply/Next:** Applies the easing parameters to the selected keyframes and then selects the next keyframe in the timeline.

- **Close:** Closes the dialog box. If you did not apply the modifications, they will be cancelled.



NOTE

If a range containing multiple keyframes is selected, only the first selected keyframe will be affected by the Seat Ease for Multiple Parameters functionality.

Using the Onion Skin in Cut-out Animation

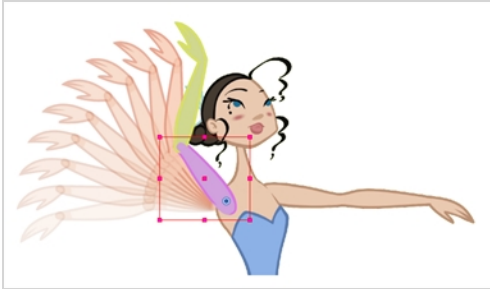

T-HFND-006-006

When animating cut-out characters, it is useful to see the previous and next frames on the animation. However, it can sometimes be confusing to see the onion skin for every part of the character. You will often only want to see the onion skin on a single part or a few parts, such as the arm that is currently being animated.



While animating in the Camera view, there is a series of different onion skin options. You can enable these options in the menu or manually in the Timeline view using the layer's Show Onion Skin  button. Only selected layers will be displayed in the onion skin preview; you can change the display options when you use the onion skin.

How to use the onion skin

1. In the Tools toolbar, click the Onion Skin  button or press Alt + O.
2. In the Tools toolbar, click the Transform  tool or press Shift + T.
3. In the Camera view, select one or more elements.
4. Select **View > Onion Skin** and one of the following commands:
 - **Add to Onion Skin:** Adds a series of selected elements to the onion skin preview.
 - **Remove From Onion Skin:** Removes a series of selected elements from the onion skin preview.
 - **Remove Unselected from Onion Skin:** Removes all elements except the ones selected from the onion skin preview.
 - **Add All to Onion Skin:** Adds all of the scene's elements to the onion skin preview.
 - **Remove All from Onion Skin:** Removes all of the scene's elements from the onion skin preview.

Add to Onion Skin

The Add to Onion Skin command adds a series of selected elements to the onion skin preview. The keyboard shortcut is Shift + S.

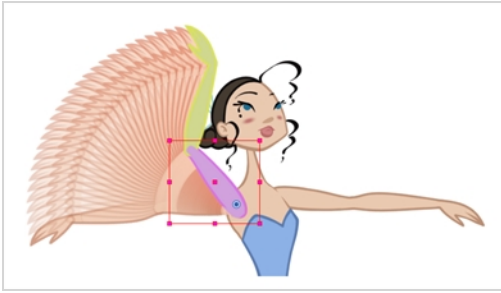

Remove from Onion Skin

The Remove From Onion Skin command removes a series of selected elements from the onion skin preview.

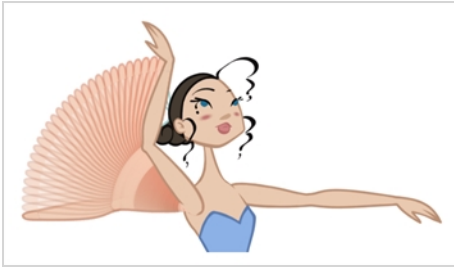

Remove Unselected from Onion Skin

The Remove Unselected from Onion Skin command removes all elements except the ones selected from the onion skin preview.

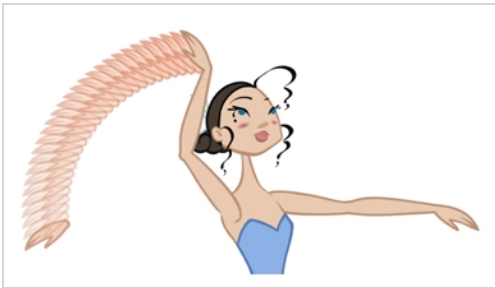

Add All to Onion Skin

The Add All to Onion Skin command adds all scene elements to the onion skin preview. The keyboard shortcut is Alt + Shift + O.

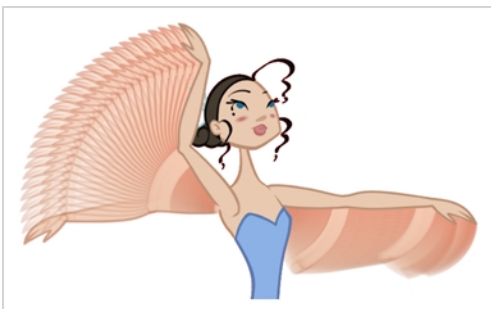

Remove All from Onion Skin

The Remove All Onion Skin command removes all scene elements from the onion skin preview. The keyboard shortcut is Ctrl + Shift + O (Windows/Linux) or ⌘ + Shift + O (macOS).

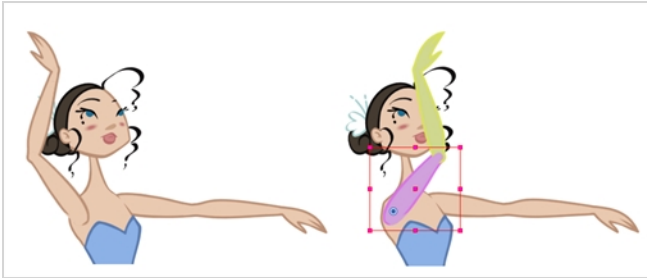

Using the Outline Mode

Use the Outline mode to temporarily convert all the drawings on a layer to outlines. You can still select and manipulate the drawings in this mode. Select a drawing by selecting its outline. The fill is not taken into account when making selections in this mode.



Toggling drawings to outlines

1. In the Timeline view, click once on the Change Track Colour button of a layer to toggle all drawings of that layer to outlines, in the Camera view.

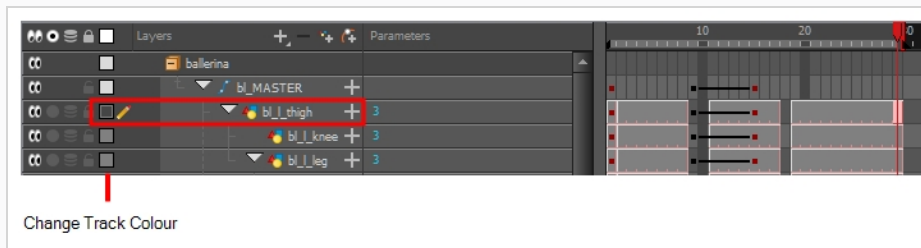



Changing the outline colour

1. In the Timeline view, double-click on the Change Track Colour button of a layer to open the Select Colour dialog box.

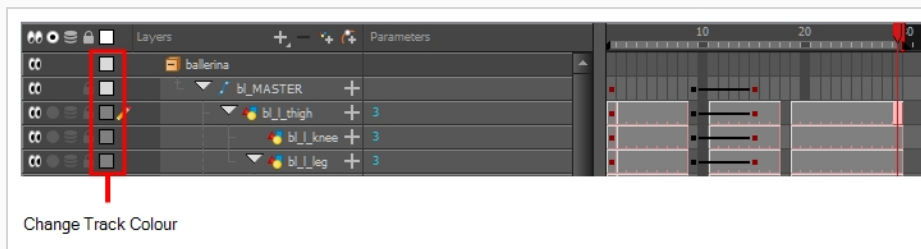

2. In the Select Colour window, select a new colour for your outlines.



3. Click Ok.

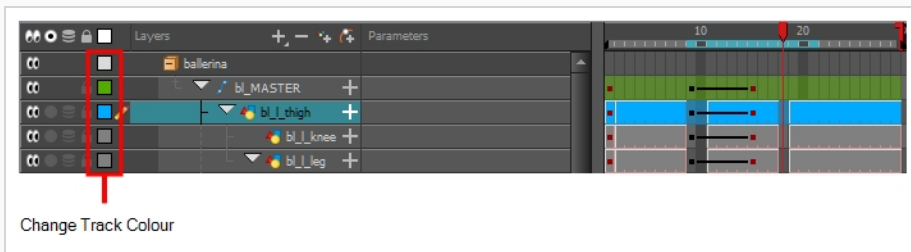

The colour swatch and frames of the selected layer take on the new colour.

4. In the Timeline view, click once on the change track colour of a layer to toggle all drawings of that layer to outlines, in the Camera view.



The outlines of the layer's drawings appear in the selected colour.

Flipping Through Poses

When animating, it is useful to flip through poses to see the flow of your animation without going through each frame in the Timeline view. Harmony lets you flip between the selected element's keyframes.

How to flip through poses

1. In the Camera or Timeline view, select a layer that contains the poses you want to view.

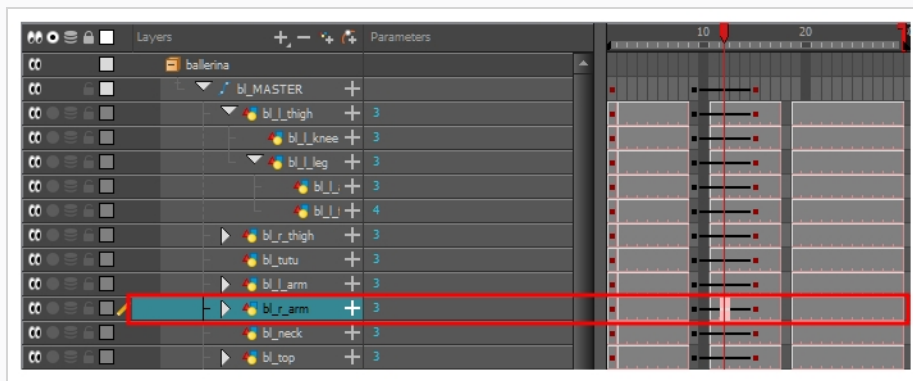
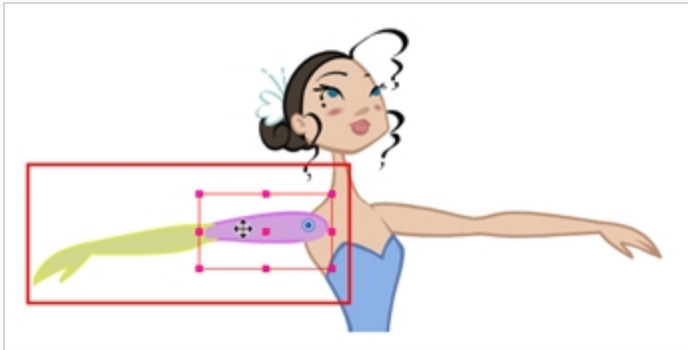



2. Do one of the following:
 - From the top menu, select **Animation > Go to Previous Keyframe** or **Go to Next Keyframe**
 - Press semicolon (;) and single quote (').



Flipping Parts

If you want to flip a part, a limb or a whole puppet, use the Transform tool and the Flip Horizontal and Flip Vertical options. If the Scaling parameter is not set to Separate Scale, the flip is not applied to the selection.

How to flip a selection

1. In the Tools toolbar, select the Transform  tool or press Shift + T.
2. In the Tool Properties view, make sure the Peg Selection Mode  is disabled.
3. In the Camera view, select the parts to be flipped.



4. In the Tool Properties view, click the Flip Horizontal  or Flip Vertical  option or press 4 or 5 respectively.

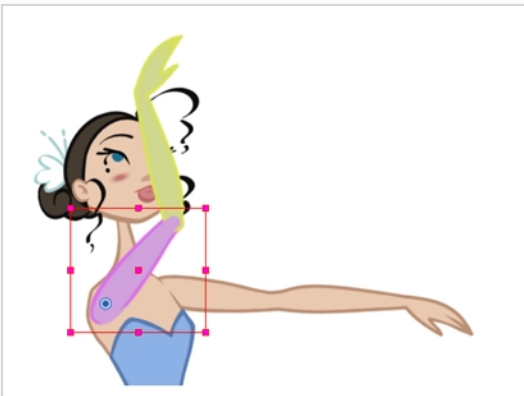

Animating Lip-Sync

Adding a lip-sync to your animation is essential to making your characters seem alive. However, it is also a particularly tedious part of the animation process.



To solve this problem, Harmony provides an automatic lip-sync detection feature. This feature analyzes the content of a sound track in your scene and associates each phoneme it detects with one of the mouth shapes in the following mouth chart, which is a standard mouth chart in the animation industry.

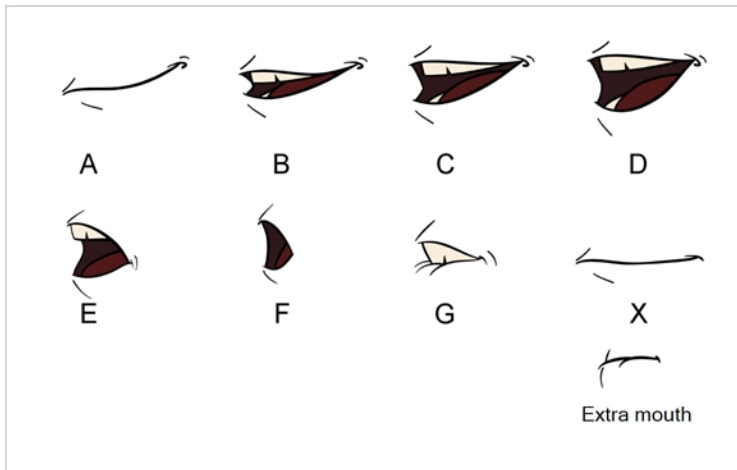

NOTE

The letters assigned to these mouth shapes are standard identifiers, they do **NOT** correspond to the sound they are meant to produce.

This is an approximation of the English phonemes each mouth shape can be used to represent:

- **A:** m, b, p, h
- **B:** s, d, j, i, k, t
- **C:** e, a
- **D:** A, E
- **E:** o
- **F:** u, oo
- **G:** f, ph
- **X:** Silence, undetermined sound

When performing automatic lip-sync detection, Harmony does not create mouth drawings. It simply fills the drawing column of your character's mouth layer with the generated lip-sync, by inserting the letter associated with the right mouth shape into each cell of the column. Therefore, for the automatic lip-sync detection to work, your character's mouth layer should already contain a mouth drawing for each drawing in the mouth chart, and these drawings should be named by their corresponding letter.

How to generate a sound detection for lip-sync using the Layer Properties view

1. In the Timeline or Xsheet view, select the sound layer.

The options for that layer will appear in the Layer Properties view.

2. In the Layer Properties, click **Detect**.

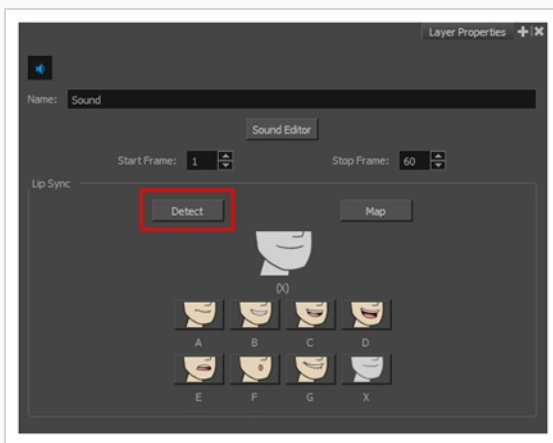

Harmony analyzes the selected sound clips and assigns a lip-sync letter to each sound cell.

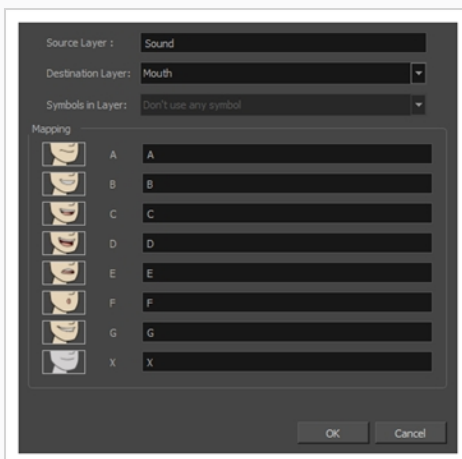

3. Click the **Map** button to open the Lip-Sync Mapping dialog box.

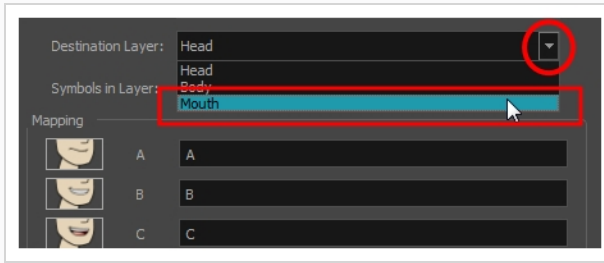

4. From the Destination Layer menu, select the layer that contains the mouth positions for the character's voice track.



**NOTE**

If the selected layer contains symbols, you can map the lip-sync using drawings located directly on the layer or use the symbol's frames. In the Symbol Layer field select **Don't Use Any Symbol** if you want to use the drawings or select the desired symbol from the drop-down menu.

5. In the Mapping section, type the drawing name or Symbol frames in the field to the right of the phoneme it represents. If your drawings are already named with the phoneme letters, you can skip this step.
6. Click **OK**.
7. In the Playback toolbar, enable the Enable Sound  option.
8. Press the Play  button in the Playback toolbar to see and hear the results in the Camera view

You can manually create the lip-syncing for your scene by selecting which mouth drawing should be exposed at each frame of your character's dialogue. For this process, you will be using the Sound Scrubbing functionality, which plays the part of your sound track at the current frame whenever you move your Timeline cursor, allowing you to identify which phonemes you should match your character's mouth to. You will also be using drawing substitution to change which mouth drawing is exposed at every frame.

How to animate lip-sync using the Timeline view

1. In the Playback toolbar, enable the **Sound Scrubbing**  button.
2. In the Timeline view, drag the red playhead along the sound layer waveform.
3. When you reach a frame where a mouth position should go, for example, an open mouth with rounded lips for an "oh" sound, click on that frame on your mouth shapes layer.
4. In the Parameters section, staying on your mouth shapes layer, place your cursor on top of the drawing name (often a letter) until it changes to the swapping  pointer.
5. Pull the cursor to see the list of mouth shape names and choose the one you want. The current drawing automatically changes to the new selection.



How to animate lip-sync using the Library view

1. In the Playback toolbar, click the Sound Scrubbing  button.
2. In the Timeline view, drag the red playhead along the waveform of your sound layer.
3. When you reach a frame where a mouth position should go, for example, an open mouth with rounded lips for an "oh" sound, click on that frame on your mouth shapes layer.
4. In the Drawing Substitution window of the Library view, drag the slider to choose a mouth shape. The current drawing is swapped for the one in the preview window.

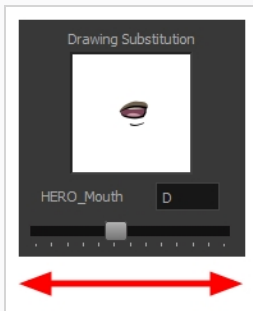

Ordering in Z-Depth



The layer ordering system in Harmony saves time and simplifies your work. There is no need to create a new layer or copy and paste artwork into other layers to change the order. The Z-axis (forward/backward) allows you to create a multiplane and move elements closer or farther from the camera. This allows you to move the puppet's pieces in front of or behind other ones without physically changing the layer position.

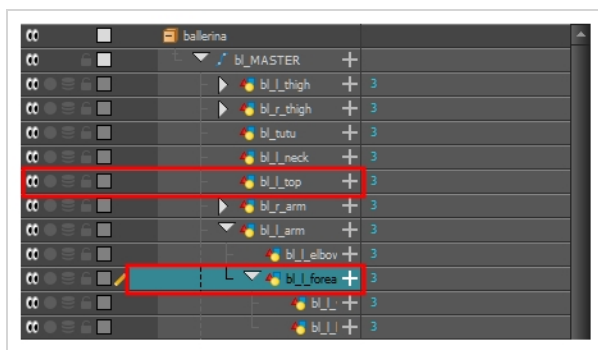

Harmony provides you with a shortcut to move the piece with a micro nudge on the Z-axis. A keyframe is created where different Z values can be entered. This allows the piece to move forward and backwards in space without requiring you to change the drawing's original position or break the layer hierarchy. This also means that the layer ordering is maintained throughout the scene. You can combine animation assets so Harmony can interpolate them.



How to nudge elements on the Z-axis

1. In the Tools toolbar, select the Transform  tool or press Shift + T.
2. In the Tools toolbar, click the Animate  button.

3. In the Camera view, select the part to be repositioned and hold down the Alt key.
4. Using the Up Arrow or Down Arrow arrow keys, nudge the part until it moves to the desired position.

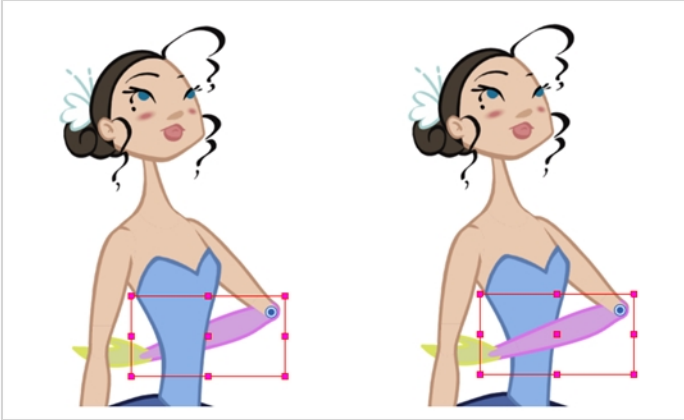

Creating Cycles

You can create cycles from a portion of your animation or completely reverse the flow of your animation.

How to create an animation cycle

1. In the Xsheet or Timeline view, select the cell range and keyframes to loop.

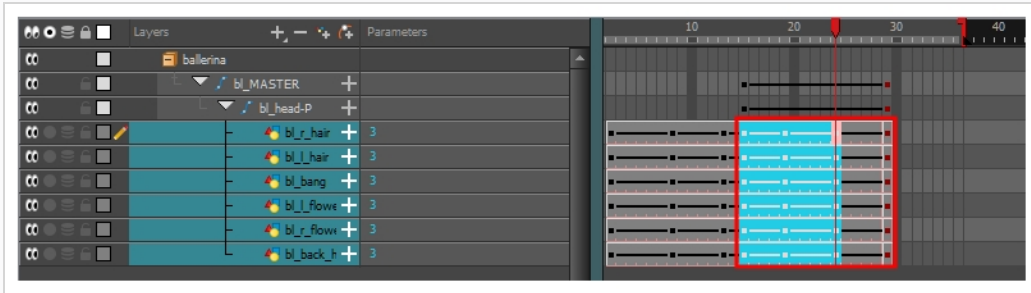

2. From the top menu, select **Edit > Copy Cells From the Timeline**.
3. In the Xsheet or Timeline view, select the cell where you want your cycles to start.

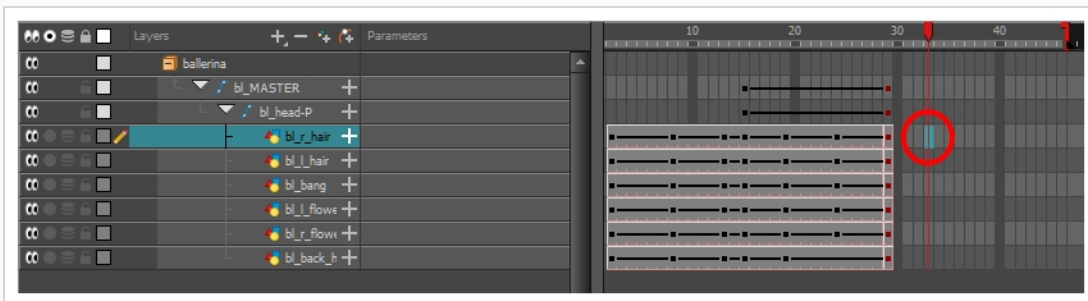

4. From the top menu, select one of the following:
 - **Edit > Paste Cycle**
 - Press **Ctrl + /** (Windows/Linux) or **⌘ + /** (macOS).

The Paste Special dialog box opens.

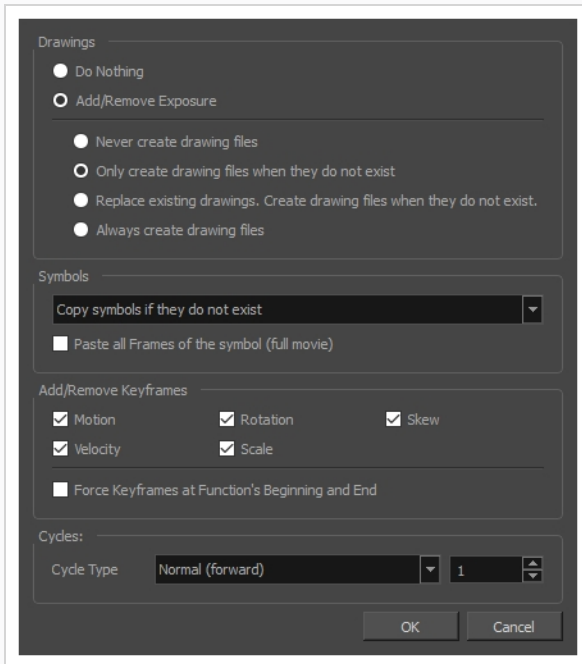

5. In the **Cycles** drop-down, select the type of cycle to paste:

- **Normal (forward)**: Pastes the selection as is, starting with the first cell and ending with the last.
- **Reverse**: Pastes the selection reversed, beginning with the last cell and ending with the first.
- **Forward -> Reverse**: Pastes the selection as a yo-yo, starting with the first cell, going to the last cell and ending with the first cell.
- **Reverse -> Forward**: Pastes the selection as a reversed yo-yo, starting with the last cell, going to the first one and ending with the last cell.

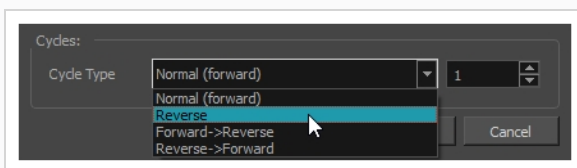

1. In the Number of Cycles field, enter the number of cycles to paste.

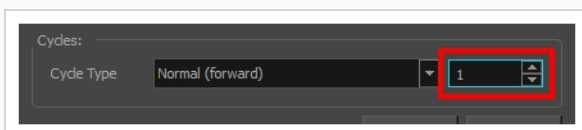

2. Click **OK**.

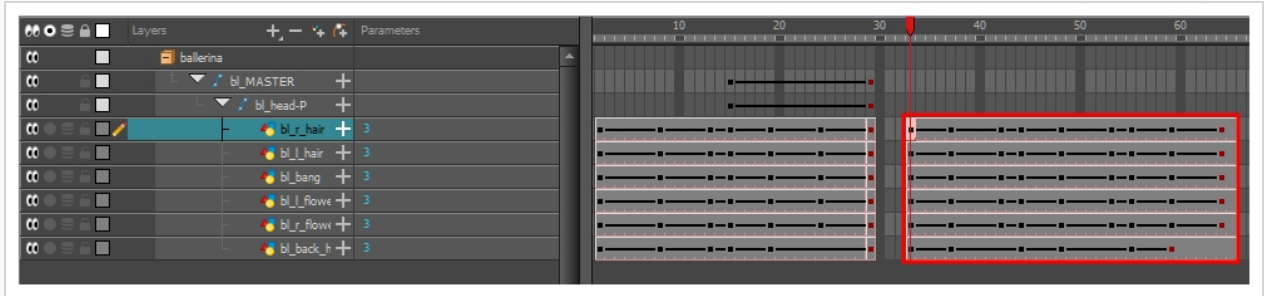

How to create a reverse animation cycle

1. In the Xsheet or Timeline view, select the cell range and keyframes to paste inverted.

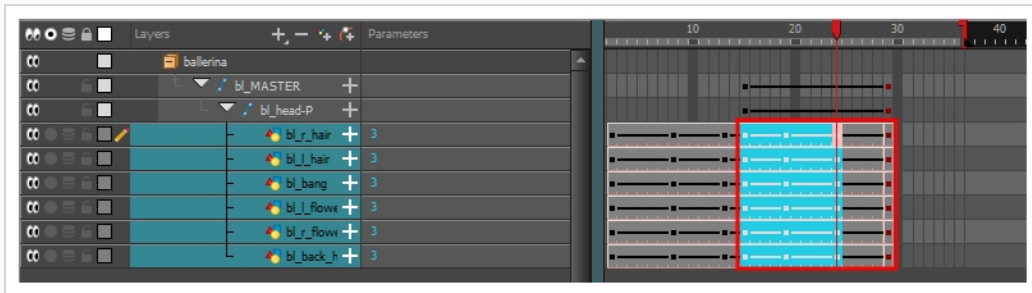

2. From the top menu, select **Edit > Copy**.
3. In the Timeline view, select the cell where you want the cycles to start.

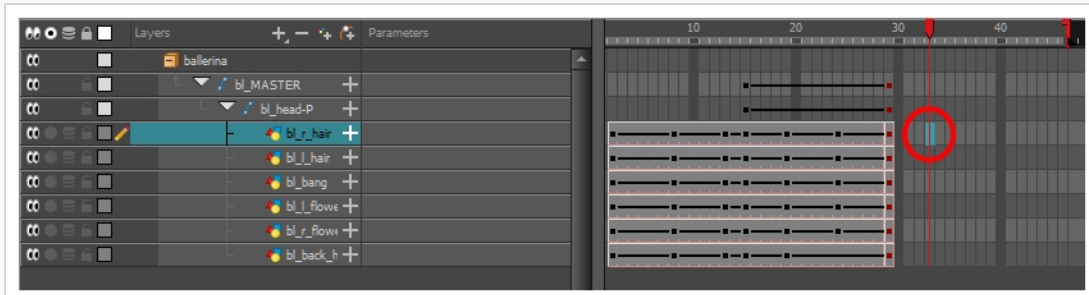

4. From the top menu, select **Edit > Paste Reverse** or press **Ctrl + .** (Windows/Linux) or **⌘ + .** (macOS).

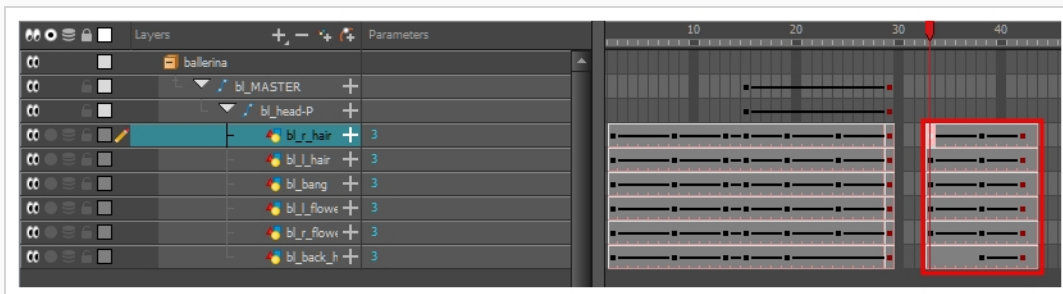

Chapter 9: Motion Paths

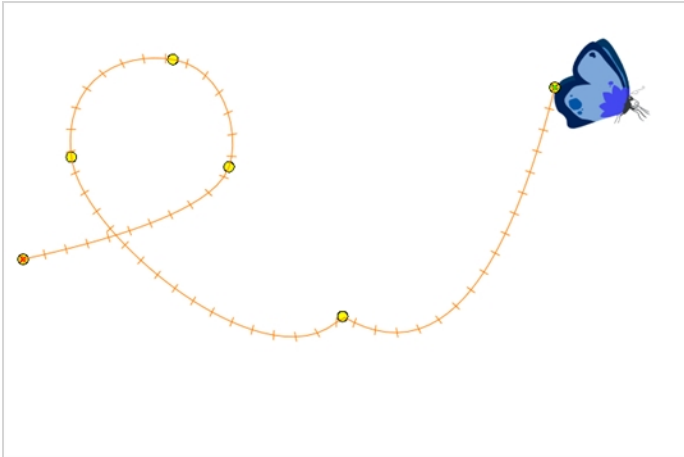

With Harmony, you can animate layers using computer-generated trajectories, create multiplane camera moves and camera shakes, adjust the easing, shape your paths with control points and much more.

Before animating the position of your layers, you need to create motion paths which are trajectories on which you can attach drawing objects. Using keyframes, you can then record key positions along the trajectory.

Harmony's wide range of features let you produce simple and advanced motions and trajectories. By creating a simple motion, you will learn the basics of animating a layer.

There are two ways to create motion paths: animated drawing layers and pegs. They each have different purposes.

About Pegs

T-HFND-009-004

A Peg layer is a trajectory that contains no drawings on which you can hook your drawings.

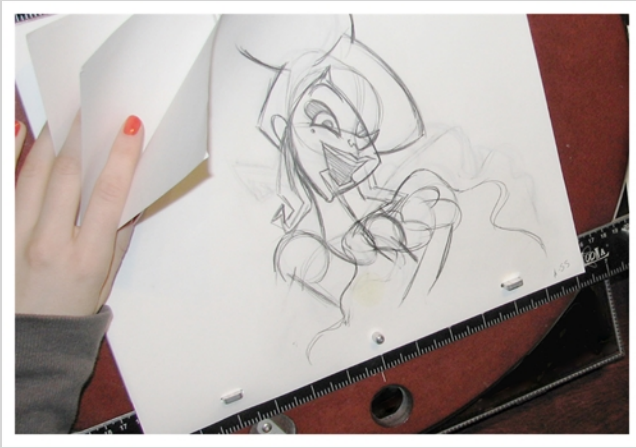

Pegs have been used for a long time in the traditional animation process, mainly for registration purposes. Peg holes at the bottom or top of the animation paper are used to keep all the sheets even and at the same registration.

There are three peg holes in regular animation paper. The centre peg hole is round while the left and right ones are oval shaped. The oval peg holes are located on each side of the page, four inches away from the centre peg hole.

To keep the drawings together, the animator uses a peg bar. This peg bar has three pins that correspond to the shape and location of the peg holes. Peg bars are normally found at the bottom and top of animation discs.

Before digital compositing, the peg bars were also used to move layers on the camera stand to create pans and camera moves. They were the equivalent of digital trajectories. Harmony makes use of these concepts to create animation and camera motion.

A peg is composed of many customizable parameters. These parameters are:

- X, Y and Z positions (3D Path or Separate Positions)
- Angle (rotation)
- Skew
- X and Y Scales

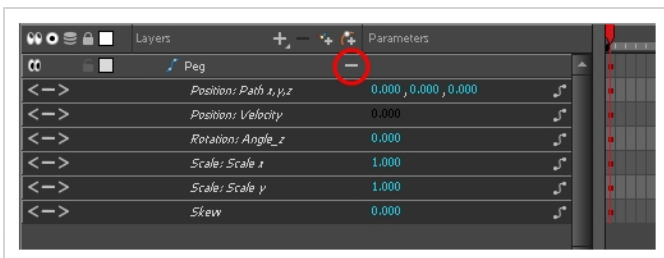

You can control a peg's trajectory the same way as the animated drawing layer.

A peg layer is mainly used to control a series of drawing layers, such as clouds, a school of fish or a flock of birds. You can attach them to a peg layer and make them follow a trajectory as a single unit. This makes trajectory modifications much easier and faster. When building a puppet, most of the time you will add a master peg to control your puppet as one object.

Adding Pegs

T-ANIMCO-001-001

You can add peg to your Timeline view and parent the layers to animate to it.

How to add a peg in the Timeline view

1. In the Timeline view, select the layer on which you want to attach a peg.

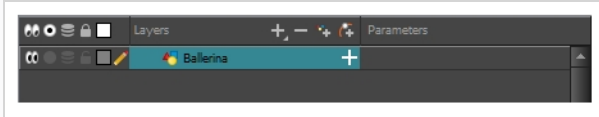

2. Do one of the following:

- From the Timeline view layers toolbar, click the Add Peg  button.
- From the top menu, select **Insert > Peg**.
- Right-click on the selected layer, then select **Insert > Peg**.
- Press Ctrl + P (Windows/Linux) or ⌘ + P (macOS).

The layer that was originally selected becomes a child of the new parent Peg layer. The new Peg layer automatically takes the name of its child layer, with the addition of the suffix -P.

The indentation of the layer, along with the "L" indicates hierarchy and that the layer is attached to the Peg layer. This relationship is called a parent-child relationship.

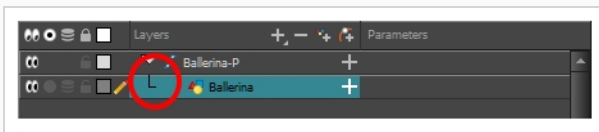

3. If you intend to add multiple pegs or if the layer name that was added to the peg does not accurately represent the content of the Peg layer, you can rename it. Click the layer name and type in a new name. Or double-click the layer and type a new name into the dialog box.

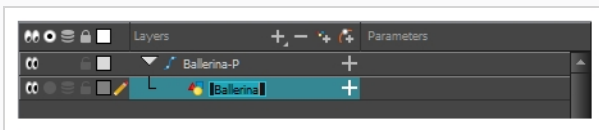

4. If you did not create your peg layer directly above the layer you intended on parenting it to, then drag the layer you want to attach to the peg and drop it directly below the Peg layer. The indentation of the layer below the Peg layer indicates whether it was correctly attached or not.

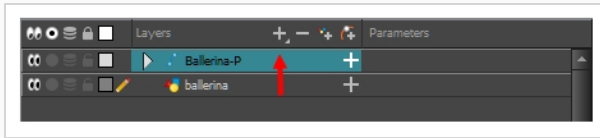



- You can unparent layers by holding down Shift and dragging the selected parents away from the child layer. Drop your selected between other layers.

Enabling Peg Selection Mode

In the Tool Properties view, the Peg Selection Mode  lets you automatically select the peg layers in the Camera view instead of the drawing layers. If you animate with pegs instead of animating the drawing layers directly, enable the Peg Selection Mode to avoid having to select in the Timeline view or use the Select Parent Skipping Effects command.

How to enable the Peg Selection Mode

1. In the Tools toolbar, select the Transform  tool or press Shift + T.
2. In the Tool Properties view, click the Peg Selection Mode  button.
3. In the Camera view, select an element parented to a peg.

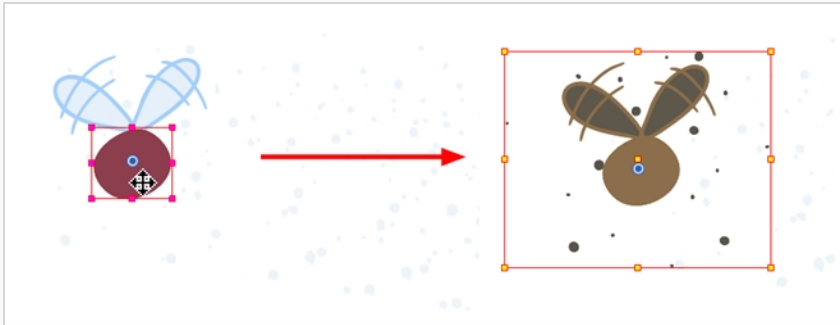

About Drawing Layers

T-ANIMCO-001-002

You can create a motion path directly on layers (animated layers).

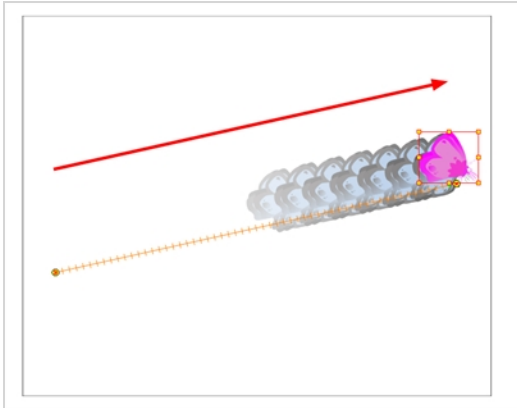

You can control and define a trajectory using several different parameters, including:

- X, Y and Z positions (3D Path or Separate Positions)
- Angle (rotation)
- Skew
- X and Y Scales

Harmony keeps track of the animation by storing each parameter of each layer in their own function curve. When you add a keyframe to a layer, a keyframe is created on each of these functions, and transformations done on a layer via the Camera view are translated into coordinates which are then stored in those functions. It is possible to edit these functions individually using the Function view, but that is rarely necessary, as Harmony provides easy-to-use tools for visually controlling trajectories and timing in the Camera and Timeline views.

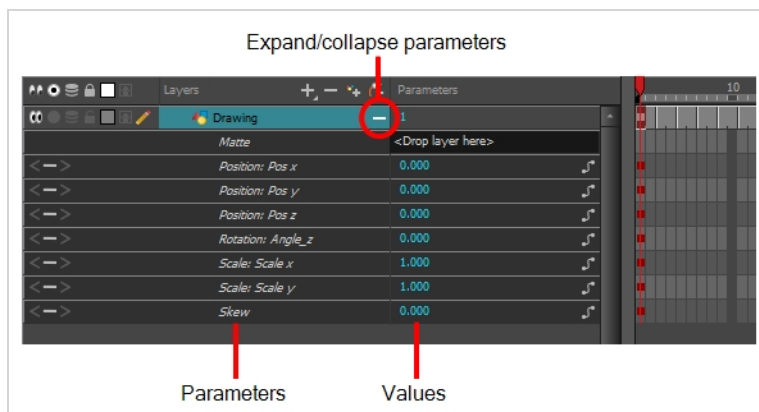

If you do not want to animate a drawing layer, you can turn off its animation parameter. To do so, simply select the layer and in the Layer Properties view, deselect the Animate Using Animation Tools option on the Controls tab. If your layer was already animated, then your keyframes will appear dimmed so you can easily identify them as ones that cannot be modified. To modify keyframes, select the Animate Using Animation Tools options.

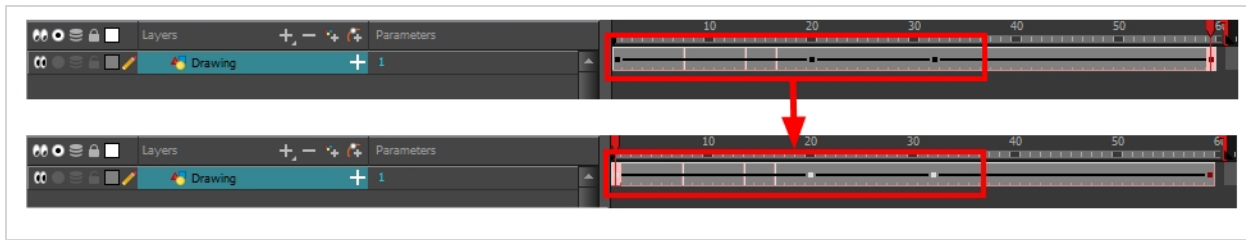

About Layer Parameters

T-HFND-009-008

A layer is composed of many customizable parameters, such as the X, Y and Z positions, angle (rotation), skew and scales. Each parameter has its own function which is a mathematical formula expressing the relationship between position values. You can view each function on a graph as a simple curve, such as the one below.

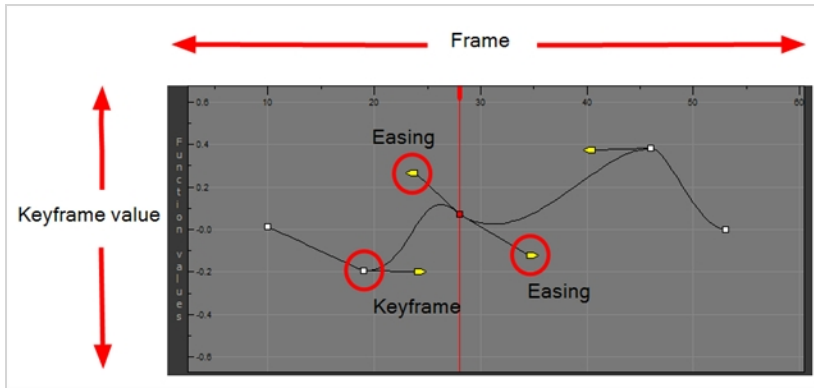

There are several options available for setting up function parameters:

- Locked Positions (3D Path)
- Separate Positions
- Locked Scales
- Separate Scales

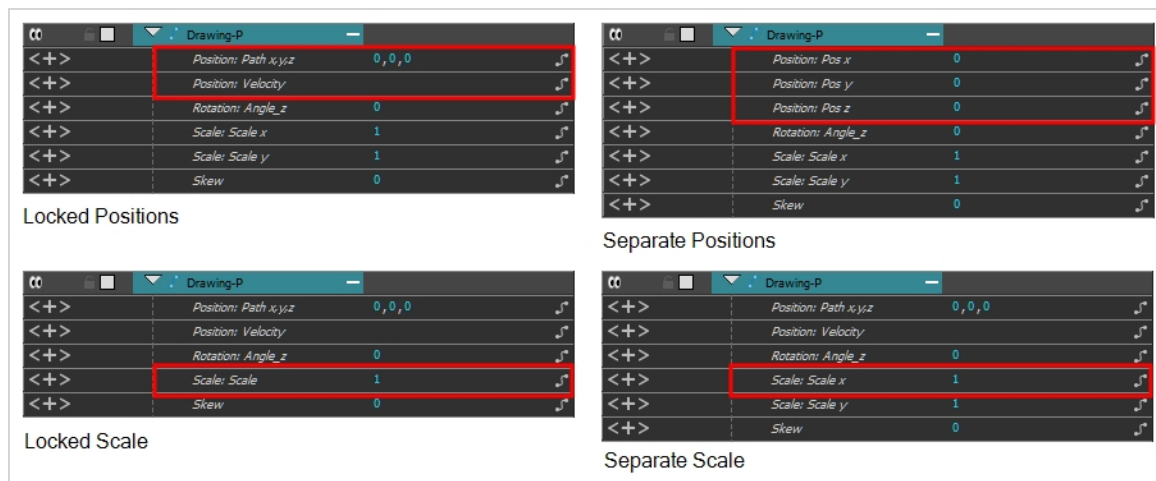

You must select 3D Path, Separate Positions, Separate Scale, or Locked Scale before starting the animation. When you lock or unlock parameters, this does not convert the functions from one to the other, but creates new ones.

In a 3D Path, the X, Y and Z curves are locked together and controlled by a single velocity function. When you add a keyframe, it is added on all three trajectories at once, as is the velocity. This is very useful for long, smooth trajectories.

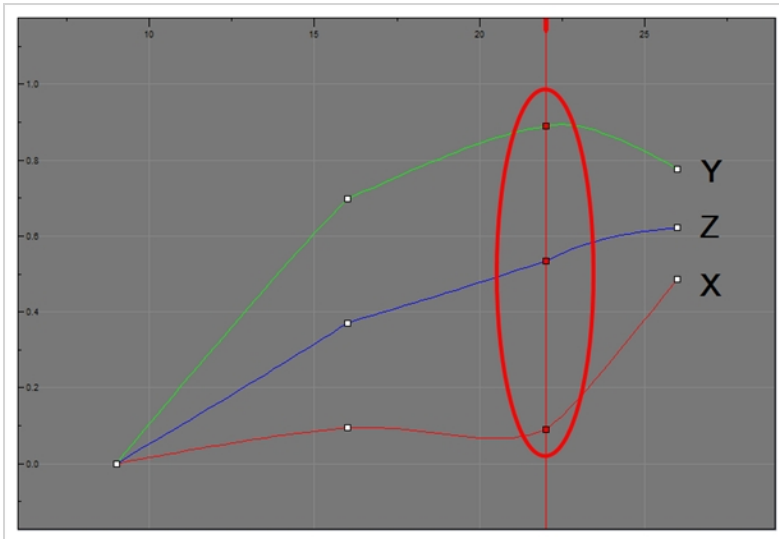

When using a 3D path, the X, Y and Z functions work together using the same keyframes. This allows for the velocity to control the curve and create a smooth trajectory. Even if a function does not have any variation on its curve (for example, all keyframes are at zero), the velocity might add a slight motion to ensure a smooth trajectory. This can cause elements that are very close to each other on the Z-axis to pop in front of one another. This is why in cut-out animation it is recommended to use separate position settings. But if you work with 3D path, you can use the Constant Z feature to avoid this from happening.

The Constant Z feature is used when creating motion keyframes. The Z function will use stop-motion keyframes and will not be interpolated, which can be very useful for cut-out animation. The Constant Z feature only works with 3D paths.

When the Separate Positions option is used, the X, Y and Z curves are independent and have velocity controls directly on their function curve. This is useful when you want to set keyframes on one of the curves without affecting the others.

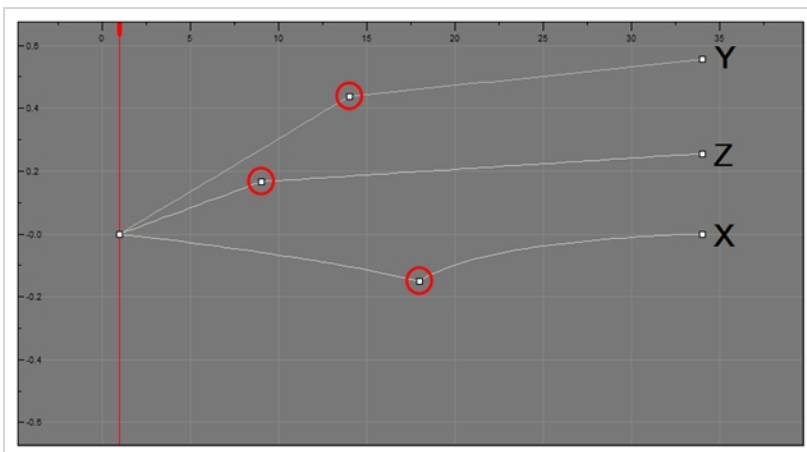

When using the Scale parameter, you can use a single function curve to control both the vertical and horizontal scale, or two separate scales. When using a single function curve, the values are the same for the X (horizontal) and Y (vertical) axes for uniform size changes without distortion. However, if you separate the scale functions, you can squash, stretch and skew your elements.

Displaying Layer Parameters

T-ANIMCO-001-004

You can easily display the parameters for each layer in the Timeline view.

How to display the layer parameters in the Timeline view

1. Do one of the following:
 - In the Timeline's left side, click a layer's Expand **+** button.
 - In the Timeline view menu, select **View > Show Functions**.
 - Press **Alt + F**.

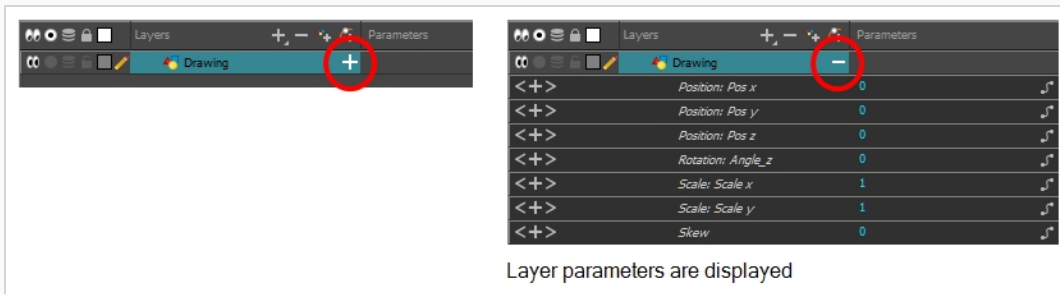

Setting Layer Parameters

T-ANIMCO-001-003

You can modify the layer parameters to different types of function and linking some of them together.

How to set the layer parameters

1. In the Timeline view, double-click on the layer on which you want to set the parameter. You can also see the parameters in the Layer Properties window when you select the layer in the Timeline view.

The Layer Properties window opens.



2. Select the **Transformation** tab.
3. In the Position section, select the **3D Path** or **Separate** option.
4. In the Scale section, select the **Locked** or **Separate** option.
5. Click **Close**.

Enabling Constant Z

T-HFND-009-008A

You can also enable the Constant Z option directly in the Function view for specific functions.

How to enable the Constant Z option

1. In the Timeline view, expand the layer on which you want to set the Constant Z feature. Note that you must select the **3D Path** option for the layer.
2. Double-click on one of the position functions to open the Function editor.
3. In the Function editor, select the Constant Z  button.

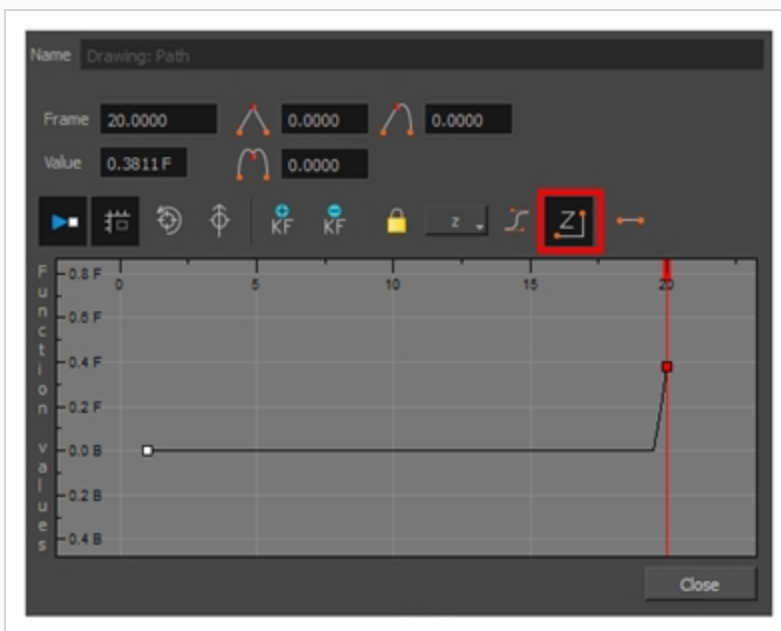

About Keyframes

T-HFND-009-005

Interpolation is the computer-generated motion between two keyframes. Some animators and compositors like to create their own in-betweens, while others like to have the computer do it. Harmony has stop-motion (no interpolation) and motion keyframes (computer-generated interpolation).

In stop-motion keyframes, there is no computer-generated motion between two keyframes. The segment is constant or flat. The drawing remains still until the playback reaches the next keyframe, then the drawing pops to its new location.

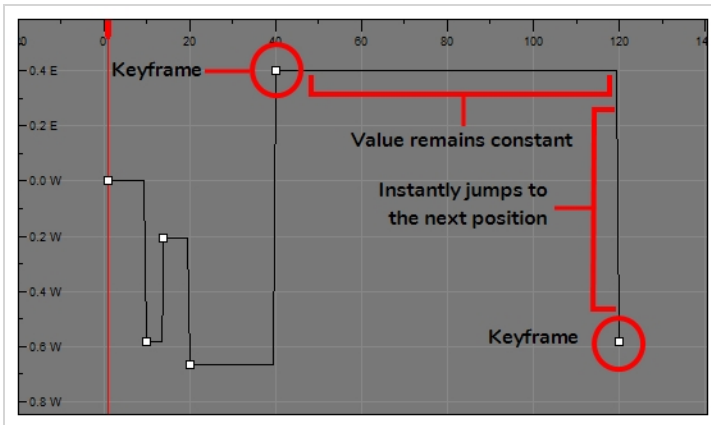

With motion keyframes, Harmony generates the interpolation between the keyframes. This means that a value for each frame between the keyframes is calculated by Harmony to progress from the value of the previous keyframe to the value of the next keyframe.

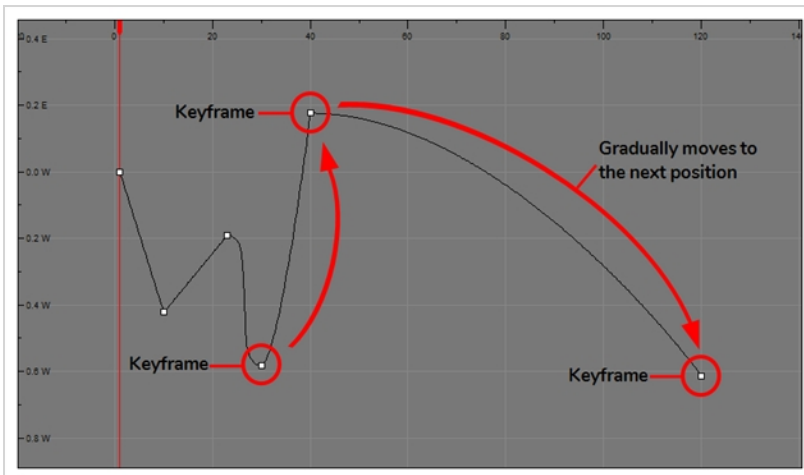

Enabling the Animate Mode

T-ANIMCO-001-007

The Animate mode records the position, rotation, scale, skew, etc. of objects as keyframes in the Timeline view. Turn off the Animate mode to reposition objects for the entire scene. When the Animate mode is disabled, keyframes are not created when an object's parameters change.

When positioning elements, make sure the Animate Mode is turned off, or it will create a keyframe on your drawing layer. The animate mode is used to animate layers over time.



How to turn the Animate mode on or off

1. In the Tools toolbar, click the Animate  button or select **Animation > Animate**.

About Keyframe Creation

There are several different ways you can create keyframes. You can add a coordinate keyframe, position keyframe or a keyframe along with your drawing duplication.

You can create a keyframe without a drawing. This adds new coordinate points but the drawing in the layer stays the same. At the same time, you may also want to duplicate your drawing if you need to modify it and do not want to modify the original.

You can also add a position keyframe instead of a regular keyframe. When you do this, keyframes will only be added on the X, Y and Z parameters of the selected layer. Keyframes are not added on the Angle, Scale and Skew parameters.

Creating Keyframes in the Timeline View

T-HFND-009-006

You can add keyframes in the Timeline view to multiple layers, a single layer or a specific parameter.

How to create keyframes in the Timeline view

1. In the Timeline view, select the cell on which you want to add a keyframe.

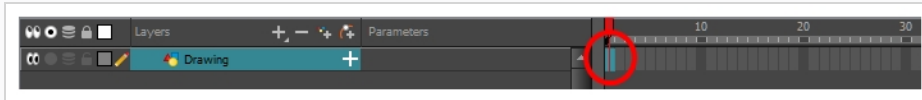

2. Add a keyframe by doing one of the following:
 - From the top menu, select **Insert > Keyframe**.
 - Right-click on the selection and select **Insert Keyframe**.
 - Press F6.
 - In the Timeline View toolbar, click the Add Keyframe  button.

If the Animate mode is enabled in the Camera view, a keyframe is automatically created on the current frame.

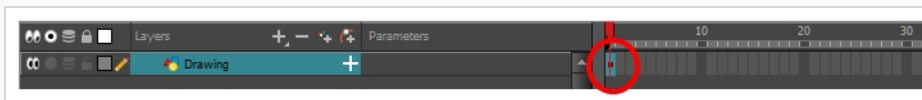

How to add a keyframe for a specific parameter

1. On the right side of the Drawing layer, press the + to expose the different functions of that drawing.
2. On the right side of the Timeline view, select a cell on the layer's function that you want to animate.

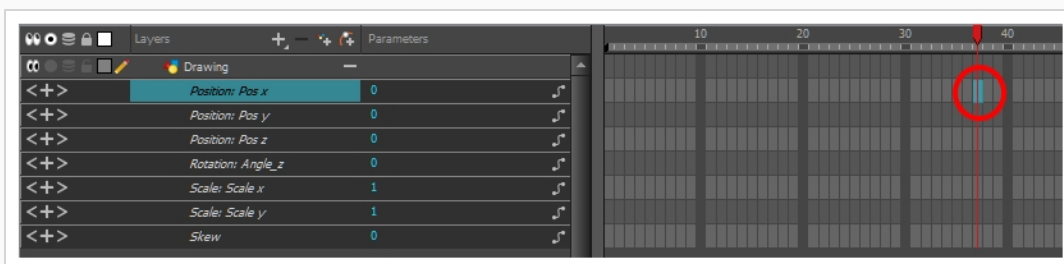

3. Do one of the following:
 - Right-click the selected cell and select **Insert Keyframe**.

- Press F6.
- In the Timeline View toolbar, click the Add Keyframe  button.

How to create a keyframe and duplicate the drawing at the same time

1. In the Timeline view, select the cell containing the drawing you want to duplicate and add a keyframe.



2. Do one of the following:
 - From the top menu, select **Insert > Keyframe and Duplicate Drawing**.
 - Right-click on the selection and select **Insert Keyframe and Duplicate Drawing**.
 - Press F6.

A keyframe and a duplicate of the drawing is created. The duplicated drawing sits on top of the original drawing.



Creating Keyframes in the Function View

You can add keyframe directly on the graph using the Function view.

How to add or delete keyframes in the Function editor

1. In the Timeline view, open the drawing or layer's parameters by clicking the Expand **+** button or press Alt + F.

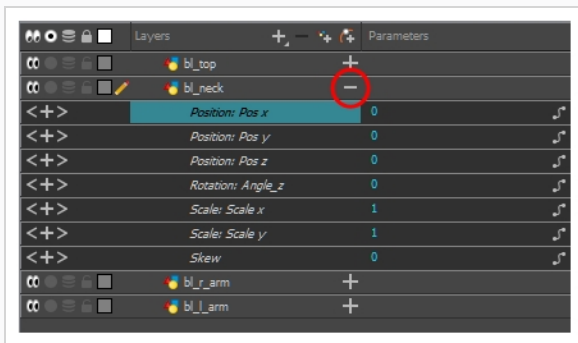

2. Double-click on the parameter layer name to open the Function editor window or click once on the parameter layer to display it in the Function view's left sidebar. If you are using the Function view, you must click on the function name from the sidebar list to view it in the graph display region.
3. In the Function editor, do one of the following:
 - In the graph section, click on the frame where you want to make changes.
 - In the Frame field, enter the frame number.

In the graph display area, the red playhead moves to that frame number.

4. In the Function editor, click the Add Keyframe **KF** button.

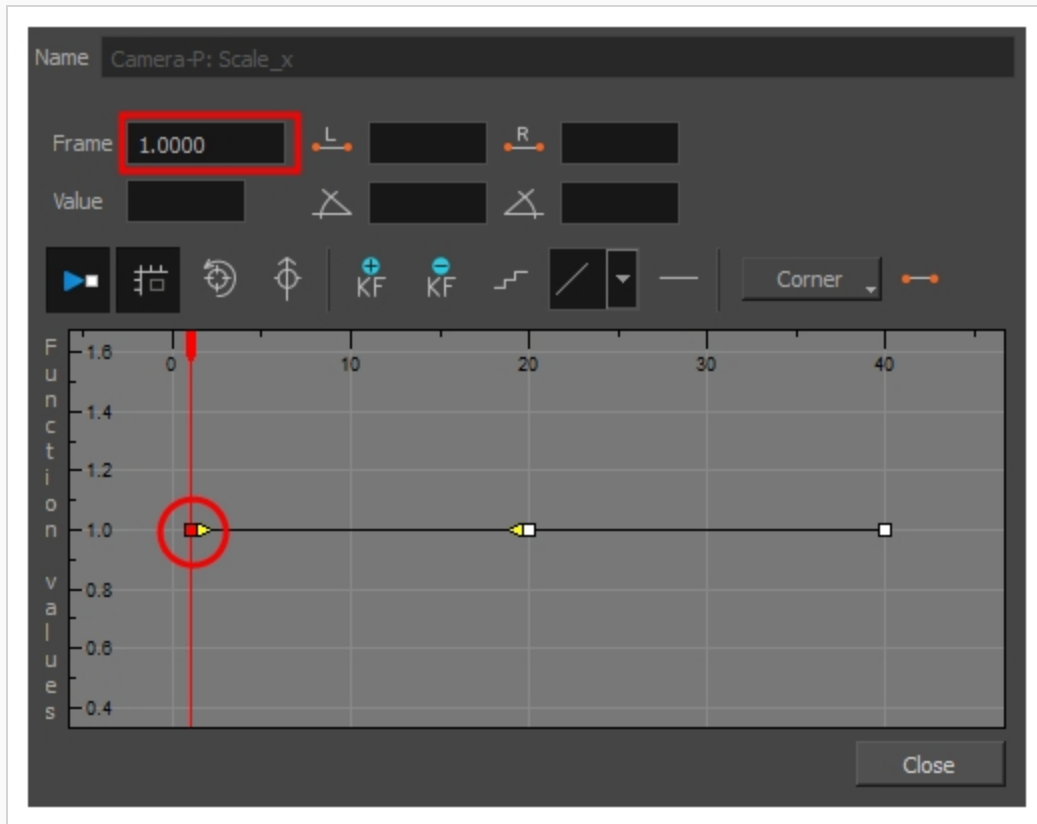

5. Click on the newly created keyframe and drag it up to increase the value of the function or down to decrease the value. Depending on the selected function, this could increase or decrease the width of the object (scale_x) or change the object's vertical position (position_y). Pull on the handles to create non-linear transition speeds between keyframes.
6. If you do not like the changes you just made, select and delete the new keyframe by pressing Del or clicking the and Delete keyframe  button.

You can delete an existing keyframe by using the same process.

Creating Keyframes in the Xsheet View

If you prefer working with the Xsheet view, you can also create keyframes and type values in the Xsheet view.

To edit a function column in the Xsheet view, you must first display the Functions section of the Xsheet view and then select the layer you want to modify. If you double-click on a function column's header, you will display the corresponding function curve in the Function editor.

How to add a keyframe in the Xsheet view

1. In the Xsheet view, click the Expand button located on the right side of the main section to show the Functions section.

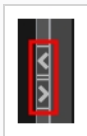

1. In the Timeline view, select the layer that contains the parameters to modify.

The columns appear in the Xsheet view if function curves were previously created by adding keyframes in the Xsheet view or Layer Properties window. Otherwise, the columns do not appear.

Drawing		Drawing Pos_x	Drawing Pos_y	Drawing Pos_z	Drawing Scale_x	Drawing Scale_y	Drawir Angle_
1	1	0.000	0.000	0.000	1.000	1.000	
2							
3							
4							
5							
6							
7							
8							
9							
10							
11							
12							
13							
14							
15							
16							

2. In the Xsheet view, go to the function column on which you want to add a keyframe.
3. Double-click on the cell on which you want to add a keyframe and type a numeric value.

Drawing Pos_x	Drawing Pos_y	Drawing Pos_z
1	0.000	0.000
2		
3	0.000	
4		
5		
6		
7		
8		
9		

4. Press Enter/Return to continue to the next cell.
5. Press Esc to exit the typing mode.

	Drawing Pos_x	Drawing Pos_y	Drawing Pos_z
1	0.000	0.000	0.000
2	2.500		
3	5.000		
4	5.000		
5			
6			
7			
8			
9			

How to convert a cell into a keyframe

1. In the Xsheet view, go to the function column on which you want to add a keyframe.
2. Select the cell to convert.

	Drawing Path x	Drawing Path y
1	0.000	0.000
2	1.000 E	
3	2.000 E	
4	3.000 E	
5	4.000 E	
6	5.000 E	0.000
7	6.000 E	
8	7.000 E	
9	8.000 E	
10	9.000 E	0.000
11		

3. Right-click on the cell and select **Set Selection As Keyframe** or press F6.

	Drawing Path x	Drawing Path y
1	0.000	0.000
2	1.000 E	
3	2.000 E	
4	3.000 E	
5	4.000 E	
6	5.000 E	0.000
7	6.000 E	
8	7.000 E	
9	8.000 E	
10	9.000 E	0.000
11		

4. To remove a keyframe, select the keyframe, right-click on the cell and select **Clear Keyframe in Selection** or press F7.

Deleting Keyframes

T-HFND-009-007



You can delete keyframes independently from drawing exposure.



NOTE

If you select a keyframe in the Timeline view and press the Del key, you will also delete the drawing exposure. To only delete the keyframe, you must use the Delete Keyframe command.

How to delete a keyframe



1. In the Timeline view, select a keyframe and do one of the following:
 - Right-click and select **Delete Keyframes**.
 - From the top menu, select **Animation > Delete Keyframe**.
 - Press F7.
 - In the Timeline View toolbar, click on the Delete Keyframes  button.
 - Use the Transform  tool to select a keyframe to delete from the trajectory in the Camera view and press Del.

Animating with Keyframes

T-ANIMCO-001-005

You can animate a layer or a peg by creating keyframes and moving your drawings in the Camera view.

How to animate a layer or a peg

1. In the Tools toolbar, select the Transform  tool or press Shift + T.
2. If your layer has a parent peg and you want to animate the drawing layer directly, make sure the Peg Selection Mode  is disabled in the Tool Properties view.
3. In the Tools toolbar, enable the Animate  mode. This allows the Transform tool to affect the position and size of a layer at the current keyframe only, whereas it would otherwise affect the layer's position and size throughout the whole scene.
4. In the Timeline view, go to the first frame.

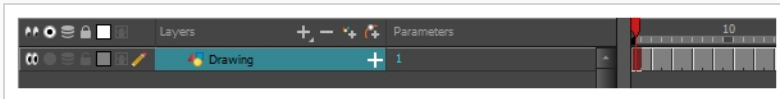

5. From the top menu, select **Animation** and make sure the **Stop-Motion Keyframe** option is unchecked. This will make it so Harmony automatically creates the animation between the animation keyframes you create.
6. Select the cell where you want to create your first keyframe
7. To create your first keyframe, do one of the following:
 - In the Timeline toolbar, click the Add Keyframe  button.
 - Right-click and select **Add Keyframe**.
 - Press F6.

A keyframe is created on the first frame of the Timeline view.

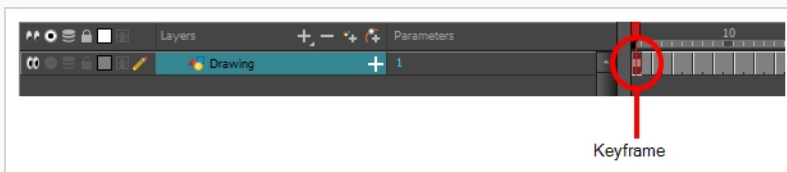

8. In the Camera view, select the element to animate and move it to its first position.

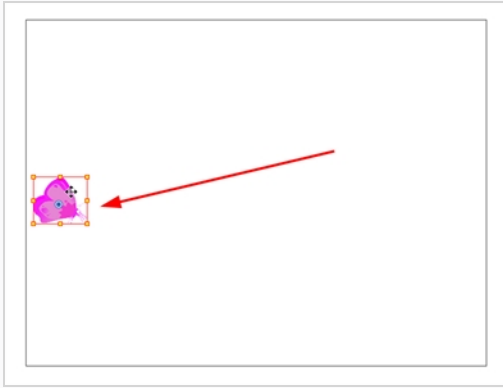

9. In the Timeline view, go to the frame on which you want to set the second position.

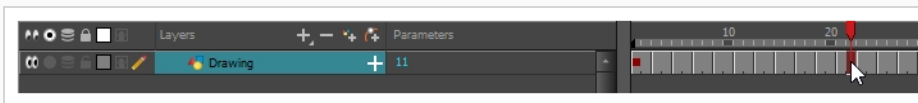

10. Select the cell where you want to create your second keyframe. right-click on the selection and select **Insert Keyframe**.

The second keyframe appears in the Timeline view, along with a line going from your first keyframe to your second keyframe. This indicates that every frame in-between will be animated by Harmony.

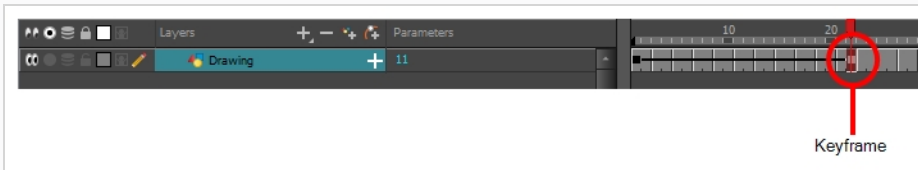

11. In the Camera view, move the element to its second position.

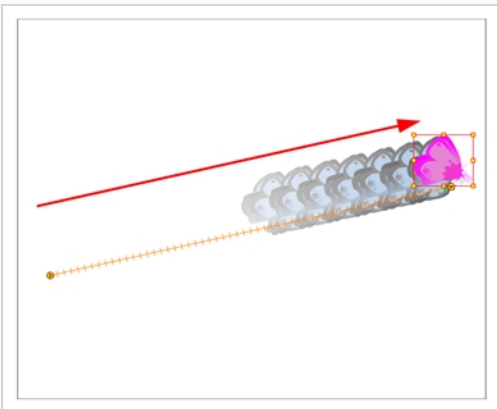

12. In the Timeline view, select the first frame to rewind to the beginning of your animation.
13. In the Playback toolbar, click on the Play ► button to preview your animation.



NOTE

If you animate layers on the Z axis, you may want to preview your animations from the Top or Side views during playback. However, playback is disabled by default in those view. To enable them, from the top menu, select **Play > Enable Playback > Top View** or **Side View**.

Changing Keyframe Values

Once a keyframe is added, beside moving the image in the Camera view, you can change its value by typing it in the Timeline and Function views.

How to change the keyframe values in the Timeline view

1. In the Timeline view, open the drawing or layer's parameters by clicking the Expand **+** button or press **Alt + F**.

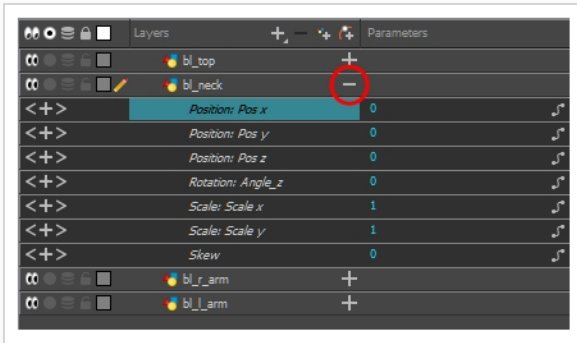

2. Select the parameter for which you want to create a function curve.
3. Place the cursor over the blue number value of the parameter and do one of the following:
 - Wait until the cursor changes to a white hand with a two-way arrow and then drag the hand left to decrease the value or right to increase the value.



- Double-click on the blue number and enter a value in the field.

How to change a keyframe value in the Function editor

1. In the Timeline view, open the peg element's parameters by clicking the Plus **+** sign next the peg layer's name.

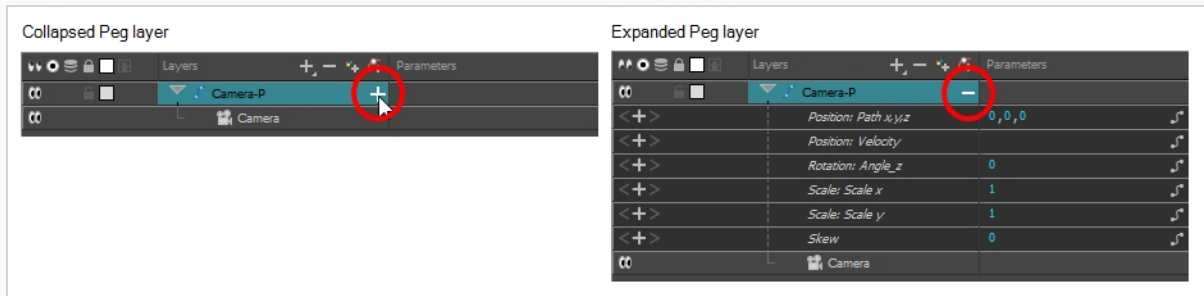

2. Double-click on the parameter layer name to open the Editor window or click once on the parameter layer to display it in the Function view.
3. In the graph of the Function editor, select a white keyframe.
The keyframe turns red and displays a pointed yellow handle.
4. In the Value field, enter a value. You can also drag the keyframe up or down in the graph.

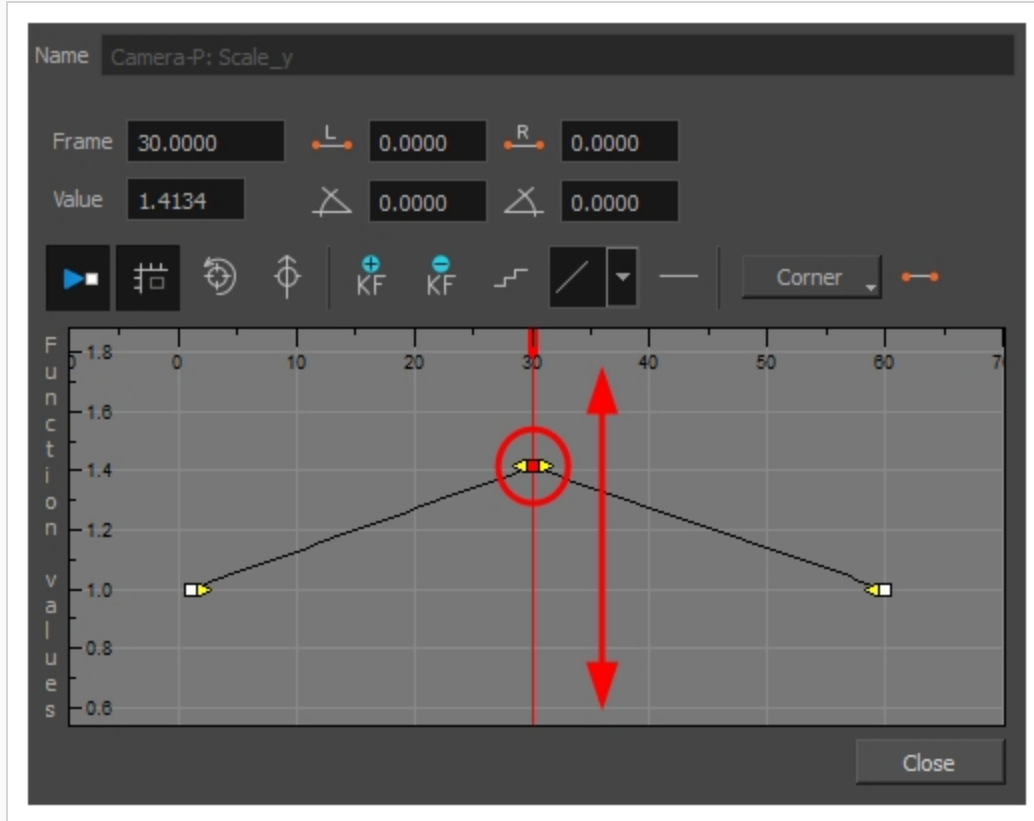

5. Press Enter/Return or click the Play  button to view the changes made in the Camera view.
6. Keep adjusting the values until you are satisfied with the results.
7. Click **Close**.

Switching Keyframe Types



T-ANIMCO-001-006

You can switch a keyframe from stop-motion to motion at any time in the Timeline view and Function Editor.

How to switch between motion and stop-motion in the Timeline view

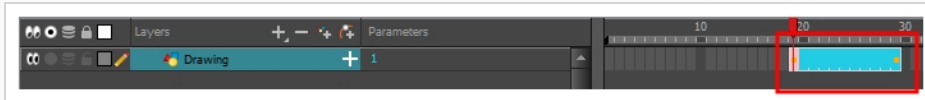
1. On the right side of the Timeline view, select one or more keyframes to modify.





2. Switch between motion and stop-motion by doing one of the following:
 - Right-click on the selected keyframes and select **Set Motion Keyframes** or **Set Stop-Motion Keyframes**.
 - Press Ctrl + K (Windows/Linux) or ⌘ + K (macOS) for motion keyframes and Ctrl + L (Windows/Linux) or ⌘ + L (macOS) for stop-motion keyframes.
 - In the Timeline View toolbar, click the Motion Keyframe  or Stop-Motion Keyframe  button.

How to switch between motion and stop-motion keyframes in the Function view

1. Open the Function view.
2. In the Timeline view, double-click on the layer that contains the keyframes you want to convert.

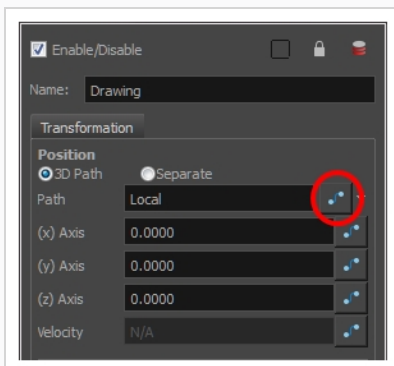
The Layer Properties window opens.



3. Do one of the following:
 - In the Transformation tab, click the Function Editor  button.

- In the Timeline view, click the Expand Function \oplus button or press Alt + F and double-click on the function to edit.

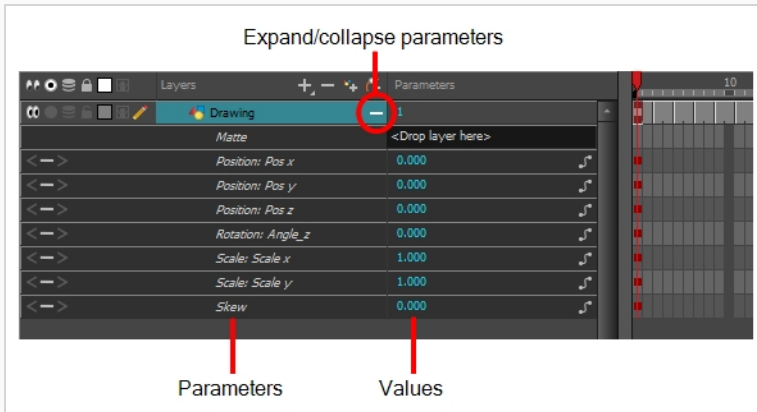

4. On the function curve, select one or more keyframes to modify.

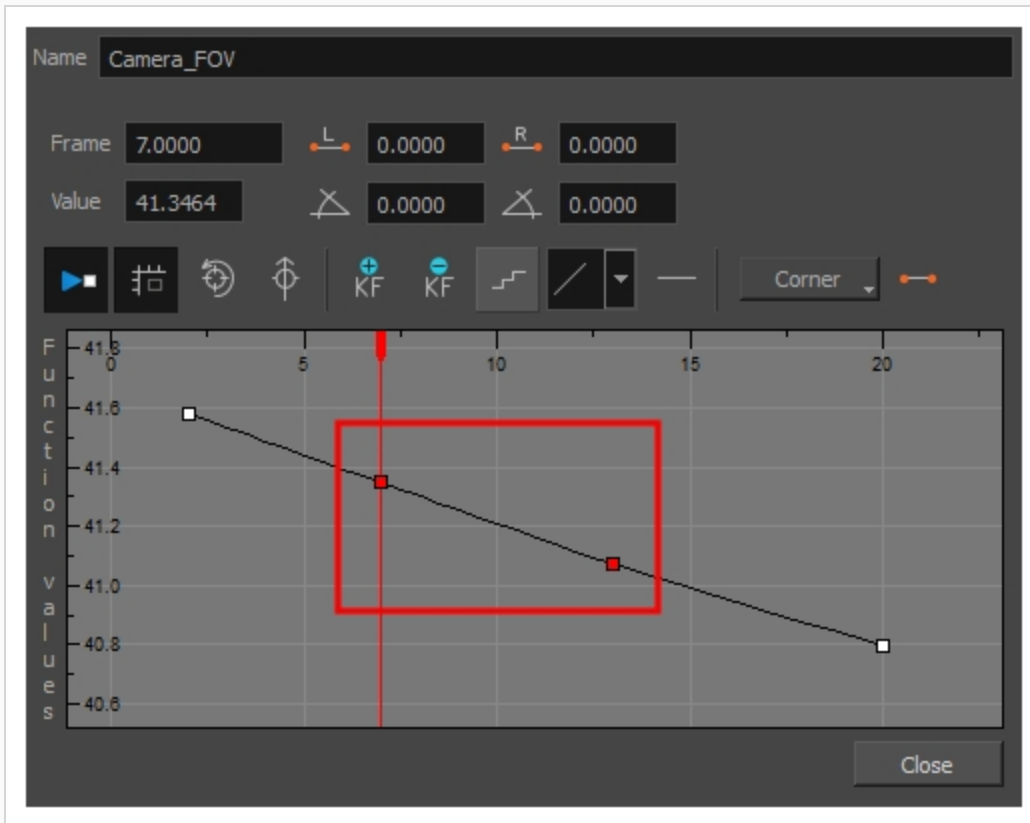

5. Select or deselect the Stop-motion Keyframe $\bullet\text{---}\bullet$ button to set a stop-motion or motion keyframe.

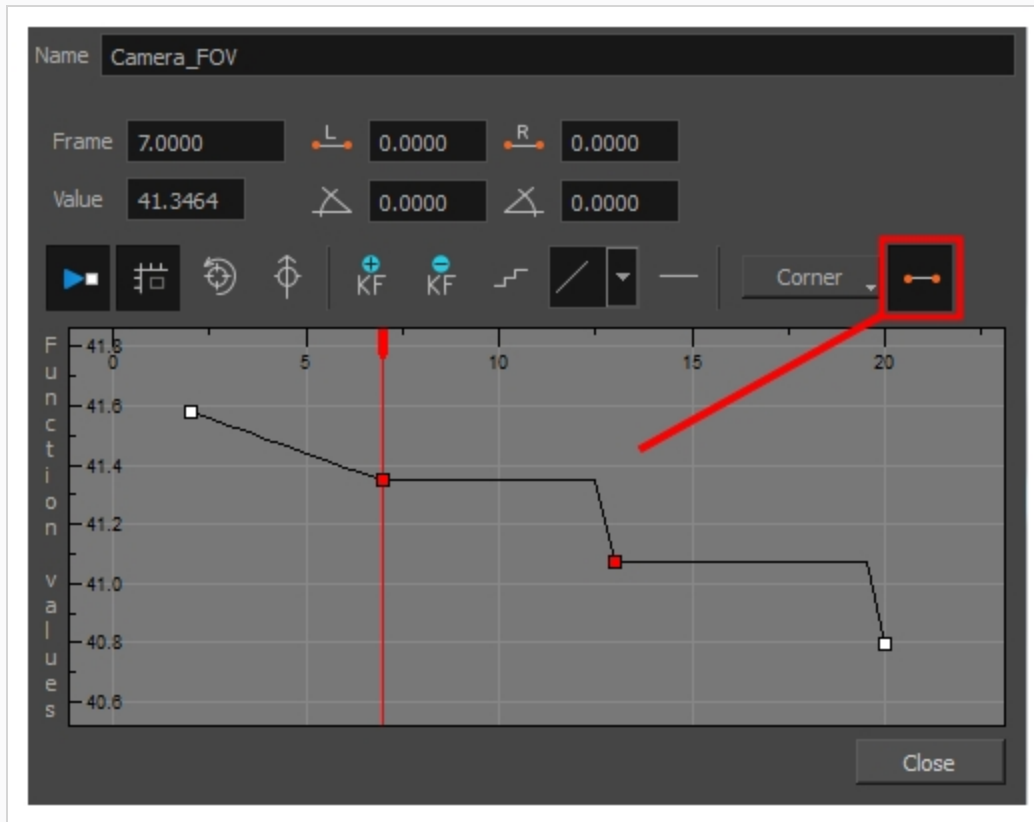

Jumping to Keyframes

You can jump between the selected layer's keyframes in the Timeline view.

How to jump to keyframes

1. In the Camera or Timeline view, select the layer that contains the keyframes you want to flip through.

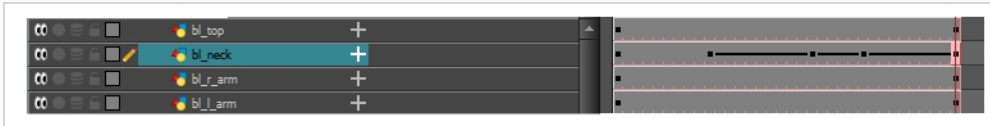

2. From the top menu, select **Animation > Go to Previous Keyframe** or **Go to Next Keyframe** or press semicolon (;) and single quote (').

About Controls

T-HFND-009-010

Camera moves and motion paths can become quite advanced, especially with moves through 3D space. Harmony provides tools to view your camera's path and make adjustments to it from both a 2D and 3D perspective.

You can display the trajectory of a motion path when you select an object from any view it can be selected in.

A motion path is easy to manipulate. One important concept to understand is that a trajectory contains both keyframes and control points. Both can be used to shape a path; each have their own behaviour, however only keyframes appear in the Timeline view.

- **Keyframes** have a transformation value and a position in space at a given frame. Keyframes are locked in time.
- **Control points** have a position but no fixed frame or timing. It is mainly used to deform a trajectory. There are no velocity handles available on a control point. The velocity segments are set between keyframes only, making curves and trajectories much smoother. Control points can only be added on a 3D path.

You can set the default Continuity, Bias and Tension parameters in the Preferences panel.

Continuity: Controls the smoothness of a transition between the segments joined by a point.

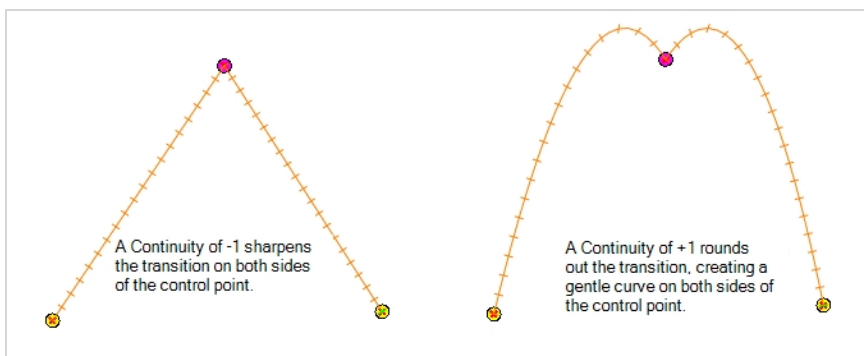

Tension: Controls how sharply the path bends as it passes through a control point or keyframe.

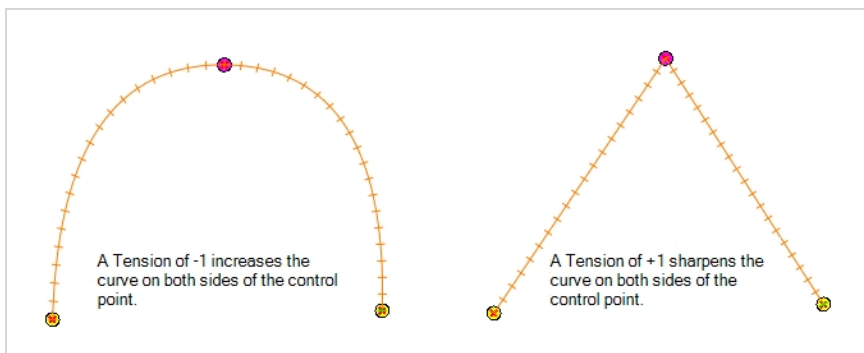

Bias: Controls the slope of the path so it flows towards one side of the motion point or the other.

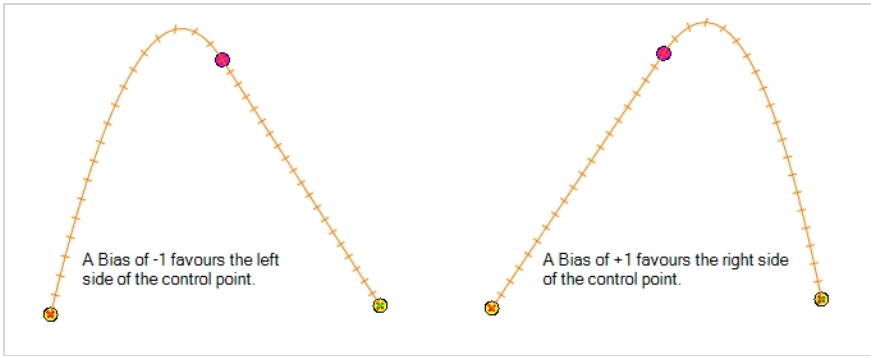

Displaying Controls

T-HFND-009-011

You can display a layer's controls to adjust a trajectory or other parameters such as a gradient's position or deformation settings.

How to display the layer's controls

1. Verify that the Camera view (click its tab) is selected and that the layer whose trajectory you want to display is selected in the Timeline view.

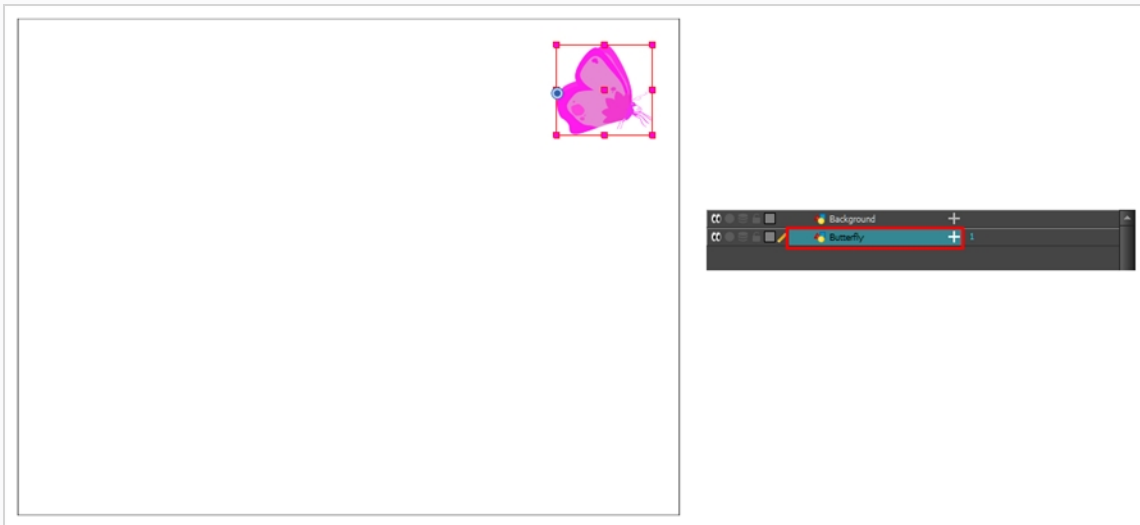

2. From the top menu, select **View > Show > Control** or press Shift + F11 or in the Camera view toolbar, click on the Show Control  button.

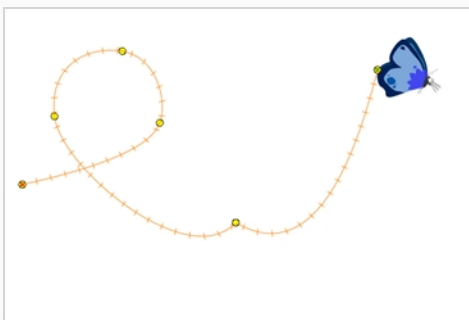

NOTE

If nothing appears in the Camera view, you may not have animated or selected the layer.

Adding Control Points

T-HFND-009-012

You can add control points on 3D Path trajectories. You need to display the layer's controls in the Camera view.

How to add a control point on a trajectory

1. In the Timeline or Camera view, select the peg or layer on which you want to add a control point.
2. If the selected element's trajectory is not displayed, select **View > Show > Control** from the top menu or press Shift + F11.

The trajectory appears in the Camera, Top, Side and Perspective views.

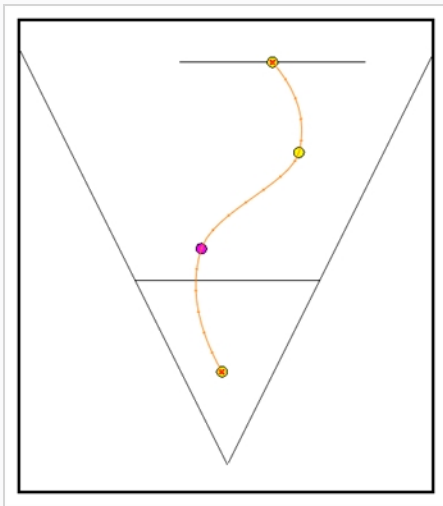

3. Add control points on a 3D path trajectory by placing the cursor where you want to add the point and press P once. If you hold the key down, control points will be added continuously until you release the key.

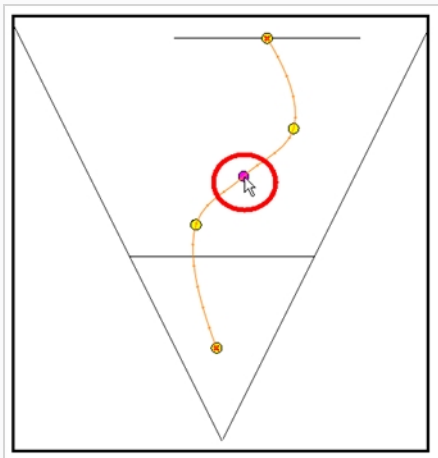

A control point is added to the trajectory.



Toggling Point Types

You can convert a control point into a keyframe and a keyframe into a control point. The position and other values will remain in both cases, only the frame will change. A control point is not locked in time.

How to switch between keyframe and control point

1. In the Camera view, use the Transform  tool select a point to convert.
2. To convert the point:
 - From the top menu, select **Animation > Lock in Time**.
 - In the Function view or Function Editor, select the keyframe to convert and click the Lock in Time  button.

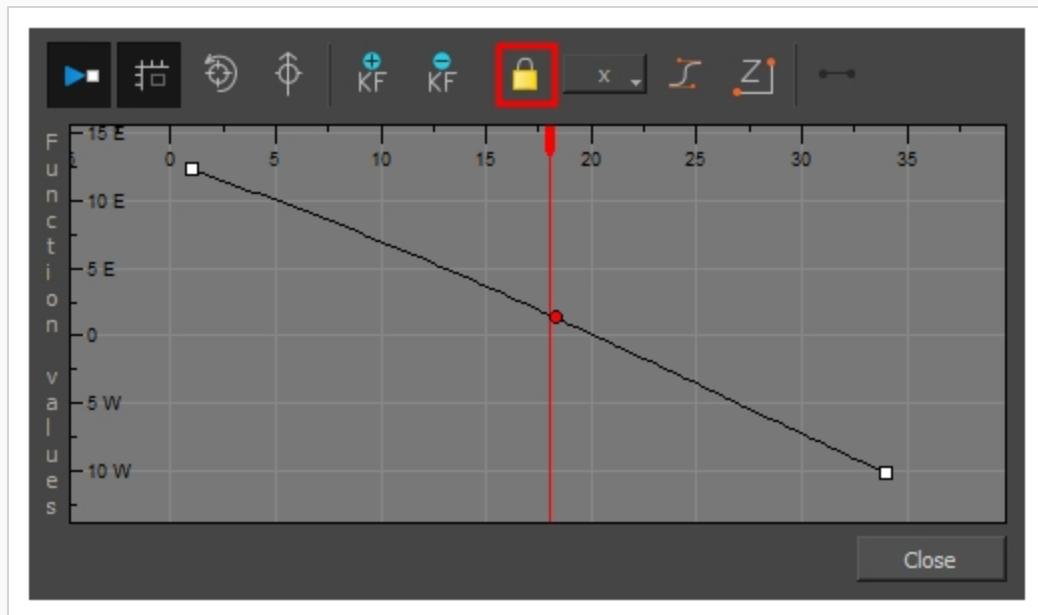

Adjusting Tension, Bias, and Continuity

You can adjust the shape of the curve passing through a point by modifying the bias, tension, and continuity settings. You can also set preferred settings as default.

How to adjust the control point preferences

1. From the top menu, select **Edit > Preferences** (Windows) or **Harmony Essentials > Preferences** (macOS).

The Preferences dialog box opens.

2. Select the **Camera** tab and adjust the parameters in the Control Points section.

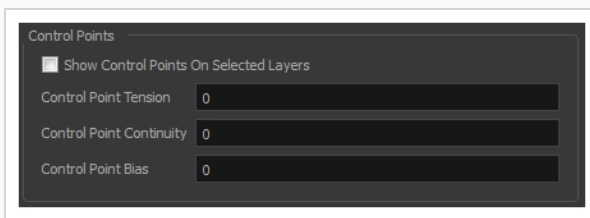

Offsetting Trajectories

By offsetting a trajectory, you can reposition the visual trajectory without offsetting or modifying your animation. By default, the trajectory is located at 0,0,0 fields. If your elements were drawn in a different location than the centre of the drawing area, it will look like the trajectory is not aligned with your drawing. Also, if you have several elements attached to one trajectory, you might want your trajectory to be at a different location to represent the group's motion better.

How to offset a trajectory

1. In the Animation Tools toolbar, select the Spline Offset  tool or press Alt + 8.
2. In the Camera, Top, Side or Timeline view, select the layer whose trajectory you want to offset.
3. From the top menu, select **View > Show > Control** to display the trajectory. If you do not display the trajectory, any transformation done using the Spline Offset tool will be ignored.

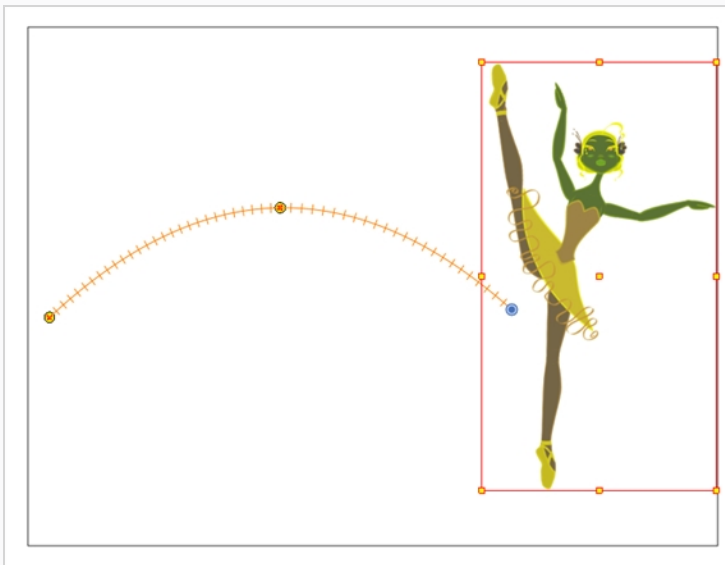

4. In the Camera view, drag the trajectory to the proper position. You can move it on the X and Y axes, but also on the Z-axis using the Top and Side views.



About Functions

By default, when a drawing layer or peg is added to a scene, no function curves are created. You will generally create the ones you need to avoid being overloaded with too many functions you might not use.

When you select an element in the Camera view and move it around, it will automatically create the corresponding function curves. If you need to create certain functions manually, you can always do it through the Layer Properties view or editor. You can then share it with other layer parameters or set keyframes directly on the function curve instead of doing it in the Timeline or Camera view.

You can also link a layer's parameter to an existing function curve or attach several parameters to the same function curve. For example, if you have an aircraft performing loops between clouds, you may want the camera to follow the aircraft's motion path. If you attach the camera to the aircraft's layer, the camera will also loop, but this may produce undesirable results and even induce a feeling of motion sickness as you watch the final animation. Instead, you can share the X, Y and Z positions of the aircraft with the camera's peg layer, but ignore the angle, scale and skew.

By default, all function curves can only be used and modified using their original parameter. If you want another layer or parameter to use the same function curve, you must share it.

There are two ways to share a function:

- Share Functions command
- Layer Properties editor

When you create a function curve in the Layer Properties view or editor, there are several choices available:

Parameter	Description
Create 3D Path	Creates a new 3D Path Column set
Create Bezier	Creates a new Bezier curve
Local	Disconnects the parameter from any function and changes it to shared.
3D Path	Displays the list of every shared 3D Path function available
Bezier	Displays the list of every shared Bezier curve available
Velobased	Displays the list of every shared velocity based curve available
3D Rotation	Displays the list of every shared 3D Rotation function available
Connected	Displays the list of every shared connected function curve

Unconnected	Displays the list of every shared unconnected function curve
All	Displays the list of every shared function curve

You have the choice of creating a new function curve or linking it to a shared function. This way, you can have two or more parameters following the same function.

Depending on your favourite working method, you can create different types of function curves to suit your needs, including:

- Bezier function
- Velobased function

When you create a function to control a parameter over time (Scale, X, Y, Z, Rotate), you can use a Bezier function.

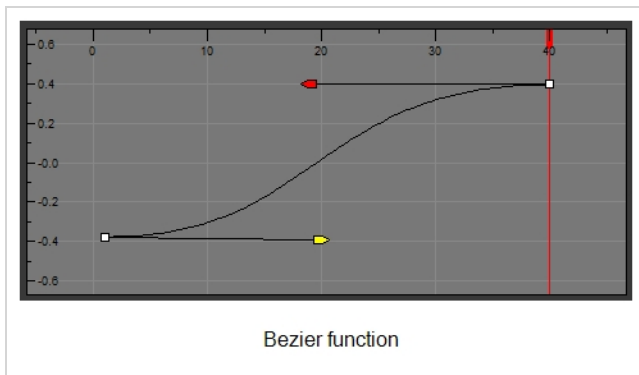

These function editors present different ways of editing the values over time. The shape of the created graph indicates the velocity of the function, regardless of the chosen editor. The type of function that you choose is largely based on your working preference.

You can also create Velobased functions for certain effects, like changes in rotation or size over time. When you do this, the Velobased functions are linked to the velocity of a 3D path. You cannot change the shape of a Velobased function to control its velocity.

With Velobased functions, you can link changes in rotation or scaling to the velocity of a 3D path. This makes it possible for changes in rotation or scaling to progress at the same speed as changes to the position of an element.

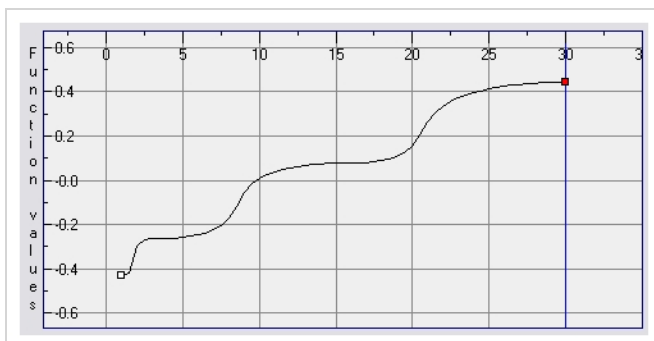

You can convert a Bezier functions so you can edit it using the controls offered by that type of function.

Creating Functions

You can create function curves in several different ways. You cannot create function curves directly in the Xsheet view. You must do this in the Layer Properties window or the Timeline view.

How to create the function curve in the Timeline view

1. In the Timeline view, expand the layer's parameters.
2. Click the Function button and, in the drop-down menu, select **Create Bezier**.

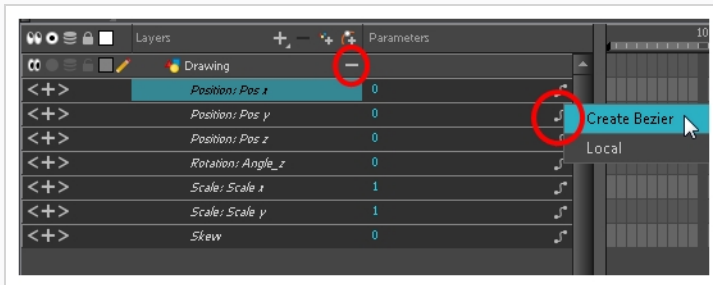

How to create function curves using the Layer Properties view

1. In the Timeline view, double-click on the layer you want to create function curves for.
The Layer Properties Editor opens.

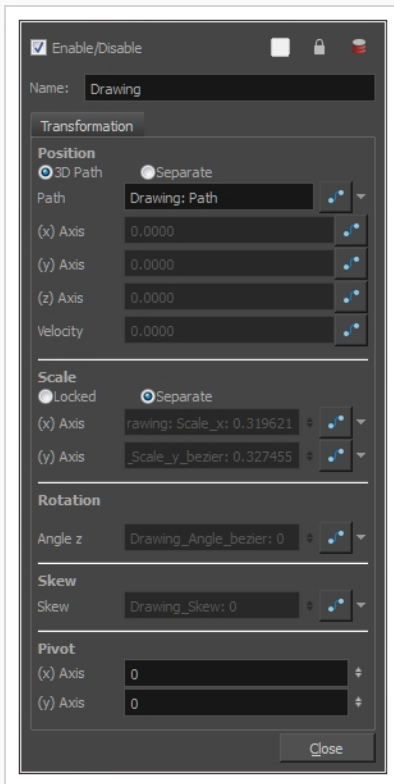

2. In the Transformation tab, click the Function Arrow button beside the local function information.
3. Create a 3D Path, Bezier, or Velobased curve.



You can click the Function  button to open the Function editor.

About Copying Motions

In the Timeline view, you can easily drag keyframes to change the animation timing, delete them, cycle them and even copy them.

When you have position keyframes set in your drawing layer and you want to move them around when moving your drawing's timing, you can use the Paste Special feature to only move selected keyframes.

You can also use the Paste Cycle and Paste Reverse feature to cycle your selection including keyframes and drawings.

If you want to cycle a portion of your animation, you can use the Paste Cycle command. You can also use the Paste Reverse command to completely reverse the flow of your animation.

Using Timeline Paste Modes

Use can copy and paste or drag and drop keyframes and drawings in the Timeline view using various modes.

How to paste a selection using different modes

1. In the Timeline view, select the cells you want to copy and paste.

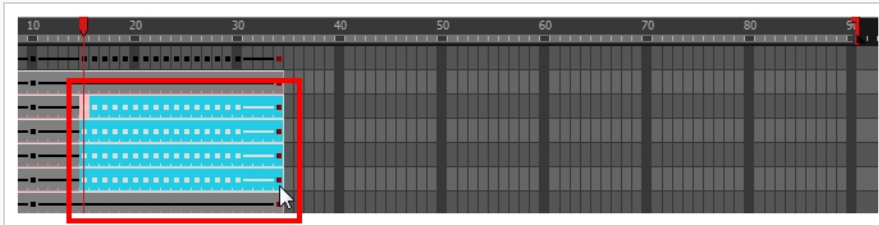

2. In the Timeline toolbar, click the desired Paste mode button.
3. From the top menu, select **Edit > Copy Cells from the Timeline** or press Ctrl + C (Windows/Linux) or ⌘ + C (macOS).
4. In the Timeline view's right side, select the cell on which you want to paste your selection.

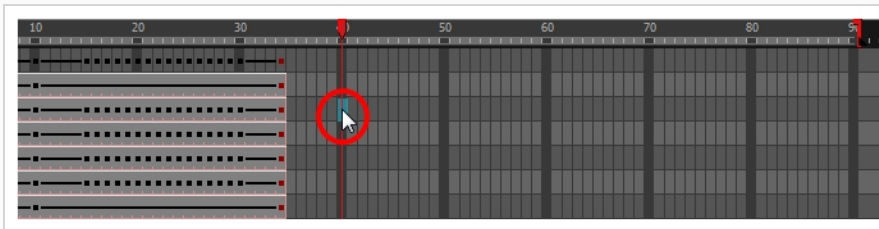

5. Select **Edit > Paste Cells in the Timeline** or press Ctrl + V (Windows/Linux) or ⌘ + V (macOS).

Paste Mode: All Drawing Attributes

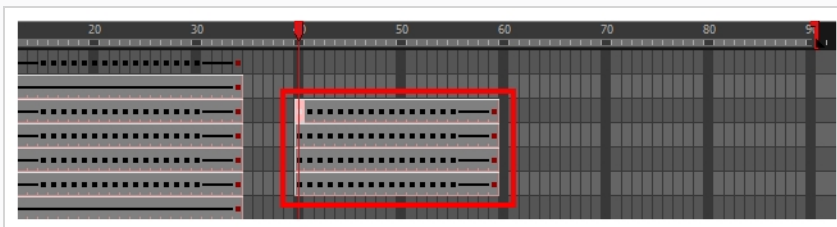

Paste Mode: Keyframes Only

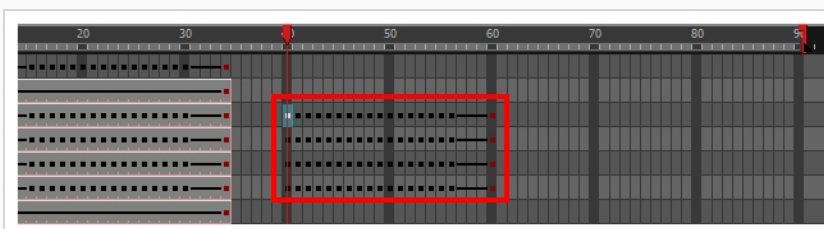

Paste Mode: Exposures Only

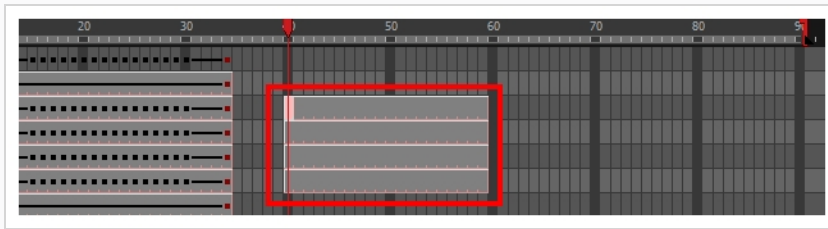

Using Paste Special

You can copy drawing exposures and keyframes and paste only a portion of your selection using Paste Special.

How to copy and paste a motion using Paste Special

1. In the Timeline view, select the keyframes to copy and paste. If you want to move the keyframes, go to step 3.

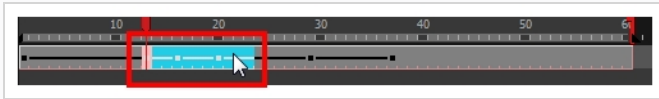

2. From the top menu, select **Edit > Copy Cells from the Timeline** or press Ctrl + C (Windows/Linux) or ⌘ + C (macOS).
3. Edit your selection by doing the following:
 - To paste the selection, in the Timeline view, select the first cell on which you want to paste your keyframes and from the top menu, select **Edit > Paste Special** or press Ctrl + B (Windows/Linux) or ⌘ + B (macOS).
 - To move the selection, in the Timeline view, drag the selection and hold down Alt. Drop the selection where you need it and release the hot key.

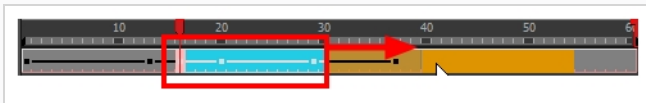

The Paste Special window opens.

4. Set the Drawing, Pegs and Functions, and Cycles parameters.
5. Click **OK**.



About Velocity

T-ANIMCO-001-009

To add ease in and ease out on motion paths, you can display the function curve and modify the Bezier or Ease curve. To apply ease to multiple functions and keyframes, you can use the Set Ease For Multiple Parameters script and set the amount.

The Velocity, or ease, is used on motion keyframes. The Velocity must be adjusted directly on the function curve in the Function view or Function editor. When a keyframe is selected, easing values appear in the right handle and left handle fields, as well as Bezier handle or Ease wheel controls on each selected keyframe. Pull on them to adjust the ease in and ease out, or type values in the fields.

You can reshape the velocity function using Bezier controls.

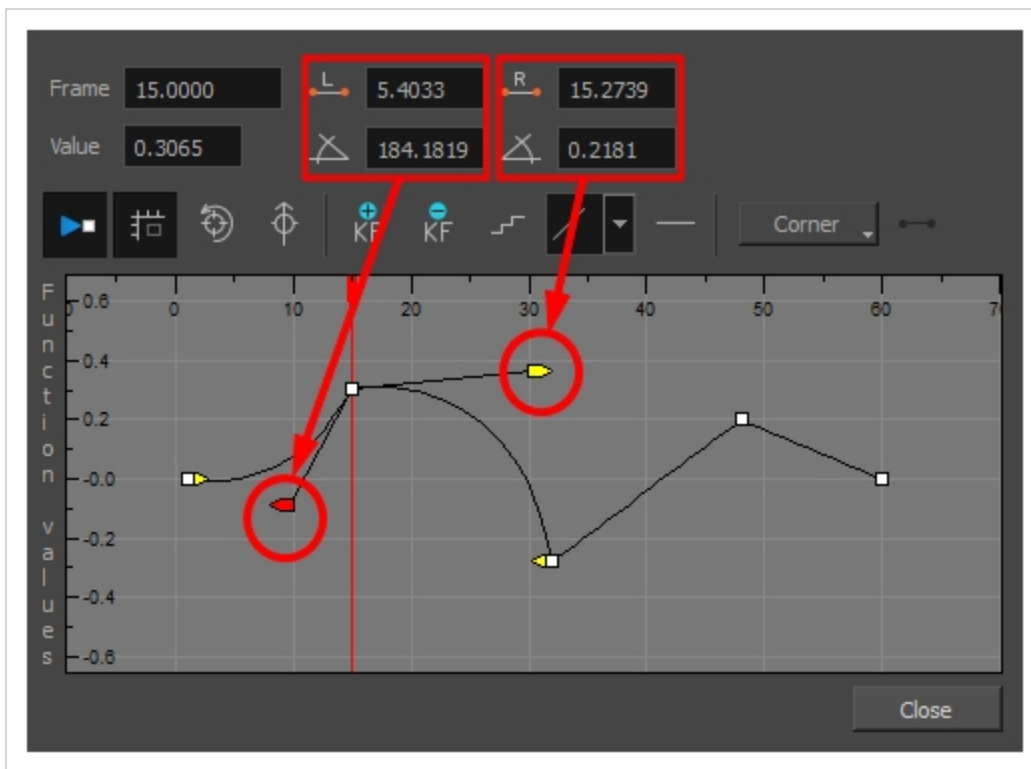

If you have several functions whose velocity you want to adjust at the same time, you can use the Set Ease for Multiple Parameters dialog box. It allows you to apply the same velocity parameters to all the selected keyframes in the same frame.

Displaying Velocity Curves

You can display a parameter's function curve and adjust the easing with the relevant controls.

How to display the velocity curve

1. In the Timeline view, click the Expand $+$ button on a layer or press Alt + F.

The layer's functions are displayed.

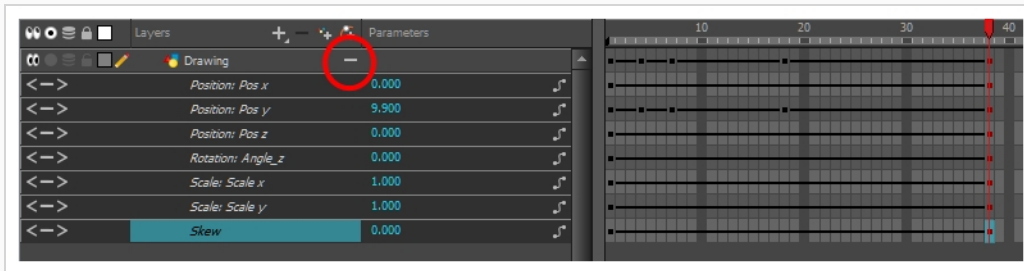

2. Double-click the desired function. Note that 3D Paths have a specific velocity curve controlling the X, Y, and Z axis together. You need to click on the **Position:Velocity** layer.

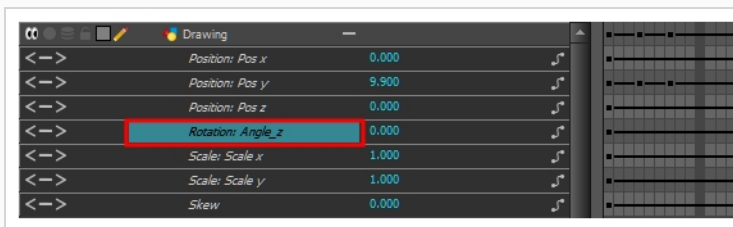

The Function Editor opens as the Bezier Editor.

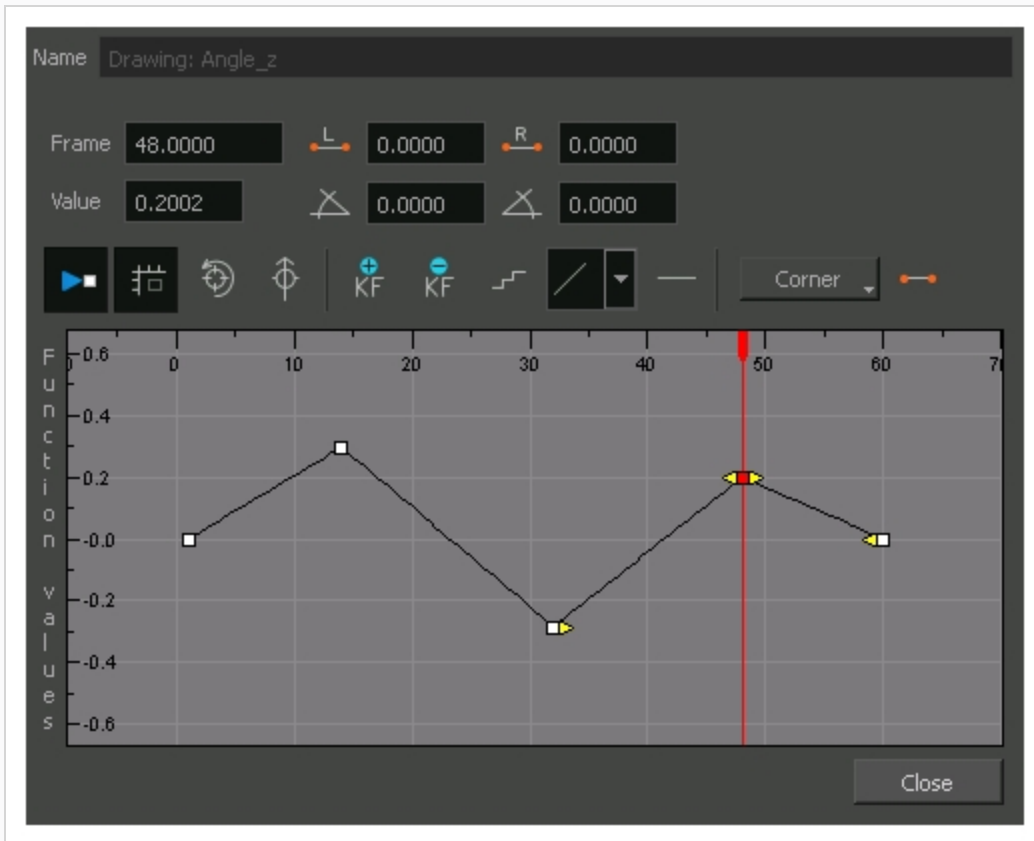

The editor will not be displayed if the function does not already exist.

Adjusting Bezier Curve Velocity

You can reshape a Bezier curve velocity using the Function view controls.

How to adjust a Bezier curve velocity

1. In the Function view, select a keyframe.
2. Drag the controls to modify the shape of the curve.

You can reshape the function using the Bézier controls.

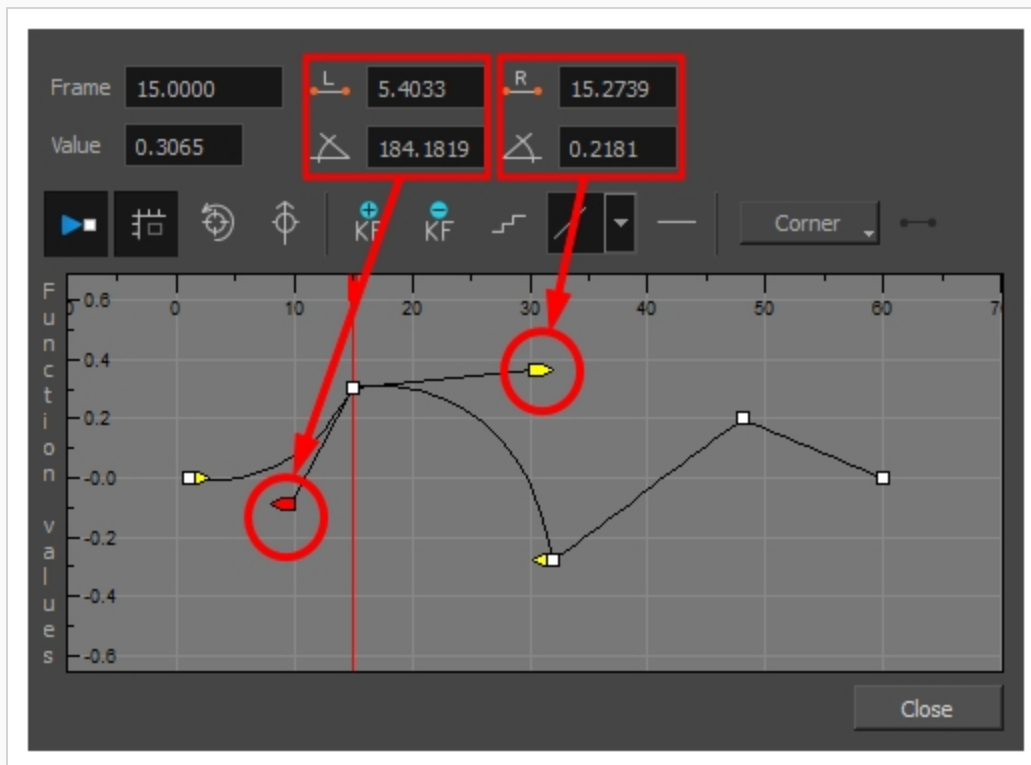

3. The Continuity options influence how you can move the handles:
 - **Straight:** Lets you move the handles together, maintaining the same angle to the point.
 - **Corner:** Lets you move the handles independently.
 - **Smooth:** Lets you move the handles together, maintaining the same distance and angle to the point.

Creating Stepped Velocity

You can create a stepped curve to hold the same value over a selected number of frames. This works well when you are animating drawings on 2s, for example, and you want to hold the same value for a function over those two frames.

How to create a step velocity

1. Click the Hold Value Editor  button.

The Hold Value editor opens.

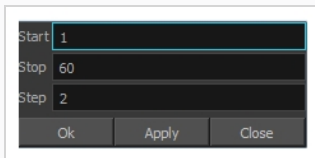

2. In the Hold Value Editor, enter the following values:

- **Start:** The starting frame for the effect.
- **Stop:** The last frame for the effect.
- **Step:** The number of frames to hold the value.

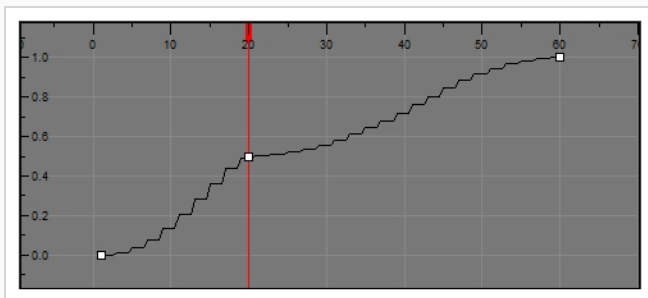

The function curve is updated based on the values you entered.







You can reshape the curve to create a linear velocity, so the values are interpolated (tweened) consistently between keyframes. That is, there is no acceleration in the effect.

How to create a step velocity for multiple parameters

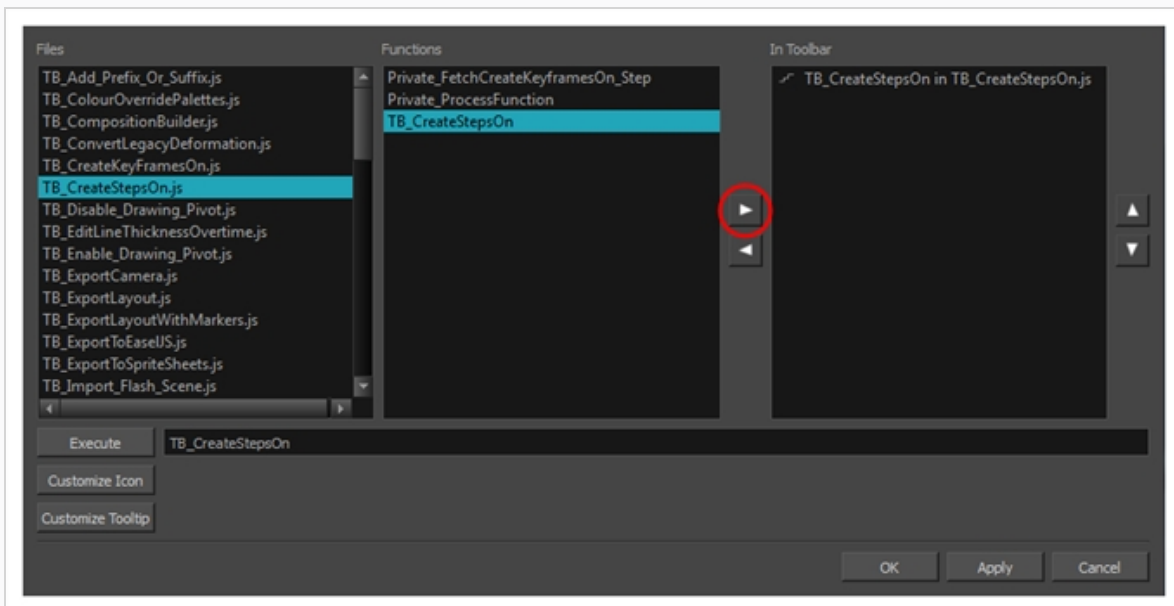
1. Add the Scripting toolbar to your interface:

- Go to the top menu and select **Windows > Toolbars > Scripting**.
 - right-click on the empty space near the top of the interface and from the quick-access menu selecting **Scripting**.
 - right-click on the empty space near the top of a view and from the quick-access menu selecting **Scripting**.
2. In the Scripting toolbar, click on the Manage Scripts  button to open the Scripts Manager window.
 3. In the Scripts Manager, in the Files section, select the file **TB_CreateStepsOn.js**.
The functions associated with that file appear in the Functions section.
 4. In the Functions section, select **TB_CreateStepsOn**.
The Add script to toolbar  button becomes active.



5. Click on the Add script to toolbar  button.
The TB_CreateStepsOn script  button is added to the Scripting toolbar.
6. Click **Apply**.
7. Click **OK**.
8. In the Timeline view, select the layer whose parameter values you would like to hold.
9. In the Scripting toolbar, click on the TB_CreateStepsOn script  button.
The Create Function Step On dialog box appears.

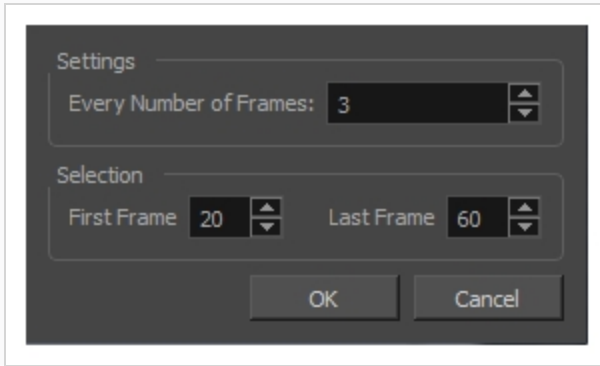

10. In the Settings section, enter the hold value by changing the number in the Every Number of Frames field.
11. In the Selection section, enter the first and last frame numbers to define the selection range.

**NOTE**

The playhead location determines the lowest value you can enter for the first frame, when defining the selection range. You need to move the playhead to frame one if you would like to set frame one as the lowest possible starting value.

12. Click OK.
13. In the Timeline view, expand the layer properties of the selected layer by clicking on its plus **+** button.

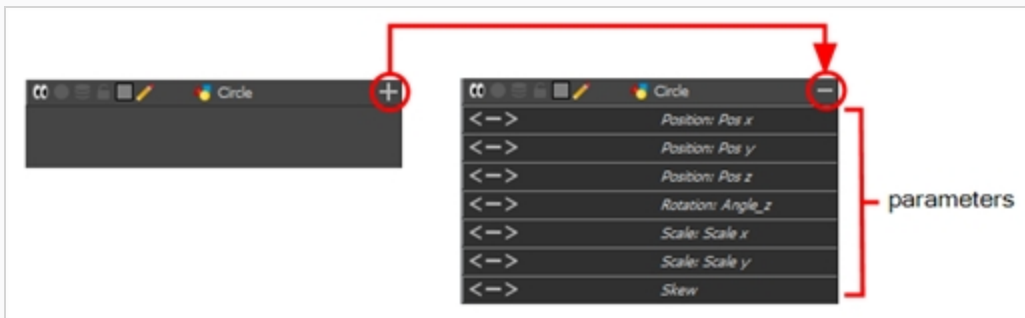

14. Double-click on a parameter layer to open its Bezier Editor. If that parameter was animated, the 3 frame hold from frame 20 to 60 was applied.

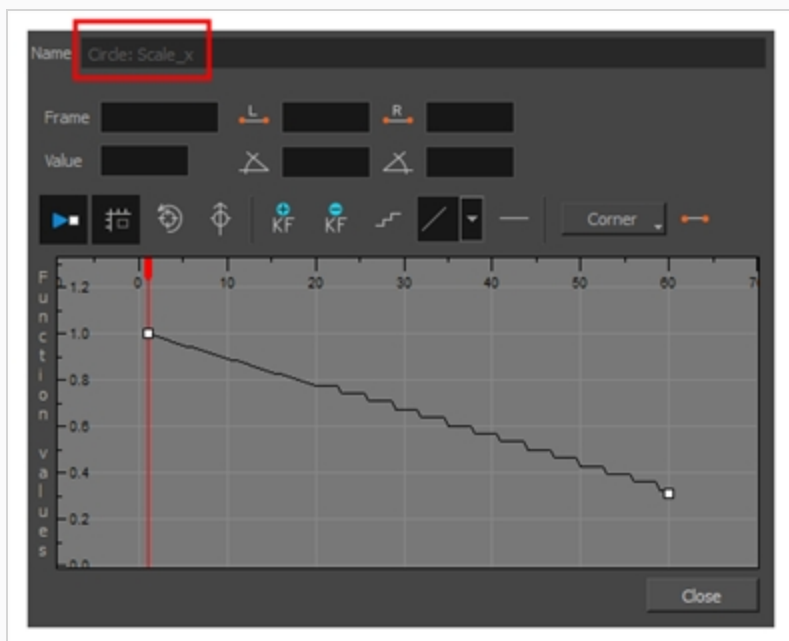
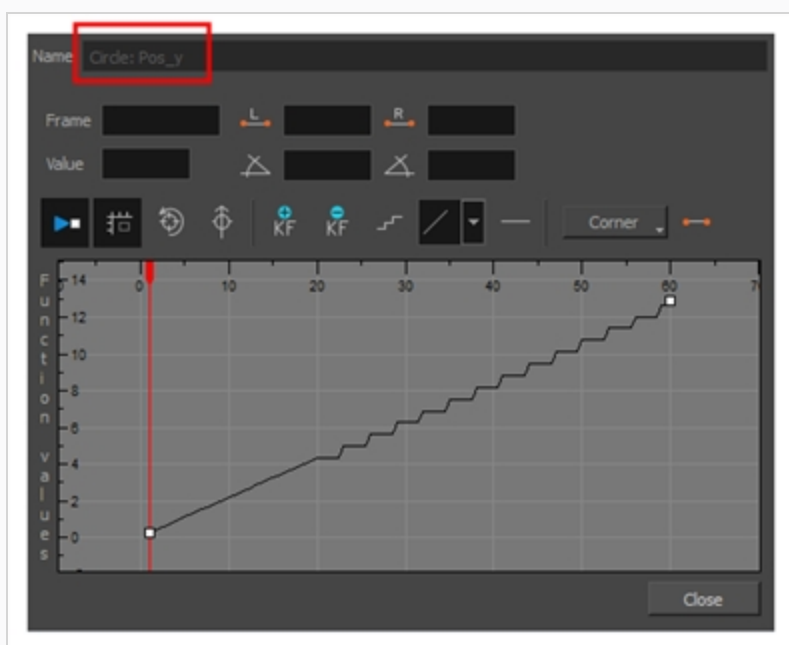

15. In the Bezier Editor, click on any of the keyframes to bring up the bezier point handles and use them to reshape the velocity curve for that parameter.

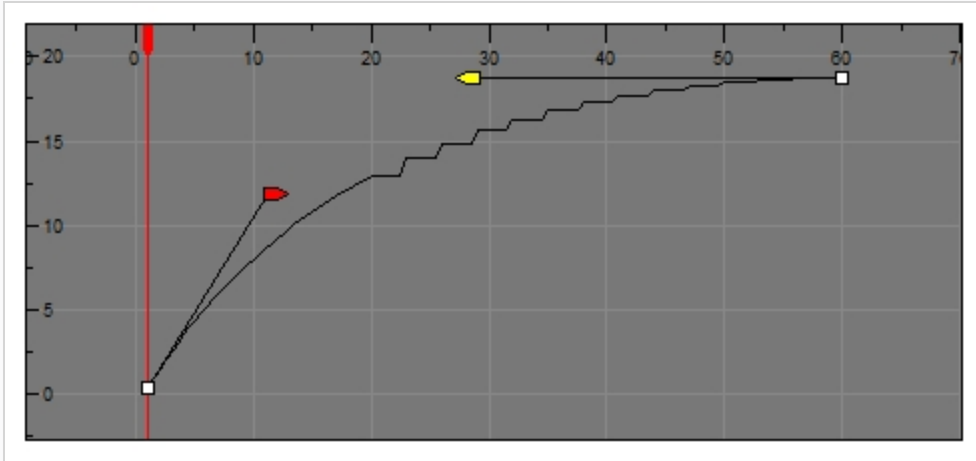

This means that multiple parameters can have the same stepped velocity, but have different ease-in ease-out curves defining that velocity.

Adjusting Velocity in the Timeline View

If you would rather avoid playing with graphs and function curves, you can adjust the velocity in the Timeline view.

How to set the ease in the Timeline view

1. In the Timeline view, select a keyframe on one or more layers.

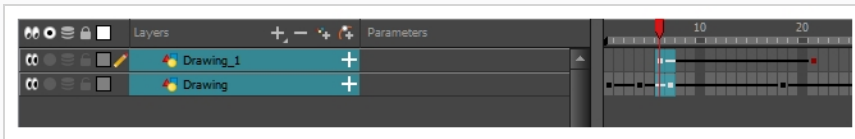

NOTE

Only the first selected keyframe will be considered when using the Set Ease For Multiple Parameter function. If many keyframes are selected on the same layer, the ease values will be applied only on the first keyframe and the rest will be ignored.

2. In the Timeline toolbar, select an option from the Set Ease Type menu.

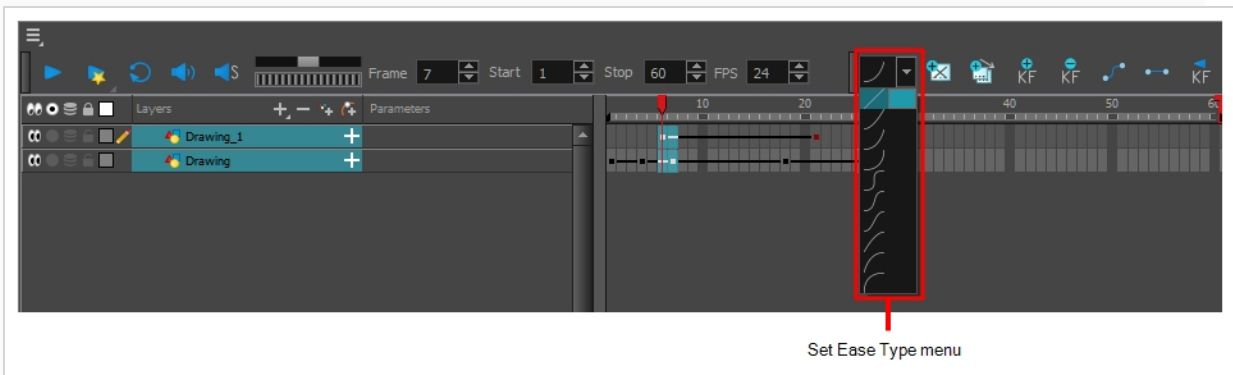

NOTE

TIP: Optimize your workflow by adding the Apply Ease to Selection  button to the Timeline toolbar. This lets you quickly reapply the ease type without going through the Set Ease Type menu each time. To add the button to the toolbar, right-click on the toolbar area of the Timeline view and select **Customize**.

Setting Ease on Multiple Parameters

T-HFND-009-013

You can adjust the velocity on multiple parameters at a same frame for consistency.

How to set the ease on multiple parameters

1. In the Timeline view, select a keyframe on one or more layers.

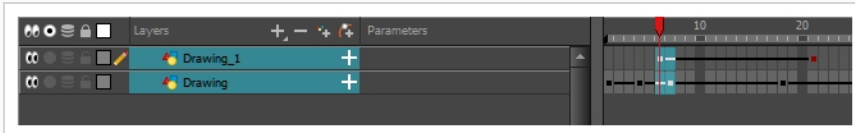

NOTE

Only the first selected keyframe will be considered when using the Set Ease For Multiple Parameter function. If many keyframes are selected on the same layer, the ease values will be applied only on the first keyframe and the rest will be ignored.

2. Do one of the following:
 - In the Timeline view, right-click and select **Set Ease For Multiple Parameters**.
 - In the Timeline toolbar, click the Set Ease For Multiple Parameters  button.

The Set Ease For Multiple Parameters dialog box opens.

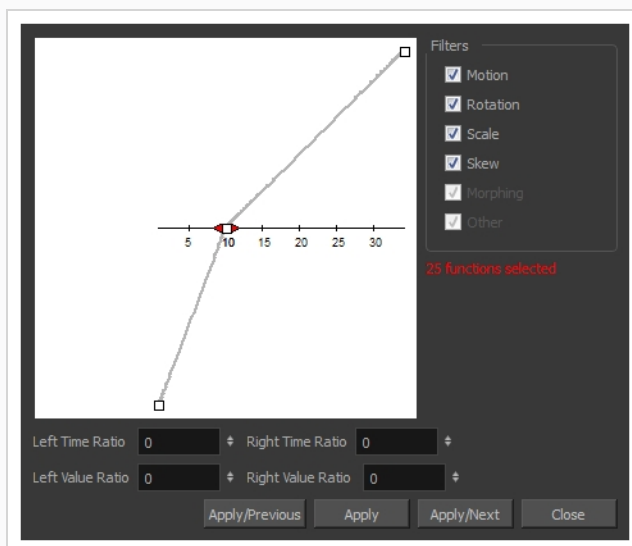

3. In the graph, adjust the Bezier handles to change the velocity for all the selected functions.

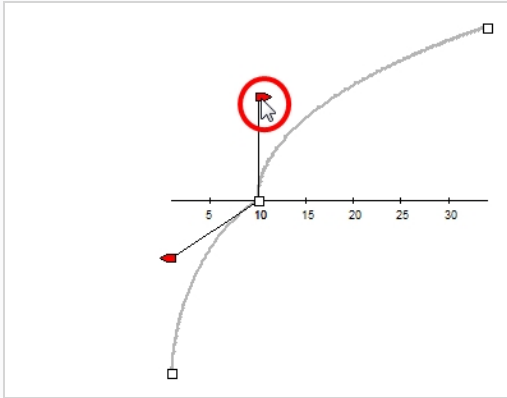

4. In the Filters section, you can apply the easing parameters to a specific type of function only, such as Rotation or Scale. Deselect the function types you do not want to affect.
 - **Motion:** Applies the easing parameters to the selected Position X, Position Y, Position Z and 3D Path functions.
 - **Rotation:** Applies the easing parameters to the selected Angle functions.
 - **Scale:** Applies the easing parameters to the selected Scale functions.
 - **Skew:** Applies the easing parameters to the selected Skew functions.
 - **Morphing:** Applies the easing parameters to the selected Morphing Velocity functions. Note that it applies to the Morphing velocity function found in the Layer Properties window, not the basic morphing ease in the Tool Properties view.
 - **Other:** Applies the easing parameters to all the other the selected functions, such as all functions created to animate effect parameters.
5. You can also adjust the easing by typing values in the Time and Value Ratio fields. The values are calculated in percentage.
 - In the Left Time Ratio and Right Time Ratio fields, type the percentage value corresponding to the length of time you want the easing to last. Stay between 0% and 100%. If you go beyond 100%, your motion will overshoot.
 - In the Left Value Ratio and Right Value Ratio fields, type the percentage value of how strong you want the easing out to be. Stay between 0% and 100%. If you go beyond 100%, your motion will overshoot.
 - If your Time Ratio and Value Ratio values are equal, you will have a linear motion.
6. Once done, click one of the following:
 - **Apply/Previous:** Applies the easing parameters to the selected keyframes and then selects the previous keyframe in the timeline.

- **Apply:** Applies the easing parameters to the selected keyframes.
- **Apply/Next:** Applies the easing parameters to the selected keyframes and then selects the next keyframe in the timeline.
- **Close:** Close the dialog box. If you did not apply the modifications, they will be cancelled.

Chapter 10: Deformations

T-RIG-007-001

Deformations let you animate bitmap or vector-based graphics, including gradients and textures. Deformations act as a skeleton with limbs and articulations you can bend, reshape, and curve. You can deform a character made out of one, or many, drawing or image layers and make it move as if it were a cut-out puppet.

A deformation skeleton is composed of deformation nodes, which are the various pieces (here represented as layers or nodes) required to articulate or deform your drawings, such as a series of bones or game bones.

About Deformation Types

The 4 types of deformer are: Bone, Game Bone, Curve and Envelope. Each type has its own advantages and limitations and need to be rigged and handled in different ways.

About Bone Deformations

T-RIG-007-002

The Bone deformation allows you to create a bone-like structure in which each part is solid, but with articulations that are flexible. This is mostly useful for animating a character's limbs, such as the arms or legs, or other parts that can be articulated such as torsos or fingers. For example, a Bone deformation can be used to articulate an arm that is made of a single drawing, so that the upper arm and forearm can be moved independently, without having to draw the upper arm and the forearm on different layers. Harmony will deform the drawing to make it look articulated. The different parts of a Bone deformation can be rotated around their joint, extended and shortened, giving you the same capabilities as animating articulations on different layers, without having to worry about parts detaching, pivot points, or clipping outlines.

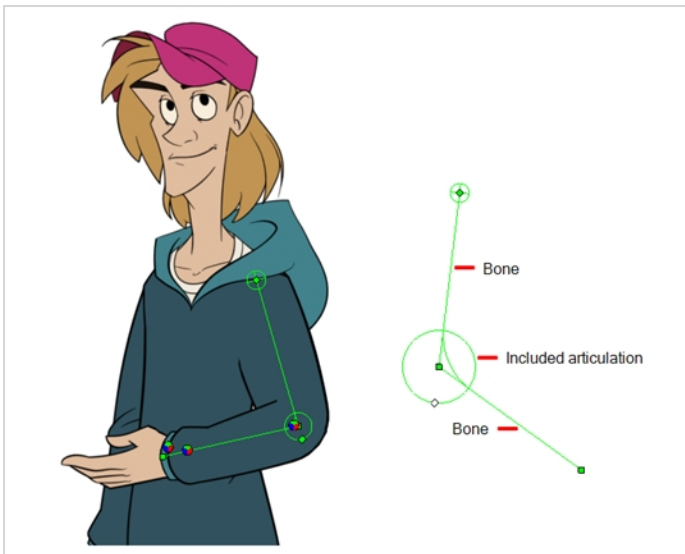

About Game Bone Deformations

T-RIG-007-003

The Game Bone deformation is very similar to the Bone deformation. It allows you to create a bone-like structure in which each part is solid, but with articulations that are flexible. This is mostly useful for animating a character's limbs, such as the arms or legs, or other parts that can be articulated such as torsos or fingers. For example, a Game Bone deformation can be used to articulate an arm that is made of a single drawing, so that the upper arm and forearm can be moved independently, without having to draw the upper arm and the forearm on different layers. Harmony will deform the drawing to make it look articulated. The different parts of a Game Bone deformation can be rotated around their joint, extended and shortened, giving you the same capabilities as animating articulations on different layers, without having to worry about parts detaching, pivot points, or clipping outlines.

The Game Bone deformation is different from the Bone deformation in which it is optimized for game engines such as Unity. Hence, it is usually only used for game development and not in animated productions. The difference between the Bone and Game Bone deformations is that Game Bone deformations do not have a Bias property. The articulation folds also look slightly more rounded.

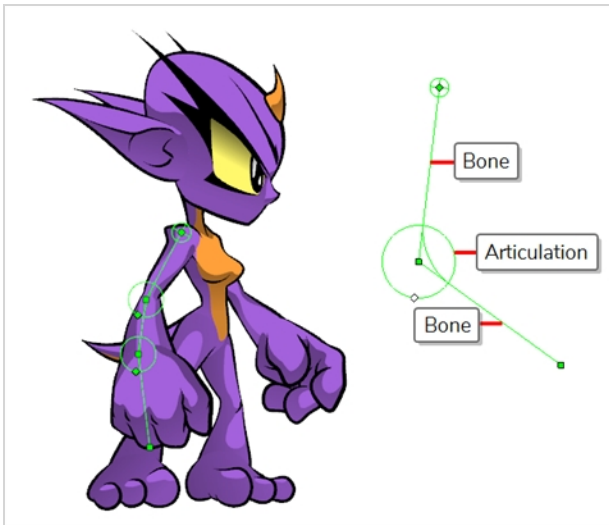

About Chain Creation

Using the Rigging tool, you can quickly create a basic deformation rig.

As you create your chains, the controls will be showing. However, whenever you close your project, the deformation controls display is turned off. When you reopen the project, you can display all controls or only some of them—see [Displaying Selected Deformation Controls on page 560](#).

Selecting Elements for Deformation

Deformation groups are added to your scene's hierarchy in different places, depending on whether a drawing or peg element is selected.

How to select the element on which to create a deformer

A deformer affects all the layers under its hierarchy. When you create a new deformer using the rigging tool, it is automatically created as a parent of the selected layer, and will affect the selected layer and all its children. Hence, it's important to select the right layer before attempting to create a deformer.

For example, if you wish to create a deformer for an arm, and the arm is broken into several layers, you could rig the arm in a hierarchy where the upper arm is the root, the forearm is the upper arm's child and the hand is the forearm's child. Then, if you create your deformer on the upper arm, it will be created as a parent of the upper arm, and will hence affect the whole arm.



You can also group several layers under a peg, and create your deformer with this peg selected. When you create a deformer on a peg, the deformer is created as a child of the peg, but as a parent of all of this peg's children. This is because a peg is likely to be more useful over a deformer than under. If you move layers that are under a deformer, they will exit the intended deformation zone, and may appear severely warped and distorted. Hence, it's better to create deformations under pegs as much as possible, and pegs under deformers should only be animated if the deformer is left untouched. Since the deformer will be created as a parent of all the peg's children, it will affect all the layers under the peg.

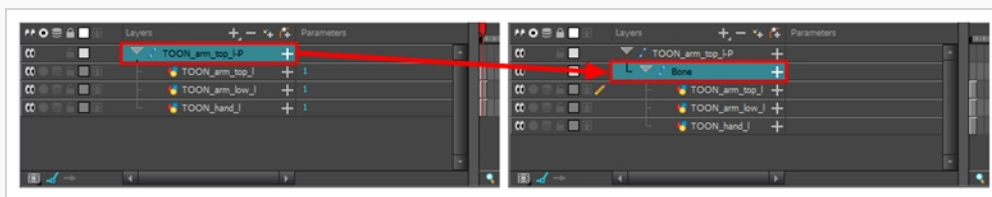

Creating Bone Deformation Chains

You can easily create bone deformation chains on parts of your rig using the Rigging tool.

How to create a Bone deformation chain

1. Make sure the right element for the creation of your deformation chain is selected—see [Selecting Elements for Deformation](#) on page 538.
2. Once your element is selected, select the **Rigging** tool in the Deformation toolbar
3. In the **Tool Properties** view, click on the **Bone** button to enable Bone mode.
4. Place the cursor at the root of your drawing or drawing hierarchy, click once and release. For example, if you're creating a deformer for a whole arm, click on the shoulder joint.

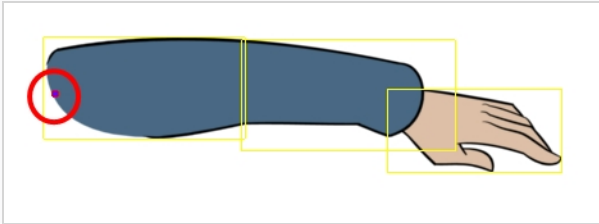

5. Move your cursor at the location where you want your first bone to finish and your second bone to start, and click again. An articulation control point will automatically be inserted between each bone you create.

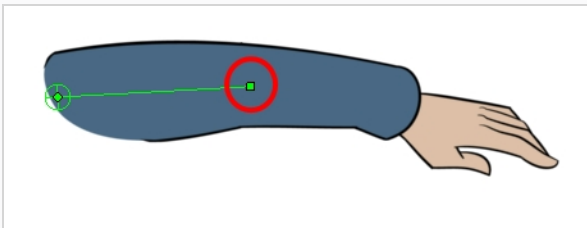

6. Move your cursor where you want the next articulation to be and click to create the next point.

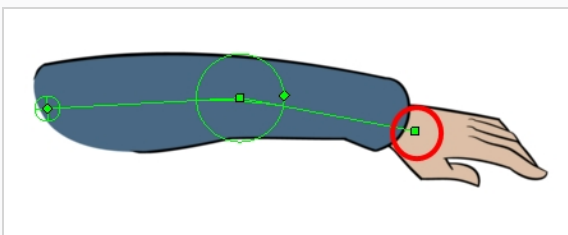

Observe that, as you create a new point, the previous point now has a circle around it. This is the radius of the articulation, which allows you to determine how much of the drawing should be part of the articulation. Every point in a bone deformer, except for the first and the last one, has a radius setting.

7. Click and hold the previous articulation's radius manipulator and adjust the articulation's radius so that it covers the limb.

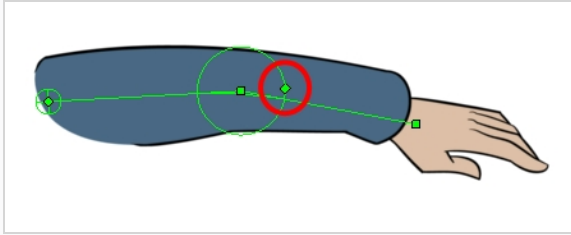



8. Repeat this until you are finished creating the Bone chain. Make sure you build each articulation in the right order going from the root to the extremity.

Creating Game Bone Deformation Chains

If you are working on a character that is meant to be exported as a game asset for use in Unity, and you want to use deformations to animate your character, you must use Game Bone deformations. These deformations replicate the type of deformation supported by Unity and can be exported to Unity as they are, without having to bake the deformations into drawings first.

How to create a Game Bone deformation chain

1. Make sure the right element for the creation of your deformation chain is selected—see [Selecting Elements for Deformation](#) on page 538.
2. Once your element is selected, select the  **Rigging** tool in the Deformation toolbar
3. In the **Tool Properties** view, click on  **Game Bone** to enable Game Bone mode.
4. Place the cursor at the root of your drawing or drawing hierarchy, click once and release. For example, if you're creating a deformer for a whole arm, click on the shoulder joint.

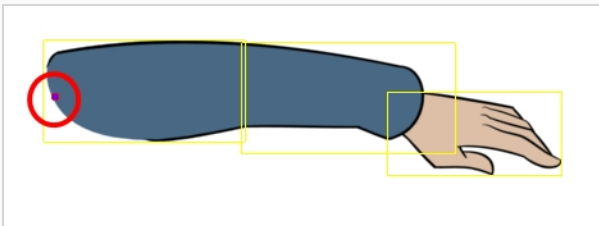

5. Move your cursor at the location where you want your first bone to finish and your second bone to start, and click again. An articulation control point will automatically be inserted between each bone you create.

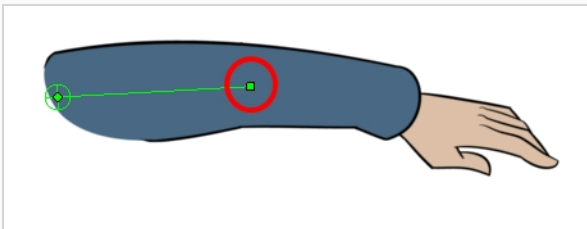

6. Move your cursor where you want the next articulation to be and click to create the next point.

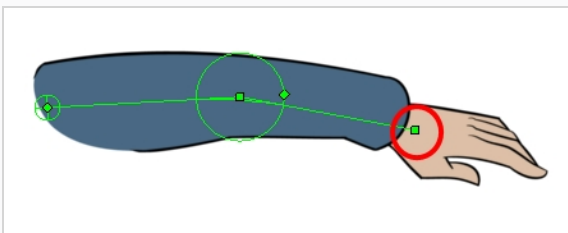

Observe that, as you create a new point, the previous point now has a circle around it. This is the radius of the articulation, which allows you to determine how much of the drawing should be part of the articulation. Every point in a bone deformer, except for the first and the last one, has a radius setting.

7. Click and hold the previous articulation's radius manipulator and adjust the articulation's radius so that it covers the limb.

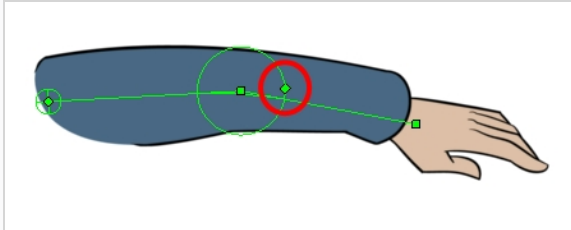

8. Repeat this until you are finished creating the Bone chain. Make sure you build each articulation in the right order going from the root to the extremity.



Creating a Split Deformation Chain

It is possible to create a deformation chain that splits into multiple branches, allowing to rig complex drawings with multiple extremities using a single deformation chain.

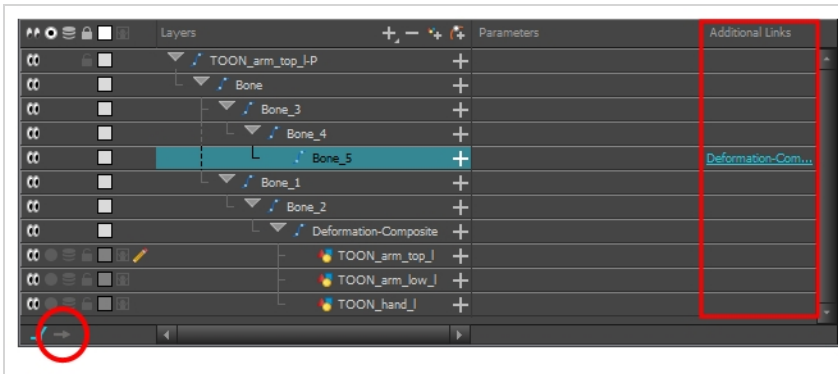
When creating a split deformation chain, a Deformation Composite layer is automatically added to your rig. This deformation composite connects all the branches of the split deformation chain to the drawing it deforms. You can see which deformation nodes are connected to the Deformation Composite in the Additional Links column of the Timeline view,.



How to create a split deformation chain

1. Select the drawing layer or the deformation chain to which you want to add a branch.
2. In the Deformation toolbar, click the Show Selected Deformers and Hide All Others  button to display the deformer controls in the Camera view. This also hides all the deformer controls that were displayed.
3. Select the Rigging  tool.

The deformation chain turns from green to red. A green chain indicates that you're animating the deformation. A red chain indicates that you're modifying the rig.
4. In the deformation chain, select the point from which you want the new deformation branch to start.
5. Place the cursor where you want your new branch's first point to be and click. A new chain is created.
6. Create the remainder of your chain's points as you would create a regular deformation.

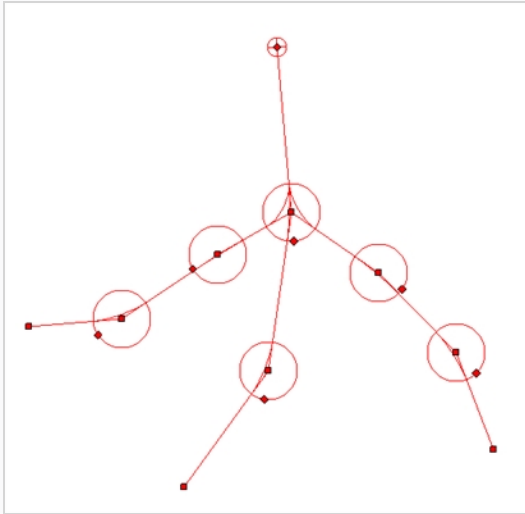



NOTE

When using the Rigging tool, you can select which existing deformation point you want the next deformation point you create to branch from at any time by selecting a point in the Camera view. When you create a deformation point, it is always linked to the currently selected point, if any. Creating a point automatically selects it, which is why deformations are built in a single chain by default.

Setting Rest Positions for Bone and Game Bones

Every deformation rig needs to have a set resting position. The resting position is important as it acts as a 0 point for all the transformations that will be made to the drawing when animating. The resting position is also where we can see what parts of the drawing are assigned to which bone or articulation.

How to set up Bone and Game Bone deformation chains

1. In the Timeline view, select the deformation nodes you want to set.
2. In the Deformation toolbar, click the Show Selected Deformers and Hide All Others  button to display the deformer controls in the Camera view. This also hides all the deformer controls that were displayed.
3. In the Deformation toolbar, click the Rigging  tool.

The chain turns from green to red. A green chain indicates the puppet is in animation mode. A red chain indicates the puppet is in a resting position. Make sure your chain is red.



4. In the Camera view, set up the deformation chain.
 - Rotate the first bone to change the angle of the chain.

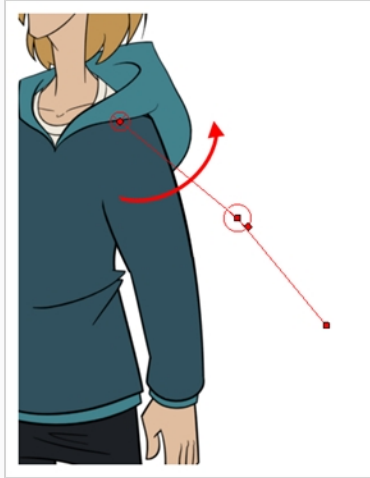

- Use the root control to reposition (offset) the entire chain.

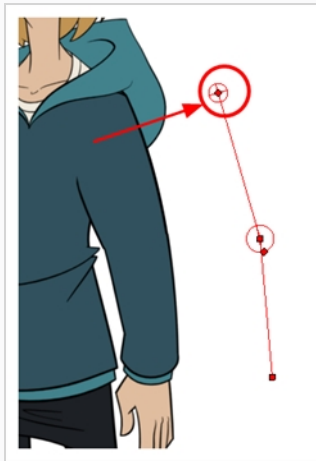

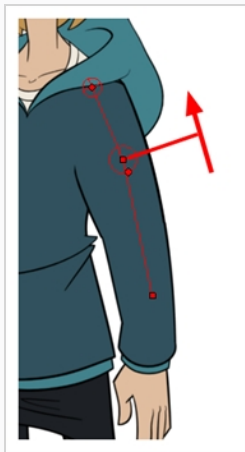

- Use the control points to reposition the articulations. This will elongate, shorten or change the direction of the bone and offset the subsequent children.



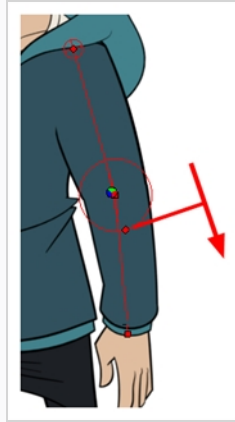

- Use the articulation's control (square) to change the size of the articulation. For quality purposes, it is recommended to have an articulation which fits the diameter of the part it controls.



5. Repeat until all the articulations and bones of the chain are correctly aligned to the element to which it is linked. You can also set additional parameters in the Layer Properties window—see the Reference guide .
6. With the deformation nodes still selected, in the Deformation toolbar, click the Reset Current Keyframe  button. This will set the current resting position as the current frame one.
7. Use the Transform  tool. For optimal results, make sure the size of the articulation is approximately the same size as the drawing.

How to add an articulation to an existing Bone or Game Bone deformation

1. Select the drawing layer or the deformation chain to which you want to add an articulation.
2. In the Deformation toolbar, click the Show the Selected Deformation Chain and Hide All Others  button to display the deformer controls in the Camera view. This also hides all the deformer controls that were displayed.
3. Select the Rigging  tool.

The deformation chain turns from green to red. A green chain indicates that you're animating the deformation. A red chain indicates that you're modifying the rig.

4. Move your cursor over the bone segment, where you want to add an articulation.
5. Hold Alt and click.

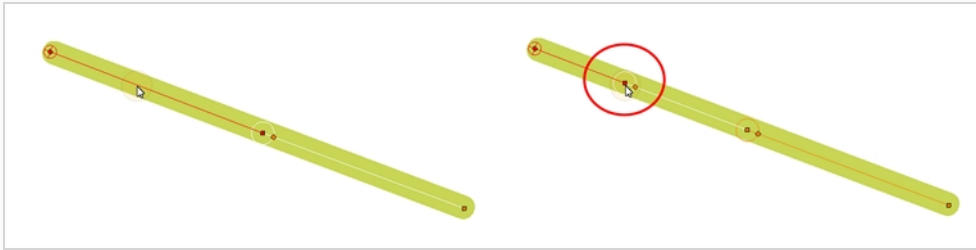

Selecting Region of Influence Types

There are four types of region of influence:

- **Zero:** This creates no influence around the deformer.
- **Infinite:** This is the default option. The influence goes all the way to the image boundaries or until it intersects with another zone of influence. When working on a cut-out puppet built on several element layers, the best choice is to keep the default Infinite option as the zone of influence type. In the following examples, the zones of influence are explained through deformation chains on a single bitmap image. It's also recommended to keep the regions of influence to Infinite when using Envelope deformers.
- **Elliptic:** This creates a region of influence following the deformer. Its size is based on a radius value. When you set up the shape of your Elliptic zone of influence, you should be as accurate as possible and make sure that only the element you want to follow the deformation is included inside the zone.
- **Shaped:** This creates a custom region of influence around the deformer that can be adjusted using control points and Bezier handles. When you set up the boundaries of your Shaped zone of influence, you should be as accurate as possible and make sure that only the elements that you want to follow the deformation are included inside the zone.

When you have an Elliptic zone of influence selected in the Node view, you can convert it to a Shaped zone using the Convert Elliptic Zone of Influence to Shape option.

How to select a region of influence type

1. In the Timeline view, select the deformation nodes you want to set the region of influence for—see [Displaying Selected Deformation Controls on page 560](#).
2. In the Deformation toolbar, click the Show Selected Deformers and Hide All Others  button to display the deformer of the selected piece.
3. In the Layer Properties window, in the Region of Influence tab, set the Influence Type:
 - Zero
 - Infinite
 - Elliptic
 - Shaped

Setting Up Elliptic Regions of Influence

An elliptical region of influence is suited for regular shapes. Modify its parameters to refine the region boundaries.

How to set up the Elliptic region of influence

1. In the Timeline view, select the deformation nodes you want to set the region of influence for—see [Displaying Selected Deformation Controls on page 560](#).
2. In the Deformation toolbar, click the Show Selected Deformers and Hide All Others  button to display the deformer of the selected piece.
3. In the Layer Properties window, in the Region of Influence tab, set the Influence type to **Elliptic**.

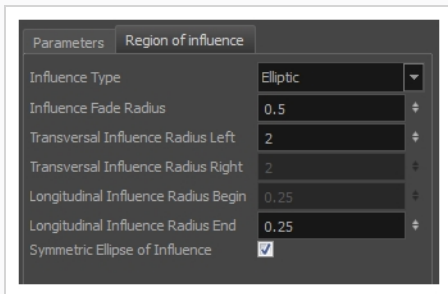

4. Set up the ellipse shape by adding values to the various fields:

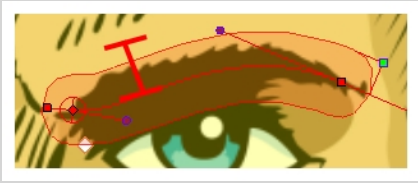
Influence Fade Radius	This defines the size of the fade area around the actual region of influence's boundaries.
Transversal Influence Radius Left	<p>When the Symmetric Ellipse of Influence option is enabled, this field controls the Left and Right transversal radius values. When disabled, it controls the size of the left transversal radius. By default, this value is set to 2.</p> 
Transversal Influence Radius Right	When the Symmetric Ellipse of Influence option is enabled, this field becomes inactive. The Left Transversal radius value is automatically applied to the Right Transversal. When the Symmetric Ellipse of Influence option is disabled, it controls the size of the Right Transversal radius. By default, this value

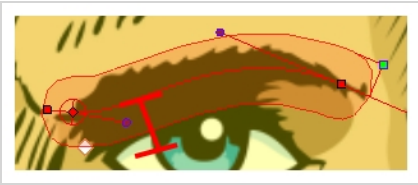
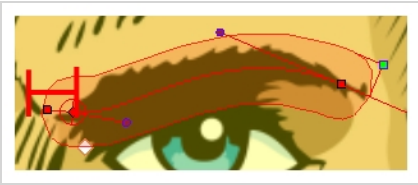
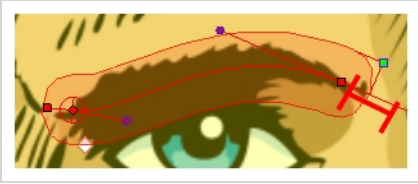
	<p>is set to 2.</p> 
Longitudinal Influence Radius Begin	<p>When the Symmetric Ellipse of Influence option is enabled, this field becomes inactive. The End Longitudinal value is automatically applied to the Begin Longitudinal value. When the Symmetric Ellipse of Influence option is disabled, it controls the size of the Begin Longitudinal radius. By default, this value is set to 0.25.</p> 
Longitudinal Influence Radius End	<p>When the Symmetric Ellipse of Influence option is enabled, this field controls both the Begin and End Longitudinal radius values. When this option is disabled, it controls the size of the End Longitudinal radius. By default, this value is set to 0.25.</p> 
Symmetric Ellipse Influence	<p>Enabled by default. The shape of the ellipse will be symmetrical on both the transversal and longitudinal radii. In this case, use the Transversal Influence Radius Left field to set the transversal radius value and use the Longitudinal Influence Radius End field to set the longitudinal radius value. The two other fields will remain unused unless you disable the Symmetric Ellipse Influence option. In that case, you can set up different radius sizes for the four radii directions.</p>

5. You can also modify the elliptic shape in the Camera view using the Rigging  tool.

- If the Symmetric Ellipse of Influence option is enabled, one control point will be available in the Camera view. Drag this point in any direction to increase or decrease the size of the Zone. Dragging it left/right will modify both longitudinal radius sizes. Dragging it up/down will modify both transversal radius sizes.

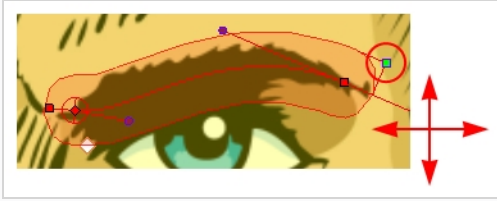

- If the Symmetric Ellipse of Influence is disabled, two control points will be available in the Camera view. Drag the top-corner point left/right to modify the end longitudinal radius size and up/down to modify the left transversal radius size. Drag the bottom-corner control point left/right to modify the beginning longitudinal radius size and up/down to modify the right transversal radius size.

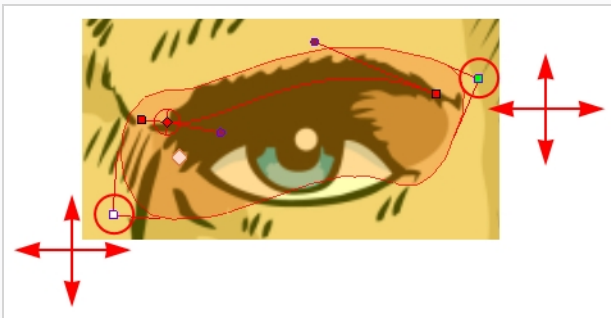

Setting Up Shaped Regions of Influence

A Shaped region of influence is suited for irregular forms. Modify the region parameters to refine the shape's boundaries.

How to set up the Shaped zone of influence

1. In the Timeline view, select the deformation nodes you want to set the region of influence for—see [Displaying Selected Deformation Controls on page 560](#).
2. In the Deformation toolbar, click the Show Selected Deformers and Hide All Others  button to display the deformer of the selected piece.

If you selected the Shaped option in the Layer Properties window or in the Rigging tool properties, the zone of influence will be square. This square has control points on all four corners and each control point as two control levers. If you converted an Elliptic zone to a shape, the zone will have more control points and handles.

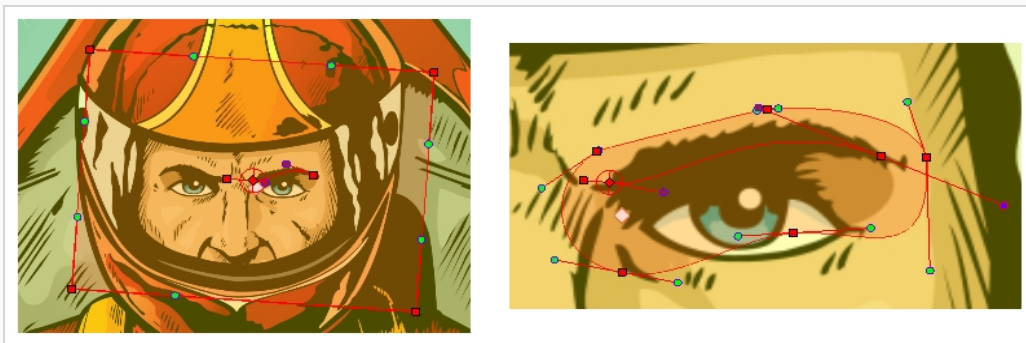

3. In the Layer Properties window, in the Region of Influence tab, set the Influence type to **Shaped**.

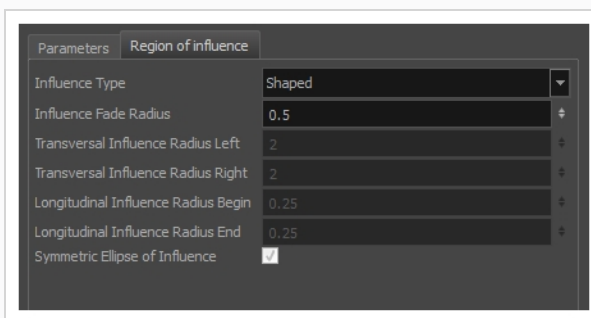

All radius options are disabled except the Influence Fade Radius option—see [Setting Up Shaped Regions of Influence on page 553](#).

- In the Camera view, use the Rigging tool and drag a control point to redefine its position and shape.

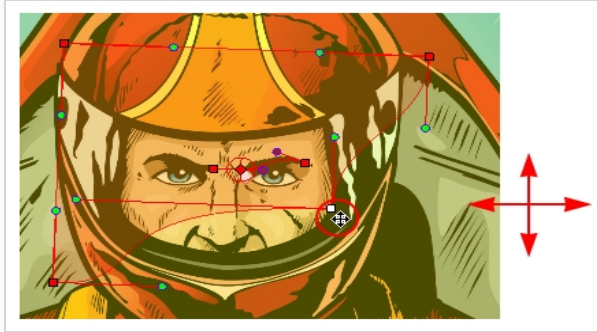

- Click and drag the control lever handle to modify the corners and redefine the shape.

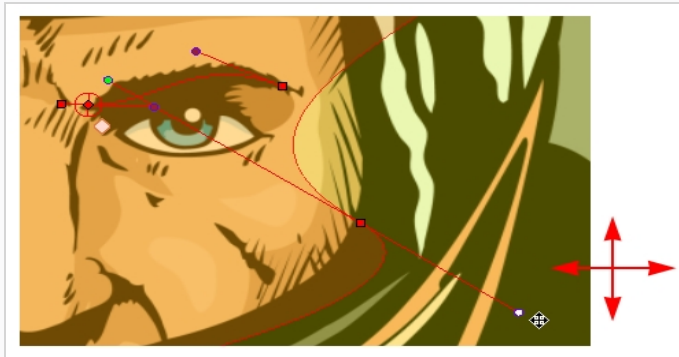

- Hold Alt down while dragging the control lever handle to move one handle at a time.

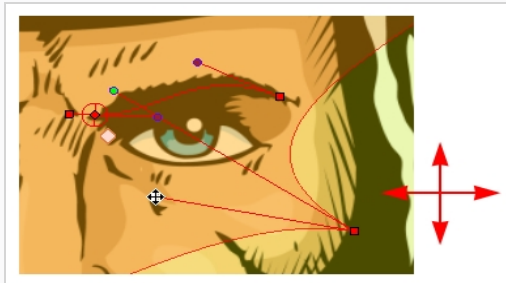



Converting Elliptic Regions of Influence into Shapes

After you have tried tweaking an elliptical region of influence, you may find that you need to convert the ellipse into a shape, in order to create a more precise region. Instead of losing all the tweaks you have made, you can use the elliptical region you have created as a base for a Shaped region of influence.

How to convert an Elliptic zone of influence to a shape

1. In the Timeline view, select the deformation nodes you want to set the region of influence for—see [Displaying Selected Deformation Controls on page 560](#).
2. In the Deformation toolbar, click the Show Selected Deformers and Hide All Others  button to display the deformer of the selected piece.



3. In the Tools toolbar, click the Rigging  button.
4. In the Tool Properties view, in the Operations section, click the Convert Elliptic Zone of Influence to Shape  button.

The zone of influence is automatically converted to a shape. The shape is retained and control points appear around the zone, so you can customize the shape.

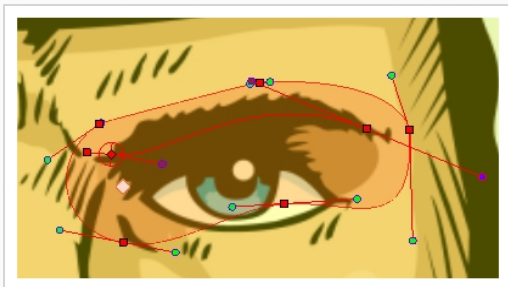

About Assembly

After you have created all the deformation chains for your character, you will need to assemble these separate body parts into a puppet. Your pieces should be properly overlapping and not set apart.



To avoid problems such as having the head stretched by the neck deformers or a hand modified by the body deformers, you can use the Kinematic Output node to assemble your pieces without propagating the deformations down the hierarchy chains.

The Kinematic Output node lets you hook a separate element that you want to be linked to the deformation chain but not be part of the deformation, such as a hand to an arm or an arm to the body. These elements will follow the movement of the chain just like a regular cut-out character hierarchy piece without being influenced by the deformation of the arm. If you don't use the Kinematic Output, the piece's pivot will not follow the deformation.

When building a cut-out puppet with deformations, each part controlled by a deformation chain will automatically rotate from the chain root point, which acts like a pivot. Because it is unlikely that every piece of your character will be rigged with a deformation chain, you must set pivot points for the pieces that are not using deformations—see [Setting Permanent Pivots on page 411](#).

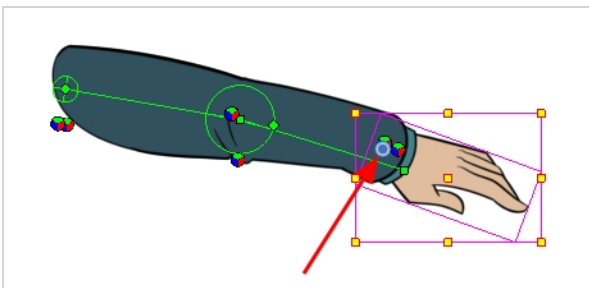

Assembling Guidelines

When assembling a puppet with deformers, there are some guidelines to keep in mind:

- You cannot parent deformers directly because deformers are not designed to be used on other deformers. To assemble deformers, you must insert a Kinematic Output node.



- Your peg must be placed above the deformer.



Assembling in the Timeline View

In order to assemble the rigged parts of your character in the Timeline view, you need to use a Kinematic Output layer.

How to assemble a puppet using the Kinematic Output node in the Timeline view

1. Select the element to attach to the Kinematic Output node, such as the hand or head peg.

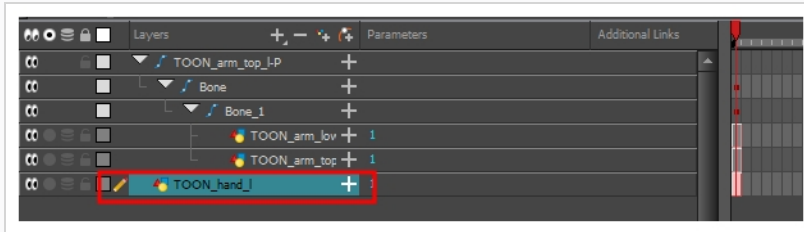

2. From the top menu, select **Insert > Kinematic Output**.

The node appears in the Timeline view as a parent of your selection.

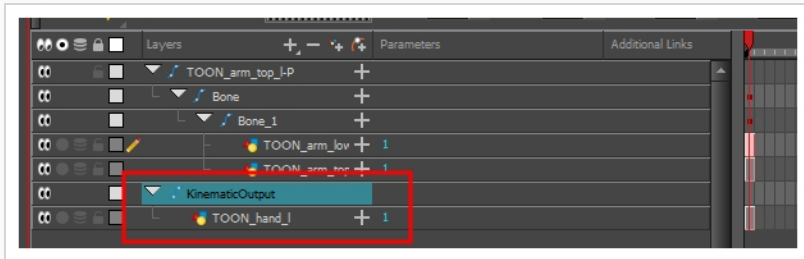

3. In the Timeline view, drag and drop the Kinematic Output layer ONTO the deformation layer you want your limb or piece to follow. For example, onto the neck deformer if you want your head to follow it without being deformed or onto the arm deformer if you want your hand to follow.

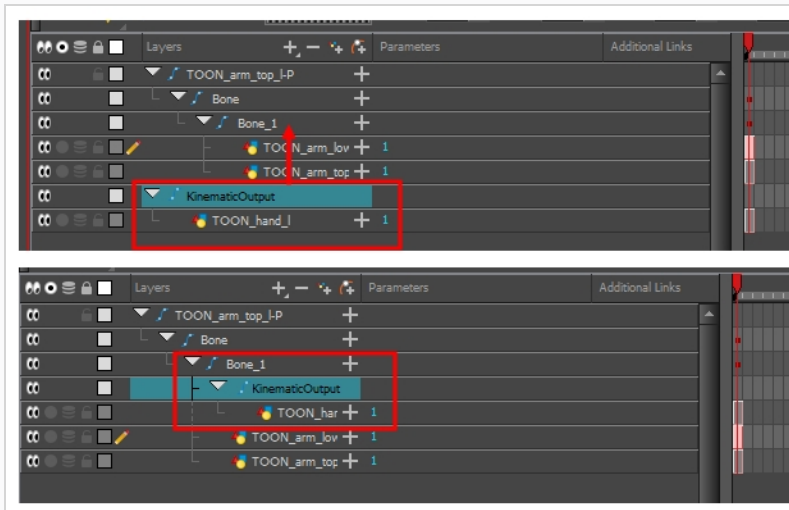

- If your pieces are no longer ordered properly, use the Z-nudging feature to reorder them—see [About Ordering Layers on page 405](#).
- It's good practice to rename the Kinematic Output layer to reflect which deformer it is assigned to as the Timeline view can become very large and layers can be positioned far apart. Select the Kinematic Output node and in the Layer Properties window, rename the node. You can also double-click on the layer's name.

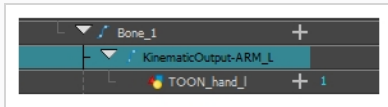

Displaying Selected Deformation Controls

Harmony lets you control which deformers are displayed in the Camera view independently from the current selection. When you create a deformation chain, its deformation controls are displayed in the Camera view. However, if you select an existing deformer or a layer that's connected to existing deformers, its deformation controls won't display right away. Likewise, deselecting a deformation chain will not hide its deformation controls. Before you can animate or modify an existing deformation chain, you must manually display it.

How to display deformation controls

1. Do one of the following:
 - In the Camera or Timeline view, select one of the drawing elements linked to the deformation chain you want to display.
 - In the Timeline view, select any part of the deformation chain you want to display.
2. In the Deformation toolbar, click the Show the Selected Deformation Chain and Hide All Others  button.

The selected deformation controls appear in the Camera view and all the others are hidden.





NOTE

The Show the Selected Deformation Chain and Hide All Others button will display all deformation chains that are in the hierarchy of the selection. For example, if the master peg of a character model is selected, all of its deformation chains will be displayed. Likewise, if multiple layers linked with different deformation chains are selected, all of their deformation chains will be displayed.

Hiding Deformation Controls

If you no longer want to animate or modify deformer, you can hide the deformation controls so that they no longer clutter the Camera view.

How to hide deformation controls

1. Do one of the following:
 - Click in the negative space of the Camera view, Timeline view or Node view to discard the current selection, then click on the Show Selected Deformation Chain and Hide All Others  button in the Deformation toolbar.
 - Select a layer that is not linked to any deformer, then click the Show the Selected Deformation Chain and Hide All Others  button in the deformation toolbar.
 - In the Camera toolbar, click the Hide All Controls  button.
 - From the top menu, select **View > Hide All Controls**.
 - Press Shift + C.

About Deformation Animation

Just like with animating pegs and drawing layers, you can animate your deformers by creating keyframes on their corresponding layers in the Timeline. Animating deformers works exactly like making modifications to a deformer, except it requires using the Transform  tool instead of the Rigging tool. When the Transform tool is selected, deformation controls in the Camera view display in green, which means they are in animation mode, whereas when the Rigging tool is selected, they display in red, meaning they are in rigging mode.

Animating Bone and Game Bone Deformers

You can add keyframes to deformers reposition their deformation controls to create animated sequences.

How to animate Bone and Game Bone deformations

1. In the Timeline view, collapse your character using the Expand/Collapse arrow.

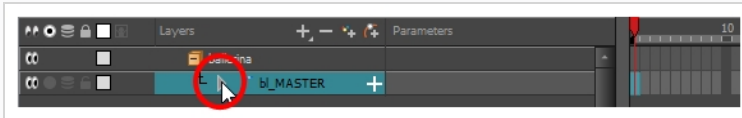

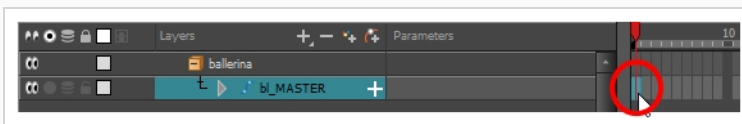

2. Select the first frame of the scene.

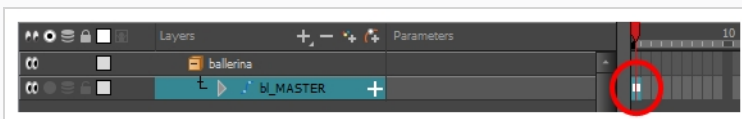

3. To ensure your model doesn't disappear after 1 frame, open the Extend Exposure dialog by doing one of the following:
 - Right-click on the first frame in the Timeline and select **Extend Exposure**.
 - Press F5.
4. In the Extend Exposure dialog, type in the amount of frames in your scene and confirm. This will make your model exposed (visible) throughout your whole scene.
5. Now, we will make your character's first pose. First, make sure there is a keyframe on the first frame of every layer of the model. This ensures that when you make the second pose later, your first pose will not be affected. To do this do one of the following:
 - In the Timeline toolbar, click the Add Keyframe **KF** button.
 - Right-click and select **Add Keyframe**.
 - Press F6.

A keyframe is added on the current frame.



6. In the Tools toolbar, select the Transform  tool or press Shift + T.
7. In the Tools toolbar, enable the Animate  mode. This allows the Transform tool to affect the position and size of a layer at the current keyframe only, whereas it would otherwise affect the layer's position and size throughout the whole scene.

8. Do one of the following:

- In the Camera or Timeline view, select one of the drawing elements linked to the deformation chain you want to display.
- In the Timeline view, select any part of the deformation chain you want to display.

9. In the Deformation toolbar, click the Show the Selected Deformation Chain and Hide All Others  button.

The selected deformation controls appear in the Camera view and all the others are hidden.

10. In the Camera view, do the following:

- Rotate the first bone to rotate the limb.



- Rotate the subsequent bones to bend the limb.



- Use the root control to reposition (offset) the entire chain.



- Use the control points to reposition the articulations. This will elongate, shorten, or change the direction of the bone and offset the subsequent children.

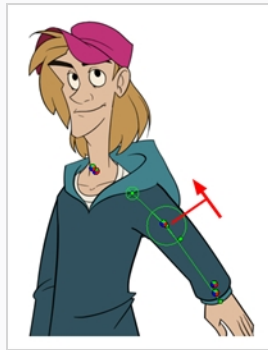

11. In the Timeline view, go to the frame on which you want to set the next key pose.
12. Add a keyframe on the current frame by doing one of the following:
 - In the Timeline toolbar, click the Add Keyframe  button.
 - Right-click and select **Add Keyframe**.
 - Press F6.
13. Transform your deformation chain's points to make your new key pose.
14. Repeat the previous steps until your animation is complete.



NOTE

When manipulating the articulation of a Bone or Game Bone deformer, you can hold the Alt key to lock the bone's angle and only shorten or elongate the bone. You can also hold the Ctrl (Windows/Linux) or ⌘ (macOS) key to break the articulation off its chain and make it into a new, separate deformer chain.



NOTE

You can also manipulate the deformer by typing values directly in the Layer Properties of the deformation effect nodes.

Bone layer properties

Game Bone layer properties (no Bias)

Resetting a Deformer to its Resting Position

If you need to reset the current pose of the entire chain for the entire scene, you have the possibility to reset the deformation chain to the resting position on the current frame, or on all frames.

How to reset the position of deformers from the Camera view

1. In the Timeline view, move the playhead to the frame where you want to reset the puppet to the resting position.
2. Do one of the following:
 - In the Camera or Timeline view, select one of the drawing elements linked to the deformation chain you want to display.
 - In the Timeline view, select any part of the deformation chain you want to display.
3. In the Deformation toolbar, click the Show the Selected Deformation Chain and Hide All Others  button.

The selected deformation controls appear in the Camera view and all the others are hidden.

4. In the Camera view, select the deformation point you want to reset. To select several deformation point, hold Ctrl and click on each point you want to reset to add them to the selection.
5. In the Deformation toolbar, click on the Reset Current Keyframe  button to reset the position of the selected chain on the current frame.

How to reset the position of deformers from the Timeline view

1. In the Timeline view, move the playhead to the frame where you want to reset the puppet to the resting position.
2. In the Timeline view, select the deformationlayer(s) you want to reset.
3. In the Deformation toolbar, click on the Reset Current Keyframe  button to reset the position of the selected chain on the current frame.



TIP

To completely reset the position and remove all keyframes on all frames, click on the Reset All Keyframes  button.

Disabling Deformation Preview

When adding new drawings while animating, you may need to see the reference drawings as their original resting position as it may be quite difficult to draw on a deformed canvas. You have the possibility to disable deformations in Harmony so that all drawings appear in their resting position.



NOTE

Disabling deformations is only a display mode. Although drawings will not appear deformed in the Camera view, even in Render View mode, they will still be deformed in the rendered images.

How to enable or disable deformation preview

1. In the Deformation toolbar, click on the Enable Deformations  button to toggle deformation preview.

Transferring Curve Positions of Legacy Deformations

You can let you transfer all of the information from first curve deformer to its parent Offset node. This is useful for a legacy scene created using Curve deformations where the Offset's position has been placed far away from the drawing to make sure it doesn't affect the drawing's deformation. You can bring back the offset and give it the first curve's position. The Envelope deformation lets you animate the offset of each curve separately. The offset no longer needs to be placed far away.

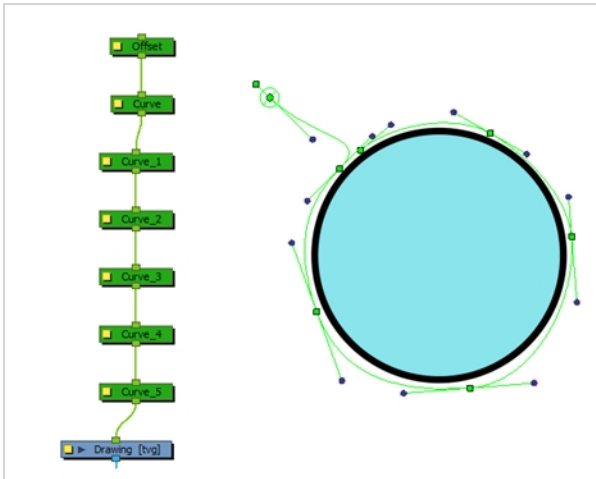

How to transfer a curve's position to its parent offset

1. In the Node view, select the root Offset and the first curve.

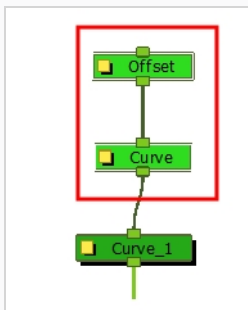

2. From the top menu, select **Animation > Deformation > Set Curves and Offsets Independent from Parent**.
3. In the Node view, select only the first curve node.

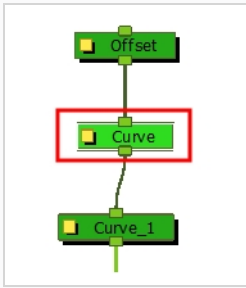

4. From the top menu, select **Animation > Deformation > Transfer Curve Values to Offset**.

In the Node view, the first Curve node is disabled and the values are transferred to the parent Offset node.

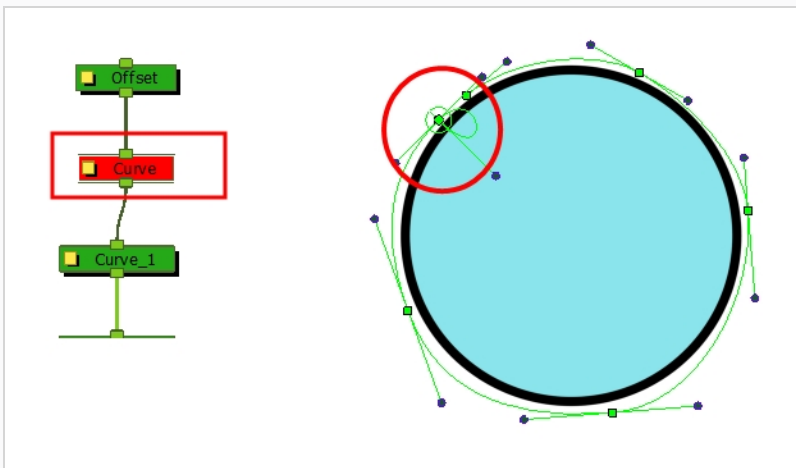

Converting Legacy Deformation Chains

You can also convert a legacy deformation rig to the new format using a script. You can select which chain you want to transform. Certain legacy nodes will remain in the structure to make sure the integrity of your original puppet is maintained.

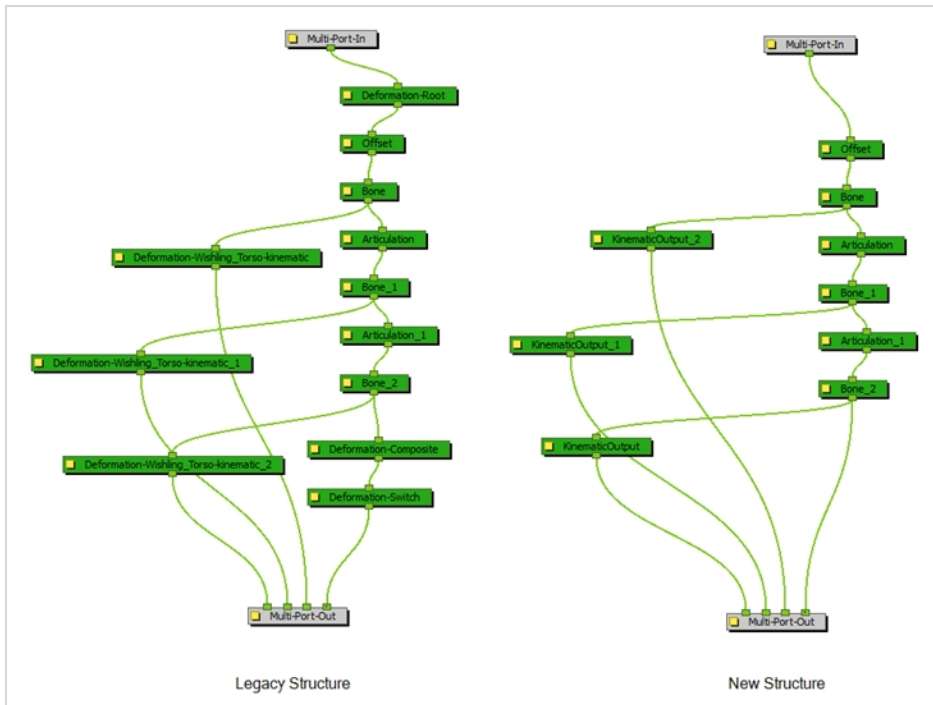

How to convert legacy deformation chains to the new structure

1. In the Node or Timeline view, select the deformation group containing the chain you want to convert to the new structure.
2. In the Scripting toolbar, click on **TB_ConvertLegacyDeformation**. If the script is not available in the toolbar, you can load it.
 - In the Scripting toolbar, click on Manage Scripts
 - In the Script Manager dialog, in the File column, select the **TB_ConvertLegacyDeformation.js** script. If you cannot find the script in the list (most likely due to a software upgrade installation), you can load the script through the Script Editor view from the default resources folder—see Importing Scripts in the Scripting guide.
 - In the Functions column, select **TB_ConvertLegacyDeformation**.
 - Click the Right Arrow button to move the function to the Scripting toolbar.

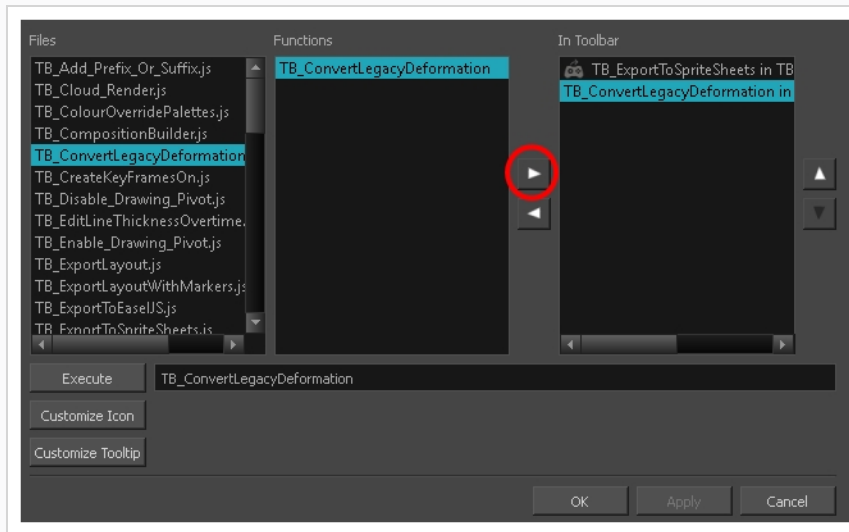

- Click **OK**.

The legacy chain is converted.

Chapter 11: Staging



Setting up your scene can be compared to building a set for a television show. This is the point when you position each scene element such as the camera frame, the background elements and the characters.

To learn how to position and animate your camera, see [Cameras on page 625](#).

About Layer Position



Setting up the scene also involves positioning the different scene elements within the camera frame.

At this time, the elements are set to a static position. See [Motion Paths on page 471](#) to learn how to animate the elements and the camera.

About the Animate Mode

T-HFND-008-001

The Animate mode records the position, rotation, scale, skew, etc. of objects as keyframes in the Timeline view. Turn off the Animate mode to reposition objects for the entire scene. When the Animate mode is disabled, keyframes are not created when an object's parameters change.

When positioning elements, make sure the Animate Mode is turned off, or it will create a keyframe on your drawing layer. The animate mode is used to animate layers over time.



How to turn the Animate mode on or off

1. In the Tools toolbar, click the Animate  button or select **Animation > Animate**.



Selecting Layers

T-HFND-008-002

There are different ways to select the layers you want to reposition.

You can select your elements directly in the Camera view using the Transform tool. When using this tool, its properties and options appear in the Tool Properties view. Always make sure that the Peg Selection Mode option in the Tool Properties view is disabled or it will limit the selection to pegs only.

How to select a layer in the Camera view

1. In the Tools toolbar, select the Transform  tool or press Shift + T.
2. In the Tool Properties view, make sure that the Peg Selection Mode  is deselected.
3. In the Camera view, click on the element to be repositioned. You can select more than one element at a time. Hold down Shift while clicking on the elements to be selected.

The corresponding layers and columns are highlighted in the Timeline and Xsheet views.

How to select from the Timeline or Xsheet view

- In the Timeline view, click the layer corresponding to the element you want to reposition.
- In the Xsheet view, click the column header corresponding to the element you want to reposition.

The selected element is highlighted in the Camera view.

How to select non-adjacent elements in the Timeline or Xsheet view

- In the Timeline view, hold down Ctrl (Windows/Linux) or ⌘ (macOS) and click on any layers that you would like to add to the selection.
- In the Xsheet view, hold down Ctrl (Windows/Linux) or ⌘ (macOS) and click on any columns that you would like to add to the selection.

The non-adjacent, selected layers and columns are highlighted in the Timeline and Xsheet views.

How to select all elements within a group in the Timeline view

1. With a group collapsed or expanded, hold down Alt and click on the group in the Timeline view.

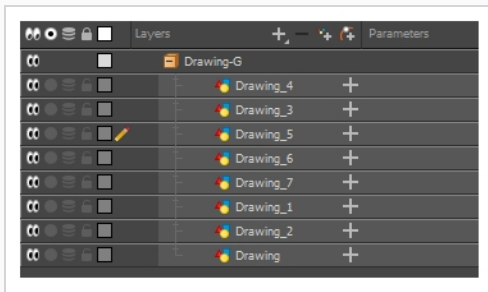

All elements contained within the group are selected.

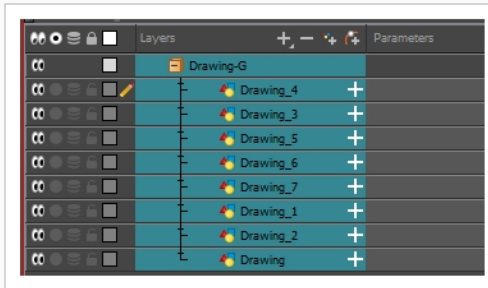

Centering on Selections

When you have many layers in the Timeline view, you may find it hard to locate which one is selected. You can use the Centre on Selection feature to display the selected object's layer in the Timeline view.

How to center on the selected layer in the Timeline view

1. In the Camera view, select a layer.
2. In the Timeline view toolbar, click the Centre on Selection  button or press O.

About the Transform Tool

T-HFND-008-003

Using the Transform tool, you can easily reposition, scale, rotate and even skew layers directly in the Camera view.

When positioning a drawing layer using the Transform tool, always make sure the Peg Selection Mode  is deselected in the Tool Properties view. Otherwise, it will limit the selection to pegs in the Camera view.

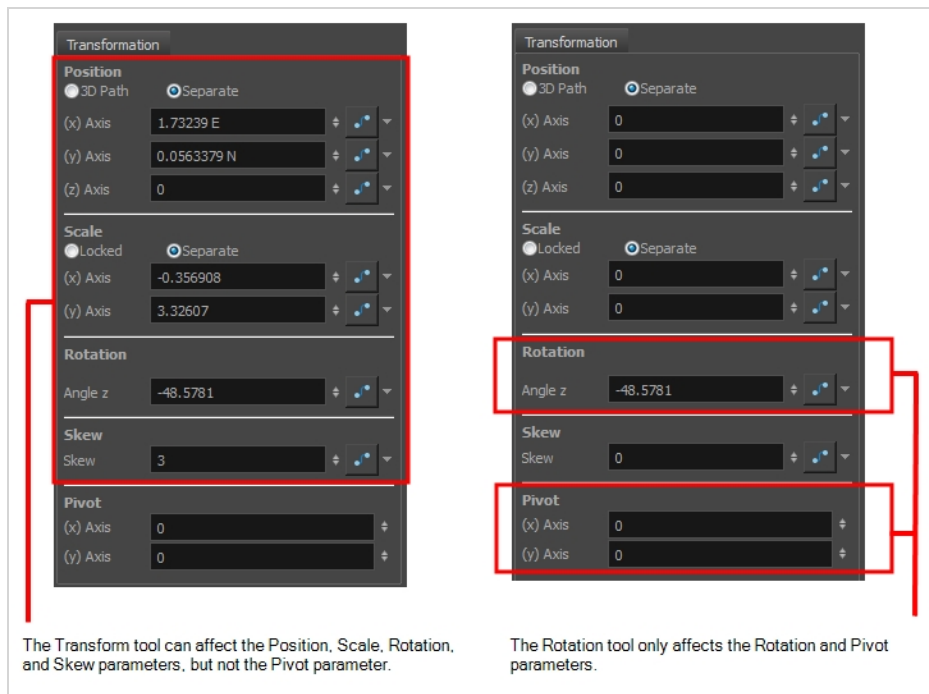

There are two different options you can use when you want to flip your element.

The Flip Horizontal and Flip Vertical options let you flip a drawing layer along the Camera view's horizontal and vertical axis.

Once your drawing layer is rotated, the original horizontal and vertical axes change. The Flip Scale X and Flip Scale Y will perform a flip on your drawing layer following its original axis.

- The Flip Horizontal command flips the layer following the Camera view X-axis.
- The Flip Scale X command uses the original X-axis of the layer and flips the element following it.

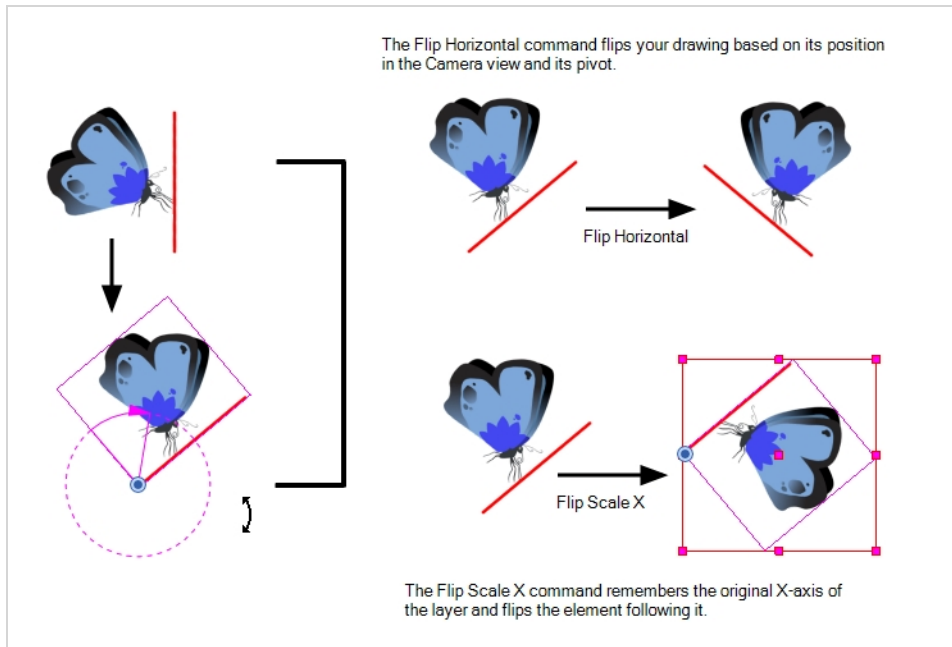



Repositioning Temporary Pivots with the Transform Tool

T-HFND-008-004

Transformations, such as rotation, scale, skew and flip are made relative to the pivot point position. You can temporarily reposition the pivot point for each transformation using the Transform tool. Note that the pivot is only moved temporarily. When animating the position, the interpolation is calculated from the permanent pivot position—see [About Advanced Animation Tools on page 587](#).

How to temporarily reposition the pivot point

1. In the Tools toolbar, select the Transform  tool.
2. In the Tool Properties view, make sure the Peg Selection Mode  is disabled.
3. In the Camera view, select your element.

The pivot point appears at the center of the scene space (coordinates 0, 0, 0), unless previously repositioned.

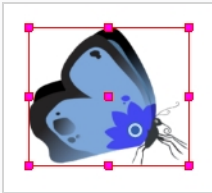

4. Click on the pivot point and drag it to a new position.

This will be the new position of the pivot point for the current transformation. It will remain in this position as long as you do not deselect the drawing. Using the Transform tool to reposition your pivot will temporarily override the existing pivot point position until you complete the current transformation. Then it returns automatically to its original position.

When you translate the pivot point using the Transform tool, the permanent pivot will appear as a ghost so you know where it is and also from where the animation will be interpolated when you create motion paths. The animation is always interpolated from the original pivot and not the temporary pivot.

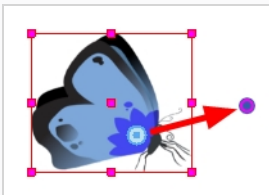



Panning with the Transform Tool

T-HFND-008-005

You can pan (translate) a layer using the Transform tool.

How to pan a layer using the Transform tool

1. In the Tools toolbar, disable the Animate  mode.
2. In the Tools toolbar, select the Transform  tool or press Shift + T.
3. In the Tool Properties view, make sure the Peg Selection Mode  is deselected.
4. In the Camera view, select a drawing layer. If you want to select multiple layers, hold down Shift and click on each layer you wish to select.
5. Drag the selection to a new area.

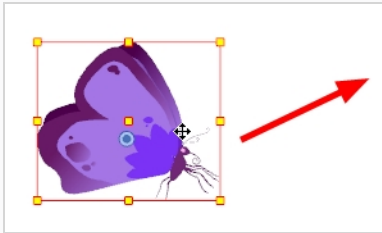



Rotating with the Transform Tool

T-HFND-008-006

You can rotate a layer from its pivot using the Transform tool. You can temporarily reposition the pivot to rotate from a different point.

How to rotate a layer using the Transform tool

1. In the Tools toolbar, disable the Animate  mode.
2. In the Tools toolbar, select the Transform  tool or press Shift + T.
3. In the Tool Properties view, make sure the Peg Selection Mode  is deselected.
4. In the Camera view, select a drawing layer. If you want to select multiple layers, hold down Shift and click on each layer you wish to select.
5. Place the pointer outside of a corner of the bounding box, then click and drag to rotate.

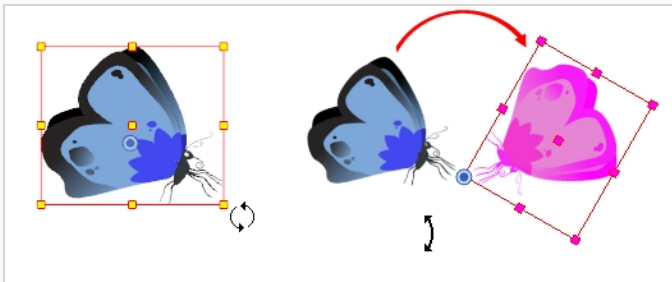



Scaling with the Transform Tool

T-HFND-008-007

You can scale a layer from its pivot using the Transform tool. You can temporarily reposition the pivot to scale from a different point.

How to scale a layer using the Transform tool

1. In the Tools toolbar, disable the Animate  mode.
2. In the Tools toolbar, select the Transform  tool or press Shift + T.
3. In the Tool Properties view, make sure the Peg Selection Mode  is deselected.
4. In the Camera view, select a drawing layer. If you want to select multiple layers, hold down Shift and click on each layer you wish to select.
5. Click and drag the top, side or corner control point.

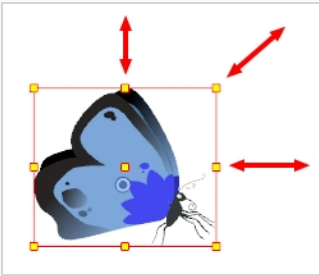

NOTE



When scaling your selection, you can hold down Shift to preserve the proportions between its width and height.

Skewing with the Transform Tool

T-HFND-008-008

You can skew a layer from its pivot using the Transform tool. You can temporarily reposition the pivot to skew from a different point.

How to skew a layer using the Transform tool

1. In the Tools toolbar, disable the Animate  mode.
2. In the Tools toolbar, select the Transform  tool or press Shift + T.
3. In the Tool Properties view, make sure the Peg Selection Mode  is deselected.
4. In the Camera view, select a drawing layer. If you want to select multiple layers, hold down Shift and click on each layer you wish to select.
5. Place the pointer on the edge of the selection's bounding box, between two control points and drag sideways or up and down.

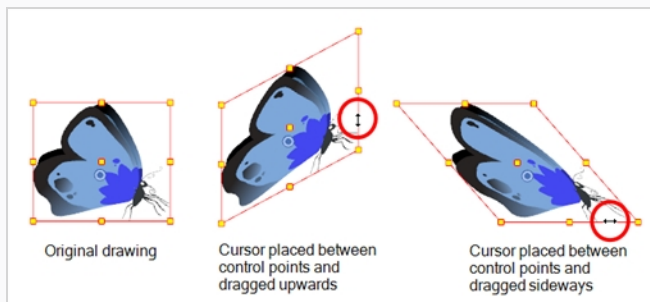







Flipping with the Transform Tool

T-HFND-008-009

You can flip a layer using the Transform tool. There are two ways to flip.



- The Flip Horizontal command flips the layer following the Camera view X-axis.
- The Flip Scale X command uses the original X-axis of the layer and flips the element following it.

How to flip a layer

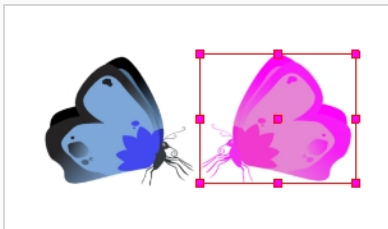
1. In the Tools toolbar, disable the Animate  mode.
2. In the Tools toolbar, select the Transform  tool or press Shift + T.
3. In the Tool Properties view, make sure the Peg Selection Mode  is deselected.
4. In the Camera view, use the Transform  tool to select a drawing layer to flip.
5. Do one of the following:
 - From the top menu, select **Animation > Flip > Flip Horizontal** or **Flip Vertical**.
 - In the Tool Properties view, click the Flip Horizontal  and the Flip Vertical  buttons.
 - Press 4 or 5.



How to flip an element following its original axis

1. In the Tools toolbar, disable the Animate  mode.
2. In the Tool Properties view, make sure the Peg Selection Mode  is deselected.
3. In the Camera view, use the Transform  tool to select an element that has already been transformed.
4. From the top menu, select **Animation > Flip > Flip Scale X** or **Flip Scale Y**.

About Advanced Animation Tools

T-HFND-008-010

You can also use the advanced animation tools to position your layers. The difference between these tools and the Transform tool is that they modify only one parameter of the position such as the rotation or the scale as the Transform tool adjusts all parameters together.



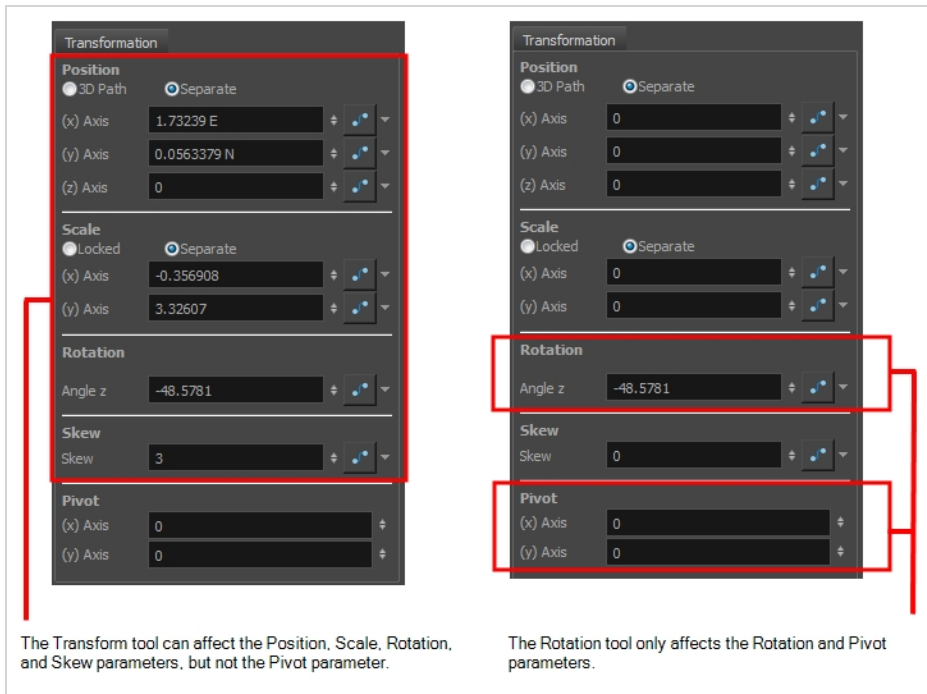

You can find the advanced animation tools in the Advanced Animation Tools toolbar.



Repositioning Permanent Pivots

Transformations made on a drawing layer, such as rotation, scale, skew and flip, are made relative to the position of the drawing's pivot point. While making transformations using the Transform tool, you can drag and drop your selection's pivot. However, this has no permanent effect. It will only temporarily change the pivot's position to help you make transformations at the selected frame, but the actual pivot point of your drawing layer will remain the same. You can reposition a layer's pivot point permanently using the advanced animation tools.

How to permanently reposition the pivot point

1. In the Advanced Animation toolbar, select the Translate , Rotate , Scale , or Skew  tool.
2. In the Camera view, Ctrl + click (Windows/Linux) or ⌘ + click (macOS) to select your element.

The pivot point appears in the Camera view.

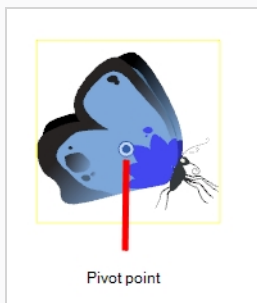

3. Drag the pivot point to a new position.

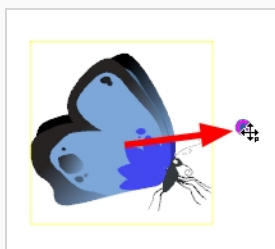

NOTE



When you permanently move the pivot point of a layer that is already animated, all the transformations done on the layer on other keyframes will be recalculated according to the new pivot point's position. Therefore, your existing animation will look completely different, except at the current frame. It is recommended to always make sure your pivot point is at its ideal position before you start animating.

Using the Translate Tool

T-LAY-004-002

You can use the Translate tool to pan your elements on the X, Y and Z axes.

How to use the Translate tool

1. In the Tools toolbar, disable the Animate  mode.
2. Do one of the following:
 - From the top menu, select **Animation > Tools > Translate**.
 - In the Advanced Animation toolbar, click the Translate  tool.
 - Press Alt + 2.
3. In the Camera view, Ctrl + click (Windows/Linux) or  + click (macOS) to select your element.
4. Drag the selection to a new area.

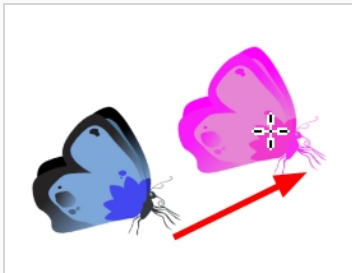



- You can select multiple layers at the same time. Press Ctrl + Shift + click (Windows/Linux) or  + Shift + click (macOS) on each element to select them.

Using the Rotate Tool

You can use the Rotate tool to rotate your objects on the x,y and z axis.

How to use the Rotate tool

1. In the Tools toolbar, disable the Animate  mode.
2. Do one of the following:
 - From the top menu, select **Animation > Tools > Rotate**.
 - In the Advanced Animation toolbar, click the Rotate  tool.
 - Press the Alt + 3.
3. In the Camera view, Ctrl + click (Windows/Linux) or  + click (macOS) to select your element.
4. Rotate the layer.

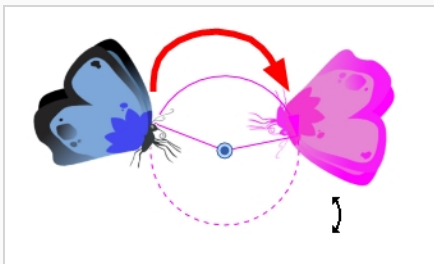



- You can select multiple layers at the same time. Press Ctrl + Shift + click (Windows/Linux) or  + Shift + click (macOS) on each element to select them.

Using the Scale Tool

You can use the Scale tool to squash, stretch, and resize your elements.

How to use the Scale tool

1. In the Tools toolbar, disable the Animate  mode.
2. Do one of the following:
 - From the top menu, select **Animation > Tools > Scale**.
 - In the Advanced Animation toolbar, click the Scale  tool.
 - Press Alt + 4.
3. In the Camera view, Ctrl + click (Windows/Linux) or  + click (macOS) to select your element.
4. Pull or push either on the side, top or corner control point. Hold down Shift to lock the selection's ratio when using the corner control points.

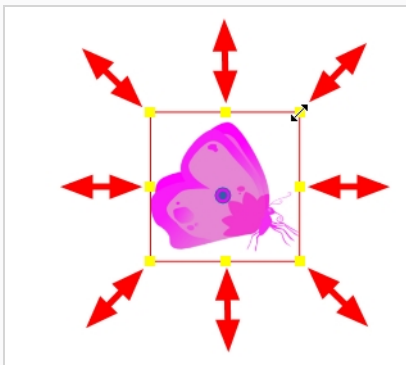



- You can select multiple layers at the same time. Press Ctrl + Shift + click (Windows/Linux) or  + Shift + click (macOS) on each element to select them.

Using the Skew Tool

You can use the Skew tool to distort your elements on the x and y axis.

How to use the Skew tool

1. In the Tools toolbar, disable the Animate  mode.
2. Do one of the following:
 - Select **Animation > Tools > Skew**.
 - In the Advanced Animation toolbar, click the Skew  tool.
 - Press Alt + 5.
3. In the Camera view, Ctrl + click (Windows/Linux) or  + click (macOS) on the element to select it and drag a side of the bounding box up, down or sideways.

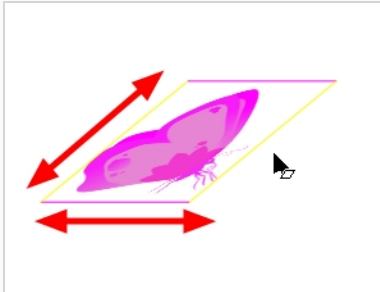

- You can select multiple layers at the same time. Press Ctrl + Shift + click (Windows/Linux) or  + Shift + click (macOS) on each element to select them.

About the Layer Properties View

T-HFND-008-011

Each layer has a series of parameters that you can modify to adjust an element's position. You can access these parameters in the Layer Properties view. In this view, you can type in a value instead of moving the object in the Camera view. These values can also be animated over time.

You can also access a layer's parameters in the Timeline view. Click on the Expand Parameters \oplus button.

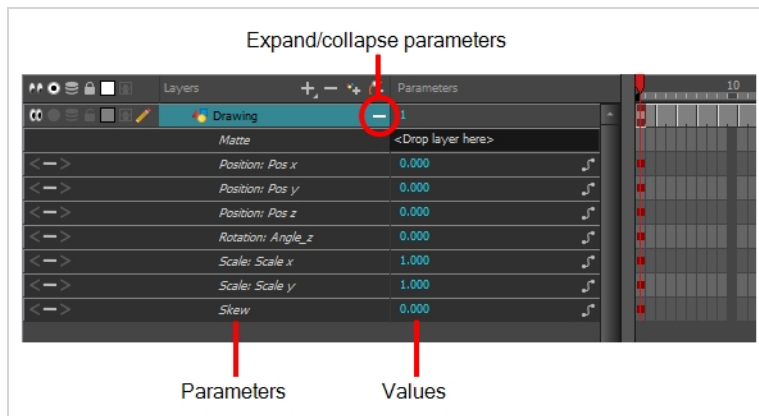

It is important to understand the coordinate values in Harmony, which is based on the origins of animation. In traditional animation, a scene's size and camera motion are calculated in fields. A field has a 4:3 ratio and measures 0.5 inches (12.7 mm) in width. A specific grid has been created for this purpose known as a field chart. Harmony uses this unit of measurement as its coordinate system.

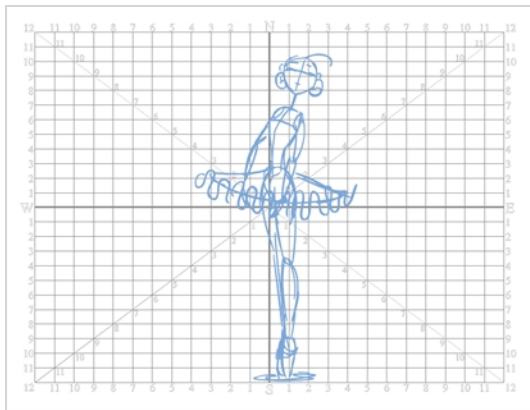

A field chart uses the cardinal directions. The X axis is the east-west (left-right) direction, the Y axis is the north-south (up-down) direction and the Z axis is the forward-backward direction.

In Harmony, a drawing's pivot is located at the centre of the field chart, regardless where your drawing has been drawn on the page. Your drawing is the entire sheet of paper, not only the drawing strokes you have drawn on the page. This allows scanned drawings, imported images and paperless drawings to be properly registered together.

If you want to move your drawing in the upper-left region of the camera frame, you would type in something like the following:

- X Axis: -4 or 4W (4 West)
- Y Axis: 5 or 5N (5 North)

If you want to move your drawing in the lower-right region of the camera frame, you would type in something like the following:

- X Axis: 3 or 3E (3 East)
- Y Axis: -2 or 2S (2 South)

Displaying the Layer Properties View

You can display the Layer Properties view in several ways.

How to display layer parameters

1. Do one of the following:
 - In the Layer Properties view is not part of your workspace, from the top menu, select **Windows > Layer Properties**. In the Timeline view, select a layer
 - In the Timeline view, double-click on a layer.
 - Press Shift + E.

The properties display—see Element/Drawing Node in the Reference guide .

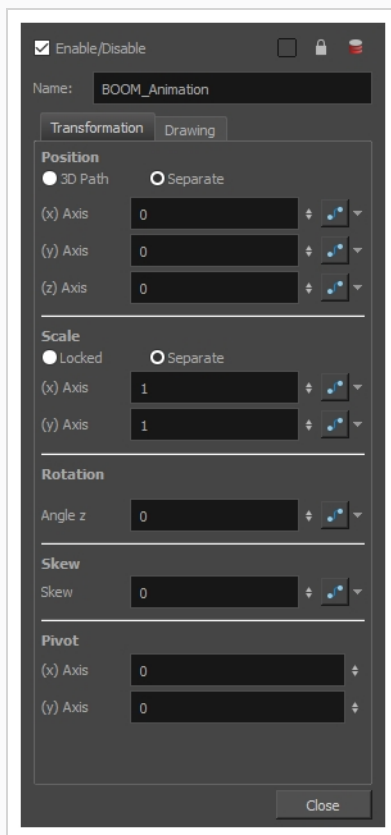

Positioning Elements with the Layer Properties View

T-HFND-008-012

You can type values to position your elements using exact coordinates.

How to position an element with coordinates

1. In the Timeline view, select a layer.
2. In the Position section, select one of the following options:
 - **Separate** to independently edit the different coordinate fields. Continue to step 3.
 - **3D Path** to use a 3D path function when animating your element. Continue to step 4.

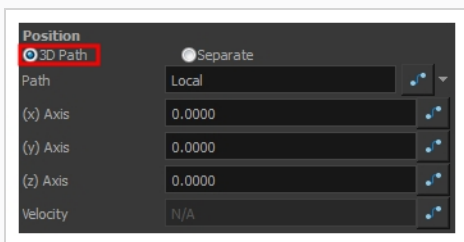
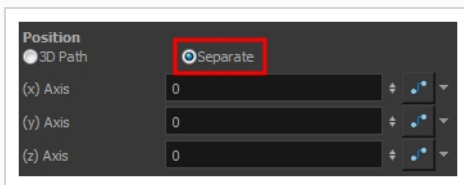

3. In the (x), (y) and (z) Axis fields, type in a new coordinates corresponding to the desired position—see [About Multiplane on page 608](#).

As you type in values, the element's position is updated in the Camera view.

4. Use the Function  buttons to create function curves and add keyframes to animate the parameter.
5. In the Scale section, select one of the following options:
 - **Locked** to resizes the element uniformly in three directions.
 - **Separate** to resize the element in any direction without affecting the others.

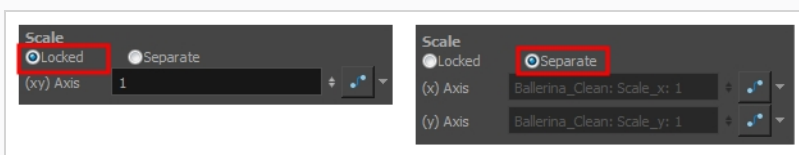

6. In the (x) and (y) Axis fields, type in a new coordinates corresponding to the desired position

- Use the Function  buttons to create function curves and add keyframes to animate the parameter.
- In the Rotation section, Angle z field, type in a degree value for the rotation angle. Note that you can enter values greater than 360 and -360 degrees. If you enter 720, the object will rotate twice.

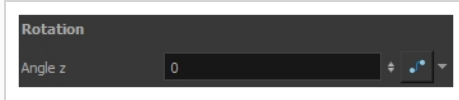

- In the Skew field, type in a degree value between -90 to 90 for the skew angle.

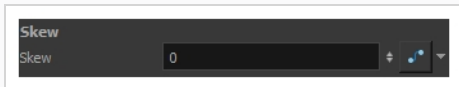

- In the Pivot section, type in the desired coordinate value to reposition the transformation pivot. This will change the permanent position of the pivot.

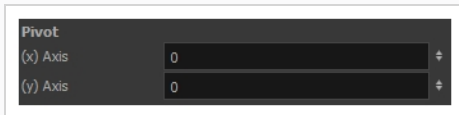





For detailed information on the Layer Properties parameters, see the Reference guide .

About Selection Locking

You can prevent correctly positioned layers from being selected in the Camera view by locking them in the Timeline view. This is useful for making a multiple selection inside the Camera view while avoiding to select them. Once a layer has been locked, its locked state will be remembered the next time you open a saved project.

You can perform five types of locking actions on your layers:

- The Lock  option lets you lock Locks one or a multiple selection of layers.
- The Unlock  button lets you unlock Unlocks one or a multiple selection of locked layers.
- The Lock All  option lets you lock Locks all the layers in the Timeline view.
- The Unlock All  button lets you unlock Unlocks all the layers in the Timeline view.
- The Lock All Others  button lets you lock Locks every layer except the selected ones.

Locking Layers

You can perform five types of locking actions on your layers. You will still be able to modify locked layers in the Timeline and Layer Properties views, but you will not be able to select them through the Camera view.

How to lock a layer or a selection of layers

1. In the Timeline view, select one or more layers.

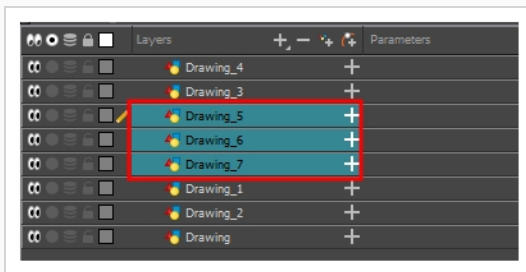

2. Do one of the following:
 - From the top menu, select **Animation > Lock > Lock**.
 - Click one of the selected layer's Lock  icon.
 - Press Ctrl + Alt + L (Windows/Linux) or ⌘ + Alt + L (macOS).

All selected layers are locked.

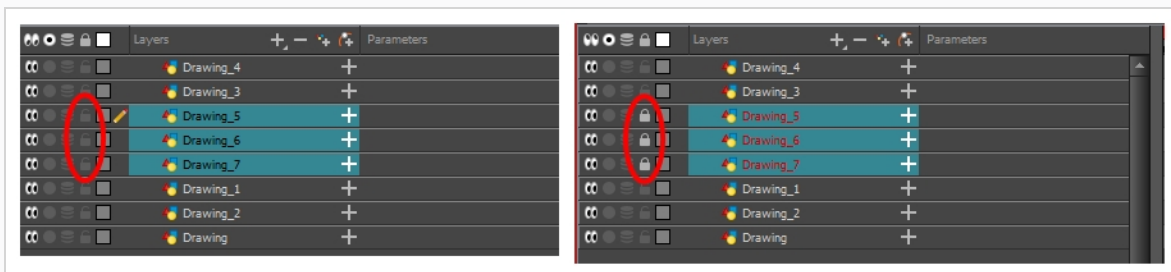

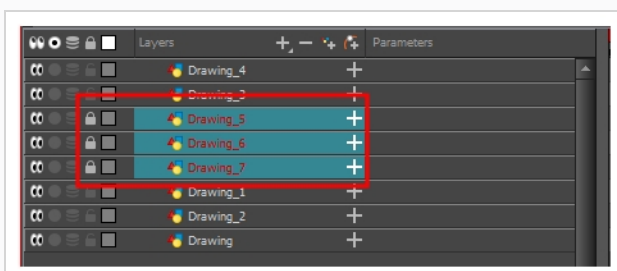

How to unlock a locked layer or a selection of locked layers

1. In the Timeline view, select one or more locked layers.



2. Do one of the following:

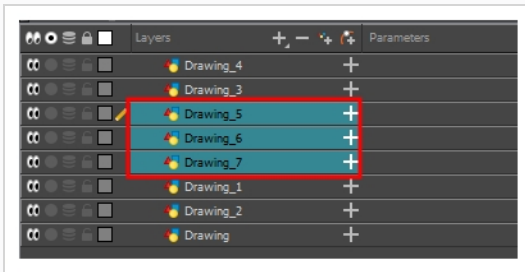

- From the top menu, select **Animation > Lock > Unlock**.
- Click a selected layer's Lock  icon.
- Press Ctrl + Shift + K (Windows/Linux) or  + Shift + K (macOS).

All selected layers are unlocked.



How to lock all layers

1. Do one of the following:

- From the top menu, select **Animation > Lock > Lock All**.
- In the Timeline view, select all layers and click Lock  icon of a selected layer.
- Press Ctrl + Shift + L (Windows/Linux) or  + Shift + L (macOS).

All layers are locked.

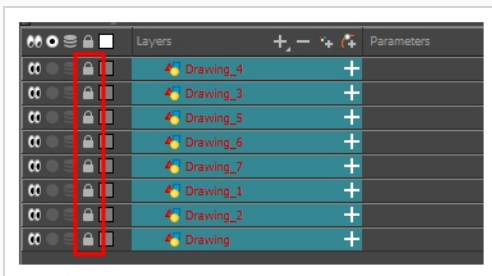

How to unlock all layers

1. Do one of the following:

- From the top menu, select **Animation > Lock > Unlock All**.
- In the Timeline view, select all layers (locked) and click Lock  icon of a selected layer.

- Press **Ctrl + Alt + Shift + L** (Windows/Linux) or **⌘ + Alt + Shift + L** (macOS).

All layers are unlocked.

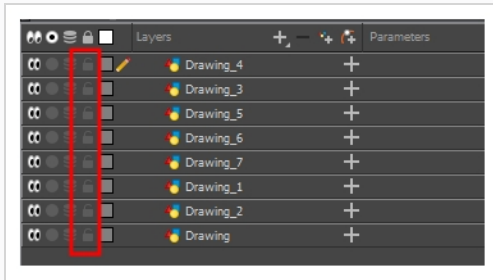

How to lock all other layers

1. In the Timeline view, select the layers you do not want to lock.

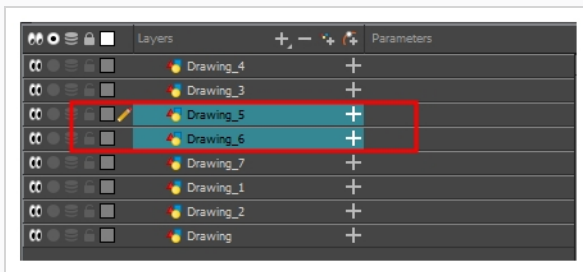

2. Do one of the following:
 - From the top menu, select **Animation > Lock > Lock All Others**.
 - Press **Ctrl + Alt + Shift + O** (Windows/Linux) or **⌘ + Alt + Shift + O** (macOS).

All layers are locked except the selected ones.

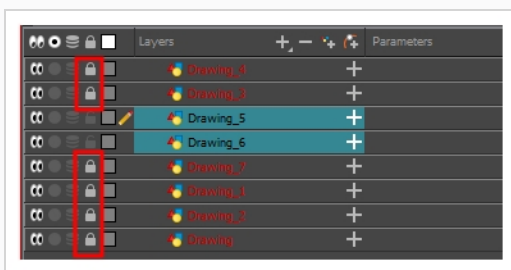

How to display locked drawings as outline

1. In the Camera View bottom toolbar, enabled the Outline Locked Drawings  option.

2. You can also set this option as a permanent preference. From the top menu, select **Edit > Preferences** (Windows/Linux) or **Harmony Essentials > Preferences** (macOS).
3. In the Preferences dialog box, select the **Camera** tab.
4. In the Tools section, select the **Show Locked Drawings As Outlines** option.

Setting the Auto-Apply Option

If you want to always work in Auto-Apply mode, you can deselect the Auto-Apply option in the Preferences dialog box (General tab). Then, each time you start Harmony, the Auto-Apply mode will be off. You must click the Apply button to see any modifications.

How to enable or disable the Auto Apply option

- From the top menu, select **Edit > Auto-Apply**.



How to enable or disable the Auto-Apply preference

1. In the top menu, select **Edit > Preferences** (Windows/Linux) or **Harmony Essentials > Preferences** (macOS).

The Preferences dialog box opens.



2. In the Preferences dialog box, select the **General** tab.
3. In the Options section, select or deselect the **Auto Apply** option.

Resetting Transformations

You can easily reset layers to their original position. With the Reset command, you can return the value of a selected element to the initial value of the active tool. For example, if the Rotate  tool is active, the transformation angle will be reset to 0 and if the Transform  tool is active, the all transformation parameters values will be reset.



When selecting elements in the Camera view using the Transform tool, always make sure that the Peg Selection Mode  is deselected in the Tool Properties view. Otherwise, it will limit the selection to pegs only.

How to reset the transformation on the current frame

1. In the Tools toolbar, select the Transform  tool or any Advanced Animation  tool.
2. In the Timeline view or directly in the Camera view, select the drawing layer(s) to reset.
3. From the top menu, select **Animation > Reset** or press R. This will reset the current frame if keyframes were created.

The selected layer(s) return to their original position.

How to reset all transformations on the current frame

1. In the Tools toolbar, select the Transform  tool or any Advanced Animation  tool.
2. In the Timeline view or directly in the Camera view, select the drawing layer(s) to reset.
3. From the top menu, select **Animation > Reset All** or press Shift + R.

The selected layer(s) return to their original position.

How to completely reset the layers' parameters

1. In the Tools toolbar, select the Transform  tool or press Shift + T.
2. In the Timeline or Camera view, select one or more drawing layers to reset.
3. Do one of the following:
 - Right-click the selected layers and select **Clear All Values**. This will remove all keyframes and reset all values for the entire layer.
 - In the Timeline View menu, select **Layers > Clear All Values**. This will remove all keyframes and reset all values for the entire layer.

The selected layers return to their original position.

About Opacity and Transparency

Harmony has two ways of adding transparency to your scene:

- The **Opacity** parameter is a parameter each drawing layer. It is set to 100% by default. By lowering it, you can make an individual layer appear more transparent.
- The **Transparency** effect is an effect layer that can be attached to individual layers or to a group. It has a Transparency parameter that is set to 50 by default. The higher it is, the more transparent the layer or group it is attached to will appear.

It is important to know when to use either approach. For example, to make a character composed of several layers transparent, it is preferable to put the character's layers in a group and add a Transparency effect to the group, as reducing the opacity of individual layers will make their overlapping parts visible—see [About Groups on page 622](#).

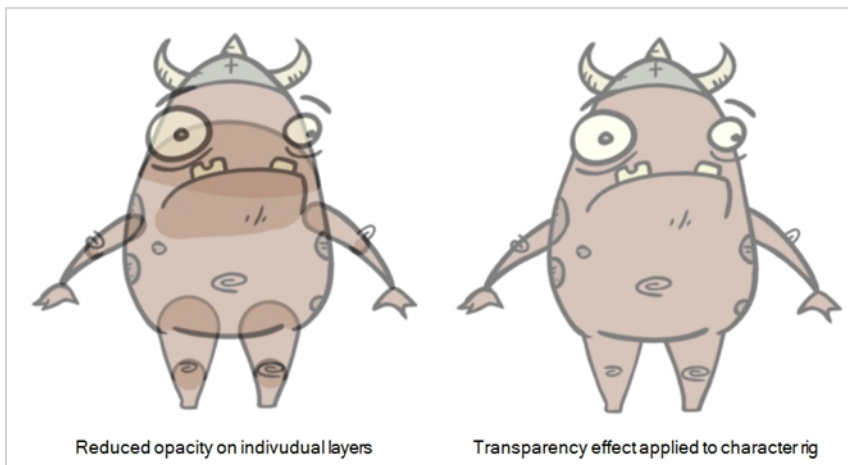

If you need to animate the transparency of elements in your scene, it is possible to animate the opacity of individual layers by creating a function for the layer's opacity parameter, which you can do from the Advanced tab of the Layer Properties view. However, this may be impractical as a layer's opacity parameter cannot be animated in the Timeline view. You can only animate it by opening the Function Editor from the Layer Properties—see [Creating Functions on page 514](#).

A layer's opacity parameter is static. If you need to animate the transparency of elements in your scene, you must use a Transparency effect, as the value of its transparency parameter can be animated. To learn how to add and animate an effect, see [Adding Effects Layers on page 689](#) and [Animating an Effect on page 697](#).

Setting the Layer Opacity

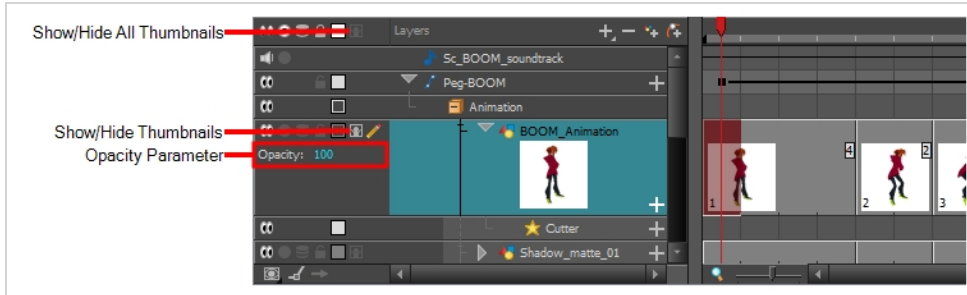

If you need specific layers to appear semi-transparent, you can quickly set a drawing layer's opacity parameter directly in the Timeline view.

A drawing layer's opacity parameter will appear in the Timeline view when this drawing layer has thumbnails display enabled:



How to set a drawing layer's opacity

1. In the Timeline view, do one of the following:

- Left of the layer's name in the Layers list, click on the Show Thumbnails  icon.
- Select the drawing layer and press T.
- Left of the Layers list header, click on the Show All Thumbnails  icon.

The Opacity parameter is displayed left of the drawing layer's thumbnail.

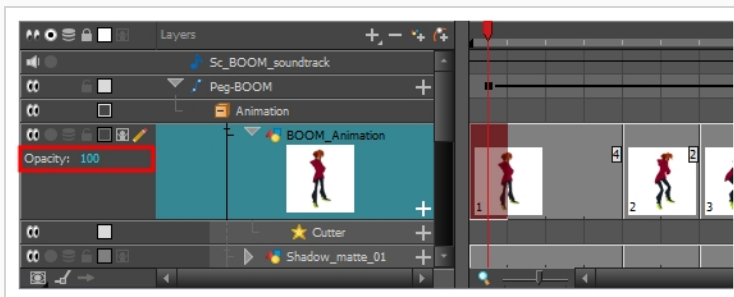

2. Do one of the following:

- Double-click on the value of the Opacity parameter and type in its new value.
- Click and drag the value of the Opacity parameter to the left to reduce it, or to the right to increase it.

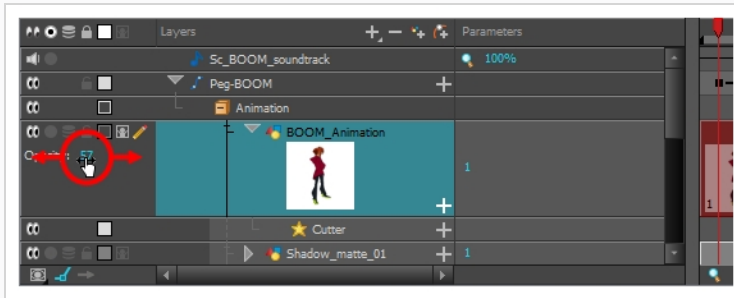

About Multiplane

T-HFND-008-013

One of the most exciting features in Harmony is the multiplane or Z-depth. In the multiplane, you can create backgrounds in several layers, spread them on the Z-axis to add depth, and then move the camera through this environment to create an impressive perspective illusion.



In live action, when the camera moves around in a scene, objects near the camera will appear to move by a greater distance than objects far from the camera. In 2D animation, multiplanes can be used to achieve a similar effect without having to use 3D.



In Harmony, a multiplane can be easily achieved by creating a scene's background over several layers, and positioning them at different depths relative to the camera.

Before creating a multiplane, make sure you have a proper understanding of the environment in which your scene happens. Picture what your scene's background would be like in 3D, then image the camera moving through the space, and how the objects in the picture move at different speeds depending on where they are in relation to the camera lens.

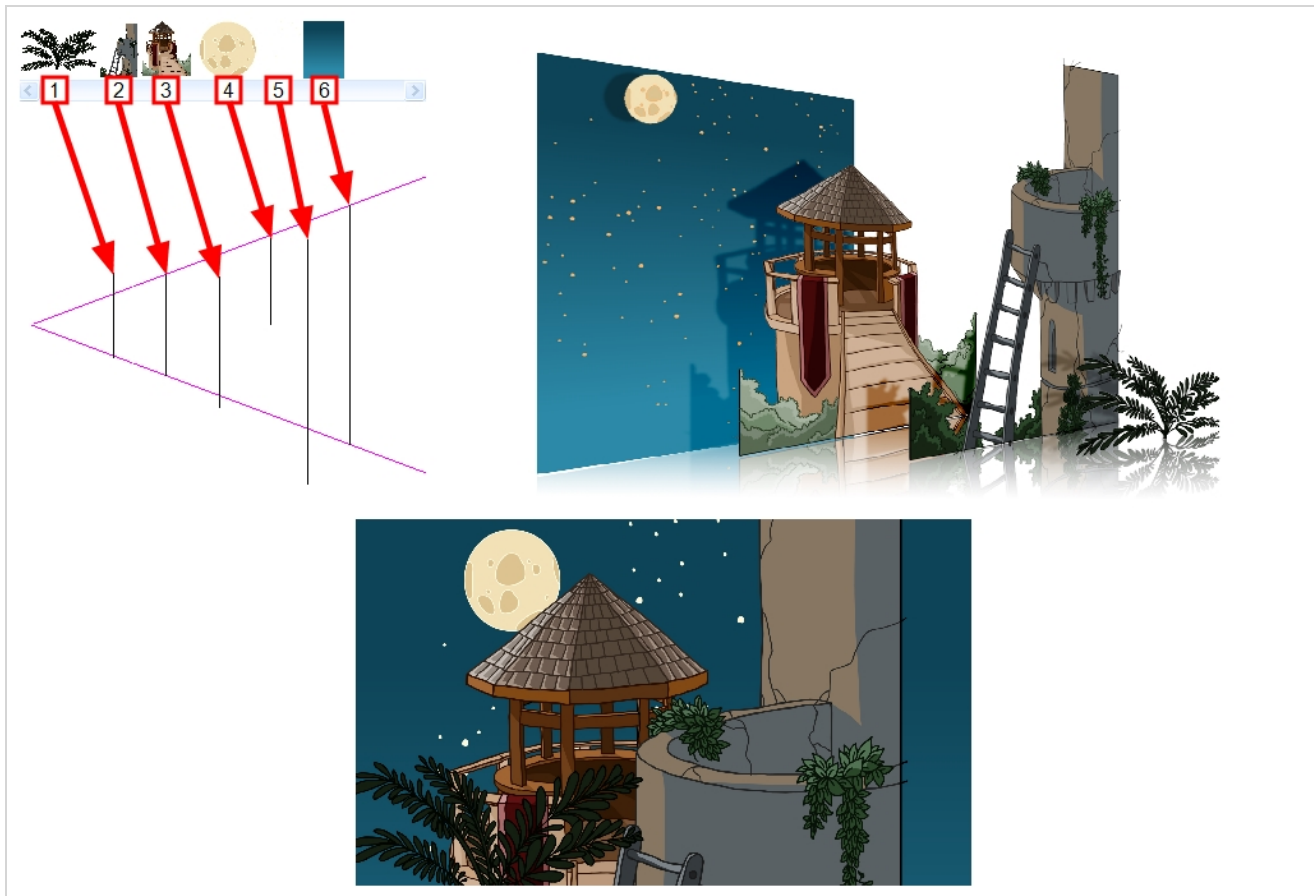
In the following example, the background is made of 6 different layers, each picturing an object that is at a different distance from the camera. On the left, you can see how each object is positioned relative to the camera, as if you were looking at them from the side. On the right, you can see how layers are positioned relative to each other as if you were looking at the scene from a corner. Below, you can see the scene from the camera's point of view.

**NOTE**

When creating a multiplane background, it is important to draw each layer fully. Even if some parts of a background layer is hidden behind a foreground layer in the camera's initial position, panning or zooming the camera may expose parts of background layers that are not initially visible.

In order to move a layer further from or closer to the Camera, you must change its position on the Z-axis. You can do this by moving a layer using the Transform Tool  in the Side or Top views. You can also move a layer on Z-axis directly from the Camera View by holding Alt and dragging the layer up or down. Positioning your element closer to the camera makes them appear bigger, and moving them further makes them appear smaller. It is also possible to move elements on the Z-axis without affecting their apparent size by using the Maintain Size  tool in the Advanced Animation toolbar.

It is a good idea to keep a Camera view open to see what your scene looks like while positioning elements in the Top and Side views.

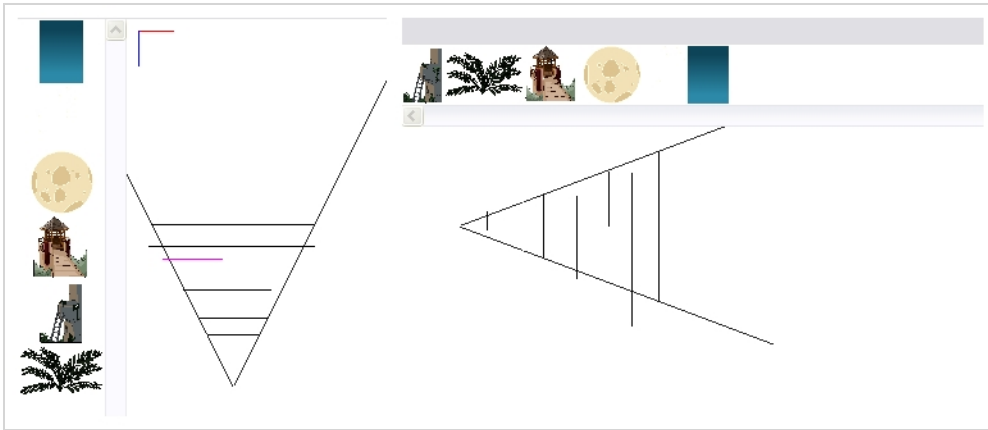

NOTE

Just like with other transformations, transformations on the Z-axis on a parent layer will also affect the apparent position on the Z-axis of its child layers. Therefore, a child layer's apparent position on the Z-axis can be affected by any of its parents.

Setting Up Multiplanes

T-HFND-008-017

You can setup your elements as a multiplane to create a parallax effect when moving your camera. You simply need to spread and scale the objects on the Z-axis.

How to rotate a scene in the Perspective view

1. In the Tools toolbar, select the Rotate View  tool.
2. Click in the view, and drag the cursor around to rotate the view or press and hold Ctrl + Alt (Windows/Linux) or ⌘ + Alt (macOS) and click and drag to rotate the view one axis at a time.

How to set up a multiplane

1. To maintain the visual scale in the Camera view as you move your element, do one of the following:
 - In the Advanced Animation toolbar, select the Maintain Size  tool.
 - From the top menu, select **Animation > Tools > Maintain Size**.
 - Press Alt + 6.
2. In the Side or Top view, select one of the layers in the thumbnails section. You can also select a layer from the Timeline view.

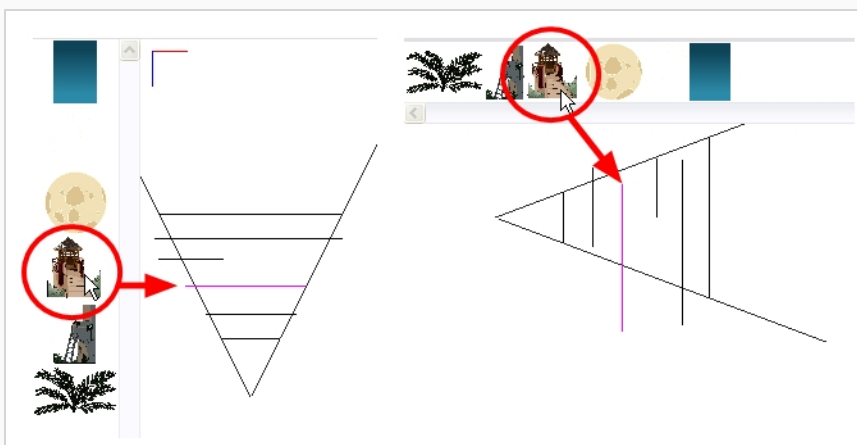

The selected layer is highlighted in the Top, Side and Camera views.

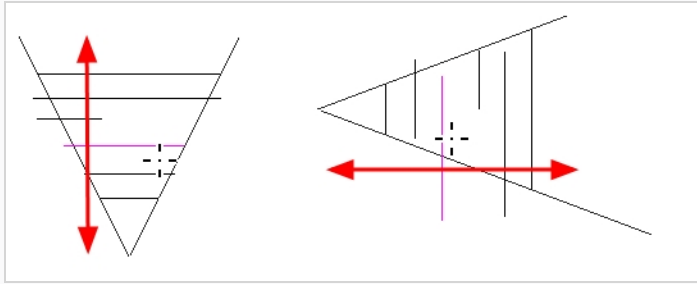

3. Drag the layer to the correct depth position in the camera cone. Your element aspect will remain the same in the Camera view.



4. For your element to scale up or down in relation to their distance to the camera, do one of the following:

- In the Tools toolbar, select the Transform  tool. Make sure the Peg Selection Mode  option is disabled in the Tool Properties view.
- In the Advanced Animation toolbar, select the Translate  tool and select a layer from the thumbnails section of the Top or Side view.
- Select a layer from the Timeline view.

The selected layer is highlighted in the camera cone.

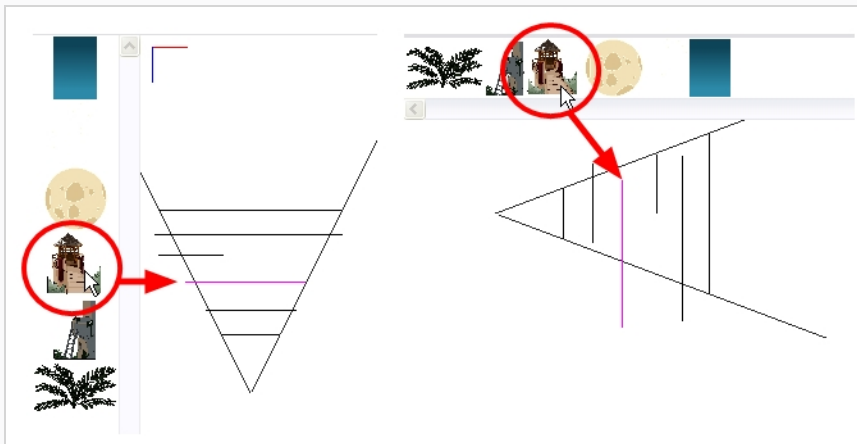

5. In the Top view, drag the element sideways to position it horizontally. Hold Shift while dragging the element to make sure it only moves along the X-axis.
6. In the Side view, drag the selected element up or down to position it vertically. Hold Shift while dragging the element to make sure it only moves along the Y-axis.

About Clone and Duplicate Layers

At times, you will need to create a large group of characters such as a crowd, school of fish or flock of birds. You can do this by cloning or duplicating a layer. The difference between cloning and duplicating is that a clone uses the same drawings for all layers. A duplicated layer is simply an independent copy.

If you want to maintain the ability to modify drawings and propagate the changes through all layers, you should clone your layer. If you simply want to copy your layers and be able to modify your drawings without affecting the original layer, use the duplicate option.

About Clone Layers

A cloned layer is linked to the original element directory. If a drawing is modified in the original or cloned layer, both will be updated. However, cloned layers can have different timings.

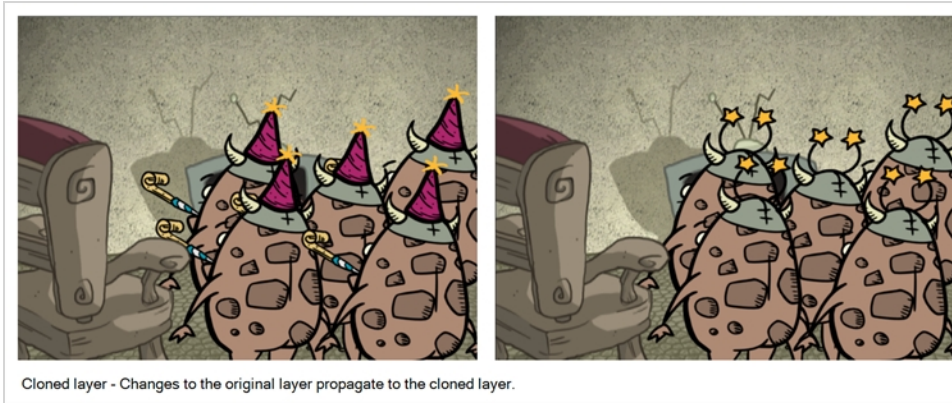

When cloning layers, you have the ability to clone the drawings and the corresponding columns (timing) or only the drawings. If you choose to clone the drawings and timing, your node will be linked to the same element folder, as well as the same drawing and function columns. Therefore, if you change the drawing exposure or keyframe on one layer, all cloned layers will be updated.

You may want to create a large group of characters reusing the same animation, but want to slightly offset the timing so they're not dancing or walking quite on the same beat. For example, if you create a walk-cycle for a soldier and want to use it for an entire army, you may want to have 50 layers with 50 different drawing exposures to produce a slight difference in the timing. If you copy your layers and drawings 50 times over, it will create a heavier scene. It is better to clone the 50 layers with only their drawings without linking to the same timing (function and exposure columns).

Cloning Layers

You can clone layers in several ways. Cloned layers use the same drawings.

How to clone a layer

1. In the Timeline view, select a layer to clone. You can select multiple layers.
2. Do one of the following:
 - From the top menu, select **Edit > Clone Drawings Only** or **Edit > Clone Drawings and Timing**.
 - In the Timeline view, right-click on the layers and select **Clone Selected Layers: Drawings Only** or **Clone Selected Layers: Drawings and Timing**.

The cloned layer appears.

About Duplicate Layers

T-HFND-006-013

You can duplicate a layer to have a copy of the drawings that are independent from the original ones, as well as an independent timing (exposure). When you need the drawings to be modified independently, you will want to duplicate the layer instead of cloning it.



Duplicated layer - Changes to the original layer do not propagate to the duplicated layer.

Duplicating Layers

T-HFND-006-014

You can easily duplicate layers. Once duplicated, the layers are completely independent. Drawings are also duplicated.

How to duplicate a layer

1. In the Timeline view, select one or more layers.
2. Do one of the following:
 - In the Timeline view, right-click on the layers and select **Duplicate Selected Layers**.
 - From the top menu, select **Edit > Duplicate**.

The duplicated layer appears.

Displaying Port Tooltips

You can display any port tooltips by clicking on a port or connecting a cable.

How to display a port's tooltip

1. In the Node view, hover the pointer over a port.

The port's tooltip displays source and destination information.

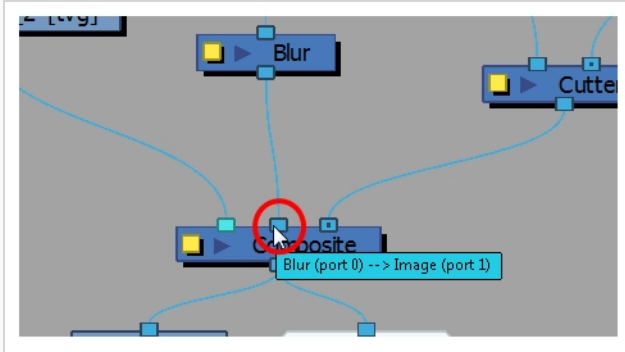

2. Click on any port to display the port type label. The label will also display as you connect cables into ports.

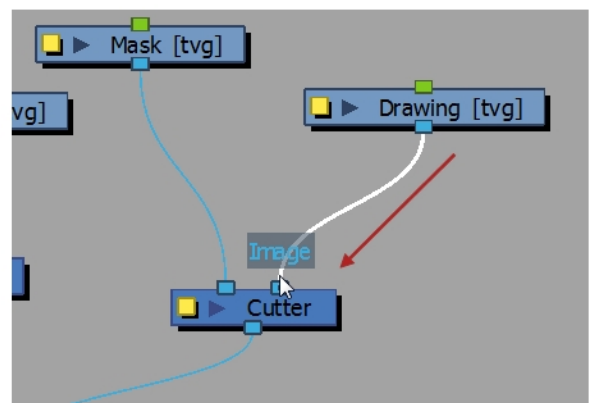
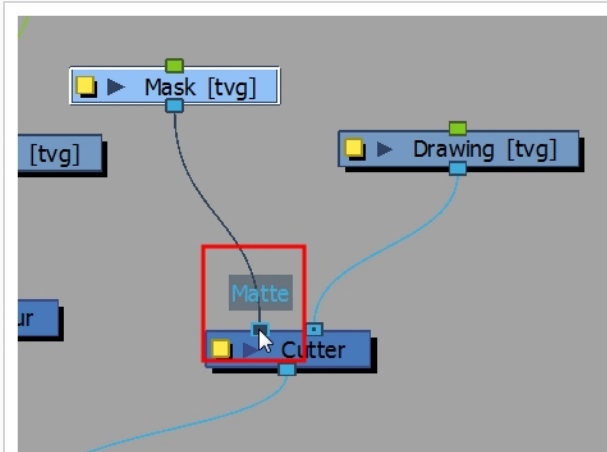

About Peg Nodes

The Peg nodes control the transformation of elements (position, scale, skewing and rotation) over time. The green ports at the top and bottom of the node indicate that it accepts transformation information which can be passed on (inputs and outputs transformation information).

One peg can be used to control many different nodes or one node can accept more than one peg. In a situation like the latter, one peg might be used to modify the rotation, while the other is used to modify the position of the effect and then animated differently over time.

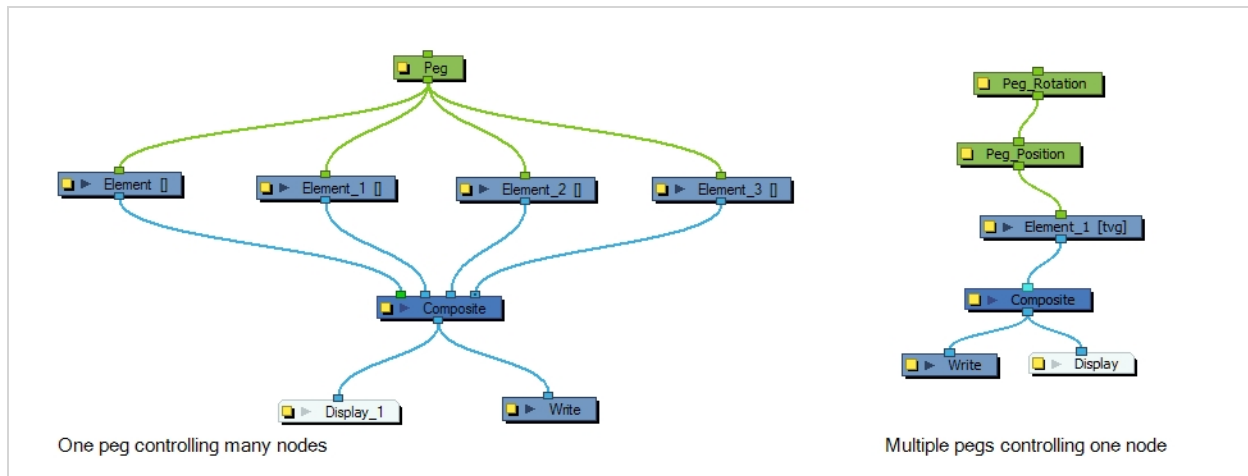

Connecting and Disconnecting Nodes

You can connect nodes by dragging cables from output ports to input ports. You can disconnect nodes by pulling on the cable connections.

How to connect nodes

1. In the Node view, do one of the following:

- Extend a cable from the first node's output port (bottom port) and connect it to the second node's input port (top port).
- Select the node to connect, hold down the Alt key and drag the node on an existing cable.

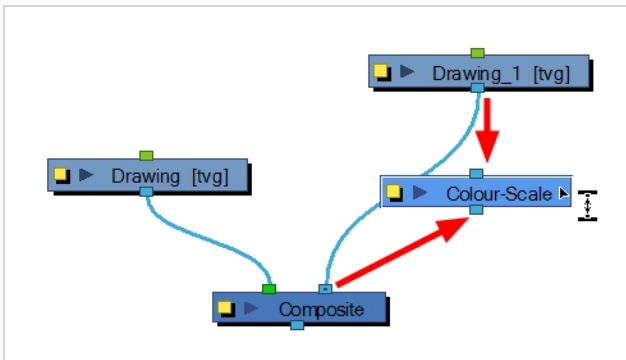

It is possible to create links between nodes in the Node view by clicking on one node and Ctrl-clicking (Windows) or ⌘-clicking (macOS) on a second port.

Select a node and Ctrl-click (Windows) or ⌘-click (macOS) a port:

- Click a node and then Ctrl-click (Windows) or ⌘-click (macOS) the input port of a different node. The nodes are linked.
- Click the output port of a node, and then Ctrl-click (Windows) or ⌘-click (macOS) a different node. The nodes are linked.
- Click the output port of a node, and then Ctrl-click (Windows) or ⌘-click (macOS) a Composite node. The node is linked to a new input port of the Composite.
- Click a port of a node and then Ctrl+ Alt-click (Windows) or ⌘+ Alt-click (macOS) port of a Composite node. The selected port replaces the link in the Composite's input port.
- Click an output port of a node and then Ctrl-click (Windows) or ⌘-click (macOS) the input port of a Group node. The selected output port replaces the link to the group.
- Click an output port of a node and then Ctrl+ Alt-click (Windows) or ⌘+ Alt-click (macOS) the input port of a Group node. The selected output port links to a new in-port of the group.

**NOTE**

You can reconnect a node's output port without disconnecting its destination port by dragging the connect from the output port to another output port while holding Ctrl (Windows/Linux) or ⌘ (macOS).

How to disconnect nodes

1. In the Node view, select the node to disconnect, hold down the Alt key and drag the node away. You can also pull on the connection cable.

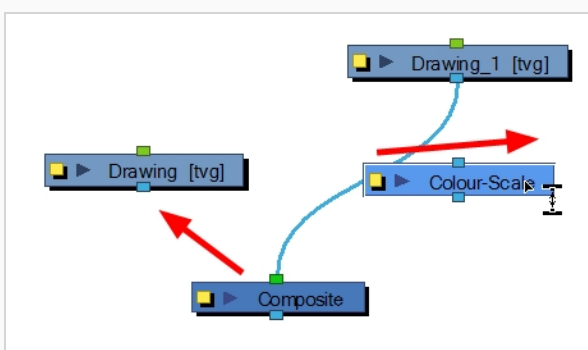

About Groups

When working with complex rigs, you may want to group layers together to avoid cluttering the Timeline view and keep your layers organized.



Groups can also be useful if you need to apply the same effect to several layers at once. For example, if transparency is applied to each individual layer making a character rig, the seams between its body parts will become visible. Instead, grouping all of the rig's layers together, and adding a Transparency effect to the group will make Harmony compose the layers inside the group together before applying the effect.

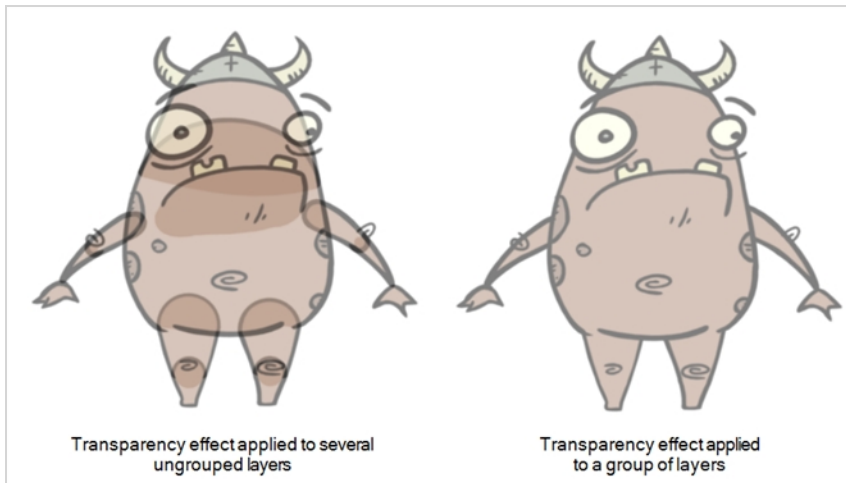

Grouping Layers

You can group your nodes to keep your work organized.

How to group layers

1. In the Timeline view, select the elements you want to group.

Any layers between the selected layers will be automatically grouped as well, so if the stacking order does not matter, move extra layers above or below the layers want to group.

2. Do one of the followings:

- Right-click on the highlighted layers and select **Group Selection**.

The layers appear indented under a new Group layer in the Timeline view.

Chapter 12: Cameras

T-HFND-009-001

Harmony contains a camera that can move along the X, Y, and Z axes. Having the camera move on the Z-axis offers the possibility to create truck in and truck outs, as well as multiplane camera moves. The default camera position is centred and backed up to 12 fields.

It is important to understand the coordinate values in Harmony, which is based on the origins of animation. In traditional animation, a scene's size and camera motion are calculated in fields. A field has a 4:3 ratio and measures 0.5 inches (12.7 mm) in width. A specific grid has been created for this purpose known as a *field chart*. Harmony uses this unit of measurement as its coordinate system.

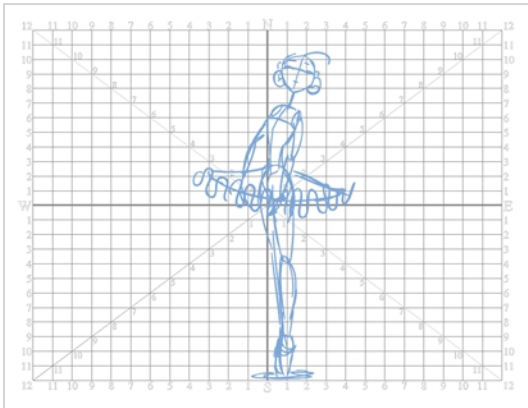

A field chart uses the cardinal directions. The X axis is the east-west (left-right) direction, the Y axis is the north-south (up-down) direction and the Z axis is the forward-backward direction.

The scene action occurs inside the camera frame, so it's really important to set it up correctly. You can adjust the camera resolution and other parameters in the Scene Settings window.

By default, a scene does not have a camera layer. In order to be able to tweak the camera's angle and position, you must add one to your scene. Although it is possible to have several cameras in the same scene, you can only view your scene using one camera at a time. This can be useful if you are still working on your scene composition and have different camera framing to try out.

The Camera layer is static which means that if you need to animate it, you must put it under a parent peg.

You can reposition your camera frame directly in the Camera view, using the advanced animation tools. Another way to set up your camera frame is to type the coordinates directly in the camera's properties. Doing this positions the camera precisely where you want it to be rather than gauging it visually.

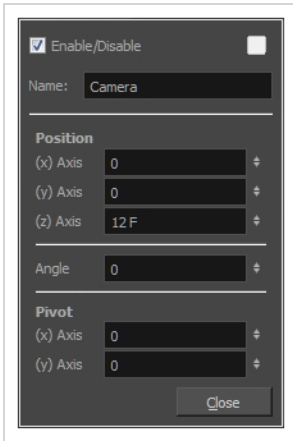

Adding a Camera

T-HFND-009-002

By default, there is no camera in the scene. The frame visible in the Camera view is only a reference based on your project's resolution. In order to position your camera, you must add one to your scene.

How to add a camera in the Timeline view or Top menu

1. Do one of the following:
 - In the Timeline view, click the Add Layer **+** button and select **Camera**.
 - From the top menu, select **Insert > Camera**.

A new camera layer is added to the scene and appears in the Timeline view.

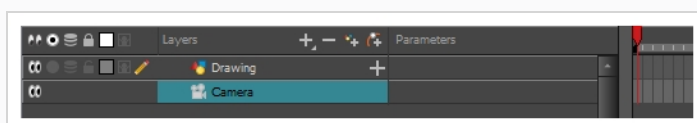

Selecting the Active Camera

T-HFND-009-003

You can add multiple cameras to your scene, but only one can be active at a time. You can select your active camera from the Camera list.



How to select the active camera from the Camera list

1. From the top menu, select **Scene > Camera > camera**.

Positioning the Camera Frame

You can grab the camera frame and move it around in the Camera view. You can also setup the camera position by entering coordinates and values in the Layer Properties view.

How to reposition the camera frame in the Camera view

1. In the Tools toolbar, disable the Animate  mode.
2. Do one of the following:
 - From the top menu, select **Animation > Tools > Translate**.
 - In the Advanced Animation toolbar, click the Translate  tool.
 - Press Alt + 2.
3. In the Camera view, click on the camera frame (thin rectangle) to select it. You can also select the camera layer from the Timeline view.

The selected camera frame is highlighted.

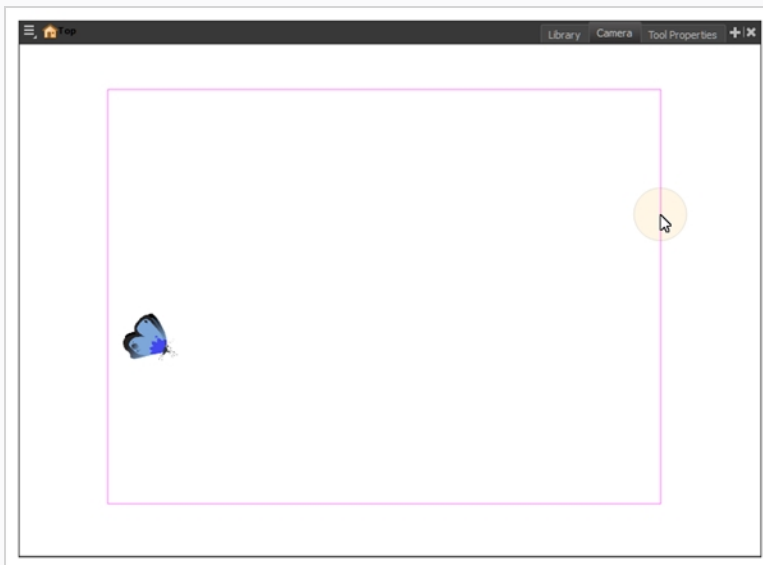

4. Drag the camera frame to a new position.

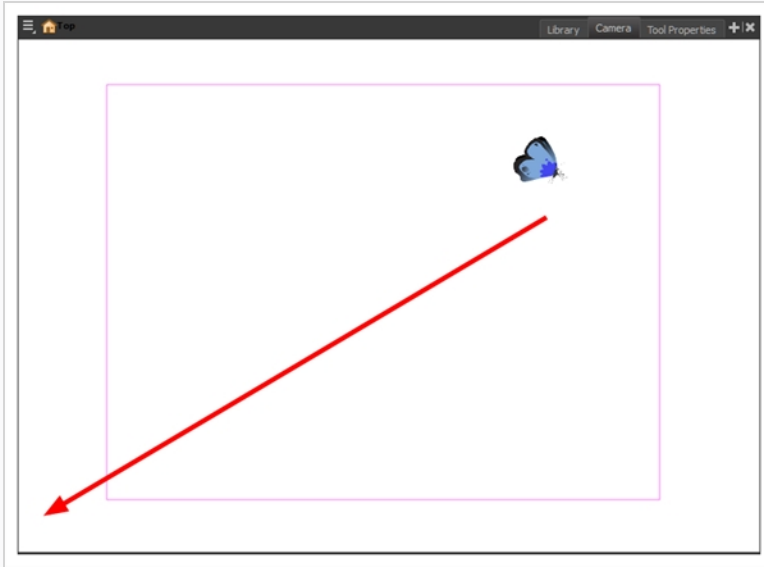

5. To tilt the camera frame, do one of the following to select the Rotate tool:
 - From the top menu, select **Animation > Tools > Rotate**.
 - In the Advanced Animation toolbar, select the Rotate  tool.
 - Press Alt + 3.
6. In the Camera view, drag to rotate the camera frame until it reaches the desired rotation angle.

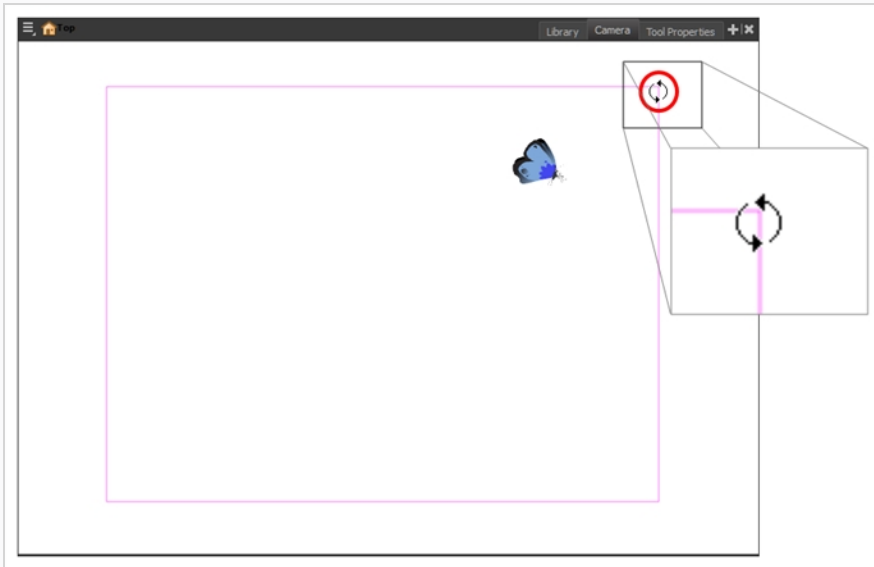

7. To move the camera frame closer to or further away from the scene, do one of the following to select the Scale tool:
 - From the top menu, select **Animation > Tools > Scale**.

- In the Advanced Animation toolbar, select the Rotate  tool.
- Press Alt + 4.

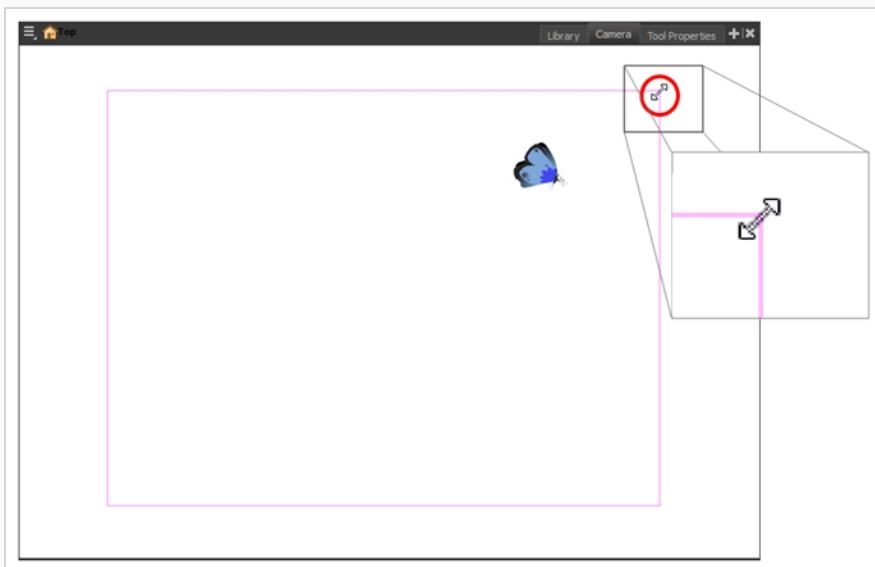
**NOTE**

The Transform tool can also be used to move the camera, but not to rotate or scale it.

How to set up the camera frame using the Layer Properties view

1. In the Timeline view, select the camera layer.
2. In the Layer Properties view, adjust the camera's properties.

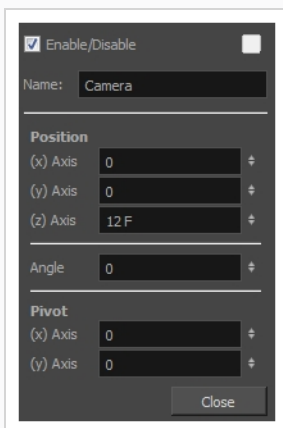



3. Type or use the numeric stepper to adjust the coordinate and angle values—see the Reference guide .

Resetting the Camera Position

You can easily reset the camera to its original position. Using the Reset command, you can reset the value of the selected element to the initial value of the active tool. For example, if the Rotate tool is active, the transformation angle will be reset to 0 and if the Transform tool is active, then all parameters values will be reset.

How to reset the camera position

1. In the Tools toolbar, select the Transform  tool or press Shift + T. If you want to reset a single parameter, select the corresponding Advanced Animation tool, such as the Rotate  tool.
2. In the Timeline or Camera view, select the camera layer.
3. From the top menu, select **Animation > Reset** or press Shift + R.

The camera automatically returns to its original position.

Animating the Camera

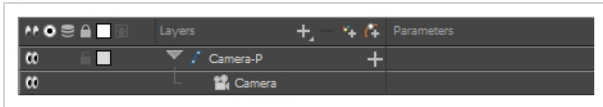

T-HFND-009-009

A scene's camera can be manipulated and animated just like any other layer. It is listed in the Timeline view and you can use the same tools and selection modes to offset or animate it. However, the camera layer itself is static, which means it keeps the same position and angle throughout the whole scene. In order to be able to animate the camera, you need to connect it to a peg layer, which can be animated, and which will directly affect the position and angle of the camera.



You can animate your camera movements directly in the Camera view. Alternatively, you can use the Side or Top views, which can be especially useful when animating a camera in a multiplane scene, where each layer is positioned at a different distance from the camera.

How to animate the camera

1. In the Tools toolbar, enable the Animate  mode.
2. In the Tools toolbar, select the Transform  tool or press Shift + T.
3. In the Timeline view, select the Camera layer.

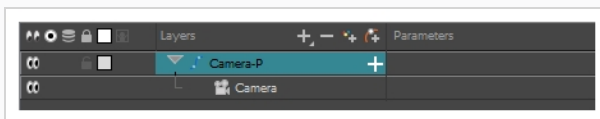

4. From the Layers toolbar, click the Add Peg  button.

A Peg layer appears directly above the Camera layer and is automatically attached to it. The new Peg layer takes the name of the camera layer with the suffix **-P** added to indicate that it is its Peg layer.

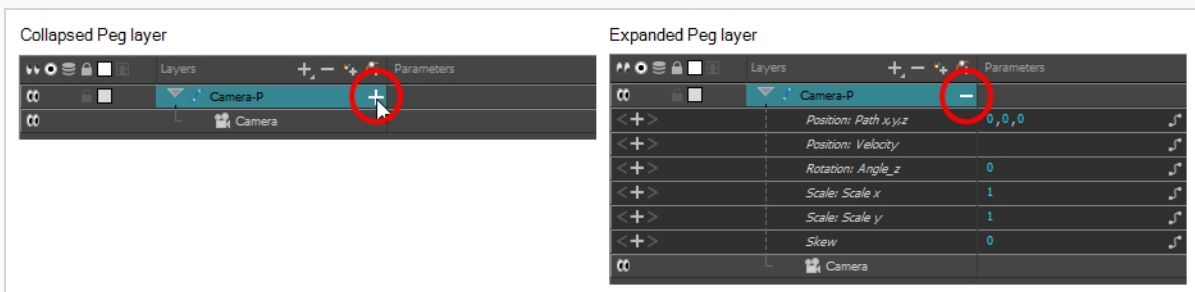

5. On the right side of the Timeline view, on the Camera Peg layer, select the frame at which you want the camera movement to start.

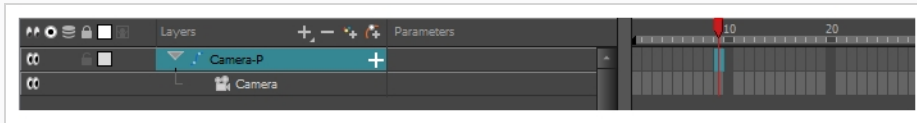

6. Do one of the following to add a keyframe:

- In the Timeline toolbar, click the Add Keyframe  button.
- Right-click and select **Add Keyframe**.
- Press F6.

A keyframe appears in that cell. Any frames preceding this keyframe cell will hold the same camera position as this keyframe.



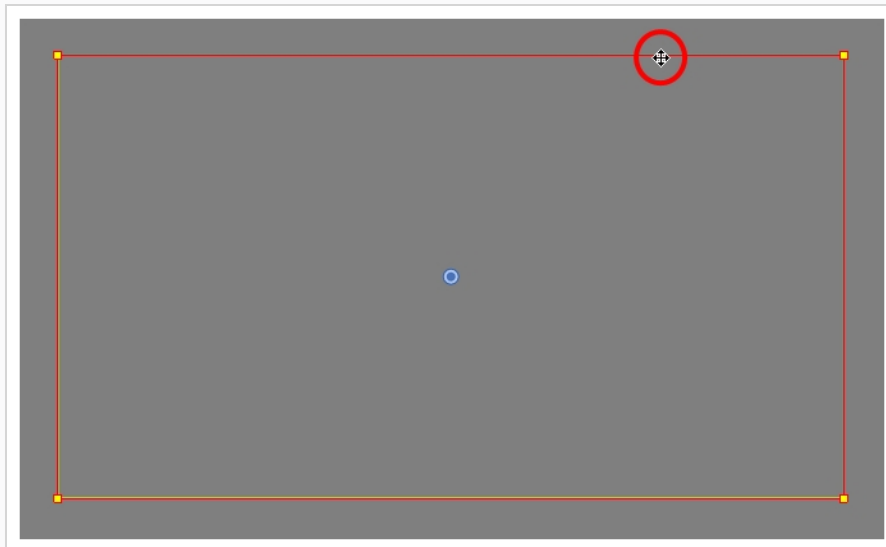

7. Do one of the following to move the camera:

- In the Camera view, select the Camera, which is now be represented by a thin yellow rectangle with a red highlight, and move it to the desired position.



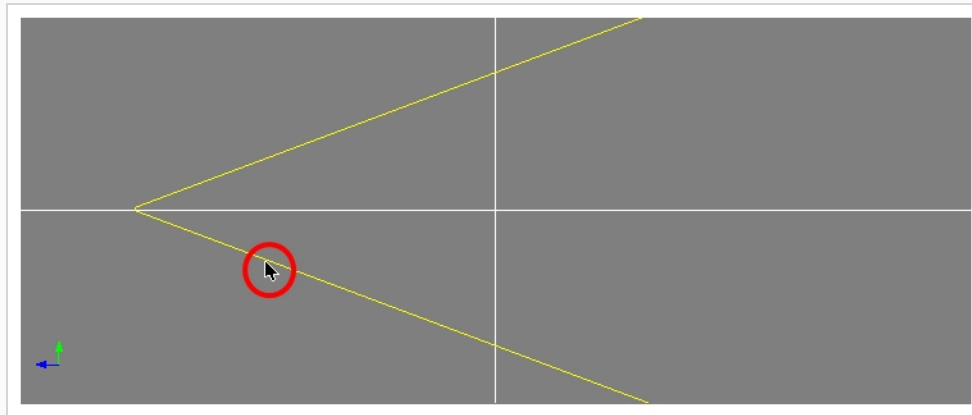

- In the Top or Side view, select the camera, which is now represented by a large, yellow V-shaped cone, and move it to the desired position.

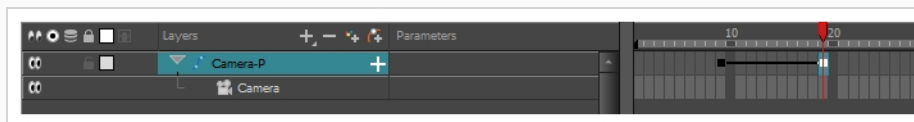

8. On the Timeline view, click on the cell where the camera movement will end.
9. Do one of the following:
 - In the Timeline toolbar, click the Add Keyframe  button.
 - Right-click and select **Add Keyframe**.
 - Press F6.

A keyframe appears in that cell.



10. Select the camera in the Camera, Top or Side view and move it to the desired position.
11. In the Timeline view, select the first frame to rewind to the beginning of your animation.
12. In the Playback toolbar, click on the Play  button to preview your animation.

Chapter 13: Import

Toon Boom Harmony allows you to import external content as well as being able to draw directly in the software. This means that characters, backgrounds and videos created in other drawing, painting and multimedia programs can be brought in and animated. You can import QuickTime videos, pictures, multilayered .psd files, as well as .ai, .swf, .pdf, and .fla files. You can also scan images and import them as bitmap or vectorize them.



NOTE

For sound import, refer to [Importing Sound](#) on page 726.

About Importing Bitmap Images

T-HFND-007-001

Images can come in many different file formats and are usually saved in a format that retains the original specifications set by the image creator. Some formats can preserve the transparency or transparent layers, while others are not resolution dependent due to their vector nature. Toon Boom Harmony supports the following bitmap image formats: JPEG, BMP, PNG (16 bits per channel RGB and RGBA), TGA, PSD (16 bits per channel), TIFF, SGI, TVG, OMF, PAL, SCAN.



When importing a bitmap image, you must decide how Harmony must process it. You can choose between the following options:

- **Import as Bitmap:** This imports the image exactly as is and ensures that it cannot be modified when working on the scene. This is useful for using backgrounds that were created in different software in your project.
- **Vectorize:** Converts a bitmap into Toon Boom vector art, which can easily be painted and edited using Harmony's vector drawing tools. This can be useful for importing line art scanned or created using a different software.

When importing images, the settings used to import are saved in your user settings.

Importing Bitmap Images As Original Bitmap

T-HFND-007-002

Importing a bitmap image in its original format ensures it is preserved exactly as is in Harmony. When importing a bitmap image, you have several options available such as where you want to import the file and how to name it.

How to import a bitmap image in its original format

1. Do one of the following:
 - From the top menu, select **File > Import > Images**.
 - In the File toolbar, click the Import Images  button.
 - In the Xsheet view, right-click anywhere in the frame area and select **Import > Images**.

The Import Images dialog box opens.

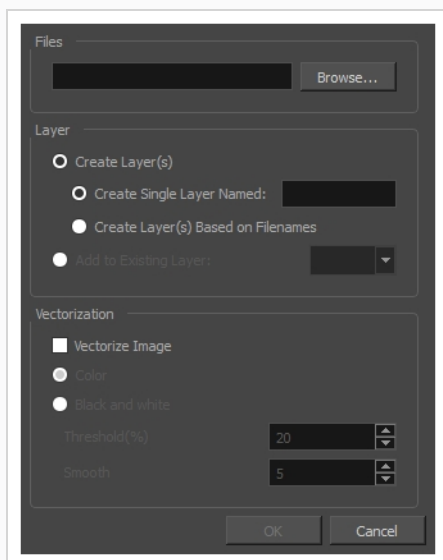

2. In the Files section of the Import Images dialog box, click **Browse** to find and select one or more images on your computer.
3. Add the bitmap image to a new layer by selecting the **Create Layer(s)** option and one of the following options:
 - **Create Single Layer Named:** Creates a new layer with the specified name and imports the images into it.
 - **Create Layer(s) Based on Filenames:** Creates a layer based on each unique filename prefix. For example, if you import three files named a-1.tga, a-2.tga and b-1.tga, this

will create two layers, one named "a" and one named "b". Layer "a" will contain the two first images and "b" will contain the third one.

- **Add to Existing Layer:** Imports the images into the specified layer. Note that you can only import into layers that are compatible with your import options. For example, if you're importing images as vector drawings, you can only import them into vector drawing layers.
4. In the Vectorization section, make sure the **Vectorize Image** option is unchecked.
 5. Click **OK**.

**NOTE**

By default, bitmap images will display in low resolution in the Camera view so as to avoid affecting playback performance. You can also adjust the display quality of a bitmap image by selecting it with the Transform tool, then opening the Bitmap Image Quality dialog via **View > Bitmap File Quality**. You can also preview your bitmap image in your scene's resolution by activating the Render Preview  mode in the Camera view.

Adjusting the Bitmap Image Display Quality

T-HFND-007-004

Your original bitmaps are imported as is in your project. In the Camera view, they may appear low quality as a proxy image is displayed in its place to insure fast playback.

If the bitmap images that you imported look blurry or slightly pixelated, you can increase the image proxy display by changing the quality of the preview in the Camera view. It will not affect the final render.

How to change the bitmap image quality

1. In the Camera view, double-click on the bitmap image to enter its symbol if the image is encapsulated or simply select the bitmap image layer in the Timeline view if it's not.
2. Do one of the following:
 - From the top menu, select **View > Bitmap File Quality**.
 - Press **Ctrl + Q** (Windows/Linux) or **⌘ + Q** (macOS).

The Bitmap Image Quality dialog box opens.

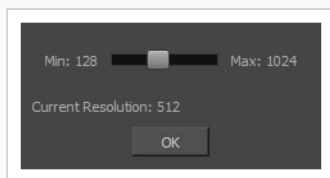

3. Drag the slider to the right to improve the quality.
4. Click **OK**.
5. If you are inside a symbol, go to the top of the Camera view and click **Top** to exit the symbol and return to your scene.

Vectorizing Images on Import

You can import bitmap images as vector drawings, which allows you to edit them using Harmony's vector drawing tools. This is especially useful to convert bitmap line art scanned or created in a different software into vector line art so it can be painted in Harmony.

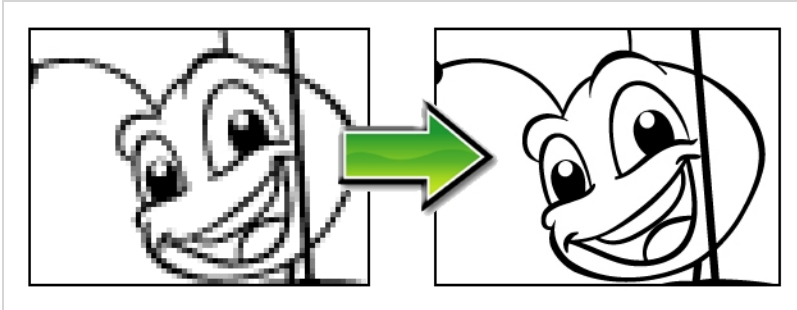

How to import and vectorize a bitmap image

1. Do one of the following:

- From the top menu, select **File > Import > Images**.
- In the File toolbar, click the Import Images  button.
- In the Xsheet view, right-click anywhere in the frame area and select **Import > Images**.

The Import Images dialog box opens.

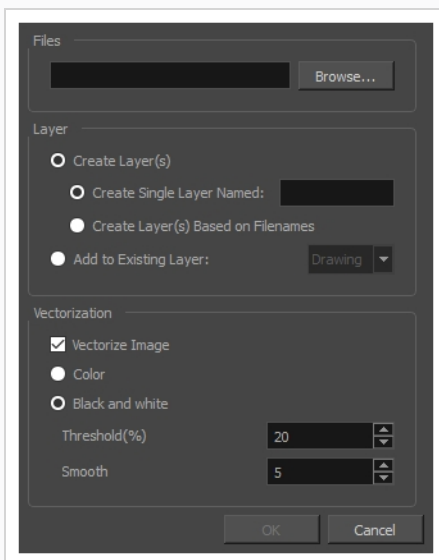

1. In the Files section of the Import Images dialog box, click **Browse** to select one or more images from your computer.

2. Select the destination for your images:
 - **Create Single Layer Named:** Creates a new layer with the specified name and imports the images into it.
 - **Create Layer(s) Based on Filenames:** Creates a layer based on each unique filename prefix. For example, if you import three files named a-1.tga, a-2.tga and b-1.tga, this will create two layers, one named "a" and one named "b". Layer "a" will contain the two first images and "b" will contain the third one.
 - **Add to Existing Layer:** Imports the images into the specified layer. Note that you can only import into layers that are compatible with your import options. For example, if you're importing images as vector drawings, you can only import them into vector drawing layers.
3. In the Vectorization section, select the **Vectorize Image** option.
4. Select one of the following options:
 - **Colour:** Imports bitmaps as vector objects with their image as a bitmap texture. The resulting drawing can be drawn or erased over, but not repainted or tweaked.
 - **Black and White:** Vectorizes drawings with a solid black line. This creates a 100% vector-based drawing and paints it with the Vectorized Line colour swatch from your scene's palette.
5. If you selected the Black and White option, set the following parameters:

Parameter	Description
Threshold	Determines what values in the scanned image will be considered as part of the drawing, and what will be ignored and eliminated in the vectorized drawing. The lower the value, the darker the image and vice versa.
Smooth	Determines how smooth the lines will be. The lower the value, the more detail will be retained. The higher the value, the more polished and easy to edit the lines will be.

6. Click **OK**.

Your vectorized images will appear in their selected destination.

Importing Multi-layer PSD Files

T-HFND-007-003

PSD files (a format exportable exclusively from Adobe Photoshop) are unique in that they are able to retain multiple layers. This is advantageous as the image remains fully editable in terms of any colour correction, effects, masking, transparency, or compositing that were made to the **.psd** file in Adobe Photoshop. Harmony supports 8 and 16 bit files.



NOTE

Note that your **.psd** image file must be set to RGB mode within Adobe Photoshop prior to being imported into Harmony.

How to import a multi-layer PSD file

1. In Adobe Photoshop, organize your file so that all your layers are “grouped” into individual folders, or that all the elements you want to import as a single layer in Harmony are grouped together in their own folder. Any layer that is not in a folder group, by itself or otherwise, will not be imported.

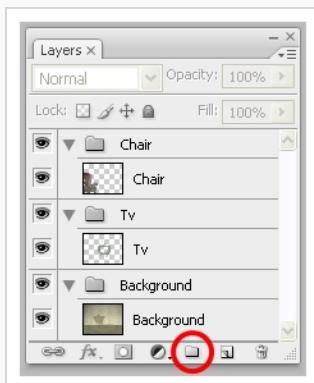

2. In Harmony, go to the top menu and select **File > Import > Images** or click the Import Images  button.

The Import Images dialog box opens.

3. In the Files section, click **Browse** to find and select the **.psd** image on your computer.
4. In the Layer section, select the **Create Layer(s)** option, then select one of the following options:
 - **Create Single Layer Named:** Creates a new layer with the specified name and imports the images into it.
 - **Create Layer(s) Based on Filenames:** Creates a layer based on each unique filename prefix. For example, if you import three files named a-1.tga, a-2.tga and b-1.tga, this will create two layers, one named "a" and one named "b". Layer "a" will contain the two first images and "b" will contain the third one.
 - **Add to Existing Layer:** Imports the images into the specified layer. Note that you can only import into layers that are compatible with your import options. For example, if you're importing images as vector drawings, you can only import them into vector drawing layers.
5. In the Import Options section, select the following option to import your image as its original format.
 - **Keep As Original Bitmap:** Retains an imported image as a bitmap. In the Alignment section, decide on the size and placement of your image within the camera frame. Depending on the Scene Settings (the height and width in pixels that you chose for your project), an image that you import may get scaled to the point where all its individual pixels become visible.
6. Decide whether to select **Vectorize Imported Items** option.
7. Click **OK**.

The Multilayer Image Import Settings dialog box opens.

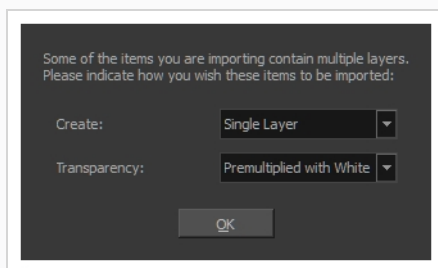

8. From the Create menu, select one of the following:
 - **Single Layer:** To import the Camera and Layout layers merged together.
 - **Separated Layers:** To keep your Camera and Layout layers separated.
9. From the Transparency menu, select one of Alpha option.
10. Click **OK**.

Your image appears as separate layers in the Timeline view, corresponding to the PSD layer group folders.



NOTE

The artwork displayed in every one of your layers as a result of a multilayer PSD file import is linked to the same source image. This means that if you use the **Drawing > Delete Selected Drawings** command to physically delete the drawing from the project folder, the exposed drawing will be deleted in all layers at once. Once deleted from the project folder, the image cannot be retrieved unless you reimport your psd file.

About Importing Vector Files

T-HFND-007-005

You can import AI (Adobe Illustrator) and PDF files into Toon Boom Harmony to convert your files to the Toon Boom format (TVG) and create a colour palette based on the colour settings of the original file.

When importing AI and PDF files:

- RGB is supported, CMYK is not.
- Gradients and textures are not supported.
- Only legacy versions of Adobe Illustrator are supported. Exported SWFs, including Actionscript 2 and Actionscript 3, cannot be imported.
- When importing an Illustrator or PDF file in Toon Boom Harmony, by default the file will be imported as separate layers. The import will use the Illustrator file's top level groups as separate layer names. However, you can change this behaviour by deselecting the PDF/Illustrator Import as Separate Layers option, to import your file as a single layer .

If a project was started in Adobe Flash and needs a more professional boost, such as camera movements or multiplaning, it can easily be imported into Harmony.

The actual *.fla file is not supported in Harmony, so you must export your project from Adobe Flash.

Importing Adobe Illustrator (.ai) files and Portable Document Files (.pdf)

T-HFND-007-006

You can import vector Adobe Illustrator (.ai) files as well as Portable Document Files (.pdf) through the Library view and File menu. Make sure to have the rights to modify your Library folder and that the colours in your file are encoded in RGB.

How to import an .ai or .pdf file

1. In the Library view, right-click on the Stage Library folder and select **Right to Modify** to unlock the library folder. Make sure the Lock icon disappears from the folder. If not, your library will remain locked and you will not be able to import files.
2. Do one of the following:
 - In the top menu, select **File > Import > SWF, Illustrator Files to Library**.
 - Right-click on any unlocked folder and select **Import Files**.

The browser window opens.

3. Find and select your AI or PDF file in the Import Files dialog box and click **Open**.

The Rename dialog box opens.

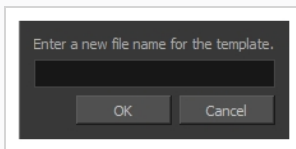

4. Type in a name for the new template or keep the name of the original AI or PDF file.
5. Click **OK**.

A new template folder is created in the Library view.

6. Drag the new template folder from the Library view to the left side of the Timeline view. Wait until the copy cursor  appears before releasing the folder.

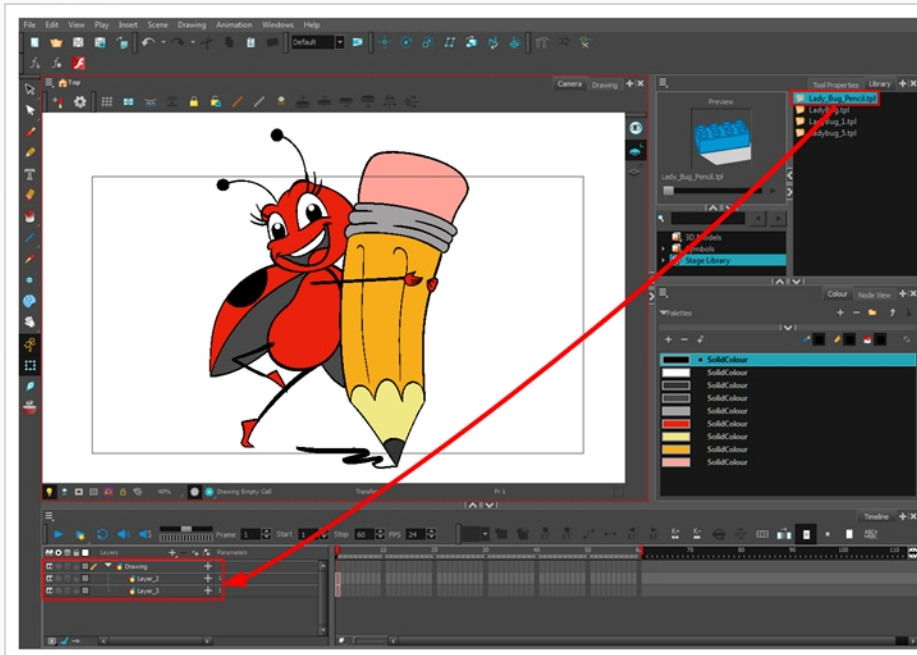

The message window opens.

7. The colour recovery dialog box appears, requesting that a colour recovery should occur. Before clicking the Yes button, you have the option of selecting the **Do Not Ask Again For This Session** option if you plan to import multiple .ai or .pdf files.

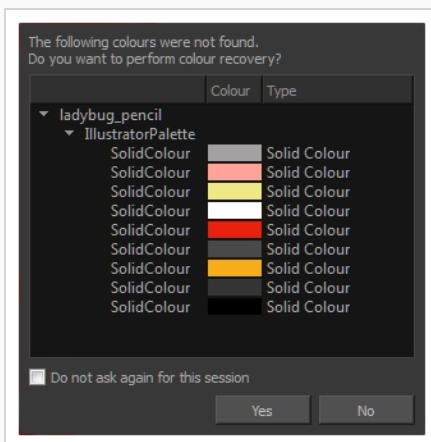

The colour palette used to create the .ai or .pdf file is imported and a new palette is created under the imported file's name.

Importing Flash Movies (.swf)

You can import Flash (.swf) files in Harmony exported for any version of Flash Player up to version 14.



IMPORTANT

Some effects are not supported when imported from Flash movies into Harmony.

How to import a SWF file

1. In the Library view, right-click on the Stage Library folder and select **Right to Modify** to unlock the library folder. Make sure the Lock icon disappears from the folder. If not, your library will remain locked and you will not be able to import files.
2. Do one of the following:
 - In the top menu, select **File > Import > SWF, Illustrator Files to Library**.
 - Right-click on any unlocked folder and select **Import Files**.

The browser window opens.

3. Find and select your .swf file from the Import Files dialog box and click **Open**.

The Rename dialog box opens.

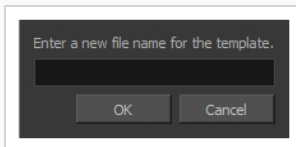

4. Type a name for the new template or keep the name of the original *.swf file.
5. Click **OK**.

A new template folder is created in the Library view.

6. Drag the new template folder from the Library view to the left side of the Timeline view. Wait until the copy cursor  appears before releasing the folder.

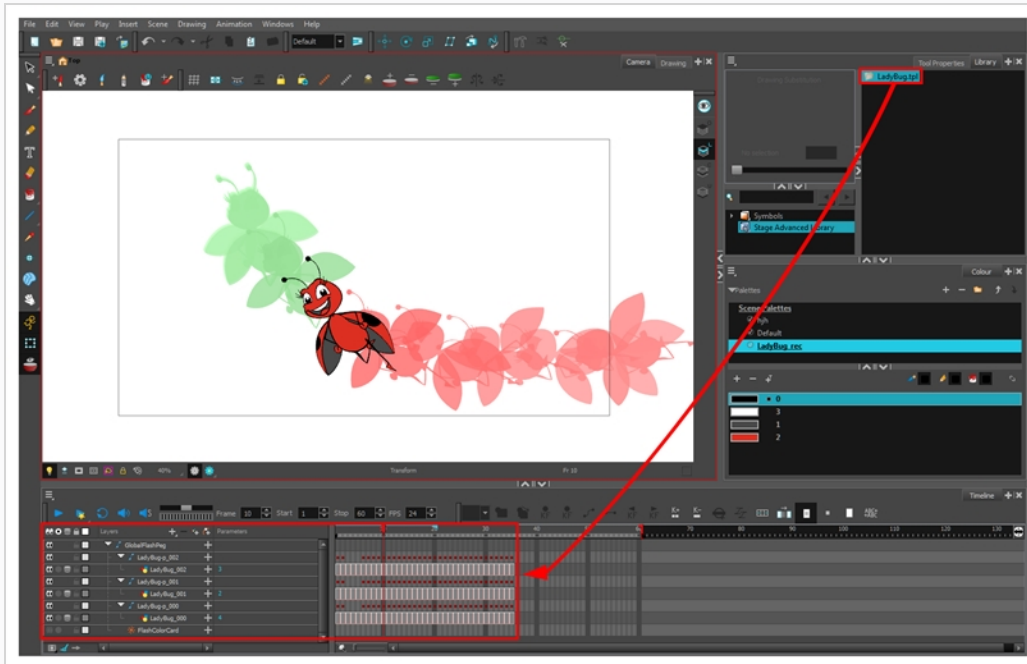

- The colour recovery dialog box appears, requesting that a colour recovery should occur. Before clicking the Yes button, you have the option of selecting the **Do Not Ask Again For This Session** option. This might be useful if you plan to import multiple *.swf files.

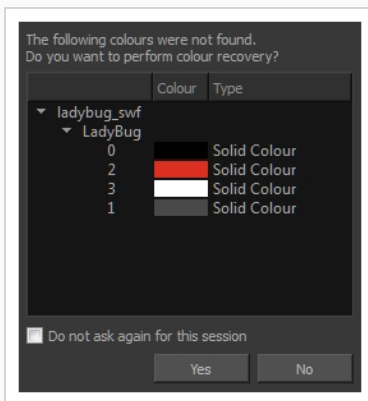

The colour palette used to create the .ai or .pdf file is imported and a new palette is created under the imported file's name.



NOTE

All the Flash layers are automatically attached to a parent peg called GlobalFlashPeg. **DO NOT DELETE THIS PEG.** To maintain the look of your movie, it's important not to delete this peg or detach its child layers.

The Adobe Flash file layers appear in the Timeline view. Symbols that were created in Flash become regular drawing layers, but can be reconverted into symbols in Harmony. Symbols within symbols or drawings within symbols collapse into their corresponding parent symbol.



NOTE



Some layers in your .swf movie may be combined in a single layer as a result of optimization enhancements in your movie file. You can easily move these elements back onto separate layers.

In addition, all drawing elements that are dynamically linked to the Toon Boom Harmony file are grouped together in one folder. In our example, this means that when you scroll through the Drawing Substitution preview in the Library view, the different hand, leg, tentacles, antennae, torso and facial positions are all organized together.

Distributing SWFs to Layers

In some instances, due to an optimization enhancement in the exported SWF file (CS4), some of the layers might be combined as a single layer. If so, you can quickly redistribute these elements onto individual layers again.

How to distribute to layers

1. In the Tools toolbar, click the Select  tool.
2. In the Camera view, select the drawing that contains elements you want to redistribute onto individual layers. To select all the elements of the selected drawing layer, press Ctrl + A (Windows/Linux) or ⌘ + A (macOS).
3. Do one of the following:
 - From the top menu, select **Drawing > Distribute to Layers**.
 - In the Tool Properties view of the Select tool, click the Distribute to Layers  button.

The number of drawing layers corresponding to the different grouped elements are created in the Timeline view. The selected elements in the original drawing layer are removed. Each element is distributed onto a new drawing layer.

4. Repeat the process for each drawing that contains elements to redistribute.

About FLA Import

You can export files from Flash and import them in Harmony to transfer character rigs, props and backgrounds.



Flash import is available on all three editions of Harmony on Windows and macOS. It is not possible to do so on GNU/Linux versions.

On the Flash side, users can work with these versions:

- Adobe Flash CS5
- Adobe Flash CS5.5
- Adobe Flash CS6
- Adobe Flash CC
- Adobe Flash CC 2014
- Adobe Flash CC 2015



NOTE

Exports from older versions of Flash are not possible.

At the scene level (top timeline), you must have a symbol, such as a movie clip or graphic. Colour shapes, shape lines, drawing objects, groups and bitmaps at the scene level won't be exported. If these elements are present, you will be prompted to perform a clean up of the scene level. For details on importing Flash files, see [Flash Export and Import Guidelines on page 672](#)

As part of preparing to import Flash files in Harmony, you must add an extension to Flash using Adobe Extension Manager—see [Installing the Export to Harmony Option on page 656](#).

It is important to use the correct version of Adobe Extension Manager:

- If more than one version of Flash is installed on your computer, be careful where you install the extension. If it's added to Adobe Extension Manager of Flash CS6, the extension will only be added in this version

and not the other.

- If you have a previous version of the extension, you must remove it first and install the latest extension—see [About FLA Import on page 654](#).

Harmony includes a script specially created to import FLA Export packages. You must add this script to your interface in order to use it—see [Displaying the Import Flash Scene Icon on page 667](#).

When you export your FLA files, a folder will be created that contains the `stage.tp1` and `export.json` files, as well as all the `.swf` and `.txt` files in your scene. The `export.json` file is used by a Harmony script to organize and construct the hierarchy from your exported files.

Once the Flash project is successfully imported into Harmony, here's how the hierarchy was constructed:

- Each symbol has its own peg in which all the transformation information is stored.
- The pivot information is stored in the peg's Layer Properties (Pivot fields). The pivot information came from the rotation point of the symbol in Flash.
- Registration point of the symbol in Flash represents the centre of the drawing space in Harmony. Therefore, the position of the drawing inside a symbol will be exactly the same in Stage.

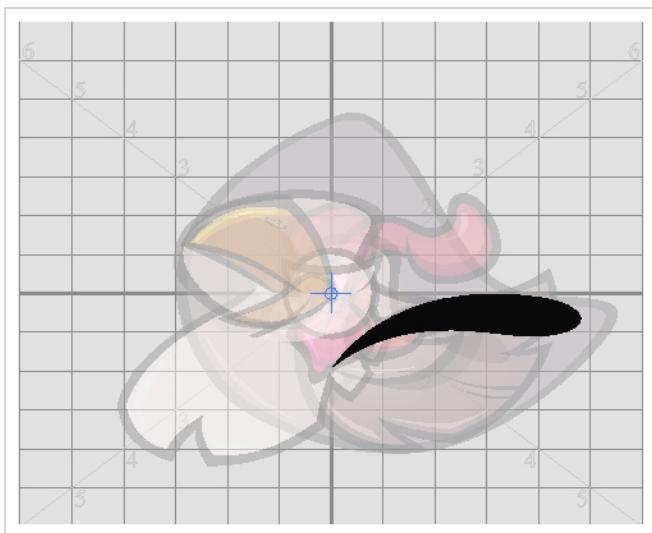

- One colour palette is created for each Flash import. One colour swatch is created per RGB value. If you have more than one zone using the same colour, they will be linked to the same colour swatch.
- If there are masks in your Flash project, they will be reconstructed in Harmony using Cutter effects. Harmony is now able to understand when more than one symbol share the same mask in Flash. Each symbol sharing the same mask will be grouped by a composite and connected to the cutter.

Installing the Export to Harmony Option

The extension is required in order for Flash to export files to Harmony. The extension is called **Export to Harmony .zxp** and is located here:

OS	Edition	Location
Windows	Premium	C:\Program Files (x86)\Toon Boom Animation\Toon Boom Harmony [version] Premium\resources\flash
	Advanced	C:\Program Files (x86)\Toon Boom Animation\Toon Boom Harmony [version] Advanced\resources\flash
	Essentials	C:\Program Files (x86)\Toon Boom Animation\Toon Boom Harmony [version] Essentials\resources\flash
macOS	Premium	Applications > Toon Boom Harmony [version] Premium > tba > resources > flash
	Advanced	Applications > Toon Boom Harmony [version] Advanced > tba > resources > flash
	Essentials	Applications > Toon Boom Harmony [version] Essentials > tba > resources > flash



NOTE

Before installing the extension, you must remove all Harmony offline and database preferences.

How to install the Export to Harmony extension

1. Launch Adobe Extension Manager.
2. In the top-right corner of the Adobe Extension Manager, click on **Install**.
An Open dialog appears.
3. In the Open dialog, browse to and select the **Export to Harmony.zxp** file, then click on Open.
A message opens informing you that you're about to install the Export to Harmony extension.
4. Click on **Accept**.
You may see the following message confirming that you want to install the extension. Click **Install**.

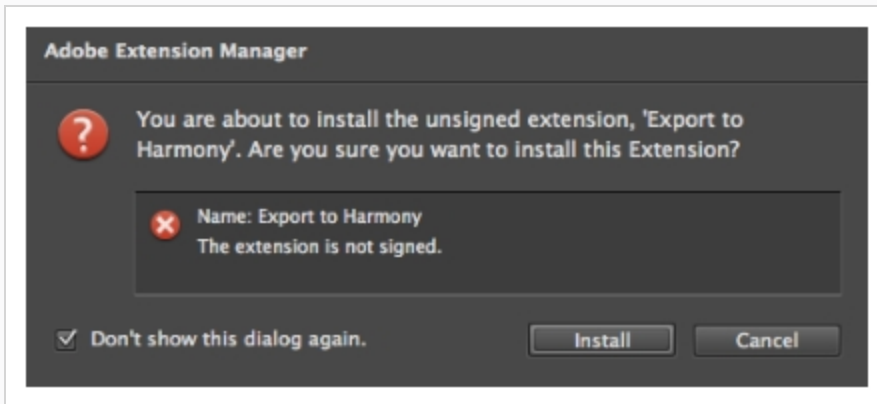

5. In order for the changes to take effect, you must close and restart Adobe Flash.
6. Click **OK**.

How to remove a previously installed Export to Harmony.zxp extension (if applicable)

1. If open, close Adobe Flash.
2. Start Adobe Extension Manager.
3. From the Products list, select **Adobe Flash**.

If you have a previous version of the **Export to Harmony.zxp** extension installed, it will be listed in the right pane.

4. Select the extension and click **Remove**.

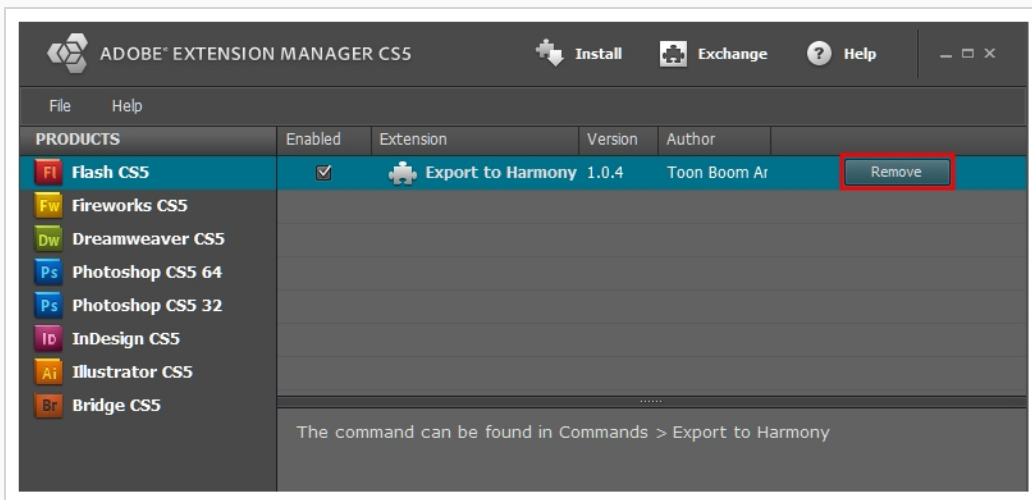

A message opens asking you to confirm the removal of the extension.

5. Click **Yes**.

Adobe has stopped maintaining and updating their Extension Manager CC, therefore, it has become difficult to install extensions. In order to link an extension from Animate CC, follow the steps below.

How to install an extension on Windows with Adobe Animate CC version 2015 and higher

1. Ensure the following software is installed:
 - Adobe Creative Cloud
 - Animate CC and Mobile Device Packaging
2. Download the ExManCmd from Adobe's website.
<https://docs.toonboom.com/go/download/ExManCmdWin>
3. Unzip the ExManCmd_win.zip package.
4. Put the ExManCmd_win folder in a safe place.



NOTE

The ExManCmd_win folder must not be deleted; this folder is necessary for installing or updating .zxp files.

5. Copy the package containing the plug-in from the Harmony installation folder to your Downloads folder:

C:\Program Files (x86)\Toon Boom Animation\Toon Boom Harmony 15.0 Essentials\resources\flash\flashexport.zip
6. Unzip the **flashexport.zip** package.
7. Open the folder containing the unzipped files.
8. Move or copy the **Export to Harmony.zxp** file directly into the ExManCmd_win folder.
9. In the ExManCmd_win folder, hold Shift and right-click to select **Open command window here**.
10. Enter the following command:

ExManCmd.exe /install <filename.zxp>
11. Press **Enter**.

If no error message displays, the extension has been installed on your computer and recognized by the Extension Manager CC.

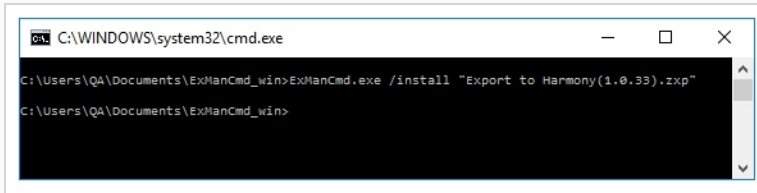

```

C:\WINDOWS\system32\cmd.exe
C:\Users\QA\Documents\ExManCmd_win>ExManCmd.exe /install "Export to Harmony(1.0.33).zxp"
C:\Users\QA\Documents\ExManCmd_win>

```

12. Open Animate CC.
13. Access Top Menu > Commands.

If the Export to Harmony option appears in the Top Menu > Commands list, your installation was successful.

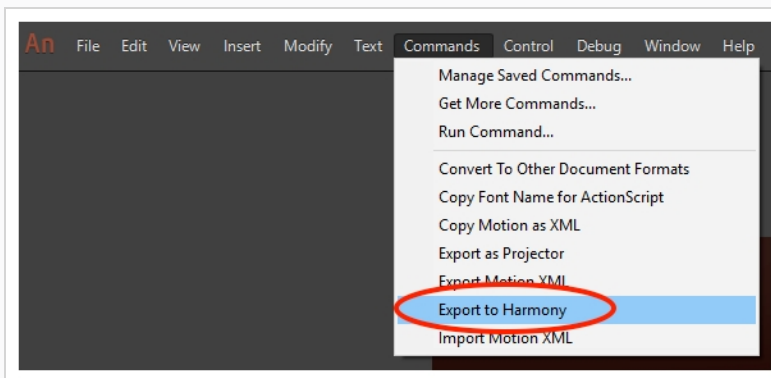

NOTE

If you have a region language other than English (US) installed on your computer, or if you have more than one language installed on your computer, Animate CC may not be able to detect in which language folder the extension has been installed. If this occurs, you will not be able to see the Export to Harmony menu option in Top Menu > Commands list. To correct this, proceed to [How to ensure Adobe detects extension files installed on your computer on page 659](#).

How to ensure Adobe detects extension files installed on your computer

1. Browse to:

C:\Users**<UserName>**\AppData\Local\Adobe\Animate **<VersionNumber>**

If Adobe detects more than one language on your computer, you will see multiple language folders in the path.

For example:

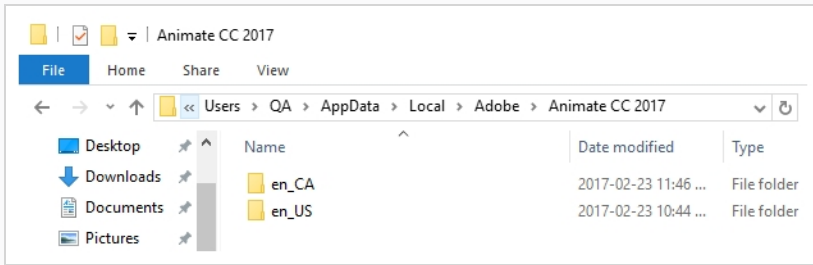

2. Look inside each folder to detect the main language used by Adobe on your computer. To do so, compare the contents of both folders.

For example, inside the en_Ca\Configuration:

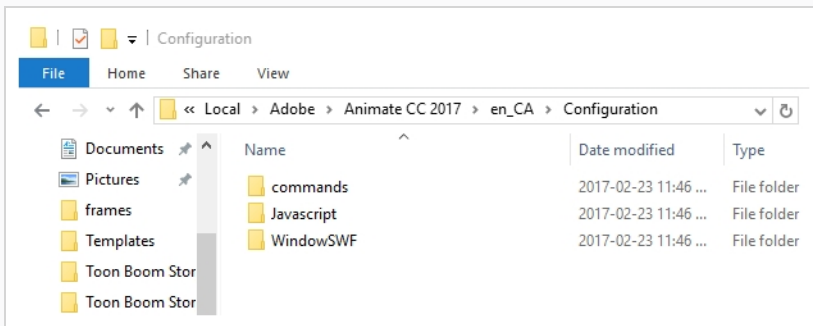

For example, inside the en_US\Configuration:

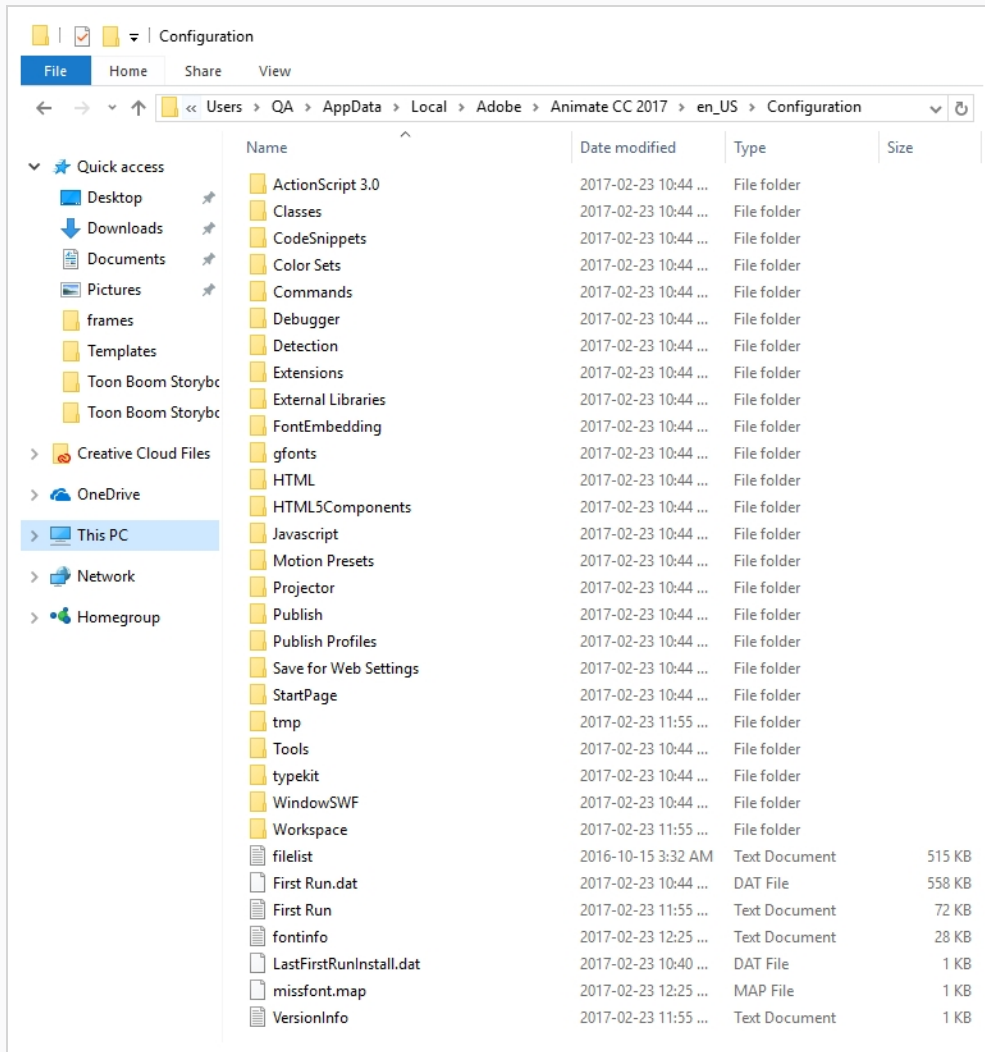

The main folder is the one with more files. In this case, Adobe is using English (US) as the main language. The folder en_CA only contains what was installed with the extension installation: commands, Javascript and WindowSWF.

3. Copy and paste the contents of the commands folder within the sub-language folder, to the commands folder within the main language folder .

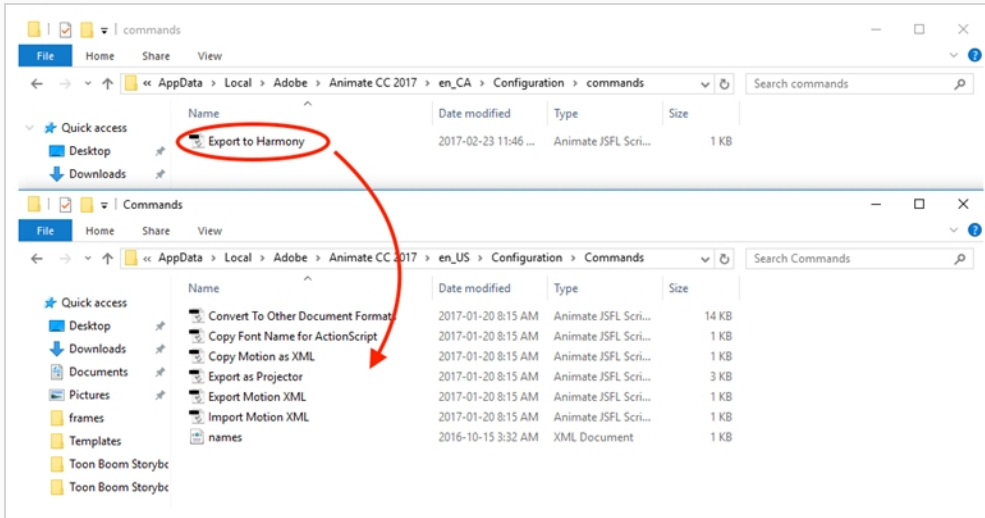

4. Copy and paste the contents of the Javascript folder within the sub-language folder, to the Javascript folder within the main language folder.

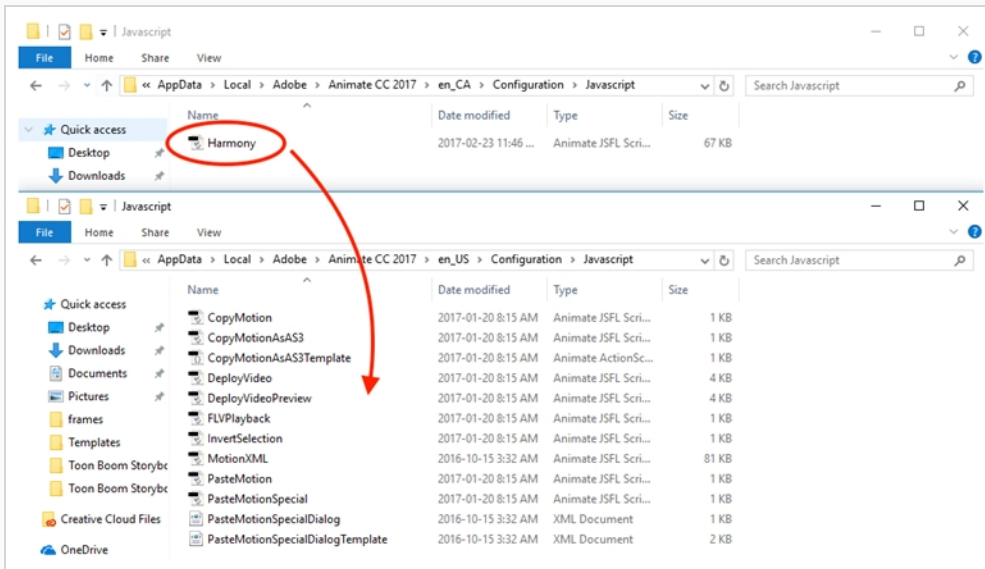

5. Copy and paste the contents of the WindowSWF folder within the sub-language folder, to the WindowSWF folder within the main language folder.

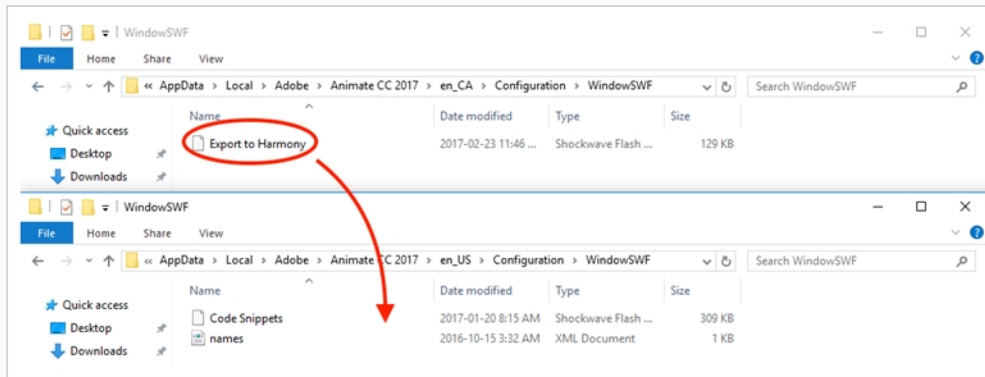

How to install an extension on macOS with Adobe Animate CC version 2015 and higher

1. Ensure the following software is installed:
 - Adobe Creative Cloud
 - Animate CC and Mobile Device Packaging

2. Download the ExManCmd from Adobe's website.

<https://docs.toonboom.com/go/download/ExManCmdMac>

3. Unzip the ExManCmd_mac file.
4. Put the ExManCmd_mac folder in a safe place.



NOTE

The ExManCmd_mac folder must not be deleted; this folder is necessary for installing or updating .zxp files.

5. Copy the package containing the plug-in from the Harmony installation folder to your Downloads folder:

```
/Applications/Toon Boom Harmony 15.0 Essentials/tba/resources/flash/flashexport.zip
```
6. Unzip the **flashexport.zip** package.
7. Open the folder containing the unzipped files.
8. Move or copy the **Export to Harmony.zxp** file directly into the ExManCmd_win folder.
9. Drag and drop the .zxp file directly into the ExManCmd_mac folder.
10. In Terminal, go to the folder where the ExManCmd_mac package was extracted.

For example, if you have put the ExManCmd_mac folder into the Downloads folder:

```
cd Downloads/ExManCmd_mac/
```

11. Enter the following command:

```
Contents/MacOS/ExManCmd --install <filename.zxp>
```

12. Press **Enter**.

If no error message displays, the extension has been installed on your computer and recognized by the Extension Manager CC.



```
ExManCmd_mac --bash -- 97x6
Last login: Thu Feb 23 12:21:08 on ttys000
|vulcan:~ qa$ cd Documents/ExManCmd_mac/
|vulcan:ExManCmd_mac qa$ ./Contents/MacOS/ExManCmd --install Export\ to\ Harmony\{1.0.33\}.zxp
|vulcan:ExManCmd_mac qa$
```

13. Open Animate CC.
14. Access Top Menu > Commands.

If the Export to Harmony option appears in the Top Menu > Commands list, your installation was successful.

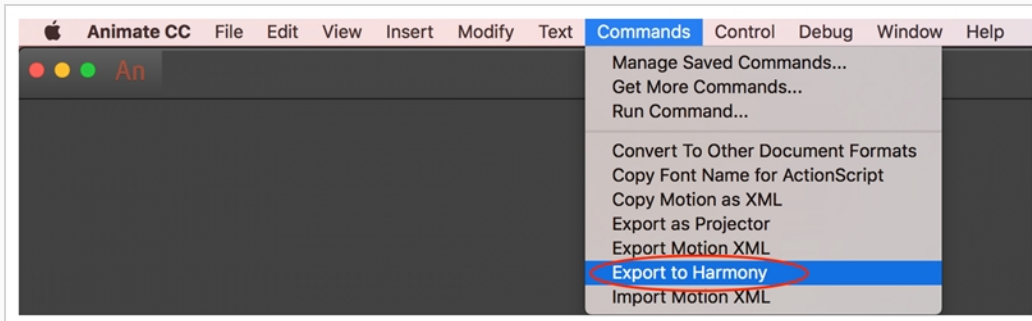

Exporting FLA Files

How to export FLA files for Harmony from Adobe Flash

1. Open your `.fla` file in Adobe Flash.



NOTE

In case of a new file, it needs to be saved before continuing the exportation process. If not, the export won't be completed.

2. Return to the scene level.

Before exporting to Harmony, it is assumed that you are at the scene level even if you're not.

3. Do one of the following:
 - Older versions of Adobe Flash: Select **Window > Other Panels > Export to Harmony**.
 - Adobe Flash CC: **Window > Extensions > Export to Harmony**.



NOTE

This window must be opened once after installing the extension in the extension manager because it creates a direct link to Harmony (even if the window is not used). Afterwards, you do not have to reopen it if there is no need to change the option.

The Export to Harmony window opens from which you can set the resolution of the files as it will appear in Harmony. The default resolution is set to 1920 x 1080, like the HD default resolution value of Harmony. If needed, you can change the compression: Photo (JPG) or Lossless (PNG).

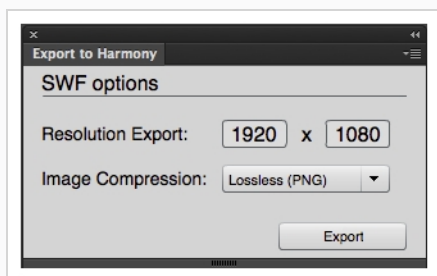

4. Do one of the following:
 - In the Export to Harmony window, click **Export** button.
 - Select **Commands > Export to Harmony**.

The Output tab displays information about the conversions necessary for the export including:

Distributing to layers, breaking apart, the presence of shapes at the scene level, ungrouping all groups to verify if any symbols are hidden inside, breaking drawing objects to transfer them as shapes, drawing substitutions, and so on. Problematic situations will also be mentioned. If nothing appears in the Output tab, then your **.fla** file is clean and does not need any conversions.

The **.txt** files contain the drawing substitution information and at which frame they are exposed. A **.swf** file is created for each symbol in Flash and a **.tpl** file is created of them. The corresponding **export.json** file is also created, which you will need when importing your Flash scene in Harmony. These files are in a folder located at the same location as the **.fla** file. The folder name is the same as the **.fla** file.



NOTE

If a folder with the same name as the **.fla** file already exists, you will be prompted to replace the folder. Be aware that saving Flash projects as **.xfl** files will automatically create a folder with the same name as the **.fla** file. In this case, the folder of the export will be created inside the folder of the **xfl**. If this not what you want, place a copy of the **.fla** in another path on your computer before the export.

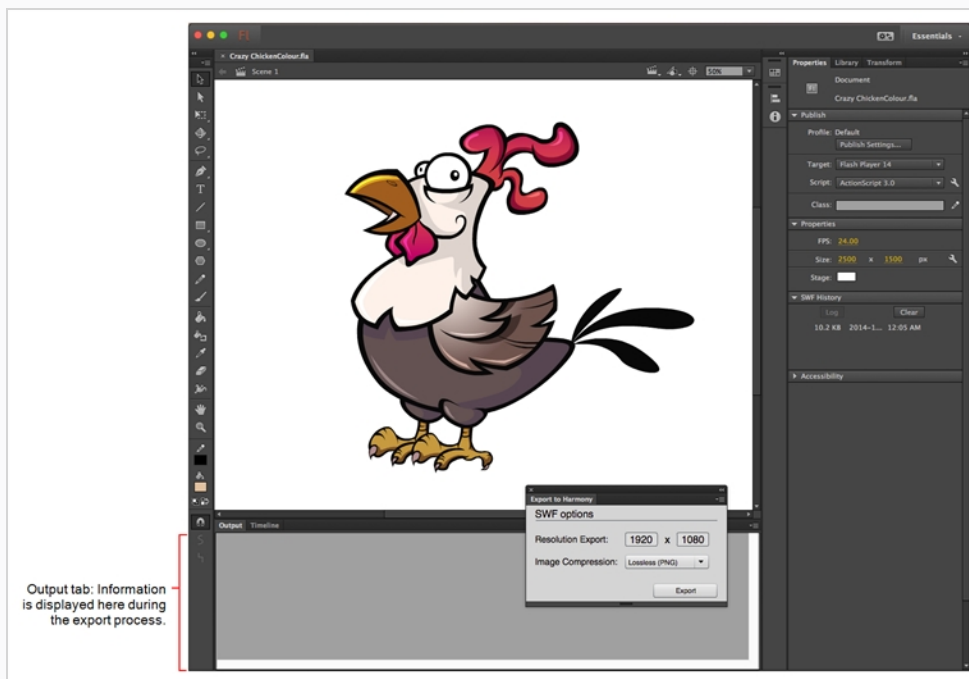

Displaying the Import Flash Scene Icon

When importing Flash files, the Scripting toolbar must be displayed, which should contain the Import Flash Scene icon. If the icon does not appear in the Scripting toolbar, add it to the toolbar. Note that you will only have to do this once. After that, you can import Flash files whenever needed.

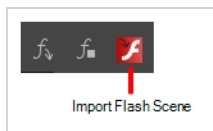

How to display the Flash Import script icon

1. From the top menu, select **Windows > Toolbars > Scripting**.

The Scripting toolbar bars appears below the File toolbar in the upper-left of the Harmony interface.



2. Click the Manage Scripts  button.

The Scripts Manager opens.

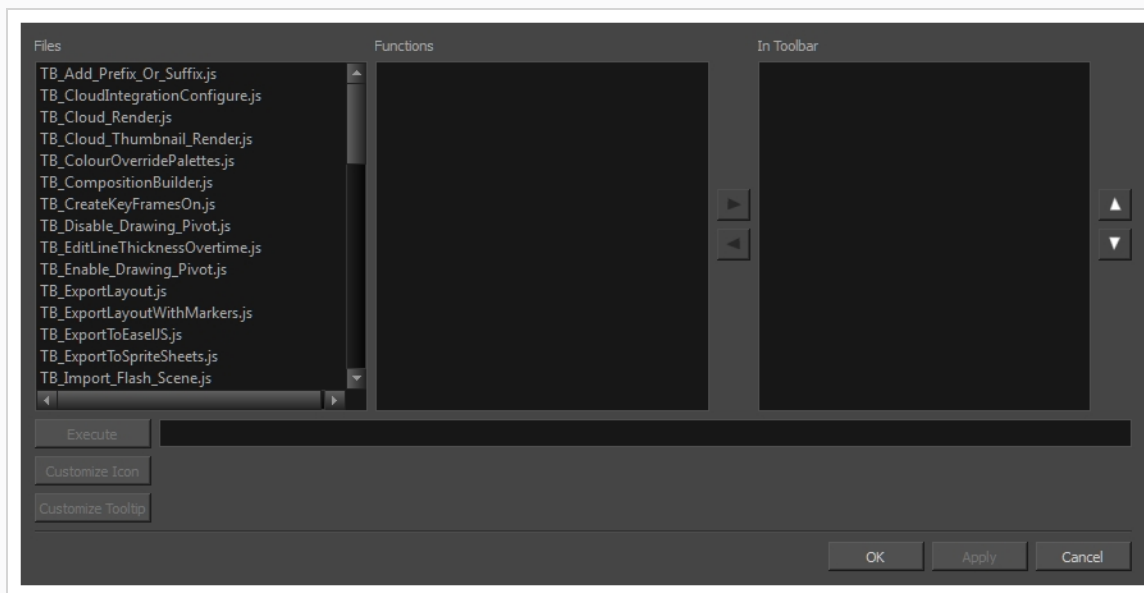

3. From the Files section, select **TB_Import_Flash_Scene.js**.

On your computer, here is the location of the script file:

- **Windows:**
 - **Toon Boom Harmony Premium:** C:\Users\[user_name]\AppData\Roaming\Toon

Boom Animation\Toon Boom Harmony\1400-scripts

- **Toon Boom Harmony Advanced:** C:\Users\[user_name]\AppData\Roaming\Toon Boom Animation\Toon Boom Advanced\1400-scripts
- **Toon Boom Harmony Essentials:** C:\Users\[user_name]\AppData\Roaming\Toon Boom Animation\Toon Boom Essentials\1400-scripts
- **macOS:**
 - **Toon Boom Harmony Premium:** /Users/[user_name]/Library/Preferences/Toon Boom Animation/Toon Boom Harmony/1400-scripts
 - **Toon Boom Harmony Advanced:** /Users/[user_name]/Library/Preferences/Toon Boom Animation/Toon Boom Advanced/1400-scripts
 - **Toon Boom Harmony Essentials:** /Users/[user_name]/Library/Preferences/Toon Boom Animation/Toon Boom Essentials/1400-scripts

On macOS, the Library folder is a hidden folder. To display the folder, hold down the Alt key.

- **Global:** [Server_Name] > USA_DB > scripts
 - **Environment:** [Server_Name] > USA_DB > environments > [environment_name]
 - **Job:** [Server_Name] > USA_DB > jobs > [job name]
 - **User:** [Server_Name] > USA_DB > users > [user_name] > stage > 1400-scripts
5. From the Functions section, select **TB_Import_Flash_Scene** and click the arrow button to move it to the In Toolbar section.

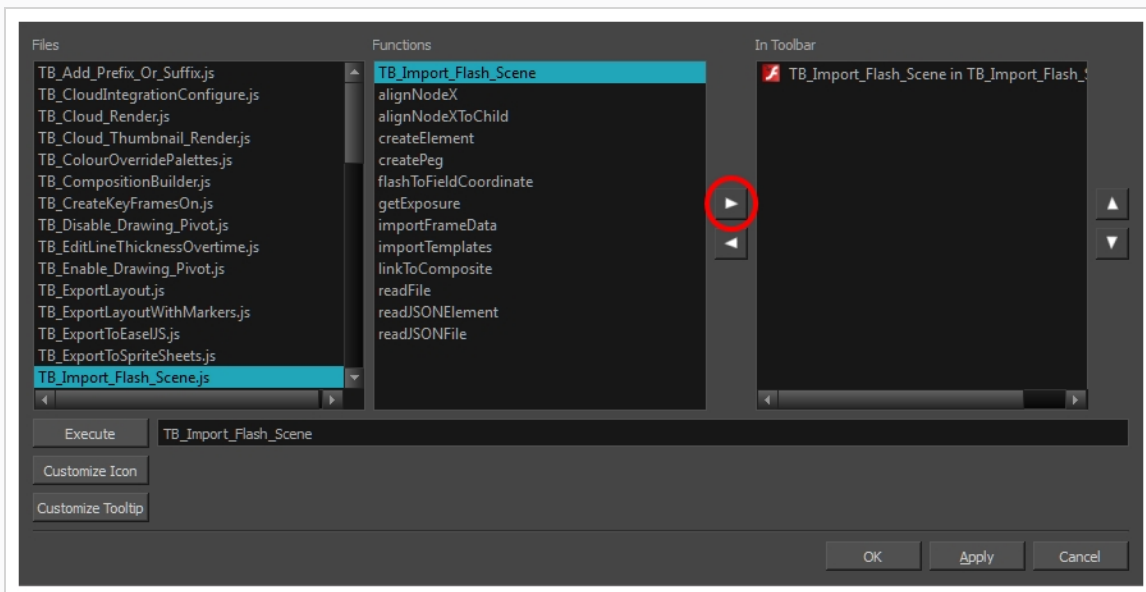

6. Click **OK**.

The Import Flash icon appears in the Scripting toolbar. Everything is now ready to import Flash scenes.

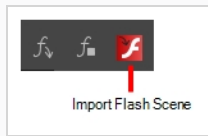

Importing FLA Files

Once your extension is installed, your FLA file has been exported and you displayed the FLA import script in your toolbar, you are ready to import your FLA file in Harmony.

How to import FLA files

1. In the Scripting toolbar, click the Import Flash  button.
2. In the Import Files dialog box, locate the **export.json** file contained in the folder that was created when you exported your files from Flash.
3. Click **Open**.

In a few moments, the colour recovery dialog box appears, requesting a colour recovery.

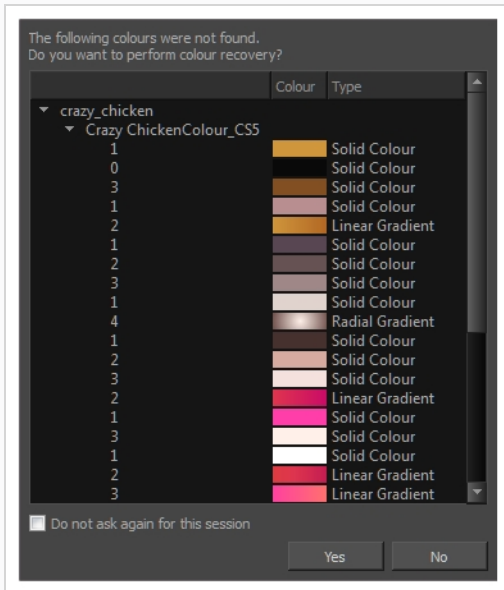

4. Before clicking **Yes**, you have the option of selecting the **Do Not Ask Again For This Session** option.

In a few moments, the **.fla** files are imported in Harmony.

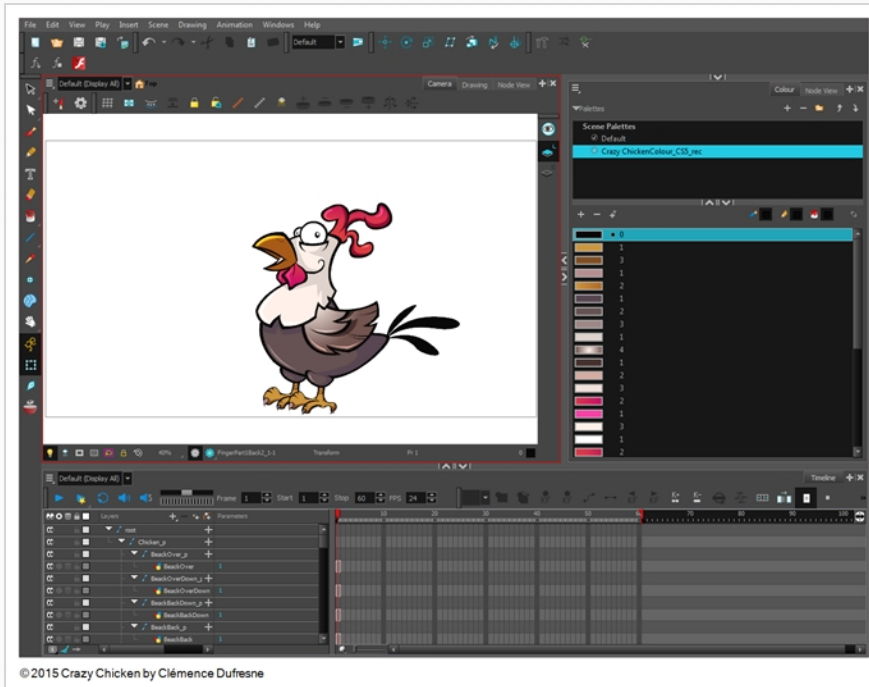

5. In the Node view, press 1 to zoom out of the Node view and see the entire node system.

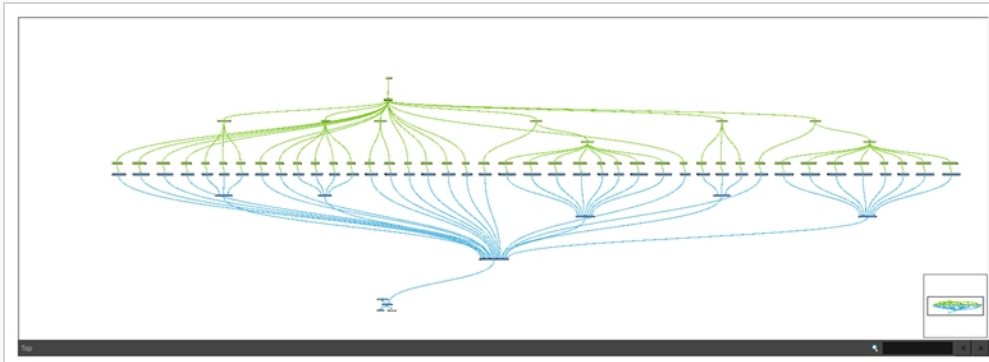

Flash Export and Import Guidelines

The following points are guidelines for you to create optimal Flash files to export to or import in Harmony.

The following are limitations that apply when importing `.swf` files, whether they were exported specifically for Harmony or just regular Flash Movie files.

Drawing Features

- The line width will be preserved, whether it's constant or varied with the Width tool.
- Any line caps and line joins other than round will be converted to round line caps and line joins
- The flow of gradients must be set to Extend Color, which is the default flow for gradients. Gradients with a Reflect or Repeat flow will cause the entire symbol in which they're located to be ignored.

Effects

The following effects will not be imported by Harmony:

- Filters (ie: Adjust Colour, Drop Shadow, Bevel, etc.)
- Colour Effects (ie: Alpha, Advanced, Brightness and Tint)
- Blending (ie: Layer, Darken, Multiply, etc.)
- Render: Cache as Bitmap (Export as Bitmap is supported)
- 3D Rotations
- Component properties

Bitmap Images

Bitmap images must be either `.jpg` or `.png` format. Symbols that have their Render mode set to Cache as Bitmap will also be imported.

Flash Export Guidelines

The following are rules to follow when exporting assets from Flash for import in Harmony.

Scene Root

What can be at the scene root:

- Only symbols. A minimum of one symbol is necessary. It could be a MovieClip or a graphic.

What cannot be used at the scene root:

- Shapes: Colour shapes and line shapes
- Bitmaps

- Drawing objects
- Groups: The group works differently at the scene level. They are understood as shapes at the scene level—see [Flash Export and Import Guidelines on page 672](#).

Timeline

These features can be used in the Flash file, but will not appear when imported in Harmony.

- Guide layers for references
- Locked layers
- Disabled layers
- Folders in the Timeline view
- Other: Several symbols on the same layer/keyframe. Harmony will spread them over several drawing layers, implicitly performing a *Distribute to Layers* operation in the process.

Not recommended:

- Mixed layers—see [Flash Export and Import Guidelines on page 672](#)
- Symbols, shapes, bitmaps and groups in the same layer/keyframe
- Symbols with drawing objects

Library View

In the Library view, the following will not be exported:

- ActionScript Linkage
- Embedded fonts

Mixed Layers

Mixed layers are something you must seriously consider before trying to export a Flash project to Harmony. Otherwise, there can be unexpected results or no export at all. In fact, it's best to avoid having mixed layers altogether.

A mixed layer is defined as a layer that has more than one instance of objects at the same keyframe. It could be a mix of symbols and groups; groups and drawing objects; symbols and shapes, and so on. Since Harmony understands symbols better than groups or drawing elements, some information can be lost along the way.

Parameter	Description
Drawing Objects	No matter what is inside a drawing object, it will always be understood as a shape. So if a drawing object shares the same layer with a shape, it won't be a real mixed layer, since they are all understood as shapes.

<p>Symbols and Drawing Objects/Shapes on the Same Layer</p>	<p>If there are symbols and drawing objects/shapes sharing the same layer, the symbols will be separated from them and all the drawing objects/shapes will be kept together. Drawing objects and shapes cannot be separated. In Harmony, the symbols will have their own Drawing node and the drawing objects/shapes will share the same Drawing node. Since only symbols can have a name, its name is propagated to the Drawing node and peg.</p> <p>Drawing objects and shapes, however, can't do this. Drawing objects and shapes will receive the name of the MovieClip followed by an underscore and an appropriate number. For example, if you have a group inside a symbol called <i>HEAD</i>, the group will be named <i>HEAD_1</i> if there is already a Drawing node that was created with the same name.</p>
<p>Mixed Instances at the Same Level as a Symbol</p>	<p>Mixed instances at the same level as a symbol can occur when, at the same level inside a symbol, there is more than one type of element sharing the same timeline at a specific frame. Those elements may be mixed layers.</p> <p>Type of problems that can occur if mixed instances are kept:</p> <ul style="list-style-type: none"> • Order of appearance can be lost • Some layers can merge together • Transparency of shapes can cut other shapes

Importing QuickTime Movies

T-ANIMPA-004-002

When creating an animation, it is not unusual to embed moving elements saved as videos within the animation. Toon Boom Harmony allows you to import QuickTime movies into your project.

How to import a QuickTime movie

1. From the top menu, select **File > Import > Movie**.
2. Browse for the QuickTime movie to import and click **Open**.

The Import Images dialog box opens.



NOTE

Do not browse for the movie file again. Leave the automatically generated field text as “many files selected”.

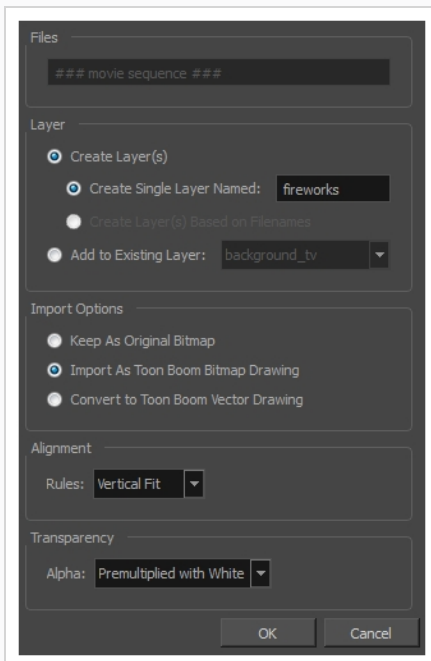

3. Make your decisions for the Layer, Alignment and Transparency sections of this dialog box—see the Reference guide .
4. Click **OK**.

The QuickTime video appears in the Timeline view as an image sequence. You can scroll through the film frame-by-frame just as you would scroll through your animation drawing-by-drawing.

About Scanning

Harmony can receive images from any TWAIN device, such as scanners or digital cameras. You can load these images as bitmaps into your scene or convert them into vector-based images that can be edited using Harmony.



You must install a TWAIN driver for your device in order to access its contents. Refer to the manufacturer of your device to get a TWAIN driver. Once all the animation layers are scanned in, you can set the timing in the digital exposure sheet.

Once your traditional animation sequences are completed and cleaned up, you're ready to scan and import them in Harmony. The scanning process is the point where the traditional production becomes digital. It's the moment where you use Harmony to control the project.



Scanning Images

Toon Boom Harmony can receive images from any TWAIN device such as scanners and digital cameras. These images can either be loaded into your scene as bitmaps or converted into vector-based images that can be edited using Toon Boom Harmony.

If your operating system does not automatically recognize your device after it has been connected, you must install the correct TWAIN drivers in order to access its contents. You can usually download the drivers from the device manufacturer's website.

How to scan images

1. From the top menu, select **File > Acquire > From TWAIN**.

The Acquire from scanner window opens.

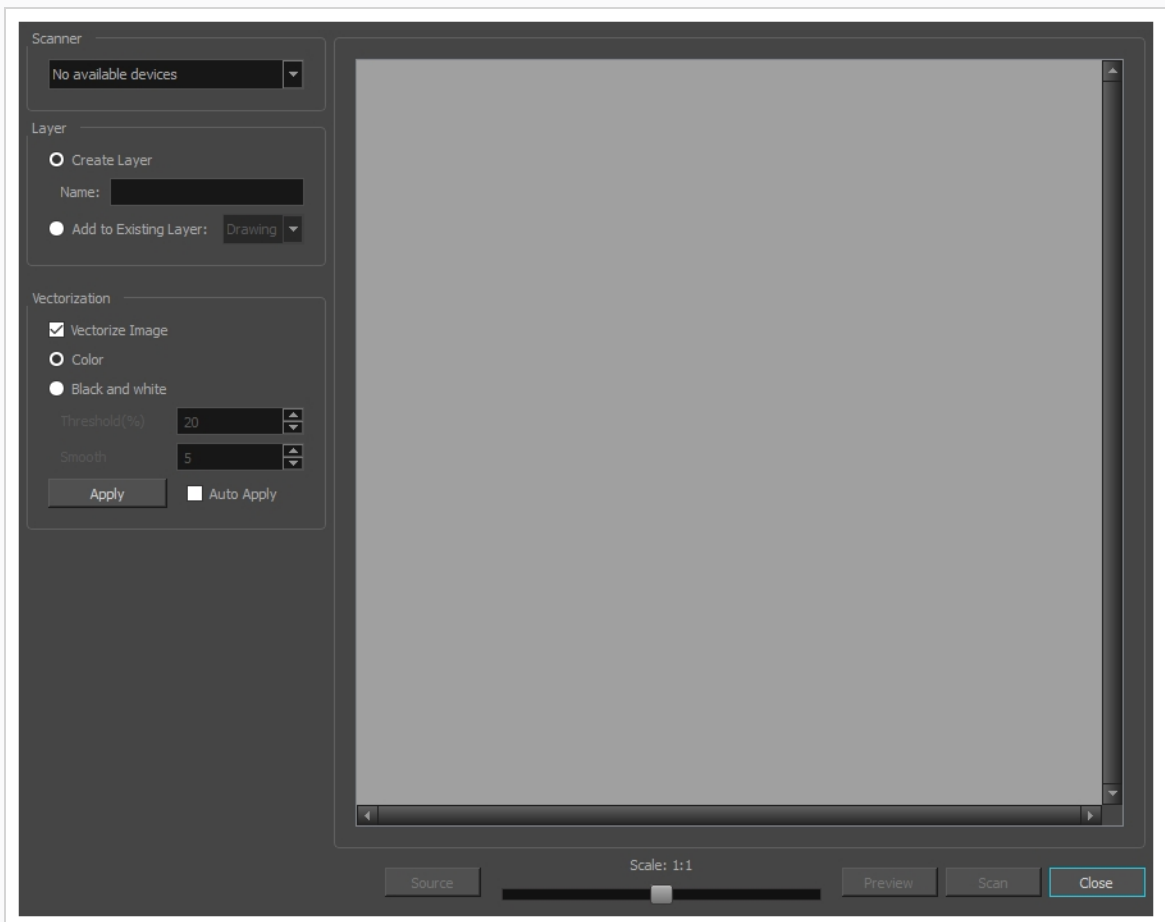

2. In the Scan Drawings window, select your scanner or other supported TWAIN device from the Scanner menu. If none are available, check your device to ensure that it's properly connected to your computer. If your device still does not appear in the menu, you may have to shut down and restart the software.

3. In the Layer section, decide if the scanned or imported image will be placed on a new layer or existing layer—see the Reference guide .
4. In the Drawing Options section, set the following options if desired:

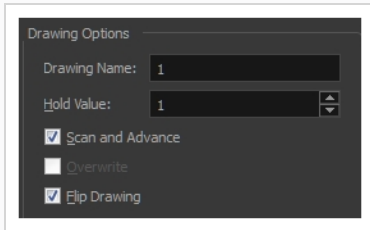

- **Drawing Name:** Name of the drawing to import.
 - **Hold Value:** Type the number of frames that the drawing will be exposed.
 - **Scan and Advance:** Lets you scan one drawing after another every time you click **Scan**.
 - **Flip Drawing:** Mirrors the drawings horizontally and scans it this way.
5. Adjust the **Scale** control and sliders in the Preview Image window until you are satisfied with the view.



6. Click **Scan** to scan your drawing.
7. If you are scanning panoramic drawings, in the Page Panning section, move the slider to the next letter to capture your next frame.

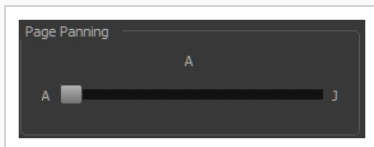

8. If you have more than one drawing, set the next drawing in place and click **Scan** again. Repeat until you have finished scanning all your drawings.

Vectorizing Scanned Drawings

You can turn scanned images into vector drawings, while maintaining the sketchiness of a pencil line or into vector images with a bitmap fill. Both options can add life to an animation, which straight vectorization with smoothing does not usually afford.

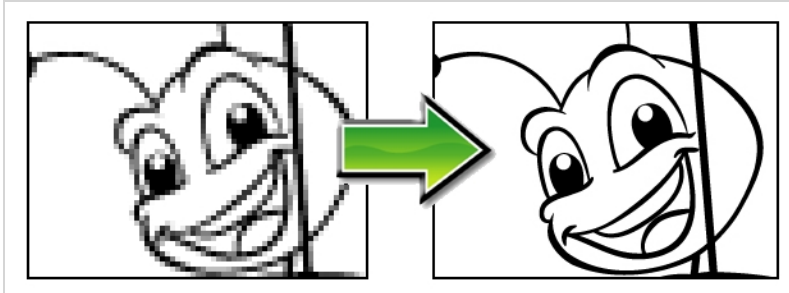

How to scan and vectorize drawings

1. From the top menu, select **File > Acquire from TWAIN** or press **Ctrl + Shift + S** (Windows/Linux) or **⌘ + Shift + S** (macOS).

The Acquire from scanner window opens.

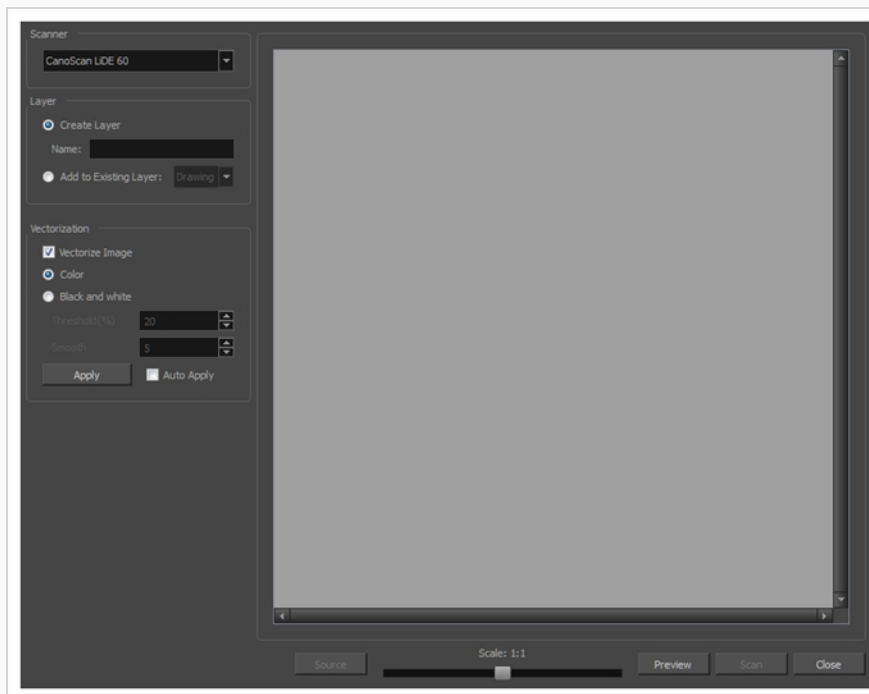

2. Select your scanner from the Scanner list.

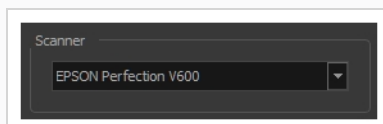

3. Click **Preview** to get a test scan of your drawing.
4. In the Layer section, select one of the following:
 - **Create Layer:** Imports an image into a new layer. Type a name for the layer in the **Name** field.
 - **Add to Existing Layer:** Imports the image into an existing layer. Select a layer from the Layer list.
5. In the Vectorization section, select the **Vectorize Image** option and then set the following:
 - **Colour:** Creates a vector rectangle with the bitmap as a texture inside.
 - **Black and White:** Vectorizes drawings as a solid black line; creates a 100% vector-based drawing. Set the Threshold and Smooth parameters.

Threshold: Determines which black, white or grey pixels become a black line. 0% means all the light pixels will be kept as black vector line. A value of 100% means only the very dark pixels become a black line.

Smooth: Determines the smoothness of lines. The higher the value, the less angular and bumpier the resulting lines will be.

Auto Apply: Automatically applies the colour or black and white settings to the scanned images.
6. Adjust the **Scale** control and the sliders in the Preview Image window until you're satisfied with the view.



7. Click **Scan** to import your drawing.
8. If you have more than one drawing, set the next drawing in place and click **Scan** again. Repeat until you have finished scanning all your drawings.

About Custom Vectorization Parameters

You can create your own vectorization settings with Harmony. The vectorization parameters you create can be saved, shared and also inserted into the `VectOptions.conf` file used by the Harmony Scan and Control Center modules when scanning or vectorizing a series of drawings.

You can use an interface to select and test the different options, as well as type in some advanced settings.

The Vectorization Parameters dialog box lets you vectorize pencil drawings, along with any red, blue or green pencil marks you may have used to indicate highlights and shadows. The drawing will be vectorized into pure red, blue, green and black (RGB values), while creating colour art zones wherever lines connect. After painting in your tones and highlights, change your pure RGB colours to transparent (0 Alpha) in the Colour Picker window and watch the indicator colour zone lines disappear.

Creating Vectorization Styles

With Harmony, you can create custom vectorization parameters that can be saved, reused, shared, or used to set the Harmony Scan module vectorization style list.

You can vectorize drawings using one of the following methods:

- **Black and White:** All the lines become vector based and 100% black. The white areas become completely transparent.
- **Greyscale:** All the lines preserve their initial textured look in grey shades as a bitmap image contained inside a vector frame. The white areas become completely transparent.
- **Four Colours:** With the advanced parameters, you can isolate the red, green, blue, and black lines and turn them into 100% vector lines, preserving their original colours—see the Reference guide .

How to create or modify the vectorization parameters

1. From the top menu, select **File > Import > From Scanner**.
You can also open it from any other import option that allows you to customize the vectorization parameters (i.e. from the scanner).
2. In the Scan Drawings window, do the following:
 - In the Layer section, decide on the layer options.
 - In the Import Options section, select the **Convert to Toon Boom Vector Drawing** option
 - Click **Preview**.
3. In the Vectorization section, click the Vectorization Parameters  button.
4. The Vectorization Parameters dialog box opens.
5. Set the different options available in the Vectorization Parameters dialog box—see the Reference guide .

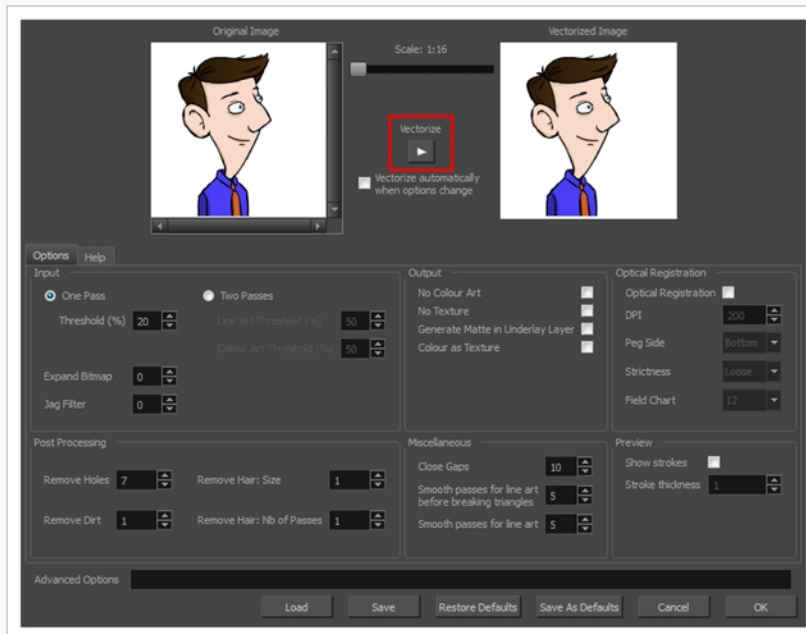

6. Click the **Vectorize** button to update the Vectorized Image preview.

The vectorized image is just a preview. The actual vectorization happens when you click **OK** in the Import Images dialog box. There are many options to try in the Vectorization Parameters dialog box. These are applied during the vectorization process.

7. To set advanced parameters, read the information on the Help tab, then type in the Advanced Options field at the bottom of the dialog box.
8. To save your vectorization parameters to reuse them later, share them, or use them to set the Harmony Scan module vectorization style list, click **Save**.
9. In the Browser window, name and save the file.

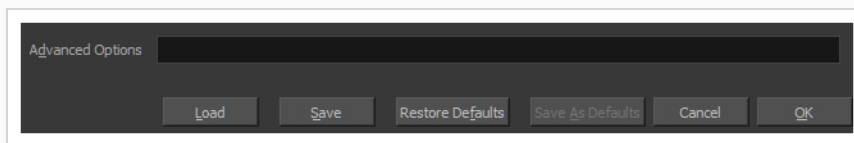



10. To save the current settings as your default settings, click **Save As Default**. To restore the default settings, click **Restore Defaults**.
11. To load a vectorization style, click **Load** and locate the existing ***.vof** file.
12. Click **OK**.

Configuring the VectOptions.conf File

Toon Boom Harmony Server uses a file called **VectOptions.conf** to get the vectorization style when batch vectorizing a series of drawings. A series of default styles is available in this file, but you will certainly want to create your own to fit your production style.

How to set the VectOptions.conf file

1. Launch Configuration Editor:

- **Windows:** Open the Start menu and, in the Programs list, select **Toon BoomHarmony 15.0 Essentials > Tools >  Configuration Editor**.
- **macOS:** In Finder, go to **Applications > Toon BoomHarmony 15.0 Essentials> Tools >  Configuration Editor**.
- **GNU/Linux:** In a terminal, type the following command:

```
$ sudo /usr/local/ToonBoomAnimation/harmonyEssentials_15.0/lnx86_64/bin/ConfigEditor
```

The Configuration Editor window opens.

2. In the bottom section of the window, select the **VectOptions.conf** tab.

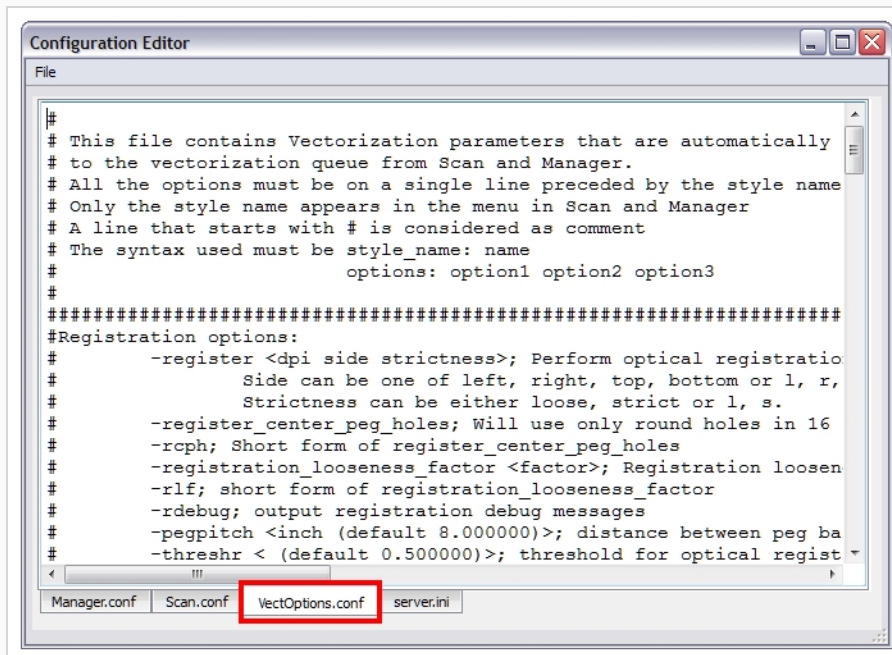

- #### 3. Scroll down the VectOptions.conf file to see all the different options available for creating your custom vectorization style. These options are the same as in the Vectorization Parameters dialog box. It is recommended that you create your vectorization style using Harmony and the

Vectorization Parameters window and copy the result parameters in this file—see [About Custom Vectorization Parameters](#) on page 681

4. Scroll down toward the bottom of the file to see the default styles. You can modify them or add new ones to the list using the parameters you got using the Vectorization Parameters window. Notice that some of the lines have a “#” sign at the beginning to indicate that the line is a comment and will not appear in the style list. The lines that have no sign at the beginning appear in the style list.

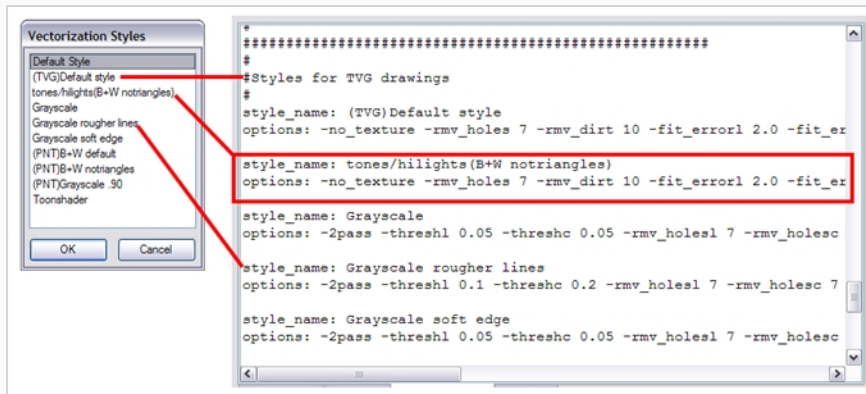

5. To create a new style, type the following below the existing styles:

style_name:

This should be followed by the name of your new style. For example: **style_name: Black Lines.**

6. Under the style name line, type the following:

options:

7. Copy and paste the information in your *.vof style when saving your settings in the Vectorization Parameters window.

▸ To open the *.vof file, use any plain text editor application.

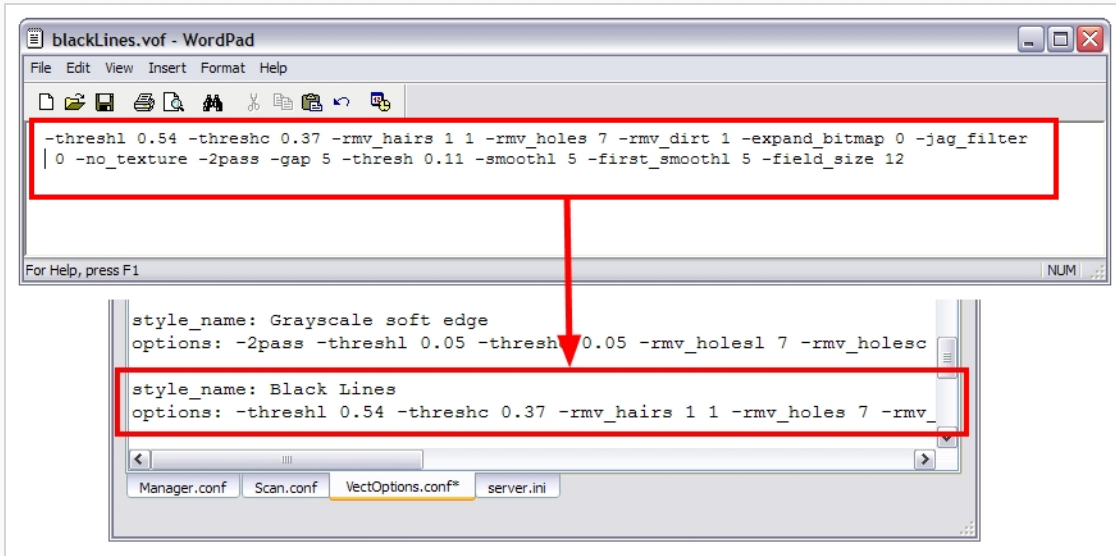

8. In the Configuration Editor's top menu, select **File > Save**.
9. If you have Toon Boom Harmony Scan on your computer, you can start the application and verify that the new style appears in the Vectorization Style list under **Edit > Vectorization Style**.



NOTE

If you are using the batch processing method available with Toon Boom Harmony Server to scan and vectorize drawings, the selected style must be available on all the machines included in the batch processing list.

Refer to the Harmony Server Guide Guide to learn more about setting up and using batch processing.

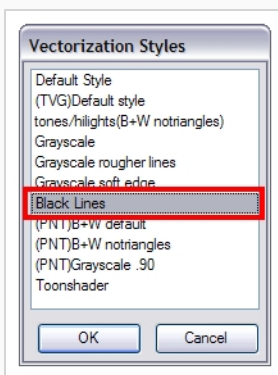

Chapter 14: Effects

T-HFND-010-001

When creating a scene, rigging a character or once your animation is finished, you can add effects such as blurs, glows, shadows, colour filters and transparency filters and to enhance your project's quality. Effects change the way layers or groups of layers are rendered in your scene.

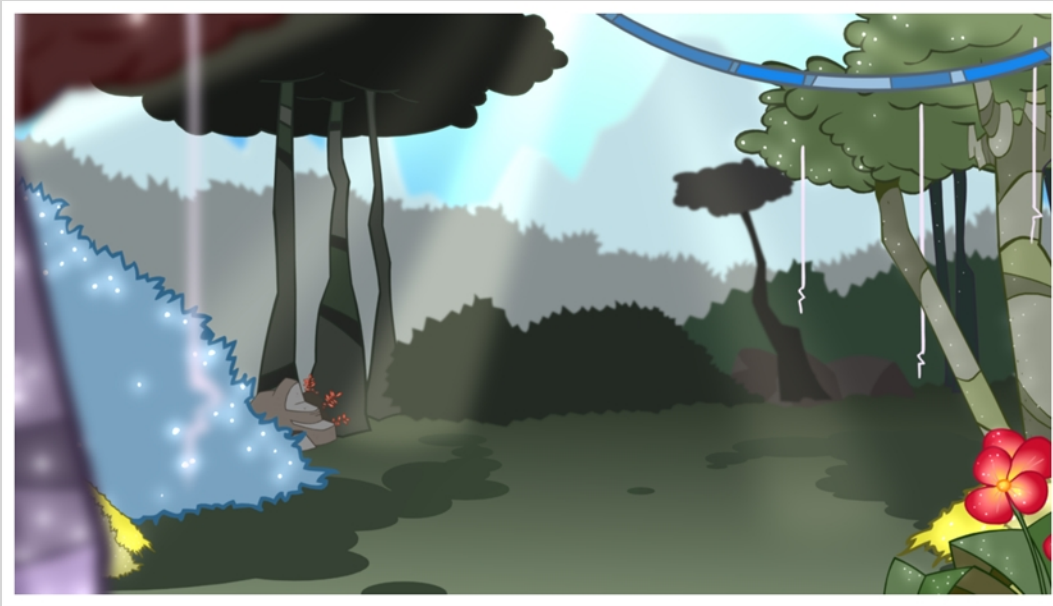

Effects are special types of layers that you can add to your scene's structure. For an effect layer to work, it must be connected as the child of a drawing, a group, or another effect. Effects only alter the element that they are connected to. This gives you flexibility in deciding which elements of your scene are affected by an effect.

Some effects need to be linked to another layer, referred to as a matte layer, which is used to define the area they should affect. The most basic example of this is the Cutter effect. Alone, a cutter effect has no impact on the drawing it is connected to. Once combined with a matte layer, the Cutter effect cuts the shape of the matte out of the drawing.



A matte layer is simply a regular drawing layer that is connected to an effect as its matte. The effect takes the shape of the drawing in the matte layer to determine the area of the drawing it affects. The colours and details in the matte layer are ignored by the effect, only its shape is taken in account.

In the Timeline view, an effect must be rigged as the child of the drawing layer or group it is meant to affect.

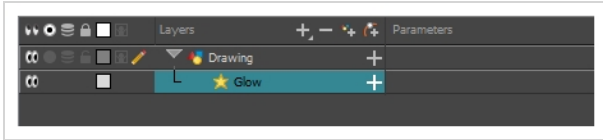

If the effect can use a matte layer, it will have a Matte parameter when you expand its parameters list. You can drag and drop the layer you want to use a matte for your effect onto the Matte parameter of your effect to link them.

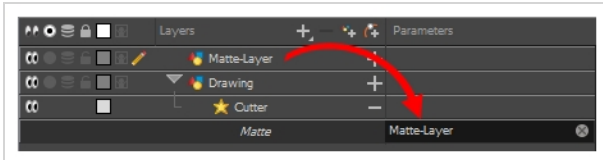

If the effect can use a matte layer, it will have a matte port on its left to which the matte layer can be connected.

Once your effect is connected, you can adjust its parameters by selecting it, then adjusting its parameters using the Layer Properties view. You can also double-click on the layer to open its Layer Properties dialog. If desired, you can even animate the parameters of your effect by converting their values to functions.

Adding Effects Layers

T-HFND-010-004

In Harmony, you can add effects through the Timeline view, connecting them to your drawing layers and then adjusting the parameters until you achieve the look you want.

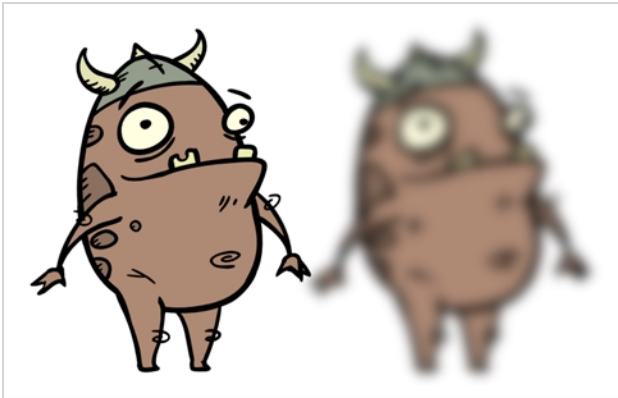

How to add an effect

1. In the Timeline view, select the layer on which you want to add an effect.
2. Do one of the following:
 - In the top menu, select **Insert > Effects** and select the effect you want to add.
 - In the Layers toolbar above the layer list, click the Add Layers **+** button, select **Effects** then select the effect you want to add.
 - Right-click on the layer, then select **Insert > Effects** and select the effect you want to add.

The effect appears in the Timeline view, underneath the selected layer.

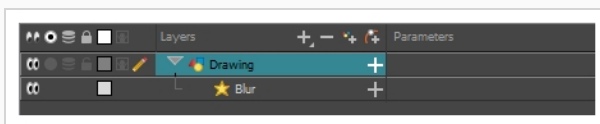

Connecting Effects

T-HFND-010-006

For an effect to work, it must be connected to a layer or group. The effect will be applied to the image output by the layer or group, and the transformed image will be composited with other elements in the scene.

How to connect an effect

1. In the Timeline view, select the effect you want to connect.
2. Drag and drop the effect over the layer or group which you want it to affect.



The effect will become a child of the layer or group on which you dropped it. It will appear right beneath that layer or group, with its icon and name indented towards the right.

Adding a Matte Drawing to an Effect

Some effects can use, or even require the use of a matte layer. The matte layer is a drawing that determines the area that the effect affects.

For example, a Cutter effect needs to be connected to a matte layer, because it uses the drawing in the matte layer to determine which part of the drawing to cut out. However, a Colour-Scale effect can be used without a matte layer, in which case it will affect the colour of all of the drawing it is connected to, but if it is connected to a matte layer, it will only affect the colours of the part of the drawing that is covered by the matte drawing.



TIP

Drawing layers can also be connected to a matte layer. When a drawing layer has a matte layer, the part of the drawing covered by the matte layer is cut out from that drawing, which is the same as if the drawing was connected to a Cutter effect—see [About Masking and Cutting Parts of Elements in your Scenes](#) on page 711.

How to connect a drawing to an effect's matte connection

1. In the toolbar above the layer list in Timeline view, click on Add Drawing Layer .
2. In the Add Drawing Layer dialog, give your new drawing layer a relevant name for a matte layer, such as "Matte-Drawing", then click on **Add and Close**.

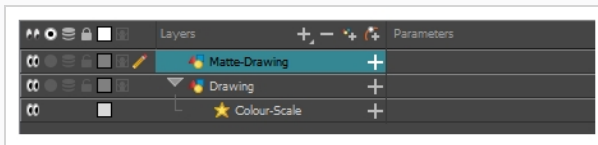

3. In the new matte drawing layer, draw a matte for your effect. Your matte can be a simple shape, but should be filled with a colour, as only parts of the matte that are opaque will be taken in account.

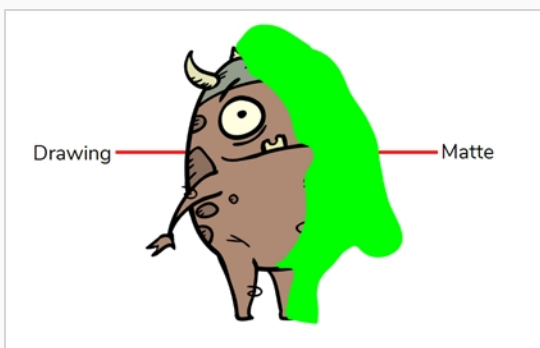



NOTE

Mattes can also have semi-transparent areas. Areas of the drawing that are covered by semi-transparent areas of the matte are partially affected by the effect.

4. In the Timeline view, locate the effect layer for which you created a matte and click on the Expand **+** button right of its name.

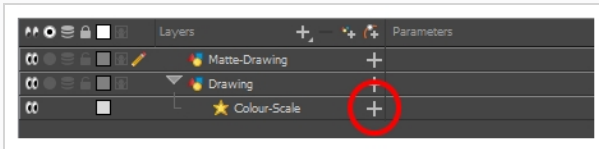

Just below the effect, a list of parameters for the effect appears. If the effect has a matte connection, the first parameter in the list will be **Matte**, and its value will be **<Drop layer here>**.

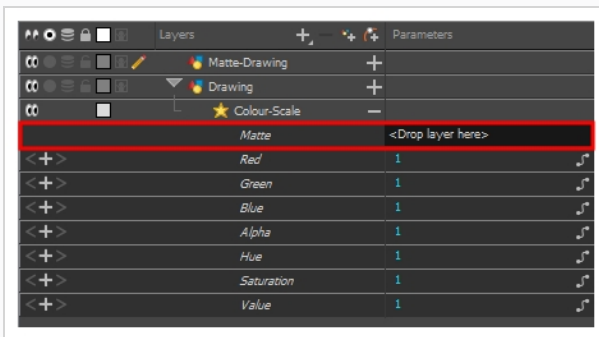

5. Click and hold on the matte layer, then drag and drop it over **<Drop layer here>**.

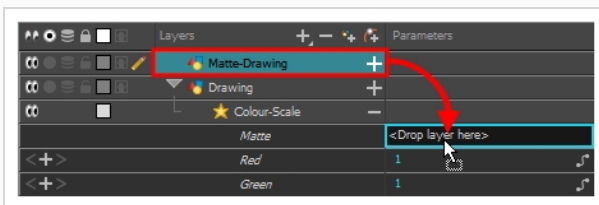

The matte layer will be set as the effect's matte property.

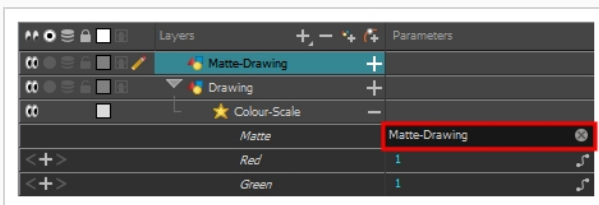

**NOTES**

- When a drawing layer is used as an effect's matte, the artwork in that layer is not visible in the scene, since it is only used as the effect's matte.
- If you want to disconnect the effect from the matte, you can click on the Unlink  button at the right of the Matte parameter to unlink the matte layer from the effect. This will make the matte drawing visible in the scene again.

6. By default, the effect is applied to the matte's opaque areas and the matte's transparent areas are ignored. If you want to invert this effect, which means apply the effect on the matte's transparent areas and ignore the matte's opaque areas, double-click on the layer (but not on its name) to open its Layer Properties dialog.
7. In the Layer Properties dialog of the effect, there should be an **Invert Matte** parameter. If the effect has several tabs in its layer properties, you might have to look through each tab to find this parameter. Check the check box for this parameter to invert the effect of the matte.

**NOTE**

For Cutter nodes, this parameter is just named **Inverted**.



Configuring an Effect

Once your effect is connected, you can configure it by changing its layer properties. There are two ways to access a layer's properties:

- By selecting it. Its layer properties will display in the Layer Properties view, which can be added to your workspace.
- By opening its Layer Properties dialog.



NOTE

Most effects do not have a visible effect in the Camera view's default preview mode (OpenGL View ) . This preview mode is very fast and is optimized for animation, but not for effects. To preview an effect as you change its parameters, you must set the Camera view's preview mode to Render View , which will update slowly, but will render the effects as they would appear in the final rendered image.

How to view a layer's properties in the Layer Properties view

1. Do one of the following to display the Layer Properties view:
 - In the top right corner of any existing view, click on the Add View button and select **Layer Properties**.
 - In the top menu, select **Windows > Layer Properties**.
2. In the Timeline view, select the effect layer you want to configure.

The selected layer's layer properties are now displaying in the Layer Properties view.

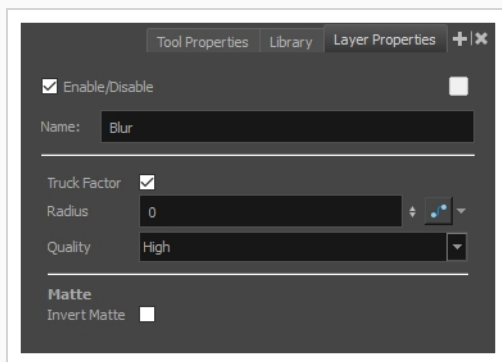

How to open a layer's Layer Properties dialog

1. In the Timeline view, double-click on the effect layer you want to configure, but not on its name.

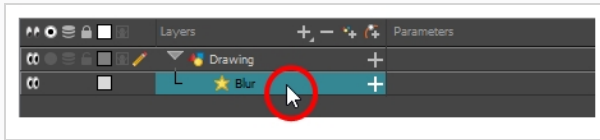

The layer's Layer Properties dialog appears.

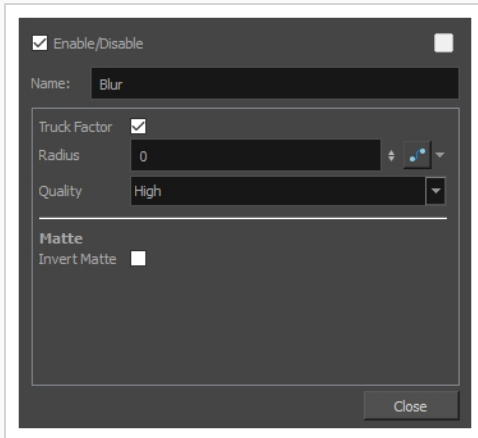

How to configure an effect

1. In the toolbar under the Camera view, click on the Render View  button to make Harmony render the effects in the Camera view.



TIP

If your scene currently does not have a background, the negative space in your scene will render in black. To circumvent this, you can add a Colour-Card layer underneath all the other layers in your scene by clicking on the Add Layer  button in the toolbar over the layer list and selecting **Colour-Card**.

2. In the Layer Properties view or the Layer Properties dialog, adjust the parameters of the effect until you have the expected results.

The preview in the Camera view will update every time you make changes, but each change may take a short while before appearing in the Camera view, as the Render Preview mode requires more computing power to update.



NOTE

For more information on how to configure certain effects, refer to [Examples of Effect Usage on page 718](#). For detailed information on the properties of each available effect, see refer to the Layers section of the Reference guide.

3. Once you are done, you can dismiss the Layer Properties dialog if it was open, and you can set the preview mode of the Camera view back to OpenGL by clicking on the OpenGL View  button in the toolbar at the bottom of the Camera view.

Animating an Effect

You may need to animate some effects to obtain the expected results. For example, you may want the radius of a Glow effect to slowly increase and decrease to make it pulsate throughout a scene, or you may want the transparency of a Transparency effect to increase from 0% to 100% to make a drawing vanish.

Almost all numerical parameters in an effect can be attached to a *function*. A function allows you to set a parameter to different values at different points in the scene by adding keyframes to it, and setting each keyframes to a specific value. Between keyframes, the value of the parameter will progress from the value of the previous keyframe to the value of the next keyframe. Drawing layers are animated by having their coordinates associated to functions. Likewise, effects can be animated by associating their parameters to functions.

Some effect parameters can be animated directly in the Timeline view, but not all. When you expand an effect's parameters in the Timeline view, some of its parameters may be hidden to avoid cluttering the Timeline view. You can animate those parameters from the Layer Properties view or the Layer Properties dialog, which display all of a layer's parameters.



NOTE

To learn how to preview animated effects, refer to [About Effects Preview on page 707](#).

How to animate an effect parameter in the Timeline view

1. In the Timeline view, locate the effect you want to animate, and click on the Expand **+** button right of its name.

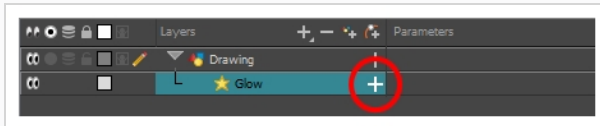

The list of parameters that effect's parameters that are available in the Timeline view appears.

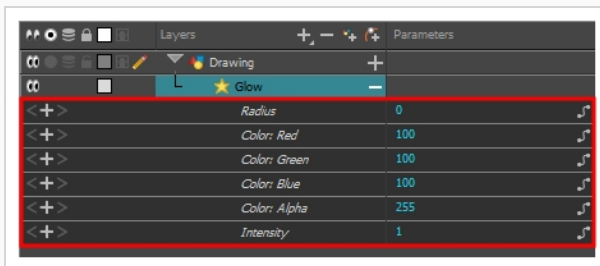

2. In the right area of the Timeline view, in the same row as the parameter you want to animate, select the frame where you want to create the first animation keyframe for the effect.

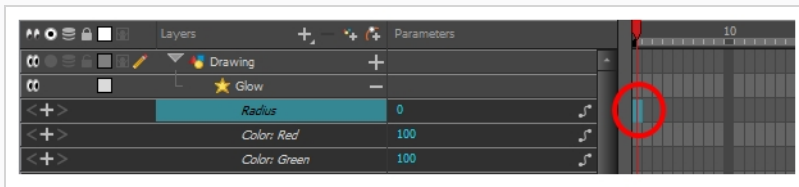

3. Create a keyframe by doing one of the following:

- In the Timeline toolbar, click the Add Keyframe  button.
- Right-click and select **Add Keyframe**.
- Press F6.

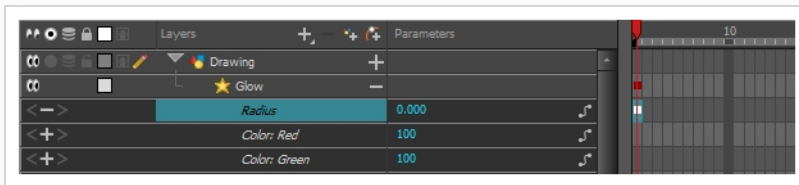

4. In the left area of the Timeline view, under the Parameters column, adjust the value of the parameter for this keyframe by doing one of the following:

- Click and hold on the value of the parameter, then drag it towards the left to reduce its value, or towards the right to increase its value.

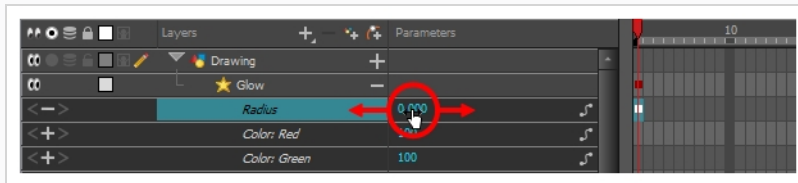

- Click on the value of the parameter. A text field will appear. Type in the new value of the parameter, then press Enter.

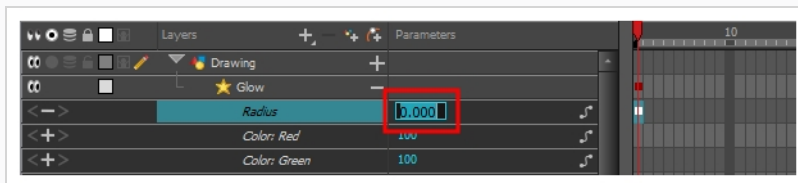

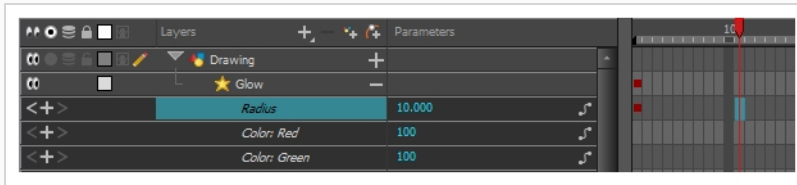

5. In the right area of the Timeline view, click on the frame where you want to create the second animation keyframe for the effect.



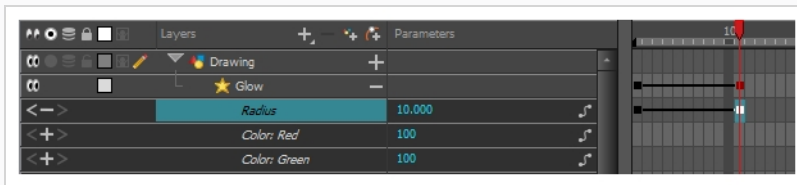

6. Create the second keyframe for your effect's animation by doing one of the following:
 - In the Timeline toolbar, click the Add Keyframe  button.
 - Right-click and select **Add Keyframe**.
 - Press F6.

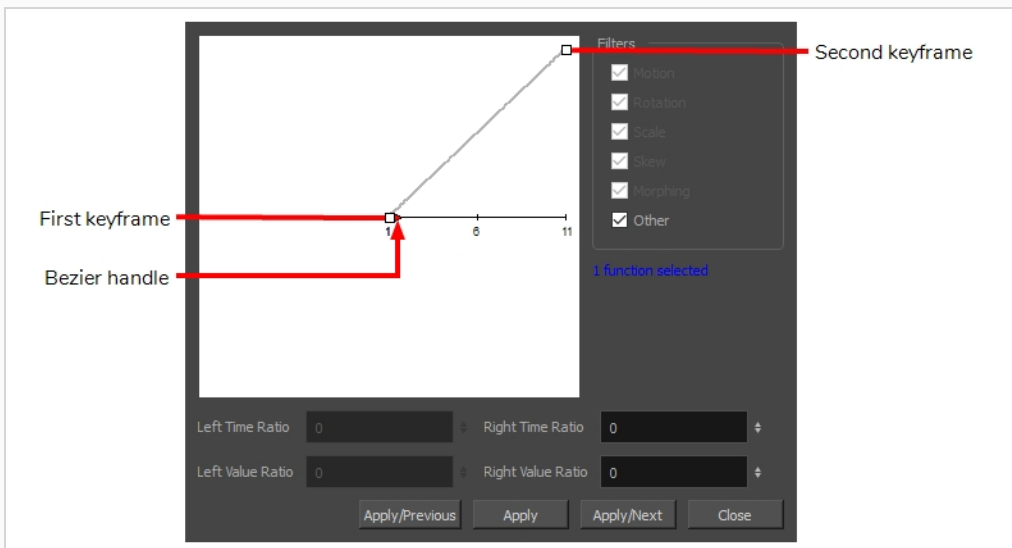

7. In the Parameters column, adjust the value of the parameter at the current keyframe.
8. Repeat the steps to create as many animation keyframe for your effect as needed.
9. To adjust the timing between the keyframes of your animation, select the first keyframe.
10. In the Timeline toolbar, click on the Set Ease for Multiple Parameters  button.

The Set Ease for Multiple Parameters dialog appear. The function graph in this dialog will be focused on the first keyframe  in your animation, which should have a Bezier handle  right next to it, pointing to the right.



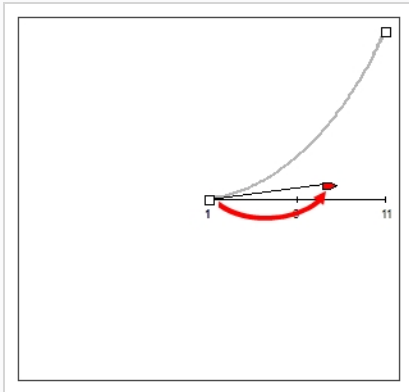

11. Click on the Bezier handle  and drag it towards the right, at any angle, to adjust the ease-in of the animation.



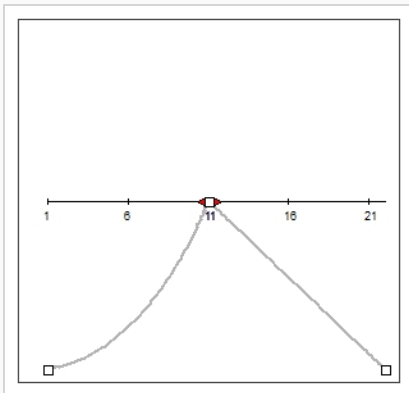

12. Click on **Apply/Next**.

The Set Ease for Multiple Parameters dialog will focus on the second keyframe. If this is the last keyframe in the animation, it will only have one Bezier handle, pointing towards the left. If there are more animation keyframes after this one, it will have two Bezier handles, one pointing in each direction.

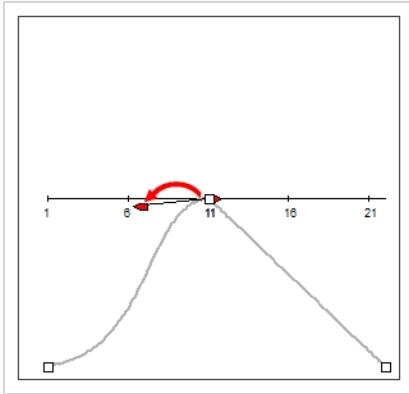

13. Click on the left Bezier handle  and drag it towards the left, at any angle, to adjust the ease-out of the animation between the previous keyframe and the current keyframe.



14. If there is a Bezier handle pointing towards the right , click on it and drag it towards the right, at any angle, to adjust the ease-in of the animation between the current keyframe and the next keyframe.

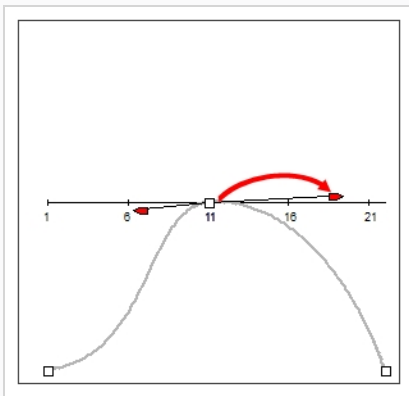

15. Repeat the previous steps until the timing for your animation is adjusted throughout the entire scene.

How to animate an effect in the Layer Properties dialog

1. Open the effect's Layer Properties by doing one of the following:
 - Add the Layer Properties view to your workspace, then select the effect in the Timeline view.
 - In the Timeline view, double-click on the effect layer, but not on its name.
2. In the effect's layer properties, locate the parameter that you want to animate and click on the Function  button to its right.

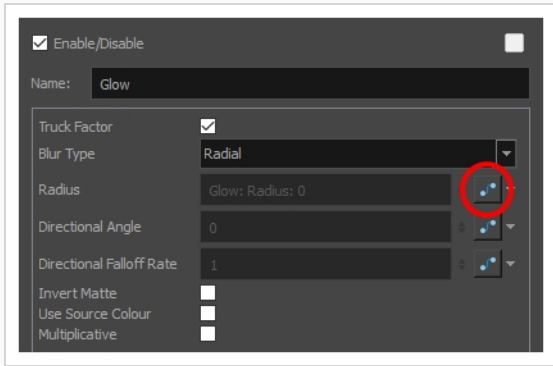

The parameter's input field will be greyed out. This is because you cannot directly edit a parameter once it is attached to a function. The field will indicate the name of the function that was created for it, in this format:

Name of layer: Name of function: Value at current frame

3. Click on the parameter's Function button again.

The Bezier Editor dialog opens.

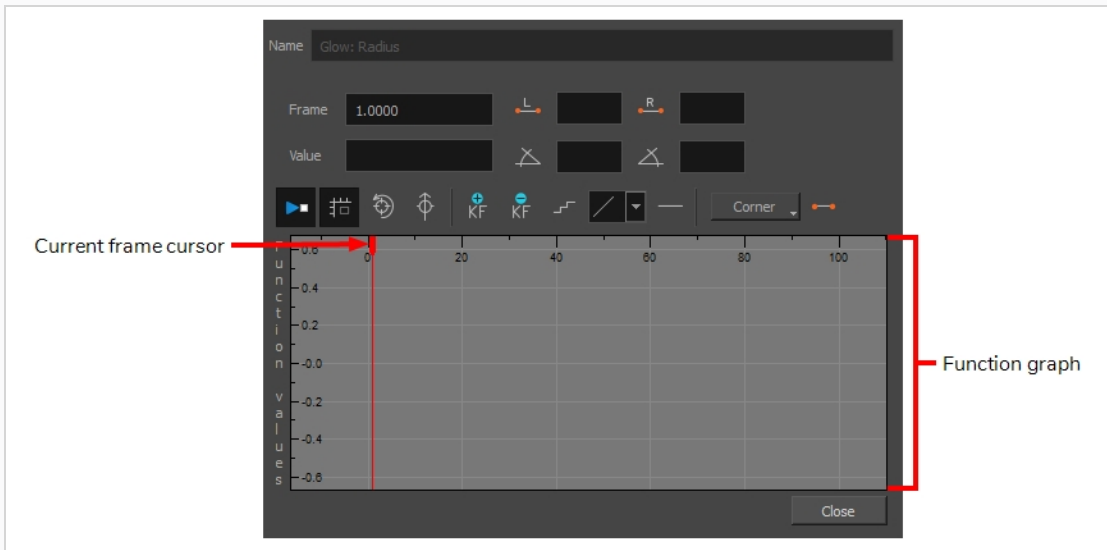

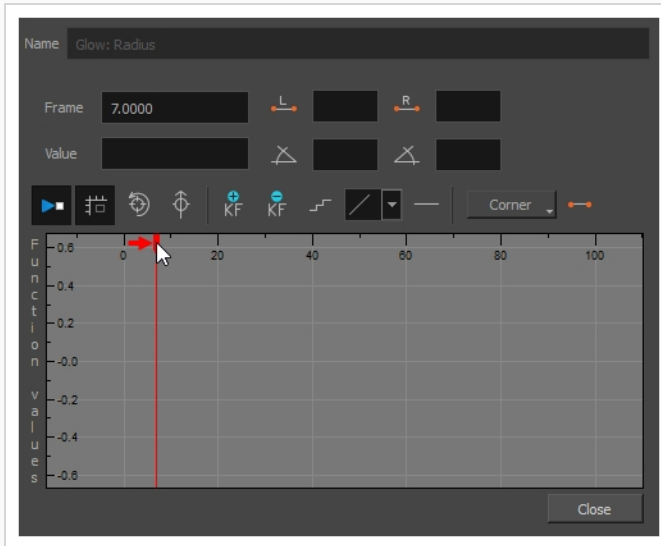

This dialog will allow you to animate the function. The function graph at the bottom is made to represent the values of the function throughout each frame in the scene.

4. In the function graph, click and drag on the red cursor  to move it to the frame where you want to create your first animation keyframe.



5. Click on the Add Keyframe  button to create the first animation keyframe for the effect.

A keyframe  is created and should be visible in the function graph. If you do not see it, that is because the function graph is not positioned to include the keyframe within its frame. To move the function graph to view the function's keyframe, click on the Reset View  or Reset View Vertically  button.

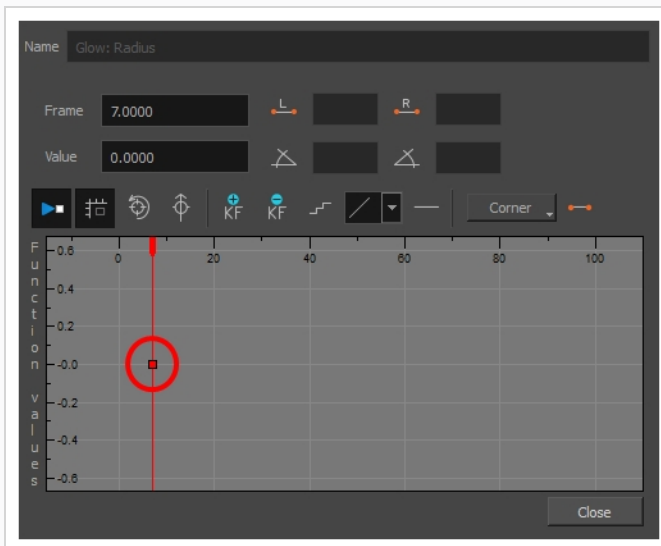

6. Adjust the value of the parameter at the current frame by doing one of the following:
 - In the **Value** field over the function graph, type in the desired value for the parameter.
 - In the function graph, click and drag on the keyframe , and move it up to increase its value, or down to decrease it.

**TIP**

If you want to set the keyframe to a value that is outside of the function graph's frame, you can press the 1 key to zoom out. You can also press the 2 key to zoom back in.

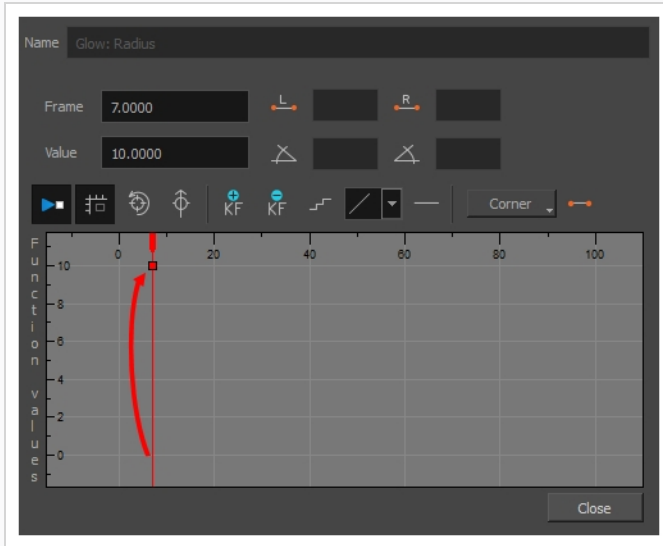

7. Click and drag on the red cursor to move it to the frame where you want to create your second animation keyframe.

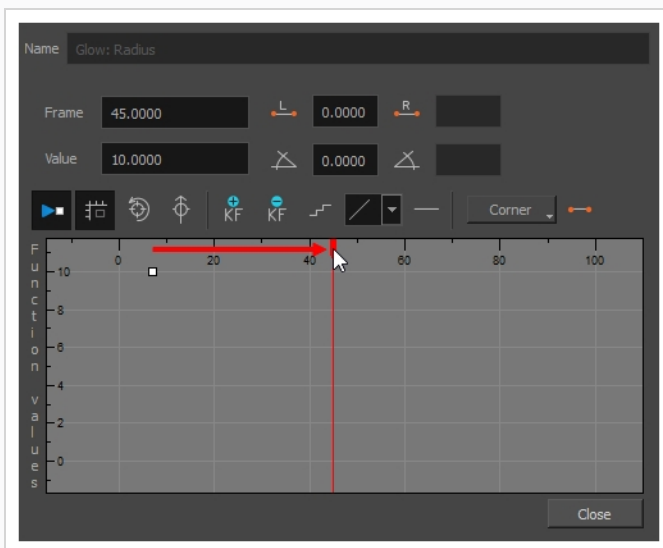

8. Click on the Add Keyframe  button to create the second animation keyframe for the effect.

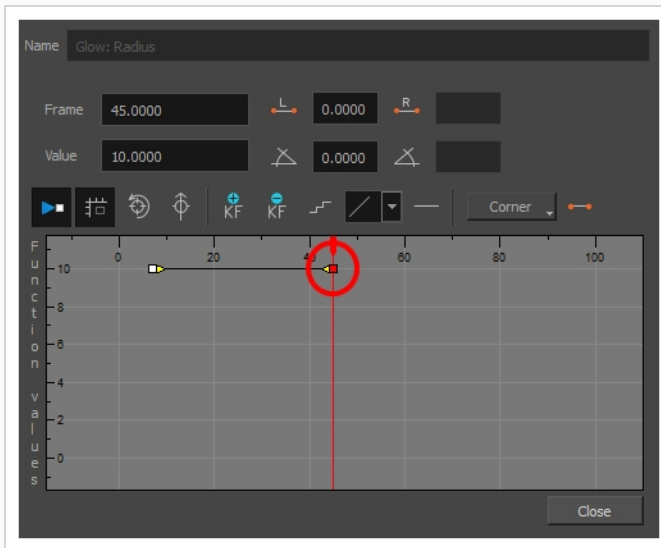

9. Adjust the value of the parameter at the current frame by doing one of the following:

- In the **Value** field over the function graph, type in the desired value for the parameter.
- In the function graph, click and drag on the keyframe , and move it up to increase its value, or down to decrease it.

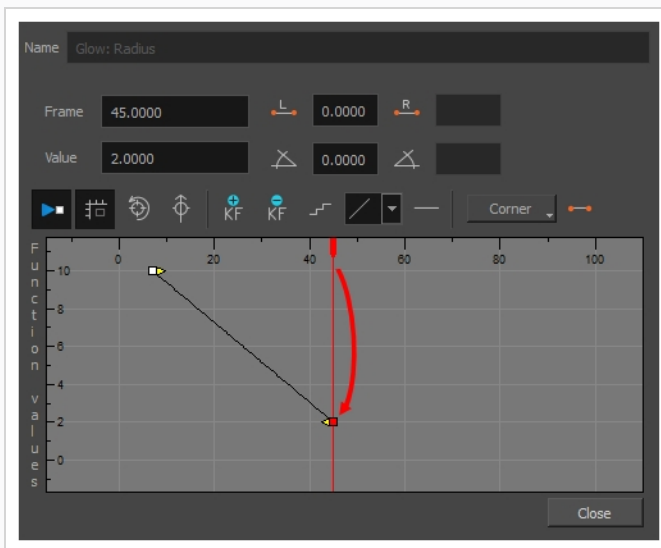

10. If you want to adjust the timing of the animation between the first and second keyframes, do the following:

- Click and drag the Bezier handle of the first keyframe  towards the right, in any direction, to affect the ease-in of the animation.

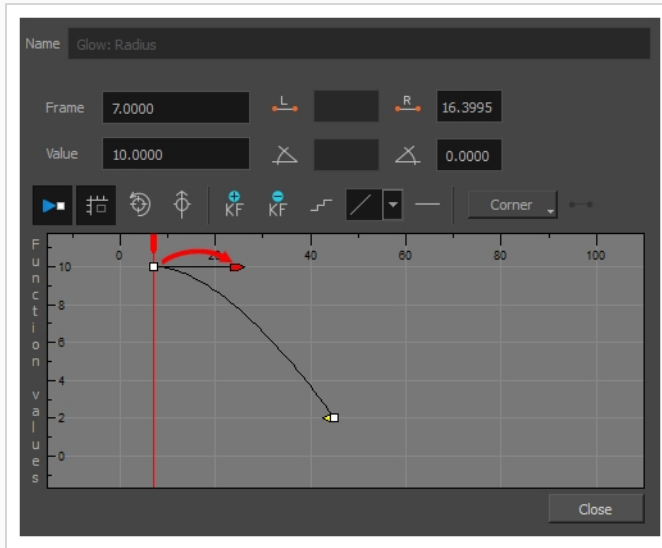

- Click and drag the Bezier handle of the second keyframe  towards the left, in any direction, to affect the ease-out of the animation.

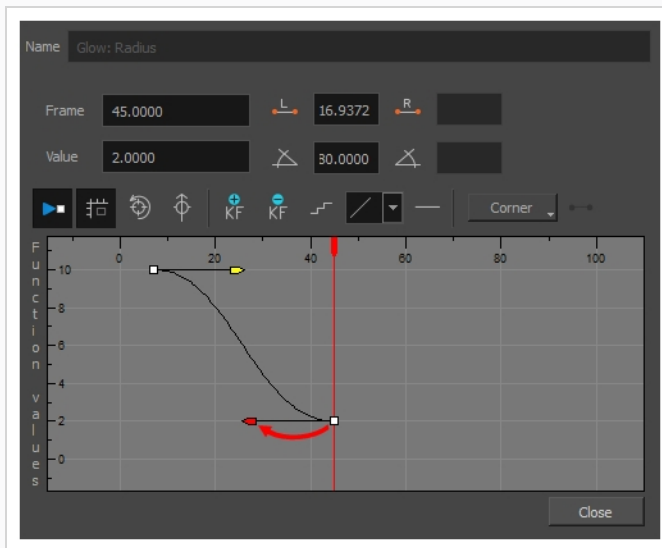

11. Repeat these steps until you created and timed every animation keyframe required to animate your effect.

About Effects Preview

T-HFND-010-010

Most effects must be rendered so you can preview them properly. Some effects can be displayed in the OpenGL view, but most of them must be rendered and previewed in the Render Mode of the Camera view.

Once you preview your effect, you may want to adjust it. By default, as soon as you modify a parameter, Harmony will recalculate the preview image. If your scene is heavy and you do not want the preview rendered automatically, deselect the Auto-Render option and do the preview update manually.

You cannot play back your animation in Render mode. You must perform a render or a preview render to see your animation with the final effects. Effects must be calculated before they can be viewed in real time.

To make your previews calculate faster, you may want to render them at a smaller resolution. You can use the Preview Resolution command so you will not have to modify the resolution of your scene every time you make a check preview.

Previewing Effects in Render Mode

T-HFND-010-011

You can preview a single final frames with all effects calculated in the Camera view when you enable the Render mode. You cannot playback your animation in Render mode. You can also disable the auto-render option when adjusting several effect parameters to avoid slowing down your computer.

How to preview effects in Render mode

1. In the Camera view status bar, click the Render View  button.

In the bottom-right corner of the Camera view, the progress bar indicates the status of the render. Depending on the size of the frame to render, it may take several seconds.

How to disable the Auto-Render option

1. In the Camera view status bar, click the Auto-Render  button. In the top menu, you can enable and disable **Scene > Render > Auto-Render**.

Once the Auto-Render option is disabled, you must request the preview update by clicking the Auto-Render  button.

How to manually update the rendering preview

1. In the Camera view status bar, click the Render  button.

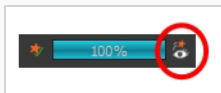

Playing Back Effects

T-HFND-010-012

To playback your effects, you need to do a temporary render.

How to play back effects

1. In the Playback toolbar, click the Render and Play  button.

The Play node opens and loads the frames.

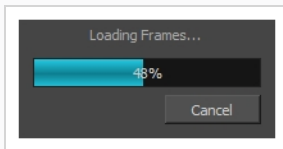

2. Once the frames are loaded, click the Play  button in the Play window.
3. Select **Scene > Render > Cancel Preview Render** to cancel the rendering.



NOTE

While previewing effects, you can press the Spacebar to stop and start playback.

Changing the Preview Resolution

The Preview Resolution command allows you to quickly get a preview at three-quarter, half, one-third, or one-quarter of the scene resolution. You can even customize the preview resolution size.

How to use the Preview Resolution command

1. From the top menu, select **View > Preview Resolution** and one of the following:
 - ▶ Same as Scene Resolution
 - ▶ 3/4 of Scene Resolution
 - ▶ 1/2 of Scene Resolution
 - ▶ 1/3 of Scene Resolution
 - ▶ 1/4 of Scene Resolution
 - ▶ Custom

If you selected the Custom option, the Custom Preview Resolution dialog box opens.

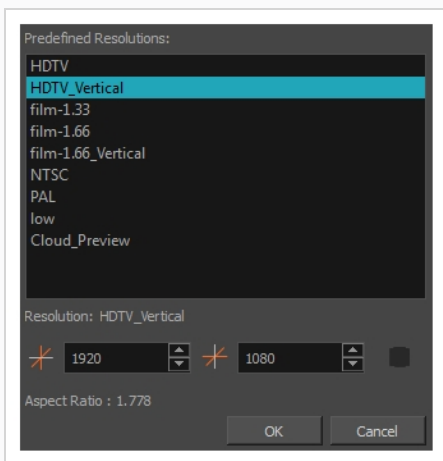

2. In the dialog box, select a resolution from the presets or type a new X-Y value.
3. Click **OK**.
4. Preview your effects animation.

About Masking and Cutting Parts of Elements in your Scenes

An important part of staging and rigging is *cutting*. Cutting is the process of making parts of a drawing that intersect with another drawing invisible. It allows you, for example, to mask parts of a character that should appear behind a background element that is drawn on the same layer as other background elements, to mask two parts of a rig that should not overlap, or to confine an effect within the outlines of an element in your scene.

There are two methods to cutting in Harmony:

- Using the matte port of a drawing layer. With this port, you can connect any drawing layer to another drawing layer or group, and use the latter as the drawing layer's matte. Any part of the drawing that intersects with the artwork in its matte will be hidden.
- Using a Cutter effect. A cutter effect can be connected to a drawing, effect or group, and then can use any other drawing layer or group as its matte. Any part of what is connected to the Cutter effect which intersects with the artwork in its matte will be hidden.

Hence, if you only want to hide parts of a single drawing layer, you can use the drawing's matte port. If you want to hide parts of a group or an effect, you will have to use a cutter effect



NOTE

In either case, the effects of cutting can be inverted. When inverted, only the parts of the artwork that intersect with the matte are visible, and everything else is hidden.

Using the Matte Port of a Drawing Layer

Each drawing in a Harmony scene has their own Matte port. Connecting a drawing or group to a drawing's matte port will make the parts of the drawing that intersect with the matte image invisible.

Optionally, you can invert a drawing layer's matte. This will make parts of the drawing that intersect with the matte image visible, and everything else hidden.

How to connect a matte drawing layer to a drawing layer

1. In the toolbar above the layer list in Timeline view, click on the Add Layer **+** button and select **Drawing**.
2. Give your new drawing layer a relevant name for a matte layer, such as "Matte-Drawing", then click on **Add and Close**.

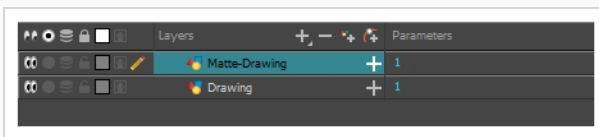

3. In the new matte drawing layer, draw a matte for your effect. Your matte can be a simple shape, but should be filled with a colour, as only parts of the matte that are opaque will be taken in account.

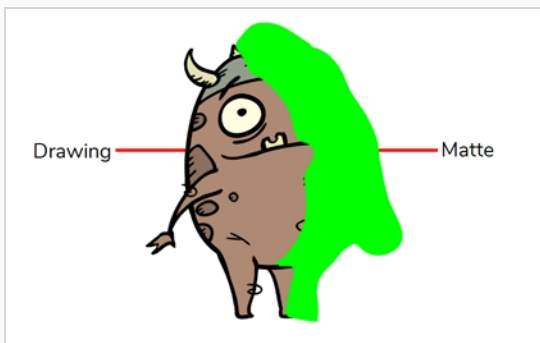

NOTE

Mattes can also have semi-transparent areas. Areas of the drawing that are covered by a semi-transparent area of the matte will appear semi-transparent. For example, if a matte is filled with a colour that has an alpha value of 64 (25% opaque), instead of making the parts of the drawing it covers completely invisible, it will subtract the matte's opacity from the opacity of those parts of the drawing, making them 75% opaque.

- In the Timeline view, click on the Expand **+** button right of the drawing layer.

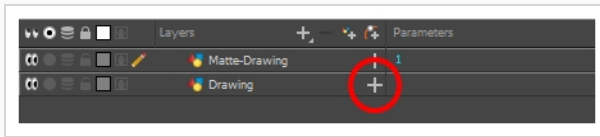

The drawing layer's parameters appear below it. The first parameter is the Matte parameter, which allows you to use another layer in your scene as the drawing layer's matte.

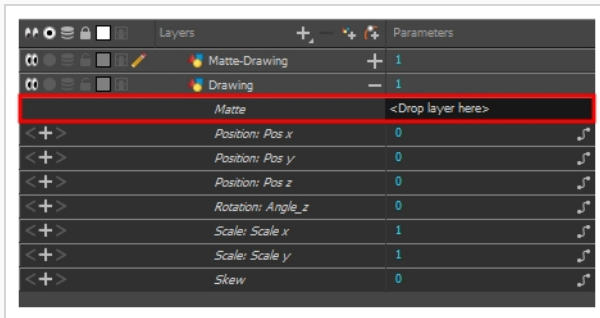

- Drag and drop your matte layer next to your drawing layer's **Matte** field, under the **Parameters** column.

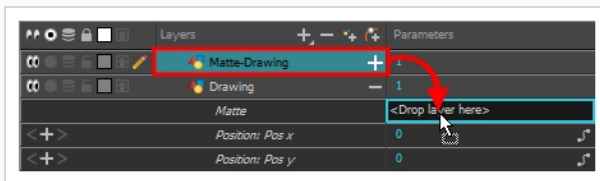

The matte drawing layer becomes the drawing layer's matte. At this point, areas of the drawing that intersect with the artwork in the matte drawing layer are hidden.

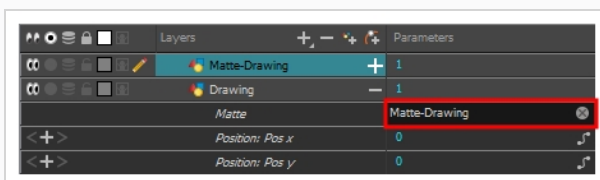

- If you want to invert the matte effect for the drawing layer, so that the artwork that intersects with the artwork in the matte layer is visible and that everything else is hidden, do the following:
 - Double-click on the drawing layer (but not on its name) to open its Layer Properties dialog
 - In the Layer Properties dialog, select the **Drawing** tab.
 - Check the **Invert Matte** check box.

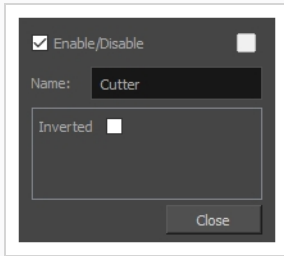

Using the Cutter Node

T-HFND-010-009A

You can use the Cutter node to hide parts of a drawing, a group or an effect. The Cutter node must be connected to a drawing that will serve as a matte. Parts of the drawing, group or effect that intersect with the matte drawing will be hidden.

Optionally, you can also invert the Cutter node's matte, which will make parts of the drawing, group or effect that intersect with the matte drawing visible, and everything else will be hidden.

How to use the Cutter effect

1. Select a drawing layer.
2. Do one of the following:
 - In the toolbar above the layer list in the Timeline view, click on the Add Layer **+** button and select **Effects > Cutter**.
 - Right-click on the layer and select **Insert > Effects > Cutter**.

The Cutter effect is created as a child of the selected layer.

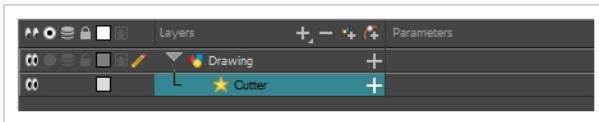

1. In the toolbar above the layer list in Timeline view, click on Add Drawing Layer **+**.
2. In the Add Drawing Layer dialog, give your new drawing layer a relevant name for a matte layer, such as "Matte-Drawing", then click on **Add and Close**.

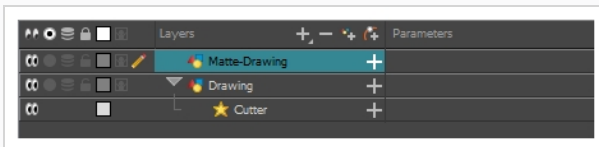

3. In the new matte drawing layer, draw a matte for your effect. Your matte can be a simple shape, but should be filled with a colour, as only parts of the matte that are opaque will be taken in account.

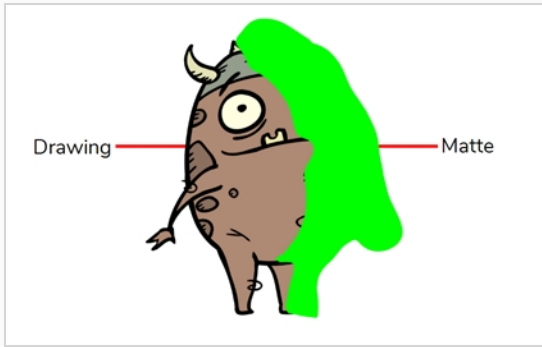

 **NOTE**
Mattes can also have semi-transparent areas. Areas of the drawing that are covered by semi-transparent areas of the matte are partially affected by the effect.

4. In the Timeline view, click on the Expand **+** button right of the Cutter layer.

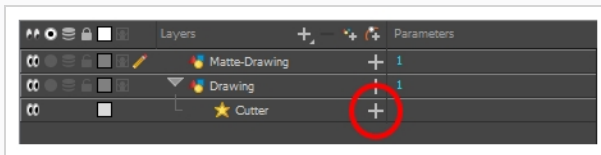

The Cutter's Matte parameter appears below it.

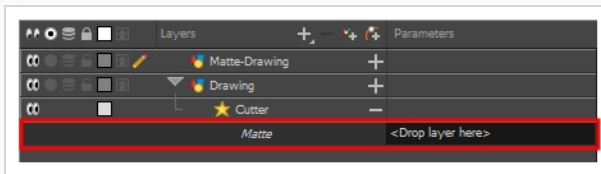

5. Drag and drop your matte layer next to your Cutter layer's **Matte** field, under the **Parameters** column.

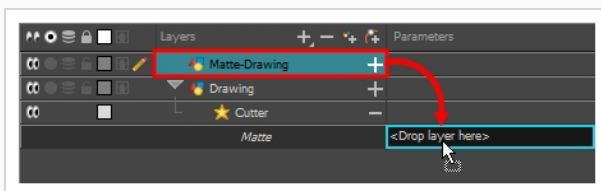

The matte drawing layer becomes the Cutter layer's matte. At this point, areas of the artwork that

intersect with the artwork in the matte drawing layer are hidden.

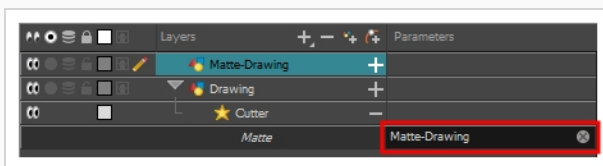

6. If you want to invert the Cutter's effect, so that the artwork that intersects with the artwork in the matte layer is visible and that everything else is hidden, double-click on the Cutter layer (but not on its name) to open its Layer Properties dialog, then check the **Inverted** parameter.

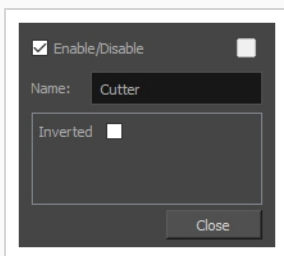

Examples of Effect Usage

The following section gives examples of how to use a few commonly used effects in Harmony.

Creating a Drop Shadow

The Shadow effect converts the drawing layer it is connected to into a dark, blurry matte. You can control the type and amount of blur, as well as the colour of the shadow.

On its own, simply connecting a drawing or group to this effect will only convert your drawing to a shadow, which might not be useful. However, it is possible to make both the original character and its shadow version appear in your scene, and have the shadow version transformed and distorted to appear as a drop shadow.

You can accomplish this by doing one of the following:

- Cloning the layers or group. You can then add the effect to the clone, and add a peg on top of the clone to transform it.
- Adding the layers or group to a symbol, then putting two instances of that symbol in your scene. You can then add the effect to one of the instances, and add a peg on top to transform it.



TIP

When creating a drop shadow against a floor, you can obtain a more realistic effect by using a Quadmap to transform the shadow instead of a Peg. A Quadmap is similar to a peg, except that it allows you to apply perspective effect to the drawings underneath it.

How to create a drop shadow for an animated character

1. In the Timeline view, select all the layers making your character's rig. If your character is under a master peg, selecting the master peg will also work.

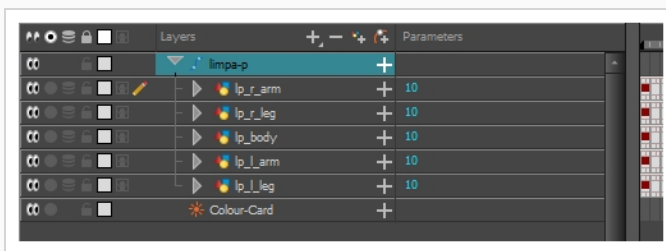

2. Make sure your character's rig is in a group. If it is not, right-click on your selection, then select Group Selection.

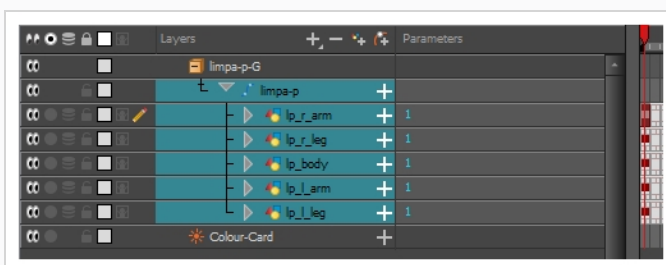

3. With your character selected in the Timeline view, create a Clone of your character by doing one of the following:

- Right click on your selection, then select **Clone Selected Layers: Drawings and Timing**.
- From the Top menu, select **Edit > Clone: Drawings and Timing**.

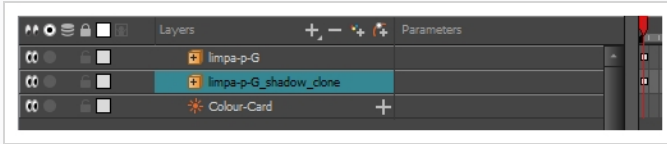

NOTE

Contrary to a duplicate, a cloned layer always has the same timing and exposure as its origin layer, even if its origin layer is changed later. Hence, you can make changes to your character's animation, and your cloned character's animation will automatically update with these changes.

4. Add a Shadow effect to your group by doing one of the following.

- In the Timeline view's layers toolbar, click on Add Layers **+** and select **Effects > Shadow**.
- Right-click on your selection, then select **Insert > Effects > Shadow**.

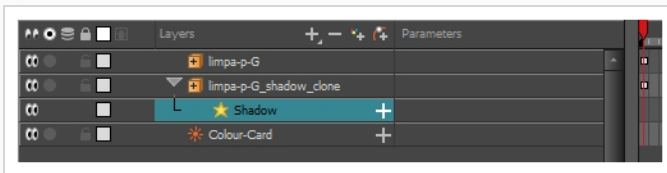

5. In the Timeline view, select the root layer of your character's clone.

6. Create a parent peg for your clone by doing one of the following:

- From the Timeline View layers toolbar, click the Add Peg **+** button.
- Press **Ctrl + P** (Windows/Linux) or **⌘ + P** (macOS).

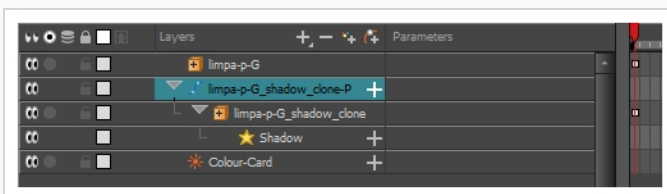

7. In the Timeline view, select your clone's parent peg.

8. In the Tools toolbar, select the Transform **□** tool.

9. In the Camera view, scale and skew your clone so that it looks like a drop-shadow.

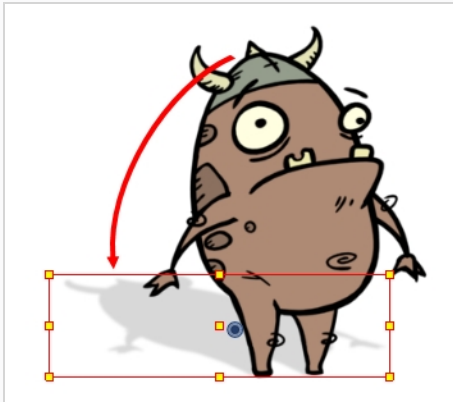

Chapter 15: Sound

With Harmony, you can import soundtracks and dialogue into your animation. There are several sound editing features you can use to synchronize sounds to individual frames or moments in time. You can also edit them to trim unwanted seconds from the beginning and end of your sound files, as well as loop sounds that you want to continue throughout your animation.

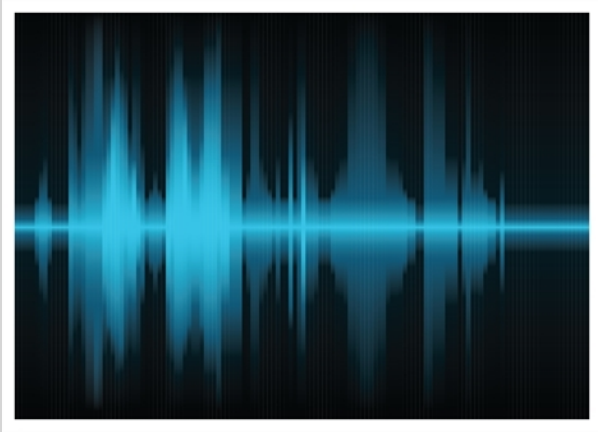

Your ability to add dialogue to animation is greatly enhanced with the Harmony automatic lip-sync detection. Harmony can analyze voice tracks to determine which of the eight animation phonemes (lip positions) would best apply to each frame of sound. With the mouth chart that is generated, you can easily draw lip positions for your character. Furthermore, Harmony can automatically apply drawings of lip positions to each frame of your animation based on the mouth chart.

About the Sound Editor

When you double-click on a sound layer in the Timeline view, the Sound Element Editor appears.

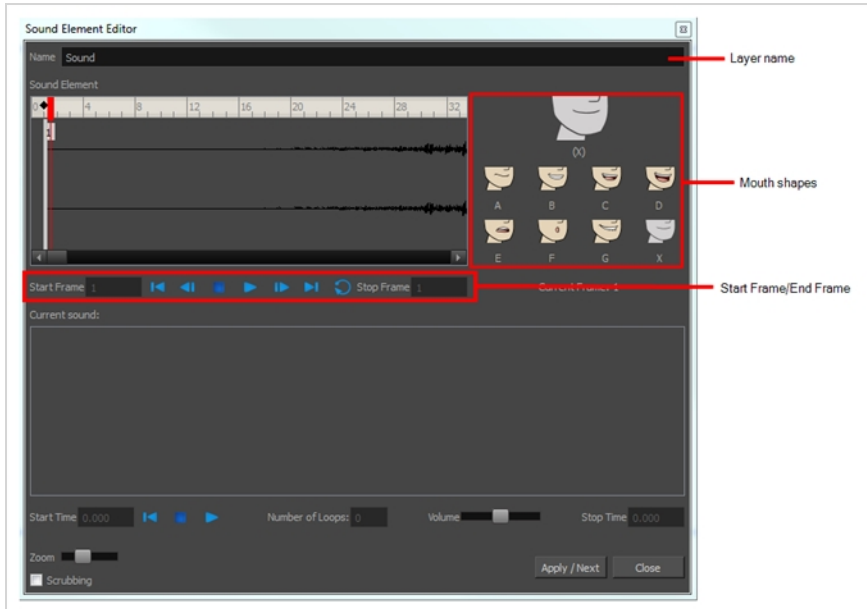

- **Mute/Unmute:** This button mutes and unmutes the sound layer during the scene play back.
- **Layer Name:** This field displays the layer's name.
- **Sound Editor:** This button opens the Sound editor.
- **Start Frame/End Frame:** These fields determine the start and end frame of the sound file.
- **Detect:** This button launches the automated lip-sync detection.
- **Map:** This button opens the Map Lip-sync dialog box.
- **Mouth Shapes:** This section shows the automated lip-sync detection during the scene play back. Click on the thumbnail image of each mouth to change the phoneme assigned to the current frame.

Sound Layer

When you select a sound layer in the Timeline view, the options related to that layer appear in the Layer Properties view.

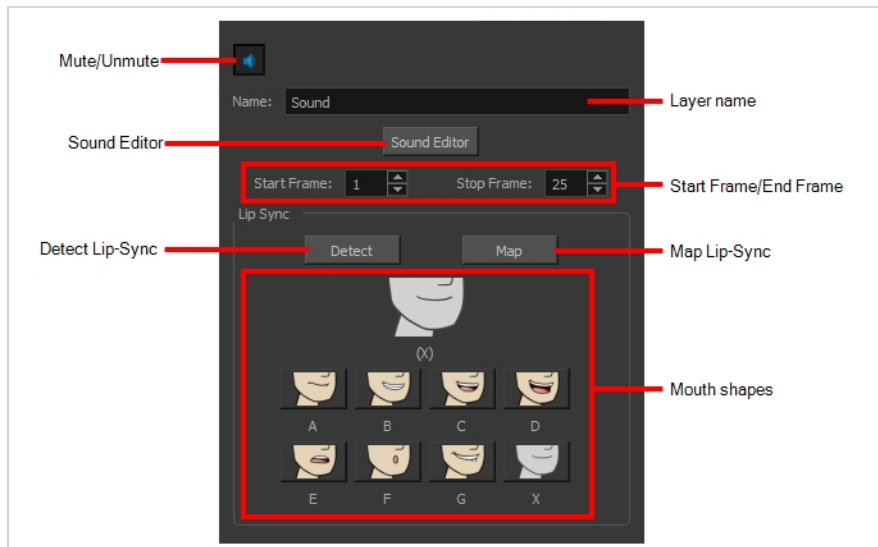

If you double-click on a sound layer in the Timeline view, or in a sound column in the Xsheet view, the Sound Element Editor dialog will open. This dialog allows you to fine-tune the sound track's lip sync, start time, stop time and volume.

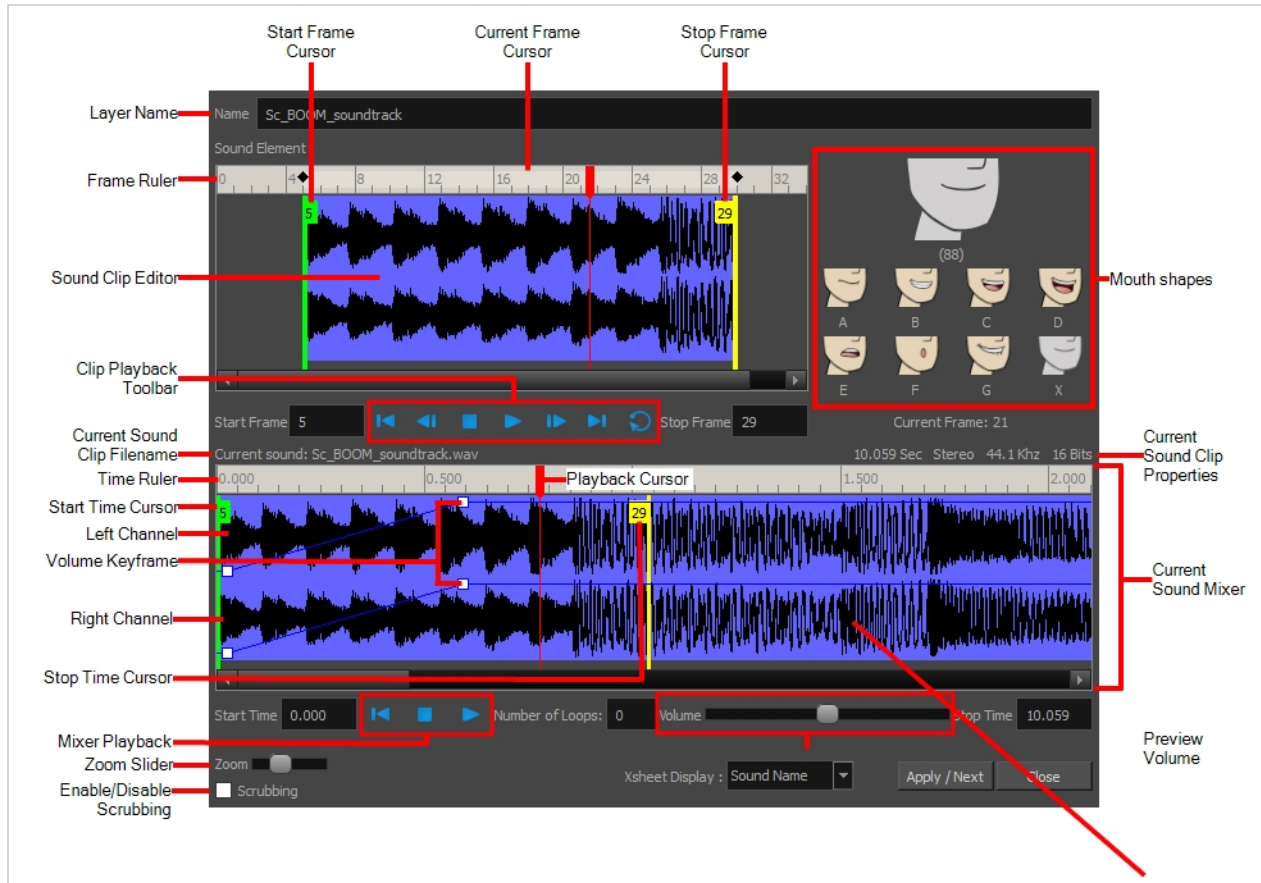

Importing Sound

T-HFND-007-009

If you wish to add sound to your animation, it is recommended to edit and mix your sound files in a sound editing software. Having full-length pre-mixed soundtracks ensures the audio preserves its timing, mixing and quality should you use third party software for post-production. Another good practice is to keep your soundtrack separated in tracks for music, sound effects and characters to make it easier to sync your animation with voices and sounds. Otherwise, it is possible to clip sound effects and adjust their volume directly in Harmony when needed.

If you create your project in Toon Boom Storyboard Pro, you can export all of your project's scenes as separate Harmony scenes. The storyboard's sound track will be cut up by scene and each piece will be inserted into the exported scenes, allowing you to save time on splitting and importing your sound track.

Harmony can import .wav, .aiff and .mp3 audio files.



NOTE

Importing a soundtrack longer than your scene will not extend your scene's length. Sound playback will stop at the end of your scene's length.

How to import a sound file

1. Do one of the following:

- From the top menu, select **File > Import > Sound**.
- In the Xsheet view, right-click anywhere in the frame area and select **Import > Sounds**.

The Select Sound File dialog box opens.

2. From the Select Sound File dialog box, find and select a sound file.

The sound file appears as a layer in the Timeline view. Its waveform is displayed in the track to help you visualize at which frames the sound effects in your soundtrack occur.



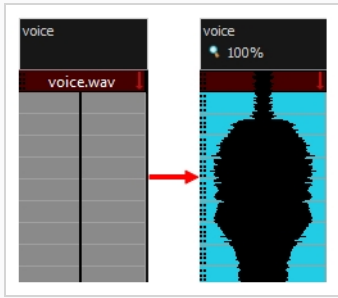

Your soundtrack also appears as a column in the Xsheet view, but will not display a waveform by default. If you wish, you can display a sound column's waveform by right-clicking on it, then selecting **Sound Display > Waveform**.



Playing Sound

T-HFND-007-010

Before playing back any sound, click the Enable Sound  button in the Playback toolbar or enable it through the Play menu (in the top menu). This will ensure that you can hear the sound layers in your scene, even the ones included within symbols.

If there are two or more sound layers and you want to listen to them independently, you can disable the unwanted sound by clicking the Disable Layer  button on the sound name layer in the Timeline view.

If you are trying to do a playback with sound and the frame rate doesn't reach 24 fps (frame per second), you can do one of the following to troubleshoot the issue:

- Shrink down the Camera view size to reduce the cached image size.
- Playback your scene without sound first, then add the sound. If you do not cache the images first without sound, the playback will try to follow the sound by skipping images that will never get cached.

How to play back sound

1. To select a starting point:

- In the Timeline view, click on a cell in the sound layer. You can also slide the red playhead to the correct cell.





2. In the Playback toolbar, activate the Enable Sound  button.

3. Do one of the following:

- Click the Play  button in the Playback toolbar.
- From the top menu, select **Play > Play** or click on the Enter/Return key.

4. To hear the sound played back again and again, do one of the following:

- Click the Loop  button in the Playback toolbar
- From the top menu, select **Play > Loop**.

5. To mute soundtrack, on the left side of the sound layer, click the Disable Layer  button.

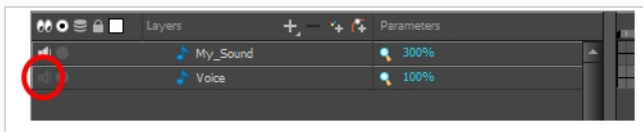

Changing the Sound Display

Within the Xsheet view, you can display the sound file in different ways, depending on your sound editing needs.

You can show or hide the waveform in the Timeline view by selecting the Waveform  button in the Timeline View toolbar. You must customize the toolbar to display this button because it is not included in this toolbar by default.

How to change the sound display in the Timeline view

1. In the Timeline view's right area, right-click in the frame section and select **Show Sound Waveforms**.

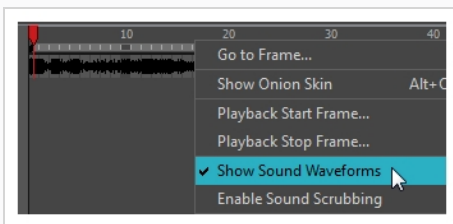

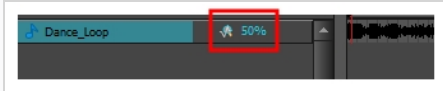

- You can change the waveform scale using the Zoom Waveform  icon on individual sound layers in the Timeline view's left side.



How to change the sound display in the Xsheet view

1. Right-click in the sound column or on the sound column header, and select **Sound Display** and one of the following:
 - **Sound Name:** Shows the name of the sound file, as well as the file format. The line running vertically through the column frames between the same file name indicates a continuity of the same sound file in these frames.
 - **Mouth Shapes:** Shows the letter (or name depending on the way you named your character's different mouth positions) in the column's frames. There is only one mouth position allotted per frame and this position should correspond to the sound file after performing a lip-sync.
 - **Waveform:** Shows a vertical display of the sound file's actual waveform. In the column header, in the field under the column name, you can type in a percentage to zoom in or

zoom out on the waveform, or pass the scroll cursor  over the Zoom Waveform  icon.

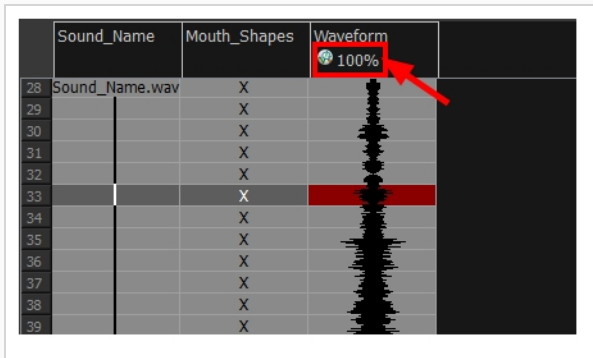

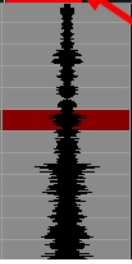
	Sound_Name	Mouth_Shapes	Waveform
28	Sound_Name.wav	X	
29		X	
30		X	
31		X	
32		X	
33		X	
34		X	
35		X	
36		X	
37		X	
38		X	
39		X	

Sound Scrubbing

Harmony uses a process known as Sound Scrubbing to let you hear sound in real-time while you move the playback pointer forward or backward. This is very useful for finely-tuned lip-synching. You can scrub sounds from the Timeline view.

How to scrub a sound from the Timeline view

1. Do one of the following:
 - ▶ From the top menu, select **Play > Enable Sound Scrubbing**.
 - ▶ Right-click in the frame bar of the Timeline view and select **Play > Enable Sound Scrubbing**.
 - ▶ In the Playback toolbar, enable the Sound Scrubbing  button.

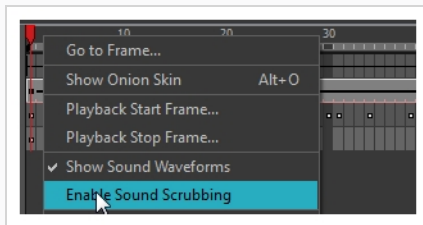

2. At the top of the Timeline view, drag the red playhead to hear the sound at each frame.



3. In the Playback toolbar, you can use the jog slider to playback forward and backward subsequent sound frames. This allows you to do a more fluid scrubbing.

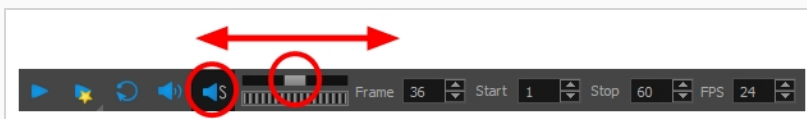

Editing Sound

Now that you have successfully imported a sound file into Harmony, it is time to familiarize yourself with the sound editing interface. The Sound Element editor makes it possible to edit sounds that were created outside of Harmony and imported into your scene.

How to open the Sound Element editor

1. Double-click on the sound layer name in the Timeline view or the sound column header in the Xsheet view.

The Sound Element Editor dialog box opens.

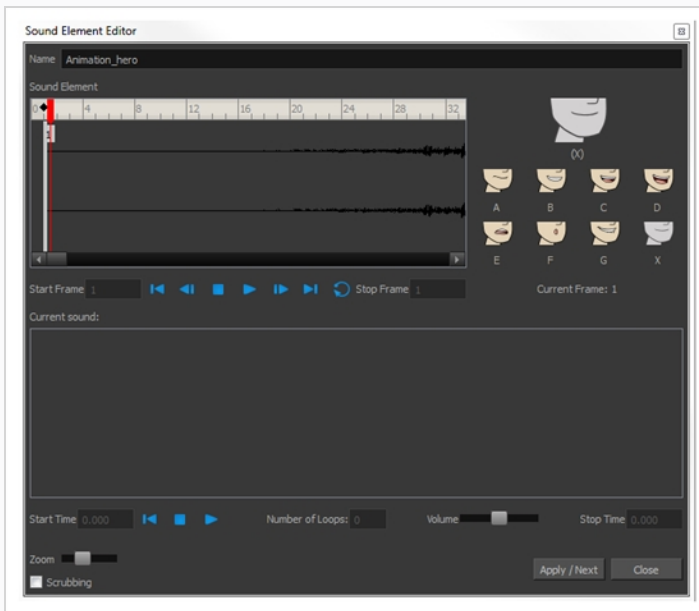

The Sound Element editor consists of three main parts.

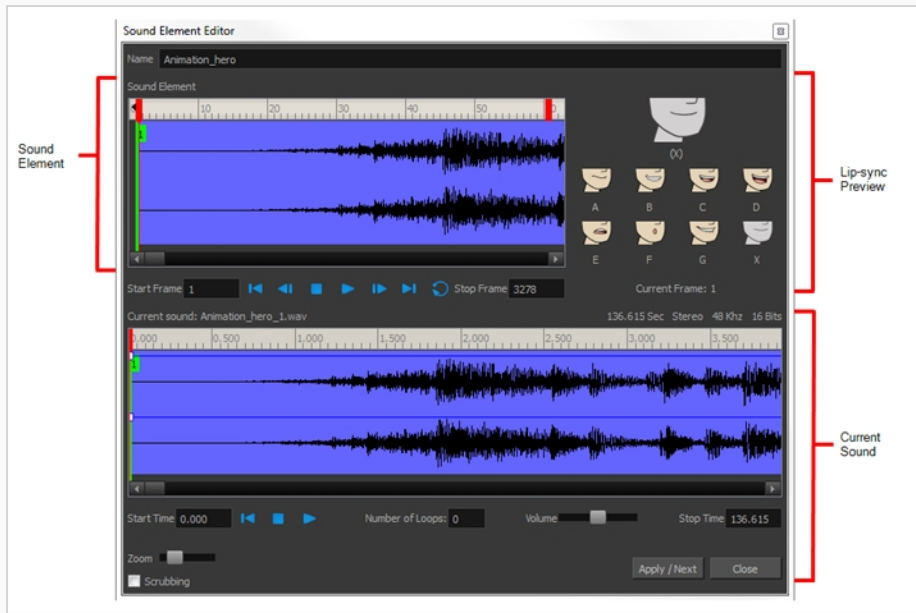

- **Sound Element:** The waveform in the Sound Element Editor is the actual sample that will be heard when the final movie is rendered. It may be shorter than the original sound sample due to the length of the scene. If any edits are made to the sound sample, they can be heard here. In the Sound Element panel, notice the coloured tabs that indicate the start and end frames of a sound segment. The frame number is displayed in the tab.
- **Current Sound:** Displays the original sound file in its entirety and is where you can edit its properties. This window remains empty until you click inside the Sound Element Editor.
- **Lip-sync Preview:** Lets you preview the automated detection and to manually insert different mouth positions to correspond with the sound sample.

Cropping Sound

To synchronize the sound with specific images in your scene, you must set a start frame for your sound. To make sure the sound ends by a certain frame, you must set an end frame.

In the Sound Element panel you will see some coloured tabs, these tabs represent the frames. The frame number is shown inside the tab flag marker. These tabs indicate the start and end frames of a sound segment.

How to change start or end frame of a sound

1. Double-click on the sound layer name in the Timeline view or the sound column header in the Xsheet view.
2. In the Sound Element editor, select a sound sample from the Sound Element section. To distinguish one sound section from another on the same sound layer, check the frame numbers that appear on tabs flanking the start and stop lines of each waveform section.

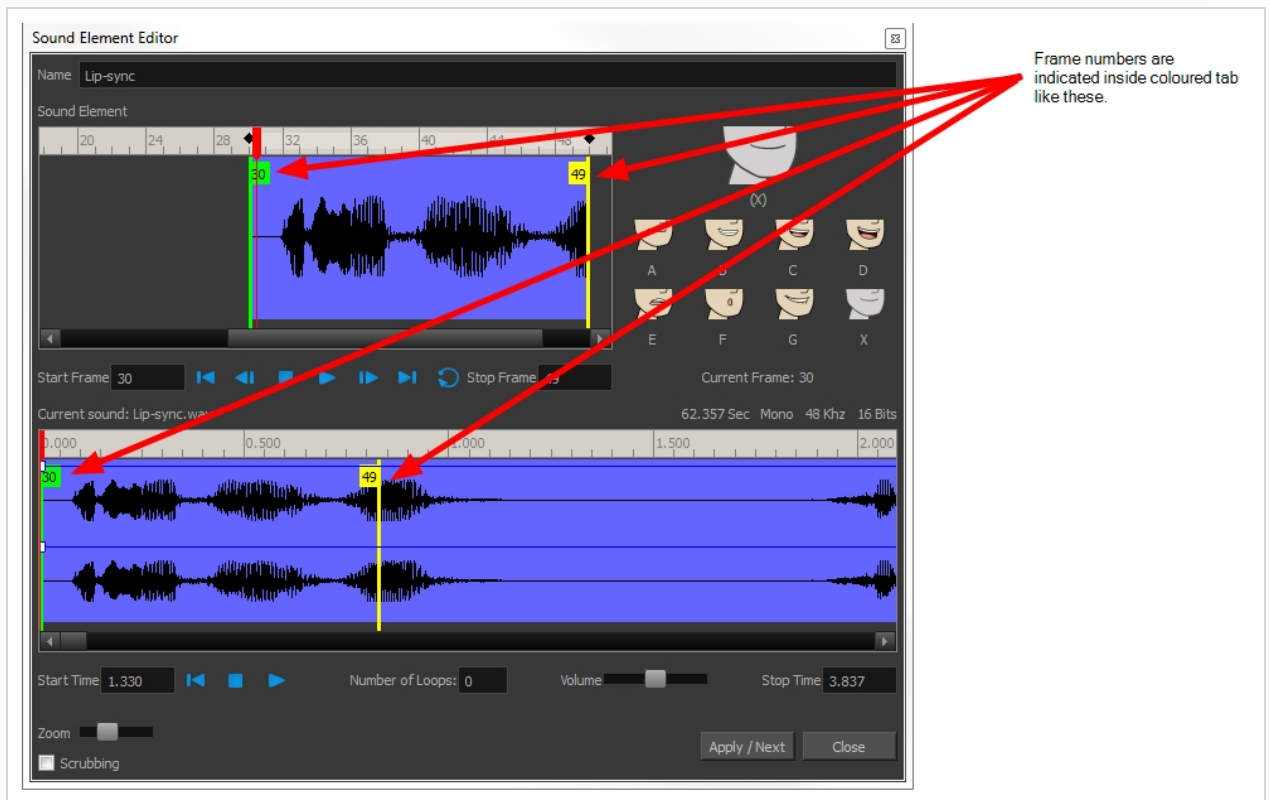

Click the Play ► button in the Current Sound section (only the selected sound plays).

3. Within the Sound Element panel, drag the selected clip to the frame number where you want it to start playing.

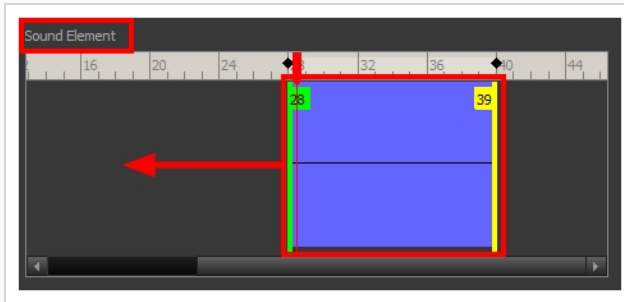

You can only move the clip to a section that does not already contain a clip; you cannot overlap two clips in the same element.

- To change the end frame, drag the yellow marker at the end of the waveform to the frame position.



- To hear how all the clips fit together in the element, click the Play button in the Sound Element section.

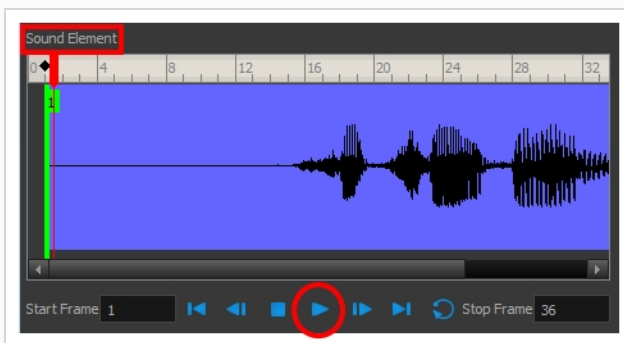

If you only want to hear the selected clip, click the Play button in the Current Sound section.

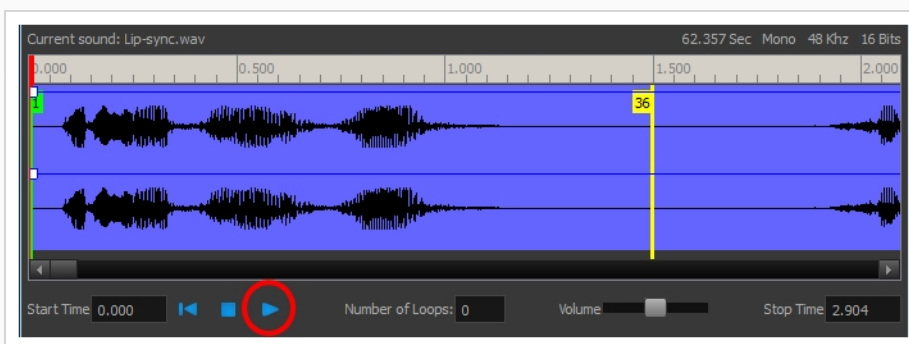

6. Click **Apply/Next**.

The Xsheet and Timeline views display the sound clip at the start frame you selected.

Trimming Sound

To play only a section of a sound file, use the Sound Element editor to select the exact part you want to use. For example, if there is a bit of noise at the start of the sound, use the Sound Element editor to cut the noise.

The Sound Element Editor does not change the original sound file; it only plays a section of it, ignoring the rest. This means that the entire sound file is included on export. If you need to be mindful of file size, it is better to edit sound files completely in a sound editor before bringing them into Harmony.

How to trim the start and end of a sound file

1. Double-click on the sound layer name in the Timeline view or the sound column header in the Xsheet view.
2. In the Sound Element editor, select a sound sample from the Sound Element section. To distinguish one sound section from another on the same sound layer, check the frame numbers that appear on tabs flanking the start and stop lines of each waveform section. Or select a soundwave and click the Play ► button in the Current Sound panel (only the selected sound plays).
3. Using the Current Sound section, decide on the part of the file you want to play by dragging the left and right boundaries of the selection area.

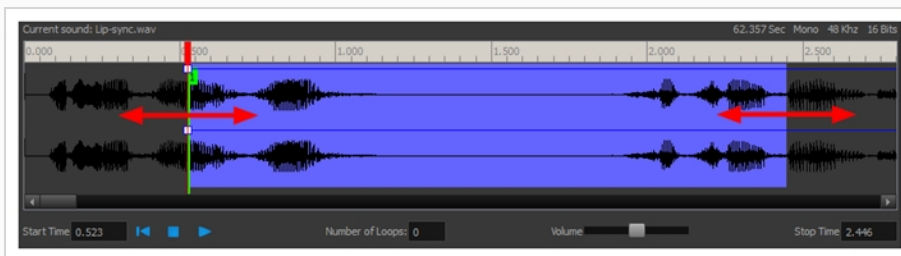

4. Click the Play ► button in the Current Sound section to check that you have trimmed the desired sections. Use the Zoom slider at the bottom of the panel to zoom in on the waveform so you can trim it more accurately.



5. Click **Apply/Next**.

The trimmed sound sample appears in both the Timeline and Xsheet views at the start and end positions you selected.

Looping Sound

To repeat a sound, specify the number of times that you want it to loop in the Sound Element editor.

How to loop a sound sample

1. Double-click on the sound layer name in the Timeline view or the sound column header in the Xsheet view.
2. From the Sound Element section, select the sound section you want to loop.
3. In the Current Sound section, type the number of times you want the sound to play in the Number of Loops field.

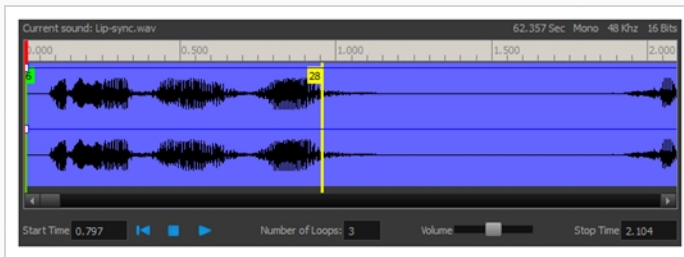

4. Press the Enter/Return key.

The looped sound appears after the current sound. They are indicated by their grey waveforms, as opposed to black.

When you loop a sound, the looped sections fill the cells in the sound element (column or layer) until the next sound sample starts or until the scene ends. This means that the looping could be cut if the next sound sample starts too soon or if the scene ends too quickly.

Mixing the Sound Volume

You can adjust the volume of an entire sound clip or modify the volume in increments by adjusting the fade-in and fade-out times, otherwise known as sound envelopes. The fade edit only affects the playback; the original sound file is not affected.

How to adjust the overall volume of the entire sound clip

1. Double-click on the sound layer name in the Timeline view or the sound column header in the Xsheet view.
2. In the Sound Element section, select the sound you want to work on.
A more detailed version of the selected sound appears in the Current Sound section.
3. In the Current Sound section, use the Volume slider to adjust the volume.

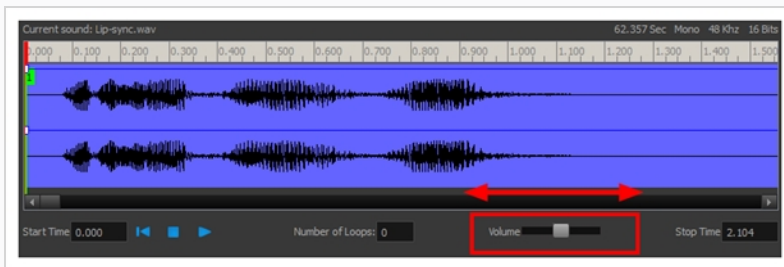

4. Click the Play ► button in the Current Sound panel to verify the volume.

How to create the fade in/out effect on a sound clip

1. Double-click on the sound layer name in the Timeline view or the sound column header in the Xsheet view.
2. In the Sound Element section, select the sound you want to work on.
3. In the Current Sound section, click on the thin blue line above the waveform to add an envelope marker.

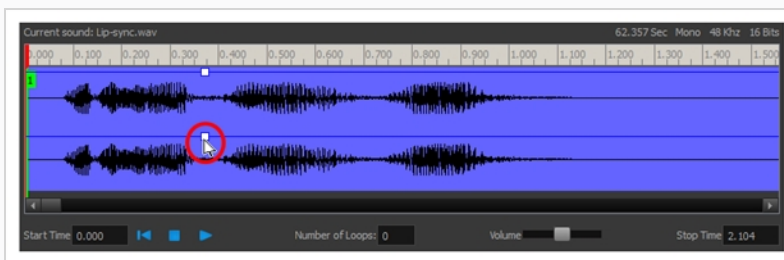

4. Drag the envelope markers to adjust the volume at that frame and to create the time of the transition. The line from the edge of the clip to the envelope marker identifies how the volume increases (fades-in) or decreases (fades-out) over time.

Dragging the marker to the bottom of the channel mutes the volume, while dragging it upwards increases the volume.



NOTE

To create an even effect, be sure to adjust the envelope markers uniformly in both the left and right (bottom and top) channels.

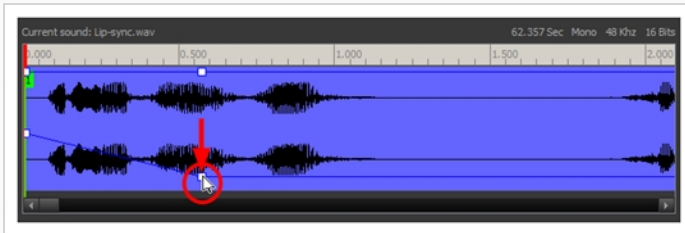

5. Click the Play ► button in the Current Sound panel to check the fade envelopes.

Setting the Playback Range

To hear a specific section of the sound element, adjust the playback range in the Sound Element editor to start or stop at specific frames. This customized playback range does not affect the actual sound in the Sound element.

How to change the playback range in the Sound Element editor

1. Drag the start or end range markers in the Sound Element section to the boundary frames you want.



2. When you click the Play ► button to play back your sound in the Sound Element editor, it only plays the sound which exists between the two markers.

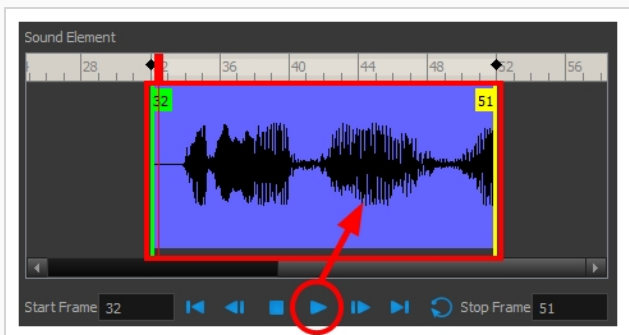

Adding an Empty Sound Layer

When performing sound editing tasks, it can be useful to chop up a sound sample into different layers. For example, when performing a lip-sync, only a single view of the various mouth positions for a character can exist on one layer. Therefore, if you want to have a character turn its head from a profile view to a three-quarter view and have mouth position changes to fit with the sound sample from these two different views, you would need to cut up the sound samples needed for the profile view mouth positions on one layer and the sound samples needed for the three-quarter view on another.

For this task, you will need an empty sound layer.

How to add an empty sound layer

1. In the Timeline Layer toolbar, click the Add Layer button.
2. From the drop-down menu, select **Sound**.

An empty (silent) sound layer appears in both the Timeline and Xsheet views.



3. Rename the layers accordingly by double-clicking on the layer name and renaming it in the Sound Element editor. Click **Apply/Next** to accept the change.

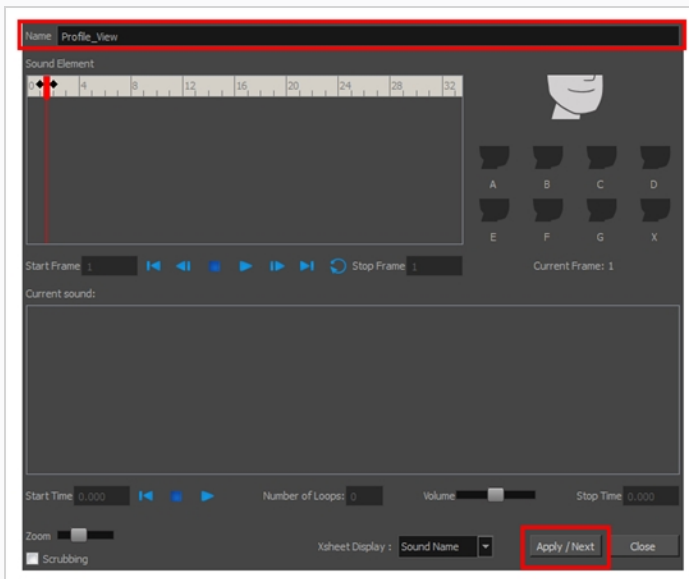

1. In the sound file you want to grab sound frames from, click the cell where you want to start the cut and Shift + click on the final cell of the cut. The sample to be cut becomes highlighted.

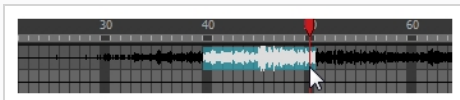

2. Drag the selection into the empty sound layer below.

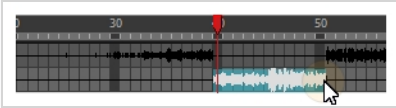

4. You can now continue to cut-up and distribute the sound sample between the two layers or carry on to the lip-synching process for each layer and its corresponding facial view.

**NOTE**

If you need to duplicate your sound layer to keep an unedited copy for safety, select the Duplicate Selected Layers button in the Timeline View toolbar. You must customize the toolbar to display this button because it is not included in this toolbar by default.

About Lip-sync

Adding a lip-sync to your animation is essential to making your characters seem alive. However, it is also a particularly tedious part of the animation process.



To solve this problem, Harmony provides an automatic lip-sync detection feature. This feature analyzes the content of a sound track in your scene and associates each phoneme it detects with one of the mouth shapes in the following mouth chart, which is a standard mouth chart in the animation industry.

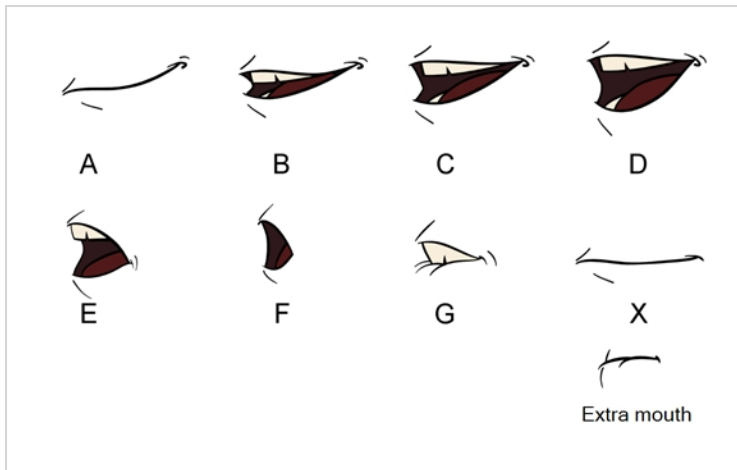

NOTE

The letters assigned to these mouth shapes are standard identifiers, they do **NOT** correspond to the sound they are meant to produce.

This is an approximation of the English phonemes each mouth shape can be used to represent:

- **A:** m, b, p, h
- **B:** s, d, j, i, k, t
- **C:** e, a
- **D:** A, E
- **E:** o
- **F:** u, oo
- **G:** f, ph
- **X:** Silence, undetermined sound

When performing automatic lip-sync detection, Harmony does not create mouth drawings. It simply fills the drawing column of your character's mouth layer with the generated lip-sync, by inserting the letter associated with the right mouth shape into each cell of the column. Therefore, for the automatic lip-sync detection to work, your character's mouth layer should already contain a mouth drawing for each drawing in the mouth chart, and these drawings should be named by their corresponding letter.

Generating a Lip-sync Detection

There are several places where you can perform a lip-sync detection: Layer Properties view, Timeline view, Xsheet view and Sound Element editor.

How to generate a sound detection for lip-sync using the Layer Properties view

1. In the Timeline or Xsheet view, select the sound layer.

The options for that layer will appear in the Layer Properties view.

2. In the Layer Properties, click **Detect**.

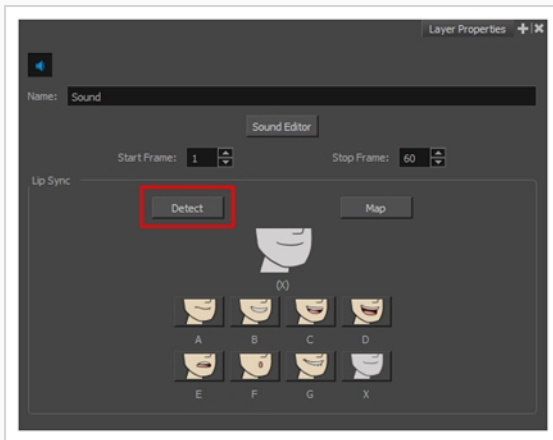

Harmony analyzes the selected sound clips and assigns a lip-sync letter to each sound cell.

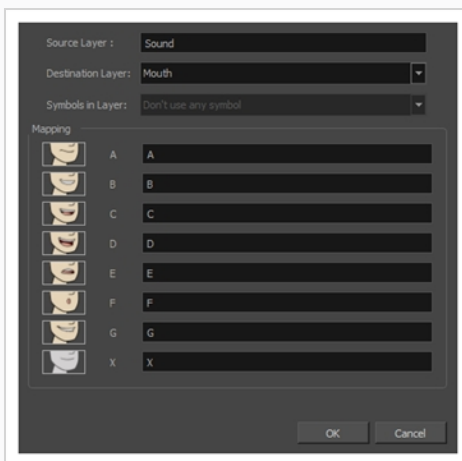

3. Click the **Map** button to open the Lip-Sync Mapping dialog box.

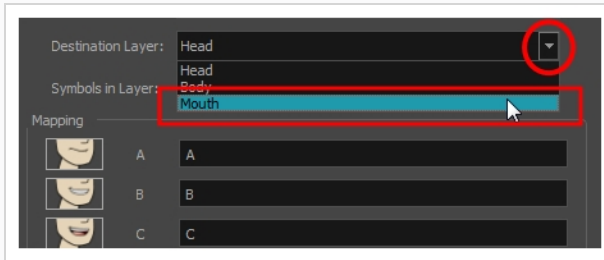

4. From the Destination Layer menu, select the layer that contains the mouth positions for the character's voice track.

**NOTE**

If the selected layer contains symbols, you can map the lip-sync using drawings located directly on the layer or use the symbol's frames. In the Symbol Layer field select **Don't Use Any Symbol** if you want to use the drawings or select the desired symbol from the drop-down menu.

5. In the Mapping section, type the drawing name or Symbol frames in the field to the right of the phoneme it represents. If your drawings are already named with the phoneme letters, you can skip this step.
6. Click **OK**.
7. In the Playback toolbar, enable the Enable Sound  option.
8. Press the Play  button in the Playback toolbar to see and hear the results in the Camera view

How to generate a sound detection for lip-sync in the Xsheet or Timeline view

1. Do one of the following:
 - In the Xsheet or Timeline view, right-click on the sound layer's cells and select **Lip-Sync > Auto Lip-Sync Detection**.
 - From the top menu, select **Animation > Lip-Sync > Auto Lip-Sync Detection**.

Harmony analyzes the selected sound clips and assigns a lip-sync letter to each frame.

How to generate a sound detection for lip-sync using the Sound Element editor

1. Do one of the following:
 - In the Timeline view, double-click on the sound layer.
 - In the Xsheet view, double-click on the sound column header.

The Sound Element editor opens.

2. In Sound Element section, select the waveform for which you want to generate a mouth chart.
3. Right-click on the sound file and select **Auto Lip-Sync Detection**.

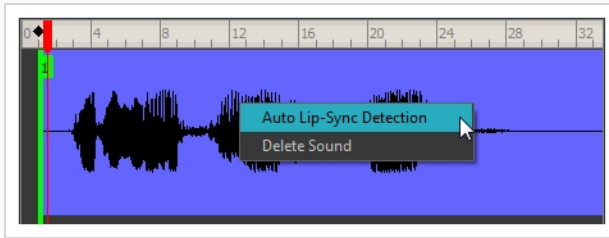

A progress bar appears while Harmony analyzes the selected sound clips and assigns a lip-sync letter to each sound cell.

Mapping the Lip-Sync Detection

Harmony can automatically map drawings in an element to the mouth chart you have generated for a sound. This can save time when you are lip-synching a voice track.

In the Layer Properties view, you can identify each lip drawing of a character. Harmony then automatically labels all of the cells in the character's element with the appropriate name.

How to automatically map lip-sync drawings to a mouth layer

- To open the Lip-Sync Mapping dialog box, do one of the following:
 - In the Layer Properties view, click on the Map button.
 - In the Timeline view, right-click on any cell in the sound sample layer and select **Lip-Sync > Map Lip-Sync**.
 - From the top menu, select **Animation > Lip-Sync > Map Lip-Sync**.

The Lip-Sync Mapping dialog box opens.

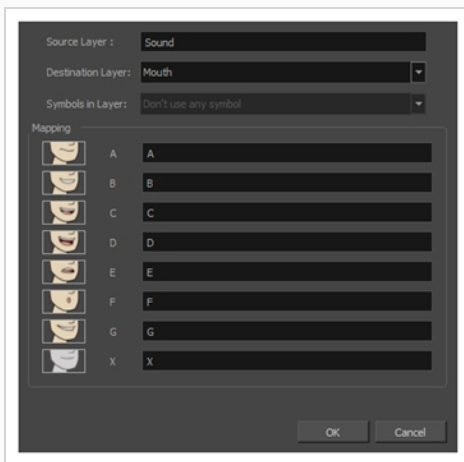

- From the Destination Layer menu, select the layer that contains the mouth positions for the character's voice track.

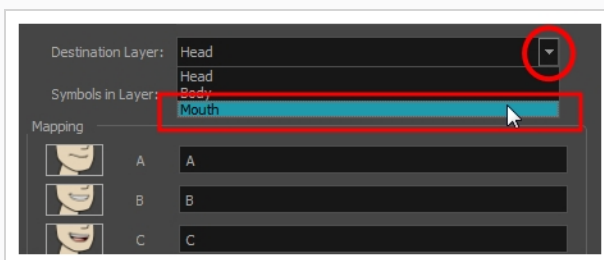

- If the selected layer contains symbols, you can map the lip-sync using drawings located directly on the layer or use the symbol's frames. In the Symbol Layer field select **Don't Use Any Symbol** if you want to use the drawings or select the desired symbol from the drop-down menu.

4. In the Mapping section, type the drawing name or Symbol frames in the field to the right of the phoneme it represents. If your drawings are already named with the phoneme letters, you do not have to do anything.

Modifying the Lip-sync Detection

You can change the mouth position assigned to a frame if you think another position is more appropriate.

For example, you may have a character who says nothing for 10 frames between two speeches. Harmony would normally assign an X image for the silent period. However, if you want your character's mouth to hang open in astonishment for these 10 frames, you can change the lip assignment for these frames from an X to an F.

If you modify the sound detection, you will need to remap the lip-sync to your animation—see [Mapping the Lip-Sync Detection](#) on page 749.

How to change the mouth position assignment of a sound from the Sound Element editor and Layer Properties view

1. Double-click the sound layer name in the Timeline view to open the Sound Element editor.
2. In the Sound Element section, drag the frame slider to the frame you want to change the mouth position assignment on.

In the Lip-sync image area, the image on top represents the lip position assigned to the current frame.

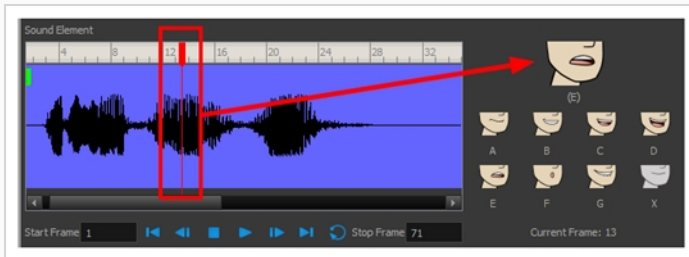

3. To change the image assigned to the frame, click on the image of the mouth position you want from below the preview image. The preview image changes to the mouth position image you select. You can perform the same operation in the Layer Properties view.

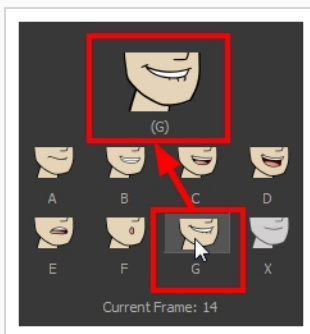

The position is updated in the Timeline view.





NOTE

Note that if you modify the lip-sync detection you must remap the detection to your mouth layer.

Manual Lip-syncing

You can manually create the lip-syncing for your scene by selecting which mouth drawing should be exposed at each frame of your character's dialogue. For this process, you will be using the Sound Scrubbing functionality, which plays the part of your sound track at the current frame whenever you move your Timeline cursor, allowing you to identify which phonemes you should match your character's mouth to. You will also be using drawing substitution to change which mouth drawing is exposed at every frame.

How to animate lip-sync using the Timeline view

1. In the Playback toolbar, enable the **Sound Scrubbing**  button.
2. In the Timeline view, drag the red playhead along the sound layer waveform.
3. When you reach a frame where a mouth position should go, for example, an open mouth with rounded lips for an "oh" sound, click on that frame on your mouth shapes layer.
4. In the Parameters section, staying on your mouth shapes layer, place your cursor on top of the drawing name (often a letter) until it changes to the swapping  pointer.
5. Pull the cursor to see the list of mouth shape names and choose the one you want. The current drawing automatically changes to the new selection.



How to animate lip-sync using the Library view

1. In the Playback toolbar, click the Sound Scrubbing  button.
2. In the Timeline view, drag the red playhead along the waveform of your sound layer.
3. When you reach a frame where a mouth position should go, for example, an open mouth with rounded lips for an "oh" sound, click on that frame on your mouth shapes layer.
4. In the Drawing Substitution window of the Library view, drag the slider to choose a mouth shape. The current drawing is swapped for the one in the preview window.

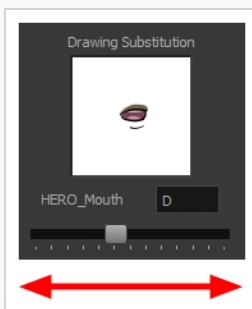

Chapter 16: Export

Now that you've finished your animation, it's time to render your movie. Depending on whether you plan to further edit your movie using a third party software, composite the movie in a larger body of work or put it up directly on the web, Harmony supports several formats for all your rendering needs.

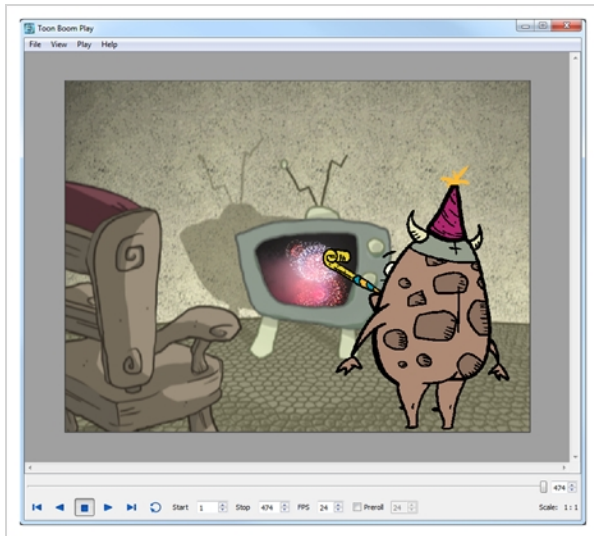

NOTE

The different editions of Harmony support the following maximum render resolutions:

- Harmony Essentials: 2K (2048x1556)
- Harmony Advanced: 4K (4096x3112)
- Harmony Premium: Unlimited

Exporting Image Sequences

In Harmony, you can export your scene as a sequence of image files, which can be played in Harmony Play or imported in a video editing software for post-production.

You can export an image sequence in a handful of different image types. If you want to export images with transparency, you can do so by selecting an image type that supports it, such as TGA, PNG or PSD, then setting the Colour Mode to Colour with Transparency. You can also export images with deep colour (16 bits/channel) by selecting a file type that supports it, such as PNG or PSD, and setting the Colour Depth to 16 bits/channel.

How to render an image sequence

1. From the top menu, select **File > Export > Images** or press Ctrl + Shift + Y (Windows/Linux) or ⌘ + Shift + Y (macOS).

The Export Images dialog box opens.

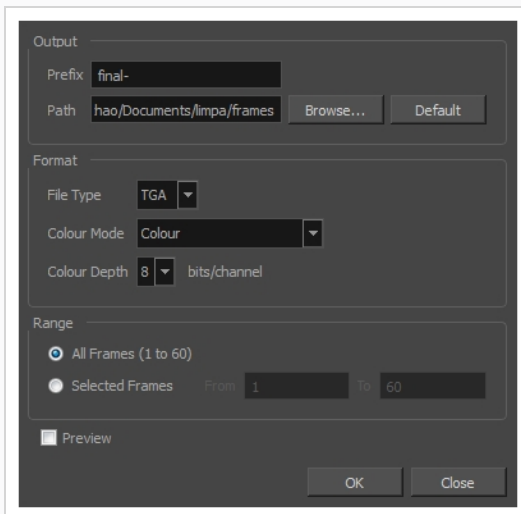

2. In the **Prefix** field, enter a prefix for the file names of the exported images. The images will be named with the prefix, followed by their frame number. T
3. Click **Browse** and select the directory in which to export your images, or click on **Default** to set the export destination to your scene's **frames** subfolder.
4. In the Format section, choose the desired image format in the **File Type** drop down list. Colour Mode and Colour Depth from their respective menus.
5. In the **Colour Mode** drop down list, select whether you want the exported images to be in **Greyscale**, **Colour** or **Colour with Transparency**.
6. In the **Colour Depth** drop down list, select whether you want the exported images to be in **8 bits/channel** or **16 bits/channel**. 8 bits per channel is the most standard colour depth, but 16 bits

per channel allows for more colour precision.

**NOTE**

Most image formats will export in Colour at 8 bits/channel. Only a few image formats, such as PNG , TGA and PSD, can be exported in different colour modes and colour depths.

1. In the Range section, select the frame range to render by doing one of the following:
 - If you want to render all the frames in your scene, select **All Frames**.
 - If you want to render a specific sequence of frames, select **Selected Frames** then, in the fields to the right, enter the number of the first and last frame of the frame sequence you wish to render.
7. Enable the **Preview** option to automatically preview the exported image sequence in Harmony Play once the render is done.
8. Click **OK**.

Harmony begins rendering the scene's frames.

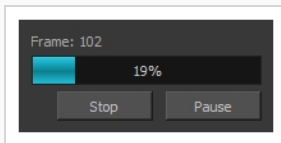

If you enabled the Preview option, the exported images will load in Harmony Play once the render is done. You can use Harmony Play to play the image sequence with the scene's soundtrack.

Exporting a Movie File

T-HFND-010-013

Using the Export Movie dialog, you can export your animation as a video file. By default, Harmony will export your entire scene in its full resolution. If you prefer, you can choose to export only a specific frame range in your scene, or to export in a smaller resolution, which can be useful if you need to save on time or disk space.

If you have specific requirements for the quality and size of your exported video files, you can use the Movie Options dialog to configure the video and audio compression settings. If you're exporting a QuickTime movie, you have access to all of the codecs and compression settings made available by QuickTime's interface.

How to export a movie file

1. From the top menu, select **File > Export > Movie**.

The Export to QuickTime Movie dialog box opens.

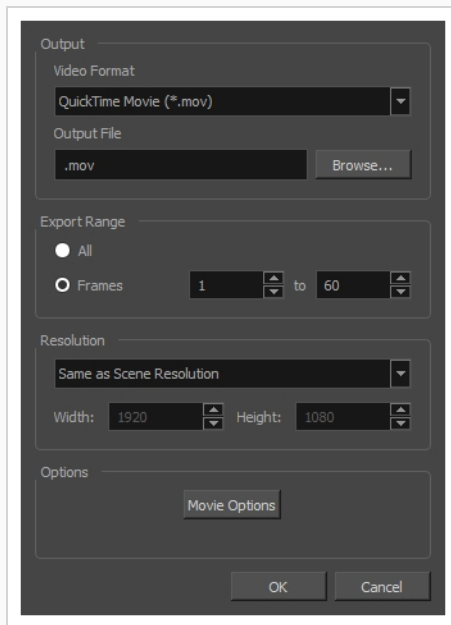

2. In the Video Format drop-down menu, select the desired format for your movie file:
 - **Quick Time Movie (*.mov)**: Available on Windows, macOS and GNU/Linux.
 - **Windows Media Video (*.wmv)**: Available on Windows only.



NOTE

On Windows and macOS, [Apple QuickTime](#) must be installed in order to export QuickTime movies. On GNU/Linux, Harmony uses a more limited, open source QuickTime-compatible library which does not require additional software.

3. Click **Browse** to select the location and file name of your exported movie file.
4. Click **OK**.
5. From the Export Range section, decide whether you want to export the entire scene (All) or a specific frame range. If you decide on the latter, enter the frame range.

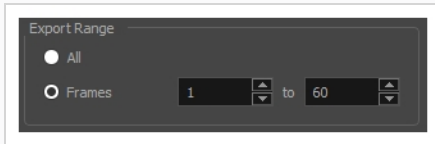

6. In the Resolution section, select one of the following from the menu:
 - A preferred resolution ratio.
 - **Custom**: Enables the Width and Height fields so you can enter a specific size.

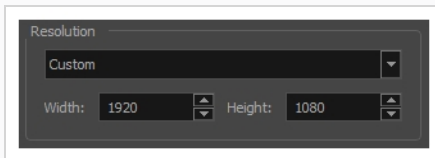
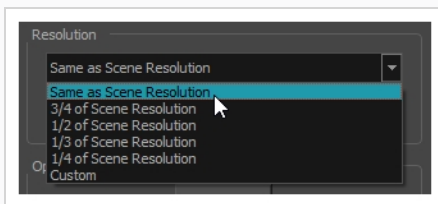

7. In the Options section, do one of the following to configure your movie's video and sound compression settings:
 - If on Windows or macOS and exporting a QuickTime movie, click on **Movie Settings** to open the QuickTime Movie Settings dialog box—see [Configuring Movie Settings for QuickTime Movies on Windows and macOS on page 762](#)
 - If on Windows and exporting in Windows Media Video format, click on Movie Settings to open the Windows Media Video Settings dialog box—see [Configuring Movie Settings for Windows Media Video](#).
8. Click **OK**.
9. In the Export to QuickTime Movie dialog box, click **OK**.

A progress bar appears.

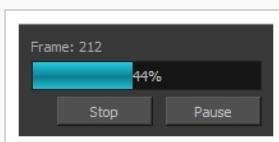

10. Browse to the location on your computer where you exported your movie and double-click on it to view it in your video player.

Configuring Movie Settings for Windows Media Video

On Windows, it is possible to export in Windows Media Video format.

How to configure video and sound settings for Windows Media Video

1. In the Video section, select the desired Variable Bit Rate Quality for your video. A higher setting will ensure a better image quality. A lower setting will create a smaller video file.

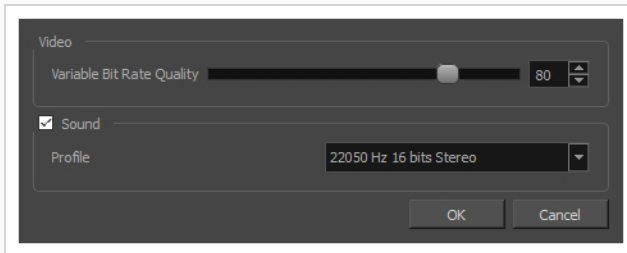

2. Using the Sound checkbox, select whether or not you want your movie file to have sound.
3. Using the Profile drop-down menu, select the preferred compression settings for your movie's soundtrack. Each profile has a combination of audio sample rate, sample size and channel mode, which cover the following options:
 - **Sample rate:** Available sample rates are 8000 Hz, 16000 Hz, 22050 Hz and 44100 Hz. The default setting is 22050 Hz. It is best to export your audio at a rate that matches the rate of your original sound files. For example, if your file has an audio sample rate of 48000 Hz and you choose a sample rate of 22050 Hz, the sound will play at the same speed, but higher frequencies will be missing, making it sound muffled. For reference, the standard sound quality is **44000 kHz** for films, and **48000 kHz** for DVD. Lower rates are liable to impact the quality of your movie's soundtrack negatively, but they can be useful if disk space or download speed is critical.
 - **Sample size:** Also known as *Bit Depth*, this determines the amount of precision used to record each wavelength in the soundtrack. The standard size is **16-bit**. If you choose **8-bit**, the amount of disk space your sound track requires is halved, but the audio will sound muffled.
 - **Channel mode:** Stereo sound has a separate sound track for the left and the right speakers, allowing to make the origin of each sound realistically match the origin of their corresponding action. If you choose Mono, your sound track may use less disk space, but both the left and right channels will be merged into a single track.



NOTE

Exporting in 8-bit audio requires [Apple QuickTime](#) to be installed.

Configuring Movie Settings for QuickTime Movies on Windows and macOS

On Windows and macOS, you can export QuickTime movies. You can configure the video and audio settings for your exported movies using the configuration interface provided by QuickTime.



NOTE

To export QuickTime Movies on Windows, [Apple QuickTime](#) must be installed on your machine.

How to configure video and sound settings for QuickTime movies on Windows and macOS

1. In the Movie Settings dialog box, select whether you want your movie to include **Video** and **Sound** data, as well as if the video should be optimized for Internet streaming.

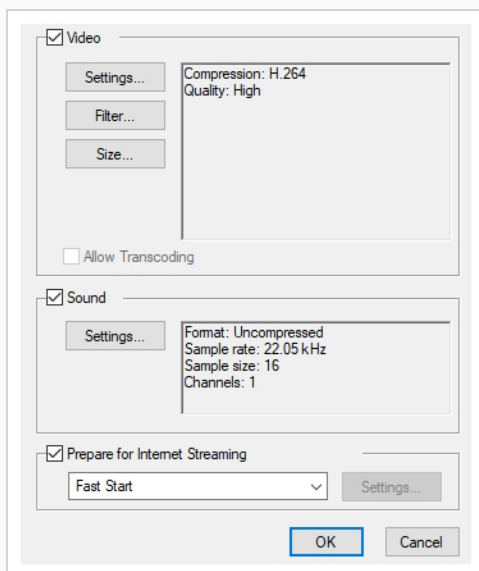

2. In the Video section, click **Settings**.

The Standard Video Compression Settings dialog box opens.

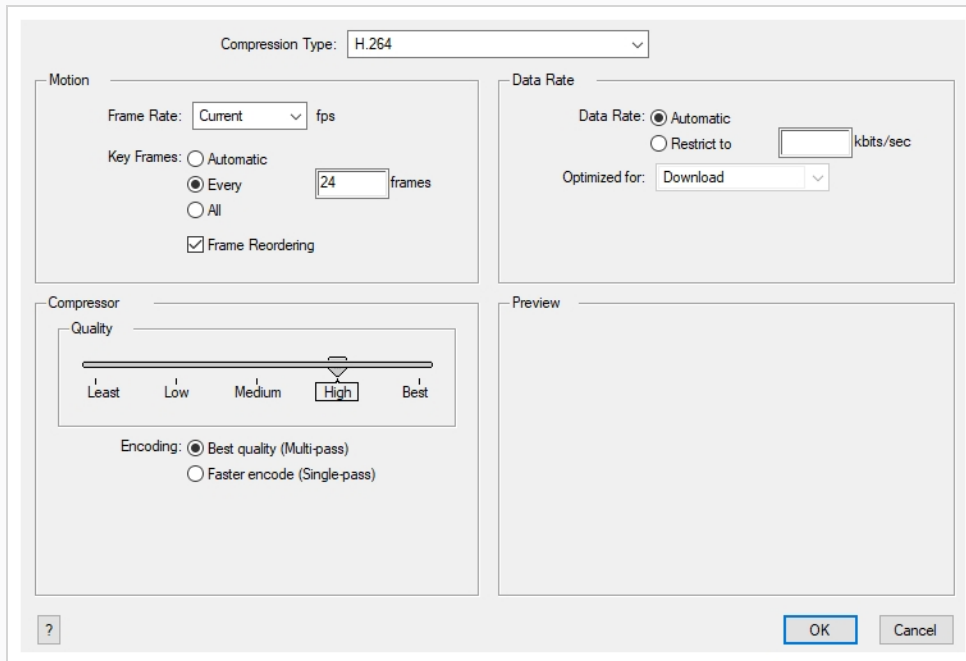

- From the Compression Type menu, select a codec. The availability of certain compression settings depends on the Compression Type selected. For example, when the Animation compression type is selected, the Data Rate option is greyed out.



TIP

If you want to render a QuickTime movie with high quality compression and transparency, you can use the **Animation** video codec with the colour depth set to **Millions of Colours+**.

- In the Motion section, choose a **Frame Rate** from the list.

By default, it is set to match the frames-per-second (fps) of your Harmony project. If you choose a lower frame rate, your export playback will be faster than your actual project. The reverse is also true for a higher frame rate.

- If you want keyframes inserted, select the **Every** option and set the number per frame.

This is the option recommended by QuickTime. For further details, refer to the QuickTime documentation.

- In the Quality section, use the slider to choose a quality setting. Remember that the better the quality of the export, the larger the file.

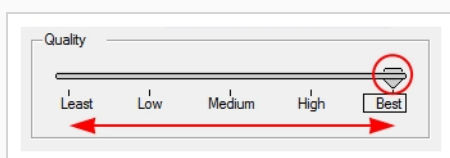

7. From the Data Rate section, either choose to allow the program to automatically select the most optimal bit rate, or enter a Restricted rate to save space and allow for faster downloading at a cost to the quality of the export.
8. In the same section, from the Optimized For menu, select the intended viewing method for the export.
9. Click **OK**.
10. From the Movie Settings dialog box, click **Sound Settings**.

The Sound Settings dialog box opens.

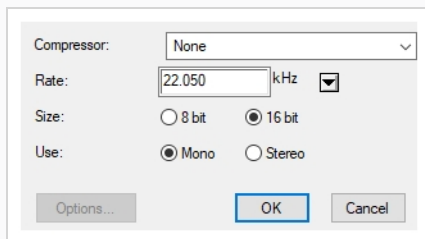

11. From the **Compressor** menu, select a compression type. The default setting is **None**. This exports your audio as is without performing any lossy compression or conversion, preserving its fidelity. Other compressors can be used if you need your movie's audio track to be exported in a specific format, or if disk space or download speed is critical, but they may impact the quality of your movie's soundtrack negatively.
12. From the **Rate** menu, select a rate. It is best to export your audio at a rate that matches the rate of your original sound files. For example, if your file has an audio sample rate of 48 kHz and you choose a conversion rate of 22.05 kHz, the sound will play at the same speed, but higher frequencies will be missing, making it sound muffled. For reference, the standard sound quality is **48 kHz** for broadcasting and DVD. Lower rates are liable to impact the quality of your movie's soundtrack negatively, but they can be useful if disk space or download speed is critical.
13. Select the **Size** of your audio's encoding. Also known as *Bit Depth*, this determines the amount of precision used to record each wavelength in the soundtrack. The standard size is **16-bit**. If you choose **8-bit**, the amount of disk space your sound track requires is halved, but the audio will sound muffled.
14. Select whether to **Use** the **Mono** or **Stereo** channel mode. Stereo sound has a separate sound track for the left and the right speakers, allowing to make the origin of each sound realistically match the origin of their corresponding action. If you choose Mono, your sound track may use less disk space, but both the left and right channels will be merged into a single track.

Exporting a QuickTime Movie with Lossless Compression and Transparency

It is possible to export a QuickTime movie with lossless video compression and transparency by using specific compression settings.

How to export a lossless QuickTime movie with transparency

1. In the Video section of the Movie Settings dialog, select **Settings**.
2. In the Standard Video Compression Settings dialog, set the **Compression Type** to **Animation**.
3. In the Compressor section, set the **Depth** to **Millions of Colors+**.

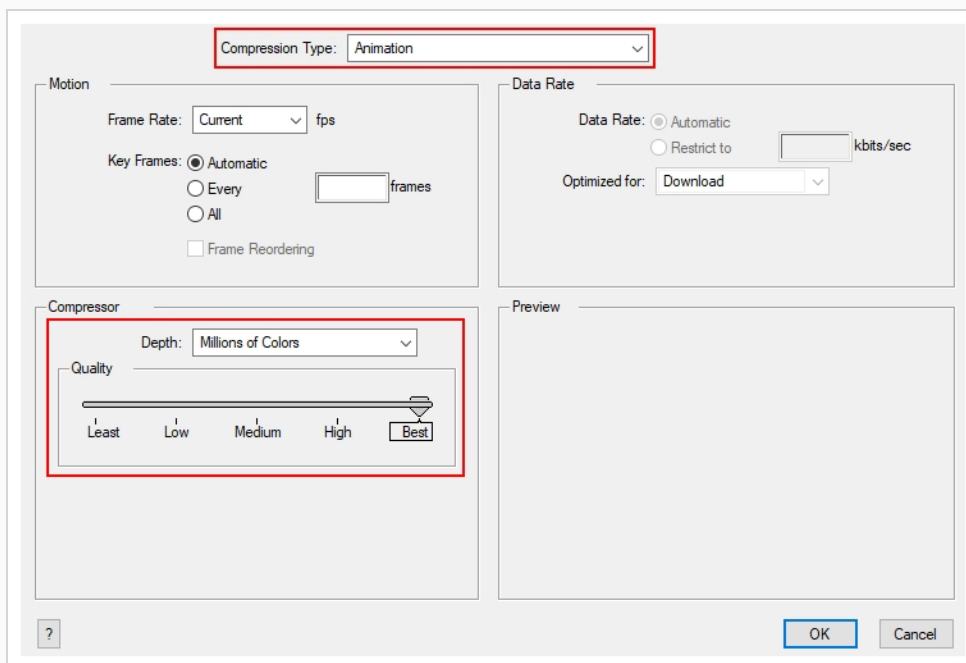

4. Click **OK**.

Exporting Flash (SWF) Movies

Batch Rendering

In Harmony Server, you can choose to render your scene locally or to send it to the render farm on your network so that other computers can render your scenes while you continue working on your station. This option is not available in Harmony Stand Alone, as render jobs are sent to a Harmony Server database, and machines that perform the render must be connected to this database.

There are two approaches to rendering a scene in Harmony Server:

- **Local Rendering** is done directly by your machine in your Harmony session. Hence, it uses your machine's resources and will prevent you from working on the scene until the render is done. You will see the render progress in real time and will be able to preview the results right after it's finished.
- **Batch Rendering** is done by sending a scene to the server's render queue so it can be processed by the render farm. This allows you to keep working on your scene while the render is being done. The rendering progress can be monitored in Control Center and, when finished, the results can be previewed in Harmony Play. Batch Rendering gives you access to additional rendering options.

When sending a scene to batch rendering, it is not rendered immediately. Computers connected to the Harmony database that are configured to render scenes for the database check for new render jobs periodically, and start performing the render job when they find one that isn't already being rendered by another machine.



NOTE

To configure a Harmony Server database and to set up clients to perform batch rendering jobs, refer to the Harmony Installation Guide.

How to send a scene to the batch rendering queue

1. Save your scene.
2. From the top menu, select **File > Export > Render Write Nodes** or press Ctrl + Shift + Y (Windows/Linux) or ⌘ + Shift + Y (macOS).
1. In the Range section, select the frame range to render by doing one of the following:
 - If you want to render all the frames in your scene, select **All Frames**.
 - If you want to render a specific sequence of frames, select **Selected Frames** then, in the fields to the right, enter the number of the first and last frame of the frame sequence you wish to render.
3. Enable **Batch Composite Options**. This will send your scene to your Harmony database's batch rendering farm, whereas disabling this option will make Harmony render your scene locally.

**NOTE**

When Batch Composite Options is enabled, the Preview option is not available. This is because Harmony does not track the progress of a render when it is performed by the Harmony database's render farm. You can only enable the Preview option when rendering locally.

4. If you want the machine that will render your scene to output detailed information about the process in its log, enable the **Debug** option.
5. If you want to split the render job for your scene into several smaller render jobs, so that the load can be shared by different machines in the render farm, enable the **Chunk** option. Then, enter the amount of frames each chunk should render in the **Size (Frames)** field.
6. If you want to render the scene from a specific camera, select the desired camera from the **Camera** drop down list. A scene can have several cameras added in the Timeline view, and each of them can be animated independently.
7. In the Resolution section, do one of the following to select the resolution in which to render the scene:
 - If you want to render the scene in its actual resolution, select **By Name** and, in the resolution preset drop down list, select **Default**.
 - If you want to render the scene in one of the available preset resolutions, select **By Name** and, in the resolution preset drop down list, select the desired resolution preset.
 - If you want to render the scene in a specific resolution, select **By Value**, then enter the **Width** and **Height** of the desired resolution, in pixels.
8. Click **OK** to start the rendering process.

A confirmation dialog box opens to inform you that the frames have been sent to the Render queue.

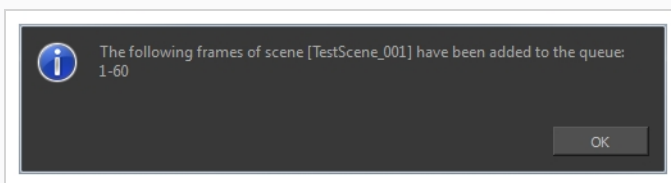

If the selected frames were already sent to the Render queue, but were not yet rendered, dialog box opens to inform you that these frames were already in the queue, but that they have been updated with the selected options.

You can also send scenes to batch rendering and check the status of the rendering queue using the Control Center application.

Chapter 17: Library

T-RIG-009-001

Using templates and symbols, you can share and reuse any elements you create in Harmony. The Harmony library lets you store several different elements such as puppets, backgrounds, animations and key poses. In fact, anything you create in Harmony can be stored in the library.

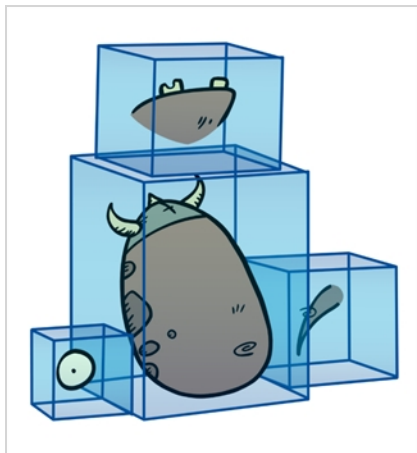

The Library view is where you can store and reuse your artwork and animation in other scenes or build props and puppets.

The library is a storage centre for all production assets; the elements stored in the library are called templates. Although it is mainly used for cut-out animation, the library is also useful for paperless and traditional animation processes. The library can contain any asset used in a Toon Boom Harmony production.

Using the library is as simple as dragging the content into the library to store your artwork and then dragging it to the Timeline or Camera view when you want to reuse it.

Additionally, the Library view's Drawing Substitution panel allows you to quickly change the current frame's exposure to one of the existing drawings in a layer. This is especially useful for animating a cut-out character's mouths, hands, eyelids and other such body parts which typically contain several drawings to choose from.

About Structure

As you will probably create a large number of symbols and templates, you will soon realize they need to be organized. You can create different libraries and subfolders to easily access your assets. For example, you can create a different library for each project and divide it into several categories, such as:

- Characters
- Props
- Backgrounds

Creating Libraries

T-LAY-005-001

There are two ways to create libraries.

- Directly through your operating system
- Using Harmony's interface

Although you can only have one symbol library folder, you can organize it by creating subfolders.

How to create a library folder through your operating system

1. On your computer, create a new folder with a relevant name in the location where you want the library to be stored.

How to create a library folder in Harmony

1. In the Library View menu, select **Folders > Open Library**.

The Browser window opens.

2. Browse for the location where you want to store your new library folder.
3. Click the New Folder button.

A new folder appears.

4. Name the new library folder with a relevant name and click **OK**.

The new library appears in the Library List section.

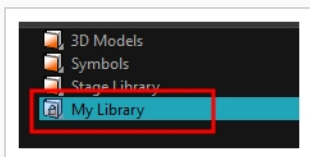

Opening Libraries

T-LAY-005-002

Folders can be opened in Harmony when you require it. You can open any folder on your hard drive or network as a library. Opening a library means linking the folder to your Library view. You only need to open the library once. The library folder is available every time you open the application until you decide to close the library and unlink it.

How to open a library

1. In the Library View menu, select **Folders > Open Library**.

The Browser window opens.

2. Browse to the location of the library folder.
3. Select the folder and click **OK**.

The new library appears in the Library Folders section.

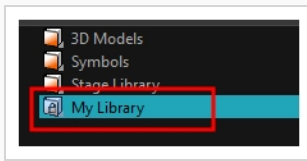

Closing Libraries

You may not always require all the library folders in the Library List. If so, you can close the ones you do not need. Closing a folder does not delete it; it only unlinks it from the Library view. If you want to reopen it, locate it on your hard drive or network and open it in the Library view.

How to close a library

1. On the right side of the Library view, select the library folder to close.
2. In the Library View menu, select **Folders > Close Library**.

The library closes.

Creating Folders

T-ANIMPA-003-009

Symbol and template libraries need to be organized. You can create different subfolders on your hard drive or in the Harmony Library view, so you can easily access assets. By default, any new library you link to your Library view is locked to prevent accidental deletion or modification of symbols and templates. You must obtain the right to modify it before being able to add a new folder to it.

How to create a folder

1. On the left side of the Library view, select the library folder to which you want to add a subfolder.
2. In the Library View menu, select **Edit > Right to Modify**.
3. In the Library View menu, select **Folders > New Folder**.

The new folder appears in the Library. Click on the library containing the new folder and click the plus [+] sign to expand it.

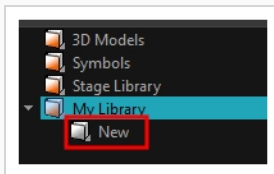

Deleting Folders

You can delete a folder from the library if its contents are no longer needed.



NOTE

All templates and symbols in the folder will be deleted from your hard drive. Once deleted, the data cannot be retrieved.

How to delete a folder

1. In the Library view's left side, select the folder to delete.
2. In the Library View menu, select **Edit > Right to Modify** or right-click on the selected library and select **Right to Modify**.
3. In the Library View menu, select **Folders > Delete Folder** or press Del.

Renaming Folders

Once you add a folder, you can rename it. This also renames the folder on your hard drive.

How to rename a folder

1. In the Library view's left side, select the folder to rename.
2. In the Library View menu, select **Edit > Right to Modify** or right-click on the selected library and select **Right to Modify**.
3. In the Library View menu, select **Folders > Rename Folder**.
4. Rename the selected folder.

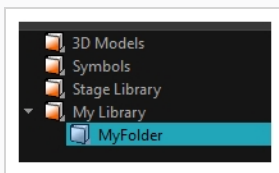

5. Press Enter/Return to validate the operation.

Refreshing Libraries

If you update the content of your libraries through your operating system, you will need to refresh your library folders in the Library view.

How to refresh a library

1. In the Library view's left side, select the folder to refresh.
2. In the Library View menu, select **Folders > Refresh** or press F5.

The library displays the new content.

Generating Thumbnails

When you display thumbnails in the Library view, the system generates a series of small images (thumbnails) for you. You can generate template thumbnails yourself, if they do not display or if the process has been stopped.

How to generate thumbnails

1. In the Library view's right side, select the template in which you want to generate thumbnails.

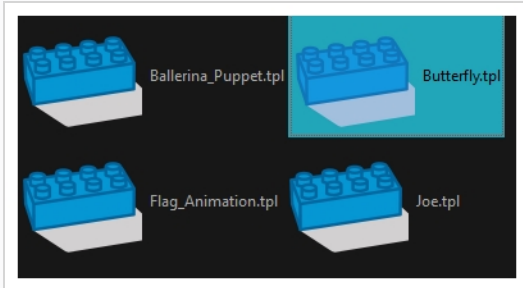

2. In the Library View menu, select **View > Generate Thumbnails**.

The progress bar appears.

Deleting Thumbnails

You can also delete thumbnails if you want to send a template to another user or studio and keep your packages small.

How to delete thumbnails

1. In the Library View menu, select **Edit > Delete Thumbnails**.

All the thumbnails contained in the library are removed.

Searching in Libraries

When working on a movie or series, you will probably end up with many templates and symbols in your library. Using the Search tool, you can quickly find the templates and symbols in your folders.

How to use the Library Search tool

1. From the left side of the Library view, select the library in which you want to search.

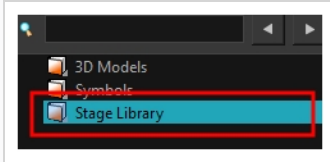

2. In the Search field, type the name or partial name of the symbol or template you are looking for.

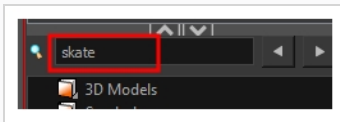

3. Click the left ◀ and right ▶ arrows to see the previous and next results. The Search engine will look for results within the library master folder and its subfolders. It will not look in other libraries.

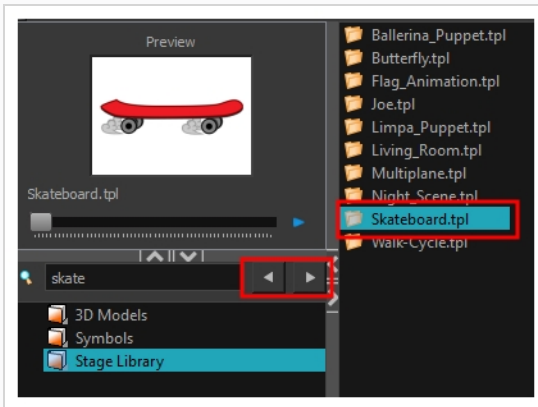

About Templates

T-LAY-005-003

When you want to reuse artwork and animation from your project in other scenes, you must create a template. A template can be seen as a portable scene or package that you can drag inside your project. A template is an individual copy of the artwork stored in the library which you can reuse in different scenes. Once a template is stored in the library, you can access it from any project.

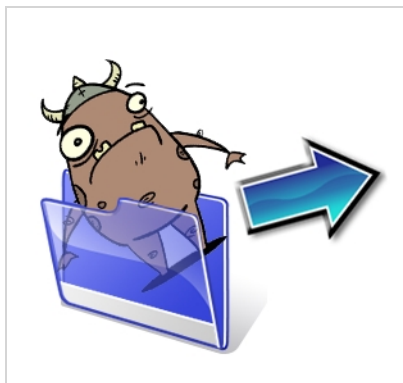

Creating Templates

T-ANIMPA-003-010

You can create a template using the Timeline view.



NOTE

If you are creating a template from a character rig master template, you should collapse everything inside a master peg and put a keyframe on the first frame before creating the template.

How to create a template from the Timeline view

1. In the Timeline view, select some cells or layers.

You can create a template from a whole hierarchy of layers by collapsing the hierarchy and selecting its root layer. This can be useful for creating templates based on character rigs or scene backgrounds.

2. In the Library view, select a folder to store the template. By default, you will have a library named **Harmony Essentials Library**, which is stored on your computer, in the Toon Boom Harmony Essentials Library subfolder of your Documents folder.
3. If the library folder is locked , right-click and select **Right to Modify**.
4. Drag the selection to the chosen library folder.

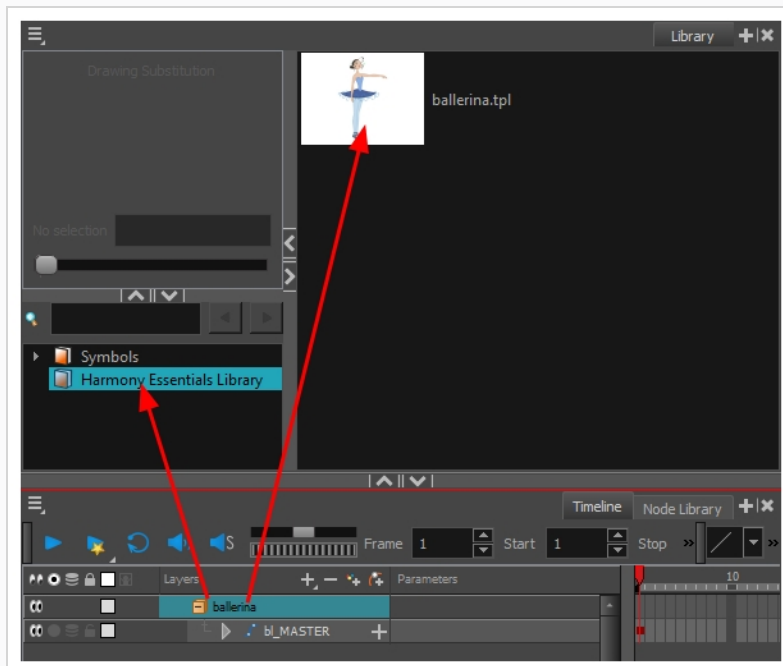

5. In the Rename dialog box, give the new template a name.

6. Click **OK**.

Deleting Templates

To delete templates from your library, use the Library view. Harmony lets you undo the action if necessary.

How to delete a template

1. In the Library view, select the folder containing the template to delete.



NOTE

If the library folder is locked, right-click on the folder and select **Right to Modify**.

2. Right-click on the selection and select **Delete** or press Del.

Editing Templates

You can open a template and edit it just like any other project. If you want modify your templates, you can edit them using the Edit Template command.

How to edit a template

1. In the Library view, select the folder containing the template to edit.



NOTE

If the library folder is locked, right-click on the folder and select **Right to Modify**.

2. Right-click on the selection and select **Edit Template**.
A new Harmony application opens.
3. Edit the template.
4. From the top menu, select **File > Save**.
5. In the top menu, select **File > Quit** (Windows/Linux) or **Harmony Essentials > Quit** (macOS).

Importing Templates

There are several ways you can import templates in your scene.

For greater control over how the action template behaves when brought into the Timeline view, you can use the Paste Special feature—see [Using Paste Special on page 804](#).



NOTE

Dragging a template into your scene copies the content in your Timeline and does not link it to the original. You can modify this individual copy at any time.

How to import a template into the Timeline or Camera view

1. In the Library view, select the template you want to import.
2. Drag the selected template to the Camera view or to the left side of the Timeline view.

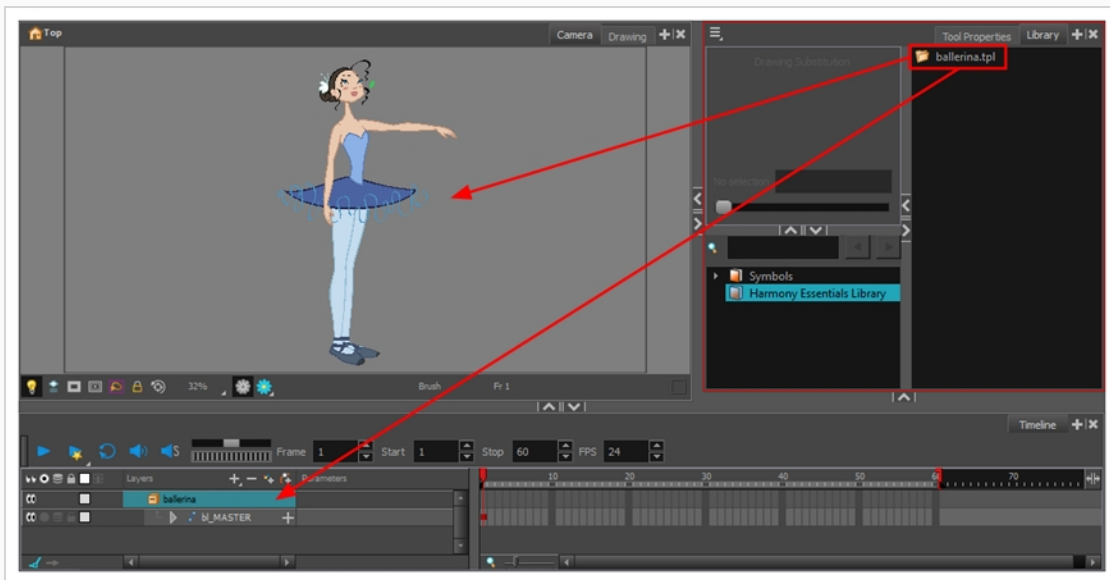

If you drop the template in the Camera view, its layers will be added at the top of your layers list. If you drop a template in the layers list in the Timeline view, it will be inserted between the layers where you dropped it.

If your template has the same layer structure as a part of your scene, you can drop the template directly onto the frames on the right side of the Timeline view. Instead of inserting new layers into your scene, this will replace the drawings and keyframes in your scene with the ones from the template. This is useful for importing pose or animation templates for characters that are already in your scene.

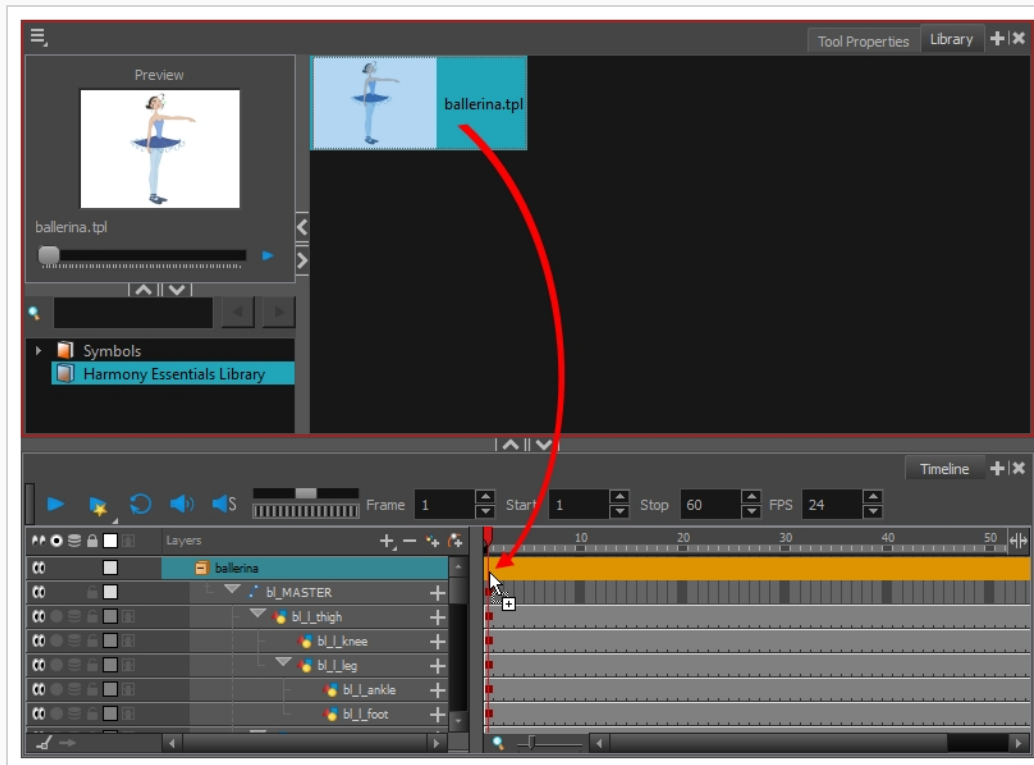

How to import a template with symbols

1. From the right side of the Library view, select the action template that contains symbols.
2. Hold down Alt as you drag it from the Library view to the right side of the Timeline view and drop it next to a template with the exact same rig.

The Paste Special window opens.

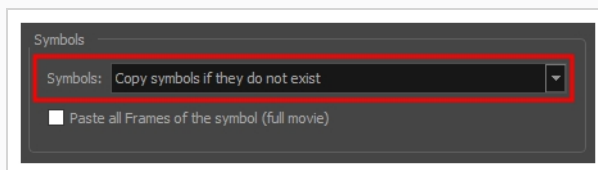

3. Select the **Advanced** tab.
4. Select one of the following options from the Symbols menu:

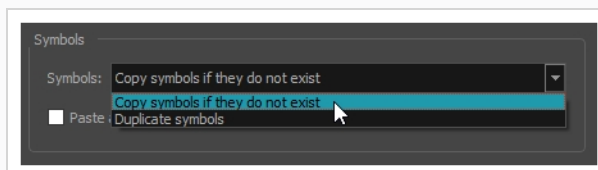

- **Copy symbols if they do not exist:** This is the default setting for this operation and will prevent symbols in an action template from being copied.
- **Duplicate symbols:** Makes copies of the symbols in your template.

Opening Templates as Folders

Since a template is like a scene, you can open the template's folder and select elements inside it such as drawings.

Instead of importing the entire contents of a template, you may only want to import a few drawings or a palette. In this case, use the Open As Folder command to import the items you want.

If you want to import a palette, simply drag the palette file into the Palette list section of the Colour view.

How to open a template as a folder

1. In the Library view, select the folder that contains the template to open. If the library folder is locked, right-click on the folder and select **Right to Modify**.
2. Right-click on the selection and select **Open As Folder**.
3. In the library list section, click on the template's folder to display its content.

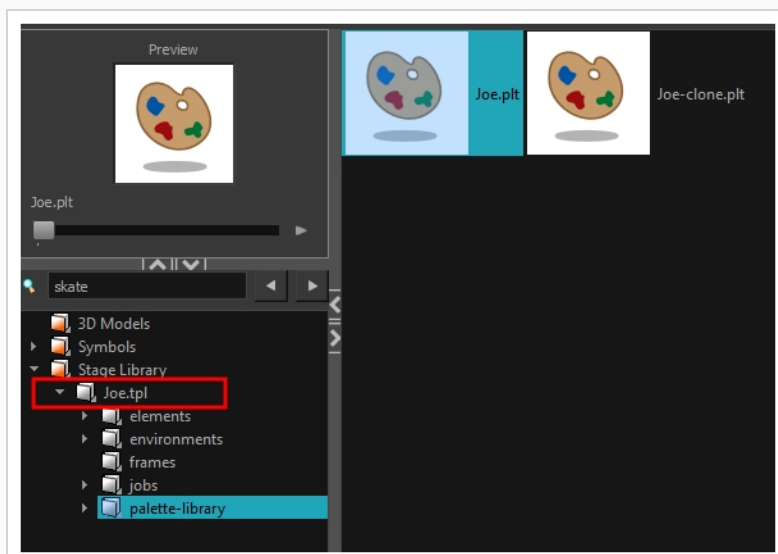

4. Drag the content to the Timeline or Colour view.

About Symbols

A symbol is a container used to build your props, puppets and looping clips. You can use symbols to contain artwork and animation and manipulate them as a single object. You can also use symbols as a placeholder in which you place a series of different drawings for each body part of your puppets or when you have a repeating cycle. However, symbols are not necessary for creating characters.



When a symbol is exposed in the Timeline view, the symbol's cells are represented as a movie strip.



When you enter a symbol to edit it, you are entering another scene with an independent timeline. You can nest many symbols one inside the other. To help you follow the hierarchy of your nested symbol, take note of the Editing stack at the top of the Camera view which displays the path to your symbol's location. You can click on the symbol's name to move up the chain.

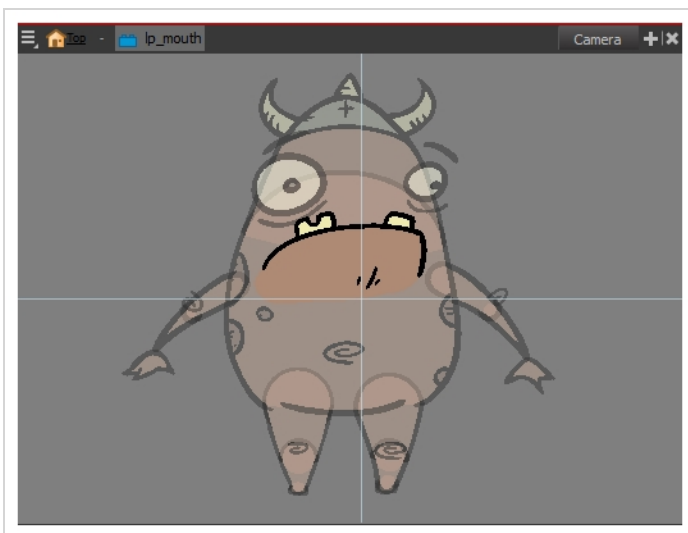

Creating Symbols

A symbol combines animation, artwork or layers into a single object that you can control in one layer. You can also create symbols out of each body part in your cut-out puppets.

To create a symbol, drag your artwork to the Symbol library. When you drag a symbol from the Symbol library into your scene, it will be linked to the original symbol. If you drag a symbol into your scene several times in the Timeline view, they will all be linked to the original symbol. If you modify one, they will all be modified.

How to create a symbol from the Timeline view

1. In the Timeline view, select the layer or cells from which you want to create a symbol.
2. Do one of the following:
 - ▶ From the top menu, select **Edit > Create Symbol**.
 - ▶ In the Edit toolbar, click the Create Symbol  button.
 - ▶ Press F8.
 - ▶ Drag your selection to the Symbol folder in the Library view.

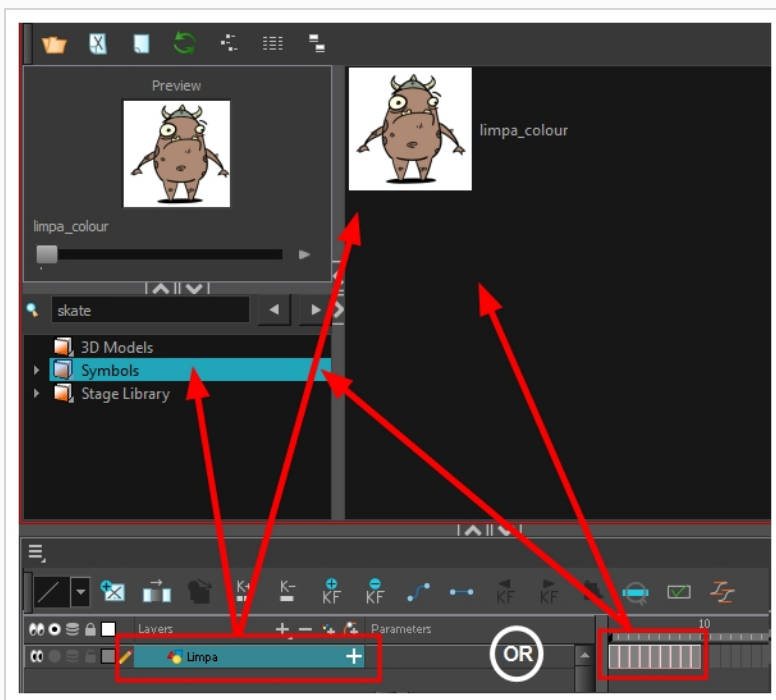

The Create Symbol dialog box opens

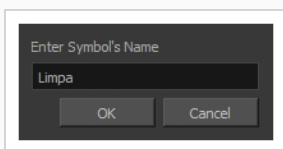

3. In the Enter Symbol's Name field, type the new symbol's name.

To rename a symbol once it is created, right-click on the symbol and select **Rename**.



4. Click **OK**.

The new symbol appears in the Library view's Symbol folder. The current selection is not replaced by the new symbol. The new symbol only appears in the library. You must drag it into your scene to use it.

Creating a Symbol from a Drawing

You can create a symbol from a drawing selection.

How to create a symbol from a drawing selection

1. In the Tools toolbar, select the Select  or Cutter  tool.
2. In the Camera view, select the drawing elements to create a symbol.

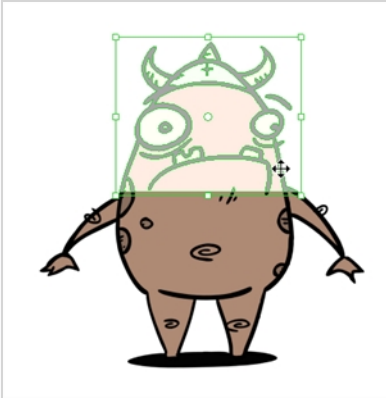

3. From the top menu, select **Edit > Create Symbol** or press F8.
 - Clicking the Create Symbol  button in the Edit toolbar will create a symbol from the entire layer.

The Create Symbol from Drawing Selection dialog box opens.

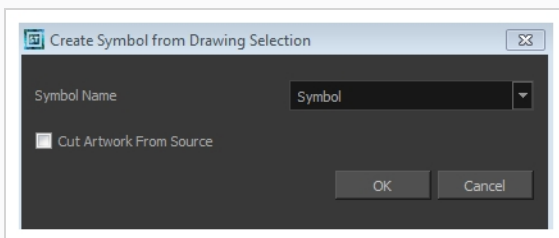

4. In the Symbol Name field, type the name of the symbol.
 - You can also select an existing layer from the Symbol Name drop-down menu. It will add your symbol on the layer's current cell. If there is already an exposure on that cell, the symbol will be added to a new layer.
5. You can choose to place the current selected artwork in the drawing or remove it:
 - To remove currently selected artwork from the drawing and place it in the new symbol, select the **Cut Artwork From Source Drawing** option.
 - To keep currently selected artwork in both the drawing and in the new symbol, deselect the **Cut Artwork From Source Drawing** option.

6. Click **OK**.

The new symbol appears in the Library view's symbol folder and in the Timeline view as a new layer.

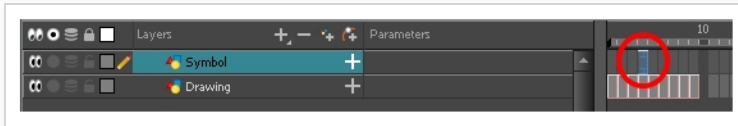

Creating Empty Symbols

You can create a symbol without any artwork in it.

How to create an empty symbol

1. In the Library view, select the **Symbol** folder.
2. Do one of the following:
 - In the Library view's right side, right-click and select **New Symbol**.
 - From the top menu, select **Insert > Create Empty Symbol in Library**.

The new empty symbol appears in the Library view.

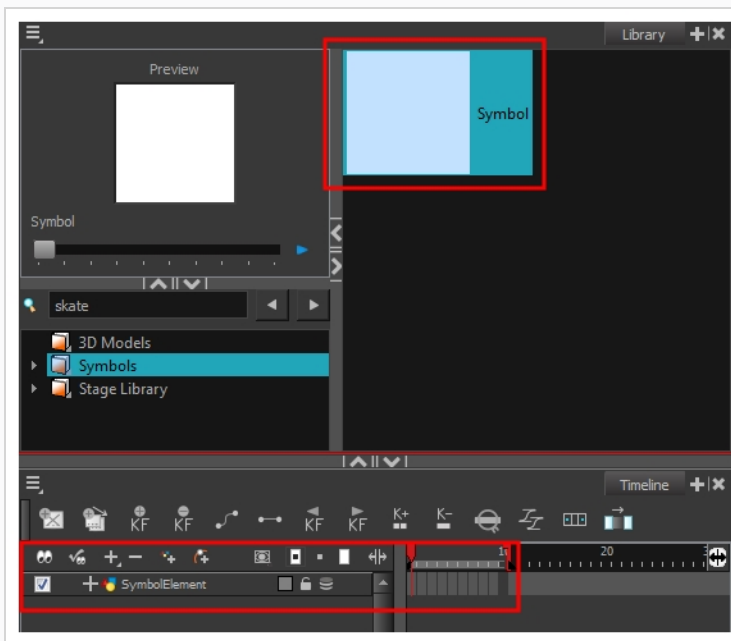

The symbol is ready for you to edit (add content to). To go back to the root timeline, click the Top 🏠 button in the Camera view.

To rename a symbol once it is created, right-click on the symbol and select **Rename**.

Deleting Symbols

When you delete a symbol, it will be deleted from your hard drive. You can use the Undo function to retrieve the data. The symbol cannot be retrieved once you close the application.

How to delete a symbol

1. In the Library view, select the symbol to delete.
2. Right-click and select **Delete** or press Del.
 - ▶ If the symbol is currently in use in the scene, a warning message displays. Click **OK** to delete the symbol from the library and scene.

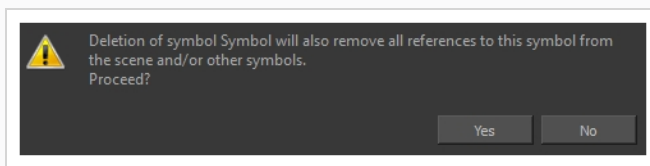

Editing Symbols

You can either edit a symbol from the Timeline view or from the Library view.

When you edit a symbol, the drawings contained in it are not placed at the centre of the stage, but are located in the position where they were created. The pivot is translated at the centre of the symbol.

How to edit a symbol from the Timeline view

1. Do one of the following:
 - ▶ In the Timeline view, double-click on the symbol's cell to edit the symbol.
 - ▶ In the Camera view, double-click on the symbol or press Ctrl + E (Windows/Linux) or ⌘ + E (macOS)).
 - ▶ Click the Edit Selected Symbol  button in the Camera View toolbar's extra buttons.

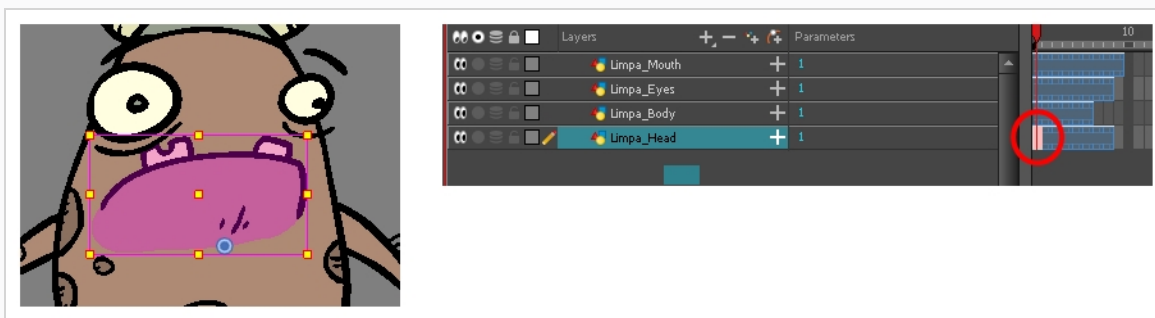

You are now inside the symbol and you are able to edit it.



2. Do one of the following:

To return to the project's timeline, click the Top  button in the Camera view's top-left corner, press Ctrl + Shift + E (Windows/Linux) or ⌘ + Shift + E (macOS).

- ▶ In the Timeline view's right side, right-click and select **Symbols > Leave Current Symbol**.

How to edit a symbol from the Library view

1. In the Library view, select the symbol to edit.
2. Right-click and select **Edit > Edit Symbol** or double-click on the symbol.

You are now inside the symbol and you are able to edit it.



To return to the project's timeline, click the Top 🏠 button in the Camera view's top-left corner, press Ctrl + Shift + E (Windows/Linux) or ⌘ + Shift + E (macOS).

Importing Symbols

There are several ways you can import symbols in your scene.

When you import a symbol from the library to the Timeline view it is linked to the original symbol in the library. If you import a symbol into your scene several times in the Timeline view, they will all be linked to the original symbol. If you modify one, they will all be modified.

How to import a symbol in the Timeline view

1. In the Library view, select the symbol you want to import.
2. Drag the selected symbol to one of the following:
 - ▶ The Timeline view's left side to import it into the centre of the camera frame.
 - ▶ The Camera view to place it at the location where you release your cursor.



NOTE

This may be useful if you saved a character's body parts as separate symbols. If you dropped them into the Timeline view, then they would all appear in the centre, haphazardly one on top of the other. It would be more efficient to arrange them into their correct places as you bring them into the scene.

Expanding Symbols

You can use the Expand Symbol command to extract a symbol's contents and place it on the root timeline. The symbol will not be removed from the Timeline view. Its contents will be copied and inserted into the root timeline. The symbol's layers will be parented to it in case you created motions and transformations on the drawing layer that contains the symbol. Breaking the hierarchy could result in the loss of any scaling and animation you may have created.

You can also expand a symbol within a group to avoid crowding the timeline with a series of layers. When you expand the symbols, the layers will be contained in a group node that you can expand to see the content.

How to expand a symbol

1. In the Timeline view, select the symbol to expand.

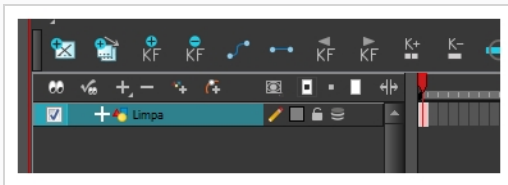

2. From the top menu, select **Edit > Expand Symbol** or press Shift + F8.

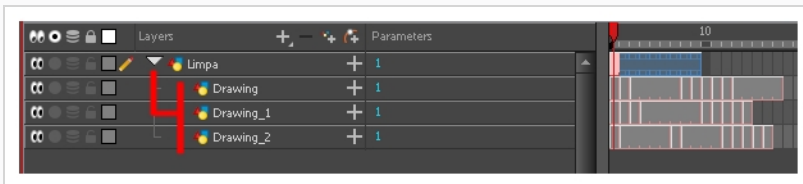

How to expand a symbol in a group

1. In the Timeline or Node view, select the symbol cell or symbol node you want to expand.

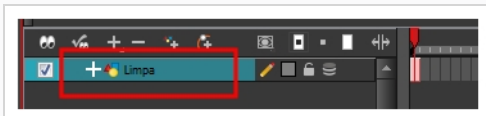

2. From the top menu, select **Edit > Expand Selected Symbol in a Group**.
3. In the Timeline view, click the plus sign (+) to see the group content. In the Node view, click the **Expand Arrow** to enter the group.

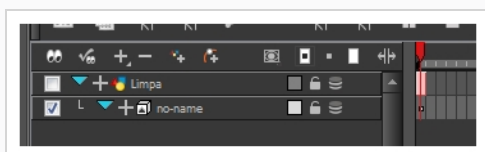

Converting Symbols to Templates

A symbol is local to the project and cannot be accessed directly from other scenes. To reuse a symbol's content in another scene, you must create a template. This conversion breaks the drawing's link with both the original scene and symbol. It then becomes a separate entity that you can import into other projects.

How to convert a symbol into a template

1. From the Library view, select the symbol to convert into a template and drag it to the Camera or Timeline view. If you drop your symbol into the Camera view instead of the Timeline view, it will not be placed in the centre of your camera frame, but rather wherever your cursor drops it within the camera frame.

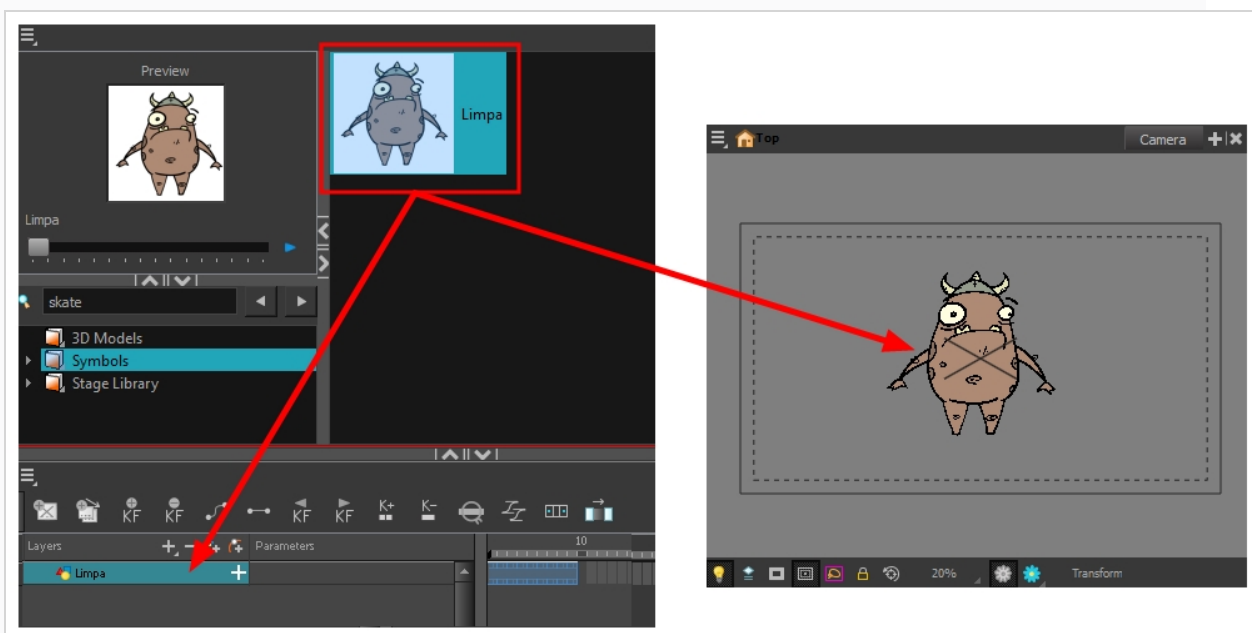

2. In the Timeline view, select the symbol's cells or layer and drag it to the Stage Library folder or to any other library folder. Make sure you have the right to modify the library folder.

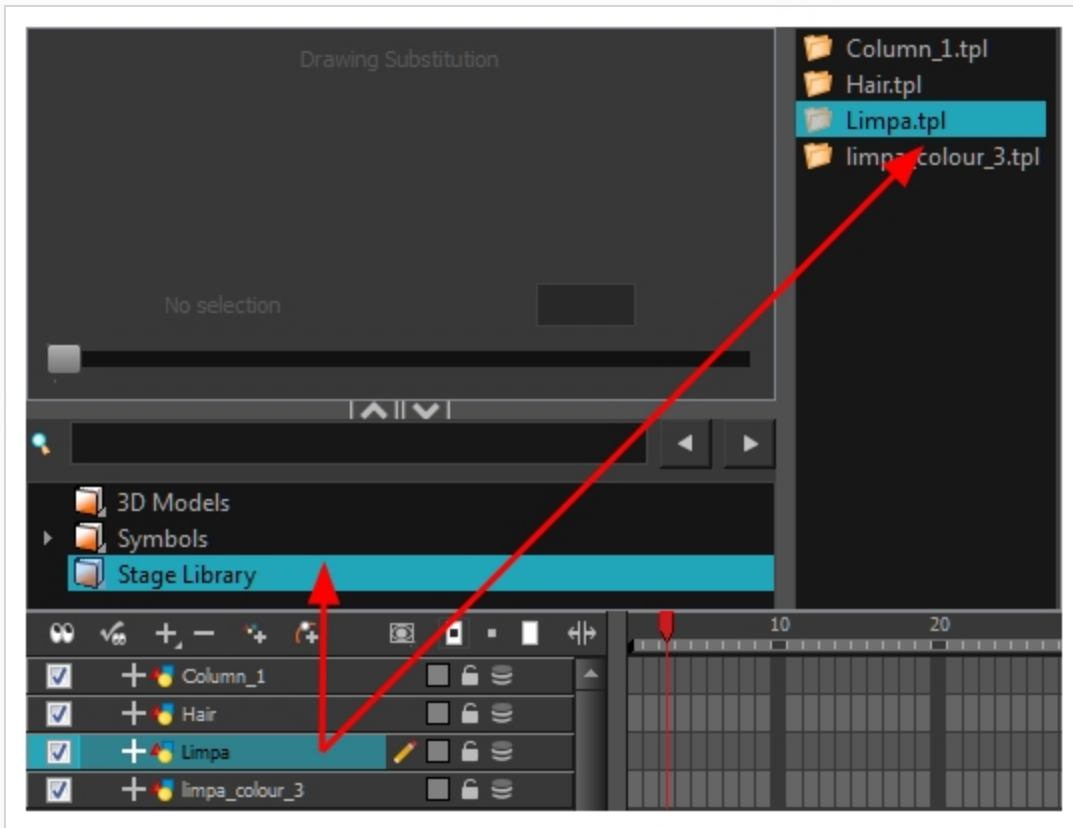

3. In the Rename dialog box, rename the new template.

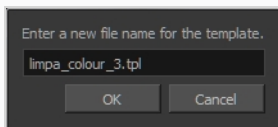

4. Click **OK**.

Importing Files in the Library

Harmony lets you import sound files and images directly through the Library view. Simply open the folder containing your files in the Library view and drag them directly from there.

How to open a file through the Library

1. In the Library view menu, select **Folders > Open Library**.
2. Browse for the folder containing the files you want to import.
3. Click **Open**.
4. From the Library's template list, drag the file you want to import in the Timeline or Camera view.

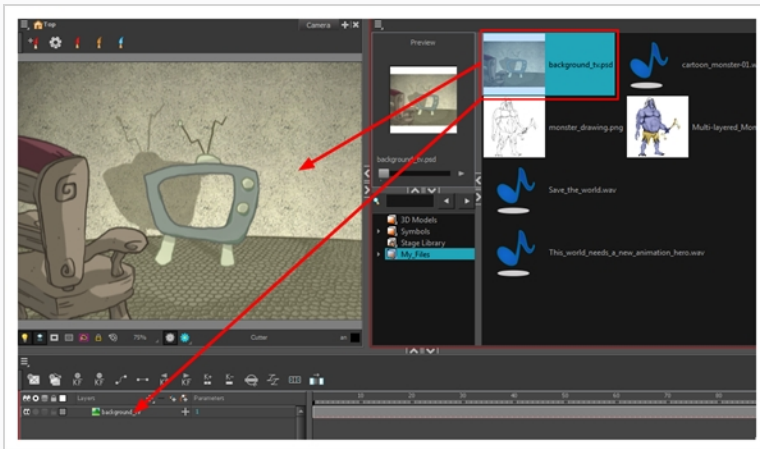

Using Paste Special

When you import a template in the Timeline view, all layers are created as well as drawings and keyframes. You can choose to import only the keyframes without the drawings or import only the drawings that are not already in your layers. You can adjust the behaviour using the Paste Special dialog box. When you import a symbol in your scene, its full length is exposed by default. If you import a symbol in the Timeline view's left side, all the frames will be exposed. However, if you import it into an existing layer, you can use the Paste Special dialog box to adjust the import behaviour to fit your requirements. Once you set the parameters, Harmony will reuse them each time you import a symbol in the Timeline view's right side until you set new parameters.

How to open the Paste Special dialog box

1. In the Library view, select the symbol or template to import.
2. Do one of the following:
 - While holding down the Alt key, click and drag on the template, then drop it on the Timeline view, over the layer and at the frame where you want to paste it.
 - Press Ctrl + C (Windows/Linux) or ⌘ + C (macOS). Then, in the Timeline view, click on the frame where you want to paste the template and press Ctrl + B (Windows/Linux) or ⌘ + B (macOS)

The Paste Special dialog box opens.

3. In the Paste Special dialog box, select the desired parameters—see the Paste Special Dialog Box topic of the Reference guide .
4. Click **OK**.

Chapter 18: Gaming

Harmony can be used to create and animate characters that can be imported in Unity. The procedure is very similar to rigging and animating characters for a regular animated production, and requires no programming skills. However, you must follow some guidelines when creating and animating your character to make sure it is properly imported in Unity.

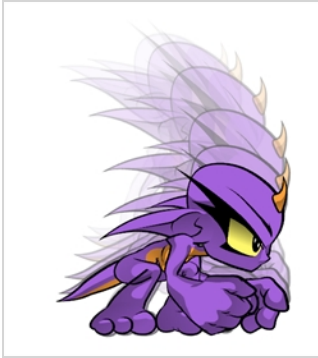

The procedure for creating game assets in Harmony can be broken down into the following steps.

- Rig and animate your characters in Harmony, while following the guidelines for rigging and animating game characters in this guide.
- Separate your character's different animation clips.
- Create anchors and props for your character, if needed.
- Export the character from Harmony into a sprite sheet format that can be imported in Unity.
- Import the exported data into Unity.

Rigging Guidelines

The following section explains how to create game assets in Harmony. You should go over this section before you start creating your character rigs, as it not only contains useful guidelines and tips for rigging game characters in Harmony, it also contains important information on what you can and cannot do when using Harmony to rig and animate game characters.

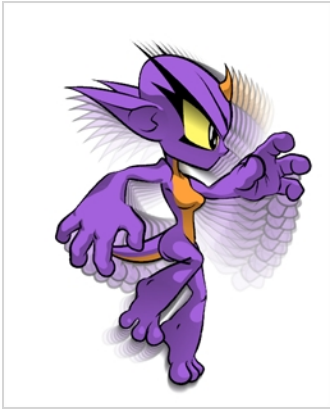

Exporting Rigged Sprite Sheets or Rendered Sprite Sheets

When creating game assets in Harmony, the first decision you should take is which type of export you intend to make:

- **Rigged Sprite Sheets** is where you export a sprite sheet with one sprite for each layer in your character along with metadata allowing Unity to build and animate your character using those sprites. This is the traditional way of exporting sprite sheets, and most other Harmony features related to gaming are optimized for it.



NOTE

In Harmony, this is simply referred to as exporting sprite sheets.

- **Rendered Sprite Sheets** is when you export a sprite sheet with one sprite representing your entire character, rendered and flattened, for each animation frame in your scene. This means that Unity does not have to reproduce the way Harmony renders your character, as it is already rendered. This method creates significantly heavier packages, does not work with some other gaming features in Harmony and is harder to import in Unity, but it ensures that what you see in Harmony is also what you will see in your game.



NOTE

In Harmony, this is referred to as exporting to Easel JS.

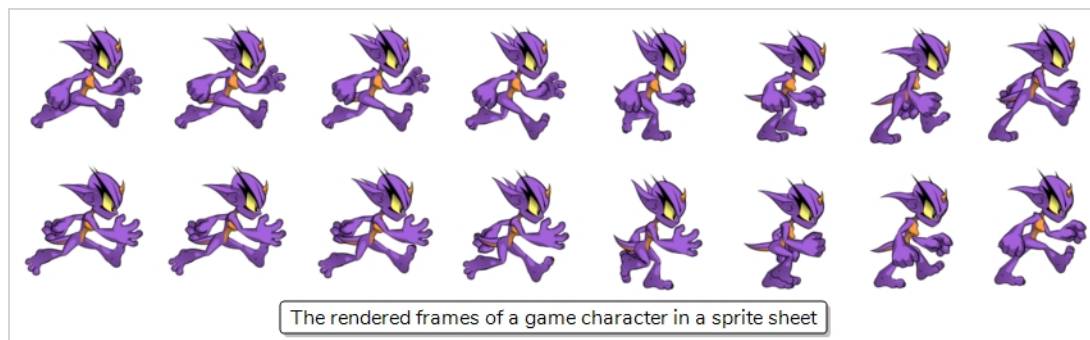
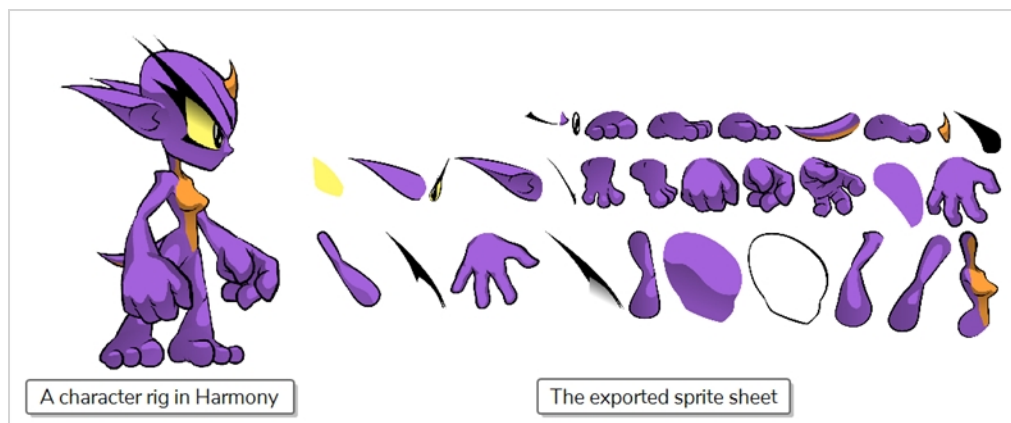

The following table offers a detailed comparison of all the advantages and limitations of between the traditional method of exporting sprite sheets versus exporting to Easel JS:

	Advantages	Disadvantages
Rigged Sprite Sheets	<ul style="list-style-type: none"> • Significantly lighter packages. • Allows you to easily import the assets in Unity using the Harmony Game SDK package. • Allows you to create props and anchors in Harmony. 	<ul style="list-style-type: none"> • Only supports Game Bone-type deformations. • Does not support any effect except for the Cutter. • Using cutters has several limitations. • The matte port of drawing layers cannot be used.
Rendered Sprite Sheets (Easel JS)	<ul style="list-style-type: none"> • All methods of animating, including morphing, curve deformations and envelope deformations are supported. • Effects are supported. • What you see is what you get. 	<ul style="list-style-type: none"> • Harder to import in Unity. This format cannot be imported using the Harmony Game SDK. Developers must write their own scripts to import the exported sprite sheets. • Exported sprite sheets are significantly heavier in file size, which may make it unsuitable for mobile games due to file-size and bandwidth limitations. • Does not allow you to create prop and anchors in Harmony.

Scene Set-Up Guidelines

The following are guidelines you must follow when creating and setting up scenes in which you intend to create game assets for Unity.

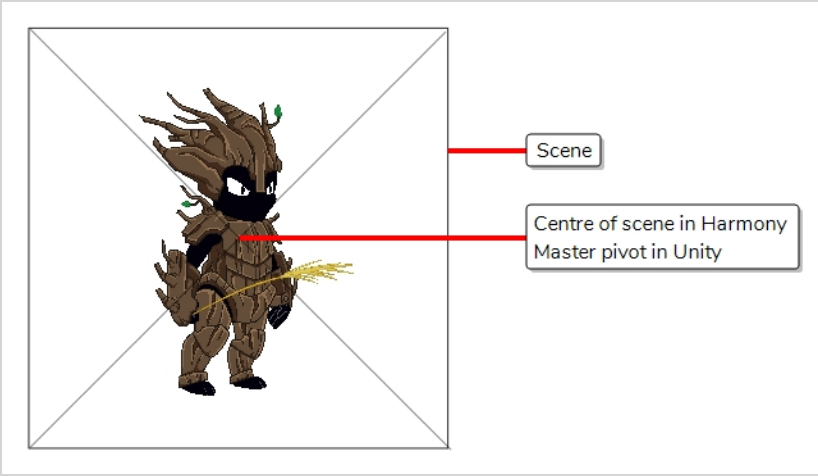
Scenes	<p>You must create one scene for each character. A scene can contain all of a character's different animations and props, but should not contain several characters that need to act independently from each other.</p>
Resolution	<p>Your scene's resolution should be square, meaning its width and height should be equal. For example, 1024 x 1024 is a proper scene resolution for a game object.</p> <p>It is highly recommended to use a power of two for the dimensions of your scene, such as 64, 128, 256, 512, 1024, etc. This is because graphics cards naturally handle textures with such dimensions. While recent video cards will adjust to non-standard texture sizes, which might cause some overhead and slow down your game's performance, older video cards might not be able to display these textures at all.</p>
Main Pivot	<p>When imported in Unity, the master pivot of your GameObject will be exactly where the centre of your scene is. Hence, if you want the pivot to be at a specific position on your character in Unity, you should position your character accordingly in your Harmony scene.</p> <p>For example, if you want the pivot point of a bipedal character to be between its two feet, at the centre of its drop shadow, you should position this character so that the point in the middle of its feet is in the centre of the scene.</p>  <p>The diagram illustrates a character within a square scene. A red line points from the center of the square to a box labeled 'Scene'. Another red line points from the center of the character's feet to a box labeled 'Centre of scene in Harmony Master pivot in Unity'.</p>
Naming	<p>Do not use non-alphanumerical characters in scene, layer, drawing and group names. Only use letters, numbers, dashes and underscores. Unity does not support Unicode characters in names.</p>

Guidelines for Rigging Game Characters in Harmony

The following are guidelines to follow when creating a character rig in Harmony if you plan to export it for use in Unity.



NOTE

You do not need to follow these guidelines if you intend to export a rendered sprite sheet—see [Exporting Rigged Sprite Sheets or Rendered Sprite Sheets on page 807](#).

Resources Usage

When rigging and animating game sprites, you need to keep in mind the size of the exported sprite sheets as well as the resources required to play out their animations.

If you are working on a console or PC game, you have a lot of leeway for both, as they often have high performance video cards and a lot of storage space.

If you are working on a mobile game, you might need to take measures to ensure your animation and sprite sheets are lightweight, as mobile devices have slower rendering hardware and more limited storage space. Also, some users may want to download your game over a mobile data network with costly data charges.

Hierarchy

When creating your character rig's structure, you should use a simple peg-layer hierarchy, which means:

- Each body part of the character that you want to animate independently is on its own drawing layer.
- Each drawing layer has its own parent peg, which should be used for animating the layer.
- Pegs can be rigged in a hierarchy to make body parts attached to each other move together. For example, a hand's peg can be rigged under the forearm's peg, and the forearm's peg under the arm's peg, etc.
- You can create groups to keep your rig structure tidy and organized.

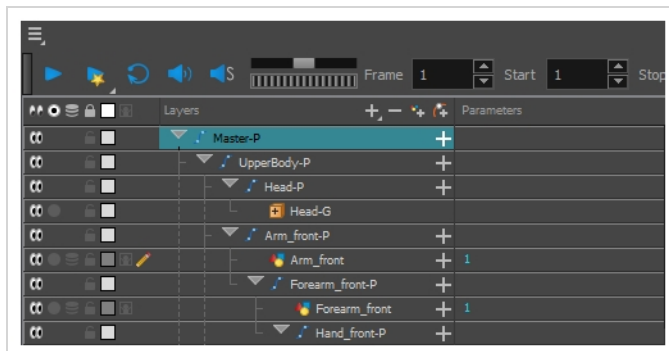

Body parts that are meant to move together with other body parts (i.e.: the head with the neck, the forearm with the arm, etc.) can be rigged together in either one of these ways:

- By rigging the peg of the child part under the peg of the parent part. For example, you could rig the forearm's parent peg to be the child of the bicep's parent peg. Moving the bicep's peg

would automatically move the forearm.

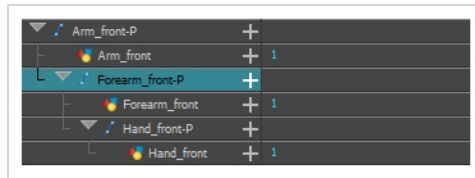

- By rigging both parts under a common peg. For example, you could rig the forearm and the bicep's parents pegs under a dedicated peg for the whole arm. You could hence move the bicep's peg independently, or move the arm peg to move both the bicep and the forearm together.

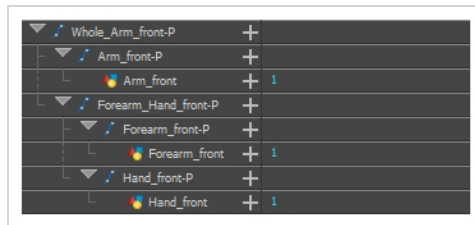

z-Axis Positioning

Nudging layers on the z-Axis to change the order in which they appear is supported and its effect will be visible in Unity. However, you should not attempt to put layers at significant distances from each other on the z-Axis in Harmony, as they will not be rendered in perspective in Unity.

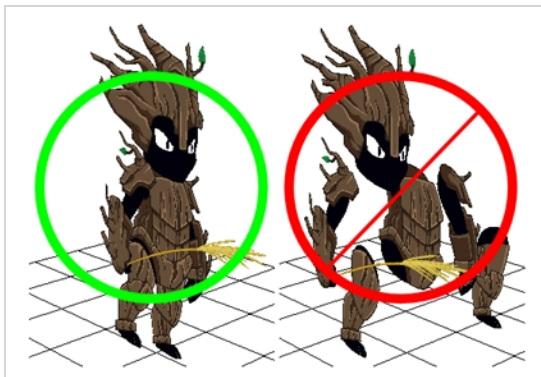

Animation functions

By default, pegs use 3D Path functions to record their position. It is recommended, but not required, to configure your pegs to use Separate position functions instead, as 3D Path functions are a bit heavier on performance. You can make a peg use separate functions by opening its Layer properties, then selecting **Separate** under the Position section.

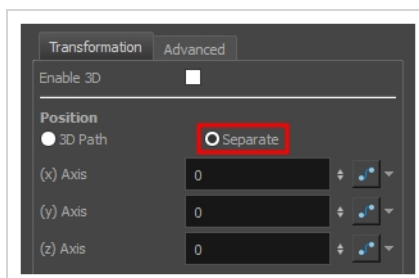



NOTE

Converting a peg or layer's function type to Separate will discard any existing animation on that peg or layer.

How to make a peg's position functions separate

1. Do one of the following to access the peg's Layer Properties:
 - Open the Layer Properties view, then select the peg layer in the Timeline view.
 - In the Timeline view, double-click on the peg layer, but not inside its name, to open its Layer Properties dialog.
2. In the **Transformation** tab of the peg's Layer Properties, under **Position**, select **Separate**.

Effects

Aside from the Cutter, you should not use any effect, as no other effect supported by Harmony can be exported to Unity.



NOTES

- This includes Colour-Override and other simple colour effects. No such effect will be exported to Unity.
- The Cutter effect also has limitations when rigging a character for gaming—see [Guidelines for using the Cutter Effect for Game Assets in Harmony on page 813](#).

Bitmap

The use of bitmap image files (i.e.: **.png** or **.tga** files) in your rig is not supported.

Symbols

The use of symbols is not supported.

Guidelines for using the Cutter Effect for Game Assets in Harmony

If you intend to use cutters in a character rig that you plan to import in Unity, you must follow the following guidelines to ensure your character displays as expected in your game.



NOTE

You do not need to follow these guidelines if you intend to export a rendered sprite sheet—see [Exporting Rigged Sprite Sheets or Rendered Sprite Sheets on page 807](#).

No Consecutive Cutters

You can only connect a single cutter under any drawing. If you connect several cutters in a chain, only one of them will take effect in Unity.



No Using groups as Mattes

You can only connect individual drawings to the matte connection of a Cutter. You cannot use a group or effect as the matte of a Cutter.



No Using the Drawing Layer's Matte connection

Although drawing nodes have their own matte connection, you should not use them. You must use Cutter effects if you want to mask parts of certain layers.



No Cutting a Deformed Drawing

You cannot connect a cutter under a drawing that is under a deformation.

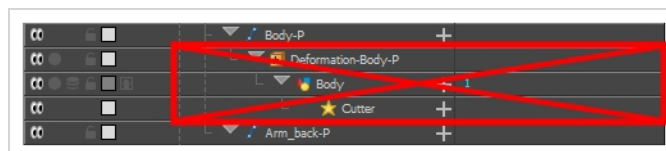

Guidelines and Tips for Animating Game Assets in Harmony

The following are guidelines to follow when animating a character in Harmony if you intend to export it for use in Unity.



NOTE

You do not need to follow these guidelines if you intend to export a rendered sprite sheet—see [Exporting Rigged Sprite Sheets or Rendered Sprite Sheets on page 807](#).

Animation on Pegs

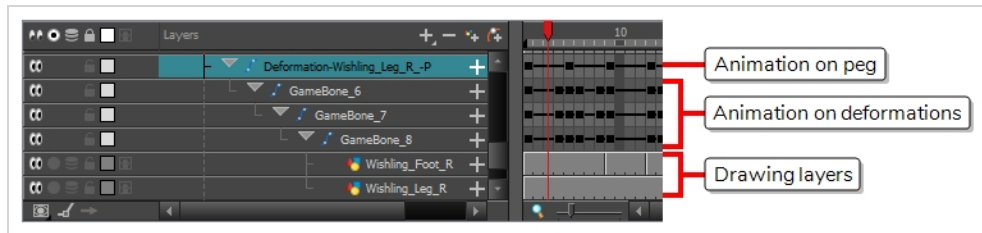

When animating game sprites in Harmony, you should animate the body parts on their parent pegs or their deformations, and not on the drawing layers directly, to keep the drawing information and the animation information separate.



TIP

To facilitate this workflow, you can enable the  Peg Selector Mode option in the Tool Properties of the Transform tool. This will ensure that, when you click on a drawing layer in the Camera view, its parent peg is selected instead.

Animation Techniques

It is recommended to use geometrical transformations—done with the  Transform tool or the  Advanced Animation tools—to animate the body parts of your rig as much as possible, as those are easier for Unity and for graphics cards to render. You should only use deformations, drawings swaps or frame by frame animation when necessary.

Deformations

If you want to use deformations for your animation, you must use Game Bone deformations. Game Bone deformations are similar to regular Bone deformations, but have less options and are designed to render the way Unity would render them—see [About Game Bone Deformations on page 536](#).

Exported Assets

Drawings that are not used by your character or its props will not be exported with the sprite sheet. Hence, you do not need to delete unused drawings from your scene to optimize the exported assets.

Guidelines for Adding Audio to your Game Assets

The Harmony Game SDK supports exporting sound clip from a Harmony scene into a Unity GameObject. However, there are important limitations to consider if you plan to do this.

No Clipping	If you clip your sound effects in Harmony, they will still be imported as whole in Unity. Hence, you should edit your sound effects in a sound editing software before importing them in Harmony. Likewise, if a sound effect extends past the end of the scene, it will not be cut off in Unity. It will play until the end.
No Volume Adjustments	If you adjust the volume envelope of a sound effect in Harmony, these adjustments will not be exported to Unity.
Importing into Unity	Sound effects exported with your Harmony assets will not automatically play with your animations in Unity. The developer must themselves program the logic for playing sound clips.

Because of these limitations, it is highly recommended to only import audio in your Harmony scene and export them with your sprite sheets when necessary, such as when you need to lip-sync your character's mouth with their dialogue. Otherwise, it is recommended to add your sound clips in Unity instead.

Creating Multiple Clips for a Game Object in Harmony

A game sprite typically has more than one animation. With Harmony, you can create all of your character's animation clips in the same scene, provided that you separate them properly.

To separate your clips, you must create one scene version for each clip you want to make. To accomplish this, you must proceed as follows:

1. First, you create a scene and, in this scene, create the full rig for your character, without animating it.
2. Then, you save a new version of your scene for the first animation clip you want to create. To do this, select **File > Save As New Version** from the top menu. Give this scene version the name you want your clip to have. For example, if you want to create your character's idle animation, you could name this scene version *Idle*.
3. In this scene version, create your character's animation. Make sure the animation starts as soon as the scene begins and that the scene ends as soon as the animation is over.
4. To create another clip, repeat steps 2 and 3 until you have all the clips you need for your character.

In the end, your scene and its versions may have something like this:

Scene	Version
SpaceDuck	<ul style="list-style-type: none">• Idle• Run• Jump• Shoot

About Anchors and Props

Anchors and props are a feature of Unity allowing you to attach a prop, such as an item or a weapon, to a body part in your character rig. This is done by creating an anchor on your rig, which is a point that can be moved and rotated, and to which the prop can be bound. For example, you could make the hand of your character an anchor, and the weapon the character wields with that hand a prop.



A prop can be enabled and disabled in Unity. Also, a single prop can have several different drawings in it, which can be switched in Unity at any time. Hence, creating props for your character allows them to carry or wear different objects and equipment without rendering a sprite sheet of your character for each object.



NOTE

To be able to export your character with anchors and props, you must export your character as a rigged sprite sheet—see [Exporting Rigged Sprite Sheets or Rendered Sprite Sheets on page 807](#).

Creating an Anchor for a Game Character

An anchor is simply a layer that has been marked as an anchor. Creating anchors is required to make props follow the animation of the layer they are rigged to.

In Unity, an anchor is a point, whereas a layer in Harmony is more like a canvas. Hence, the exact position of the anchor is based on the position of the layer's pivot point in Harmony. Because of this, it is recommended to create a layer specifically for the anchor in Harmony, instead of using one of your character's existing layers, so that you can position its pivot point without affecting your character's animation.

For example, if the character's hand is meant to be an anchor for a weapon prop, the hand's pivot point would usually be on the wrist to optimize animation, but you'd want the anchor for this hand to be positioned in the palm. Hence, you could create an empty drawing layer, rigged under the same peg as the hand, make this layer the anchor, and position its pivot point in the hand's palm.



NOTE

For a layer to work as an anchor, it must have a drawing, because drawings store pivot points. Hence, if you want an empty layer to be used as an anchor, you must put an empty drawing in it so that you can set its pivot point.

How to create an anchor

1. If the Game toolbar is not already in your workspace, do one of the following to add it:
 - In the top menu, select **Windows > Toolbars > Game**.
 - Right-click on any existing toolbar and select **Game**.

The Game toolbar is added to your workspace.



2. In the Timeline view, scroll to and select the layer for the body part which you want to use as an anchor.

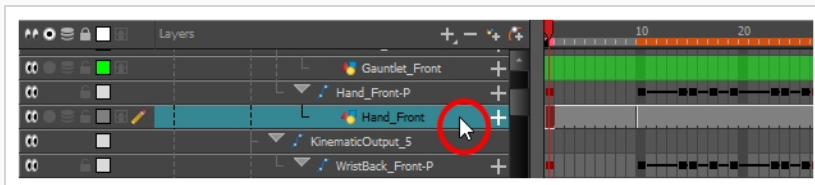

3. Create a new drawing layer by doing one of the following:
 - In the toolbar over the layers list, click on  Add Drawing Layer
 - Right-click on the layer and select **Insert > Drawing Layer**.
 - Press Ctrl + R

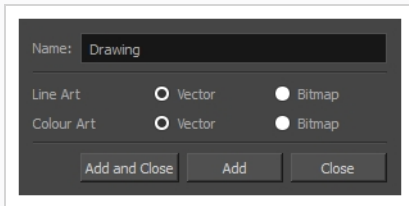

4. In the Add Drawing Layer dialog, type in a name for your anchor.

**TIP**

To make it easier to associate your anchor and its props in Unity, it is recommended to give your layer a name that indicates which prop it will be attached to. For example, if you are creating an anchor for a prop layer named **Weapon**, you could name it **Weapon_anchor**.

5. Click on **Add and Close**.

The anchor layer will be created as a sibling to the body part you previously selected. If you animated this body part's parent peg, the anchor layer will move at the same time as that body part.

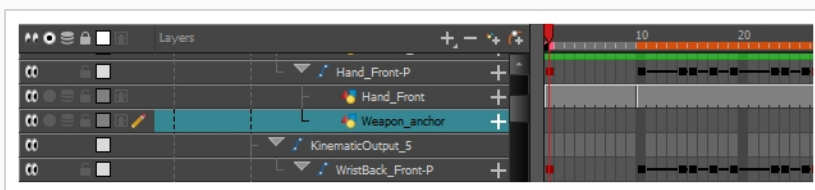

6. In the Timeline view, select the first frame in the anchor layer.

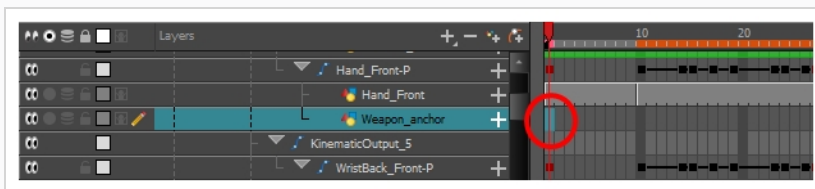

7. In the anchor layer, create an empty drawing by doing one of the following:
 - In the Timeline view, right-click on the first frame of the layer and select **Drawings > Create Empty Drawing**.
 - In the top menu, select **Drawing > Create Empty Drawing**.
 - Press Alt + Shift + R.

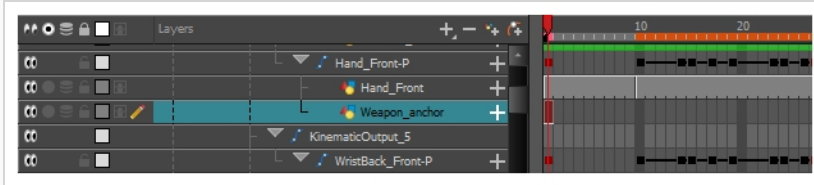

8. Extend the exposure of the empty drawing until the end of your scene by doing one of the following:
 - In the top menu, select **Animation > Cell > Extend Exposure**.
 - Press F5.

The Extend Exposure dialog appears.

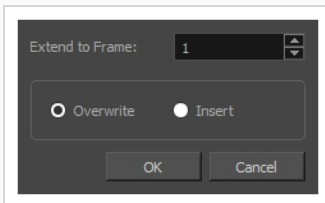

9. In the **Extend to Frame** field of the Extend Exposure dialog, type in the amount of frames in your scene.
10. Click on **OK**.

The exposure of the anchor drawing is extended until the end of the scene.

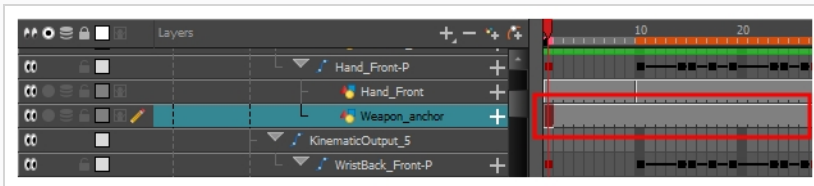



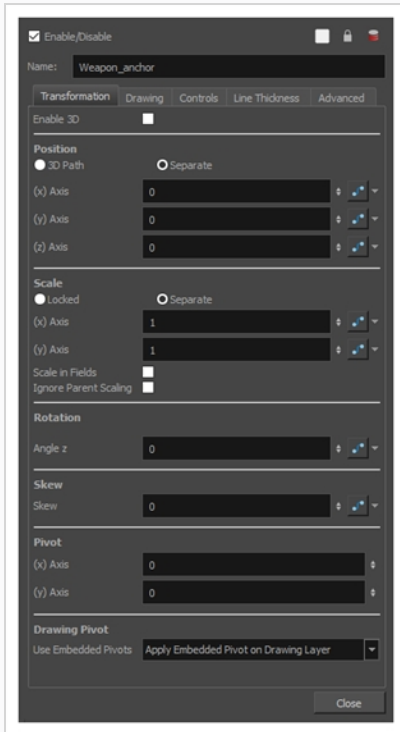

11. In the Timeline view, double-click on the anchor layer (but not on its name) to open its Layer Properties dialog.

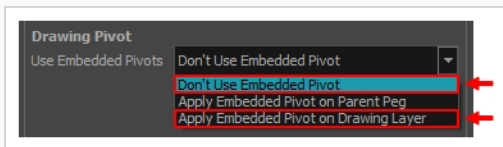

- In the **Transformation** tab, under the **Drawing Pivot** section, open the **Use Embedded Pivots** drop-down and select either **Don't Use Embedded Pivot** or **Apply Embedded Pivot**.



- Close the Layer Properties dialog.
- In the Advanced Animation toolbar, select either the  **Translate**,  **Rotate**,  **Scale** or  **Skew** tool.
- In the Camera view, click and drag on the pivot point  and position it where you want the anchor to be positioned.

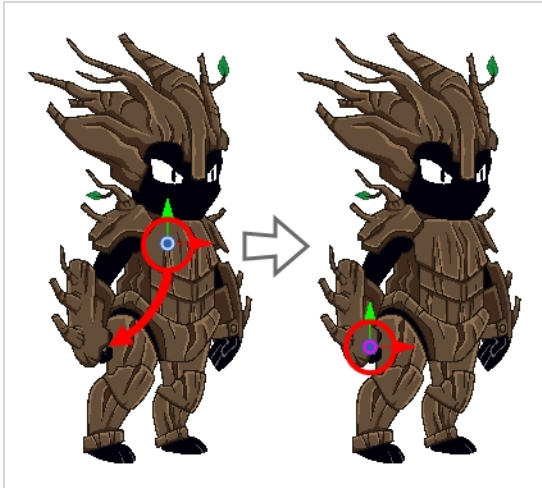

16. In the Game toolbar, click on  **Toggle Anchor**.

The layer will now be an anchor. Its colour in the Timeline view will be changed to red.

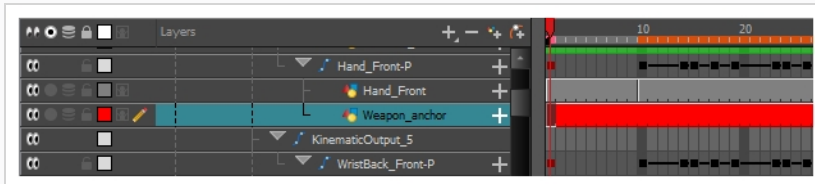

In the **Metadata Editor** view, its **Node Metadata** should contain the following entry:

```
game.isAnchor
```

You now have an anchor layer for which you can create props.

Creating Props for Game Characters

A prop is simply a drawing layer that has been marked as a prop. To make sure it follows its anchor's animation, it must be either rigged as a child or a sibling of the anchor in the rig hierarchy.

A prop can have one or several drawings. All drawings in a prop will be exported with your character, and it will be possible to switch between the different drawings for your prop in Unity.

How to create a prop

1. If the Game toolbar is not already in your workspace, do one of the following to add it:

- In the top menu, select **Windows > Toolbars > Game**.
- Right-click on any existing toolbar and select **Game**.

The Game toolbar is added to your workspace.



2. Select the anchor layer to which you want your prop to be attached.

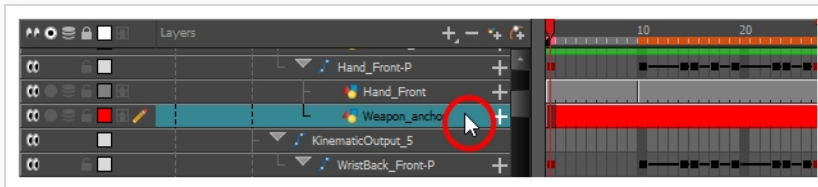

3. Create a new drawing layer by doing one of the following:

- In the toolbar over the layers list, click on **Add Drawing Layer**
- Right-click on the layer and select **Insert > Drawing Layer**.
- Press **Ctrl + R**

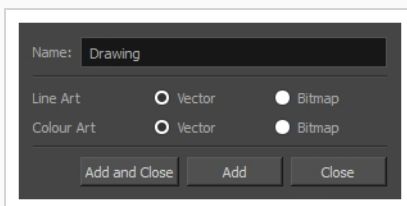

4. In the Add Drawing Layer dialog, type in a name for your prop layer.
5. Click on **Add and Close**.

The prop layer will be created as a sibling to the anchor layer you previously selected. If you animate the anchor layer's parent peg, the prop will also move along with it.

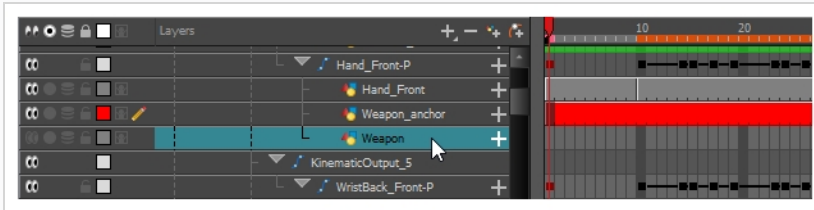

TIP

You can also rig the prop to be a child of the anchor layer, like so:

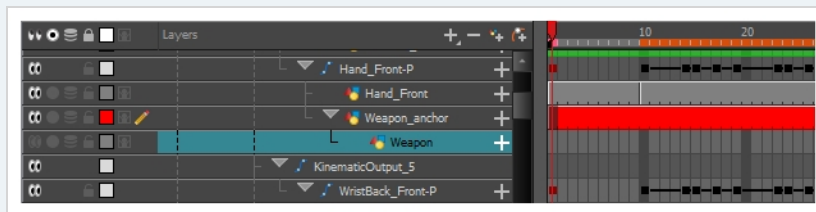



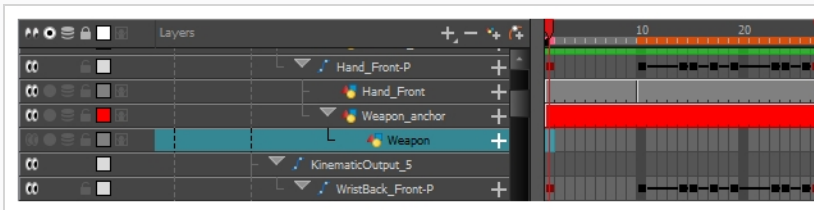

6. In the Timeline view, select the first frame of the prop layer.

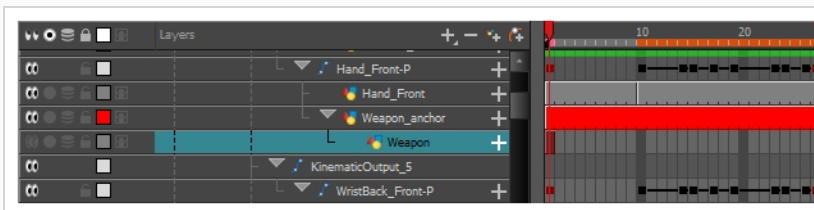

7. Create an empty drawing in the prop layer by doing one of the following:

- In the Timeline view, right-click on the first frame of the layer and select **Drawings > Create Empty Drawing**.
- In the top menu, select **Drawing > Create Empty Drawing**.
- Press **Alt + Shift + R**.



8. In the Advanced Animation toolbar, select either the  **Translate**,  **Rotate**,  **Scale** or  **Skew** tool.

9. In the Camera view, click and drag on the pivot point  and position it where you want the anchor to be positioned.

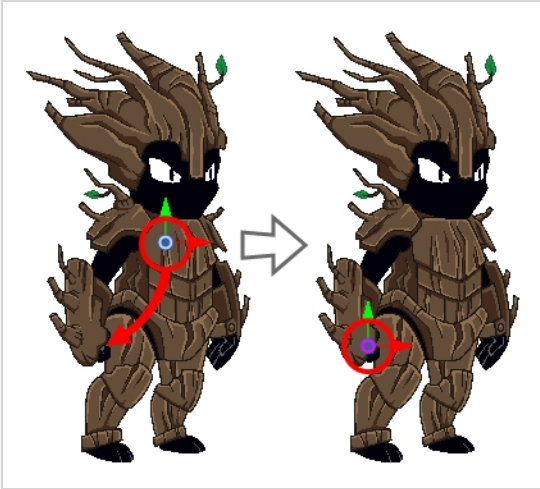

10. In the Game toolbar, click on  **Toggle Prop**.

The layer will now be a prop layer. Its colour in the Timeline view will be changed to **green**.

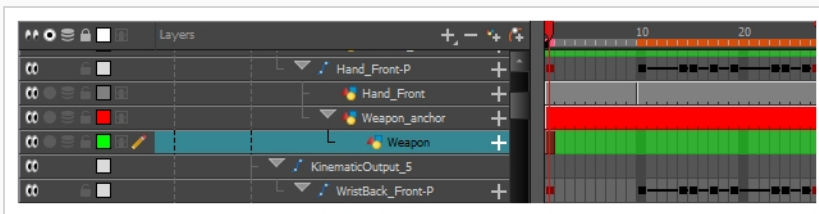

In the Metadata Editor view, its Node Metadata will contain the following entry:

`game.isProp`

You can now start drawing your props in the prop layer.

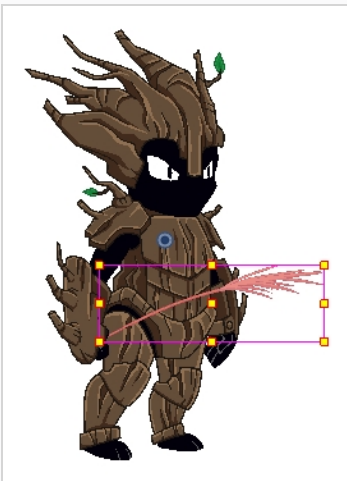



TIP

You can create several drawings in a single prop layer. You will get to toggle between those drawings after attaching the prop to the anchor in Unity.

Adding Metadata Notes to Game Props

You can add metadata notes to props, which will have a name and value. This metadata will be accessible in Unity. It will be visible in the Inspector view when the prop is selected in the Hierarchy view

You can use this mechanic to add properties to your props in Harmony, then use them in Unity. For example, if a character has a weapon for a prop, you could add the attack power of that weapon as a metadata note for the prop.

How to add metadata to a prop

1. If the Metadata Editor view is not in your workspace, do one of the following:
 - In the top-right corner of a view, click the **+ Add View** button and select **Metadata Editor**.
 - In the top menu, select **Windows > Metadata Editor**.
2. In the Timeline view, select the prop layer to which you want to add metadata.

The name of the layer appears near the top of the Node Metadata section.



3. In the Node Metadata section, click on the **+ Add Node Metadata Entry** button to create a new metadata entry.

The Add Metadata dialog box appears.

4. In the Add Metadata dialog box, type in **game** . followed by the name of the metadata variable you want to add.



NOTE

For the prop's metadata to be imported in Unity, its name must begin with **game** followed by a period.

5. Do one of the following:

- Click on the **Add** button if you want to add more metadata entries.
- Click on the **Add and Close** button to add this metadata entry and close the Add Metadata dialog.

The metadata entries you created are added to the Metadata Editor view, in the Node Metadata section.

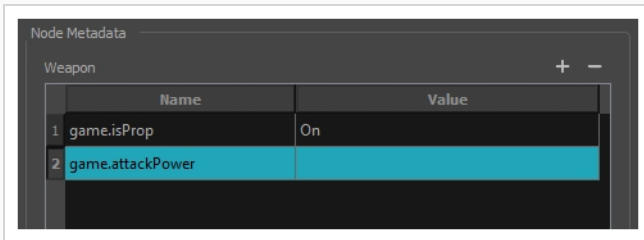

6. In the Metadata Editor view, double-click on the cell right of the name of the new metadata entry, in the Value column, to edit the entry's value.

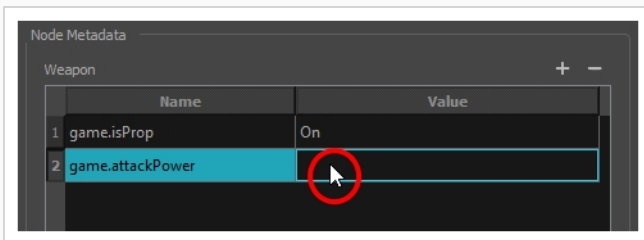

7. Type in the value for this metadata entry and press ENTER.

You now created a metadata entry with a name and value for your prop.

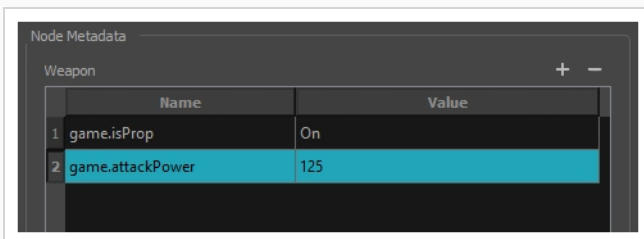

Using the Harmony Game Previewer

If you are not a developer and would like to see if your animations and rigs will work once imported in Unity, you can use the Harmony Previewer application. You can visualize your characters in the Unity game engine with no programming required.

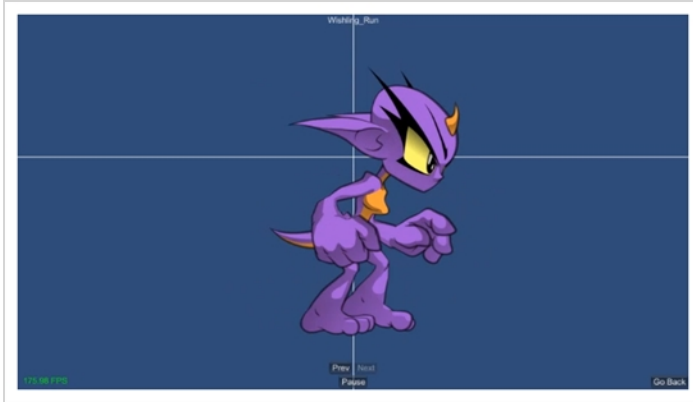

To get the latest version of the Harmony Game Previewer, visit our Gaming landing page:

<https://www.toonboom.com/games>

How to use the previewer on Windows



1. Download the Harmony Game Previewer for Windows:
 - <https://docs.toonboom.com/go/download/GamePreviewer-12-2-windows>
2. Extract the following to your hard drive:
 - GamePreviewer-[version].exe
 - GamePreviewer-[version]_Data folder
3. Copy your export from Harmony to this folder:
 - GamePreviewer-[version]_Data\StreamingAssets\HarmonyResources\
4. Start the Game Previewer application.
5. Select the export you want to preview.

How to use the previewer on macOS

1. Download the Harmony Game Previewer for macOS:
 - <https://docs.toonboom.com/go/download/GamePreviewer-12-2-mac>

2. Extract the GamePreviewer-[version].app.
3. Right-click on the GamePreviewer-[version].app and select **Show Package Contents**.
4. Copy your export from Harmony to this folder:
Contents/Data/StreamingAssets/HarmonyResources/
5. Start the Game Previewer application.
6. Choose the export you want to preview

About Exporting to Unity

Using the  **Export to Sprite Sheet** and  **Export to Easel JS** buttons in the Game toolbar, you can export your character into a package containing sprite sheets and metadata that can be imported into a game engine.

Specifically, if you use the Export to Sprite Sheet option, your character will be exported as a rigged, animated skeleton with sprites, in a format that can easily be imported using the Harmony Game SDK package for Unity, without any scripting required.



If you use the Export to Easel JS option, your character will be exported with each animation frame rendered as a full body sprite, along with metadata that can be used to import it in Unity. However, you will need to program the logic for importing the spritesheet into Unity yourself.

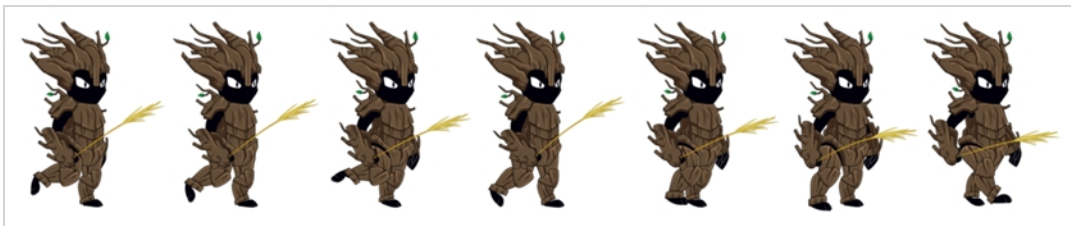

TIP

Since both the Export to Sprite Sheet and Export to Easel JS dialogs are scripts, you can modify them in Harmony's Script Editor view, to make them export in a format that is compatible with your game engine. Those scripts are named **TB_ExportToSpriteSheets.js** and **TB_ExportToEaselJS.js**, respectively.

Before exporting your character as a spritesheet, ensure that:

- Your scene is saved. Harmony creates the sprites using the drawing files in your scene folder. Hence, any unsaved changes will not appear in the exported sprite sheets.
- The dimensions of your scene are set to a number that is a power of two, such as 512, 1024, 2048, etc. Graphic cards work with textures the dimensions of which are a power of two.
- Your character rig is positioned so that the centre of the stage is where you want its pivot point to be.
- You respected all the guidelines for rigging and animating game assets—see [Rigging Guidelines on page 806](#).

Installing the Scripts for Exporting Game Sprite Sheets

The scripts that are required for exporting game assets have been significantly updated in Harmony 15.0.5.

Because scripts packaged with Harmony are copied to your user preferences when you first launch Harmony, but do not get replaced by Harmony when you launch it again, if you have used any version of Harmony between 15.0.0 and 15.0.4 inclusively, your preferences have the older versions of these scripts, and the updated scripts will not be copied to your preferences so as to avoid overwriting these older scripts.

Hence, you must update the scripts in your preferences manually in order to be able to export your game assets from Harmony. To do this, you must copy them from the Harmony installation directory to your preferences.

How to copy the new gaming scripts to your preferences on Windows

1. Open an Explorer window.
2. Navigate to the following location:

C:\Program Files (x86)\Toon Boom Animation\Toon Boom Harmony 15.0 Essentials\resources\scripts

3. Select the following file:

TB_ExportToSpriteSheets.js

4. Right-click on the selected files and select **Copy**.
5. In the top menu, select **View** and check the **Hidden items** option in the **Show/hide** section.

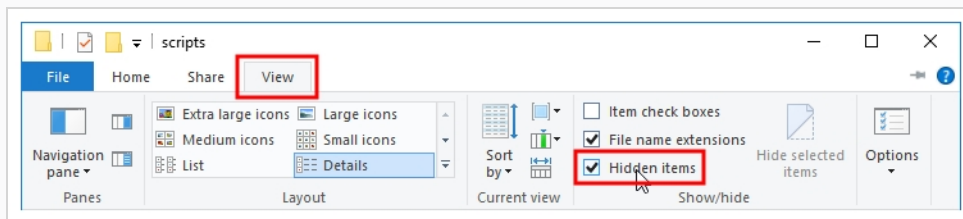

6. Navigate to the folder of your user's scripts:
 - If you are using Harmony Stand Alone:

C:\Users\<<your username>\AppData\Toon Boom Animation\Toon Boom Harmony Essentials\1500-scripts
 - If you are using Harmony Server:

C:\USA_DB\users\<<username>\Harmony Essentials\1500-scripts
7. Right-click inside the folder and select **Paste**.
8. When prompted, confirm that you want to replace the existing files.

How to copy the new gaming scripts to your preferences on macOS

1. Open a Finder window.
2. Navigate to the following location:

**`/Applications/Toon Boom Harmony 15.0
Essentials/tba/resources/scripts`**

3. Select the following file:

`TB_ExportToSpriteSheets.js`

4. Right-click on the selected file and select **Copy "TB_ExportToSpriteSheets.js"**.
5. Navigate to the folder of your user's scripts:
 - If you are using Harmony Stand Alone:

- a. While holding the Alt key, in the top menu, select **Go > Library**.

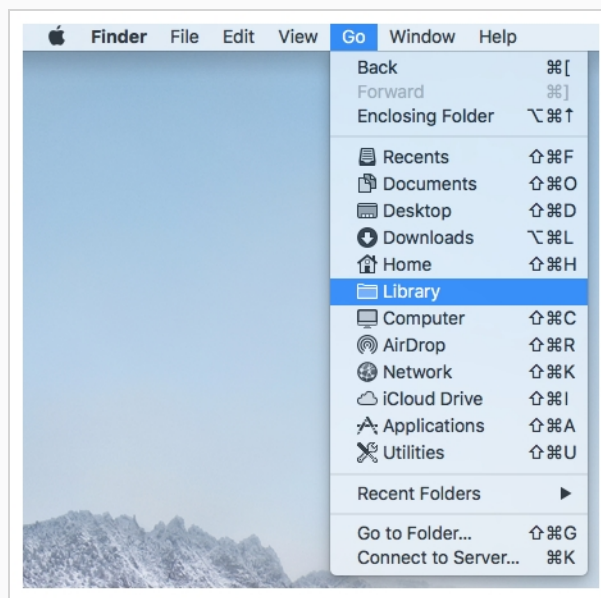

- b. From there, go to **Preferences/Toon Boom Animation/Toon Boom Harmony Essentials/1500-scripts**.
- If you are using Harmony Server:
 - a. In the top menu, select **Go > Computer**.
 - b. From there, double-click on the name of your computer's main partition (usually **Macintosh HD**), then go to **USA_DB/users/<username>/Harmony Essentials/1500-scripts**.

6. Right-click inside the folder and select **Paste**.
7. When prompted, confirm that you want to replace the existing files.

Exporting a Game Character as a Rigged Sprite Sheets

The Export to Sprite Sheets dialog allows you to export your rig into a sprite sheet and its animation into animation metadata, in a package that can be directly imported into Unity using the Harmony package for Unity.

To export all the clips for your character, you will need to start by exporting the sprite sheet from your base scene, then open each scene version and export their animation clip one by one.

How to export sprite sheets for a character

1. If the Game toolbar is not already in your workspace, do one of the following to add it:
 - In the top menu, select **Windows > Toolbars > Game**.
 - Right-click on any existing toolbar and select **Game**.

The Game toolbar is added to your workspace.



2. Open the base scene version for your character, that is: the scene version in which you built your character rig.
3. **Make sure every drawing used by every scene version of your character is exposed at least once in this scene version.** To do this:
 - a. Add as many frames to your scene as there are drawings in the layer with the most drawings.
 - b. Leave the first frame with the drawings for your character's normal poses.
 - c. In subsequent frames, expose the other drawings in each layer until every drawing used for all of your character's animation clips is exposed for at least one frame.
4. In the Game toolbar, click on the  **Export to Sprite Sheets** button.

The Export to Sprite Sheets dialog appears.

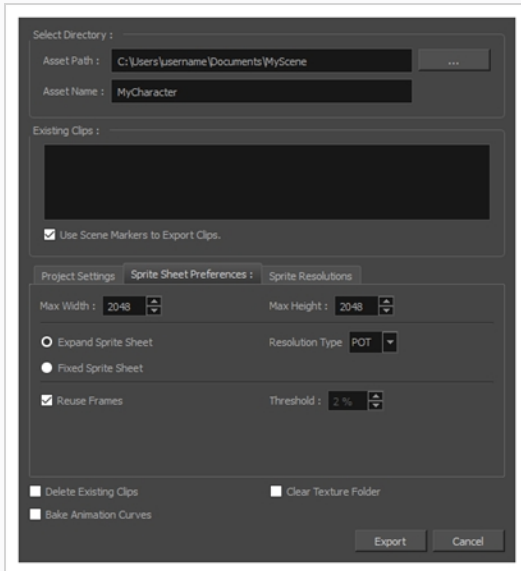

5. Right of the **Asset Path** field, click on the ... button.

A folder select dialog opens.

6. Browse to and select the directory in which you want to create your asset directory.



NOTE

You do not need to create a directory specifically for your exported assets. One will be created with the name in the Asset Name field.

7. In the **Asset Name** field, type in the name of the directory in which to export your assets. This will also be the name of the GameObject in Unity.
8. Under **Existing Clips**, make sure the **Use Scene Markers to Export Clips** option is unchecked.



NOTE

Scene markers are not supported in Harmony Essentials. They are supported in Harmony Advanced and Harmony Premium.

9. Select the **Sprite Resolutions** tab.

This tab contains a list of all the resolutions in which your sprite sheets will be exported.

10. Do the following to export in the resolutions you want your game support:
 - To add a resolution, click on the **+ Add Resolution** button. A row will be added to the list. Double-click on each field in the new row to type in its name, its width and its height, in that

order from left to right.

- To remove a resolution, select it in the list, then click on the — **Remove Resolution** button.
11. For most usages, the other default parameters in the dialog should be fine. To learn more about the parameters in the Export to Sprite Sheet dialog, refer to the Export to Sprite Sheet Dialog Box topic of the Reference guide.
 12. Click on **Export**.
Harmony will export the sprite sheet for your base rig.
 13. Open the scene version for the first animation clip for your character.
 14. Repeat steps **5** to **14** to export the animation for this scene version. Make sure to export in the exact same directory in which you exported the sprite sheet for your base rig.
 15. Repeat for each scene version containing an animation clip for your character.

Exporting Game Assets to Easel JS

The Export to Easel JS dialog allows you to export your game character as a sprite sheet, in which each animation frame in your scene is rendered as an individual sprite.

Since the Export to Easel JS dialog renders each frame in your scene, there will not be any visible difference between the way your character is rendered by Harmony and how it is rendered in your game engine.

However, the Export to Easel JS dialog has the following important limitations:

- Contrary to the Export to Sprite Sheet dialog, the Export to Easel JS only outputs a sprite sheet and an XML document delimiting each sprite in the sheet. Hence, they cannot be imported into Unity using the Harmony Game SDK package. You must program the logic to import those sprite sheets into your game engine yourself.
- The Export to Easel JS dialog does not export anchors and props.
- Fully rendered sprite sheets are much heavier in size than rigged sprite sheets, which is what the Export to Sprite Sheet dialog exports.

How to export a game character to Easel JS

1. Do the following to add the Game toolbar to your workspace:
 - In the top menu, select **Windows > Toolbars > Game**.
 - Right-click on any existing toolbar and select **Game**.

The Game toolbar is added to your workspace.



2. Open the base scene version for your character, that is: the scene version in which you built your character rig.
3. In the Game toolbar, click on the  **Export to Easel JS** button.

The Export to Easel JS dialog appears.

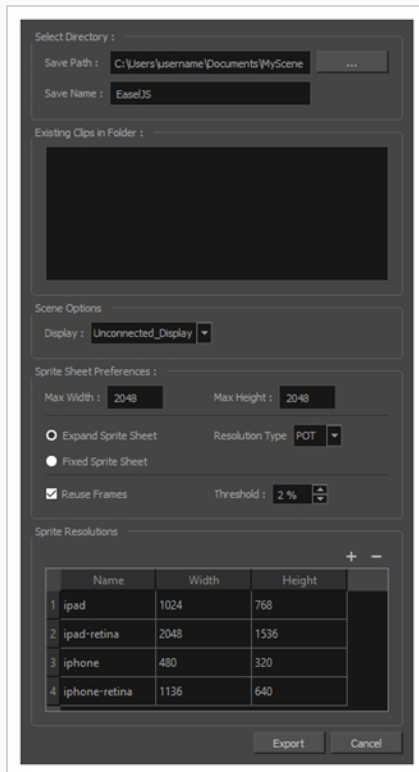

- Right of the **Asset Path** field, click on the ... button.

A folder select dialog opens.

- Browse to and select the directory in which you want to create your asset directory.



NOTE

You do not need to create a directory specifically for your exported assets. One will be created with the name in the Asset Name field.

- In the **Asset Name** field, type in the name of the directory in which to export your assets. This will also be the name of the GameObject in Unity.
- In the **Sprite Resolutions** section, there is a list of all the resolutions in which your sprite sheets will be exported. Do the following to export in the resolutions you want your game support:
 - To add a resolution, click on the **+ Add Resolution** button. A row will be added to the list. Double-click on each field in the new row to type in its name, its width and its height, in that order from left to right.
 - To remove a resolution, select it in the list, then click on the **- Remove Resolution** button.

8. For most usages, the other default parameters in the dialog should be fine. To learn more about the parameters in the Export to Sprite Sheet dialog, refer to the Export to Easel JS Dialog Box topic of the Reference guide.

9. Click on **Export**.

Harmony will export the sprite sheet for your base rig.

10. Open the scene version for the first animation clip for your character.

11. Repeat steps **3** to **10** to export the animation for this scene version. Make sure to export in the exact same directory in which you exported the sprite sheet for your base rig.

12. Repeat for each scene version containing an animation clip for your character.

Converting Exported Game Assets from XML to Binary

Programmers may be interested to note that the XML data exported by Harmony can be converted afterwards to a more optimized binary data structure. To convert XML to Binary format, use the **Xml2Bin** utility. This utility converts the XML data structure generated through the Toon Boom Harmony software to a compressed binary data structure. This utility is available in the gaming SDK in the following directory:

HarmonySDK/Source/Utils/

This directory contains the following:

- **macosx**: Precompiled binary for macOS.
- **win32**: Precompiled binary for Windows.
- **Xml2Bin**: Xml2Bin sources.
- **Xml2Bin/proj.mac/Xml2Bin.xcodeproj**: XCode project for macOS.
- **Xml2Bin/proj.win32/Xml2Bin.sln**: Visual Studio project for Windows.

The C++ code that handles the data structure can be reused and parsed in your own code if you want to integrate with other game engines.

About Working in Unity

The following section details how to import a character which you have created in Harmony and exported using the Export to Sprite Sheet dialog into a Unity project. Once your character is imported, you will also learn how to preview the clips and the props you created in Harmony in Unity, if applicable.



NOTES

- The following section does not explain how to import a package exported using the Export to Easel JS dialog, as this dialog only exports a basic sprite sheet.
- The following section does not explain how to create a game in Unity. It only explains how to import and preview assets created in Harmony.
- No coding skills are required to follow the methods in this section

About the Sample Unity Project

Toon Boom includes a sample Unity project that contains all the scripts necessary to import the data exported from Harmony. Inside this project is an Assets folder which contains the following folders:

- Plugins
- Scenes (demo scenes and a previewer)
- Scripts (all Harmony scripts)
- StreamingAssets (this is where all the Harmony scene files should be exported to)

By configuring the Harmony script, you can automatically export animations into the StreamingAssets folder. This way, Unity will dynamically load the most up-to-date assets as soon as they appear in the folder. You can also manually place exported Harmony data into this location.

About the Unity Interface

Here are the main components of the Unity interface and their equivalents in Harmony:

Unity	Harmony	Description
Scene view	Perspective view	This is where you set the scene, selecting and positioning environments, the player, the camera, enemies, and all other GameObjects.
Game view	Camera view	The rendered view from the camera(s) in your game. It is representative of the final, published game.
Inspector	Layer Properties	Displays detailed information about the selected GameObject, including all attached Components and their properties.
Hierarchy	Layers in Timeline view	Displays the hierarchy of elements in the scene, and lets you set up parent-child relationships for different game objects.
Project Browser	---	Lets you access and manage a project's assets.

The main camera displays the scene and is located in the Hierarchy. To show a Harmony object, you must add a special component. With the main camera selected, in the Inspector, select **Add Component > Scripts > Harmony Camera**.

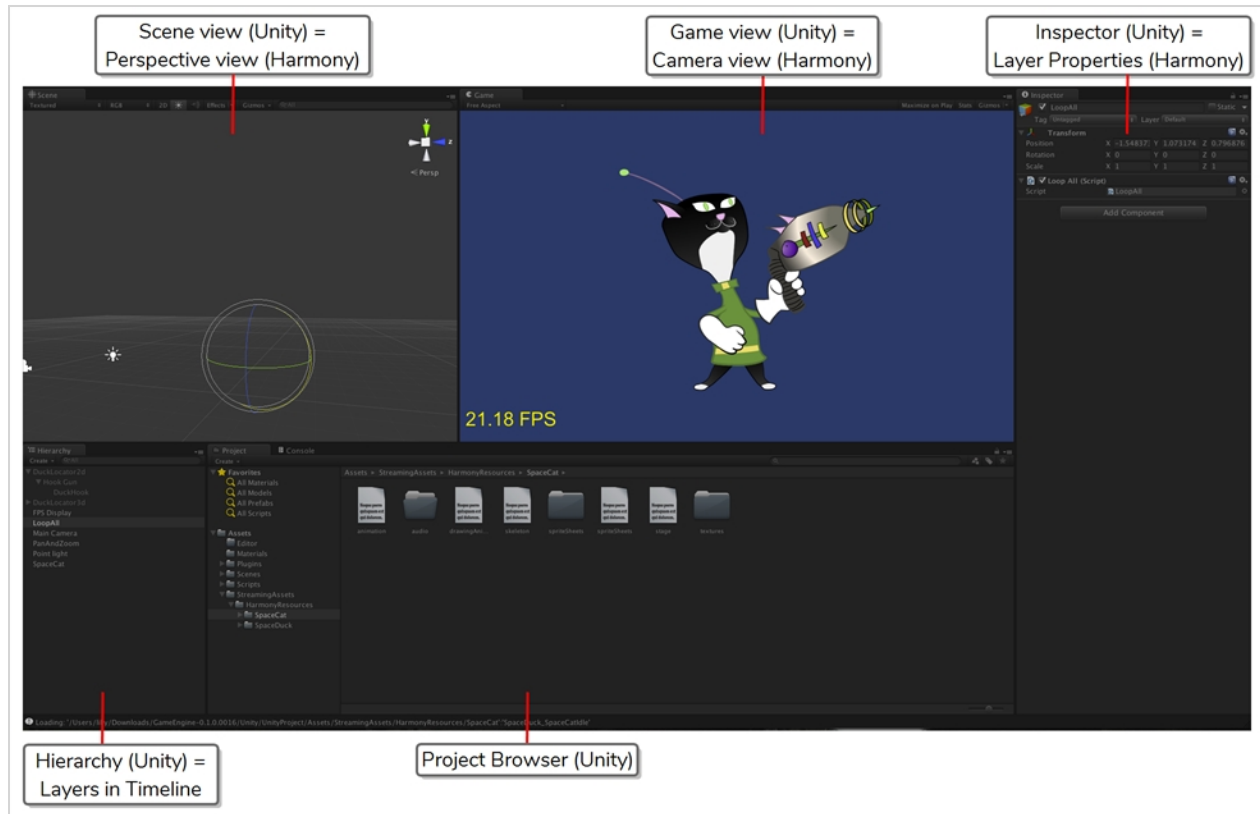

Importing Harmony Files into Unity

Once you've finished creating your artwork and cyclable animated character movements in Harmony, it's time to import them into Unity for game integration.

How to import Harmony files directly into Unity

1. Create a Unity 2D project.
2. The SDK Harmony project needs to be imported to your project in order for the assets to be brought in. Do one of the following:
 - Go to the Unity Asset Store (<https://docs.toonboom.com/go/download/UnityPackage>) and save the Harmony Game SDK file on your computer. Then import it in your project from the following: **Top Menu > Asset > Import Package > Custom Package**.
 - Search for the Harmony Game SDK in the Unity Asset Store, then download and import the package. You can access the Asset Store from the following: **Top Menu > Window > Asset Store**.



NOTE

For each new Unity project, you must repeat step 2 as it contains the necessary files and folders to make the Harmony import process work.

3. Add the exported game object to the scene by going to **Top Menu > GameObject > Harmony >**
 - **Harmony Object:** Lets you browse for the exported Harmony project folder. If you've already saved this to your StreamingAssets folder, you can browse to it through there. Then it adds the Harmony scene to your Unity file, and sets up the rendering, audio, and animation scripts you need to get going.
 - **Harmony Texture Object:** Lets you browse for the exported Harmony project folder similarly to Harmony Object, but creates a Unity plane to render your animation on it.

About Game Objects

GameObjects are the fundamental objects in Unity that represent characters, props and scenery. Basically everything you create in Unity will be a GameObject. There are two main types of GameObject you can use to import Harmony data:

- **Create Empty**
- **Create Other > Plane**

To understand the process fully, there are two examples using an empty GameObject and a plane GameObject with the SpaceCat demo file. Everything you do will be based on the GameObject you create to load your Harmony data.

Using Empty Game Objects

An Empty Game object is a regular GameObject in which you can load the exported Harmony data. All the individual body parts on the sprite sheet come in as separate elements, but are treated as one whole object with a dynamically created bounding box. If you put a transparency on this object, you would see the overlapping transparencies of all the individual objects. This creates a higher-quality render and should be the default if you're not animating the transparency of an object. With this option, direct rendering will read the depth information in the scene but not write it. Note that with this option, the rendering cannot be customized.

How to use an empty GameObject

1. Select **GameObject > Create Empty**.
2. Rename the empty GameObject so it's clear in the Hierarchy. Since we're using the SpaceCat demo file, rename the GameObject to **SpaceCat** by doing one of the following:
 - Double-click on the name and rename it in the Hierarchy.
 - Select the GameObject and rename it in the Inspector.
3. At this point, it's an empty object. Accessing Harmony data is done through scripts.
 - Select the SpaceCat GameObject.
 - In the Inspector, go to **Add Component > Scripts > Harmony Renderer**.

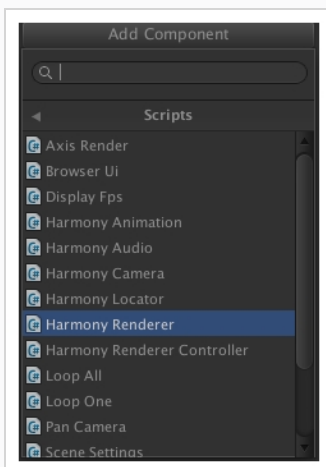

A new section appears in the Inspector called Harmony Renderer (Script).

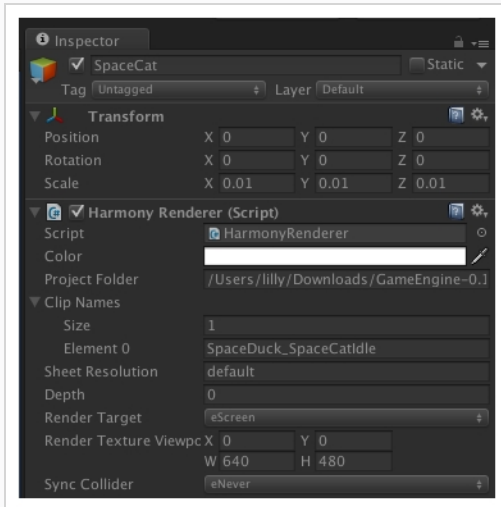

This will let you load an animation file. You must put the path of the asset relative to the HarmonyResources folder. Before this, you must export from Harmony directly to this folder, or manually copy and paste the data here.

4. You exported a scene called SpaceCat. In the Project Folder, place **HarmonyResources/SpaceCat** under the Transform information at the top, under Scale. Set the values to 0.01 for X, Y, and Z because the default Harmony project is for an HD screen.
5. You won't see anything until you define a few parameters:
 - Set the Clip Name Size to 1. A second field will appear, Element 0.
 - Enter the clip name for the animation you want to load.
6. Double-check on the right Clip Name to put in Element 0; you can check the output you exported from Harmony.
7. Double-check the **stage.xml** file, which was exported to the folder you specified when exporting from Harmony. Our default export path is to StreamingAssets, so it will automatically load in the game engine.
8. Look in the Project tab, under **Assets > StreamingAssets > HarmonyResources > [ExportName]**.

You'll find the data that was exported. In this case, we're looking for SpaceCat. Select the file marked **stage** to load the data you want to double-check.

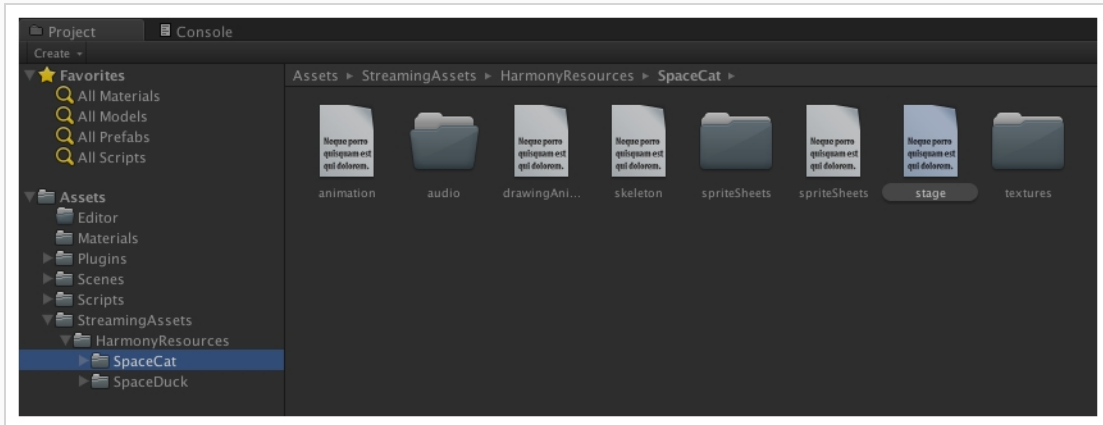

The text data appears in the Inspector.

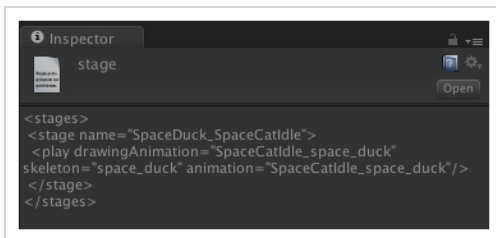

The name to use for loading the object is the stage name. In this case, **SpaceDuck_SpaceCatIdle**.

9. If your GameObject has animation in it, and you want it to load the animation data from the Harmony export, add one more component by doing the following:
 - Select the GameObject.
 - In the Inspector, select **Add Component** and select **Scripts > Harmony Animation**.
10. To loop the animation, you must set a GameObject to define it:
 - Select **GameObject > Create Empty** and rename it: **LoopAll**.
 - Click the **LoopAll** GameObject to display its properties in the Inspector.
 - Click **Add Component > Scripts > Loop All**.

When you play the animation, it will loop as it plays back. The Loop All command simply iterates on all GameObjects on runtime and asks them to loop, which is useful when testing the animation. When programming the actual game, you should write additional scripts to control the different elements separately.

Attaching Props to Anchors in Unity

An anchor is an attachment point you can use to bind one or several props to a specific location that is predefined by the anchor.

A prop is a game item that will be attached to an anchor. It could be a stick held within the character's hand, a helmet attached to the character's head...the possibilities are endless. Props are easy to turn on or off, and easily swappable from within Harmony or Unity.



How to attach the prop to an anchor

1. Open up your character in the Hierarchy view to have access to both the props and the anchors.
2. Click on the prop you wish to attach, and drag it onto the appropriate anchor.

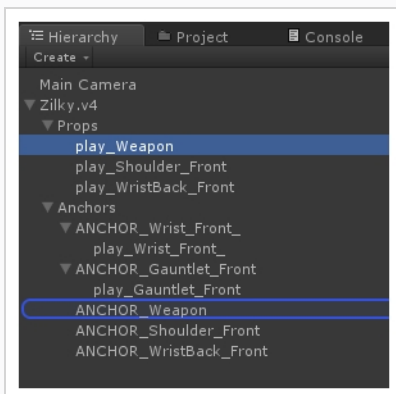

3. Repeat these steps for each prop and anchor in your project.
4. In the Inspector view, under Frame, you can select which frame you wish to show. If you only had one drawing in your prop, then you will not have multiple options.

5. If part of your character is cut off by the plane of the character, now that the props are showing, you will need to regenerate the mesh. To do so, select your GameObject. After this is done, go to **Inspector View > Render > Generate Mesh**.

Attaching Props to Anchors in Unity

An anchor is an attachment point you can use to bind one or several props to a specific location that is predefined by the anchor.

A prop is a game item that will be attached to an anchor. It could be a stick held within the character's hand, a helmet attached to the character's head...the possibilities are endless. Props are easy to turn on or off, and easily swappable from within Harmony or Unity.



How to attach the prop to an anchor

1. In the **Hierarchy** view, click on the right-pointing arrow left of your GameObject to expand its content and see its Props and Anchors hierarchies.

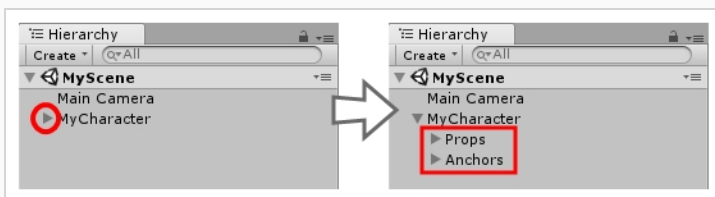

2. Expand both the Props and Anchors hierarchies to view your character's list of props and anchors.

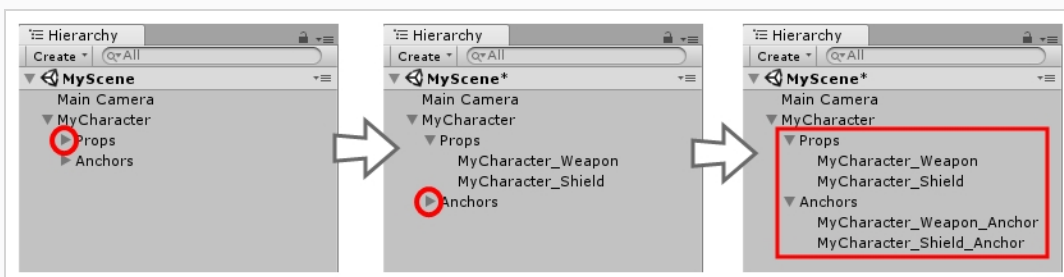

3. Select a prop, then drag and drop it over the anchor you want to attach it to. It should end up being

a child of the anchor.

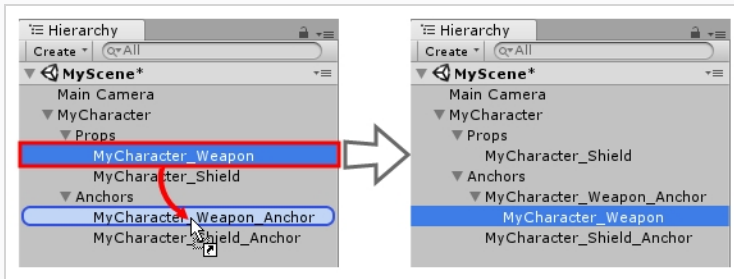

4. Select the prop in the **Hierarchy** view to view its properties in the **Inspector** view.

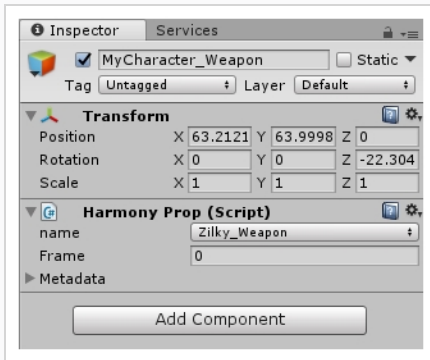

Each prop has a Frame property. The prop has one frame for each drawing that was in the prop's drawing layer in Harmony. Its default value, 0, makes the prop invisible.

5. Select the **Frame** field.
6. Type in the index of the drawing you want to display in the prop object. For example, if your prop only had one drawing in Harmony, type 1 to display it. If your prop had 5 drawings, type a number between 1 and 5 to display one of those drawings in the prop object.

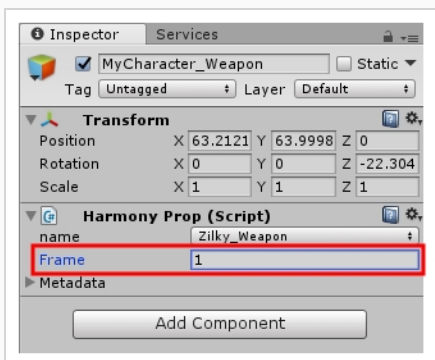

The selected prop frame will display in the Scene view, attached to its anchor.

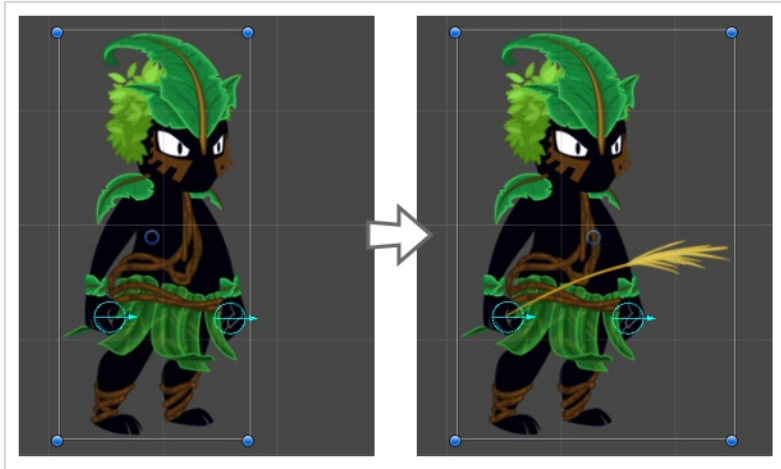

Troubleshooting

Unity Questions

Q. My Harmony asset does not appear in the Unity Editor.

A. There are several possible reasons for this. Check the following:

- Has the HarmonyRenderer plugin been copied to the Assets/Plugins directory? The plugin is named **HarmonyRenderer.bundle** on macOS and **HarmonyRenderer.dll** on Windows.
- Is the clip name valid? Make sure the clip name exists in the stage.xml file.
- Are the binary files up to date? If you updated the Toon Boom Game Engine SDK to a newer version, make sure to regenerate the binary files if you use them so they're compatible with the SDK.

Q. My Harmony asset does not appear in iOS or Android when exported from Unity.

A. There are several possible reasons for this. Check the following:

- Make sure the Harmony assets are copied in the **StreamingAssets** directory. Since the HarmonyRenderer plugin cannot use Unity's asset database, the Harmony assets were packaged as plain files so they are accessible to the plugin.
- Is the plugin for iOS the same version as the one used for the editor? The plugin for iOS is in the **Assets/Plugins/iOS** directory.
- Is the clip name spelled correctly? Windows and macOS aren't usually case sensitive file systems, but iOS and Android are. This implies that an asset that is visible on the editor will not appear on the mobile platform because it cannot be found.
- Make sure the size of your sprite sheets does not exceed the hardware limit of the device you're working on. Otherwise, the texture might not appear at all.
- Is the path to the project folder an absolute path? If it is, it might not work on the mobile device as that path will not exist on the platform. Make sure to use relative paths to the **StreamingAssets** directory.

Q. My Harmony asset does not composite properly with other 2D sprites in Unity. The 2D sprites always appear behind the Harmony assets even if I change the order index in the GameObjects.

A. The 2D sprites from Unity and the Harmony assets cannot currently composite together. There are, however, several solutions for working around this problem:

Use 2D textures instead of 2D sprites. The 2D textures, when attached to a geometry in Unity, will composite like the other 3D elements in the scene and you can change the compositing order by incrementing or decrementing the Z value of the transform.

Use multiple cameras to render your scene in parts. Here's how:

Harmony Camera

1. Create a new camera.
2. Make sure you set the Harmony GameObjects to a specific layer (top-right of the game object inspector).
3. In the camera, set the culling mask to this layer (and the other layers you want rendered in the background).
4. Add the HarmonyCamera component to this camera so the Harmony GameObjects render properly.

Sprite Camera

1. Create a new camera.
2. Make sure to set the 2D sprite objects to a specific layer.
3. In the camera, set the culling mask to this layer (and the other layers you want rendered in front of the 2D sprites).
4. Make sure to set the clear flags to **Depth Only** or **Don't Clear**.
5. Set the depth to be higher than the Harmony camera.
6. Afterwards, if you move the camera, make sure to move both cameras simultaneously if you want to keep Game Objects in sync.

Q. How can you specify the frame rate of the animation? My animation does not play at the same frame rate in Harmony and in the Game Previewer in the Unity Editor.

A. The Game Previewer previews the animation at a default of 24 frames per second. In your game, using the HarmonyAnimation component, you can schedule animations at the speed you want.

Example

```

HarmonyAnimation animation = GetComponent<HarmonyAnimation>();
if (animation != null)
{
    animation.PlayAnimation( frameRate, clipName );
}

```

Q. I cannot see my character in the Scene view in Unity. Is there any way to preview the Harmony asset?

A. Since the rendering of Harmony assets is implemented in a plugin, it does not update any Renderer component in the GameObject, and so cannot be shown directly in the Scene view.

However, you should still be able to preview your assets in the Game view (even when not playing). To help find and position assets, we also added bounding box shapes rendered in the editor and the Game view.

Q. How is memory management handled in Unity for Harmony assets?

A. Most of the memory extensive algorithms are executed in the C++ plugin. The data structure is maintained alive as long as a GameObject refers to it. This means you can instantiate as many clones of a character without

reloading the data. Upon destruction, the `GameObject` will issue a clean-up call to the plugin and delete its associated rendering object. The sprite sheet and animation data are kept alive as long as a single `GameObject` uses them and a cleanup call is issued once they are destroyed.

Q. The Harmony assets memory does not appear in the Unity profiler. Can we profile the assets memory?

A. The Unity profiler does not pick up Harmony assets in its traces. Since the Harmony `GameObject` refers to a C++ plugin for its asset management and rendering, its memory cannot be recorded in the profiler. Profilers such as the one provided with XCode or Visual Studio should allow you to track your application's memory including the Harmony assets and should also provide a more accurate result.

General Questions

Q. How can you specify the resolution used for the drawings in the sprite sheet?

A. The drawing resolution is not fixed in Harmony. Since you're exporting the scene to multiple sprite sheets in multiple resolutions, every drawing will have a different resolution in the end. You can use the Drawing view to see the resolution of a drawing compared to the rest of the scene. By enabling the light table in the Drawing view, you will see all of the scene's drawings untransformed in the same proportion as they will appear in the sprite sheet. More specifically, the resolution used in the sprite sheet for a drawing is the size it appears untransformed in the Camera view, scaled to the sprite sheet resolution ("Sprite Resolutions" in the Export Sprite Sheet dialog box).

Once you know that, you can easily adjust the size of a single drawing. Use the Select tool to scale down a drawing and use the Transform tool to scale it back up so it does not change visually in the Camera view. This should allow you to alter the size of drawings in the sprite sheet.

Q. The assets take time to load on mobile devices. Is there any way to speed up the process?

A. Harmony exports an interchange XML format that is intended to be compatible with multiple game engines. However, reading data from the XML files is slow and this is mostly intended to test the assets in your project. At some point, they should be converted to a binary compact data structure that can be read into memory a lot faster than the XML.

You can use the `Xml2Bin` tool provided with the game engine SDK to convert your XML files to binary. This tool is in the `Utils/Xml2Bin` folder and a precompiled version for macOS is available in the `Utils/macOSx` folder.

Q. There are problems with the character I exported in the game engine. Pieces are not exported or are not showing in the proper order. What can I do ?

A. To integrate with the game engine SDK, all animations in Harmony must follow certain guidelines. Here are some of the key points for building a character that is compatible with the rendering in the game engine SDK:

- Build your rig in the Timeline view. The game engine SDK data structure is similar to what is displayed in the Timeline view and an advanced node system might not always export properly.
- Because every top level node in your scene will render separately in the game engine SDK, they may not intersect. A top level node is also isolated in its separate sprite sheet to allow the artist better memory

segmentation of the character. If you created a character with top level nodes and this was not the intended result, create a top level group or peg to group them all together.

- Use micro-Z ordering if necessary. With no Z ordering, a child layer will appear behind its parent (as it does in Harmony). To change the ordering, add some Z offset to the child layer.
- The export script does not handle plain bitmap images. Toon Boom vector drawings and Toon Boom bitmap drawings are supported though.
- The export script does not handle symbols.