



*Harmony*  
Premium

---

# Toon Boom Harmony Premium 16.0 Reference Guide



---

TOON BOOM ANIMATION INC.  
4200 Saint-Laurent, Suite 1020  
Montreal, Quebec, Canada  
H2W 2R2

---

+1 514 278 8666  
contact@toonboom.com  
toonboom.com

## Legal Notices

Toon Boom Animation Inc.  
4200 Saint-Laurent, Suite 1020  
Montreal, Quebec, Canada  
H2W 2R2

Tel: +1 514 278 8666  
Fax: +1 514 278 2666

[toonboom.com](http://toonboom.com)

### Disclaimer

The content of this document is the property of Toon Boom Animation Inc. and is copyrighted. Any reproduction in whole or in part is strictly prohibited.

The content of this document is covered by a specific limited warranty and exclusions and limit of liability under the applicable License Agreement as supplemented by the special terms and conditions for Adobe® Flash® File Format (SWF). For details, refer to the License Agreement and to those special terms and conditions.

### Trademarks

Toon Boom® is a registered trademark. Harmony™ and the Toon Boom logo are trademarks of Toon Boom Animation Inc. All other trademarks of the property of their respective owners.

### Publication Date

01-15-2020

Copyright © 2020 Toon Boom Animation Inc., a Corus Entertainment Inc. company. All rights reserved.



# Table of Contents

<b>Table of Contents</b> .....	<b>2</b>
<b>Introduction</b> .....	<b>16</b>
<b>Chapter 1: Dialog Boxes</b> .....	<b>18</b>
Add Column Dialog Box .....	22
Add Drawing Layer Dialog Box .....	25
Add Frames Dialog Box .....	27
Add Prefix or Suffix Dialog Box .....	28
Add Synced Drawing Layer Dialog Box .....	29
Advanced Save Dialog Box .....	31
Attribute Information Dialog Box .....	36
Auto-Matte Dialog Box .....	39
Close Gaps Dialog Box .....	40
Column Properties Dialog Box .....	41
Column Types Dialog Box .....	43
Configure Line Art to Colour Art Dialog Box .....	44
Convert to Synced Drawing Layer Dialog Box .....	46
Create Cycle Dialog Box .....	47
Create Drawing from Drawing Selection Dialog Box .....	48
Create Function Step On Dialog Box .....	49
Create Palette Dialog Box .....	52
Create Palette from Selection Dialog Box .....	53
Database Selector Dialog Box .....	55
Edit Default Paste Preset Dialog Box .....	57
Edit Exposure Paste Preset Dialog Box .....	59
Element Manager Dialog Box .....	61
Envelope Creator Dialog Box .....	63
Export Layout Image Dialog Box .....	68
Export Soundtracks Dialog Box .....	71

Export to Animated GIF Dialog Box .....	73
Export to Easel JS Dialog Box .....	76
Export to Flash Movie Dialog Box .....	79
Export to Video Dialog Box .....	81
Export to Sprite Sheet Dialog Box .....	84
Expression Dialog Box .....	87
Extend Exposure Dialog Box .....	89
Fill Cells Randomly Dialog Box .....	90
Fill Exposure Using Render Changes Dialog Box .....	91
Fill Selection Dialog Box .....	94
Import 3D Models Dialog Box .....	95
Import Images Dialog Box .....	97
Interpolation Grid Wizard Dialog Box .....	104
Interpolation Slider Wizard Dialog Box .....	111
Manage Local Cache Dialog Box .....	114
Manage Tool Presets Dialog Box .....	116
Marker Colour Dialog Box .....	118
Mini Playback Dialog Box .....	120
QuickTime Movie Settings Dialog Box .....	121
New Scene Dialog Box .....	124
New Tool Preset Dialog Box .....	126
Onion Skin and Light Table Transparency Dialog Box .....	128
Palette Browser Dialog Box .....	129
Palette Operations Dialog Box .....	132
Paste Preset Dialog Box .....	134
Paste Special Dialog Box .....	136
Pose Copier Dialog Box .....	141
Preferences Dialog Box .....	143
Recolour Drawings Dialog Box .....	144
Remove Dirt Dialog Box .....	146

---

Remove Hair Dialog Box .....	147
Render 3D Model Dialog Box .....	148
Render Write Nodes Dialog Box .....	153
Save Dialog Box .....	157
Scene Settings Dialog Box .....	159
Scripts Manager Dialog Box .....	170
Select Colour Dialog Box .....	172
Selection Presets Dialog Box .....	174
Sequence Fill Dialog Box .....	177
Set Ease for Multiple Parameters Dialog Box .....	179
Show Hidden Columns Dialog Box .....	181
OpenQuickTime Sound Options Dialog Box .....	183
QuickTime Sound Settings Dialog Box .....	185
QuickTime Standard Video Compression Settings Dialog Box .....	187
Timeline Scene Marker Dialog Box .....	192
Tint Offset/Blend Dialog Box .....	193
Toolbar Manager Dialog Box .....	195
Vectorization Parameters Dialog Box .....	196
Versions Dialog Box .....	206
OpenQuickTime Video Options Dialog Box .....	207
Windows Media Video Settings Dialog Box .....	209
Xsheet Column Width Dialog Box .....	211
<b>Chapter 2: Menus .....</b>	<b>212</b>
Main Menu .....	214
Animation Menu .....	215
Drawing Menu .....	225
Edit Menu .....	233
File Menu .....	237
Help Menu .....	241
Insert Menu .....	243

---

Play Menu .....	245
Scene Menu .....	247
View Menu .....	249
Windows Menu .....	255
View Menus .....	257
3D Graph View Menu .....	258
Camera View Menu .....	260
Colour View Menu .....	277
Drawing View Menu .....	280
Function View Menu .....	292
Library View Menu .....	294
Model View Menu .....	296
Node View Menu .....	298
Node Library View Menu .....	303
Onion Skin View Menu .....	304
Perspective View Menu .....	306
Script Editor View Menu .....	312
Side View Menu .....	317
Timeline View Menu .....	322
Top View Menu .....	327
Xsheet View Menu .....	332
<b>Chapter 3: Nodes / Layers .....</b>	<b>342</b>
3D Nodes .....	349
3D Kinematic Output Node .....	350
Flatten Node .....	353
Render Maya Batch Node .....	355
Subnode Animation Node .....	361
Z Buffer Smoothing Node .....	365
Combine Nodes .....	367
Blending Node .....	368

---

Composite Node .....	374
Composite-Generic Node .....	379
Cutter Node .....	385
Highlight Node .....	387
Image Switch Node .....	391
Matte-Composite Node .....	393
Tone Node .....	397
Transformation Switch Node .....	401
Constraint Nodes .....	403
Constraint Switch Node .....	405
Dynamic Spring Node .....	408
Multi-Points Constraint Node .....	414
Static Transformation Node .....	417
Three-Points Constraint Node .....	420
Transformation Gate Node .....	423
Transformation Limit Node .....	425
Two-Points Constraint Node .....	431
Deformation Nodes .....	437
Articulation Node .....	438
Auto Fold Node .....	441
Auto Muscle Node .....	443
Bone Nodes .....	447
Curve Node .....	451
Deformation Composite Node .....	455
Deformation Root Node .....	458
Deformation Scale Node .....	459
Deformation Switch Node .....	464
Deformation Uniform Scale Node .....	466
Deformation Wave Node .....	468
Fold Node .....	471

Game Bone Node .....	475
Glue Node .....	477
Kinematic Output Node .....	479
Mesh Warp Node .....	480
Offset Node .....	484
Refract .....	486
Stick Node .....	488
Turbulence Node .....	490
Filter Nodes .....	494
Anti-Flicker Node .....	496
Auto-Patch Node .....	498
Bloom Node .....	500
Blur-Box Node .....	504
Blur-Directional Node .....	507
Connection .....	508
Layer Properties .....	509
Blur-Gaussian Node .....	511
Blur-Radial Node .....	514
Blur-Radial-Zoom Node .....	516
Blur-Variable Node .....	520
Brightness Contrast Node .....	522
Channel Selector Node .....	524
Channel Swap Node .....	526
Chroma-Keying Node .....	528
Colour Banding Node .....	534
Colour Art Node .....	537
Colour-Override Node .....	540
Colour-Scale Node .....	545
Colour Selector Node .....	547
Contrast Node .....	550

---

Dither Node .....	552
Focus Node .....	554
Focus Multiplier Node .....	557
Glow Node .....	559
Grain Node .....	563
Greyscale Node .....	565
Hue-Saturation Node .....	567
Layer Selector Node .....	574
Line Art Node .....	577
Luminance Threshold Node .....	579
Matte-Blur Node .....	582
Matte-Resize Node .....	585
Median Node .....	587
Motion-Blur Node .....	590
Negate Node .....	592
Overlay Layer Node .....	594
Pixelate Node .....	596
Remove Transparency Node .....	598
Shadow Node .....	600
Transparency Node .....	603
Underlay Layer Node .....	605
Generator Nodes .....	608
Animated Matte Generator Node .....	609
Burn-In Node .....	620
Colour-Card Node .....	624
Element / Drawing Node .....	627
Connection .....	628
Field Chart Node .....	644
Gradient Node .....	649
Grid Node .....	655

Lens Flare Node .....	658
Turbulent Noise Node .....	661
Group Nodes .....	665
Group Node .....	666
Multi-Port-In Node .....	667
Multi-Port-Out Node .....	668
Miscellaneous Nodes .....	669
External Node .....	670
Master Controller Node .....	673
Note Node .....	679
OpenGL Bypass Node .....	680
OpenGL-Cache-Lock Node .....	682
Render Preview Node .....	685
Script Node .....	686
Visibility Node .....	689
Move Nodes .....	690
Apply Image Transformation Node .....	691
Apply Peg Transformation Node .....	694
Camera Node .....	698
OrthoLock Node .....	700
Peg Node .....	702
Shake Node .....	704
Transform-Loop Node .....	708
Quadmap Node .....	711
Quake Node .....	714
Output Nodes .....	717
Crop Node .....	718
Display Node .....	721
Multi-Layer Write Node .....	722
Scale Output Node .....	726



---

Write Node .....	728
Image Formats for Rendering Write Nodes .....	733
Particle Nodes .....	739
3D Region .....	741
Baker .....	743
Baker Composite .....	746
Bounce .....	747
Explosion .....	749
Gravity .....	751
Image Fracture .....	753
Kill .....	759
Move Particles .....	761
Orbit .....	763
Planar Region .....	766
Random .....	769
Region Composite .....	770
Repulse .....	771
Rotation Velocity .....	772
Sink .....	775
Size .....	776
Sprite Emitter .....	778
System Composite .....	788
Velocity .....	789
Visualizer .....	792
Vortex .....	794
Wind-Friction .....	796
Shading Nodes .....	797
Light Position Node .....	798
Light Shader Node .....	800
Normal Map Node .....	803

Normal Map Converter Node .....	807
Tone Shader Node .....	809
Volume Object Node .....	813
Plugin Nodes .....	815
Sparkle .....	816
Selection Preset Note Node .....	819
Sound Layer .....	821
<b>Chapter 4: Tools Properties .....</b>	<b>824</b>
Brush Tool Properties .....	826
Centerline Editor Tool Properties .....	847
Close Gap Tool Properties .....	849
Contour Editor Tool Properties .....	850
Cutter Tool Properties .....	854
Drawing Pivot Tool Properties .....	858
Dropper Tool Properties .....	860
Edit Gradient/Texture Tool Properties .....	861
Ellipse Tool Properties .....	862
Envelope Tool Properties .....	871
Eraser Tool Properties .....	874
Ink Tool Properties .....	893
Inverse Kinematics Tool Properties .....	895
Line Tool Properties .....	898
Morphing Tool Properties .....	908
Paint Tool Properties .....	912
Pencil Tool Properties .....	919
Pencil Editor Tool Properties .....	929
Perspective Tool Properties .....	934
Polyline Tool Properties .....	937
Rectangle Tool Properties .....	945
Reposition All Drawings Tool Properties .....	954

---

Rigging Tool Properties .....	956
Select Tool Properties .....	959
Shift and Trace Tool Properties .....	971
Smooth Editor Tool Properties .....	974
Stroke Tool Properties .....	976
Text Tool Properties .....	978
Transform Tool Properties .....	981
Zoom Tool Properties .....	984
<b>Chapter 5: Toolbars .....</b>	<b>986</b>
Top Toolbars .....	988
Advanced Animation Toolbar .....	989
Art Layer Toolbar .....	991
Control Point Toolbar .....	993
Coordinate Toolbar .....	995
Deformation Toolbar .....	996
Display Toolbar .....	1001
Easy Flipping Toolbar .....	1002
Edit Toolbar .....	1003
File Toolbar .....	1004
Flip Toolbar .....	1005
Game Toolbar .....	1006
Mark Drawing Toolbar .....	1007
Master Controller Toolbar .....	1008
Mini Playback Toolbar .....	1009
Onion Skin Toolbar .....	1010
Playback Toolbar .....	1012
Scripting Toolbar .....	1015
Shift and Trace Toolbar .....	1016
Tool Presets Toolbar .....	1018
Tools Toolbar .....	1019

Workspace Toolbar .....	1025
View Toolbars .....	1026
3D Graph View Toolbar .....	1027
Animated Matte Generator Toolbar .....	1028
Script Editor Toolbar .....	1031
Timeline View Toolbar .....	1036
Xsheet View Toolbar .....	1038
<b>Chapter 6: Views .....</b>	<b>1040</b>
3D Graph View .....	1042
Animated Matte Generator View .....	1044
Camera View .....	1051
Colour View .....	1058
Coordinates and Control Points View .....	1066
Drawing View .....	1069
Drawing Substitutions View .....	1072
Function View .....	1074
Guides View .....	1077
Integrated Help View .....	1080
Layer Properties View .....	1081
Library View .....	1083
Master Controller View .....	1086
Message Log View .....	1088
Metadata Editor View .....	1089
Model View .....	1091
Node View .....	1092
Node Library View .....	1094
Onion Skin View .....	1097
Perspective View .....	1103
Script Editor View .....	1106
Side View .....	1111

Timeline View .....	1113
Tool Properties View .....	1123
Top View .....	1124
Xsheet View .....	1126



# Introduction

Harmony has several commands, dialog boxes, and buttons. The Reference section lists all of them along with the matching definition. To understand how to use these functions in a production context, read the User guide.

In the Reference guide, you will learn about the various parameters available in dialog boxes, menus, nodes, toolbars, views, and windows.

The Preferences guide provides additional details about each individual preference.





# Chapter 1: Dialog Boxes

Dialog boxes contain controls such as options and lists through which you can carry out a particular command or task. For example, in the Scene Settings dialog box, you must indicate the resolution and alignment. A typical dialog box looks as follows:

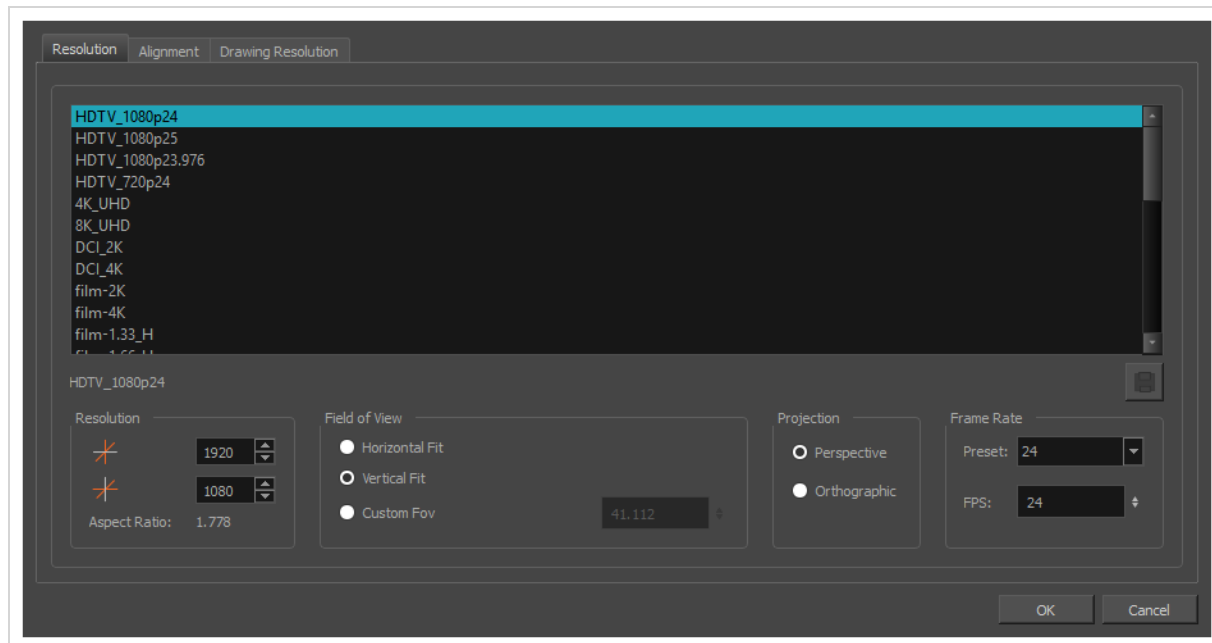

Add Column Dialog Box .....	22
Add Drawing Layer Dialog Box .....	25
Add Frames Dialog Box .....	27
Add Prefix or Suffix Dialog Box .....	28
Add Synced Drawing Layer Dialog Box .....	29
Advanced Save Dialog Box .....	31
Attribute Information Dialog Box .....	36
Auto-Matte Dialog Box .....	39
Close Gaps Dialog Box .....	40
Column Properties Dialog Box .....	41
Column Types Dialog Box .....	43
Configure Line Art to Colour Art Dialog Box .....	44
Convert to Synced Drawing Layer Dialog Box .....	46
Create Cycle Dialog Box .....	47
Create Drawing from Drawing Selection Dialog Box .....	48

Create Function Step On Dialog Box .....	49
Create Palette Dialog Box .....	52
Create Palette from Selection Dialog Box .....	53
Database Selector Dialog Box .....	55
Edit Default Paste Preset Dialog Box .....	57
Edit Exposure Paste Preset Dialog Box .....	59
Element Manager Dialog Box .....	61
Envelope Creator Dialog Box .....	63
Export Layout Image Dialog Box .....	68
Export Soundtracks Dialog Box .....	71
Export to Animated GIF Dialog Box .....	73
Export to Easel JS Dialog Box .....	76
Export to Flash Movie Dialog Box .....	79
Export to Video Dialog Box .....	81
Export to Sprite Sheet Dialog Box .....	84
Expression Dialog Box .....	87
Extend Exposure Dialog Box .....	89
Fill Cells Randomly Dialog Box .....	90
Fill Exposure Using Render Changes Dialog Box .....	91
Fill Selection Dialog Box .....	94
Import 3D Models Dialog Box .....	95
Import Images Dialog Box .....	97
Interpolation Grid Wizard Dialog Box .....	104
Interpolation Slider Wizard Dialog Box .....	111
Manage Local Cache Dialog Box .....	114
Manage Tool Presets Dialog Box .....	116
Marker Colour Dialog Box .....	118
Mini Playback Dialog Box .....	120
QuickTime Movie Settings Dialog Box .....	121
New Scene Dialog Box .....	124

---

New Tool Preset Dialog Box .....	126
Onion Skin and Light Table Transparency Dialog Box .....	128
Palette Browser Dialog Box .....	129
Palette Operations Dialog Box .....	132
Paste Preset Dialog Box .....	134
Paste Special Dialog Box .....	136
Pose Copier Dialog Box .....	141
Preferences Dialog Box .....	143
Recolour Drawings Dialog Box .....	144
Remove Dirt Dialog Box .....	146
Remove Hair Dialog Box .....	147
Render 3D Model Dialog Box .....	148
Render Write Nodes Dialog Box .....	153
Save Dialog Box .....	157
Scene Settings Dialog Box .....	159
Scripts Manager Dialog Box .....	170
Select Colour Dialog Box .....	172
Selection Presets Dialog Box .....	174
Sequence Fill Dialog Box .....	177
Set Ease for Multiple Parameters Dialog Box .....	179
Show Hidden Columns Dialog Box .....	181
OpenQuickTime Sound Options Dialog Box .....	183
QuickTime Sound Settings Dialog Box .....	185
QuickTime Standard Video Compression Settings Dialog Box .....	187
Timeline Scene Marker Dialog Box .....	192
Tint Offset/Blend Dialog Box .....	193
Toolbar Manager Dialog Box .....	195
Vectorization Parameters Dialog Box .....	196
Versions Dialog Box .....	206
OpenQuickTime Video Options Dialog Box .....	207

Windows Media Video Settings Dialog Box .....209

Xsheet Column Width Dialog Box .....211

## Add Column Dialog Box

The Add Column dialog box lets you add a column in the Xsheet view.

By default, when you create a new scene, there is one drawing column in the Xsheet view and one corresponding drawing layer in the Timeline view.

You can add an element for each drawing and it will appear as a column in the Xsheet view, a layer in the Timeline view, and a node in the Node view.

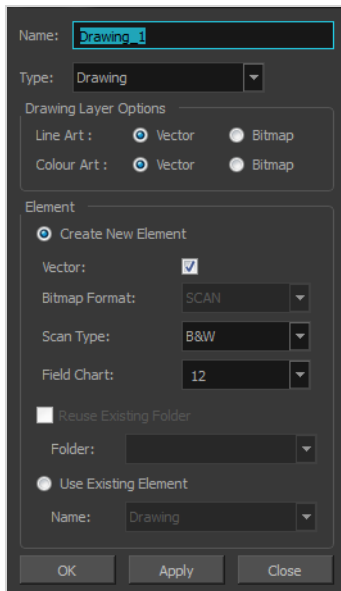

### How to access the Add Column dialog box

1. Do one of the following:
  - In the Xsheet menu, select **Columns > Add Columns**.
  - Click the Add Columns  button.
  - Press Shift + C.



#### NOTE

The Add Column dialog box contains additional parameters for working with elements which will only display if you set advanced preferences. To do this, press Ctrl + U (Windows/Linux) or ⌘ + U (macOS) to open the Preferences dialog box. Select the **Advanced** tab, then select the **Advanced Element Mode** option and click **OK**.

Parameter	Description
-----------	-------------

Name	Lets you give the new column a meaningful name.
Type	Lets you select a type of column to create. Choices include: Drawing, Timing, Sound, 3D Path, 3D Rotation, Bezier Curve, Ease Curve, Expression and Annotation.
Drawing Layer Options	
Line Art	Creates a vector or bitmap drawing column in the Line Art layer.
Colour Art	Creates a vector or bitmap drawing column in the Colour Art layer.
Element	
Create New Element	Creates an independent column with its own drawing folder.
Vector	Select this option if you want the layer to contain vector drawings. Deselect this option if you want the layer to contain bitmap images. Most of the time, the Vector option will be enabled.
Bitmap Format	Lets you select the type of bitmap image to insert in the column. Select <b>SCAN</b> from the list if you are planning to scan drawings using the Toon Boom Harmony Scan module.
Scan Type	If you chose <b>SCAN</b> from the Bitmap Format list, select the kind of scanning you want to achieve.
Field Chart	When importing traditional animation, lets you indicate the size of paper on which the animation or background was drawn. If you are not using perforated animation paper, leave the 12 field default value as is.
Reuse Existing Element	Links your column to an existing folder within the Element folder of your scene.
Folder	Lets you select the folder to which you want to link your new column.
Use Existing Element	Uses drawings from an existing column in the new column. Both columns will be attached to the same set of drawings, but their timing will remain independent from one another. If you modify one of the drawings, it will be modified in both columns. This is the same principle as the Clone column.

---

Name	Lets you select the column to which you want to link your new column.
Add and Close	Adds the selected type of layers to the Timeline view and corresponding column in the Xsheet view and closes the dialog box. The names of the layers/columns are automatically numbered incrementally.
Add	Adds the selected type of layers to the Timeline view and corresponding column in the Xsheet view. The dialog box remains open for you to add as many layers/columns as needed. The names of the layers/columns are automatically numbered incrementally.
Close	Closes the dialog box.

## Add Drawing Layer Dialog Box

The Add Drawing Layer dialog box lets you add a drawing layer to your project.

By default, when you create a new scene, there is one drawing column in the Xsheet view and one corresponding drawing layer in the Timeline view.

You can add an element for each drawing and it will appear as a column in the Xsheet view, a layer in the Timeline view, and a node in the Node view.

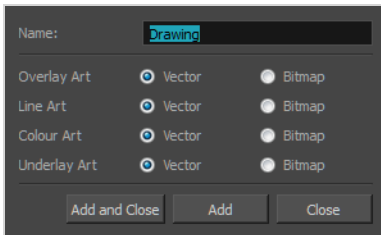
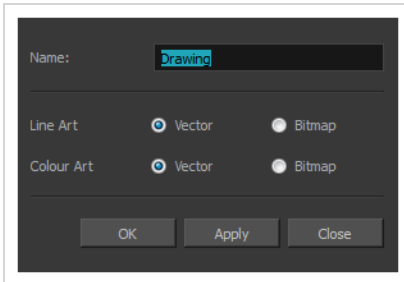

### How to access the Add Drawing Layer dialog box

1. Do one of the following:
  - In the Timeline view, click the Add Drawing Layer  button.
  - From the top menu, select **Insert > Drawing**.
  - Press Ctrl + R (Windows/Linux) or ⌘ + R (macOS).

Parameter	Description
Name	Lets you give the new layer a meaningful name.
Overlay Art	Creates a vector or bitmap drawing layer in the Overlay Art layer.
Line Art	Creates a vector or bitmap drawing layer in the Line Art layer.



---

Colour Art	Creates a vector or bitmap drawing layer in the Colour Art layer.
Underlay Art	Creates a vector or bitmap drawing layer in the Underlay Art layer.
Add and Close	Adds the selected type of layers to the Timeline view and corresponding column in the Xsheet view and closes the dialog box. The names of the layers/columns are automatically numbered incrementally.
Add	Adds the selected type of layers to the Timeline view and corresponding column in the Xsheet view. The dialog box remains open for you to add as many layers/columns as needed. The names of the layers/columns are automatically numbered incrementally.
Close	Closes the dialog box.

## Add Frames Dialog Box

The Add Frames dialog box lets you add frames anywhere in the middle of the scene—before or after a selection. If you select a frame row in the Xsheet view, Harmony will add the new frames before or after the selection, depending on your choice.

### How to access the Add Frames dialog box

1. In the Timeline or Xsheet view, select a frame or a range of frames.

	Drawing_3	Drawing_2	Drawing_1	Drawing
1	13	15	1	1
2	14		2	
3	1		3	
4			4	
5		1	5	1
6		2	6	
7		3		
8	2	4		



2. Do one of the following:
  - From the top menu, select **Scene > Frame > Add Frames Before Selection** or **Add Frames After Selection**.
  - In the Xsheet view, right-click and select **Frames > Add Frames Before Selection** or **Add Frames After Selection**.
  - In the Xsheet toolbar, click the Add Frames  button to add frame after your selection.
  - Press Ctrl + G (Windows/Linux) or ⌘ + G (macOS) to add frames before the selection, or Ctrl + H to add frames after the selection.

The Add Frames dialog box opens.

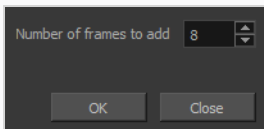

Parameter	Description
Number of frames to add	Lets you enter the number of frames needed in the scene.

## Add Prefix or Suffix Dialog Box

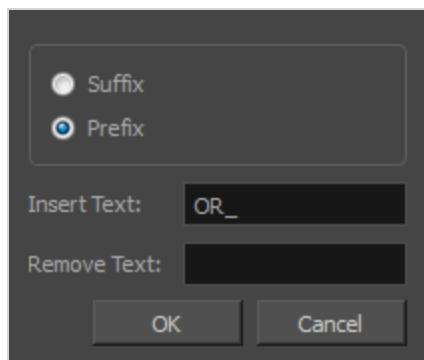

The Add Prefix or Suffix dialog box lets you add or remove a prefix or suffix for a multi-layer or multi-node selection.

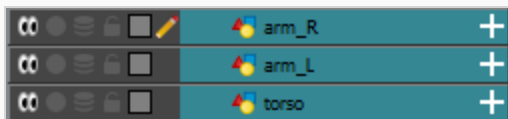

### How to access the Add Prefix or Suffix dialog box

1. In the Network or Timeline view, select all the nodes or layers to rename or press Ctrl + A (Windows/Linux) or ⌘ + A (macOS).



2. In the Scripting toolbar, click the Add Prefix or Suffix Script  button. If the Scripting toolbar is not visible, you can display it by selecting **Windows > Toolbars > Scripting** from the top menu. If the Add Prefix or Suffix Script  button is not visible in the Scripting toolbar.

The Add Prefix or Suffix dialog box opens.

Parameter	Description
Suffix	Allows you put a defined set of characters (letters, numbers, symbols) after the pre-existing layer or node name.
Prefix	Allows you put a defined set of characters (letters, numbers, symbols) before the pre-existing layer or node name.
Insert Text	Enter a set of characters to be added to the selected layers or nodes.
Remove Text	Enter a set of characters to be removed from the selected layers or nodes.

## Add Synced Drawing Layer Dialog Box

The Add Synced Drawing Layer dialog box lets you add a drawing layer to your project that will automatically be synced with the currently selected layer.

Depending on whether the Support Overlay and Underlay Arts option was selected in the Advanced tab of the Preferences panel, the Add Synced Drawing Layer dialog box may look one of two ways.

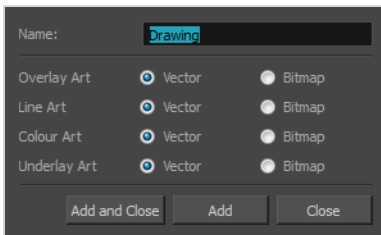
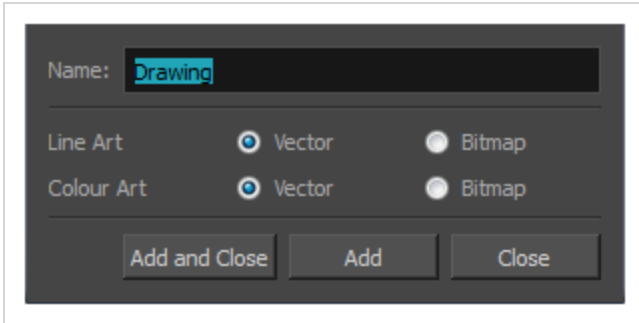

### How to access the Add Synced Drawing Layer dialog box

1. In the Timeline view, right-click on the drawing layer you would like to sync with another layer.
2. From the right-click menu, select **Add Synced Drawing Layer**.

Parameter	Description
Name	Lets you give the new layer a meaningful name.
Overlay Art	Creates a vector or bitmap drawing layer in the Overlay Art layer.
Line Art	Creates a vector or bitmap drawing layer in the Line Art layer.
Colour Art	Creates a vector or bitmap drawing layer in the Colour Art layer.
Underlay Art	Creates a vector or bitmap drawing layer in the Underlay Art layer.

---

Add and Close	Adds the selected type of layers to the Timeline view and corresponding column in the Xsheet view and closes the dialog box. The names of the layers/columns are automatically numbered incrementally.
Add	Adds the selected type of layers to the Timeline view and corresponding column in the Xsheet view. The dialog box remains open for you to add as many layers/columns as needed. The names of the layers/columns are automatically numbered incrementally.
Close	Closes the dialog box.

## Advanced Save Dialog Box

In Harmony Server, the Advanced Save dialog box lets you save the scene as a new version, overwrite an existing version, set a new current version, display a list of modified drawings, colour palettes, and modified colour palette lists.

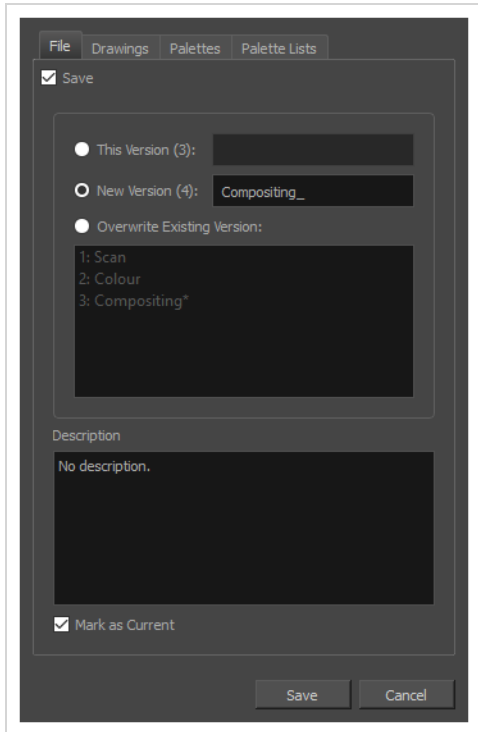

### How to access the Advanced Save dialog Box

1. Make sure that you have the necessary rights to save the current scene version. If you do not, you can acquire the rights by selecting **File > Rights to Modify Scene Version** or **Rights to Modify Scene** from the top menu.
2. From the top menu, select **File > Advanced Save**.

The Advanced Save dialog appears.

## File Tab

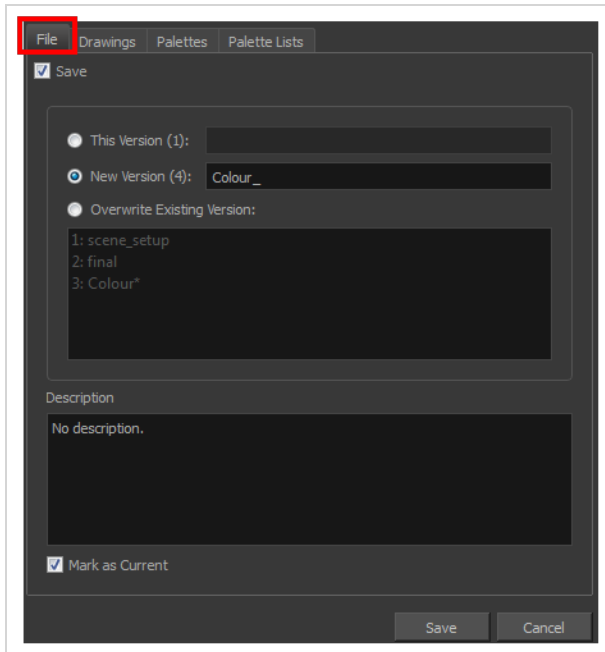

Parameter	Description
Save	<ul style="list-style-type: none"> <li>▶ Enable this option if you want to save the modifications made to the current scene.</li> <li>▶ Deselect the Save option if you only want to save specific components of your scene listed in the Drawings, Palettes or Palette Lists tabs. This will disable all option in the File tab.</li> </ul>
This Version (number)	Saves the current version of the scene. You can rename the current version by typing a new name into the field.
New Version (number)	Saves the current scene as a new version. You can name this new version by typing a name into the field.
Overwrite Existing Version	Lets you select an existing version of your scene from the list to overwrite it.
Description	Use this field to add or edit an existing description for the scene version you want to save.
Mark as Current	Lets you set this scene version as the current one. This version will be automatically selected as the default current version when the scene is selected in the <b>Database Selector</b> dialog box

## Drawings (Harmony Server only)

The Drawings tab lists the modified drawings.

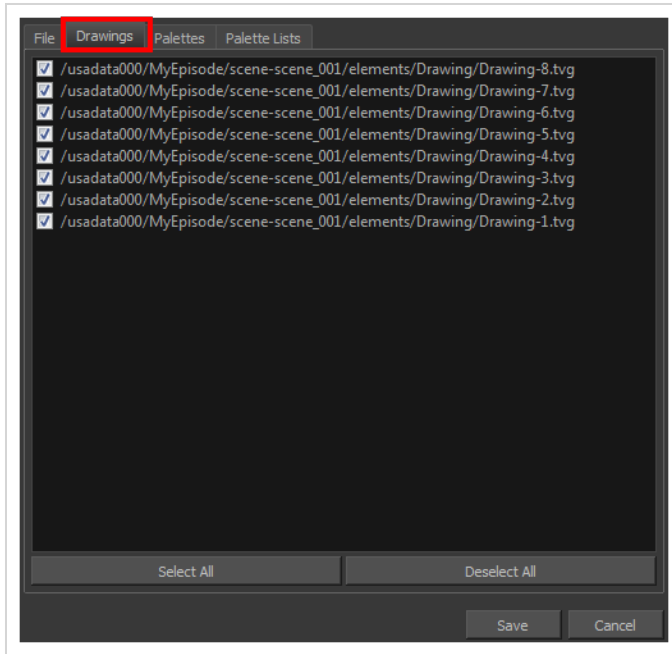

Parameter	Description
Drawing list	Lets you select the modified drawings to save, and deselect the ones you do not want to save.
Select All	Selects all modified drawings in list.
Deselect All	Deselects all modified drawings in the list.

## Palettes Tab

The Palette tab lists the modified colour palettes.



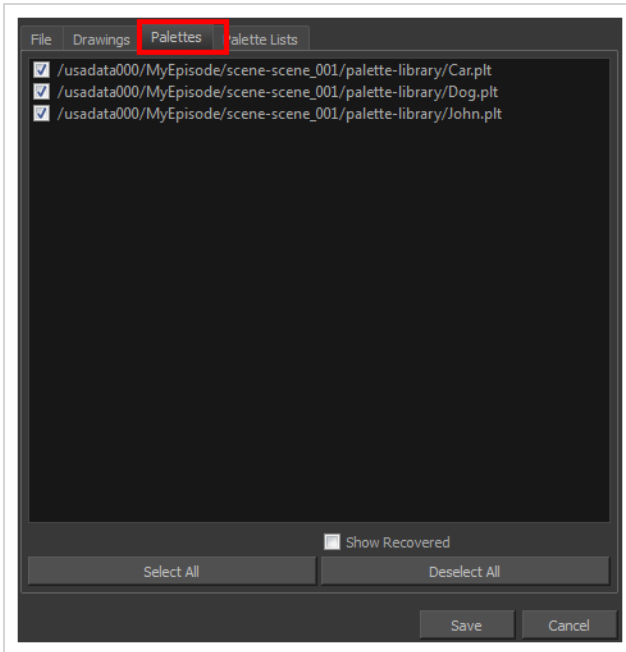

Parameter	Description
Colour Palette list	Lets you select the colour palette to save, and deselect the ones you do not want to save.
Show Recovered	Displays the recovered palettes in the list of modified palettes.
Select All	Selects all modified colour palettes in the palette list.
Deselect All	Deselects all modified colour palettes in the palette list.

## Palette Lists Tab

The Palette Lists tab lists all the modified colour palette lists.

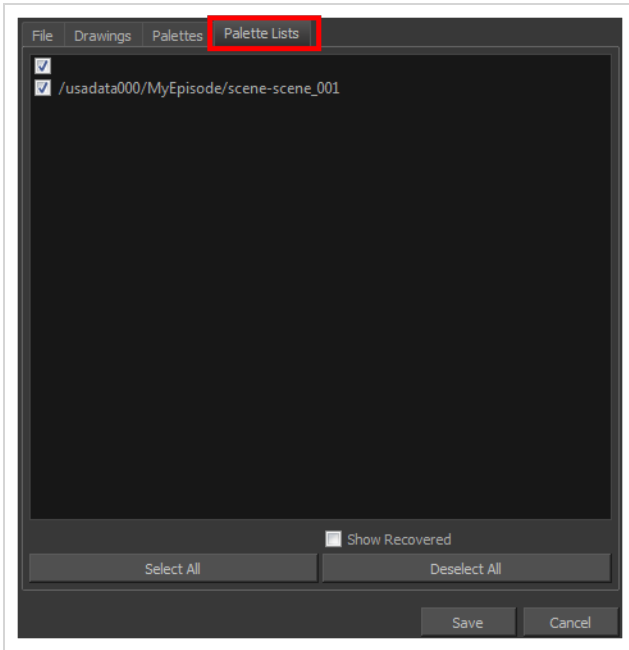



Parameter	Description
Palette Lists	Lets you select the modified palette list to save, and deselect the ones you do not want to save.
Show Recovered	Displays the recovered palettes in the list of modified palettes.
Select All	Selects all modified palette lists in the list.
Deselect All	Deselects all modified palette lists in the list.

## Attribute Information Dialog Box

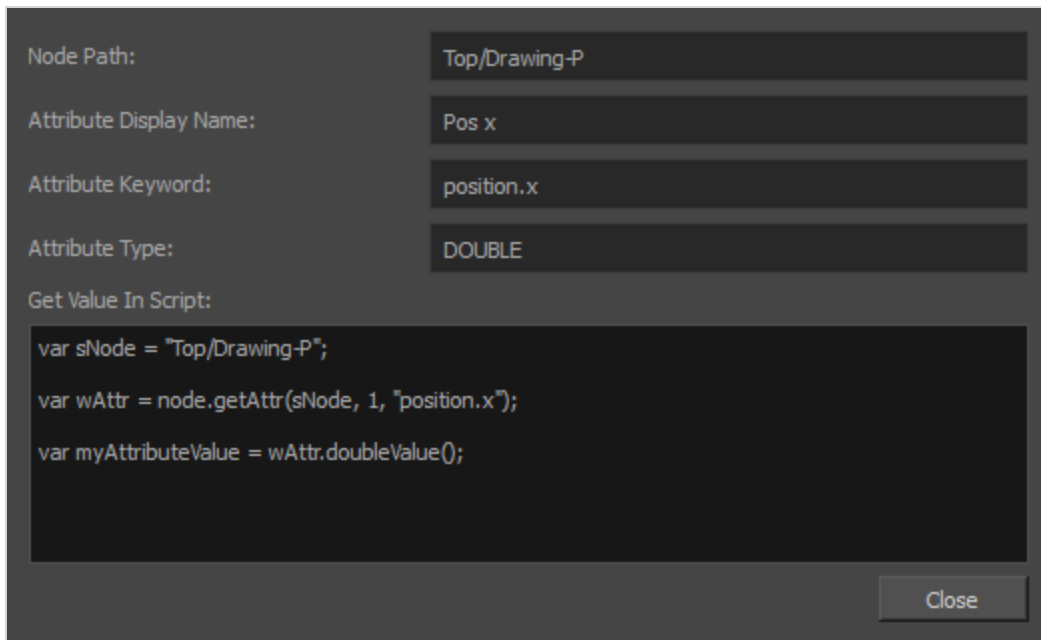
The Attribute Information dialog box displays information for accessing a specific attribute in a specific node through the Harmony scripting interface.



### How to access the Attribute Information Dialog Box

1. In the top-left corner of the Node view, click on the  Menu button and select **View > Show Attribute Information**.
2. In the Node view, locate the node which you want to manipulate through scripting.
3. Click on the  Layer Properties button for this node.

The Layer Properties dialog for this node appears. Right of each attribute is a  Show Attribute Information button.

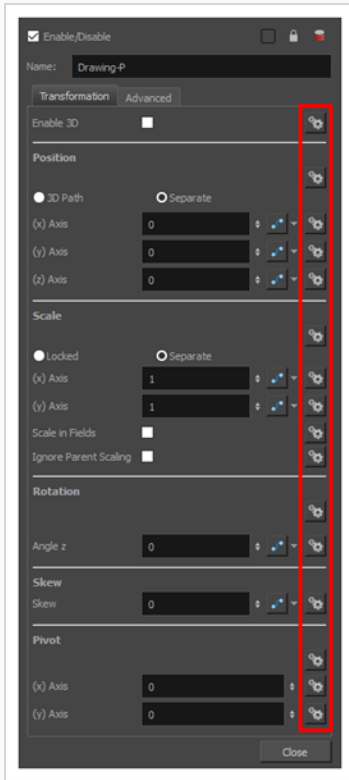

4. Click on the  Show Attribute Information button next to the attribute which you want to access through scripting.

The Attribute Information dialog appears and displays information on the attribute, as well as a sample script to access the attribute.

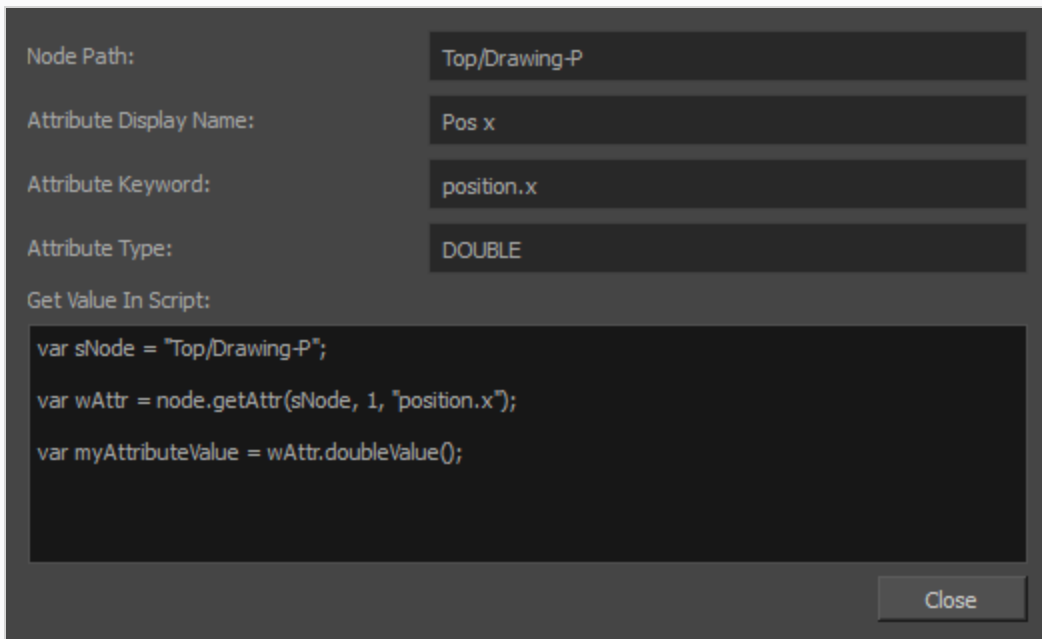

---

Parameter	Description
Node Path	The path to access the node in your scene's node system. This path is the hierarchy of groups in which the node is located, and always starts with <b>Top</b> , which represents the root of the scene's group hierarchy. For example, if the node is named <b>master-P</b> and is inside a group named <b>CH001_MyCharacter</b> in the scene's root, its path would be <b>Top/CH001_MyCharacter/master-P</b> .
Attribute Display Name	The user friendly name of the attribute. This name cannot be used in the Harmony scripting interface.
Attribute Keyword	The actual name of the attribute in the Harmony scripting interface.
Attribute Type	The type of the attribute.
Get Value in Script	A sample script to access the attribute and store its value in a variable.

## Auto-Matte Dialog Box

The Auto-Matte dialog box lets you generate a matte for a drawing.

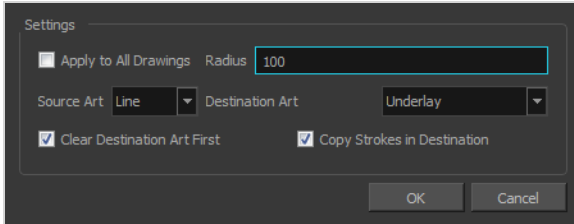

### How to access the Auto Matte dialog box

1. In the Camera or Drawing view, select the drawing you want to create a matte for.
2. Do one of the following:
  - From the top menu, select **Drawing > Generate Auto-Matte**.
  - In the Camera or Drawing menu, select **Drawing > Generate Auto-Matte**.

Parameter	Description
Settings	
Apply to all Drawings	Creates a matte for all the drawings included in layer.
Radius	Lets you increase or decrease the radius value depending on the precision or roughness of your line. Use a lower value, the closer to your lines' contours the matte will be shaped. The higher the value, the looser the matte will be shaped.
Source Art	Lets you select the layer from which you want the matte created: <b>Line Art, Colour Art, Underlay</b> or <b>Overlay</b> .
Destination Art	Lets you select the layer on which you want the matte to be created: <b>Line Art, Colour Art, Underlay</b> or <b>Overlay</b> .
Clear Destination Art First	Deletes existing artwork on the destination layer before adding a matte to it.
Copy Strokes in Destination	Copies the contour of your lines as invisible lines in the matte drawing. This is useful if you need to reuse the lines later.

## Close Gaps Dialog Box

The Close Gaps dialog box lets you close up drawing areas that not are closed. This may sometimes happen when painting. You can close small gaps in a drawing by creating small, invisible strokes between the two closest points to close the colour zone. You do not need to trace directly over the gap. You can draw it a few millimeters away. The two closest points automatically close the gap.

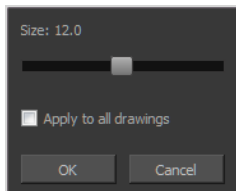

### How to access the Close Gaps dialog box

1. Select **View > Show > Show Strokes** or press K to see a preview of the result.
2. To flatten the strokes you draw, click the Auto-Flatten  button in the Tool Properties view.
3. Select **Drawing > Clean Up > Close Gaps** or press Shift + F10 (Windows/Linux only).

The Close Gaps dialog box opens.

Parameter	Description
Size	Lets you set the size of the gap you want to be closed.
Apply to all drawings	Closes all gaps in the drawing of the selected layer.

## Column Properties Dialog Box

The Column Properties dialog box lets you add, delete or modify elements (drawing folders) in your scene.

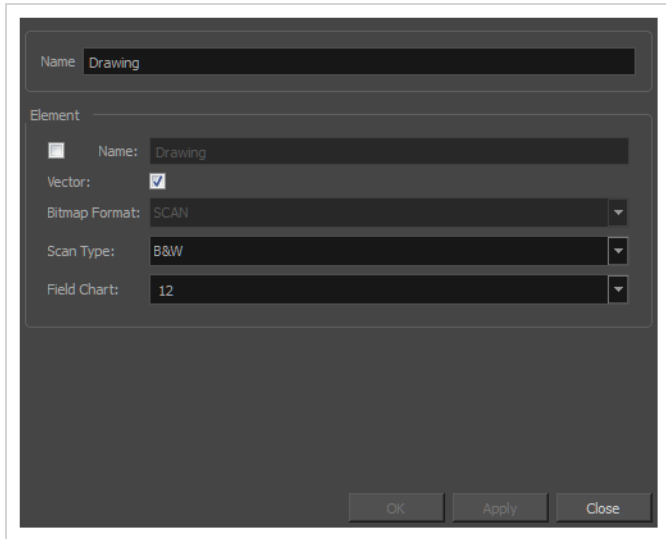

### How to access the Drawing dialog box

1. In the Xsheet view, double-click on a column name. Do not click on the drawing folder name that the column is linked to (this also appears in the column header just below the column name).

Parameter	Description
Name	Type in a new name in this field to create an element or to rename the selected element.
Element	
Name	Type in a new name in this field to create an element or to rename the selected element.
Vector	Select this option if the new element is a vector drawing or if you want to enable the parameters on the selected element in the Elements list.
Bitmap Format	Lets you select the file format of the bitmap layer.
Scan Type	If you're planning to scan elements with the Toon Boom Harmony Scan module, select the scan type from the list.



Field Chart	If you're importing traditional animation, select the size of the paper on which the animation was drawn.
-------------	---

## Column Types Dialog Box

The Columns Types dialog box lets you show or hide columns in the exposure sheet.

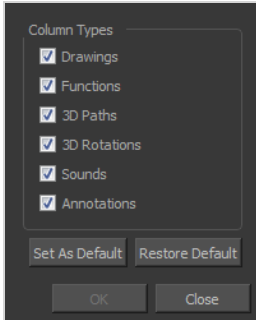

### How to access the Columns Types dialog box

1. In the Xsheet view, select **View > Column Types Manager**.

The Column Types dialog box opens.

Parameter	Description
Column Types	Lets you select the types of columns to display in the Xsheet view.
Save as Default	Makes these new settings the default ones used each time you start Harmony.
Restore Default	Returns the settings to their defaults.

## Configure Line Art to Colour Art Dialog Box

The Configure Line Art to Colour Art dialog box lets you modify settings for the Line Art and Colour Art layers.

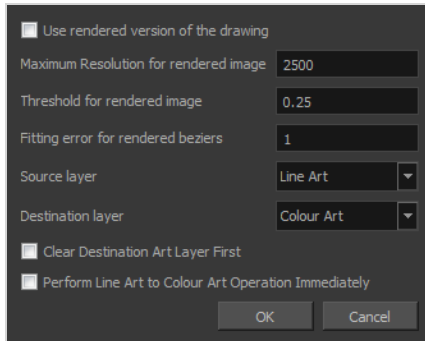

### How to access the Configure Line Art to Colour Art dialog box

1. In the Tools toolbar, select the Select tool.
2. In the Tool Properties view, hold down the Shift key and click on the Create Colour Art from Line Art button.

Parameter	Description
Use rendered version of the drawing	Renders the drawing and vectorize it to calculate the position of the centreline that will produce the colour art stroke.
Maximum Resolution for rendered image	The size of the rendered image.
Threshold for rendered image	The value of grey processed to create the rendered vectorized arts.
Fitting error for rendered Beziers	This value represents how precise the fitting of the colour art zone in relation to the line art will be.
Source layer	Lets you select the layer (Line Art, Colour Art, Underlay or <b>Overlay</b> ) you want the colour art to be created from.
Destination layer	Lets you select the layer (Line Art, Colour Art, Underlay or <b>Overlay</b> ) you want the colour art to be created on.
Clear Destination Art Layer First	Deletes the content before the colour art is added. This is useful when you already have artwork on the destination layer.

Perform Line Art to Colour Art Operation Immediately	Performs the <b>Create Colour Art from Line Art</b> command when you click OK.
--	--

## Convert to Synced Drawing Layer Dialog Box

The Sync Layer feature allows for drawings to be separated on different layers, but to have the same timing.

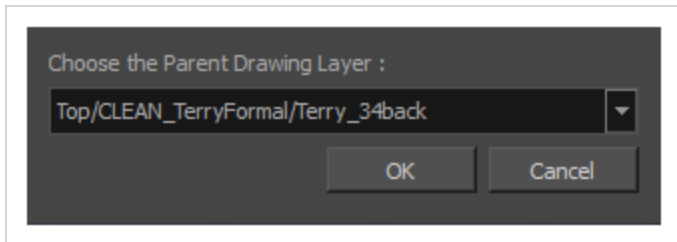

### How to access the Convert to Synced Drawing Layer dialog box

1. right-click on a drawing layer you would like to sync with another layer.
2. From the right-click menu, select **Sync Layers With**.

In the Choose the Parent Drawing Layer drop-down list, with the exception of the selected layer, every layer in your scene is listed.

3. To sync a layer with your currently selected layer, from the drop-down list, select a parent drawing layer and click OK. The child layer immediately updates to the parent layer's timing.

## Create Cycle Dialog Box

The Create Cycle dialog box lets you create cycles from a series of drawings and exposures.

When you create a drawing cycle, all the repeated drawings are linked to the same original files. When modify, repaint, or correct a drawing named “1” for example, all drawings named “1” are updated simultaneously. In order to modify a drawing independently from its other exposures, you must duplicate the drawing.

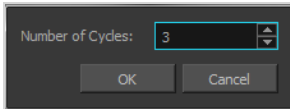

### How to access the Create Cycle dialog box

1. In the Timeline or Xsheet view, select the cell range to loop.

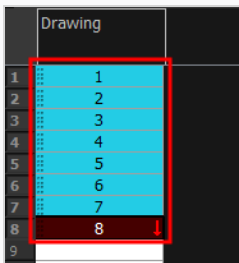
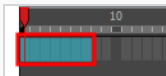

2. In the Timeline toolbar, click the Create Cycle  button (you may have to customize the toolbar to display it).

The Create Cycle dialog box opens.

Parameter	Description
Number of Cycles	Lets you specify the number of cycles, including the current selection.

## Create Drawing from Drawing Selection Dialog Box

The Create Drawing from Drawing Selection dialog box lets you cut a part of a drawing and send it to a new or existing layer.

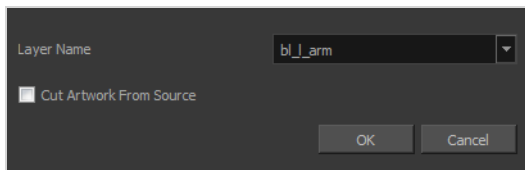

### How to access the Create Drawing from Drawing Selection dialog box

1. From the top menu, select **Edit > Create Drawing From Drawing Selection** or press F9 (Windows/Linux) or ⌘ + F9 (macOS).

The Create Drawing From Drawing Selection dialog box opens.



Parameter	Description
Layer Name	Lets you enter a name for the layer using the naming convention you established.
Cut Artwork From Source	Lets you cut the selected artwork from the model.

## Create Function Step On Dialog Box

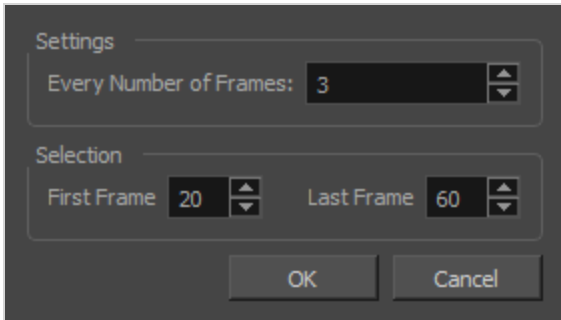
The Create Function Step On dialog box lets you hold the same value over a selected number of frames for multiple parameters (pos x, scale y, etc.). This works well when you are animating drawings on 2s or 3s, for example, and you want to hold the same value for a function over those two or three frames.



### How to access the Create Function Step On dialog box

1. Add the Scripting toolbar to your interface:
  - Go to the top menu and select **Windows > Toolbars > Scripting**.
  - right-click on the empty space near the top of the interface and from the quick-access menu selecting **Scripting**.
  - right-click on the empty space near the top of a view and from the quick-access menu selecting **Scripting**.
2. In the Scripting toolbar, click on the Manage Scripts  button to open the Scripts Manager window.
3. In the Scripts Manager, in the Files section, select the file **TB\_CreateStepsOn.js**.  
The functions associated with that file appear in the Functions section.
4. In the Functions section, select **TB\_CreateStepsOn**.  
The Add script to toolbar  button becomes active.



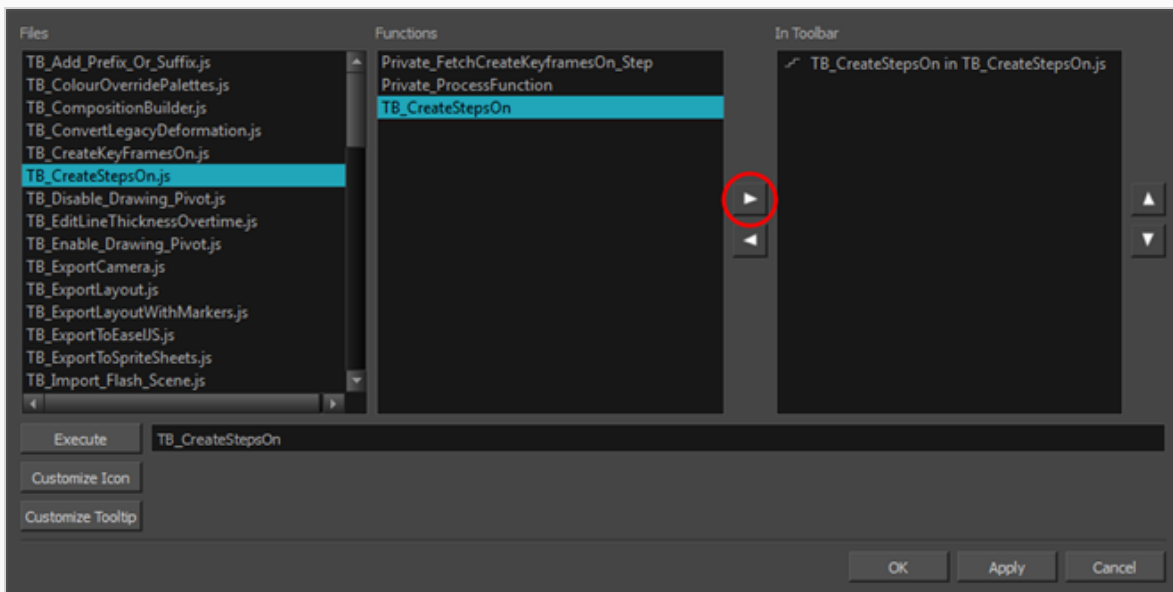

5. Click on the Add script to toolbar ▷ button.  
The TB\_CreateStepsOn script ⌘ button is added to the Scripting toolbar.
6. Click **Apply**.
7. Click **OK**.
8. In the Timeline view, select the layer whose parameter values you would like to hold.
9. In the Scripting toolbar, click on the TB\_CreateStepsOn script ⌘ button.

The Create Function Step On dialog box appears.

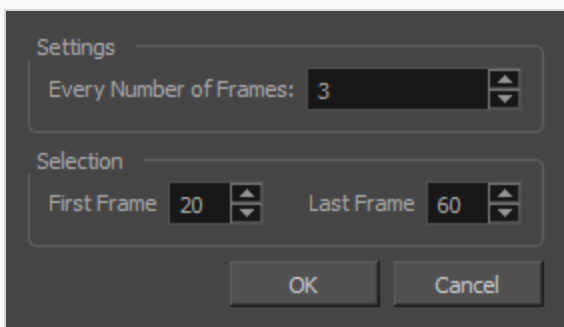

Parameter	Description
Settings	
Every Number of Frames	Enter in the number of frames you would like to hold your functions.

Selection	
First Frame	Enter in the frame number of where you would like the stepped holds to start. The playhead location determines the lowest value you can enter for the first frame. You need to move the playhead to frame one if you would like to set frame one as the lowest possible starting value.
Last Frame	Enter in the frame number of where you would like the stepped holds to stop.

## Create Palette Dialog Box

The Create Palette dialog box allows you to create a colour palette for your scene. Palettes created with this dialog box are added to your scene's palette list, and stored in your scene's **palette-library** subdirectory.

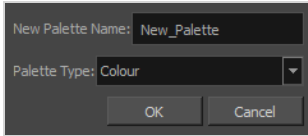

### NOTE

If you have the Advanced Palette Lists preference enabled, the dialog will also have a palette browser, which allows you to decide where the palette is stored and whether to add it to the scene or the element's palette list—see [Palette Browser Dialog Box on page 129](#).

### How to access the Create Palette dialog box

1. Do one of the following:
  - In the Colour View, click the New Palette **+** button over the palette list.
  - From the Colour view menu, select **Palettes > New**

Parameter	Description
New Palette Name	Allows you to type in the name of the palette to create.
Palette Type	Allows you choose the palette type to create: <ul style="list-style-type: none"> <li>• <b>Colour:</b> A colour palette can contain colours, gradients and bitmap textures.</li> <li>• <b>Pencil Texture:</b> A pencil texture palette can contain textures to apply as transparency filters to pencil lines, in combination to their line colour, to create various styles of pencil lines.</li> </ul>

## Create Palette from Selection Dialog Box

The Create Palette from Selection dialog box allows you to create a palette that contains all the colours used by all the drawings in the selected drawing layers.

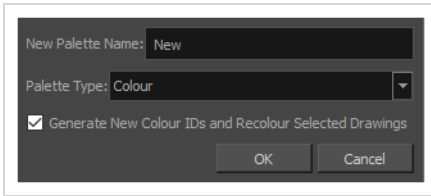

This can be useful, for example, if the colour design for a character model or rig, a background or another kind of asset was made using several different palettes, and you need to consolidate all of the colours used by the asset into its own dedicated palette.



### NOTES

- The Create Palette from Selection dialog uses the colours in all the drawings in the selected layers, even drawings that are not exposed.
- For tasks related to this dialog box, see the User Guide.

### How to access the Create Palette from Selection dialog box

1. In the Timeline, Xsheet, Camera or Node view, select one or more drawing layers.
2. In the top-left corner of the Colour view, open the  View Menu and select **Palettes > New Palette from Selected Drawings**.

Parameter	Description
New Palette Name	Allows you to type in the name of the palette to create.
Palette Type	Allows you choose one of the type of palette to create: <ul style="list-style-type: none"> <li>• <b>Colour:</b> Creates a palette containing all the colours, gradients and bitmap textures used in the selected drawing layers.</li> <li>• <b>Pencil Texture:</b> Creates a palette containing all the pencil textures used in the selected drawing layers.</li> </ul>
Generate New Colour IDs and Recolour Selected Drawings	By default, the Create Palette from Selection dialog box generates the palette by copying the colour swatches used in the selected drawings from their original palette into a new palette, along with their colour ID. This means that the colour swatches in the generated palette will use the same colour IDs as the ones in the original palettes.

If you select this option, Harmony will generate a palette with new colour IDs, and will replace the old colour IDs in your artwork with the new ones. This will usually have no visible effect, and will prevent the swatches in the new palette from having the same colour IDs as the swatches you originally used to colour your artwork. When two palettes have a swatch with the same colour ID, Harmony uses the swatch from the top-most palette in the palette list.

**NOTE**

If your artwork uses Colour-Override effects, the colour IDs used by these Colour-Override will not be replaced with the new colour IDs, making the Colour-Override ineffective unless you reconfigure them manually. Hence, you should avoid using this parameter if you are consolidating the palette of a character rig that uses a lot of Colour-Overrides.

## Database Selector Dialog Box

The Database Selector dialog box lets you connect to your studio's central database when working on Harmony Server.



### NOTE

When you connect to the database, you cannot create new scenes directly from Harmony. The available scenes must have been already created using the Control Center module.

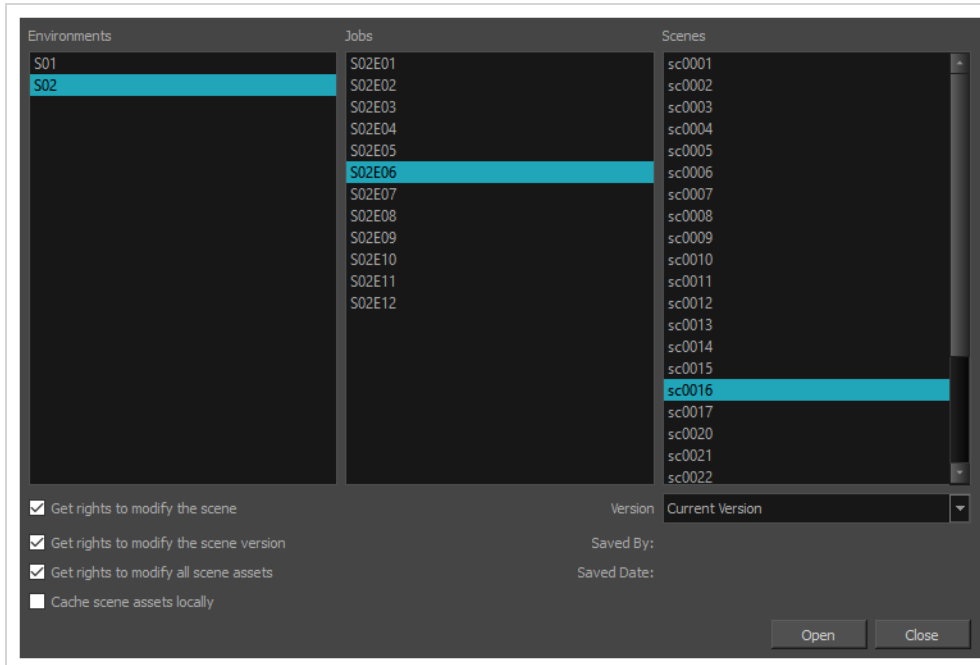

### How to access the Database Selector dialog box

1. Start Harmony
2. In the log-in dialog, select **Connect to Database**.
3. In the **User Name** field, type in your Harmony Server username.
4. Click on **OK**.

The Database Selector dialog box opens.

Parameter	Description
Environments	Lets you select the scene's environment (project, movie).

Jobs	Lets you select the scene's job (episode, sequence).
Scenes	Lets you select the scene.
Get rights to modify the scene	Allows you to modify the selected version of the scene as well as to manage and overwrite other versions. Other users will not be able to open a different version of the scene until you close the scene.
Get rights to modify the scene version	Allows you to modify the currently selected scene version only. Unless the <b>Get rights to modify the scene</b> option is also checked, you will not be able to change other versions of the scene. This allows other users to modify different versions of the scene while you are working on the selected version.
Get rights to modify all scene assets	Automatically gets the rights to modify all of the scene's assets, locking other users from making changes to them until you close the scene. This means that you will have the rights to modify all the scene's versions, drawings, palettes, its palette list, but not its library folder. If this option is unchecked, drawings and palettes will be locked unless you unlock them manually. This can allow another user to work on the scene's drawings and palettes in Paint while you are working on the scene's timing or staging in Harmony.
Cache scene assets locally	<p>Downloads the scene's drawings to your computer before opening the scene. Harmony will then load the drawings from your computer during the session, instead of loading them from their original location over the network. This can significantly increase performance, especially with resource-heavy scenes.</p> <p>When you save your scene, the updated drawings will be uploaded automatically to the database, so you do not have to re-upload them manually.</p> <div style="border: 1px solid green; padding: 10px; margin-top: 10px;">  <p><b>NOTE</b> If this option is checked, it may take a while to download all of the scene's assets when opening a particularly heavy scene.</p> </div>
Version	If you saved different versions of a scene, this lets you select one to open.

## Edit Default Paste Preset Dialog Box

The Edit Default Paste Preset dialog box lets you modify settings for the keyframe and exposure paste presets, as well as setting the defaults.

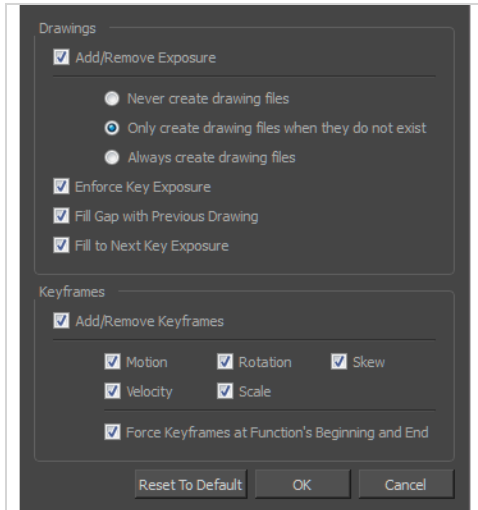

### How to access the Edit Default Paste Preset dialog box

1. From the Timeline menu, select **Edit > Modify Paste Presets > All** or **Key Frame** or **Exposure**.

Parameter	Description
Drawings	
Add/Remove Exposure	<b>Never create drawing files:</b> When adding exposures to a drawing layer, drawing files will not be created.
	<b>Only create drawing files when they do not exist:</b> When adding exposures to a drawing layer, new drawings will be created only when drawings with the same name do not already exist in the destination.
	<b>Always create drawing files:</b> When adding exposures to a drawing layer, new drawings will always be created. If drawing files with the same name already exist, Harmony will create a new name for the drawing.
Enforce Key Exposure	If there are key exposures that exist on copied drawings, they are preserved when pasting. No key exposures are added. This is the default behavior when pasting.



Fill Gap with Previous Drawing	Fills selected area in the Xsheet or Timeline view with the previous drawing.
Fill to Next Key Exposure	Fills selected area till the next key exposure.
Keyframes	
Add/Remove Keyframes	<b>Motion:</b> Copies the properties of the selected motion keyframe to the new frame.
	<b>Velocity:</b> Copies the properties of the selected velocity keyframe to the new frame.
	<b>Rotation:</b> Copies the properties of the selected rotation keyframe to the new frame.
	<b>Scale:</b> Copies the properties of the selected scale keyframe to the new frame.
	<b>Skew:</b> Copies the properties of the selected skew keyframe to the new frame.
	<b>Force Keyframes at Function's Beginning and End:</b> Adds a keyframe to the beginning and end of the pasted function, reproducing the source function.

## Edit Exposure Paste Preset Dialog Box

The Edit Exposure Paste Preset dialog box lets you reuse key exposures as you animate.

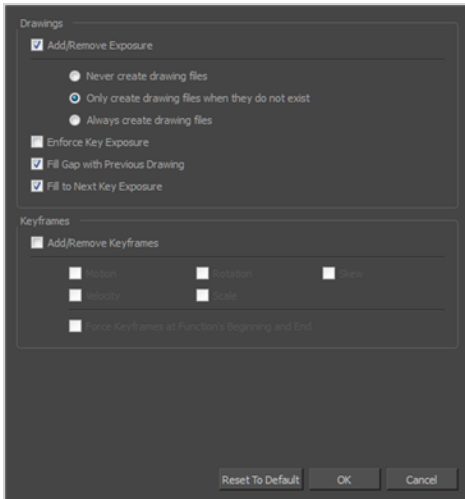

### How to access the Edit Exposure Paste Preset dialog box

1. From the Timeline view menu, select **Edit > Modify Paste Presets > Exposure**.

The Edit Exposure Paste Preset dialog box opens.

Parameter	Description
Drawings	
Add/Remove Exposure	<b>Never create drawing files:</b> When adding exposures to a drawing layer, drawing files will not be created.
	<b>Only create drawing files when do they do not exist:</b> When adding exposures to a drawing layer, new drawings will be created only when drawings with the same name do not already exist in the destination.
	<b>Always create drawing files:</b> When adding exposures to a drawing layer, new drawings will always be created. If drawing files with the same name already exist, Harmony will create a new name for the drawing.
Enforce Key Exposure	Creates a key exposure on the same drawing.
Fill Gap with Previous Drawing	Fills selected area in the Xsheet or Timeline view with the previous drawing.

Fill to Next Key Exposure	Fills selected area till the next key exposure.
Keyframes	
Add/Remove Keyframes	<b>Motion:</b> Copies the properties of the selected motion keyframe to the new frame.
	<b>Velocity:</b> Copies the properties of the selected velocity keyframe to the new frame.
	<b>Rotation:</b> Copies the properties of the selected rotation keyframe to the new frame.
	<b>Scale:</b> Copies the properties of the selected scale keyframe to the new frame.
	<b>Skew:</b> Copies the properties of the selected skew keyframe to the new frame.
	<b>Force Keyframes at Function's Beginning and End:</b> Adds a keyframe to the beginning and end of the pasted function, reproducing the source function.
Reset to Default	Return all values to their defaults.

## Element Manager Dialog Box

The Element Manager window lets you Open the Element Manager window where you can add, delete or modify elements (drawing folders) in your scene. If you have drawing folders that are not linked to a column in your scene, use the Element Manager to delete them if needed. See [xref Reference > Windows > Element Manager](#).

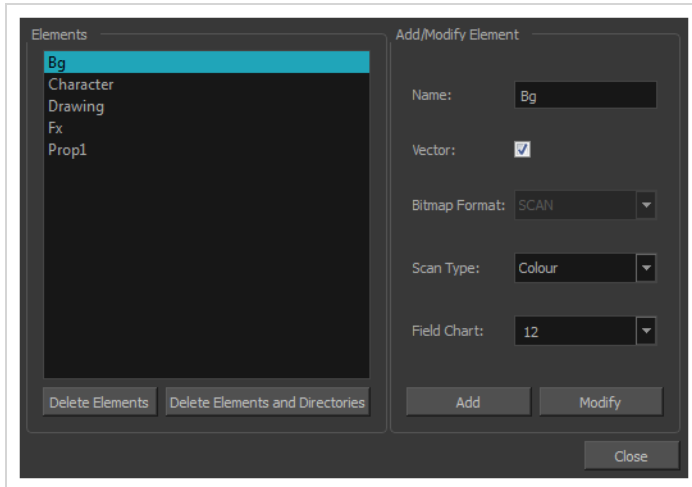

### How to access the Element Manager window

1. From the top menu, select **Scene > Element Manager**.

Parameter	Description
Elements	
Delete Elements	Deletes the selected elements.
Delete Elements and Directories	Deletes the selected layer and its directories (drawing folder).
Add/Modify Element	
Name	Type in a new name in this field to create an element or to rename the selected element.
Vector	Select this option if the new element is a vector drawing or if you want to enable the parameters on the selected element in the Elements list.

Bitmap Format	Lets you select the file format of the bitmap layer.
Scan Type	If you're planning to scan elements with the Toon Boom Harmony Scan module, select the scan type from the list.
Field Chart	If you're importing traditional animation, select the size of the paper on which the animation was drawn.
Add	Creates a new element with the current parameters entered in the <b>Add/Modify Element</b> section.
Modify	Applies the parameter changes made to the selected element.

## Envelope Creator Dialog Box

The Envelope Creator Dialog box allows you to procedurally generate a curve or envelope deformation chain based on the artwork in the current layer. The deformation chain can be made to wrap around the outer shape of the artwork or to go through its centre line. It will be created as a parent of the current layer, allowing you to use it to deform and animate the artwork in the layer instantly after creating it.

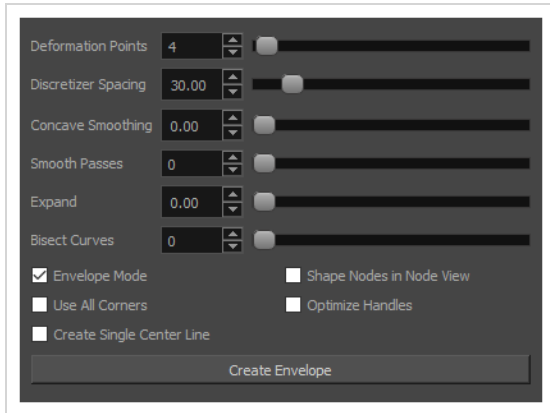

### How to access the Envelope Creator dialog box

1. Select the node or layer for which you want to create a deformation chain.
2. In the top menu, select **Animation > Envelope Creator > Create Envelope**.

The Envelope Creator dialog appears.

## Parameters

Parameter	Description
Deformation Points	<p>The amount of deformation points to create in the deformation chain. The higher the amount of points, the more faithful to the outer shape of your artwork the deformation chain will be, but the harder it will be to animate.</p> <p>Envelope with 4 deformation points      Envelope with 8 deformation points</p>

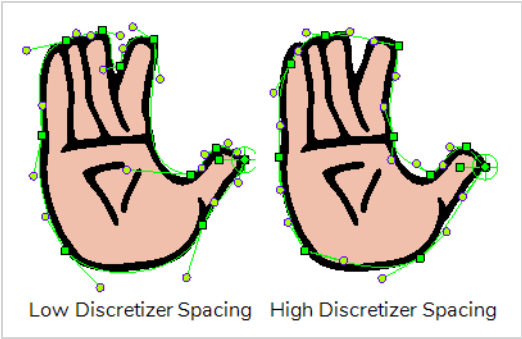
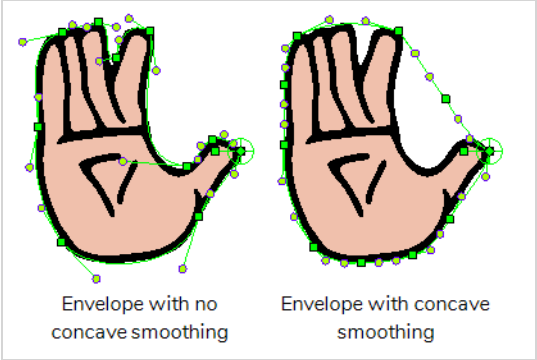

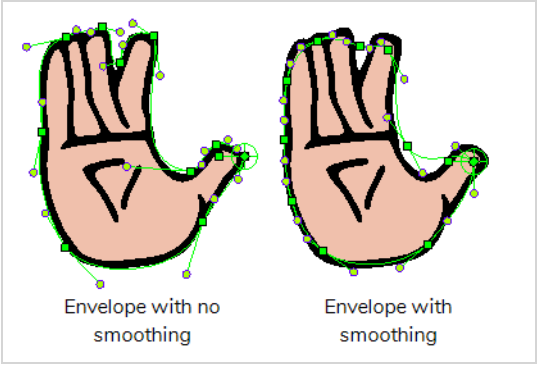
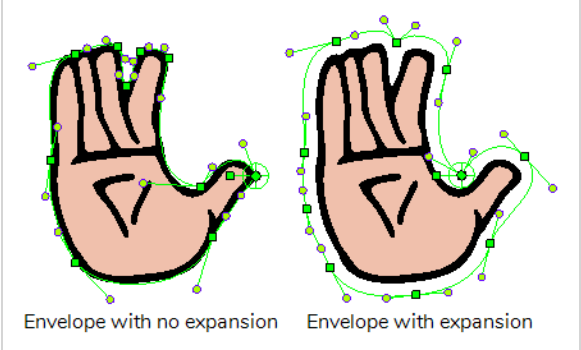
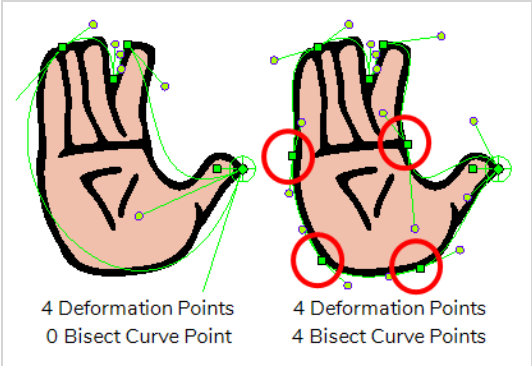
Parameter	Description
	<div style="border: 1px solid #add8e6; padding: 10px;">  <b>TIP</b>            You can enable the <b>Use All Corners</b> option to let the Envelope Creator calculate how many points to create based on the amount of corners in your artwork.         </div>
Discretizer Spacing	<p>The scale at which the Envelope Creator analyzes the drawing's details. A lower setting will cause the shape of the envelope to match the contours of the drawing more closely, but may cause the Envelope Creator to hang when generating an envelope and to generate points for small dents and bumps in the contour of the artwork. A higher setting will allow the Envelope Creator to ignore subtle details in the contour which would not be useful for the deformation chain.</p>  <p style="text-align: center;">Low Discretizer Spacing    High Discretizer Spacing</p>
Concave Smoothing	<p>Smooths out the concavities of the envelope. Increasing this parameter makes the concave corners in the envelope moved away from the centre of the envelope, making the shape of the envelope closer to a convex shape. The position of convex corners is not affected by this parameter.</p>  <p style="text-align: center;">Envelope with no concave smoothing    Envelope with concave smoothing</p>
Smooth Passes	<p>The amount of smoothing applied to the corners and angles in the shape of the deformation chain.</p>

Parameter	Description
	 <p style="text-align: center;">Envelope with no smoothing      Envelope with smoothing</p>
Expand	<p>Expands the outer shape of the envelope. This ensures that the contours of the artwork are inside the envelope instead of meshing with it.</p>  <p style="text-align: center;">Envelope with no expansion      Envelope with expansion</p>
Bisect Curves	<p>The amount of extra points to add over the segments of the deformation chain. While points added with the Deformation Points parameter are laid out to match the corners of the shape, the points added with the Bisect Curves setting are added to the middle of the segments between those points.</p> <p>This parameter determines the total amount of Bisect Curves points to add to the whole envelope. Those points are distributed along the envelope, with priority given to longer segments. An extremely long segment may have several Bisect Curves points added to it, like in this example:</p>  <p style="text-align: center;">4 Deformation Points      4 Deformation Points 0 Bisect Curve Point      4 Bisect Curve Points</p>

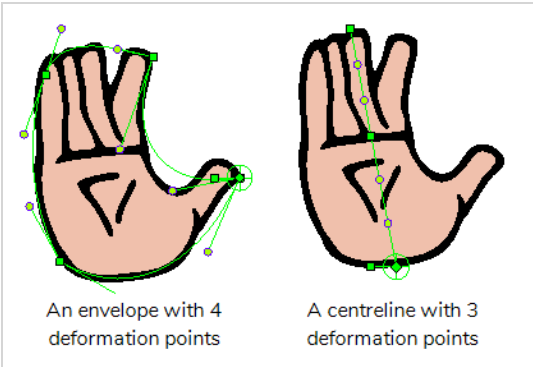
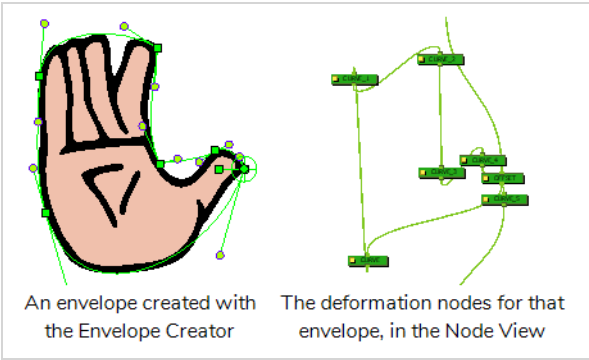

## Options

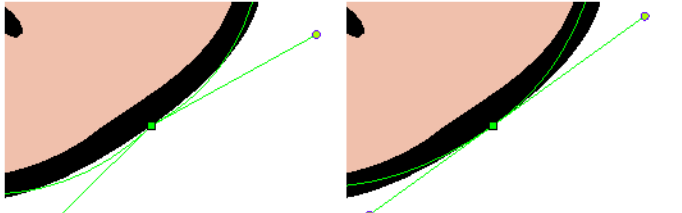
Parameter	Description
Envelope Mode	By default, the Envelope Creator will generate a Curve type deformation chain. This means that the first point in the chain is not used to deform the artwork, but rather, to offset the deformation chain and move the drawing. With Envelope mode enabled, the first point in the deformation chain has the same purposes as all the other points, which is to deform the drawing.
Use All Corners	When enabled, this ignores the Deformation Points parameter and creates a deformation point for each corner the Envelope Creator detects in the shape of the artwork.
Create Single Center Line	<p>When enabled, this creates a deformation chain that goes through the centre line of the artwork, instead of going around the outer contour of the artwork.</p>  <p>An envelope with 4 deformation points      A centerline with 3 deformation points</p>
Shape Nodes in Node View	<p>Lays out the deformation nodes in the node view so that they resemble the shape of the deformation chain, allowing you to visually identify which deformation node corresponds to which deformation point in the chain.</p>  <p>An envelope created with the Envelope Creator      The deformation nodes for that envelope, in the Node View</p>
Optimize Handles	When the envelope has very wide angle corners, the Bezier handles for these points may be almost aligned, but not exactly. With this option enabled, Bezier handles that are almost aligned will be automatically aligned.

Parameter	Description
	<div data-bbox="370 285 1068 611" style="border: 1px solid black; padding: 5px; margin-bottom: 10px;">  <p data-bbox="402 541 691 594">Bezier handles for a wide angle corner</p> <p data-bbox="734 541 1045 594">With the Optimize Handles option, these Bezier handles are aligned.</p> </div> <div data-bbox="370 646 1430 911" style="border: 1px solid green; padding: 10px; background-color: #e0f2f1;"> <p data-bbox="396 674 456 737"></p> <p data-bbox="477 680 553 705"><b>NOTE</b></p> <p data-bbox="477 728 1403 884">When two Bezier handles for a point are aligned, the point does not act as a corner, but rather as a control point for the curve of the shape. Rotating a handle that is aligned with the opposite handle also rotates the opposite handle, making sure that the point does not become a corner. You can rotate one of the handles independently from the other by holding the Alt key.</p> </div>

## Buttons

Parameter	Description
Create Envelope	Automatically generates a deformation chain around the artwork in the current layer, using the parameters in this dialog box. The deformation chain will be placed as a parent of the current layer.

## Export Layout Image Dialog Box

The Export Layout Image dialog box allows you to export your drawings as bitmap images matching the scene resolution size, taking camera motions into account, to paint them in an external bitmap editing software.

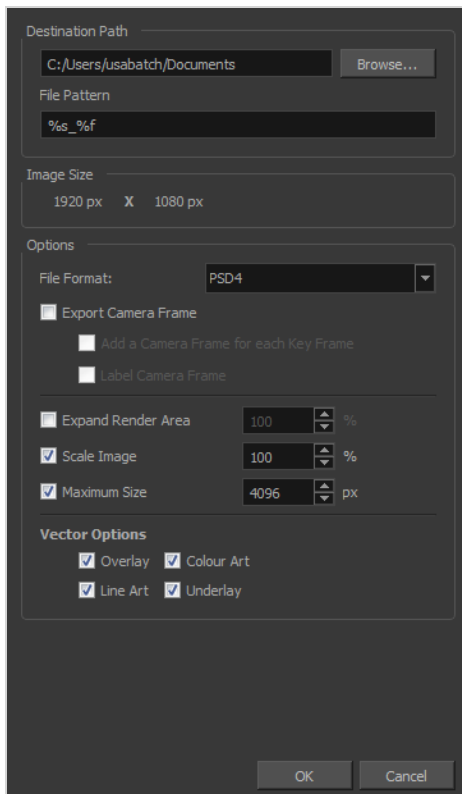

### Access Method

- From the top menu, select one of the following:
  - File > Export > Layout Image** to export all the elements in your scene to the layout .psd file.
  - File > Export > Layout Image from Selection** to export only the selected elements.

The Export Layout Image dialog box opens.

Parameter	Description
Destination Path	Use the Browse button to select a location to save your layout and name the resulting .psd file.
File Pattern	Automatically puts the name of the scene and/or the frame number in the name of the file you create.

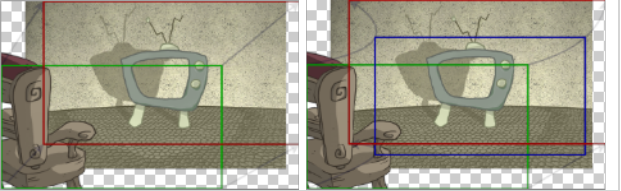
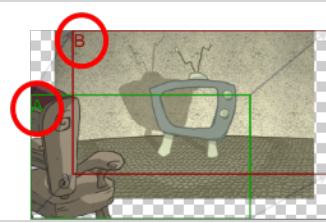
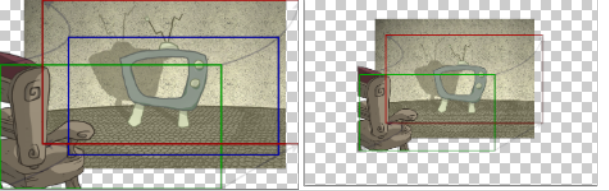
<p>Image Size</p>	<p>The size of the .psd image file that will be exported. The resulting image will be 72 dpi as the standard television resolution and its size in pixel will fit your scene resolution settings. i.e HDTV, NTSC, PAL, etc. Note that if you have a camera movement going over the normal camera frame limit, for example a pan, the image will be bigger.</p>
<p>Options</p>	<p><b>File Format:</b> Lets you select the format to export your layout.</p> <p><b>Export Camera Frame:</b> Prints the first and last camera frame of each scene into the exported layout images. If exporting in .psd format, the camera frames will be printed on a separate layer.</p> <p><b>Add a Camera Frame for Each Keyframe:</b> If a scene contains a camera movement with more than two keyframes, this prints each camera keyframe into the layout.</p>  <p><b>Label Camera Frame:</b> Adds the camera position label in the top-left corner of each camera frame. Camera frames are labeled with a letter of the alphabet indicating their respective order.</p> 
	<p><b>Expand Render Area:</b> Expands the area to render into the layouts. By default, only the area of the scene that is covered by the camera is rendered, and exported layout images are cropped at the edges of the camera frames. If enabled, this option adds space around the render area and captures extra details outside the camera frames. By default, the render area is expanded by 10%. You can use the input field to the right of the option to change this ratio.</p>  <p><b>Scale Image:</b> Ensures that when a camera close-up is included in a scene, the exported image is larger so that the closest camera frame is at least the size of the chosen image size. This way, the layout does not appear pixelated when zooming in on the closest camera frame. If disabled, the size of the exported images will be</p>

	<p>based off the chosen Base Image Size and Expand Render Area options.</p> <p><b>Maximum Size:</b> If the Scale Image Up to Smallest Camera Frame option is enabled, this ensures images do not get scaled up too much. If enabled, images will be limited to 4096 pixels in width and height by default.</p>
	<p><b>Vector Options</b></p> <p>If you export one or more vector-based drawing layers in your layout image, you have the option to export only the drawing layers you want. Enable or disable the following options to export or prevent the export of the corresponding art layers.</p> <p><b>Overlay:</b> Exports the art in the Overlay layer of the drawings to be exported to the layout image.</p> <p><b>Line Art:</b> Exports the art in the Line layer of the drawings to be exported to the layout image.</p> <p><b>Colour Art:</b> Exports the art in the Colour layer of the drawings to be exported to the layout image.</p> <p><b>Underlay:</b> Exports the art in the Underlay layer of the drawings to be exported to the layout image.</p>

## Export Soundtracks Dialog Box

The Export Soundtracks dialog box lets you export a sound file to use it in another application, such as an editing software. Harmony allows you to export sound files as a merged soundtrack or as a series of individual files. The exported soundtracks are generated as \*.wav files.

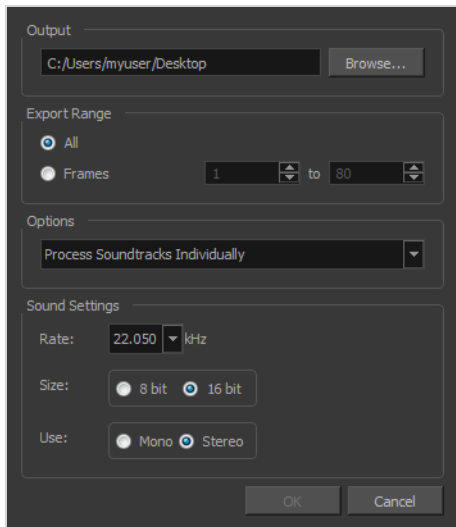

### How to access the Export Soundtracks dialog box

1. From the top menu, select **File > Export > Soundtrack**.

The Export Soundtracks dialog box opens.

Parameter	Description
Output	Lets you specify the location in which the file will be exported.
Export Range	
All	Exports the sound over all the frames of your scene.
Frames	Sets the start and end frames in the corresponding fields on the right.
Options	
Process Soundtracks Individually	Each soundtrack from all layers is exported as individual files.

---

Merge All Soundtracks	One single file is created, combining all the sound files you imported in your scene. Note that it will only use the sound files in the selected frame range set in the Export Range section. If you selected to export all the frames, all the sound files will be processed.
Sound Settings	
Rate	Lets you set the rate of the soundtrack.
Size	Lets you export the soundtrack at 8 or 16 bits.
Use	Lets you export the soundtrack as mono or stereo.

## Export to Animated GIF Dialog Box

Using the Export to Animated GIF dialog box, you can export your scene, or an excerpt of it, as an animated GIF image.

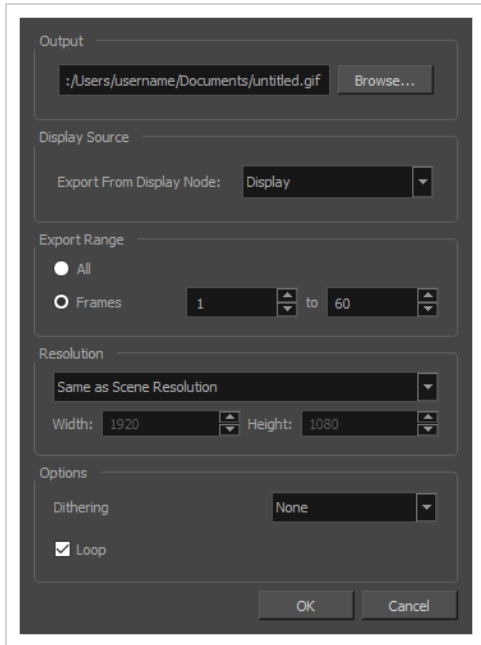

Animated GIFs are a portable format commonly used for exchanging short animations and clips on the web. They can be played in any web browser and in many image viewers.

Animated GIFs are a convenient sharing format, but they are not a publishing format. They are not as optimized for fast download and playback as movie files, cannot contain audio and, most importantly, can only contain up to 256 different colours throughout the entire animation. Hence, if your animation contains textures or gradients, it is likely to lose quality when exported as an animated GIF, as Harmony will have to limit the amount of different colours used in the exported image.



### NOTE

For steps on how to use the Export to Animated GIF dialog box, see the User Guide.



### How to access the Export to Animated GIF dialog box

1. In the top menu, select **File > Export > Animated GIF**.

The Export to Animated GIF dialog box appears.



Parameter	Description
Output	
Output	The full path and file name of the GIF file to export.
Browse	Opens a dialog allowing you to browse to the desired export directory and enter the desired file name.
Display Source	
Export from Display Node	<p>Allows you to select the display node from which to render your scene.</p> <div style="border: 1px solid green; padding: 10px; margin-top: 10px;"> <p> <b>NOTE</b></p> <p>If there is no Display node in your scene, the only available option will be Display All. This renders all the nodes in your scene, including ones that are not connected to anything. You can add other Display nodes to your scene and connect them under specific parts of your scene to be able to render these parts only.</p> </div>
Export Range	
All	Exports all the frames in your scene.
Frames	Allows you to specify a range of frames to render.
Resolution	
Resolution list	<p>Lets you specify a resolution to export in relative to your scene's actual resolution:</p> <ul style="list-style-type: none"> <li>• <b>Same as Scene Resolution:</b> Exports a movie in the same resolution as your scene's resolution.</li> <li>• <b>3/4 of Scene Resolution:</b> Exports a movie at 75% of the scene's width and height.</li> <li>• <b>1/2 of Scene Resolution:</b> Exports a movie at 50% of the scene's width and height.</li> <li>• <b>1/4 of Scene Resolution:</b> Exports a movie at 25% of the scene's width and height.</li> <li>• <b>Custom:</b> Allows you specify the preferred resolution of your exported video file, in pixels, in the <b>Width</b> and <b>Height</b> fields below.</li> </ul>

Parameter	Description
Width	If you selected the Custom resolution, use this field to specify the width, in pixels, of the exported movie.
Width	If you selected the Custom resolution, use this field to specify the height, in pixels, of the exported movie.
Options	Options
Dithering	<p>Since GIF images can only have up to 256 colours, you have the option to add dithering to the rendered image. Dithering blends pixels of different colours where the image contains gradients to simulate colours that do not exist in the GIF image's colour palette.</p> <ul style="list-style-type: none"> <li>• <b>None:</b> No dithering will be applied. Each pixel rendered is rendered with the colour in the palette that is the closest to its actual colour.</li> </ul>  <ul style="list-style-type: none"> <li>• <b>Diffusion:</b> Blends pixels in irregular patterns to blend pixels and simulate the colour as closely as possible.</li> </ul>  <ul style="list-style-type: none"> <li>• <b>Pattern:</b> Blends pixels in regular checkered patterns to simulate the colour without created clusters of pixels.</li> </ul> 
Loop	If this option is checked, the exported GIF animation will loop when previewed in web browsers and other image viewers that support animated GIFs. Otherwise, it will only play once and stop.

## Export to Easel JS Dialog Box

The Export to Easel JS window lets you flatten an image sequence of your animation. Even if you have a fully rigged puppet or a single drawing layer with your animation sequence, the outcome will still be a flattened output of each frame, grouped together in your sprite sheet. This allows for more flexibility and freedom of work as you have access to any tools or effect modules you want to use. However, this can result in heavier files depending on the length, complexity and export size of your animation.

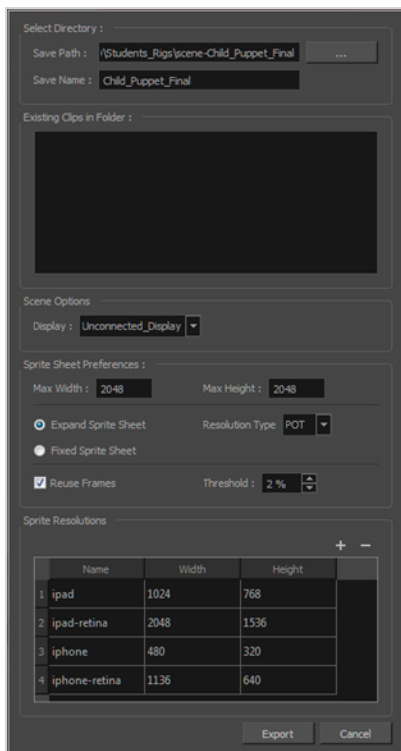

### How to access the Export to Easel JS window

1. Select **Windows > Toolbars > Game**.

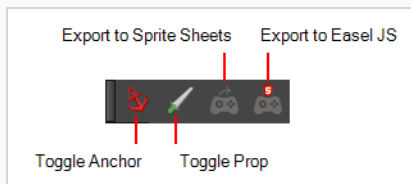

2. Click the Export to Easel JS  button.

Parameter	Description
Select Directory	

Save Path	The folder path where you want to save your export.
Save Name	The folder name in which you will save your export. This will also be the name of your asset in Unity. Your scene file name will be used as the clip name.
Existing Clips in Folder	Displays the clips in the folder.
Scene Options	
Display	Here, you must select the Display of your character. This is the one that will be used to render out all of the information attached to that Display node. If the Unconnected_Display option is selected, all of the visual information in your scene will be rendered out.
Sprite Sheet Preferences	
Max Width	This is a value, in pixels, for the maximum width and height the exported sprite sheet should be. By default, both values are set to 2048 pixels.
Max Height	
Expand Sprite Sheet	Uses the minimum size necessary up until it reaches the maximum resolution.
Fixed Sprite Sheet	Creates a texture of the specified size (Max Width and Max Height) even if it does not fill it up completely by all the drawings in your scene.
Resolution Type	<p><b>POT:</b> Exports to sprite sheets with sizes that are a power of 2. For example: 1024 x 1024. This is optimized for many graphics cards, but consumes more memory.</p> <p><b>NPOT:</b> Some game engines are optimized specifically to render to non powers of two, so that it will avoid those numbers. Example: 1000 x 1000.</p>
Reuse Frames	This option works in tandem with the Threshold option. The export will compare the drawings in your project to reuse a maximum of similar drawings and reduce the amount of information found in the sprite sheet, making it lighter. The export will omit the creation of new drawings if the difference is less than the threshold percentage.
Threshold	Calculates the differences between multiple drawings. A 2% threshold will prevent the creation of a new drawing if the drawing is too similar to an existing drawing. For instance, with a 2% threshold, and my drawing is 100 pixels big, only 2 of those pixels need to be different from my other drawing in order to

	create a new one. The higher the threshold, the fewer similar drawings you will have.
Sprite Resolutions	Size of the render of the individual sprite, when it exports each drawing out.

## Export to Flash Movie Dialog Box

The Export to Flash Movie dialog box lets you export your animation as a Flash (.swf) movie.

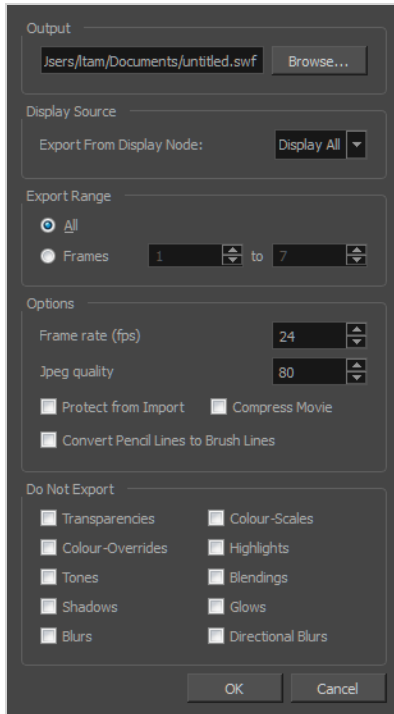

### How to access the Export to Flash Movie dialog box

1. From the top menu, select **File > Export > SWF**.

The Export to Flash Movie (.swf) dialog box opens.

Parameter	Description
Output	Lets you specify the location in which the file will be exported.
Display Source	Lets you select a Display node to read from in the Export From Display Node menu.
Export Range	
All	Exports all the frames of your movie.
Frames	Export a frame range which you specify

Options	
Frame Rate	Lets you enter a Frame rate (fps). By default, it will be set to match the fps of your Harmony project. If you choose a lower frame rate, your export playback will be faster than your actual project. The reverse is also true for a higher frame rate.
Jpeg Quality	<p>Lets you select a JPEG quality:</p> <ul style="list-style-type: none"> <li>▶ 100 = Full quality</li> <li>▶ 50 = Average quality at about 1/5th of the size.</li> <li>▶ 25 = Medium quality where loss of high image resolution starts to occur.</li> <li>▶ 10 = Low quality where “macro-blocking” or large pixelation become obvious.</li> <li>▶ 1 = Lowest quality where there is extreme loss of colour and detail and the image becomes nearly unrecognizable.</li> </ul>
Protect from Import	Prevents the movie from being imported into another application.
Convert Pencil Lines to Brush Lines	Retains the thickness of pencil lines.
Compress Movie	Compresses the movie for a lighter format. The movie may lose some quality, but the file will be lighter.
Do Not Export	<p>Lets you select the effects you do <b>NOT</b> want to be rendered in the SWF movie.</p> <div style="border: 1px solid green; padding: 10px; margin-top: 10px;"> <p> <b>NOTE</b></p> <p>Certain Harmony effects are not listed in this section as they are not compatible and therefore not available for SWF export. These effects will not appear in the SWF render.</p> </div>

## Export to Video Dialog Box

The Export to Video dialog box lets you export your animation as a movie file.

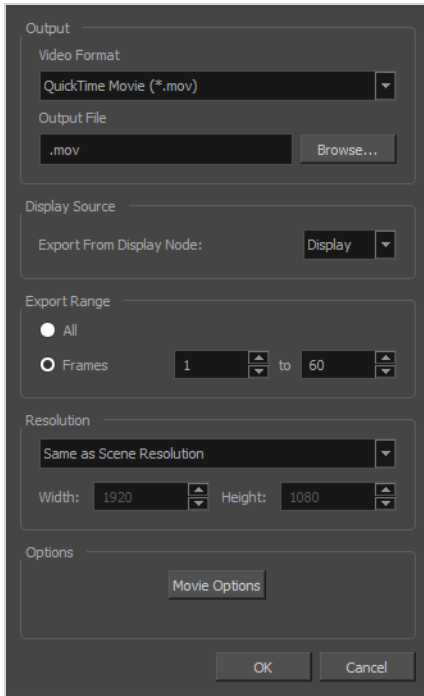



If you added burn-in information to your scene, it will be included in your exported file—see [Burn-In Node](#) on page 620.



### How to access the Export to QuickTime Movie dialog box

1. From the top menu, select **File > Export > Movie**.

Parameter	Description
Output	
Video Format	Choose among the following output formats: <ul style="list-style-type: none"> <li>• <b>Quick Time Movie (*.mov)</b>: Available on Windows, macOS and GNU/Linux.</li> <li>• <b>Windows Media Video (*.wmv)</b>: Available on Windows only.</li> </ul>



	<div style="border: 1px solid green; padding: 10px;">  <p><b>NOTE</b></p> <p>On Windows and macOS, <a href="#">Apple QuickTime</a> must be installed in order to export QuickTime movies. On GNU/Linux, Harmony uses a more limited, open source QuickTime-compatible library which does not require additional software.</p> </div>
Output file	The full path and file name of the movie file to export.
Browse	Opens a dialog allowing you to browse to the desired export directory and enter the desired filename.
Display Source	
Export from Display Node	<p>Lets you select the display node from which to render your scene.</p> <div style="border: 1px solid green; padding: 10px;">  <p><b>NOTE</b></p> <p>If there is no Display node in your scene, the only available option will be Display All. This renders all the nodes in your scene, including ones that are not connected to anything. You can add other Display nodes to your scene and connect them under specific parts of your scene to be able to render these parts only.</p> </div>
Export Range	
All	Exports all the frames in your scene.
Frames	Lets you specify the frame range to export using the two input fields to the right. The first input field is for specifying the first frame to export, and the second one is for specifying the last frame to export. All the frames in-between, including the ones specified, will be exported.
Resolution	
Resolution list	<p>Lets you specify a resolution to export in relative to your scene's actual resolution:</p> <ul style="list-style-type: none"> <li>• <b>Same as Scene Resolution:</b> Exports a movie in the same resolution as your scene's resolution.</li> <li>• <b>3/4 of Scene Resolution:</b> Exports a movie at 75% of the scene's width and height.</li> </ul>

	<ul style="list-style-type: none"> <li>• <b>1/2 of Scene Resolution:</b> Exports a movie at 50% of the scene's width and height.</li> <li>• <b>1/4 of Scene Resolution:</b> Exports a movie at 25% of the scene's width and height.</li> <li>• <b>Custom:</b> Allows you specify the preferred resolution of your exported video file, in pixels, in the <b>Width</b> and <b>Height</b> fields below.</li> </ul>
<p>Width / Height</p>	<p>Lets you specify the width and height of video file you wish to export, in pixels. To preserve your scene's aspect ratio, changing the value of the Width or Height field will automatically update the other field with a proportional value.</p>
<p>Options</p>	
<p>Movie Options</p>	<p>Opens the movie settings dialog box for your selected video format, in which you can set the video and audio compression settings for your video file—see <a href="#">QuickTime Movie Settings Dialog Box</a> and <a href="#">Windows Media Video Settings Dialog Box</a>.</p> <div data-bbox="597 953 1430 1094" style="border: 1px solid #c8e6c9; padding: 10px; margin-top: 10px;"> <p> <b>NOTE</b> This button is available on Windows and macOS only.</p> </div>
<p>Video Options</p>	<p>Opens the video settings dialog box, which allows you to set the video compression settings for your video file—see <a href="#">OpenQuickTime Video Options Dialog Box</a>.</p> <div data-bbox="597 1283 1430 1423" style="border: 1px solid #c8e6c9; padding: 10px; margin-top: 10px;"> <p> <b>NOTE</b> This button is available on GNU/Linux only.</p> </div>
<p>Sound Options</p>	<p>Opens the audio settings dialog box, which allows you to set the audio compression settings for your video file—see <a href="#">OpenQuickTime Sound Options Dialog Box</a>.</p> <div data-bbox="597 1610 1430 1751" style="border: 1px solid #c8e6c9; padding: 10px; margin-top: 10px;"> <p> <b>NOTE</b> This button is available on GNU/Linux only.</p> </div>

## Export to Sprite Sheet Dialog Box

The Export to Sprite Sheets window export to multiple resolutions, generating multiple .xml files and one or multiple sprites sheets depending how many sprite resolutions you defined.

This saves different animations of the same character into the same name. For example, if there's an idle, run, and jump animation, these should all share the same Save Name. You can think of it as the overall collection of animations. Inside are the different saved scene versions whose drawings you can reuse for all the animations in that character set. Each scene version will be displayed as an item in the list.

When you export an animation, only the drawings used in that scene are exported. All the drawings are exported individually first and then atlated together into a sprite sheet.

If you saved multiple animations to the same Save Name (i.e. SpaceDuck: run, idle), then it will reatlas the sprite sheet to include all the drawings from all the animations in that folder, creating a new animation file, but reusing the same skeleton.

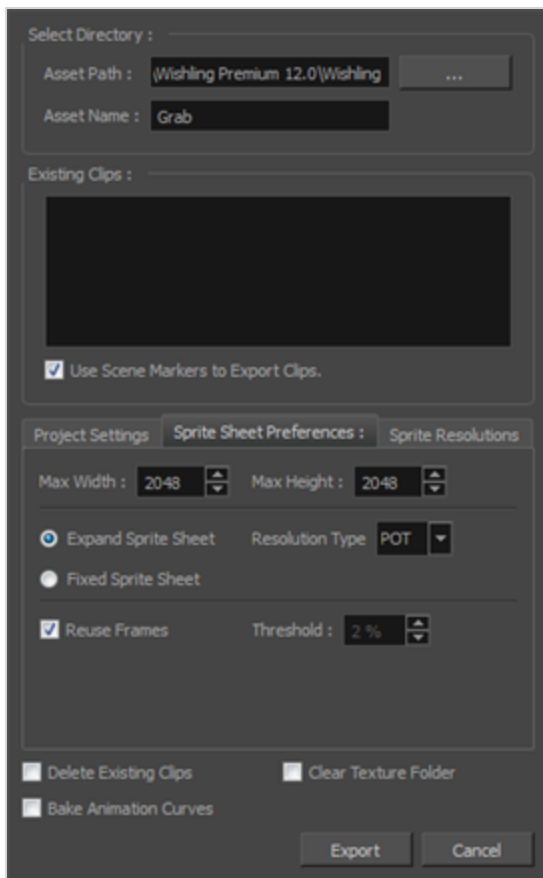

### How to access the Export to Sprite Sheets window

1. Select **Windows > Toolbars > Game**.

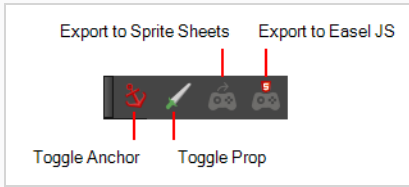

2. Click the Export to Sprite Sheets  button.

Parameter	Description
Select Directory	
Asset Path	The folder path where you want to save your export.
Asset Name	The folder name in which you will save your export. This will also be the name of your asset in Unity. Your scene file name will be used as the clip name.
Existing Clips in Folder	
Preview Window	Displays a list of pre-existing clips in the same export folder location, most likely exported there from a previous time.
Use Scene Markers to Export Clips	Uses scene markers to define the export range, instead of exporting the entire scene.
Project Settings	
Unit Scale	Lets you change the scale when exporting to Unity to accommodate the size of the export without it affecting the Harmony scene. This helps you resize assets properly for Unity without having to resize them in Harmony. The basic scale is one Animation Field for one Unity unit.
Preset	Lets you select the unit conversion from Harmony to Unity, by selecting one of 4 presets. Note: a field is a unit of measure in traditional animation grid.
Sprite Sheet Preferences	
Max Width	This is a value, in pixels, for the maximum width and height the exported sprite sheet should be. By default, both values are set to 2048 pixels.

Max Height	Makes linear values for interpolation. This increases the amount of memory used but frees up the calculation so it is not done on the fly.
Expand Sprite Sheet	Uses the minimum size necessary up until it reaches the maximum resolution.
Fixed Sprite Sheet	Creates a texture of the specified size (Max Width and Max Height) even if it does not fill it up completely by all the drawings in your scene.
Resolution Type	<p><b>POT:</b> Exports to sprite sheets with sizes that are a power of 2. For example: 1024 x 1024. This is optimized for many graphics cards, but consumes more memory.</p> <p><b>NPOT:</b> Some game engines are optimized specifically to render to non powers of two, so that it will avoid those numbers. Example: 1000 x 1000.</p>
Reuse Frames	This option works in tandem with the Threshold option. The export will compare the drawings in your project to reuse a maximum of similar drawings and reduce the amount of information found in the sprite sheet, making it lighter. The export will omit the creation of new drawings if the difference is less than the threshold percentage.
Threshold	Calculates the differences between multiple drawings. A 2% threshold will prevent the creation of a new drawing if the drawing is too similar to an existing drawing. For instance, with a 2% threshold, and my drawing is 100 pixels big, only 2 of those pixels need to be different from my other drawing in order to create a new one. The higher the threshold, the fewer similar drawings you will have.
Sprite Resolutions	Size of the render of the individual sprite, when it exports each drawing out.
Delete Existing Clips	Select this option to delete any pre-existing clips in the export location.
Bake Animation Curves	Makes linear values for interpolation. This increases the amount of memory used but frees up the calculation so it is not done on the fly.
Clear Texture Folder	Removes any information from the texture folder within the Harmony file. This has no incidence towards the Unity export but contributes to a lighter Harmony file.

## Expression Dialog Box

In Harmony, you can use expressions to automate the calculation of effect values based on the values in another function. An expression is a mathematical formula that allows you to manipulate the value in the source function to create new values for the destination effect.

The Expression dialog box is where you write expressions. It's a simple text editor that can handle incomplete or invalid JS programs although they will not be evaluated. Harmony can save and load invalid JS programs.

The Expression editor evaluates the current script at the current global frame and reports any errors or returns the numerical result of the program.

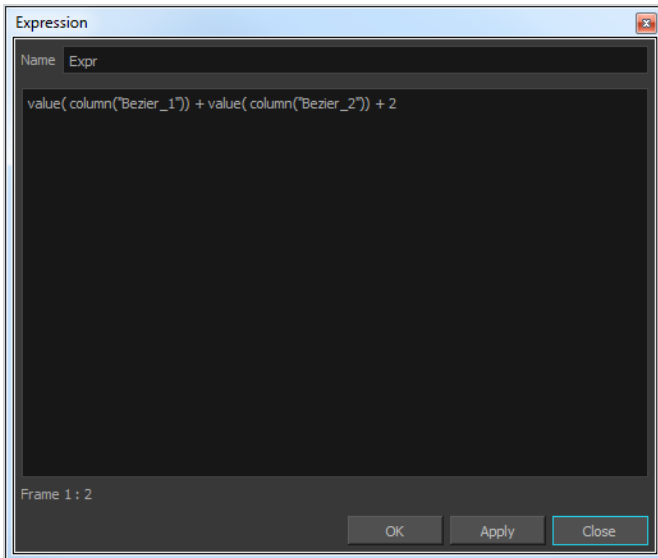

### How to access the Expression dialog box

1. In the Xsheet view menu, select **Columns > Add Columns** or press Shift + C.

The Add Column dialog box opens.

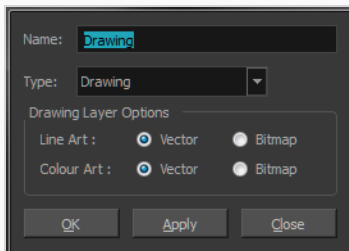

2. In the Name field, type a name for the column.
3. From the Type menu, select **Expression** and click **OK**.
4. Double-click on the column's header to open the Expression dialog box.

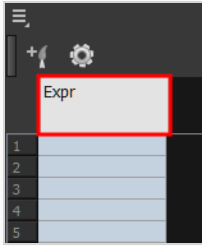

The Expression dialog box opens.

Parameter	Description
Name	Indicates the name of the expression column in the Xsheet. You can edit this name.
Description field	Area in which you can type in expressions.

## Extend Exposure Dialog Box

The Extend Exposure dialog box lets you extend the exposure of a selected cell in the Timeline or Xsheet.

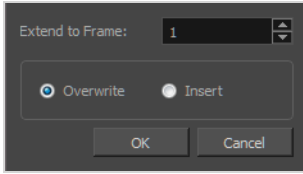

### How to access the Extend Exposure dialog box

1. Select a cell and do one of the following:
  - From the top menu, select **Animation > Cell > Extend Exposure**.
  - Press F5.

The Extend Exposure dialog box opens.

Parameter	Description
Extend to Frame	Lets you enter the frame up to which you want to extend the exposure. You can expose the drawing in the frames and replace the drawings that were originally there or move the subsequent frames forward in time.
Overwrite	Lets you expose the drawing in the frames and replace the drawings that were orginally there.
Insert	Lets you expose the drawing in the frames and move the subsequent frames forward in the Timeline view.



## Fill Cells Randomly Dialog Box

The Fill Cells Randomly dialog box lets you fill in random values over a selection. You can give a maximum and a minimum value and create a range for Harmony to choose the random values from. The selection can be over one cell or a cell range in one column or more or an entire column or many entire columns.

### How to access the Fill Cells Randomly dialog box

1. Do one of the following:
  - Select **Animation > Cell > Fill Cells Randomly**.
  - In the Xsheet view, click the Fill Cells Randomly  button (you may have to customize the toolbar to display it).

The Fill Cells Randomly dialog box opens.

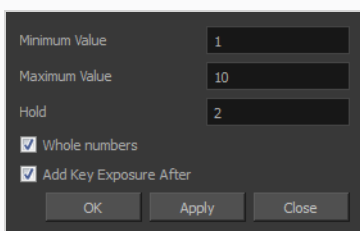

Parameter	Description
Minimum Value	The lowest value to be used in the randomized exposure or keyframe value.
Maximum Value	The highest value to be used in the randomized exposure or keyframe value.
Hold	The exposure holding value.
Whole Numbers	If you are applying this to a drawing column, this option lets you avoid having decimal points.
Add Key Exposure After	Inserts a key exposure on the frame following the last cell of the selection.

## Fill Exposure Using Render Changes Dialog Box

The Fill Exposure Using Render Changes dialog box lets you detect if a threshold of changes has occurred between two consecutive images and then expose the affected textures for further processing. It can be used for example to change the texture on a characters shirt only when the shape of the shirt is changed significantly from the previous frame. This avoids unnecessary repetitive texture changes on every frame.

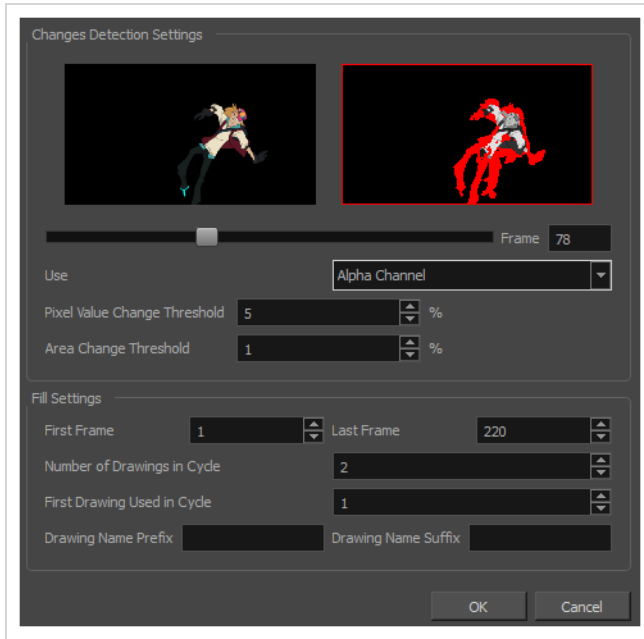

### How to access the Fill Exposure Using Render Changes dialog box

1. In the Timeline view, select the textures or live-action sequence.

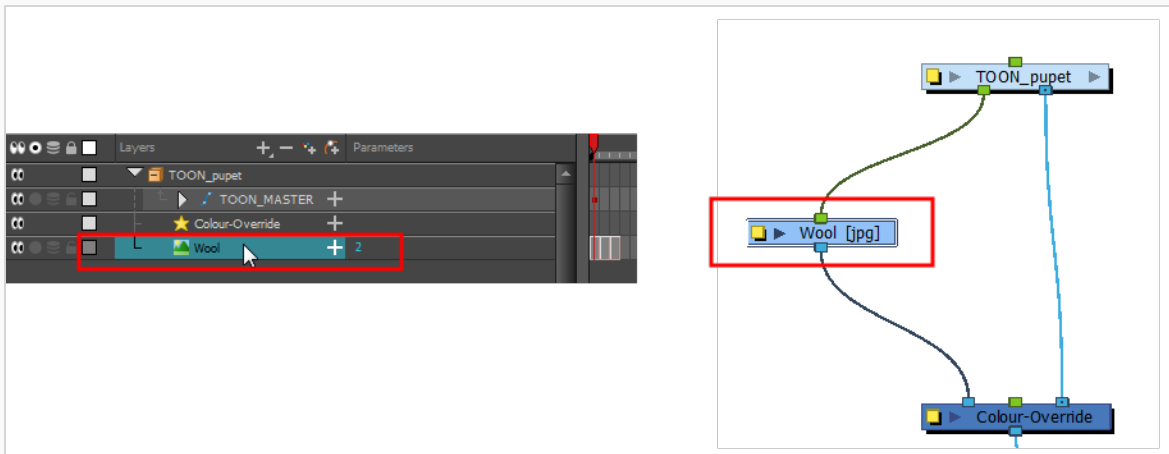

2. From the top menu, select **Scene > Default Display > desired Display node**.
3. From the top menu, select **Animation > Exposure Fill > Using Render Change**.

Wait while Harmony creates a low resolution render of the images to preview.

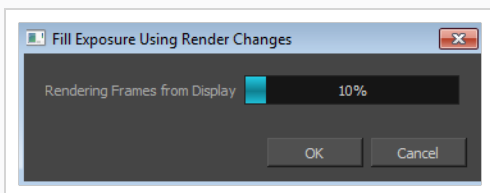

4. In the Fill Exposure Using Render Changes window, use the Frame slider to view the motion change analysis.
5. Based on your style preference, adjust the parameters to assign when the texture exposure changes will occur. You can adjust the type of filter to use for the motion detection, as well as threshold values to indicate what will be considered a big enough motion variation for an exposure change.

Parameter	Description
Changes Detection Settings	<b>Frame:</b> Use the slider to see when a change is necessary. A red edge indicates there is a large enough motion for the texture to change.
	<b>Use:</b> Lets you use either the Red, Green, Blue, or Alpha channel, or Luminance difference between frames to analyze the motion changes. The Alpha channel is selected by default as it is the most commonly used parameter.
	<b>Pixel Value Change Threshold:</b> The percentage of change in a pixel to be considered different from one frame to another. The higher the value, the more change is required when comparing two images in order for a new texture to be used.
	<b>Area Change Threshold:</b> The percentage of non-empty pixels that must change from one frame to another to be considered different.
Fill Settings	These settings let you change the exposure. You can also decide on how many images you want to cycle.
	<b>First/Last Frame:</b> Lets you set the first and last frame for the exposure change. You can set this for the entire scene or for part of the scene (frames 20 to 32 for example).
	<b>Number of Drawings in Cycle:</b> Lets you set of the number of drawings to include in the cycle.

	<p><b>First Drawing Used in Cycle:</b> Lets you set the first drawing used in the cycle. Your drawings must be named using numeric values only, or number values with a prefix or suffix. It cannot only be letters.</p>
	<p><b>Drawing Name Prefix:</b> Adds a prefix before the number. For example, texture_01, texture_02 and so on.</p>
	<p><b>Drawing Name Suffix:</b> Adds a suffix after the number. For example, 01_texture, 02_texture and so on.</p>

## Fill Selection Dialog Box

The Fill Selection dialog box lets you fill the same value over an entire selection. The selection can be over one cell, a cell range in one column, a cell range over many columns, an entire column, or many columns. You can use numbers, words, letters, or any alphanumeric value.

### How to access the Fill Selection dialog box

1. In the Timeline or Xsheet view, select a cell range.

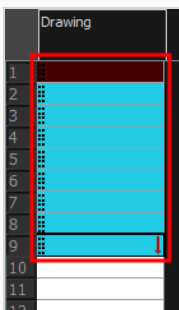

1. Do one of the following:
  - From the top menu, select **Animation > Cell > Fill Selection**.
  - In the Xsheet toolbar, click the Fill Selection  button. Note that you may have to add this button to your toolbar by right-clicking on it and selecting **Customize**.
  - Press **Ctrl + T** (Windows/Linux) or **⌘ + T** (macOS).

The Fill Selection dialog box opens.

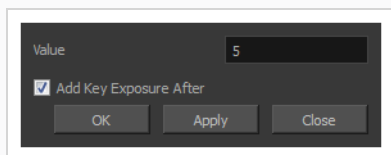

Parameter	Description
Value	This is the value to be used in the filled selection.
Add Key Exposure After	Inserts a key exposure on the frame following the last cell of the selection.

## Import 3D Models Dialog Box

Use the Import 3D Models dialog box to import 3D models into Harmony.

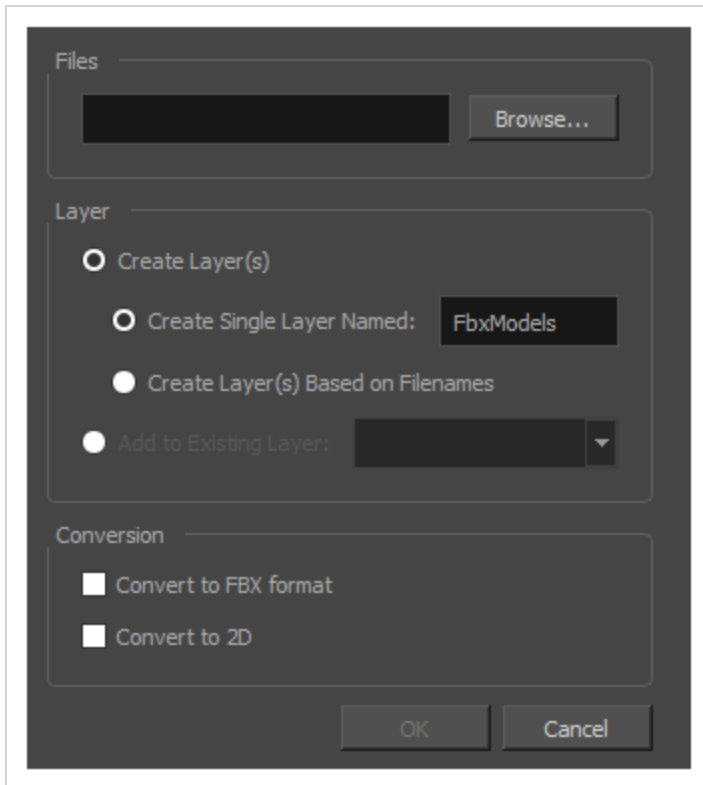

### How to open the Import 3D Models dialog box

1. From the top menu, select **File > Import > 3D Models**.

The Import 3D Models dialog box opens.

Parameter	Description
Files	
Browse	Lets you locate and select 3D model file formats from a location on your computer or a location accessible from your computer (network, server, etc.).
Layer	
Create Layers(s)	This option is selected by default. A new layer will be created for the selected 3D model files for the import. You have two choices:

Create Single Layer Named	Creates a new layer for your 3D model that you can name. Name the new layer immediately by entering a name into the provided field.
Create Layer(s) Based on Filenames	Creates a layer based on each unique filename prefix. For example, the filenames a-1.obj, a-2.obj and b-1.obj will create layers named "a" and "b", where "a" has two 3D models and "b" has one. When creating a single layer from these three filenames, all three models will be imported to the new layer.
Add to Existing Layer	Imports the selected files to an existing layer in the scene. Once this option is selected the adjacent drop-down list becomes active. Select an existing layer name from the drop-down list. Note that if you select a vector layer, it will encapsulate the 3D model inside a symbol.
Conversion	
Convert to FBX format	Check this option if your file isn't already a Filmbox (.fbx) file and you would like it to be. This format incorporates all associated files, such as the texture files.
Convert to 2D	Check this option if you want to render the 3D model into a 2D image and import it into a bitmap layer instead of as a 3D object. You will be prompted to select the position and angle from which to render the 3D model, as well as to apply geometrical transformations to it before rendering it—see <a href="#">Render 3D Model Dialog Box</a> on page 148.

# Import Images Dialog Box

T-HFND-007-011

The Import Images dialog box lets you import bitmap images and vectorize them, making the images editable. Then you can use a variety of drawing tools to edit the image. Or you can always keep the original bitmap image as is.

Also, you can choose to import bitmap images on bitmap or vector layers depending on your project..

## How to open the Import Images dialog box

1. Do one of the following:

- From the top menu, select **File > Import > Images**.
- In the File toolbar, click the Import Images  button.
- In the Xsheet view, right-click anywhere in the frame area and select **Import > Images**.

The Import Images dialog box opens.

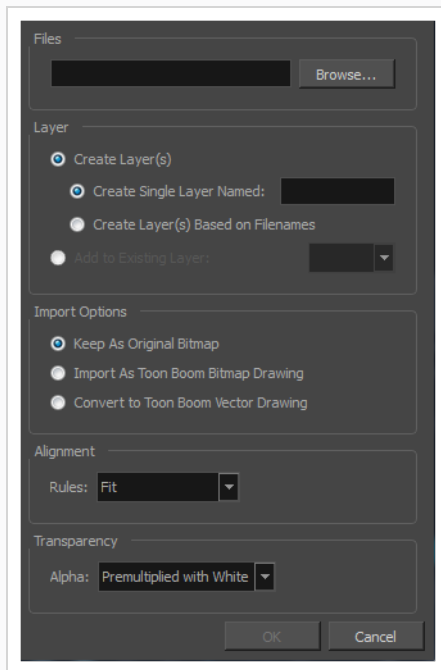

Parameter	Description
Files	



Browse	Lets you find and select images on your computer.
Layer	
Create Layers(s)	Create layers for imported images.
Create Single Layer Named	Creates a new layer with the specified name and imports the images into it.
Create Layer(s) Based on Filenames	Creates a layer based on each unique filename prefix. For example, if you import three files named a-1.tga, a-2.tga and b-1.tga, this will create two layers, one named "a" and one named "b". Layer "a" will contain the two first images and "b" will contain the third one.
Add to Existing Layer	Imports the images into the specified layer. Note that you can only import into layers that are compatible with your import options. For example, if you're importing images as vector drawings, you can only import them into vector drawing layers.
Import Options	Depending on how you choose to import images, the Alignment section offers different options.
Keep as Original Bitmap	Retains an imported image as a bitmap. In the Alignment section, decide on the size and placement of your image within the camera frame. Depending on the Scene Settings (the height and width in pixels that you chose for your project), an image that you import may get scaled to the point where all its individual pixels become visible.
Import as Toon Boom Bitmap Drawing	Imports a drawing into a vector layer where you can edit the image using the drawing tools.
Convert to Toon Boom Vector Drawing	Imports a drawing and converts it to a Toon Boom vector drawing.
Alignment (Keep As Original Bitmap)	
Rules	<p><b>Fit:</b></p> <p>Adjusts the image's size to fit completely within the scene's field, both vertically and horizontally, making sure the entire image is visible.</p> <p>If the image's orientation is portrait, then it will adjust the image's height to fit the</p>

field's height, without affecting the image's aspect ratio:

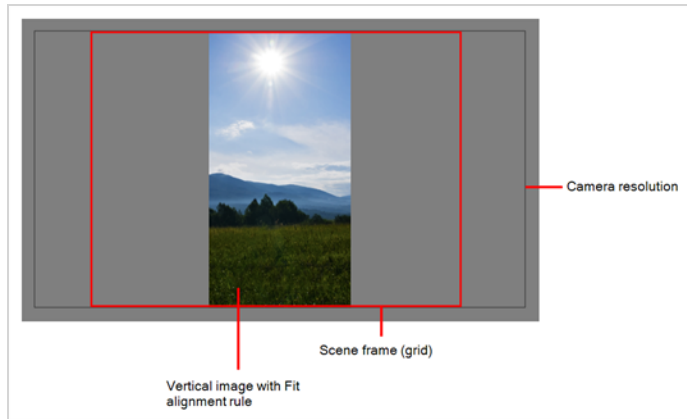

If the image orientation is landscape, then it will adjust the image's width to fit the field's width, without affecting the image's aspect ratio:

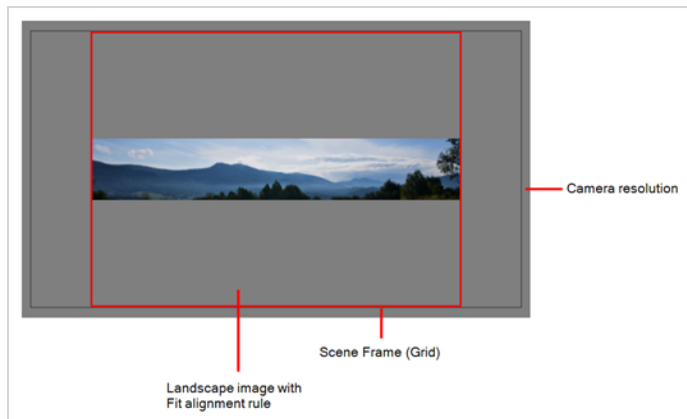

**Pan:**

This has the opposite effect to the fit parameter. The image's smallest dimension will be made to fit the scene frame's matching dimension, and the image's largest dimension will be adjusted proportionally, making the image fill the entire scene field, and bleed past its boundaries if its aspect ratio does not match the field's aspect ratio. This option can be used to import a panning background image, also referred to as a pan.

If the image's orientation is portrait, it will adjust the image's width to fit the field's width, without affecting its aspect ratio:

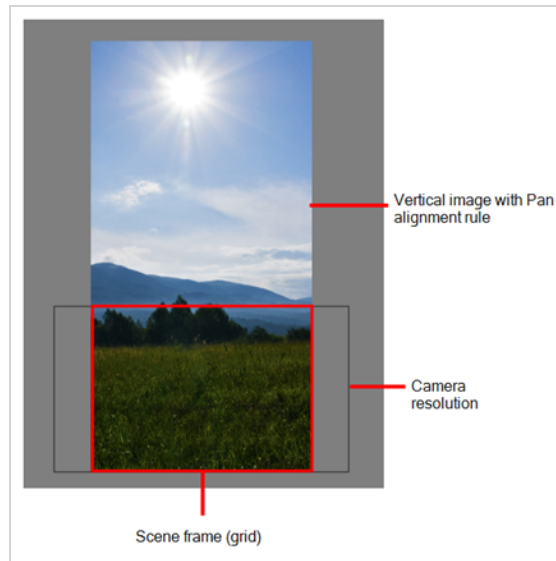

If the image's orientation is landscape, it will adjust the image's height to fit the field's height, without affecting its aspect ratio:

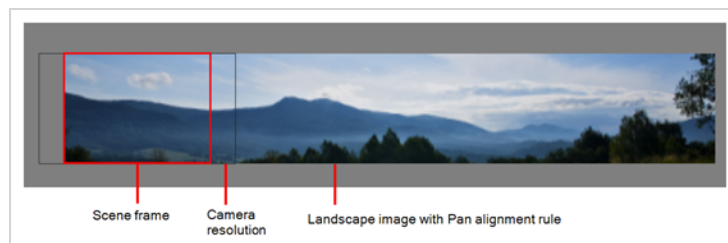

This has the opposite effect to the fit parameter. The image's smallest dimension will be made to fit the scene frame's matching dimension, and the image's largest dimension will be adjusted proportionally, making the image fill the entire scene field, and bleed past its boundaries if its aspect ratio does not match the field's aspect ratio. This option can be used to import a panning background image, also referred to as a pan.

If the image's orientation is portrait, it will adjust the image's width to fit the field's width, without affecting its aspect ratio:

**Project Resolution:** Scales the image to fit the scene's resolution, making each pixel in the image take one pixel in the scene's field. For example, if the image's dimensions in pixels are half of the scene's resolution in pixels, then the image's dimensions will appear to be half of the scene field's dimensions.

Alignment (Import as Toon Boom Bitmap Drawing)

Rules

**Horizontal Fit:**

Adjusts the image's size so that its width matches the scene's width, without affecting its aspect ratio.

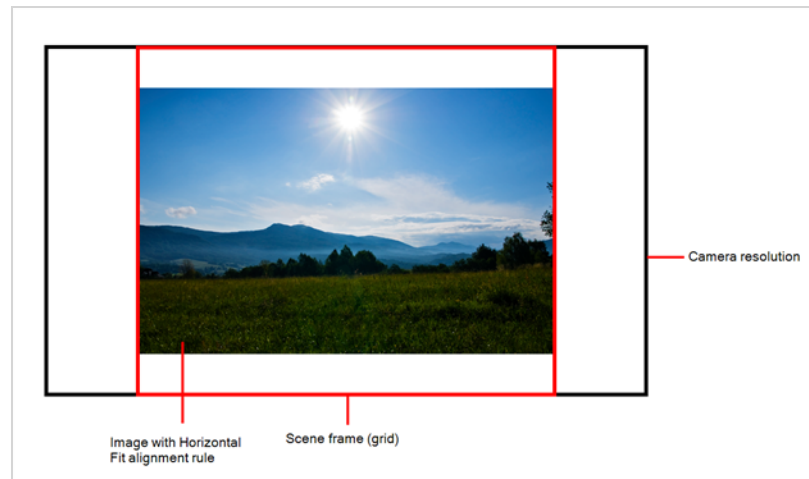

**Vertical Fit:**

Adjusts the image's size so that its height matches the scene's height, without affecting its aspect ratio.

This has the opposite effect to the fit parameter. The image's smallest dimension will be made to fit the scene frame's matching dimension, and the image's largest dimension will be adjusted proportionally, making the image fill the entire scene field, and bleed past its boundaries if its aspect ratio does not match the field's aspect ratio. This

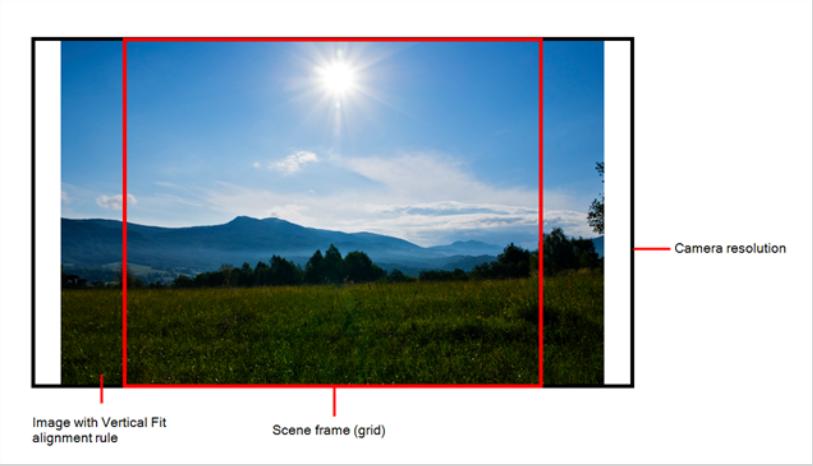
	 <p><b>Actual Size:</b> Imports the image in its actual size, without adjusting its size relative to the scene's resolution. For example, if the image's dimensions in pixels are half of the scene's resolution in pixels, then the image's dimensions will appear to be half of the scene field's dimensions.</p>
<p>Transparency</p>	
<p>Alpha</p>	<p><b>Premultiplied with White:</b> Individual pixels at the edge of an image are blended with white.</p> <p><b>Premultiplied with Black:</b> Pixels at the edge of an image are blended with black.</p> <p><b>Straight:</b> Pixels at the edge of an image are blended with black, white and greys.</p> <p><b>Clamp Colour to Alpha:</b> Premultiplies the colour value with the alpha value. When the colour is clamped to the alpha, the colour value cannot be higher than the alpha value. It calculates the real colour value faster. When the RGB values are multiplied with the alpha value, that is to say, if you have a pixel of value R=247, G=188, B=29 and the alpha is 50% or the image has a 50% transparency, then the actual RGB values that are output would be half of the amounts listed above.</p>
<p>Vectorization</p>	
<p>Black and White</p>	<p>Vectorizes drawings with a solid black line. This creates a 100% vector-based drawing and paints it with the Vectorized Line colour swatch from your scene's palette.</p>
<p>Grey</p>	<p>Vectorizes the image as a mix of vector contour and greyscale bitmap filling. Lines keep the texture from the scan, and the white of the paper becomes transparent.</p>

New Preset	Lets you create a new preset.
Delete Preset	Lets you delete any preset in the list.
Edit Preset	Lets you edit the vectorization parameters for the selected preset.

## Interpolation Grid Wizard Dialog Box

T-HSCP-003-006

The Interpolation Grid dialog box allows you to create a 2D point Master Controller which can be used to position a character model based on a grid of poses.

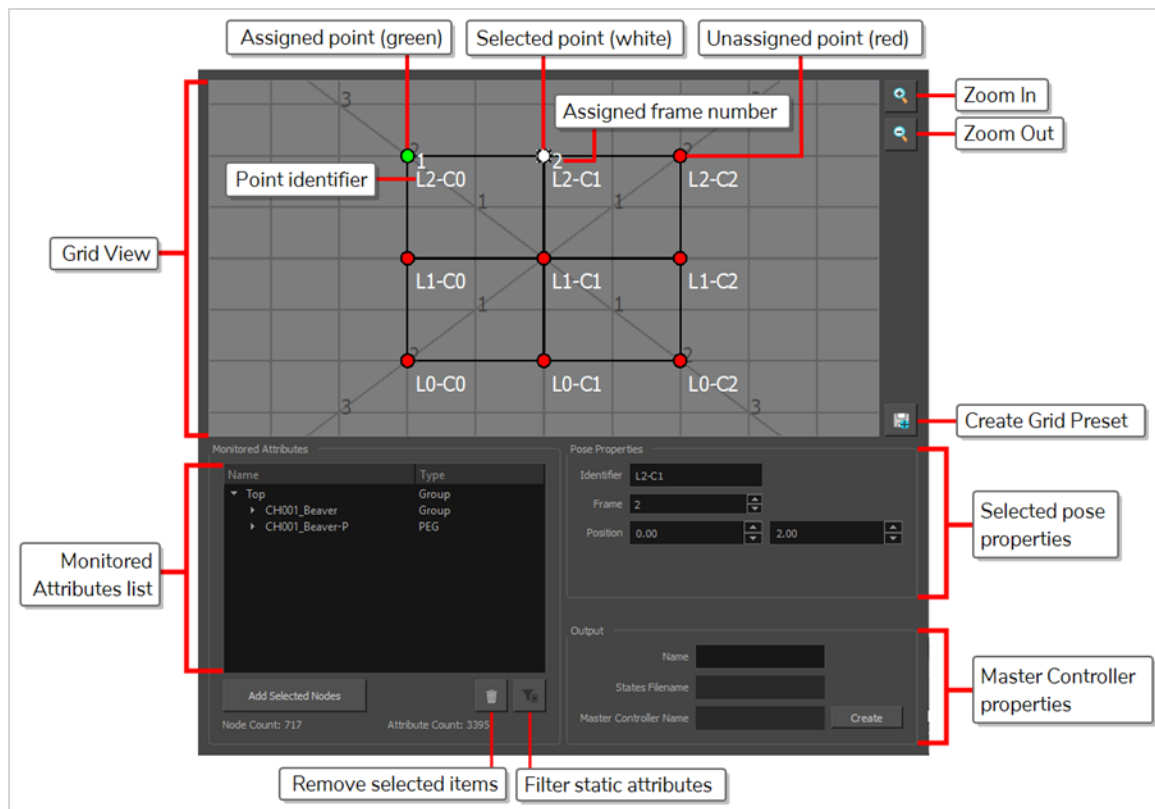

To use the Interpolation Wizard, you must first create enough poses to make a grid of poses. For example, key poses of a character's head looking in every direction can be laid out in a grid:

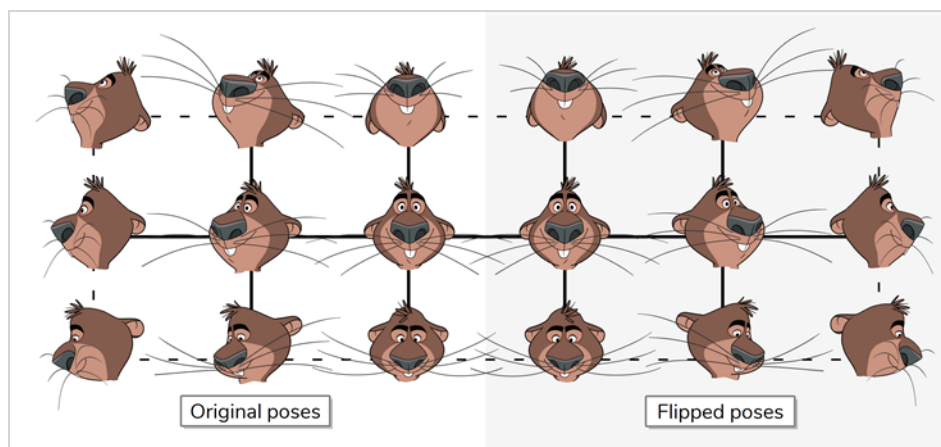

Once you've done that, you need to select the layers and/or groups you want your Master Controller to control which, in this case, would be all the layers making the character's head. Then, you can open the Interpolation Grid Wizard.

The Wizard will start out by displaying the Grid Parameters dialog, in which you can specify the vertical and horizontal size of your grid in the **Key Poses** fields.

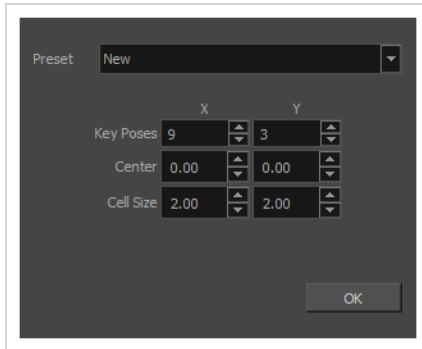

Optionally, you can also select its centre point and the size of its cells in the **Center** and **Cell size** fields. The coordinates used for the center position and cell size are based on a 4:3, 12 fields traditional animation grid. You display one over your character as a reference by adding a Grid node to your scene—see [Grid Node](#)

Then, the Interpolation Grid dialog will generate a grid with the specified size in the specified position and with the specified cell size. Each point in the grid will be represented by a **red** dot. You must select each of these dots and associate them with the frame number containing the pose you want the point to represent. Once a point is associated to a pose, it becomes **green**.

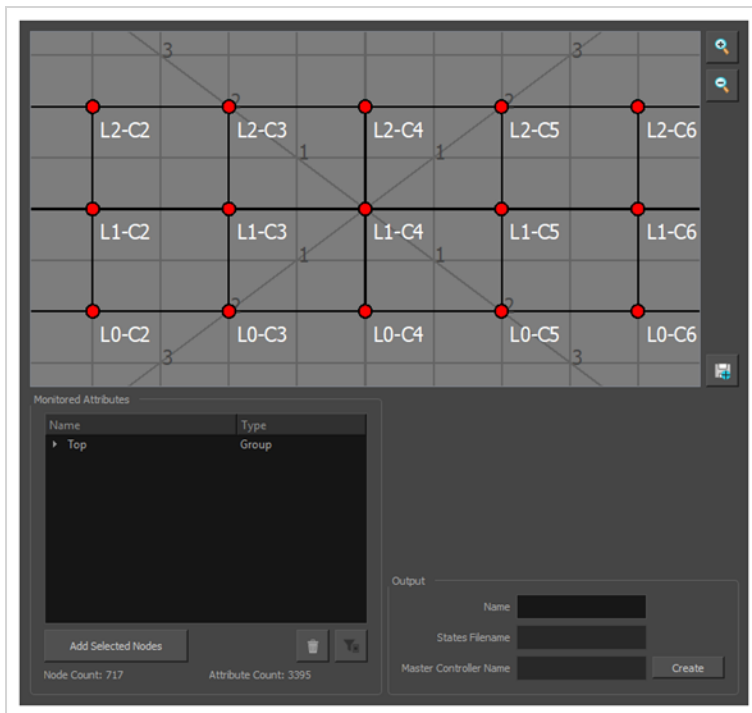

When you click on **Create**, this grid of poses will be stored in a pose database and a 2D point Master Controller will be created. This Master Controller will use this pose database to change your character's pose when you move the 2D point around in the Camera view.



## How to access the Interpolation Grid Wizard

1. Do one of the following to add the Master Controller toolbar to your workspace:

- Right-click on an existing toolbar and select **Master Controller**.
- In the top menu, select **Windows > Toolbars > Master Controller**.

The Master Controller toolbar appears.

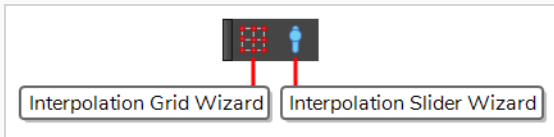

1. In the Timeline view, select the layers and groups you want your Master Controller to control.



### NOTE



If you select a group, all of the layers inside it will be added to the list of layers your Master Controller will control.



2. In the Master Controller toolbar, click on the  Interpolation Grid Wizard button.

## Grid Parameters Dialog Parameters

Parameter	Description
Preset	Allows you to select and load a grid preset you previously created. If you have not created any, you can ignore this drop-down and set up a new grid in the fields below.
Key Poses	The numbers of columns and rows to create the Interpolation Grid with. The product of these two amounts is the amount of poses you will need to provide to the Interpolation Grid Wizard.
Center	The coordinates of the centre of the Interpolation Grid, relative to the centre of the scene, in horizontal and vertical fields.
Cell Size	The size of each cell in the Interpolation Grid, in horizontal and vertical fields.
OK	Dismisses the Grid Parameters dialog box and creates the grid with the selected parameters in the Interpolation Grid dialog box, so that you can start configuring the points in the grid.

## Interpolation Grid Dialog Parameters

Icon	Parameter	Description
<b>Grid</b>		
	Grid View	<p>Displays the Interpolation Grid.</p> <p>Each point in the grid is represented by a coloured dot:</p> <ul style="list-style-type: none"> <li>• Red dots are dots that need to be assigned to a pose (frame number).</li> <li>• Green dots are dots that are already assigned to a pose (frame number).</li> </ul> <p>You must fill each point in the grid with poses, until they are all green, before you can create your Master Controller.</p> <p>To fill a point, simply click on it to select it. This will make the Select Frame dialog appear, in which you can type in the frame number to associate the point to.</p> <p>Selecting a point makes the <b>State Properties</b> section of the dialog appear. In this section, you can change the identifier and the frame number of the point, and you can also modify its position in the grid.</p> <p>The grid is laid out over a standard 12 fields 4:3 animation grid. This grid is the same grid that displays in the Camera view if you add a Grid node to your scene. Hence, by adding a Grid node to your scene, you can use it as a reference to align the interpolation grid with specific areas in the scene.</p> <p>You can pan around the grid view by clicking and dragging on it.</p>
	Zoom In	Zooms into the grid view.
	Zoom Out	Zooms out of the grid view.
	Save Preset	<p>Saves the current grid and all of its properties as a grid preset. This allows you to quickly reload the current grid's size, its centre point, its cell size, as well as each point's assigned frame and other properties into the Interpolation Grid Wizard later, when you want to create another 2D point widget. This can be very useful if you create several character models in different scenes, with the same poses at the same frames.</p> <p>You can select a grid preset to use in the Grid Parameters dialog that</p>

Icon	Parameter	Description
		appears when you open the Interpolation Grid Wizard.
<b>Monitored Attributes</b>		
	Attribute List	<p>The list of nodes (ie: layers, pegs, deformation points, etc.) that will be affected by the Master Controller. If you expand any of the listed nodes, you will find the list of attributes (ie: position, angle, scale, etc.)</p> <p>The list is structured in a group/node/attributes hierarchy, with Top representing the root of your scene. By expanding a group, you will find all of the nodes inside that group. By expanding a node, you will find all of its attributes.</p>
	Add Selected Nodes	<p>If you first select groups nodes in the Timeline or Node view, you can click on this button to add these nodes' attributes to the Monitored Attributes list. This allows you to add more nodes to the list of nodes that will be controlled by the Master Controller.</p> <p>If you select a group, this button will add the group as well as every node inside that group to the Monitored Attributes list.</p>
	Remove Selected Items	<p>Removes the groups, nodes or attributes that are currently selected in the Monitored Attributes list from the Monitored Attributes list. This allows you to remove nodes from the list of nodes that will be controlled by the Master Controller.</p> <p>If you select a group, this button will remove the group as well as every node inside that group from the Monitored Attributes list.</p> <p>If you select specific attributes in a node, this button will only remove these attributes from the Monitored Attributes list, and will leave the other attributes in the list. This allows you to make the Master Controller only control specific attributes for a node and ignore others.</p>
	Filter Static Attributes	Remove every attribute that does not change across any of the poses added to the grid. This will optimize the performance of the Master Controller as well as reduce the amount of storage space it uses without impacting its functionality.

Icon	Parameter	Description
		<div style="border: 1px solid #c8e6c9; padding: 10px;">  <p><b>NOTE</b> This option can only be used once you have filled your entire grid with poses.</p> </div>
	Node Count	The amount of nodes (layers, pegs, deformation points, etc.) that will be controlled by the Master Controller.
	Attribute Count	The amount of attributes (position, angle, scale, etc.) that will be controlled by the Master Controller.
<b>Pose Properties</b>		
	Identifier	Allows you to type in a custom label for the currently selected point.
	Frame	Allows you to view and update the frame number (pose) associated with the currently selected point.
	Position	<p>Allows you to update the position of the selected point on the grid, in horizontal and vertical field coordinates.</p> <p>By default, all points in the grid are created to be at an equal distance from one another. By using these fields to edit the position of points, you can make a fully customized grid.</p>
<b>Output</b>		
	Name	Allows you to enter the name for the Master Controller node that will be created at the end of the process.
	States Filename	<p>Displays the name of the corresponding states file name, based on the Master Controller node name.</p> <p>The attribute values of the associated poses are recorded in an external file. When the Master Controller node is created, the matching states file is created.</p>
	Master Controller Name	Displays the complete Master Controller node name including the <b>mc_</b> prefix.

Icon	Parameter	Description
	Create	Generate the Master Controller and its database of poses.

## Interpolation Slider Wizard Dialog Box

The Interpolation Slider dialog allows you to generate a Slider Master Controller which can be used to position a character model based on a range of two or more key poses.

To use the Interpolation Slider Wizard, all you need to do is to provide it with a selection of layers and/or groups (ie: a character rig, or part of a character rig) as well as a range of frames. The Interpolation Slider dialog will store all the poses for the selected layers in the selected range of frames in a file, and generate a Slider widget which, when manipulated by the user, is scripted to apply one of these poses, or an intermediary between two of these poses, onto these layers.

A good example of how this dialog can be used is by creating poses of your characters in key angles (ie: front, 3/4 front, side, 3/4 back and back, as well as the flipped versions of these angles), and creating a slider made to interpolate between all these poses. If done properly, and provided that all the poses provided can be interpolated, the result will be a slider widget that can be used to pose the character in any angle.

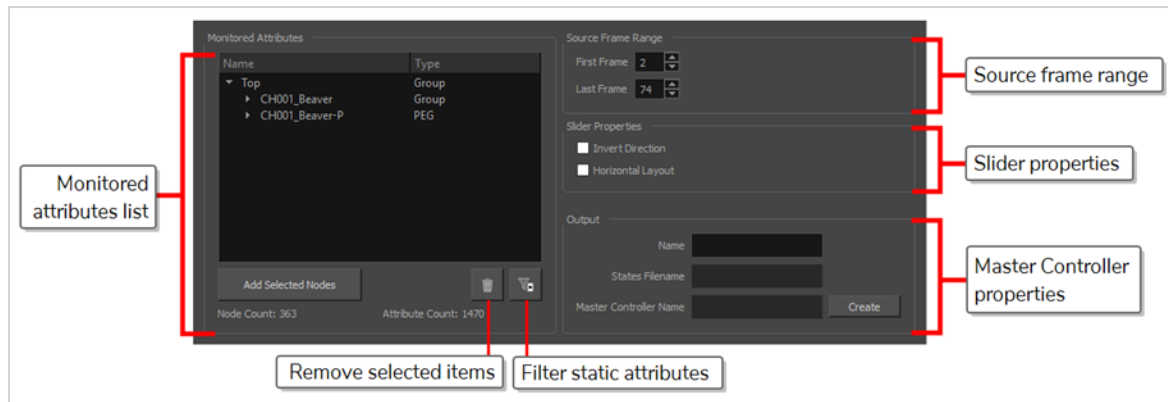



### How to access the Interpolation Slider Wizard

1. Do one of the following to add the Master Controller toolbar to your workspace:
  - Right-click on an existing toolbar and select **Master Controller**.
  - In the top menu, select **Windows > Toolbars > Master Controller**.

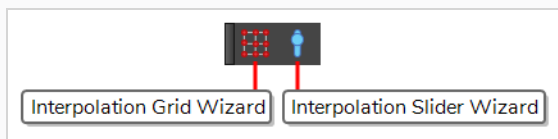
The Master Controller toolbar appears.



1. In the Timeline view, select a range of frames.
2. In the Master Controller toolbar, click on the  Interpolation Slider Wizard button.

Icon	Parameter	Description
<b>Source Frame Range</b>		
	First Frame	The frame number of the first frame in the selection.
	Last Frame	The frame number of the last frame in the selection.
<b>Slider Properties</b>		
	Invert Direction	By default, the slider will interpolate from the first pose to the last pose by sliding the handle from bottom to top, or from left to right if the Horizontal Layout option is checked. If this option is checked, the slider will interpolate from the first pose to the last pose by sliding the handle from the top to the bottom, or from right to left.
	Horizontal Layout	By default, the slider will slide on a vertical axis. If this option is checked, it will slide on a horizontal axis.
<b>Monitored Attributes</b>		
	Attribute List	<p>The list of nodes (ie: layers, pegs, deformation points, etc.) that will be affected by the Master Controller. If you expand any of the listed nodes, you will find the list of attributes (ie: position, angle, scale, etc.)</p> <p>The list is structured in a group/node/attributes hierarchy, with Top representing the root of your scene. By expanding a group, you will find all of the nodes inside that group. By expanding a node, you will find all of its attributes.</p>
	Add Selected Nodes	<p>If you first select groups nodes in the Timeline or Node view, you can click on this button to add these nodes' attributes to the Monitored Attributes list. This allows you to add more nodes to the list of nodes that will be controlled by the Master Controller.</p> <p>If you select a group, this button will add the group as well as every node inside that group to the Monitored Attributes list.</p>
	Remove Selected Items	<p>Removes the groups, nodes or attributes that are currently selected in the Monitored Attributes list from the Monitored Attributes list. This allows you to remove nodes from the list of nodes that will be controlled by the Master Controller.</p>

Icon	Parameter	Description
		<p>If you select a group, this button will remove the group as well as every node inside that group from the Monitored Attributes list.</p> <p>If you select specific attributes in a node, this button will only remove these attributes from the Monitored Attributes list, and will leave the other attributes in the list. This allows you to make the Master Controller only control specific attributes for a node and ignore others.</p>
	Filter Static Attributes	Remove every attribute that does not change during the selected frame range. This will optimize the performance of the Master Controller as well as reduce the amount of storage space it uses without impacting its functionality.
	Node Count	The amount of nodes (layers, pegs, deformation points, etc.) that will be controlled by the Master Controller.
	Attribute Count	The amount of attributes (position, angle, scale, etc.) that will be controlled by the Master Controller.
<b>Output</b>		
	Name	Allows you to type in a base name for your Master Controller.
	States Filename	Displays the path and name of the file where the poses database will for the Master Controller will be stored. This path is relative to the scene directory.
	Master Controller Name	Displays the name of the Master Controller node that will be added to your scene. This is the name of your Master Controller the prefix <b>mc_</b> .
	Create	Generate the Master Controller and its database of poses.



## Manage Local Cache Dialog Box

The Manage Local Cache dialog box displays a list of all the Harmony Server scenes for which you have cached drawings. In this dialog, you can check if the drawings you have in a scene's cache match the drawings in the database server, you can delete unused caches and you can change the directory in which scene data is cached.

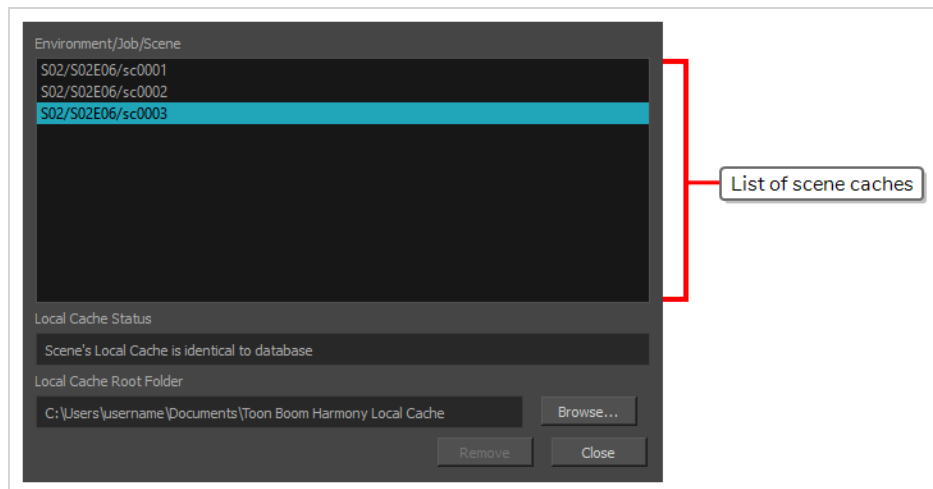

### NOTE



A scene's data is cached on your computer when you check the **Cache scene assets locally** option in the Database Selector before opening the scene—see [Database Selector Dialog Box](#) on page 55.

### How to access the Manage Local Cache dialog box

1. In the top menu, select **File > Manage Local Caches**.

The Manage Local Caches dialog appears.

Parameter	Description
List of scene caches	<p>The list of caches stored on your computer. There is one item for each scene for which there is cached data. Each item is identified by the scene's environment, followed by its job, then its name, in this format:</p> <p style="text-align: center;">Environment/Job/Scene</p> <p>If you select a scene cache in the list, the Manage Local Caches dialog will compare the drawings that are cached on your computer to the drawings in the actual scene in the database, and report if they are identical or not in the <b>Local Cache Status</b> field.</p>
Local Cache	If you select a cache, the Manage Local Cache dialog will analyze whether the data in the selected

Parameter	Description
Status	<p>cache matches the data in the actual scene in the Harmony Server database.</p> <p>If it displays <b>Scene's Local Cache is identical to the database</b>, then the drawings in the selected cache on your computer are identical to the drawings in the corresponding scene in the database, meaning that your cache and that the database are up to date.</p> <p>If it displays <b>Scene's Local Cache is different than database</b>, then some drawings in the selected cache on your computer are different from the drawings in the corresponding scene in the database. This usually means one of the following:</p> <ul style="list-style-type: none"> <li>• If the selected cache is the cache of the currently opened scene and you just saved your scene, Harmony may still be uploading the updated drawings to the database. In this case, you can close the dialog, wait a few seconds, and reopen it to see if Harmony is done uploading the drawings. If it is, it will report that the cache is identical to the database.</li> <li>• If this is not the cache of the currently opened scene, it is likely that the database scene has been changed by someone else since the last time you opened it. That would mean that the database version is more up to date than your cache. This is not a problem, as next time you open the scene, your cache will be updated.</li> </ul>
Local Cache Root Folder	Indicates where scene caches are stored on your computer. By default, scene caches are stored in a folder named Toon Boom Harmony Local Cache, inside your Documents folder.
Browse	<p>Allows you to change the folder where caches are downloaded when you open a scene.</p> <div data-bbox="378 1136 1430 1335" style="border: 1px solid #c8e6c9; padding: 10px;"> <p> <b>NOTE</b></p> <p>The caches that are currently stored on your machine will not be moved to their new location. Hence, when you change the local cache root folder, the list of scene caches will become empty until you open a scene.</p> </div>
Remove	<p>Deletes the selected scene cache from your computer.</p> <div data-bbox="378 1457 1430 1625" style="border: 1px solid #c8e6c9; padding: 10px;"> <p> <b>NOTE</b></p> <p>This button is greyed out if the selected scene cache is for the currently opened scene, as this cache is currently in use by Harmony.</p> </div>
Close	Closes the dialog.

## Manage Tool Presets Dialog Box

The Tool Presets window lets you create new tool presets and manage them.

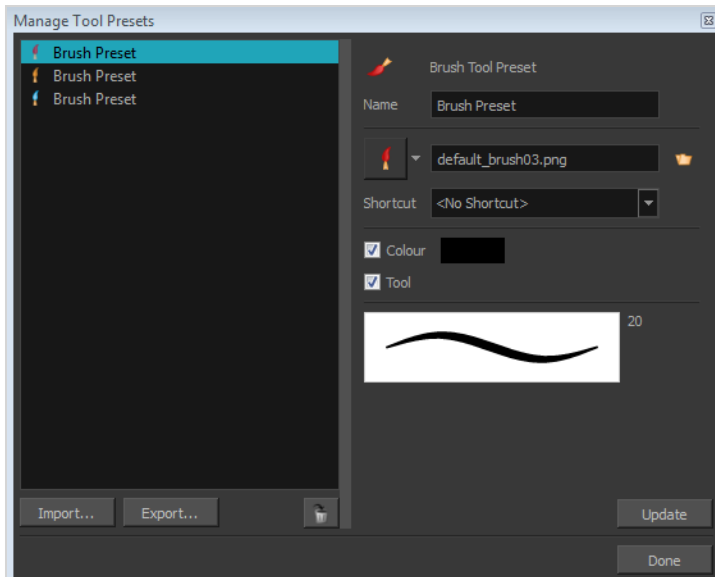

### How to access the Manage Tool Presets window

1. Do one of the following:
  - From the top menu, select **Windows > Toolbars > Tool Presets**.
  - Right-click an empty area below the top menu and select **Tool Presets**.

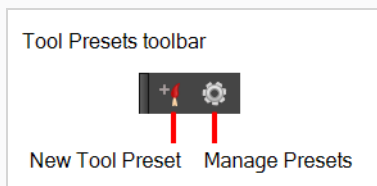

2. In the Tool Presets toolbar, click the Manage Presets button.

Parameter	Description
Icon	Lets you select a preset to manage.
Import	Lets you import an existing preset.
Export	Lets you export a preset for use in other projects.

Delete	Removes the preset from the list of tool presets.
Name	Lets you change the name of the preset.
Icon list	Lets you select an icon for the preset.
Folder icon	Lets you select an image for the preset.
Shortcut	Lets you assign a keyboard shortcut to the new preset.
Colour	Saves the current colour into the tool preset.
Tool	If you disable this option, only the colour will be associated. You could, for example, set three different colours with shortcuts not associated with any tool. The colour preset would then work on any selected tool. Selecting the brush tool was only a vehicle to get into the New Tool Preset dialog box.
Update	After adjusting the settings for a preset, the current properties are applied to the presets, as well as any other changes you made in the Manage Tool Presets window.

## Marker Colour Dialog Box

The Marker Colour dialog box lets you set the colour of scene markers that are displayed at the top of the Timeline view (in the frame counter area). Using colours for scene markers helps to differentiate them visually, making them easy to identify in the Timeline view.

You can select a colour by choosing from a basic set of colours, using the colour wheel or by specifying the HSV or RGB values. Once you have selected a colour, you can adjust its intensity and save it as a custom colour that you can reuse.

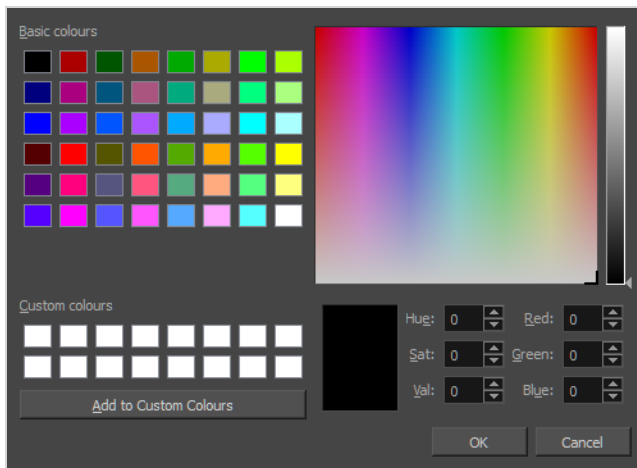

### How to access the Marker Colour dialog box

1. In the frame counter area of the Timeline view, select a frame range to mark.

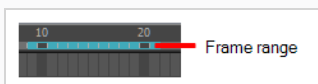

2. Right-click and select **Create Scene Marker**.

The Timeline Scene Marker dialog box opens. The Colour box displays a black colour swatch, or the colour of the last scene marker you created.

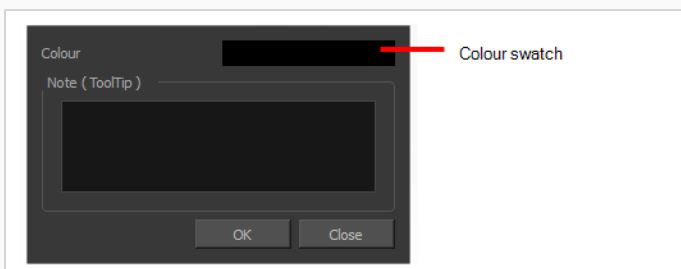

3. Click the colour swatch.

The Marker Colour dialog box opens.

<b>Parameter</b>	<b>Description</b>
Basic colours	A basic set of colours to choose from.
Custom colours	Displays the custom colours you previously stored using the Add to Custom Colours button.
Add to custom colours	Lets you add the selected colour to the Custom colours list above.
Colour wheel	Lets you select a colour by dragging the T-shaped pointer.
Value slider	Once you select a colour, you can drag the slider to change the intensity and see it previewed in the Colour Preview window below..
Colour Preview	Displays the colour you are currently selecting. To apply the colour, click OK.
Hue, Saturation, Value	Lets you set the hue (colour), saturation (amount of colour) and brightness (value) of the colour.
Red, Green, Blue	Lets you set the red, green and blue values.

## Mini Playback Dialog Box

The Mini Playback dialog box allows you to configure and start Mini Playback. Mini Playback allows you to quickly preview a short span of animation starting a few frames before the current frame and ending a few frames after the current frame, at a customizable frame rate.

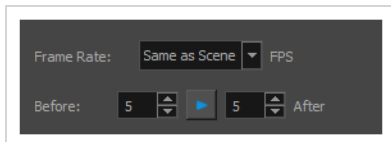

### How to access the Mini Playback dialog

1. Do one of the following:

- In the top menu, select **Play > Mini Playback**.
- In the Mini Playback toolbar, click on the  Mini Playback Dialog button.

Icon	Parameter	Description
	Frame Rate	The speed at which Mini Playback should play your animation. By default, it is set to <b>Same as Scene</b> to play at the same pace as your scene's frame rate. Otherwise, you can choose among a set of commonly used frame rates.
	Before	The amount of frames before the current frame at which to start Mini Playback.
	Play	Starts Mini Playback. Playback will start at the amount of frames in the <b>Before</b> field before the current frame, and end at the amount of frames in the <b>After</b> field after the current frame, at the frame rate in the <b>Frame Rate</b> drop-down.
	After	The amount of frames after the current frame at which to end Mini Playback.

## QuickTime Movie Settings Dialog Box

The Movie Settings dialog box lets you set the compression settings for the movie you will export.

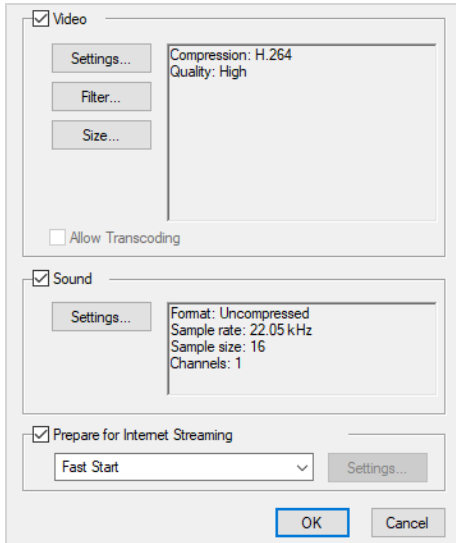

### NOTE

This dialog can only be accessed on Windows and macOS. On Windows, [Apple QuickTime](#) must be installed to be able to export QuickTime Movie (.mov) files.

### How to access the Movie Settings dialog box from the Export Movie dialog

1. From the top menu, select **File > Export > Movie**.  
The Export Movie dialog box opens.
2. Set Movie Format to **QuickTime Movie (\*.mov)**.
3. Click on the **Movie Settings** button.

### How to access the Movie Settings dialog box from the Write node Layer Properties

1. In the Node view, locate your scene's Write node.
2. Open the Write node's Layer Properties by doing one of the following:
  - Click on the yellow square at the left end of the Write node.



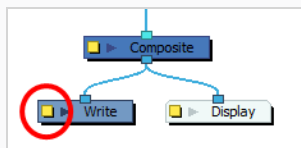

- Right-click on the Write node, then select **Layer Properties**.
3. In the Write node's Layer Properties, enable the **Movie** option.
    1. To the right of the Movie check box, open the drop down menu and select **QuickTime Movie (\*.mov)**.
    2. To the right of Movie Options, click on **Customize**.

Parameter	Description
Video	
Settings	Opens the Standard Video Compression Settings dialog box. This is where you can set the video compression settings for the movie you will export—see <a href="#">QuickTime Standard Video Compression Settings Dialog Box on page 187</a> .
Filter	Opens the Choose Video Filter dialog box, where you can select from a range of filters to apply to your video export.
Size	Opens the Export Size Settings dialog box. This dialog is available because of the way the Apple QuickTime interface is designed, but its settings are not taken in account by Harmony. The size of the exported video is determined by Harmony.
Sound	
Settings	Opens the Sound Settings dialog box. This is where you can you set the sound compression settings for the movie you will export—see <a href="#">QuickTime Sound Settings Dialog Box on page 185</a> .
Prepare for Internet Streaming	<p>If this option is enabled, the video will be optimized to start playing while it is downloading, as videos do in web browsers and web-based streaming applications.</p> <ul style="list-style-type: none"> <li>• <b>Fast Start:</b> The video plays as soon as enough data required to start playback has been downloaded.</li> <li>• <b>Fast Start - Compressed Header:</b> Same as Fast Start, except the header is compressed for an even faster start. Requires QuickTime 3.0 or later.</li> </ul>

	<ul style="list-style-type: none"><li>• <b>Hinted Streaming:</b> Allows you to optimize the movie file for streaming through QuickTime Server Software. Click on the Settings button to configure how hints are created in your movie file.</li></ul>
--	---

## New Scene Dialog Box

The New Scene window lets you create a new scene.

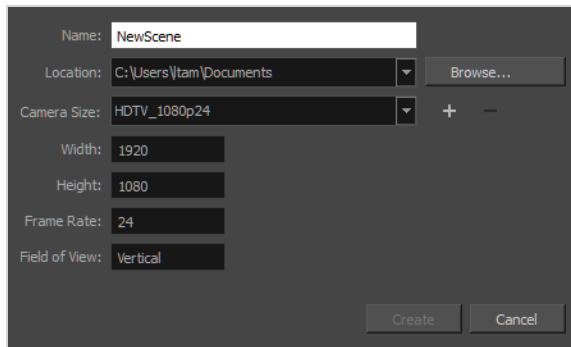

### How to access the New Scene window

- Do one of the following:
  - From the top menu, select **File > New**.
  - In the File toolbar, click the New  button.
  - Press Ctrl + N (Windows/Linux) or ⌘ + N (macOS).

The New Scene dialog box opens.

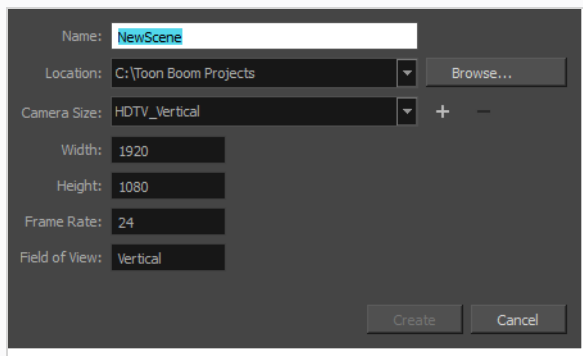

Parameter	Description
Name	Lets you type in a name for the new scene.
Location	Lists the locations you used most frequently for storing scenes.
Browse	Opens a browser in which you can specify a location for the new scene that is not listed in the Location list.

Camera Size	Opens a list of resolutions.
+ (Create Custom Resolution)	Opens the New Resolution window in which you can create a custom resolution that is added to the Camera Size list.
- (Delete Custom Resolution)	Lets you remove a custom resolution from the Camera Size list.
Width	Indicates the width of the resolution you chose from the Camera Size list.
Frame Rate	Indicates the frame rate of the resolution you chose from the Camera Size list.

## New Tool Preset Dialog Box

The New Tool Preset dialog box lets you create new tool presets and manage them.

Tool presets let you save a variety of settings and are very efficient for accessing the tools you use most often. That way, the tool is already set with the desired properties, such as colour, line thickness, whether to enable Draw Behind or Auto Flatten mode, and so on. You can create presets for these tools and many more: Brush, Pencil, Eraser, Rectangle, Ellipse, and Line.

The difference between a tool preset and a brush preset is that when you save a tool preset, you have the option of saving the colour and assigning a shortcut, which you cannot do with brush presets.

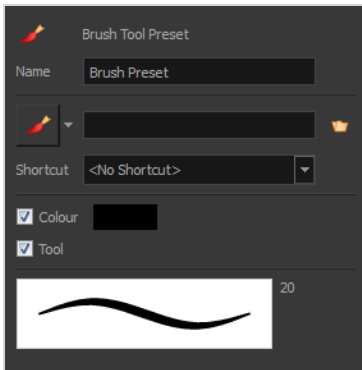

### How to access the New Tool Preset dialog box

1. Do one of the following:

- From the top menu, select **Windows > Toolbars > Tool Presets**.
- Right-click an empty area below the top menu and select **Tool Presets**.

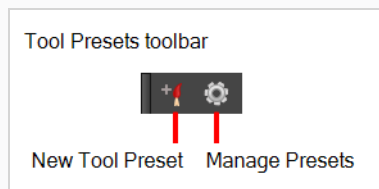

2. In the Tool Presets toolbar, click the New Tool Preset button.

Parameter	Description
Name	Lets you give the preset a meaningful name.
Icon list	Lets you select an icon for the preset.
Folder icon	Lets you select an image for the preset.

Shortcut	Lets you assign a keyboard shortcut to the preset.
Colour	Saves the current colour into the tool preset.
Tool	If you disable this option, only the colour will be associated. You could, for example, set three different colours with shortcuts not associated with any tool. The colour preset would then work on any selected tool. Selecting the brush tool was only a vehicle to get into the New Tool Preset dialog box.

## Onion Skin and Light Table Transparency Dialog Box

T-ANIMPA-006-009

This dialog box lets you adjust the Onion Skin and Light table transparency parameters.

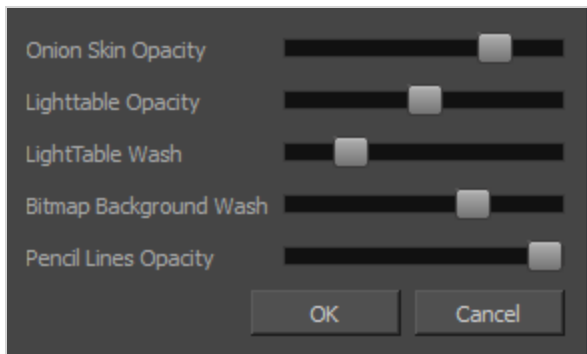

### How to access the Onion Skin and Light Table Transparency dialog box

- In the Drawing view toolbar, click on the Top Light  button to open the Onion Skin and Light Table Transparency dialog box.

Command	Description
Onion Skin Opacity	Sets the maximum opacity value for the onion skin opacity display. Moving the slider all the way to the left = 0% opacity. Moving the slider all the way to the right = 100% opacity.
Lighttable Opacity	Sets the maximum opacity value for the light table display. Moving the slider all the way to the left = 0% opacity. Moving the slider all the way to the right = 100% opacity.
LightTable Wash	Sets the washed-out value for the light table display. Moving the slider all the way to the left = 0% opacity. Moving the slider all the way to the right = 100% opacity.
Bitmap Background Wash	Sets the maximum opacity value for the background wash. Moving the slider all the way to the left = 0% opacity. Moving the slider all the way to the right = 100% opacity. Only works for bitmap layers.
Pencil Lines Opacity	Sets the maximum opacity value for central vector lines (lines made by the Pencil or Shape tools). Moving the slider all the way to the left = 0% opacity. Moving the slider all the way to the right = 100% opacity.

## Palette Browser Dialog Box

The Palette Browser dialog allows you to decide the level of palette list and palette storage to use when you want to create, clone, link to or import a palette.

This dialog only appears if you have the Advanced Palette Lists preference enabled, which is disabled by default. When Advanced Palette Lists mode is disabled, Harmony automatically stores palettes in a scene's palette list, inside the scene's **palette-library** subdirectory.

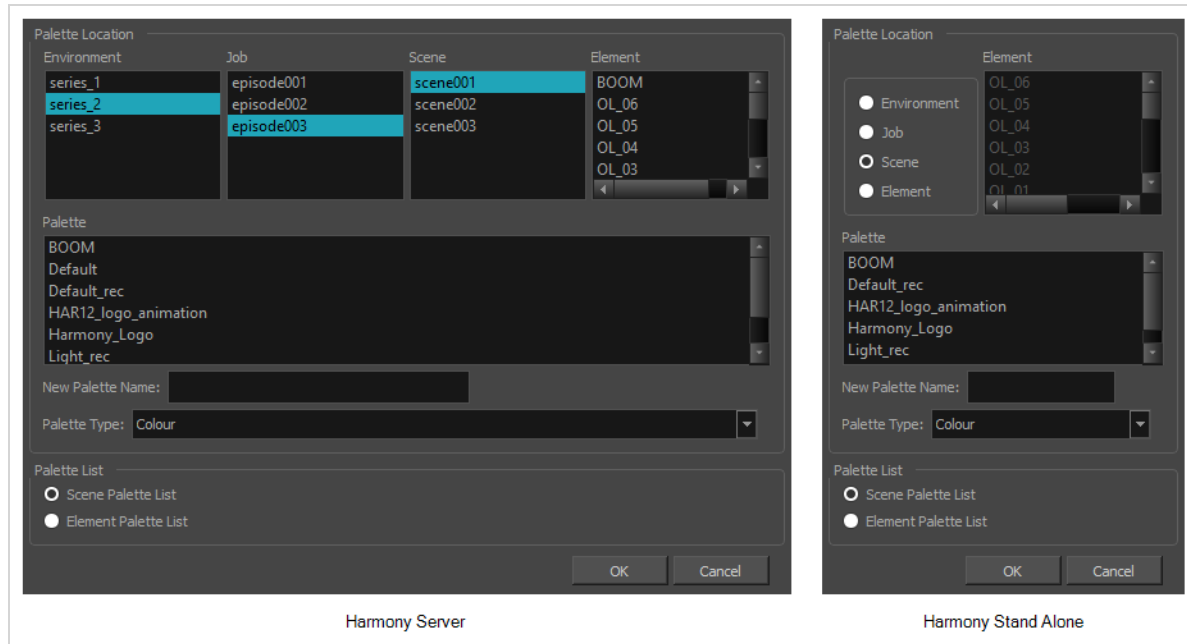

### How to access the Palette Browser dialog box

1. Start Harmony and log in.
  2. Close the Database Selector dialog box.
  3. From the top menu, select **Tools > Palette Operations**.
1. In the Palette Operations dialog box that opens, select the palette you want to clone at the location and level in which it was stored.
  2. Click **Clone**.

Parameter	Description
Palette Location	<p>This allows you to browse for the physical location of the palette file in your database.</p> <p>If you are using Harmony Stand Alone, you can still select the scene's own job or</p>



	<p>environment as a location. Stand alone scenes have a provisional job and environment storage space inside the scene's directory. The files in these storage spaces can be imported into a database scene's actual job and environment when importing the scene to a Harmony database. If you never intend to use Harmony Server, you should keep your palettes inside your scene or element's palette libraries.</p>
Environment	<p>Stores the palette file in the selected environment's palette library. Environments are typically used to contain a whole production, series or feature film.</p> <ul style="list-style-type: none"> <li>• In Harmony Server, this stores the palette in <code>/USA_DB/environments/[environment name]/palette-library</code>.</li> <li>• In Harmony Stand Alone, this stores the palette inside the scene's directory, under <code>environments/Digital/palette-library</code>.</li> </ul>
Job	<p>Stores the palette file in the selected job's palette library. Jobs are typically used to contain episodes in a series, or any set of scenes that is intended to be put in the same sequence.</p> <ul style="list-style-type: none"> <li>• In Harmony Server <code>/USA_DB/jobs/[job name]/palette-library</code>.</li> <li>• In Harmony Stand Alone, this stores the palette inside the scene's directory, under <code>jobs/Digital/palette-library</code>.</li> </ul>
Scene	<p>Stores the palette file in the selected scene's palette library, which is the <b>palette-library</b> subdirectory of the scene's directory.</p>
Element	<p>Stores the palette file inside the selected element's palette library. This library is located inside the scene's directory, under <code>elements/[element name]/palette-library</code>.</p>
Palette	<p>This lists the existing palettes in the selected location.</p>
New Palette Name	<p>If you are creating or cloning a palette, use this field to enter the palette file's name. The palette will be listed under this name in your palette list. On your file system, it will be named after its palette name, followed by the extension <code>.plt</code>.</p>
Palette Type	<p>When creating a palette, you can choose between the following palette types:</p> <ul style="list-style-type: none"> <li>• <b>Colour:</b> A colour palette can contain colours, gradients and bitmap textures.</li> <li>• <b>Pencil Texture:</b> A pencil texture palette can contain textures to apply as transparency filters to pencil lines, in combination to their line colour, to create various styles of pencil lines.</li> </ul>

Palette List	This allows you to decide if you want the palette to be added to your scene's palette list, or to the currently selected element's palette list.
Scene Palette List	Adds the palette to the scene's palette list. Palettes in the scene's palette list are available to all the elements in your scene. This is especially useful if you are doing digital animation, where character models can be made of many layers that need to use the same palette.
Element Palette List	Adds the palette to the currently selected element's palette list. Palettes in an element's palette list can only be used by the drawings in this element, and will only be listed in the Colour view when this element is selected. This can be useful if you are doing traditional animation, where each character is usually drawn on a single layer, and you want each layer to have its own palette.

## Palette Operations Dialog Box

When you start Toon Boom Harmony connected to the database, you can access the Palette Operations dialog box which lets you clone, rename, or delete palettes in your database, without having to open a scene or browse the database's file system in your operating system's shell.

In Harmony, palettes are individual \*.plt files that can be copied, transferred and stored. When a palette is created from Harmony, it needs to be stored somewhere. By default, the palette file is stored in the scene directory in a palette-library folder unless you specify a different location.

There are four locations where you can find palette-library folders: Element, Scene, Job and Environment.

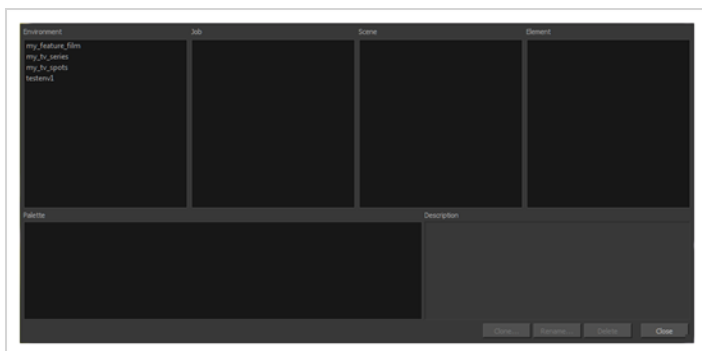

### How to access the Palette Operations dialog box

1. Start Harmony and log in.
2. Close the Database Selector dialog box.
3. From the top menu, select **Tools > Palette Operations**.

Parameter	Description
Environment	The production, project, feature film or series.
Job	The episode and sequence from each environment.
Scene	The scenes from each job.
Element	The layers and columns in each scene.
Palette	The scene palettes.

Description	Notes, if any, of the project.
Clone	Opens the Palette Browser dialog box from which you can select the level in which to store the palette file.
Rename	Lets you rename a palette.
Delete	Lets you delete a palette. <div data-bbox="565 562 1430 730" style="border: 1px solid #c8e6c9; padding: 10px;"> <b>NOTE</b> It is not recommended to disable the warning message that appears when you are attempting to delete a palette as this operation cannot be undone.</div>
Close	Closes the Palette Operations dialog box.

## Paste Preset Dialog Box

When pasting key frames and exposures, you can modify the existing presets to your liking. There are three presets you can modify: the default presets for both key frames and exposures, key frames only and exposures only.

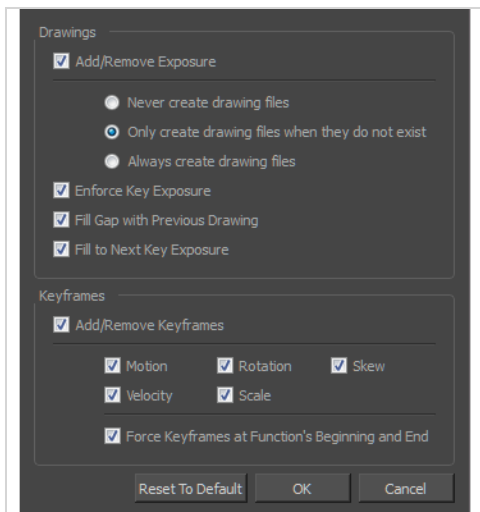

Parameter	Description
Drawings	
Add/Remove Exposure	<b>Never create drawing files:</b> When adding exposures to a drawing layer, drawing files will not be created.
	<b>Only create drawing files when they do not exist:</b> When adding exposures to a drawing layer, new drawings will be created only when drawings with the same name do not already exist in the destination.
	<b>Always create drawing files:</b> When adding exposures to a drawing layer, new drawings will always be created. If drawing files with the same name already exist, Harmony will create a new name for the drawing.
Enforce Key Exposure	If there are key exposures that exist on copied drawings, they are preserved when pasting. No key exposures are added. This is the default behavior when pasting.
Fill Gap with Previous Drawing	Fills selected area in the Xsheet or Timeline view with the previous drawing.
Fill to Next Key Exposure	Fills selected area till the next key exposure.

Keyframes	
Add/Remove Keyframes	<b>Motion:</b> Copies the properties of the selected motion keyframe to the new frame.
	<b>Velocity:</b> Copies the properties of the selected velocity keyframe to the new frame.
	<b>Rotation:</b> Copies the properties of the selected rotation keyframe to the new frame.
	<b>Scale:</b> Copies the properties of the selected scale keyframe to the new frame.
	<b>Skew:</b> Copies the properties of the selected skew keyframe to the new frame.
	<b>Force Keyframes at Function's Beginning and End:</b> Adds a keyframe to the beginning and end of the pasted function, reproducing the source function.

## Paste Special Dialog Box

The Paste Special dialog box lets you determine how templates and symbols are imported in the Timeline view.

When you import a template in the Timeline view, all layers are created as well as drawings and keyframes. You can choose to import only the keyframes without the drawings or import only the drawings that are not already in your layers. You can adjust the behaviour using the Paste Special dialog box. When you import a symbol in your scene, its full length is exposed by default. If you import a symbol in the Timeline view's left side, all the frames will be exposed. However, if you import it into an existing layer, you can use the Paste Special dialog box to adjust the import behaviour to fit your requirements. Once you set the parameters, Harmony will reuse them each time you import a symbol in the Timeline view's right side until you set new parameters.

### How to access the Paste Special dialog box

1. In the Library view, select the symbol or template to import.
2. Do one of the following:
  - While holding down the Alt key, click and drag on the template, then drop it on the Timeline view, over the layer and at the frame where you want to paste it.
  - Press Ctrl + C (Windows/Linux) or ⌘ + C (macOS). Then, in the Timeline view, click on the frame where you want to paste the template and press Ctrl + B (Windows/Linux) or ⌘ + B (macOS)

The Paste Special dialog box opens.

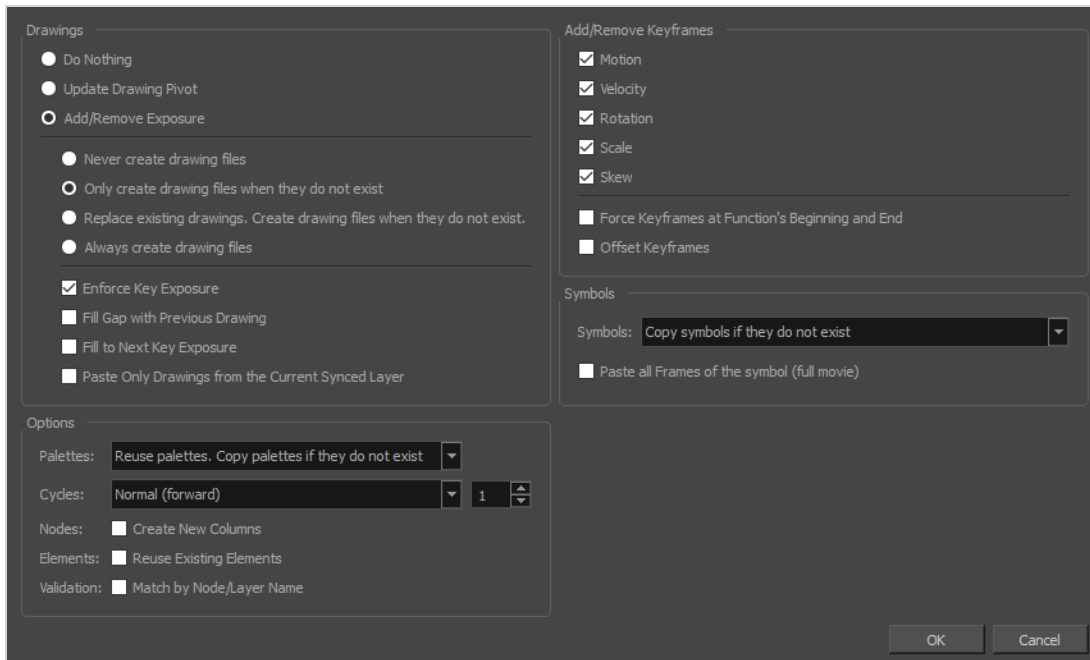

Parameter	Description
Drawings	
Do Nothing	Does not create or overwrite drawings.
Update Drawing Pivot	Revises the drawing pivot in the destination to use the same drawing pivot as the first drawing in the template. If you have a range of drawings selected in the destination, the pivot points of all selected drawings will be updated.
Add/Remove Exposure	<p><b>Never create drawing files:</b> When adding exposures to a drawing layer, drawing files will not be created.</p>
	<p><b>Only create drawing files when they do not exist:</b> When adding exposures to a drawing layer, new drawings will be created only when drawings with the same name do not already exist in the destination.</p>
	<p><b>Replace existing drawings. Create drawing files when they do not exist:</b> Replace drawings with the same names to update a scene with new modified drawings and preserve the animation.</p> <p><b>Tip:</b> If you don't want to lose the existing animation when pasting a template, such as when placing new drawings after the animation, then delete the template's animation. It will still have updated the drawings but not override the existing animation.</p>
	<p><b>Always create drawing files:</b> When adding exposures to a drawing layer, new drawings will always be created. If drawing files with the same name already exist, Harmony will create a new name for the drawing.</p>
	<p><b>Enforce Key Exposure:</b> If there are key exposures that exist on copied drawings, they are preserved when pasting. No key exposures are added. This is the default behavior when pasting.</p>
	<p><b>Fill Gap with Previous Drawing:</b> Fills selected area in the Xsheet or Timeline view with the previous drawing.</p>
	<p><b>Fill to Next Key Exposure:</b> Fills selected area till the next key exposure.</p>
	<p><b>Paste all frames of the symbol (full movie):</b> When enabled, the Paste Special command exposes all the symbol's frames instead of only the first one.</p>



Symbols	
Copy symbols if they do not exist	This is the default setting for this operation and will prevent Symbols in an Action template from being copied.
Duplicate symbols	Creates a duplicate of the symbol instead of linking the Symbol instance to the original one. The new Symbol is created in the Library.
Paste all Frames of the symbol (full movie)	When enabled, the Paste Special command exposes all the symbol's frames instead of only the first one.
Add Remove/Keyframes	
Motion	Copies the properties of the selected motion keyframe to the new frame.
Velocity	Copies the properties of the selected velocity keyframe to the new frame.
Rotation	Copies the properties of the selected rotation keyframe to the new frame.
Scale	Copies the properties of the selected scale keyframe to the new frame.
Skew	Copies the properties of the selected skew keyframe to the new frame.
Force Keyframes at Function's Beginning and End	Adds a keyframe to the beginning and end of the pasted function, reproducing the source function.
Offset Keyframes	When pasting functions, offsets keyframes from the function's last frame value by the values in the pasted function. This will continue the progression of a function instead of repeating the values.
Options	
Palettes	<p><b>Do nothing:</b> Does not create, overwrite, merge or link palettes.</p> <p><b>Reuse palettes. Copy palettes if they do not exist:</b> Palettes in the destination drawings are left as they are.</p> <p><b>Copy and overwrite existing palettes:</b> Overwrites destination palettes with the palettes from the source drawings.</p>

	<p><b>Copy and create new palette files:</b> Creates new palette files, placing them at the same relative environment and scene level as the source. If the palettes in the templates were stored at the environment level of the source scene, the paste operation will place the palettes in the environment level of the destination scene.</p> <p><b>Copy and create new palette files in element folder:</b> Creates new palette files in the element folders of the destination scene, rather than in the same relative job or environment.</p> <p><b>Copy palette and merge colours. Add new colours only:</b> Adds new colours to the destination palettes and ignores colours that are the same in the two palettes.</p> <p><b>Copy palettes and update existing colours:</b> Adds new colours to the destination palette and updates duplicate colours in the destination with colour values from the source.</p> <p><b>Link to original palettes (colour model):</b> Links the colour palettes in the destination scene to the palettes in the source. Use this to link drawings to the palettes in a colour model.</p> <p><b>Copy scene palettes and merge colours. Add new colours only:</b> Adds new colours to the destination scene palettes and ignores colours that are the same in the two palettes.</p> <p><b>Copy scene palettes and update existing colours:</b> Adds new colours to the destination scene palette and updates duplicate colours in the destination with the colour values from the source.</p>
<p>Cycles</p>	<p><b>Normal (forward):</b> Pastes your selection as is, starting with the first cell and ending with the last.</p> <p><b>Reverse:</b> Pastes your selection in reverse, starting with the last cell and ending with the first.</p> <p><b>Forward &gt; Reverse:</b> Pastes your selection as a yo-yo, starting with the first cell, going to the last one and ending with the first cell.</p> <p><b>Reverse &gt; Forward:</b> Pastes your selection as a reverse yo-yo, starting with the last cell, going to the first one and ending with the last cell.</p>
<p>Nodes</p>	<p><b>Create New Columns:</b> A new column is created when you copy and paste nodes from the Node view or layer in the Timeline view. If the layers are linked to function curves, the function curves, drawings and timing will be duplicated.</p>
<p>Elements</p>	<p><b>Reuse existing elements:</b> Lets you paste existing elements without creating new ones. This should be used only when pasting within versions of the same scene.</p>
<p>Validation</p>	<p><b>Match by Node/Layer Name:</b> When pasting a template with a hierarchy onto another hierarchy, this option looks to match the pasting elements with the same layer or node name, rather than the same hierarchical structure. This means that</p>

	<p>even if the two hierarchies are different, a new pose of a character's body part will still be pasted on the correct body part layer, as long as both layers are named the same.</p>
--	---

# Pose Copier Dialog Box

T-RIG3-007-007

The pose copier contains many buttons and other information to facilitate the insertion of poses in the animation.

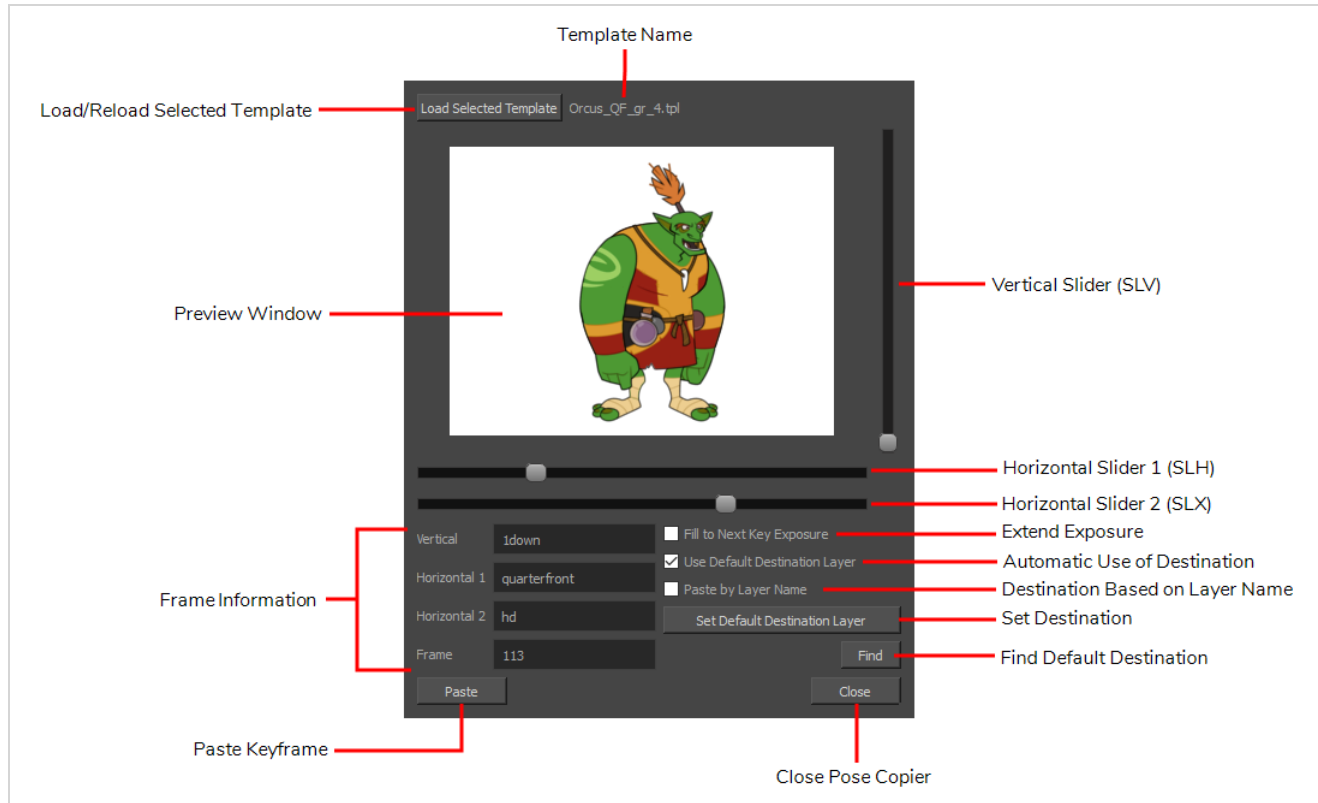

Parameter	Description
Preview Window	Based on master template's generated thumbnails, previews currently selected frames.
Load Selected Template	Updates the template with the newly selected template.
Template Name	Name of the currently selected template.
Vertical Slider (SLV)	Linked to the slv- node of the node system.
Horizontal Slider 1 (SLH)	Linked to the slh- node of the node system. Default slider for the pose copier if no guide layers are created.

Horizontal Slider 2 (SLX)	Linked to the slx- node of the node system.
Fill to Next Key Exposure	Having this option checked will automatically extend the exposure of the pasted frame up to the next key.
Use Default Destination Module	When enabled, the pasted keys will automatically refer to the destination defined in the option Set Default Destination Module.
Paste by Layer Name	When this option is checked the pasted layers will look for the individual layer name instead of matching the hierarchy of the template.
Set Default Destination Module	Instead of selecting the destination every time, the layer set as default destination will automatically paste the keys onto those layers.
Find	This will center on the default destination in the timeline.
Paste	Paste the current position of the pose copier onto the destination.
Vertical	Currently selected frame on the vertical slider. (based on frame name in slv-node)
Horizontal 1	Currently selected frame on the horizontal slider 1. (based on frame name in slh-node)
Horizontal 2	Currently selected frame on the horizontal slider 2. (based on frame name in slx-node)
Frame	Frame number of the selected frame within the master template.

## Preferences Dialog Box

The Preferences dialog box lets you adjust preferences to suit your work style, allowing you to work more efficiently.



### NOTE

To learn more about the individual preferences, refer to the Preferences guide.

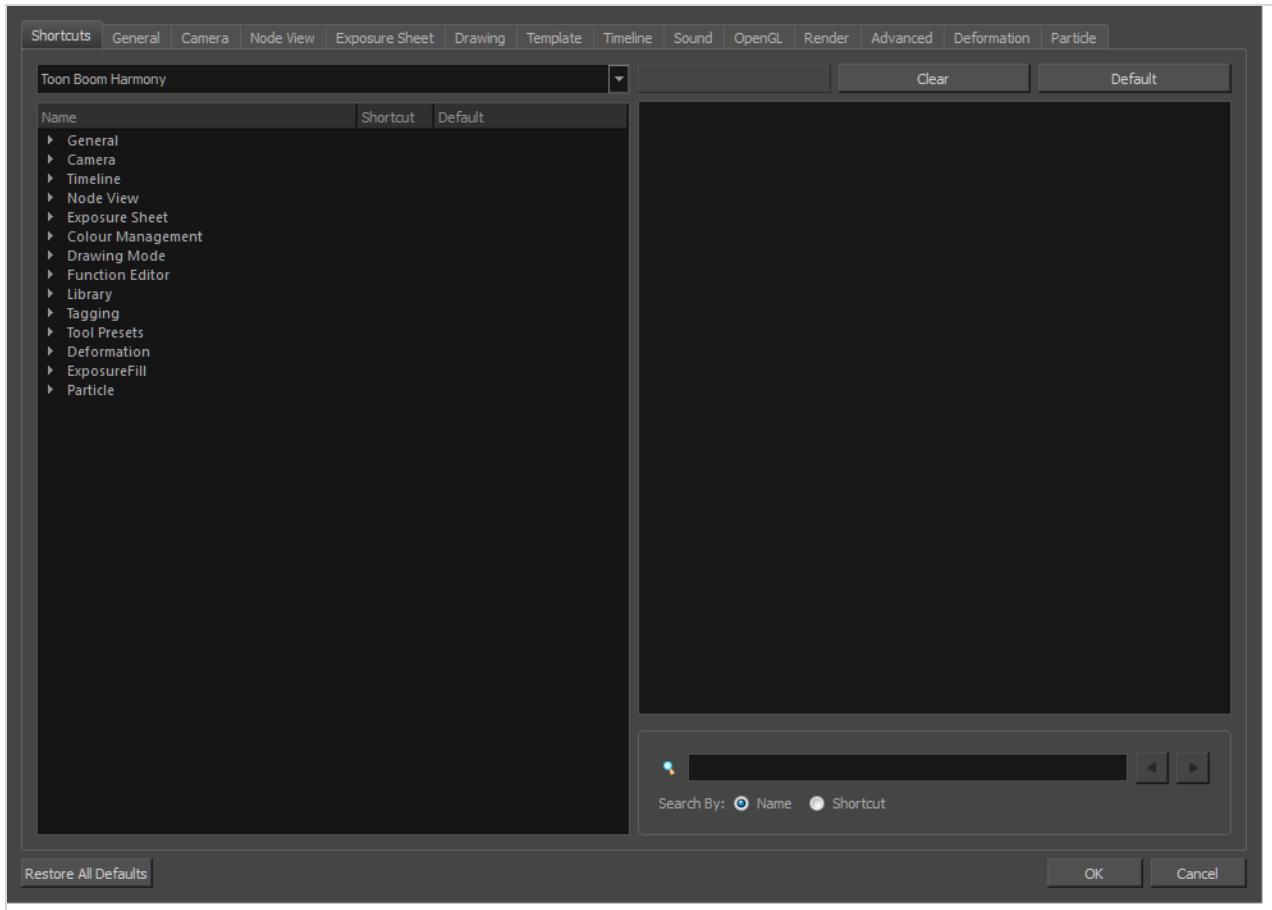

### NOTE

Some preferences require you to exit and restart the application, or close a view and reopen it.

### How to access the Preferences dialog box

Do one of the following:

- Select **Edit > Preferences** (Windows/Linux) or **Harmony Premium > Preferences** (macOS).
- Press **Ctrl + U** (Windows/Linux) or **⌘ + U** (macOS).

## Recolour Drawings Dialog Box

The Recolour Drawing dialog box allows you to replace all instances of a colour or texture in drawings with a different colour or texture swatch in one of the scene's palettes. This replaces the colours or textures in the drawings without requiring you to modify the palettes. You can use this dialog to perform colour replacement in the current drawing, in all the drawings in one or several layers or in all drawings in your scene.

This dialog will replace the colour or texture that is currently selected in the Colour view with the colour or texture that you select inside the dialog.

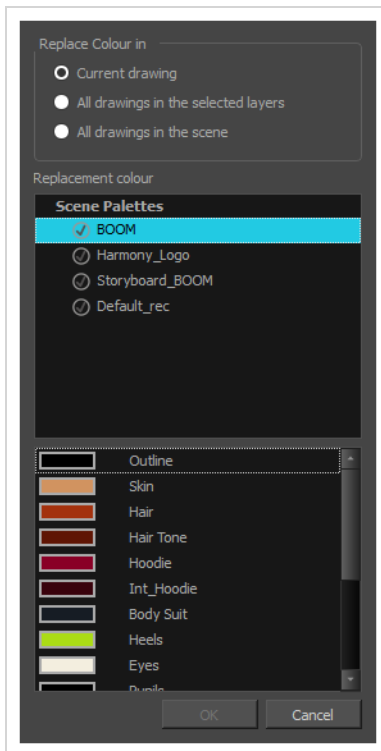

### How to access the Recolour Drawings dialog

1. In the Colour view, select the colour or texture swatch you want to replace by doing one of the following:
  - Select the palette in which the colour or texture swatch is located, then select the swatch you wish to replace.
  - If the drawing in the Camera or Drawing view contains the colour or texture you want to replace, select the Dropper  tool in the Tools toolbar, then click on that colour or texture in the drawing. The Colour view will automatically select that colour or texture's palette as well as that colour or texture's swatch.

2. Do one of the following:

- Right-click on the swatches list, then select **Recolour Drawings**.
- Open the Colour view menu , then select **Colours > Recolour Drawings**.

Parameter	Description
Replace Colour In	<p>Allows you to select which drawings will be affected by the colour replacement:</p> <ul style="list-style-type: none"> <li>• <b>Current drawing:</b> Replaces the selected colour in the currently selected drawing only.</li> <li>• <b>All drawings in the currently selected layers:</b> Replaces the selected colour in all the drawings in the layer that is currently selected in the Timeline, Xsheet or Node view.</li> </ul> <div data-bbox="643 793 1430 930" style="border: 1px solid #c8e6c9; padding: 10px; margin: 10px 0;">  <b>NOTE</b>  This option can work with several drawing layers selected. </div> <ul style="list-style-type: none"> <li>• <b>All drawings in the scene:</b> Replaces the selected colour in every drawing in the current scene.</li> </ul>
Replacement Colour	<p>Allows you to select the palette and colour or texture swatch to replace the selected colour or texture with.</p>



## Remove Dirt Dialog Box

The Remove Dirt dialog box lets you select small dots and hairs on a drawing for removal.

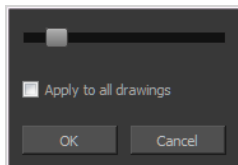

When paper drawings are passed through a scanner, there can be some hair and dirt scattered across them. These lines and dots need to be cleaned. Harmony provides different tools to help get rid of them quickly.

### How to access the Remove Dirt dialog box

1. Do one of the following:
  - From the top menu, select **Drawing > Clean Up > Remove Dirt**.
  - From the Camera or Drawing View menu, select **Drawing > Clean Up > Remove Dirt**.
  - Press Shift + D.

Parameter	Description
Slider	<p>Lets you adjust the amount of detail removed from the layer.</p> <p>Raising the Remove Dirt level will select bigger dots. When selecting larger dots, be careful not to lose small details like pupils and nostrils. Once you have chosen the level, you can apply it to the current drawing or the entire animation sequence. This is a quick way to get rid of most dirt and dust.</p> <p>During this process, the dirt that will be removed is highlighted in red.</p>
Apply to all drawings	Applies the operation to all drawings in the layer.

## Remove Hair Dialog Box

The Remove Hair dialog box lets you remove any small strokes created in the Colour Art layer from very thick lines or filled zones. Increasing the Remove Hair level value will select larger strokes for removal from the drawing.

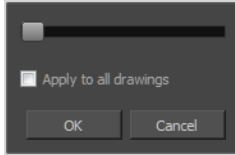

When paper drawings are passed through a scanner, there can be some hair and dirt scattered across them. These lines and dots need to be cleaned. Harmony provides different tools to help get rid of them quickly.

### How to access the Remove Hair dialog box

1. In the Timeline or Xsheet view, select the drawing containing the drawing to clean.
2. From the top menu, select **View > Show > Show Strokes** to display the invisible lines or press K.
3. In the top menu, select **Drawing > Clean Up > Remove Hair**.

Parameter	Description
Slider	Lets you adjust the number of length of hairs selected.
Apply to all drawings	Applies the operation to all drawings in the layer.

## Render 3D Model Dialog Box

The Render 3D Model dialog box allows you to render a 3D model into a 2D bitmap layer. In this dialog, you can pick the point of view and angle from which the model is rendered, as well as apply geometrical transformations to the model before rendering it.

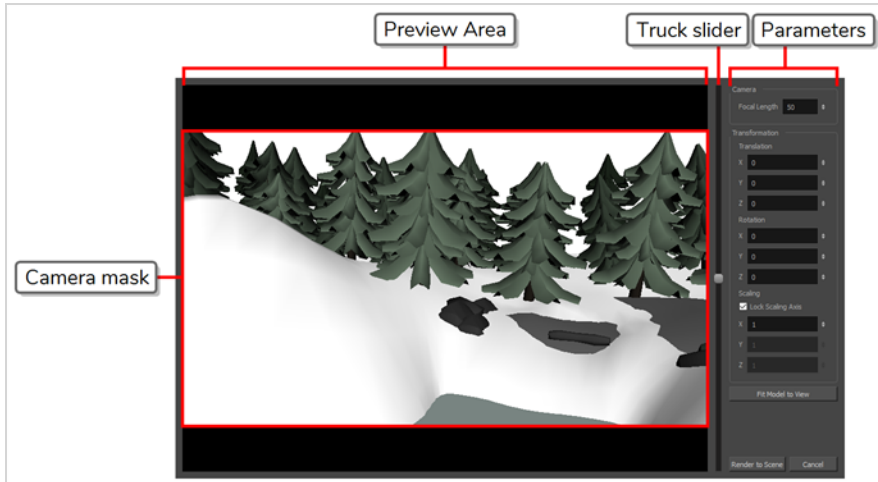

### NOTE

For information on how to use this dialog, see the User Guide.

### How to access the Render 3D Model dialog box

1. In Harmony, select **File > Import > 3D Models**.

The Import 3D Models dialog box opens.

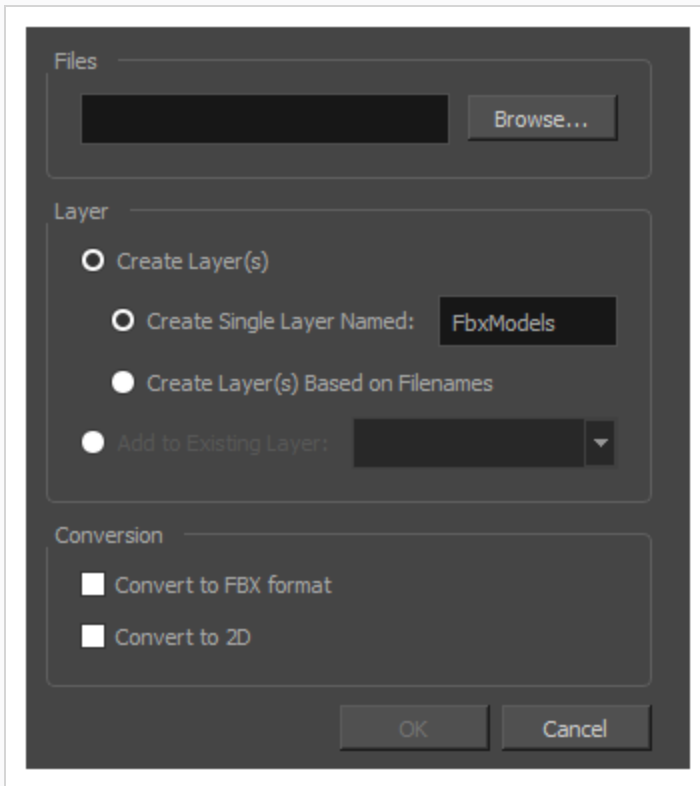

2. In the **Files** field, click on **Browse**.

An Open dialog appears.

3. Browse to and select your 3D model, then click on **Open**.

**NOTE**

If you want to import a 3D model as a rendered 2D image, you can only import a single 3D model at a time.

**NOTE**



You can only import .osb, .3ds, .obj, .fbx, .abc and .dae type 3D models.

4. In the Import 3D Models dialog, check the **Convert to 2D** checkbox.
5. Click on **OK**.

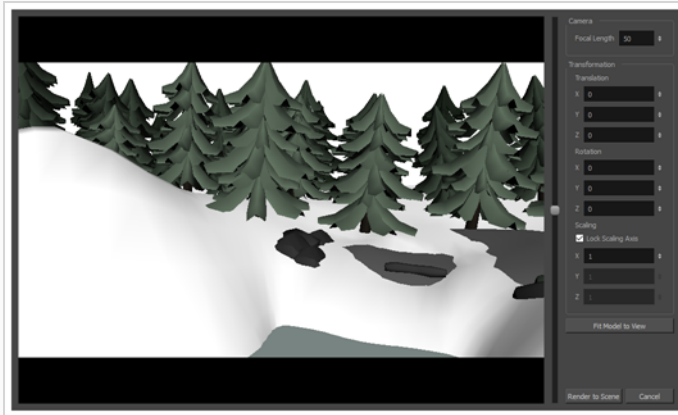
The Render 3D Model dialog appears.

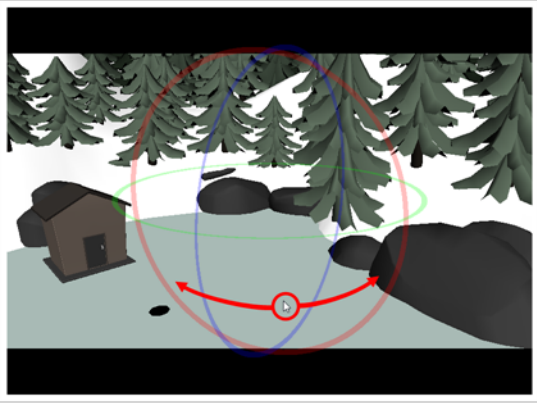

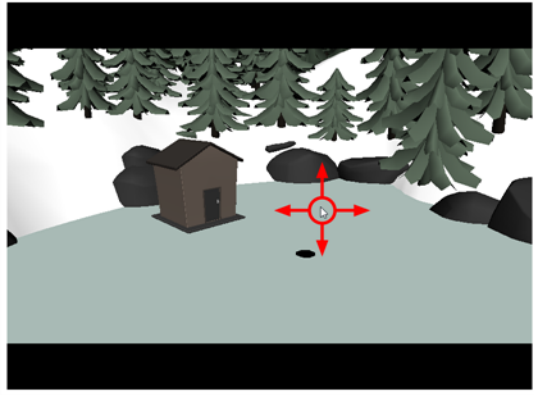
Parameter	Description
Preview Area	<p>The preview area displays the 3D model as it will be rendered in the scene. Black bars display around the area to mark parts of the areas that are outside of the camera frame.</p> <p>In this area, you can:</p> <ul style="list-style-type: none"> <li>• Either click and drag on the vertical slider to the right or scroll the mouse wheel up or down to adjust the distance between the camera and the model.</li> <li>• Hold Ctrl + Shift (Windows/Linux) or ⌘ + Shift (macOS), then click and drag on the preview area to rotate the camera.</li> </ul>  <ul style="list-style-type: none"> <li>• Hold Spacebar, then click and drag on the preview area to pan the camera laterally.</li> </ul>

Parameter	Description
	
<b>Camera</b>	
Focal Length	<p>The angle of the camera cone used to render the 3D model. A wide angle will render the model with less perspective, and a narrow angle will render it with exaggerated perspective.</p> <div data-bbox="451 940 1430 1140" style="border: 1px solid #c8e6c9; padding: 10px;"> <p> <b>NOTE</b> Increasing this setting will also decrease the perceived size of the 3D model, and decreasing it will increase its perceived size. You must then adjust the camera's distance from the model or the model's scaling to compensate.</p> </div>
<b>Transformation</b>	
Translation	<p>The position of the 3D model relative to the center of the stage:</p> <ul style="list-style-type: none"> <li>• <b>X:</b> The horizontal position of the 3D model, from west to east.</li> <li>• <b>Y:</b> The vertical position of the 3D model, from south to north.</li> <li>• <b>Z:</b> The position of the 3D model relative to the camera, from near to far.</li> </ul>
Rotation	<p>The angle of the 3D model relative to its default angle:</p> <ul style="list-style-type: none"> <li>• <b>X:</b> The rotation angle of the model around the horizontal axis.</li> <li>• <b>Y:</b> The rotation angle of the model around the vertical axis.</li> <li>• <b>Z:</b> The rotation angle of the model around the z-axis.</li> </ul>
Scaling	<p>The size of the 3D model relative to its default size:</p> <ul style="list-style-type: none"> <li>• <b>Lock Scaling Axis:</b> When enabled, you can use the X scaling field to set the scaling of the 3D model on all axes, preserving its proportions.</li> </ul>

---

Parameter	Description
	<ul style="list-style-type: none"><li data-bbox="500 285 935 310">• <b>X:</b> The horizontal scaling of the model.</li><li data-bbox="500 338 902 363">• <b>Y:</b> The vertical scaling of the model.</li><li data-bbox="500 390 964 415">• <b>Z:</b> The scaling of the model on the z-axis.</li></ul>
Fit Model to View	Click on this button to automatically adjust the model's Truck, Translation X and Translation Y parameters so that the model fits inside the camera field and is positioned in its centre.
Render to Scene	Rasterize the 3D model into a bitmap layer and add it to the current panel.
Cancel	Dismiss this dialog and do not import the 3D model.

## Render Write Nodes Dialog Box

The Render Write Nodes dialog box lets you configure your scene to render locally or sent it to a render farm so other computers can render your scenes while you continue working on your station.

In Harmony Stand Alone, the Render Write Nodes dialog box will look as follows:

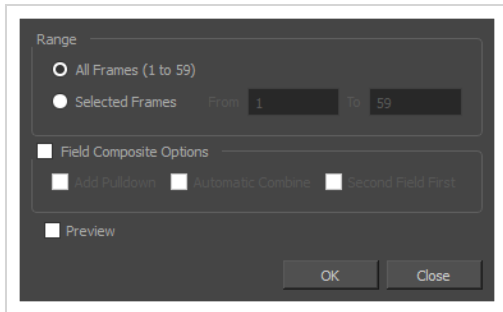

In Harmony Server, the Render Write Nodes dialog box will have an additional section, **Batch Composite Options**, which allows to set parameters for the server's batch rendering service:

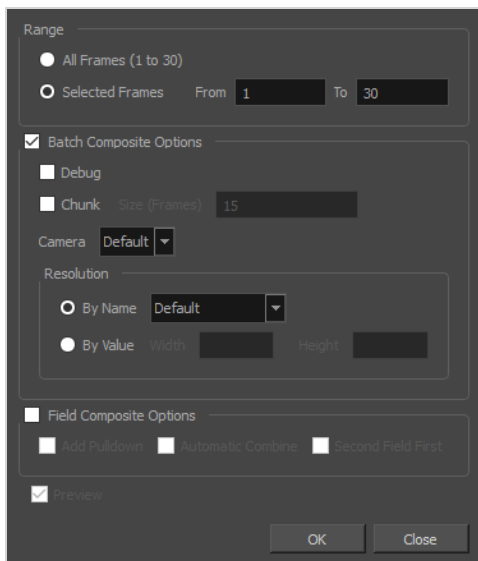

There are two approaches to rendering a scene in Harmony Server:

- **Local Rendering** is done directly by your machine in your Harmony session. Hence, it uses your machine's resources and will prevent you from working on the scene until the render is done. You will see the render progress in real time and will be able to preview the results right after it's finished.
- **Batch Rendering** is done by sending a scene to the server's render queue so it can be processed by the render farm. This allows you to keep working on your scene while the render is being done. The rendering progress can be monitored in Control Center and, when finished, the results can be previewed in Play. Batch Rendering gives you access to additional rendering options.

In either case, the render will be output in the same folder and in the same file formats, as those are determined by the scene's Write nodes. However, batch rendering supports additional options, such as rendering in chunks, or in different resolutions than the scene's resolution.



## How to access the Render Write Nodes dialog box

1. Do one of the following:

- From the top menu, select **File > Export > Render Write Nodes**.
- Press Ctrl + Shift + Y (Windows/Linux) or ⌘ + Shift + Y (macOS).

The Render Write Nodes dialog box opens.

Parameter	Description
Range	
All Frames	Sends all the frames in the scene to be rendered.
Selected Frames	Sends the specified range of frames to be rendered.
Batch Composite Options	Check this to send the scene to batch rendering and unlock batch rendering options. Otherwise, the scene will be rendered locally.
Debug	Instructs the batch rendering service to log debug information. When this is checked, the machine that processes the render will have more information about the compositing process in its batch rendering service's log.
Chunk	When checked, this splits the render job sent to the server's render queue into several smaller render jobs, allowing it to be processed by several machines in the render farm. Note that this only affects Frame renders. If the render includes a movie file, the movie will still be exported as a single file once all the frames have been rendered.
Size (Frames)	Specifies the amount of frames each chunk will include. For example, when rendering a 50 frames scene by chunks of 30, this will make the first render job render frames 1 to 30, and the second render job render frames 31 to 50.
Camera	If you created a scene with several Camera nodes, this allows you to specify which one to use for the render.
Resolution	This allows you to set the width and height of the rendered images or movie, either:  <b>By Name:</b> Allows you to select between Default or one of the available resolution presets. If Default is selected, the scene will be rendered in its own resolution.

	<p><b>By Value:</b> Allows you to set the width and height of the rendered images in pixels.</p>																		
<p>Field Composite Options</p>																			
<p>Add Pulldown</p>	<p>Renders using the 3:2 pull-down technique. Every odd-numbered frame will be rendered on 3 images, and every even-numbered frame will be rendered on 2 images.</p> <p>The exported images will be named in pairs to indicate that they are to be combined together. Therefore, the exported frames will follow this scheme:</p> <table border="1" data-bbox="561 621 1216 1413"> <thead> <tr> <th>Exported Image File</th> <th>Rendered Frame</th> </tr> </thead> <tbody> <tr> <td>final-0001-f1.tga</td> <td>Frame 1 of the scene</td> </tr> <tr> <td>final-0001-f2.tga</td> <td>Frame 1 of the scene</td> </tr> <tr> <td>final-0002-f1.tga</td> <td>Frame 1 of the scene</td> </tr> <tr> <td>final-0002-f2.tga</td> <td>Frame 2 of the scene</td> </tr> <tr> <td>final-0003-f1.tga</td> <td>Frame 2 of the scene</td> </tr> <tr> <td>final-0003-f2.tga</td> <td>Frame 3 of the scene</td> </tr> <tr> <td>final-0004-f1.tga</td> <td>Frame 3 of the scene</td> </tr> <tr> <td>final-0004-f2.tga</td> <td>Frame 3 of the scene</td> </tr> </tbody> </table> <p>This makes a scene animated in 24 frames per second output in 60 images per second. Hence, once the paired images are combined, this will make a 30 frames per second render.</p>	Exported Image File	Rendered Frame	final-0001-f1.tga	Frame 1 of the scene	final-0001-f2.tga	Frame 1 of the scene	final-0002-f1.tga	Frame 1 of the scene	final-0002-f2.tga	Frame 2 of the scene	final-0003-f1.tga	Frame 2 of the scene	final-0003-f2.tga	Frame 3 of the scene	final-0004-f1.tga	Frame 3 of the scene	final-0004-f2.tga	Frame 3 of the scene
Exported Image File	Rendered Frame																		
final-0001-f1.tga	Frame 1 of the scene																		
final-0001-f2.tga	Frame 1 of the scene																		
final-0002-f1.tga	Frame 1 of the scene																		
final-0002-f2.tga	Frame 2 of the scene																		
final-0003-f1.tga	Frame 2 of the scene																		
final-0003-f2.tga	Frame 3 of the scene																		
final-0004-f1.tga	Frame 3 of the scene																		
final-0004-f2.tga	Frame 3 of the scene																		
<p>Automatic Combine</p>	<p>Combines each pair of images rendered with Pulldown by interlacing them together.</p>																		
<p>Second Field First</p>	<p>By default, when images rendered with Pulldown are combined, the first image in a pair is rendered on odd lines (referred to as the first field), and the second is rendered on even lines (referred to as the second field). This does the opposite: The second image in a pair is rendered on odd lines and the first one is rendered on even lines.</p>																		

Preview	When rendering locally, this opens the rendered image sequence in Play immediately after the render is done.
---------	--

## Save Dialog Box

The Save dialog box appears when you save a scene for the first time in Harmony Server.

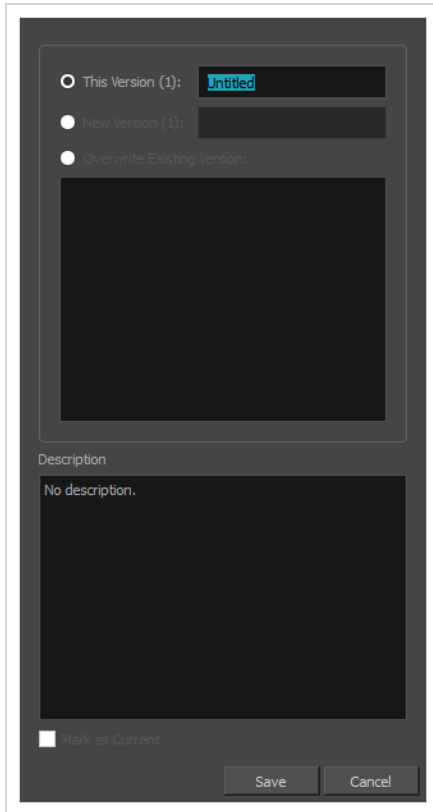

### How to access the Save dialog Box

1. Make sure you have the necessary rights to save the current scene version. If you do not, you can acquire the rights by selecting **File > Rights to Modify Scene Version** or **Rights to Modify Scene** in the top menu.
2. Do one of the following:
  - In the top menu, select **File > Save**.
  - In the File toolbar, click on the  Save button.
  - Press Ctrl + S (Windows/Linux) or ⌘ + S (macOS).

When saving the scene for the first time, the Save dialog box opens, prompting you to name the version.

Parameter	Description
-----------	-------------

This Version	Allows you to enter the name of the current version.
Description	Enter a short description of the current version.

## Scene Settings Dialog Box

The Scene Settings dialog box lets you select settings for the resolution of your scene, its alignment and the resolution of bitmap drawings and textured brush strokes.

You are already required to select resolution and alignment settings when creating a scene, but those settings can also be modified later using the Scene Settings dialog box.

### How to access the Scene Settings dialog box

1. In the top menu, select **Scene > Scene Settings**.

The Scene Settings dialog box opens.

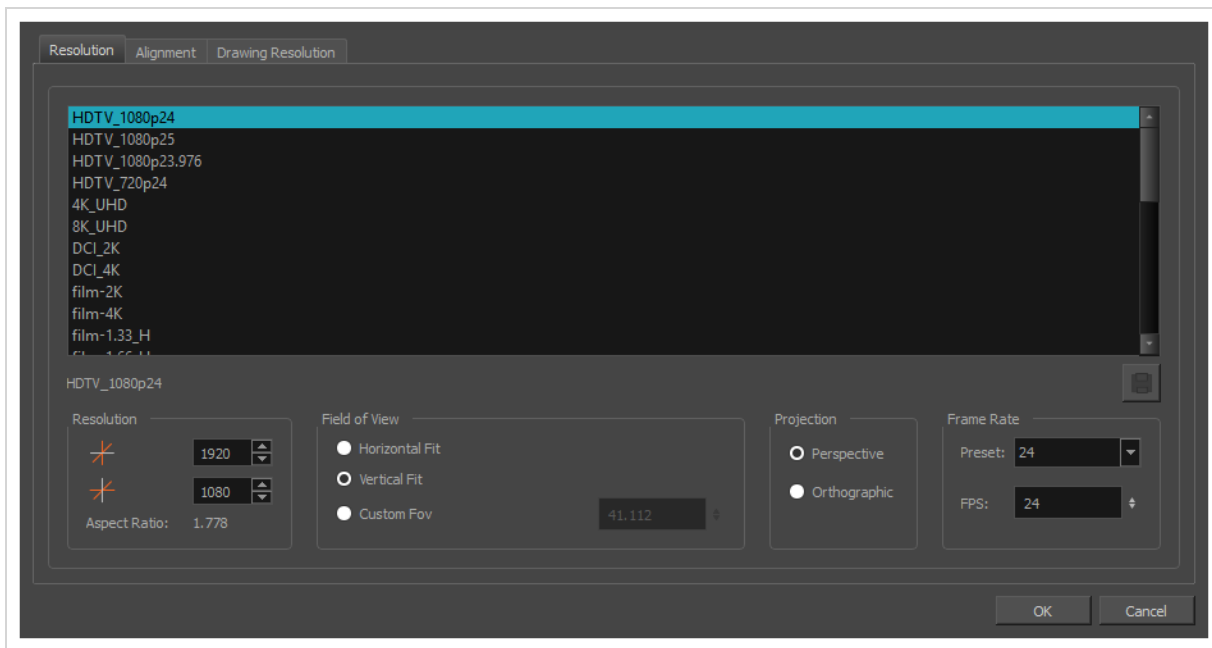

## Resolution Tab



The resolution tab allows you to set the width and height of your scene in pixels, the angle of the field of view and the way elements are projected across the depth of your scene.

Icon	Parameter	Description
	Resolution Presets	<p>You can select your project's resolution (camera frame size) from this preset list.</p> <ul style="list-style-type: none"> <li>• <b>HDTV_1080p24:</b> The standard definition for high definition television at 24 frames per second, mostly used in the Americas and some Asian countries that used the NTSC standard for</li> </ul>

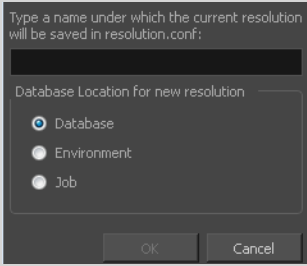

		<p>analogue television.</p> <ul style="list-style-type: none"> <li>• <b>HDTV_1080p25:</b> The standard definition for high definition television at 25 frames per second, usually for broadcasting in European, African, Asian and Australian countries that used the PAL or SECAM standard for analogue television.</li> <li>• <b>HDTV_1080p23.976:</b> The standard definition for high definition television at 23.976 frames per second. This is useful if the remainder of your pipeline uses the 23.976 framerate for legacy reasons.</li> <li>• <b>HDTV_720p24:</b> The former standard high definition resolution at 24 frames per second.</li> <li>• <b>4K_UHD:</b> A standard ultra HD (4K) format for television productons. 4K implies that the width of the image is of, give or take, 4000 pixels.</li> <li>• <b>8K_UHD:</b> A standard ultra HD (8K) format for television productions. 8K implies that the width of the image is of, give or take, 8000 pixels.</li> <li>• <b>DCI_2K:</b> A standard HD format for cinema.</li> <li>• <b>DCI_4K:</b> A standard ultra HD (4K) format for cinema.</li> <li>• <b>film-2K:</b> A standard HD format for film projectors with a low aspect ratio.</li> <li>• <b>film-4K:</b> A standard ultra HD (4K) format for film projectors with a low aspect ratio.</li> <li>• <b>film-1.33_H:</b> The standard resolution for the academy film format that conforms to the standard 4:3 aspect ratio.</li> <li>• <b>film-1.66_H:</b> The standard resolution for widescreen film format that conforms to the 16:9 aspect ratio.</li> <li>• <b>film-1.66_V:</b> The standard resolution for widescreen film format, but with a vertical field of view.</li> <li>• <b>Cineon:</b> The standard format for 35 mm Kodak/Cineon film.</li> <li>• <b>NTSC:</b> The standard resolution and framerate for analogue standard definition televisions in most of the Americas (except Brazil, Paraguay, Uruguay and Argentina), Japan, Taiwan, South Korea, the Philippines and Myanmar.</li> <li>• <b>PAL:</b> The standard resolution and framerate for analogue standard definition televisions in Europe, Africa, Australia, most of Asia, Brazil, Uruguay and Argentina.</li> <li>• <b>2160p-240p:</b> A series of standard widescreen presets named after their resolution heights.</li> </ul>
--	--	---

		<ul style="list-style-type: none"> <li>• <b>low:</b> A resolution based on NTSC with half of its standard dimensions.</li> <li>• <b>Web_Video:</b> A legacy format for web streaming.</li> <li>• <b>Game_512:</b> A preset for the gaming pipeline, with a square canvas.</li> <li>• <b>Game_512_Ortho:</b> Like Game_512, except with Orthographic projection so that elements moved on the Z axis do not appear smaller or bigger.</li> <li>• <b>WebCC_Preview:</b> The preset used by WebCC to render previews of scenes in a Harmony Server database.</li> <li>• <b>HDTV:</b> The standard definition for high definition television at 24 frames per second, with a horizontal fit field of view.</li> <li>• <b>HDTV_Vertical:</b> The standard definition for high definition television at 24 frames per second, with a vertical fit field of view.</li> </ul>
	<p>Selected Resolution Preset</p>	<p>Displays the name of the selected resolution preset just below the presets list. If you have made any changes to the resolution since selecting a preset, this will display "(custom)".</p>
	<p>Save Resolution Setting</p>	<p>Allows you to save the current resolution settings as a new preset. If you have a resolution preset selected, this button is only available if you have made changes to the resolution since selecting the preset. You will be prompted to type in the name of the new resolution preset. If using Harmony Server, you will also be asked to select in which part of the database you want the preset to be saved.</p> 
	<p>Resolution</p>	<p>The resolution of the scene defines the width and height of the canvas in pixels. By default, the scene will be rendered in this resolution. If using bitmap layers or textured brush strokes, the definition of the pixels in your artwork will also be based on the scene's resolution.</p>
	<p>Scene Width</p>	<p>The width of the resolution for the scene, in pixels.</p>

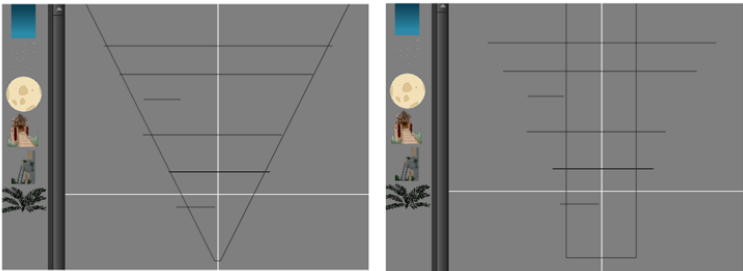
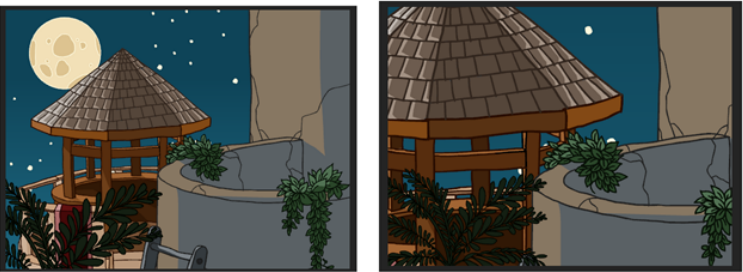

	Scene Height	The width of the resolution for the scene, in pixels.
	Aspect Ratio	Displays the ratio between the horizontal and vertical dimensions of the scene. For example, if the scene width and height are the same value, this ratio equals 1. The standard aspect ratio for widescreen televisions is 1.777. For legacy displays, it is 1.333.
	Field of View	<p>The angle of the field of view, which determines the size of the camera cone as well as the way the field grid used to position elements is adjusted to fit the scene.</p> <ul style="list-style-type: none"><li>• Horizontal Fit: The field of view is automatically adjusted so that the field grid and camera cone fit the horizontal length of the scene.</li><li>• Vertical Fit: The field of view is automatically adjusted so that the field grid and camera cone fits the vertical length of the scene.</li><li>• Custom FOV: Enter the angle of the field of view manually. A greater angle will make a wider camera cone and smaller fields. A smaller angle will mean a more narrow camera cone and bigger fields.</li></ul>

		<div style="border: 1px solid green; padding: 10px;">  <p><b>NOTES</b></p> <ul style="list-style-type: none"> <li>• Objects in Harmony are positioned in fields, based on a traditional animation grid which, by default, extends to 12 fields from the center in each direction, and which has 4:3 proportions by default. In a scene with 4:3 proportions, this grid fits the camera field perfectly. However, since most scenes have an aspect ratio of 16:9, the grid does not fit the camera field perfectly. If the field of view is Horizontal Fit, the grid's width will match the scene's width, but will extend beyond its vertical edges. If the field of view is Vertical Fit, the grid's height will match the scene's height, will not extends to its horizontal edges.</li> <li>• To avoid distorting elements, the field of view angle is applied directly to the vertical axis, and the one applied on the horizontal axis is calculated proportionally to the aspect ratio of the scene.</li> <li>• The field of view may affect the way 3D-rotated elements and 3D objects are rendered. If too wide, objects may appear distorted when seen from an angle. If too low, objects may seem flat and may lack foreshortening.</li> </ul> </div>
	<p>Projection</p>	<p>The Projection settings allows you to modify the type of camera your scene is using. You can either use a perspective camera (regular camera) or orthographic camera (no perspective).</p> <ul style="list-style-type: none"> <li>• <b>Perspective:</b> Objects placed closer to the camera will be displayed bigger and objects placed further away will be displayed smaller. Elements that are 3D-rotated as well as 3D objects will be rendered in a realistic perspective.</li> <li>• <b>Orthographic:</b> The size of objects does not depend on their position on the Z-axis. Moving an element forward or backward will not change its apparent size, only its order relative to other elements. 3D-rotated elements and 3D objects will have no foreshortening. This option is more often useful when using Harmony for gaming, and more information about this option is available in the Gaming guide. This option can also be useful if you don't need any perspective in your project and want to use the Z-axis to order elements, or if you want to</li> </ul>

		<div data-bbox="751 191 1427 390" style="border: 1px solid #4a90e2; padding: 10px; margin-bottom: 10px;">  <p><b>TIP</b></p> <p>In order to create scenes with the Orthographic camera by default, you need to create a new custom scene resolution.</p> </div> <div data-bbox="672 417 1432 741" style="border: 1px solid #ccc; padding: 5px; margin-bottom: 10px;">  <p style="text-align: center;">Perspective camera                      Orthographic camera</p> </div> <div data-bbox="672 772 1432 1096" style="border: 1px solid #ccc; padding: 5px;">  <p style="text-align: center;">Perspective camera                      Orthographic camera</p> </div>
	Frame Rate	<p>The amount of animation frames to play each second. Increasing the FPS will make your animation play faster, and decreasing it will make it play slower.</p> <ul style="list-style-type: none"> <li>• Preset: Allows you to select a frame rate for your scene among one of many commonly used preset frame rates.</li> <li>• FPS: Allows you to type in the frame rate for your scene.</li> </ul> <div data-bbox="672 1438 1427 1703" style="border: 1px solid #7ed321; padding: 10px; margin-top: 10px;">  <p><b>NOTE</b></p> <p>The standard framerate for film production is 24 frames per second. However, televisions in some countries play at 25 frames per second. Some productions may use 23.976 frames per second to preserve compatibility with legacy standard displays.</p> </div>

## Alignment Tab

The alignment tab is used to determine the aspect ratio, the position and the size of the field grid used to position elements in the scene.

In Harmony are positioned in *fields*, a unit used in traditional animation which traditionally ranges from 0 to 12 followed by a cardinal direction, and in which 0,0 is the center of the scene.

The default Alignment setting in Harmony is based on such a traditional 4:3 drawing grid. In a scene with an aspect ratio of 4:3, this means that positioning an element 12 fields in any direction will make it reach one of the edges of the camera field. For example, 12 North is the vertical position of the upper edge of the camera field, and 12 East is the horizontal position of the right edge of the camera field.

However, since the most commonly used scene resolutions have an aspect ratio of 16:9, and the default grid is in a 4:3 proportion, the grid used to position element will not be in the same proportions as the camera field. The way this is handled is determined by the Field of View setting in the Resolution tab. If your field of view is set to Horizontal fit, the field grid will be made to fit the scene horizontally, and stretch beyond the vertical edges of the scene. This means that 12 East will still be the right edge of the screen, but the position of the upper edge of the scene will be about 9.36 North. Likewise, if the field of view is set to Vertical Fit, the upper edge of the field will be at 12 North, but the right edge will be at about 16 East.

Some artists or studios may prefer to use a square fields grid, where fields have the same size horizontally and vertically.

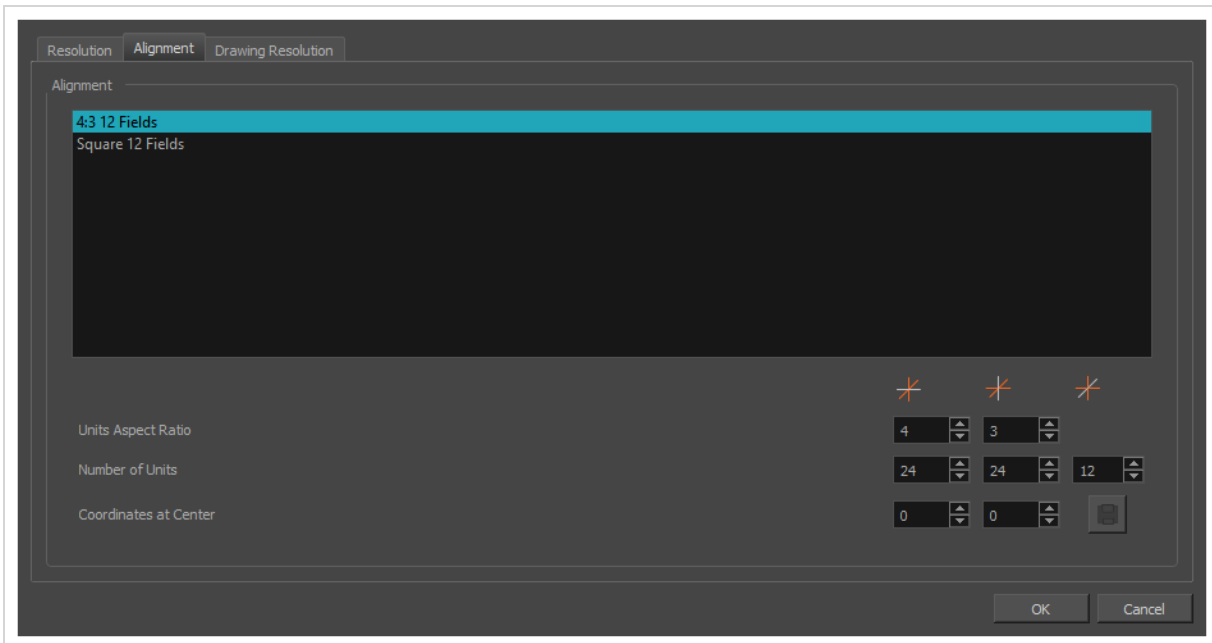

Parameter	Description
Alignment	<p>The list of alignment presets. By default, Harmony has these two alignment presets:</p> <ul style="list-style-type: none"> <li> <b>4:3 12 Fields:</b> Defines the units of your project to have a 4:3 ratio and sets up 12 of these units to run both vertically and horizontally in four cardinal quarters (NW, NE, SW, SE). This is the default setting, and it corresponds to an animation grid used in traditional animation. Hence, coordinates based on a traditional animation grid can be entered in Harmony as is to                     </li> </ul>

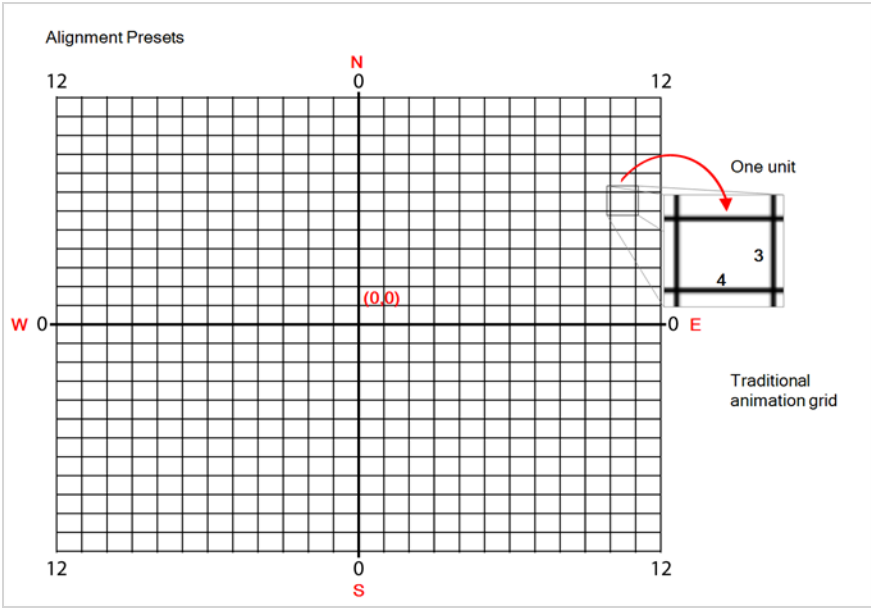
	<p>position elements where they are expected to be.</p> <ul style="list-style-type: none"> <li>• <b>Square 12 Fields:</b> Defines the units of your project to have a 1:1 or square ratio and sets up 12 units to run both vertically and horizontally in four cardinal quarters (NW, NE, SW, SE).</li> </ul> <div style="border: 1px solid green; padding: 10px; margin-top: 10px;"> <p> <b>NOTE</b></p> <p>When the Grid is displayed in the Camera and Drawing view, it is always based on the 4:3 12 Fields alignment preset, regardless of your scene's alignment setting. To display the grid, from the top menu, select <b>View &gt; Grid &gt; Show Grid.</b></p> </div>
<p>Units Aspect Ratio</p>	<p>The aspect ratio of each field. This describes the proportional difference between the width and the height of the field. By default, it is set to 4:3, which means the width of each field will take 4 unites of length for each 3 units the height of the field takes. In other words, the width of a field is 1.333 times its height. If set to, for example, 1:1, the fields will be perfectly square.</p> <div style="text-align: center; margin-top: 10px;">  </div>
<p>Number of Units</p>	<p>The number of fields the grid should have in each direction. In the Number of Units fields, enter the number of horizontal, vertical and depth units for your scene's grid.</p> <p>The grid is a specific size based on the scene's resolution and field of view angle. Changing the amount of units for each direction will not change the size of the grid, but rather, the size of the units. Hence, if an element is offset at 3 North, 4 East, and you change the number of horizontal and vertical units from 24 to 12, the element will become offset twice as far from the centre as it originally was.</p> <p>The third setting in this field determines the amount of units across the Z axis.</p>

	<p>This determines how far each unit will take an element further or closer to the camera when moved on the Z-axis. By default, the grid has 12 fields across the Z-axis, which is half the amount of fields on the X and Y axes by default. Hence, each field on the Z-axis is worth exactly twice the length of a field on the horizontal axis.</p> <p>Animators who are familiar with traditional animation method will understand the default setting of 24 units horizontal by 24 units vertical as it corresponds to a traditional animation grid.</p>
Coordinates at Centre	<p>The offset for the centre of the fields grid. The centre of the fields grid is where elements are positioned by default, when they themselves are at coordinates 0,0. To change the centre, you must enter its offset from the actual centre of the grid in fields. For example, if your fields grid is 24 x 24, and you want the centre to be at the top-left corner, you should enter -12,-12.</p>
Save	<p>Saves your current Alignment settings and be able to select them later from the list.</p>

**TIP**

If you prefer working in pixel-based positions, you must set the aspect ratio of your units to be the same as the aspect ratio of your scene resolution, set the horizontal number of units to the width of your scene in pixels, the vertical number of units to the height of your scene in pixels, and the depth number of units to the width of your scene in pixels. This way, each unit will translate to exactly 1 pixel, in all directions.

**NOTE**

Each layer also has an alignment rule, which determines how it is positioned relative to the fields grid. By default, it is set to "Centre First Page". However, this alignment rule is made to be compatible to 4:3 fields grids. Hence, if you change your scene's alignment rules, your layers will be offset. To avoid this issue, change the alignment rules of your layers to "Centre" via the Advanced tab of the Layer Properties view.

## Drawing Resolution Tab

The drawing resolution tab is used to set the pixel density of bitmap drawings as well as of bitmap textures in textured brush strokes in vector drawings. Also, it is used to set the size of the canvas for bitmap drawings relative to the size of the scene.

**NOTE**

These settings are applied to newly created drawings in the scene, but not to existing drawings in your scene. To change the pixel density of existing vector drawings, you must select **Drawing > Change Vector Drawing Brush Resolution** from the top menu. To change the pixel density and canvas size of existing bitmap drawings, you must select **Drawing > Change Bitmap Drawing Resolution** from the top menu.

**NOTE**

You can change the default drawing resolution settings for new scenes in the Drawing tab of the Preferences dialog.

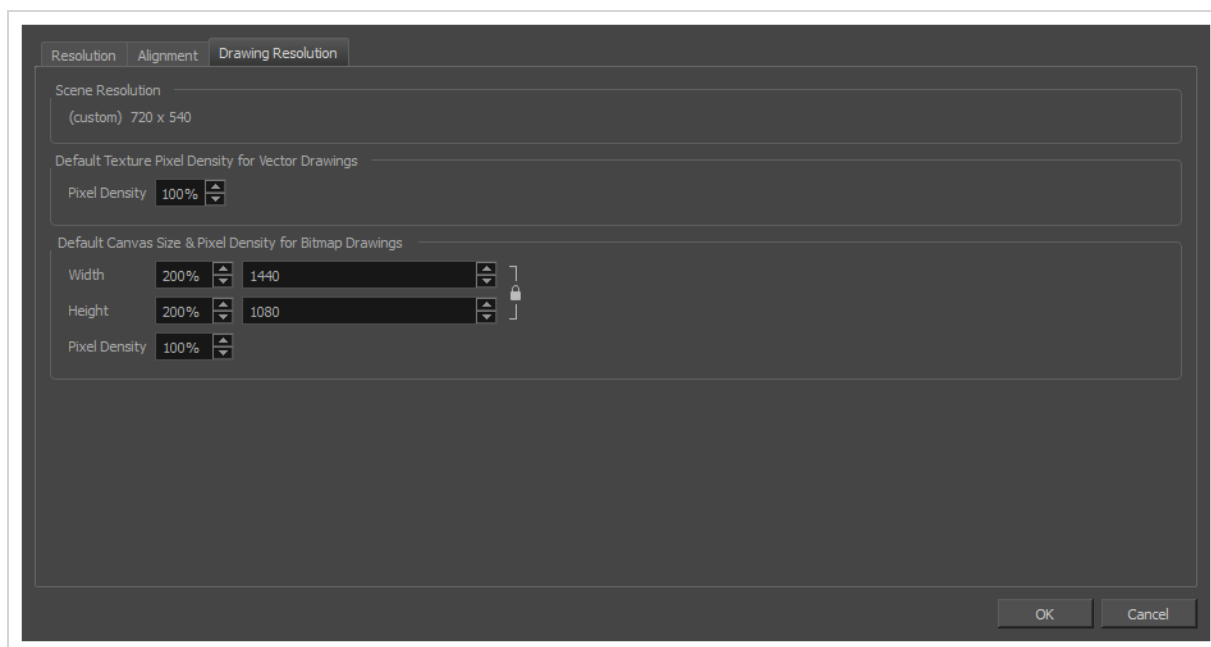

Parameter	Description
Scene Resolution	This indicates the currently selected scene resolution preset and its dimensions in pixels.
Default Texture Density for Vector Drawings	<b>Pixel Density:</b> Determines the amount of pixels to store in textured brush strokes for each pixel that displays when the drawing is not zoomed in or scaled up. For example, at 100%, zooming in or scaling up textured brush strokes will make them lose texture quality. If set to 200%, textured brush strokes can be zoomed in or scaled up until they're twice their original size without losing picture quality.
Default Canvas Size and	<b>Width:</b> The default width of the canvas when creating drawings in a bitmap

<p>Pixel Density for Bitmap Drawings</p>	<p>drawing layer. The percentage is relative to the width of the scene. Its default value, 200%, makes the width of the canvas twice the width of the stage.</p> <p><b>Height:</b> The default height of the canvas when creating drawings in a bitmap drawing layer. The percentage is relative to the height of the scene. Its default value, 200%, makes the height of the canvas twice the height of the stage.</p> <p><b>Pixel Density:</b> Determines the amount of pixels to store for each pixel that displays on the screen when the drawing is not zoomed in or scaled up. For example, at 100%, zooming in or scaling up a bitmap drawing will make it lose picture quality. If set to 200%, bitmap drawings can be zoomed in or scaled up until they're twice their original size without losing picture quality.</p>
--	---



## Scripts Manager Dialog Box

The Scripts Manager dialog allows you to create buttons in the Scripting toolbar. Each button you create can run a specific function in one of your scripts. You can also choose an icon and a tool tip for the button, if you want.

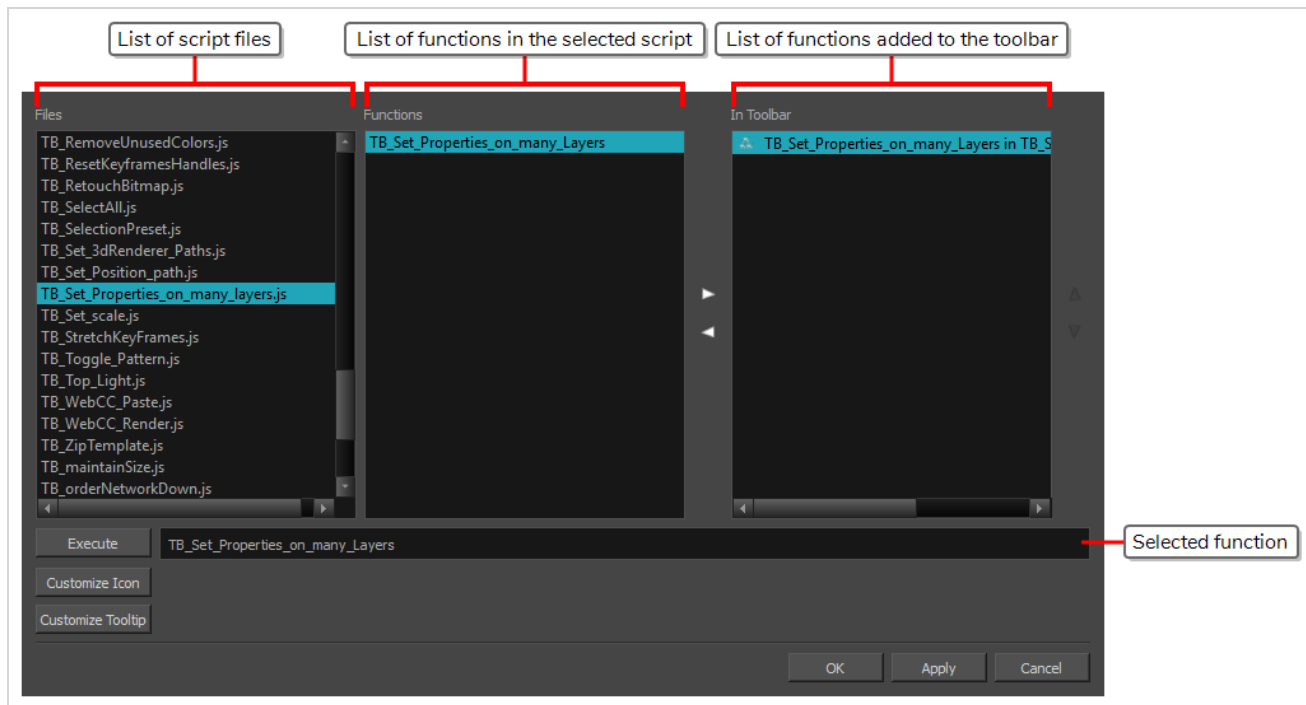

### NOTE

For tasks related to this dialog box, see the User Guide.

### How to access the Scripts Manager Dialog Box

1. In the Scripting toolbar, click on the  Manage Scripts button.

The Scripts Manager dialog box opens.

Parameter	Description
Files	A list of the available JavaScript files.
Functions	A list of the available functions for the selected script.
In Toolbar	The list of script functions already added to the Scripting toolbar.

Execute	<p>Runs the selected function.</p> <div data-bbox="565 247 1430 386" style="border: 1px solid #00a0e3; padding: 5px;">  <p><b>TIP</b> Press Esc to interrupt the execution of the script.</p> </div>
Customize Icon	<p>Allows you to select an icon for the toolbar button. Clicking on this button will open an Open dialog prompting you to browse for and select a <b>.png</b>, <b>.jpg</b>, <b>.xpm</b> or <b>.svg</b> file.</p>
Customize Tooltip	<p>Allows you to type in a custom tooltip for the toolbar button.</p>

## Select Colour Dialog Box

The Select Colour dialog box lets you set the colour of layers and columns. Using colours for layers and columns helps to differentiate them visually, making them easy to identify. The colours you choose will be reflected in the Node view.

You can select a colour by choosing from a basic set of colours, using the colour wheel or by specifying the HSV or RGB values. Once you have selected a colour, you can adjust its intensity and save it as a custom colour that you can reuse.

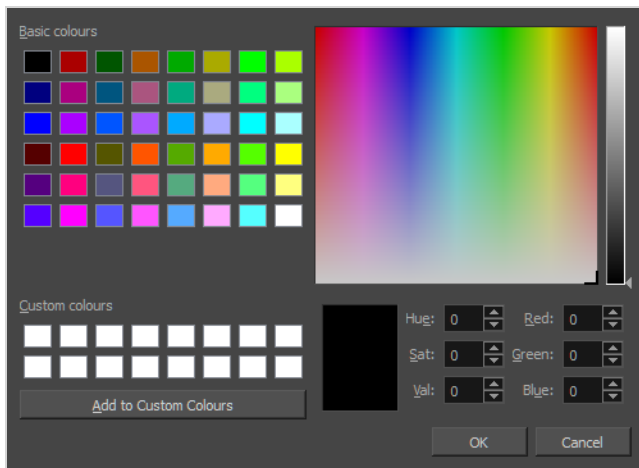

### How to access the Select Colour dialog box in the Timeline view

1. In the Timeline view, click the Change Track Colour  button of the layer you want to modify.

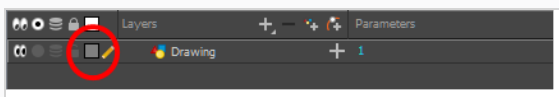

The Select Colour dialog box opens.

### How to access the Select Colour dialog box in the Xsheet view

1. In the Xsheet view, select one or more columns to modify.
2. Right-click on the column's header and select **Colour > Change Columns Colour**.

The Select Colour dialog box opens.

Parameter	Description



Basic colours	A basic set of colours to choose from.
Custom colours	Displays the custom colours you previously stored using the Add to Custom Colours button.
Add to custom colours	Lets you add the selected colour to the Custom colours list above.
Colour wheel	Lets you select a colour by dragging the T-shaped pointer.
Value slider	Once you select a colour, you can drag the slider to change the intensity and see it previewed in the Colour Preview window below..
Colour Preview	Displays the colour you are currently selecting. To apply the colour, click OK.
Hue, Saturation, Value	Lets you set the hue (colour), saturation (amount of colour) and brightness (value) of the colour.
Red, Green, Blue	Lets you set the red, green and blue values.

## Selection Presets Dialog Box

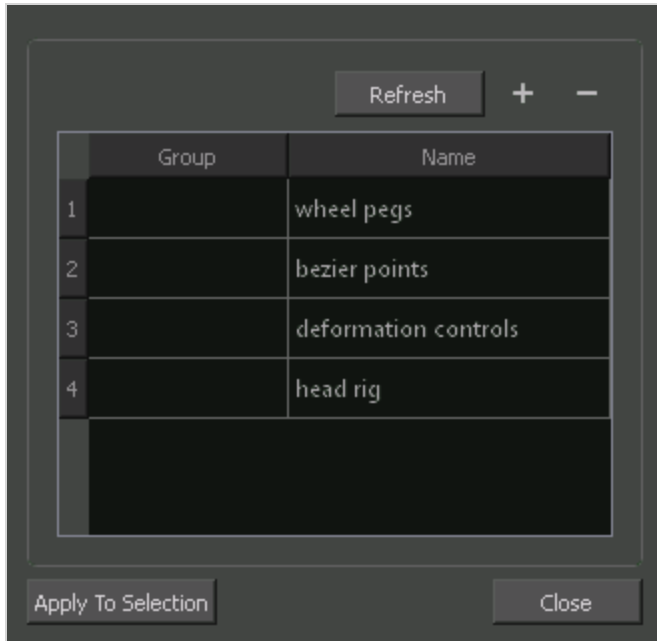

As you're animating, you might find that you are constantly selecting the same pegs, drawing layers, bezier points on a deformation envelope, part of a character rig, etc. You can create a preset that automatically selects any defined element or group of elements.



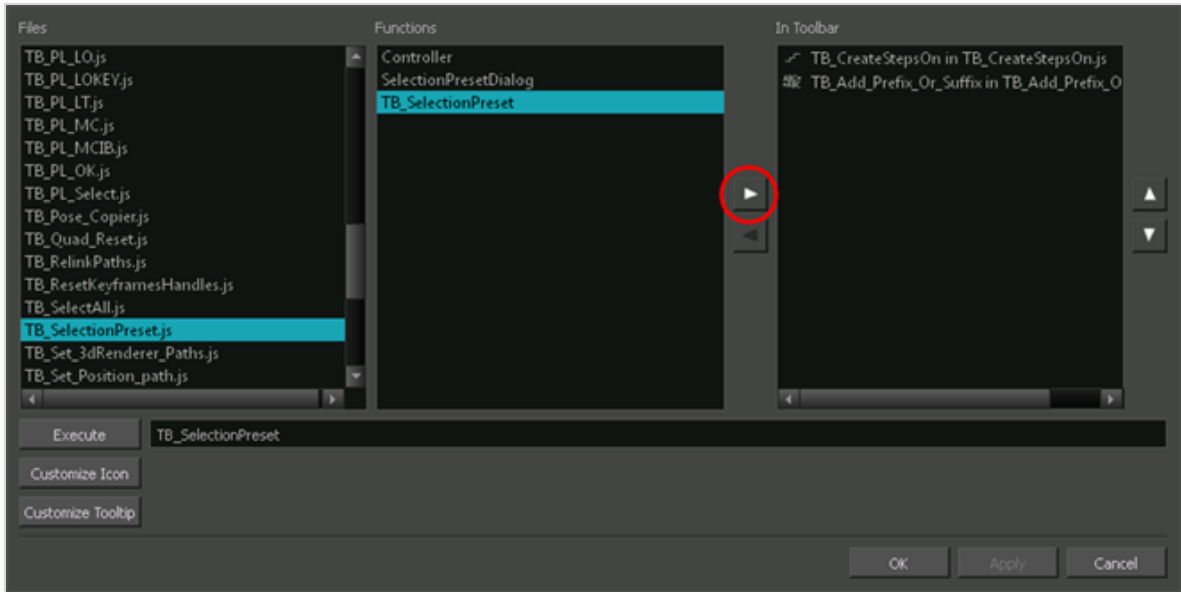

### How to access the Selection Presets dialog box

1. Add the Scripting toolbar to your interface:
  - Go to the top menu and select **Windows > Toolbars > Scripting**.
  - right-click on the empty space near the top of the interface and from the quick-access menu selecting **Scripting**.
  - right-click on the empty space near the top of a view and from the quick-access menu selecting **Scripting**.
2. In the Scripting toolbar, click on the Manage Scripts  button to open the Scripts Manager window.
3. In the Scripts Manager, in the Files section, select the file **TB\_SelectionPreset.js**.  
The functions associated with that file appear in the Functions section.
4. In the Functions section, select **TB\_SelectionPreset**.  
The Add script to toolbar  button becomes active.



5. Click on the Add script to toolbar  button.  
The TB\_SelectionPreset script  button is added to the Scripting toolbar.
6. Click **Apply**.
7. Click **OK**.
8. In the Scripting toolbar, click on the TB\_SelectionPreset  button.  
The Selection Presets window opens.

Parameter	Description
Refresh	Removes any highlighted zones from the Group column.
 Add Selection Preset	Opens the Save Selection As Preset dialog box. After entering a name for the new preset and clicking OK, a new Selection Preset is added to the Selection Presets list. Note: before clicking on the Add button, make a selection in your scene of the elements for which you wish to create a Selection Preset.
 Delete Selection Preset	Deletes the selected Selection Preset from the list.
Group	Double-click in this area, next to the Selection Preset you wish to use, to select the elements defined by the preset.
Name	Displays the name of the preset.

Apply to Selection	Selects the elements defined by the selected preset from the Name list.
Close	Closes the Selection Presets window.

## Sequence Fill Dialog Box

The Sequence Fill dialog box lets you create a numbered sequence over a selection. The sequence can be forward, backward, single, double or higher increment, as a cycle, and so on. The selection can be over one cell or a cell range in one column or more or an entire column or many entire columns.

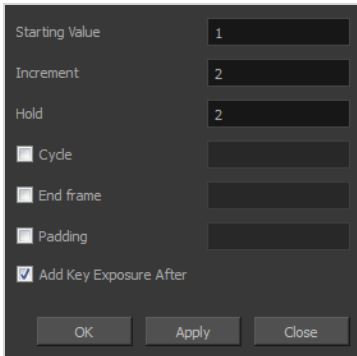

### How to access the Sequence Fill dialog box

1. In the Timeline or Xsheet view, select a cell range.

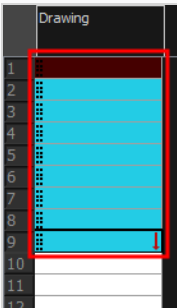
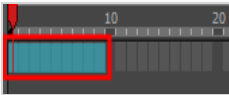

2. Do one of the following:
  - From the top menu, select **Animation > Cell > Sequence Fill**.
  - In the Timeline view, right-click and select **Exposure > Sequence Fill**.
  - In the Xsheet toolbar, click the Sequence Fill  button (you may have to customize the toolbar to display it).
  - Press **Ctrl + M** (Windows/Linux) or **⌘ + M** (macOS).

The Sequence Fill dialog box opens.



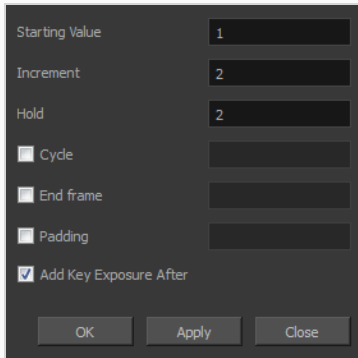

Parameter	Description
Starting Value	The first number in the sequence.
Increment	Lets you type the number by which the drawing number will increase from frame to frame. For example, an increment of 1 gives you: <b>1-2-3-4</b> ; an increment of 2 gives you: <b>1-3-5-7</b> ; and -2 gives you this: <b>8-6-4-2</b> .
Hold	The exposure holding value.
Cycle	Enable this option to cycle the values and enter the number of cycles in the Cycle field.
End Frame	Enable this option to stop the fill at a specific frame within the selection. Indicate the frame number in the End Frame field.
Padding	Enable this option to add a 0 padding before the drawing name. In the Padding field, enter as many hash symbols (#) as digit you want in your drawing name, including the value itself.
Add Key Exposure After	Inserts a key exposure on the frame following the last cell of the new fill selection.

## Set Ease for Multiple Parameters Dialog Box

The Edit Set Ease for Multiple Parameters dialog box lets you apply ease to multiple functions and keyframes. You can display the function curve and modify the Bezier or Ease curve.

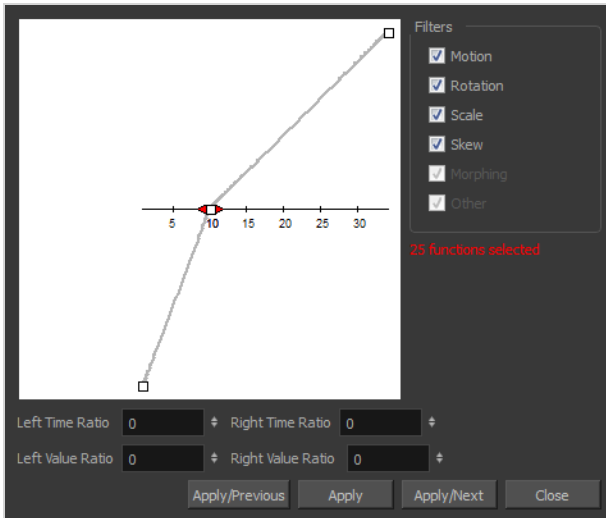

### How to access the Set Ease for Multiple Parameters dialog box

1. In the Timeline view, select a keyframe on one or more layers.

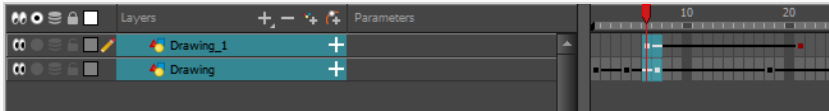

2. Do one of the following:
  - In the Timeline view, right-click and select **Set Ease For Multiple Parameters**.
  - In the Timeline toolbar, click the Set Ease For Multiple Parameters  button.

The Set Ease For Multiple Parameters dialog box opens.

Parameter	Description
Filters	
Motion	<b>Motion:</b> Applies the easing parameters to the selected Position X, Position Y, Position Z and 3D Path functions.

	<p><b>Rotation:</b> Applies the easing parameters to the selected Angle functions.</p>
	<p><b>Scale:</b> Applies the easing parameters to the selected Scale functions.</p>
	<p><b>Skew:</b> Applies the easing parameters to the selected Skew functions.</p>
	<p><b>Morphing:</b> Applies the easing parameters to the selected Morphing Velocity functions. Note that it applies to the Morphing velocity function found in the Layer Properties window, not the basic morphing ease in the Tool Properties view.</p>
	<p><b>Other:</b> Applies the easing parameters to all the other the selected functions, such as all functions created to animate effect parameters.</p>
Left and Right Time Ratio	<p>Lets you type the percentage value corresponding to the length of time you want the easing to last. Stay between 0% and 100%. If you go beyond 100%, your motion will overshoot.</p>
Left and Right Value Ratio	<p>Lets you type the percentage value of how strong you want the easing out to be. Stay between 0% and 100%. If you go beyond 100%, your motion will overshoot.</p>
Apply/Previous	<p>Applies the easing parameters to the selected keyframes and then selects the previous keyframe in the timeline.</p>
Apply	<p>Applies the easing parameters to the selected keyframes.</p>
Apply/Next	<p>Applies the easing parameters to the selected keyframes and then selects the next keyframe in the timeline.</p>
Close	<p>Close the dialog box. If you did not apply the modifications, they will be cancelled.</p>

## Show Hidden Columns Dialog Box

The Show Hidden Columns dialog box lets you display all the columns contained in the exposure sheet. It can be used to hide individual columns.

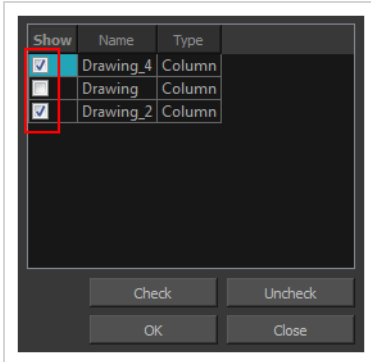

### How to access the Show Hidden Columns dialog box

1. In the Xsheet view, do one of the following:
  - Click the thick grey line that represents a hidden column.
  - Right-click on the column header and select **Show Hidden Columns**.
  - Press Alt + Shift + H.

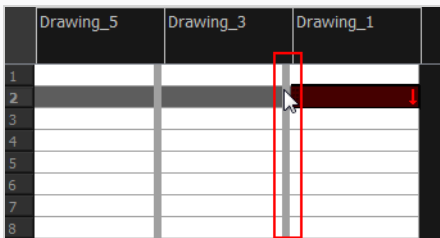

The Show Hidden Columns dialog box opens.

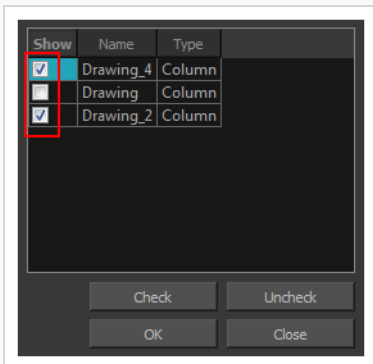

---

Parameter	Description
Show	Lets you select the hidden columns to display in the Xsheet view.
Name	Name of the drawing.
Type	Indicates the column type such as column, timing, and expression.
Check	Selects all columns.
Uncheck	Deselects all selected columns.

## OpenQuickTime Sound Options Dialog Box

The OpenQuickTime Video Options dialog box is used to configure the audio compression settings when exporting a QuickTime movie file on Linux.

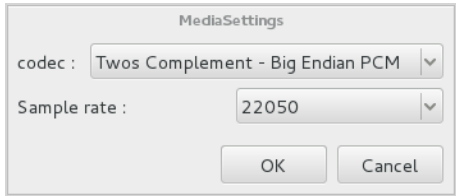

On Windows and macOS, Harmony uses Apple QuickTime to export QuickTime movies, and hence uses QuickTime's interface to configure video and audio compression settings for exporting movies. Since QuickTime is not supported on GNU/Linux, Harmony uses the OpenQuickTime library to create QuickTime-compatible movie files, which have a more limited set of compression settings.

### How to access the OpenQuickTime Sound Options dialog box from the Export Movie dialog

1. From the top menu, select **File > Export > Movie**.  
The Export Movie dialog box opens.
2. Set Movie Format to **QuickTime Movie (\*.mov)**.
3. Click on the **Sound Options** button.

### How to access OpenQuickTime Video Options dialog box from the Write node Layer Properties

1. In the Node view, locate your scene's Write node.
2. Open the Write node's Layer Properties by doing one of the following:
  - Click on the yellow square at the left end of the Write node.

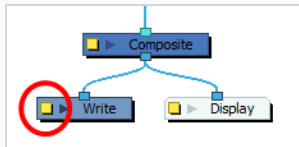

- Right-click on the Write node, then select **Layer Properties**.
3. In the Write node's Layer Properties, enable the **Movie** option.

4. To the right of the Movie check box, open the drop down menu and select **QuickTime Movie (\*.mov)**.
5. To the right of Sound Options, click on **Customize**.

Parameter	Description
Codec	<p>Lets you select a codec. By default, the following codecs will be available:</p> <ul style="list-style-type: none"> <li>• <b>A-Law 2:1:</b> This codec uses logarithms to compress audio data. The resulting audio stream requires half the disk space of uncompressed audio data, but is of noticeably lower quality.</li> <li>• <b>IMA 4:1:</b> This codec compresses audio data to require a quarter of the disk space required for uncompressed audio data. It is not supported by a lot of software.</li> <li>• <b>Twos Complement - Little Endian PCM:</b> A standard uncompressed audio codec.</li> <li>• <b>Twos Complement - Big Endian PCM:</b> A legacy standard uncompressed audio codec. This codec may be compatible with older editing interfaces.</li> <li>• <b>(mu)-Law 2:1:</b> Similarly to A-Law, this codec uses logarithms to compress audio data. The resulting audio stream requires half the disk space of uncompressed audio data, but is of noticeably lower quality.</li> </ul>
Sample rate	<p>The sample rate at which to export your scene's audio. The only available option is <b>22050Hz</b>.</p>

## QuickTime Sound Settings Dialog Box

The Sound Settings dialog box lets you set the audio compression settings when you want to export a QuickTime Movie (.mov) file.

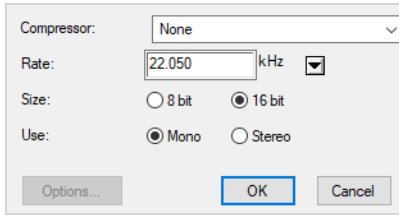

### NOTE

This dialog can only be accessed on Windows and macOS. On Windows, [Apple QuickTime](#) must be installed to be able to export QuickTime Movie (.mov) files.

### How to access the Sound Settings Dialog Box from the Export Movie dialog

1. From the top menu, select **File > Export > Movie**.  
The Export Movie dialog box opens.
2. Set Movie Format to **QuickTime Movie (\*.mov)**.
3. Click on the **Movie Settings** button.
4. In the Movie Setting dialog box that opens, click **Settings** in the Sound section.

### How to access the Sound Settings Dialog Box from the Write node Layer Properties

1. In the Node view, locate your scene's Write node.
2. Open the Write node's Layer Properties by doing one of the following:
  - Click on the yellow square at the left end of the Write node.

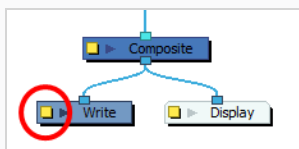

- Right-click on the Write node, then select **Layer Properties**.
3. In the Write node's Layer Properties, enable the **Movie** option.



1. To the right of the Movie check box, open the drop down menu and select **QuickTime Movie (\*.mov)**.
2. To the right of Movie Options, click on **Customize**.
3. In the Movie Setting dialog box that opens, click **Settings** in the Sound section.

Parameter	Description
Compressor	Lets you select a compression type. The default setting is <b>None</b> . This exports your audio as is without performing any lossy compression or conversion, preserving its fidelity. Other compressors can be used if you need your movie's audio track to be exported in a specific format, or if disk space or download speed is critical, but they may impact the quality of your movie's soundtrack negatively.
Rate	Lets you select the audio rate at which to export. It is best to export your audio at a rate that matches the rate of your original sound files. For example, if your file has an audio sample rate of 48 kHz and you choose a conversion rate of 22.05 kHz, the sound will play at the same speed, but higher frequencies will be missing, making it sound muffled. For reference, the standard sound quality is <b>48 kHz</b> for broadcasting and DVD. Lower rates are liable to impact the quality of your movie's soundtrack negatively, but they can be useful if disk space or download speed is critical.
Size	Lets you select the encoding size. Also known as <i>Bit Depth</i> , this determines the amount of precision used to record each wavelength in the audio track. The standard size is <b>16-bit</b> . If you choose <b>8-bit</b> , the amount of disk space the audio track of your movie file requires is halved, but the audio quality will be significantly lower.
Use	Lets you decide whether to use the <b>Mono</b> or <b>Stereo</b> channel mode. Stereo sound has a separate audio track for the left and the right speakers, allowing to make the origin of each sound realistically match the origin of their corresponding action. If you choose Mono, the audio track in the exported movie file may use less disk space, but both the left and right channels will be merged into a single track.

## QuickTime Standard Video Compression Settings Dialog Box

The Standard Video Compression Settings dialog box lets you configure the video compression settings when exporting a QuickTime Movie (.mov) file.

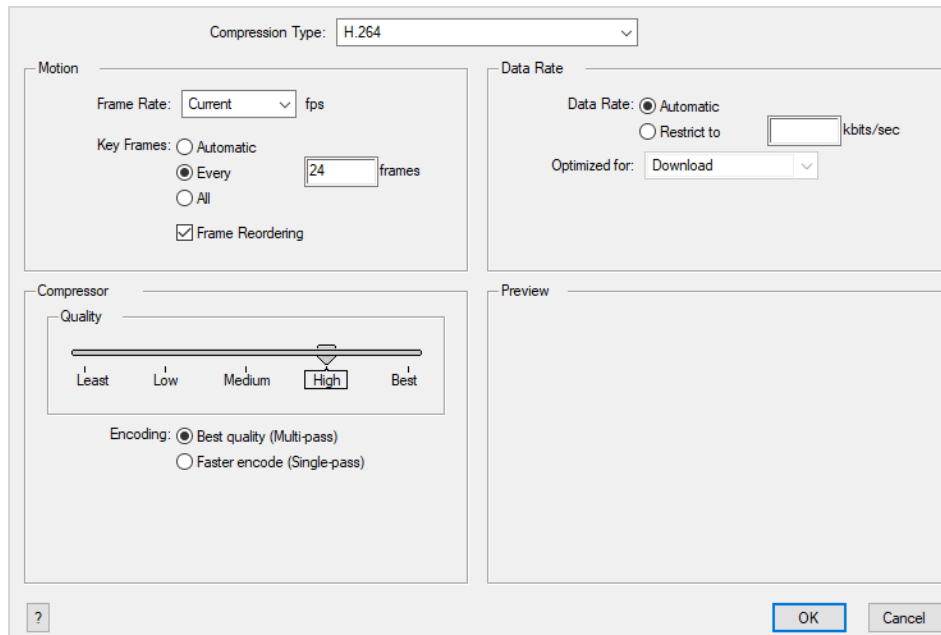

### NOTE

This dialog can only be accessed on Windows and macOS. On Windows, [Apple QuickTime](#) must be installed to be able to export QuickTime Movie (.mov) files.

### How to access the Standard Video Compression Settings Dialog Box from the Export Movie dialog

1. From the top menu, select **File > Export > Movie**.  
The Export Movie dialog box opens.
2. Set Movie Format to **QuickTime Movie (\*.mov)**.
3. Click on the **Movie Settings** button.
4. In the Movie Setting dialog box that opens, click **Settings** in the Video section.



## How to access the Standard Video Compression Settings Dialog Box from the Write node Layer Properties

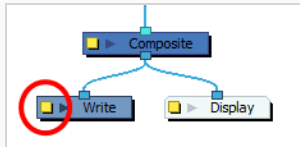

1. In the Node view, locate your scene's Write node.
2. Open the Write node's Layer Properties by doing one of the following:
  - Click on the yellow square at the left end of the Write node.



- Right-click on the Write node, then select **Layer Properties**.
3. In the Write node's Layer Properties, enable the **Movie** option.
    1. To the right of the Movie check box, open the drop down menu and select **QuickTime Movie (\*.mov)**.
    2. To the right of Movie Options, click on **Customize**.
    3. In the Movie Setting dialog box that opens, click **Settings** in the Video section.

Parameter	Description
Compression Type	<p>Allows you to select the codec to use for the video stream of your movie file. The availability of codecs may vary between machines. If you are unsure of which codec is best fit for you, it is recommended to use <b>H.264</b> for maximum portability, and to use <b>Animation</b> if quality is more important.</p> <div style="border: 1px solid green; padding: 5px; margin-top: 10px;"> <p> <b>NOTE</b> The Animation codec, among a few others, allows you to set the colour depth to <b>Millions of Colors+</b>, which supports transparency.</p> </div>
Motion	
Frame Rate	The amount of frames per second for the video stream. Leave this setting to <b>Current</b> to use your project's frame rate.
Key Frames	Some codecs compress the video by recording a limited amount of <b>keyframes</b> , which are frames in which the entire picture is encoded, pixel by pixel and, in-between, recording <b>deltas</b> , which are frames that are only defined by their

Parameter	Description
	<p>difference with the previous frame. This significantly reduces the size of the movie file. However, the less keyframes a movie has, the more it is likely to encounter decoding errors, and the harder it is for players to scrub or jump to a specific time in the video. This option allows you to decide when keyframes are inserted in the video stream.</p> <p><b>Automatic:</b> Lets the encoder decide when keyframes should be inserted.</p> <p><b>Every ... frames:</b> Allows you to set the exact interval, in frames, at which keyframes should be inserted.</p> <p><b>All:</b> Encodes every frame as a keyframe. This option will significantly impact file size, but will make it easier to scrub through the video without causing any rendering error.</p> <div data-bbox="565 751 1430 961" style="border: 1px solid #c8e6c9; padding: 10px;"> <p> <b>NOTE</b> If you are using the H.264 codec, you must set the Key Frames option to <b>All</b>, or you will get an error message when you confirm the compression settings.</p> </div>
Frame Reordering	Encodes frames in a different order than the one at which they are meant to be displayed. This allows for more efficient compression, but may not be compatible with some players.
Compressor	
Depth	<p>Allows you to set the colour depth for your video. A lower colour depth will reduce the size of the video stream but will have significant impacts on picture quality.</p> <div data-bbox="565 1402 1430 1577" style="border: 1px solid #bbdefb; padding: 10px;"> <p> <b>TIP</b> Set this to <b>Millions of Colors+</b> if you want to export a video with transparency.</p> </div>
Quality	Lets you choose a quality setting for the video compression. A higher quality setting will increase the size of the movie file, but will look better. A lower quality setting will reduce the size of the movie file, but will cause blurriness and compression artifacts to appear in the picture.
Scan Mode / Interlaced	Allows you to choose between the following scan modes:

Parameter	Description
	<ul style="list-style-type: none"> <li>• <b>Interlaced:</b> Frames are encoded starting with their odd-numbered scanlines, then their even-numbered scanlines.</li> <li>• <b>Progressive:</b> Frames are encoded whole, from the highest scanline to the lowest scanline.</li> </ul> <div style="border: 1px solid green; padding: 5px; margin-top: 10px;">  <b>NOTE</b>  Some codecs will display a drop-down allowing you to select Interlaced or Progressive, while others will simply have an Interlaced checkbox. </div>
Aspect Ratio	<p>Allows you to select one of the following aspect ratios:</p> <ul style="list-style-type: none"> <li>• <b>4:3:</b> For output on standard definition displays.</li> <li>• <b>16:9:</b> For output to widescreen displays.</li> </ul>
Filter	<p>When exporting with the <b>PNG</b> compression type, this determines the algorithm with which each pixel is encoded relative to other pixels. Leaving this option to <b>Best</b> will export in the most space-efficient filter, without compromising picture quality. Picking a filter may increase rendering speed a bit, at the expense of some disk space.</p>
Data Rate	
Automatic	<p>Lets the encoder use the optimal bit rate for your compression settings.</p>
Restrict To	<p>Allows you to specify the encoding bit rate.</p> <div style="border: 1px solid green; padding: 5px; margin-top: 10px;">  <b>NOTE</b>  This setting will override other compression settings, so that the specified bit rate is respected. </div>
Optimized For	<p>Optimize the encoding to be responsive depending on the intended viewing method:</p> <ul style="list-style-type: none"> <li>• <b>CD/DVD-ROM:</b> Optimizes the bit rate for a video that will be played using an optical disc player.</li> <li>• <b>Download:</b> Optimizes the bit rate for a file that is going to be downloaded, then viewed from the user's hard drive.</li> <li>• <b>Streaming:</b> Optimized the bit rate for a video that will be streamed from</li> </ul>

Parameter	Description
	the web and played as the video is being downloaded.

## Timeline Scene Marker Dialog Box

The Timeline Scene Marker dialog box lets you create and manage scene markers in the Timeline view. Scene markers are visual indicators displayed at the top of the Timeline view in the frame counter area. You can use it to denote anything relevant to your work. You can indicate the frames you want to clean up, a change in action, an impact, or where you intend to apply an effect. You can also add a note to a scene marker, which is displayed when you hover over the scene marker.

### How to access the Timeline Scene Marker dialog box

1. In the frame counter area of the Timeline view, do one of the following:
  - ▶ Drag to select the frame range to mark.
  - ▶ Right-click and select **Scene Markers > Mark Current Frame**.

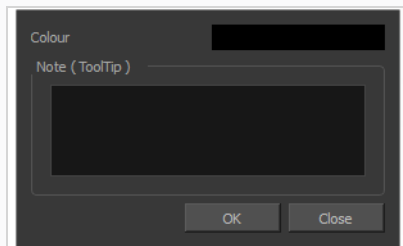

Parameter	Description
Colour swatch	Opens the Mark Colour dialog box where you can select a colour for the scene marker.
Note (Tooltip)	Lets you type in a name for your scene marker. Making the name meaningful will help you to quickly identify scene markers especially when there are many of them in the frame counter area of the Timeline view.

## Tint Offset/Blend Dialog Box

You can offset, blend, or mix the colours in a colour palette using the sliders and increasing the Amount value.

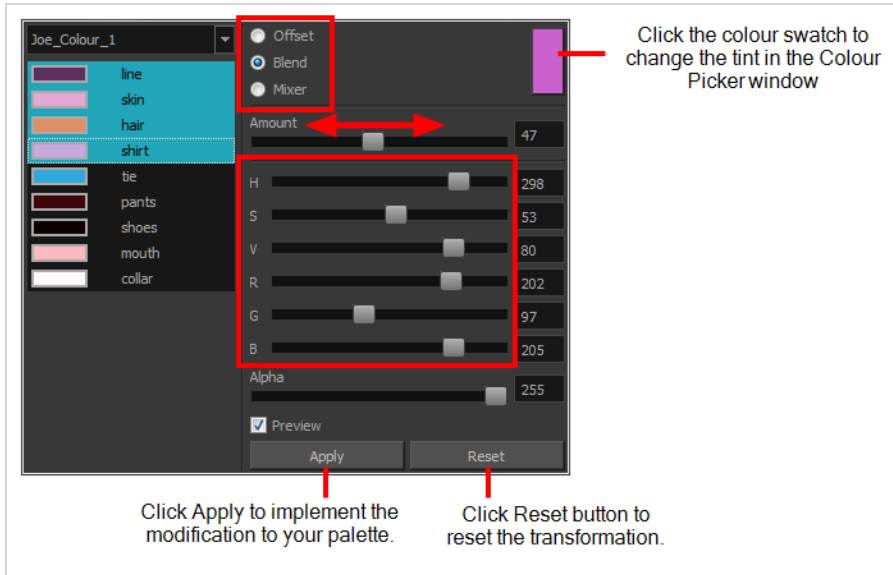

### How to access the Tint Offset/Blend dialog box

1. From the Colour View menu, select **Palettes > Tint Panel** or right-click and select **Tint Panel**.

The Blend/Offset Tint panel opens.

Parameter	Description
Offset	Offsets the selected colours by the adjustments made using the HSB and RGB sliders. Use the Amount slider to adjust the degree of offset. Use the Alpha slider to adjust the opacity of the selected colour.
Blend	Blends the selected colours with the colour swatch in the top-right corner. Use the Amount slider to adjust the degree of blend. A blend of 100% turns the selected colours into the same colour as the swatch. Adjusting the HSB and RGB sliders affect the swatch colour, which in turn affects the selected colours on the left. Use the Alpha slider to adjust the opacity of the swatch.
Mixer	Select a Base and Tint colour to form a third colour swatch. Use the slider just beneath to mix the Base and Tint colours by different amounts. This will affect the mixed swatch whether it is selected or not. Select either the Tint or Base swatch and use the HSB and RGB sliders to adjust its colour. This will affect the mixed



	swatch colour, which in turn affects the selected colours on the left.
--	--

## Toolbar Manager Dialog Box

The Toolbar Manager dialog box lets you customize the toolbar in any of the views. You can add your favourite tools to a toolbar for an efficient workflow.

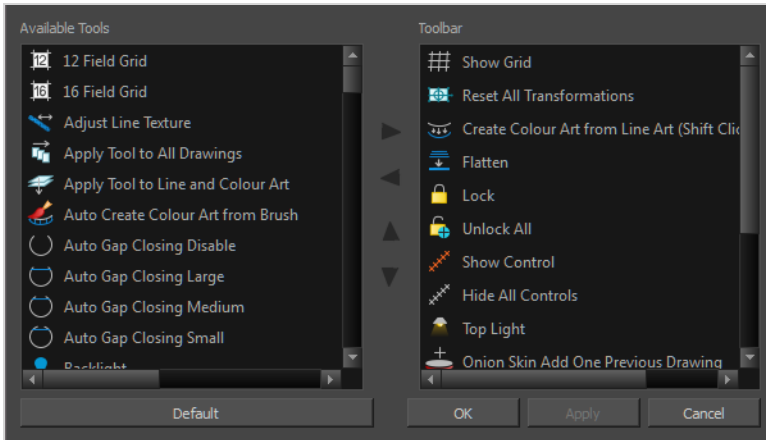

### How to access the Toolbar Manager dialog box

1. Right-click on a toolbar in any view and select **Customize**. Note that the menu will not appear if you right-click on a disabled icon.

Parameter	Description
Available Tools	Displays the complete list of tools available for customizing a toolbar.
Toolbar	Displays a list of the tools currently available on the toolbar.
Default	Restores the toolbar with its default items.

## Vectorization Parameters Dialog Box

The Vectorization Parameters dialog box lets you vectorize pencil drawings, along with any red, blue or green pencil marks you may have used to indicate highlights and shadows. The drawing will be vectorized into pure red, blue, green and black (RGB values), while creating colour art zones wherever lines connect. After painting in your tones and highlights, change your pure RGB colours to transparent (0 Alpha) in the Colour Picker window and watch the indicator colour zone lines disappear.

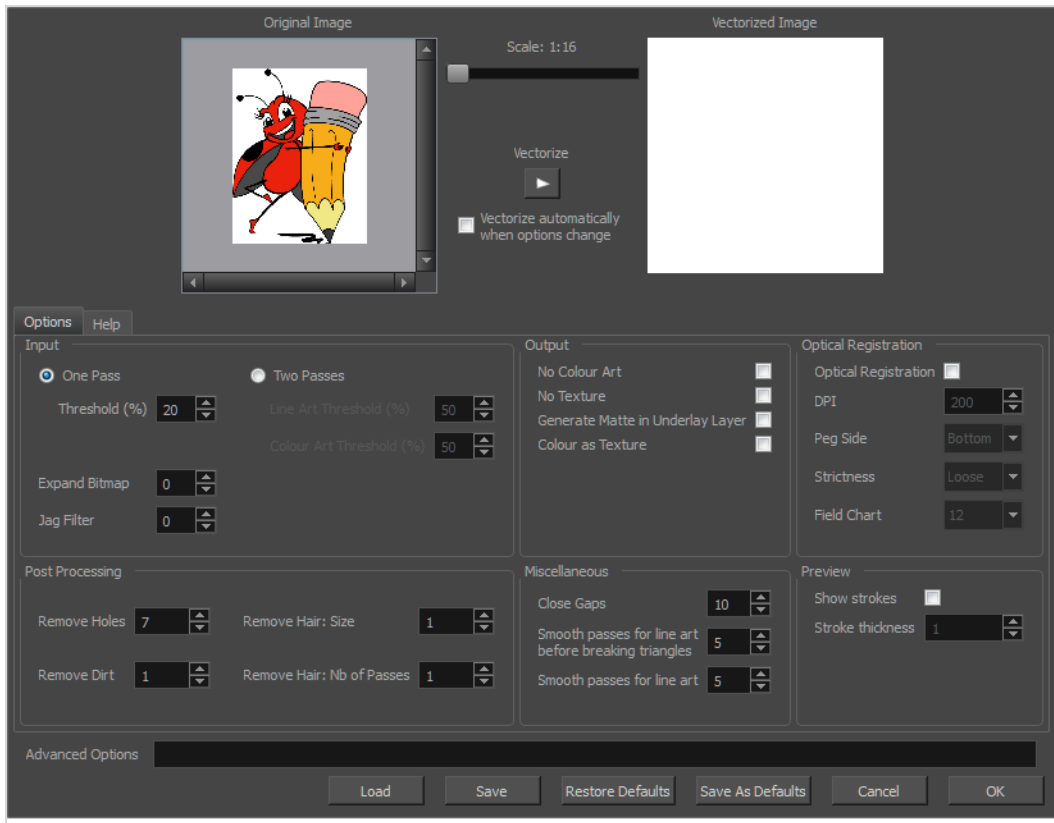

### How to open the Vectorization Parameters dialog box

1. From the top menu, select **File > Import > From Scanner**.  
You can also open it from any other import option that allows you to customize the vectorization parameters (i.e. from the scanner).
2. In the Scan Drawings window, do the following:
  - In the Layer section, decide on the layer options.
  - In the Import Options section, select the **Convert to Toon Boom Vector Drawing** option
  - Click **Preview**.

- In the Vectorization section, click the Vectorization Parameters  button.

## Options Tab

The Options tab contains the main vectorization settings. More settings are available in the Help tab.

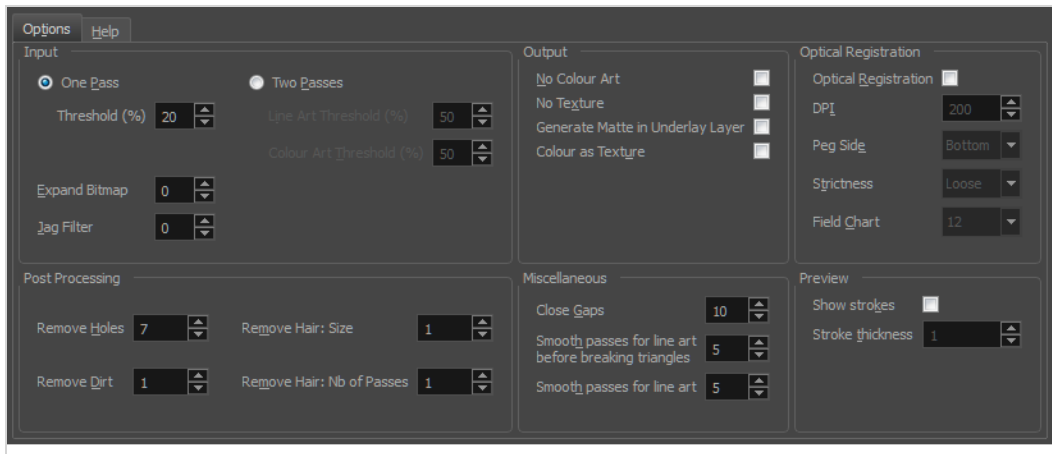

Parameter	Description
Input	The input filters are applied to the bitmap image before it is vectorized.
One Pass	One threshold value is applied to both the Line and Colour Art. For drawings with distinct vector-style lines of mattes, you only need one pass.
Two Passes	Applies a different threshold value to each layer. For greyscale drawings, you may want to perform the vectorization process twice to apply different threshold values to the Line and Colour Art layers.
Threshold	Determines which values in the scanned image are considered part of the Line and Colour Art layer and what will be eliminated from the vectorized drawing; 0% is white and 100% is black. The threshold is between these two values.
Expand Bitmap	Lets you enter a value to scale the bitmap to detect small variations in the line. Use this option if you scanned a greyscale image and want to preserve small variations in the texture to apply to the line art.
Jag Filter	Lets you enter a value to scale back the bitmap to remove some of the line's roughness. This is useless when you have a drawing that appears quite rough;

	the Jag filter will eliminate excess strokes in the final drawing.
Line Art Threshold (%)	Determines which values in the scanned image are considered part of the Line Art layer and what will be eliminated from the vectorized drawing; 0% is white and 100% is black. The threshold is between these two values.
Colour Art Threshold (%)	Determines which values in the scanned image are considered part of the Colour Art layer and what will be eliminated from the vectorized drawing; 0% is white and 100% is black. The threshold is between these two values.
Output	The output filters are applied during the vectorization process.
No Colour Art	Does not generate filling zones in the Colour Art layer.
No Texture	Does not generate texture in the Line Art layer in the final images. Select this option to create solid lines in the final line art.
Generate Matte in Underlay Layer	Creates an opaque zone behind your drawing's lines to avoid seeing through the layers.
Colour as Texture	Converts colour values into a texture layer.
Optical Registration	The optical registration options are used to automatically align drawings based on the position of the peg holes on the animation paper. The peg holes must appear in the scanned drawings for the optical registration to work.
DPI	Lets you enter the dots-per-inch value of your image. You must enter the same value as the DPI used to scan the image.
Peg Side	Lets you select the position of the peg holes on your drawings. Identify whether they are on the top, bottom, left or right.
Strictness	Determines how exact the location of the peg holes must be for the software to recognize them. There are two values to choose from:  <b>Strict:</b> The peg holes must be in a tightly defined area to be recognized.  <b>Loose:</b> The peg holes can be recognized somewhere in a larger area. This is the recommended setting.
Field Chart	Lets you indicate the size of the animation paper, 12 or 16.

Post Processing	The Post Processing filters are applied to the final vector images.
Remove Holes	Removes holes of a specified value that might make painting difficult.
Remove Dirt	Removes stray marks and dirt of a specified value. Try a value around 500.
Remove Hair Size	Removes small strokes that have no line art.
Remove Hair: Number of Passes	The number of times the drawing will be analyzed to identify hair marks.
Miscellaneous	
Close Gaps	Closes gaps in the Colour Art so you can paint it.
Smooth Passes for Line Art Before Breaking Triangles	The number of times the smoothing operation runs before creating the triangles that break lines in the drawing. If unnecessary triangles are appearing in the drawing, increase this value.
Smooth Passes for Line Art	The number of times the smoothing operation is performed after the triangles have been created. This further smooths the line art.
Preview	
Show Strokes	Shows the strokes in the Vectorized Image panel.
Stroke Thickness	Shows the size of the strokes.

## Help Tab

The Help tab contains the most advanced vectorization settings which you type in the Advanced Option fields at the bottom of the Vectorization Parameters dialog box.

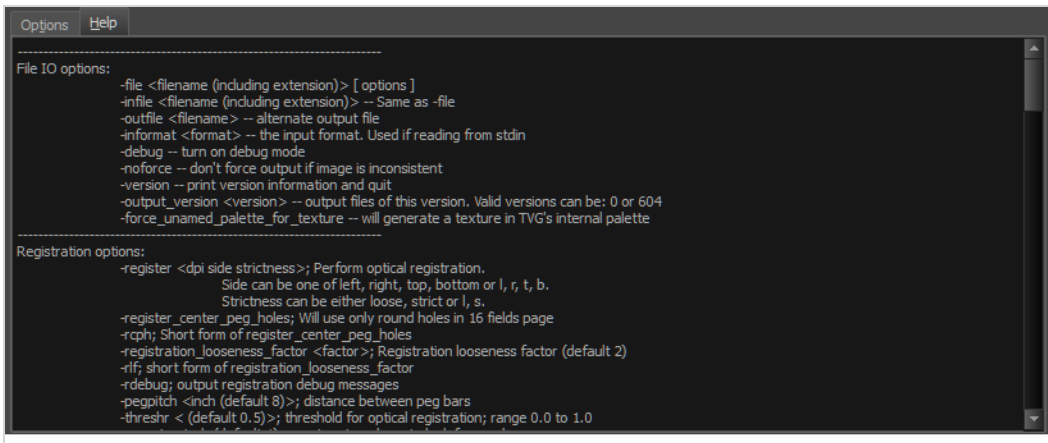

## File IO Options

- file** <filename (including extension)> [ options ]
- infile** <filename (including extension)>; same as -file
- outfile** <filename>; alternate output file
- informat** <format>; the input format. Used if reading from stdin
- debug**; turn on debug mode
- noforce**; don't force output if image is inconsistent
- version**; print version information and quit
- output\_version** <version>; output files of this version. Valid versions can be: 0 or 604
- force\_unnamed\_palette\_for\_texture**; will generate a texture in TVG's internal palette

## Registration Options

- register** <dpi side strictness>; perform optical registration.
  - Side can be one of left, right, top, bottom or l, r, t, b.
  - Strictness can be either loose, strict or l, s.
- register\_center\_peg\_holes**; will use only round holes in 16 fields page
- rcph**; short form of register\_center\_peg\_holes
- registration\_looseness\_factor** <factor>; registration looseness factor (default 2.000000)
- rlf**; short form of registration\_looseness\_factor
- rdebug**; output registration debug messages
- pegpitch** <inch (default 8.000000)>; distance between peg bars
- threshr** <(default 0.500000)>; threshold for optical registration; range 0.0 to 1.0

- rmargin** <inch (default 1)>; region size where to look for peg bars
- peg\_distance\_from\_center** <inch (default 5.25)>; peg distance from centre of the image
- pdfc**; short form of -peg\_distance\_from\_center
- out\_peg\_position** <side (default same)>; wanted position of the peg on the drawing.
  - Can be one of right, left, top, bottom (or r, l, t, b) or same.
  - A rotation will be performed if it is different from the side passed to -register.
- output\_peg\_matrix**; output the peg transformation matrix on standard output.
- scanner\_calibrate**; < (default 1.0000 1.0000) > x and y scale factors to be applied to scanner image.

## Filtering Options

- pixel** <pixel\_shape (default '4x3')>; Valid values: 4x3
- gap** <worldUnits (default 10)>; close gaps up to this big
- pencil**; generate line art only
- keep\_dirt**; don't filter out dirt
- thresh** <threshold (default 0.2)>; range 0.0 to 1.0
- rmv\_hairs** <worldUnits (default 1)> <passes (default 1)>
  - remove hairs of size smaller than "size" in "passes" passes
- rmv\_holes** <area (default 7)>; remove holes smaller than "area"
- rmv\_dirt** <area (default 1)>; remove dirt smaller than "area"
  - try values between 100 and 500 for rmv\_holes and rmv\_dirt. The area is in world units squared
- rmv\_triangles** <worldUnits (default 30.000000)>; remove triangles at "pixels"
  - distance from each other. Use -no\_break to remove all triangles
- no\_texture**; don't generate textured strokes
- color\_as\_texture**; will vectorize the alpha channel and put the RGB colour in a textured colour
- noclosegap**; disable all gap closing algorithms
- no\_break**; disable the breaking of line art
- jag\_filter** <pixels (default 0)>; expand the pixels in the vectorization bitmap
- expand\_bitmap** <pixels (default 0)>; expand the pixels in the vectorization bitmap
- fit\_errorc** <error (default 1.000000)>; fitting error for the colour art
- fit\_errorl** <error (default 1.000000)>; fitting error for the line art
- smoothl** <passes (default 1)>; number of smooth passes for line art



- smoothc** <passes (default 1)>; number of smooth passes for colour art
- first\_smooth** <passes (default 0)>; number of smooth passes for line art before breaking triangles
- first\_smoothl** <passes (default 0)>; number of smooth passes for line art before breaking triangles
- first\_smoothc** <passes (default 0)>; number of smooth passes for line art in colour art pass (needs -2pass)
- 2pass**; specify two sets of parameters; one for line art "l", one for colour art "c"
  - (-thresh, -rmv\_holes and -rmv\_dirt will be overridden by -threshl, threshc, -rmv\_holesl, -rmv\_holesc, -rmv\_dirtl and -rmv\_dirtc)
- threshl** <threshold for line art (default 0.5)>; range 0.0 to 1.0
- threshc** <threshold for color art (default 0.5)>; range 0.0 to 1.0
- jag\_filterl** <pixels (default 0)>; expand the pixels in the vectorization bitmap for line art
- jag\_filterc** <pixels (default 0)>; expand the pixels in the vectorization bitmap for colour art
- expand\_bitmapl** <pixels (default 0)>; expand the pixels in the vectorization bitmap for line art
- expand\_bitmapc** <pixels (default 0)>; expand the pixels in the vectorization bitmap for colour art
- rmv\_holesl** <area (default 7)>; remove line art holes smaller than "area"
- rmv\_holesc** <area (default 7)>; remove colour art holes smaller than "area"
- rmv\_dirtl** <area (default 1)>; remove line art dirt smaller than "area"
- rmv\_dirtc** <area (default 1)>; remove colour art dirt smaller than "area"
  - try values between 100 and 500 for rmv\_holesl, rmv\_holesc, rmv\_dirtl and rmv\_dirtc. The values are in world units squared
- margins** <inch (default 0.25)>; remove margin around bitmap
- top\_margin** <inch (default 0.25)>; remove margin at top of bitmap
- bottom\_margin** <inch (default 0.25)>; remove margin at bottom of bitmap
- left\_margin** <inch (default 0.25)>; remove margin at left of bitmap
- right\_margin** <inch (default 0.25)>; remove margin at right of bitmap
- remove\_peg\_bars**; remove the peg bar holes
- field\_size** <fields (default 12 or use value in scan file)>; set the drawing to this field size
- fs**; short hand for -field\_size
- peg\_bar\_size** <inch (default 1)>; the size of the peg bar region
- noframe**; do not put a frame around the colour art
- frame\_fields** <default -1.000000>; put a frame of the specified dimension around the colour art
- downscale\_input** <default 1>; downscale the raw input by this integer factor

**-downscale\_texture** <default 1>; downscale the output texture by this integer factor

**-buildmatte**; generate a matte on underlay for line test

**-buildmatte\_colourart**; generate a matte on colour art for line test

**NOTE**

-buildmatte and -buildmatte\_colourart are mutually exclusive

**-copystrokes**; copy original strokes when building matte.

## Options for bitmap that has no registration information

**-pixel\_margins** <inch (default 0)>; remove margin around bitmap

**-top\_pixel\_margin** <inch (default 0)>; remove margin at top of bitmap

**-bottom\_pixel\_margin** <inch (default 0)>; remove margin at bottom of bitmap

**-left\_pixel\_margin** <inch (default 0)>; remove margin at left of bitmap

**-right\_pixel\_margin** <inch (default 0)>; remove margin at right of bitmap

**-dpi** <(default -1)>; dpi information of input bitmap

## RGB Keying Options

**-rgb**; generate separate zones for red, green and blue lines

**-rgb\_alpha** <value (default 255)>; generate red, green and blue colour with alpha of this value

**-no\_red**; ignore red colour in vectorization

**-no\_green**; ignore green colour in vectorization

**-no\_blue**; ignore blue colour in vectorization

**-flatten**; flatten the drawing after generating colours

**-rmv\_rgb\_dirt** <threshold area default 0.0>; remove red, green and blue regions smaller than area

**-expand\_bitmap\_rgb** <pixels (default 0)>; expand the pixels in the vectorization bitmap for rgb

**-threshrgb** <value> <threshold for rgb vectorization default 0.200000>;

**-threshsv** <saturation threshold default 0.500000> <value threshold default 0.500000>; thresholds on saturation and value to consider a pixel to be grey

## Colour Vectorization Options

**-color\_vectorize**; perform a colour vectorization

**-file2** <colour art filename>; specify the colour art bitmap

- penstyle** <center alpha (0.0-20.0)> <edge alpha (0.0-20.0)> <gamma (0-10)><centre pressure effect (0.0-1.0)> <edge pressure effect (0.0-1.0)><texture bitmap downscaling (0.2-20)> <texture bitmap file (valid filename or "" if no file)>; generate brush texture for the line art
- pressure\_variation** <strategy (0, 1 or 2)> <min pressure (0.0-1.0)> <max pressure (0.0-1.0)> <max variation (0.0-1.0)>; specify a pressure strategy for the centre line.
- blur\_radius** <pixels (default 0)>; blur the penstyle texture generated
- color\_contour\_smooth\_passes** <times (default 3)>; perform number of smooth passes on contour before computing texture
- ccsp** <times (default 3)>; short for -color\_contour\_smooth\_passes
- color\_rmv\_holesl** <world units (default 0.000000)>; remove holes of this size when computing texture
- color\_fill\_holesl** <world units (default 0.000000)>; fill holes of this size for colour line art

## Bubble Usage (implemented only for colour vectorization's line art)

- create\_bubbles**; add bubbles into the LineArt. Implemented for colour vectorization only
- bubble\_gap** <value (default 3)>; max number of colour art points between 2 bubbles
- bubble\_length** <value (default 10)>; max number of circles in a bubble
- min\_radius** <value (default 1.5000)>; min radius of a circle in a bubble relative to the line thickness (must be >= 1.0)
- max\_radius** <value (default 3.5000)>; max radius of a circle in a bubble relative to the line thickness (must be >= 1.0)
- uniform\_gap**; the space between bubbles is constant

## 4 Colour Vectorization

-**4colours** [key:value] ... [key:value] ; The key value list can be empty. The list of keys is:

**rgbdiff:value** ; between [0.0-1.0] or [0-255]

**dark:value** ; between [0.0-1.0] or [0-255]

**grey:value** ; between [0.0-1.0] or [0-255]

**white:value** ; between [0.0-1.0] or [0-255]

**dirt:value** ; dirt area. 200 is a good value

**rt:value** ; between [0.0-1.0] or [0-255]

**gt:value** ; between [0.0-1.0] or [0-255]

**bt:value** ; between [0.0-1.0] or [0-255]



**NOTE**

There must be no space between the colon and the key/value. For example: -4colours rgbdiff:20  
dark:20 grey:120 white:250 dirt:200 rt:240 gt:240 bt:240

## Versions Dialog Box

The Versions window lets you delete any unnecessary versions of scenes when working with Harmony Server. When working with multiple versions of a scene, you may want to clean up the database by deleting the ones you no longer need.

### How to access the Versions window

1. Make sure you have the necessary rights. If you do not, select **File > Rights to Modify Scene**.
2. Select **File > Manage Versions**.

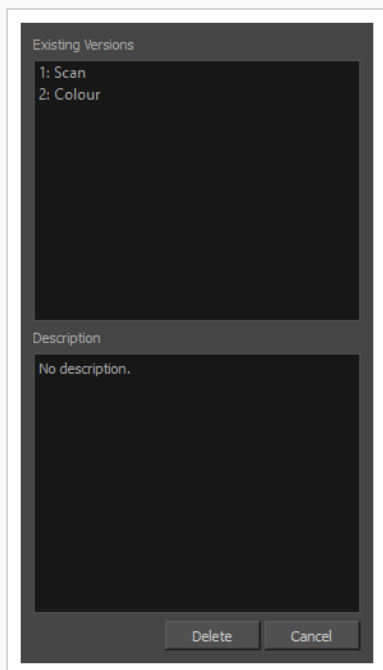

Parameter	Description
Existing Versions	Displays the different versions of a scene that you can delete.
Description	Displays information about the selected version.
Delete	Removes the selected version of a scene. <div style="border: 1px solid red; padding: 5px; margin-top: 10px;">  <b>IMPORTANT</b>            This operation cannot be undone.         </div>

## OpenQuickTime Video Options Dialog Box

The OpenQuickTime Video Options dialog box is used to configure the video compression settings when exporting a QuickTime movie file on Linux.

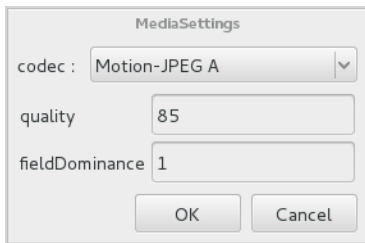

On Windows and macOS, Harmony uses Apple QuickTime to export QuickTime movies, and hence uses QuickTime's interface to configure video and audio compression settings for exporting movies. Since QuickTime is not supported on GNU/Linux, Harmony uses the OpenQuickTime library to create QuickTime-compatible movie files, which have a more limited set of compression settings.

### How to access the OpenQuickTime Video Options dialog box from the Export Movie dialog

1. From the top menu, select **File > Export > Movie**.

The Export Movie dialog box opens.

2. Set Movie Format to **QuickTime Movie (\*.mov)**.
3. Click on the **Video Options** button.

### How to access OpenQuickTime Video Options dialog box from the Write node Layer Properties

1. In the Node view, locate your scene's Write node.
2. Open the Write node's Layer Properties by doing one of the following:
  - Click on the yellow square at the left of your Write node.
  - Right-click on the Write node, then select **Layer Properties**.
3. In the Write node's Layer Properties, enable the **Movie** option.
4. To the right of the Movie check box, open the drop down menu and select **QuickTime Movie (\*.mov)**.
5. To the right of Video Options, click on **Customize**.

Parameter	Description
Codec	<p>Lets you select a codec. By default, the following codecs will be available:</p> <ul style="list-style-type: none"> <li>• <b>Motion-JPEG A:</b> A very portable codec that performs lossy JPEG compression and interlaces the frames. Motion-JPEG A compression is less efficient than Photo JPEG in terms of quality and file size, but may be a more portable alternative for software that does not support Photo JPEG.</li> <li>• <b>Photo JPEG:</b> Encodes the movie as a sequence of JPEG images. JPEG images have lossy compression. This is the most efficient codec for file size.</li> <li>• <b>Portable Network Graphics (PNG):</b> Encodes the movie as a sequence of PNG images. PNG images have lossless compression.</li> <li>• <b>Tag Image File Format (TIFF):</b> Encodes the movie as a sequence of uncompressed TIFF images. This codec is lossless.</li> <li>• <b>Uncompressed (RGB):</b> Encodes the movie as uncompressed bitmap data. This codec is lossless.</li> </ul>
Quality	<p>For JPEG-type codecs, lets you set the JPEG compression quality. By default, this will be set to 85. Possible values range from 0 to 100. The higher the quality, the more disk space the resulting video file will take.</p>
fieldDominance	<p>For codecs with interlacing. This is set to 1 by default. If set to 1, the first field will be encoded on odd frames, and the second field will be encoded on even frames. If set to 2, the first field will be encoded on even frames, and the second field will be encoded on odd frames.</p>
compression	<p>The amount of lossless compression to perform when exporting in PNG format. PNG compression is lossless, but higher compression settings will take longer to encode and decode.</p>
packbits	<p>For TIFF movies, this option adds extra lossless compression to the encoding.</p>
lendian	<p>Encodes data in little endian byte order, instead of big endian.</p>

## Windows Media Video Settings Dialog Box

The WMV Settings dialog box lets you set the video and audio settings when exporting a Windows Media Video (.wmv) movie.

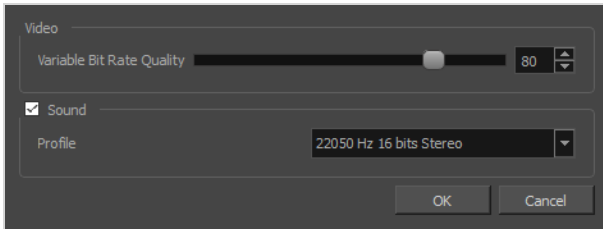

### NOTE

The option to export to Windows Media Video is only available on Windows.

### How to access the WMV Settings dialog box from the Export Movie dialog

1. From the top menu, select **File > Export > Movie**.  
The Export Movie dialog box opens.
2. Set Movie Format to **Windows Media Video (\*.wmv)**.
3. Click on the **Movie Settings** button.

### How to access the WMV Settings dialog box from the Write node Layer Properties

1. In the Node view, locate your scene's Write node.
2. Open the Write node's Layer Properties by doing one of the following:
  - Click on the yellow square at the left end of the Write node.

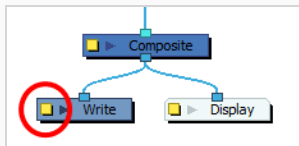

- Right-click on the Write node, then select **Layer Properties**.
3. In the Write node's Layer Properties, enable the **Movie** option.
    1. To the right of the Movie check box, open the drop down menu and select **Windows Media Video (\*.wmv)**.
    2. To the right of Movie Options, click on **Customize**.



Parameter	Description
Video	
Variable Bit Rate Quality	Lets you choose a quality setting ranging from 5 to 100 for the video stream. The higher the quality of the export, the larger the resulting file.
Sound	
Profile	<p>Lets you choose among preset combinations of audio sample rates, sample sizes and channel modes for the audio stream:</p> <ul style="list-style-type: none"> <li>• <b>Sample rate:</b> Available sample rates are 8000 Hz, 16000 Hz, 22050 Hz and 44100 Hz. The default setting is 22050 Hz. It is best to export your audio at a rate that matches the rate of your original sound files. For example, if your file has an audio sample rate of 48000 Hz and you choose a sample rate of 22050 Hz, the sound will play at the same speed, but higher frequencies will be missing, making it sound muffled. For reference, the standard sound quality is <b>44000 kHz</b> for films, and <b>48000 kHz</b> for DVD. Lower rates are liable to impact the quality of your movie's audio track negatively, but they can be useful if disk space or download speed is critical.</li> <li>• <b>Sample size:</b> Also known as Bit Depth, this determines the amount of precision used to record each wavelength in the audio track. The standard size is <b>16-bit</b>. If you choose <b>8-bit</b>, the amount of disk space the audio track of your movie file requires is halved, but the audio quality will be significantly lower.</li> <li>• <b>Channel mode:</b> Stereo sound has a separate audio track for the left and the right speakers, allowing to make the origin of each sound realistically match the origin of their corresponding action. If you choose Mono, the audio track in the exported movie file may use less disk space, but both the left and right channels will be merged into a single track.</li> </ul> <div data-bbox="643 1457 1429 1629" style="border: 1px solid green; padding: 10px; margin-top: 10px;">  <p><b>NOTE</b> Exporting in 8-bit audio requires <a href="#">Apple QuickTime</a> to be installed.</p> </div>

## Xsheet Column Width Dialog Box

The Xsheet Column Width dialog box lets modify the width of a column in the Xsheet view and use it as the default column width.

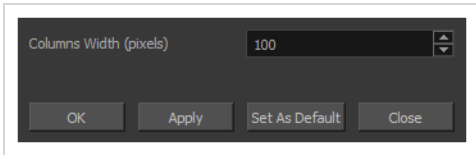

### How to access the Xsheet Column Width Dialog Box

1. In the Xsheet view, select a column.
2. From the Xsheet menu, select **View > Set Columns Width**.

The Xsheet Column Width dialog box opens.

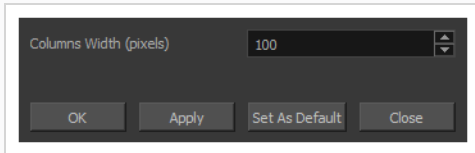

Parameter	Description
Columns Width (pixels)	Lets you set the width of the selected columns (in pixels).
Apply	Applies the value you entered to the selected column without closing the dialog box.
Set As Default	Uses the value you entered as the default for all columns in the Xsheet.

## Chapter 2: Menus

The Menus section covers all the menu entries available in Harmony. There are several types of menus in Harmony: main menus, quick-access menus and view menus. Menus contains most of the functions available. They may also have a toolbar button or keyboard shortcut equivalent.

Main Menu .....	214
Animation Menu .....	215
Drawing Menu .....	225
Edit Menu .....	233
File Menu .....	237
Help Menu .....	241
Insert Menu .....	243
Play Menu .....	245
Scene Menu .....	247
View Menu .....	249
Windows Menu .....	255
View Menus .....	257
3D Graph View Menu .....	258
Camera View Menu .....	260
Colour View Menu .....	277
Drawing View Menu .....	280
Function View Menu .....	292
Library View Menu .....	294
Model View Menu .....	296
Node View Menu .....	298
Node Library View Menu .....	303
Onion Skin View Menu .....	304
Perspective View Menu .....	306
Script Editor View Menu .....	312
Side View Menu .....	317
Timeline View Menu .....	322

Top View Menu .....	327
Xsheet View Menu .....	332

## Main Menu

The top menu contains most of the commands available in Harmony. Depending on the view you're working in and the selected element, some commands are available and others not. The top menu is always located at the very top of the interface.

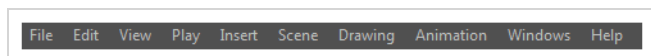
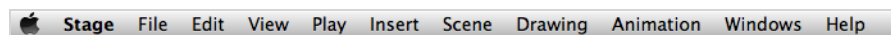

On macOS, there is also a Harmony Premium category that contains the following commands: Preferences, About, and Quit.













<b>Animation Menu</b> .....	<b>215</b>
<b>Drawing Menu</b> .....	<b>225</b>
<b>Edit Menu</b> .....	<b>233</b>
<b>File Menu</b> .....	<b>237</b>
<b>Help Menu</b> .....	<b>241</b>
<b>Insert Menu</b> .....	<b>243</b>
<b>Play Menu</b> .....	<b>245</b>
<b>Scene Menu</b> .....	<b>247</b>
<b>View Menu</b> .....	<b>249</b>
<b>Windows Menu</b> .....	<b>255</b>

## Animation Menu

The Animation menu lets you access tools, adjust animation timing, set deformation, morphing and IK parameters, lock or unlock layers, and select elements in the Xsheet and Timeline views.

### How to access the Animation menu

- At the top of the interface, select **Animation**.

Command	Description
Animate	
Animate Current Frame	When this option is selected, every time you use the  Transform,    Advanced Animation or  Inverse Kinematic tools to manipulate an element in your scene, the position of the element will be stored in a keyframe at the current frame. This allows you to animate elements in your scene without creating keyframes manually.
Animate Onion Skin Range	When this option is selected, if you use the  Transform or    Advanced Animation tools to make transformations to an element in your scene, the transformations will be stored as keyframes at the beginning and at the end of the current Onion Skin range, as well as on every existing keyframe in-between. This can be useful if you want to reposition an element that you have already animated, but only during a specific range of frames, which you can define by enabling Onion Skin and setting the Onion Skin range to cover that range of frames.
Animate Off	When this option is selected, if you use the  Transform or    Advanced Animation tools to make transformation to an element in your scene, the transformations will affect the element throughout the whole scene. This can be useful if you want to reposition an element after you have already animated it.
Stop-Motion Keyframe	Sets a stop-motion keyframe which there is no computer-generated motion between two keyframes. The segment is constant or flat. The drawing remains still until the playback reaches the next keyframe, then the drawing pops to its new location.
Delete Keyframe	Deletes the selected keyframes.

Tools	
Transform	Allows you to select drawing layers and position, rotate, scale and skew them.
Inverse Kinematics	Allows you to pose a character model by pulling on its extremities, such as hands and feet, and have the other connected limbs follow. Can be used on any piece connected in a hierarchy.
Translate	Lets you move the selected element along the X and Y axes.
Rotate	Turns a selected element around its pivot point.
Scale	Increases or decreases the size of a selected element. You can scale an object up to make it larger or down to make it smaller. Press Shift to scale the element while maintaining its proportions.
Skew	Slants the selected element.
Maintain Size	Keeps elements the same size aspect ratio in the Camera view as you move them towards or away from the camera.
Spline Offset	Lets you reposition the visual trajectory without offsetting or modifying your animation. By default, the trajectory is located at 0,0,0 fields. If your elements were drawn in a different location than the centre of the drawing area, it will look like the trajectory is not aligned with your drawing. Also, if you have several elements attached to one trajectory, you might want your trajectory to be at a different location to represent the group's motion better.
Reposition Drawing	Lets you reposition, scale, rotate or skew all drawing strokes on every drawing included in a layer.
Cell	
Increase Exposure	Adds one more exposure to a selected cell; repeating this action adds an extra cell each time. This is an efficient way to extend a drawing's exposure and is always set in Insert mode. Increasing an exposure pushes the existing exposure forward.
Decrease Exposure	Decreases exposure of a selected cell by one; repeating this action

	decreases one exposure adds an extra cell each time. This is an efficient way to shorten a drawing's exposure. Decreasing an exposure pulls in the existing exposure.
Set Exposure to	Lets you set the exposure to 1, 2, 3 or a custom exposure.
Extend Exposure	Lets you enter the frame up to which you want to extend the exposure. You can expose the drawing in the frames and replace the drawings that were originally there or move the subsequent frames forward in time.
Add Key Exposure	Adds a key exposure to the selected cell.
Remove Key Exposure	Removes only the key exposure (key frames) not all the exposures. The existing key exposure is replaced by the preceding exposure.
Remove Duplicate Key Exposure	<p>When working with drawings to adjust the timing of a mouth in a lipsync, for example, and forcing the use of specific key exposures, unnecessary key exposures will be created. You can delete these duplicates without affecting the rest of the drawing. The first drawing of the selection will be used for the range.</p> <div style="border: 1px solid green; padding: 10px; margin-top: 10px;">  <p><b>NOTE</b> Duplicate key exposures may occur when pasting with the Enforce Key Exposure option selected.</p> </div>
Fill Empty Cells	Lets you fill empty cells to extend the exposure of single frame drawings to fill the range of empty cells after each one. When creating drawings on cells that are not side-by-side, the exposure of the first drawing no longer fills automatically. You must select the frame range where you want your drawings to hold their exposure up to the next drawing and use the Fill Empty Cells command.
Insert Blank Cell	Adds an empty cell between other cells.
Clear Exposure	Removes the exposure from the selected cell.
Clear Exposure and Pull	Replaces the exposure from the selected cell with exposures that follow it.
Fill Selection	Lets you fill the same value over an entire selection. The selection can



	be over one cell, a cell range in one column, a cell range over many columns, an entire column, or many columns. You can use numbers, words, letters, or any alphanumeric value.
Sequence Fill	Lets you create a numbered sequence over a selection. The sequence can be forward, backward, single, double or higher increment, as a cycle, and so on. The selection can be over one cell or a cell range in one column or more or an entire column or many entire columns.
Fill Cells Randomly	Lets you fill in random values over a selection. You can give a maximum and a minimum value and create a range for Harmony to choose the random values from. The selection can be over one cell or a cell range in one column or more or an entire column or many entire columns.
Hold Exposure	Lets you expose a drawing for three, four, or five cells and so on.
Deformation	
Set Curves and Offsets Independent from Parent	When you transfer a curve's position to its parent offset, first you must to set curves and offsets independent from parent.
Transfer Curve Values to Offset	Lets you transfer all of the information from first curve deformer to its parent Offset node. This is useful for a legacy scene created using Curve deformations where the Offset's position has been placed far away from the drawing to make sure it doesn't affect the drawing's deformation. You can bring back the offset and give it the first curve's position. The Envelope deformation lets you animate the offset of each curve separately. The offset no longer needs to be placed far away.
Convert Elliptic Deformation ROI to Shape	After you have created a deformation chain using Elliptic as the Zone of Influence type, you can select your deformer and click on this button to convert it to a Shaped type. Control points will appear around the shape making it easy to customize. You can also convert the Elliptic zone of influence to a shape. Select <b>Animation &gt; Deformation &gt; Convert Elliptic Deformation ROI to Shape</b> . This will create a much smaller initial zone of influence than if you were to convert it directly to a shape.
Convert Deformed Drawing to Drawings	Convert deformation animations to drawing sequences, so you can adjust the drawings using the drawing tools. You may also want to change the timing and set it on double frames instead of single frame.

Convert to New Drawing and Add Deformation Chain	Takes the pose/drawing and the deformer of the selected frame and converts it to a new pose/drawing with the corresponding deformer.
Envelope Creator	
Create Envelope	<p>Opens the Envelope Creator dialog, which allows you to automatically generate a deformation chain based on the artwork in the current layer.</p> <p>Among other things, the Envelope Creator dialog allows you to set the parameters for the amount of deformation points in the envelope as well as its shape and type.</p>
Draw Envelope	<p>Opens the Envelope Drawer dialog, which allows you to draw a deformation chain in the Camera view using a mouse or pen tablet. The deformation chain will be created as a parent of the current layer.</p> <p>Among other things, the Envelope Drawer dialog allows you to set the parameters for the amount of deformation points are created and how the shape of your drawing is processed.</p>
Exposure Fill	
Using Render Change	<p>Modifies the timing (exposure) of the selected layer, lets you adjust the parameters to assign when the texture exposure changes will occur. You can adjust the type of filter to use for the motion detection, as well as threshold values to indicate what will be considered a big enough motion variation for an exposure change.</p>
Master Controller	
Launch Interpolation Grid Wizard	<p>Opens the Interpolation Grid wizard, which allows you to create a 2D point widget Master Controller that can pose your rig, or part of your rig, according to a grid of preset poses—see <a href="#">Interpolation Grid Wizard Dialog Box on page 104</a>.</p>
Launch Interpolation Slider Wizard	<p>Opens the Interpolation Slider wizard, which allows you to create a slider widget Master Controller that can pose your rig, or part of your rig, according to a line-up of 2 or more poses—see <a href="#">Interpolation Slider Wizard Dialog Box on page 111</a>.</p>
Morphing	
Create Morphing	Allows you to create and configure a morphing sequence, which will

	automatically generate the in-betweens between two drawings in the current layer.
Insert Morphing Key Drawing	Creates a morphing keyframe from a selected morphing frame.
Delete Morphing	Once a cell is selected in a morphing sequence, deletes the entire sequence between the two keyframes.
Convert Morphing to Drawing	Lets you convert your morphing inbetweens to real drawings you can edit. This is useful when manually editing a morphing sequence or if you prefer to have animation timing in double frame (on twos) instead of single frame (on ones).
Contour Hint	<p>The Contour Hint point is used on the colour fill zone and brush lines; in other words, on Contour vectors. It allows you to control the line thickness and contour position. Also, if a contour is not animated correctly, you can use hints to correct the animation. For example, if a flag is not waving properly.</p> <p>When adding a Contour Hint point, make sure to place it far enough away from the contour so you can see it snap to the contour.</p> <p>Contour Hint points are yellow.</p>
Zone Hint	<p>The Zone Hint point is used on a colour zone to control the proximity rule. The Zone Hint is placed in the centre of the colour zone. Sometimes a colour zone is not associated with the corresponding one by default. For example, in a splash animation there are many water droplets that are the same colour. Harmony automatically morphs the droplet to the nearest one. This is not always the one you may have predicted. A Zone Hint will force a colour zone to morph with another one.</p> <p>Zone Hint points are cyan in colour.</p>
Pencil Hint	<p>A Pencil Hint point is used to control a pencil line, also known as central vector. It can be used on drawings that were done using the Pencil, Polyline, Ellipse, Line and Rectangle tools. Like the Contour Hint, the Pencil Hint snaps to the central vector. Make sure to place it far enough away from the line so you will see it snap when you move it.</p> <p>Pencil Hint points are magenta in colour.</p>
Appearing Point Hint	An Appearing Point Hint is used to control the trajectory of an appearing shape. A shape will appear in the destination drawing when

	<p>there is no corresponding shape in the source drawing. If you do not place an Appearing Point Hint to control the point of appearance, the shape will appear from its centre and expand outwards.</p> <p>Appearing Point Hint points are violet in colour.</p>
Vanishing Point Hint	<p>A Vanishing Point Hint is used to control the trajectory of a vanishing shape. A shape will vanish from the source drawing when there is no corresponding shape in the destination drawing. If you do not place a Vanishing Point Hint to control the point of disappearance, the shape will vanish into its centre.</p> <p>Vanishing Point Hint points are green in colour.</p>
Switch Between Morphing Key Drawings	<p>Toggles between the two key drawings in your morphing sequence. This option is useful while setting hints. You can use the default keyboard shortcut F4 to toggle between your drawings.</p>
Go to First Frame	<p>Goes to the first frame of your morphing sequence.</p>
Go to Previous Frame	<p>Goes to the previous frame of the selected frame in the morphing sequence.</p>
Go to Next Frame	<p>Goes to the next frame of the selected frame in the morphing sequence.</p>
Go to Last Frame	<p>Goes to the last frame of your morphing sequence.</p>
Suggest Hints	<p>Automatically sets hint points on key drawings as a help tool. If you're not sure where to set hints, you can use this option. It will set the main hints which you can then fine tune.</p>
Hide Hints	<p>Temporarily hides the hint points from the key drawings. Use this option when you have a series of hint points hiding some lines you would like to see.</p>
IK Constraints	
Set IK Nail	<p>Blocks the X, Y and Z positions.</p>
Set IK Hold Orientation	<p>Blocks the angle.</p>

Set IK Hold X	Blocks only the X position.
Set IK Hold Y	Blocks only the Y position.
Remove All Constraints	Removes all nails except the minimum and maximum angles.
Lip-Sync	
Change Mouth Shape to	Lets you change the mouth shape to one of the following: A, B, C, D, E, F, G, X.
Auto Lip-Sync Detection	Generates a sound detection for lip-sync.
Map Lip-Sync	Automatically maps drawings in an element to the mouth chart you have generated for a sound. This can save time when you are lip-synching a voice track.
Flip	
Flip Horizontal	Flips the selection horizontally.
Flip Vertical	Flips the selection vertically.
Flip Scale X	Once your drawing layer is rotated, the original horizontal and vertical axes change. The Flip Scale X and Flip Scale Y will perform a flip on your drawing layer following its original axis. Remembers the original X-axis of the layer and flips the element following it.
Flip Scale Y	Remembers the original Y-axis of the layer and flips the element following it.
Linear Motion	Switches between a linear and curved corner.
Lock in Time	Indicates whether the point is locked to a specific frame (keyframe) or only locked to a specific position and the curve can flow through it freely as other points are being added, moved, or adjusted (control point).
No Z Dragging	Keeps the Z value constant when you drag a character using the Transform or Translate tool.

Substitute Drawing Previous	Replaces the drawing or cell's symbol on the current frame by the previous drawing.
Substitute Drawing Next	Replaces the drawing or cell's symbol on the current frame by the next drawing.
Go to Previous Keyframe	Goes to the previous keyframe.
Go to Next Keyframe	Goes to the next keyframe.
Select Previous Keyframe /Point	Select the previous keyframe/point.
Select Next Keyframe /Point	Select the next keyframe/point.
Select Child Skipping Effects	Lets you select the first element parented to the selected peg element in the Timeline view skipping effects in the hierarchy.
Select Child	Lets you select the first element parented to the selected peg element in the Timeline view.
Select Children	Lets you select all elements parented to the selected peg element in the Timeline view.
Select Group Content	Selects all of the contents of the group.
Select Parent Skipping Effects	Lets you select the parent of the selected element in the Timeline view skipping effects in the hierarchy.
Select Parent	Lets you select the parent of the selected element in the Timeline view.
Select Previous Sibling	Lets you select the previous element (above current element) in the Timeline view.
Select Next Sibling	Lets you select the next element (below current element) in the Timeline view.
Lock	
Lock	Locks one or a multiple selection of layers.

Unlock	Unlocks one or a multiple selection of locked layers.
Lock All	Locks all the layers in the Timeline view.
Unlock All	Unlocks all the layers in the Timeline view.
Lock All Others	Locks every layer except the selected ones.
Reset	Returns the value of the selected element to the initial value of the active tool. For example, if the Rotate tool is active, the transformation angle will be reset to 0 and if the Transform tool is active, all the transformation values will be reset.
Reset All	Resets all transformations on the current frame in a selected layer. Your keyframe will remain, but all the values will return to the starting value. All transformations are reset regardless of the tool you're using.
Reset All Except Z	Resets all transformations on the current frame except the Z position. This is useful when doing cut-out animation. Cut-out puppets often have a particular Z ordering for the different views of a character. You might want to reset the transformation, but not necessarily the Z position.

## Drawing Menu

The Drawing menu lets you access many tools related to drawing, painting, dirt removal, optimizing strokes, and more.

### How to access the Drawing menu

- At the top of the interface, select **Drawing**.

Command	Description
Drawing Tools	Allows you to select one of the drawing tools available in Harmony.
Select	Allows you to select and reposition, scale, rotate and skew brush strokes, pencil lines, shapes and other parts of your artwork.
Contour Editor	Allows you to edit the vector contours of brush strokes, pencil lines and shapes in your artwork. You can add, remove, tweak and move vector points, move the Bezier handles of the vector points as well as deform vector outlines.
Centerline Editor	Allows you to tweak and deform a brush stroke by manipulating the points at the centre of its line rather than its contour.
Pencil Editor	Allows you to adjust the thickness of a pencil line at its different points and corners, tweak the shape of its extremities and scale its texture.
Cutter	Allows you to cut a part of your artwork, then reposition, scale, rotate and skew it.
Smooth Editor	Allows you to optimize contours and lines by removing its extra points, making them easier to edit.
Perspective	Allows you to deform artwork by applying a perspective effect on it.
Envelope	Allows you to deform and warp artwork by moving points and tweaking lines in a grid.
Reposition All Drawings	Allows you to reposition, scale, rotate and skew all drawings in the current layer.



Drawing Pivot	Allows you to position the pivot on a drawing layer by clicking where you want its location to be.
Brush	A pressure-sensitive tool for creating a contour shape with a thick and thin line effect, as if created with a paint brush.
Pencil	A pressure-sensitive tool for drawing outlines. Pencil lines are made of central vector lines, making them easier to tweak and edit than brush strokes.
Text	Allows you to add text and to format it.
Eraser	A pressure-sensitive tool for erasing parts of a drawing.
Dropper	Allows you to select a colour by clicking on a colour in your artwork.
Morphing	Allows you to create and configure a morphing sequence, which will automatically generate the in-betweens between two drawings in the current layer.
Line	Draws a straight line segment going from one point to the other.
Rectangle	Draws a rectangle.
Ellipse	Draws an ellipse.
Polyline	Allows you to draw shapes, segmented lines or complex curved lines by clicking to create each point in the sequence of line segments.
Paint	Allows you to fill colour zones with a colour or texture.
Ink	Allows you to recolour pencil lines with precision by changing the colour of one segment at a time.
Repaint Brush	Like the Brush tool, but only paints over existing brush strokes.
Close Gap	Allows you to close open shapes so that they can be filled with the Paint tool. By drawing a stroke near a small gap in a shape, this tool will create a small invisible stroke connecting the two closest points around the gap.



Stroke	Allows you to create invisible lines that can serve as colour zones that can be filled, or close the gaps in existing colour zones.
Edit Gradient/Texture	Allows you to adjust the position, angle and size of gradients and textures in a colour zone.
Hand	Allows you to pan the Camera and Drawing views.
Zoom	Allows you zoom in and out of the Camera and Drawing views.
Rotate View	Lets you rotate the Camera and Drawing views just like with a real animation disc.
Shift and Trace	Allows you to temporarily move drawings so you can trace over them in other drawings using Onion Skin.
Clean Up	
Remove Dirt	Opens the Remove Dirt dialog box where you can specify the number and size of dots removal from a selected drawing.
Remove Hair	Opens the Remove Hair dialog box where you can specify the number and length of hairs for removal from a selected drawing. This removes any small strokes created in the Colour Art layer from very thick lines or filled zones. Increase the value to select larger strokes for removal from the drawing.
Close Gaps	Closes small gaps in a drawing by creating small, invisible strokes between the two closest points to close the colour zone. You do not need to trace directly over the gap. You can draw it a few millimeters away. The two closest points automatically close the gap.
Remove Art Inside Selection	Removes any art inside a selection. It is recommended that you clean your Colour Art level as well. If you have a stroke accumulation in the Colour Art, it can result in large output files, especially if you work in high definition resolutions.
Remove Art Inside Selection on All Drawings	Removes any art inside all drawings selected with the Permanent Selection option in the Select tool.
Remove Art Outside	Removes any art existing outside a selection. It is recommended that you clean

Selection	the Colour Art level as well. If you have a stroke accumulation in the Colour Art, it can result in large output files, especially if you work in high-definition resolutions.
Remove Art Outside Selection on All Drawings	Removes any art outside all drawings selected with the Permanent Selection option in the Select tool.
Paint	
<div style="border: 1px solid green; padding: 10px;">  <p><b>NOTE</b> The Paint commands require you to use the Permanent Selection option in the Select tool so you can maintain a selection over multiple drawings.</p> </div>	
Unpaint Selection	Unpaints any art existing inside a selection.
Unpaint Selection on All Drawings	Unpaints all art contained inside a selection on all the drawings within the same layer.
Unpaint Outside Selection	Unpaints any art existing outside a selection. If no selection have been drawn using the Select tool, the entire drawing will be unpainted.
Unpaint Outside Selection on All Drawings	Unpaints all art outside a selection on all the drawings within the same layer.
Repaint Selection	Repaints any art inside a selection.
Repaint Selection on All Drawings	Repaints any art inside a selection on all the drawings contained within the same layer.
Repaint Outside Selection	Repaints any art outside a selection. If no selection has been drawn using the Select tool, the entire drawing will be repainted.
Repaint Outside Selection on All Drawings	Repaints any art outside a selection on all the drawings contained within the same layer.
Convert	

Pencil Lines to Brush Strokes	Converts the selected centreline pencil strokes into contour strokes brush lines.
Brush Strokes to Pencil Lines	Converts selected contour strokes into centreline pencil strokes. The brush stroke thickness will be lost.
Strokes to Pencil Lines	Converts the selected invisible line to a pencil line.
Break Apart Text Layers	Text is treated as a single drawing object. This separates the text so each character becomes an individual drawing object you can select and modify independently.
Optimize	
Flatten	Merges drawing objects and brush strokes into a single layer. If you draw new lines to fix a drawing or line with many brush strokes, it can be useful to flatten them all into a single shape. By default, lines are drawn one on top of each other. If you intend to repaint the lines or modify their shape, it will be easier if they are flattened.
Smooth	Smooths selected drawing strokes and removes extra points.
Create Contour Strokes	Adds a permanent invisible line around a shape that was drawn directly in Harmony. This allows you to unpaint lines with the Paint tool but maintain the shape of the lines, should you need to repaint later.
Remove Contour Strokes	Remove any permanently invisible lines that were created while scanning and vectorizing drawings or manually adding contour strokes. This is useful for removing the intersection triangles created during vectorization.
Remove Extra Strokes	Removes strokes inside painted area. This option only works after the painted drawing is flattened.
Optimize	Reduces the number of layers, such as overlapping brush strokes, in the selected drawing objects. Drawing objects will only be flattened and optimized if the selected objects do not change the appearance of the final image when they are merged.
Crop Brush Textures	Crops an unnecessarily large texture bitmap that lies unseen beneath the vector contour of a textured line. This often occurs when you cut and paste textured lines from one drawing into another. If you cut a portion from a textured line

	and paste it into a different drawing, Harmony pastes the entire unseen texture bitmap from the source drawing into the new one, even if you only took a small portion of the source drawing. Using the Crop Brush Texture command will crop away extraneous texture that does not touch the vector area. If there are many textured lines in your scene, this will greatly reduce the file size.
Reduce Drawing Texture Resolution	When you import and vectorize as texture (colour) a high resolution image, the size of your drawing can be heavy. You can reduce the size and resolution of the textures in a drawing.
Transform	
Flip Horizontal	Flips the current selection horizontally.
Flip Vertical	Flips the current selection vertically.
Rotate 90 CW	Rotates the current selection 90 degrees clockwise.
Rotate 90 CCW	Rotates the current selection 90 degrees counter-clockwise.
Rotate 180	Rotates the current selection 180 degrees.
Arrange	
Bring to Front	Moves the selected art to the front (on top).
Bring Forward	Moves the selected art one level forward (closer to the front).
Send Backward	Moves the selected art one level lower (behind).
Send to Back	Moves the selected art behind everything (bottom / back).
Create Empty Drawing	Creates a drawing in the selected cell, replacing any drawing that may already be exposed in that cell and the following ones until it meets another drawing, key exposure or a blank cell.
Duplicate Drawings	Lets you duplicate the drawing and work on a copy of it. This lets you modify an existing drawing but retain the original. When duplicating a drawing, the selected cell is replaced with the new drawing. The exposure of the original drawing that was on the current cell is removed. The original drawing is not

	deleted from the project folder or other cells in which it is exposed.
Delete Selected Drawings	Permanently removes selected drawings. Once you save your project, these drawings cannot be recovered.
Rename Drawing	Lets you give a selected drawing a new name.
Rename Drawing with Prefix	Lets you rename a drawing sequence with a prefix, which can be quite useful for cut-out puppet breakdown and deformation animation. This applies to any deformation work done in pre-Harmony 12 versions.
Rename by Frame	Lets you rename a series of drawings relative to their frame position. This is useful in hand-drawn animation.
Select Strokes with Current Colour	Lets you select drawing elements and painted areas with the same colour as the currently selected colour in your colour palette.
Distribute to Layers	<p>Every selected stroke in the Camera view is placed on separate layers; one layer per stroke. If artwork is composed of several strokes, you must group them to put them on the same layer.</p> <p>This operation cannot be done in the Drawing view.</p>
Create Colour Art from Line Art	<p>Lets you use the outline you traced on one of the four embedded layers (line art, colour art, overlay, underlay) and create invisible strokes to paint your drawings on separate layers. This provides more inking and painting flexibility.</p> <p>You can also configure this option to create the invisible strokes on any of the four embedded layers.</p>
Create Breaking Triangles	<p>Useful for brush strokes, creates triangular breaks at natural line intersections. These intersections are the probable locations where colour line breaks may occur, such as where a sleeve meets a hand.</p> <p>This makes it easier to soft trace lines in different colours when there are flattened or unflattened clean brush strokes.</p>
Generate Auto-Matte	Fills colour based on currently selected colour swatch on different drawing layers (overlay, underlay) so overlapping lines are more visible during a line test.
Adjust Line Texture Opacity	Lets you adjust the contrast and opacity of textured lines in a drawing.

<p>Change Vector Drawing Brush Resolution</p>	<p>Allows you to change the pixel density of textured brush strokes in vector drawings in your scene.</p> <div data-bbox="592 283 1429 483" style="border: 1px solid #c8e6c9; padding: 10px;">  <p><b>NOTE</b> When you create a new vector drawing, its pixel density for textured brush strokes is based on the settings in the Drawing Resolution tab of the Scene Settings dialog.</p> </div>
<p>Change Bitmap Drawing Resolution</p>	<p>Allows you to change the pixel density and canvas size of existing bitmap drawings in your scene.</p> <div data-bbox="592 640 1429 840" style="border: 1px solid #c8e6c9; padding: 10px;">  <p><b>NOTE</b> When you create a new bitmap drawing, its canvas size and pixel density are based on the settings in the Drawing Resolution tab of the Scene Settings dialog.</p> </div>
<p>Previous Drawing</p>	<p>When a cell is selected in the Timeline or Xsheet view, displays the previous drawing.</p>
<p>Next Drawing</p>	<p>When a cell is selected in the Timeline or Xsheet view, displays the next drawing.</p>
<p>Previous Layer</p>	<p>When a cell is selected in the Timeline or Xsheet view, displays the previous layer.</p>
<p>Next Layer</p>	<p>Once a cell is selected in the Timeline or Xsheet view, you can navigate between the drawings, frames, and layers. Displays the previous drawing, next drawing, previous layer or next layer.</p> <p>When a cell is selected in the Timeline or Xsheet view, displays the next layer.</p>
<p>Colour Protection</p>	
<p>Toggle Current Colour Protection</p>	<p>Temporarily enables/disables the Colour Protection feature so you can quickly correct wrongly inked or painted areas under protected colour without readjusting the Current Colour Protection option.</p>
<p>Respect Colour Protection</p>	<p>In the Colour view, you can protect a colour swatch to avoid repainting or unpainting the zones linked to that swatch. If you using the Paint tool and this option is deselected, you will repaint or unpaint the protected colours on your drawings until you enable the option again.</p>

## Edit Menu

The Edit menu lets you repeat and undo actions, cut/copy/paste selected objects, select and manipulate objects, work with symbols, and access the Preferences dialog box.

### How to access the Edit menu

- From the top menu, select **Edit**.

Command	Description
Undo	Removes the last change made to your project. Harmony supports multiple undo, so you can undo changes you made in the order you made them.
Redo	Redoes an operation you have undone. This command is active only after you use the Undo command.
Cut	Removes selected objects. You can then paste the object or its properties to another object.
Copy	Copies selected objects and properties.
Paste	Places an object you cut or copied into the location you select in a view.
Paste Special	Opens the Paste Special dialog box which lets you determine how templates and symbols are imported in the Timeline view.  There are advanced paste options for drawings, timings, keyframes, layers, as well as palettes and symbols.
Paste Special Again	Pastes new drawings with the previous Paste Special settings.
Paste Cycle	Cycles a portion of an animation. You can increase or decrease the number of cycles to paste and select a type of cycle: Normal, Reverse, Forward-Reverse and Reverse-Forward.
Paste Reverse	Reverses the timing of drawings or keyframes in range of selection after copying.



Delete	Removes selected objects.
Select All	Selects all drawing objects in the current drawing window in the Drawing, Timeline and Camera views. This helps you manage multiple objects as one when moving them.
Deselect All	Deselects all selected objects in the Drawing and Camera views.
Invert Selection	Deselects the currently selected items and selects all other items that were not selected. For example, if some lines are selected in a drawing, this command will deselect them and select any other lines in the drawing that were not selected.
Auto-Apply	Automatically applies changes you make to a property window or dialog box. Harmony applies the modification automatically and displays the result in the Camera view. When working on a heavy scene, it is useful to turn off this option. If you want to always work in Auto-Apply mode, you can deselect the Auto-Apply option in the Preferences dialog box (General tab). Then, each time you start Harmony, the Auto-Apply mode will be off. You must click the Apply button to see any modifications.
Create Symbol	Creates a symbol from selected drawing elements in the Drawing or Camera view, nodes in the Node view, or a layer or cells in the Timeline view.
Open Merge Editor	Lets you bring together (merge) the layer or drawings from different versions of the same scene.
Expand Symbol	<p>Extracts a symbol's contents and places it on the root timeline. Its contents will be copied and inserted into the root timeline. The symbol will not be removed from the Timeline view once it is expanded.</p> <p>The symbol's layers will be parented to it in case you created motions and transformations on the drawing layer that contain the symbol. Breaking the hierarchy could result in the loss of any scaling and animation you may have created.</p>
Expand Selected Symbol in Groups	Expands a symbol within a group to avoid crowding the timeline with a series of layers. When you expand the symbols, the layers will be contained in a group node that you can expand to see the content.
Duplicate Selected Symbol	Creates a duplicate of a selected symbol. If other symbols are nested

	inside the new symbol, they are not duplicated. If you modify them, the original and other instances will also be modified.
Create Drawing from Drawing Selection	Breaks a character into its main body parts. There is no need to create any layers prior to this process. Make sure your model is well centered and sized in the Camera view.
Clone: Drawings Only	Creates a copy of the drawings in the selected layer in the Timeline view or column in the Xsheet view. The timing is not copied.
Clone: Drawings and Timing	Creates a copy of the drawings and their timings in the selected layer in the Timeline view or column in the Xsheet view.
Duplicate	Duplicates a layer to have a copy of the drawings that are independent from the original ones, as well as an independent timing (exposure). When you need the drawings to be modified independently, you will want to duplicate the layer instead of cloning it.
Merge	There are two methods of merging drawings. <ul style="list-style-type: none"> <li>You can merge selected drawings in adjacent elements. The columns and layers will be left intact, and each new merged drawing will reside in the frames of the left-most column or lower layer.</li> <li>You can merge elements. All drawings will be merged. Unused columns and layers will be deleted, but the original drawing files are still accessible.</li> </ul>
Group	
Group	Groups selected drawing objects in the Camera or Drawing view.
Ungroup	Ungroups a selected group of drawing objects in the Camera or Drawing view.
Group Selected Layers	Groups selected layers in the Timeline view or nodes selected in the Node view.
Ungroup Selected Layers	Ungroups a selected group in the Timeline or Node views.
Move to Parent Group	Moves selected nodes in the Node view up to the parent group level, maintaining all connections.

Edit Drawing Mode	When the Auto-Get Rights to Modify Drawings option is selected in the Preferences dialog box (General tab), the system automatically gets the rights to modify drawings when you select a drawing. Otherwise, you must manually get the rights to modify drawings.
Edit Palette List Mode	When the Auto-Get Rights to Modify Palette option is selected in the Preferences dialog box (General tab), the system automatically gets the rights to modify palettes and palette lists when you select a colour from a palette. Otherwise, you must manually get the rights to modify a palette or palette list.
Get Rights to Modify Drawing	Manually releases the rights to modify a selected drawing.
Release Rights to Modify Drawing	Manually releases rights to modify a selected drawing.
Force Release Rights to Modify Drawing	This option is always available even if the Get Rights to Modify All Scene Assets option is not selected in the Database Selector dialog box.
Preferences	Opens the Preferences dialog box where you can set your preferences for Harmony.



## File Menu

The File menu lets you open, close, save, scan, print, and import and export files.

### How to access the File menu

- From the top menu, select **File**.

Command	Description
New	Creates a new scene while closing any scene already open. The New Scene dialog box opens, asking for directory, name, and resolution information.
Open	Displays the Open Scene dialog box where you can browse for a scene file. You can open a new scene from the current one and the previous scene will close.
Open Recent	Displays a list of the most recently opened scenes.
Clear	Clears the list of recently opened scenes.
Close	Closes the currently opened scene, but does not close the Harmony application.
Save	Saves all changes made to the opened scene, drawings, palettes, and palette lists.
Advanced Save	Lets you do the following: <ul style="list-style-type: none"> <li>• Save the scene as the current version.</li> <li>• Save different versions representing different stages of the production of your scene.</li> <li>• Save different versions representing different scene setups.</li> <li>• Choose specific assets that you want to save, such as drawings or palettes.</li> </ul>
Rights to Modify Scene Version	Allows you to modify the selected version of the scene as well as to manage and overwrite other versions. Other users will not be able to open a different version of the scene until you close the scene.
Rights to Modify Scene	Allows you to modify the currently selected scene version only. Unless the <b>Get rights to modify the scene</b> option is also checked, you will not be able to change other versions of the scene. This allows other users to modify different versions of the scene while you are working on the selected version.

Read Changed Drawings	<p>Determines which drawing files have been modified on disk since you loaded them. All updated drawings will be reloaded.</p> <div data-bbox="487 283 1429 420" style="border: 1px solid green; padding: 5px;">  <b>NOTE</b>  Reloading a locked drawing will discard unsaved changes. </div>
Manage Versions	Allows you to manage all the versions of the current scene.
Manage Local Cache	Opens the Manage Local Cache dialog, in which you can see all the Harmony Server database scenes that were cached locally, delete unused caches and check if the data in a scene's cache matches the data on the database server.
Save As	<p>Saves the current file with a different name and at a different location.</p> <p>Saves the current state of a scene as another scene. The Save As window prompts you for a new name and a different location for this scene before saving it. This will create a complete scene directory for the new scene.</p> <div data-bbox="487 919 1429 1060" style="border: 1px solid green; padding: 5px;">  <b>NOTE</b>  The scene name <b>cannot</b> exceed 23 characters. </div>
Save as New Version	Saves the current scene as another version. The Save Version dialog box prompts you to give a name for this new version. This will create a new .xstage file in your current project directory.
Back Up Scene	Backs up the current scene to a location you choose.
Update Database Scene	Updates your database with only the changes you made to the scene. To do this, you must enter your host name and host port in the Preferences dialog box, General tab.
Download Database Changes	If any changes were made to the scene you downloaded, you can perform an update by downloading these changes, which will be integrated into your scene.
Remove Unused Files	Removes the unused palettes from the scene list.
Import	
From Scanner	Imports drawings from a TWAIN scanner.

Images	Imports bitmap images which you can choose to vectorize.
3D Models	Once you have exported a model using a 3D authoring software, you can import it and integrate it in your 2D animation scene. You have the possibility to convert your 3D models to *.osb files upon import to Harmony and save them as such. This will allow Harmony to render 3D files with the associated textures without the need to copy them manually (as long as the auxiliary files are linked correctly and named appropriately on your disk).
Link to Images	Links to images stored on a centralizer server when working with Harmony Server.
Movie	Lets you convert a QuickTime movie to an image sequence and audio file.
Sound	Lets you import sound files into your project.
Colour Model	Lets you import TVG drawing file into your project. Once imported, it is display in the Model view for use as a colour model which you can load into any Harmony scene.
SWF, Illustrator Files to Library	Lets you import SWF files into your project.
Export	
Movie	Exports animation as a QuickTime movie.
Render Write Nodes	Renders all the Write nodes in a node structure.  When working with Harmony Server, you can send your scene to batch processing and to a render farm.
Soundtrack	Exports a sound file as a merged soundtrack or series of individual files. The exported soundtracks are generated as *.wav files.
SWF	Exports a Flash movie file.  Harmony supports exporting Flash movie files with a limited subset of vector and bitmap effects, the latter which can be previewed in Render View  mode.
OpenGL Frames	Exports OpenGL frames (fast display mode) for a quick screen renders of a scene that contain no transparency channel. Heavier scenes containing 3D, multiple effects and camera moves can be fairly long to export.

---

Layout Image	Exports all the elements in your scene to a layout .psd file.
Layout Image from Selection	Exports only the selected elements to a layout .psd file.
Print	
Xsheet	Prints the exposure sheet so you can take it to your animation table, provide a copy to the animator, or create your Xsheet skeleton directly in Harmony.
Node View	Prints the Node view for reference purposes.
Quit	Closes the application.

## Help Menu

The Help menu lets you display the Harmony documentation, Welcome screen and end user license agreement, as well as access the Toon Boom website, and identify the product name and version number.

### How to access the Help menu

- At the top of the interface, select **Help**.

Command	Description
Online Help	Opens the Harmony Help system, complete with instructions on how to use the system. This requires an internet connection.
Getting Started	Opens the Harmony Getting Started Guide (in PDF format) in a browser window. Requires Acrobat Reader.
Toon Boom on the Web	Opens the Toon Boom website, which features a Support and Community > Forum section.
Customer Experience Improvement Program	<p>The Customer Experience Improvement Program allows Toon Boom to collect usage information. The data does not contain any personally identifiable information and cannot be used to identify you. The data will consist of a basic hardware description, a project summary and usage information. The information is used only for software improvement purposes, as well as for sharing with third parties for the same reason.</p> <p>This program is enabled by default but is voluntary. If you prefer not to participate, you can opt out when you first launch the software, by using a global preference, or by a command line argument.</p>
About	Identifies the product name and version number.
Show Welcome Screen	Displays the Harmony Welcome screen.
Show End User License Agreement	Displays the End User License Agreement.
Debug Mode	When enabled, information is logged in the Message Log view about the preview generated in the Camera view, each time the preview is refreshed. In OpenGL preview mode, summary information is logged about the amount of nodes to process and the time it takes to generate



the preview. In Render Preview mode, detailed information about each composite and effect that is processed is logged.

Additionally, this option makes the Node view display information on each of its node about the amount of time a node must be processed to generate the OpenGL preview, and the total amount of time (in milliseconds) it takes for the node to process all its ingoing connections.

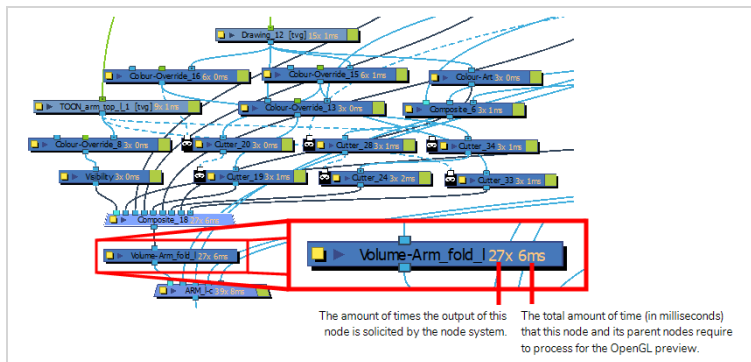

This can be useful if the complexity of a scene is impacting application performance, as it may help you identify the parts of your node system that have the most impact on the time it takes to generate the preview.



#### NOTE

The time indicated is cumulative from the top-down. This means a child node will always indicate that it takes at least as much time to process as its parent.

Shortcuts

Displays the complete list of keyboard shortcuts for Harmony.

## Insert Menu

The Insert menu lets you create empty symbols in the Library view, different types of layers in the Timeline view, keyframes and control points.

### How to access the Insert menu

- At the top of the interface, select **Insert**.

Command	Description
Create Empty Symbol in Library	Creates an empty symbol in the Library view to which you can edit (add content).
Bone	Adds a new Bone layer to the Timeline view.
Camera	Adds a new Camera layer to the Timeline view.
Colour-Card	Adds a new Colour-Card layer to the Timeline view.
Drawing	Adds a new Drawing layer to the Timeline view and a column in the Xsheet view.
Game Bone	Adds a new Game Bone layer to the Timeline and Node views.
Group	Adds a new Group layer to the Timeline and Node views.
Kinematic Output	Adds dd a new Kinematic Output layer to the Timeline and Node views.
Peg	Adds a new Peg layer to the Timeline and Node views.
Quadmap	Adds a new Quadmap layer to the Timeline and Node views.
Particle	
Basic Particle System	Adds a new layer with a basic particle system in the Timeline and Node views.

Basic Gravity-based System	Adds a new layer with a basic gravity-based particle system in the Timeline view.
Keyframe	Adds a keyframe to the selected cell in the Timeline view.
Keyframe and Duplicate Drawing	Adds a keyframe to the selected drawing layer cell in the Timeline view and creates a duplicate of the drawing, which sits on top of the original drawing.
Position Keyframe	Adds a position keyframe whereby keyframes will only be added on the X, Y and Z parameters of the selected layer. Keyframes are not added on the Angle, Scale and Skew parameters.
Control Point	Adds a control point to the trajectory of the selected element or peg in the Camera view when the element or peg is in a 3D path. Note that you must have a 3D path in the peg portion in order to add a control point.

## Play Menu

The Play menu lets you play back animation and sound. Use it to scrub the sound to create your lip-sync, loop the playback, navigate through frames, and change the playback range and speed.

### How to access the Play menu

- At the top of the interface, select **Play**.

Command	Description
Play	Plays the scene in the Camera or Drawing view.
Render and Play	<p>Renders your scene's frames, then opens the rendered frames in Play for playback.</p> <p>This allows you to preview your scene's animation in real time, with the effects rendered and with no risk of slowdown.</p>
Record and Play	<p>Exports your scene as it appears in the Camera view into a movie file, then opens it in your workstation's default video player.</p> <p>This allows you to preview your animation without any risk of slowdown, but it does not preview the effects in your scene. However, it is much faster than Render and Play.</p> <p>This button automates the usage of the Export OpenGL Frames dialog see</p>
Test SWF Movie	Quickly exports your scene as a Flash Movie (.swf), then opens it in your workstation's default web browser.
Stop	Stops playback.
Mini Playback	Open the Mini Playback dialog. This dialog allows you to set the amount of frames before and after the current frame to playback when using Mini Playback, to set the speed of Mini Playback and to start Mini Playback.
Start Mini Playback	Begins Mini Playback using the last settings entered in the Mini Playback dialog. By default, Mini Playback will play 5 frames before and after the current frame, at the scene's frame rate.

Playback Speed	Opens the Set New Frame Rate dialog box where you can set the frame rate at which the playback plays.
Loop	If pressed, your scene will repeat indefinitely when playing. Otherwise, it will stop when the end is reached.
Enable Sound	Turns on sound during playback.
Enable Sound Scrubbing	Turns on sound scrubbing during playback.
Start Frame	Opens the Set Playback Start Frame dialog box , in which you can enter the frame number from which to start playback.
Stop Frame	Opens the Set Playback Stop Frame dialog box, in which you can set the frame number at which to stop playback.
First Frame	Moves the red playhead to the first frame.
Previous Frame	Moves the red playhead to the previous frame.
Next Frame	Moves the red playhead to the next frame.
Last Frame	Moves the red playhead to the last frame.
Go to Frame	Opens the Go to Frame dialog box where you can enter the frame number on which the red playhead to be positioned in the Timeline view.
Enable Playback	
Top View	Plays back your animation in the Top view.
Side View	Plays back your animation in the Side view.
Perspective View	Plays back your animation in the Perspective view.

## Scene Menu

The Scene menu lets you set the scene length, add frames to the scene, view different displays of the scene, set render options, access the Scene Settings dialog box and Elements Manager window, and verify the drawing and palette files in your project.

### How to access the Scene menu

- At the top of the interface, select **Scene**.

Command	Description
Scene Length	Lets you set the length of the scene in frames.
Frame	
Add Frames at Start	Adds the number of frames you specify to the beginning of the scene.
Add Frames at End	Adds the number of frames you specify to the end of the scene.
Add Frames Before Selection	Adds the number of frames you specify before or after your selection.
Add Frames After Selection	
Remove Selected Frames	Deletes the selected frames from your scene.
Camera	
Default Camera	Lets you select a camera. If you only add one camera to your scene, you will only see Default Camera in your list.
Default Display	
Display All	Shows the contents of a specific Display node, updating the contents of the Camera, Top, Side, Perspective, and Timeline views.
Display	
Scene Settings	Opens the Scene Settings dialog box where you can set the resolution, alignment, bitmap resolution and many other parameters.

Render	
Auto Render	Automatically recalculates the preview image whenever you modify a parameter. If your scene is heavy and you do not want the preview rendered automatically, deselect the Auto-Render option and do the preview update manually. Note that this will slow down Harmony as it takes resources to update every frame.
Auto Render Write	Renders a frame each time the current frame is changed. You must have a Write node in your node structure to use this command.
Recalculate All	Refreshes the node structure and rerenders the display when the Camera view is in render mode.
Recalculate Selected	Refreshes the node structure and rerenders the display of selected elements when the Camera View is in render mode.
Cancel Preview Render	Cancels a render that was started.
Element Manager	Opens the Element Manager window where you can add, delete or modify elements (drawing folders) in your scene. If you have drawing folders that are not linked to a column in your scene, use the Element Manager to delete them if needed. See <a href="#">xref Reference &gt; Windows &gt; Element Manager</a> .
Check Files	Verifies the integrity of the drawing and palette files in your project.

## View Menu

The View menu lets you manipulate the view by zooming, panning, or rotating. You can also display the grid and change its size, use the onion skin feature to help with drawing, and set the preview resolution.



### How to access the View menu

- At the top of the interface, select **View**.

Command	Description
Toggle Full Screen	<p>Cycles through the following display modes:</p> <ul style="list-style-type: none"> <li>• <b>Normal Full-Screen:</b> The main application window becomes full screen.</li> <li>• <b>View Full-Screen:</b> The selected view becomes full screen and all other views are collapsed.</li> <li>• <b>Normal:</b> The main application window is restored to its original size and collapsed views are expanded.</li> </ul>
Zoom In	Zooms in the view.
Zoom Out	Zooms out the view.
Rotate View CW	Rotates the Camera view 30 degrees clockwise, like an animation table.
Rotate View CCW	Rotates the Camera view 30 degrees counter-clockwise, like an animation table.
Mirror View	Temporarily flips the Camera or Drawing view horizontally, allowing you to view and edit your artwork as if it was being mirrored.
Reset Zoom	Resets the view's zoom to its default position.
Reset Rotation	Resets the view's rotation to its default position.
Reset Pan	Resets the view's pan to its default position.
Reset View	Resets the view to its default position.





Next Colour	Goes to the next colour in the Colour view.
Previous Colour	Goes to the previous colour in the Colour view.
Grid	
Show Grid	Displays the grid.
Grid Outline Only	Displays the outline of the grid only.
Underlay	Displays the grid under the drawing elements.
Overlay	Displays the grid over the drawing elements.
Square Grid	Displays a standard square grid.
12 Field Grid	Displays a 12-field size grid.
16 Field Grid	Displays a 16-field size grid.
Onion Skin	
Show Onion Skin	Lets you preview the previous and next drawings. By default, the previous drawings appear in a shade of red and the next drawings are displayed with a shade of green. You can change these colours in the Preferences dialog box.
Add to Onion Skin	Adds a series of selected elements to the onion skin preview.
Remove from Onion Skin	Removes a series of selected elements from the onion skin preview.
Remove Unselected from Onion Skin	Removes all elements except the ones selected from the onion skin preview.
Add All to Onion Skin	Adds all of the scene's elements to the onion skin preview.
Remove All from Onion Skin	Removes all of the scene's elements from the onion skin preview.

<p>Onion Skinning by Frames</p>	<p>Selects the drawings to display in the Onion Skin by their frame number relative to the current frame. For example, if the Onion Skin is set to include 2 drawings before and after the current frame, it will include the drawings up to two frames before and up to two frames after the current frame, even if those drawings are the same as the one in the current frame. This is more useful for cut-out animation as it allows you to position a drawing relative to its position in adjacent frames.</p> <div data-bbox="680 499 1429 638" style="border: 1px solid #c8e6c9; padding: 5px;">  <p><b>NOTE</b> This option only works in the Camera view.</p> </div>
<p>Onion Skinning by Drawings</p>	<p>Selects the drawings to display in the Onion Skin by the amount of different drawings before and after the current frame. For example, if the Onion Skin is set to include 2 drawings before and after the current frame, this will display the nearest two different drawings before and after the drawing in the current frame in the Onion Skin, even if those drawings are further than 2 frames away from the current frame. This is more useful for frame-by-frame animation.</p> <div data-bbox="680 970 1429 1171" style="border: 1px solid #c8e6c9; padding: 5px;">  <p><b>NOTE</b> When this option is enabled, the handles allowing you to adjust the extent of the Onion Skin in the Timeline view are not available.</p> </div>
<p>No Previous Drawing</p>	<p>Removes the previous drawing's onion skin and displays only the next drawing.</p>
<p>Previous Drawing</p>	<p>Displays the previous drawing.</p>
<p>Previous Two Drawings</p>	<p>Displays the previous two drawings.</p>
<p>Previous Three Drawings</p>	<p>Displays the previous three drawings.</p>
<p>No Next Drawing</p>	<p>Do not show the onion skin for all of the next drawings.</p>
<p>Next Drawing</p>	<p>Show the onion skin for the next drawing.</p>
<p>Next Two Drawings</p>	<p>Show the onion skin for the next two drawings.</p>

Next Three Drawings	Show the onion skin for the next three drawings.
Reduce One Previous Drawing	Reduces the number of previous visible drawings by one.
Add One Previous Drawing	Adds one drawing to the number of previous visible drawings.
Reduce One Next Drawing	Reduces the number of next visible drawings by one.
Add One Next Drawing	Adds one drawing to the number of next visible drawings.
Light Table	Turns on the light table so you can see the previous and subsequent active layers in washed-out colours. It is useful for seeing the other layers when designing, animating or cleaning up your animation.
Backlight	Produces a silhouette effect by changing the drawing's coloured areas into a single dark, solid colour. Use this to verify the completeness of the ink and paint process. Any unpainted zones can be seen as the light shows through the unpainted areas of the silhouetted drawing.
Show	
Symbol Pivot	Displays a symbol's pivot. The Symbol pivot is similar to the Drawing pivot. Each symbol cell can have its own pivot and act the same as the Drawing pivot. The Symbol pivot can also be referred to as embedded pivot. Inside a symbol, each drawing can have its own pivot.
Safe Area	Displays the TV safety zone and the centre of the camera frame. The safe area adapts to the scene resolution, as well as the safety zone and frame's centre.
Camera Mask	Displays a black mask around the scene's frame to avoid seeing the unnecessary artwork. This option is handy when you're animating and setting up the scene. It allows you to see your scene's composition better.
Control	Displays the controls of the selected element.
Current Drawing on Top	Displays the selected drawing on top of everything while you draw. By enabling this option, each time you select a drawing tool, the selected drawing is displayed in front of everything in the Camera view. The Timeline and Node view ordering remain unchanged. You only need to

	enable this option once, it is not necessary to do it each time you select a drawing tool.
Outline Locked Drawings	Displays drawing that are locked in the Timeline view (cannot be selected in the Camera view) as wireframes.
Show Strokes	Displays the strokes in your drawings so that the invisible lines stand out.
Show Strokes with Colour Wash	Displays strokes with washed-out colours.
Hide All Controls	Hides the controls of the selected element.
Deformation	
Show Current Deformers and Hide All Others	Shows all current deformers and hides all other manipulators displayed in the Camera view.
Particle	
Show Particles as Dots in OpenGL	Displays the particles as dots in the OpenGL preview mode. This makes the playback speed faster for a heavy scene.
Preview Manager	Opens the Preview Manager where you can set options for the quality of previews, and clearing and updating the cache.
Preview Resolution	
Same as Scene Resolution	Lets you choose a resolution for previewing a scene.
3/4 of Scene Resolution	
1/2 of Scene Resolution	
1/3 of Scene Resolution	
1/4 of Scene Resolution	
Custom	Lets you select a resolution from a list of presets or enter X and Y

	values for a custom preview resolution.
Bitmap File Quality	<p>Let's you increase or decrease the preview quality of raw bitmap images. By default, bitmap files imported in Harmony will display in a low resolution in the Camera view to avoid hindering performance.</p> <div data-bbox="678 411 1429 646"><b>TIP</b><p>You can change the default resolution in which bitmap files are displayed in the Camera view by changing the Small Bitmap Resolution preference located in the Camera tab of the Preferences dialog.</p></div> <div data-bbox="678 674 1429 909"><b>NOTE</b><p>This only affects the way bitmap images display in the OpenGL preview of the scene in the Camera view. The preview quality of bitmap images does not affect the final render.</p></div>

## Windows Menu

The Windows menu lets you customize your workspace to suit your working style, save it as a new workspace, and load it from the Workspace toolbar. You can also show or hide the different toolbars and views in Harmony.

### How to access the Windows menu

- From the top menu, select **Windows**.

Command	Description
Restore Default Workspace	Returns modified workspaces to their original default layout if you do not like the current modifications or inadvertently closed some windows.
Workspace	
Workspace Manager	Opens the Workspace Manager where you can modify, create, delete, rename and reorder your workspaces.
Save Workspace	Saves the current workspace along with any modifications you made.
Save Workspace As...	Saves the workspace as a new version to avoid overwriting the current one.
Workspace	Lets you open workspaces designed specifically for animating, compositing, hand drawing, scripting and the default workspace.
Toolbars	Lets you show or hide these toolbars: Tool Presets, Art Layer, Playback, File, Edit, Advanced Animation, Scripting, Coordinate, Control Point, Display, Tools, Flip, Onion Skin, Mark Drawing, Easy Flipping, Workspace, Deformation, Drawing View, Camera View, Xsheet View and Timeline View.
Camera	Shows or hides the Camera view.
Colour	Shows or hides the Colour view.
Coord. and Control Points	Shows or hides the Coordinates and Control Points view.

Drawing	Shows or hides the Drawing view.
Function	Shows or hides the Function view.
Layer Properties	Shows or hides the Layer Properties view.
Library	Shows or hides the Library view.
Message Log	Shows or hides the Message Log view.
Model	Shows or hides the Model view.
Node Library	Shows or hides the Library view.
Node View	Shows or hides the Node view.
Perspective	Shows or hides the Perspective view.
Side	Shows or hides the Side view.
Timeline	Shows or hides the Timeline view.
Tool Properties	Shows or hides the Tool Properties view.
Top	Shows or hides the Top view.
Xsheet	Shows or hides the Xsheet view.
3D Graph	Shows or hides the 3D Graph view.
Integrated Help	Shows or hides the Integrated Help view.
Metadata Editor	Shows or Hides the Metadata Editor view.
Script Editor	Shows or hides the Script Editor view.

# View Menus

A view menu contains commands specifically related to that view.

## How to access a view menu

1. In the top-left corner of a view, click the Menu  button.

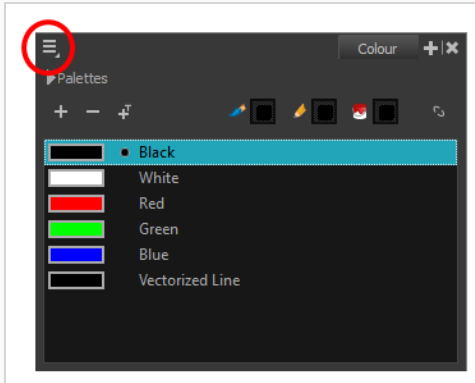

3D Graph View Menu .....	258
Camera View Menu .....	260
Colour View Menu .....	277
Drawing View Menu .....	280
Function View Menu .....	292
Library View Menu .....	294
Model View Menu .....	296
Node View Menu .....	298
Node Library View Menu .....	303
Onion Skin View Menu .....	304
Perspective View Menu .....	306
Script Editor View Menu .....	312
Side View Menu .....	317
Timeline View Menu .....	322
Top View Menu .....	327
Xsheet View Menu .....	332





## 3D Graph View Menu

The 3D Graph View menu lets you access commands related to the 3D Graph view, such as selecting different subnodes, disabling and enabling subnodes and inserting the 3D Kinematic Output node.

### How to access the 3D Graph menu

- In the upper-left corner of the 3D Graph view, click the menu  button.

Command	Description
Edit	
Copy Subnode Name	<p>Copies the name of the currently selected subnode. This can be useful if you need to enter the name of a subnode in the properties of a 3D Kinematic Output node.</p> <div style="border: 1px solid #add8e6; padding: 10px; margin-top: 10px;"> <p> <b>TIP</b> You can also automatically create a 3D Kinematic Output node with the selected subnode's name in its properties by selecting the subnode in the 3D Graph view, then clicking on Add 3D Kinematic Output  in the 3D Graph toolbar.</p> </div>
Select All	Selects all the listed subnodes.
Deselect All	Deselects all the subnodes.
Select Child Subnodes	Changes the selection to the first subnode that is a child of the currently selected subnode.
Select Parent Subnode	Changes the selection to the parent of the currently selected subnode.
Select Next Sibling Subnode	Changes the selection to the subnode just below the currently selected subnode in the list, provided that they have the same parent.
Select Previous Sibling Subnode	Changes the selection to the subnode just above the currently selected subnode in the list, provided that they have the same parent.
Subnodes	

Enable	Enables the selected subnode, making it and all its enabled children visible. You can also enable a selection of multiple subnodes.
Disable	Disables the selected subnode, making it and all its children invisible. You can also disable a selection of multiple subnodes.
Insert	
Make Properties Available	When the 3D model is connected to a Subnode Animation node, this will add the properties (ie: position, angle, scale) of the selected subnode to the Subnode Animation node's list of properties in the Timeline view. This is useful if you want to add keyframes to a subnode before animating it or if you want to outline which subnodes should be animated and which ones should not.
3D Kinematic Output	Creates a 3D Kinematic Output node and connects it under the 3D Model's Subnode Animation node. This 3D Kinematic Output node will be configured to use the currently selected subnode's animation. You can then connect this 3D Kinematic Output node to an element in your scene to apply the selected subnode's animation to that element.
Extended Mode	Displays non-key subnodes in the subnode list. By default, those nodes are hidden because they are not useful for animation and they can significantly bloat up the subnode list. However, it may be useful to have access to these nodes in order to debug issues with the visibility of parts of your 3D model.

## Camera View Menu

The Camera View menu lets you do many things in the Camera view, including selecting and editing objects in different views, changing the display, setting morphing parameters, accessing tools and many more.

### How to access the Camera menu

- In the upper-left corner of the Camera view, click the menu  button.

Command	Description
Edit	
Cut	Removes selected objects. You can then paste the object or its properties to another object.
Copy	Copies selected objects and properties.
Paste	Places an object you cut or copied into the location you select in a view.
Delete	Removes selected objects.
Select All	Selects all drawing objects in the current drawing window in the Drawing, Timeline and Camera views. This helps you manage multiple objects as one when moving them.
Deselect All	Deselects all selected objects in the Drawing and Camera views.
Select Stroke With Current Colour	Select the strokes that contain the currently selected colour.
Invert Selection	Deselects the currently selected items and selects all other items that were not selected. For example, if some lines are selected in a drawing, this command will deselect them and select any other lines in the drawing that were not selected.
Select Child Skipping Effects	Lets you select the first element parented to the selected peg element in the Timeline view skipping effects in the hierarchy.
Select Child	Lets you select the first element parented to the selected peg element in the Timeline view.

Select Children	Lets you select all elements parented to the selected peg element in the Timeline view.
Select Parent Skipping Effects	Lets you select the parent of the selected element in the Timeline view skipping effects in the hierarchy.
Select Parent	Lets you select the parent of the selected element in the Timeline view.
Select Previous Sibling	Lets you select the previous element (above current element) in the Timeline view.
Select Next Sibling	Lets you select the next element (below current element) in the Timeline view.
Group	<b>Group:</b> Groups selected drawing objects in the Camera or Drawing view.
	<b>Ungroup:</b> Ungroups a selected group of drawing objects in the Camera or Drawing view.
View	
Navigation	<b>Zoom In:</b> Zooms in the view.
	<b>Zoom Out:</b> Zooms out the view.
	<b>Rotate View CW:</b> Rotates the Camera view 30 degrees clockwise, like an animation table.
	<b>Rotate View CCW:</b> Rotates the Camera view 30 degrees counter-clockwise, like an animation table.
	<b>Reset Zoom:</b> Resets the view's zoom to its default position.
	<b>Reset Rotation:</b> Resets the view's rotation to its default position.
	<b>Reset Pan:</b> Resets the view's pan to its default position.
	<b>Reset View:</b> Resets the view to its default position.
Switch to Colour Art	Displays the Colour Art layer. When switching art layers, you can edit the selected

	layer without affecting the other one.
Preview Line Art and Colour Art	Displays all Art layers.
Open GL View	Switches the Camera view to fast display, letting you see your animation play in real time. The OpenGL display requires less memory. The final look of your effects is not shown in the OpenGL View Mode. You must switch to the Render View Mode to see your effects.
Render View	Switches the Camera view to a fully rendered display showing the final image of the current frame. If a modification is done to your current frame or if you move to a different frame, click the <b>Update Preview</b> button to update the display if your preview does not update automatically. The Render View Mode display lets you see the final look of your frames including effects and antialiasing. You cannot play back your scene in Render View Mode. To see your scene fully rendered and to play it back, you must press the Render and Play button in the Playback toolbar.
Matte View	Switches the Camera view to a matte display showing the alpha channel of the elements in your scene. The transparency level ranges from 0 to 100 percent. Zero percent is completely transparent and represented by black and 100 percent is completely opaque and represented by white. Everything in between these extremes has a transparency level somewhere between 1 and 99 percent and is represented in various shades of grey.
Grid	<b>Show Grid:</b> Displays the grid.
	<b>Grid Outline Only:</b> Displays the outline of the grid only.
	<b>Underlay:</b> Displays the grid under the drawing elements.
	<b>Overlay:</b> Displays the grid over the drawing elements.
	<b>Square Grid:</b> Displays a standard square grid.
	<b>12 Field Grid:</b> Displays a 12-field size grid.
	<b>16 Field Grid:</b> Displays a 16-field size grid.
Onion Skin	<b>Show Onion Skin:</b> Lets Lets you preview the previous and next drawings. By

	<p>default, the previous drawings appear in a shade of red and the next drawings are displayed with a shade of green. You can change these colours in the Preferences dialog box.</p>
	<p><b>Add to Onion Skin:</b> Adds Adds a series of selected elements to the onion skin preview.</p>
	<p><b>Remove from Onion Skin:</b> Removes Removes a series of selected elements from the onion skin preview.</p>
	<p><b>Remove Unselected from Onion Skin:</b> Removes Removes all elements except the ones selected from the onion skin preview.</p>
	<p><b>Add All to Onion Skin:</b> Adds Adds all of the scene's elements to the onion skin preview.</p>
	<p><b>Remove All from Onion Skin:</b> Removes Removes all of the scene's elements from the onion skin preview.</p>
	<p><b>Onion Skinning by Drawing:</b></p>
	<p><b>No Previous Drawing:</b></p>
	<p><b>Previous Drawing:</b> Displays the previous drawing.</p>
	<p><b>Previous Two Drawings:</b> Displays the previous two drawings.</p>
	<p><b>Previous Three Drawings:</b> Displays the previous three drawings.</p>
	<p><b>No Next Drawing:</b> Displays no next drawing.</p>
	<p><b>Next Drawing:</b> Displays the next drawing.</p>
	<p><b>Next Two Drawings:</b> Displays the next two drawings.</p>
	<p><b>Next Three Drawings:</b> Displays the next three drawings.</p>
	<p><b>Reduce One Previous Drawing:</b> Reduces the number of previous visible drawings by one.</p>

	<p><b>Add One Previous Drawing:</b> Adds one drawing to the number of previous visible drawings.</p>
	<p><b>Reduce One Next Drawing:</b> Reduces the number of next visible drawings by one.</p>
	<p><b>Add One Next Drawing:</b> Adds one drawing to the number of next visible drawings.</p>
Light Table	<p>Turns on the light table so you can see Turns on the light table so you can see the previous and subsequent active layers in washed-out colours. It is useful for seeing the other layers when designing, animating or cleaning up your animation.</p>
Backlight	<p>Produces Produces a silhouette effect by changing the drawing's coloured areas into a single dark, solid colour. Use this to verify the completeness of the ink and paint process. Any unpainted zones can be seen as the light shows through the unpainted areas of the silhouetted drawing.</p>
Show	<p><b>Symbol Pivot:</b> Displays a symbol's pivot. The Symbol pivot is similar to the Drawing pivot. Each symbol cell can have its own pivot and act the same as the Drawing pivot. The Symbol pivot can also be referred to as <i>embedded pivot</i>. Inside a symbol, each drawing can have its own pivot.</p> <p><b>Safe Area:</b> Displays Displays the TV safety zone and the centre of the camera frame. The safe area adapts to the scene resolution, as well as the safety zone and frame's centre.</p> <p><b>Camera Mask:</b> Displays Displays a black mask around the scene's frame to avoid seeing the unnecessary artwork. This option is handy when you're animating and setting up the scene. It allows you to see your scene's composition better.</p> <p><b>Control:</b> Displays the controls of the selected element.</p> <p><b>BBox Selection Style:</b> Lets you change the display style of selected elements to a bounding box style. This removes the default overlay highlight and leaves only the bounding box around the selected element.</p> <p><b>Outline Locked Drawings:</b> Drawings that are locked in the Timeline view (cannot be selected in the Camera view) are displayed as wireframes.</p> <p><b>Show Current Drawing on Top:</b> Displays Displays the selected drawing on top of everything while you draw. By enabling this option, each time you select a drawing tool, the selected drawing is displayed in front of everything in the</p>

	<p>Camera view. The Timeline and Node view ordering remain unchanged. You only need to enable this option once, it is not necessary to do it each time you select a drawing tool.</p> <p><b>Show Strokes:</b> Displays the strokes in your drawings so that the invisible lines stand out.</p> <p><b>Show Strokes with Colour Wash:</b> Displays strokes with washed-out colours.</p> <p><b>Highlight Selected Colour:</b></p> <p><b>Show Scan Information:</b> Displays a status bar showing the scanning information at the bottom of the Drawing and Camera view.</p>
Hide All Controls	Hides the controls of the selected element.
Render Current Frame	Renders only the current frame.
Auto Render	Automatically recalculates the preview image whenever you modify a parameter. If your scene is heavy and you do not want the preview rendered automatically, deselect the Auto-Render option and do the preview update manually. Note that this will slow down Harmony as it takes resources to update every frame.
Layer Properties	Displays the Layer Properties window of the selected layer in the Timeline view.
Preview Manager	Opens the Preview Manager where you can set options for the quality of previews, and clearing and updating the cache.
Bitmap File Quality	<p>Let's you increase or decrease the preview quality of raw bitmap images. By default, bitmap files imported in Harmony will display in a low resolution in the Camera view to avoid hindering performance.</p> <div style="border: 1px solid #0070C0; padding: 10px; margin-top: 10px;">  <p><b>TIP</b></p> <p>You can change the default resolution in which bitmap files are displayed in the Camera view by changing the Small Bitmap Resolution preference located in the Camera tab of the Preferences dialog.</p> </div>



	<div style="border: 1px solid green; padding: 10px;">  <p><b>NOTE</b> This only affects the way bitmap images display in the OpenGL preview of the scene in the Camera view. The preview quality of bitmap images does not affect the final render.</p> </div>
Drawing	
Clean Up	<p><b>Remove Dirt:</b> Opens the Remove Dirt dialog box where you can specify the number and size of dots removal from a selected drawing.</p> <p><b>Remove Hair:</b> Opens the Remove Hair dialog box where you can specify the number and length of hairs for removal from a selected drawing. This removes any small strokes created in the Colour Art layer from very thick lines or filled zones. Increase the value to select larger strokes for removal from the drawing.</p> <p><b>Close Gaps:</b> Closes small gaps in a drawing by creating small, invisible strokes between the two closest points to close the colour zone. You do not need to trace directly over the gap. You can draw it a few millimeters away. The two closest points automatically close the gap.</p> <p><b>Remove Art Inside Selection:</b> Removes any art inside a selection. It is recommended that you clean your Colour Art level as well. If you have a stroke accumulation in the Colour Art, it can result in large output files, especially if you work in high definition resolutions.</p> <p><b>Remove Art Inside Selection On All Drawings:</b> Removes any art inside all drawings selected with the Permanent Selection option in the Select tool.</p> <p><b>Remove Art Outside Selection:</b> Removes any art existing outside a selection. It is recommended that you clean the Colour Art level as well. If you have a stroke accumulation in the Colour Art, it can result in large output files, especially if you work in high-definition resolutions.</p> <p><b>Remove Art Outside Selection On All Drawings:</b> Removes any art outside all drawings selected with the Permanent Selection option in the Select tool.</p>
Paint	<p><b>Unpaint Selection:</b> Unpaints any art existing inside a selection.</p> <p><b>Unpaint Selection on All Drawings:</b> Unpaints all art contained inside a selection on all the drawings within the same layer.</p>

	<p><b>Unpaint Outside Selection:</b> Unpaints any art existing outside a selection. If no selection have been drawn using the Select tool, the entire drawing will be unpainted.</p>
	<p><b>Unpaint Outside Selection on All Drawings:</b> Unpaints all art outside a selection on all the drawings within the same layer.</p>
	<p><b>Repaint Selection:</b> Repaints any art inside a selection.</p>
	<p><b>Repaint Selection on All Drawings:</b> Repaints any art inside a selection on all the drawings contained within the same layer.</p>
	<p><b>Repaint Outside Selection:</b> Repaints any art outside a selection. If no selection has been drawn using the Select tool, the entire drawing will be repainted.</p>
	<p><b>Repaint Outside Selection on All Drawings:</b> Repaints any art outside a selection on all the drawings contained within the same layer.</p>
<p>Convert</p>	<p><b>Pencil Lines to Brush Strokes:</b> Converts the selected centreline pencil strokes into contour strokes brush lines.</p>
	<p><b>Brush Strokes to Pencil Lines:</b> Converts selected contour strokes into centreline pencil strokes. The brush stroke thickness will be lost.</p>
	<p><b>Strokes to Pencil Lines:</b> Converts the selected invisible line to a pencil line.</p>
	<p><b>Brush Apart Text Layers:</b> Text is treated as a single drawing object. This separates the text so each character becomes an individual drawing object you can select and modify independently.</p>
<p>Optimize</p>	<p><b>Flatten:</b> Merges Merges drawing objects and brush strokes into a single layer. If you draw new lines to fix a drawing or line with many brush strokes, it can be useful to flatten them all into a single shape. By default, lines are drawn one on top of each other. If you intend to repaint the lines or modify their shape, it will be easier if they are flattened.</p>
	<p><b>Smooth:</b> Smooths selected drawing strokes and removes extra points.</p>
	<p><b>Create Contour Strokes:</b> Adds a permanent invisible line around a shape that was drawn directly in Harmony. This allows you to unpaint lines with the Paint tool but maintain the shape of the lines, should you need to repaint later.</p>

	<p><b>Remove Contour Strokes:</b> Remove any permanently invisible lines that were created while scanning and vectorizing drawings or manually adding contour strokes. This is useful for removing the intersection triangles created during vectorization.</p>
	<p><b>Remove Extra Strokes:</b> Removes strokes inside painted area. This option only works after the painted drawing is flattened.</p>
	<p><b>Optimize:</b> Reduces Reduces the number of layers, such as overlapping brush strokes, in the selected drawing objects. Drawing objects will only be flattened and optimized if the selected objects do not change the appearance of the final image when they are merged.</p>
	<p><b>Crop Brush Textures:</b> Crops Crops an unnecessarily large texture bitmap that lies unseen beneath the vector contour of a textured line. This often occurs when you cut and paste textured lines from one drawing into another. If you cut a portion from a textured line and paste it into a different drawing, Harmony pastes the entire unseen texture bitmap from the source drawing into the new one, even if you only took a small portion of the source drawing. Using the Crop Brush Texture command will crop away extraneous texture that does not touch the vector area. If there are many textured lines in your scene, this will greatly reduce the file size.</p>
	<p><b>Reduce Drawing Texture Resolution:</b> When you import and vectorize as texture (colour) a high resolution image, the size of your drawing can be heavy. You can reduce the size and resolution of the textures in a drawing.</p>
Arrange	<p><b>Bring to Front:</b> Moves the selected art to the front (on top).</p>
	<p><b>Bring Forward:</b> Moves the selected art one level forward (closer to the front).</p>
	<p><b>Send Backward:</b> Moves the selected art one level lower (behind).</p>
	<p><b>Send to Back:</b> Moves the selected art behind everything (bottom / back).</p>
Transform	<p><b>Flip Horizontal:</b> Flips the current selection horizontally.</p>
	<p><b>Flip Vertical:</b> Flips the current selection vertically.</p>
	<p><b>Rotate 90 CW:</b> Rotates the current selection 90 degrees clockwise.</p>

	<p><b>Rotate 90 CCW:</b> Rotates the current selection 90 degrees counter-clockwise.</p>
	<p><b>Rotate 180:</b> Rotates the current selection 180 degrees.</p>
Create Empty Drawing	Creates a drawing in the selected cell, replacing any drawing that may already be exposed in that cell and the following ones until it meets another drawing, key exposure or a blank cell.
Duplicate Drawings	<p>Lets you duplicate the drawing and work on a copy of it. This lets you modify an existing drawing but retain the original. When duplicating a drawing, the selected cell is replaced with the new drawing. The exposure of the original drawing that was on the current cell is removed. The original drawing is not deleted from the project folder or other cells in which it is exposed.</p> <p>When duplicating a drawing, the selected cell is replaced with the new drawing. The exposure of the original drawing that was on the current cell is removed. The original drawing is not deleted from the project folder or other cells in which it is exposed.</p>
Delete Selected Drawings	Permanently removes selected drawings. Once you save your project, these drawings cannot be recovered.
Rename Drawing	Lets you give a selected drawing a new name.
Create Colour Art From Line Art	<p>Lets you use the outline you traced on one of the four embedded layers (line art, colour art, overlay, underlay) and create invisible strokes to paint your drawings on separate layers. This provides more inking and painting flexibility.</p> <p>You can also configure this option to create the invisible strokes on any of the four embedded layers.</p>
Generate Auto-Matte	<p>Automatically creates a matte from a selected drawing or all drawings on a layer.</p> <p>Opens the auto-Matte dialog box where you can set the radius of the lines depending on how precise or rough your line is.</p> <p>You can also select the source and destination layers from which the matte will be created.</p>
Adjust Line Texture Opacity	Lets you adjust the contrast and opacity of textured lines in a drawing.
Change Bitmap Drawing Resolution	Lets you change the resolution of bitmap art for individual drawings. You can reduce the resolution of your bitmap file as well as increase it. Be careful

	<p>because enlarging the bitmap resolution on an existing drawing will result in a loss of quality. Harmony will perform a pixel smoothing pass (resampling) and create additional pixels to avoid losing too much quality, but only to a certain extent. This feature is very useful when you need to have a full resolution of a bitmap image (such as imported bitmaps as .psd or .tga for the background) for tracing to create a matte directly in Harmony. By default, Harmony creates small thumbnail images when imported as bitmap in order to increase performance by using a small thumbnail image instead of using the original large size bitmap for animation work in Harmony. This will make difficult to view details or trace due to the low resolution (blurry). This option temporary increases the resolution of bitmaps up to their original bitmap resolution to make tracing easier.</p>
Previous Drawing	<p>Once a cell is selected in the Timeline or Xsheet view, you can navigate between the drawings, frames, and layers. Displays the previous drawing, next drawing, previous layer or next layer.</p> <p>Displays the previous drawing, next drawing, previous layer or next layer.</p>
Next Drawing	
Previous Layer	
Next Layer	
Colour Protection	<p><b>Toggle Current Colour Protection:</b> Temporarily enables/disables the Colour Protection feature so you can quickly correct wrongly inked or painted areas under protected colour without readjusting the Current Colour Protection option.</p>
	<p><b>Respect Colour Protection:</b> In the Colour view, you can protect a colour swatch to avoid repainting or unpainting the zones linked to that swatch. If you using the Paint tool and this option is deselected, you will repaint or unpaint the protected colours on your drawings until you enable the option again.</p>
Drawing Tools	
Select	<p>Allows you to select and reposition, scale, rotate and skew brush strokes, pencil lines, shapes and other parts of your artwork.</p>
Contour Editor	<p>Allows you to edit the vector contours of brush strokes, pencil lines and shapes in your artwork. You can add, remove, tweak and move vector points, move the Bezier handles of the vector points as well as deform vector outlines.</p>
Centerline Editor	<p>Allows you to tweak and deform a brush stroke by manipulating the points at the centre of its line rather than its contour.</p>
Pencil Editor	<p>Lets you modify the thick and thin contour of a pencil line (basically a central</p>

	vector shape). Shape control points along the central spine allow you to adjust the stroke curve and position.
Cutter	Allows you to cut a part of your artwork, then reposition, scale, rotate and skew it.
Smooth Editor	Allows you to optimize contours and lines by removing its extra points, making them easier to edit.
Perspective	Allows you to deform artwork by applying a perspective effect on it.
Envelope	Allows you to deform and warp artwork by moving points and tweaking lines in a grid.
Reposition All Drawings	Allows you to reposition, scale, rotate and skew all drawings in the current layer.
Drawing Pivot	Allows you to position the pivot on a drawing layer by clicking where you want its location to be.
Brush	A pressure-sensitive tool for creating a contour shape with a thick and thin line effect, as if created with a paint brush.
Pencil	A pressure-sensitive tool for drawing outlines. Pencil lines are made of central vector lines, making them easier to tweak and edit than brush strokes.
Text	Allows you to add text and to format it.
Eraser	A pressure-sensitive tool for erasing parts of a drawing.
Dropper	Allows you to select a colour by clicking on a colour in your artwork.
Morphing	Allows you to create and configure a morphing sequence, which will automatically generate the in-betweens between two drawings in the current layer.
Line	Draws a straight line segment going from one point to the other.
Rectangle	Draws a rectangle.

Ellipse	Draws an ellipse.
Polyline	Allows you to draw shapes, segmented lines or complex curved lines by clicking to create each point in the sequence of line segments.
Paint	Allows you to fill colour zones with a colour or texture.
Ink	Allows you to recolour pencil lines with precision by changing the colour of one segment at a time.
Repaint Brush	Lets you repaint existing brush strokes. The new brush strokes will be cropped to fit in existing artwork.
Close Gap	Allows you to close open shapes so that they can be filled with the Paint tool. By drawing a stroke near a small gap in a shape, this tool will create a small invisible stroke connecting the two closest points around the gap.
Stroke	Allows you to create invisible lines that can serve as colour zones that can be filled, or close the gaps in existing colour zones.
Edit Gradient/Texture	Allows you to adjust the position, angle and size of gradients and textures in a colour zone.
Hand	Allows you to pan the Camera and Drawing views.
Zoom	Allows you zoom in and out of the Camera and Drawing views.
Rotate View	Lets you rotate the Camera and Drawing views just like with a real animation disc.
Animation	
Insert Keyframe	Adds a keyframe on the selected cell in the Timeline view. If the Animate mode is enabled in the Camera view, a keyframe is automatically created on the current frame.
Insert Control Point	Adds a control point to a 3D path function.
Set Stop-Motion Keyframe	Sets a stop-motion keyframe which there is no computer-generated motion between two keyframes. The segment is constant or flat. The drawing remains still until the playback reaches the next keyframe, then the drawing pops to its new

	location.
Set Motion Keyframe	Sets a motion keyframe. With motion keyframes, Harmony generates the interpolation between the keyframes. This means that a value for each frame between the keyframes is calculated by Harmony to progress from the value of the previous keyframe to the value of the next keyframe.
Flip	Flips the position of an element on its axis.
Set Ease for Multiple Parameters	Lets you set the ease in and ease out on multiple functions and keyframes. This opens the Set Ease For Multiple Parameters where you can modify the Bezier or Ease curve. You can apply easing parameters to a certain type of function only, such as rotation or scale.
Linear Motion	Transforms a curved path to a linear path removing tension, bias, and continuity.
Lock in Time	Indicates whether the point is locked to a specific frame (keyframe) or only locked to a specific position and the curve can flow through it freely as other points are being added, moved, or adjusted (control point).
No Z Dragging	Keeps the Z value constant when you drag a character using the Transform or Translate tool.
Substitute Drawing Previous	Replaces the drawing or cell's symbol on the current frame by the next drawing.
Substitute Drawing Next	
Select Previous Keyframe/Point	Select the previous keyframe/point.
Select Next Keyframe/Point	
Lock	Locks a layer so it cannot be selected in the Camera view.
Reset	Returns the value of the selected element to the initial value of the active tool. For example, if the Rotate tool is active, the transformation angle will be reset to 0 and if the Transform tool is active, all the transformation values will be reset.



Reset All	Resets Resets all transformations on the current frame in a selected layer. Your keyframe will remain, but all the values will return to the starting value. All transformations are reset regardless of the tool you're using.
Reset All Except Z	Resets Resets all transformations on the current frame except the Z position. This is useful when doing cut-out animation. Cut-out puppets often have a particular Z ordering for the different views of a character. You might want to reset the transformation, but not necessarily the Z position.
Animation Tools	
Transform	Allows you to select drawing layers and position, rotate, scale and skew them.
Translate	Lets you move the selected element along the X and Y axes.
Rotate	Turns a selected element around its pivot point.
Scale	Increases or decreases the size of a selected element. You can scale an object up to make it larger or down to make it smaller. Press Shift to scale the element while maintaining its proportions.
Maintain Size	Keeps elements the same size aspect ratio in the Camera view as you move them towards or away from the camera.
Skew	Slants the selected element.
Reposition Drawing	Lets you reposition, scale, rotate or skew all drawing strokes on every drawing included in a layer.
Spline Offset	Lets you Lets you reposition the visual trajectory without offsetting or modifying your animation. By default, the trajectory is located at 0,0,0 fields. If your elements were drawn in a different location than the centre of the drawing area, it will look like the trajectory is not aligned with your drawing. Also, if you have several elements attached to one trajectory, you might want your trajectory to be at a different location to represent the group's motion better.
Inverse Kinematic Tool	Allows you to pose a character model by pulling on its extremities, such as hands and feet, and have the other connected limbs follow. Can be used on any piece connected in a hierarchy.

IK Constraints	
Set IK Nail	Blocks the X, Y and Z positions.
Set IK Hold Orientation	Blocks the angle.
Set IK Hold X	Blocks only the X position.
Set IK Hold Y	Blocks only the Y position.
Set IK Min Angle	Sets limitations on the angle parameter to prevent the puppet from bending too far.
Set IK Max Angle	
Remove All Constraints	Removes all nails except the minimum and maximum angles.
Morphing	
Morphing	Allows you to create and configure a morphing sequence, which will automatically generate the in-betweens between two drawings in the current layer.
Contour Hint	<p>The Contour Hint point is used on the colour fill zone and brush lines; in other words, on Contour vectors. It allows you to control the line thickness and contour position. Also, if a contour is not animated correctly, you can use hints to correct the animation. For example, if a flag is not waving properly.</p> <p>When adding a Contour Hint point, make sure to place it far enough away from the contour so you can see it snap to the contour.</p> <p>Contour Hint points are yellow.</p>
Zone Hint	<p>The Zone Hint point is used on a colour zone to control the proximity rule. The Zone Hint is placed in the centre of the colour zone. Sometimes a colour zone is not associated with the corresponding one by default. For example, in a splash animation there are many water droplets that are the same colour. Harmony automatically morphs the droplet to the nearest one. This is not always the one you may have predicted. A Zone Hint will force a colour zone to morph with another one.</p> <p>Zone Hint points are cyan in colour.</p>

Pencil Hint	<p>A Pencil Hint point is used to control a pencil line, also known as central vector. It can be used on drawings that were done using the Pencil, Polyline, Ellipse, Line and Rectangle tools. Like the Contour Hint, the Pencil Hint snaps to the central vector. Make sure to place it far enough away from the line so you will see it snap when you move it.</p> <p>Pencil Hint points are magenta in colour.</p>
Vanishing Point Hint	<p>A Vanishing Point Hint is used to control the trajectory of a vanishing shape. A shape will vanish from the source drawing when there is no corresponding shape in the destination drawing. If you do not place a Vanishing Point Hint to control the point of disappearance, the shape will vanish into its centre.</p> <p>Vanishing Point Hint points are green in colour.</p>
Appearing Point Hint	<p>An Appearing Point Hint is used to control the trajectory of an appearing shape. A shape will appear in the destination drawing when there is no corresponding shape in the source drawing. If you do not place an Appearing Point Hint to control the point of appearance, the shape will appear from its centre and expand outwards.</p> <p>Appearing Point Hint points are violet in colour.</p>
Switch Between Morphing Key Drawings	<p>Toggles Toggles between the two key drawings in your morphing sequence. This option is useful while setting hints. You can use the default keyboard shortcut F4 to toggle between your drawings.</p>
Suggest Hints	<p>Automatically sets Automatically sets hint points on key drawings as a help tool. If you're not sure where to set hints, you can use this option. It will set the main hints which you can then fine tune.</p>
Hide Hints	<p>Temporarily Temporarily hides the hint points from the key drawings. Use this option when you have a series of hint points hiding some lines you would like to see.</p>

## Colour View Menu

The Colour View menu lets you access commands related to the Colour view such as creating new palettes, adding new colour swatches, and displaying the Tint panel.

### How to access the Colour menu

- In the upper-left corner of the Colour view, click the menu  button.

Command	Description
Palettes	
New	Creates a new colour palette.  By default, Toon Boom Harmony is set to the Basic mode. For simple productions, it is recommended to use the Basic mode. This setting stores the palettes automatically for you and saves them at the Scene level. When you use the Advanced Palette Lists mode, you can decide at which level you want to store your palettes: Environment, Job, Scene, or Element.
Link	Lets you access other palettes created in the project and link them to your scene.
Link to External	Lets you you link an external palette to your scene without copying it in your project.
Import	Imports a colour palette located on your hard drive.
Remove	Removes the selected palette from the palette list.
Remove and Delete on Disk	Removes the selected palette from the palette list and deletes the palette file from the disk.
Rename	Lets you five the selected colour palette a new name.
Duplicate	Creates a copy of the original palette, using the same names and colour values, but has a different ID and is independent from the original palette. This ensures that both the duplicate and original palettes are completely independent.
Clone	Creates a copy of the master palette. The colours in each palette have the same properties. The colours have the same identification number pointing to the same

	colour zones, but they can have different names and RGBA values.
Pencil Texture Palette	Displays the colour palette containing the pencil line textures.
Move Up	Moves the selected colour palette up one level.
Move Down	Moves the selected colour palette down one level.
Colour Editor	Opens the Colour Editor where you can pick and edit colour swatches.
Tint Panel	Opens the Tint panel where you can modify a series of colours to blend a tint in them or offset their RGBA values.
Current Palette Overrides	When clone palettes are present in the palette list, by default, priority is given to the palette that is the highest in the palette list to decide which colours to apply to drawings. With this option enabled, priority is given to the currently selected palette. Selecting any of the clone palettes will make drawings use colours from the selected palette instead.
Display Colour Values	Display the colour values beside their colour swatches in the palette list.
Colours	
Cut	Cuts the selected colour swatch from the palette.
Copy	Copies the selected colour swatch which you can paste in a different palette.
Copy Colour ID	Copies a colour swatch's colour ID so you can keep a reference file of colour IDs or use them with custom plug-ins. Example of a colour ID: <b>075cf5b552401130</b> .
Paste Colour Values	Pastes the colour value of the copied swatch over an existing colour swatch.
Paste As New Colours	Creates a new colour swatch from the colour value of the copied swatch.
Paste As Clones	Pastes a copied colour to a new palette as a clone of the original one. Both colour use the same colour ID. They have to be in different palettes.

New	Creates a new colour swatch from the colour swatch that was last selected.
Edit	Opens the Colour Picker window in which you can edit the selected colour swatch.
Delete	Deletes the selected colour swatch from the palette.
New Texture	Lets you add a bitmap colour swatch to your palette. You can load photos and textures and paint your drawings with it. The bitmap image must be a .tga or .psd file format.
Edit Texture	Opens the browser to replace the texture used in a textured colour swatch. All zones using the swatch will be updated with the new texture.
Scale Down Texture	Lets you set a new maximum texture size or scaling factor.
New Default Colour	Creates a new colour using the default colour set in the preferences.
Protect Colour	Locks a selected colour, so if you ever paint over it accidentally, the work already done will not be affected. You can also block the filling colours if you painted all of the animation in Line Art and plan to repaint the lines.
Swatch Mode	Displays the colour swatches with its corresponding name inside the swatch. When this option is not selected, the names of the colour swatches are displayed beside the swatch.
Independent Bitmap Colour	Bitmap colour selection is independent from the vector colour selection.
Bitmap Colour Sliders	
RGB	Displays the colour picking sliders as RGB (red, green, blue).
HSV	Displays the colour picking sliders as HSV (hue, saturation, value).

## Drawing View Menu

The Drawing View menu lets you access tools, set morphing parameters, lock or unlock layers, and select elements in the Drawing view.

### How to access the Drawing menu

- In the upper-left corner of the Drawing view, click the menu  button.

Command	Description
Edit	
Cut	Removes selected objects. You can then paste the object or its properties to another object.
Copy	Copies selected objects and properties.
Paste	Places an object you cut or copied into the location you select in a view.
Delete	Removes selected objects.
Select All	Selects all drawing objects in the current drawing window in the Drawing, Timeline and Camera views. This helps you manage multiple objects as one when moving them.
Deselect All	Deselects all selected objects in the Drawing and Camera views.
Select Stroke With Current Colour	Select the strokes that contain the currently selected colour.
Invert Selection	Deselects the currently selected items and selects all other items that were not selected. For example, if some lines are selected in a drawing, this command will deselect them and select any other lines in the drawing that were not selected.
View	
Zoom In	Zooms in the view.
Zoom Out	Zooms out the view.

Reset Zoom	Resets the view's zoom to its default position.
Rotate View CW	Rotates the Camera view 30 degrees clockwise, like an animation table.
Rotate View CCW	Rotates the Camera view 30 degrees counter-clockwise, like an animation table.
Reset Rotation	Resets the view's rotation to its default position.
Reset Pan	Resets the view's pan to its default position.
Reset View	Resets the view to its default position.
Switch to Colour Art	Displays the Colour Art layer. When switching art layers, you can edit the selected layer without affecting the other one.
Preview Line Art and Colour Art	Displays all Art layers.
Grid	<b>Show Grid:</b> Displays the grid.
	<b>Grid Outline Only:</b> Displays the outline of the grid only.
	<b>Underlay:</b> Displays the grid under the drawing elements.
	<b>Overlay:</b> Displays the grid over the drawing elements.
	<b>Square Grid:</b> Displays a standard square grid.
	<b>12 Field Grid:</b> Displays a 12-field size grid.
	<b>16 Field Grid:</b> Displays a 16-field size grid.
Onion Skin	<b>Show Onion Skin:</b> Lets Lets you preview the previous and next drawings. By default, the previous drawings appear in a shade of red and the next drawings are displayed with a shade of green. You can change these colours in the Preferences dialog box.
	<b>Show Centre Line:</b>



	<b>No Previous Drawing:</b> Displays no previous drawing.
	<b>Previous Drawing:</b> Displays the previous drawing.
	<b>Previous Two Drawings:</b> Displays the previous two drawings.
	<b>Previous Three Drawings:</b> Displays the previous three drawings.
	<b>No Next Drawing:</b> Displays no next drawing.
	<b>Next Drawing:</b> Displays the next drawing.
	<b>Next Two Drawings:</b> Displays the next two drawings.
	<b>Next Three Drawings:</b> Displays the next three drawings.
	<b>Reduce One Previous Drawing:</b> Reduces the number of previous visible drawings by one.
	<b>Add One Previous Drawing:</b> Adds one drawing to the number of previous visible drawings.
	<b>Reduce One Next Drawing:</b> Reduces the number of next visible drawings by one.
	<b>Add One Next Drawing:</b> Adds one drawing to the number of next visible drawings.
Light Table	Turns on the light table so you can see Turns on the light table so you can see the previous and subsequent active layers in washed-out colours. It is useful for seeing the other layers when designing, animating or cleaning up your animation.
Backlight	Produces Produces a silhouette effect by changing the drawing's coloured areas into a single dark, solid colour. Use this to verify the completeness of the ink and paint process. Any unpainted zones can be seen as the light shows through the unpainted areas of the silhouetted drawing.
Show	
Show Strokes	Displays the strokes in your drawings so that the invisible lines stand out.

Show Strokes with Colour Wash	Displays strokes with washed-out colours.
Highlight Selected Colour	Identify a selected colour swatch used in a drawing.
Show Morphing Key Drawing Thumbnail	When using the Morphing tools, this displays the source or destination drawing as a reference in the bottom corner of the Drawing view.
Show Scan Information	Displays a status bar showing the scanning information at the bottom of the Drawing and Camera view.
Desk	
No Thumbnail	Changes the size of the drawing desk thumbnails.
Small Thumbnail	
Medium Thumbnail	
Large Thumbnail	
Remove Selected Drawing	Clears selected drawing from drawing desk.
Remove All Drawings	Clears all drawing from drawing desk.
Drawing	
Clean Up	<b>Remove Dirt:</b> Opens the Remove Dirt dialog box where you can specify the number and size of dots removal from a selected drawing.
	<b>Remove Hair:</b> Opens the Remove Hair dialog box where you can specify the number and length of hairs for removal from a selected drawing. This removes any small strokes created in the Colour Art layer from very thick lines or filled zones. Increase the value to select larger strokes for removal from the drawing.
	<b>Close Gaps:</b> Closes small gaps in a drawing by creating small, invisible strokes between the two closest points to close the colour zone. You do not need to trace

	<p>directly over the gap. You can draw it a few millimeters away. The two closest points automatically close the gap.</p>
	<p><b>Remove Art Inside Selection:</b> Removes any art inside a selection. It is recommended that you clean your Colour Art level as well. If you have a stroke accumulation in the Colour Art, it can result in large output files, especially if you work in high definition resolutions.</p>
	<p><b>Remove Art Inside Selection On All Drawings:</b> Removes any art inside all drawings selected with the Permanent Selection option in the Select tool.</p>
	<p><b>Remove Art Outside Selection:</b> Removes any art existing outside a selection. It is recommended that you clean the Colour Art level as well. If you have a stroke accumulation in the Colour Art, it can result in large output files, especially if you work in high-definition resolutions.</p>
	<p><b>Remove Art Outside Selection On All Drawings:</b> Removes any art outside all drawings selected with the Permanent Selection option in the Select tool.</p>
Paint	<p><b>Unpaint Selection:</b> Unpaints any art existing inside a selection.</p>
	<p><b>Unpaint Selection on All Drawings:</b> Unpaints all art contained inside a selection on all the drawings within the same layer.</p>
	<p><b>Unpaint Outside Selection:</b> Unpaints any art existing outside a selection. If no selection have been drawn using the Select tool, the entire drawing will be unpainted.</p>
	<p><b>Unpaint Outside Selection on All Drawings:</b> Unpaints all art outside a selection on all the drawings within the same layer.</p>
	<p><b>Repaint Selection:</b> Repaints any art inside a selection.</p>
	<p><b>Repaint Selection on All Drawings:</b> Repaints any art inside a selection on all the drawings contained within the same layer.</p>
	<p><b>Repaint Outside Selection:</b> Repaints any art outside a selection. If no selection has been drawn using the Select tool, the entire drawing will be repainted.</p>
	<p><b>Repaint Outside Selection on All Drawings:</b> Repaints any art outside a selection on all the drawings contained within the same layer.</p>

Convert	<p><b>Pencil Lines to Brush Strokes:</b> Converts the selected centreline pencil strokes into contour strokes brush lines.</p>
	<p><b>Brush Strokes to Pencil Lines:</b> Converts selected contour strokes into centreline pencil strokes. The brush stroke thickness will be lost.</p>
	<p><b>Strokes to Pencil Lines:</b> Converts the selected invisible line to a pencil line.</p>
	<p><b>Brush Apart Text Layers:</b> Text is treated as a single drawing object. This separates the text so each character becomes an individual drawing object you can select and modify independently.</p>
Optimize	<p><b>Flatten:</b> Merges Merges drawing objects and brush strokes into a single layer. If you draw new lines to fix a drawing or line with many brush strokes, it can be useful to flatten them all into a single shape. By default, lines are drawn one on top of each other. If you intend to repaint the lines or modify their shape, it will be easier if they are flattened.</p>
	<p><b>Smooth:</b> Smooths selected drawing strokes and removes extra points.</p>
	<p><b>Create Contour Strokes:</b> Adds a permanent invisible line around a shape that was drawn directly in Harmony. This allows you to unpaint lines with the Paint tool but maintain the shape of the lines, should you need to repaint later.</p>
	<p><b>Remove Contour Strokes:</b> Remove any permanently invisible lines that were created while scanning and vectorizing drawings or manually adding contour strokes. This is useful for removing the intersection triangles created during vectorization.</p>
	<p><b>Remove Extra Strokes:</b> Removes strokes inside painted area. This option only works after the painted drawing is flattened.</p>
	<p><b>Optimize:</b> Reduces Reduces the number of layers, such as overlapping brush strokes, in the selected drawing objects. Drawing objects will only be flattened and optimized if the selected objects do not change the appearance of the final image when they are merged.</p>
	<p><b>Crop Brush Textures:</b> Crops Crops an unnecessarily large texture bitmap that lies unseen beneath the vector contour of a textured line. This often occurs when you cut and paste textured lines from one drawing into another. If you cut a portion from a textured line and paste it into a different drawing, Harmony pastes the entire unseen texture bitmap from the source drawing into the new one, even if</p>

	<p>you only took a small portion of the source drawing. Using the Crop Brush Texture command will crop away extraneous texture that does not touch the vector area. If there are many textured lines in your scene, this will greatly reduce the file size.</p>
	<p><b>Reduce Drawing Texture Resolution:</b></p> <p>When you import and vectorize as texture (colour) a high resolution image, the size of your drawing can be heavy. You can reduce the size and resolution of the textures in a drawing.</p>
Arrange	<p><b>Bring to Front:</b> Moves the selected art to the front (on top).</p>
	<p><b>Bring Forward:</b> Moves the selected art one level forward (closer to the front).</p>
	<p><b>Send Backward:</b> Moves the selected art one level lower (behind).</p>
	<p><b>Send to Back:</b> Moves the selected art behind everything (bottom / back).</p>
Transform	<p><b>Flip Horizontal:</b> Flips the current selection horizontally.</p>
	<p><b>Flip Vertical:</b> Flips the current selection vertically.</p>
	<p><b>Rotate 90 CW:</b> Rotates the current selection 90 degrees clockwise.</p>
	<p><b>Rotate 90 CCW:</b> Rotates the current selection 90 degrees counter-clockwise.</p>
	<p><b>Rotate 180:</b> Rotates the current selection 180 degrees.</p>
Create Empty Drawing	<p>Creates Creates a drawing in the selected cell, replacing any drawing that may already be exposed in that cell and the following ones until it meets another drawing, key exposure or a blank cell.</p>
Duplicate Drawings	<p>Lets you duplicate the drawing and work on a copy of it. This lets you modify an existing drawing but retain the original. When duplicating a drawing, the selected cell is replaced with the new drawing. The exposure of the original drawing that was on the current cell is removed. The original drawing is not deleted from the project folder or other cells in which it is exposed.</p> <p>When duplicating a drawing, the selected cell is replaced with the new drawing. The exposure of the original drawing that was on the current cell is removed. The original drawing is not deleted from the project folder or other cells in which it is</p>

	exposed.
Delete Selected Drawings	Permanently removes selected drawings. Once you save your project, these drawings cannot be recovered.
Rename Drawing	Lets you give a selected drawing a new name.
Create Colour Art From Line Art	<p>Lets you use the outline you traced on one of the four embedded layers (line art, colour art, overlay, underlay) and create invisible strokes to paint your drawings on separate layers. This provides more inking and painting flexibility.</p> <p>You can also configure this option to create the invisible strokes on any of the four embedded layers.</p>
Generate Auto-Matte	<p>Automatically creates a matte from a selected drawing or all drawings on a layer.</p> <p>Opens the auto-Matte dialog box where you can set the radius of the lines depending on how precise or rough your line is.</p> <p>You can also select the source and destinatin layers from which the matte will be created.</p>
Adjust Line Texture Opacity	Lets you adjust the contrast and opacity of textured lines in a drawing.
Change Bitmap Drawing Resolution	<p>Lets you Lets you change the resolution of bitmap art for individual drawings. You can reduce the resolution of your bitmap file as well as increase it. Be careful because enlarging the bitmap resolution on an existing drawing will result in a loss of quality. Harmony will perform a pixel smoothing pass (resampling) and create additional pixels to avoid losing too much quality, but only to a certain extent. This feature is very useful when you need to have a full resolution of a bitmap image (such as imported bitmaps as .psd or .tga for the background) for tracing to create a matte directly in Harmony. By default, Harmony creates small thumbnail images when imported as bitmap in order to increase performance by using a small thumbnail image instead of using the original large size bitmap for animation work in Harmony. This will make difficult to view details or trace due to the low resolution (blurry). This option temporary increases the resolution of bitmaps up to their original bitmap resolution to make tracing easier.</p>

Previous Drawing	Once a cell is selected in the Timeline or Xsheet view, you can navigate between the drawings, frames, and layers. Displays the previous drawing, next drawing, previous layer or next layer.  Displays the previous drawing, next drawing, previous layer or next layer.
Next Drawing	
Previous Layer	
Next Layer	
Colour Protection	<b>Toggle Current Colour Protection:</b> Temporarily enables/disables the Colour Protection feature so you can quickly correct wrongly inked or painted areas under protected colour without readjusting the Current Colour Protection option.
	<b>Respect Colour Protection:</b> In the Colour view, you can protect a colour swatch to avoid repainting or unpainting the zones linked to that swatch. If you using the Paint tool and this option is deselected, you will repaint or unpaint the protected colours on your drawings until you enable the option again.
Drawing Tools	
Select	Allows you to select and reposition, scale, rotate and skew brush strokes, pencil lines, shapes and other parts of your artwork.
Contour Editor	Allows you to edit the vector contours of brush strokes, pencil lines and shapes in your artwork. You can add, remove, tweak and move vector points, move the Bezier handles of the vector points as well as deform vector outlines.
Centerline Editor	Allows you to tweak and deform a brush stroke by manipulating the points at the centre of its line rather than its contour.
Pencil Editor	Lets you modify the thick and thin contour of a pencil line (basically a central vector shape). Shape control points along the central spine allow you to adjust the stroke curve and position.
Cutter	Allows you to cut a part of your artwork, then reposition, scale, rotate and skew it.
Smooth Editor	Allows you to optimize contours and lines by removing its extra points, making them easier to edit.
Perspective	Allows you to deform artwork by applying a perspective effect on it.

Envelope	Allows you to deform and warp artwork by moving points and tweaking lines in a grid.
Reposition All Drawings	Allows you to reposition, scale, rotate and skew all drawings in the current layer.
Drawing Pivot	Allows you to position the pivot on a drawing layer by clicking where you want its location to be.
Brush	A pressure-sensitive tool for creating a contour shape with a thick and thin line effect, as if created with a paint brush.
Pencil	A pressure-sensitive tool for drawing outlines. Pencil lines are made of central vector lines, making them easier to tweak and edit than brush strokes.
Text	Allows you to add text and to format it.
Eraser	A pressure-sensitive tool for erasing parts of a drawing.
Dropper	Allows you to select a colour by clicking on a colour in your artwork.
Morphing	Allows you to create and configure a morphing sequence, which will automatically generate the in-betweens between two drawings in the current layer.
Line	Draws a straight line segment going from one point to the other.
Rectangle	Draws a rectangle.
Ellipse	Draws an ellipse.
Polyline	Allows you to draw shapes, segmented lines or complex curved lines by clicking to create each point in the sequence of line segments.
Paint	Allows you to fill colour zones with a colour or texture.
Ink	Allows you to recolour pencil lines with precision by changing the colour of one segment at a time.



Repaint Brush	Lets you repaint existing brush strokes. The new brush strokes will be cropped to fit in existing artwork.
Close Gap	Allows you to close open shapes so that they can be filled with the Paint tool. By drawing a stroke near a small gap in a shape, this tool will create a small invisible stroke connecting the two closest points around the gap.
Stroke	Allows you to create invisible lines that can serve as colour zones that can be filled, or close the gaps in existing colour zones.
Edit Gradient/Texture	Allows you to adjust the position, angle and size of gradients and textures in a colour zone.
Hand	Allows you to pan the Camera and Drawing views.
Zoom	Allows you zoom in and out of the Camera and Drawing views.
Rotate View	Lets you rotate the Camera and Drawing views just like with a real animation disc.
Morphing	
Morphing	Allows you to create and configure a morphing sequence, which will automatically generate the in-betweens between two drawings in the current layer.
Contour Hint	<p>The Contour Hint point is used on the colour fill zone and brush lines; in other words, on Contour vectors. It allows you to control the line thickness and contour position. Also, if a contour is not animated correctly, you can use hints to correct the animation. For example, if a flag is not waving properly.</p> <p>When adding a Contour Hint point, make sure to place it far enough away from the contour so you can see it snap to the contour.</p> <p>Contour Hint points are yellow.</p>
Zone Hint	<p>The Zone Hint point is used on a colour zone to control the proximity rule. The Zone Hint is placed in the centre of the colour zone. Sometimes a colour zone is not associated with the corresponding one by default. For example, in a splash animation there are many water droplets that are the same colour. Harmony automatically morphs the droplet to the nearest one. This is not always the one you may have predicted. A Zone Hint will force a colour zone to morph with another one.</p> <p>Zone Hint points are cyan in colour.</p>

Pencil Hint	<p>A Pencil Hint point is used to control a pencil line, also known as central vector. It can be used on drawings that were done using the Pencil, Polyline, Ellipse, Line and Rectangle tools. Like the Contour Hint, the Pencil Hint snaps to the central vector. Make sure to place it far enough away from the line so you will see it snap when you move it.</p> <p>Pencil Hint points are magenta in colour.</p>
Vanishing Point Hint	<p>A Vanishing Point Hint is used to control the trajectory of a vanishing shape. A shape will vanish from the source drawing when there is no corresponding shape in the destination drawing. If you do not place a Vanishing Point Hint to control the point of disappearance, the shape will vanish into its centre.</p> <p>Vanishing Point Hint points are green in colour.</p>
Appearing Point Hint	<p>An Appearing Point Hint is used to control the trajectory of an appearing shape. A shape will appear in the destination drawing when there is no corresponding shape in the source drawing. If you do not place an Appearing Point Hint to control the point of appearance, the shape will appear from its centre and expand outwards.</p> <p>Appearing Point Hint points are violet in colour.</p>
Switch Between Morphing Key Drawings	<p>Toggles Toggles between the two key drawings in your morphing sequence. This option is useful while setting hints. You can use the default keyboard shortcut F4 to toggle between your drawings.</p>
Go to First Frame	<p>Goes to the first frame of your morphing sequence.</p>
Go to Previous Frame	<p>Goes to the previous frame of the selected frame in the morphing sequence.</p>
Go to Next Frame	<p>Goes to the next frame of the selected frame in the morphing sequence.</p>
Go to Last Frame	<p>Goes to the last frame of your morphing sequence.</p>
Suggest Hints	<p>Automatically sets Automatically sets hint points on key drawings as a help tool. If you're not sure where to set hints, you can use this option. It will set the main hints which you can then fine tune.</p>
Hide Hints	<p>Temporarily Temporarily hides the hint points from the key drawings. Use this option when you have a series of hint points hiding some lines you would like to see.</p>

## Function View Menu

The Functions View menu lets you do many things in the Camera view, including selecting and editing objects in different views, changing the display, setting morphing parameters, accessing tools and many more.

### How to access the Function menu

- In the upper-left corner of the Function view, click the menu  button.

Command	Description
Edit	
Cut	Removes selected objects. You can then paste the object or its properties to another object.
Copy	Copies selected objects and properties.
Paste	Places an object you cut or copied into the location you select in a view.
Delete	Removes selected objects.
Select Next Keyframe	Selects the next keyframe.
Select Previous Keyframe	Selects the previous keyframe.
Select Left Handle	Selects the left handle of the selected keyframe.
Select Right Handle	Selects the right handle of the selected keyframe.
Select All	Selects all objects in the Function view. This helps you manage multiple objects as one.
Deselect All	Deselects all selected objects in the Function view.
View	

Show Current Frame	Displays the current frame
Toggle Grid	Enables the display of the grid.
Reset Zoom	Resets the view's zoom to its default position.
Reset Pan	Resets the view's pan to its default position.
Reset View	Resets the view to its default position.
Function List	
Auto Load Selection	
Clear	
Load Selection	
Add Selection	
Remove Selection	
Show	<b>Show Motion:</b>
	<b>Show Rotation:</b>
	<b>Show Scale:</b>
	<b>Show Skew:</b>
	<b>Show Other:</b>



## Library View Menu

The Library View menu lets you access commands specific to the Library view, such as opening a Library or getting the rights to modify a library folder.

### How to access the Library menu

- In the upper-left corner of the Library view, click the menu  button.

Command	Description
View	
List	Displays the contents of the selected folder as a list.
Thumbnails	Displays the contents of the selected folder as a thumbnails.
Details	Displays the details of the selected file.
Generate Thumbnails	Creates a thumbnail to display in the preview window.
Edit	
New Symbol	Creates a new symbol from a drawing or part of a drawing in the Drawing or Camera view, a layer in the Timeline view, or a node in the Node view.  If your selection is in the Timeline or Node view, the new symbol appears in the Symbol folder. The current selection is not replaced by the new symbol. The new symbol only appears in the library. You must drag it into your scene to use it.  If your selection is in the Drawing or Camera view, the new symbol appears in the Symbol folder and in the Timeline view as a new layer.
Cut	Cuts the selected file in the Library view.
Copy	Copies the selected file in the Library view.
Paste	Pastes the selected file in the Library view.
Delete	Deletes the selected file in the Library view.

Delete Thumbnails	Deletes any thumbnails that were generated for display in the preview window.
Edit Symbol	Places you inside the symbol where you can edit it. To return to the project's timeline, click the Top  button in the Camera view's top-left corner, press Ctrl + Shift + E (Windows/Linux) or  + Shift + E (macOS).
Remove Unused Files	Removes any files not in use in the selected template.
Rename Template	Lets you rename a selected template.
Import Files	Imports vector files such as AI, PDF, and SWF. You requires the right to modify the library in which you want to import the files.
Folders	
New Folder	Creates a new folder in the Library view. Before you can create a new folder, you must have the right to modify the folder in which you are creating the new folder.
Refresh	Updates the view and its contents.
Open Library	Lets you open a library on your computer.
Close Library	Unlinks a library folder from your library list.

## Model View Menu

The Model View menu lets you load models and view them in different ways, as well as access some drawing tools.

### How to access the Model menu

- In the upper-left corner of the Model view, click the menu  button.

Command	Description
Previous Model	Shows the previous model loaded in the Model view.
Next Model	Shows the next model loaded in the Model view.
Import Model	Imports a TVG drawing as a model in the Model view.
Use Current Drawing as Model	Loads the currently selected drawing in the scene as a model in the Model view.
Load Default Models	Loads TVG drawings placed in a custom <code>models</code> folder located in the scene folder.
Clear Model	Removes the model from the Model view.
Zoom In	Zooms in the view.
Zoom Out	Zooms out the view.
Reset Zoom	Resets the view's zoom to its default position.
Reset Pan	Resets the view's pan to its default position.
Reset View	Resets the view to its default position.
Rotate View CW	Rotates the Camera view 30 degrees clockwise, like an animation table.
Rotate View CCW	Rotates the Camera view 30 degrees counter-clockwise, like an animation table.

Reset Rotation	Resets the view's rotation to its default position.
Select	Activates the Select tool. This tools is also available on the Tools toolbar.
Cutter Selection	Allows to cut a section of the model to paste it in your scene.
Dropper	Activates the Dropper tool. This tools is also available on the Tools toolbar.
Zoom	Activates the Zoom tool. This tools is also available on the Tools toolbar.



## Node View Menu

The Node View menu lets you organize the nodes according to how you like to work and the nodes you use most often. You can easily add categories and subcategories, remove categories you don't use, and rename categories.

### How to access the Node menu

- In the upper-left corner of the Node view, click the menu  button.

Command	Description
File	
Print	Lets you print the contents of the Node view. You must be connected to a printer.
Edit	
Cut	Removes selected objects. You can then paste the object or its properties to another object.
Copy	Copies selected objects and properties.
Paste	Places an object you cut or copied into the location you select in a view.
Paste Special	Lets you copy and paste selected drawings into a different layer or paste the selection in the same layer to duplicate the drawings.
Paste Special Again	Pastes new drawings with the previous Paste Special settings.
Delete	Removes selected objects.
Select All	Selects all drawing objects in the current drawing window in the Drawing, Timeline and Camera views. This helps you manage multiple objects as one when moving them.
Deselect All	Deselects all selected objects in the Drawing and Camera views.
Invert Selection	Deselects the currently selected items and selects all other items that were not

	selected. For example, if some lines are selected in a drawing, this command will deselect them and select any other lines in the drawing that were not selected.
Layer Properties	Shows or hides the Layer Properties view.
Recalculate Selected	Refreshes the node structure and rerenders the display of selected elements when the Camera View is in render mode.
Recalculate All	Refreshes the node structure and rerenders the display when the Camera view is in render mode.
Tag	You can tag elements in the Timeline or Node views to view only those elements. When you tag elements, an asterisk appears beside the item in the Timeline view. Once your elements are tagged and you have switched over to View Tagged Layers mode, the Timeline view will display only tagged elements. The red bar on the left of the layers indicates you are in this view mode.
	<b>Timeline Tag:</b> Tags selected elements in the Timeline or Node views.
	<b>Timeline Untag:</b> Untags selected layer in the Timeline view.
	<b>Timeline Untag All:</b> Untags all tagged elements.
	<b>Timeline Untag All Others:</b> Untags all elements except the selected one.
Auto Render Write	Renders a frame each time the current frame is changed. You must have a Write node in your node structure to use this command.
Select Child Skipping Effects	Lets you select the first element parented to the selected peg element in the Timeline view skipping effects in the hierarchy.
Select Child	Lets you select the first element parented to the selected peg element in the Timeline view.
Select Group Content	Select contents within the group node.
Select Children	Lets you select all elements parented to the selected peg element in the Timeline view.
Select Parent	Lets you select the parent of the selected element in the Timeline view skipping

Skipping Effects	effects in the hierarchy.
Select Parent	Lets you select the parent of the selected element in the Timeline view.
Select Previous Sibling	Lets you select the previous element (above current element) in the Timeline view.
Select Next Sibling	Lets you select the next element (below current element) in the Timeline view.
View	
Zoom In Node View	Zooms in the view.
Zoom Out Node View	Zooms out the view.
Reset Zoom	Resets the view's zoom to its default position.
Centre on Selection	Centre the display of the Node view on the selected node. This is useful when you have many nodes in the Node view, you may find it hard to locate which one is selected.
Reset Pan	Resets the view's pan to its default position.
Reset View	Resets the view to its default position.
Show All Nodes	Display all nodes.
Editor	Display the Layer Properties editor of the selected node.
Publish Attribute Node	To quickly access parameters for nodes that are grouped, you can select your most common parameters to modify and make them appear in the group Layer Properties editor. This way, you can access them directly without having to enter the group every time.
Show Selected Thumbnails	Displays the thumbnails of selected nodes.
Hide All Thumbnails	Hides all the thumbnails of selected nodes.

Navigator	<b>Hide Navigator:</b> Hides the navigator.
	<b>Top Right:</b> Places the navigator in the top-right corner of the Node view.
	<b>Top Left:</b> Places the navigator in the top-left corner of the Node view.
	<b>Bottom Right:</b> Places the navigator in the bottom-right corner of the Node view.
	<b>Bottom Left:</b> Places the navigator in the top-left corner of the Node view.
Cable Style	<b>Line:</b> Use straight lines to show the connections between nodes.
	<b>Bezier:</b> Use curved (Bezier) lines to show the connections between nodes.
Nodes	
Enable	Activate the selected node.
Disable	Deactivate the selected node.
Enable All	Activate all nodes.
Disable All Others	Deactivates all nodes except for those those selected. This operation only affects the current level layers. It does not affect the nested nodes within a group. Deactivated nodes appear in red.
Clone Selected Nodes: Drawings and Timing	Creates a copy of the selected element that is linked to the original. If a drawing is modified in the original or cloned layer, both will be updated. However, cloned layers can have different timings.
Clone Selected Nodes: Drawings Only	When you clone a node, it does not automatically connect itself to the Composite node of your scene.  You can clone the drawings only or both the drawings and timing.
Duplicate Selected Nodes	Creates an independent copy of the selected element. This useful when you need to modify the element independently, including the timing (exposure). Changes to the original element do not propagate to the duplicate.
Group Selection	Creates a simple group from your selection. The resulting group displays the same number of connections as elements in the group.

Group Selection with Composite	Group a selection.
Ungroup	Ungroups the selected group of nodes.
Move to Parent Group	Moves selected nodes up to the parent group level.
Exit Group	Exits the group.
Clear Published Attributes	Removes the most common parameters you selected for quick access in the Layer Properties editor of a group.
Insert	
Composite	Adds a Composite node to the Node view.
Display	Adds a Display node to the Node view.
Drawing	Opens the Add Drawing Layer dialog box where you can specify the type of layer to add.
Group	Adds a Group node to the Node view.
Parent Peg	Adds a new peg to the timeline as a parent of the selected layer.
Peg	Adds a Peg node to the Node view.
Effects	Lets you add effects from these categories: 3D, Combine, Deformation, Favourites, Filter, Generator, Group, Misc, Move, Output, Particle, Sapphire, Shading and Plugins.
Backdrop	Adds a backdrop to the Node view. Backdrops are a way to work with complex node systems that let you associate a selected set of nodes by colour.

## Node Library View Menu

The Node Library View menu lets you organize the nodes according to how you like to work and the nodes you use most often. You can easily add categories and subcategories, remove categories you don't use, and rename categories.

### How to access the Node Library menu

- In the upper-left corner of the Node Library view, click the menu  button.

Command	Description
New Category	Adds a new category to the list of categories to which you can organize nodes according to how you like to work and the nodes you use most often.
Rename Category	Renames an existing category.
Remove Category	Remove a category you no longer need.
Remove Node	Removes a node from a category.
Refresh	Updates the view and its contents.



## Onion Skin View Menu

The Onion Skin view menu contains extra options for controlling the Advanced Onion Skin. It is accessible via the Onion Skin view—see [Onion Skin View on page 1097](#)

### How to access the Onion Skin view menu

1. In the top-left corner of the Onion Skin view, click on the  View Menu button.

Command	Description
Advanced Onion Skin	<p>Enables Advanced Onion Skin. Advanced Onion Skin allows you to select, on the fly, which drawings to include in your Onion Skin, even if those drawings are not consecutive drawings, as well as the opacity scales for the drawings before and after the current frame.</p> <p>The controls for selecting which drawings to display in the Onion Skin as well as their opacity sliders are only accessible when Advanced Onion Skin is enabled. Otherwise, when using regular Onion Skin, the opacity of drawings in the Onion Skin is determined by the Onion Skin settings in the Preferences dialog. The amount of drawings to include in the Onion Skin is set using the Onion Skin Add / Reduce One Previous Drawing and Onion Skin Add / Reduce One Next Drawing commands, available in the Camera and Drawing toolbars as well as in View &gt; Onion Skin in the top menu.</p>
Original Colors	Displays the onion skin using the actual colours of the drawings.
Coloured	Displays the onion skin using the colours selected for the previous and next drawings in the Onion Skin view.
Coloured Outlines	Displays the onion skin using the colours selected for the previous and next drawings, but only as outlines instead of filled shapes.
Onion Skin by Frames	<p>Selects the drawings to display in the Onion Skin by the amount of different drawings before and after the current frame. For example, if the Onion Skin is set to include 2 drawings before and after the current frame, this will display the nearest two different drawings before and after the drawing in the current frame in the Onion Skin, even if those drawings are further than 2 frames away from the current frame. This is more useful for frame-by-frame animation.</p> <div style="border: 1px solid green; padding: 10px; margin-top: 10px;"> <p> <b>NOTE</b> When this option is enabled, the handles allowing you to adjust the extent of the Onion Skin in the Timeline view are not available.</p> </div>

Command	Description
Onion Skin by Drawings	<p>Selects the drawings to display in the Onion Skin by the amount of different drawings before and after the current frame. For example, if the Onion Skin is set to include 2 drawings before and after the current frame, this will display the nearest two different drawings before and after the drawing in the current frame in the Onion Skin, even if those drawings are further than 2 frames away from the current frame. This is more useful for frame-by-frame animation.</p> <div data-bbox="370 489 1430 657" style="border: 1px solid #c8e6c9; padding: 10px;">  <b>NOTE</b>            When this option is enabled, the handles allowing you to adjust the extent of the Onion Skin in the Timeline view are not available.         </div>
Apply Colour Wash	<p>Displays onion skins with a lighter, less saturated colour. The further away the drawing is from the current frame, the more washed its colour appears.</p> <div data-bbox="370 814 1430 982" style="border: 1px solid #c8e6c9; padding: 10px;">  <b>NOTE</b>            The minimum and maximum colour wash values for Onion Skin can be customized in the Drawing tab of the Preferences dialog.         </div>
Enable Onion Skin for Other Elements	<p>In the Drawing View, when the Light Table is enabled, making other layers visible alongside the current layer, this will make the Onion Skin for other visible layers appear alongside the Onion Skin for the current layer. Drawings for elements above the current layer will appear in blue, and drawings for elements below will appear in yellow.</p> <div data-bbox="370 1209 1430 1377" style="border: 1px solid #c8e6c9; padding: 10px;">  <b>NOTE</b>            The drawings from other elements that get displayed in the Onion Skin are the drawings that are exposed at the same time as the drawings displayed in the current layer's Onion Skin.         </div>
Link Sliders	<p>When enabled, the opacity sliders in the Onion Skin view will move simultaneously as you adjust one of them, so that the opacity levels for previous and next drawings progresses from the opacity level of the first drawing to the opacity level of the last drawing.</p> <p>When this mode is enabled, you can adjust the first and last sliders for previous or next drawings, then, optionally, adjust a single one of the sliders in-between to create a segmented progression.</p> <p>However, if you want to make the opacity of Onion Skin drawings to vary in any way that is more complex, you must disable this option.</p>



## Perspective View Menu











The Perspective View menu lets you select and edit elements, manipulate the view during scene setup, set parameters for animation and access animation tools.

### How to access the Perspective menu

- In the upper-left corner of the Perspective view, click the menu  button.

Command	Description
Edit	
Cut	Removes selected objects. You can then paste the object or its properties to another object.
Copy	Copies selected objects and properties.
Paste	Places an object you cut or copied into the location you select in a view.
Delete	Removes selected objects.
Select All	Selects all drawing objects in the current drawing window in the Drawing, Timeline and Camera views. This helps you manage multiple objects as one when moving them.
Deselect All	Deselects all selected objects in the Drawing and Camera views.
Invert Selection	Deselects the currently selected items and selects all other items that were not selected. For example, if some lines are selected in a drawing, this command will deselect them and select any other lines in the drawing that were not selected.
Select Child Skipping Effects	Lets you select the first element parented to the selected peg element in the Timeline view skipping effects in the hierarchy.
Select Child	Lets you select the first element parented to the selected peg element in the Timeline view.
Select Children	Lets you select all elements parented to the selected peg element in the

	Timeline view.
Select Parent Skipping Effects	Lets you select the parent of the selected element in the Timeline view skipping effects in the hierarchy.
Select Parent	Lets you select the parent of the selected element in the Timeline view.
Select Previous Sibling	Lets you select the previous element (above current element) in the Timeline view.
Select Next Sibling	Lets you select the next element (below current element) in the Timeline view.
View	
Zoom In	Zooms into the view, towards the view's pivot point, up to 80,000%.
Zoom Out	Zooms out of the view, away from the view's pivot point, up to 1%.
Move Forward	Moves infinitely forward into the view, using the direction set by the current position and angle of rotation.
Move Backward	Moves infinitely backwards out of the view, using the direction set by the current position and angle of rotation.
Reset Zoom	Resets the view's zoom to its default position.
Reset Pan	Resets the view's pan to its default position.
Reset View	Resets the view to its default position.
Face Selected to Draw	Resets any rotations made and brings the selected object to the center of the view. Displaying the drawing object at this perspective is intended to facilitate drawing on the object.
Look at Selected	Resets view to have the selected object at the center, without resetting the rotation angles or zoom.
Layer Properties	Shows or hides the Layer Properties view.

Light Table	Turns on the light table so you can see Turns on the light table so you can see the previous and subsequent active layers in washed-out colours. It is useful for seeing the other layers when designing, animating or cleaning up your animation.
Camera Cone	Displays the camera cone.
Control	Displays the controls of the selected element.
Hide All Controls	Hides the controls of the selected element.
Enable Playback	Plays back your animation in the Perspective view.
Animation	
Animate Animate	
Animate Current Frame	When this option is selected, every time you use the  Transform,  Rotate,  Advanced Animation or  Inverse Kinematic tools to manipulate an element in your scene, the position of the element will be stored in a keyframe at the current frame. This allows you to animate elements in your scene without creating keyframes manually.
Animate Onion Skin Range	When this option is selected, if you use the  Transform or  Rotate,  Advanced Animation tools to make transformations to an element in your scene, the transformations will be stored as keyframes at the beginning and at the end of the current Onion Skin range, as well as on every existing keyframe in-between. This can be useful if you want to reposition an element that you have already animated, but only during a specific range of frames, which you can define by enabling Onion Skin and setting the Onion Skin range to cover that range of frames.
Animate Off	When this option is selected, if you use the  Transform or  Rotate,  Advanced Animation tools to make transformation to an element in your scene, the transformations will affect the element throughout the whole scene. This can be useful if you want to reposition an element after you have already animated it.
Insert Keyframe	Adds a keyframe to the currently selected frame in the Timeline view.
Insert Control Point	Adds a control point to the motion path at the currently selected frame. This control point does not appear in the Timeline, but can be used to reshape the

	<p>motion path. In order for this command to work, layers must be set to 3D Path.</p>
<p>Set Stop-Motion Keyframe</p>	<p>Sets a stop-motion keyframe which there is no computer-generated motion between two keyframes. The segment is constant or flat. The drawing remains still until the playback reaches the next keyframe, then the drawing pops to its new location.</p>
<p>Set Motion Keyframe</p>	<p>Sets a motion keyframe. With motion keyframes, Harmony generates the interpolation between the keyframes. This means that a value for each frame between the keyframes is calculated by Harmony to progress from the value of the previous keyframe to the value of the next keyframe.</p>
<p>Flip</p>	<p><b>Flip Horizontal:</b> Flips the current selection horizontally.</p>
	<p><b>Flip Vertical:</b> Flips the current selection vertically.</p>
	<p><b>Flip Scale X:</b> Once your drawing layer is rotated, the original horizontal and vertical axes change. The Flip Scale X and Flip Scale Y will perform a flip on your drawing layer following its original axis. Remembers the original X-axis of the layer and flips the element following it.</p>
	<p><b>Flip Scale Y:</b> Remembers the original Y-axis of the layer and flips the element following it.</p>
<p>Set Ease for Multiple Parameters</p>	<p>Opens the Set Ease for Multiple Parameters dialog box where you can change the velocity of selection functions.</p>
<p>Linear Motion</p>	<p>Straightens out the motion path on either sides of the selected control point.</p>
<p>Lock in Time</p>	<p>Indicates whether the point is locked to a specific frame (keyframe) or only locked to a specific position and the curve can flow through it freely as other points are being added, moved, or adjusted (control point).</p>
<p>No Z Dragging</p>	<p>Locks the Z value when you're animating in 3D space. This means you can only reposition your object along the x and y axes.</p>
<p>Substitute Drawing Previous</p>	<p>Replaces the drawing or cell's symbol on the current frame by the next drawing.</p>
<p>Substitute Drawing Next</p>	

Select Previous Keyframe /Point	Select the previous keyframe/point.
Select Next Keyframe /Point	Select Next Keyframe /Point
Lock	<b>Lock:</b> Locks Locks one or a multiple selection of layers.
	<b>Unlock:</b> Unlocks Unlocks one or a multiple selection of locked layers.
	<b>Lock All:</b> Locks Locks all the layers in the Timeline view.
	<b>Unlock All:</b> Unlocks Unlocks all the layers in the Timeline view.
	<b>Lock All Others:</b> Locks Locks every layer except the selected ones.
Reset	Returns Returns the value of the selected element to the initial value of the active tool. For example, if the Rotate tool is active, the transformation angle will be reset to 0 and if the Transform tool is active, all the transformation values will be reset.
Reset All	Resets Resets all transformations on the current frame in a selected layer. Your keyframe will remain, but all the values will return to the starting value. All transformations are reset regardless of the tool you're using.
Reset All Except Z	Resets Resets all transformations on the current frame except the Z position. This is useful when doing cut-out animation. Cut-out puppets often have a particular Z ordering for the different views of a character. You might want to reset the transformation, but not necessarily the Z position.
Animation Tools	
Transform	Allows you to select drawing layers and position, rotate, scale and skew them.
Translate	Lets you move the selected element along the X and Y axes.
Rotate	Turns a selected element around its pivot point.
Scale	Increases or decreases the size of a selected element. You can scale an object up to make it larger or down to make it smaller. Press Shift to scale the

	element while maintaining its proportions.
Maintain Size	Keeps elements the same size aspect ratio in the Camera view as you move them towards or away from the camera.
Skew	Slants the selected element.
Reposition Drawing	Lets you reposition, scale, rotate or skew all drawing strokes on every drawing included in a layer.
Spline Offset	Lets you Lets you reposition the visual trajectory without offsetting or modifying your animation. By default, the trajectory is located at 0,0,0 fields. If your elements were drawn in a different location than the centre of the drawing area, it will look like the trajectory is not aligned with your drawing. Also, if you have several elements attached to one trajectory, you might want your trajectory to be at a different location to represent the group's motion better.



## Script Editor View Menu

The Script Editor view menu gives you access to all of the commands needed for editing and testing scripts in the Script Editor view—see [Script Editor View on page 1106](#).



### How to access the Script Editor view menu



1. Add the Script Editor view to your workspace by doing one of the following:
  - In the top-right corner of an existing view, click on the **+** Add View button and select Script Editor.
  - In the top menu, select **Windows > Script Editor**.
2. In the top-left corner of the Script Editor view, click on the **☰** Menu button.

Button	Description
File	
New Script	<p>Creates a new script. When you click on this button, you are first prompted to type in a name for the script. Then, you will be prompted to select which location to save the script in:</p> <ul style="list-style-type: none"> <li>• <b>User:</b> Saves the script to a directory in your user preferences directory. You will be able to run and edit the script from any scene as long as you are logged in as the same user.</li> </ul> <div data-bbox="574 1241 1429 1476" style="border: 1px solid green; padding: 10px; margin: 10px 0;"> <p> <b>NOTE</b></p> <p>If you are using Harmony Stand Alone, the script will be saved to the preferences for your account on your computer. If you are using Harmony Server, the script will be saved to the preferences for your Harmony database user.</p> </div> <ul style="list-style-type: none"> <li>• <b>Global:</b> If you are using Harmony Server, select this option to save the script to the Harmony database's global script directory. Anyone who is logged in to the database will be able to edit and run this script.</li> <li>• <b>Environment:</b> If you are using Harmony Server, select this option to save the script to the current scene's environment. Anyone will be able to edit and run the script as long as they are working on a scene inside this environment.</li> <li>• <b>Job:</b> If you are using Harmony Server, select this option to save the script to the current scene's job. Anyone will be able to edit and run the script as long as they are working on a scene inside this job.</li> <li>• <b>Scene:</b> Save the script to the scene's <b>scripts</b> sub-folder. Anyone will be able to</li> </ul>

Button	Description
	<p>edit and run the script when working on this specific scene.</p> <ul style="list-style-type: none"> <li>• <b>System Variable:</b> Save the script to the directory in the <code>TOONBOOM_GLOBAL_SCRIPT_LOCATION</code> environment variable. This option is only available if this environment variable is set.</li> </ul> <div data-bbox="496 470 1430 611" style="border: 1px solid #c8e6c9; padding: 10px; margin-top: 10px;">  <p><b>NOTE</b> For more information on script locations, see <a href="#">Script list on page 1106</a>.</p> </div>
<p style="text-align: center;">Import Script</p>	<p>Allows you to import a script from your machine into Harmony. When you click on this button, you are prompted to browse for and select a script on your file system. Then, you are prompted to select which location to import the script in:</p> <ul style="list-style-type: none"> <li>• <b>User:</b> Saves the script to a directory in your user preferences directory. You will be able to run and edit the script from any scene as long as you are logged in as the same user.</li> </ul> <div data-bbox="574 926 1430 1157" style="border: 1px solid #c8e6c9; padding: 10px; margin-top: 10px;">  <p><b>NOTE</b> If you are using Harmony Stand Alone, the script will be saved to the preferences for your account on your computer. If you are using Harmony Server, the script will be saved to the preferences for your Harmony database user.</p> </div> <ul style="list-style-type: none"> <li>• <b>Global:</b> If you are using Harmony Server, select this option to save the script to the Harmony database's global script directory. Anyone who is logged in to the database will be able to edit and run this script.</li> <li>• <b>Environment:</b> If you are using Harmony Server, select this option to save the script to the current scene's environment. Anyone will be able to edit and run the script as long as they are working on a scene inside this environment.</li> <li>• <b>Job:</b> If you are using Harmony Server, select this option to save the script to the current scene's job. Anyone will be able to edit and run the script as long as they are working on a scene inside this job.</li> <li>• <b>Scene:</b> Save the script to the scene's <code>scripts</code> sub-folder. Anyone will be able to edit and run the script when working on this specific scene.</li> <li>• <b>System Variable:</b> Save the script to the directory in the <code>TOONBOOM_GLOBAL_SCRIPT_LOCATION</code> environment variable. This option is only available if this environment variable is set.</li> </ul>



Button	Description
	<div style="border: 1px solid #c8e6c9; padding: 10px;">  <p><b>NOTES</b></p> <ul style="list-style-type: none"> <li>• When you import a script, any user interface (.ui) or icon (.png) file that is in the same directory and has the same filename as the script will also be imported.</li> <li>• For more information on script locations, see <a href="#">Script Editor View on page 1106</a>.</li> </ul> </div>
Delete Script	<p>Deletes the selected script.</p> <div style="border: 1px solid #c8e6c9; padding: 10px;">  <p><b>NOTES</b></p> <ul style="list-style-type: none"> <li>• You cannot delete a script if it is in the Application Resources location, as those are scripts that are installed with Harmony.</li> <li>• If you delete a script that was originally in Application Resources but which you copied to another location so you could make changes to it, the original version of the script in the Application Resources folder will be restored to the list.</li> </ul> </div>
Refresh Script File List	<p>Refresh the list of scripts in the Script Editor. If there are new scripts in your user preferences or your scene's scripts sub-folder, click on this button to be able to open them in the Script Editor.</p>
Editor	
Set External Editor	<p>Allows you to type in the path and name for your preferred text editing software.</p> <div style="border: 1px solid #c8e6c9; padding: 10px;">  <p><b>NOTES</b></p> <ul style="list-style-type: none"> <li>• On macOS, only typing the name of your preferred text editing software is enough if that application supports the AppleScript Open Document protocol.</li> <li>• On Windows and GNU/Linux, unless your text editor is in your system's <b>PATH</b> environment variable, you will have to type in the full path to the editor.</li> </ul> </div>
External Editor	<p>Opens the selected script in the chosen external text editing software.</p>

Button	Description
Play/Debug	
Set Target	<p>Prompts you to select which script and which function to use with the <b>Run</b> and <b>Debug</b> commands.</p> <div data-bbox="496 470 1430 800" style="border: 1px solid #90EE90; padding: 10px;"> <p> <b>NOTES</b></p> <ul style="list-style-type: none"> <li>• You can set the entire script as the target by selecting the <b>&lt;Nothing&gt;</b> function from the functions list.</li> <li>• You cannot link an entire script to a toolbar button. Only functions within scripts can be added as toolbar buttons. Therefore, running or debugging an entire script rather than one of its functions should be done for testing purposes only.</li> </ul> </div>
Run	<p>Runs the target script and function.</p> <div data-bbox="496 919 1430 1249" style="border: 1px solid #90EE90; padding: 10px;"> <p> <b>NOTES</b></p> <ul style="list-style-type: none"> <li>• If you have not set a target script and function, you will be prompted to set one when you select this command.</li> <li>• You can set or change the target script and function by selecting <b>Set Target</b> from this menu.</li> <li>• If you are editing <b>&lt;&lt;&lt;Sandbox&gt;&gt;&gt;</b>, this button will simply run what you typed into the sandbox, regardless of whether another target is set.</li> </ul> </div>
Debug	<p>Open the target script and function in the Qt Script Debugger, in which you can test and debug the function.</p> <div data-bbox="496 1413 1430 1743" style="border: 1px solid #90EE90; padding: 10px;"> <p> <b>NOTES</b></p> <ul style="list-style-type: none"> <li>• If you have not set a target script and function, you will be prompted to set one when you select this command.</li> <li>• You can set or change the target script and function by selecting <b>Set Target</b> from this menu.</li> <li>• If you are editing <b>&lt;&lt;&lt;Sandbox&gt;&gt;&gt;</b>, this button will simply debug what you typed into the sandbox, regardless of whether another target is set.</li> </ul> </div>
Stop	<p>If a script is currently running, this interrupts its execution.</p>

Button	Description
Help	
Scripting Interface Documentation	<p data-bbox="495 373 1347 436">Opens the reference documentation for the Harmony scripting interface in a web browser.</p> <div data-bbox="495 468 1429 640" style="border: 1px solid #c8e6c9; padding: 5px;"> <b>NOTE</b> This documentation is installed with Harmony and does not require Internet access.</div>



## Side View Menu





The Side View menu lets you position elements in 3D space, set parameters for animation and access animation tools—see [Side View on page 1111](#).

### How to access the Side menu

- In the upper-left corner of the Side view, click the menu  button.

Command	Description
Edit	
Cut	Removes selected objects. You can then paste the object or its properties to another object.
Copy	Copies selected objects and properties.
Paste	Places an object you cut or copied into the location you select in a view.
Delete	Removes selected objects.
Select All	Selects all drawing objects in the current drawing window in the Drawing, Timeline and Camera views. This helps you manage multiple objects as one when moving them.
Deselect All	Deselects all selected objects in the Drawing and Camera views.
Invert Selection	Deselects the currently selected items and selects all other items that were not selected. For example, if some lines are selected in a drawing, this command will deselect them and select any other lines in the drawing that were not selected.
Select Child Skipping Effects	Lets you select the first element parented to the selected peg element in the Timeline view skipping effects in the hierarchy.
Select Child	Lets you select the first element parented to the selected peg element in the Timeline view.
Select Children	Lets you select all elements parented to the selected peg element in the Timeline view.

Select Parent Skipping Effects	Lets you select the parent of the selected element in the Timeline view skipping effects in the hierarchy.
Select Parent	Lets you select the parent of the selected element in the Timeline view.
Select Previous Sibling	Lets you select the previous element (above current element) in the Timeline view.
Select Next Sibling	Lets you select the next element (below current element) in the Timeline view.
View	
Zoom In	Zooms in the view.
Zoom Out	Zooms out the view.
Reset Zoom	Resets the view's zoom to its default position.
Reset Pan	Resets the view's pan to its default position.
Reset View	Resets the view to its default position.
Layer Properties	Shows or hides the Layer Properties view.
Camera Cone	Displays the camera cone.
Control	Displays the controls of the selected element.
Hide All Controls	Hides the controls of the selected element.
Enable Playback	Plays back your animation in the Perspective view.
Animation	
Animate	
Animate Current Frame	When this option is selected, every time you use the  Transform,  Advanced Animation or  Inverse Kinematic tools to manipulate an

	<p>element in your scene, the position of the element will be stored in a keyframe at the current frame. This allows you to animate elements in your scene without creating keyframes manually.</p>
<p>Animate Onion Skin Range</p>	<p>When this option is selected, if you use the  Transform or  Advanced Animation tools to make transformations to an element in your scene, the transformations will be stored as keyframes at the beginning and at the end of the current Onion Skin range, as well as on every existing keyframe in-between. This can be useful if you want to reposition an element that you have already animated, but only during a specific range of frames, which you can define by enabling Onion Skin and setting the Onion Skin range to cover that range of frames.</p>
<p>Animate Off</p>	<p>When this option is selected, if you use the  Transform or  Advanced Animation tools to make transformation to an element in your scene, the transformations will affect the element throughout the whole scene. This can be useful if you want to reposition an element after you have already animated it.</p>
<p>Insert Keyframe</p>	<p>Adds a keyframe to the selected cell in the Timeline view.</p>
<p>Insert Control Point</p>	
<p>Set Stop-Motion Keyframe</p>	<p>Sets a stop-motion keyframe which there is no computer-generated motion between two keyframes. The segment is constant or flat. The drawing remains still until the playback reaches the next keyframe, then the drawing pops to its new location.</p>
<p>Set Motion Keyframe</p>	<p>Sets a motion keyframe. With motion keyframes, Harmony generates the interpolation between the keyframes. This means that a value for each frame between the keyframes is calculated by Harmony to progress from the value of the previous keyframe to the value of the next keyframe.</p>
<p>Flip</p>	<p><b>Flip Horizontal:</b> Flips the current selection horizontally.</p>
	<p><b>Flip Vertical:</b> Flips the current selection vertically.</p>
	<p><b>Flip Scale X:</b> Once your drawing layer is rotated, the original horizontal and vertical axes change. The Flip Scale X and Flip Scale Y will perform a flip on your drawing layer following its original axis. Remembers the original X-axis of the layer and flips the element following it.</p>
	<p><b>Flip Scale Y:</b> Remembers the original Y-axis of the layer and flips the element</p>

	following it.
Set Ease for Multiple Parameters	Opens the Set Ease for Multiple Parameters dialog box where you can change the velocity of selection functions.
Linear Motion	Transforms a curved path to a linear path removing tension, bias, and continuity.
Lock in Time	Indicates whether the point is locked to a specific frame (keyframe) or only locked to a specific position and the curve can flow through it freely as other points are being added, moved, or adjusted (control point).
No Z Dragging	Keeps the Z value constant when you drag a character using the Transform or Translate tool.
Substitute Drawing Previous	Replaces the drawing or cell's symbol on the current frame by the next drawing.
Substitute Drawing Next	
Select Previous Keyframe /Point	Select the previous keyframe/point.
Select Next Keyframe /Point	Select Next Keyframe /Point
Lock	<b>Lock:</b> Locks one or a multiple selection of layers.
	<b>Unlock:</b> Unlocks one or a multiple selection of locked layers.
	<b>Lock All:</b> Locks all the layers in the Timeline view.
	<b>Unlock All:</b> Unlocks all the layers in the Timeline view.
	<b>Lock All Others:</b> Locks every layer except the selected ones.
Reset	Returns the value of the selected element to the initial value of the active tool. For example, if the Rotate tool is active, the transformation angle will be reset to 0 and if the Transform tool is active, all the transformation values will be reset.

Reset All	Resets Resets all transformations on the current frame in a selected layer. Your keyframe will remain, but all the values will return to the starting value. All transformations are reset regardless of the tool you're using.
Reset All Except Z	Resets Resets all transformations on the current frame except the Z position. This is useful when doing cut-out animation. Cut-out puppets often have a particular Z ordering for the different views of a character. You might want to reset the transformation, but not necessarily the Z position.
Animation Tools	
Transform	Allows you to select drawing layers and position, rotate, scale and skew them.
Translate	Lets you move the selected element along the X and Y axes.
Rotate	Turns a selected element around its pivot point.
Scale	Increases or decreases the size of a selected element. You can scale an object up to make it larger or down to make it smaller. Press Shift to scale the element while maintaining its proportions.
Maintain Size	Keeps elements the same size aspect ratio in the Camera view as you move them towards or away from the camera.
Reposition Drawing	Lets you reposition, scale, rotate or skew all drawing strokes on every drawing included in a layer.
Spline Offset	Lets you Lets you reposition the visual trajectory without offsetting or modifying your animation. By default, the trajectory is located at 0,0,0 fields. If your elements were drawn in a different location than the centre of the drawing area, it will look like the trajectory is not aligned with your drawing. Also, if you have several elements attached to one trajectory, you might want your trajectory to be at a different location to represent the group's motion better.



## Timeline View Menu

The Timeline View menu lets you modify layers, keyframe and timing.

### How to access the Timeline menu

- In the upper-left corner of the Timeline view, click the menu  button.

Parameter	Description
Import	
From Scanner	Imports drawings from a TWAIN scanner.
Images	Imports bitmap images which you can choose to vectorize.
Sounds	Lets you import sound files into your project.
Edit	
Cut cells from Xsheet	Removes selected objects. You can then paste the object or its properties to another object.
Copy cells from Xsheet	Copies selected objects and properties.
Paste	Places an object you cut or copied into the location you select in a view.
Paste Special	Lets you copy and paste selected drawings into a different layer or paste the selection in the same layer to duplicate the drawings.
Paste Special Again	Pastes new drawings with the previous Paste Special settings.
Paste Cycle	Cycles a portion of an animation. You can increase or decrease the number of cycles to paste and select a type of cycle: Normal, Reverse, Forward-Reverse and Reverse-Forward.
Paste Reverse	Reverses the timing of drawings or keyframes in range of selection after copying.

Delete	Removes selected objects.
Modify Paste Presets	Lets you modify existing presets when pasting keyframes and exposures. There are three presets you can modify: the default presets for both key frames and exposures, key frames only and exposures only.
Select All	Selects all drawing objects in the current drawing window in the Drawing, Timeline and Camera views. This helps you manage multiple objects as one when moving them.
Deselect All	Deselects all selected objects in the Drawing and Camera views.
Invert Selection	Deselects the currently selected items and selects all other items that were not selected. For example, if some lines are selected in a drawing, this command will deselect them and select any other lines in the drawing that were not selected.
Select Synced Layers	Selects all the layers synced to the selected layer. The selected layer must be a synced in order for this option to be enabled.
Select Child Skipping Effects	Lets you select the first element parented to the selected peg element in the Timeline view skipping effects in the hierarchy.
Select Child	Lets you select the first element parented to the selected peg element in the Timeline view.
Select Children	Lets you select all elements parented to the selected peg element in the Timeline view.
Select Parent Skipping Effects	Lets you select the parent of the selected element in the Timeline view skipping effects in the hierarchy.
Select Parent	Lets you select the parent of the selected element in the Timeline view.
Select Previous Sibling	Lets you select the previous element (above current element) in the Timeline view.
Select Next Sibling	Lets you select the next element (below current element) in the Timeline view.
Lock	<b>Lock:</b> Locks Locks one or a multiple selection of layers.

	<p><b>Unlock:</b> Unlocks Unlocks one or a multiple selection of locked layers.</p>
	<p><b>Lock All:</b> Locks Locks all the layers in the Timeline view.</p>
	<p><b>Unlock All:</b> Unlocks Unlocks all the layers in the Timeline view.</p>
	<p><b>Lock All Others:</b> Locks Locks every layer except the selected ones.</p>
Tag	<p><b>Timeline Tag:</b> You can tag elements in the Timeline or Node views to view only those elements. When you tag elements, an asterisk appears beside the item in the Timeline view. Once your elements are tagged and you have switched over to View Tagged Layers mode, the Timeline view will display only tagged elements. The red bar on the left of the layers indicates you are in this view mode.</p>
	<p><b>Timeline Untag:</b> Untags selected layer in the Timeline view.</p>
	<p><b>Timeline Untag All:</b> Untags all tagged elements.</p>
	<p><b>Timeline Untag All Others:</b> Untags all elements except the selected one.</p>
Scene Markers	<p><b>Mark Current Frame:</b> Places a scene marker on the current frame on which the playhead is parked. The marker appears in the frame counter area of the Timeline view. You can customize the colour of the scene marker and add text to display as a tooltip when you hover over the marker—see .</p>
	<p><b>Create Scene Marker:</b> Creates a scene marker from a selected frame range in the frame counter area of the Timeline view.</p>
	<p><b>Edit Scene Marker:</b> Lets you edit an existing scene marker.</p> <p><b>NOTE:</b> It's important to select the <u>entire</u> length of the scene marker, otherwise the Timeline Scene Marker dialog box will not open for editing.</p>
	<p><b>Delete Scene Marker:</b> Removes an existing scene marker.</p>
Share Functions	<p>Lets you share an existing function curve. By default, all function curves can only be used and modified using their original parameter. If you want another layer or parameter to use the same function curve, you must share it.</p>
View	

Cycle to Next View Mode	Displays the new view mode.
Normal View Mode	Displays the Normal view mode, the default in the Timeline view. It shows everything connected to the chosen display. In this mode, anything not connected to the currently set default display will not be shown in the Timeline view. This also means that you cannot add certain elements to the Timeline view, as by default, when added they are not connected to any display or composite node. An example of such an element is a peg.
Selection Only Mode	Displays only elements currently selected in the Camera or Node view. This makes it easier to concentrate on one or a few elements at a time.
View Tagged Layers	<p>Lets you see only elements which have been assigned a Tagged status. An item that has been tagged will appear in the Timeline view with a small asterisk beside its name.</p> <p>Once your elements are tagged and you have switched over to View Tagged Layers mode, the Timeline view will display only tagged elements. The red bar on the left of the layers indicates you are in this view mode. While in this mode, the asterisks are not displayed beside the tagged elements.</p>
Show Functions	
Centre on Selection	Centers the Timeline view on the selected layer. This useful when you have many layers in the Timeline view, you may find it hard to locate which one is selected.
Change Track Colour	Opens the colour picker window to modify the colour of the selected layer.
Default Track Colour	Resets the layer colour.
Collapse/Expand	Toggles between expanding and collapsing all parent layers in the Timeline view.
Collapse All	Collapses all parented layers in the Timeline view.
Expand All	Expands all parented layers in the Timeline view.
Set Tempo Marker	Lets you set a marker that synchronizes your animation with a musical score. This lets you reproduce the FPB (Frames Per Beat) and use the tempo signature as tempo markers. The Xsheet view lets you pace your animation according to the tempo or beat of the soundtrack music or to any rhythmic sound, such as the ticking of a clock or water leaking from a spout. See .

---

Layers	
Add Synced Drawing Layer	Creates a new drawing layer whose timing is synced immediately with the currently selected drawing layer.
Sync Layer With	Opens the Convert to Synced Drawing Layer dialog box. In this dialog box, every other drawing layer in the project can be selected, parented and have its timing synced to the currently selected layer.
Unsync Layer	Unsyncs the parent layer of a synced pairing, when the child layer is selected.





## Top View Menu



The Top View menu lets you position elements in 3D space, set parameters for animation and access animation tools—see [Top View](#) on page 1124.

### How to access the Top menu

- In the upper-left corner of the Top view, click the menu  button.

Command	Description
Edit	
Cut Drawing Object	Removes selected objects. You can then paste the object or its properties to another object.
Copy Drawing Object	Copies selected objects and properties.
Paste	Places an object you cut or copied into the location you select in a view.
Delete Drawing Object	Removes selected objects.
Select All	Selects all drawing objects in the current drawing window in the Drawing, Timeline and Camera views. This helps you manage multiple objects as one when moving them.
Deselect All	Deselects all selected objects in the Drawing and Camera views.
Invert Selection	Deselects the currently selected items and selects all other items that were not selected. For example, if some lines are selected in a drawing, this command will deselect them and select any other lines in the drawing that were not selected.
Select Child	Lets you select the first element parented to the selected peg element in the Timeline view.
Select Children	Lets you select all elements parented to the selected peg element in the Timeline view.
Select Parent	Lets you select the parent of the selected element in the Timeline view.

Select Previous Sibling	Lets you select the previous element (above current element) in the Timeline view.
Select Next Sibling	Lets you select the next element (below current element) in the Timeline view.
View	
Zoom In	Zooms in the view.
Zoom Out	Zooms out the view.
Reset Zoom	Resets the view's zoom to its default position.
Reset Pan	Resets the view's pan to its default position.
Reset View	Resets the view to its default position.
Layer Properties	Shows or hides the Layer Properties view.
Camera Cone	Displays the camera cone.
Control	Displays the controls of the selected element.
Hide All Controls	Hides the controls of the selected element.
Enable Playback	Plays back your animation in the Perspective view.
Animation	
Animate	
Animate Current Frame	When this option is selected, every time you use the  Transform,  Advanced Animation or  Inverse Kinematic tools to manipulate an element in your scene, the position of the element will be stored in a keyframe at the current frame. This allows you to animate elements in your scene without creating keyframes manually.
Animate Onion Skin	When this option is selected, if you use the  Transform or  Advanced Animation tools to make transformations to an element in your scene,

Range	the transformations will be stored as keyframes at the beginning and at the end of the current Onion Skin range, as well as on every existing keyframe in-between. This can be useful if you want to reposition an element that you have already animated, but only during a specific range of frames, which you can define by enabling Onion Skin and setting the Onion Skin range to cover that range of frames.
Animate Off	When this option is selected, if you use the  Transform or  Advanced Animation tools to make transformation to an element in your scene, the transformations will affect the element throughout the whole scene. This can be useful if you want to reposition an element after you have already animated it.
Insert Keyframe	Adds a keyframe to the selected cell in the Timeline view.
Insert Control Point	
Set Stop-Motion Keyframe	Sets a stop-motion keyframe which there is no computer-generated motion between two keyframes. The segment is constant or flat. The drawing remains still until the playback reaches the next keyframe, then the drawing pops to its new location.
Set Motion Keyframe	Sets a motion keyframe. With motion keyframes, Harmony generates the interpolation between the keyframes. This means that a value for each frame between the keyframes is calculated by Harmony to progress from the value of the previous keyframe to the value of the next keyframe.
Flip	<b>Flip Horizontal:</b> Flips the current selection horizontally.
	<b>Flip Vertical:</b> Flips the current selection vertically.
	<b>Flip Scale X:</b> Once your drawing layer is rotated, the original horizontal and vertical axes change. The Flip Scale X and Flip Scale Y will perform a flip on your drawing layer following its original axis. Remembers the original X-axis of the layer and flips the element following it.
	<b>Flip Scale Y:</b> Remembers the original Y-axis of the layer and flips the element following it.
Set Ease for Multiple Parameters	Opens the Set Ease for Multiple Parameters dialog box where you can change the velocity of selection functions.



Linear Motion	
Lock in Time	Indicates whether the point is locked to a specific frame (keyframe) or only locked to a specific position and the curve can flow through it freely as other points are being added, moved, or adjusted (control point).
No Z Dragging	
Substitute Drawing Previous	Replaces the drawing or cell's symbol on the current frame by the next drawing.
Substitute Drawing Next	
Select Previous Keyframe /Point	Select the previous keyframe/point.
Select Next Keyframe /Point	Select Next Keyframe /Point
Lock	<b>Lock:</b> Locks one or a multiple selection of layers.
	<b>Unlock:</b> Unlocks one or a multiple selection of locked layers.
	<b>Lock All:</b> Locks all the layers in the Timeline view.
	<b>Unlock All:</b> Unlocks all the layers in the Timeline view.
	<b>Lock All Others:</b> Locks every layer except the selected ones.
Reset	Returns the value of the selected element to the initial value of the active tool. For example, if the Rotate tool is active, the transformation angle will be reset to 0 and if the Transform tool is active, all the transformation values will be reset.
Reset All	Resets all transformations on the current frame in a selected layer. Your keyframe will remain, but all the values will return to the starting value. All transformations are reset regardless of the tool you're using.
Reset All Except Z	Resets all transformations on the current frame except the Z position. This

	<p>is useful when doing cut-out animation. Cut-out puppets often have a particular Z ordering for the different views of a character. You might want to reset the transformation, but not necessarily the Z position.</p>
Animation Tools	
Transform	Allows you to select drawing layers and position, rotate, scale and skew them.
Translate	Lets you move the selected element along the X and Y axes.
Rotate	Turns a selected element around its pivot point.
Scale	Increases or decreases the size of a selected element. You can scale an object up to make it larger or down to make it smaller. Press Shift to scale the element while maintaining its proportions.
Maintain Size	Keeps elements the same size aspect ratio in the Camera view as you move them towards or away from the camera.
Spline Offset	Lets you Lets you reposition the visual trajectory without offsetting or modifying your animation. By default, the trajectory is located at 0,0,0 fields. If your elements were drawn in a different location than the centre of the drawing area, it will look like the trajectory is not aligned with your drawing. Also, if you have several elements attached to one trajectory, you might want your trajectory to be at a different location to represent the group's motion better.

## Xsheet View Menu

The Xsheet View menu lets you modify columns, keyframe and timing.

### How to access the Xsheet menu

- In the upper-left corner of the Xsheet view, click the menu  button.

Parameter	Description
File	
Import	<b>Images:</b> Imports bitmap images which you can choose to vectorize.
	<b>From Scanner:</b> Imports drawings from a TWAIN scanner.
	<b>Sounds:</b> Lets you import sound files into your project.
Print	Prints the exposure sheet so you can take it to your animation table, provide a copy to the animator, or create your Xsheet skeleton directly in Harmony.
Edit	
Cut cells from Xsheet	Removes selected objects. You can then paste the object or its properties to another object.
Copy cells from Xsheet	Copies selected objects and properties.
Paste	Places an object you cut or copied into the location you select in a view.
Paste Special	Lets you copy and paste selected drawings into a different layer or paste the selection in the same layer to duplicate the drawings.
Paste Special Again	Pastes new drawings with the previous Paste Special settings.
Paste Cycle	Cycles a portion of an animation. You can increase or decrease the number of cycles to paste and select a type of cycle: Normal, Reverse, Forward-Reverse and Reverse-Forward.

Paste Reverse	Reverses the timing of drawings or keyframes in range of selection after copying.
Delete	Removes selected objects.
Select All	Selects all drawing objects in the current drawing window in the Drawing, Timeline and Camera views. This helps you manage multiple objects as one when moving them.
Deselect All	Deselects all selected objects in the Drawing and Camera views.
Insert Mode	Adds a new value or a new value sequence over existing ones, the new values are inserted between the old ones. The existing timing sequence is pushed down the column. The Insert mode opposite of the Overwrite mode, which is the Xsheet default mode.
Gestural Drag Mode	Lets you drag a cell to any other frame in the same column or into another column.  This feature does not apply to Annotation columns.
Send to Function View	Sends selected objects to the Function view where you can edit and adjust its function curve and parameters.
View	
Zoom In Xsheet	Zooms in the view.
Zoom Out Xsheet	Zooms out the view.
Reset Zoom	Resets the view's zoom to its default position.
Reset Pan	Resets the view's pan to its default position.
Reset View	Resets the view to its default position.
Set Tempo Marker	
Expand/Collapse	<b>Collapse Selection:</b>
	<b>Expand Selection:</b>

	<b>Collapse All:</b>
	<b>Expand All:</b>
Column Properties	Lets you rename a column, and enable or disable a column. To view additional properties, select <b>Edit &gt; Preferences</b> from the top menu. In the Preferences dialog box, select the <b>Advanced</b> tab, then select the <b>Advanced Element Mode</b> option.
Show Column List	
Column Types Manager	Lets you add advanced column types to create particular animation paths. When you create these columns, they are not linked automatically to any particular drawing layer. You can create a motion path using these columns and then link or unlink several drawing or peg layers to it.
Show Thumbnails	Displays column thumbnails making it easier to identify a particular column. This option displays a small thumbnail picture of the current frame below the column header.
Show Selection	
Set Columns Width	Lets you change the column width (in pixels) and set it as the default.
All Columns to Default Width	Returns all columns to their default width of 100 pixels.
Change Columns Colour	Lets you customize the colour of the column by selecting one from the Select Colour dialog box. The colour you select is also reflected in the corresponding layer in the Timeline view.
Default Column Colour	Removes the colour you assigned to a column (if any).
Hide Selected Columns	Hides selected columns.
Unhide All Columns	Displays all columns.
Show Hidden Columns	Displays columns that were previously hidden.



Enable Playback	Plays back your animation in the Perspective view.
Columns	
Add Columns	Lets you add a column. You can specify the column name, type, and set drawing layer options in the Add Column dialog box that opens.
Delete Columns	Removes the selected column. You have the option to delete the associated drawing files and element folders.
Clone Selected Columns: Drawings Only	Creates a copy of the selected column that is linked to the original. If a drawing is modified in the original or cloned column, both will be updated. However, cloned columns can have different timings.  You can clone the drawings only or both the drawings and timing.
Clone Selected Columns: Drawings and Timing	
Duplicate Selected Columns	Creates an independent copy of the selected column. This useful when you need to modify the element independently, including the timing (exposure). Changes to the original element do not propagate to the duplicate.
Merge Selected Columns	There are two methods of merging drawings. <ul style="list-style-type: none"> <li>You can merge selected drawings in adjacent elements. The columns and layers will be left intact, and each new merged drawing will reside in the frames of the left-most column or lower layer.</li> <li>You can merge elements. All drawings will be merged. Unused columns and layers will be deleted, but the original drawing files are still accessible.</li> </ul>
Frames	
Add Frames At Start	Adds the number of frames you specify to the end of the scene.
Add Frames At End	
Add Frames Before Selection	Adds the number of frames you specify before or after your selection.
Add Frames After Selection	

Remove Selected Frames	Deletes the selected frames from your scene.
Drawings	
Create Empty Drawing	Creates Creates a drawing in the selected cell, replacing any drawing that may already be exposed in that cell and the following ones until it meets another drawing, key exposure or a blank cell.
Duplicate Drawings	<p>Lets you duplicate the drawing and work on a copy of it. This lets you modify an existing drawing but retain the original. When duplicating a drawing, the selected cell is replaced with the new drawing. The exposure of the original drawing that was on the current cell is removed. The original drawing is not deleted from the project folder or other cells in which it is exposed.</p> <p>When duplicating a drawing, the selected cell is replaced with the new drawing. The exposure of the original drawing that was on the current cell is removed. The original drawing is not deleted from the project folder or other cells in which it is exposed.</p>
Rename Drawing	Lets you give a selected drawing a new name.
Mark Drawing As	<p>Marks selected drawings as one of the following: Key, Breakdown, In-between, RetakeKey, RetakeBD or RetakeIB.</p> <p>This helps to keep the Xsheet well organized while animating.</p> <p>When working with several animators, directors or even other studios, the necessity for retakes will often arise. Harmony gives you the possibility to mark new drawings as either Retake Key, Retake Breakdown, or Retake In-betweens.</p>
Substitute Drawing Previous	Replaces the drawing or cell's symbol on the current frame by the next drawing.
Substitute Drawing Next	
Exposure	
Increase	Adds Adds one more exposure to a selected cell; repeating this action adds an extra cell each time. This is an efficient way to extend a drawing's exposure and is always set in Insert mode. Increasing an exposure pushes the existing exposure forward.

Decrease	Decreases exposure of a selected cell by one; repeating this action decreases one exposure adds an extra cell each time. This is an efficient way to shorten a drawing's exposure. Decreasing an exposure pulls in the existing exposure.
Set Exposure to	Lets you set the exposure to 1, 2, 3 or a custom exposure.
Extend Exposure	Lets you extend the length of a selected cell.
Add Key Exposure	Adds a key exposure to the selected cell.
Remove Key Exposure	Removes only the key exposure (key frames) not all the exposures. The existing key exposure is replaced by the preceding exposure.
Remove Duplicate Key Exposure	<p>When working with drawings to adjust the timing of a mouth in a lipsync, for example, and forcing the use of specific key exposures, unnecessary key exposures will be created. You can delete these duplicates without affecting the rest of the drawing. The first drawing of the selection will be used for the range.</p> <div style="border: 1px solid green; padding: 10px; margin-top: 10px;"> <p> <b>NOTE</b> Duplicate key exposures may occur when pasting with the Enforce Key Exposure option selected.</p> </div>
Fill Empty Cells	Lets you Lets you fill empty cells to extend the exposure of single frame drawings to fill the range of empty cells after each one. When creating drawings on cells that are not side-by-side, the exposure of the first drawing no longer fills automatically. You must select the frame range where you want your drawings to hold their exposure up to the next drawing and use the Fill Empty Cells command.
Insert Blank Cell	Adds Adds an empty cell between other cells.
Clear Exposure	Removes the exposure from the selected cell.
Clear Exposure and Pull	Replaces the exposure from the selected cell with exposures that follow it.
Fill Selection	Lets you Lets you fill the same value over an entire selection. The selection can be over one cell, a cell range in one column, a cell range over many columns, an entire column, or many columns. You can use numbers, words, letters, or any alphanumeric value.



Sequence Fill	Lets you Lets you create a numbered sequence over a selection. The sequence can be forward, backward, single, double or higher increment, as a cycle, and so on. The selection can be over one cell or a cell range in one column or more or an entire column or many entire columns.
Fill Cells Randomly	Lets you Lets you fill in random values over a selection. You can give a maximum and a minimum value and create a range for Harmony to choose the random values from. The selection can be over one cell or a cell range in one column or more or an entire column or many entire columns.
Hold Exposure	Lets you expose a drawing for three, four, or five cells and so on.
Motion	
Insert Keyframe	
Insert Keyframe and Duplicate Drawing	
Delete Keyframes	Deletes the selected keyframes.
Go to Previous Keyframe	
Go to Next Keyframe	
Set Stop-Motion Keyframe	Sets a stop-motion keyframe which there is no computer-generated motion between two keyframes. The segment is constant or flat. The drawing remains still until the playback reaches the next keyframe, then the drawing pops to its new location.
Set Motion Keyframe	Sets a motion keyframe. With motion keyframes, Harmony generates the interpolation between the keyframes. This means that a value for each frame between the keyframes is calculated by Harmony to progress from the value of the previous keyframe to the value of the next keyframe.
Morphing	
Create Morphing	Allows you to create and configure a morphing sequence, which will automatically generate the in-betweens between two drawings in the current layer.

Delete Morphing	Once a cell is selected in a morphing sequence, deletes the entire sequence between the two keyframes.
Insert Morphing Key Drawing	Creates a morphing keyframe from a selected morphing frame.
Convert Morphing to Drawing	Lets Lets you convert your morphing inbetweens to real drawings you can edit. This is useful when manually editing a morphing sequence or if you prefer to have animation timing in double frame (on twos) instead of single frame (on ones).
Lip-Sync	
Change Mouth Shape to	Lets you change the mouth shape to one of the following: A, B, C, D, E, F, G, X.
Auto Lip-Sync Detection	Generates a sound detection for lip-sync.
Map Lip-Sync	Automatically maps Automatically maps drawings in an element to the mouth chart you have generated for a sound. This can save time when you are lip-synching a voice track.
Sound Display	
Sound Name	Shows the name of the sound file, as well as the file format. The line running vertically through the column frames between the same file name indicates a continuity of the same sound file in these frames.
Mouth Shapes	Shows the letter (or name depending on the way you named your character's different mouth positions) in the column's frames. There is only one mouth position allotted per frame and this position should correspond to the sound file after performing a lip-sync.
Waveform	Shows a vertical display of the sound file's actual waveform. In the column header, in the field under the column name, you can type in a percentage to zoom in or zoom out on the waveform, or pass the scroll cursor  over the Zoom Waveform  icon.
Sound Edit	

Insert Blank Cell	Places an empty cell between other cells.
Clear Exposure and Pull	Replaces the exposure from the selected cell with exposures that follow it.
Annotation	
Import File	Lets you import an image file in an Annotation column.
Change Pen Colour	Lets you change the pen colour by selecting one from the Select Colour dialog box.
Pen Width	Lets you select a pen preset or change the pen width (in pixels).
Eraser Width	Lets you modify the width of the Eraser tool.
Erase All	Removes all text and drawn annotations. Annotations that you type in cannot be erased using this method.
Erase Selected Images	Removes images you select in the Annotation column.
Erase Selected Texts	Removes text you select in the Annotation column.
Enable Drawing	Lets you draw in the Annotation column using your mouse or pen tablet.



## Chapter 3: Nodes / Layers

The Node view is a visual representation of how every element in your scene, be it drawing layers, pegs, effects and others are combined together to form the final composited image. It allows you to rig the elements in your scene together and add a wide range of effects to your scene. Getting to know how to use the Node view is important especially for rigging cut-out models, adding effects to scene or managing the way your scene is composited, rendered and displayed in Harmony.

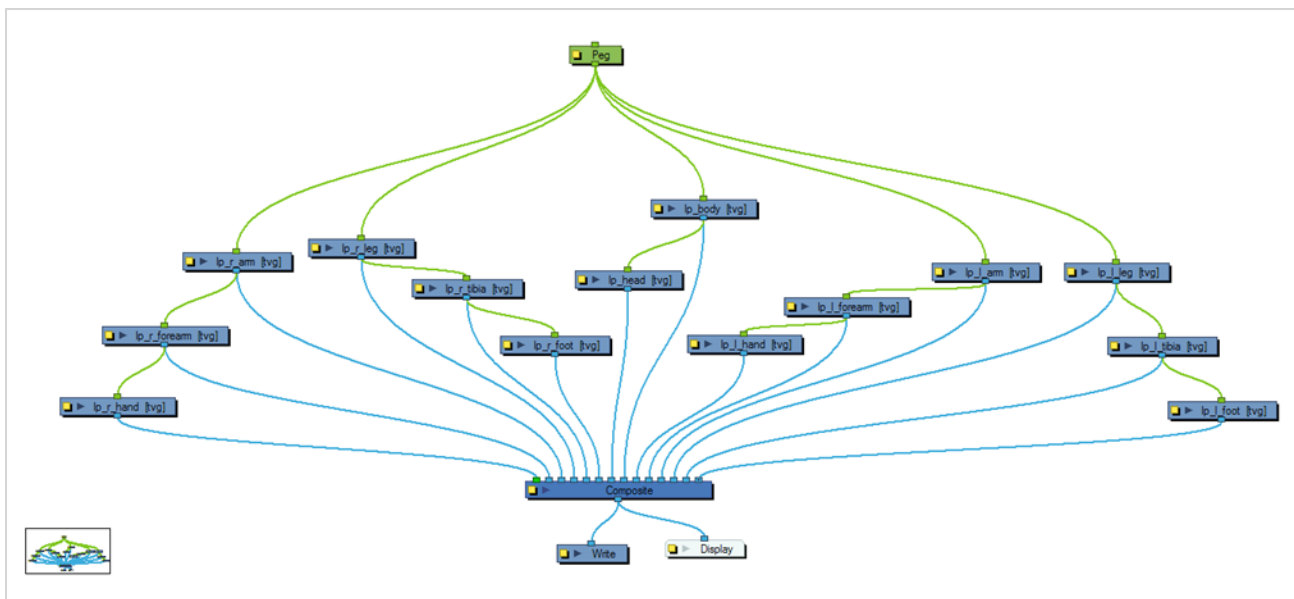

3D Nodes .....	349
3D Kinematic Output Node .....	350
Flatten Node .....	353
Render Maya Batch Node .....	355
Subnode Animation Node .....	361
Z Buffer Smoothing Node .....	365
Combine Nodes .....	367
Blending Node .....	368
Composite Node .....	374
Composite-Generic Node .....	379
Cutter Node .....	385
Highlight Node .....	387
Image Switch Node .....	391
Matte-Composite Node .....	393

Tone Node .....	397
Transformation Switch Node .....	401
Constraint Nodes .....	403
Constraint Switch Node .....	405
Dynamic Spring Node .....	408
Multi-Points Constraint Node .....	414
Static Transformation Node .....	417
Three-Points Constraint Node .....	420
Transformation Gate Node .....	423
Transformation Limit Node .....	425
Two-Points Constraint Node .....	431
Deformation Nodes .....	437
Articulation Node .....	438
Auto Fold Node .....	441
Auto Muscle Node .....	443
Bone Nodes .....	447
Curve Node .....	451
Deformation Composite Node .....	455
Deformation Root Node .....	458
Deformation Scale Node .....	459
Deformation Switch Node .....	464
Deformation Uniform Scale Node .....	466
Deformation Wave Node .....	468
Fold Node .....	471
Game Bone Node .....	475
Glue Node .....	477
Kinematic Output Node .....	479
Mesh Warp Node .....	480
Offset Node .....	484
Refract .....	486

---

Stick Node .....	488
Turbulence Node .....	490
Filter Nodes .....	494
Anti-Flicker Node .....	496
Auto-Patch Node .....	498
Bloom Node .....	500
Blur-Box Node .....	504
Blur-Directional Node .....	507
Connection .....	508
Layer Properties .....	509
Blur-Gaussian Node .....	511
Blur-Radial Node .....	514
Blur-Radial-Zoom Node .....	516
Blur-Variable Node .....	520
Brightness Contrast Node .....	522
Channel Selector Node .....	524
Channel Swap Node .....	526
Chroma-Keying Node .....	528
Colour Banding Node .....	534
Colour Art Node .....	537
Colour-Override Node .....	540
Colour-Scale Node .....	545
Colour Selector Node .....	547
Contrast Node .....	550
Dither Node .....	552
Focus Node .....	554
Focus Multiplier Node .....	557
Glow Node .....	559
Grain Node .....	563
Greyscale Node .....	565

Hue-Saturation Node .....	567
Layer Selector Node .....	574
Line Art Node .....	577
Luminance Threshold Node .....	579
Matte-Blur Node .....	582
Matte-Resize Node .....	585
Median Node .....	587
Motion-Blur Node .....	590
Negate Node .....	592
Overlay Layer Node .....	594
Pixelate Node .....	596
Remove Transparency Node .....	598
Shadow Node .....	600
Transparency Node .....	603
Underlay Layer Node .....	605
Generator Nodes .....	608
Animated Matte Generator Node .....	609
Burn-In Node .....	620
Colour-Card Node .....	624
Element / Drawing Node .....	627
Connection .....	628
Field Chart Node .....	644
Gradient Node .....	649
Grid Node .....	655
Lens Flare Node .....	658
Turbulent Noise Node .....	661
Group Nodes .....	665
Group Node .....	666
Multi-Port-In Node .....	667
Multi-Port-Out Node .....	668



---

Miscellaneous Nodes .....	669
External Node .....	670
Master Controller Node .....	673
Note Node .....	679
OpenGL Bypass Node .....	680
OpenGL-Cache-Lock Node .....	682
Render Preview Node .....	685
Script Node .....	686
Visibility Node .....	689
Move Nodes .....	690
Apply Image Transformation Node .....	691
Apply Peg Transformation Node .....	694
Camera Node .....	698
OrthoLock Node .....	700
Peg Node .....	702
Shake Node .....	704
Transform-Loop Node .....	708
Quadmap Node .....	711
Quake Node .....	714
Output Nodes .....	717
Crop Node .....	718
Display Node .....	721
Multi-Layer Write Node .....	722
Scale Output Node .....	726
Write Node .....	728
Image Formats for Rendering Write Nodes .....	733
Particle Nodes .....	739
3D Region .....	741
Baker .....	743
Baker Composite .....	746

Bounce .....	747
Explosion .....	749
Gravity .....	751
Image Fracture .....	753
Kill .....	759
Move Particles .....	761
Orbit .....	763
Planar Region .....	766
Random .....	769
Region Composite .....	770
Repulse .....	771
Rotation Velocity .....	772
Sink .....	775
Size .....	776
Sprite Emitter .....	778
System Composite .....	788
Velocity .....	789
Visualizer .....	792
Vortex .....	794
Wind-Friction .....	796
Shading Nodes .....	797
Light Position Node .....	798
Light Shader Node .....	800
Normal Map Node .....	803
Normal Map Converter Node .....	807
Tone Shader Node .....	809
Volume Object Node .....	813
Plugin Nodes .....	815
Sparkle .....	816
Selection Preset Note Node .....	819

Sound Layer .....821

## 3D Nodes

The nodes found in the 3D category are used to handle and render 3D objects such as animating the sub-nodes or rendering using Maya.

<b>3D Kinematic Output Node</b> .....	<b>350</b>
<b>Flatten Node</b> .....	<b>353</b>
<b>Render Maya Batch Node</b> .....	<b>355</b>
<b>Subnode Animation Node</b> .....	<b>361</b>
<b>Z Buffer Smoothing Node</b> .....	<b>365</b>

## 3D Kinematic Output Node

A 3D Kinematic Output node can be used to connect the animation for a subnode to another node. This allows to use a subnode's animation on other elements in the scene, as if it was part of a hierarchy of peg and the subnode was the parent peg.

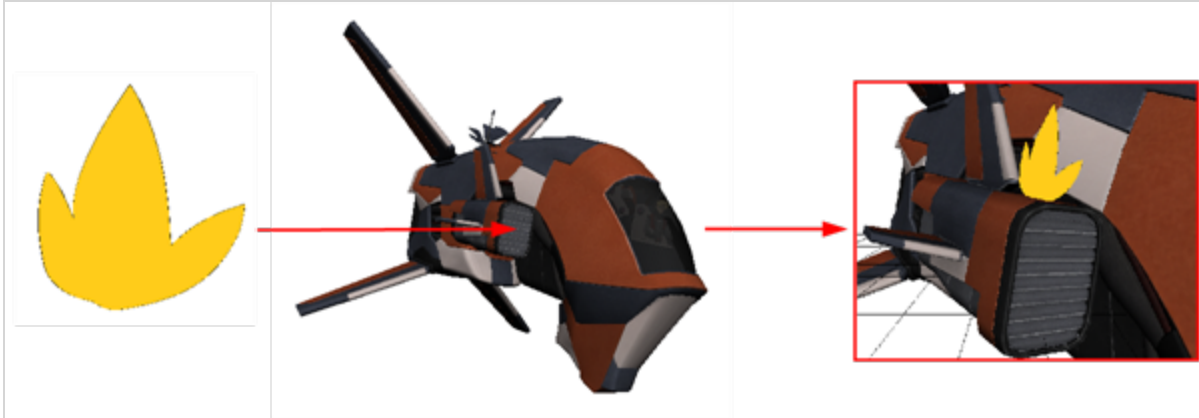

## Connection

The 3D Kinematic Output node must be connected under a Subnode Animation node, from which it will take one of the subnode's animation, and then connected as a parent of the node on which it must apply that animation.

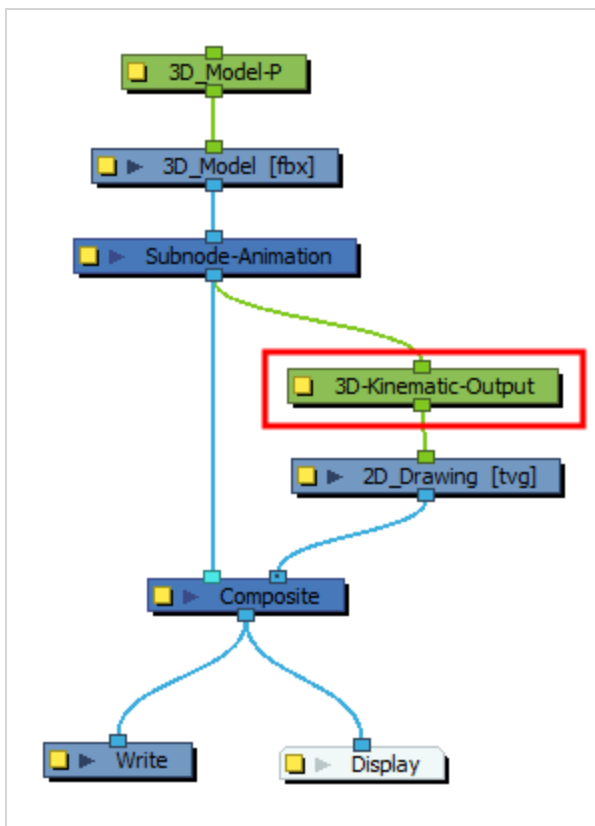

**TIP**

You can quickly create a 3D Kinematic Output node by selecting a subnode in the 3D Graph view, then clicking on the Add 3D Kinematic Output  button. The 3D Kinematic node will be connected under the model's Subnode Animation node, and configured to apply the selected subnode's animation to its child. It must then be connected to a child element in the Node view.

**NOTE**

It is not possible to animate the subnodes of a 3D model without a Subnode Animation node. Hence, the 3D Kinematic Output node must be connected under a Subnode Animation node, and not directly under a 3D model—see [Subnode Animation Node on page 361](#).

## Properties

The Subnode Name attribute of a 3D Kinematic Output node determines which of the 3D model's subnode will be used to animate the node's child.

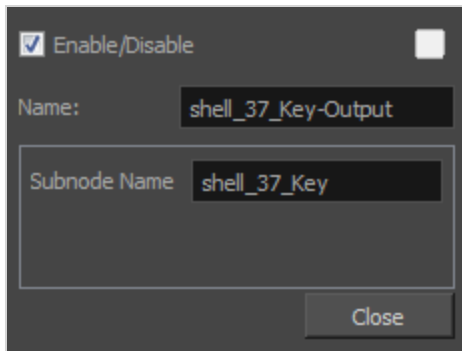

Parameter	Description
Enable/Disable	Allows you to enable or disable the node. When disabled, a node has no visible effect on the rendered image, nor on the preview in the Camera, Perspective, Side and Top views.
Colour Swatch	Sets the colour of the layer in the Timeline view and of the node in the Node view.
Name	Allows you to enter a name for the node. It is recommended to use the name of the subnode followed by <b>-Output</b> .
Subnode Name	Use this field to enter in the part of the 3D model whose movements you

	<p>would like to track. Entering the name of the 3D model subnode into this field is what lets the 3D Kinematic Output node know which part of the model to read.</p>
--	---

## Flatten Node

The Flatten node is used to transform 3D objects into flat planes when ordered in the Composite node. That plane can then be moved around like any other drawing. Instead of intersecting with 2D layers, the 3D object will either be behind or in front.

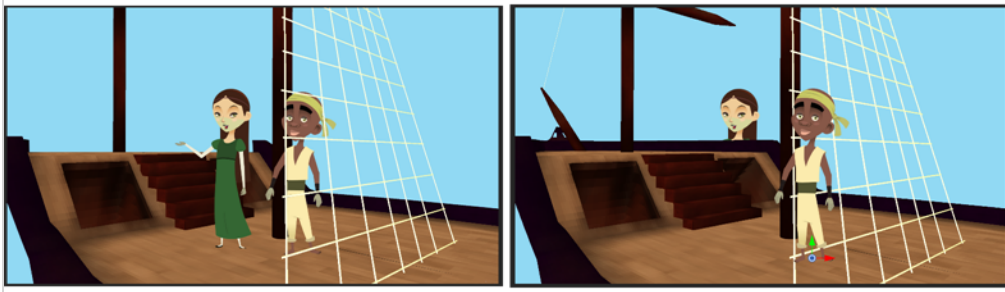

When all objects are at the same distance (z value) from the camera, the order is based on the Composite ports. When elements are placed at different distances from the camera, the z axis value overrides the composite port ordering.

## Connection

The Flatten Node takes a 3D image in its input port and outputs a 2D image.

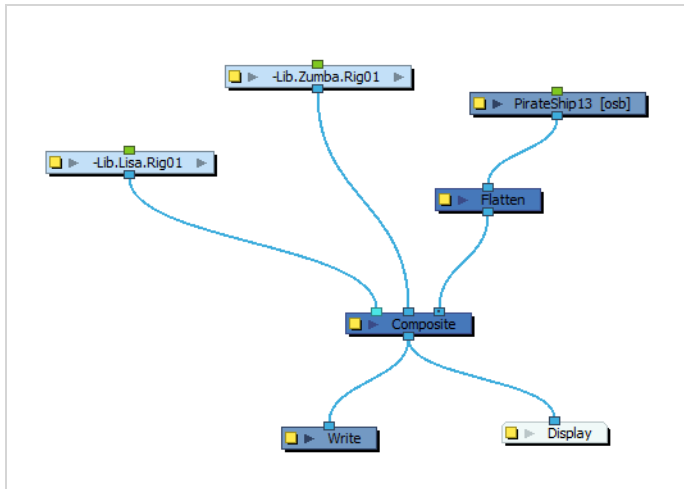

## Layer Properties

Parameter	Description
Enable/Disable	Allows you to enable or disable the node. When disabled, a node has no visible effect on the rendered image, nor on the preview in the Camera, Perspective, Side and Top views.



---

Parameter	Description
Colour Swatch	Sets the colour of the layer in the Timeline view and of the node in the Node view.
Name	Allows you to enter a name for the node.

## Render Maya Batch Node

By default, 3D models imported in Harmony are rendered using OpenGL. The Maya Batch Render can be used to render a 3D model connected to it through Autodesk Maya, then output the rendered image to the scene so that it can be composited. It can be configured to use one of several of the rendering engines supported by Maya, such as RenderMan, Mental Ray and Maya Software.



### NOTE

The Maya Batch Render node is basically a Script Node pre-configured to take the input image and process it through the `renderMayaBatch()` built-in function of the Harmony scripting interface—see [Script Node](#).

## Connection

The MayaBatchRender node takes a 3D model in its input port, and outputs a 2D rendered image when the scene is rendered.

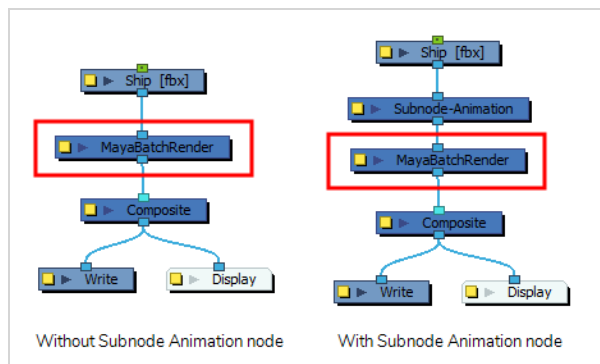

### NOTE

The Maya Batch Render node does not affect the OpenGL preview of the scene in the Camera view. To see the effect of the Maya Batch Render node in Harmony, you must set the preview mode of the Camera view to Render View  mode.

## Configuration

For the Maya Batch Render node to work, the following conditions must be met:

- The path to Autodesk Maya and, if needed, to RenderMan, must have been set on your machine using the `TB_Set_3dRendererer_Paths.js` script which is bundled with Harmony.
- The original Maya project in which the 3D model was created must be in the element folder of the 3D model you imported into your Harmony scene, and must have the same file name as the 3D model you imported, but with the appropriate extension. Additionally, the model's textures should also be in the

element folder.

In the following example, the 3D model is a Filmbox (.fbx) model that was imported in a Harmony scene into an element named **Ship**. The .fbx file was named **Ship-1.fbx**. Hence, for the Maya Batch Render node to render it, the original Maya project must be in the folder of the **Ship** element. Since the Maya project has the extension .ma and the 3D model is named **Ship-1.fbx**, the Maya project must be named **Ship-1.ma**:

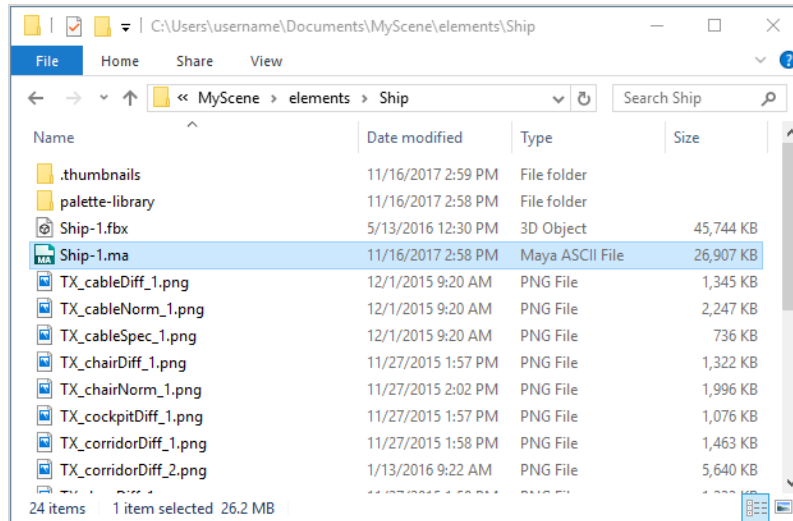

## NOTES

- You can also make the Maya Batch Render node source the Maya project from its original location—see [Specifications Tab on page 358](#).
- For detailed steps on how to use the Maya Batch Render node, refer to the *3D Integration* chapter of the User Guide.

## Layer Properties

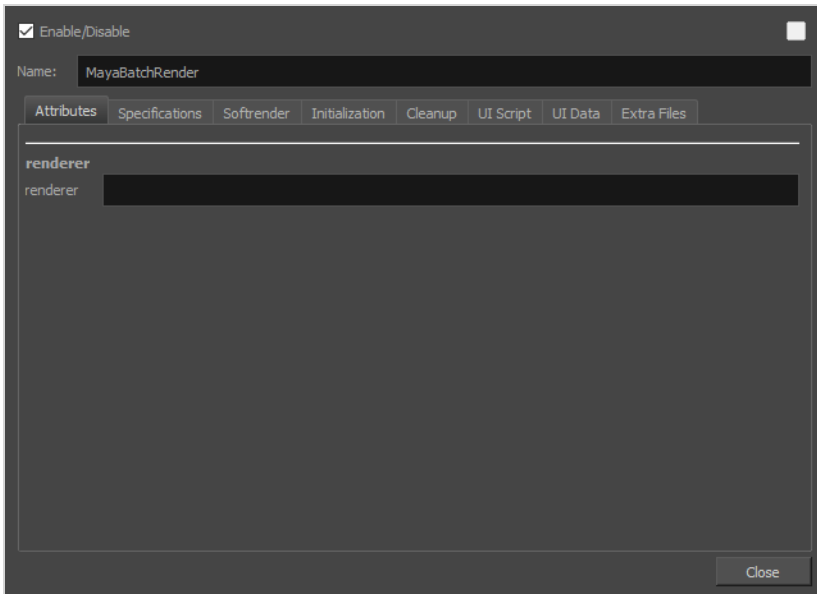

Parameter	Description
Enable/Disable	Allows you to enable or disable the node. When disabled, a node has no visible effect on the rendered image, nor on the preview in the Camera, Perspective, Side and Top views.
Colour Swatch	Sets the colour of the layer in the Timeline view and of the node in the Node view.
Name	Allows you to enter a name for the node.

## Attributes Tab

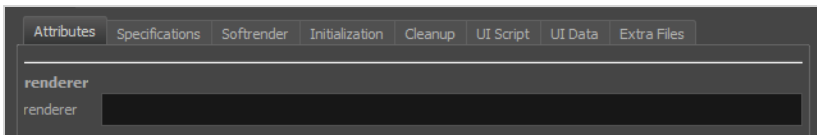

Parameter	Description
Renderer	Specify the rendering engine to use. The following engines are supported: <ul style="list-style-type: none"> <li>• 'renderMan' (or 'reyes')</li> <li>• 'renderManRIS' (or 'RIS')</li> <li>• 'arnold'</li> </ul>

Parameter	Description
	<ul style="list-style-type: none"> <li>'mentalRay'</li> <li>'mayaSoftware' (or 'maya')</li> </ul>

## Specifications Tab

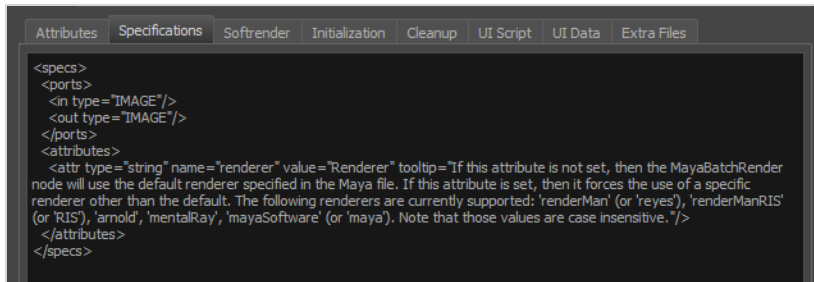

The specification tab is used to define the attributes in the Attributes tab as well as the input and output ports of the node. By default, it is configured to have one input image port, one output image port, and a Renderer parameter in the Attributes tab, which allows you decide which rendering engine to use to render the 3D model. The following is the default Specifications script for the Maya Batch Render node:

```
<specs>
  <ports>
    <in type="IMAGE"/>
    <out type="IMAGE"/>
  </ports>
  <attributes>
    <attr type="string" name="render" value="" tooltip="If this attribute is not set,
then the MayaBatchRender node will use the default renderer specified in the Maya file. If
this attribute is set, then it forces the use of a specific renderer other than the
default. The following renderers are currently supported: 'renderMan' (or 'reyes'),
'renderManRIS' (or 'RIS'), 'arnold', 'mentalRay', 'mayaSoftware' (or 'maya'). Note that
those values are case insensitive."/>
  </attributes>
</specs>
```

By default, the Maya Batch Render node expects the Maya project for the 3D model to be in the same directory as the 3D model itself, with the same file name, but a different extension. However, you can add another attribute to the node which allows you to specify the path to the Maya project to use for rendering the 3D model. To do this, add the bolded line to the Specifications tab:

```
<specs>
  <ports>
    <in type="IMAGE"/>
    <out type="IMAGE"/>
  </ports>
  <attributes>
```

```

<attr type="string" name="renderer" value="" tooltip="If this attribute is not set,
then the MayaBatchRender node will use the default renderer specified in the Maya file. If
this attribute is set, then it forces the use of a specific renderer other than the
default. The following renderers are currently supported: 'renderMan' (or 'reyes'),
'renderManRIS' (or 'RIS'), 'arnold', 'mentalRay', 'mayaSoftware' (or 'maya'). Note that
those values are case insensitive."/>
  <attr type="string" name="OriginalMayaFileName" value="" tooltip="Write your
project path here"/>
</attributes>
</specs>

```

After changing the content of the Specifications tab, you must save, close and re-open the scene before you can see the new OriginalMayaFileName field in the Attributes tab. You can then type in the path to the Maya project that the Maya Batch Render node should render.

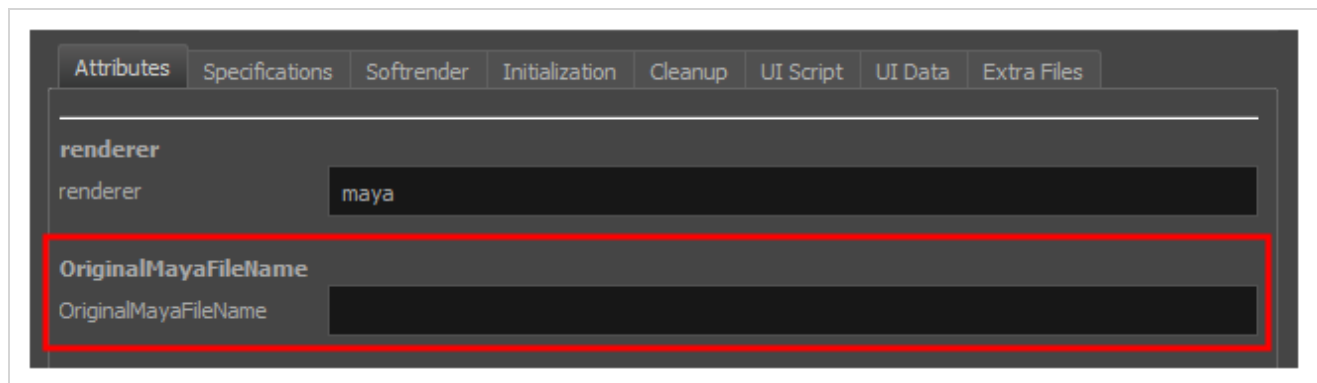

## NOTES

- The path should include the name of the project file as well as its extension.
- You must use forward slashes (/) to separate the directories in the path, even on Windows, like in this example:  
**C:/Users/username/Documents/MyProject.ma**
- You can use a relative path. The path is relative to the element folder containing the 3D model used in the Harmony scene. For example, ../../ points to the scene directory.

## Softrender Tab

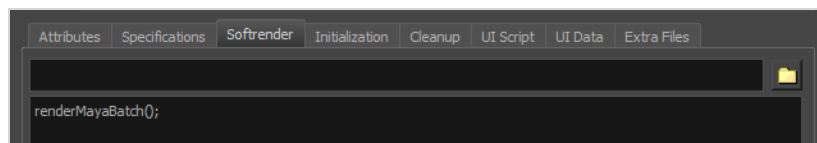

This tab contains the script to execute when the scene is rendered. By default, it contains this single function:

```
renderMayaBatch();
```

This function takes the 3D model in the input image and renders it using Autodesk Maya, using the rendering engine specified in the Attributes tab. To do this, it uses the original Maya project for the 3D model and instructs Autodesk Maya to render it, but with the transformations in position, angle and scale applied to it in the current frame of the Harmony scene. Autodesk Maya then produces an OpenEXR (.**exr**) image with deep pixels, which Harmony integrates into the scene and composites it with other elements and effects.

**NOTE**

The other tabs in the Maya Batch Render node properties are the standard tabs for a Script node. This is because the Maya Batch Render node is just a Script node set up to execute **renderMayaBatch () ;**. For more information, see [Script Node on page 686](#).

## Subnode Animation Node

When manipulating 3D models, by default, it is only possible to animate the transformation on the whole model. Transformations on their individual parts (subnodes) are static. In order to be able to animate the subnodes in a 3D model, it must be connected to a Subnode Animation node, which will store the animation information for individual subnodes and apply it to the model.

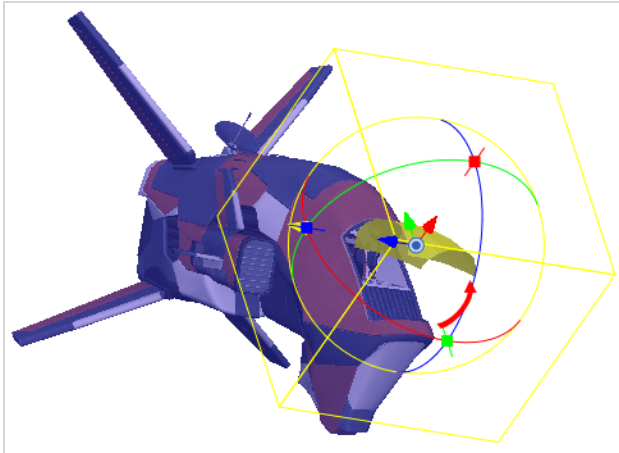

## Connection

The Subnode Animation node takes a 3D model in its input port. As soon as a 3D model is connected to a Subnode-Animation node, its subnodes become animatable individually. Once you start animating the model's subnodes, the node outputs the 3D model with its subnodes animated.

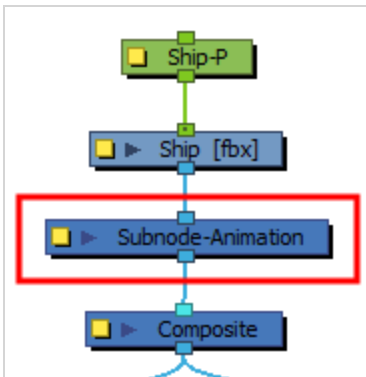

The parameters for each subnode that is animated will appear in the node's parameters in the timeline.

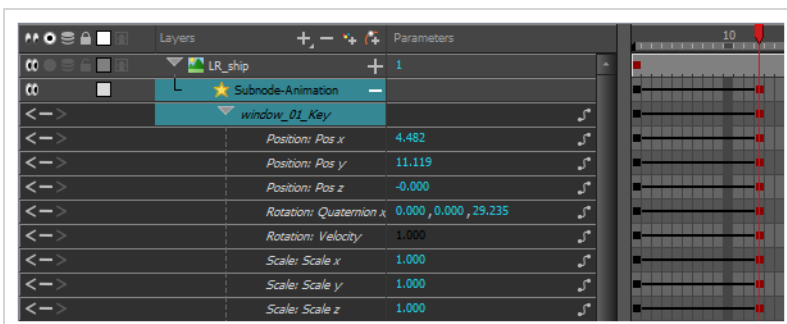





**TIP**

You can add the parameters for a subnode to the Subnode Animation node without animating it first. To do this, select the subnode, then click on the Make Properties Available  button in the 3D Graph view. This can be useful if you want to make a keyframe with the subnode's resting position before animating it.

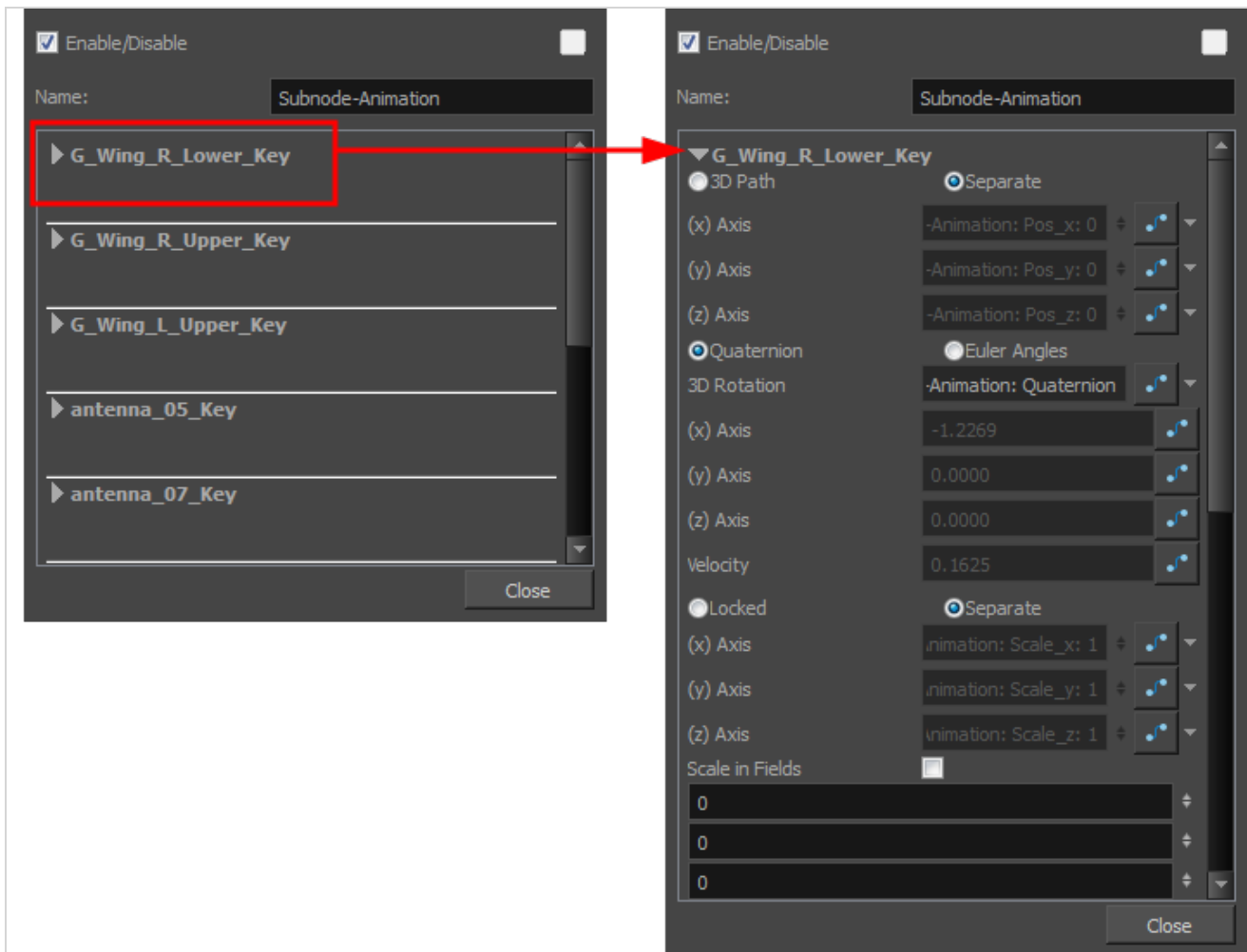

## Layer Properties

All animatable 3D model subnodes appear in a list in the Subnode Animation Layer Properties. Expand any of the subnodes in the list to view its individual properties.



Click on any of the Function buttons  to open the Function Editor for that parameter.

If movements have already been created in the Camera view, you may not be able to edit some of the fields. They just display the value of that parameter at the given position in the Timeline. If you would like to edit these fields, change the field type to Local.

Parameter	Description
Enable/Disable	Allows you to enable or disable the node. When disabled, a node has no visible effect on the rendered image, nor on the preview in the Camera, Perspective, Side and Top views.
Colour Swatch	Sets the colour of the layer in the Timeline view and of the node in the Node view.
Name	Allows you to enter a name for the node.
Position	<p><b>3D Path:</b> Lets you use a 3D path function to animate an element.</p> <p><b>Separate:</b> Lets you independently edit the different coordinate fields.</p> <p><b>Path:</b> When the 3D Path option is selected, lets you choose the path type. You can do this from the field menu, located after the Function button .</p> <p><b>Path (x) Axis:</b> Lets you type in a new East/West coordinate corresponding to the desired position.</p> <p><b>Path (y) Axis:</b> Lets you type in a new North/South coordinate corresponding to the desired position.</p> <p><b>Path (z) Axis:</b> Lets you type in a new Forward/Backward coordinate corresponding to the desired position.</p> <p><b>Velocity:</b> When the 3D Path option is selected, lets you set the speed at which movement occurs across the X, Y and Z axes.</p>
Rotation	<p><b>Quaternion:</b> Rotations made on the X, Y and Z axes are linked, as is the velocity which acts on the three rotation functions simultaneously.</p> <p><b>Euler Angles:</b> Rotations can be made on the X, Y and Z axes independent of each other; each has its own velocity.</p> <p><b>3D Rotation:</b> When the Quaternion option is selected, lets you choose the path type. You can do this from the field menu, located after the Function button .</p> <p><b>(x) Axis:</b> Lets you enter the horizontal rotation value in degrees.</p> <p><b>(y) Axis:</b> Lets you enter the vertical rotation value in degrees.</p> <p><b>(z) Axis:</b> Lets you enter the depth scale value in degrees.</p> <p><b>Velocity:</b> When the Quaternion option is selected, lets you set the speed at which rotation occurs across the X, Y and Z axes.</p>
Scale	<p><b>Locked:</b> Resizes the element while keeping its ratio. The X and Y axes scale proportionally</p> <p><b>Separate:</b> Resizes the element allowing to modify the ratio (squash and stretch).</p>

	<p><b>(x) Axis:</b> Lets you enter the horizontal scale value.</p> <p><b>(y) Axis:</b> Lets you enter the vertical scale value.</p> <p><b>(z) Axis:</b> Lets you enter the depth scale value.</p> <p><b>Scale in Fields:</b> Instead of using the standard scaling units, when this option is enabled, images are scaled using field units, based on the traditional animation field chart. Enter in the x, y, z values respectively in the fields below.</p>
--	---

## Z Buffer Smoothing Node

Rendering engines such as Maya and Mental Ray output images in a format that uses a simple Z-buffer that does not allow for proper antialiasing around the edges of the geometry. Hence, it is ultimately better for image quality to render using RenderMan or Arnold if possible. Otherwise, if a different rendering engine must be used and there appears to be pixelated hard seams around 3D models, the Z Buffer Smoothing node can be used to smooth out the edges of the rendered model.

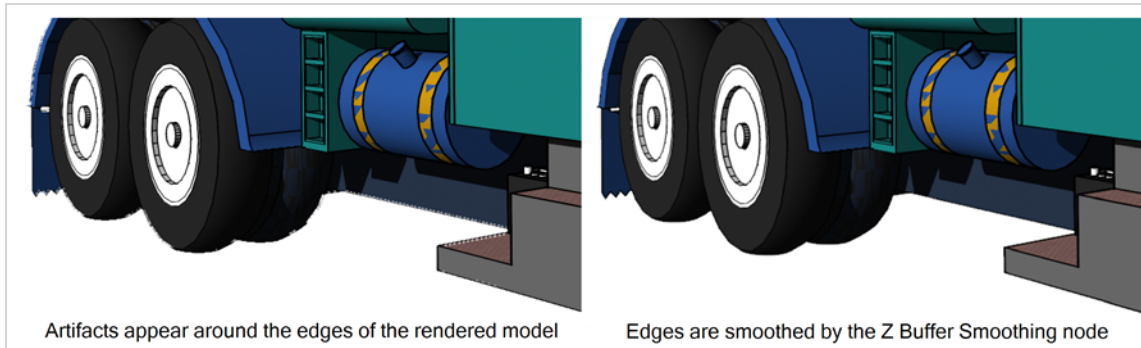

## Connection

The Z-Buffer-Smoothing node takes the rendered 3D model output by a MayaBatchRender node as its input image, and outputs the rendered 3D model with its edges smoothed.

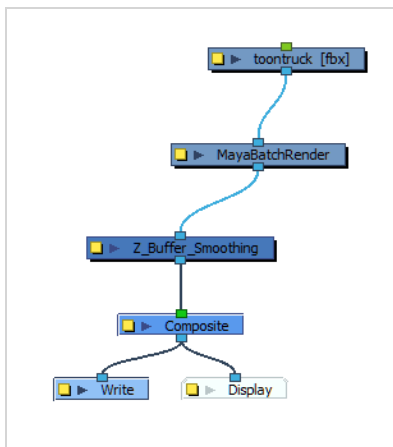

## Layer Properties

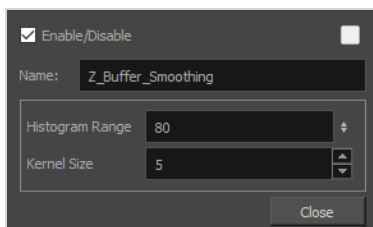

Parameter	Description
Enable/Disable	Allows you to enable or disable the node. When disabled, a node has no visible effect on the rendered image, nor on the preview in the Camera, Perspective, Side and Top views.
Colour Swatch	Sets the colour of the layer in the Timeline view and of the node in the Node view.
Name	Allows you to enter a name for the node.
Histogram Range	<p>Lets you define the range of clean pixels in the depth histogram when rendering 3D models. Only opaque or semi-transparent values are considered.</p> <p>A low value means fewer pixels are used in the depth calculations and may flatten your object, while a higher value uses more pixels in the depth calculations, but may not eliminate all the image artifacts.</p>
Kernel Size	Lets you determine the size of the matrix used for calculating the depth of a single pixel. For example, for an operation with a kernel size of 3 pixels, Harmony uses the pixels within a 1-pixel radius to calculate the effect. A larger kernel size means longer calculations.

## Combine Nodes

The nodes found in the Combine category are used to take two or more elements and combine them into a new image.

<b>Blending Node</b> .....	<b>368</b>
<b>Composite Node</b> .....	<b>374</b>
<b>Composite-Generic Node</b> .....	<b>379</b>
<b>Cutter Node</b> .....	<b>385</b>
<b>Highlight Node</b> .....	<b>387</b>
<b>Image Switch Node</b> .....	<b>391</b>
<b>Matte-Composite Node</b> .....	<b>393</b>
<b>Tone Node</b> .....	<b>397</b>
<b>Transformation Switch Node</b> .....	<b>401</b>

## Blending Node

T-COMP2-005-001

By default, layers are composited onto each other directly. This means that opaque pixels in front-most layers hide pixels in layers further back, and semi-transparent pixels on front-most layers are blended with pixels further back proportionally to their alpha ratio. This does the job for solid objects. However, some types of layers and effects may look better when composited into the scene using more advanced approaches. The Blending node can be used to composite an element, effect or composite using one of many different algorithms that may make it look much better in the final render.

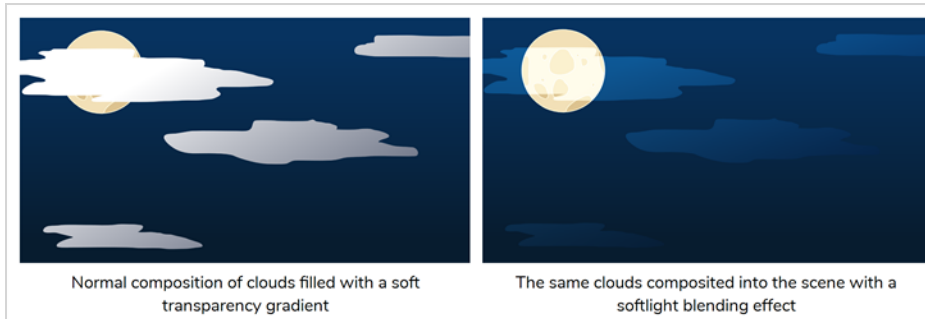

### NOTE

The effect of the Blending node is only visible when the Camera view is in Render Preview  mode.

## Connection

A Blending node can be connected under a layer, an effect or a composite to affect the way it will be composited into the scene.

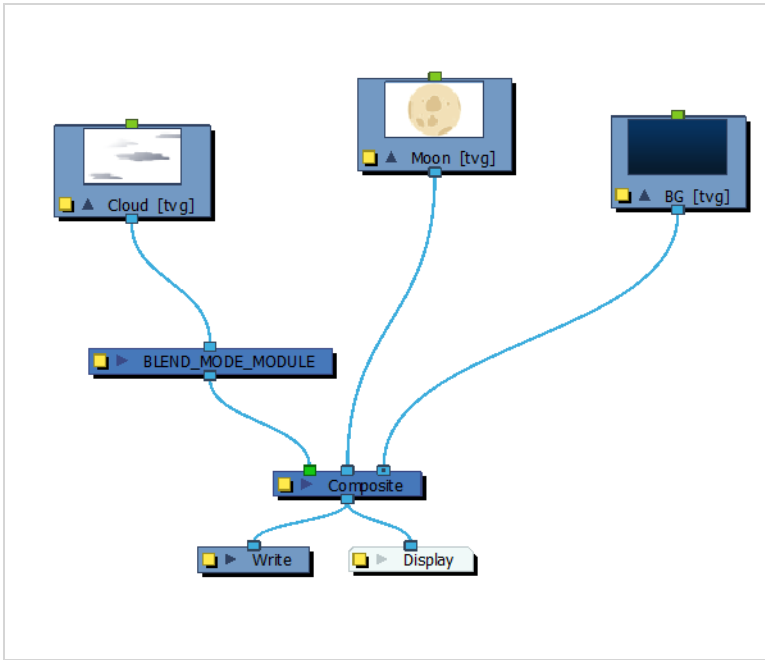

## Properties

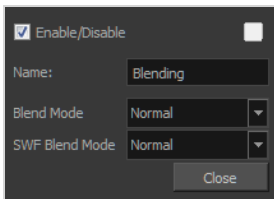

Parameter	Description
Enable/Disable	Allows you to enable or disable the node. When disabled, a node has no visible effect on the rendered image, nor on the preview in the Camera, Perspective, Side and Top views.
Colour Swatch	Sets the colour of the layer in the Timeline view and of the node in the Node view.
Name	Allows you to change the name given to the node.
Blend Mode	Choose the blending effect mode you wish to apply to your layer.







**NOTE**

Some of the available blending modes have a BETA or Legacy variant to them.

- A BETA blending mode is one that has been recently added in Harmony and which was made to more closely resemble results obtained in professional photo editing software such as Adobe Photoshop.
- A Legacy blending mode is a blending mode that was present in older versions of Harmony. Starting from Harmony 10, these blending modes were enhanced by de-multiplying colours before compositing the image then re-multiplying them. Their legacy version remain available to ensure scenes created in older versions of Harmony do not render differently.

- **Normal:** Composites the image without any specific blending effect.
- **Add / Add Legacy:** Adds the colour values of each channel in the overlay pixel and the underlay pixel. For example, adding two dark grey pixels with a value of 100 in each channel will result in a light grey pixel with a value of 200 in each channel. Likewise, if one of the pixels is red and the other is green, the resulting pixel will be yellow.
- **Burn / BETA Colour Burn:** Darkens each channel in the underlay pixel with the darkness value of the corresponding channel in the overlay pixel, by increasing the contrast of the underlay pixel.
- **Darken / BETA Darken:** For each channel, uses the value that is the darkest between the underlay pixel and the overlay pixel.
- **BETA Linear Burn:** Darkens each channel in the underlay pixel with the darkness value of the corresponding channel in the overlay pixel, by reducing the brightness of the underlay pixel.
- **Multiply / BETA Multiply:** Multiplies the value of each channel in the underlay pixel with the value of each channel in the overlay pixel, treating those values as ratios. Multiplying anything with black will result in black, and multiplying anything with white will leave the colour unchanged.
- **Dodge / BETA Colour Dodge:** Lightens each channel in the underlay pixel with the brightness value of the corresponding channel in the overlay pixel, by decreasing the contrast of the underlay pixel.
- **Erase:** Subtracts the overlay pixel's alpha from the underlay pixel, "cutting out" the overlay from the underlay. The overlay pixel's colour information is ignored.
- **Lighten / Lighten Legacy / BETA Lighten:** For each channel, uses the value that is the brightest between the underlay pixel and the overlay pixel.
- **BETA Linear Dodge:** Lightens each channel in the underlay pixel with the

	<p>brightness value of the corresponding channel in the overlay pixel, by increasing the brightness of the underlay pixel.</p> <ul style="list-style-type: none"><li>• <b>Screen / BETA Screen:</b> The reverse of multiply. Multiplies the reverse value of each channel in the underlay and overlay pixel, treating those values as ratios. Multiplying anything with white will result in white, and multiplying anything with black will leave the colour unchanged.</li><li>• <b>Vividlight:</b> This colour dodges overlay pixels with a value above 50% onto underlay pixels, and colour burns overlay pixels with a value below 50% onto underlay pixels. The brighter the overlay pixel is, the more intense the colour dodging effect will be. The darker the overlay pixel is, the more intense the colour burning effect will be.</li><li>• <b>Hardlight / Hardlight Legacy / BETA Hardlight:</b> This screens overlay pixels with a value above 50% onto underlay pixels, and multiplies overlay pixels with a value below 50% onto underlay pixels. The brighter the overlay pixel is, the more intense the screen effect will be. The darker the overlay pixel is, the more intense the multiplying effect will be. Blending any colour with white or black will result in white or black, and blending a colour with plain grey will leave the colour unchanged.</li><li>• <b>Linearlight:</b> This linear dodges overlay pixels with a value above 50% onto underlay pixels, and linear burns overlay pixels with a value below 50% onto underlay pixels. The brighter the overlay pixel is, the more intense the linear dodging effect will be. The darker the overlay pixel is, the more intense the linear burning effect will be.</li><li>• <b>Overlay / Overlay Legacy / BETA Overlay:</b> Like hardlight, except it screens or multiplies the underlay pixel over the overlay pixel, based on the value of the underlay pixel.</li><li>• <b>Pin Light:</b> For each channel, if the overlay pixel's value is above 50%, use the lightest pixel between the underlay and overlay pixels. If the overlay pixel's value is below 50%, use the darkest pixel between the underlay and overlay pixels.</li><li>• <b>Softlight / BETA Softlight:</b> Each channel of the overlay pixel lightens or darkens the corresponding channel of the underlay pixel on a softer scale. The effect is proportional to how dark or bright the overlay pixel is, but inversely proportional to how dark or bright the underlay pixel is.</li><li>• <b>Difference / Difference Legacy:</b> For each channel, this takes the darkest pixel among the overlay and underlay pixels, subtract it from the lightest pixel, and outputs the result.</li><li>• <b>Divide / Divide Legacy / BETA Divide:</b> For each channel, this divides the value of the underlay pixel by the value overlay pixel. Both values are treated as ratios, so the resulting colour is brighter. A white overlay pixel will leave the underlay colour unaffected, and a black overlay pixel will always result in white.</li><li>• <b>Exclusion / BETA Exclusion:</b> Adds the overlay and underlay pixel, then</li></ul>
--	--

	<p>subtracts the multiplied value of both pixels twice. This results in an effect similar to Difference, except that while the Difference mode produces consistently high contrast pixels, the contrast of the resulting pixels with the Exclusion mode is proportional to how dark or bright the overlay pixels are.</p> <ul style="list-style-type: none"> <li>• <b>Subtract / Subtract Legacy / BETA Subtract:</b> For each channel, subtracts the value of the overlay pixel from the value of the underlay pixel. For example, if the underlay pixel is white, and the overlay pixel is dark gray, the resulting pixel will be light gray. Likewise, if the underlay pixel is yellow, and the overlay pixel is red, the resulting pixel will be green, as yellow is a mix of green and red.</li> <li>• <b>Alpha:</b> Adds the opacity of the overlay pixel to the opacity of the underlay pixel, ignoring the colour of the overlay pixel.</li> </ul> <div data-bbox="597 678 1430 921" style="border: 1px solid green; padding: 10px; margin: 10px 0;"> <p> <b>NOTE</b></p> <p>The effect of this blending mode can only be observed if you render images with an alpha channel or if you set the Camera view to Matte View  mode. To do this, click on the Render View  mode button while it is selected to open its menu, then select  <b>Matte View</b>.</p> </div> <ul style="list-style-type: none"> <li>• <b>Colour:</b> Outputs a colour with the hue and saturation of the overlay pixel, and the luminosity of the underlay pixel. The overlay layer can hence be used to "colourize" the underlay layer.</li> <li>• <b>Hue:</b> Outputs a colour with the luminosity and saturation of the underlay pixel and the hue of the overlay pixel.</li> <li>• <b>Invert:</b> Inverts the underlay pixel proportionally to the alpha value of the overlay pixel. The overlay image hence acts as a "matte" for an invert effect.</li> <li>• <b>Luminosity / BETA Luminosity:</b> Outputs a colour with the hue and saturation of the underlay pixel and the luminosity of the overlay pixel. This is the reverse of the Colour blending mode.</li> <li>• <b>Replace:</b> Ignores the underlay pixel completely, outputting the overlay pixel as if nothing existed behind it. This applies to all overlay pixels that have an alpha value of at least 1, so the negative space of the overlay image will not hide the underlay image. If the overlay pixel is not fully opaque, it will be mixed with black.</li> <li>• <b>Saturation:</b> Outputs a colour with the luminosity and hue of the underlying colour, and the saturation of the source colour.</li> </ul>
SWF Blend Mode	<p>If you intend to export your scene in SWF format, you can use this option to choose which blend mode to use for this effect in the exported Flash movie. Since Flash does not support all the blending modes supported by Harmony, this is left as a separate option. You can ignore this option if you don't intend to export your scene in SWF format.</p>

- **Normal:** Composites the image without any specific blending effect.
- **Multiply:** Multiplies the value of each channel in the underlay pixel with the value of each channel in the overlay pixel, treating those values as ratios. Multiplying anything with black will result in black, and multiplying anything with white will leave the colour unchanged.
- **Screen:** The reverse of multiply. Multiplies the reverse value of each channel in the underlay and overlay pixel, treating those values as ratios. Multiplying anything with white will result in white, and multiplying anything with black will leave the colour unchanged.
- **Lighten:** For each channel, uses the value that is the brightest between the underlay pixel and the overlay pixel.
- **Darken:** For each channel, uses the value that is the darkest between the underlay pixel and the overlay pixel.
- **Difference:** For each channel, this takes the darkest pixel among the overlay and underlay pixels, subtract it from the lightest pixel, and outputs the result.
- **Add:** Adds the colour values of each channel in the overlay pixel and the underlay pixel. For example, adding two dark grey pixels with a value of 100 in each channel will result in a light grey pixel with a value of 200 in each channel. Likewise, if one of the pixels is red and the other is green, the resulting pixel will be yellow.
- **Subtract:** For each channel, subtracts the value of the overlay pixel from the value of the underlay pixel. For example, if the underlay pixel is white, and the overlay pixel is dark gray, the resulting pixel will be light gray. Likewise, if the underlay pixel is yellow, and the overlay pixel is red, the resulting pixel will be green, as yellow is a mix of green and red.
- **Invert:** Inverts the underlay pixel proportionally to the alpha value of the overlay pixel. The overlay image hence acts as a "matte" for an invert effect.
- **Overlay:** Like hardlight, except it screens or multiplies the underlay pixel over the overlay pixel, based on the value of the underlay pixel.
- **Hardlight:** This screens overlay pixels with a value above 50% onto underlay pixels, and multiplies overlay pixels with a value below 50% onto underlay pixels. The brighter the overlay pixel is, the more intense the screen effect will be. The darker the overlay pixel is, the more intense the multiplying effect will be. Blending any colour with white or black will result in white or black, and blending a colour with plain grey will leave the colour unchanged.

## Composite Node

The Composite node allows you to use several images and output a single image. You can compare that to doing pre-compositions in editing software. You can connect several drawing, image generators and effect nodes in your Composite node and one bitmap (or vector in some cases) comes out of it.

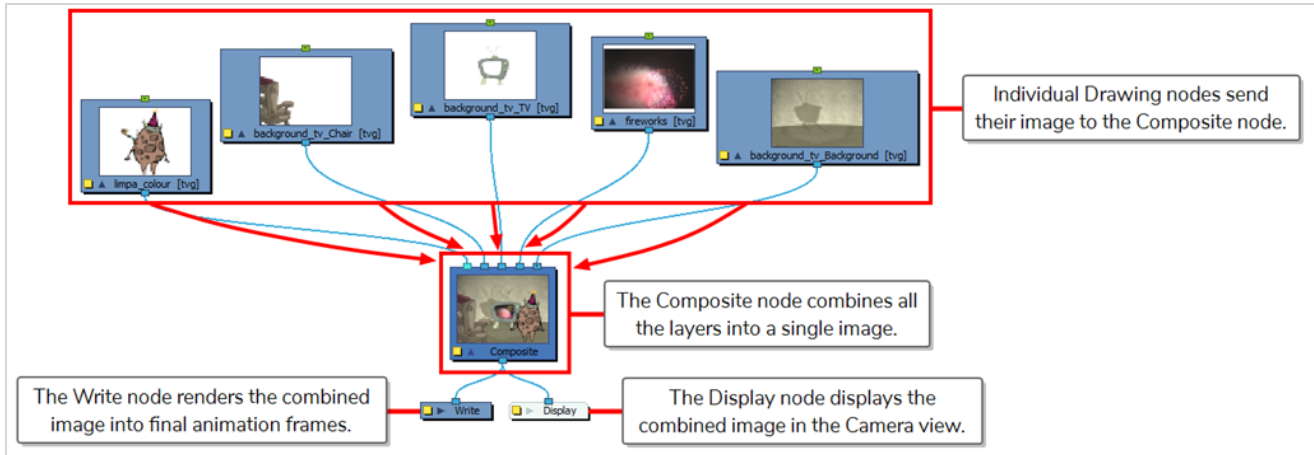

Using Composites is necessary if you wish to apply effects to several layers combined. For example, if you want a character rig that is composed of several layers to appear transparent, you must connect all the layers of your character's rig to the same composite, and connect a Transparency effect to that composite.

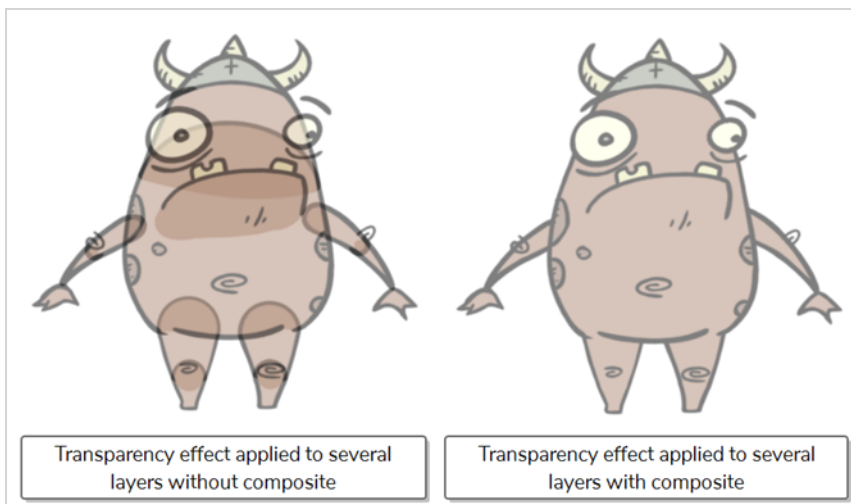
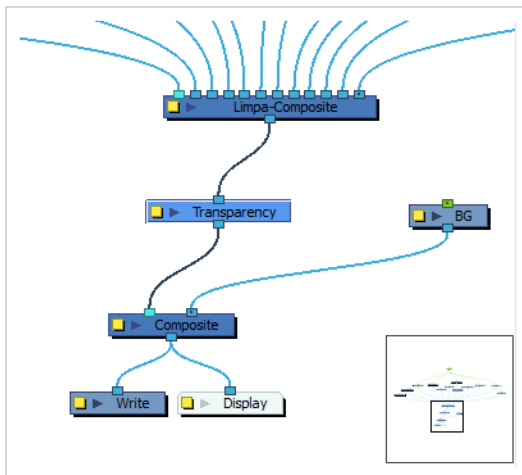

# Properties

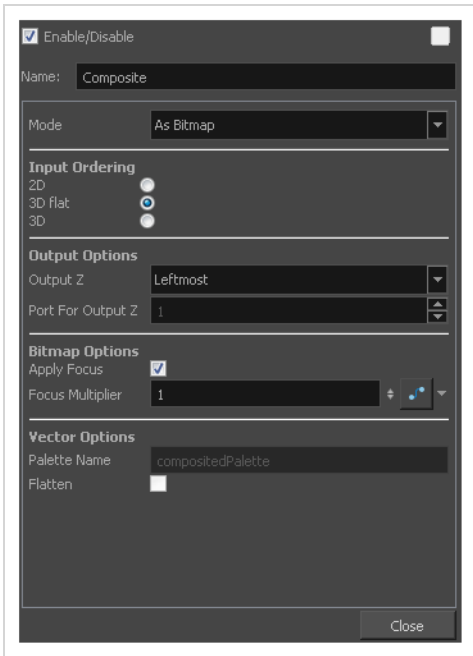

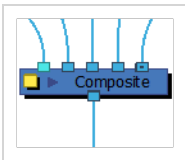
Parameter	Description
Enable/Disable	Allows you to enable or disable the node. When disabled, a node has no visible effect on the rendered image, nor on the preview in the Camera, Perspective, Side and Top views.
Colour Swatch	Sets the colour of the layer in the Timeline view and of the node in the Node view.
Name	Allows you to enter a name for the node.
Mode	<ul style="list-style-type: none"> <li>• <b>As Bitmap:</b> This is the default mode for composites. A bitmap composite outputs a single flat image.</li> </ul>  <ul style="list-style-type: none"> <li>• <b>As Seamless Bitmap:</b> mode works very similarly to bitmap mode, except it prevents seams from appearing between vector shapes that have matching outlines or when vector drawings are 3D-rotated and made to mesh together.</li> </ul>

	<div data-bbox="643 191 824 344" data-label="Image"> </div> <div data-bbox="643 384 1430 552" data-label="Text"> <p><b>NOTE</b> Shadow, Glow, Blending and Focus effects do not work when connected to a Seamless Bitmap composite.</p> </div> <ul data-bbox="613 583 1425 716" style="list-style-type: none"> <li>• <b>As Vector:</b> This mode outputs a flat vector drawing made of all the connected drawings. Vector composites should be used carefully, as they only work with vector layers and do not work with effects or bitmap layers.</li> </ul> <div data-bbox="643 741 834 894" data-label="Image"> </div> <ul data-bbox="613 930 1425 1136" style="list-style-type: none"> <li>• <b>Passthrough:</b> This mode simply passes all the information sent to the Composite, including artwork, effects and transformation, onto the next composite as is, as a multi-layered image. This means that if an effect is applied to the output, the effect will be applied individually on each layer in the output image. Hence, a Passthrough composite does not really perform any composition and is essentially an organization tool.</li> </ul> <div data-bbox="643 1161 841 1314" data-label="Image"> </div> <div data-bbox="643 1354 1430 1522" data-label="Text"> <p><b>NOTE</b> If a Composite set to Pass Through it is the last one in the compositing chain, it will act the same as a Bitmap composite.</p> </div>
Input Ordering	<p><b>2D:</b> Elements connected in the node are composited based on their port ordering. The Z-axis (forward-backward) values are ignored. The scaling value will be correct, but the actual position on the Z-axis is ignored.</p> <p>You can use the 2D composite type to create effects such as a camera recording overlay on your scene. Since you always want this element to be in front regardless of the other elements' Z-axis position, you can set the option to 2D.</p>

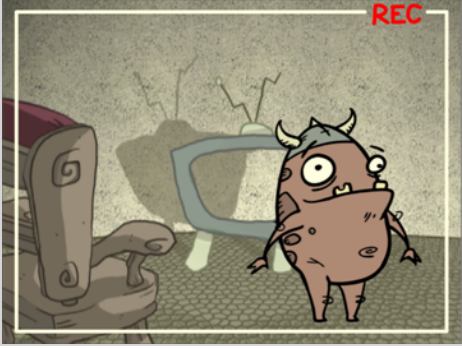
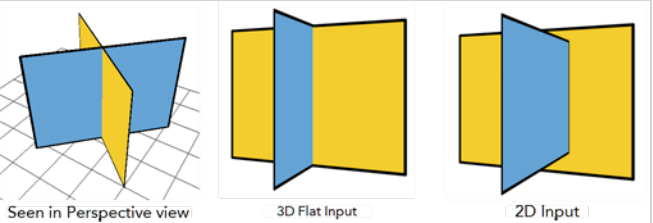
	 <p><b>3D Flat:</b> The Z-axis value of the elements connected in the Composite node are considered, so the visual representation is correct in the Camera view. The output is a flat image.</p>  <p><b>3D:</b> The Z-axis value of the elements connected in the composite node are considered, so the visual representation is correct in the Camera view. The image is not flattened. The 3D aspect of the elements are kept. For example, if you rotated elements on the three axes, the information is retained and elements composited in lower levels are able to intersect with the elements coming from a 3D Composite node.</p> <p>The 3D Composite node should only be used in advanced cases. It is better to use a Pass Through composite type than a 3D composite type. This way, all the elements are composited in the final Composite node.</p>
<p>Output Options</p>	<p><b>Output Z:</b> Identifies which element's front-back value from the current composition is applied to the entire composited image in the next operation. If you select Portnumber, identify the appropriate port by its position using the Port For Output Z menu.</p> <p><b>Port for Output Z:</b> When using the Portnumber option in the Output Z menu, you can select which port you want to use as the Z value for the Composite node. The port used appears in a bright green colour on the Composite node. By default, the leftmost port is displayed in front and the rightmost port is displayed behind.</p>
<p>Bitmap Options</p>	<p>These options are active when you select the As Bitmap mode.</p> <p><b>Apply Focus:</b> Activates the Focus effect for this node in the composite operation.</p> <p><b>Focus Multiplier:</b> The value entered in this field is used as a multiplier for the radius value specified in the Focus or Focus-Multiplier nodes.</p>



Vector Options	<p>These options are active when you select the As Vector mode.</p> <p><b>Palette Name:</b> When you render files using As Vector Composite nodes, use this field to set the name of the palette files that Toon Boom Harmony will create for them.</p> <p><b>Flatten:</b> Flattens vector drawings into one vector drawing file. Any transparency will be lost in the process. This creates smaller vector files, but might increase the time required to composite the drawings. This can be useful when reusing drawings. Because they will be vector files, you can still apply vector-based transformations and effects.</p>
----------------	---

## Composite-Generic Node

T-COMP2-005-002

The Composite-Generic node is a customizable effect that can be used to fit scenarios where the colours and alpha values of elements must be processed and combined in very specific ways. It can be configured to reproduce the effects of a Tone or Highlight node, or many of the blending effects available in the Blending node, but it offers significantly more control the way the effect is applied.

Among other things, the Composite Generic can be configured to apply a simple blending effect. However, contrary to the Blending node, the Composite Generic node does not composite its input image onto every element that is behind it in the scene. Rather, it composites one image, connected to its left input port, onto another, connected to its right input port. The resulting composited image is then composited onto the scene as normal.

Another interesting capability of the Composite Generic node is that it can use the colours and the alpha of either or both the overlay and the underlay image to make the output image. With the Colour Operation and Alpha Operation parameters, the colours and alpha values can be composited in different ways.



### NOTE

Because colours with an alpha value are premultiplied with black, their actual values in the back-end are typically different than what they appear to be in the rendered image. Hence, mixing a colour operation and alpha operation that are not meant to work together may not only have undesired results on the way the overlay image is blended into the underlay image, it may even have undesired results on the colour composition of elements behind the Composite Generic node.

## Connection

The Composite Generic node has two input ports and one output port. It will composite the image connected to its left input port (the overlay) onto the image connected to its right input port (the underlay) based on its properties, and will output the resulting composited image.

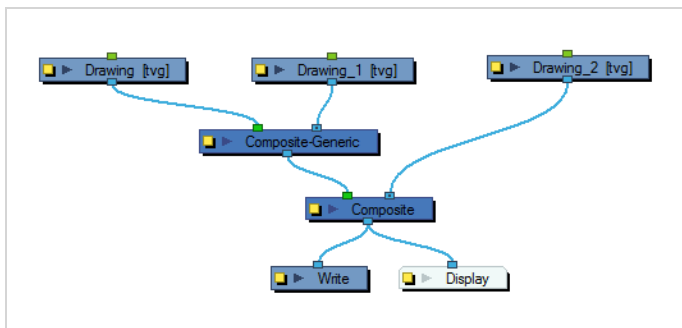

# Properties

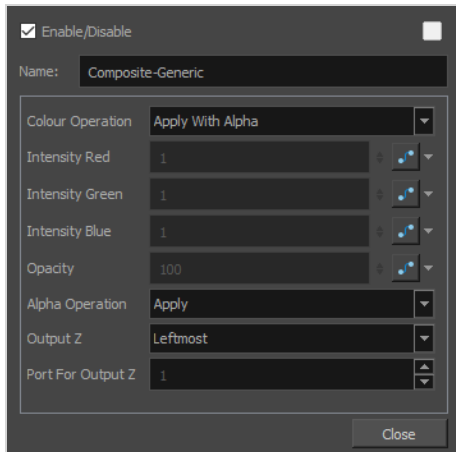

Parameter	Description
Enable/Disable	Allows you to enable or disable the node. When disabled, a node has no visible effect on the rendered image, nor on the preview in the Camera, Perspective, Side and Top views.
Colour Swatch	Sets the colour of the layer in the Timeline view and of the node in the Node view.
Name	Allows you to enter a name for the node.
Colour Operation	<p>The algorithm used to composite the colours of the underlay and overlay images together. Note that the way the alpha of the under and overlay images are composited depends entirely on the Alpha Operation parameter.</p> <div style="border: 1px solid green; padding: 10px; margin-top: 10px;"> <p> <b>NOTE</b></p> <p>Some of the available blending modes have a BETA or Legacy variant to them.</p> <ul style="list-style-type: none"> <li>• A BETA blending mode is one that has been recently added in Harmony and which was made to more closely resemble results obtained in professional photo editing software such as Adobe Photoshop.</li> <li>• A Legacy blending mode is a blending mode that was present in older versions of Harmony. Starting from Harmony 10, these blending modes were enhanced by de-multiplying colours before compositing the image then re-multiplying them. Their legacy version remain available to ensure scenes created in older versions of Harmony do not render differently.</li> </ul> </div>

	<p>In the following descriptions, the <i>underlay</i> image is the image connected to the right input port of the node, and the <i>overlay</i> image is the image connected to the left input port of the node.</p> <p><b>Right:</b> Only outputs colour values from the underlay image and ignores colour values from the overlay image.</p> <p><b>Left:</b> Only outputs colour values from the overlay image and ignores colour values from the underlay images.</p> <p><b>Apply With Alpha:</b> Composites the overlay pixel onto the underlay pixel proportionally to its alpha value. This is the standard composition technique when layers are connected to a composite.</p> <p><b>Apply Tone Highlight:</b> Applies the colour of overlay pixel the same way a Tone or Highlight effect would apply its colour to the underlay pixel.</p> <p><b>Apply Add / Apply Add Legacy:</b> Adds the colour values of each channel in the overlay pixel and the underlay pixel. For example, adding two dark grey pixels with a value of 100 in each channel will result in a light grey pixel with a value of 200 in each channel. Likewise, if one of the pixels is red and the other is green, the resulting pixel will be yellow.</p> <p><b>Apply Matte For Overlay:</b> Multiplies the colour values of the underlay image with the transparency ratio of the overlay image. This uses the overlay image as a "matte" to remove colours from the underlay image. You can then combine the resulting image with the colour values of the other image element by connecting this Composite Generic node to another Composite Generic node with its Colour Operation parameter set to Apply Overlay Into Matte. This is useful if the matte of the overlay and the colours of the overlay are to be stored in separate images.</p> <p><b>Apply Overlay Into Matte:</b> Multiplies the colour values of the overlay by the alpha values of the underlay image, then adds the resulting colour to the colour values of the underlay image. This is useful if you have darkened an area of an underlay with a matte using a different Composite Generic with its Colour Operation parameter set to Apply Matte for Overlay. This parameter will take the colours from the overlay and apply them on the area darkened by the matte.</p> <p><b>Apply Transparency:</b> Multiplies the colour values of the underlay image with the transparency ratio of the overlay image. This setting is designed to be combined with the Apply Transparency Matte alpha operation. However, it is technically the same as Apply Matte For Overlay.</p> <p><b>Apply Multiplicative Tone:</b> Multiplies the value of each channel in the underlay pixel with the value of each channel in the overlay pixel, treating those values as ratios. Multiplying anything with black will result in black, and multiplying anything with white will leave the colour unchanged.</p> <p><b>Multiply Colours:</b> Multiplies the value of each channel in the underlay pixel with the value of each channel in the overlay pixel, treating those values as ratios. Multiplying anything with black will result in black, and multiplying anything with white will leave the colour unchanged.</p>
--	--

**Divide Colours / Divide Colours Legacy:** For each channel, this divides the value of the underlay pixel by the value overlay pixel. Both values are treated as ratios, so the resulting colour is brighter. A white overlay pixel will leave the underlay colour unaffected, and a black overlay pixel will always result in white.

**Lighten / Lighten Legacy / BETA Lighten:** For each channel, uses the value that is the brightest between the underlay pixel and the overlay pixel.

**Softlight / Softlight Legacy / BETA Softlight:** Each channel of the overlay pixel lightens or darkens the corresponding channel of the underlay pixel on a softer scale. The effect is proportional to how dark or bright the overlay pixel is, but inversely proportional to how dark or bright the underlay pixel is.

**Hardlight / Hardlight Legacy / BETA Hardlight:** This screens overlay pixels with a value above 50% onto underlay pixels, and multiplies overlay pixels with a value below 50% onto underlay pixels. The brighter the overlay pixel is, the more intense the screen effect will be. The darker the overlay pixel is, the more intense the multiplying effect will be. Blending any colour with white or black will result in white or black, and blending a colour with plain grey will leave the colour unchanged.

**Overlay / Overlay Legacy / BETA Overlay:** Like hardlight, except it screens or multiplies the underlay pixel over the overlay pixel, based on the value of the underlay pixel.

**Linear Light:** This linear dodges overlay pixels with a value above 50% onto underlay pixels, and linear burns overlay pixels with a value below 50% onto underlay pixels. The brighter the overlay pixel is, the more intense the linear dodging effect will be. The darker the overlay pixel is, the more intense the linear burning effect will be.



**Pinlight:** For each channel, if the overlay pixel's value is above 50%, use the lightest pixel between the underlay and overlay pixels. If the overlay pixel's value is below 50%, use the darkest pixel between the underlay and overlay pixels.

**Vividlight:** This colour dodges overlay pixels with a value above 50% onto underlay pixels, and colour burns overlay pixels with a value below 50% onto underlay pixels. The brighter the overlay pixel is, the more intense the colour dodging effect will be. The darker the overlay pixel is, the more intense the colour burning effect will be.

**Exclusion:** Adds the overlay and underlay pixel, then subtracts the multiplied value of both pixels twice. This results in an effect similar to Difference, except that while the Difference mode produces consistently high contrast pixels, the contrast of the resulting pixels with the Exclusion mode is proportional to how dark or bright the overlay pixels are.

**Dodge:** Lightens each channel in the underlay pixel with the brightness value of the corresponding channel in the overlay pixel, by decreasing the contrast of the underlay pixel.

**Burn:** Darkens each channel in the underlay pixel with the darkness value of the corresponding channel in the overlay pixel, by increasing the contrast of the

	<p>underlay pixel.</p> <p><b>Hue:</b> Outputs a colour with the luminosity and saturation of the underlay pixel and the hue of the overlay pixel.</p> <p><b>Saturation:</b> Outputs a colour with the luminosity and hue of the underlying colour, and the saturation of the source colour.</p> <p><b>Colour:</b> Outputs a colour with the hue and saturation of the overlay pixel, and the luminosity of the underlay pixel. The overlay layer can hence be used to "colourize" the underlay layer.</p> <p><b>Luminosity:</b> Outputs a colour with the hue and saturation of the underlay pixel and the luminosity of the overlay pixel. This is the reverse of the Colour blending mode.</p>
<p>Intensity Red / Green / Blue</p>	<p>The factor by which to multiply each channel in the overlay image. You can set this to a value between 0 and 1 to reduce the impact of the corresponding channel in the overlay image, or to a value above 1 to increase it.</p> <div data-bbox="565 842 1430 1010" style="border: 1px solid #c8e6c9; padding: 10px; margin-top: 10px;"> <p> <b>NOTE</b> These parameters are only available when a BETA Colour Operation is selected.</p> </div>
<p>Opacity</p>	<p>A value between 0 and 100 determining the opacity level of the overlay image when composited onto the underlay image.</p> <div data-bbox="565 1167 1430 1304" style="border: 1px solid #c8e6c9; padding: 10px; margin-top: 10px;"> <p> <b>NOTE</b> This parameter is only available for certain Colour Operation settings.</p> </div>
<p>Alpha Operation</p>	<p><b>Right:</b> The transparency of the output image is based on the alpha values of the underlay image only.</p> <p><b>Left:</b> The transparency of the output image is based on the alpha values of the overlay image only.</p> <p><b>Apply:</b> Combines the alpha values of the overlay and underlay image. When combined with the <b>Apply with Alpha</b> colour operation, this results in standard alpha-based compositing.</p> <p><b>Add:</b> The alpha value of each pixel is the sum of the alpha value of the underlay pixel and of the alpha value of the overlay pixel.</p> <p><b>Subtract:</b> The alpha value of each pixel is based on the alpha value of the underlay pixel subtracted by the alpha value of the overlay pixel.</p> <p><b>Apply Transparent Matte:</b> The alpha value of each pixel is based on the alpha value of the underlay pixel, multiplied by the transparency of the overlay pixel,</p>

	<p>effectively multiplying their transparency.</p> <p><b>Black:</b> Outputs every pixel as fully transparent of both the output as fully transparent, leaving behind only the effect of premultiplication of their colour values onto the rendered image.</p> <p><b>White:</b> Sets the matte of the entire output image to white, so that it is fully opaque. The bounding box of the output image will be filled with black and semi-transparent pixels will be mixed with black.</p>
Output Z	<p><b>Leftmost:</b> Indicates that the Z value for the output image will be taken from the node in the left port.</p> <p><b>Rightmost:</b> Indicates that the Z value for the output image will be taken from the node in the right port.</p> <p><b>Backmost:</b> Indicates that the Z value for the output image will be taken from the image that is the farthest back in the scene.</p> <p><b>Frontmost:</b> Indicates that the Z value for the output image will be taken from the image that is closest to the front of the scene.</p> <p><b>Portnumber:</b> Indicates that the Z value for the output image will be taken from the node in the selected port. Enter the appropriate port in the <b>Port for Output Z</b> field.</p>

## Cutter Node

T-HFND-010-009

The Cutter effect cuts out a portion of an image. To do this, it needs to be connected to the drawing it is intended to cut as well as to a matte layer. The cutter will take the shape of the drawing in the matte layer and cut this shape out of the drawing layer. This is especially useful if you want to make a character disappear between a background element, or if you want to cut out a hole in the middle of a character.

Like all effects that use a matte, the Cutter's effect has an Inverted parameter, which is disabled by default. When enabled, the Cutter will have the reverse effect: Instead of cutting the matte's shape out of the drawing, it will cut everything outside of the matte's shape out of the drawing, leaving only the parts of the drawing that are covered by the matte.

The Cutter effect can be used with 2D-3D integration. Rendered 2D drawings, integrated with 3D models, display soft, anti-aliased edges, even where the Cutter effect is applied.



Refer to the following example to connect this effect:

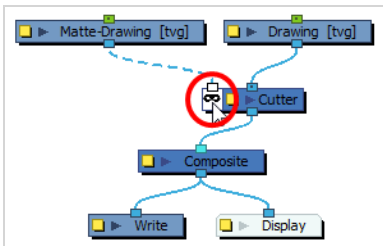

## Properties

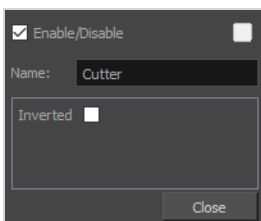



---

Parameter	Description
Enable/Disable	Allows you to enable or disable the node. When disabled, a node has no visible effect on the rendered image, nor on the preview in the Camera, Perspective, Side and Top views.
Colour Swatch	Sets the colour of the layer in the Timeline view and of the node in the Node view.
Name	Allows you to enter a name for the node.
Inverted	When this option is enabled, the Cutter node will invert the matte shape to cut the drawing. Instead of cutting the image intersecting with the matte, it will cut any artwork outside of the matte shape.

## Highlight Node

T-HFND-010-009C

The Highlight node allows you to brighten an image's area to simulate a light source. For this effect, you will need to create a matte to determine the shape and position of the highlight on a separate element, so that you can blur the edges to create a softer effect. By adjusting the Highlight properties, you can control the type and amount of blur, as well as the colour of the Highlight effect.



### Connection

The Highlight node takes an image of any type in the right (Image) input port, and a matte drawing in the left (Matte) input port. It outputs a version of the input image with a highlight applied over it everywhere where the input image and the matte drawing intersect.

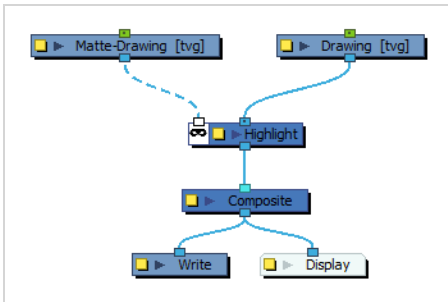

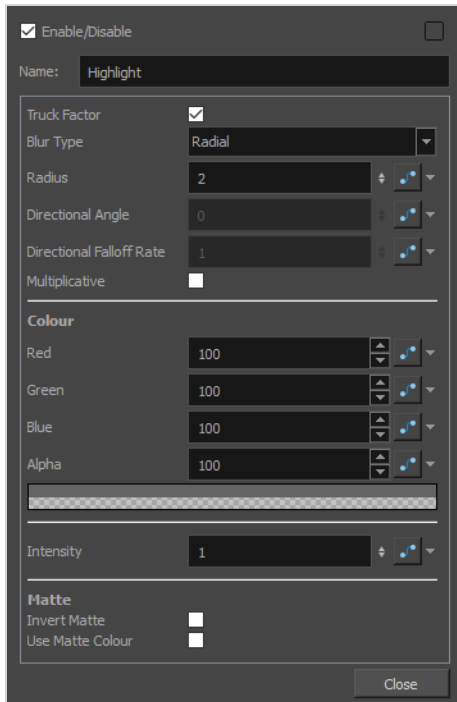

## Layer Properties



Parameter	Description
Enable/Disable	Allows you to enable or disable the node. When disabled, a node has no visible effect on the rendered image, nor on the preview in the Camera, Perspective, Side and Top views.
Colour Swatch	Sets the colour of the layer in the Timeline view and of the node in the Node view.
Name	Allows you to enter a name for the node.
Truck Factor	Activated by default, this option readjusts the blur when the elements undergo a change of depth or scale. When disabled, the effect's values will remain unchanged regardless of depth or scale changes. It is recommended that this option be disabled when multiple drawings are composited and attached this effect.
Blur Type	Allows you to choose between the following blur types for the effect: <ul style="list-style-type: none"> <li>• <b>Radial:</b> The edges of the matte are blurred evenly around points that make up the edge of the matte.</li> <li>• <b>Directional:</b> The matte is blurred in the direction configured with the Directional Angle and Directional Falloff Rate parameters.</li> </ul>
Radius	Enter a value for the size of the blur. The larger the value, the greater the blur effect. The blur

Parameter	Description
	radius is affected by the drawing scale and camera position.
Directional Angle	<p>If you set the Blur Type to Directional, this sets the angle of the blur. The value goes from 0 to 360, with 0 meaning west, and angles going counterclockwise. For example:</p> <ul style="list-style-type: none"> <li>• <b>0</b>: Blurs the image to the west.</li> <li>• <b>90</b>: Blurs the image to the south.</li> <li>• <b>180</b>: Blurs the image to the east.</li> <li>• <b>270</b>: Blurs the image to the north.</li> </ul>
Directional Falloff Rate	<p>The distance where the blur fades from the edge of the image. Select a decimal value between 0 and 1. For example:</p> <ul style="list-style-type: none"> <li>• <b>0</b>: Makes the blur fade out slowly, distributing the blur evenly from the edge of the character to the farthest edge of the blur.</li> <li>• <b>1</b>: Makes the blur fade out quickly. The blur is heaviest closer to the edge of the image.</li> </ul>
Multiplicative	Multiplies the colours of the effect with the colours of the source image. This intensifies the effect.
<b>Colour</b>	
Red	The amount of red to add to the colour of the source image.
Green	The amount of green to add to the colour of the source image.
Blue	The amount of blue to add to the colour of the source image.
Alpha	The alpha value of the effect.
Colour Swatch	Opens the Colour Picker dialog, in which you can visually select a colour for the effect.
Intensity	Allows you to set the factor by which to multiply the intensity of the effect. This parameter can take a decimal value between 0 and 1. At 1, the effect is fully applied. At 0, the effect is not visible.
<b>Matte</b>	

Parameter	Description
Invert Matte	Inverts the matte used to generate the effect. By default, the affect is applied to opaque areas of the matte and transparent areas of the matte are ignored. When this option is enabled, the effect is applied to transparent areas of the matte and opaque areas of the matte are ignored.
Use Matte Colour	<p>Instead of using the colour in the Colour parameters, this uses the colours in the matte drawing to generate the effect.</p> <div data-bbox="407 541 1430 684" style="border: 1px solid #c8e6c9; padding: 10px;"><p> <b>NOTE</b> The effect of this parameter is only visible in Render View  mode.</p></div>

## Image Switch Node

T-COMP2-005-004

The Image Switch effect lets you use multiple effects, such as Colour Override, and choose which port will be sent to rendering if you want to apply different variations of an effect that cannot be changed over time. You then create multiple separate versions of the effect, connect them all to the Image Switch, and then if you want to change to a different version of the effect at different points in your scene, you would add a curve and animate the port number. Image Switch simply lets you change over time which port is being rendered.

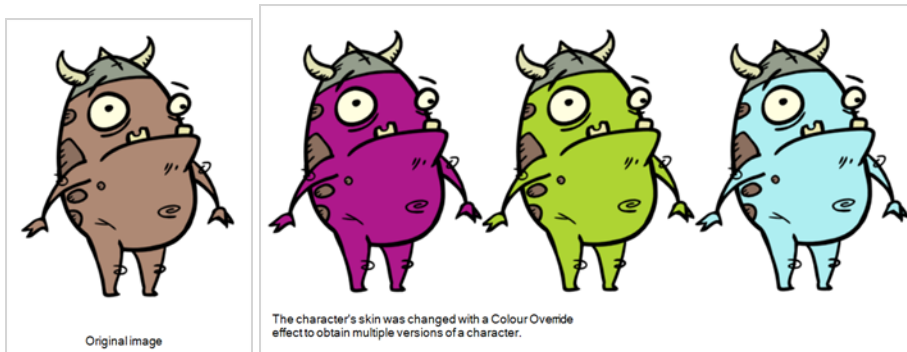

Refer to the following example to connect this effect:

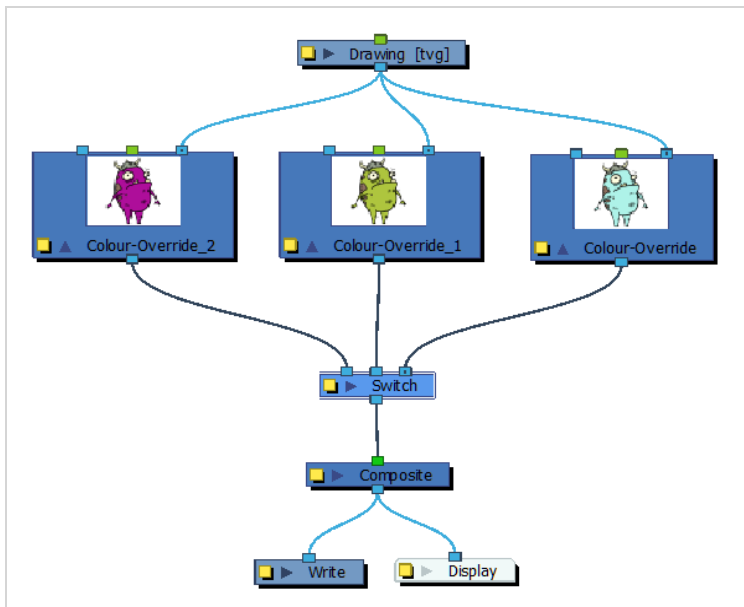

## Properties

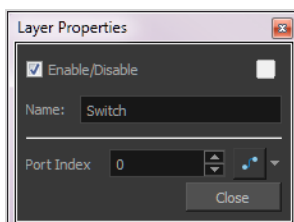

Parameter	Description
Enable/Disable	Allows you to enable or disable the node. When disabled, a node has no visible effect on the rendered image, nor on the preview in the Camera, Perspective, Side and Top views.
Colour Swatch	Sets the colour of the layer in the Timeline view and of the node in the Node view.
Name	Allows you to enter a name for the node.
Port Index	<p>Switches from one image to another. There is no gradual animation from one colour to another as you are only changing (over time) which port will be rendered. Use whole values.</p> <p>Click the Function  button to open the Function editor to animate a parameter over time—see .</p>

## Matte-Composite Node

T-COMP2-005-003

The Matte-Composite node is a type of composite that is specifically designed to combine different matte drawings into a single matte, which can then be connected to the matte port of an effect or drawing node.

Contrary to a regular composite, the Matte-Composite node allows deciding whether each drawing connected to it is added, subtracted or intersected with the resulting composited matte, and each drawing connected to it can be composited as is, or inverted.



### NOTE

Since the Matte-Composite node is meant to output mattes, it ignores colours and only composites alpha levels. The output image will be in plain white, with varying degrees of transparency.

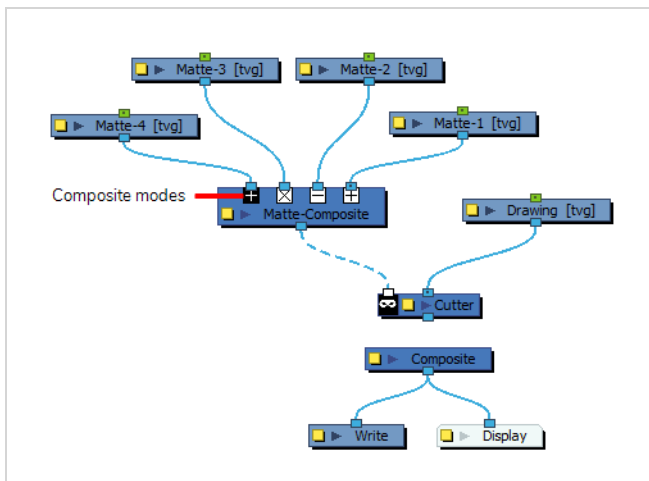

## Connection

Like a regular composite, the Matte-Composite node can be connected to as many input images as needed, and combines them together. Its output port should be connected to the matte port of an effect.





The matte is generated by creating a matte from the first drawing connected to it, then compositing each subsequent drawing on top of it. Like with a Composite node, the order in which connected drawings are composited goes from right to left.

Each node connected to the Matte-Composite's input ports has its own composite mode as well as its own invert setting. In the Node view, you can immediately tell the mode in which the node is applied by looking at the symbol just below each input port:





- A  sign means the drawing is added to the composite matte.
- A  sign means the drawing is subtracted from the composite matte.
- A  sign means the drawing is intersected with the composite matte.



You can also tell whether the node is composited as is if the sign is black on white , or inverted if the sign is white on black .



### TIP

In the Node view, you can quickly toggle between composite modes by double-clicking on the symbol. This will cycle between Add , Add Inverted , Subtract  and Intersect . If you want to set a connection to another combination of composite mode and invert setting, you must do it in the layer properties of the Matte-Composite node.

## Properties

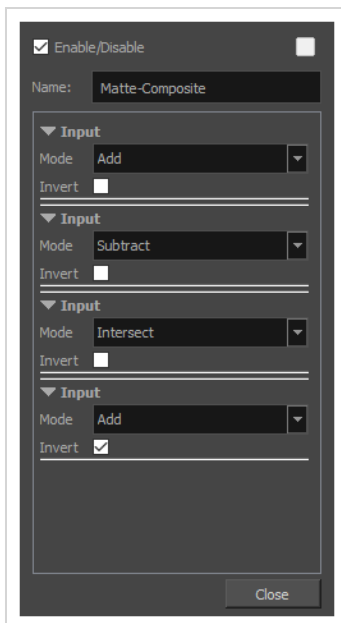

Parameter	Description
Name	Allows you to enter a name for the node.
Input Parameters	Each input connection has its own set of Input parameters, which determines how each node connected to the Matte-Composite node is composited into the resulting matte.
Mode	Each node connected to the Matte Composite node can be composited into the resulting matte in one of the following ways: <ul style="list-style-type: none"> <li>• <b>Add:</b> The alpha of each pixel is added to the matte, resulting in combined shapes.</li> </ul>

	<div data-bbox="643 191 1084 472" data-label="Image"> </div> <ul data-bbox="613 506 1406 569" style="list-style-type: none"> <li>• <b>Subtract:</b> The alpha of each pixel is subtracted from the matte. This cuts the drawing's shape out of the matte.</li> </ul> <div data-bbox="643 594 1110 896" data-label="Image"> </div> <ul data-bbox="613 930 1406 1031" style="list-style-type: none"> <li>• <b>Intersect:</b> The alpha ratio of each pixel is multiplied by the alpha ratio of the corresponding pixel on the matte. The resulting matte is made of the areas where the drawings intersect.</li> </ul> <div data-bbox="643 1056 1110 1358" data-label="Image"> </div>
<p>Invert</p>	<p>When enabled, the drawing is composited onto the matte with its alpha values reversed, as if its transparent pixels were opaque and its opaque pixels were transparent. This means that the shape of the negative space of the drawing will be composited to the matte instead of its actual shape.</p>

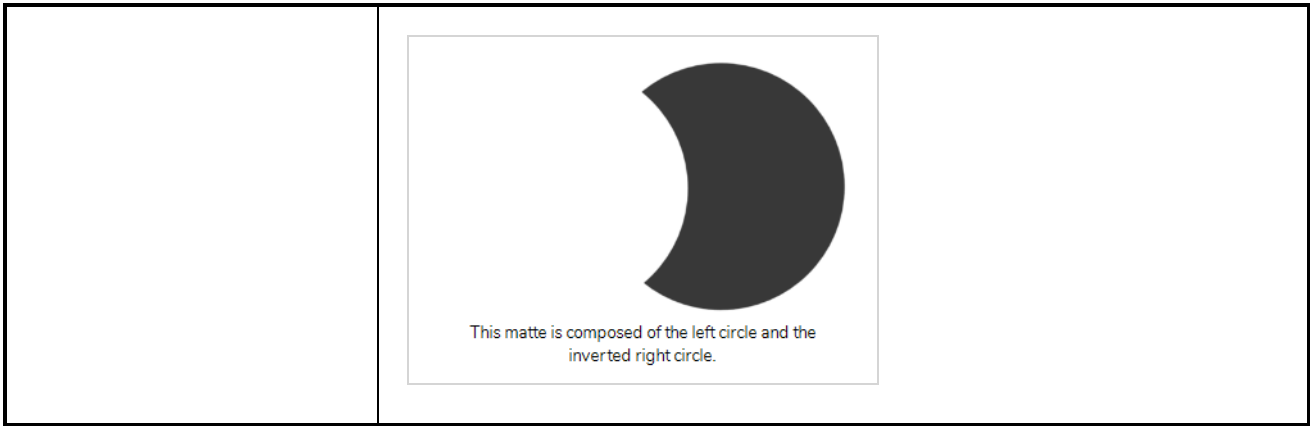

## Tone Node

T-COMP2-004-004

The Tone effect allows you to add a dark-coloured region to your drawing and simulate the shaded area away from a light source. To produce the tone effect, create a drawing to control where the tone will appear. The Tone effect uses a matte to determine the shape and position of the tone on your drawing and can be blurred at the edges to create a softer effect.

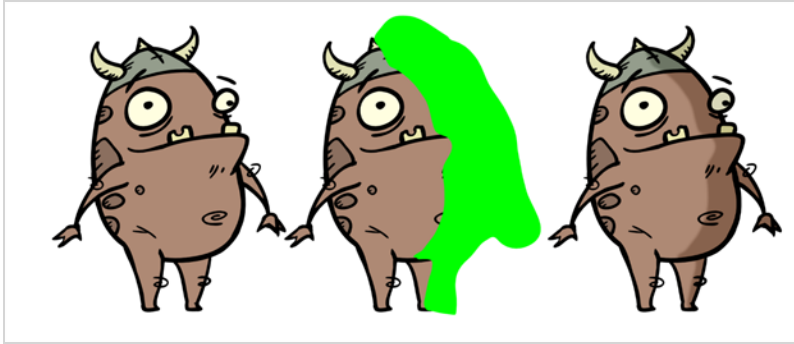

## Connection

The Tone node takes an image of any type in the right (Image) input port, and a matte drawing in the left (Matte) input port. It outputs a version of the input image with a tone applied over it everywhere where the input image and the matte drawing intersect.

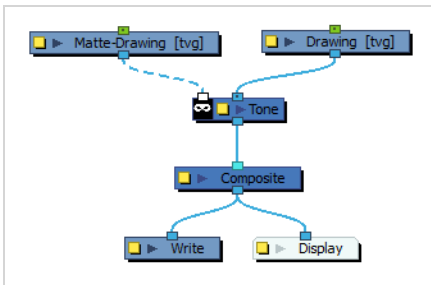

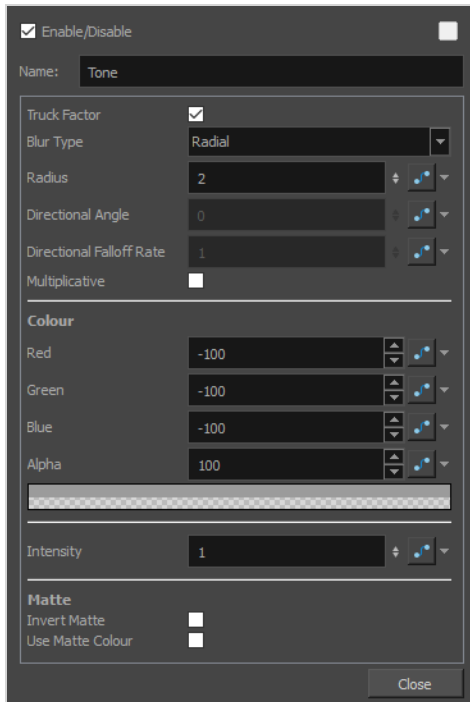

## Layer Properties



Parameter	Description
Enable/Disable	Allows you to enable or disable the node. When disabled, a node has no visible effect on the rendered image, nor on the preview in the Camera, Perspective, Side and Top views.
Colour Swatch	Sets the colour of the layer in the Timeline view and of the node in the Node view.
Name	Allows you to enter a name for the node.
Truck Factor	Activated by default, this option readjusts the blur when the elements undergo a change of depth or scale. When disabled, the effect's values will remain unchanged regardless of depth or scale changes. It is recommended that this option be disabled when multiple drawings are composited and attached this effect.
Blur Type	Allows you to choose between the following blur types for the effect: <ul style="list-style-type: none"> <li>• <b>Radial:</b> The edges of the matte are blurred evenly around points that make up the edge of the matte.</li> <li>• <b>Directional:</b> The matte is blurred in the direction configured with the Directional Angle and Directional Falloff Rate parameters.</li> </ul>
Radius	Enter a value for the size of the blur. The larger the value, the greater the blur effect. The blur

Parameter	Description
	radius is affected by the drawing scale and camera position.
Directional Angle	<p>If you set the Blur Type to Directional, this sets the angle of the blur. The value goes from 0 to 360, with 0 meaning west, and angles going counterclockwise. For example:</p> <ul style="list-style-type: none"> <li>• <b>0</b>: Blurs the image to the west.</li> <li>• <b>90</b>: Blurs the image to the south.</li> <li>• <b>180</b>: Blurs the image to the east.</li> <li>• <b>270</b>: Blurs the image to the north.</li> </ul>
Directional Falloff Rate	<p>The distance where the blur fades from the edge of the image. Select a decimal value between 0 and 1. For example:</p> <ul style="list-style-type: none"> <li>• <b>0</b>: Makes the blur fade out slowly, distributing the blur evenly from the edge of the character to the farthest edge of the blur.</li> <li>• <b>1</b>: Makes the blur fade out quickly. The blur is heaviest closer to the edge of the image.</li> </ul>
Multiplicative	Multiplies the colours of the effect with the colours of the source image. This intensifies the effect.
<b>Colour</b>	
Red	The amount of red to subtract from the colour of the source image. To obtain a shadow effect, the value must be negative.
Green	The amount of green to subtract from the colour of the source image. To obtain a shadow effect, the value must be negative.
Blue	The amount of blue to subtract from the colour of the source image. To obtain a shadow effect, the value must be negative.
Alpha	The alpha value of the effect.
Colour Swatch	Opens the Colour Picker dialog, in which you can visually select a colour for the effect.
Intensity	Allows you to set the factor by which to multiply the intensity of the effect. This parameter can take a decimal value between 0 and 1. At 1, the effect is fully applied. At 0, the effect is not visible.

Parameter	Description
<b>Matte</b>	
Invert Matte	Inverts the matte used to generate the effect. By default, the affect is applied to opaque areas of the matte and transparent areas of the matte are ignored. When this option is enabled, the effect is applied to transparent areas of the matte and opaque areas of the matte are ignored.
Use Matte Colour	Instead of using the colour in the Colour parameters, this uses the colours in the matte drawing to generate the effect. <div data-bbox="407 632 1430 779" style="border: 1px solid #c8e6c9; padding: 10px;"> <b>NOTE</b> The effect of this parameter is only visible in Render View  mode.</div>

## Transformation Switch Node

The Transformation-Switch node acts as a on and off switch for the deformation chains. It is used when building multi-pose (multiple deformation chains) rigs. the Transformation-Switch can also be used with other node types than Deformation nodes. It can be used with any transformation nodes such as Peg and Quadmap nodes.

Refer to the following example to connect this effect:

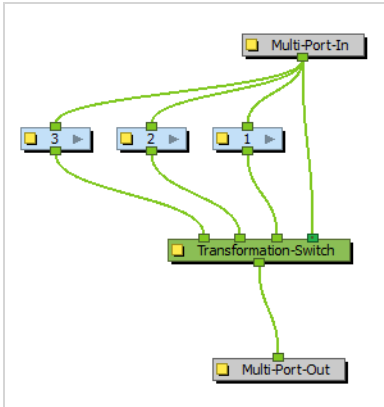

The Transformation-Switch replaces the Deformation-Switch node.

## Properties

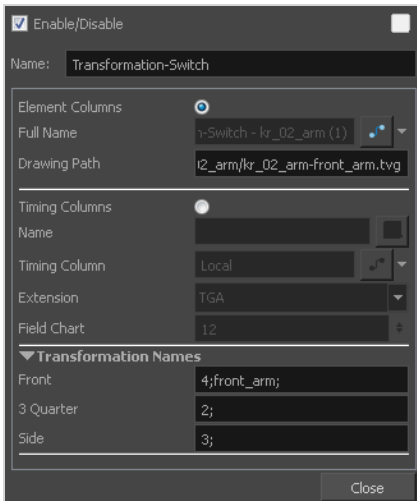

Parameter	Description
Enable/Disable	Allows you to enable or disable the node. When disabled, a node has no visible effect on the rendered image, nor on the preview in the Camera, Perspective, Side and Top views.



Colour Swatch	Sets the colour of the layer in the Timeline view and of the node in the Node view.
Name	Use this field to rename the node.
Element Columns	<p><b>Full Name:</b> Select which element to connect to the node from the list of elements that already exist in your scene.</p> <p><b>Drawing Path:</b> Displays the full path to the current drawing.</p>
Timing Columns	<p><b>Name:</b> Path to the file you want to link to.</p> <p><b>Timing Column:</b> Link to the column that contains the desired timing.</p> <p><b>Extension:</b> When linking to a background file, enter its file name extension.</p> <p><b>Field Chart:</b> If you are importing traditional animation, select the size of the paper on which the animation was drawn.</p>
Transformation Names	List the drawing names associated to each transformation chain. You can enter additional drawings and separate the names with semi-colons (;).

## Constraint Nodes

Constraint nodes are a series of nodes that can be used to subject parts of a cut-out character rig to certain physical constraints. Specifically, they are designed to add the following capabilities for rigging and animation:

- Create points on drawings which, when moved, will translate, rotate and scale the drawing so that the parts of the drawings those points are attached remain locked to those points.
- Lock the different parts of a rig by their articulations. This makes it so moving a part of a rig that is constrained to its adjacent parts will move those other body parts along it, and rotate the part being moved as needed.
- Automate a "spring" like movement based on a simple translation. Specifically, the Dynamic Spring node is able to apply a delayed movement on a part of a character rig based on the movement of its parents. This can also be wielded to automate follow-through action for parts like hair, ears, whiskers, and such.
- Limit, switch between, turn on and off or interpolate different transformations applied by pegs onto elements.
- Bake transformations into the resting position of elements.

Constraint nodes use the pivot point of pegs connected to them to define their constraint points. Rigging with constraint nodes is more complicated than rigging with a mere hierarchy of pegs and elements, as it requires using the different nodes together, like building blocks, to define precisely the relationship between adjacent parts of a rig. They however allow the animator to pose and animate a character rig by moving the pivot points of its articulations rather than by transforming its individual layers, while the constraint nodes take care of making the appropriate transformations to the adjacent body parts. The resulting procedure is potentially much more natural and streamlined.

Harmony features the following Constraint nodes:

- **Two-Point Constraint:** Constrains a drawing between the pivot-point of two pegs. This node can be configured to stretch and squash the drawing it transforms automatically, as well as to stop stretching or squashing the drawing past specified limits. This can be especially useful for rigging limbs together and allow the animator to manipulate them by their articulations.
- **Three-Point Constraint:** Constrains a drawing between the pivot-point of three pegs.
- **Multi-Point Constraint:** Constrains a drawing between the pivot-point of multiple pegs.
- **Dynamic Spring:** Applies the movement of the parent peg with inertia and tension factors onto the child element. This can be used to automatically generate life-like ease and overshoot, as well as follow-through animation.
- **Transform Limit:** Filters the transformations from the parent node by multiplying each type of transformation (ie: translations, rotation, scale, etc.) by a factor going from 0% to 100%, before applying it to the child node.

- **Transformation-Gate:** This node can be used to dynamically select which one of several transformations from several connected parent nodes is applied to its child. It is also able to make an interpolation between two transformations from two of its parents, and apply the interpolated transformation to its child. It can be used with constraint nodes or any other node that outputs a transformation, such as pegs and quadmaps.
- **Constraint Switch:** This node can be connected to the leftmost input port of any other constraint node to temper its effect. It does so by applying a ratio ranging from 0% to 100% to the transformations applied by the constraint node it is connected to. If connected to a Transformation-Gate, it can remotely control which input port the Transformation-Gate uses to apply transformations to its child.
- **Static Constraint:** Can be used to permanently store (or "bake") the transformation applied by its parent or parents. Once transformations are baked into the node, it can be disconnected from the parent, then connected to a child to apply the baked transformation onto it, acting like a transformation template or a resting position.

**NOTE**

Constraint nodes do not deform drawings like deformation nodes do, they apply standard transformations such as translations, rotations and scaling on them. The Multi-Point Constraint can optionally apply a perspective (quadmap) transformation on elements.

Constraint Switch Node .....	405
Dynamic Spring Node .....	408
Multi-Points Constraint Node .....	414
Static Transformation Node .....	417
Three-Points Constraint Node .....	420
Transformation Gate Node .....	423
Transformation Limit Node .....	425
Two-Points Constraint Node .....	431

## Constraint Switch Node

The Constraint Switch node is used to remotely affect the Value and/or Target Gate parameter of other Constraint nodes.

Each node in the Constraint category has an Active parameter that can be set to a value ranging from 0 to 100. This value is used to determine how much of the transformation calculated by a constraint node should actually be applied to its child element. When set to 100, the transformation is fully applied. Then set to 0, the transformation is not applied at all. When set to a value between 0 and 100, the effect the constraint node has on its child is proportionally tempered.

The Constraint Switch has its own Active parameter. When connected to a constraint node, the Active value of that constraint node is multiplied by the Active value of the Constraint Switch. For example, if a Constraint Switch with an Active parameter set to 50 is connected to a Two-Points Constraint node with an Active parameter of 50, the effective Active value of the Two-Points Constraint node will be 25, and only 25% of its transformation will be applied. Likewise, if the Active value of the Constraint Switch is set to 0, it will effectively "switch off" the constraint node, and if it is set to any value below 0, it will reverse the effect of the constraint node.

A Constraint Switch can also be used to remotely control the Target Gate parameter of a Transformation Gate. A Transformation Gate takes several transformations as inputs and outputs one of the transformations. The Target Gate is the numerical index of the port the Transformation Gate takes the transformation from when its Value parameter is set to 100. The Target Gate for a Transformation Gate can be set within its own properties, but if a Constraint Switch is connected to it, the Constraint Switch's Target Gate parameter will override the Transformation Gate's Target Gate parameter.

## Connection

The Constraint Switch node can be connected to the leftmost input port of any constraint node, except for the Static-Transformation node. The input port for a Constraint Switch will be the same shade of aquamarine as the Constraint-Switch node itself.

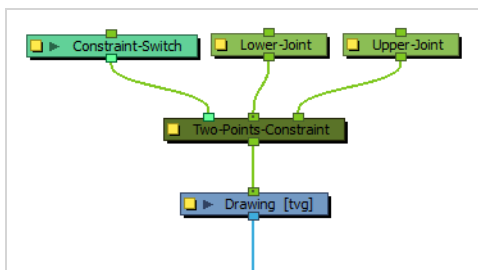

A Constraint-Switch node can be connected to several constraint nodes to control them simultaneously.

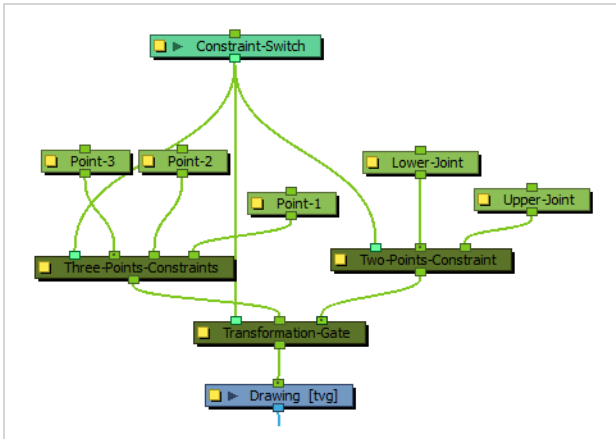

## Controls

When the control of a Transformation Switch is displayed, a slider displays in the Camera view which can be used to manually set the value of the Active parameter.

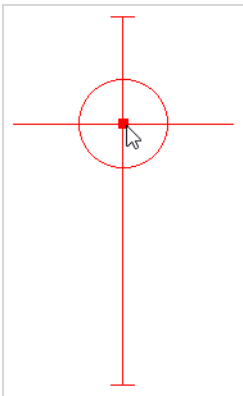

## Properties

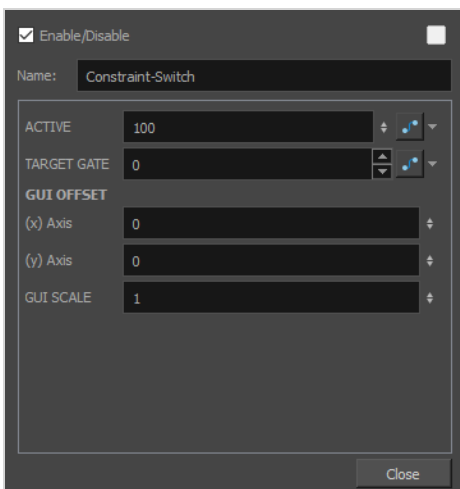

Parameter	Description
-----------	-------------

Active	<p>Defines the influence applied to the constraint node the Constraint Switch node is connected to. This value is multiplied with the value of the Active parameter of the constraint node to calculate its effective Active parameter.</p> <p>For example, if a Constraint Switch with an Active parameter set to 50 is connected to a Two-Points Constraint node with an Active parameter of 50, the effective Active value of the Two-Points Constraint node will be 25, and only 25% of its transformation will be applied. Likewise, if the Active value of the Constraint Switch is set to 0, it will effectively "switch off" the constraint node, and if it is set to any value below 0, it will reverse the effect of the constraint node.</p>
Target Gate	<p>If the Constraint Switch is connected to a Transformation Gate node, this parameter overrides the Target Gate parameter. of the Transformation Gate.</p>
GUI Offset	<p>When displaying this node's control, a slider displays in the Camera view to control the node's Active parameter. The following parameters affect the way the slider is displayed.</p>
(x) Axis	<p>Offsets the horizontal position of the slider in the Camera view..</p>
(y) Axis	<p>Offsets the vertical position of the slider in the Camera view.</p>
GUI Scale	<p>Multiplies the size of the slider in the Camera view. This parameter is set to 1 by default.</p>

## Dynamic Spring Node

The Dynamic Spring node takes the animated transformation from the parent node then applies tension and inertia to make it into a "spring" motion.

When filtered with a Dynamic-Spring node, a peg that performs a simple translation from point A to point B with no ease-in or ease-out will result in an ease-in from point A, an ease-out to point B followed by a realistic overshoot.

## Connection

A Dynamic Spring node must be connected to a peg or other transformation node through its rightmost input port. The spring effect will be applied to the transformation sent through this port.

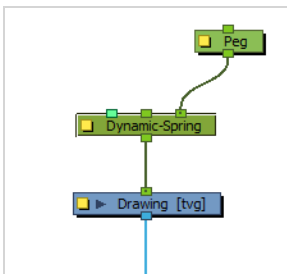

Rigged together with a Two-Points Constraint node and another peg to offset the pivot point of the original, you can automate the follow through action. In this example, the Movement-Peg node animates the Hair element from its top part. The same animation is also sent through a Dynamic-Spring node, then a peg that offsets the pivot point towards the bottom of the hair (via its own Pivot parameters) which results in the top of the hair being pulled by a regular motion while the bottom follows through with realistic ease and overshoot.

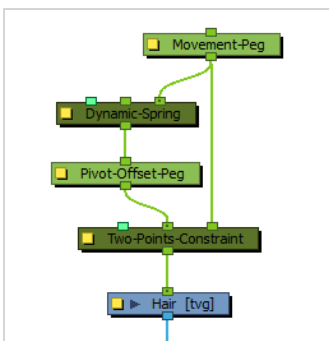

The spring effect the Dynamic Spring applies is based on the motion of the entire hierarchy of its parents, not just on the motion of its immediate parent. This may cause undesired effects. For example, if a Dynamic-Spring is connected to a hand drawing, and the forearm the hand is rigged to rotates, the hand will track behind the motion of the arm and appear detached from its wrist. This can be cancelled out by using the middle port of the Dynamic-Spring node. This port is used to cancel out the spring effect of another motion before applying the spring to its element. Hence, in this example, you would circumvent this issue by connecting the forearm peg to the middle port of the dynamic spring.

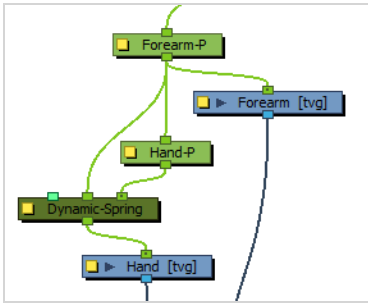

**NOTE**

The same effect can be achieved using the Ignore Parents and Parent Name properties of the Dynamic Spring node.

At last, the leftmost port of the Dynamic-Spring node can be connected to a Constraint Switch, the Active parameter of which is multiplied against the Active parameter of the Dynamic Spring node to reduce or disable its effect.

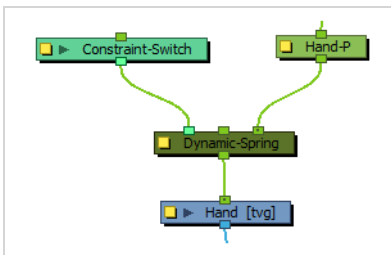



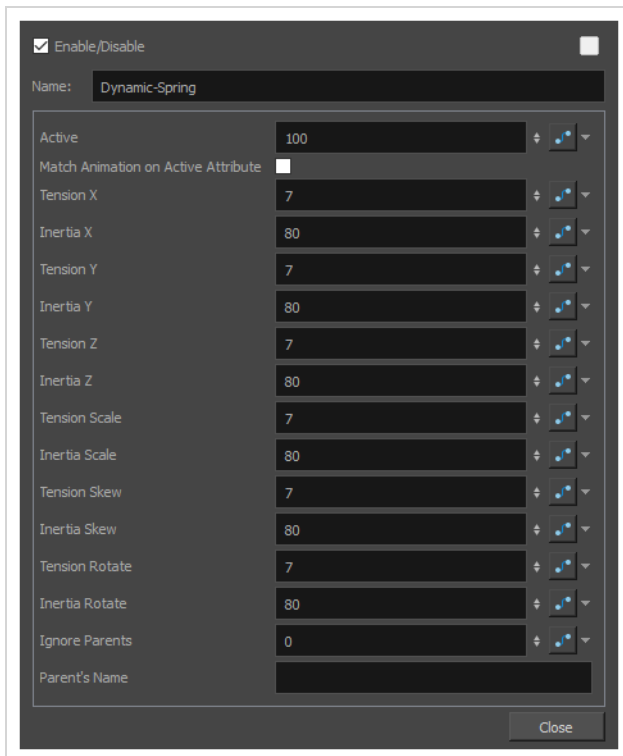

# Properties

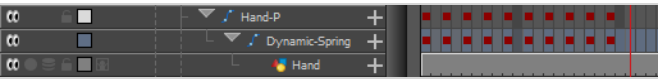

Parameter	Description
Active	<p>The percentage of influence the Dynamic Spring node has on the transformation.</p> <p>If a Transformation Switch node is connected to the Dynamic Spring node, the Active parameters of the Transformation Switch and the Dynamic Spring nodes will be multiplied together.</p>
Match Animation on Active Attribute	<p>When enabled, the Dynamic Spring node will only perform a movement when its own attributes have a keyframe or an interpolation. This option can be useful if, for example, the animation must be done on twos or threes. You can enable this option, then add stop-motion keyframes on the Dynamic Spring node in the Timeline view on every frame where you want it to update the child element's position. The latter will remain static between keyframes.</p> <p>In the example below, the Match Animation on Active Attribute option has been enabled, and stop-motion keyframes have been added to the Dynamic Spring node to match the timing of the hand's animation. The frames are a light shade of blue where the Dynamic Spring node applies a movement to the child element, and are grey where it does not.</p> 

	<div data-bbox="565 191 1430 485" style="border: 1px solid #c8e6c9; padding: 10px;">  <p><b>NOTE</b></p> <p>The Dynamic Spring node will animate on ones after its last keyframe. Hence, to animate on twos, you must add keyframes on the Dynamic Spring node until it completely stops moving the element. The animation of the Dynamic Spring node often stops several frames later than the animation of the parent peg, because it adds an extra overshoot a movement.</p> </div>																																				
<p>Tension (X/Y/Z/Scale/Skew/Rotate)</p>	<p>The tension applied to each parameter of the animation. The higher it is, the more the child element will appear to "snap" to the position of the original movement.</p> <div data-bbox="565 642 1430 1373" style="border: 1px solid #bbdefb; padding: 10px;">  <p><b>TIP</b></p> <p>You can set the Tension for all parameters to the same value by creating a function for the Tension X parameter, then linking every other Tension parameter to that function. If you create a single keyframe in this function, the parameter will remain constant throughout the scene.</p> <div data-bbox="673 863 1265 1331" style="border: 1px solid #ccc; padding: 5px; background-color: #f5f5f5;"> <table border="0"> <tr><td>Tension X</td><td>+ Dynamic-Spring: Tension_X: 100</td><td></td></tr> <tr><td>Inertia X</td><td>+ Dynamic-Spring: Inertia_X: 20</td><td></td></tr> <tr><td>Tension Y</td><td>+ Dynamic-Spring: Tension_X: 100</td><td></td></tr> <tr><td>Inertia Y</td><td>+ Dynamic-Spring: Inertia_X: 20</td><td></td></tr> <tr><td>Tension Z</td><td>+ Dynamic-Spring: Tension_X: 100</td><td></td></tr> <tr><td>Inertia Z</td><td>+ Dynamic-Spring: Inertia_X: 20</td><td></td></tr> <tr><td>Tension Scale</td><td>+ Dynamic-Spring: Tension_X: 100</td><td></td></tr> <tr><td>Inertia Scale</td><td>+ Dynamic-Spring: Inertia_X: 20</td><td></td></tr> <tr><td>Tension Skew</td><td>+ Dynamic-Spring: Tension_X: 100</td><td></td></tr> <tr><td>Inertia Skew</td><td>+ Dynamic-Spring: Inertia_X: 20</td><td></td></tr> <tr><td>Tension Rotate</td><td>+ Dynamic-Spring: Tension_X: 100</td><td></td></tr> <tr><td>Inertia Rotate</td><td>+ Dynamic-Spring: Inertia_X: 20</td><td></td></tr> </table> </div> </div>	Tension X	+ Dynamic-Spring: Tension_X: 100		Inertia X	+ Dynamic-Spring: Inertia_X: 20		Tension Y	+ Dynamic-Spring: Tension_X: 100		Inertia Y	+ Dynamic-Spring: Inertia_X: 20		Tension Z	+ Dynamic-Spring: Tension_X: 100		Inertia Z	+ Dynamic-Spring: Inertia_X: 20		Tension Scale	+ Dynamic-Spring: Tension_X: 100		Inertia Scale	+ Dynamic-Spring: Inertia_X: 20		Tension Skew	+ Dynamic-Spring: Tension_X: 100		Inertia Skew	+ Dynamic-Spring: Inertia_X: 20		Tension Rotate	+ Dynamic-Spring: Tension_X: 100		Inertia Rotate	+ Dynamic-Spring: Inertia_X: 20	
Tension X	+ Dynamic-Spring: Tension_X: 100																																				
Inertia X	+ Dynamic-Spring: Inertia_X: 20																																				
Tension Y	+ Dynamic-Spring: Tension_X: 100																																				
Inertia Y	+ Dynamic-Spring: Inertia_X: 20																																				
Tension Z	+ Dynamic-Spring: Tension_X: 100																																				
Inertia Z	+ Dynamic-Spring: Inertia_X: 20																																				
Tension Scale	+ Dynamic-Spring: Tension_X: 100																																				
Inertia Scale	+ Dynamic-Spring: Inertia_X: 20																																				
Tension Skew	+ Dynamic-Spring: Tension_X: 100																																				
Inertia Skew	+ Dynamic-Spring: Inertia_X: 20																																				
Tension Rotate	+ Dynamic-Spring: Tension_X: 100																																				
Inertia Rotate	+ Dynamic-Spring: Inertia_X: 20																																				
<p>Inertia (X/Y/Z/Scale/Skew/Rotate)</p>	<p>The inertia applied to each parameter of the animation. The higher it is, the more the child element will appear to be weighted against the spring effect.</p>																																				

	<div data-bbox="589 212 651 281" style="float: left; margin-right: 10px;"></div> <p><b>TIP</b></p> <p>You can set the Inertia for all parameters to the same value by creating a function for the Inertia X parameter, then linking every other Inertia parameter to that function. If you create a single keyframe in this function, the parameter will remain constant throughout the scene.</p> <div data-bbox="672 405 1265 877" style="border: 1px solid #ccc; padding: 5px; background-color: #f0f0f0;"> <table border="1"> <tr><td>Tension X</td><td>+ Dynamic-Spring: Tension_X: 100</td><td></td></tr> <tr><td>Inertia X</td><td>+ Dynamic-Spring: Inertia_X: 20</td><td></td></tr> <tr><td>Tension Y</td><td>+ Dynamic-Spring: Tension_X: 100</td><td></td></tr> <tr><td>Inertia Y</td><td>+ Dynamic-Spring: Inertia_X: 20</td><td></td></tr> <tr><td>Tension Z</td><td>+ Dynamic-Spring: Tension_X: 100</td><td></td></tr> <tr><td>Inertia Z</td><td>+ Dynamic-Spring: Inertia_X: 20</td><td></td></tr> <tr><td>Tension Scale</td><td>+ Dynamic-Spring: Tension_X: 100</td><td></td></tr> <tr><td>Inertia Scale</td><td>+ Dynamic-Spring: Inertia_X: 20</td><td></td></tr> <tr><td>Tension Skew</td><td>+ Dynamic-Spring: Tension_X: 100</td><td></td></tr> <tr><td>Inertia Skew</td><td>+ Dynamic-Spring: Inertia_X: 20</td><td></td></tr> <tr><td>Tension Rotate</td><td>+ Dynamic-Spring: Tension_X: 100</td><td></td></tr> <tr><td>Inertia Rotate</td><td>+ Dynamic-Spring: Inertia_X: 20</td><td></td></tr> </table> </div>	Tension X	+ Dynamic-Spring: Tension_X: 100		Inertia X	+ Dynamic-Spring: Inertia_X: 20		Tension Y	+ Dynamic-Spring: Tension_X: 100		Inertia Y	+ Dynamic-Spring: Inertia_X: 20		Tension Z	+ Dynamic-Spring: Tension_X: 100		Inertia Z	+ Dynamic-Spring: Inertia_X: 20		Tension Scale	+ Dynamic-Spring: Tension_X: 100		Inertia Scale	+ Dynamic-Spring: Inertia_X: 20		Tension Skew	+ Dynamic-Spring: Tension_X: 100		Inertia Skew	+ Dynamic-Spring: Inertia_X: 20		Tension Rotate	+ Dynamic-Spring: Tension_X: 100		Inertia Rotate	+ Dynamic-Spring: Inertia_X: 20	
Tension X	+ Dynamic-Spring: Tension_X: 100																																				
Inertia X	+ Dynamic-Spring: Inertia_X: 20																																				
Tension Y	+ Dynamic-Spring: Tension_X: 100																																				
Inertia Y	+ Dynamic-Spring: Inertia_X: 20																																				
Tension Z	+ Dynamic-Spring: Tension_X: 100																																				
Inertia Z	+ Dynamic-Spring: Inertia_X: 20																																				
Tension Scale	+ Dynamic-Spring: Tension_X: 100																																				
Inertia Scale	+ Dynamic-Spring: Inertia_X: 20																																				
Tension Skew	+ Dynamic-Spring: Tension_X: 100																																				
Inertia Skew	+ Dynamic-Spring: Inertia_X: 20																																				
Tension Rotate	+ Dynamic-Spring: Tension_X: 100																																				
Inertia Rotate	+ Dynamic-Spring: Inertia_X: 20																																				
Ignore Parents	<p>If this property is set to any value but 0, the Dynamic Spring will go up its own hierarchy up to the value of this property, and consider the node at this level to be the "Ignored parent". The transformations applied by this parent and all its parents will not be taken in account for the spring effect.</p> <div data-bbox="589 1171 651 1241" style="float: left; margin-right: 10px;"></div> <p><b>NOTE</b></p> <p>This has the same effect as connecting one of the node's parents to its middle port.</p>																																				
Parent's Name	<p>If the Ignore Parents property is set to any value but 0, this property will also be used in determining which parent to consider as the "Ignored parent". When looking up the parent hierarchy of the Dynamic Spring node, if it finds any node with a matching name, it will consider it the "Ignored parent", and the transformations applied by this parent and all its parents will not be taken in account for the spring effect.</p> <div data-bbox="589 1640 651 1709" style="float: left; margin-right: 10px;"></div> <p><b>NOTE</b></p> <p>When both the Ignore Parents and the Parent's Name parameters are set, the "Ignored parent" will be the first node in the Dynamic Spring node's parent hierarchy that either matches the name of the Parent's Name parameter or the parent level in the Ignore Parents parameter.</p>																																				



**TIP**

This parameter only works if the Ignore Parents parameter is set to any value but 0. If you want the ignored parent to only be matched by its name and not its level in the hierarchy, you can set the Ignore Parents parameter to an improbably high number (ie: 100 or 1000), and set the Parent's Name to the name of the parent to ignore.

## Multi-Points Constraint Node

The Multi-Points Constraint translates, rotates and scales a drawing to make it follow the pivots of the pegs that are connected to it. Optionally, it can also apply a perspective transformation on the element.

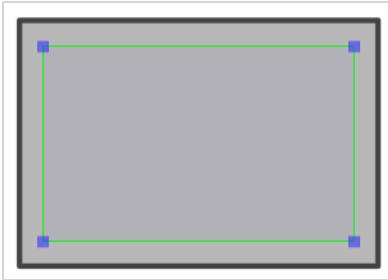



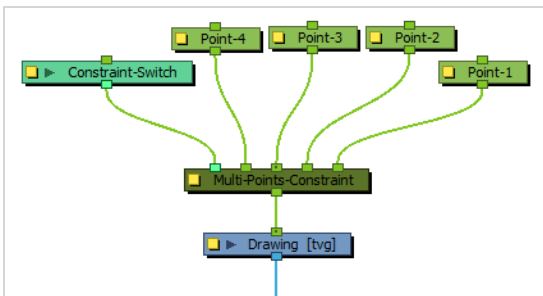

### Connection

The Multi-Points Constraint node must be connected to at least two Peg nodes, and can be connected to as many Peg nodes as needed. The pivot point of each peg will define the resting position of one of the points used to transform the drawing connected under it. When one of the pegs is moved, the Multi-Points Constraint will transform the drawing so that it follows the pivot point of that peg.



#### NOTE

The resting position of the points is based on the pivot point of the peg. The pivot point of a peg can be set by selecting the peg with the Translate , Rotate , Scale  or Skew  tool, then clicking and dragging the pivot in the Camera view, or by entering its coordinates in the layer properties of the peg.

Only the position of the pegs is considered by the Multi-Point Constraint. The position of the peg connected to the rightmost input port on the Z-axis will be applied to the element.

Optionally, the Three-Points Constraint node can be connected to a Constraint-Switch, which can be used to reduce the effect of the Three-Points Constraint node on the element it is connected by setting its Active parameter between 0 and 100.

## Controls

When the controls of the Multi-Points Constraint are displayed, the position of the points are displayed with blue squares linked by a green line.

These points are only a visual representation and cannot be manipulated.

### How to animate an element connected to a Multi-Points Constraint

1. In the Tools toolbar, select the Transform tool or press Shift + T.
2. Do one of the following:
  - Select one of the pegs the Three-Points Constraint is connected to, then move the peg by clicking and dragging the centre point in the Camera view.
  - In the layer properties of the element, disable the **Animate Using Animation Tools** option. Then, select the element, and click and drag the element near one of the points. The point that is the closest to the mouse cursor will be automatically selected and moved.

Optionally, the leftmost input port of a Multi-Points Constraint node can be connected to a Constraint-Switch, which can be used to reduce the effect of the Multi-Points Constraint node on the element it is connected by setting its Active parameter between 0 and 100.

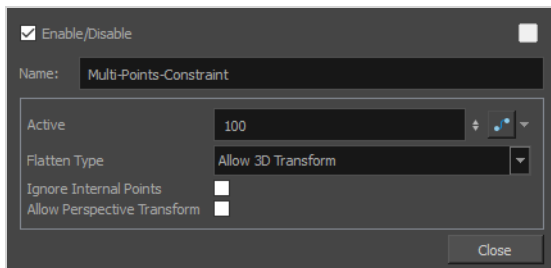

Parameter	Description
Active	<p>The percentage of influence the constraint has on its child element. If set to 100, the element will follow the points closely. If set to 0, the element will not be affected by the constraint.</p> <p>If a Transformation Switch node is connected to the Multi-Points Constraint node, the Active parameters of the Transformation Switch and the Multi-Points Constraint nodes will be multiplied together.</p>
Flatten Type	<p>This parameter defines what happens if one of the pegs defining the constraint points is moved on the Z-axis:</p> <ul style="list-style-type: none"> <li>• <b>Ignore 3D Transform:</b> The element will be constrained to the vertical and horizontal position of the pegs, and will ignore their position on the Z</li> </ul>

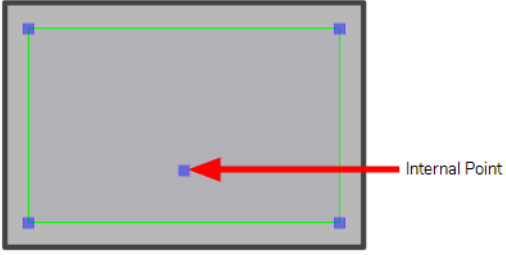
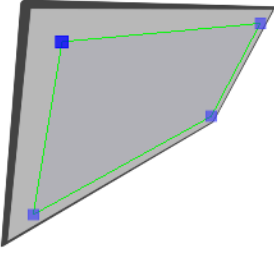
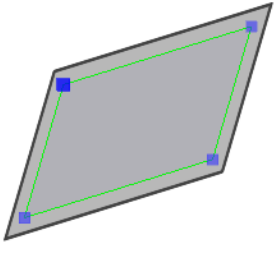
	<p>axis.</p> <ul style="list-style-type: none"> <li>• <b>Allow 3D Transform:</b> The element will be 3D-rotated to follow the position of the pegs in the 3D space.</li> <li>• <b>Project to Plane:</b> The element will be constrained in 2D, but will be made to follow the perceived position of the points from the camera's point of view. This means the 3D position of the points will be projected on a 2D plane that is parallel to the camera.</li> </ul> <div data-bbox="643 499 1430 730" style="border: 1px solid green; padding: 10px;"> <p> <b>NOTE</b></p> <p>This projection is based on the position of the primary point peg on the Z-axis. Hence, if the three pegs are on a different position on the Z-axis, there may be a perceived offset between the position of the non-primary points and their effect on the element.</p> </div>
Ignore Internal Points	<p>If enabled, internal points will be ignored by the Multi-Point Constraint.</p> <p>The envelope used to transform the element is always a convex shape. If any point connected to the Multi-Points Constraint is not an extreme point in its resting position, it is considered an internal point.</p> <div data-bbox="561 970 1133 1276" style="border: 1px solid gray; padding: 10px;">  </div>
Allow Perspective Transform	<p>If this option is enabled, the Multi-Point Constraint node will apply a perspective deformation to the drawing instead of scaling, rotating and skewing the drawing to try to make it track the points.</p> <div data-bbox="561 1474 1192 1822" style="border: 1px solid gray; padding: 10px;"> <div style="display: flex; justify-content: space-around;"> <div style="text-align: center;">  <p>Perspective Transformation</p> </div> <div style="text-align: center;">  <p>Regular Transformation</p> </div> </div> </div>

## Static Transformation Node

The Static Transformation node can be used to store, or "bake" the transformation from its immediate parent or from its entire hierarchy of parents, then be connected to a node to apply this transformation to it. The transformation the node stores cannot be animated nor reset. It can hence be used to act as a sort of "resting" position for an element, without having to apply the required transformations to the element or to its parent peg.

### Connection

To store transformations into a Static Transformation node, you must first connect a node containing these transformations to its input port.

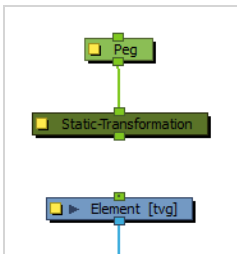

Once the transformations from the parent node have been baked into the Static Transformation node via its layer properties, you must disconnect the Static Transformation node from its parent, then connect it to a child so that this transformation is applied to it.

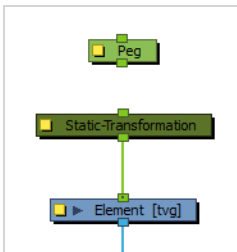

The Static-Transformation node will also dynamically apply its parent's transformations onto the child on top of its own static transformations, so it can be used as an intermediary in a rig.

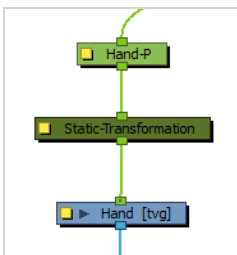



## Properties

The layer properties of the Static Transformation allow you to bake the transformations of its parent or parent hierarchy into its own attributes. Optionally, you can also fine-tune the stored transformation.

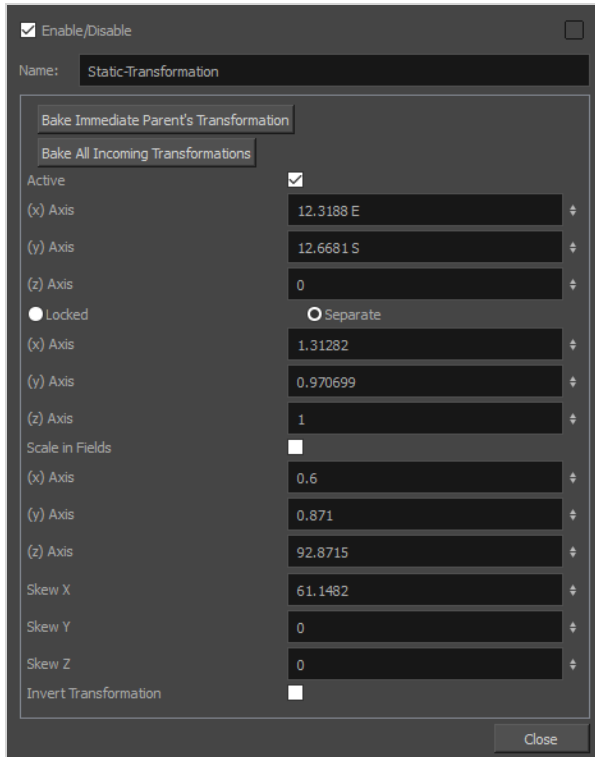

Parameter	Description
Bake Immediate Parent's Transformations	Copies the transformations applied by its parents at the current frame into its own attributes, making the node into a static template of the immediate parent peg's transformations.
Bake All Incoming Transformations	Bakes the transformations of the node's entire hierarchy of parents added up into its own attributes, making the node into a static template of all the transformations applied by its parents combined into a single set of coordinates.
Active	If unchecked, the node will not apply transformations to its child.
Static Transformations	The static transformations baked into the node: <ul style="list-style-type: none"> <li>• <b>(x) Axis:</b> The horizontal translation baked into the node.</li> <li>• <b>(y) Axis:</b> The vertical translation baked into the node.</li> <li>• <b>(z) Axis:</b> The translation on the Z-axis baked into the node.</li> </ul>

	<ul style="list-style-type: none"> <li>• <b>Locked:</b> Use a single value for the scale factor baked into the node, preserving the child's proportions.</li> <li>• <b>Separate:</b> Use a separate value for the horizontal, vertical and depth scale factors.</li> <li>• <b>(x) Axis:</b> The horizontal scale factor baked into the node.</li> <li>• <b>(y) Axis:</b> The vertical scale factor baked into the node.</li> <li>• <b>(z) Axis:</b> The depth scale factor baked into the node.</li> <li>• <b>Scale in Field:</b> When checked, the scale factor will be expressed in a proportion based on the amount of fields for the scene's camera.</li> </ul>
	<ul style="list-style-type: none"> <li>• <b>(x) Axis:</b> The rotation around the X-axis baked into the node.</li> <li>• <b>(y) Axis:</b> The rotation around the Y-axis baked into the node.</li> <li>• <b>(z) Axis:</b> The rotation around the Z-axis baked into the node.</li> </ul>
	<ul style="list-style-type: none"> <li>• <b>Skew X:</b> The skew angle on the X-axis baked into the node.</li> <li>• <b>Skew Y:</b> The skew angle on the Y-axis baked into the node.</li> <li>• <b>Skew Z:</b> The skew angle on the Z-axis baked into the node.</li> </ul>
<p>Invert Transformations</p>	<p>If checked, all transformations baked into the node will be applied negatively.</p>

## Three-Points Constraint Node

The Three-Points Constraint translates, rotates and scales a drawing to make it follow the pivots of the three pegs connected to it.

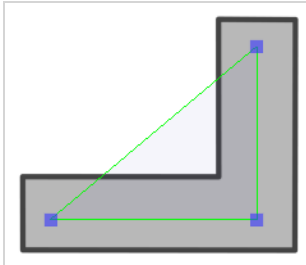



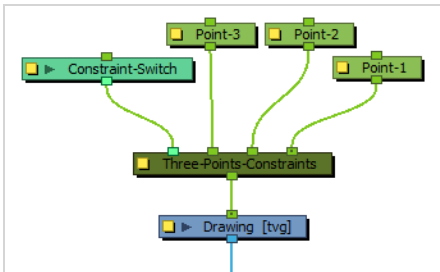

### Connection

The Three-Points Constraint node must be connected to three Peg nodes. The pivot point of each peg will define the resting position of one of the points used to transform the drawing connected under it. When one of the pegs is moved, the Three-Points Constraint will transform the drawing so that it follows the pivot point of that peg.



#### NOTE

The resting position of the points is based on the pivot point of the peg. The pivot point of a peg can be set by selecting the peg with the Translate , Rotate , Scale  or Skew  tool, then clicking and dragging the pivot in the Camera view, or by entering its coordinates in the layer properties of the peg.

Optionally, the leftmost input port of a Three-Points Constraint node can be connected to a Constraint-Switch, which can be used to reduce the effect of the Three-Points Constraint node on the element it is connected by setting its Active parameter between 0 and 100.

### Controls

When the controls of the Three-Points Constraint are displayed, the position of the three points are displayed with blue squares linked by a green line.

These points are only a visual representation and cannot be manipulated.

## How to animate an element connected to a Three-Points Constraint

1. In the Tools toolbar, select the Transform tool or press Shift + T.
2. Do one of the following:
  - Select one of the pegs the Three-Points Constraint is connected to, then move the peg by clicking and dragging the centre point in the Camera view.
  - In the layer properties of the element, disable the **Animate Using Animation Tools** option. Then, select the element, and click and drag the element near one of the points. The point that is the closest to the mouse cursor will be automatically selected and moved.

## Properties

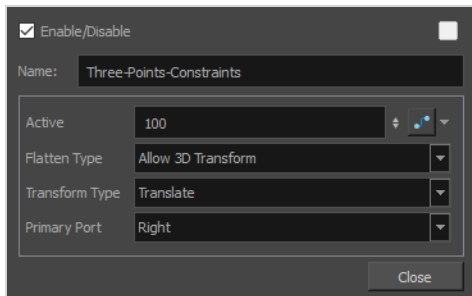

Parameter	Description
Active	<p>The percentage of influence the constraint has on its child element. If set to 100, the element will follow the three points closely. If set to 0, the element will not be affected by the constraint.</p> <p>If a Transformation Switch node is connected to the Three-Points Constraint node, the Active parameters of the Transformation Switch and the Three-Points Constraint nodes will be multiplied together.</p>
Flatten Type	<p>This parameter defines what happens if one of the pegs defining the constraint points is moved on the Z-axis:</p> <ul style="list-style-type: none"> <li>• <b>Ignore 3D Transform:</b> The element will be constrained to the vertical and horizontal position of the pegs, and will ignore their position on the Z axis.</li> <li>• <b>Allow 3D Transform:</b> The element will be 3D-rotated to follow the position of the pegs in the 3D space.</li> <li>• <b>Project to Plane:</b> The element will be constrained in 2D, but will be made to follow the perceived position of the points from the camera's point of view. This means the 3D position of the points will be projected on a 2D</li> </ul>

	<p>plane that is parallel to the camera.</p> <div data-bbox="643 247 1430 483" style="border: 1px solid green; padding: 10px;">  <b>NOTE</b>  This projection is based on the position of the primary point peg on the Z-axis. Hence, if the three pegs are on a different position on the Z-axis, there may be a perceived offset between the position of the non-primary points and their effect on the element. </div>
Transform Type	<p>By default, only the position of the points is used to transform the element. Since those points are defined by pegs, these pegs can also be subjected to scale, angle and skew transformations that would be normally ignored by the Three-Points Constraint node. This parameter can be used to apply the other transformations done on the peg of the primary point on the element, rather than ignoring them.</p> <ul style="list-style-type: none"> <li>• <b>Translate:</b> Ignores the transformations done on the primary peg, only applies the transformations required for the element to track the three points.</li> <li>• <b>Transform:</b> Applies the transformations calculated by the Three-Points Constraint node to make the element to track the three points, then applies the scale, angle and skew values of the primary peg on top of them.</li> <li>• <b>Local Transform:</b> Applies the scale, angle and skew values of the primary peg on the element, then applies the transformations calculated by the Three-Points Constraint node for the element to track the three points.</li> </ul>
Primary Port	<p>Defines which one of the ports, and hence, which one of the pegs the node is connected to, is used to define the primary point.</p> <p>The primary point affects the other parameters in the following ways:</p> <ul style="list-style-type: none"> <li>• When the Flatten Type is set to <b>Ignore 3D Transform</b> or <b>Project to Plane</b>, the position of the element on the Z-axis will be the one of the primary point.</li> <li>• When the Flatten Type is set to <b>Project to Plane</b>, the position of the primary point on the Z-axis is used as the plane on which to project the 3D positions of the points.</li> <li>• If the Transform Type is set to <b>Transform</b> or <b>Local Transform</b>, the scale, angle and skew transformations of the primary peg will be applied to the element.</li> </ul>

## Transformation Gate Node

The Transformation Gate can be connected to several pegs, or any node that outputs a geometric transformation, and dynamically select which one of these nodes controls its child element. For example, it is possible to connect two pegs to the Transformation Gate, and have the first peg transform the child element of the Transformation Gate for the first half of the scene, then the second peg transform the child element for the second half of the scene.

The Transformation Gate is also able to make an interpolation between two of the input transformations, and apply this combined transformation to its child.

### Connection

The Transformation-Gate can be connected to as many nodes that output as transformation, such as Pegs, Quadmaps or other Constraint nodes, as needed.

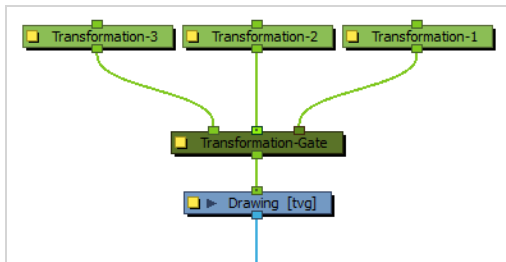

In the Node view, the colour of the input ports indicate which ports are active. The lightest input port is the target gate, which is the gate from which the transformation applied to the child element is sourced. The darkest input port is the default gate. The other ports are ignored.

If the Active parameter of the node is set to any value between 0 and 100, the shade difference between the target gate and default gate will fade. This indicates that the transformations going through the target gate and default gate are combined to create the transformation applied to the child element.

Optionally, a Transformation-Gate node can also be connected to a Constraint-Switch node, which can be used to multiply the Active parameter of the Transformation-Gate and override its Target Gate parameter.

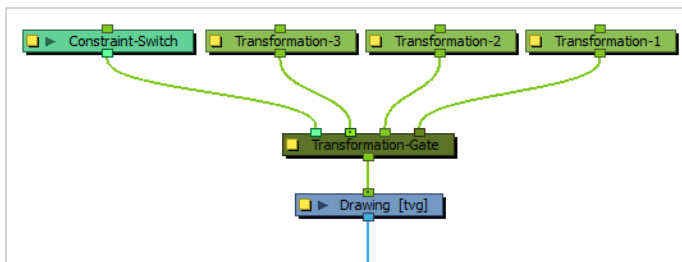

## Properties

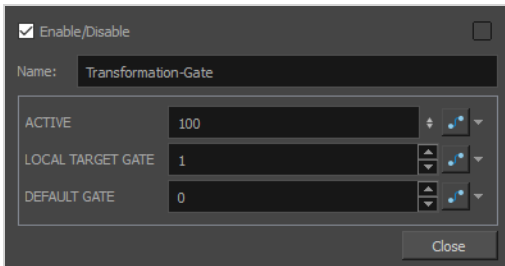

Parameter	Description
Active	<p>The percentage of the transformation sent to the target gate that is applied to the child element. If set to 100, only the transformation sent through the target gate will be applied. If set to 0, only the transformation sent through the default gate will be applied. If set to any value between 0 and 100, an interpolation of the transformations sent through the target gate and the default gate will be generated and applied to the child element.</p>
Local Target Gate	<p>The index of the input port referred to as the target gate.</p> <p>The input ports are numbered starting from 0. In the node view, they are ordered from right to left. Set this parameter to 0 to make the rightmost input port the target gate, to 1 to make the second rightmost port the target gate, etc.</p> <div style="border: 1px solid green; padding: 5px; margin-top: 10px;"> <p> <b>NOTE</b></p> <p>If the Transformation Gate is connected to a Constraint Switch, the Target Gate parameter of the Constraint Switch will override this value.</p> </div>
Default Gate	<p>The index of the input port referred to as the default gate.</p> <p>The input ports are numbered starting from 0. In the node view, they are ordered from right to left. Set this parameter to 0 to make the rightmost input port the target gate, to 1 to make the second rightmost port the target gate, etc.</p>

## Transformation Limit Node

The Transformation Limit node can be used as an intermediary between two nodes to limit the effect of the parent peg's transformations onto the child, by applying a ratio to the transformations applied to the parent before applying them to the child. This ratio can be set for each coordinate in the node's properties and can be animated.



### NOTE

This node is designed to limit 2D and 3D translations, but not 3D rotations or scaling.

## Connection

The Transformation Limit node must be connected to its parent peg by its right input port, and must be connected to the peg or element it will apply the transformation to via its output port. Transformations applied by the parent peg will be recalculated by the Transformation Limit node, then applied on its child.

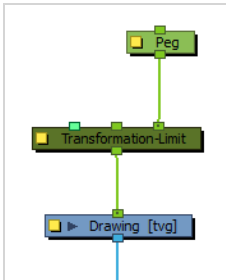

The transformations that are processed by the Transform Limit node are not the ones of its immediate parent, but rather, the ones of the entire hierarchy of parents it is connected to combined. If you need the Transformation-Limit node to only process the transformations of one or some of its parents and ignore the parents past a certain point in the hierarchy, simply connect the first parent the Transformation-Limit node should ignore to its middle input port.

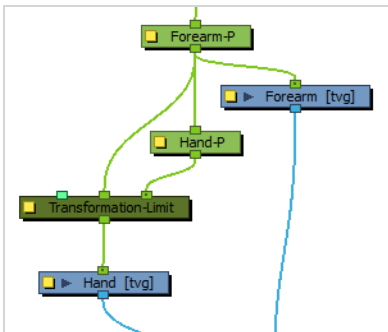

The effect of the Transformation Limit node on the transformation can be tempered by lowering its Active parameter. The Transformation Limit node can also be connected to a Constraint Switch node, the Active parameter of which will be multiplied with the Active parameter of the Transformation limit node, and hence can also be used to temper its effect on its child.



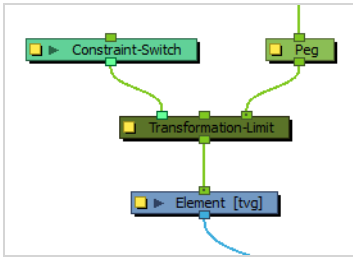

## Controls

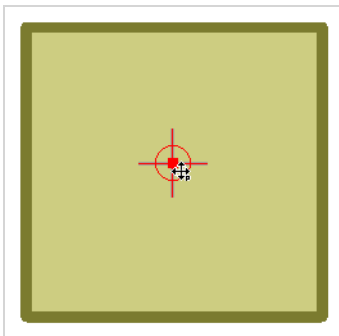

Because the Transformation Limit node can significantly influence the position of its child element relative to its peg pivot, the Transformation Limit has its own pivot point. The position of this pivot can be set in its layer properties, but can also be set visually by displaying its control in the Camera view and dragging it to the desired position using the Transform tool.

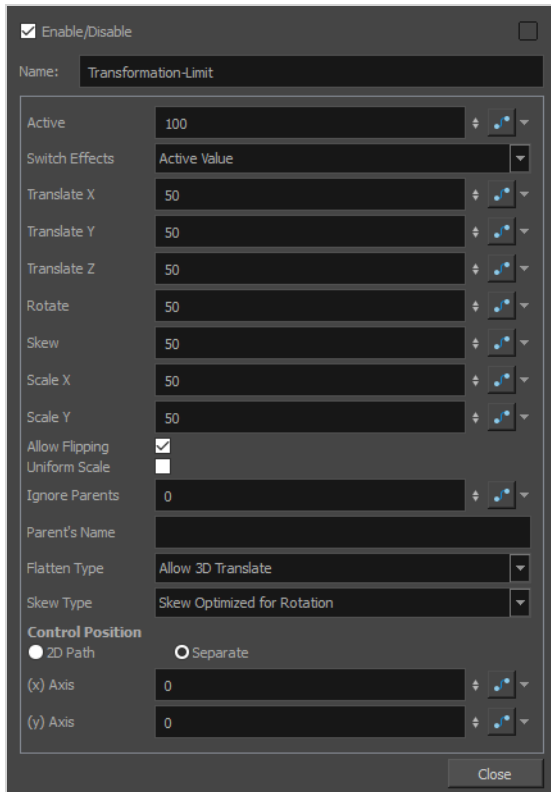

# Properties



Parameter	Description
Active	The percentage of influence the Transformation Limit node has on the transformation before it applies it to the child. For example, if its Translate X parameter is set to 50, and its Active parameter is set to 50, the effective Translate X limit will be 75.
Switch Effects	Defines which coordinate limits the Active parameter affects. If set to <b>Active value</b> , it will affect the limits for all coordinates. If set to <b>XYZ Translation, Scale, Rotation, Scale/Skew</b> or <b>Skew</b> , it will affect the limit on the corresponding coordinates. If the Transformation-Limit node is connected to a Constraint Switch, this parameter will also dictate the effect of the switch.
Translate X	The percentage of the parent's horizontal translation to apply to the child.
Translate Y	The percentage of the parent's vertical translation to apply to the child.
Translate Z	The percentage of the parent's translation on the Z axis to apply to the child.

Rotate	The percentage of the parent's rotation to apply to the child.
Skew	The percentage of the parent's skew to apply to the child.
Scale X	The percentage of the parent's horizontal scale to apply to the child.
Scale Y	The percentage of the parent's vertical scale to apply to the child.
Allow Flipping	If disabled, the child element will not be flipped when one of the parent's scale transformations is negative.
Uniform Scale	Averages the horizontal and vertical scale factors to preserve the proportions of the child.
Ignore Parents	<p>If this property is set to any value but 0, the Transformation Limit node will go up its own hierarchy up to the value of this property, and consider the node at this level to be the "Ignored parent". The transformations applied by this parent and all its parents will not be affected by the Transform Limit.</p> <div style="border: 1px solid green; padding: 10px; margin-top: 10px;">  <b>NOTE</b>  This has the same effect as connecting one of the node's parents to its middle port. </div>
Parent's Name	<p>If the Ignore Parents property is set to any value but 0, this property will also be used in determining which parent to consider as the "Ignored parent". When looking up the parent hierarchy of the Transformation Limit node, if it finds any node with a matching name, it will consider it the "Ignored parent", and the transformations applied by this parent and all its parents will not be taken in account for the spring effect.</p> <div style="border: 1px solid green; padding: 10px; margin-top: 10px;">  <b>NOTE</b>  When both the Ignore Parents and the Parent's Name parameters are set, the "Ignored parent" will be the first node in the node's parent hierarchy that either matches the name of the Parent's Name parameter or the parent level in the Ignore Parents parameter. </div>

	<div style="border: 1px solid #add8e6; padding: 10px;">  <p><b>TIP</b></p> <p>This parameter only works if the Ignore Parents parameter is set to any value but 0. If you want the ignored parent to only be matched by its name and not its level in the hierarchy, you can set the Ignore Parents parameter to an improbably high number (ie: 100 or 1000), and set the Parent's Name to the name of the parent to ignore.</p> </div>
<p>Flatten Type</p>	<p>Affects how the translations are applied in the 3D space.</p> <ul style="list-style-type: none"> <li>• <b>Allow 3D Translate:</b> The parent's translation on the Z-axis will be affected by the Translate Z parameter, then applied to the Z axis position of the child, as with other parameters. This is the default behavior.</li> <li>• <b>Project 3D Translate to Plane:</b> The parent's translation on the Z-axis will be projected on the X and Y translations based on the position of the camera. This gives the illusion that the apparent position of the element from the point of view of the camera changes realistically depending on its position on the Z-axis, but without actually moving it on the Z-axis and hence without changing its order relative to other elements.</li> <li>• <b>Project and Scale 3D Translate to Plane:</b> The parent's translation on the Z-axis will be projected on the X and Y translations and on the X and Y scales, based on the position of the camera. This gives the illusion that the apparent position and size of the element from the point of view of the camera changes realistically depending on its position on the Z-axis, but without actually moving it on the Z-axis and hence without changing its order relative to other elements.</li> </ul>
<p>Skew Type</p>	<p>Affects how Skew of the parent is applied to the child.</p> <ul style="list-style-type: none"> <li>• <b>Skew Applied as Rotation:</b> Adds the value of the skew calculated by the Transformation Limit node to the rotation applied to the child.</li> <li>• <b>Skew Ignored by Rotation:</b> Processes the skew and rotation coordinates separately. Because the effect of these parameters is intertwined, this may yield unexpected results, but which may be preferable when transformations are fine tuned and manually calculated.</li> <li>• <b>Skew Optimized for Rotation:</b> Processes the skew and rotation coordinates together before applying them to the child element. The result will look more like what the human eye would guess the element would look like with a limit applied to its rotation and skew.</li> </ul>
<p>Control Position</p>	<p>The following parameters affect the pivot point used to apply the transformations calculated by the Transformation Limit node.</p> <p><b>2D Path:</b> The horizontal and vertical position of the pivot point are stored in a single function of control points. This makes the trajectory curvilinear and the</p>

	<p>pace of the movement set to a velocity function.</p> <p><b>Separate:</b> The horizontal and vertical position of the pivot point are stored in separate functions of coordinates. This makes a trajectory where each point is joined by a straight line and each coordinate can have its own curve.</p>
	<p><b>Path:</b> If the 2D Path option is selected, this allows you to create or link to a 2D Path function.</p> <p><b>(x) Axis:</b> The position of the pivot point on the horizontal axis.</p> <p><b>(y) Axis:</b> The position of the pivot point on the vertical axis.</p>

## Two-Points Constraint Node

The Two-Points Constraint translates, rotates and scales a drawing to make it follow the pivots of the two pegs connected to it. Hence, it allows an animator to position an element (for example, a limb) by moving the two points at its extremities (the articulations).

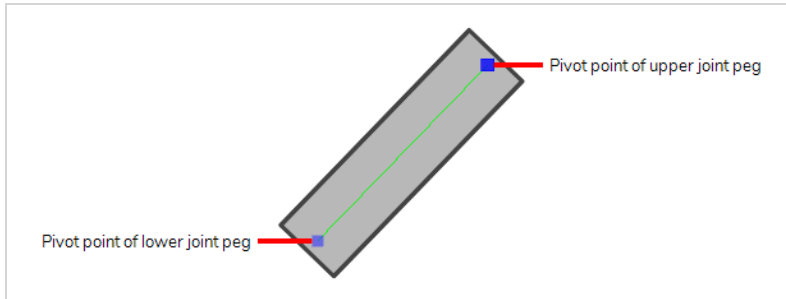



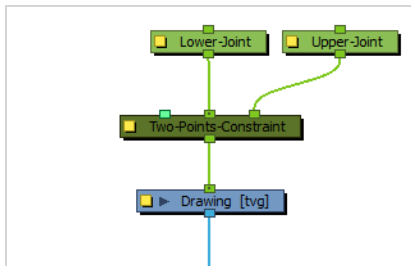

Contrary to Three-Points Constraint and Multi-Points Constraint nodes, Two-Points Constraint can automatically stretch and squash the element they are connected to depending on the distance between the two points. This effect can be fine-tuned in the layer properties of the Two-Point Constraint node.

## Connection

The Two-Points Constraint node must be connected to two Peg nodes. The pivot point of each peg will define the resting position of one of the points used to transform the drawing connected under it. When one of the pegs is moved, the Two-Points Constraint will transform the drawing so that it follows the pivot point of that peg.



### NOTE

The resting position of the points is based on the pivot point of the peg. The pivot point of a peg can be set by selecting the peg with the Translate , Rotate , Scale  or Skew  tool, then clicking and dragging the pivot in the Camera view, or by entering its coordinates in the layer properties of the peg.

It is possible to rig multiple Two-Points Constraint nodes together in order to connect adjacent parts of a character rig by their articulation. For example, the upper and lower part of an arm or a leg could be rigged together in the following fashion, to allow the animator to manipulate them by their articulations:

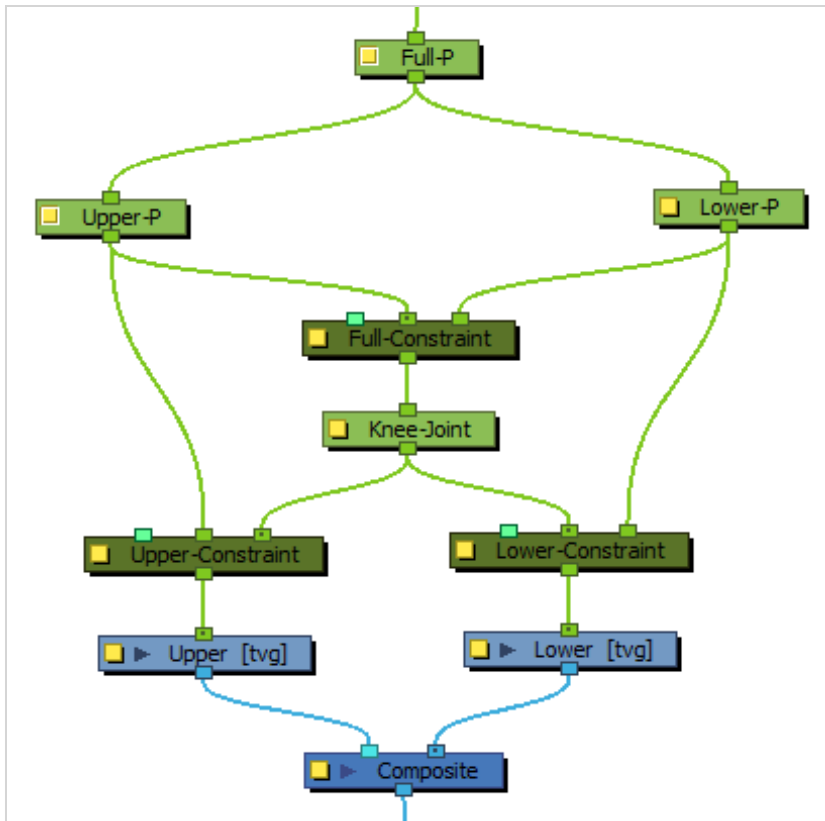

Optionally, the leftmost input port of a Two-Points Constraint node can be connected to a Constraint-Switch, which can be used to reduce the effect of the Two-Points Constraint node on the element it is connected by setting its Active parameter between 0 and 100.

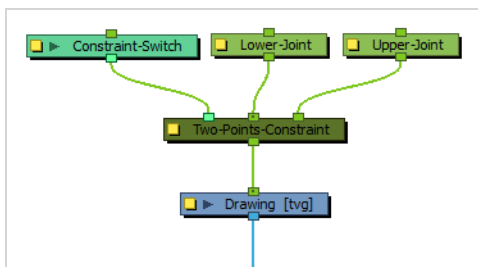

#### TIP

It is recommended to disable the **Animate Using Animation Tools** property of the element the Two-Points Constraint node is connected to. This will allow the animator to animate the Two-Points Constraint by selecting the element, then clicking and dragging near one of the two points using the Transform tool. The Two-Points Constraint will automatically select the closest point to the mouse cursor and move it.

## Controls

When the controls of the Two-Points Constraint are displayed, the position of the two points are displayed with blue squares linked by a green line.

These points are only a visual representation and cannot be manipulated.

### How to animate an element connected to a Two-Points Constraint

1. In the Tools toolbar, select the Transform tool or press Shift + T.
2. Do one of the following:
  - Select one of the pegs the Two-Points Constraint is connected to, then move the peg by clicking and dragging the centre point in the Camera view.
  - In the layer properties of the element, disable the **Animate Using Animation Tools** option. Then, select the element, and click and drag the element near one of the two points. The point that is the closest to the mouse cursor will be automatically selected and moved.

## Properties

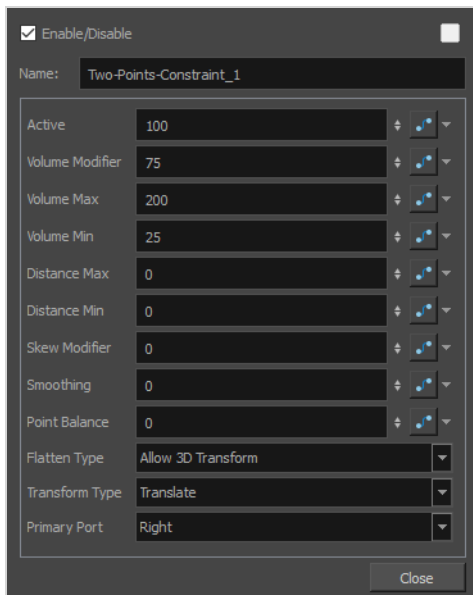

Parameter	Description
Active	<p>The percentage of influence the constraint has on its child element. If set to 100, the element will follow the two points closely. If set to 0, the element will not be affected by the constraint.</p> <p>If a Transformation Switch node is connected to the Two-Points Constraint node,</p>



	<p>the Active parameters of the Transformation Switch and the Two-Points Constraint nodes will be multiplied together.</p>
Volume Modifier	<p>Defines how much the Two-Points Constraint node should preserve the width of the child element when the distance between the points causes it to stretch or squash.</p> <p>If set to 100, the width of the element will increase when squashed and decreased when stretched based on the Volume Max and Volume Min parameters. If set to 0, the element will always have the same width regardless of how much it is stretched or squashed. The value can be set to a number between 0 and 100 to reduce the effect of the volume modifications, to a number above 100 to increase it, or to a negative number to reverse the volume modification logic.</p>
Volume Max	<p>The maximum width of the element when squashed.</p> <p>This value represents a percentage of the element's original width. If set to 0, no minimum width will be applied.</p>
Volume Min	<p>The minimum width of the element when stretched.</p> <p>The value represents a percentage of the element's original width. If set to 0, no maximum width will be applied.</p>
Distance Min	<p>The minimum distance between the two points. If the points are brought closer together than their minimum distance, the element will stop transforming.</p> <p>This value represents a percentage of the distance between the two points when in their respective resting positions.</p>
Distance Max	<p>The maximum distance between the two points. If the points are brought farther from each other than their maximum distance, the element will stop transforming.</p> <p>This value represents a percentage of the distance between the two points when in their respective resting positions.</p>
Skew Modifier	<p>When set to 0, the element is rotated to follow the two points. If set to 100, the element will skew to follow the two points. If set between 0 and 100, the element will be transform with a combination of rotation and skewing to follow the two points.</p>
Smoothing	<p>When the two points are moved away from each other and reach their maximum distance, this value will adds an extra buffer of distance that the two points can reach before the element stops stretching. In this buffer, the way the element stretches is tapered, making it stop stretching smoothly instead of abruptly.</p> <p>This value represents a percentage of the distance between the two points when</p>

	<p>in their respective resting positions.</p>
<p>Point Balance</p>	<p>This parameter comes in effect when the two points are being moved at a distance exceeding their maximum distance. If set to 0, the element will stop stretching and remain locked against the primary point. If set to 100, the element will stop stretching and remain locked against the second point. If set to a value between 0 and 100, the element will be moved between both points, at a distance from the primary point that is proportional to this setting.</p>
<p>Flatten Type</p>	<p>This parameter defines what happens if one of the pegs defining the constraint points is moved on the Z-axis:</p> <ul style="list-style-type: none"> <li>• <b>Ignore 3D Transform:</b> The element will be constrained to the vertical and horizontal position of the pegs, and will ignore their position on the Z axis.</li> <li>• <b>Allow 3D Transform:</b> The element will be 3D-rotated to follow the position of the pegs in the 3D space.</li> <li>• <b>Project to Plane:</b> The element will be constrained in 2D, but will be made to follow the perceived position of the points from the camera's point of view. This means the 3D position of the points will be projected on a 2D plane that is parallel to the camera.</li> </ul> <div data-bbox="643 1024 1429 1255" style="border: 1px solid #c8e6c9; padding: 10px; margin-top: 10px;"> <p> <b>NOTE</b>          This projection is based on the position of the primary point peg on the Z-axis. Hence, if the two pegs are on a different position on the Z-axis, there may be a perceived offset between the secondary point and its effect on the element.</p> </div>
<p>Transform Type</p>	<p>By default, only the position of the points is used to transform the element. Since those points are defined by pegs, these pegs can also be subjected to scale, angle and skew transformations that would be normally ignored by the Two-Points Constraint node. This parameter can be used to apply the other transformations done on the peg of the primary point on the element, rather than ignoring them.</p> <ul style="list-style-type: none"> <li>• <b>Translate:</b> Ignores the transformations done on the primary peg, only applies the transformations required for the element to track the two points.</li> <li>• <b>Transform:</b> Applies the transformations calculated by the Two-Points Constraint node to make the element to track the two points, then applies the scale, angle and skew values of the primary peg on top of them.</li> <li>• <b>Local Transform:</b> Applies the scale, angle and skew values of the primary peg on the element, then applies the transformations calculated by the Two-Points Constraint node for the element to track the two points.</li> </ul>

Primary Port	<p>Defines which one of the ports, and hence, which one of the pegs the node is connected to, is used to define the primary point, leaving the other port for the secondary point.</p> <p>The primary point affects the other parameters in several ways:</p> <ul style="list-style-type: none"><li>• The Point Balance parameter ranges from 0 to 100, with 0 making the element balance towards the primary point and 100 making it balance towards the secondary point.</li><li>• When the Flatten Type is set to <b>Ignore 3D Transform</b> or <b>Project to Plane</b>, the position of the element on the Z-axis will be the one of the primary point.</li><li>• When the Flatten Type is set to <b>Project to Plane</b>, the position of the primary point on the Z-axis is used as the plane on which to project the 3D positions of the points.</li><li>• If the Transform Type is set to <b>Transform</b> or <b>Local Transform</b>, the scale, angle and skew transformations of the primary peg will be applied to the element.</li></ul>
--------------	--

## Deformation Nodes

The Deformation nodes category includes all the nodes which are used to make deformers. In Harmony, deformers are made of chains of deformation nodes connected in a hierarchy. By default, deformation chains made with the Rigging tool are created in groups by default to avoid cluttering the Node and Timeline views. Each deformation node represents a point in a deformation chain.

This category also includes nodes that are made to deform drawings without being part of a deformation chain, such as the Mesh Warp node.

<b>Articulation Node</b> .....	<b>438</b>
<b>Auto Fold Node</b> .....	<b>441</b>
<b>Auto Muscle Node</b> .....	<b>443</b>
<b>Bone Nodes</b> .....	<b>447</b>
<b>Curve Node</b> .....	<b>451</b>
<b>Deformation Composite Node</b> .....	<b>455</b>
<b>Deformation Root Node</b> .....	<b>458</b>
<b>Deformation Scale Node</b> .....	<b>459</b>
<b>Deformation Switch Node</b> .....	<b>464</b>
<b>Deformation Uniform Scale Node</b> .....	<b>466</b>
<b>Deformation Wave Node</b> .....	<b>468</b>
<b>Fold Node</b> .....	<b>471</b>
<b>Game Bone Node</b> .....	<b>475</b>
<b>Glue Node</b> .....	<b>477</b>
<b>Kinematic Output Node</b> .....	<b>479</b>
<b>Mesh Warp Node</b> .....	<b>480</b>
<b>Offset Node</b> .....	<b>484</b>
<b>Refract</b> .....	<b>486</b>
<b>Stick Node</b> .....	<b>488</b>
<b>Turbulence Node</b> .....	<b>490</b>

## Articulation Node

The Articulation node is no longer used in the current release of Harmony. This node is still available for compatibility purposes with previous deformation rigs.

The Articulation node is used between two bones (legacy) to create a joint where the limb or element will rotate. The current Bone and Game Bone nodes include the articulation parameters.

## Properties

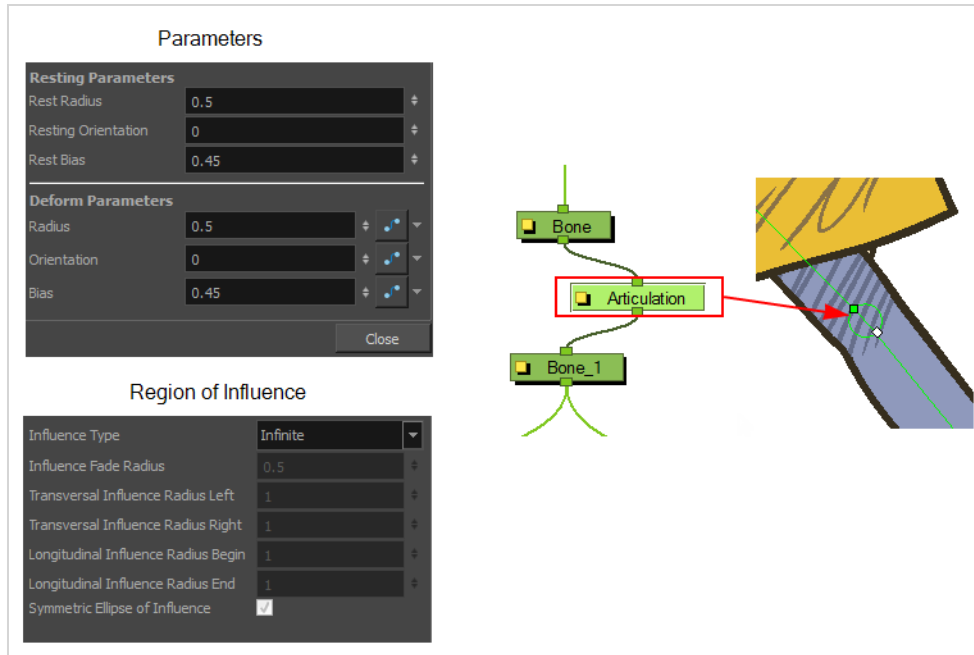

Parameter	Description
Enable/Disable	Allows you to enable or disable the node. When disabled, a node has no visible effect on the rendered image, nor on the preview in the Camera, Perspective, Side and Top views.
Colour Swatch	Sets the colour of the layer in the Timeline view and of the node in the Node view.
Name	Use this field to rename the node.
<b>Resting Parameters</b>	
Rest Radius	Lets you set the resting radius of the articulation (size of the circle).

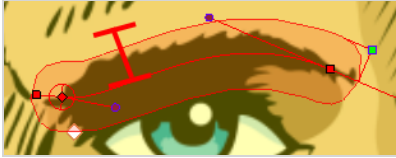
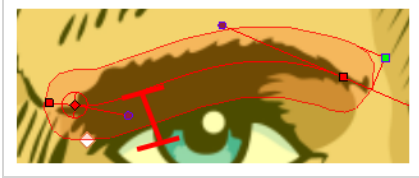
Resting Orientation	Lets you set the resting rotation angle value of the articulation.
Rest Bias	Lets you set the resting bias value of the articulation, which can also be seen as the steepness of the articulation. The smaller the bias value, the smoother the articulation angle, and the larger the bias value, the more angular the articulation is.
<b>Deformation Parameters</b>	
Radius	Lets you set the radius of the articulation (size of the circle). When animated, this value will be connected to a function.
Orientation	Lets you set the rotation angle value of the articulation. When animated, this value will be connected to a function.
Bias	Lets you set the bias value, which can also be seen as the steepness of the articulation. When animated, this value will be connected to a function.
<b>Region of Influence</b>	
Influence Fade Radius	This defines the size of the fade area around the actual region of influence's boundaries.
Transversal Influence Radius Left	<p>When the Symmetric Ellipse of Influence option is enabled, this field controls the Left and Right transversal radius values. When disabled, it controls the size of the left transversal radius. By default, this value is set to 2.</p> 
Transversal Influence Radius Right	<p>When the Symmetric Ellipse of Influence option is enabled, this field becomes inactive. The Left Transversal radius value is automatically applied to the Right Transversal. When the Symmetric Ellipse of Influence option is disabled, it controls the size of the Right Transversal radius. By default, this value is set to 2.</p> 

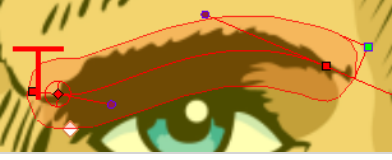
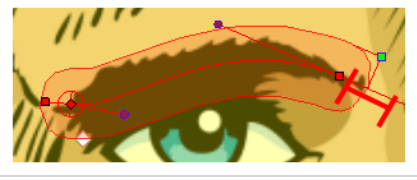
<p>Longitudinal Influence Radius Begin</p>	<p>When the Symmetric Ellipse of Influence option is enabled, this field becomes inactive. The End Longitudinal value is automatically applied to the Begin Longitudinal value. When the Symmetric Ellipse of Influence option is disabled, it controls the size of the Begin Longitudinal radius. By default, this value is set to 0.25.</p> 
<p>Longitudinal Influence Radius End</p>	<p>When the Symmetric Ellipse of Influence option is enabled, this field controls both the Begin and End Longitudinal radius values. When this option is disabled, it controls the size of the End Longitudinal radius. By default, this value is set to 0.25.</p> 
<p>Symmetric Ellipse Influence</p>	<p>Enabled by default. The shape of the ellipse will be symmetrical on both the transversal and longitudinal radii. In this case, use the Transversal Influence Radius Left field to set the transversal radius value and use the Longitudinal Influence Radius End field to set the longitudinal radius value. The two other fields will remain unused unless you disable the Symmetric Ellipse Influence option. In that case, you can set up different radius sizes for the four radii directions.</p>

## Auto Fold Node

The AutoFold node lets you automatically fix the folding area of a deformer, so no line overlap occurs. If your drawing pieces are separated on different layers, you will not need the AutoFold node. The AutoFold node is similar to the Fold node, but since it's automated, it is optimized to fit the most standard folding point with fewer controls to set up. You can also avoid this issue by separating your drawing onto two layers or separating your drawing in two pieces using the Cutter tool and repasting it in place in the same drawing.

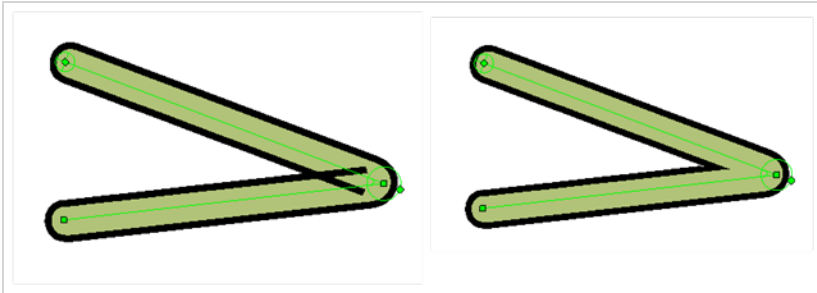

Connect the AutoFold node directly under the Deformation node which is causing the unwanted line effect, for example the forearm.

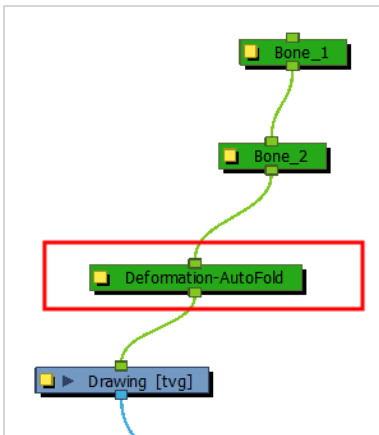

## Properties

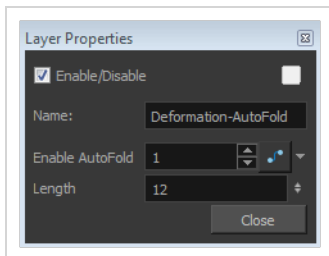

Parameter	Description
Enable/Disable	Allows you to enable or disable the node. When disabled, a node has no visible

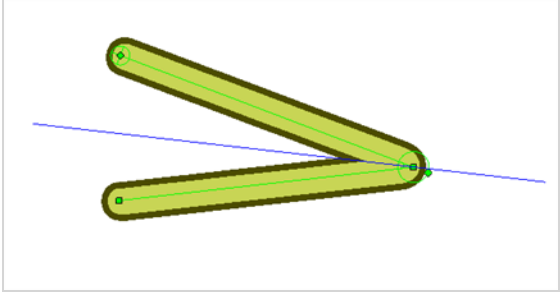

	effect on the rendered image, nor on the preview in the Camera, Perspective, Side and Top views.
Colour Swatch	Sets the colour of the layer in the Timeline view and of the node in the Node view.
Name	Name this field to rename the node.
Enable AutoFold	Type <b>1</b> to enable it or <b>0</b> to disable the effect. If you connect this option to a function, then you can enable or disable the effect at a specific point in your animation.
Length	Sets the length of the fold axis line.  A diagram showing two yellow, rounded rectangular bars joined at one end. A blue line, representing the fold axis, extends from the joint point to the right. The bars are slightly curved and have small green circles at their free ends.

## Auto Muscle Node

The Auto-Muscle node is used to simulate muscle movement. This will allow your characters to flex their muscles when they lift something or to create muscle tone when they move. When the Auto-Muscle node is connected to a Bone Deformer that is rotated, the drawing is automatically inflated to simulate muscle movement in the limb.



### NOTE

Connect the Auto-Muscle node above the drawing you want to add a muscle to and after the Bone chain.

## Properties

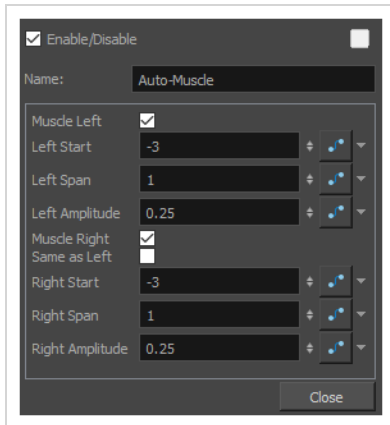

Parameter	Description
Enable/Disable	Allows you to enable or disable the node. When disabled, a node has no visible effect on the rendered image, nor on the preview in the Camera, Perspective, Side and Top views.
Colour Swatch	Sets the colour of the layer in the Timeline view and of the node in the Node view.
Name	Use this field to rename the node.
Muscle Left	This option is enabled by default. When enabled, the left side of the Bone Deformer will inflate as the articulation is rotated toward the direction of the Bone Deformer. Disable this option if you do not want the left side of the bone to inflate.

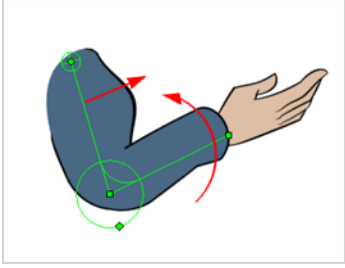
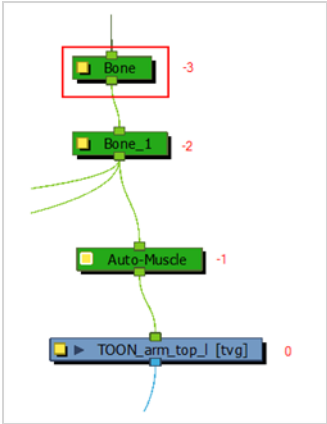
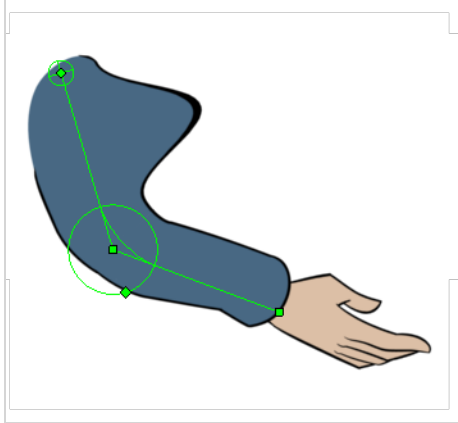
	
Left Start	<p>The default value of the starting position of the left muscle is set to -2. This means it will start at the deformer situated two steps before the position where the Auto-Muscle is connected. You can change the starting point by typing the number corresponding to the deformer node.</p> 
Left Span	<p>This parameter controls the length (muscle length) over which the effect node will be applied to the left side of the deformer. By default the setting is 1, representing the length of the deformer to which it is applied.</p>
Left Amplitude	<p>This parameter controls the physical size of the left muscle. Increase the value to make the muscle bigger, decrease the value to make it smaller.</p> 

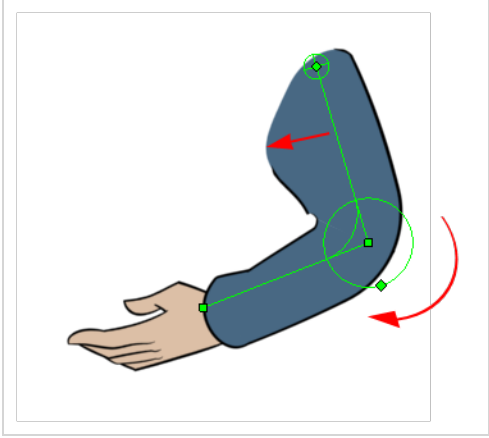
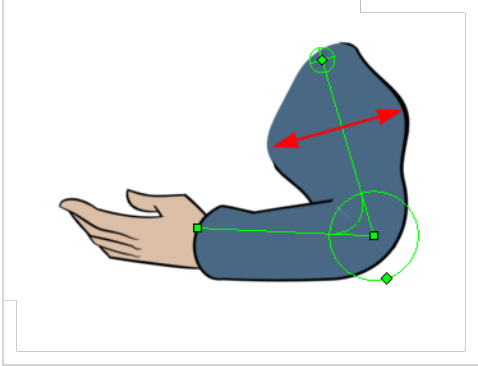
<p>Muscle Right</p>	<p>This option is enabled by default. When enabled, the right side of the Bone Deformer will inflate as the articulation is rotated toward the direction of the Bone Deformer. Disable this option if you don't want the right side of the bone to inflate.</p> 
<p>Same as Left</p>	<p>This option is enabled by default, allowing each side of the Bone Deformer to inflate to follow the rotation of the articulation. Enable this option to synchronize the right muscle with the left so both muscles inflate when the articulation is rotated to the left.</p> 
<p>Right Start</p>	<p>The default value of the starting position of the right muscle is set to -2. This means it will start at the deformer situated two steps before where the Auto-Muscle is connected, in this case, Bone. You can change the starting point by typing the number corresponding to the deformer node.</p>

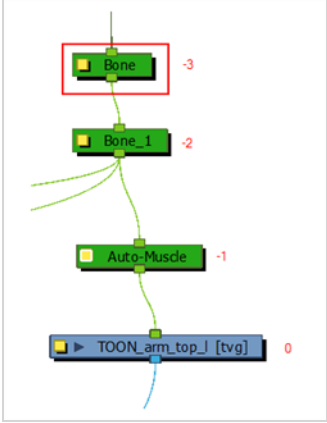
	
Right Span	<p>This parameter controls the length (muscle length) over which the effect node will be applied to the right side of the deformer. By default the setting is 1, representing the length of the deformer to which it is applied.</p>
Right Amplitude	<p>This parameter controls the physical size of the right muscle. Increase the value to make the muscle bigger, decrease the value to make it smaller.</p>

## Bone Nodes

The Bone node is one of the main nodes used to build a deformation rig. Each Bone node consists of a bone and an articulation. You can chain Bone nodes to create a skeleton chain for your character. The Rigging tool can be used to create and connect those nodes automatically.

## Properties

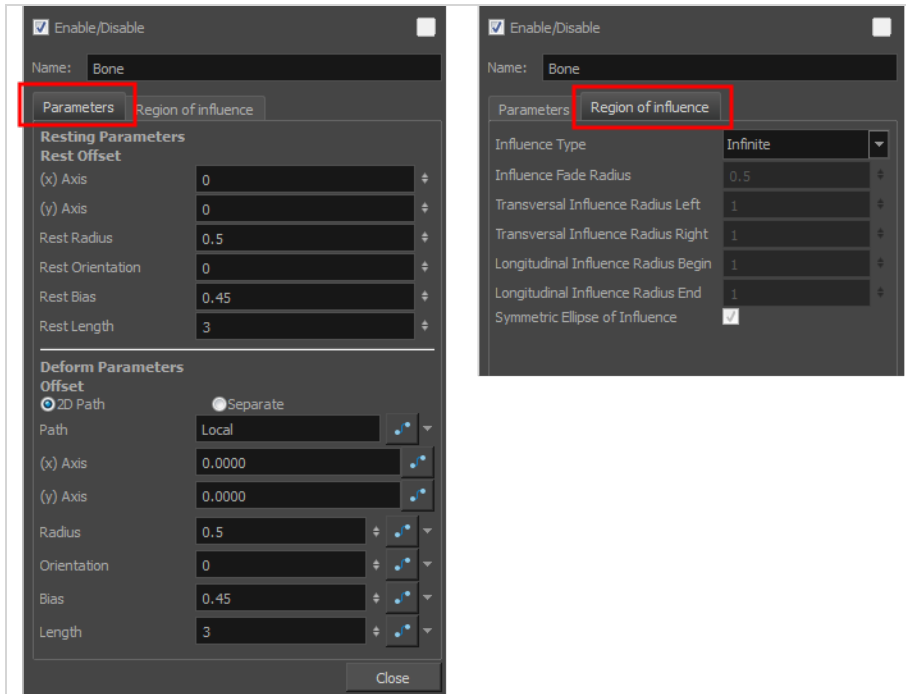

Parameter	Descriptions
Enable/Disable	Allows you to enable or disable the node. When disabled, a node has no visible effect on the rendered image, nor on the preview in the Camera, Perspective, Side and Top views.
Colour Swatch	Sets the colour of the layer in the Timeline view and of the node in the Node view.
Name	Allows you to enter a name for the node.
<b>Resting Parameters Rest Offset</b>	
(x) Axis	This is the bone x-axis (horizontal) coordinates for the resting position.
(y) Axis	This is the bone y-axis (vertical) coordinates for the resting position.

Rest Radius	This is the articulation's radius value (articulation size) for the resting position.
Rest Orientation	This is the bone's orientation angle for the resting position.
Rest Bias	This is the articulation's bias (roundness and smoothness) for the resting position.
Rest Length	This is the bone's length for the resting position.
<b>Deform Parameters Offset</b>	
2D Path	When this option is enabled, the X and Y-axis parameters are controlled by the same 2D path function.
Separate	When this option is enabled, the X and Y-axis parameters are individual one from another.
Path	When using a 2D Path, this field displays the name of the function.
(x) Axis	This is the bone X-axis (horizontal) coordinates for the animation position. This parameter can be linked to a function to be animated over time.
(y) Axis	This is the bone y-axis (vertical) coordinates for the animation position. This parameter can be linked to a function to be animated over time.
Radius	This is the articulation's radius value (articulation size) for the animation position. This parameter can be linked to a function to be animated over time.
Orientation	This is the bone's orientation angle for the animation position. This parameter can be linked to a function to be animated over time.
Bias	This is the articulation's bias (roundness and smoothness) for the animation position. This parameter can be linked to a function to be animated over time.
Length	This is the bone's length for the animation position. This parameter can be linked to a function to be animated over time.
<b>Region of Influence</b>	

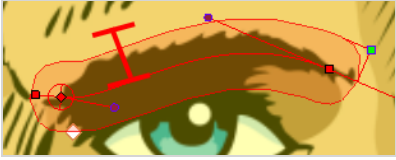
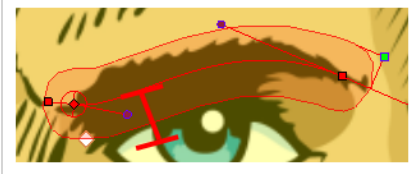
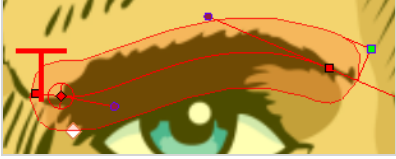
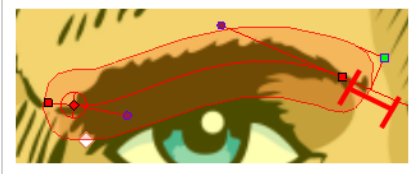
<p>Influence Fade Radius</p>	<p>This defines the size of the fade area around the actual region of influence's boundaries.</p>
<p>Transversal Influence Radius Left</p>	<p>When the Symmetric Ellipse of Influence option is enabled, this field controls the Left and Right transversal radius values. When disabled, it controls the size of the left transversal radius. By default, this value is set to 2.</p> 
<p>Transversal Influence Radius Right</p>	<p>When the Symmetric Ellipse of Influence option is enabled, this field becomes inactive. The Left Transversal radius value is automatically applied to the Right Transversal. When the Symmetric Ellipse of Influence option is disabled, it controls the size of the Right Transversal radius. By default, this value is set to 2.</p> 
<p>Longitudinal Influence Radius Begin</p>	<p>When the Symmetric Ellipse of Influence option is enabled, this field becomes inactive. The End Longitudinal value is automatically applied to the Begin Longitudinal value. When the Symmetric Ellipse of Influence option is disabled, it controls the size of the Begin Longitudinal radius. By default, this value is set to 0.25.</p> 
<p>Longitudinal Influence Radius End</p>	<p>When the Symmetric Ellipse of Influence option is enabled, this field controls both the Begin and End Longitudinal radius values. When this option is disabled, it controls the size of the End Longitudinal radius. By default, this value is set to 0.25.</p> 



**Symmetric Ellipse Influence**

Enabled by default. The shape of the ellipse will be symmetrical on both the transversal and longitudinal radii. In this case, use the Transversal Influence Radius Left field to set the transversal radius value and use the Longitudinal Influence Radius End field to set the longitudinal radius value. The two other fields will remain unused unless you disable the Symmetric Ellipse Influence option. In that case, you can set up different radius sizes for the four radii directions.

## Curve Node

The Curve node is one of the main nodes for building a deformation rig. You can chaining Curve nodes to create a Bezier handles skeleton. The Rigging tool can be used to create and connect the nodes automatically.

## Properties

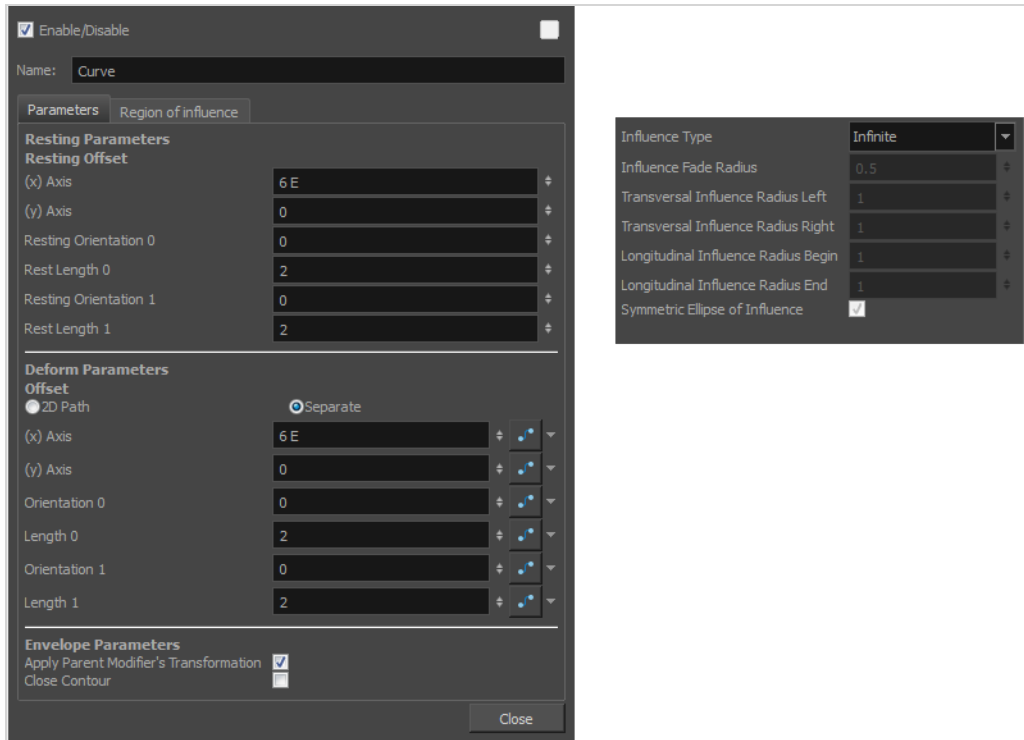

Parameter	Description
Enable/Disable	Allows you to enable or disable the node. When disabled, a node has no visible effect on the rendered image, nor on the preview in the Camera, Perspective, Side and Top views.
Colour Swatch	Sets the colour of the layer in the Timeline view and of the node in the Node view.
Name	Allows you to enter a name for the node.
<b>Resting Parameters Resting Offset</b>	
(x) Axis	This is the curve x-axis (horizontal) coordinates for the resting position.
(y) Axis	This is the curve y-axis (vertical) coordinates for the resting position.

Resting Orientation 0	This is the orientation for the first Bezier handle for the resting position.
Rest Length 0	This is the length for the first Bezier handle for the resting position.
Resting Orientation 1	This is the orientation for the second Bezier handle for the resting position.
Rest Length 1	This is the length for the second Bezier handle for the resting position.
<b>Deform Parameters Offset</b>	
2D Path	When this option is enabled, the X and Y-axis parameters are controlled by the same 2D path function.
Separate	When this option is enabled, the X and Y-axis parameters are individual one from another.
(x) Axis	This is the curve X-axis (horizontal) coordinates for the animation position.
(y) Axis	This is the curve Y-axis (vertical) coordinates for the animation position.
Orientation 0	This is the orientation for the first Bezier handle for the animation position.
Length 0	This is the length for the first Bezier handle for the animation position.
Orientation 1	This is the orientation for the second Bezier handle for the animation position.
Length 1	This is the length for the second Bezier handle for the animation position.
<b>Envelope Parameters</b>	
Apply Parent Modifier's Transformation	When this option is disabled, the deformation from the parent curves are no longer affecting the current curve. Interesting effects can be achieved when disabling this effect on the last child curve and rotating the Offset point. The curve tail end will remain pinned on the spot while the rest of the curves deforms.
Close Contour	When this option is enabled, the extrimity of the curve is snapped to the initial chain's Offset point. This creates an Envelope deformation. More than one curve can be linked to the Offset point.

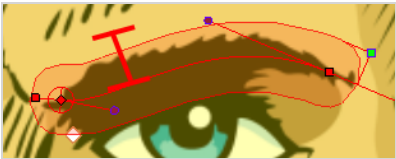
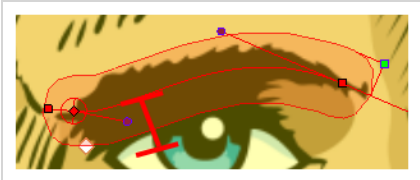
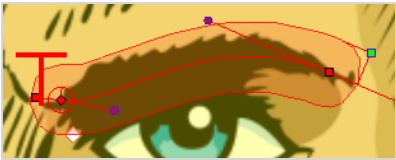
Region of Influence	
Influence Fade Radius	This defines the size of the fade area around the actual region of influence's boundaries.
Transversal Influence Radius Left	<p>When the Symmetric Ellipse of Influence option is enabled, this field controls the Left and Right transversal radius values. When disabled, it controls the size of the left transversal radius. By default, this value is set to 2.</p> 
Transversal Influence Radius Right	<p>When the Symmetric Ellipse of Influence option is enabled, this field becomes inactive. The Left Transversal radius value is automatically applied to the Right Transversal. When the Symmetric Ellipse of Influence option is disabled, it controls the size of the Right Transversal radius. By default, this value is set to 2.</p> 
Longitudinal Influence Radius Begin	<p>When the Symmetric Ellipse of Influence option is enabled, this field becomes inactive. The End Longitudinal value is automatically applied to the Begin Longitudinal value. When the Symmetric Ellipse of Influence option is disabled, it controls the size of the Begin Longitudinal radius. By default, this value is set to 0.25.</p> 
Longitudinal Influence Radius End	<p>When the Symmetric Ellipse of Influence option is enabled, this field controls both the Begin and End Longitudinal radius values. When this option is disabled, it controls the size of the End Longitudinal radius. By default, this value is set to 0.25.</p>

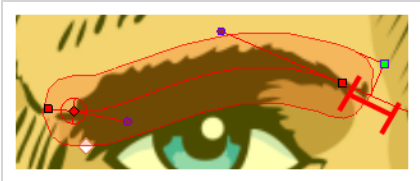
	
Symmetric Ellipse Influence	<p>Enabled by default. The shape of the ellipse will be symmetrical on both the transversal and longitudinal radii. In this case, use the Transversal Influence Radius Left field to set the transversal radius value and use the Longitudinal Influence Radius End field to set the longitudinal radius value. The two other fields will remain unused unless you disable the Symmetric Ellipse Influence option. In that case, you can set up different radius sizes for the four radii directions.</p>

## Deformation Composite Node

The Deformation-Composite node is automatically added to a rig when creating a split deformation chain. It is used to link the different nodes of a split deformation chain together before deforming the drawing it is linked to. You can customize its parameters to influence the result of the combination.



## Properties

Parameter	Description
Enable/Disable	Allows you to enable or disable the node. When disabled, a node has no visible effect on the rendered image, nor on the preview in the Camera, Perspective, Side and Top views.
Colour Swatch	Sets the colour of the layer in the Timeline view and of the node in the Node view.
Name	Use this field to rename the node.
Output Kinematic Only	This option is disabled by default, allowing the deformation chain to output deformation and position information. This option should be enabled in order to output the chain information position only. This will allow you to connect a part to the hierarchy without it undergoing the deformation applied to the rest of the chain.
Output Selected Port Only	This option is important if you have several deformation chains for one element, as in the case of a character with multiple poses. <ul style="list-style-type: none"> <li>When this option is enabled, it will only use the selected chain, which you will be able to define in the Output Kinematic Chain options of the Deformation-Composite. In some situations, this</li> </ul>

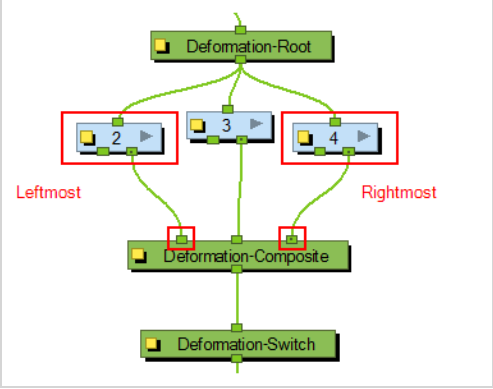
	<p>option is enabled and setup automatically (For example, when you are working with the Create Posed Deformer in Create Deformation Above/Under enabled).</p> <ul style="list-style-type: none"> <li>When this option is disabled, all the different chains for this element will be used at once.</li> </ul>
Output Kinematic Chain	<p>Lets you select a deformation chain option to use. This parameter is used when the Output Selected Port Only option is enabled.</p> 
	<p><b>Rightmost:</b> Only the first chain connected to the right of the composite node will be used.</p>
	<p><b>Leftmost:</b> Only the first chain connected to the left of the composite node will be used.</p>
	<p><b>Select:</b> If you select this option, you can define which chain to output according to the order they are connected from left to right.</p>
	<p><b>Use First Connected Element's Exposure as Key:</b> Allows the deformation effect to automatically detect which deformation chain to use (subgroup) by detecting the exposure of the first element connected to the deformation. This option is used in the case of a multiple pose rig.</p>
<p><b>Use Parent Composite's Connected Element Exposure:</b> When the Output Kinematic Only option enabled, the information from the parent element's exposure is used to attach the child to the correct chain, following which pose is exposed—see</p>	
Output Kinematic Chain Selection	When the Output Selected Port Only option is selected AND the Select

option is used as the Output Kinematic Chain setting, this field defines which deformation chain you want to use on your element. Select the number which corresponds to the left to right order that the chains are connected to the Deformation-Composite node.

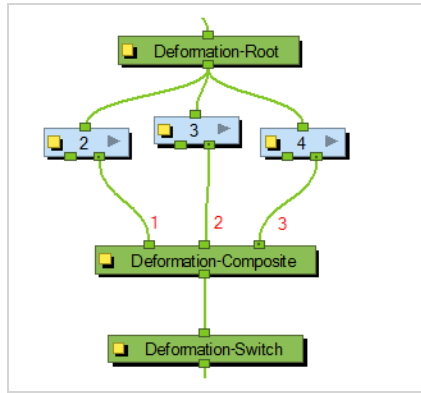

You can attach this value to a function and enable different chains over a period of time on specific frames. This value can be modified in the Timeline view by using the Deformation-Switch layer. Since the Deformation-Composite node is only visible in the Node view, the layer has a reference to this parameter enabling you to easily edit the value when working in the Timeline view.



## Deformation Root Node

The Deformation-Root is used when creating manual legacy multi-pose rigs. It can be placed at the start of the deformation chains. This node is no longer used for the current multi-pose rig structure.

You can modify the quality level of the Deformation effect in the Deformation-Root Layer Properties window:

## Properties

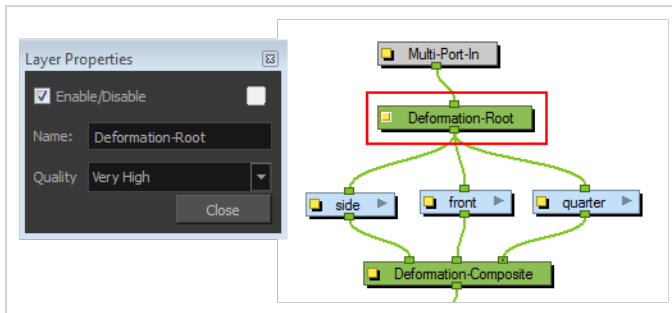

Parameter	Description
Enable/Disable	Allows you to enable or disable the node. When disabled, a node has no visible effect on the rendered image, nor on the preview in the Camera, Perspective, Side and Top views.
Colour Swatch	Sets the colour of the layer in the Timeline view and of the node in the Node view.
Name	Use this field to rename the node.
Quality	<p>Defines the number of slices the graphic is split into and used when undergoing a deformation. The higher the quality level, the more slices are created and the smoother the deformation applied to the graphic. There are five levels of quality:</p> <ul style="list-style-type: none"> <li>• Low</li> <li>• Medium</li> <li>• High</li> <li>• Very High (default value)</li> <li>• Extreme</li> </ul>

## Deformation Scale Node

The deformer can only be scaled along the centre axis to adjust the length of the limb. The Deformation-Scale can be used in combination with a Bone or Curve deformer to scale a drawing so it follows the opposite direction of the deformer axis (the width). For example, when combined with function curves this can be used to create advanced muscle effects. All these settings can be animated over time.

### How to set up the Deformation-Scale effect node

1. In the Node view, navigate to the node to which you want to add a Deformation-Scale effect.
2. In the Node Library view, select a Deformation-Scale node and drag it to the Node view.
3. Connect the Deformation-Scale node directly under the lower deformer node of your chain.

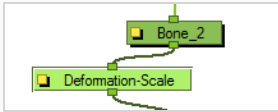

4. In the Node view, select the Deformation-Scale node and select **View > Show > Control** to display its controls in the Camera view.

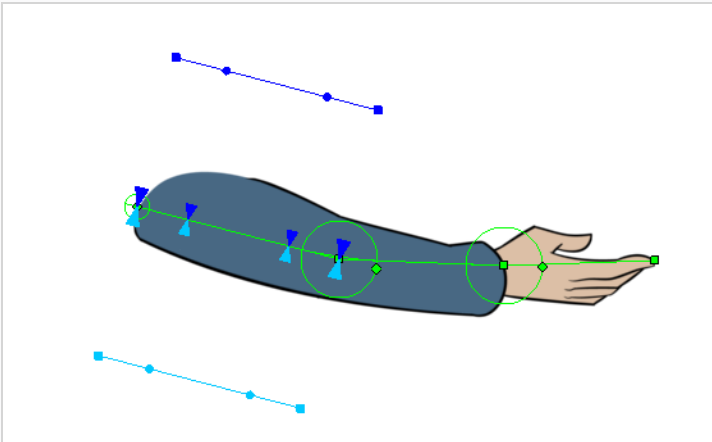

#### TIP

You can animate the different parameters of the Deformation-Scale node. To do this, make sure the Animate mode is set to  Animate Current Frame in the Tools toolbar before you manipulate it.

**NOTE**

If the controls are too far away from the deformer, you can change the default display of the Deformation-Scale and Deformation-Uniform-Scale controls in the Preferences dialog box to bring them closer.

5. Click on the square yellow button of the Deformation-Scale node to open the Layer Properties window.

## Properties

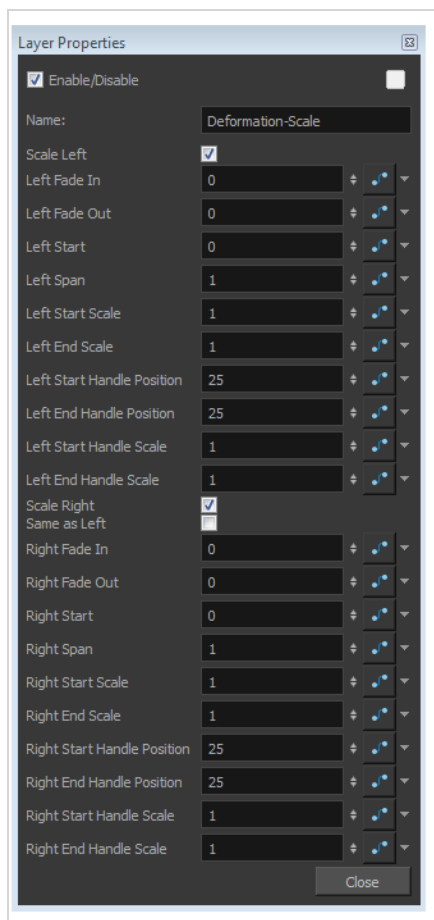

Parameter	Description
Enable/Disable	Allows you to enable or disable the node. When disabled, a node has no visible effect on the rendered image, nor on the preview in the Camera, Perspective, Side and Top views.

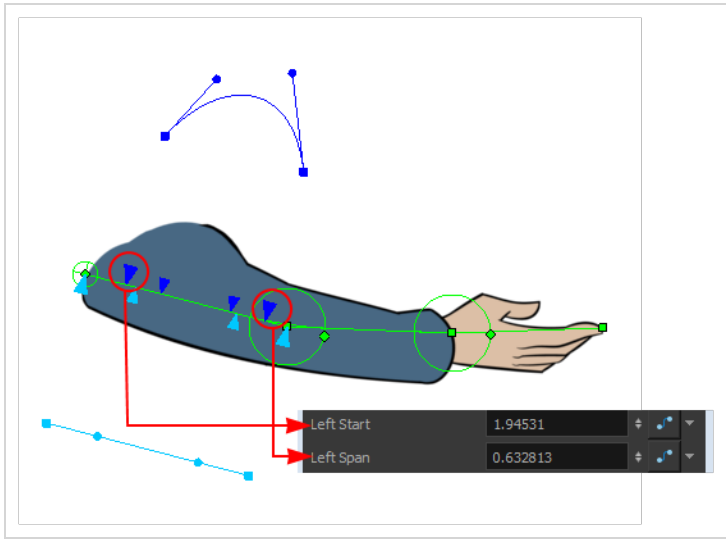
Colour Swatch	Sets the colour of the layer in the Timeline view and of the node in the Node view.
Name	Use this field to rename the node.
This series of options controls the left scaling deformation.	
Scale Left	This option is enabled by default. It allows the left side of the deformer to be scaled. In the Camera view, the dark blue controls are used for the left side. If you disable this option, the controls will be hidden and no scaling deformation will occur for this side.
Left Fade In	The value is set to 0 (no fade) by default. Increase the value to add a fade effect to smooth the transition between the starting point of the scale and the area before it.
Left Fade Out	The value is set to 0 (no fade) by default. Increase the value to add a fade effect to smooth the transition between the Left Span point of the scale and the area after it.
Left Start	<p>Defines the starting point of the left scale deformation. The default value is 0 and represents the Deformation-Root. Each main control point count for +1.</p> <p>Move the first blue arrow along the deformer's central axis to set the starting point of the Deformation-Scale and the last arrow to set the length (span) of the transformation.</p>  <p>The diagram shows a hand deformer with several control points. A blue line with arrows indicates the central axis. A green line with a diamond marker shows the 'Left Start' point. A red line with a square marker shows the 'Left Span' point. A UI panel at the bottom right displays the values: Left Start: 1.94531 and Left Span: 0.632813.</p>
Left Span	Defines the length of the left scale effect.
Left Start Scale	<p>Defines the start of the left scale effect.</p> <p>Drag the square scaling curve control points away and forward from the deformer</p>

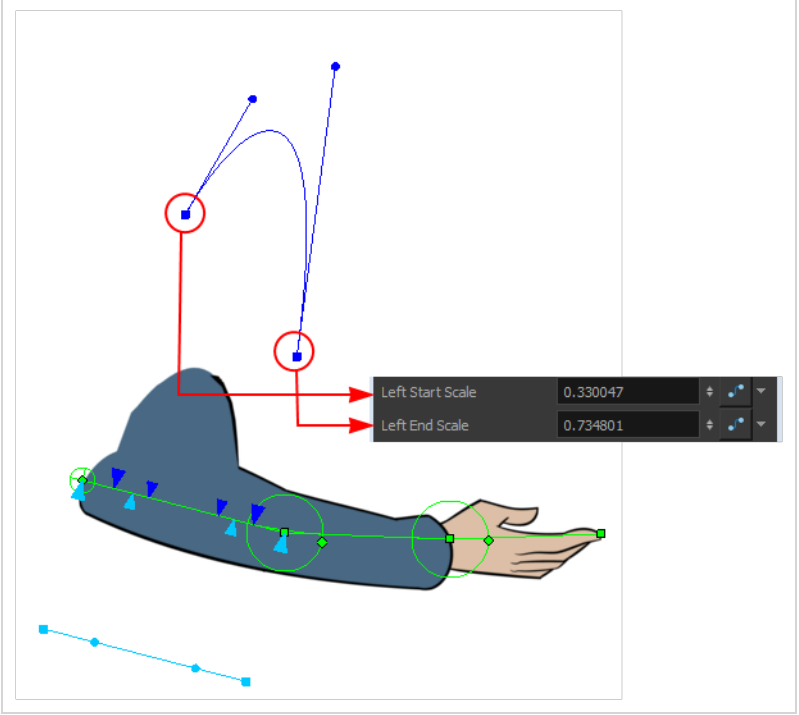
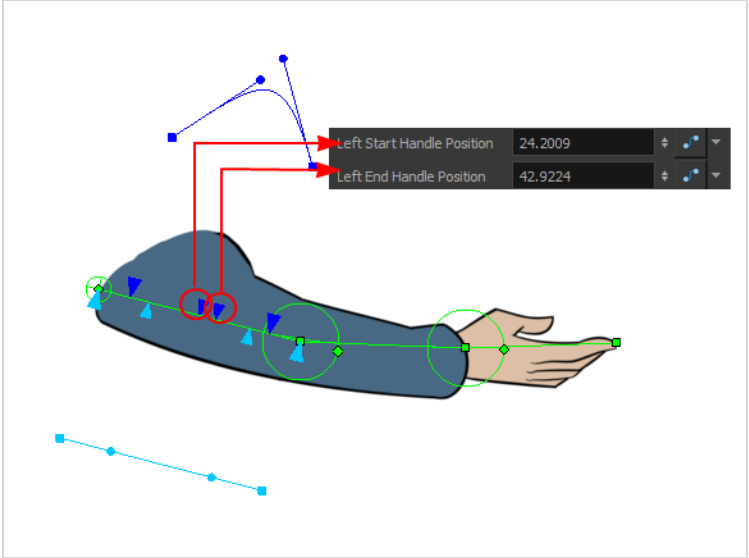
	<p>axis to set the scaling value at the starting and ending point.</p> 
Left End Scale	<p>Defines the end of the left scale effect.</p>
Left Start Handle Position	<p>Defines the starting position of the left handle.</p> <p>Drag the two middle blue arrows along the deformer's centre axis to set the position of the curve handles.</p> 

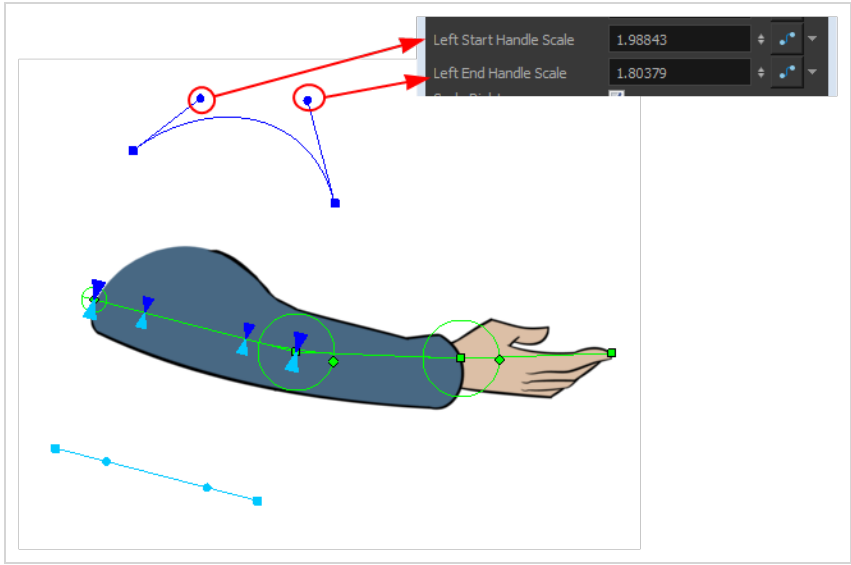
<p>Left End Handle Position</p>	<p>Defines the ending position of the left handle.</p>
<p>Left Start Handle Scale</p>	<p>Defines the starting position of the left scale handle.</p> <p>To modify the scaling value of the curve, drag the two control handles away and forward from the deformation axis.</p> 
<p>Left End Handle Scale</p>	<p>Defines the ending position of the left scale handle.</p>
<p>Scale Right</p>	<p>This option is enabled by default. It allows the right side of the deformer to be scaled. In the Camera view, the light blue controls are used for the right side. If you disable this option, the controls will be hidden and no scaling deformation will occur for this side.</p>
<p>Same as Left</p>	<p>This option is disabled by default. It means that the left and right sides will use different scaling parameters. If you enable this option, the right side controls will be hidden in the Camera view and the left parameters will be used for both side for a symmetrical scaling effect.</p>
<p>The right side parameters are a mirror of the left side parameters</p>	

## Deformation Switch Node

The Deformation-Switch (Legacy) node acts as a on and off switch for the deformation chain. It is used when building legacy multi-pose rigs. It is also the node which controls the Region of Influence Fade area. The Deformation-Switch also displays a Kinematic Chain Selection Reference option, which allows you to modify the chain selection directly in the Timeline view.

The Deformation-Switch has been replaced with the Transformation-Switch node.

## Properties

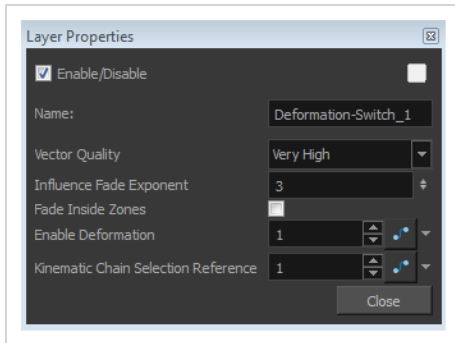

Parameter	Description
Enable/Disable	Allows you to enable or disable the node. When disabled, a node has no visible effect on the rendered image, nor on the preview in the Camera, Perspective, Side and Top views.
Colour Swatch	Sets the colour of the layer in the Timeline view and of the node in the Node view.
Name	Use this field to rename the node.
Vector Quality	Defines the quality of the deformation effect when your drawings are stretched and deformed. There are five levels of quality: <ul style="list-style-type: none"> <li>• Low</li> <li>• Medium</li> <li>• High</li> <li>• Very High (default value)</li> <li>• Extreme</li> </ul>
Influence Fade Exponent	A value of 1 is similar to a linear curve. A higher value will result in an ease-in type of curve. A lower value will result in an ease-out type of curve.

Fade Inside Region	This option is disabled by default. The fade effect will occur outside the zone of influence. Enable this option to have the fade effect inside the Zone of Influence.
Enable Deformation	Acts as an on/off switch for the deformation. The value of this field is set to 1 by default, which means the deformation is enabled. Enter a value of 0 to disable it.
Kinematic Chain Selection Reference	Determines which chain is selected and used at a specific frame. It is a reference to the option in the Deformation-Composite node. Having this reference in the Deformation-Switch node allows you to use and modify the chain selection value directly in the Timeline view since the Deformation-Composite node is only visible in the Node view.



## Deformation Uniform Scale Node

The Deformation-Uniform-Scale effect node let you create the squash and stretch effect on your animated deformation rig. You can scale the rigged element on the opposite axis of the deformer (width).

### How to use the Deformation-Uniform-Scale node

1. In the Node view, navigate to the deformation node to which you want to add a Deformation-Uniform-Scale node.
2. In the Node Library view, select the Deformation-Uniform-Scale node and drag it to the Node view.
3. Connect the Deformation-Uniform-Scale node directly below the lowest deformation node in your chain.

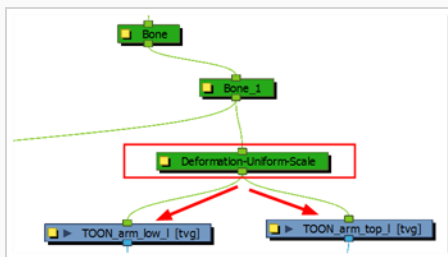

4. Connect the Deform-Uniform-Scale node to all the drawing nodes it should scale.
5. In the Node view, select the Deformation-Uniform-Scale node.
6. Display the Uniform Scale controls in the Camera view by pressing Shift + F11.
7. In the Camera view, drag the handle to resize the width of the limb. You can also use the Scale field to enter a specific value. These parameters can be animated over time.

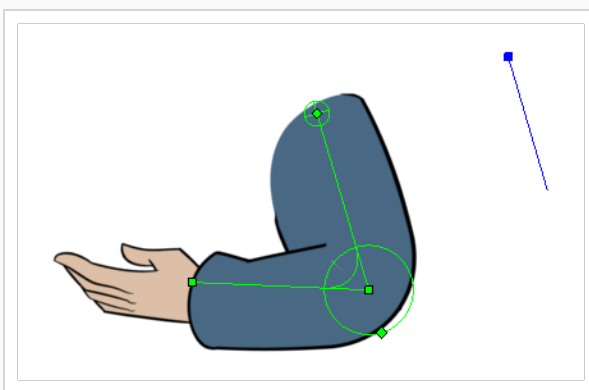

**NOTE**

If the controls are too far away from the deformer, you can change the default display of the Deformation-Scale and Deformation-Uniform-Scale controls in the Preferences dialog box to bring them closer.

## Properties

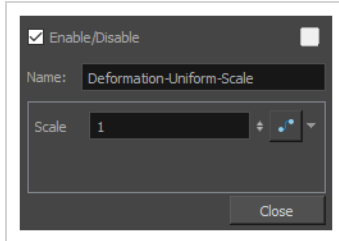

Parameter	Description
Enable/Disable	Allows you to enable or disable the node. When disabled, a node has no visible effect on the rendered image, nor on the preview in the Camera, Perspective, Side and Top views.
Colour Swatch	Sets the colour of the layer in the Timeline view and of the node in the Node view.
Name	Allows you to enter a name for the node.
Scale	Use this field to type in the value to resize the width of the limb.

## Deformation Wave Node

The Deformation-Wave effect deforms the chain by adjusting the scaling in a waveform style. It can be used to animate a wave deformation effect on your deformation chain over a period of time.

### How to use the Deformation-Wave effect

1. In the Node view, navigate inside the Deformation node to which you want to add a Deformation-Wave effect.
2. In the Node Library view, select an Deformation-Wave node and drag it to the Node view.
3. Connect the Deformation-Wave node to your deformation chain.

A wave deformation is applied to the limb or art connected to the deformation chain.

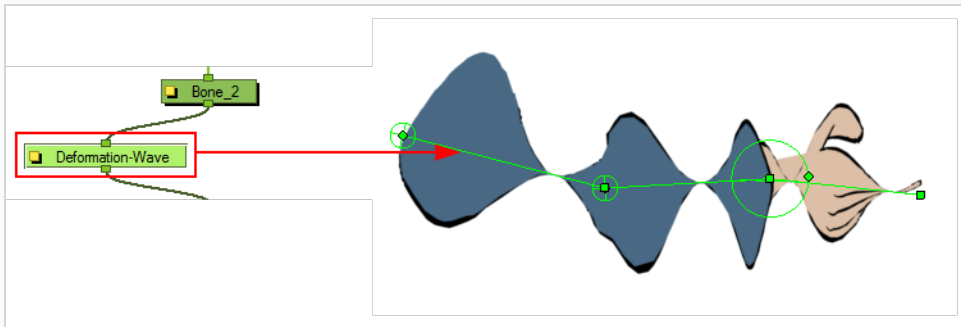

4. In the Node view, open the Layer Properties window of the Deformation-Wave node.

## Properties

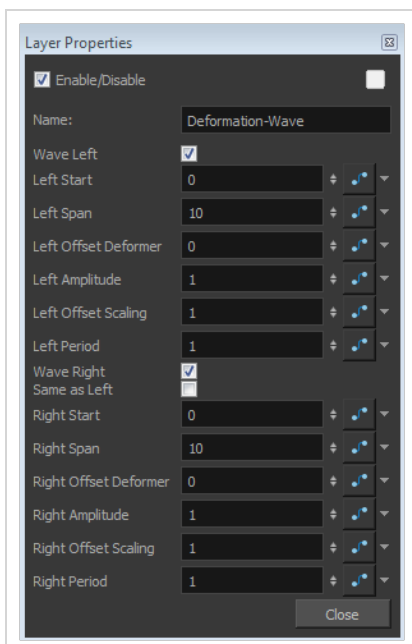

Parameter	Description
Enable/Disable	Allows you to enable or disable the node. When disabled, a node has no visible effect on the rendered image, nor on the preview in the Camera, Perspective, Side and Top views.
Colour Swatch	Sets the colour of the layer in the Timeline view and of the node in the Node view.
Name	Use this field to rename the node.
Wave Left	This option is enabled by default, allowing the Deformation-Wave effect to be applied on the left side of the deformer chain. Disable this option to prevent the effect from being applied.
Left Start	Defines the length of the left wave effect.
Left Span	Defines the starting point of the left wave deformation. The default value is 0 and represents the root point. Each main control point count for +1.
Left Offset Deformer	This is the parameter you may want to connect to a function. It controls the offset of the deformation on the left side and allows you to create a fluid wave animation along the deformer axis.
Left Amplitude	Controls the height of the left wave effect.
Left Offset Scaling	Used to apply an offset value to the amplitude of the left wave. The wave will be lifted and become higher, or dropped and become lower, depending whether the value is increased or decreased.
Left Period	Controls the interval of occurrence of the left waves. By default the value is 1, meaning that a wave will occur for every deformer. If you decrease the value to 0.5, it will result in a wave occurring every half deformer.
Wave Right	By default this option is enabled, allowing the Deformation-Wave effect to be applied on the right side of the deformer chain. Disable this option to prevent the effect from being applied.
Same as Left	This option is disabled by default. It allows the left and right size of the Deformation-Wave to be controlled separately. Select this option if you want the effect to be symmetrical and controlled by the left side parameters.

Right Start	Defines the starting point of the right wave deformation. The default value is 0 and represents the Deformation-Root. Each main control point count for +1.
Right Span	Defines the length of the right wave effect.
Right Offset Deformer	This is the parameter you might want to connect to a function. It controls the offset of the deformation on the right side, allowing you to create a fluid wave animation along the deformer axis.
Right Amplitude	Controls the height of the right wave effect.
Right Offset Scaling	Used to apply an offset value to the amplitude of the right wave. The wave will be lifted and become higher, or dropped and become lower, depending whether the value is increased or decreased.
Right Period	Controls the interval of occurrence of the right side waves. By default the value is 1, meaning that a wave will occur for every deformer. If you decrease the value at 0.5 it will result in a wave occurring every half deformer.

## Fold Node

The Fold effect is used when bending a deformation further than the drawing is able to take it. This may result in an unwanted overlap of the line art at the junction of the articulation or deformation. The Fold effect lets you control certain parameters that will help eliminate the unwanted line effect. You can also avoid this issue by separating your drawing onto two layers or separating your drawing in two pieces using the Cutter tool and repasting it in place in the same drawing.



The Fold effect works best with the Curve deformers.

### How to set up the Fold node

1. In the Node view, navigate to the Deformation node causing the unwanted overlap (in this case, an articulation).
2. In the Node Library view, select the **Fold** node and drag it to the Node view.
3. Connect the Deformation-Fold node directly under the deformation effect node which is causing the unwanted line effect.

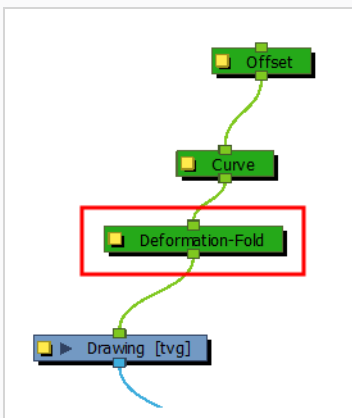

4. In the Node view, select the **Deformation-Fold** node.
5. From the top menu, select **View > Show > Control** or press Shift + F11 (Windows/Linux) or ⌘ + F11 (macOS) to display its controls in the Camera view.
6. In the Tools toolbar, select the Transform  tool.

7. In the Camera view, set up the Deformation-Fold. You can also set these parameters directly in the Deformation-Fold properties:

- ▶ Click on the fold axis and rotate it to match the angle of the bend articulation.

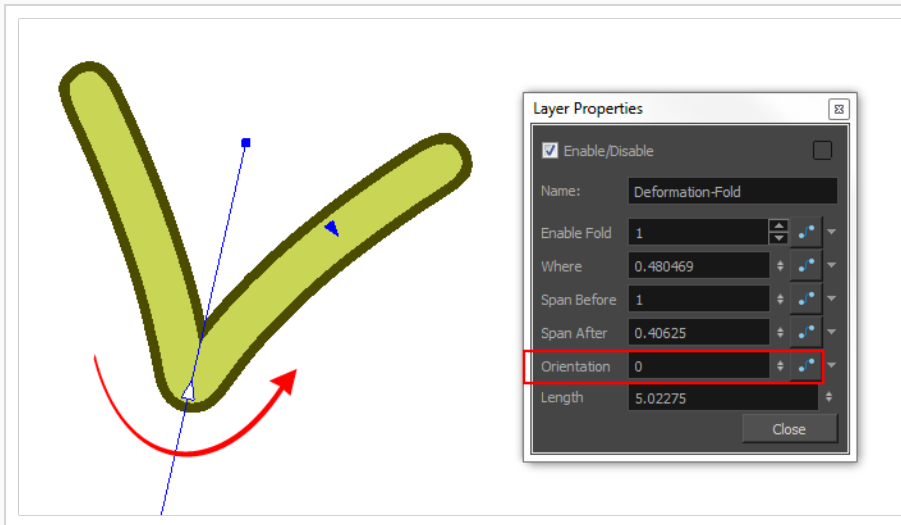

- ▶ Use the middle arrow to position the axis along the deformer's central line. It should be in the corner of the bending area.

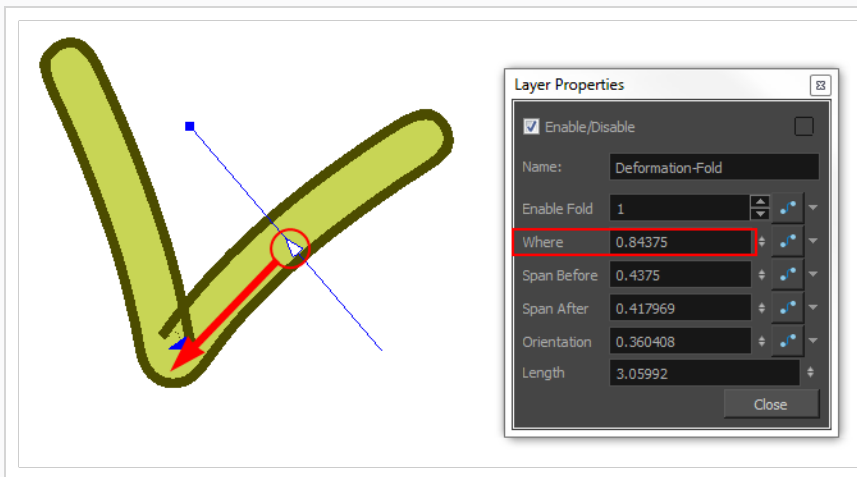

- ▶ Use the right and left arrows to control the appearance of the two overlapping lines.

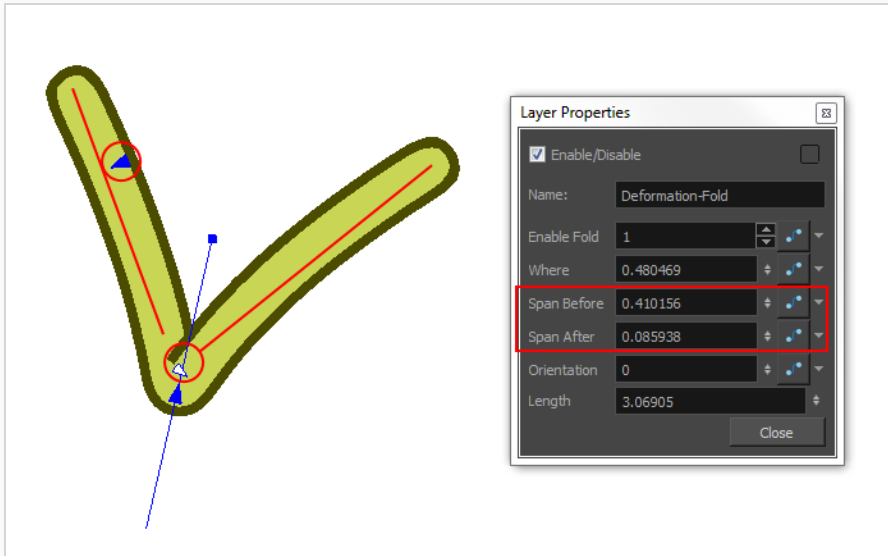

- ▶ Use the axis's square handle to lengthen or shorten the axis.

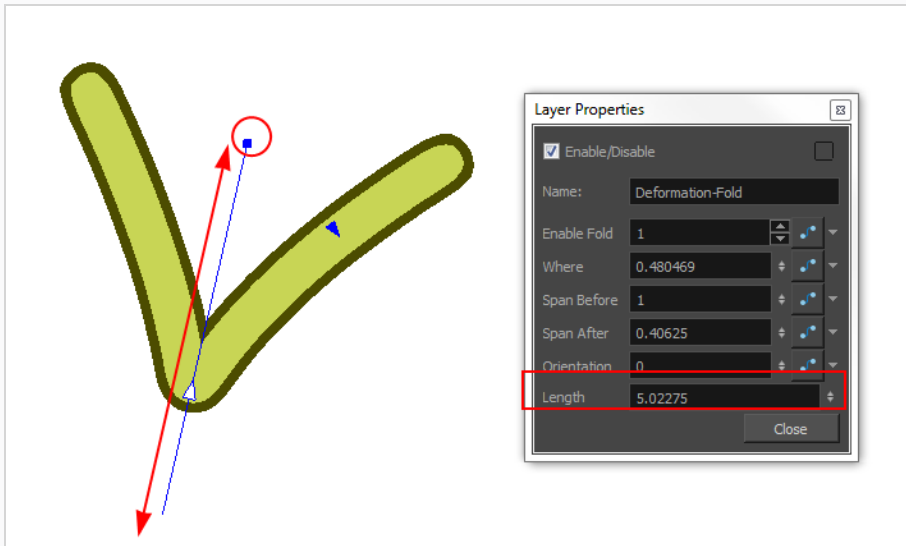

8. If your character moves a lot and you need to adjust the fold at different positions to follow the limb animation, you can set up the Deformation-Fold node in a different position over time. To be able to do this, make sure that the Animate mode is set to  **Animate Current Frame** in the Tools toolbar.
9. You can also enable/disable the Deformation-Fold node over time by connecting a function to the Enable Fold parameter in the Layer Properties. A value of 1 enables the effect, a value of 0 disables the effect.



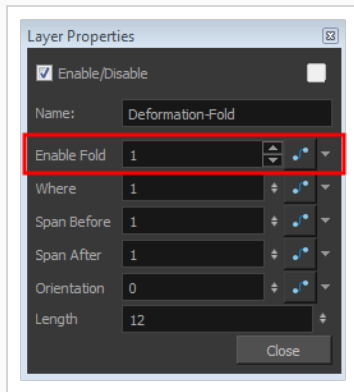

## Game Bone Node

The Bone node is one of the main node used to build a deformation rig. Each Bone node consists of a bone and an articulation. Chaining Bone nodes will create a skeleton chain for your character. The Rigging tool can be used to create and connect those nodes automatically.

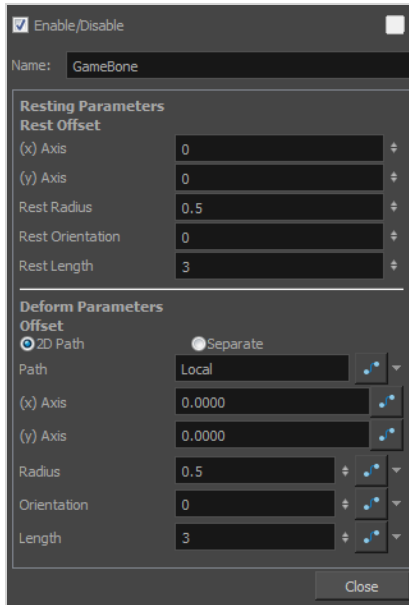

Parameter	Descriptions
<b>Resting Parameters Rest Offset</b>	
(x) Axis	This is the bone X-axis (horizontal) coordinates for the resting position.
(y) Axis	This is the bone Y-axis (vertical) coordinates for the resting position.
Rest Radius	This is the articulation's radius value (articulation size) for the resting position.
Rest Orientation	This is the bone's orientation angle for the resting position.
Rest Length	This is the bone's length for the resting position.
<b>Deform Parameters Offset</b>	
2D Path	When this option is enabled, the X and Y axis parameters are controlled by the same 2D path function.

---

Separate	When this option is enabled, the X and Y axis parameters are individual from each other.
Path	When using a 2D Path, this field displays the name of the function curve.
(x) Axis	This is the bone X-axis (horizontal) coordinates for the animation position. This parameter can be linked to a function curve to be animated over time.
(y) Axis	This is the bone Y-axis (vertical) coordinates for the animation position. This parameter can be linked to a function curve to be animated over time.
Radius	This is the articulation's radius value (articulation size) for the animation position. This parameter can be linked to a function curve to be animated over time.
Orientation	This is the bone's orientation angle for the animation position. This parameter can be linked to a function curve to be animated over time.
Length	This is the bone's length for the animation position. This parameter can be linked to a function curve to be animated over time.

## Glue Node



The Glue effect lets you repair the cracks that appear between joints during animation.

The Glue node has three ports:

- **Left Port** (Matte): Receives the matte.
- **Middle Port** (Port A): Receives the element that will not be used to fill the joint.
- **Right Port** (Port B): Receives the element that will be used to fill the joint.

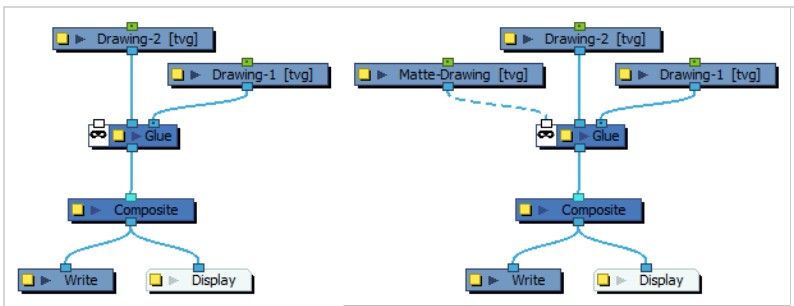

For most effects with the Glue node, the default options are sufficient. However, you can modify these options using the Glue editor.

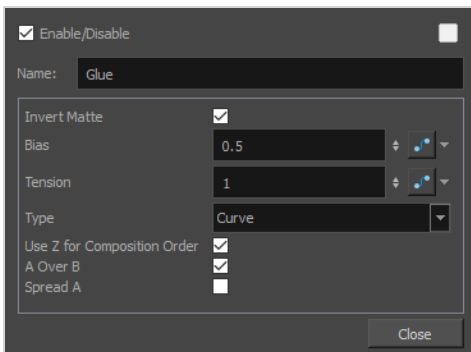

## Glue Properties

Parameter	Description
Invert Matte	Activate this option to invert the matte used to fill the joint. If you want to use the "B" element as the matte, you must select this element.

Parameter	Description
Bias	Indicates the tendency to favour the static or moving element. Set to 0, it favours element A; set to 1 it favours element B; set to 0.5 it is in between A and B.
Tension	Indicates how tight the joint will be. Set to 1, the tension has no effect; set less than 1, the tension decreases; set greater than 1, the tension increases.
Type	From this menu, select the type of joint to create. You can choose from among Curve (default), Line and Corner.
Use Z for Composition Order	You can use this option to choose the drawing with the higher front-back value to create the joint.
A Over B	Indicates which image is rendered on top in the final image. By default, A is rendered on top of B, which indicates that the image in the middle port (A) is rendered on top of the image in the right port (B).
Spread A	By default, the image in port B is spread to fill the joint. You can use this option to choose the image in the A port to create the joint. If you select this option, the drawing node must receive position information from the "B" element. Thus, you must connect the Drawing node of the "B" element to the Drawing node of the matte.

## Kinematic Output Node

The Kinematic Output node lets you hook a separate element that you want to be linked to the deformation chain but not be part of the deformation, such as a hand to an arm or an arm to the body. These elements will follow the movement of the chain just like a regular cut-out character hierarchy piece without being influenced by the deformation of the arm. If you don't use the Kinematic Output, the piece's pivot will not follow the deformation.

Connect a Kinematic Output node below the deformation node you want your drawing to follow.

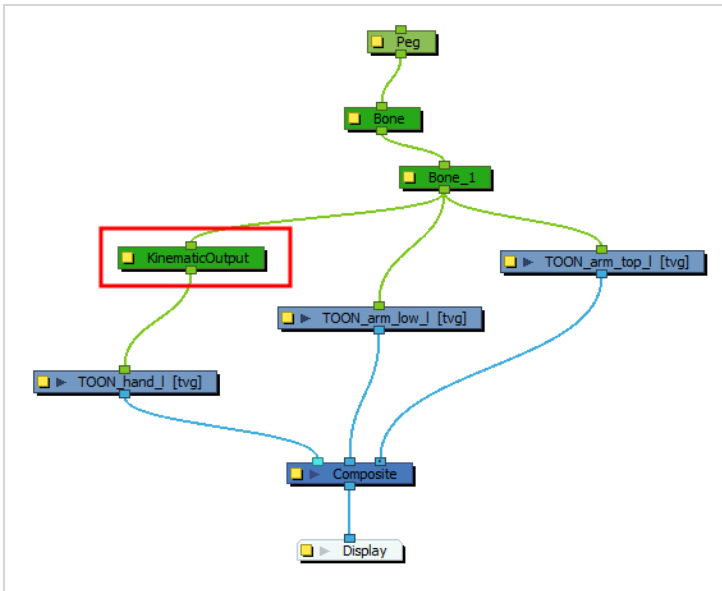

## Mesh Warp Node

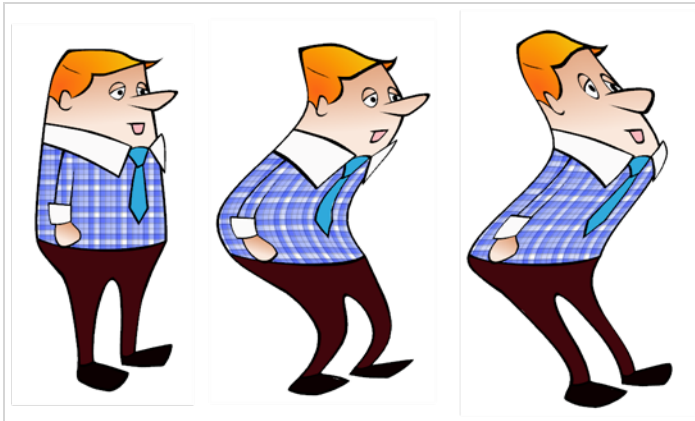

Use the Mesh Warp effect to distort your drawings. With this node you can create effects such as a character in a warped mirror and looking through a glass jar. You can also animate the position of the grid to perform the distortion over time.

The Mesh Warp node is a position node, same as a Peg node.

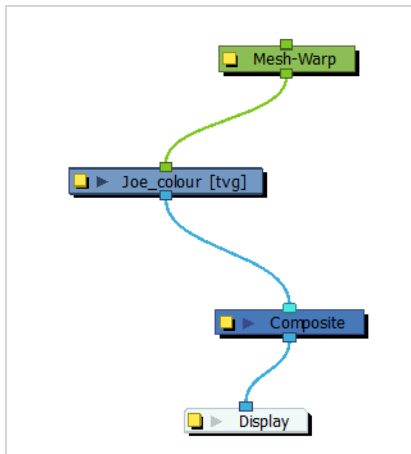

### How to use the Mesh Warp Effect

1. In the Node Library, under the Filter tab, select the Mesh Warp node and drag it to the Node view.
2. In the Node view, connect the Mesh-Warp node to your drawing or group nodes to deform.

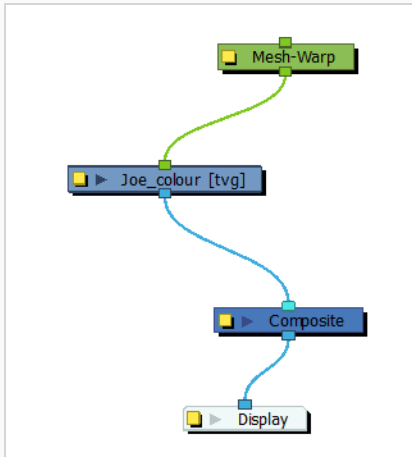

3. In the Node view, select the Mesh Warp node.
4. Select **View > Show > Control** or press Shift + F11 (Windows/Linux) or ⌘ + F11 (macOS) to display the deformation grid.

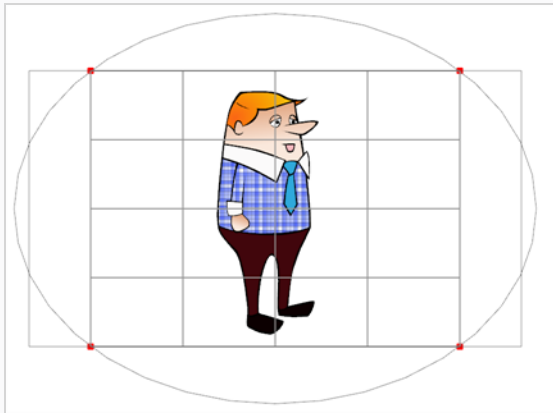

5. Move the intersection points and move the Bezier handles to deform the grid.

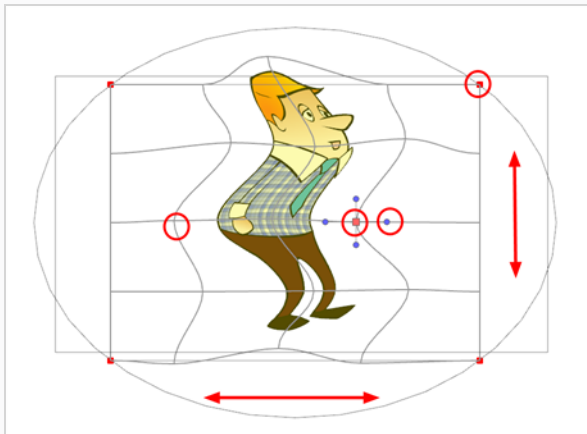



- Grab the grid in the void spaces to pan it around. Using keyframes, you can animate its position over time.

## Mesh Warp Properties

Use the Mesh Warp editor to adjust the grid size, deformation quality and the region of interest.

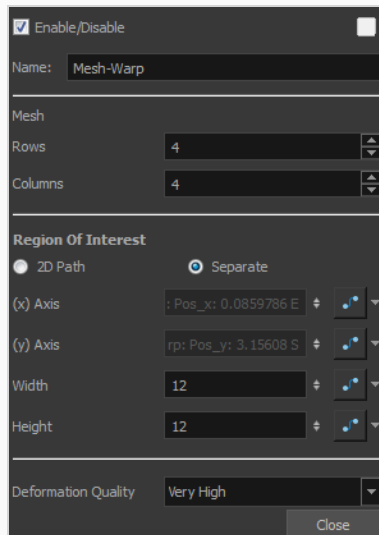

Parameter	Description
Rows	Increase or decrease the Rows value to change the amount of rows to use in the deformation grid.
Columns	Increase or decrease the Columns value to change the amount of columns to use in the deformation grid.
Region of Interest	Select the 2D Path option if you want both your X and Y curves to be controlled by the same velocity function. Select the Separate option if you want your X and Y curves to be independent and have independent velocity.
(x) Axis	This is the X position of the grid. This value can be animated overtime to move the grid horizontally.
(y) Axis	This is the Y position of the grid. This value can be animated overtime to move the grid vertically.

Width	This is the width value of the grid. This value can be animated overtime to squash or stretch the grid horizontally.
Height	This is the height value of the grid. This value can be animated overtime to squash or stretch the grid vertically.
Deformation Quality	This is the quality of the warm deformation. It ranges from Low to Extreme. The higher the quality, the better the formation will look, but the longer it will take to render.

## Offset Node

The Offset node lets you position the root of your deformation chain. It is automatically added to your deformation rig when you create a Curve or Envelope deformation rig using the Rigging  tool.

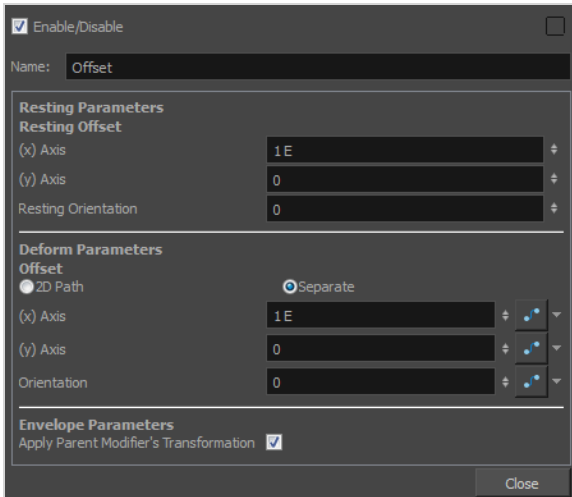

Parameter	Description
Name	Use this field to rename the node.
(x) Axis	Sets the resting position on the X (east/west) axis.
(y) Axis	Sets the resting position on the Y (north/south) axis.
Resting Orientation	Sets the rotation angle of the resting position.
Offset Type	Lets you choose the type of coordinates to use:  <b>Separate:</b> The two coordinates are set separately. If they are connected to a function, each one will have its own function curve. This is the default setting.  <b>2DPath:</b> The two coordinates are set together within a single 2D path function.
(x) Axis (y) Axis	This option is only available when the Type is set to Separate. It is used to set the active position value of the Deformation-Root on the X (east/west) and Y (north/south) axis.  You can enter the value, use the up and down arrow buttons to choose a value, or use the Transform tool, when Setup mode is NOT enabled, to move the deformation chain. Remember, that if you want to add a keyframe, you need to enable Animation mode from the Tools toolbar.

Path	<p>This option is only available when the Type is set to 2D Path. It is used to set the active position value of both the Y and X axis. Use the Transform tool when Setup mode is NOT enabled to move the deformation chain along the 2D path. Remember, if you want to add a keyframe, you need to enable the Animation mode on the Tools toolbar.</p>
Orientation	<p>Sets the rotation angle of the active position of the Deformation-Root. You can enter the angle, use the up and down arrow buttons to choose the desired value, or use the Transform tool when Setup mode is NOT enabled to rotate the deformation chain. Remember, if you want to add a keyframe, you need to enable Animation mode on the Tools toolbar.</p>
Apply Parent Modifier's Transformation	<p>When this option is disabled, the parent's deformations no longer affect the current deformer.</p>

## Refract

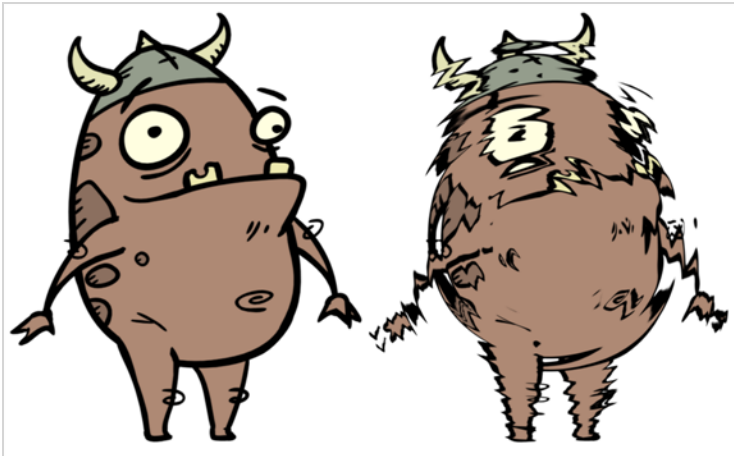

Use the Refract effect to create effects such as ripples and heat haze. This effect is based on the refraction of light, which occurs when a beam of light passes through media of different density, causing the light to refract or change angles. This effect makes objects appear distorted or offset from their actual positions. If you imagine an object in a pool of water the part beneath the surface of the water appears offset from its true position.

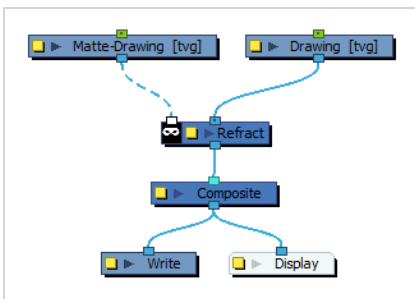

This creates the effect of a volume passing over an image, refracting the light that bounces off the contents below.

The refraction effect uses the matte's alpha values to taper the refractions. Hence, you can create a nice refraction effect with a drawing containing solid strokes if you run it through a Blur-Radial effect to blur its alpha values.

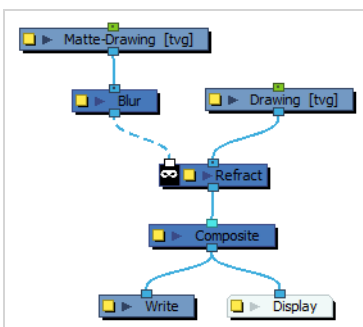

You can make the ripple effect move across the image by hooking the matte drawing to a peg and animating the peg.

## Refract Properties

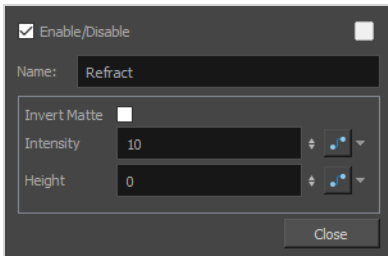

Parameter	Description
Name	Allows you to change the name given to the node.
Invert Matte	Inverts the matte used to generate the effect. By default, the effect is applied to the opaque areas of the matte drawing. When this option is enabled, the effect is applied to the transparent areas of the matte instead.
Intensity	The amount of refraction to apply to the image. You can attach the value to a function curve to change its value over time.
Height	The amount of depth to add to the refraction effect. When coupled with the Intensity effect, this value can create the effect of bending the objects below the refraction matte. You can attach the value to a function curve to change its value over time.

## Stick Node

The Stick node is available for compatibility with previous versions of deformation rigs. This node is the legacy Bone node. When the Stick node is imported in the Node view, it is renamed Bone.

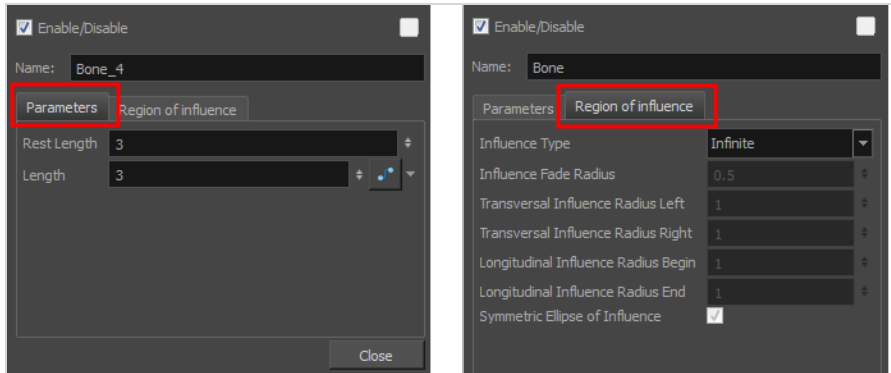

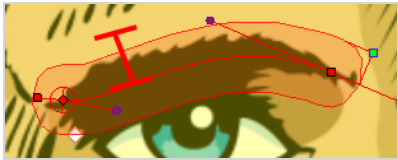
Parameter	Descriptions
Rest Length	This is the bone's length for the resting position.
Length	This is the bone's length for the animation position. This parameter can be linked to a function to be animated over time.
<b>Region of Influence</b>	
Influence Fade Radius	This defines the size of the fade area around the actual region of influence's boundaries.
Transversal Influence Radius Left	When the Symmetric Ellipse of Influence option is enabled, this field controls the Left and Right transversal radius values. When disabled, it controls the size of the left transversal radius. By default, this value is set to 2. 
Transversal Influence Radius Right	When the Symmetric Ellipse of Influence option is enabled, this field becomes inactive. The Left Transversal radius value is automatically applied to the Right Transversal. When the Symmetric Ellipse of Influence option is disabled, it controls the size of the Right Transversal radius. By default, this value is set to 2.

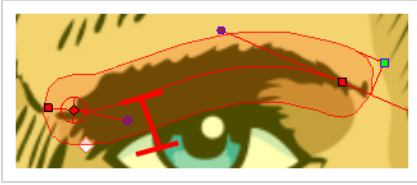
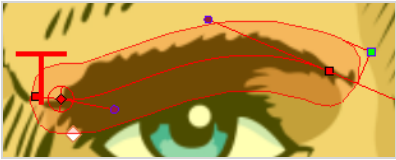
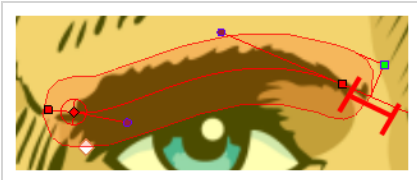
	
<p>Longitudinal Influence Radius Begin</p>	<p>When the Symmetric Ellipse of Influence option is enabled, this field becomes inactive. The End Longitudinal value is automatically applied to the Begin Longitudinal value. When the Symmetric Ellipse of Influence option is disabled, it controls the size of the Begin Longitudinal radius. By default, this value is set to 0.25.</p> 
<p>Longitudinal Influence Radius End</p>	<p>When the Symmetric Ellipse of Influence option is enabled, this field controls both the Begin and End Longitudinal radius values. When this option is disabled, it controls the size of the End Longitudinal radius. By default, this value is set to 0.25.</p> 
<p>Symmetric Ellipse Influence</p>	<p>Enabled by default. The shape of the ellipse will be symmetrical on both the transversal and longitudinal radii. In this case, use the Transversal Influence Radius Left field to set the transversal radius value and use the Longitudinal Influence Radius End field to set the longitudinal radius value. The two other fields will remain unused unless you disable the Symmetric Ellipse Influence option. In that case, you can set up different radius sizes for the four radii directions.</p>



## Turbulence Node

The Turbulence effect is a mathematically generated effect that uses fractal noise to create turbulent distortions in an image. You can see the effect when used with an image as the background. You can create flowing water, funhouse mirrors, and waving flags.



For detailed video tutorials and sample scenes by Adam Phillips, see:

<https://www.toonboom.com/resources/video-tutorials/chapter/adam-phillips-harmony-effects>

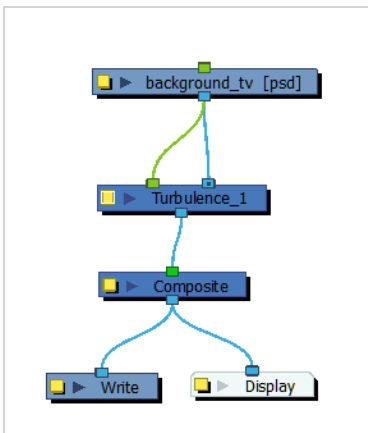

## Turbulence Properties

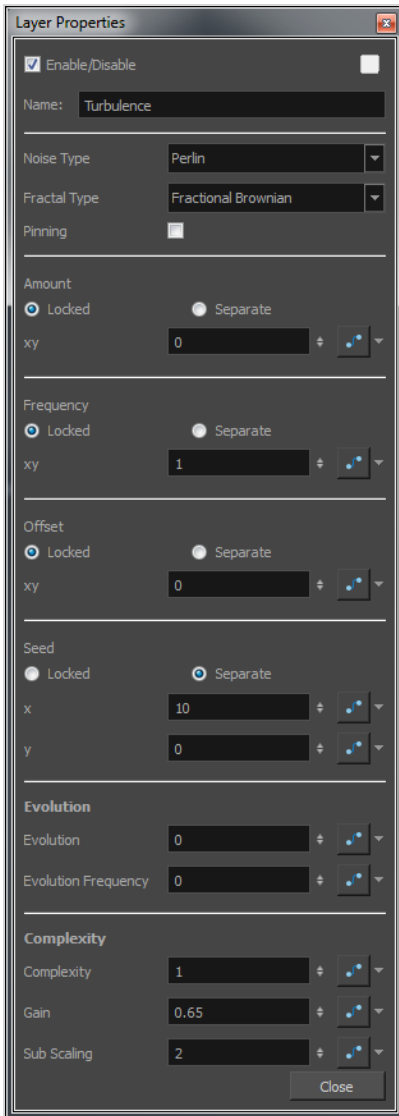

Parameter	Description
Noise Type	<p>The algorithm used to generate the noise:</p> <ul style="list-style-type: none"> <li>• <b>Perlin:</b> Creates pseudo random patterns. The greyscale contains a continuity between different tones of grey.</li> <li>• <b>Simplex:</b> Creates a more contrasted noise pattern with more variation than Perlin. There is a smooth variation of intensity.</li> <li>• <b>Sinusoidal:</b> Creates a repeated wavelike pattern.</li> <li>• <b>Sub Scaling:</b> Applies Perlin noise twice. The second noise is added where dark areas appear in the original. The frequency of the second iteration is higher so the noise is smaller.</li> </ul>

	<ul style="list-style-type: none"> <li>• <b>Rocky:</b> Uses the Perlin pattern but converts the very high and low values to more moderate values. For example, the whites become light greys and the blacks become dark greys.</li> <li>• <b>Small Bumps:</b> Uses the Perlin pattern. The transitional grey areas between blacks and whites become inverted so they look like dark lines. The extremes, black and white areas, become whitish.</li> </ul>
Fractal Type	<p>Transforms the noise pattern generated by the Noise type and controls the way layers are composited. These are variations of the basic noise.</p> <ul style="list-style-type: none"> <li>• <b>Turbulent Twist:</b> Applies a turbulent effect on the pattern so it changes the transition between black and white by adding more modulation.</li> <li>• <b>Fractional Brownian:</b> Applies a basic application of noise and composites by adding subsequent layer with the Complexity parameter.</li> <li>• <b>Threshold:</b> Changes the dark greys into black values so there is more black in the noise for higher contrast.</li> <li>• <b>Invert Threshold:</b> Inverts all the values of the Threshold type so a negative image of it is created.</li> <li>• <b>Terrain:</b> Adds contrast and converts the dark greys into white or light greys.</li> </ul>
Pinning	Constrains the effect within the image boundaries.
Amount	Specifies the amplitude of displacement.
Frequency	The density of displacement appearing in the noise. A higher value produces a greater amount of displacement in a given area; a lower value produces a smaller amount.
Offset	Moves the entire image.
Seed	This value determines the starting noise pattern on the first evolution of the effect.
Locked	Applies parameter value while retaining the X and Y ratio.
Separate	Allows you to apply different parameter values to X and Y.
xy	When locked, applies parameter values to both X and Y. When separated, allows you to apply different value to X and Y.

Evolution	Determines the displacement pattern over time.
Evolution Frequency	This factor makes the complexity iterations animate or transform at a higher speed. In other words, the second, third, etc. passes, controlled by the Complexity parameter, will mutate faster than the main one.
Complexity	<p>The number of noise layers that make up the noise. Each successive layer has a higher frequency, resulting in a smaller noise effect. You can have up to seven passes. Increasing this number increases the depth and amount of detail in the noise. Use Complexity with Sub Scaling when the value is 1 or greater.</p> <div data-bbox="565 611 1430 747" style="border: 1px solid green; padding: 5px;"> <b>NOTE</b> Increasing the Complexity results in longer rendering times.</div>
Gain	Controls the amount of opacity present in the iteration of noise. This also affects the layer when using Sub Scaling. With a value of 0, you will not see the sub noise. A value of 1 will show the sub noise just as strong as the main one. For example, with water ripples, a higher amount of Gain will reveal more ripple or subripples.
Sub Scaling:	The factor by which the main noise is modified at each iteration of complexity. A value of 1 make the two noises identical. A value of 2 makes the sub noise twice as small. The next iteration would be 4 times smaller. Values must be greater than 1.

## Filter Nodes

Here is the list of the main filter effects available in Harmony.

Anti-Flicker Node .....	496
Auto-Patch Node .....	498
Bloom Node .....	500
Blur-Box Node .....	504
Blur-Directional Node .....	507
Connection .....	508
Layer Properties .....	509
Blur-Gaussian Node .....	511
Blur-Radial Node .....	514
Blur-Radial-Zoom Node .....	516
Blur-Variable Node .....	520
Brightness Contrast Node .....	522
Channel Selector Node .....	524
Channel Swap Node .....	526
Chroma-Keying Node .....	528
Colour Banding Node .....	534
Colour Art Node .....	537
Colour-Override Node .....	540
Colour-Scale Node .....	545
Colour Selector Node .....	547
Contrast Node .....	550
Dither Node .....	552
Focus Node .....	554
Focus Multiplier Node .....	557
Glow Node .....	559
Grain Node .....	563
Greyscale Node .....	565
Hue-Saturation Node .....	567

<b>Layer Selector Node</b> .....	<b>574</b>
<b>Line Art Node</b> .....	<b>577</b>
<b>Luminance Threshold Node</b> .....	<b>579</b>
<b>Matte-Blur Node</b> .....	<b>582</b>
<b>Matte-Resize Node</b> .....	<b>585</b>
<b>Median Node</b> .....	<b>587</b>
<b>Motion-Blur Node</b> .....	<b>590</b>
<b>Negate Node</b> .....	<b>592</b>
<b>Overlay Layer Node</b> .....	<b>594</b>
<b>Pixelate Node</b> .....	<b>596</b>
<b>Remove Transparency Node</b> .....	<b>598</b>
<b>Shadow Node</b> .....	<b>600</b>
<b>Transparency Node</b> .....	<b>603</b>
<b>Underlay Layer Node</b> .....	<b>605</b>

## Anti-Flicker Node

Use the Anti-Flicker to compensate for flickering in your output to TV formats. The Anti-Flicker effect applies a vertical blur to the rendered output. You should place the Anti-Flicker before a Write node in the Node view.



Refer to the following example to connect this effect:

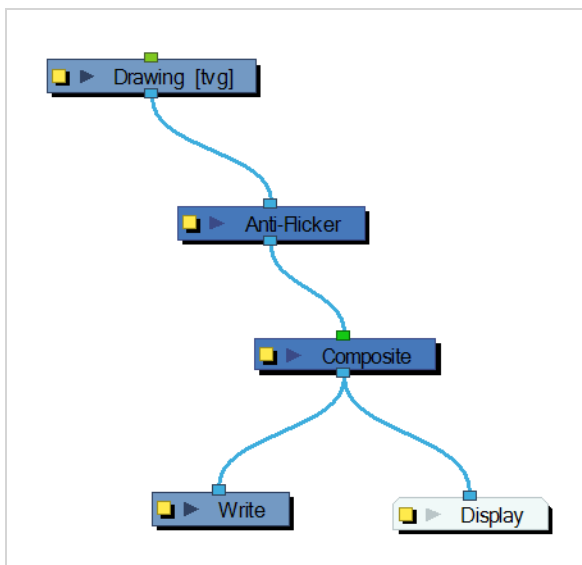

Use the Anti-Flicker editor to control the amount of blur that is applied to rendered output. In the Radius field, enter a value for the number of pixels to be considered in the blur.

## Properties

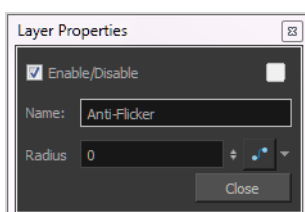

Parameter	Description
Name	Allows you to enter a name for the node.
Radius	Size of the blur. The larger the value, the greater the strength or reach of the blur. The blur radius is affected by the drawing scale and camera position. Click the Edit Curve button to change these values over time by adjusting the function curve.



## Auto-Patch Node

T-RIG-005-001

The Auto Patch node is used mainly when creating joint patches for cut-out puppets drawn with pencil lines and painted in the Colour Art layer. Instead of removing a portion of the outline to attempt to create a seamless joint, you can draw complete pieces, and with the Auto Patch node, automatically create a perfect articulation.

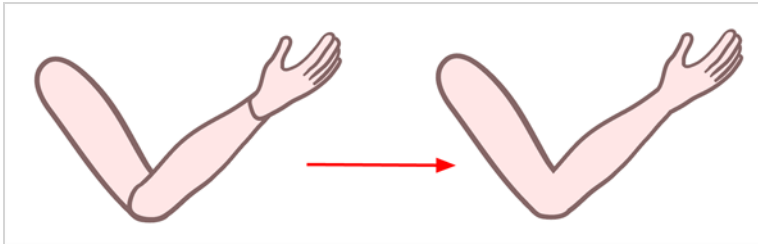

The requirements for this effect to work are:

- Drawing outlines must be drawn in pencil lines
- Drawing outlines must be drawn in the Line Art layer
- Drawing fill colours must be painted in the Colour Art layer

Pencil lines are central vector lines. The vector is located along the centre of the line. This means that when you paint a zone delimited by a pencil line, the colour fill will expand to the centre of the pencil line.

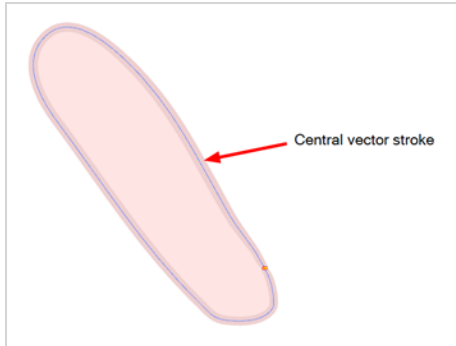

When using the regular patch technique, recommended for the brush line, the result with pencil lines is very odd looking because the colour fill zone is bigger than the pencil line inner contour.



Instead of using the regular patch method, you can use the Auto Patch node. It will automatically extract the Colour Art and clip it to the right size. Then, you can connect it in front of the piece to be covered.

The node connection for the Auto Patch is quite simple. Once your basic character rigging is done, add the Auto Patch node to the joints you want to cover. There is no need to set any parameters.

Refer to the following example to connect this effect:

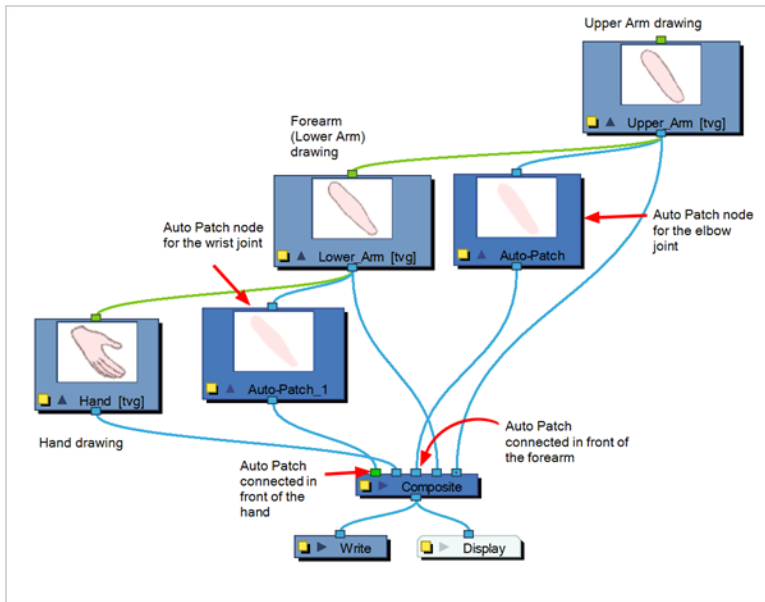

## Properties

Parameter	Description
Name	Allows you to enter a name for the node.

## Bloom Node

The Bloom effect is used to make a specular area blurrier on a bitmap image, such as street lamps at night.



## Connection

The Bloom node takes an image of any type as its input and outputs an image in which pixels that pass the threshold are softened, blurred and their gamma is adjusted.

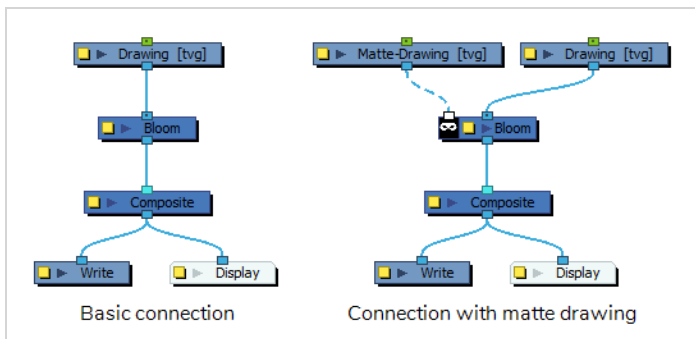

Optionally, it can also be connected to a matte image. In this case, only the parts of the input image that intersect with the matte will be affected by the effect.

The Bloom node is a combination of the Luminance Threshold, Cutter, Blur-Gaussian and Composite Generic nodes—see [Luminance Threshold Node](#) on page 579, [Cutter Node](#) on page 385, [Blur-Gaussian Node](#) on page 511, and [Composite-Generic Node](#) on page 379.

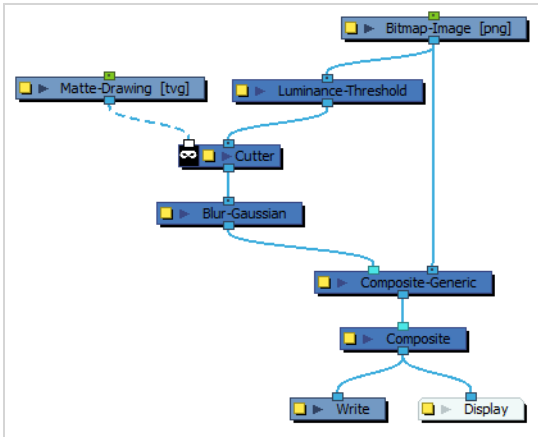

## Layer Properties

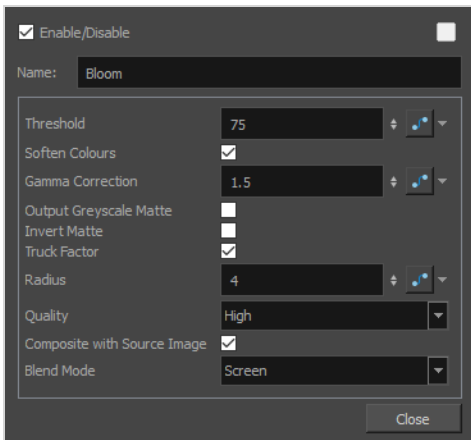

Parameter	Description
Name	Allows you to enter a name for the node.
Threshold	Controls how much of the dark value to clamp off. A high value will keep only the bright areas of your image.

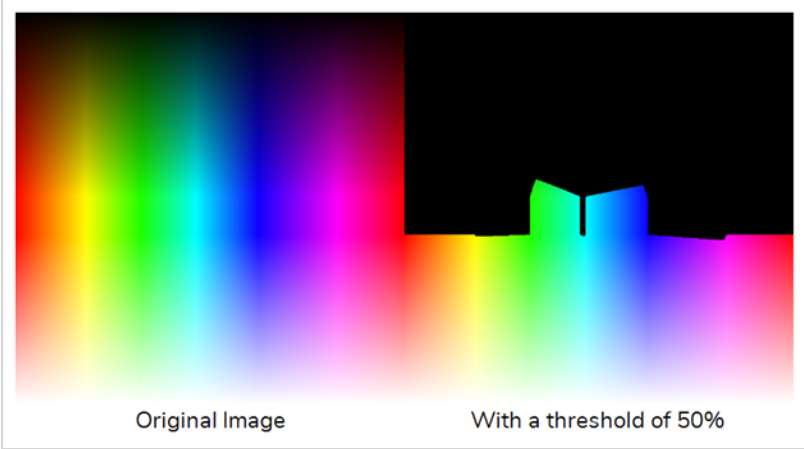
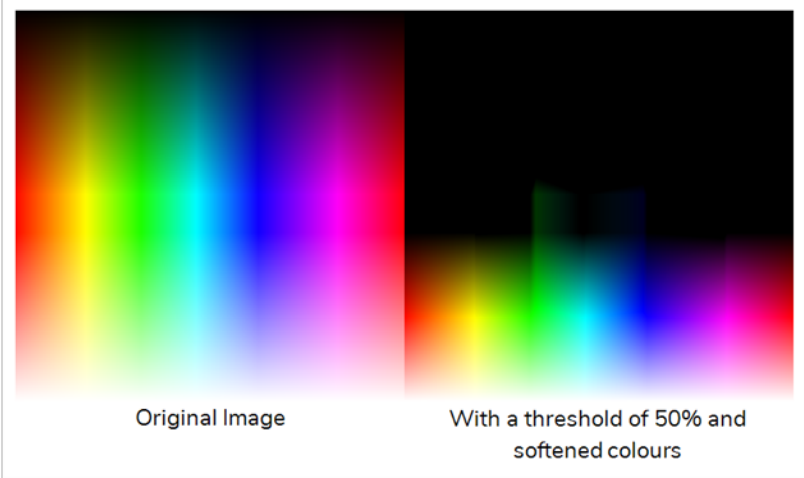
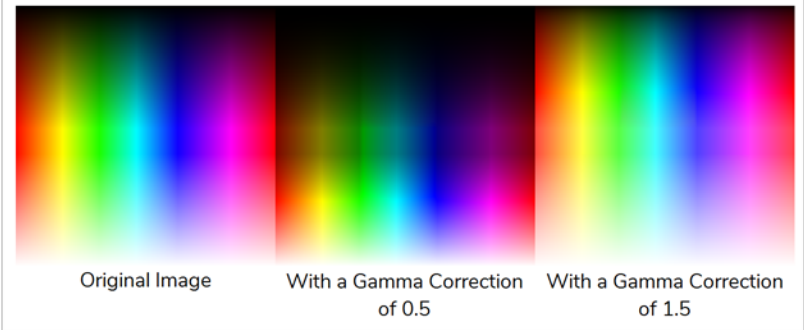
Parameter	Description
	 <p>The image shows two side-by-side color gradients. The left one is labeled 'Original Image' and shows a smooth rainbow spectrum from red to purple. The right one is labeled 'With a threshold of 50%' and shows the same rainbow spectrum, but the top portion is black, and the bottom portion is a solid, bright white, with a sharp vertical line separating the two.</p>
Soften Colours	<p>Brings back the entire spectrum of luminance in areas defined by the threshold to avoid having only bright values.</p>  <p>The image shows two side-by-side color gradients. The left one is labeled 'Original Image' and shows a smooth rainbow spectrum. The right one is labeled 'With a threshold of 50% and softened colours' and shows the same rainbow spectrum, but the top portion is black, and the bottom portion is a smooth, dark-to-bright gradient, with a sharp vertical line separating the two.</p>
Gamma Correction	<p>Multiplies the gamma value to make the area brighter or darker. A value of 1 keeps the gamma the same as the original image. You can use the gamma modification on the whole image if you use a threshold of 0 for example.</p>  <p>The image shows three side-by-side color gradients. The left one is labeled 'Original Image' and shows a smooth rainbow spectrum. The middle one is labeled 'With a Gamma Correction of 0.5' and shows a darker, more muted rainbow spectrum. The right one is labeled 'With a Gamma Correction of 1.5' and shows a brighter, more saturated rainbow spectrum.</p>

Parameter	Description
Output Greyscale Matte	Allows you output an image in levels of grey. This can be used in combination with a Blending or Cutter node, or other effects that use greyscale mattes.
Invert Matte	Inverts the matte used to generate the effect. By default, the effect is applied to the opaque areas of the matte drawing. When this option is enabled, the effect is applied to the transparent areas of the matte instead.
Truck Factor	Activated by default, this option readjusts the blur when the elements undergo a change of depth or scale. When this option is deselected, the effect's values remain unchanged regardless of any depth or scale changes. This option should be deselected when multiple drawings are composited and attached to this effect.
Radius	Adjusts the amount of blur applied to the image.
Quality	Controls the quality of the blur. A higher quality yields better results, but will be slower to render.
Composite with Source Image	Blends the area defined by the threshold with the original image.
Blend Mode	Defines the blending mode between the original image and the area defined by the threshold to avoid having to add a Composite Generic node after the Bloom node.

## Blur-Box Node

T-COMP2-003-003

The Blur - Box effect is a quick and easy way to create a blurring effect. The Box blur changes the colour value of each pixel based on the pixels next to it in the vertical and horizontal directions. The look of the blur is similar to the look achieved using Gaussian blur, but renders much faster. This effect is useful when a fast rendering time is important, and the quality of the blur is less important. Also, you can use a matte with this effect to isolate areas of the image.

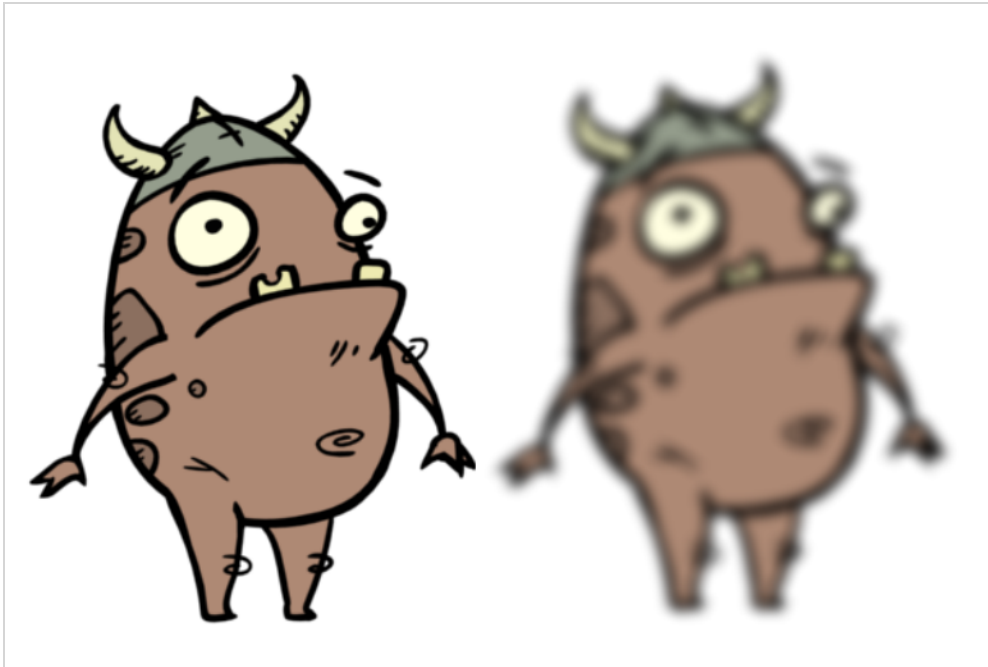

Refer to the following example to connect this effect:

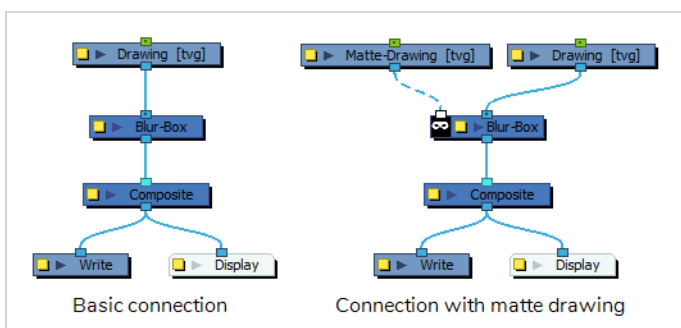

For detailed video tutorials and sample scenes by Adam Phillips, see:

<https://www.toonboom.com/resources/video-tutorials/chapter/adam-phillips-harmony-effects>

# Properties

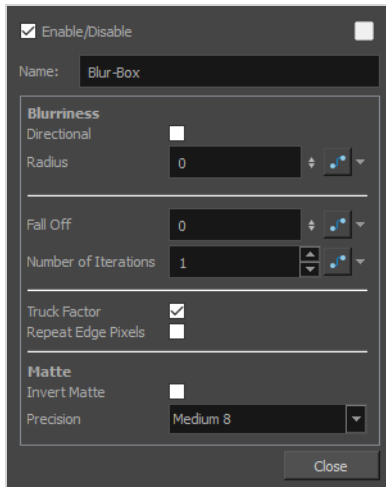

Parameter	Description
Name	Allows you to enter a name for the node.
Truck Factor	Activated by default, this option readjusts the blur when the elements undergo a change of depth or scale. When this option is deselected, the effect's values remain unchanged regardless of any depth or scale changes. This option should be deselected when multiple drawings are composited and attached to this effect.
Repeat Edge Pixels	Makes the blur algorithm operate as if the pixel values beyond the edge of the layer are the same as the values of the edge pixels. This keeps edges sharp, preventing them from darkening and becoming more transparent.
<b>Blurriness</b>	
Directional	Blurs according to the length, width, and angle you specify. For example, if a character is walking east, the blur may fall to the west.
Radius	Size of the blur. The larger the value, the greater the strength or reach of the blur. The blur radius is affected by the drawing scale and camera position. Click the Edit Curve button to change these values over time by adjusting the function curve.
Length	Length of the blur.
Width	Thickness of the blur.



Parameter	Description
Angle	The direction in which the blur is applied: sideways, up, down, 90 degrees, 45 degrees, and so on.
Bidirectional	Applies the blur on both sides of the pixel.
Fall Off	The distance where the blur fades from the edge of the image. Select a value between 0 and 1. A fall-off rate of 0 causes the blur to fade out slowly, distributing the blur evenly from the edge of the character to the farthest edge of the blur. A fall-off rate of 1 causes the blur to fade out quickly, so the blur is heaviest closer to the edge of the image.
Number of Iterations	The number of times the blur is applied to the image. A higher number of iterations creates smoother transitions between colours and increases the blur, but also increases render time.
<b>Matte</b>	
Invert Matte	Inverts the matte used to generate the effect. By default, the effect is applied to the opaque areas of the matte drawing. When this option is enabled, the effect is applied to the transparent areas of the matte instead.
Precision	Blurs the image the number of times the precision indicates at different radius (between 0 and the specified radius).

## Blur-Directional Node

T-COMP2-003-005

The Blur-Directional effect creates the effect of a motion blur that pulls and smears the image from one contour edge to a different direction or angle. This effect is useful in creating the impression of speed, such as the streaks of colour that follow a car travelling at high speed.



## Connection

The Blur-Directional node takes an image of any type as its input and outputs a blurred bitmap image.

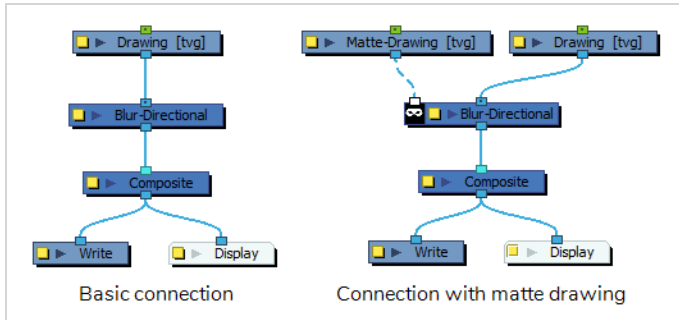

Optionally, it can also be connected to a matte image. In this case, only the parts of the input image that intersect with the matte will be affected by the effect.

## Layer Properties

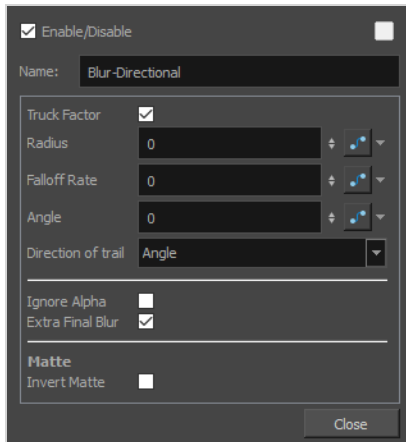

Parameter	Description
Name	Allows you to enter a name for the node.
Truck Factor	Activated by default, this option readjusts the blur when the elements undergo a change of depth or scale. When this option is deselected, the effect's values remain unchanged regardless of any depth or scale changes. This option should be deselected when multiple drawings are composited and attached to this effect.
Radius	Size of the blur. The larger the value, the greater the strength or reach of the blur. The blur radius is affected by the drawing scale and camera position. Click the Edit Curve button to change these values over time by adjusting the function curve.
Falloff Rate	The distance where the blur fades from the edge of the image. Select a value between 0 and 1. A fall-off rate of 0 causes the blur to fade out slowly, distributing the blur evenly from the edge of the character to the farthest edge of the blur. A fall-off rate of 1 causes the blur to fade out quickly, so the blur is heaviest closer to the edge of the image.
Angle	The angle of the blur. The value goes from 0 to 360, with 0 meaning west, and angles going counterclockwise. For example: <ul style="list-style-type: none"> <li>• <b>0</b>: Blurs the image to the west.</li> <li>• <b>90</b>: Blurs the image to the south.</li> <li>• <b>180</b>: Blurs the image to the east.</li> <li>• <b>270</b>: Blurs the image to the north.</li> </ul>

Parameter	Description
Direction of trail	If you do not set an Angle for the direction of the blur, you can select a direction (north, south, east, or west) from this menu. The calculations for this feature are faster than the calculations for the Angle setting.
Ignore Alpha	Controls the leading edge of the blur. Deselect this option for a solid or hard leading edge on the blur.
Extra Final Blur	Adds a second blur after the Blur-Directional is created. If you have a Blur-Directional that begins at 0 and gradually gets stronger, deselect this option to ensure a smooth progression.
Number of Iterations	The number of times the blur is applied to the image. A higher number of iterations creates smoother transitions between colours and increases the blur, but also increases render time.
<b>Matte</b>	
Invert Matte	Inverts the matte used to generate the effect. By default, the effect is applied to the opaque areas of the matte drawing. When this option is enabled, the effect is applied to the transparent areas of the matte instead.

## Blur-Gaussian Node

T-COMP2-003-002

The Blur-Gaussian effect softens the image, reducing the amount of noise and detail. The look of the Gaussian blur is smooth, but does take some rendering time. This effect is useful when rendering time is less important, and quality is more important. Also, you can use a matte with this effect to isolate areas of the image.

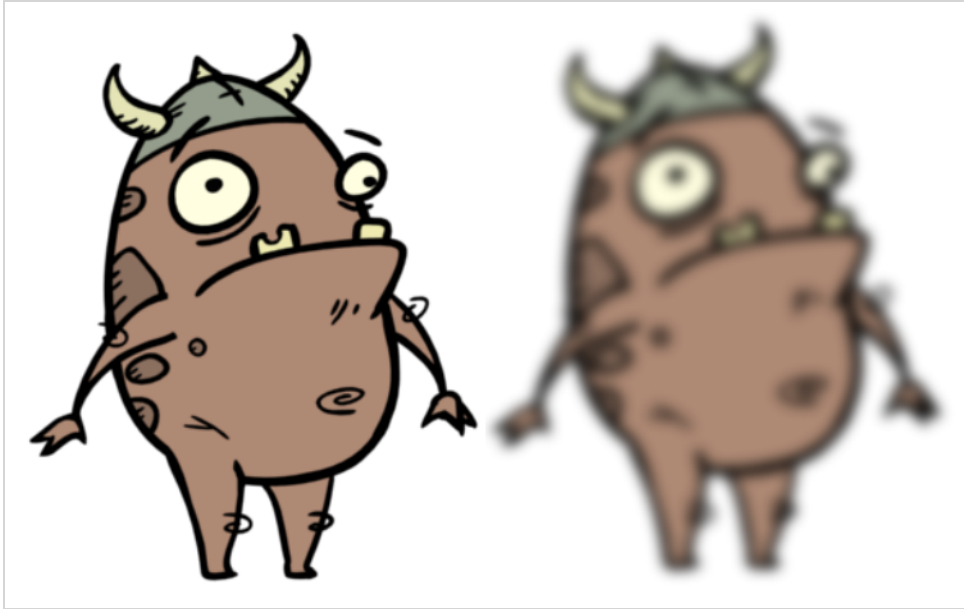

For detailed video tutorials and sample scenes by Adam Phillips, see:

<https://www.toonboom.com/resources/video-tutorials/chapter/adam-phillips-harmony-effects>

Refer to the following example to connect this effect:

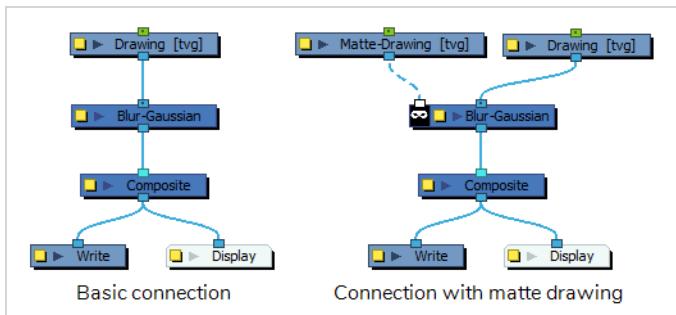

## Properties

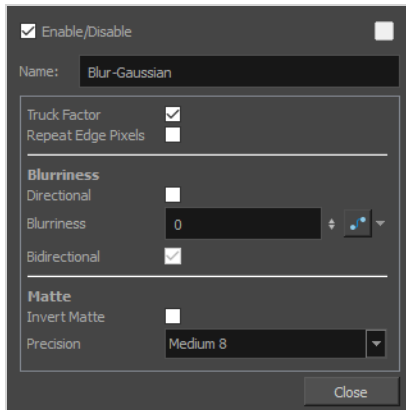

Parameter	Description
Name	Allows you to enter a name for the node.
Truck Factor	Activated by default, this option readjusts the blur when the elements undergo a change of depth or scale. When this option is deselected, the effect's values remain unchanged regardless of any depth or scale changes. This option should be deselected when multiple drawings are composited and attached to this effect.
Repeat Edge Pixels	Makes the blur algorithm operate as if the pixel values beyond the edge of the layer are the same as the values of the edge pixels. This keeps edges sharp, preventing them from darkening and becoming more transparent.
<b>Blurriness</b>	
Directional	Blurs according to the length, width, and angle you specify. For example, if a character is walking east, the blur may fall to the west.
Blurriness	Amount of blur applied to the layer.
Horizontal Blurriness	Length of the blur.
Vertical Blurriness	Thickness of the blur.
Angle	The direction in which the blur is applied: sideways, up, down, 90 degrees, 45 degrees, and so on.

Parameter	Description
Bidirectional	Blurs in both horizontal and vertical directions.
<b>Matte</b>	
Invert Matte	Inverts the matte used to generate the effect. By default, the effect is applied to the opaque areas of the matte drawing. When this option is enabled, the effect is applied to the transparent areas of the matte instead.
Precision	Blurs the image the number of times the precision indicates at different radius (between 0 and the specified radius).



## Blur-Radial Node

T-HFND-010-007

The Blur-Radial effect creates an effect that softens, fogs or obscures the image evenly in all directions. This effect is useful when you want to make cloudy images not realistically seen in detail, such as a drawing object that is farther back or in the background of your scene, usually blurry due to the laws of atmospheric perspective. Other uses include the general softening of objects such as snow, stars and shadows that do not naturally have a hard outline.

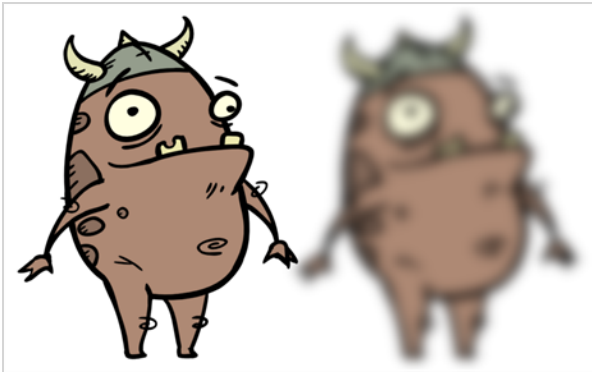

Refer to the following example to connect this effect:

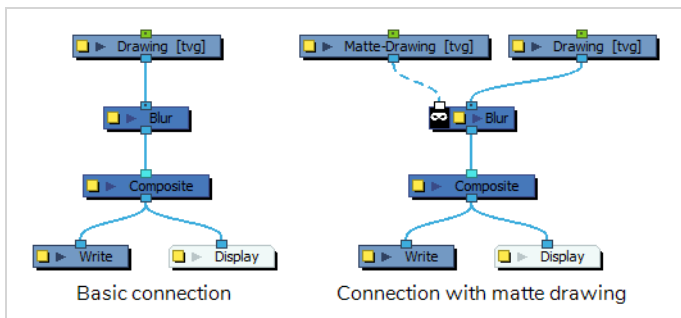

## Properties

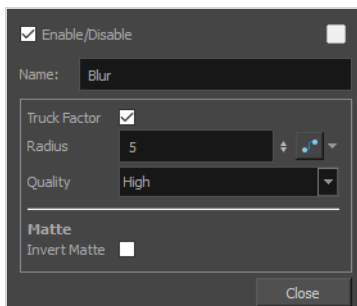

Parameter	Description
Name	Allows you to enter a name for the node.
Truck Factor	Activated by default, this option readjusts the blur when the elements undergo a change of depth or scale. When this option is deselected, the effect's values remain unchanged regardless of any depth or scale changes. This option should be deselected when multiple drawings are composited and attached to this effect.
Radius	Size of the blur. The larger the value, the greater the strength or reach of the blur. The blur radius is affected by the drawing scale and camera position. Click the Edit Curve button to change these values over time by adjusting the function curve.
Quality	Select High for a slow and accurate operation or Low for a faster operation with a more raw look.
<b>Matte</b>	
Invert Matte	Inverts the matte used to generate the effect. By default, the effect is applied to the opaque areas of the matte drawing. When this option is enabled, the effect is applied to the transparent areas of the matte instead.

## Blur-Radial-Zoom Node

T-COMP2-003-007

The Blur - Radial Zoom effect creates blurs around a centre point, simulating the look of a zooming or rotating camera. You can use a matte to isolate the area of the image from which you want the effect to radiate from. For example, in the illustration below, a circular matte was created to mask the eyeball and a Negate effect was applied so the blur is outside the matte. Then the centre point was positioned on the character's iris, which is the centre of the matte.



For detailed video tutorials and sample scenes by Adam Phillips, see:

<https://www.toonboom.com/resources/video-tutorials/chapter/adam-phillips-harmony-effects>

Refer to the following example to connect this effect:

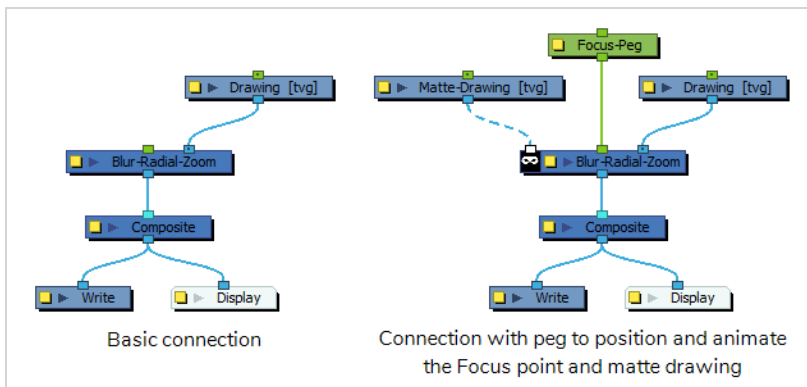

# Properties

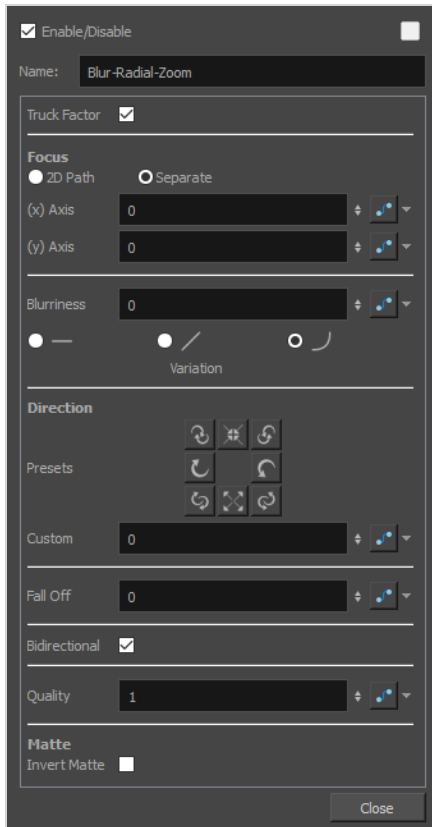

Parameter	Description
Enable/Disable	Allows you to enable or disable the node. When disabled, a node has no visible effect on the rendered image, nor on the preview in the Camera, Perspective, Side and Top views.
Colour Swatch	Sets the colour of the layer in the Timeline view and of the node in the Node view.
Name	Allows you to enter a name for the node.
Truck Factor	Activated by default, this option readjusts the blur when the elements undergo a change of depth or scale. When this option is deselected, the effect's values remain unchanged regardless of any depth or scale changes. This option should be deselected when multiple drawings are composited and attached to this effect.
Focus	The focus point is the point from which the radial-zoom blur radiates. By default, it is in the centre of the stage, but it can be positioned anywhere and it can also be animated.

Parameter	Description
	<p>If you want to animate the focus point, you can choose which type of function to use to store the animation.</p> <ul style="list-style-type: none"> <li>• <b>2D Path:</b> The horizontal and vertical position are on the same function. This makes the point move in a curvilinear trajectory between each keyframe.</li> <li>• <b>Separate:</b> The horizontal and vertical position are on separate functions. This makes the point move in a straight line between each keyframe and it allows you to modulate the trajectory differently on each axis.</li> </ul> <div data-bbox="565 663 1430 898" style="border: 1px solid green; padding: 10px;"> <p> <b>NOTE</b> The position of the Focus point is also influenced by the transformation information sent to the node's middle input (Focus Point) port. You can attach a peg to the middle input-port and position or animate the focus point by positioning or animating the peg.</p> </div>
(x) Axis	The horizontal position of the focus point.
(y) Axis	The vertical position of the focus point.
Blurriness	Amount of blur applied to the layer.
Variation	<p><b>Constant:</b> An equal, constant blur is applied on all pixels.</p> <p><b>Linear:</b> A gradual blur is applied on all pixels.</p> <p><b>Quadratic:</b> An exponential blur is applied on all pixels.</p>
<b>Direction</b>	Lets you select preset blur types or create a custom blur.
Presets	A set of preset radial, zoom, and spiral blurs to get you started. You can then adjust the type to customize the blur.
Custom	Create your own blur by entering a value for the direction of the blur lines.
Fall Off	The distance where the blur fades from the edge of the image. Select a value between 0 and 1. A fall-off rate of 0 causes the blur to fade out slowly, distributing the blur evenly from the edge of the character to the farthest edge of the blur. A fall-off rate of 1 causes the blur to fade out quickly, so the blur is heaviest closer to the edge of the image.

Parameter	Description
Bidirectional	Applies the blur on both sides of the pixel.
Quality	Affects the quality of the blur by defining how fine the reference radial grid is on the image. This determines the width of all the wedges. A higher quality yields achieve better results, but will be slower to render.
<b>Matte</b>	
Precision	Blurs the image the number of times the precision indicates at different radius (between 0 and the specified radius).

## Blur-Variable Node

T-COMP2-003-004

Use the Blur-Variable effect to create a radial blur that varies within a single image based on the white and black values in the matte you supply. You can set one blur value for the black regions in the matte, and another blur value for the white regions. The blur value for each grey region is interpolated between your black and white blur settings.

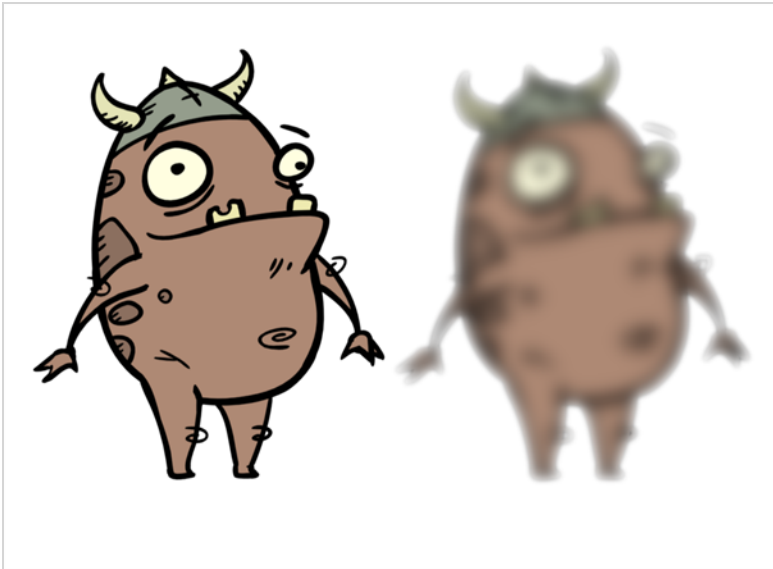

The following example is a network for a Variable Blur effect. A black and white copy of the character was used to create the effect. Use the Blur-Variable editor to control the blur value for the white and black radius.

Refer to the following example to connect this effect:

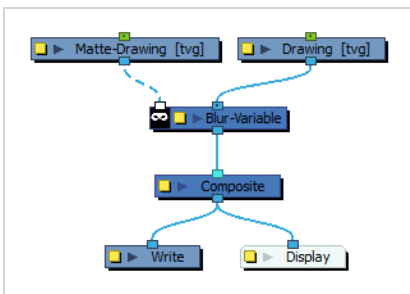

## Properties

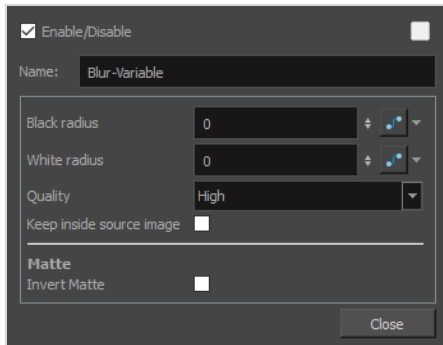

Parameter	Description
Name	Allows you to enter a name for the node.
Black radius	The amount of blur to apply to the black (transparent) values in the matte. Higher values create more blur in the colour image's regions that correspond to the black matte region.
White radius	The amount of blur to apply to the white (opaque) values in the matte. Higher values create more blur in the colour image's regions that correspond to the white matte region.
Quality	Select High for a slow and accurate operation or Low for a faster operation with a more raw look.
Keep inside source image	This option confines the blur to the source image.
<b>Matte</b>	
Invert Matte	Inverts the matte used to generate the effect. By default, the effect is applied to the opaque areas of the matte drawing. When this option is enabled, the effect is applied to the transparent areas of the matte instead.



## Brightness Contrast Node

The Brightness and Contrast effect allows you to modify the brilliance or dullness of an image or to create a greater difference between the lights and darks of an image by increasing their respective intensities. This effect can be used when an image appears too flat. Increasing the brightness or contrast can give a drawing a more attractive and 3D quality. This can be useful if you want to push your background to the rear by making it look dull and flat and pulling your foreground elements to the front by giving them a higher contrast.

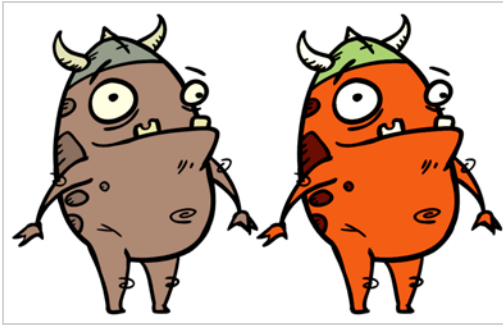

## Connection

The Brightness Contrast node takes an image of any type as its input and outputs an image with different brightness and contrast parameters.

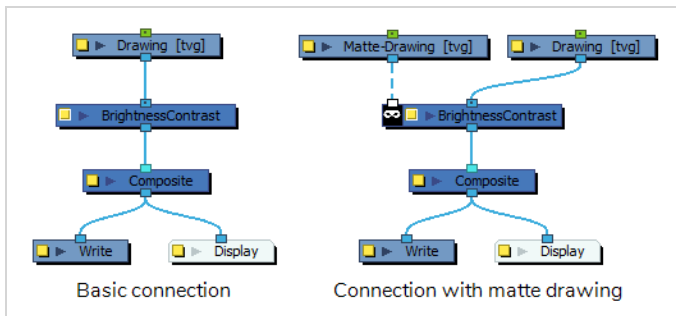

Optionally, it can also be connected to a matte image. In this case, only the parts of the input image that intersect with the matte will be affected by the effect.

## Layer Properties

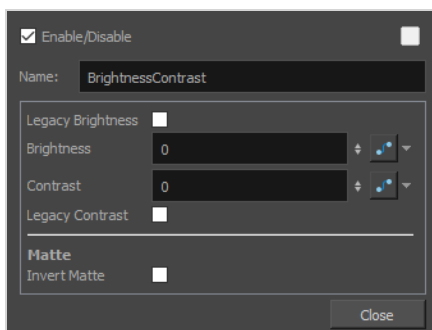

Parameter	Description
Name	Allows you to enter a name for the node.
Legacy Brightness	If you created this effect in an older version of Harmony, this option is enabled by default to prevent enhancements done to the effect in more recent versions of Harmony from affecting the rendered image.
Brightness	A value less than 0 will darken the image; a value greater than 0 will brighten it. Attach a Bezier or Ease function to change the brightness over time.
Contrast	A value less than 0 will reduce contrast; a value greater than 0 will increase contrast. Attach a Bezier or Ease function to change the contrast over time.
Legacy Contrast	If you created this effect in an older version of Harmony, this option is enabled by default to prevent enhancements done to the effect in more recent versions of Harmony from affecting the rendered image.
<b>Matte</b>	
Invert Matte	Inverts the matte used to generate the effect. By default, the effect is applied to the opaque areas of the matte drawing. When this option is enabled, the effect is applied to the transparent areas of the matte instead.

## Channel Selector Node

The Channel Selector effect allows you to filter out some of the colour channels in an image.

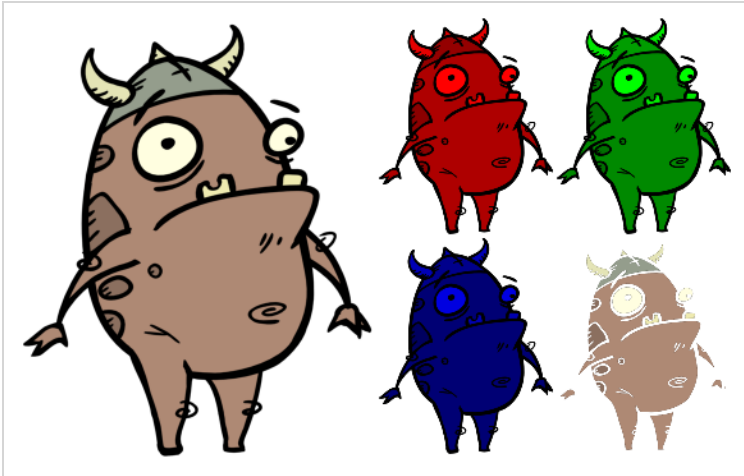

Refer to the following example to connect this effect:

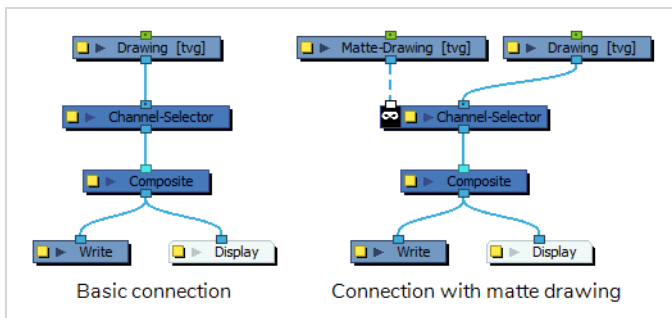

## Properties

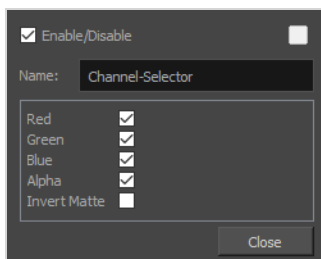

Parameter	Description
Name	Allows you to enter a name for the node.
Red	Allows the red values to go through.

Parameter	Description
Green	Allows the green values to go through.
Blue	Allows the blue values to go through.
Alpha	<p>Allows the alpha values to go through.</p> <div data-bbox="565 527 1430 726" style="border: 1px solid #c8e6c9; padding: 10px;"> <b>NOTE</b> When this parameter is disabled, the input image is composited with the scene as if the alpha value of each pixel was the sum of the red, green and blue values.</div>
Invert Matte	Inverts the matte used to generate the effect. By default, the effect is applied to the opaque areas of the matte drawing. When this option is enabled, the effect is applied to the transparent areas of the matte instead.

## Channel Swap Node

The Channel Swap effect lets you take the image information from one channel and use it in another channel to achieve interesting effects. You can extract the following: red, green, blue, alpha values, hue, saturation, lightness, and luminance, as well as turn the information on or off.

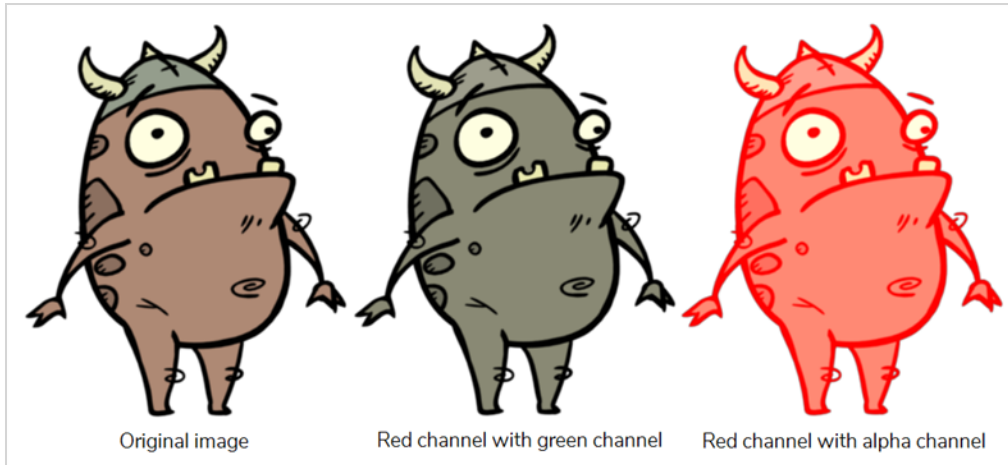

For detailed video tutorials and sample scenes by Adam Phillips, see:

<https://www.toonboom.com/resources/video-tutorials/chapter/adam-phillips-harmony-effects>

Refer to the following example to connect this effect:

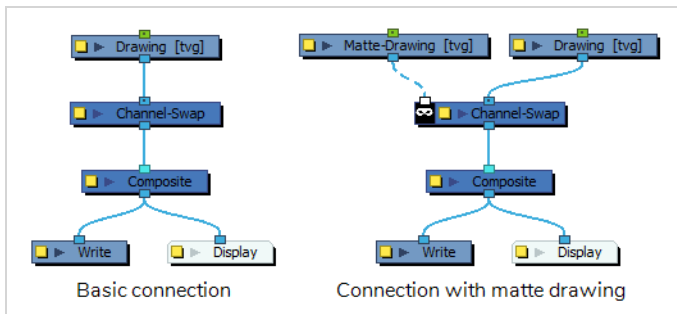

## Properties

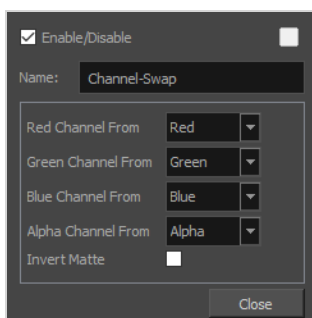

<b>Parameter</b>	<b>Description</b>
Name	Allows you to enter a name for the node.
Red Channel From	Allows you to select from which channel to get the red values.
Green Channel From	Allows you to select from which channel to get the green values.
Blue Channel From	Allows you to select from which channel to get the blue values.
Alpha Channel From	Allows you to select from which channel to get the alpha values.
Invert Matte	Inverts the matte used to generate the effect. By default, the effect is applied to the opaque areas of the matte drawing. When this option is enabled, the effect is applied to the transparent areas of the matte instead.

## Chroma-Keying Node

The Chroma-Keying effect lets you create an alpha channel (transparency zone) for a bitmap image or image sequence. For example, if you have a series of bitmap images with a character filmed on a green or blue screen, you can use this node to create an alpha channel based on the screen colour and cut it out from your image sequence.



Refer to the following example to connect this effect:

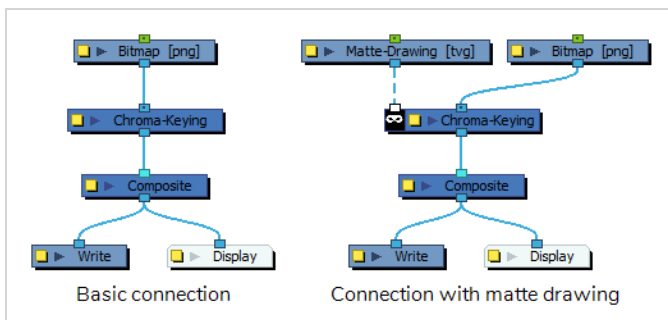

### NOTES

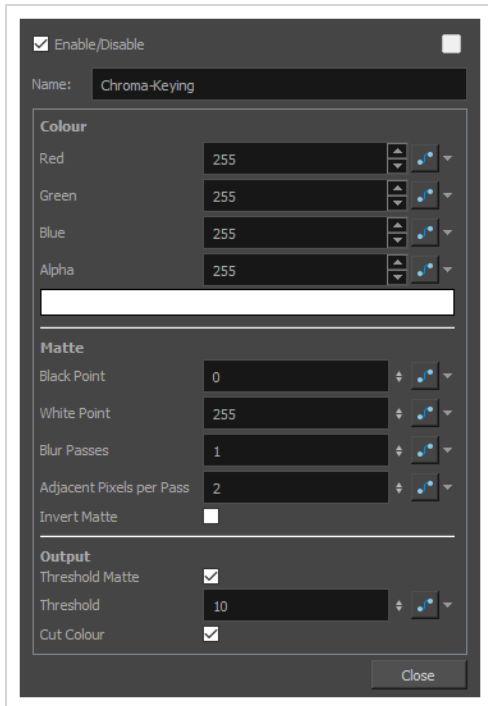

- The input image must be a bitmap image.
- If a matte drawing is connected to the Chroma-Keying node, only the parts of the input image that intersect with the matte will be keyed out.

# Properties





Parameter	Description
Name	Allows you to enter a name for the node.
<b>Colour</b>	
Colour	<p>The colour to filter out of the image. This should be set to the colour of the background in the image.</p> <ul style="list-style-type: none"> <li>• <b>Red:</b> The red value of the background colour.</li> <li>• <b>Green:</b> The green value of the background colour.</li> <li>• <b>Blue:</b> The blue value of the background colour.</li> <li>• <b>Alpha:</b> The alpha value of the background colour.</li> </ul>
Colour Swatch	Opens the Colour Picker dialog, in which you can visually select a colour for the effect.

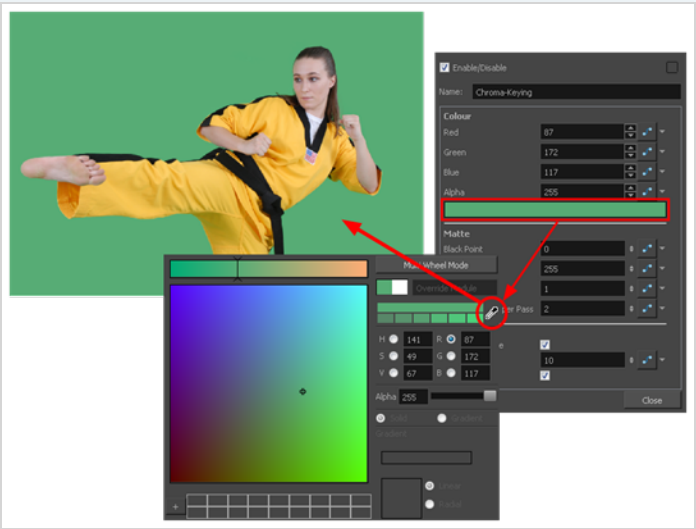

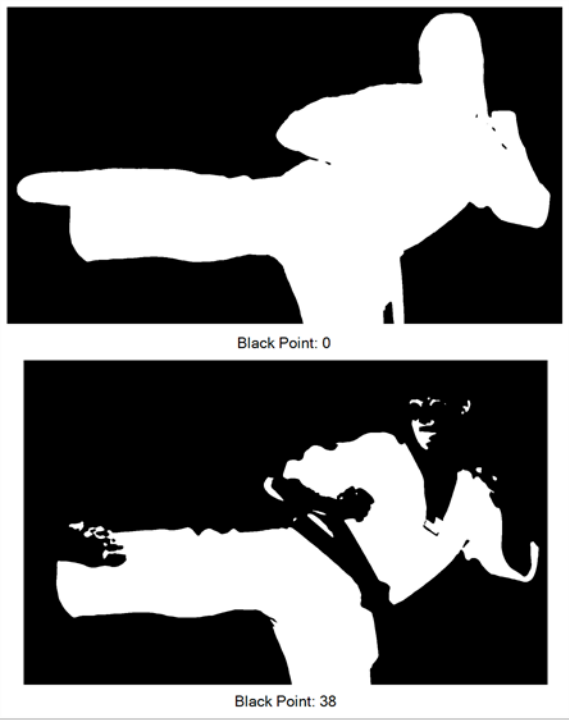
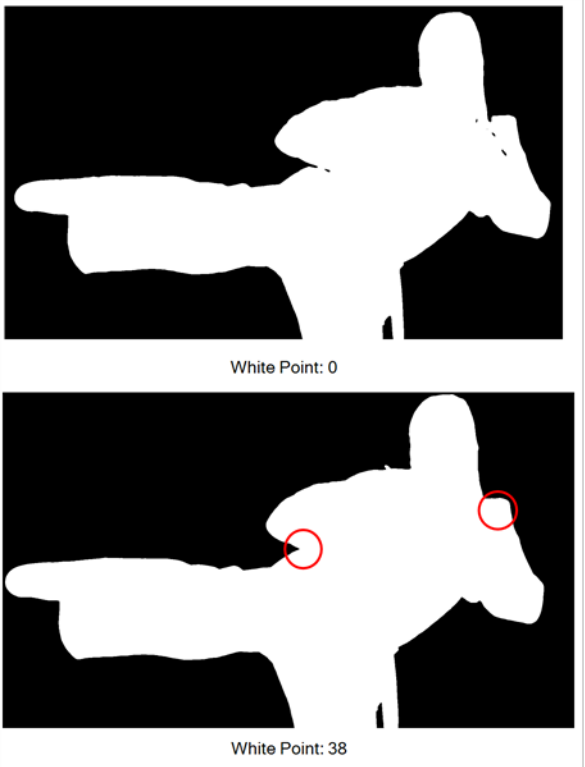
Parameter	Description
	<p> <b>TIP</b></p> <p>Since the Chroma Key node works better if its colour is set to the exact colour of the background of your image, it is recommended to open the Colour Picker dialog, then click and drag on the Dropper  and drop it over the background of your image to instantly select its background colour.</p> 
<b>Matte</b>	
Black Point	Increases the transparent (black) portion of the Chroma Key matte. This will reduce the edge of the visible image.

Parameter	Description
	<div data-bbox="565 285 1130 999" style="border: 1px solid black; padding: 10px;">  <p style="text-align: center;">Black Point: 0</p> <p style="text-align: center;">Black Point: 38</p> </div>
<p>White Point</p>	<p>Reduces the transparent (black) portion of the Chroma Key matte. This will increase the edge of the visible image.</p> <div data-bbox="565 1140 1146 1902" style="border: 1px solid black; padding: 10px;">  <p style="text-align: center;">White Point: 0</p> <p style="text-align: center;">White Point: 38</p> </div>

Parameter	Description
Blur Passes	<p>Allows you to set the number of times the input image is blurred before it is processed, which smooths out the small areas.</p> 
Adjacent Pixels per Pass	<p>When blurring the matte edge's with the Blur Passes parameter, the Adjacent Pixel parameter will blur the matte border with the next few pixels (amount indicated in the field) to create a nicer edge.</p>  <p style="text-align: center;">Adjacent Pixel: 0                      Adjacent Pixel: 2</p>
Invert Matte	<p>If a matte drawing is connected to the node, by default, only parts of the input image that intersect with opaque areas of the matte drawing are keyed out. If this option is enabled, only parts of the input image that intersect with transparent areas of the matte drawing are keyed out.</p>
<b>Output</b>	
Threshold Matte	<p>Applies a threshold (tolerance) to the selected colour to be removed. The Threshold amount is set in the Threshold field.</p>
Threshold	<p>Increases or decreases the tolerance for the selected colour to be removed from the image. The higher the value, the more coloured pixels will be considered in the Chroma-Keying matte. The pixel colour value will not have to be as close to the RGB value as the one selected in the colour swatch. A lower Threshold value means the RGB values must be closer to the selected colour in order to be part of</p>

Parameter	Description
	 <p>the matte.</p>
Cut Colour	<p>Removes the selected colour from the image and leaves a transparent zone so you can see the background and other layers behind the image. If the option is disabled, the colour will remain, but an alpha channel is created that you can use with any other nodes with a a Matte input.</p>

## Colour Banding Node

Use the Colour Banding effect to add a colour banding visual effect to your elements. The node will associate a flat colour to the different regions of your element. These regions are delimited according to the alpha values that are set up in the effect node and which will be recognized on the original element. You can use this effect to change the visual style of a particle node, for example, by giving it a more cartoonish look.

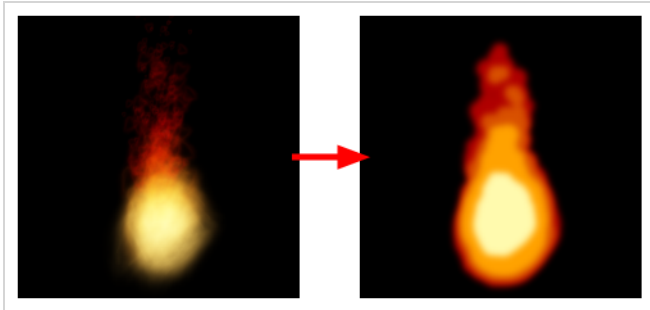

In this example, a Colour Banding node has been connected to a fire created with particle effects.

Refer to the following example to connect this effect:

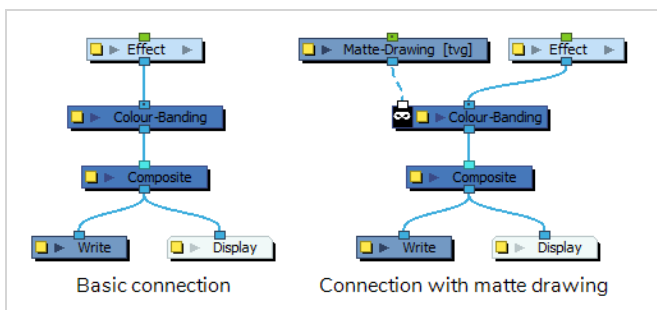

## Properties

The Colour Banding node requires you to configure it with four colours, and to assign each of these colours with a threshold. Colours with a high threshold will replace brighter areas of the input image, and colours with a low threshold will replace its darker areas. Hence, the order in which you configure these colours does not matter.



### TIP

If you only want to use 1, 2 or 3 colours, you can exclude a colour by setting its threshold to 100.

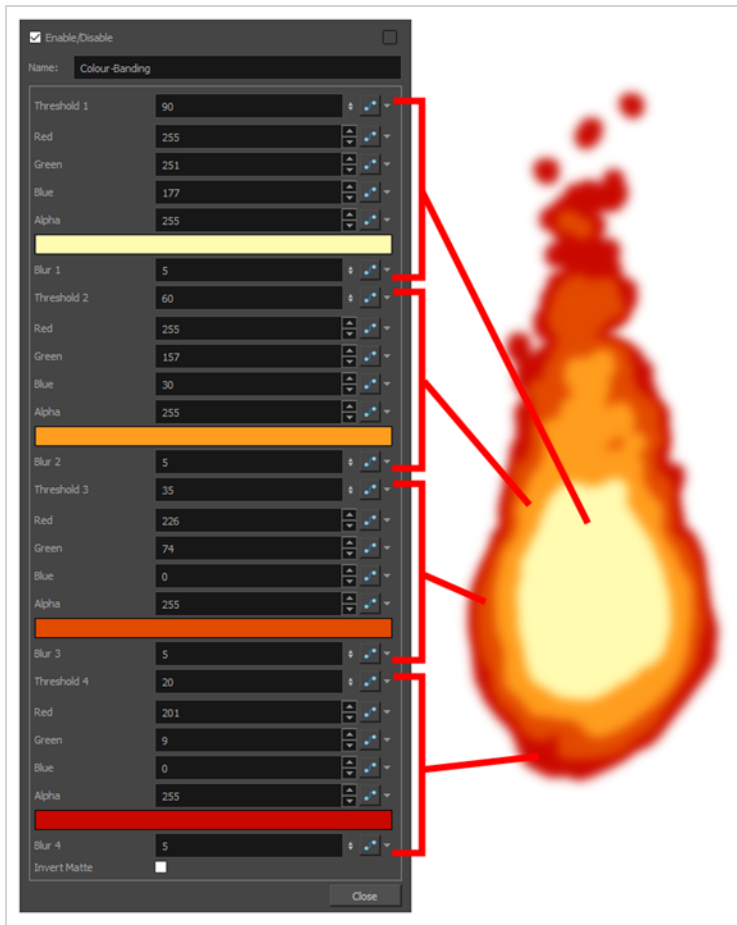

Parameter	Description
Name	Allows you to enter a name for the node.
Threshold	<p>The minimum value required in the source pixel for this colour to replace the source image colour. The threshold can be set to a value between 0 and 100. A high setting will make the colour replace brighter areas of the input image, whereas a low setting will make it replace darker areas.</p> <p>Colours are applied on the output image in order of their threshold. The colour with the lowest threshold is applied first, then the one with the second lowest threshold is applied over it, followed by the one with the second highest threshold and finally the one with the highest threshold.</p> <p>Setting this parameter to 100 will remove the colour from the effect, allowing you to use less than four colours if preferred.</p>
Colour	<p>The colour with which to fill the zone that exceeds the threshold:</p> <ul style="list-style-type: none"> <li>• <b>Red:</b> The amount of red in the colour.</li> <li>• <b>Green:</b> The amount of green in the colour.</li> </ul>

Parameter	Description
	<ul style="list-style-type: none"><li>• <b>Blue:</b> The amount of blue in the colour.</li><li>• <b>Alpha:</b> The amount of alpha in the colour.</li></ul>
Colour Swatch	Opens the Colour Picker dialog, in which you can visually select a colour for the zone.
Blur	The amount of blurriness to apply to the zone.
Invert Matte	Inverts the matte used to generate the effect. By default, the effect is applied to the opaque areas of the matte drawing. When this option is enabled, the effect is applied to the transparent areas of the matte instead.

## Colour Art Node

The Colour-Art effect lets you isolate the colour art in a layer. Placing a Colour Art node after a drawing node in the Node view only displays the Colour Art output. You can connect the Colour-Art node after nodes of any type. Any bitmap information will pass through the node and be processed.



This effect will only work if there is something on the Colour Art layer of the drawing.

Refer to the following example to connect this effect:

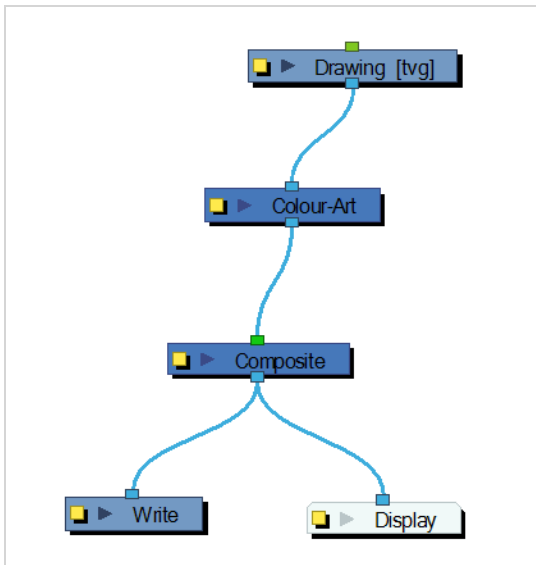



## Properties

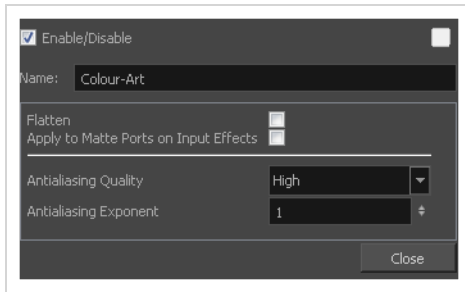

Parameter	Description
Name	Allows you to enter a name for the node.
Flatten	<p>When placing the node below a Composite node containing several drawing nodes, such as a cut-out character, you can use this option to flatten the extracted result. For example, when extracting a series of outlines, parts that may have been hidden by colour fills might now be visible. Enable the Flatten option to cut the extra artwork. Harmony will use the colour fills to cut unnecessary artwork. If your zones are not painted, nothing will be cut. This option works with both pencil lines and brush strokes.</p>
Apply to Matte Ports on Input Effects	At times, you may have situations where your node is placed below a Cutter node using a mask input and a drawing input. By default, the effect only processes the colours in the drawing input. The mask drawing remains untouched. If you want to also filter the mask drawing, select the <b>Apply to Matte Ports on Input Effects</b> option.
Antialiasing Quality	Smoothness setting applied to Colour-Art. Choose from Low (no antialiasing), Medium Low, Medium and High (extensive antialiasing). The higher the setting, the greater the amount of antialiasing applied. Higher quality images require more time to render and more memory from your system. Use a lower quality when rendering a pencil test.
Antialiasing Exponent	Controls the extent of the area around the Colour-Art edges used in the antialiasing process. A higher value uses less area, resulting in sharper edges,

	<p>while a lower value uses more area, resulting in softer edges. If the Antialiasing Quality value is set to Low (no antialiasing), this value is ignored.</p>
--	---

## Colour-Override Node

The Colour-Override effect processes the colours in a drawing layer. Using this effect, you can change colours from the palette without affecting the actual palette, swap clone palettes, or even replace a specific colour zone. You can also substitute colour areas with bitmap textures. The drawings in this layer must be .tvg files as the Colour-Override uses the colour palettes linked to them.

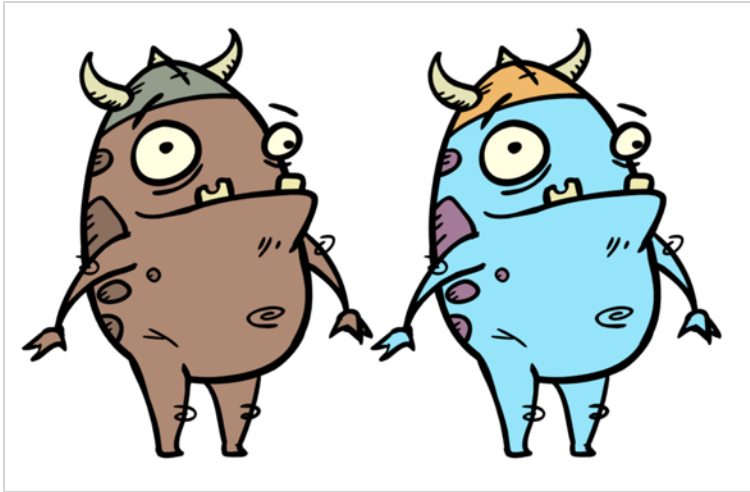

The Colour-Override effect lets you:

- Change colour values in drawings during the compositing process.
- Use colour values from a specific colour palette in the palette list.
- Establish the priority of override palettes in the palette list. For example, you may have different clones of the same palette, such as a daytime and nighttime version.
- Isolate specific areas of a drawing by selecting certain colours. For example, using specific colours to generate a matte for a glow effect.
- Hide certain colours.

Refer to the following example to connect this effect:

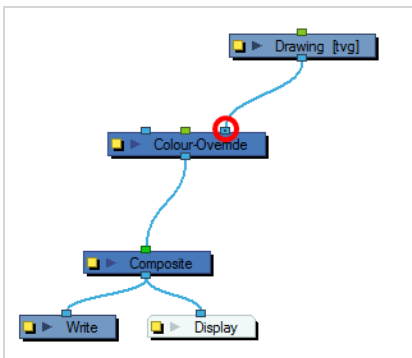

## Interface

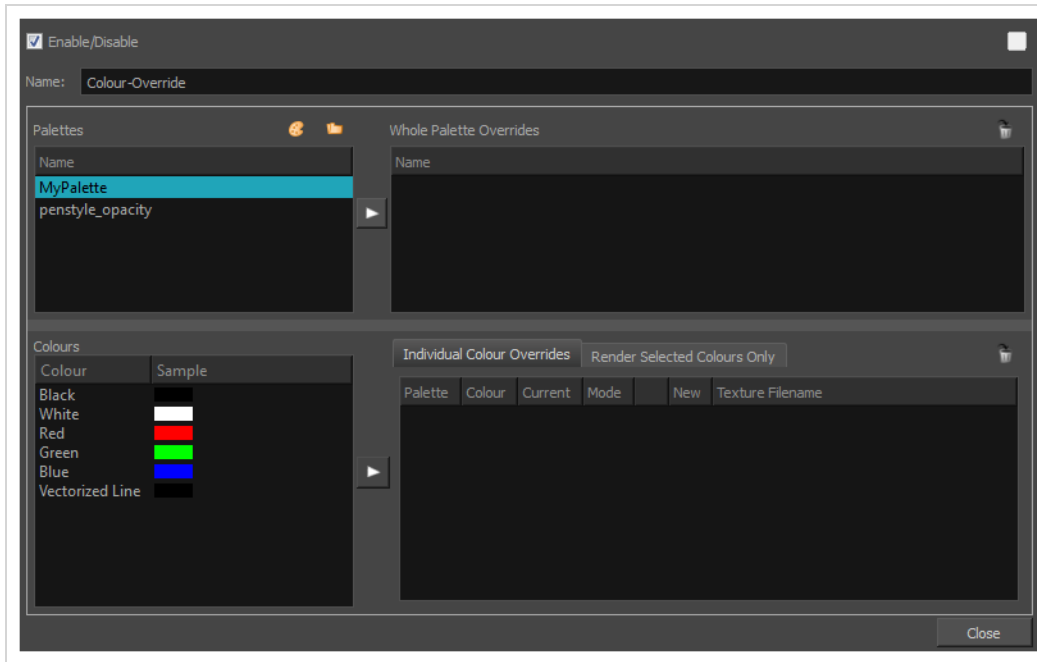

## Palettes

The Palettes section displays the palettes in the palette list of the selected layer. You can move these palettes into the Whole Palette Overrides section to reorder them. If you have cloned palettes, the higher one in the list will override the others. This is useful for overriding the clone palette ordering set in the scene through the Colour view.

You can load additional palettes in the palette list from either your project, by clicking on The Palette 🧠 button, or your computer by clicking on the Browse 📁 button.

- The Palette 🧠 button allows you to load a palette contained within the project hierarchy (Environment, Job, Scene and Elements).
- The Browse 📁 button allows you to load a palette located outside the project hierarchy, anywhere on your system or server. If you link to a palette outside of your project, you will be prompted with the following warning message:

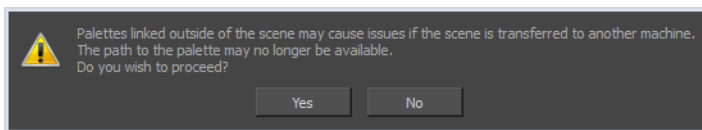

You can hover your mouse over the palette name in any of the override sections to display the path to the palette.

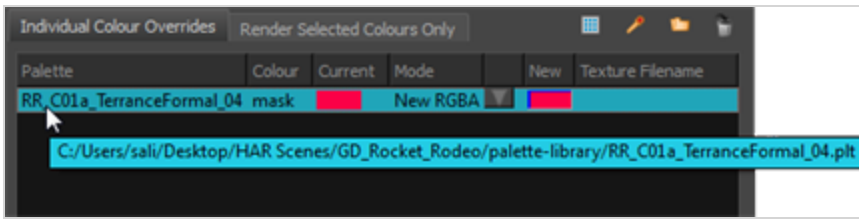

## Colours

The Colours section displays the colour swatches of the selected palette. Move a swatch into the Colour-Overrides section to change its value.

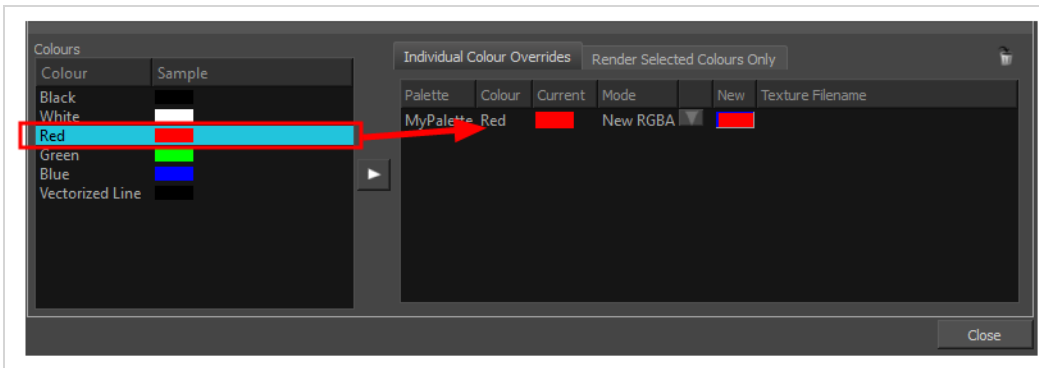

## Whole Palette Overrides

The Whole Palette Overrides section forces the use of a particular palette (clone palette) or palette list ordering during the compositing process. You must drag palettes from the Palettes section to change their order. Harmony uses the palettes in the order they appear in the palette list to find the colour values associated with the colour IDs of each colour zone. To apply a different version of a colour palette to, for example, switch from a day to a night palette, use the Override section to change the order of the colour palettes (you must be working with cloned palettes).

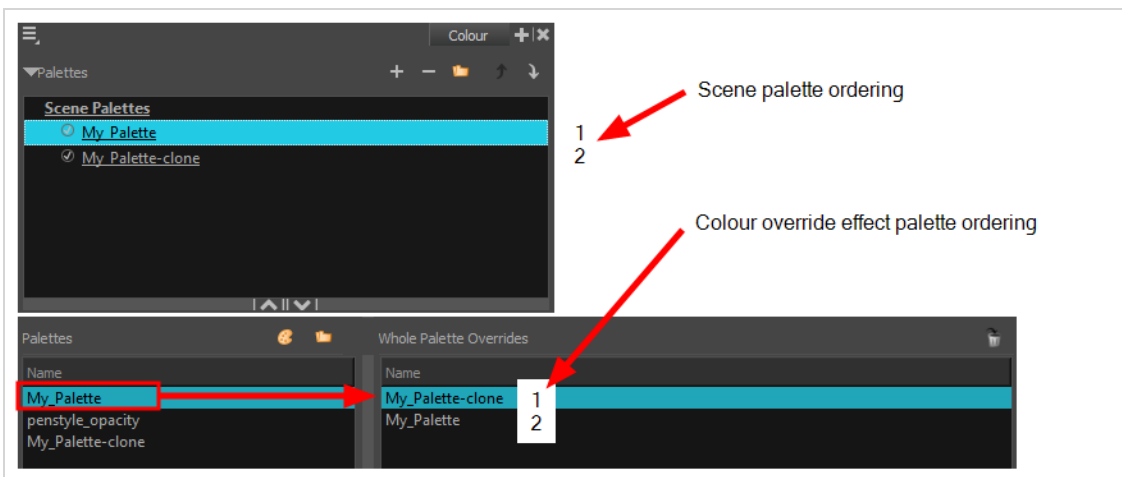

## Individual Colour Overrides

When you drag a swatch from the Colours section to this section, you can override its value. You can also override a colour with a texture. The default override mode is set to New RGBA so you can override the RGB value as well as the transparency value.

The Current column always displays the colours from the currently active palette. Selecting a clone palette in the Palettes area will not change the colours if you haven't changed the active palette in the Whole Palette Overrides section. The update will be done once you close and reopen the Colour Override Layer Properties window.

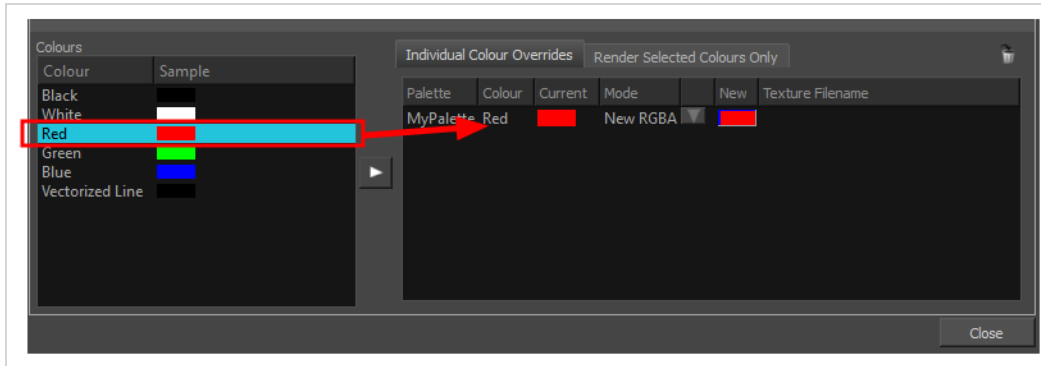

## Render Selected Colours Only

The Render Selected Colours Only section is used to display some colours and ignore all others. You may, for example, want to display only the colour used for the character outline and ignore all the filling colours.

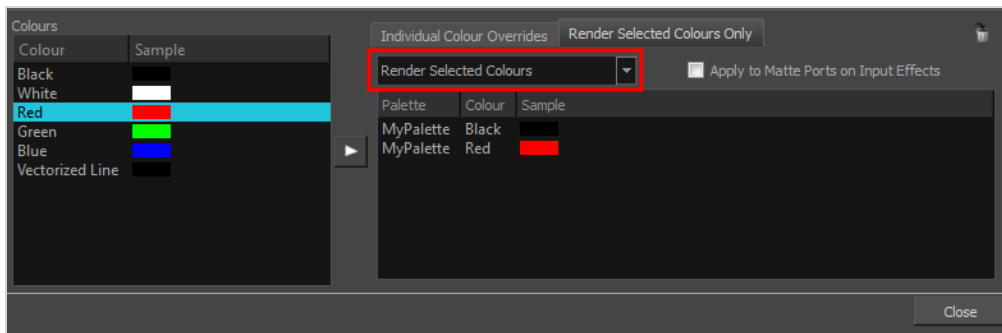

Only the colour swatches listed in the Rendered Selected Colours Only section will be rendered. The option is not activated by default. If you want to display only the selected colours, you must select the correct option from the Rendering menu:

- **Render All:** This is the default option. All colours in the palettes are rendered regardless of the listed selection. This allows you to quickly switch back and forth between your selection of colours and all the colours without having to delete and add your swatches from and to the list.
- **Render Selected Colours:** When this option is selected, the Colour Override module displays only the colours listed in your selection.

- **Rendered Selected Colours and Bitmaps:** This option displays all colours listed as well as any bitmap images passing through the Colour Override node. For example, if you have a Composite node grouping a series of drawing and bitmap nodes, the vector colours will be filtered through the Colour Override nodes but the bitmap images will pass through without being affected. Note that you must be in Render View mode to see the colours and bitmaps.

You might have situations where your Colour Override node is placed below a Cutter node using a mask input and a drawing input. By default, the Colour Override only processes the colours in the drawing input. The mask drawing remains untouched. If you want the Colour Override to also filter the mask drawing, select the **Apply to Matte Ports on Input Effects** option.

## Colour-Scale Node

The Colour-Scale effect offsets an image's colours. This effect is useful in creating ambient transitions, such as from daytime to nighttime.

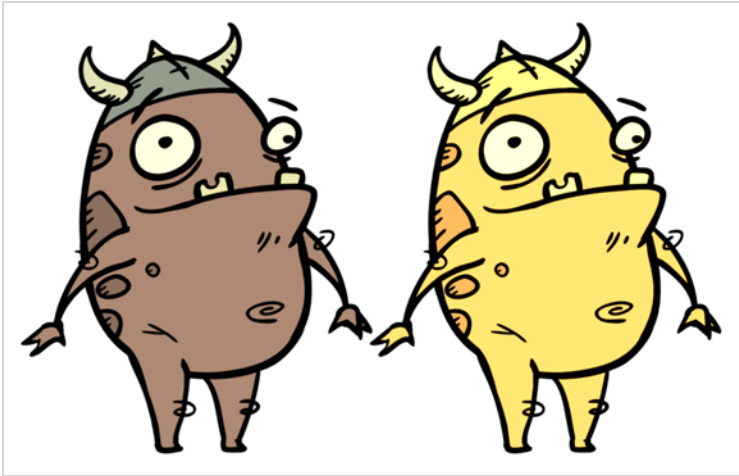

Refer to the following example to connect this effect:

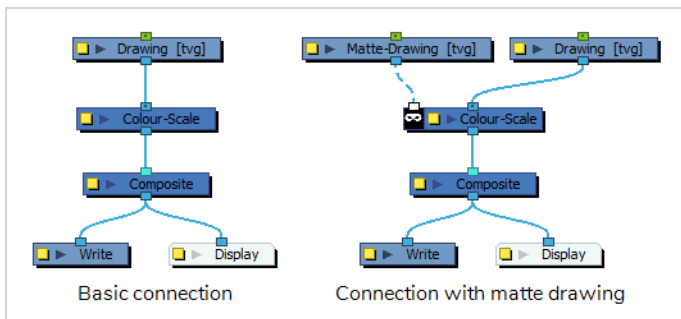

## Properties

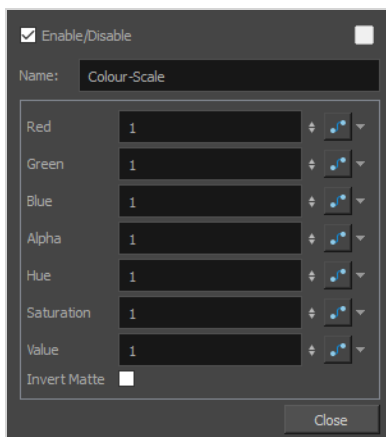



Parameter	Description
Name	Allows you to enter a name for the node.
Red	The factor by which to multiply red values in the image.
Green	The factor by which to multiply green values in the image.
Blue	The factor by which to multiply blue values in the image.
Alpha	The factor by which to multiply alpha values in the image.
Hue	The colour or hue to offset the image.
Saturation	The amount of colour to offset the image.
Value	<p>Enter the value for the colour to offset the image. The actual colour values of the image are not changed; instead, the channels are multiplied by a selected amount. For example:</p> <ul style="list-style-type: none"> <li>• A value of 1 does not change the colour values.</li> <li>• A value greater than 1 brings the colour channel value closer to 255 (or white).</li> <li>• A value less than 1 brings the colour channel value closer to zero (0 or black).</li> </ul>
Invert Matte	Inverts the matte used to generate the effect. By default, the effect is applied to the opaque areas of the matte drawing. When this option is enabled, the effect is applied to the transparent areas of the matte instead.

## Colour Selector Node

The Colour Selector node filters colours in the input image and outputs an image containing only the selected colours. The colours to display can be selected in the Layer Properties of the Colour Selector.

The Colour Selector does not just cut out the colours that are not selected from the input image, it outputs the image it is connected to as if these colours were invisible. Hence, if two brush strokes with different colours overlay each other, and the colour of the overlaying brush stroke is filtered out, the underlay brush stroke will not be cropped, it will display as if the overlay stroke did not exist.

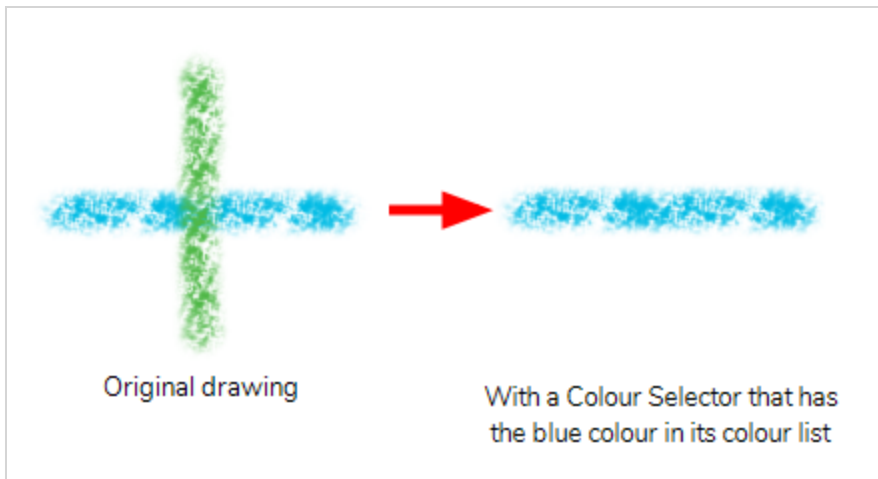

### NOTE

The Colour Selector node works exactly as when using the Render Selected Colours Only tab of the Colour Override node, except that it is made for that specific purpose, allowing the use of this feature to be more simple and streamlined.

## Connection

To use the Colour Selector, simply connect it as the intermediary between an image output (such as a drawing or composite's output port) and an image input (such as a composite's input port):

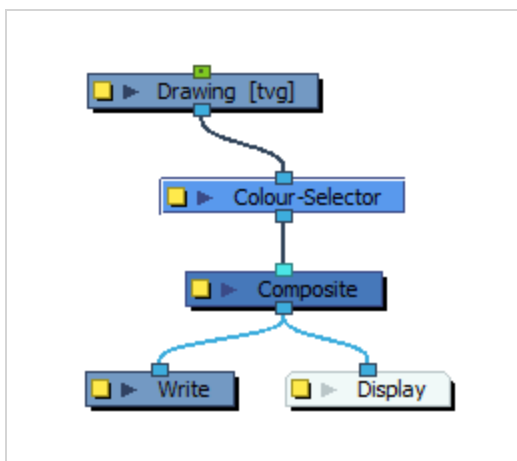

The Colour Selector node will take the input image and output the image without the colours that are not in its colours list in its layer properties. By default, no colours are in the Colour Selector's list, so the output image will be completely invisible until colours are added.

## Properties

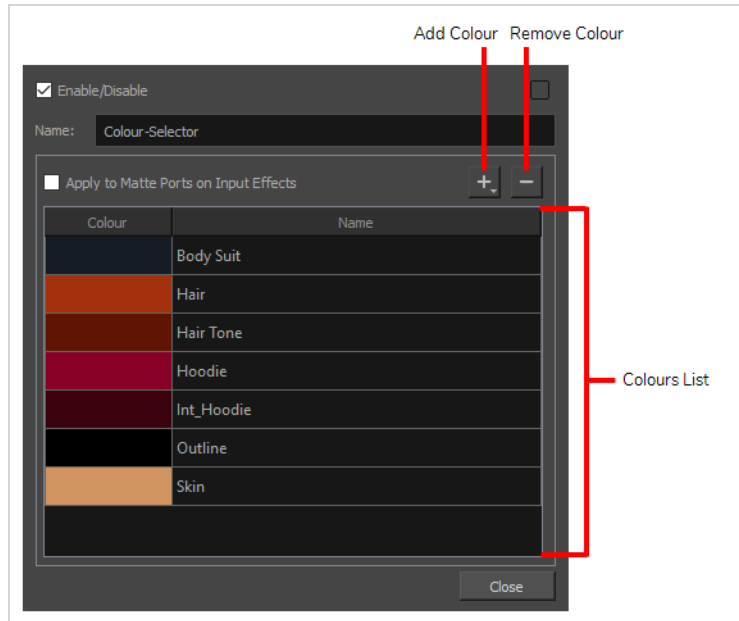

Parameter	Description
Name	Allows you to enter a name for the node.
Apply to Matte Ports on Input Effects	By default, the Colour Selector does not filter out colours in drawings that are connected to the matte port of a node. This is because drawings connected to a matte port are used for their shape and transparency levels, and not their colours. If this option is checked, the Colour Selector will filter out the colours that are not in the list, even in drawings that are connected to a matte port.
Add Colour Menu	<p>The Add Colour menu allows you to add colours to the list of selected colours. You must add colours to the list for the Colour-Selector to know which colours to let through.</p>

	<p>The Add Colour menu has three sections:</p> <ul style="list-style-type: none"><li>• <b>The palette list:</b> The first section lists all palettes in the scene. When you select one of the palettes, it will list all the colours in that palette. This allows you to add any colour available in your scene to the list of selected colours.</li><li>• <b>The drawing list:</b> The second section lists all drawings connected to the Colour Selector node. When you select a drawing, it will only list the colours used by that drawing. This allows you to quickly select a colour that is used by one of the drawings being filtered, without having to go through every colour in the scene.</li><li>• <b>Add All Colours:</b> This option will instantly add all colours used by all drawings connected to the Colour Selector node. You can then remove the colours you want to hide using the Remove Colour button. This can be useful if you only want to filter out a few of many colours.</li></ul>
Remove Colour	Removes the selected colour from the list.
Selected colour list	The list of colour that the Colour Selector will let through. Every other colour in the input image will be filtered out.

## Contrast Node

Use the Contrast effect to increase or decrease the level of contrast in an image. This is done by changing the contrast in the dark and bright pixels and setting the transition point between dark and bright.

You can enter static values in the dialog box fields or you can attach these values to function curves to change over time.



Refer to the following example to connect this effect:

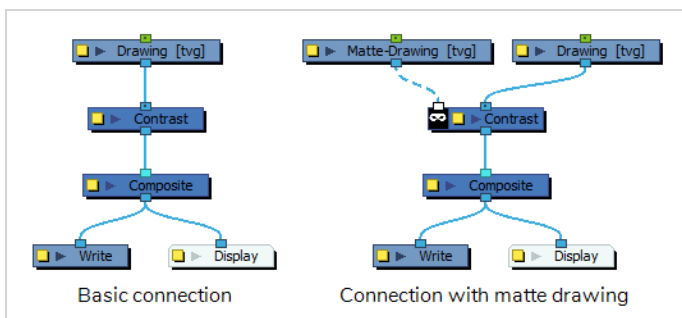

## Properties

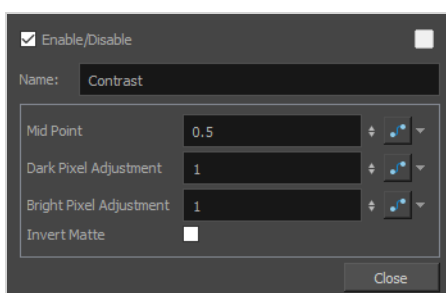

Parameter	Description
Name	Allows you to enter a name for the node.
Mid Point	<p>The value that separates dark from bright colours. The midpoint is a value between 0 and 1 that represents the percentage of the 0 to 255 RGB channel range.</p> <ul style="list-style-type: none"><li>• <b>Pixels with colour values lower than the midpoint:</b> These are considered dark pixels.</li><li>• <b>Pixels with colour values higher than the midpoint:</b> These are considered bright pixels.</li></ul>
Dark Pixel Adjustment Bright Pixel Adjustment	<p>The amount of contrast to be applied to pixels that fall on either side of the Mid Point value.</p> <ul style="list-style-type: none"><li>• <b>A value equal to 1:</b> No change.</li><li>• <b>A value less than 1:</b> Makes the pixel brighter.</li><li>• <b>A value greater than 1:</b> Makes the pixel darker.</li></ul>
Invert Matte	Inverts the matte used to generate the effect. By default, the effect is applied to the opaque areas of the matte drawing. When this option is enabled, the effect is applied to the transparent areas of the matte instead.

## Dither Node

Dithering is the process of approximating a higher number of colours in a low bit-depth colour system. Use the Dither effect to give the appearance of greater colour variability in 8-bit per channel colour images.

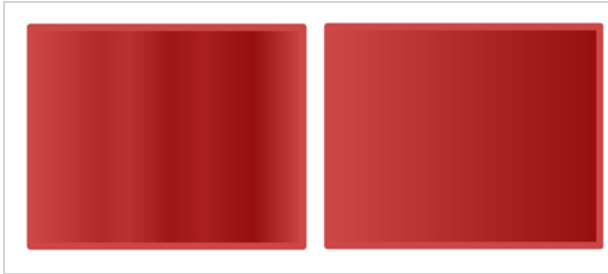

Refer to the following example to connect this effect:

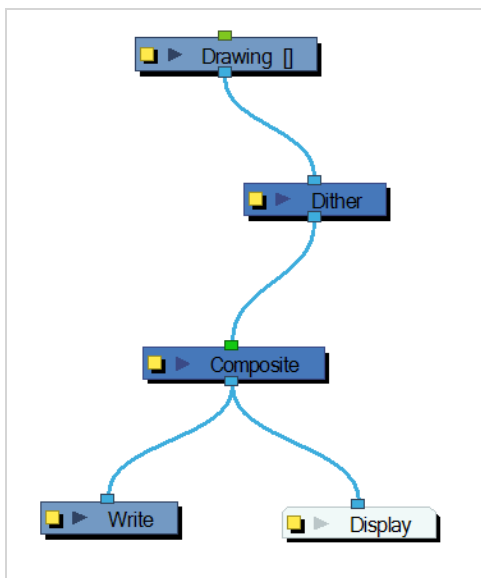

The Dither effect is useful in the case of a gradient that varies between 100 and 105 in the blue channel, for example. Since the difference in the colour values is not great, banding might appear in the image. In this case, use the Dither node to give the impression of greater values of blue, decreasing the unwanted banding effect.

The results of the dither operation may be imperceptible.

## Properties

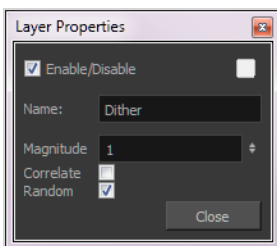

<b>Parameter</b>	<b>Description</b>
Name	Allows you to enter a name for the node.
Magnitude	A magnitude of 1 performs a normal dithering operation, using all bands of colour. A magnitude greater than 1 introduces a bias towards brighter colours. A magnitude of less than 1 creates a faster transition between bands of colour, lessening the bias towards brighter colours.
Correlate	When selected, the three colour channels (RGB) are changed simultaneously, for better colour accuracy. When this option is not selected, the three channels are dithered separately, resulting in smoother transitions.
Random	The standard algorithm for the dithering operation.



## Focus Node

T-COMP2-011-006

Use the Focus effect to set up depth-of-field effects for your scene. The Focus node is used to determine how much blur will be applied to images, based on their distance from the focal point.



The focal point can be the zero value of your scene or you can link the Focus node to another node, such as a drawing or peg layer, to retrieve the focal point from the node's Z-axis position.

Refer to the following example to connect this effect:

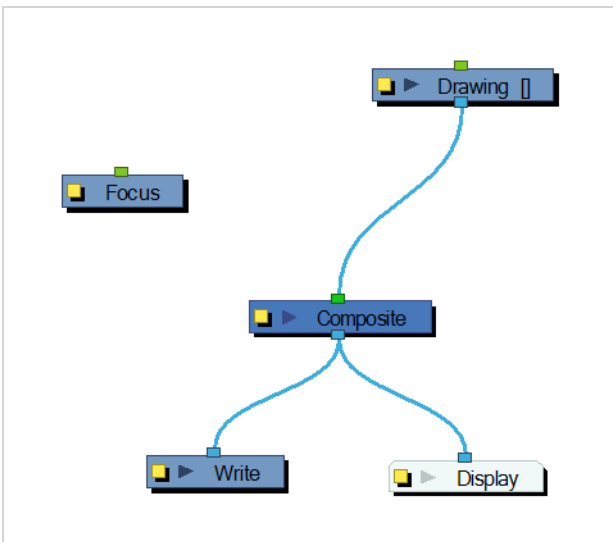

Use the Focus editor to determine how the focus will change as objects move farther from the focal point.

In the Side view window, you can see how the blur values change based on their distance from the focal point. Select the Focus node in the Node view, make sure you are using the Transform tool, then right-click on the Side view window and select Control from the pop-up menu.

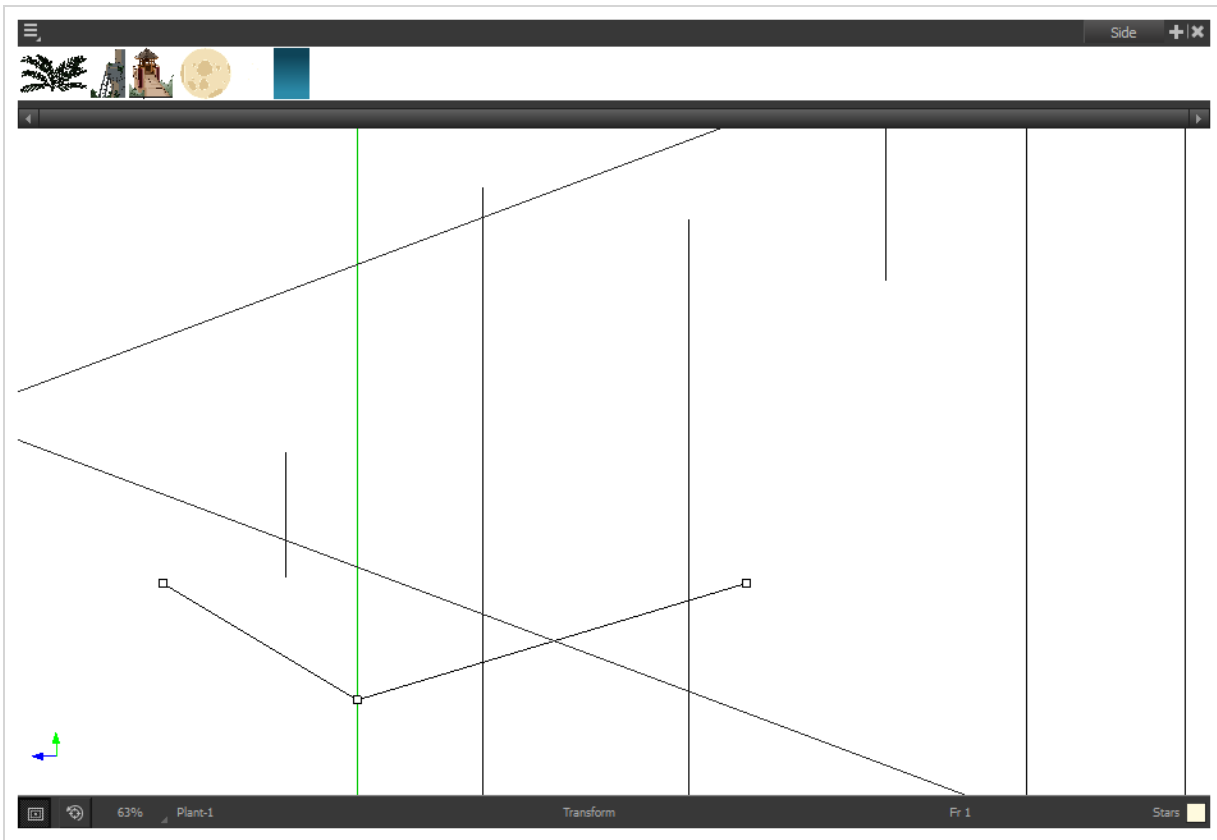

If you edited the function curve and adjusted the velocity, you can also adjust the Bezier handles in the Side view.

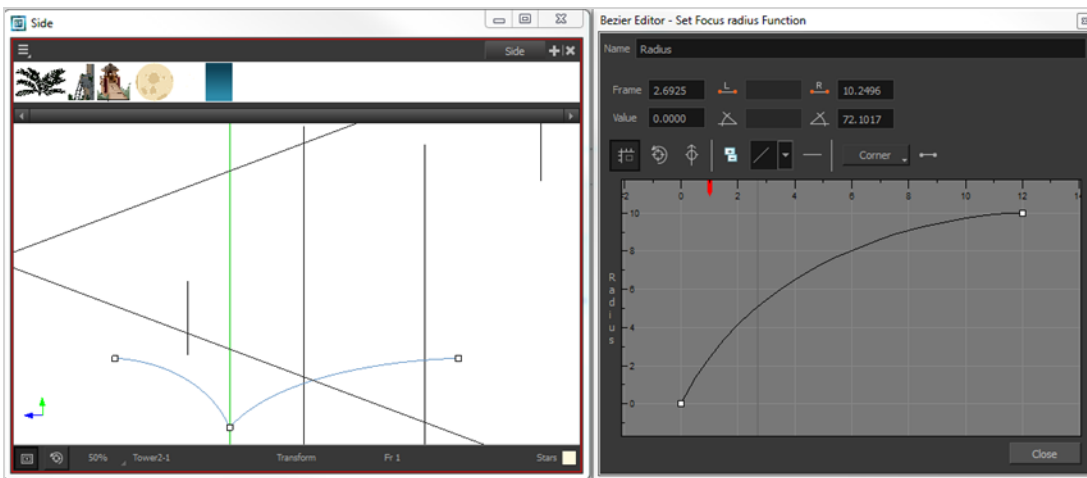

## Properties

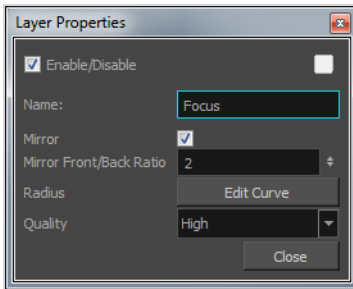

Parameter	Description
Name	Allows you to enter a name for the node.
Mirror	Select this option to also blur images in front of the focal point.
Mirror Front/Back Ratio	When the Mirror option is selected, this ratio is applied to the calculation of the blur on images in front of the focal point. The default ratio of 1:2 produces realistic results. Experiment with different values to create customized effects.
Radius	Controls the amount of blur applied to an element based on its distance from the focal point. Click on the Edit Curve button to change these values by adjusting the function curve.
Quality	Controls the quality of the blur. A higher quality will achieve better results but will be slower to render.

## Focus Multiplier Node

T-COMP2-011-006A

The Focus Multiplier effect works with the Focus node. This node applies a blur to the selected layer, based on the blur radius in the Focus node.

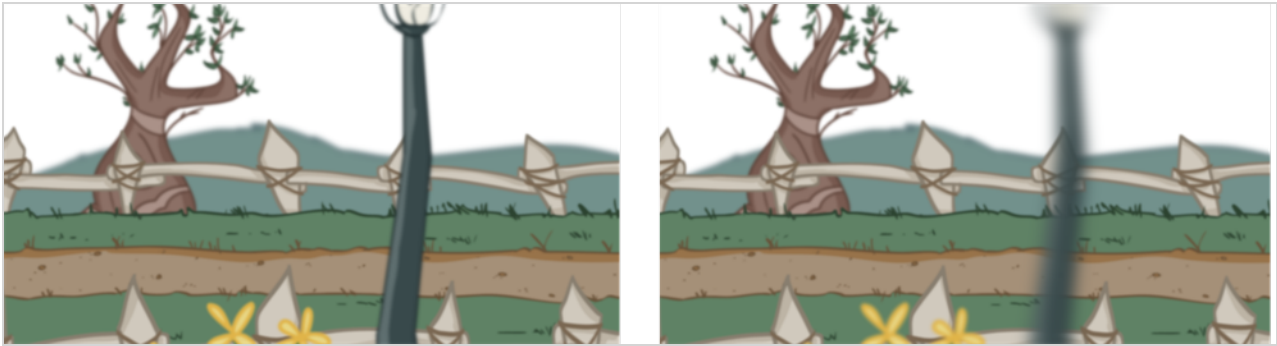

Use the Focus Multiplier node when you want to apply the focus to selected elements or when you need to apply the focus before doing more effects in a composite operation.

Refer to the following example to connect this effect:

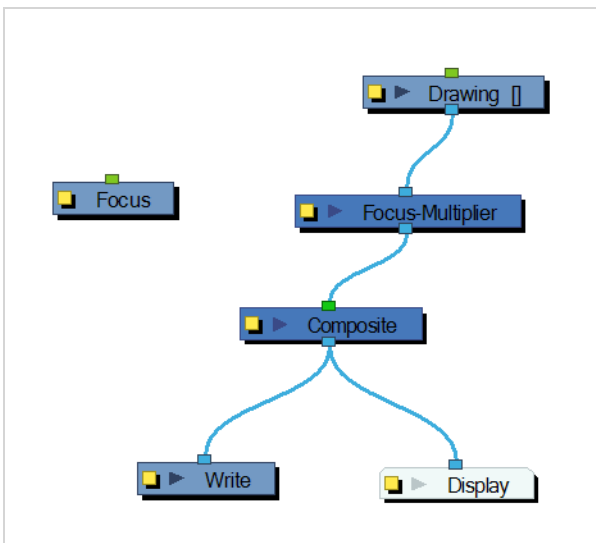

You must disable the Apply Focus option in the Composite node in order to apply the focus effect to the selected node only. If you do not disable that option, the focus effect will be calculated twice on the selected node.

Use the Focus Multiplier editor to multiply the Focus Radius by a selected value. You can enter a static value in the Multiplier field or attach it to a function curve.

## Properties

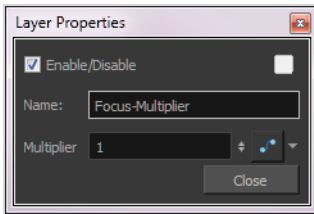

Parameter	Description
Name	Allows you to enter a name for the node.
Multiplier	This is the value by which the normal focus radius value is multiplied.

## Glow Node

T-HFND-010-009B

The Glow effect turns your image into a glow area with a bright soft-edged light or diffuse light region around an image. The Glow effect is useful for creating a shining rim around objects, such as the sun or stars. Clone your layer or connect it a second time to the Composite node to display the original image on top of the glow.



Refer to the following example to connect this effect:

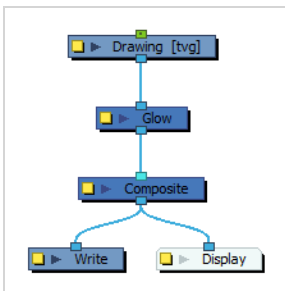



### NOTE

If this effect is connected below a Composite node set to Pass-Through, the effect will be applied to each element connected in the Composite node individually. If some of these elements are overlapping, the effect will also overlap.

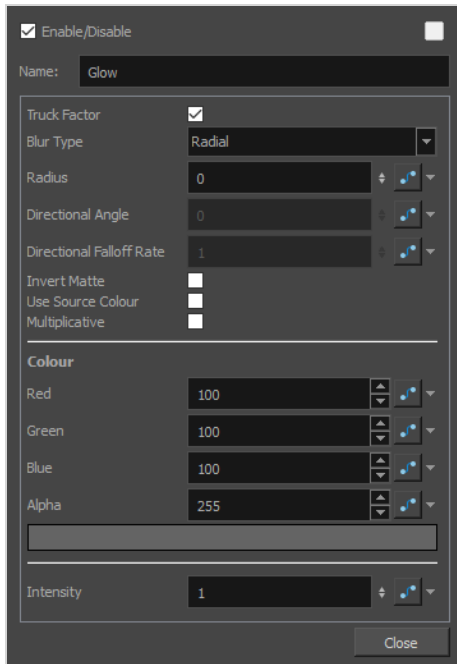
# Properties



Parameter	Description
Enable/Disable	Allows you to enable or disable the node. When disabled, a node has no visible effect on the rendered image, nor on the preview in the Camera, Perspective, Side and Top views.
Colour Swatch	Sets the colour of the layer in the Timeline view and of the node in the Node view.
Name	Allows you to enter a name for the node.
Truck Factor	Activated by default, this option readjusts the blur when the elements undergo a change of depth or scale. When disabled, the effect's values will remain unchanged regardless of depth or scale changes. It is recommended that this option be disabled when multiple drawings are composited and attached this effect.
Blur Type	Allows you to choose between the following blur types for the effect: <ul style="list-style-type: none"> <li>• <b>Radial:</b> The edges of the matte are blurred evenly around points that make up the edge of the matte.</li> <li>• <b>Directional:</b> The matte is blurred in the direction configured with the Directional Angle and Directional Falloff Rate parameters.</li> </ul>

Parameter	Description
Radius	Enter a value for the size of the blur. The larger the value, the greater the blur effect. The blur radius is affected by the drawing scale and camera position.
Directional Angle	<p>If you set the Blur Type to Directional, this sets the angle of the blur. The value goes from 0 to 360, with 0 meaning west, and angles going counterclockwise. For example:</p> <ul style="list-style-type: none"> <li>• <b>0</b>: Blurs the image to the west.</li> <li>• <b>90</b>: Blurs the image to the south.</li> <li>• <b>180</b>: Blurs the image to the east.</li> <li>• <b>270</b>: Blurs the image to the north.</li> </ul>
Directional Falloff Rate	<p>The distance where the blur fades from the edge of the image. Select a decimal value between 0 and 1. For example:</p> <ul style="list-style-type: none"> <li>• <b>0</b>: Makes the blur fade out slowly, distributing the blur evenly from the edge of the character to the farthest edge of the blur.</li> <li>• <b>1</b>: Makes the blur fade out quickly. The blur is heaviest closer to the edge of the image.</li> </ul>
Invert Matte	Inverts the matte used to generate the effect. By default, the effect is applied to opaque areas of the drawing. When this option is enabled, the effect is applied to transparent or empty areas of the drawing.
Use Source Colour	<p>Instead of using the colour in the Colour parameters, this uses the colours in the source drawing to generate the effect.</p> <div style="border: 1px solid green; padding: 5px; margin-top: 10px;"> <p> <b>NOTE</b> The effect of this parameter is only visible in Render View  mode.</p> </div>
Multiplicative	Multiplies the colours of the effect with the colours of the background. This intensifies the effect.
<b>Colour</b>	
Red	The amount of red to add to the colour in the background image.
Green	The amount of green to add to the colour in the background image.



---

Parameter	Description
Blue	The amount of blue to add to the colour in the background image.
Alpha	The alpha value of the effect.
Colour Swatch	Opens the Colour Picker dialog, in which you can visually select a colour for the effect.
Intensity	Allows you to set the factor by which to multiply the intensity of the effect. This parameter can take a decimal value between 0 and 1. At 1, the effect is fully applied. At 0, the effect is not visible.

## Grain Node

Use the Grain effect to add a film grain to an image; the film grain looks like video noise.

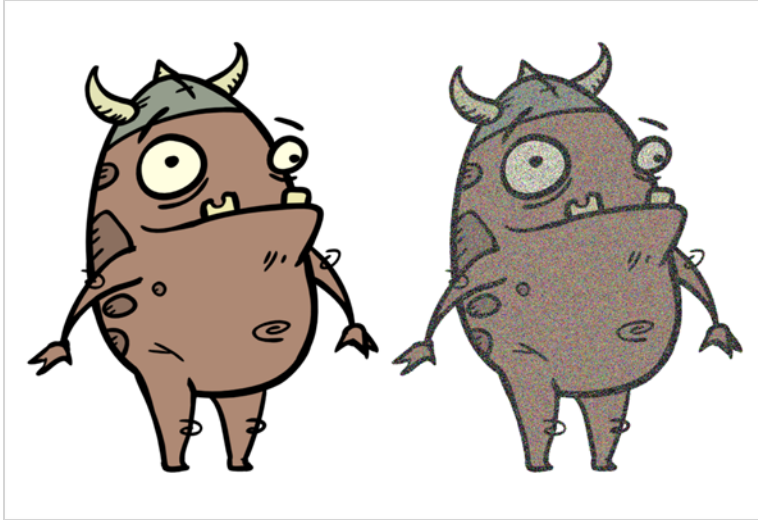

Refer to the following example to connect this effect:

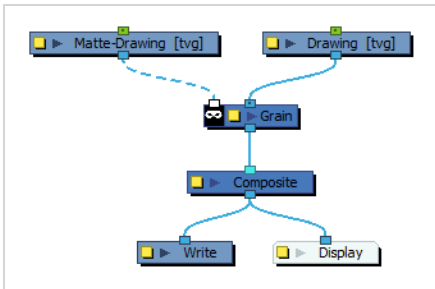

The Grain node has two input ports.

- On the left port, attach the element that will act as the matte defining the grain area.
- On the right port, attach the element on which you want to apply the grain effect.

The Grain node requires a matte drawing. If you simply want to apply a grain over the source drawing, simply connect it to both the image input port and the matte input port of the node:

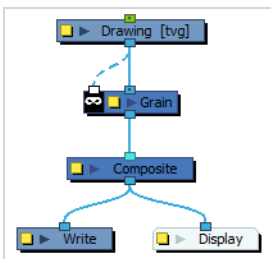

## Properties

In the Layer Properties of the Grain node, you can adjust the amount of grain to add to an image as well as the sharpness and softness of the grain.

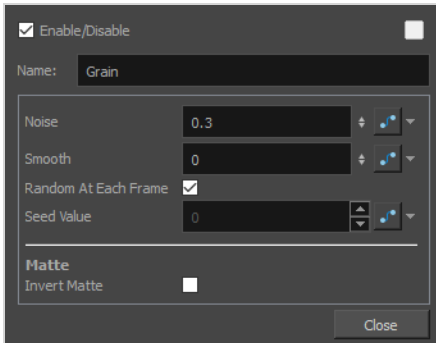

Parameter	Description
Name	Allows you to enter a name for the node.
Noise	The amount of grain to add to the image based on the percentage of pixels to alter. The larger the value, the courser the grain. The smaller the value is to 0 (zero), the finer the grain.
Smooth	The amount of blending to apply to the grain effect, based on the blur radius, to make the effect appear less pixelated. The larger the value, the greater the smoothing.
Random at Each Frame	Computes the colour shift in the grain using a different value at each composite. This means that your images will look different each time you render them. Deselect this option and select a Seed Value to ensure the same result every time you composite the grain effect.
Seed Value	This value corresponds to a unique pattern in the grain. If you want to retain this pattern in other frames, you can reuse this value.
<b>Matte</b>	
Invert Matte	Inverts the matte used to generate the effect. By default, the effect is applied to the opaque areas of the matte drawing. When this option is enabled, the effect is applied to the transparent areas of the matte instead.

## Greyscale Node

The Greyscale effect lets you convert a colour image to greyscale. This example demonstrates what happens when you set the greyscale to 100% using the Greyscale node.

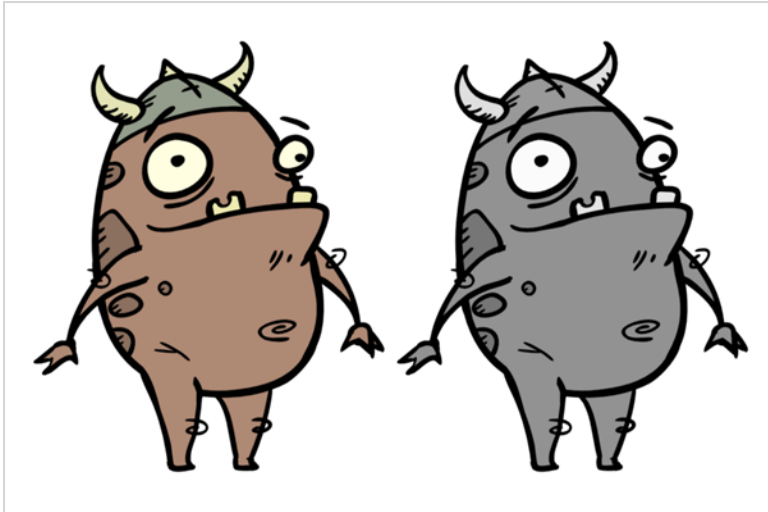

### TIP

You can use this effect in combination with the Brightness Contrast effect to adjust the different levels of grey in the output image.

Refer to the following example to connect this effect:

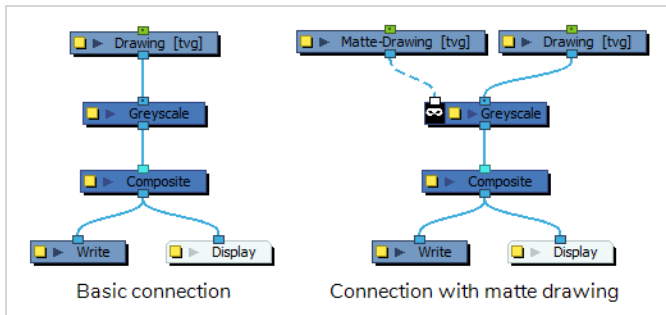

## Properties

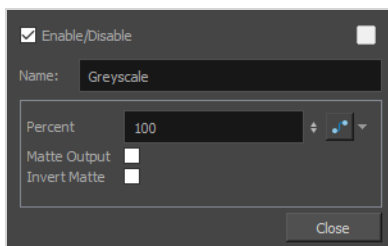

Parameter	Description
Name	Allows you to change the name given to the node.
Percent	The percentage of greyscale to apply to the input image. Lowering this parameter will only partially desaturate the image's colours.
Matte Output	Preserves the colours of the input image, but applies the greyscale version of the input image to the alpha channel of the output image. As a result, the darker a pixel in the image is, the more transparent it is. White pixels will remain opaque, and black pixels will become invisible.
Invert Matte	Inverts the matte used to generate the effect. By default, the effect is applied to the opaque areas of the matte drawing. When this option is enabled, the effect is applied to the transparent areas of the matte instead.

## Hue-Saturation Node

The Hue-Saturation effect lets you adjust the hue, saturation and lightness values individually or by using the HLS picker or Hue Range picker. You can achieve effects over the entire image, such as a sepia tone. Changes you make to the values are additive to the final image.



For detailed video tutorials and sample scenes by Adam Phillips, see:

<https://www.toonboom.com/resources/video-tutorials/chapter/adam-phillips-harmony-effects>

## Connection

The Hue-Saturation node takes an image of any type as its input and outputs an image with different hue, saturation and lightness parameters.

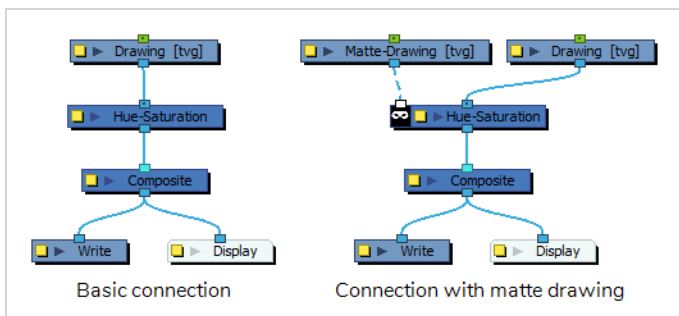

Optionally, it can also be connected to a matte image. In this case, only the parts of the input image that intersect with the matte will be affected by the effect.

## Layer Properties

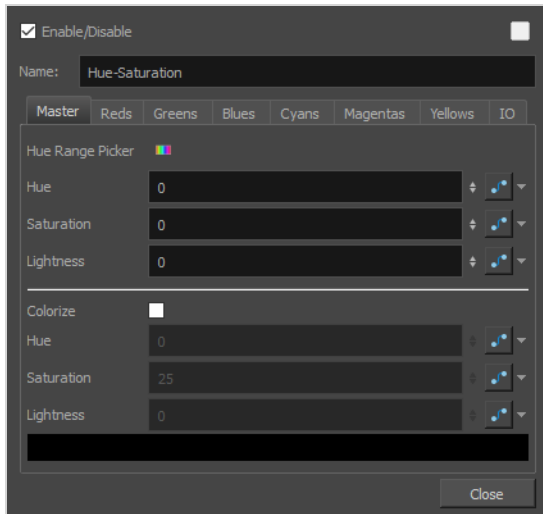

Parameter	Description
Enable/Disable	Allows you to enable or disable the node. When disabled, a node has no visible effect on the rendered image, nor on the preview in the Camera, Perspective, Side and Top views.
Colour Swatch	Sets the colour of the layer in the Timeline view and of the node in the Node view.
Name	Allows you to enter a name for the node.

## Master Tab

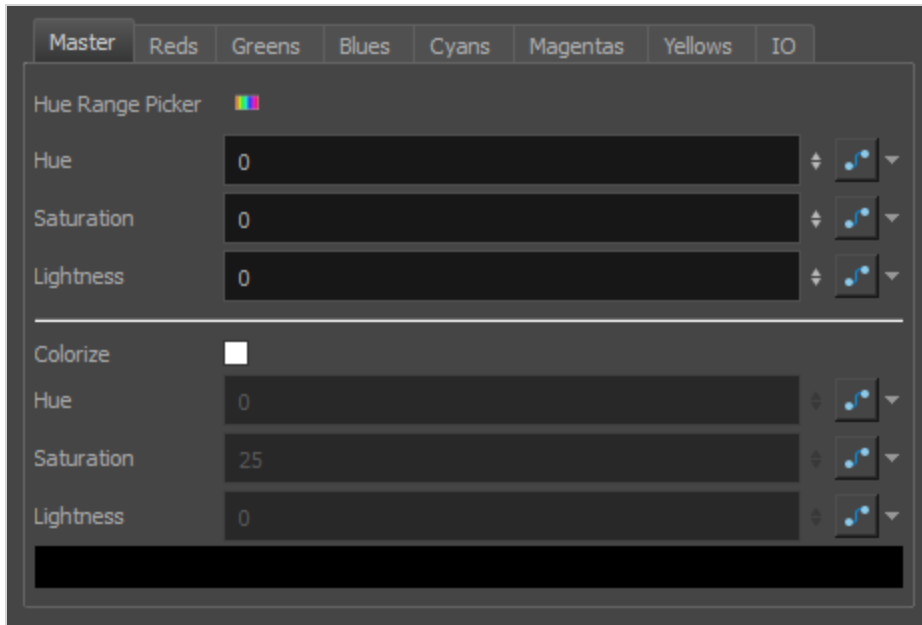

The master tab allows you to adjust the hue, saturation and lightness settings for all the hues in the source drawing simultaneously. It should be used unless you want to apply specific parameters on specific ranges of hues.

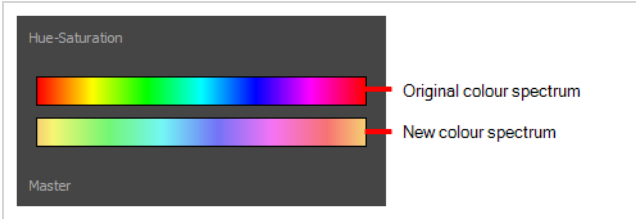
Parameter	Description
Hue Range Picker 	<p>Opens the Hue Range Picker. In the Master tab, the Hue Range Picker can only be used to see the original colour spectrum of the image and compare it to the colour spectrum as processed by the Hue-Saturation effect.</p> 
Hue	Offsets the hues in the source image. The hue of every pixel in the source image is offset on the spectrum of hues. This parameter can be set to a value between -360 and 360.
Saturation	Changes the saturation of the source image. This parameter can be set to a value between -100 and 100. Negative values make the image closer to a greyscale

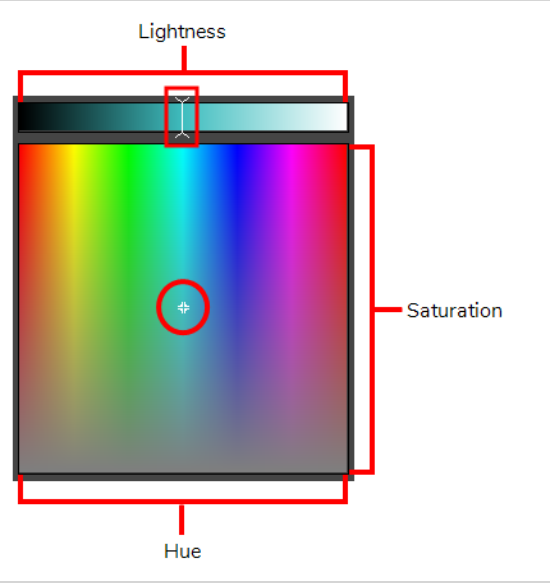

Parameter	Description
	image. Positive values make the colours appear more saturated by exacerbating the difference between each channel.
Lightness	Changes the lightness of the source image. The lightness can vary between -100 and 100, where -100 makes the image solid black and 100 makes the image solid white. Hence, negative values darkens the colours by making every pixel proportionally closer to black, and positive values lighten the colours by making every pixel proportionally closer to white.
Colourize	<p>Enables colourization. Instead of affecting the existing colours of the input image, the Hue-Saturation effect will convert the image to greyscale, then add a single colour over the levels of grey based on the Hue, Saturation and Lightness settings you input below.</p> <div style="border: 1px solid green; padding: 5px; margin-top: 10px;">  <p><b>NOTE</b> When the Colourize parameter is enabled, fields below the check box are accessible and fields above the check box are greyed out.</p> </div>
Hue	The colour with which to colourize the image.
Saturation	The saturation with which to colourize the image. A lower setting will make the colorized image closer to a greyscale image. A higher setting will make the colour more saturated.
Lightness	Changes the lightness of the source image. The lightness can vary between -100 and 100, where -100 makes the image solid black and 100 makes the image solid white. Hence, negative values darkens the colours by making every pixel proportionally closer to black, and positive values lightens the colours by making every pixel proportionally closer to white.
Colour Swatch	<p>When Colourize mode is enabled, you can click on the colour swatch to open a Hue, Saturation and Lightness picker.</p> <p>The lightness can be selected by moving the slider at the top. The hue and saturation can be selected by moving the cursor in the box underneath the slider.</p>

Parameter	Description
	

## Hue Tabs

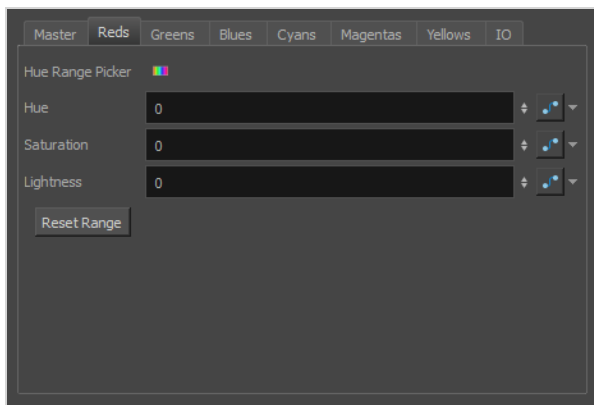

The other tabs in the Hue-Saturation Layer Properties are meant to allow you to specify the hue, saturation and lightness parameters for specific colour ranges. By default, each tab is configured to affect a specific colour range corresponding to their tab name, namely:

- Reds
- Greens
- Blues
- Cyans
- Magentas
- Yellows

At their default settings, all tabs combined cover the entire spectrum of hues. The colour spectrum that each tab affects can however be customized.

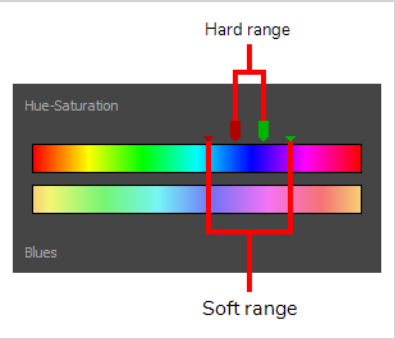
Parameter	Description
Hue Range Picker 	<p>Open the Hue Range Picker dialog. This allows you to tweak the range of hues that the settings in the current tab affects. For example, this is the default range for the Blue tab:</p>  <p>Every pixel in the source drawing that has a hue within the hard range will be affected by the settings in the tab.</p> <p>As for pixels with a hue within the soft range, how much they are affected by the settings in the tab depends on how much their hue is closer to the hard range or to the limit of the soft range. The further away from the hard range the hue of a pixel is, the lesser the effect of the hue, saturation and lightness settings on this pixels is. This allows you to taper the effect of the ranges so as to not create hard seams between areas of different colours.</p>
Hue	Offsets the hues in the area covered by the selected hue range. The hue of every pixel in this area is offset on the spectrum of hues. This parameter can be set to a value between -360 and 360.
Saturation	Changes the saturation of the area covered by the selected hue range. This parameter can be set to a value between -100 and 100. Negative values make the area closer to greyscale. Positive values make the colours in the area appear more saturated by exacerbating the difference between each channel.
Lightness	Changes the lightness of the area covered by the selected hue range. The lightness can vary between -100 and 100, where -100 makes the area solid black and 100 makes the area solid white. Hence, negative values darkens the colours by making every pixel proportionally closer to black, and positive values lighten the colours by making every pixel proportionally closer to white.
Reset Range	Resets the range selected in the Hue Range Picker to the default range for the current colour tab.

## IO Tab

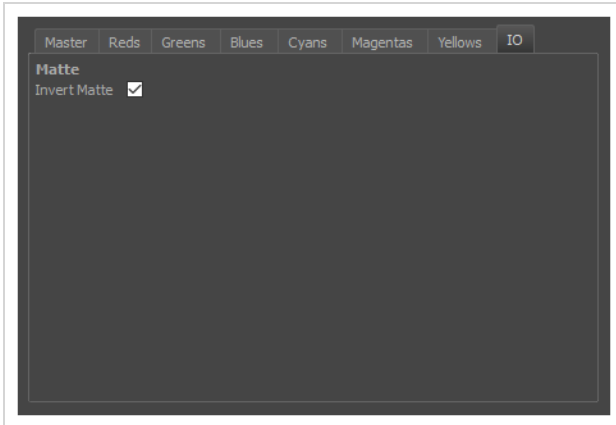

The IO tab contains parameters relating to the input and out ports of the effect.

Parameter	Description
Invert Matte	Inverts the matte used to generate the effect. By default, the effect is applied to the opaque areas of the matte drawing. When this option is enabled, the effect is applied to the transparent areas of the matte instead.

## Layer Selector Node

The Layer Selector effect lets you isolate and display one or more art layers:

- Overlay
- Line Art
- Colour Art
- Underlay

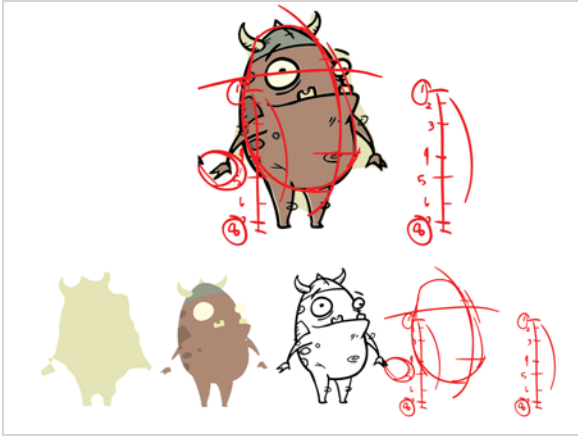

Refer to the following example to connect this effect:

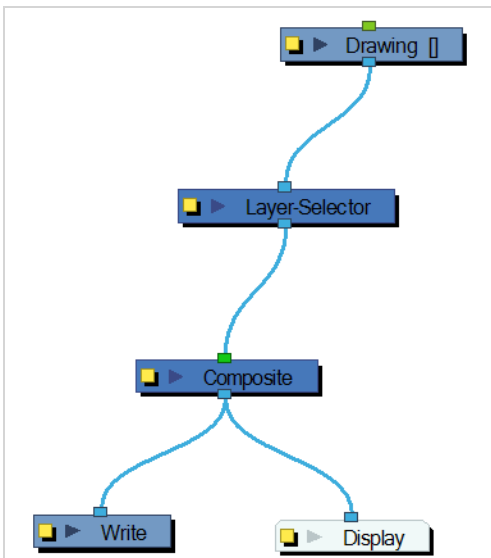

# Properties

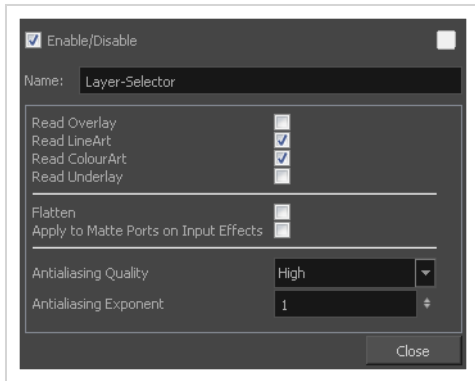

Parameter	Description
Name	Allows you to change the name given to the node.
Read Overlay, Line Art, Colour Art, Underlay	Turns the display of the Overlay, Line Art, Colour Art and Underlay layers on or off.
Flatten	<p>When placing the node below a Composite node containing several drawing nodes, such as a cut-out character, you can use this option to flatten the extracted result. For example, when extracting a series of outlines, parts that may have been hidden by colour fills might now be visible. Enable the Flatten option to cut the extra artwork. Harmony will use the colour fills to cut unnecessary artwork. If your zones are not painted, nothing will be cut. This option works with both pencil lines and brush strokes.</p>
Apply to Matte Ports on Input Effects	At times, you may have situations where your node is placed below a Cutter node using a mask input and a drawing input. By default, the effect only processes the colours in the drawing input. The mask drawing remains untouched. If you want to also filter the mask drawing, select the <b>Apply to Matte Ports on Input Effects</b> option.
Antialiasing Quality	Smoothness setting applied to the art layer. Choose from Low (no antialiasing), Medium Low, Medium and High (extensive antialiasing). The higher the quality of the chosen setting, the greater the amount of antialiasing that is applied. Higher

---

	quality images require more time to render and more memory from your system.
Antialiasing Exponent	Controls the amount of area around the art layer edges that is used in the antialiasing process. A higher value uses less area, resulting in sharper edges, while a lower value uses more area, resulting in softer edges. If the Antialiasing Quality value is set to Low (no antialiasing), this value is ignored.

## Line Art Node

The Line Art effect lets you read only the Line Art in an element. Place a Line Art node after a drawing node in the Node view to display only the node's Line Art output. The Line Art node can be connected after nodes of any type. Any bitmap information will pass through and be processed.

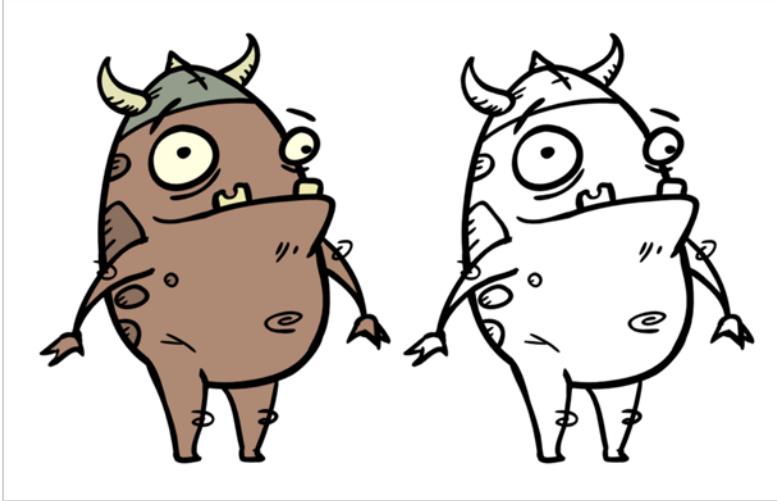

This effect will only work if you drew something on the Line Art layer of the drawing.

Refer to the following example to connect this effect:

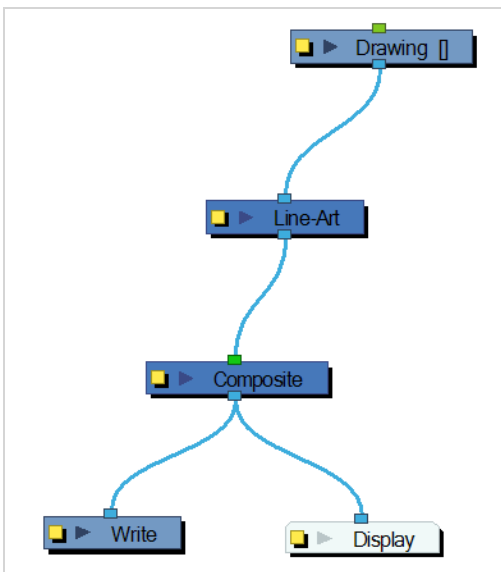



## Properties

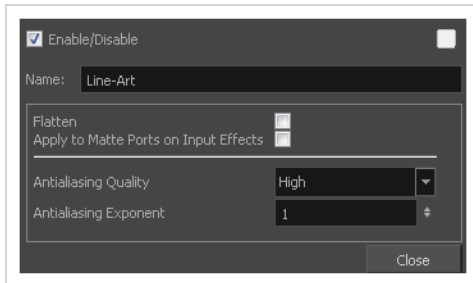

Parameter	Description
Name	Allows you to change the name given to the node.
Flatten	<p>When placing the node below a Composite node containing several drawing nodes, such as a cut-out character, you can use this option to flatten the extracted result. For example, when extracting a series of outlines, parts that may have been hidden by colour fills might now be visible. Enable the Flatten option to cut the extra artwork. Harmony will use the colour fills to cut unnecessary artwork. If your zones are not painted, nothing will be cut. This option works with both pencil lines and brush strokes.</p>
Apply to Matte Ports on Input Effects	<p>At times, you may have situations where your node is placed below a Cutter node using a mask input and a drawing input. By default, the effect only processes the colours in the drawing input. The mask drawing remains untouched. If you want to also filter the mask drawing, select the <b>Apply to Matte Ports on Input Effects</b> option.</p>
Antialiasing Quality	<p>Smoothness setting applied to the art layer. Choose from Low (no antialiasing), Medium Low, Medium and High (extensive antialiasing). The higher the quality of the chosen setting, the greater the amount of antialiasing that is applied. Higher quality images require more time to render and more memory from your system.</p>
Antialiasing Exponent	<p>Controls the amount of area around the art layer edges that is used in the antialiasing process. A higher value uses less area, resulting in sharper edges, while a lower value uses more area, resulting in softer edges. If the Antialiasing Quality value is set to Low (no antialiasing), this value is ignored.</p>

## Luminance Threshold Node

The Luminance Threshold effect generates a matte by thresholding the luminance of an image. This works well with bitmap images that have many shades of colours. A pure vector image with flat colors could use a color override to isolate areas.



Thresholding is a method to segment or isolate certain zones in an image. This effect will isolate areas based on the image's luminance. Thresholding is used within the Bloom effect—see [Bloom Node on page 500](#).

## Connection

The Luminance-Threshold node takes an image of any type as its input and outputs an image in which pixels that do not pass the threshold are filtered out and the remaining pixels are softened and have their gamma adjusted.

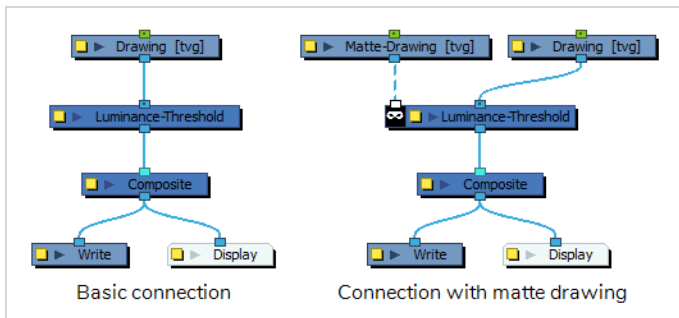

Optionally, it can also be connected to a matte image. In this case, only the parts of the input image that intersect with the matte will be affected by the effect.

## Layer Properties

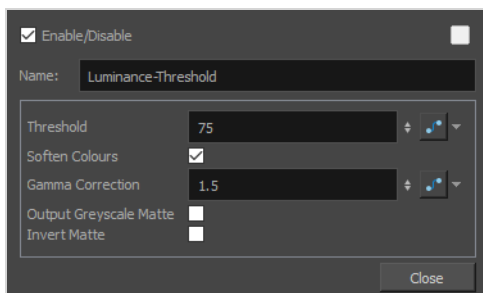

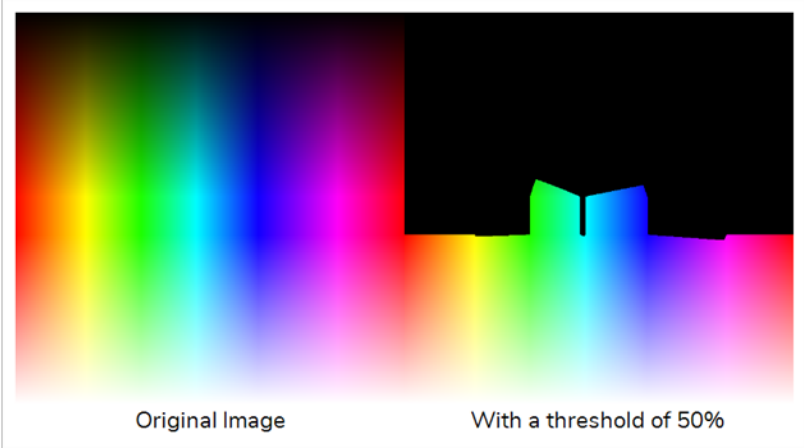
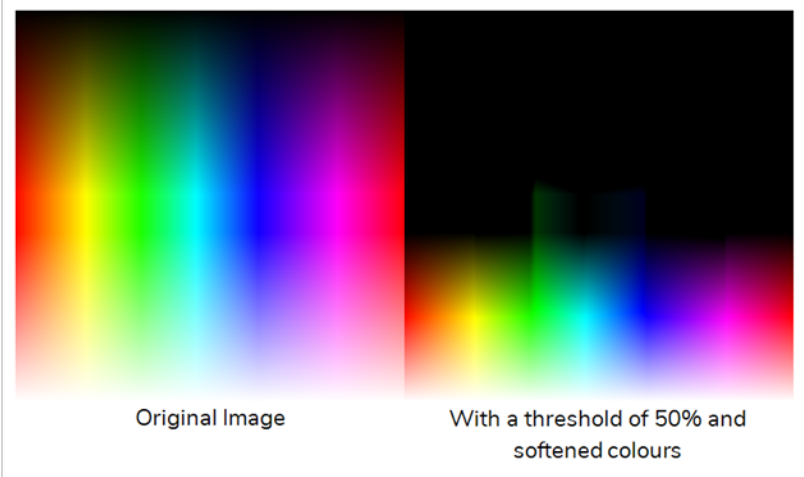
Parameter	Description
Enable/Disable	Allows you to enable or disable the node. When disabled, a node has no visible effect on the rendered image, nor on the preview in the Camera, Perspective, Side and Top views.
Colour Swatch	Sets the colour of the layer in the Timeline view and of the node in the Node view.
Name	Allows you to enter a name for the node.
Threshold	<p>Controls how much of the dark value to clamp off. A high value will keep only the bright areas of your image.</p> 
Soften Colours	<p>Brings back the entire spectrum of luminance in areas defined by the threshold to avoid having only bright values.</p> 
Gamma Correction	Multiplies the gamma value to make the area brighter or darker. A value of 1 keeps the gamma the same as the original image. You can use the gamma modification on the whole image if

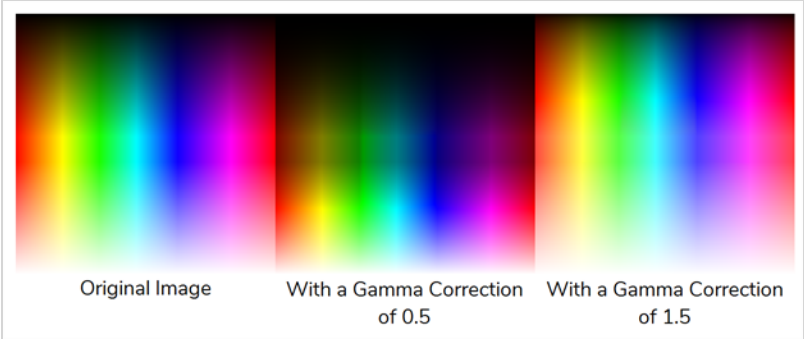
Parameter	Description
	<p>you use a threshold of 0 for example.</p> 
<p>Output Greyscale Matte</p>	<p>Allows you output an image in levels of grey. This can be used in combination with a Blending or Cutter node, or other effects that use greyscale mattes.</p>
<p>Invert Matte</p>	<p>Inverts the matte used to generate the effect. By default, the effect is applied to the opaque areas of the matte drawing. When this option is enabled, the effect is applied to the transparent areas of the matte instead.</p>

## Matte-Blur Node

Use the Matte-Blur effect to blur a matte or change its colour. Here is an example of a network with the result of a Matte-Blur effect.

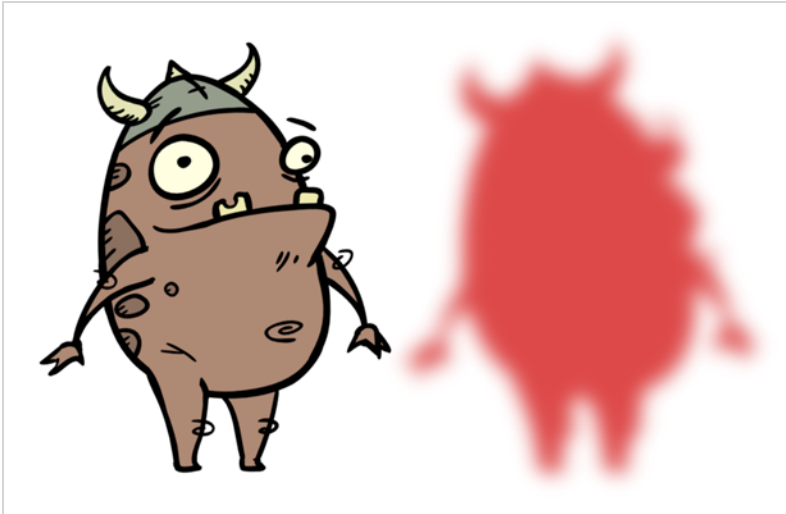

Refer to the following example to connect this effect:

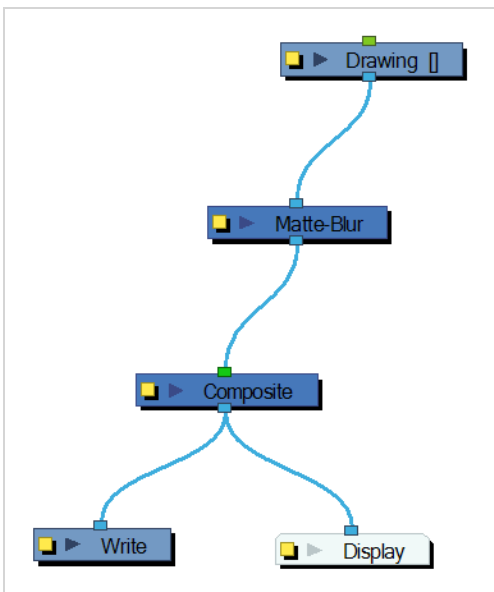

### NOTE

If this effect is connected below a Composite node set to Pass-Through, the effect will be applied to each element connected in the Composite node individually. If some of these elements are overlapping, the effect will also overlap.

## Properties

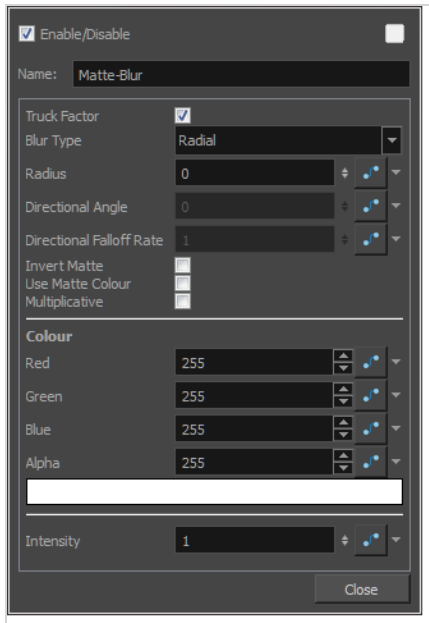

Parameter	Description
Name	Allows you to enter a name for the node.
Truck Factor	Activated by default, this option readjusts the blur when the elements undergo a change of depth or scale. When this option is deselected, the effect's values remain unchanged regardless of any depth or scale changes. This option should be deselected when multiple drawings are composited and attached to this effect.
Blur Type	<p><b>Directional:</b> Blurs the matte in the direction you select. For example, if a character is walking east, the blur may fall to the west.</p> <p><b>Radial:</b> Blurs the edges of the matte evenly around points that make up its edge.</p>
Radius	Enter a value for the size of the blur. The larger the value, the greater the blur effect. The blur radius is affected by the drawing scale and camera position.
Directional Angle	<p>If you select a Blur Directional type, you can select the direction of the blur by entering a value from 0 to 360 in this field.</p> <ul style="list-style-type: none"> <li>▶ <b>0:</b> Blurs the image to the west.</li> <li>▶ <b>90:</b> Blurs the image to the south.</li> <li>▶ <b>180:</b> Blurs the image to the east.</li> <li>▶ <b>270:</b> Blurs the image to the north.</li> </ul>

Directional Fall-off Rate	<p>The distance where the blur fades from the edge of the image. Select a value between 0 and 1.</p> <ul style="list-style-type: none"><li>• A fall-off rate of zero causes the blur to fade out slowly, distributing the blur evenly from the edge of the character to the farthest edge of the blur.</li><li>• A fall-off rate of 1 causes the blur to fade out quickly so that the blur is heaviest closer to the edge of the image.</li></ul>
Invert Matte	<p>Inverts the matte used to create the glow. The matte will become a black silhouette while the glow fills the background space.</p>
Use Source Colour	<p>Uses the colours painted in the matte for the glow effect. If you deselect this option, select a colour and alpha values in the Colour section.</p>
Multiplicative	<p>Creates a more diffused glow.</p>
Colour	<p>Lets you choose the colour and alpha values for the glow effect.</p>
Intensity	<p>Allows you to set the factor by which to multiply the intensity of the effect. This parameter can take a decimal value between 0 and 1. At 1, the effect is fully applied. At 0, the effect is not visible.</p>

## Matte-Resize Node

The Matte-Resize effect lets you evenly expand a matte outward in all directions. The matte increases size from its centre.

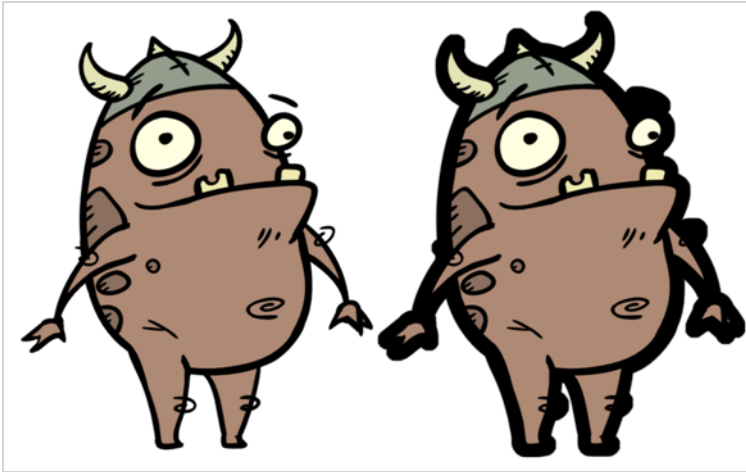

Refer to the following example to connect this effect:

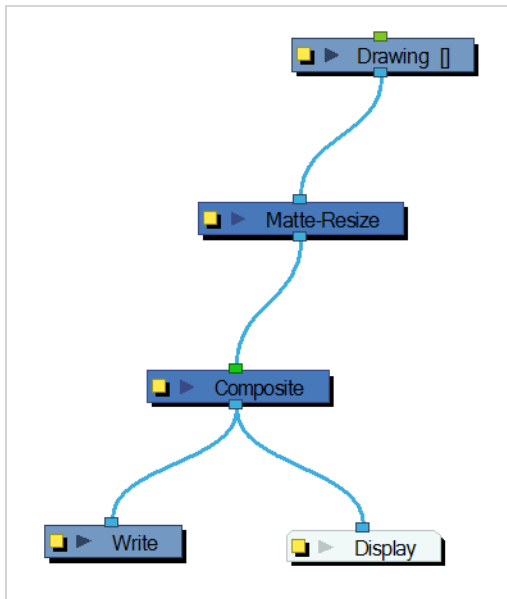

If you use the Matte-Resize node to create a pulsating glow, you can enlarge the region without softening the edges. Using the Blur-Radial effect, the effect may be softer than you intend. This node produces a limited antialiased matte, which can have slightly jagged edges. You could use this node in combination with other nodes, such as:

- Tone
- Highlight
- Glow



- Shadow
- Matte-Blur

## Properties

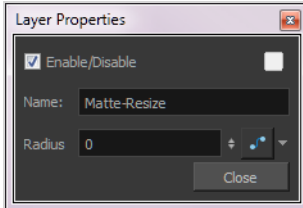

Parameter	Description
Name	Allows you to change the name given to the node.
Radius	Lets you enter a static value for the radius (size increase or decrease) of the matte. You can also attach the Radius value to a function column to change the value over time.

## Median Node

The Median effect lets you reduce the noise in a drawing while preserving its edges. Harmony sorts the values of pixels within a specified radius and uses the median value. You can also use this effect to create a Impressionist type of style.

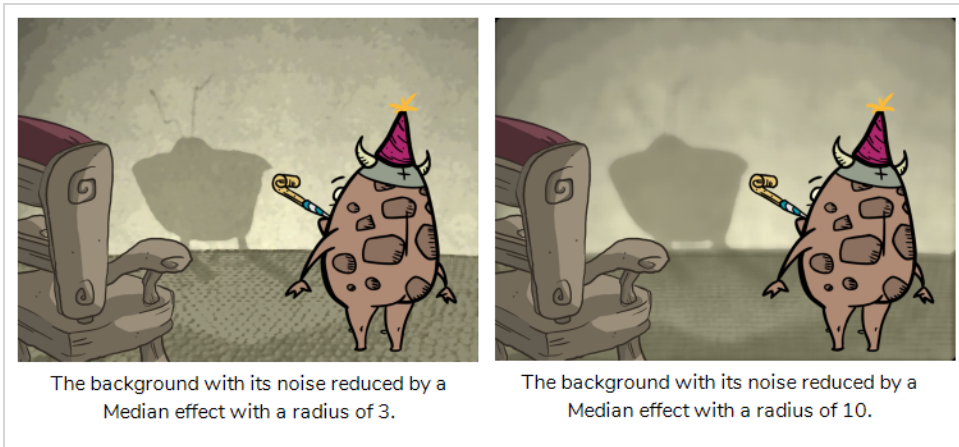
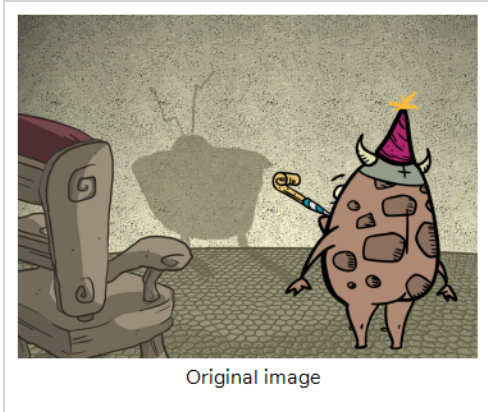

## Connection

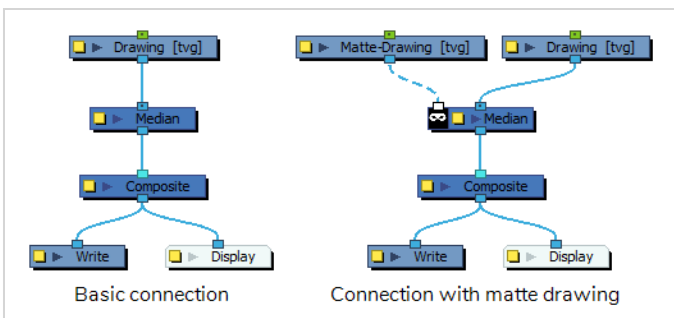

The Luminance-Threshold node takes a bitmap image as its input and outputs a bitmap image in which pixels that do not pass the threshold are filtered out.

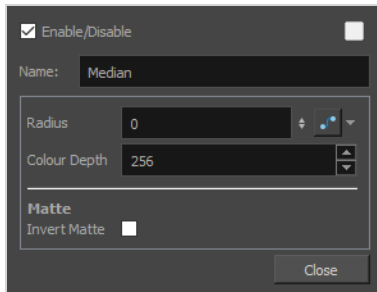

Optionally, it can also be connected to a matte image. In this case, only the parts of the input image that intersect with the matte will be affected by the effect.

## Layer Properties

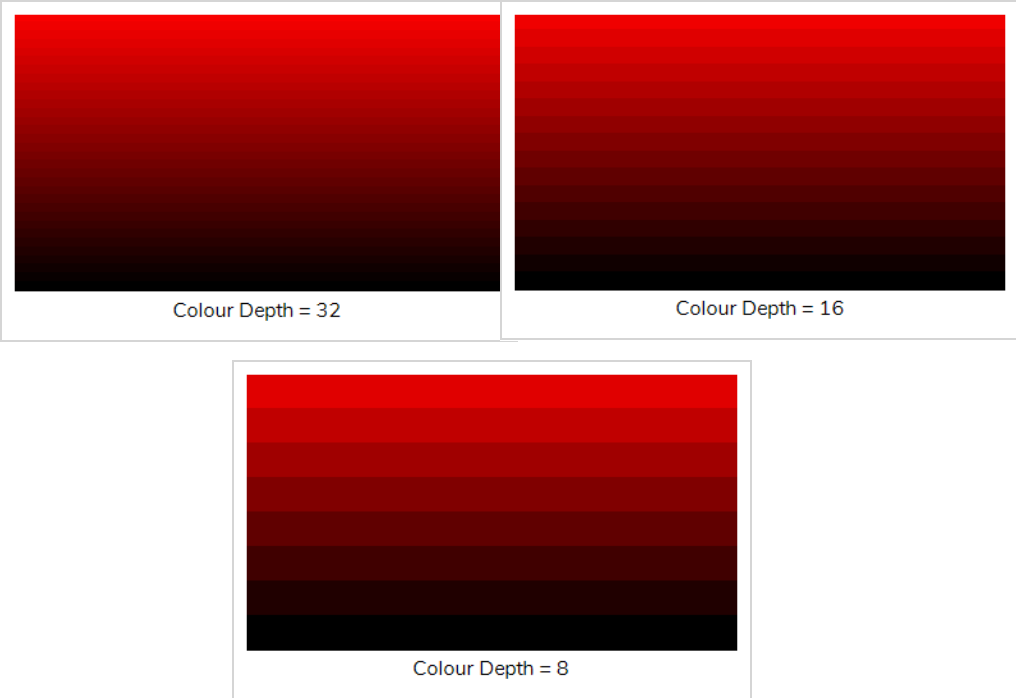

Parameter	Description
Enable/Disable	Allows you to enable or disable the node. When disabled, a node has no visible effect on the rendered image, nor on the preview in the Camera, Perspective, Side and Top views.
Colour Swatch	Sets the colour of the layer in the Timeline view and of the node in the Node view.
Name	Allows you to enter a name for the node.
Radius	<p>Lets you specify the size of the area of values to consider determining the median value. A median is calculated by sorting all the pixel values from the surrounding area into numerical order. Then the middle pixel value is used to replace the pixel being considered.</p> <p>The median tends to make an image look a bit blurrier because it reduces the contrast of adjacent pixels. However, it does a good job of smoothing the image and removing artifacts.</p>
Colour Depth	<p>Determines the number of levels per colour channel. The larger the number, the more levels of colour are used in the image and the more time it takes to render. Conversely, the lower the colour depth, the fewer colours are used, the faster it is to render.</p> <div style="display: flex; justify-content: space-around; align-items: center;"> <div style="text-align: center;">  <p>Colour Depth = 256</p> </div> <div style="text-align: center;">  <p>Colour Depth = 64</p> </div> </div>

Parameter	Description
	
<p>Invert Matte</p>	<p>Inverts the matte used to generate the effect. By default, the effect is applied to the opaque areas of the matte drawing. When this option is enabled, the effect is applied to the transparent areas of the matte instead.</p>

## Motion-Blur Node

The Motion-Blur effect is used to create a faded trail behind objects animated on a motion path. You cannot create a Motion-Blur on a hand-drawn animation. The layer must be moving along a trajectory (motion path) in order to work properly.

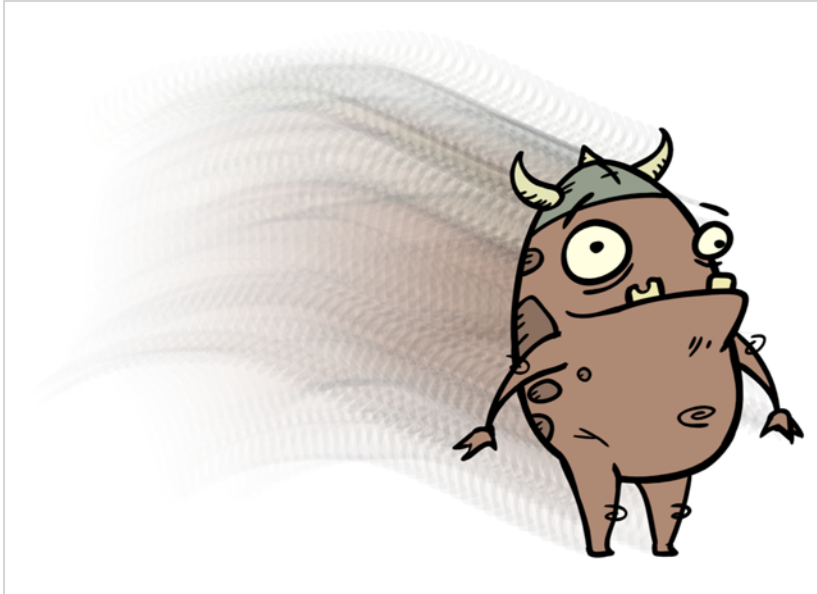

## Connection

As a filter-type effect, the Motion-Blur node takes an input image in its right-most input port, and outputs the blurred image from its only output port.

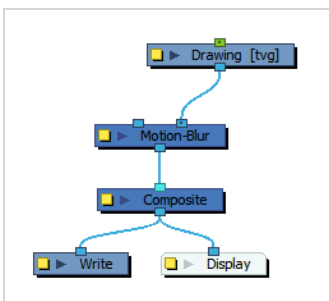

You can also connect another drawing to its left-most input port to act as the matte. The shape of the matte input drawing will determine the area of the actual input drawing to blur.

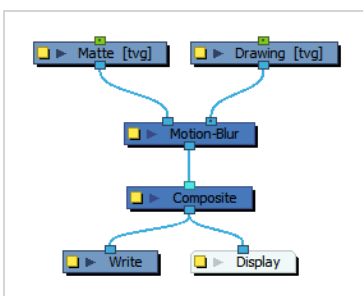

## Properties

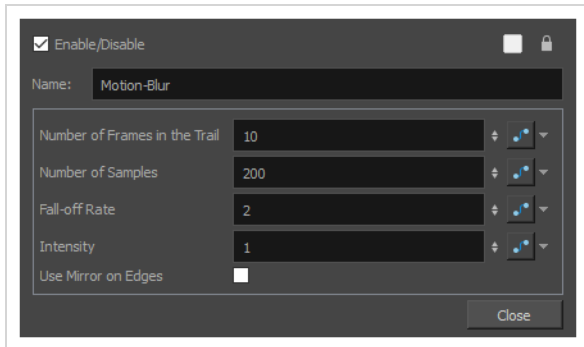

Parameter	Description
Name	Allows you to enter a name for the node.
Number of Frames in Trail	The number of frames before the current frame that will be used in the trail.
Number of Samples	The number of copies of each drawing used in the trail. The higher the number, the more continuous the trail appears.
Fall-off Rate	<p>The distance where the blur fades from the edge of the image. Select a value between 0 and 1.</p> <ul style="list-style-type: none"> <li>A fall-off rate of 0 causes the trail to fade out slowly, distributing the colour evenly from the edge of the character to the farthest edge of the trail.</li> <li>A fall-off rate of 1 causes the trail to fade out quickly so that the trail is more opaque closer to the edge of the image and transparent at the end of the trail.</li> </ul>
Intensity	Select a value to define the opacity of the trail between 0 and 10. A value of 10 will make the trail very dark and almost opaque, where as a value of 0 will make the trail quite pale and ghostly transparent.
Use Mirror on Edges	When enabled this option appear when the image is close to the edge of the camera frame. It forces the software to use a mirror of the image to calculate the blur so that it appears on both sides of the drawing object. Without this option once your drawing reaches the edge of the Camera frame, it gets cropped so does the trail.

## Negate Node

The Negate effect lets you invert the colour and/or alpha values in the Colour Art and Line Art of an image. The original value of each channel (RGB or A) is subtracted from the maximum value of that channel (255 for 8-bit channels) to produce the negative image.

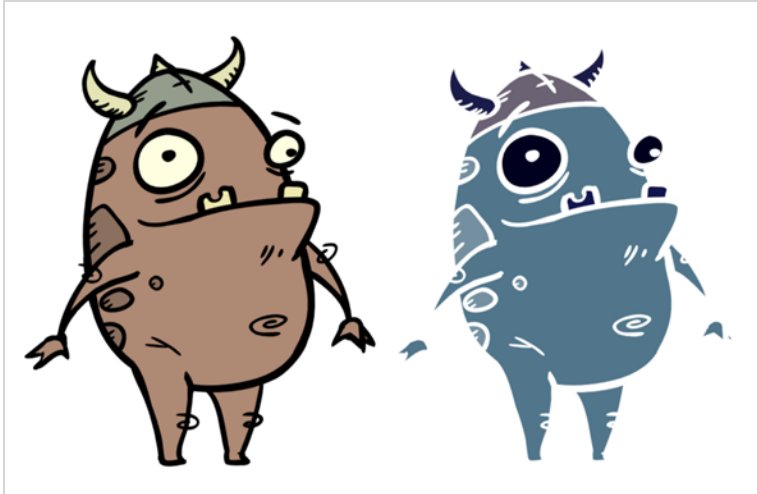

## Connection

The Negate node takes an image of any type as its input and outputs an image in which colour values are inverted relative to their maximum.

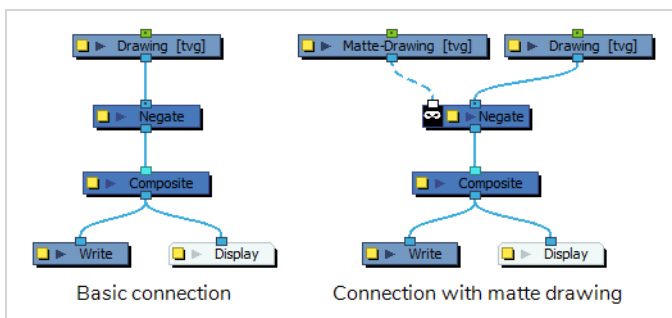

Optionally, it can also be connected to a matte image. In this case, only the parts of the input image that intersect with the matte will be affected by the effect.

## Layer Properties

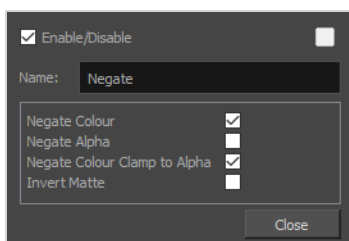

Parameter	Description
Enable/Disable	Allows you to enable or disable the node. When disabled, a node has no visible effect on the rendered image, nor on the preview in the Camera, Perspective, Side and Top views.
Colour Swatch	Sets the colour of the layer in the Timeline view and of the node in the Node view.
Name	Allows you to enter a name for the node.
Negate Colour	Inverts the values of the colour channels.
Negate Alpha	Inverts the transparency value (alpha channel).
Negate Colour Clamp to Alpha	Limits the negated area to the alpha channel.
Invert Matte	Inverts the matte used to generate the effect. By default, the effect is applied to the opaque areas of the matte drawing. When this option is enabled, the effect is applied to the transparent areas of the matte instead.



## Overlay Layer Node

The Overlay Layer effect lets you read an element's Overlay Art layer. By placing an Overlay Layer node after a drawing node in the Node view, you can display only the node's Overlay layer output. The Overlay Layer node can be connected after nodes of any type. Any bitmap information will pass through and be processed.

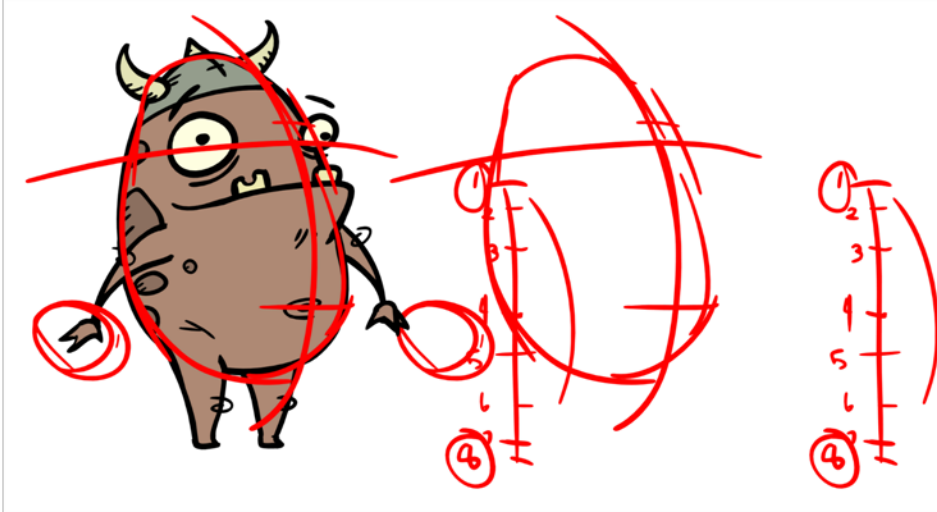

This effect will only work if something has been drawn or painted on a drawing's Overlay Art layer.

Refer to the following example to connect this effect:

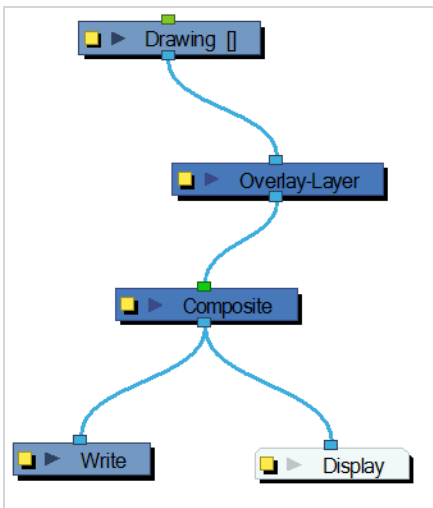

## Properties

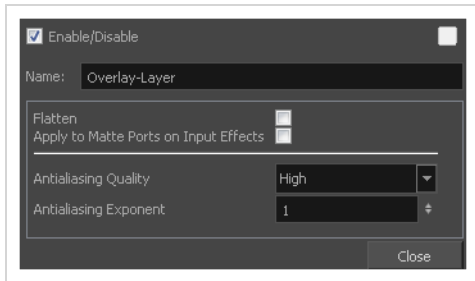

Parameter	Description
Name	Allows you to change the name given to the node.
Flatten	<p>When placing the node below a Composite node containing several drawing nodes, such as a cut-out character, you can use this option to flatten the extracted result. For example, when extracting a series of outlines, parts that may have been hidden by colour fills might now be visible. Enable the Flatten option to cut the extra artwork. Harmony will use the colour fills to cut unnecessary artwork. If your zones are not painted, nothing will be cut. This option works with both pencil lines and brush strokes.</p>
Apply to Matte Ports on Input Effects	At times, you may have situations where your node is placed below a Cutter node using a mask input and a drawing input. By default, the effect only processes the colours in the drawing input. The mask drawing remains untouched. If you want to also filter the mask drawing, select the <b>Apply to Matte Ports on Input Effects</b> option.
Antialiasing Quality	Smoothness setting applied to the art layer. Choose from Low (no antialiasing), Medium Low, Medium and High (extensive antialiasing). The higher the quality of the chosen setting, the greater the amount of antialiasing that is applied. Higher quality images require more time to render and more memory from your system.
Antialiasing Exponent	Controls the amount of area around the art layer edges that is used in the antialiasing process. A higher value uses less area, resulting in sharper edges, while a lower value uses more area, resulting in softer edges. If the Antialiasing Quality value is set to Low (no antialiasing), this value is ignored.

## Pixelate Node

The Pixelate effect lets you apply a mosaic effect to an image (and its matte) based on the matte you supply. Pixelation makes the image look like it is made up of square tiles.

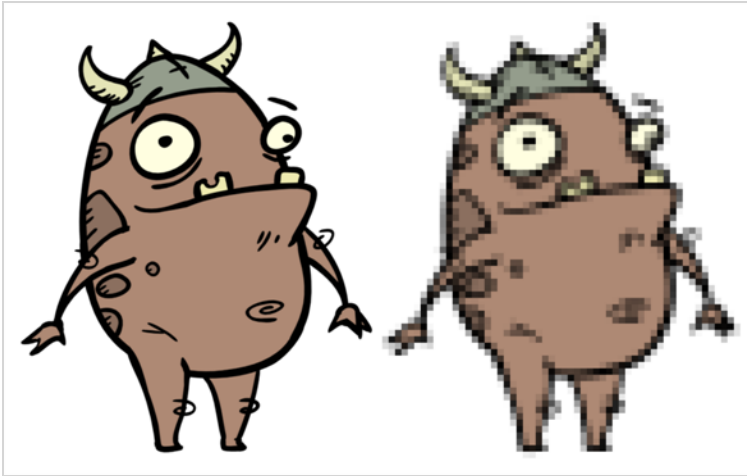

## Connection

The Pixelate node takes an image of any type in the right (Image) input port, and a matte drawing in the left (Matte) input port. It outputs a version of the input image where the parts of the image that intersect with the matte are pixelated.

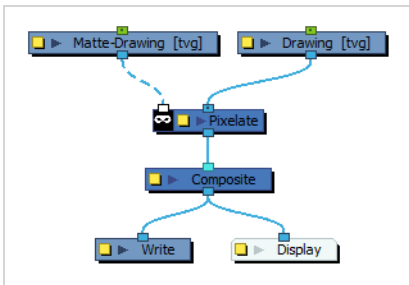

The Pixelate node requires a matte drawing. If you want to pixelate the entire input image, simply connect it to both the Image input port and the Matte input port.

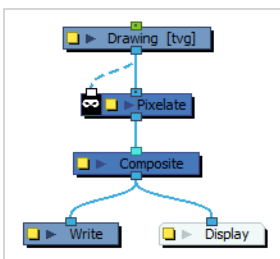

## Layer Properties

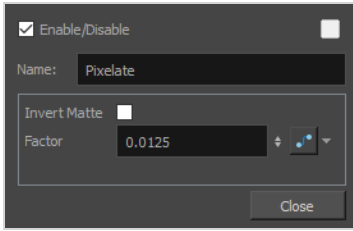

Parameter	Description
Enable/Disable	Allows you to enable or disable the node. When disabled, a node has no visible effect on the rendered image, nor on the preview in the Camera, Perspective, Side and Top views.
Colour Swatch	Sets the colour of the layer in the Timeline view and of the node in the Node view.
Name	Allows you to enter a name for the node.
Invert Matte	Inverts the matte used to generate the effect. By default, the effect is applied to the opaque areas of the matte drawing. When this option is enabled, the effect is applied to the transparent areas of the matte instead.
Factor	The pixelation factor. This parameter takes a decimal value between 0 and 1. The higher the value, the bigger the pixels. The default value is 0.0125 and creates sizeable pixels, so this parameter must be set to low values unless you want the pixels to take up the whole stage.

## Remove Transparency Node

The Remove Transparency effect negates transparent values in an image. You can use the Remove Transparency node to remove the result of antialiasing around an image.

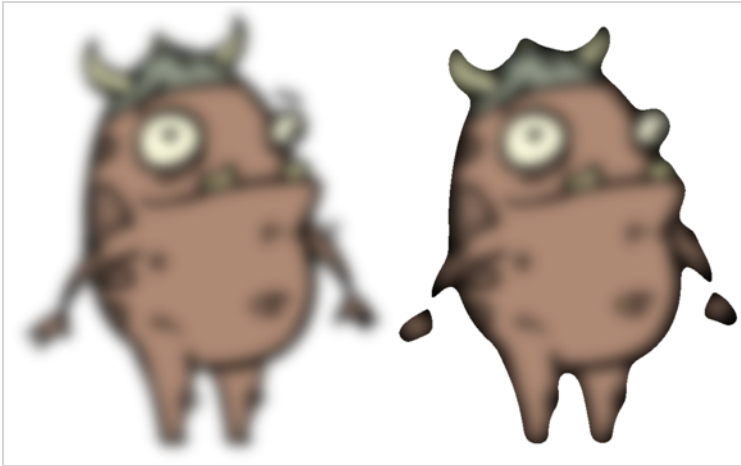

Refer to the following example to connect this effect:

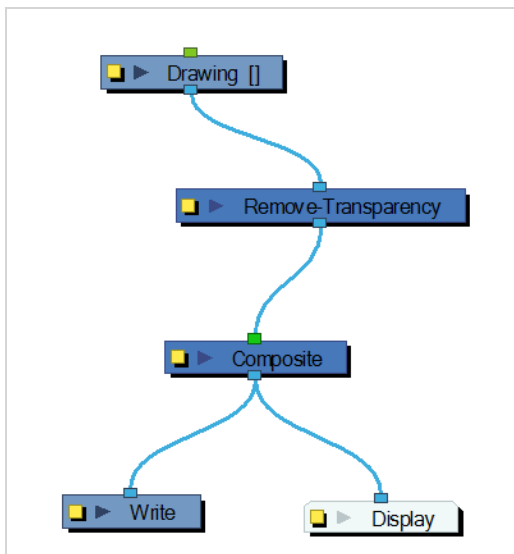

## Properties

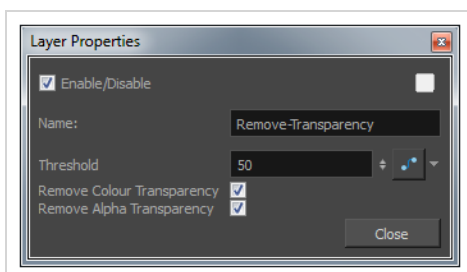

<b>Parameter</b>	<b>Description</b>
Name	Allows you to change the name given to the node.
Threshold	All values above the Threshold represent a transparent value. In this field, you must identify the value above which all alpha values are considered transparent. Alpha is measured from 0 to 255.
Remove Colour Transparency	Determines which pixels in the Colour-Art (RGB channels) to make fully opaque or fully transparent.
Remove Alpha Transparency	When selected, the Threshold value is used to determine which pixels in the alpha channel to make fully opaque or fully transparent.

## Shadow Node

With the Shadow effect, you can turn a drawing into a shadow. It doesn't matter if the drawing layer is a fully coloured character. The Shadow effect will render it into a grey, semitransparent, slightly blurry silhouette. You must connect your layer a second time to the your Composite node to see the original image displayed on top of the shadow.

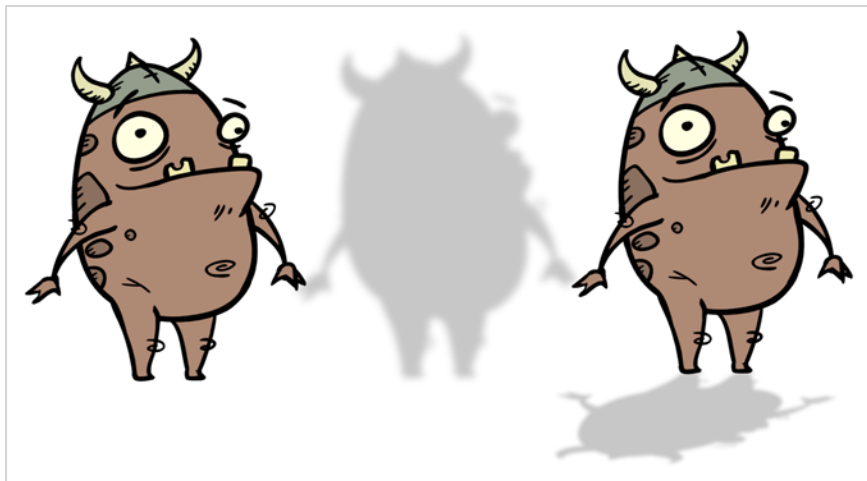

Refer to the following example to connect this effect:

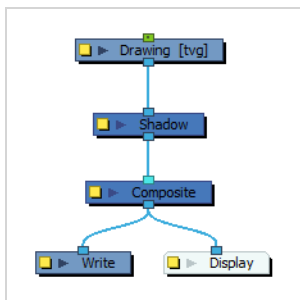

### NOTE



If this effect is connected below a Composite node set to Pass-Through, the effect will be applied to each element connected in the Composite node individually. If some of these elements are overlapping, the effect will also overlap.

## Properties

Parameter	Description
Enable/Disable	Allows you to enable or disable the node. When disabled, a node has no visible effect on the rendered image, nor on the preview in the Camera, Perspective, Side and Top views.

Parameter	Description
Colour Swatch	Sets the colour of the layer in the Timeline view and of the node in the Node view.
Name	Allows you to enter a name for the node.
Track Factor	Activated by default, this option readjusts the blur when the elements undergo a change of depth or scale. When disabled, the effect's values will remain unchanged regardless of depth or scale changes. It is recommended that this option be disabled when multiple drawings are composited and attached this effect.
Blur Type	Allows you to choose between the following blur types for the effect: <ul style="list-style-type: none"> <li>• <b>Radial:</b> The edges of the matte are blurred evenly around points that make up the edge of the matte.</li> <li>• <b>Directional:</b> The matte is blurred in the direction configured with the Directional Angle and Directional Falloff Rate parameters.</li> </ul>
Radius	Enter a value for the size of the blur. The larger the value, the greater the blur effect. The blur radius is affected by the drawing scale and camera position.
Directional Angle	If you set the Blur Type to Directional, this sets the angle of the blur. The value goes from 0 to 360, with 0 meaning west, and angles going counterclockwise. For example: <ul style="list-style-type: none"> <li>• <b>0:</b> Blurs the image to the west.</li> <li>• <b>90:</b> Blurs the image to the south.</li> <li>• <b>180:</b> Blurs the image to the east.</li> <li>• <b>270:</b> Blurs the image to the north.</li> </ul>
Directional Falloff Rate	The distance where the blur fades from the edge of the image. Select a decimal value between 0 and 1. For example: <ul style="list-style-type: none"> <li>• <b>0:</b> Makes the blur fade out slowly, distributing the blur evenly from the edge of the character to the farthest edge of the blur.</li> <li>• <b>1:</b> Makes the blur fade out quickly. The blur is heaviest closer to the edge of the image.</li> </ul>
Invert Matte	Inverts the matte used to generate the effect. By default, the effect is applied to opaque areas of the drawing. When this option is enabled, the effect is applied to transparent or empty areas of the drawing.



Parameter	Description
Use Source Colour	<p>Instead of using the colour in the Colour parameters, this uses the colours in the source drawing to generate the effect.</p> <div style="border: 1px solid green; padding: 5px; margin-top: 10px;">  <b>NOTE</b>            The effect of this parameter is only visible in Render View  mode.         </div>
Multiplicative	Multiplies the colours of the effect with the colours of the background. This intensifies the effect.
<b>Colour</b>	
Red	The amount of red to subtract from the colour in the background image. To obtain a shadow effect, this value must be negative.
Green	The amount of green to subtract from the colour in the background image. To obtain a shadow effect, this value must be negative.
Blue	The amount of blue to subtract from the colour in the background image. To obtain a shadow effect, this value must be negative.
Alpha	The alpha value of the effect.
Colour Swatch	Opens the Colour Picker dialog, in which you can visually select a colour for the effect.
Intensity	Allows you to set the factor by which to multiply the intensity of the effect. This parameter can take a decimal value between 0 and 1. At 1, the effect is fully applied. At 0, the effect is not visible.

## Transparency Node

T-HFND-010-008

The Transparency effect is used to make an image partially transparent. The Transparency effect is useful when fading images in and out, such as a phantom or to make something partially see-through, such as a window.

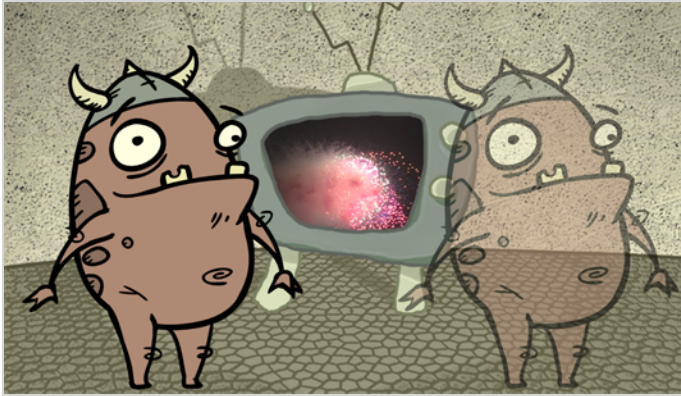

Refer to the following example to connect this effect:

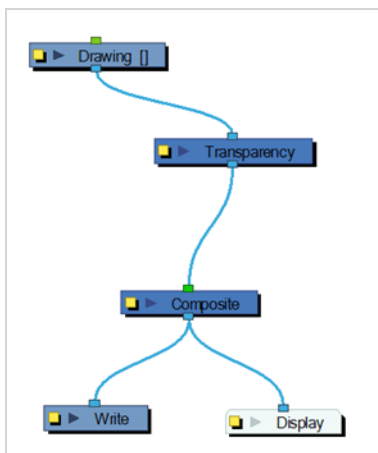

You can enter a value in the Transparency field or change the transparency value over time by linking it to a function curve. Entering a value of 100 in the Transparency field will make the element 100% transparent, in other words, invisible. Entering a value of 0 will render the element completely opaque.

It is also possible to adjust a drawing layer's transparency directly in the Layer Properties window without using the Transparency node. In the layer's properties, go to the Drawing tab and adjust the Opacity parameter. This parameter is visible in OpenGL mode.

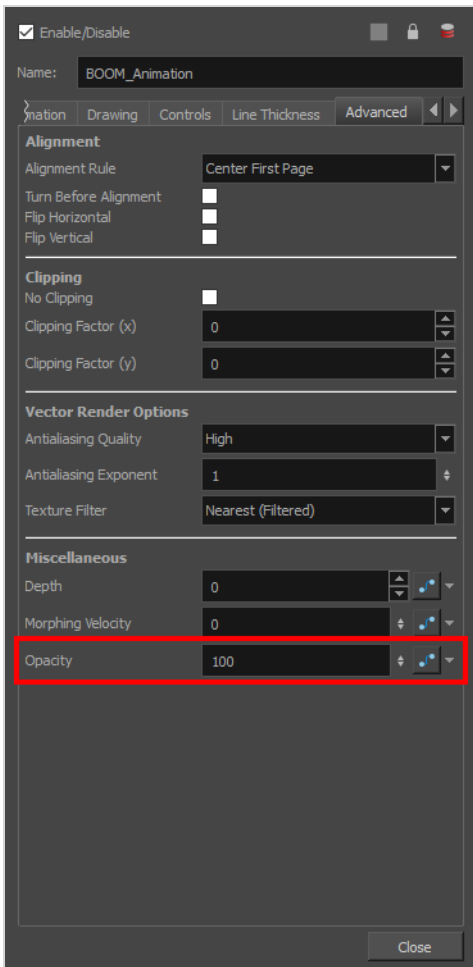

## Properties

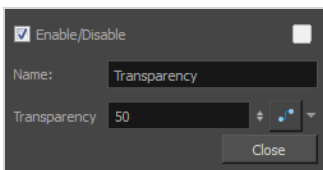

Parameter	Description
Name	Allows you to enter a name for the node.
Transparency	Lets you set the opacity of an element. Values range from 0 to 100. A value of 100 will make the element 100% transparent and a value of 0 will render the element completely opaque.

## Underlay Layer Node

The Underlay Layer effect lets you read an element's Underlay Art layer. By placing an Underlay Layer node after a drawing node in the Node view, you can display only the node's Underlay layer output. The Underlay Layer node can be connected after nodes of any type. Any bitmap information will pass through and be processed.

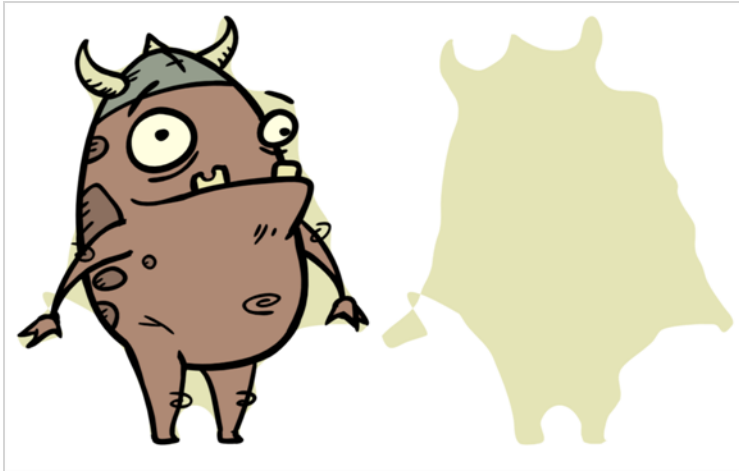

This effect will only work if something has been drawn or painted on a drawing's Underlay layer.

Refer to the following example to connect this effect:

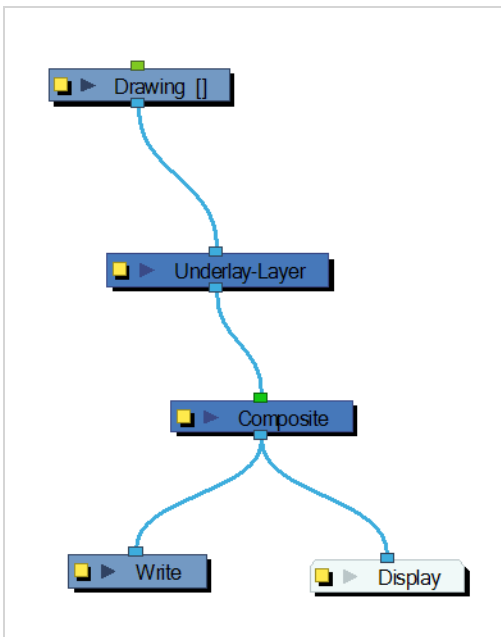

## Properties

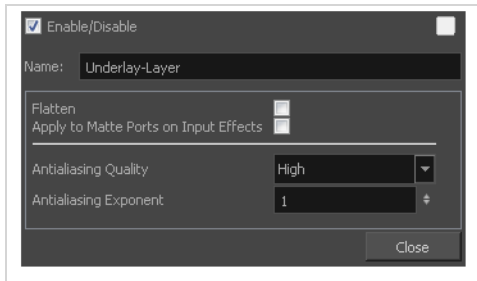

Parameter	Description
Name	Allows you to change the name given to the node.
Flatten	<p>When placing the node below a Composite node containing several drawing nodes, such as a cut-out character, you can use this option to flatten the extracted result. For example, when extracting a series of outlines, parts that may have been hidden by colour fills might now be visible. Enable the Flatten option to cut the extra artwork. Harmony will use the colour fills to cut unnecessary artwork. If your zones are not painted, nothing will be cut. This option works with both pencil lines and brush strokes.</p>
Apply to Matte Ports on Input Effects	At times, you may have situations where your node is placed below a Cutter node using a mask input and a drawing input. By default, the effect only processes the colours in the drawing input. The mask drawing remains untouched. If you want to also filter the mask drawing, select the <b>Apply to Matte Ports on Input Effects</b> option.
Antialiasing Quality	Smoothness setting applied to the art layer. Choose from Low (no antialiasing), Medium Low, Medium and High (extensive antialiasing). The higher the quality of the chosen setting, the greater the amount of antialiasing that is applied. Higher quality images require more time to render and more memory from your system.
Antialiasing Exponent	Controls the amount of area around the art layer edges that is used in the antialiasing process. A higher value uses less area, resulting in sharper edges, while a lower value uses more area, resulting in softer edges. If the Antialiasing

	Quality value is set to Low (no antialiasing), this value is ignored.
--	---

## Generator Nodes

The nodes found in the Generator category are nodes that output an image without requiring an input image. Hence, they generate an image rather than transforming an existing image. Among those nodes is the Element node, also known as drawing layers, which generate an image based on the drawing exposed at the current frame. Other nodes in this category generate an image based on their parameters.

<b>Animated Matte Generator Node</b> .....	<b>609</b>
<b>Burn-In Node</b> .....	<b>620</b>
<b>Colour-Card Node</b> .....	<b>624</b>
<b>Element / Drawing Node</b> .....	<b>627</b>
<b>Connection</b> .....	<b>628</b>
<b>Field Chart Node</b> .....	<b>644</b>
<b>Gradient Node</b> .....	<b>649</b>
<b>Grid Node</b> .....	<b>655</b>
<b>Lens Flare Node</b> .....	<b>658</b>
<b>Turbulent Noise Node</b> .....	<b>661</b>

## Animated Matte Generator Node

The animated matte generator is a very advanced tool in Harmony's suite of effects which, once connect to a drawing or character model, gives you three important capabilities.

- Digitally animate the lines and contours of vector drawings
- Create animated feathered (gradient) visual effects in specific shapes.
- Snap to the contours of a drawing to make the shape of its effect match the shape of the drawing.

The resulting image can be used as a deformed drawing or an effect, and can also be used as a transparency mask for other drawings or effects.

At the very least, the Animated Matte Generator node requires a vector drawing to be connected to its **Image Source** (right) input port. The node will generate animatable control points for each of the vector shapes in each of the drawings in its matte drawing layer, which can be manipulated and animated, allowing you to animate your drawing's vector points directly.

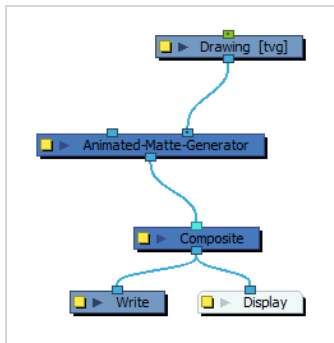

### TIP

If the image source layer is moved, rotated or scaled, either directly or because of a parent peg, the control points of the Animated Matte Generator will follow these transformations. If you want the matte generated by the Animated Matte Generator node to follow the animation of another drawing, you can simply connect that drawing's output port to the image source drawing's input port.



### IMPORTANT

If the Overlay and Underlay Arts preference is enabled, the Overlay art layer of the source drawing is reserved for annotations. Any artwork in the Overlay art layer of the source drawing will be ignored by the Animated Matte Generator node.

Based on its parameters, the Animated Matte Generator node will either output the source drawing after deforming it to match the position of the control points, or a feathered special effects matte gradating from its inner contour to its outer contour. In either case, this allows to animate the image source, either as a simple vector drawing, as a special effect or as part of a more complex rig, without making new drawings for it.



Optionally, another vector drawing may be connected to the node's **Snapping Source** (left) input port. Using the Set to Snap editing mode in the Animated Matte Generator view, you can set some of the points and contours of the input drawing to automatically snap to the snapping source drawing's contours, making it easier to animate a matte to follow the contours of a drawing in your scene. A contour that is set to snap to one of the snapping source's contours will even match the precise shape of this contour.

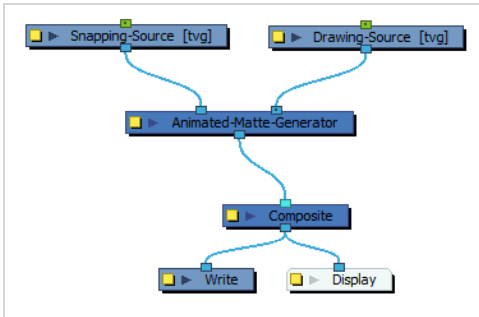

### IMPORTANT

Only single vector drawing layers can be used for the image source and the snapping source of an Animated Matte Generator. The input ports of an Animated Matte Generator node should not be connected to a composite, an effect, or anything but a vector drawing node.

Often, an Animated-Matte-Generator will be used to add a fine-tuned effect, such as a glow or shadow, on part of a drawing. A typical set-up to accomplish this will make use of the Colour Selector node and Cutter nodes to trim the effect generated by the Animated Matte Generator so that it only affects zones of the drawing that are painted with the specific colour. Since the effect generated for this drawing should follow that drawing's movements, if any, pegging the Animated Matte Generator's drawing source to the drawing the effect is applied over will lock their position together. Likewise, it may be useful to connect the drawing the effect will be applied over as the Animated Matte Generator's snapping source, since the matte might need to be snapped to that drawing's contours.

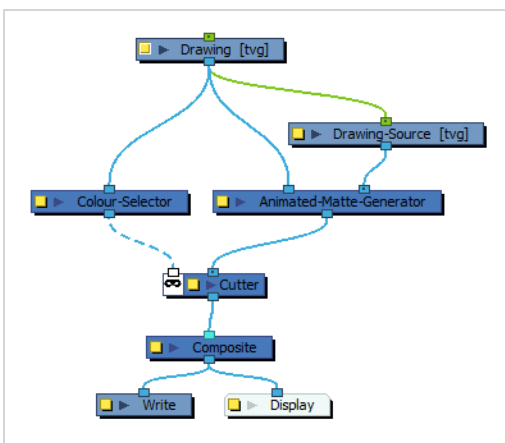

You can instantly add this template to your scene by clicking on the Add Matte Generator button in the Animated Matte Generator view. As an alternative, the Add Matte Generator as Mask button will add a similar template, except that the Animated-Matte Generator will be connected to the Cutter's matte port, and the

drawing's Colour-Selector will be connected to the Cutter's input port. This can be used for example to use the Animated Matte Generator as a sophisticated transparency filter for an effect or element in your scene.

The contours of an Animated Matte Generator can be configured and animated by using the Animated Matte Generator view along with its control points in the Camera view.

### How to access the Animated Matte Generator view

1. Do one of the following:
  - From the top-right corner of any currently visible view, click the Add View **+** button and select **Animated Matte Generator**.
  - From the top menu, select **Windows > Animated Matte Generator**.

### How to display the Animated Matte Generator controls and enable the Animated Matte Generator view options

1. In the Tools toolbar, select the Transform tool or press Shift + T.
2. In the Timeline or Node view, select the Animated Matte Generator node you wish to configure or animate.
3. In the Camera view toolbar, click on Show Controls  or press Shift + F11.



#### NOTE

For more information on the Animated Matte Generator view, see [Animated Matte Generator View on page 1044](#).

## Layer Properties

Using the Layer Properties dialog or view, you can configure the kind of matte the Animated Matte Generator should output, how the matte's points and contours should snap to its snapping source as well as the colours and other parameters for generating a feathered effect.



#### NOTE

The examples below demonstrate the effects of using the Animate Matte Generator with a simple drawing of a square. However, it is able to deform vector drawings of any shape and complexity.

## Matte tab

The matte tab allows you to configure whether the Animated Matte Generator node will output a deformed version of its input source drawing or a feathered effect based on its outer and inner contour as well as how the contour's control points and lines should snap to the snapping source's contours, if any.

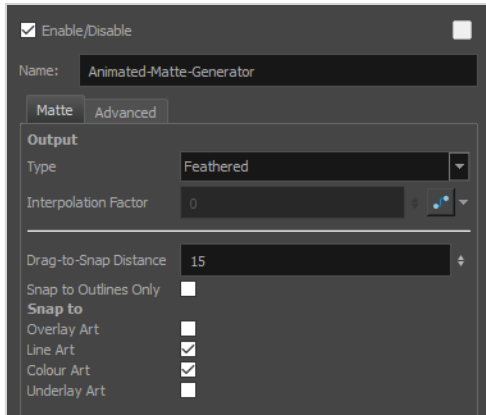

Property	Description
Output	
Type	<p>Determines which one of the following type of matte the node generates:</p> <ul style="list-style-type: none"> <li> <b>Feathered:</b> Generates a matte that gradates from the inner contour's colour to the outer contour's colour, based on the parameters in the <b>Advanced</b> tab.           <div data-bbox="578 1178 1024 1476" style="text-align: center;"> </div> </li> <li> <b>Outer Contour:</b> Displays the matte drawing as deformed by the outer contour's control points.           <div data-bbox="578 1598 1024 1896" style="text-align: center;"> </div> </li> </ul>

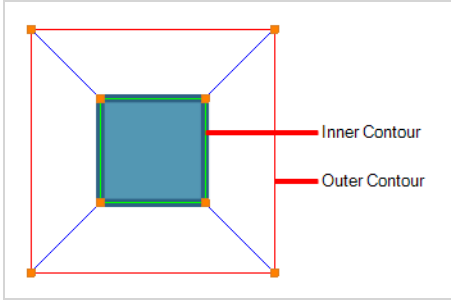
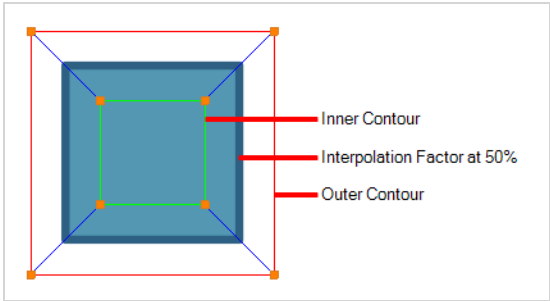
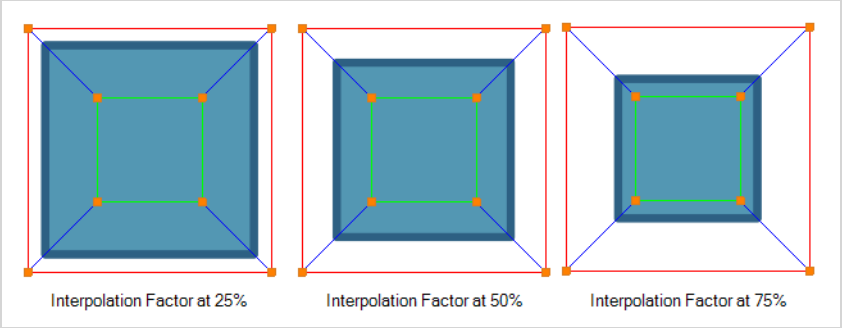
	<ul style="list-style-type: none"> <li> <b>Inner Contour:</b> Displays the matte drawing as deformed by the inner contour's control points.                     </li> </ul>  <ul style="list-style-type: none"> <li> <b>Interpolate between contours:</b> Displays the matte drawing as deformed by a contour that is an intermediate between the outer contour and the inner contour. How close to the inner or outer contour this intermediate contour is is based on the <b>Interpolation Factor</b> parameter below.                     </li> </ul> 
<p>Interpolation Factor</p>	<p>When the output type is set to <b>Interpolate between contours</b>, the matte drawing is deformed according to a contour that is an intermediate between the outer contour and the inner contour.</p> <p>The interpolation factor determines the percentage by which the intermediate contour is interpolated from the outer contour to the inner contour. For example, if the interpolation factor is set to 50, the intermediate contour will be halfway between the outer contour and the inner contour. By default, it is set to 0, which means the intermediate contour is the same shape as the outer contour. If it is set to 100, the intermediate contour will match the inner contour.</p> 

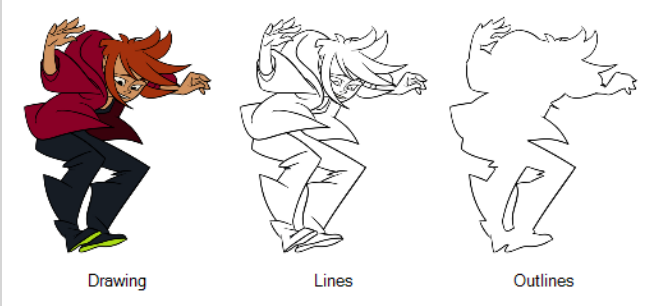
	<div style="border: 1px solid #add8e6; padding: 10px;">  <p><b>TIP</b></p> <p>The Interpolation Factor parameter can be animated. This can be useful if you want your drawing to morph back and forth between two different shapes, one of which would be defined by the outer contour and the other defined by the inner contour.</p> </div>
Snap	
Drag-to-Snap Distance	<p>If the Animated Matte Generator mode has a drawing connected to its Snapping Source port, and some of the matte's control points or contours are set to snap to that drawing, those points will always snap to the closest contour in the snapping source drawing, as long as it can find a contour within a certain distance.</p> <p>This distance is determined by the Drag-to-Snap distance parameter. By default, it is set to 15. You can increase it if you want the snapping points to snap to contours from a further distance to their actual position, or decrease it if you only want snapping points to snap to contours that are very close to their actual position.</p>
Snap to Outlines Only	<p>Make Snapping points and contours only snap to the outlines of the snapping source drawing. In this case, a contour is an outline that defines the silhouette of the drawing.</p> <div style="text-align: center;">  <p style="display: flex; justify-content: space-around; margin-top: 5px;"> <span>Drawing</span> <span>Lines</span> <span>Outlines</span> </p> </div>
Snap to	<p>Allows you to select which ones of the snapping source drawing's art layers the matte's points and contours will snap to, if they are set to snap. This can be useful if your snapping source drawing has its line art and colour art on different layers, as both art layers are likely to have a lot of meshing contours.</p>

## Advanced Tab

The settings in the Advanced tab are only available when the matte's output type is set to Feathered. A feathered matte ignores the colours and pencil lines in the drawing and, instead, uses the outer and inner matte's shape to generate a gradated colour effect, the colours and parameters of which can be set in the Advanced tab.

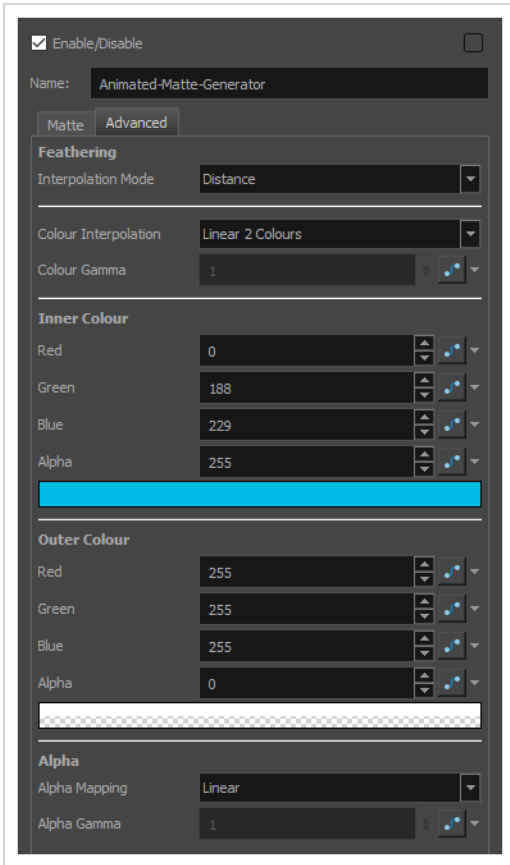

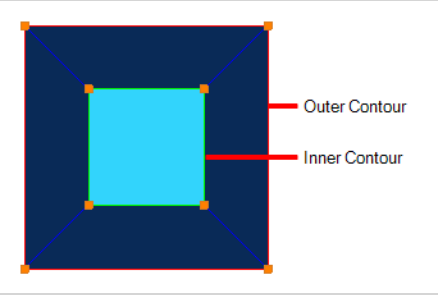

Property	Description
Feathering	
Interpolation Mode	<p>Determines the way the colour is gradated from the inner contour to the outer contour:</p> <ul style="list-style-type: none"> <li> <b>None:</b> The outer and the inner contour are solid shapes, filled with their respective colours.                     </li> </ul>  <ul style="list-style-type: none"> <li> <b>Parametric:</b> Generates a linear gradient going from each side of the inner contour to the corresponding side of the outer contour. This mode is different from the Distance interpolation mode by how it makes the gradients track the matching sides of the inner and outer contours.                     </li> </ul>

	<div data-bbox="576 184 1128 562" style="text-align: center;"> <p>Outer Contour    Inner Contour      Outer Contour    Inner Contour</p> <p>Parametric Mode                      Distance Mode</p> </div> <ul style="list-style-type: none"> <li>• <b>Dot:</b> Generates a gradient going from the inner contour to the outer contour, but based on a power function that creates the illusion of a thinner, harder outline.</li> </ul> <div data-bbox="576 682 1015 976" style="text-align: center;"> <p>Outer Contour</p> <p>Inner Contour</p> </div> <ul style="list-style-type: none"> <li>• <b>Distance:</b> Generates a linear gradient going from the inner contour to the outer contour.</li> </ul> <div data-bbox="576 1096 1015 1390" style="text-align: center;"> <p>Outer Contour</p> <p>Inner Contour</p> </div>
Colour	
Colour Interpolation	<p>Determines the way the colours between the inner and outer contours are generated:</p> <ul style="list-style-type: none"> <li>• <b>Constant:</b> Generates a gradient based on the inner colour, gradating in transparency only. The inner contour will have the opacity of the inner colour, and will gradate towards full transparency towards the outer contour.</li> </ul>

	<div data-bbox="576 184 1016 478" data-label="Image"> <p>A square diagram showing a gradient from a light blue inner square to a dark blue outer square. The inner square is outlined in green and labeled 'Inner Contour'. The outer square is outlined in red and labeled 'Outer Contour'. Blue lines connect the corners of the inner square to the corners of the outer square, and the gradient fills the space between them.</p> </div> <ul style="list-style-type: none"> <li>• <b>Linear 2 Colours:</b> Creates a gradient that steadily gradates from the inner colour to the outer colour.</li> </ul> <div data-bbox="576 598 1016 892" data-label="Image"> <p>A square diagram showing a gradient from a light blue inner square to a dark blue outer square. The inner square is outlined in green and labeled 'Inner Contour'. The outer square is outlined in red and labeled 'Outer Contour'. Blue lines connect the corners of the inner square to the corners of the outer square, and the gradient fills the space between them, appearing slightly more compressed towards the inner square compared to the linear version.</p> </div> <ul style="list-style-type: none"> <li>• <b>Gamma 2 Colours:</b> Creates a gradient that gradates from the inner colour to the outer colour on a Gamma curve, the power of which can be set in the Colour Gamma field. For more information, see the Colour Gamma field section below.</li> </ul>
<p>Colour Gamma</p>	<p>When the Colour Interpolation parameter is set to <b>Gamma 2 Colours</b>, use this field to enter the gamma power used to generate the gradient. By default, it is set to 1, creating a linear gradient. When set to any value between 0 and 1, the gradient will ease in from the inner colour to the outer colour. When set to any value above 1, the gradient will ease out from the inner colour to the outer colour.</p> <div data-bbox="496 1283 1065 1602" data-label="Image"> <p>Two square diagrams side-by-side. The left one is labeled 'Colour Gamma set to 0.5' and shows a gradient that eases in from the inner square. The right one is labeled 'Colour Gamma set to 2' and shows a gradient that eases out from the inner square.</p> </div>
<p>Inner Colour</p>	<p>The colour used to fill the matte's inner contour.</p>
<p>Outer Colour</p>	<p>The colour used for the matter's outer contour.</p>

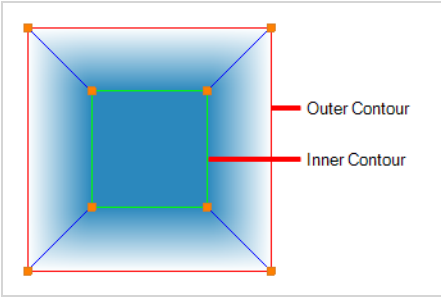

	<div data-bbox="500 191 1430 390" style="border: 1px solid #c8e6c9; padding: 10px; margin-bottom: 10px;"> <p> <b>NOTE</b> If the Interpolation mode is set to None, this colour will fill the outer contour. Otherwise, it is used to create a gradient going from the inner contour to the outer contour.</p> </div> <div data-bbox="500 417 1430 648" style="border: 1px solid #c8e6c9; padding: 10px;"> <p> <b>NOTE</b> If the Colour Interpolation parameter is set to Constant, this parameter is ignored and the outer colour will be set to the same colour as the inner colour, except with an alpha value of zero, making the matter a single solid colour with a transparency gradient.</p> </div>
Alpha	<p data-bbox="500 804 1360 863">Determines the way the alpha between the inner contour and the outer contour is gradated:</p> <ul data-bbox="548 892 1403 951" style="list-style-type: none"> <li>• <b>Linear:</b> Steadily gradates from the inner contour's alpha to the outer contour's alpha.</li> </ul> <div data-bbox="578 978 1016 1272" style="text-align: center;">  </div> <ul data-bbox="548 1308 1419 1404" style="list-style-type: none"> <li>• <b>Gamma:</b> Calculates the alpha going from the inner contour to the outer contour based on a Gamma curve, the power of which can be set in the Alpha Gamma field. For more information, see the Alpha Gamma field section below.</li> </ul>
Alpha Gamma	<p data-bbox="500 1472 1430 1673">When the Colour Mapping parameter is set to <b>Gamma</b>, use this field to enter the gamma power used to calculate the alpha values in the gradient. By default, it is set to 1, creating a linear alpha gradient. When set to any value between 0 and 1, the gradient's alpha values will ease in from the inner contour's alpha value to the outer contour's alpha value. When set to any value above 1, the alpha values of the gradient will ease out from the inner contour's alpha value to the outer contour's alpha value.</p>

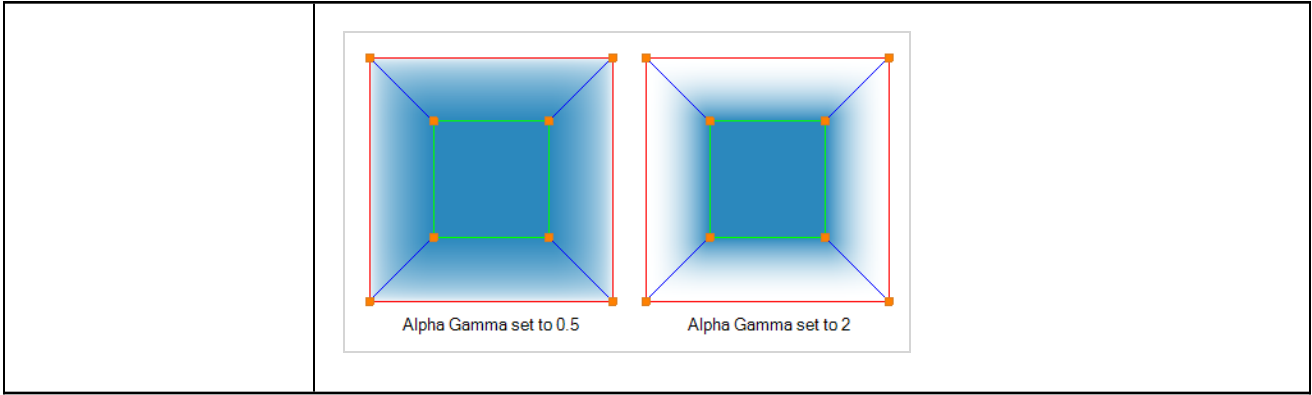

## Burn-In Node



The Burn-In effect lets you add scene information which is visible in the Camera view. The information is displayed on top of any content in the scene. You can choose to display the scene name, timecode, frame count, environment and job, as well as add a frame offset if you need blank frames to precede the scene content. Also, to make the information more visible, you can also add a background and choose its colour, and customize the text font and alignment.

When you attach a Burn-In node to a Composite node, the burn-in information is rendered when you export the scene.



### NOTE

When you're working with 3D objects with a high Z position value, you may find the objects obscuring the scene information. To work around this, use a peg to ensure the burned in scene information is always visible.

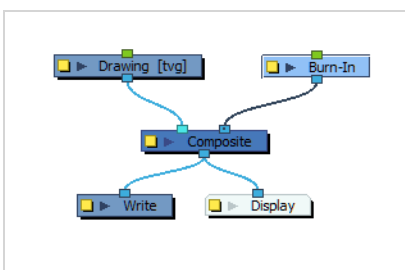

## How to add burn in scene information

1. In the Node Library, drag a **Burn-In** node to the Node view.
2. Connect it to the Composite node.
3. On the Burn-In node, click the square yellow properties button.

The Burn-In property window displays.

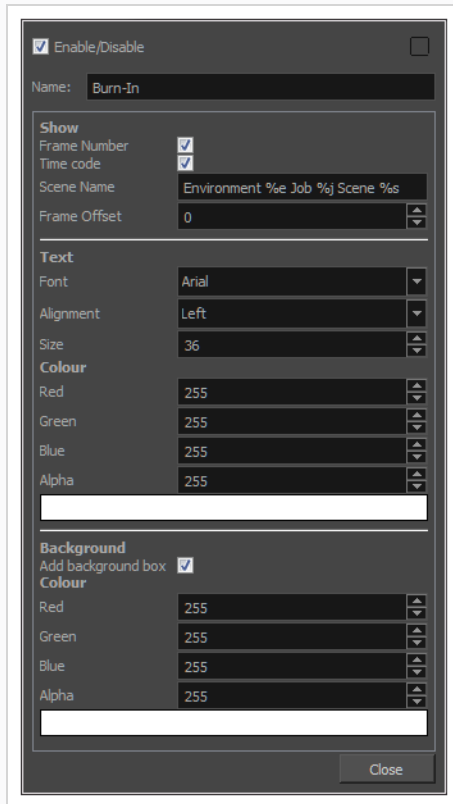

4. In the Show section, enter the following information:
  - ▶ **Frame Number:** The frame number to start the burn-in information.
  - ▶ **Time code:** The time code at which the burn-in information starts.
  - ▶ **Scene name:** By default the scene name, environment and job information is display. Type the following to display specific types of information.
    - Scene Name:** %s
    - Environment:** %e
    - Job:** %j
  - ▶ **Frame Offset:** Add lead-in frames before the scene begins or at a specific frame. Use positive values for frames that precede the scene content and negative values to start your scene information at a certain frame number.

5. In the Text section, customize the text that is displayed.
6. In the Background section, add a background box to make the text more visible and then customize the colour.

## Burn-In Properties

Parameter	Description
Name	Allows you to enter a name for the node.
<b>Show</b>	
Frame Number	Displays the number of the current frame.
Time Code	Displays the time code of the current frame.
Scene Name	<p>Lets you display different types of information, including the scene name, environment and job. You can display one or all of these pieces of information. To do so, type the following in the Scene Name field:</p> <ul style="list-style-type: none"> <li>• Scene Name: %s</li> <li>• Environment: %e</li> <li>• Job: %j</li> </ul> <p>You can rearrange the order in which the information is displayed. For example, you may want to see the job before the environment.</p>
Frame Offset	<p>Lets you add blank lead-in frames before the scene or somewhere in the scene. Use positive values for frames that precede the scene content and negative values to start your scene information at a certain frame number.</p>
<b>Text</b>	
Font	Lets you select a font for the information displayed.
Alignment	Lets you set the alignment of the text: Left, Center, Right.
Size	Lets you set the size of the text.
<b>Background</b>	

Add Background Box	Adds a box behind the scene information which is useful when the scene contains colours or content that may make it difficult to read the scene information.
<b>Colour</b>	
Red/Green/Blue/Alpha	Lets you enter R, G, B and A values for the colour of the background box.
Colour Swatch	Opens the Colour Picker dialog, in which you can visually select a colour for the effect.

## Colour-Card Node

T-ANIMPA-012-001

The Colour Card allows you to fill the scene's background with a solid colour when there is no background image. If no drawing or colour-card is present to cover the scene's background, the scene will be rendered on a pitch black canvas.



### NOTE

By default, the Colour Card has a Z ordering value of **12 Backward**. This puts the Colour card behind all elements that have a value lower than **12 Backward**. Most of the time, the Colour card will appear automatically behind all the scene elements as they are all set to **0 Backward**, unless you have changed the Z ordering of the scene components. If so, the Colour Card will be in front of the elements that are pushed back to more than 12 fields backward.

## Connection

The Colour Card only needs to be connected to a composite, and does not require an input image.

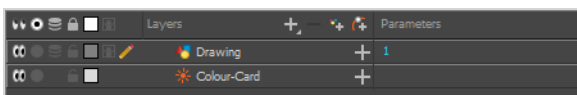
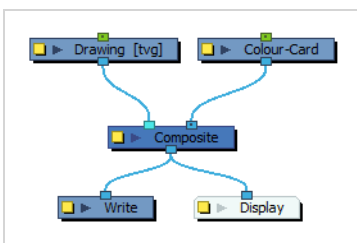

It is recommended to connect your Colour Card to the right-most port of the Composite for coherence, but because a Colour Card has a default position on the z-axis of 12 Backward, it will appear behind all the elements in your scene regardless of where you connect it on the scene's composite.

Optionally, a Colour Card can also be connected to a matte image. In this case, the Colour Card will only fill the shape of the matte with its colour, rather than the whole scene.

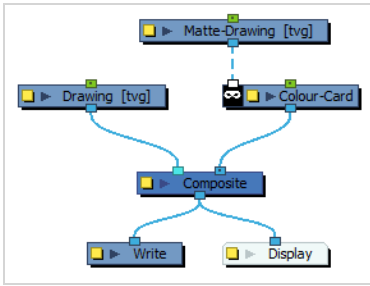

## Layer Properties

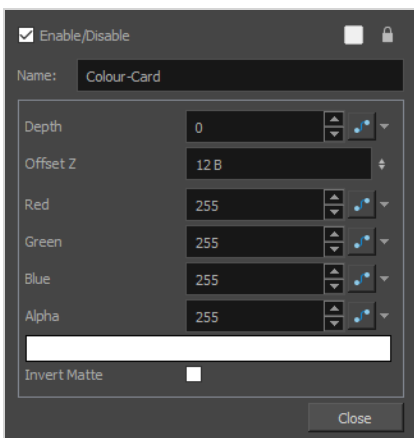

Parameter	Description
Enable/Disable	Allows you to enable or disable the node. When disabled, a node has no visible effect on the rendered image, nor on the preview in the Camera, Perspective, Side and Top views.
Colour Swatch	Sets the colour of the layer in the Timeline view and of the node in the Node view.
Name	Allows you to enter a name for the node.
Depth	This parameter can be used to determine whether the colour card displays behind or in front of elements with the same position on the z-axis. Elements and Gradient nodes also have a depth parameter.
Offset Z	The position of the Colour Card on the Z-axis. By default, this is set to 12 B to ensure the Colour Card appears behind other elements in the scene. You can set this to 0 F to make the Colour Card respect the order in which nodes are connected to the composite.



---

Parameter	Description
Colour	<p>The colour and transparency of the Colour Card. You can also attach these parameters to function columns to change their values over time.</p> <p>Click the colour swatch to open the Colour Picker window and select a colour.</p>
Colour Swatch	<p>Opens the Colour Picker window in which you can specify the colour.</p>
Invert Matte	<p>If an image is connected to the Colour Card's matte port, by default, the colour is only applied on the opaque areas of the matte. If this parameter is enabled, the colour is applied to the transparent areas of the matte instead.</p>

## Element / Drawing Node

The Element node is at the very core of a scene's structure. An element is a directory in which drawings are stored, which is associate to an Xsheet column indicating when and for how long each drawing is exposed, and which is in turn linked to a layer which indicates the position of the drawings in the scene. The Element node allows you to connect the element to effects, pegs and composites, determining how its drawings are processed and rendered.

## Connection

The Element node does not need an input image. It generates its output image from the drawings in its element and their exposure. Hence, it can be simply connected to a composite.

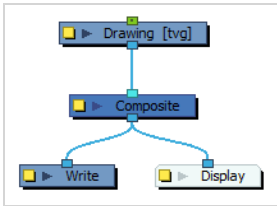

Although Element nodes can be transformed and animated on their own, it is typical to connect their input port to a Peg. This allows you to keep the position and animation information of the element in a separate node, making it easier to manipulate the exposure and the transformations separately. This is especially useful in digital cut-out animation where manipulating and transforming layers is often the main method of simulating movement, and changing drawings is the secondary method.

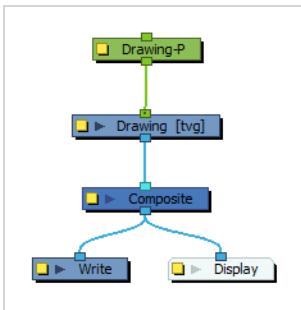

You can also connect an Element node to another Element node. Just like with pegs, any transformation done on the parent Element node, whether on itself or through one of its parents, will also be applied to the child Element node.

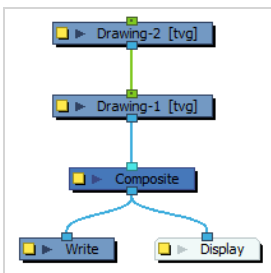

Optionally, you can connect a matte drawing to the left edge of an Element node. When an Element node is connected to a matte drawing, only the parts of the drawings that intersect with the opaque areas of the matte drawing will be rendered. This allows you to accomplish the same effect as connecting the Element node to a cutter node, without using an extra node.

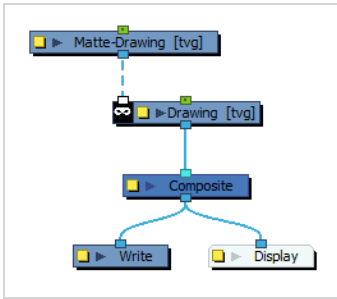

## Layer Properties

The drawing node's properties are organized in the following tabs:

- [Transformation Tab](#)
- [Drawing Tab](#)
- [Controls Tab](#)
- [Line Thickness](#)
- [Advanced Tab](#)

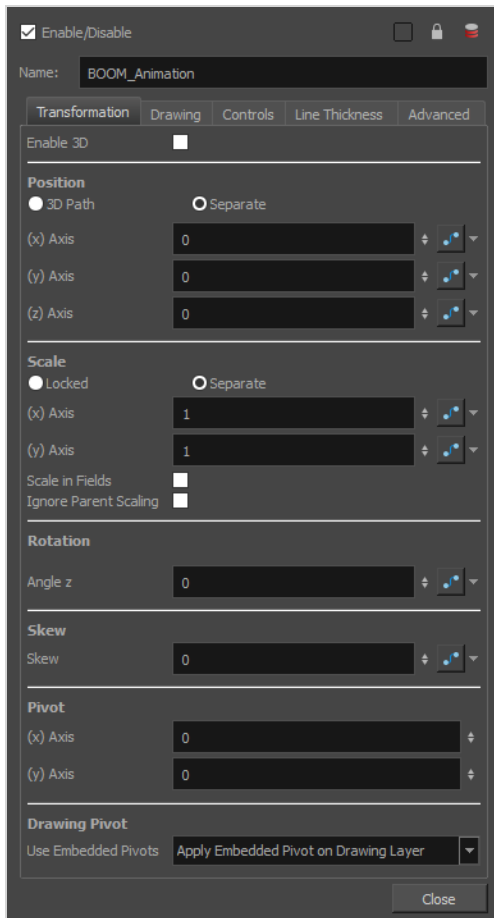

## Transformation Tab

The Transformation tab contains parameters for adjusting the position, scale, rotation, skew and pivots of an element.



Parameter	Description
Enable 3D	Allows the layer to be rotated and scaled in 3D. This means it can be rotated on the X and Y axes and scaled on the Z axis.
Position	<p><b>3D Path:</b> Use a 3D path to position the element. A 3D path uses a single function to define the position on the X, Y and Z axes. This function is made of control points linked by a curvilinear path, making the movement follow a natural curve. The pace and ease of the movement is determined by a single velocity function.</p> <p><b>Separate:</b> Positions the element using separate functions for the X, Y and Z axes. This allows to control the direction and pace of the movement across all three axes separately. Unless ease is applied to the axes, the trajectory of the element will follow straight lines going between each keyframe.</p>
	<p><b>Path:</b> If the 3D Path option is selected, this field allows you to create or select the 3D Path function used to position the element.</p> <p><b>Path (x) Axis:</b> The position of the element on the East-West axis, in fields.</p> <p><b>Path (y) Axis:</b> The position of the element on the South-North axis, in fields.</p>

	<p><b>Path (z) Axis:</b> The position of the element in the Back-Front axis, in fields.</p> <p><b>Velocity:</b> If the 3D Path option is selected, this function is used to control the pace at which the element moves towards each control point in the 3D Path function, on all three axes simultaneously.</p>
Scale	<p><b>Locked:</b> Uses a single scale parameter to scale the element, preserving its proportions.</p> <p><b>Separate:</b> Uses a separate parameter to scale the element on the X and Y axis, as well as on the Z axis if the element is 3D-enabled, allowing to stretch or squash the element.</p>
	<p><b>(x) Axis:</b> The horizontal scale factor. The default value is 1.</p> <p><b>(y) Axis:</b> The vertical scale factor. The default value is 1.</p> <p><b>(z) Axis:</b> The depth scale factor for 3D-enabled elements. The default value is 1.</p> <p><b>Scale in Fields:</b> With this option enabled, the scale factor is based on the amount of fields in the scene. For example, to shrink one of the dimensions of an element to half its original size, the scale factor would normally be set to 0.5. If this option is enabled and the amount of fields in the scene is 12, then the scale factor to shrink the element by half would be 6.</p> <p><b>Ignore Parent Scaling:</b> When this option is enabled, scaling factors applied to a parent layer will not be applied to the current layer. This can be handy in cut-out rigs when you need to scale an arm without affecting the forearm.</p>
Rotation	<p><b>Angle z:</b> The angle at which the element is rotated, based on the 360 degrees scale. Values below 0 or above 360 degrees will cause the rotation to cycle.</p>
Rotation (3D enabled)	<p><b>Quaternion:</b> Similar to a 3D Path, the Quaternion determines the angle of a 3D object using a single function.</p> <p><b>Euler Angles:</b> Determines the angle of a 3D object by rotating it on the X, Y and Z axes using separate angles.</p> <hr/> <p><b>3D Rotation:</b> If the Quaternion option is selected, this field allows you to create or select the Quaternion function used to rotate the element.</p> <p><b>(x) Axis:</b> The angle at which the element is rotated on the horizontal axis.</p> <p><b>(y) Axis:</b> The angle at which the element is rotated at the vertical axis.</p> <p><b>(z) Axis:</b> The angle at which the element is rotated on the depth axis.</p> <p><b>Velocity:</b> If the Quaternion option is selected, this function is used to control the speed at which the element is rotated on all 3 axes.</p>

Skew	<p><b>Skew:</b> The angle at which the element is skewed. This value can range from -90 to 90 degrees.</p>
Pivot	<p><b>(x) Axis:</b> The horizontal position of the pivot point of the element relative to the pivot point of the drawing, in fields.</p> <p><b>(y) Axis:</b> The vertical position of the pivot point of the element relative to the pivot point of the drawing, in fields.</p> <div data-bbox="565 504 1429 672" style="border: 1px solid green; padding: 10px; margin-top: 10px;"> <p> <b>NOTE</b></p> <p>These parameters can be changed visually by clicking and dragging the pivot point when using on of the tools in the Advanced Animation toolbar.</p> </div>
Drawing Pivot	<p>An element layer has two pivots:</p> <ul style="list-style-type: none"> <li>• The pivot of the element, which is set by the Pivot parameters above.</li> <li>• The pivot of the currently exposed drawing, which is set using the Drawing Pivot  tool.</li> </ul> <p>This preference is used to determine what to do with the pivot point of the currently exposed drawing:</p> <ul style="list-style-type: none"> <li>• <b>Don't Use Embedded Pivot:</b> Ignores the pivot point of the exposed drawing. The pivot point of the element is positioned using the Pivot parameters above, relative to the centre of the drawing.</li> <li>• <b>Apply Embedded Pivot on Parent Peg:</b> Use the pivot point of the exposed drawing to determine the position of the pivot point of the parent peg of the drawing layer. This is useful when making a character rig where each element has a parent peg, and those parent pegs are intended to be used for animation. The pivot point of these parent pegs will be based on the pivot point set for the exposed drawing.</li> <li>• <b>Apply Embedded Pivot on Drawing Layer:</b> Use the pivot point of the drawing to determine the pivot point of the element. This means the pivot point is positioned using the Pivot parameters above, but relative to the pivot point of the drawing.</li> </ul>

**TIP**

The two latter options are useful when making a character rig where a layer can represent a body part from different angles. Since each angle is represented by a drawing, and each angle is liable to have a different pivot point, you can set the pivot point of each angle by using the Drawing Pivot  tool on each drawing. Then, if you want to animate the drawing layers directly, you can set this parameter to the **Apply Embedded Pivot on Drawing Layer** option, and if you want to animate using the parent pegs of the drawing layers, you can set this parameter to the **Apply Embedded Pivot on Parent Peg** option, so that these pivots are used when animating the different parts of the rigs.

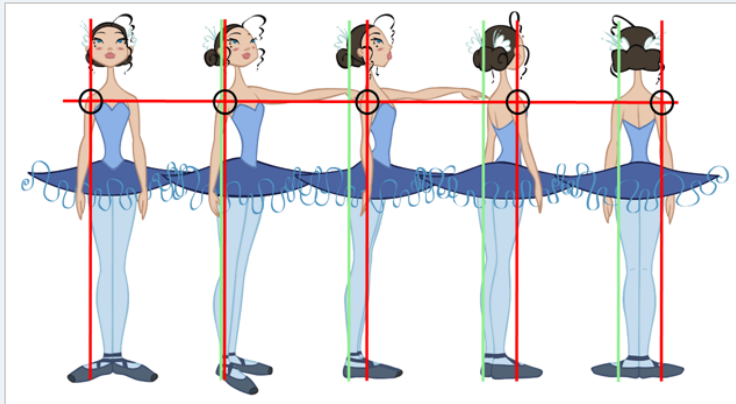

## Drawing Tab

The Drawing tab contains parameters for element and timing columns, the art layers, bitmap images and the element's matte drawing.



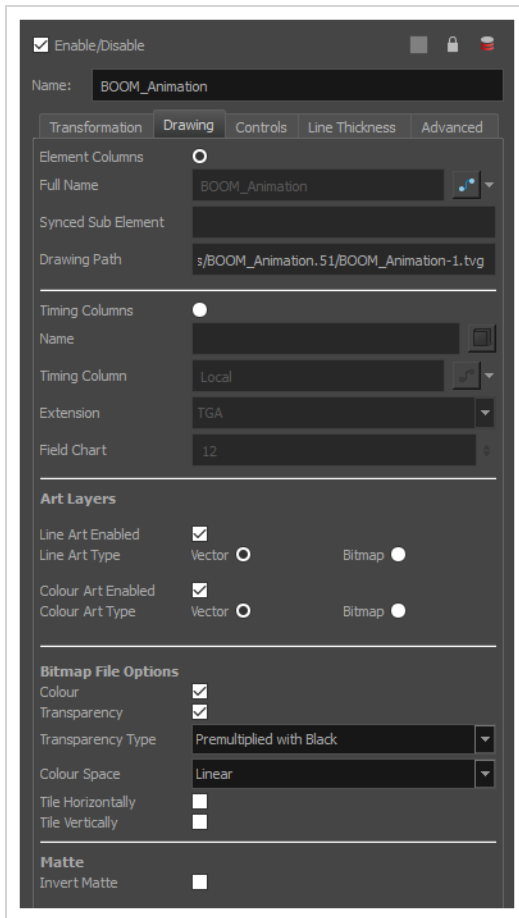

Parameter	Description
Element Columns	<p><b>Full Name:</b> Select which element to connect to the node from the list of elements that already exist in your scene.</p> <p><b>Synced Sub Element:</b> If the layer is synced to another layer, this field displays the name of the layer's sub-element. A sub-element is an element stored inside another element for syncing layers.</p> <p><b>Drawing Path:</b> Displays the full path to the current drawing.</p>
Timing Columns	<p><b>Name:</b> The path to the drawing file the element links to.</p> <p><b>Timing Column:</b> The name of the Xsheet timing column used for the layer's timing.</p> <p><b>Extension:</b> The extension of the drawing file the element links to.</p> <p><b>Field Chart:</b> The size of the field chart used for the drawings the element links to. This setting is useful when linking to traditional animation drawings.</p>
Art Layers	These parameters allow you to set whether each art layer in the drawing layer is

	<p>enabled, and whether they should contain vector or bitmap artwork. By default, options for the Line Art and Colour Art layers will be available. If the Enable Overlay and Underlay Arts preference is enabled, options for the Overlay Art and Underlay Art layers will also be available.</p> <p><b>Enabled:</b> Determines whether the art layer is displayed.</p> <p><b>Vector:</b> Makes the art layer enabled for vector artwork, Vector drawing tools will be used to draw in this art layer, and vector artwork information will be preserved.</p> <p><b>Bitmap:</b> Makes the art layer enabled for bitmap artwork. Only bitmap-compatible drawing tools will be enabled when drawing on this layer, and all artwork will be rasterized into a bitmap image.</p>
<p>Bitmap File Options</p>	<p><b>Colour:</b> Determines whether or not the colours in the image is processed. If unchecked, the image will be solid black.</p> <p><b>Transparency:</b> Determines whether or not the transparency in the image is processed. If unchecked, the image will be fully opaque.</p>
	<p><b>Transparency Type:</b> If the layer contains bitmap images with a transparency channel, there are several approaches to rendering the image's transparency. You may need to select the proper transparency type to make sure Harmony renders the image as intended.</p> <ul style="list-style-type: none"> <li>• <b>Premultiplied with Black:</b> Semi-transparent pixels in the original image are blended with black.</li> <li>• <b>Premultiplied with White:</b> Semi-transparent pixels in the original image are blended with white.</li> <li>• <b>Straight:</b> Semi-transparent pixels in the original image are left as is (unmatted).</li> <li>• <b>Clamp Colour to Alpha:</b> Semi-transparent pixels in the original image are blended with black. On import, each of the RGB channels is clamped so that a color value never exceed the alpha value for a given pixel. When the RGB values are multiplied with the alpha value, that is to say, if you have a pixel of value R=247, G=188, B=29 and the alpha is 50% or the image has a 50% transparency, then the actual RGB values output would be half of the amounts listed above.</li> </ul>
	<p><b>Colour Space:</b> If the element is displaying original bitmap files that are not tagged with their colour space information, this allows you to set the colour space in which Harmony should render the image.</p> <ul style="list-style-type: none"> <li>• <b>Linear:</b> The default value. The linear colour space is one where the intensity of each primary is directly proportional to their value. Typically, visuals are rendered in a linear colour space until the final compositing stage.</li> </ul>



	<ul style="list-style-type: none"> <li>• <b>sRGB:</b> The most common colour space used with computer and digital device displays. With this colour space, the relation between the value of each primary and their intensity is defined by a gamma function.</li> <li>• <b>Rec.709:</b> A colour space commonly used for HD television. It is very similar to sRGB with a slightly lower gamma curve.</li> </ul> <p><b>Tile Horizontally:</b> Repeats the bitmap image infinitely to the left and to the right of the layer. This can be useful for making looping backgrounds.</p> <p><b>Tile Vertically:</b> Repeats the bitmap image infinitely to over and underneath the layer. This can be useful for making looping backgrounds.</p> <div style="border: 1px solid green; padding: 10px; margin-top: 10px;"> <p> <b>NOTE</b></p> <p>When both the <b>Tile Horizontally</b> and <b>Tile Vertically</b> options are used together, the bitmap image is tiled all over the scene.</p> </div>
Matte	<p><b>Invert Matte:</b> If a drawing, composite or effect is connected to the drawing's matte input port, the part of the drawing that intersect with the matte's opaque areas will be cut out by default. If this parameter is enabled, the part of the drawing that intersect with the matte's transparent areas will be cut out instead.</p>

## Controls Tab

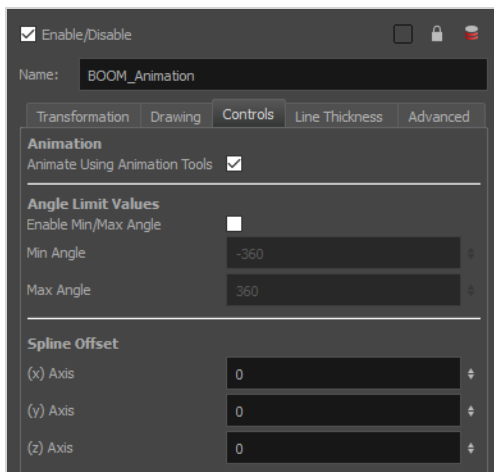
The Controls tab contains animation control options.





Parameter	Description
Animation	<p><b>Animate Using Animation Tools:</b> By default, a drawing layer can be animated directly, as if it was its own peg. If you disable this option, it will only be possible</p>

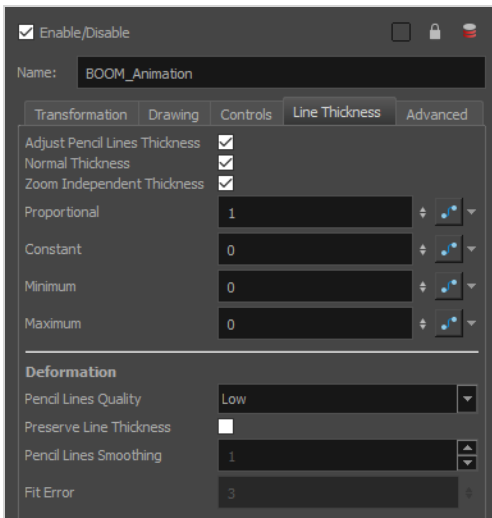

	<p>to animate the layer using its parent peg. If the layer has no parent peg, it will be immutable.</p> <p>This can be useful if you want to create cut-out character rigs that should only be animated using pegs, which can help separate the drawing exposure from the transformations on the drawings. If every drawing layer in a character rig has this option disabled, only layers that have a parent peg will be animatable, and the animator will only be able to animate on the pegs. This also rules out the possibility of accidentally animating an element directly and using its parent peg concurrently.</p> <p>When this option is disabled, clicking on the drawing layer in the Camera view with the Transform tool will automatically select the layer's parent peg.</p>
Angle Limit Values	<p>Lets you set a maximum and minimum rotation angle for a drawing. This option is used mainly for a cut-out character when you do not want an elbow to bend too far in or out.</p> <p><b>Enable Min/Max Angle:</b> Activates the minimum and maximum angle constraints.</p> <p><b>Min Angle:</b> The minimum rotation angle for the element.</p> <p><b>Max Angle:</b> The maximum rotation angle for the element.</p>
Spline Offset	<p>If the layer's controls are displayed, you can see its animation trajectory in the Camera view. This is referred to as the <i>spline</i>. By default, the position of each point in the spline is based on the element's pivot point. However, you can use the spline offset to give it a more fitting position if desired. You can do this by using the Spline Offset tool of the Advanced Animation toolbar, or by manually entering the offset values in the Spline Offset fields.</p> <p><b>(x) Axis:</b> The horizontal offset of the spline, in fields.</p> <p><b>(y) Axis:</b> The vertical offset of the spline, in fields.</p> <p><b>(z) Axis:</b> The depth offset of the spline, in fields.</p> <div data-bbox="565 1398 1430 1707" style="border: 1px solid #add8e6; padding: 10px; margin-top: 10px;"> <p> <b>TIP</b></p> <p>To display the animation trajectory of the layer in the Camera view, select the layer, then do one of the following:</p> <ul style="list-style-type: none"> <li>• In the Camera toolbar, click on Show Control .</li> <li>• From the top menu, select <b>View &gt; Show &gt; Control</b>.</li> <li>• Press Shift + F11 (Windows/Linux) or  + F11 (macOS).</li> </ul> </div>

## Line Thickness

The Line Thickness tab contains options regarding the way pencil lines in the element are rendered. These options can be very useful to enhance the quality of line art without having to work on it.



Parameter	Description
Line Thickness	<p><b>Adjust Pencil Lines Thickness:</b> Enables the options below to adjust the line thickness in the rendered image.</p> <p><b>Normal Thickness:</b> This setting makes the line thickness adjustments take one of two very different behaviors:</p> <ul style="list-style-type: none"> <li>• <b>Enabled:</b> The line thickness settings are applied to pencil lines in all art layers in the element. This setting should be used if you want to adjust the line thickness of pencil lines.</li> <li>• <b>Disabled:</b> The line thickness settings are applied to all art, whether brush strokes or pencil lines, in the line art layer, so that it fits the desired thickness pattern around art in the colour art layer. This setting should be used for drawings that have their line art on the line art layer and their colour art on the colour art layer, which is typical of traditional and paperless animation productions.</li> </ul> <div data-bbox="643 1373 1430 1577" style="border: 1px solid green; padding: 10px; margin: 10px 0;"> <p> <b>NOTE</b> When this option is disabled, all artwork in the line art layer that does not surround artwork in the colour art layer will be cropped out.</p> </div> <p><b>Zoom Independent Thickness:</b> Makes the thickness of pencil lines remain unchanged when the camera zooms in or zooms out.</p> <p><b>Proportional:</b> The factor by which to adjust line thickness. The original line thickness in the drawing will be multiplied by this value. A value between 0 and 1 can be used to make pencil lines thinner.</p> <p><b>Constant:</b> The offset by which to adjust line thickness. This value will be added</p>

	<p>to the original line thickness in the drawing. A negative number can be entered to make pencil lines thinner.</p> <p><b>Minimum:</b> The minimum pencil line thickness allowed. Line thickness will not go below this value.</p> <p><b>Maximum:</b> The maximum pencil line thickness allowed. Line thickness will not go above this value. Set it to 0 to disable maximum line thickness.</p>
Deformation	<p><b>Pencil Lines Quality:</b> The quality of the rendered pencil lines when deformed by deformation chains. Increasing this parameter is unlikely to yield noticeable result unless rendering in very high resolutions.</p> <p><b>Preserve Line Thickness:</b> If this option is checked, the thickness of pencil lines will not be affected by deformations. Only their directions will be affected. Also, if a pencil line is textured, it will not be stretched or squashed by deformations.</p> <div data-bbox="565 751 1429 919" style="border: 1px solid #c8e6c9; padding: 10px; margin: 10px 0;"> <p> <b>NOTE</b> This setting must be enabled for the Pencil Lines Smoothing and Fit Error parameters to be available.</p> </div> <p><b>Pencil Lines Smoothing:</b> The smoothing factor applied to pencil lines when rendering. This value can range from 0 to 10. The higher it is, the more corners and points will appear smoothed out.</p> <p><b>Fit Error:</b> When this parameter is increased, pencil lines in the rendered image will have less vector points and the curves between the remaining vector points will be adjusted to fit the original shape. This setting can be increased if the amount of details and points in the pencil lines creates problems around deformation articulations and corners. Its value can range from 1 to 100.</p> <div data-bbox="565 1276 1429 1444" style="border: 1px solid #c8e6c9; padding: 10px; margin: 10px 0;"> <p> <b>NOTE</b> The Fit Error parameter will have no effect if the Pencil Lines Smoothing parameter is set to 0.</p> </div>

## Advanced Tab

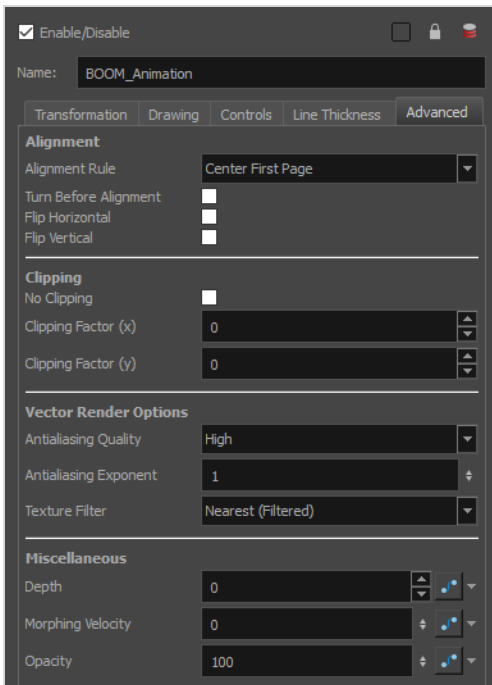

The Advanced tab contains options for setting the alignment of drawings, clipping, line thickness, vector render options, and more.



Parameter	Description
Alignment	<p><b>Alignment Rule:</b> The alignment rule selections are intended to deal with drawings that were created on paper of a different size or orientation from the default alignment rule (set up in the Scene Settings dialog box) or imported bitmap images. The drawings are then scaled to match the Harmony alignment rectangle. Note that alignment rules are not based on the camera frame, but on the scene frame. Refer to the Fundamentals Guide to learn more about scene alignment and scene settings.</p> <ul style="list-style-type: none"> <li>• <b>Left:</b> The default alignment for drawings; aligns the drawings to the left side of the scene’s alignment rectangle. Harmony scales the drawings to match their height to the alignment rectangle of the scene.</li> <li>• <b>Right:</b> Aligns the drawings to the right side of the alignment rectangle. Harmony scales the drawings to match their height to the height of the alignment rectangle of the scene.</li> <li>• <b>Top:</b> Aligns the drawings to the top of the alignment rectangle. Harmony scales the drawings to match their widths to the width of the alignment rectangle of the scene.</li> <li>• <b>Bottom:</b> Aligns the drawings to the bottom of the alignment rectangle. Harmony scales the drawings to match their widths to the width of the alignment rectangle of the scene.</li> <li>• <b>Centre Fit:</b> Centers the drawings.</li> <li>• <b>Centre Fill:</b> Centers the drawings and then scales them so the width or height fills the available space.</li> </ul>

	<ul style="list-style-type: none"> <li>• <b>Centre LR:</b> Aligns the drawings in the left-right centre of the alignment rectangle. Harmony scales the drawings to match their height to the height of the alignment rectangle of the scene.</li> <li>• <b>Centre TB:</b> Aligns the drawings in the top-bottom centre of the alignment rectangle. Harmony scales the drawings to match their widths to the width of the alignment rectangle of the scene.</li> <li>• <b>Stretch:</b> Scales the drawings so they fit within the alignment rectangle of the scene. This is particularly useful for images that you will manipulate with a Quadmap node. If the drawings in the Quadmap node do not have the same aspect ratio as the alignment rectangle of the scene (from the Scene Settings dialog box), the handles on the quadmap will not appear on the corners of the image, making it difficult to manipulate the quadmap. In this case, you would set the drawing layer of the quadmap images to Stretch to make the handles appear on the corner of the image. This can have the effect of distorting the images, but it is not an issue with images that will be distorted through the Quadmap node anyways.</li> <li>• <b>As Is:</b> Leaves the drawings aligned as they are.</li> <li>• <b>Centre First Page:</b> Aligns the centre of the first part of a standard pan cel with the centre of the field chart.</li> </ul> <p><b>Turn Before Alignment:</b> Rotates the drawings in the selected element 90 degrees to the left before scaling and aligning them according to the alignment rule, and before performing any offset, rotation or scaling for the element or peg. This and the Alignment Rule are intended for drawings that were created on paper of a different size or orientation than the other paper in the scene, and requires alignment so they are treated accurately.</p> <p><b>Flip Horizontal:</b> Flips the drawing on the horizontal axis.</p> <p><b>Flip Vertical:</b> Flips the drawing on the vertical axis.</p>
Clipping	<p><b>No Clipping:</b> By default, when using the Apply-Image-Transformation node on a bitmap layer, the image is clipped by the camera frame before the transformation. This can cause the resulting image to appear cropped if the peg connected to the Apply-Image-Transformation node brings the element from outside of the camera frame, or shrinks it. Enable this option to avoid clipping the image—see <a href="#">Apply Image Transformation Node on page 691</a>.</p> <div style="border: 1px solid green; padding: 10px; margin-top: 10px;"> <p> <b>NOTE</b>          In the great majority of cases, it is recommended to use an Apply-Peg-Transformation node instead to avoid clipping—see <a href="#">Apply Peg Transformation Node on page 694</a>.</p> </div>



	<p><b>Clipping Factor (X):</b> This parameter would extend the horizontal clipping area of vector drawings before effects are applied to it. Using this parameter is no longer required as Harmony manages the clipping areas of vector drawings automatically, and is only made available for legacy support.</p> <p><b>Clipping Factor (Y):</b> This parameter would extend the vertical clipping area of vector drawings before effects are applied to it. Using this parameter is no longer required as Harmony manages the clipping areas of vector drawings automatically, and is only made available for legacy support.</p>
Vector Render Options	<p><b>Antialiasing Quality:</b> The smoothness (antialiasing) setting used to make the crisp vector contours appear smooth.</p> <ul style="list-style-type: none"> <li>• <b>None - No Transparency:</b> Disables antialiasing, renders semi-transparent pixels either fully opaque or fully transparent, and fills single-pixel gaps with an opaque pixel to avoid generating out-of-place gaps when lines intersect each other.</li> <li>• <b>Low:</b> Disables antialiasing, but renders transparency.</li> <li>• <b>Medium Low:</b> Renders vector artwork with basic antialiasing.</li> <li>• <b>Medium:</b> Renders vector shapes with improved antialiasing. Bitmap texture fills will appear blurred.</li> <li>• <b>High:</b> Renders vector shapes with improved antialiasing, without blurring bitmap texture fills.</li> </ul> <div data-bbox="565 1094 1430 1297" style="border: 1px solid #add8e6; padding: 10px; margin: 10px 0;"> <p> <b>TIP</b> It is recommended to leave this setting to <b>High</b> unless you are working on a pencil test, or another type of scene where rendering speed is more important than rendering quality.</p> </div> <div data-bbox="565 1325 1430 1598" style="border: 1px solid #add8e6; padding: 10px; margin: 10px 0;"> <p> <b>TIP</b> If the production requires exporting line art without antialiasing to colour them in a third-party software, it is recommended to use the <b>None - No Transparency</b> setting. This setting automatically fills one-pixel gaps created by crisp lines intersecting each other, which would otherwise need to be filled manually in the third-party software.</p> </div> <p><b>Antialiasing Exponent:</b> Determines how much the artwork is scaled up to apply antialiasing onto it. A higher value will result in sharper edges, and a lower value will result in softer edges. Typical values range between 0 and 3. Higher values may be attempted but may result in overly crisp outlines. Negative values will cause the outlines to appear blurry.</p> <p><b>Texture Filter:</b> This setting determines how textures in the element are resampled when rendering:</p>

	<ul style="list-style-type: none"><li>• <b>Bilinear:</b> This option takes the four pixels around each point and makes a bilinear interpolation between them, which may make them look blurry.</li><li>• <b>Nearest:</b> When sampling the texture up, this option generates extra pixels by using the colour of the nearest defined pixel. When sampling the texture down, this option simply removes pixels from the texture.</li><li>• <b>Nearest (Filtered):</b> This option is similar to <b>Nearest</b>, but it adds an extra layer of resampling to make all pixels look like they are the same size.</li></ul>
Miscellaneous	<p><b>Depth:</b> Overrides the order of cables in the node system to determine the forward/backward order in which this element is rendered. The Z position value overrides the depth value.</p> <p><b>Morphing Velocity:</b> When morphing drawings in the element using the Morphing tool, this parameter can be used to create or select the velocity function used to determine the pace of the morphing animation.</p> <p><b>Opacity:</b> Lets you quickly change the transparency of the selected element. Opacity settings here will be reflected in both <b>OpenGL</b> preview, and full render.</p>

## Field Chart Node

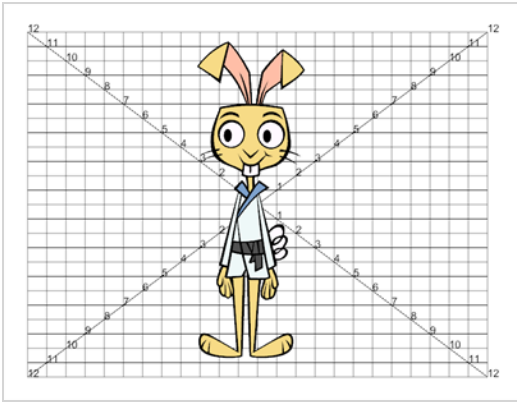

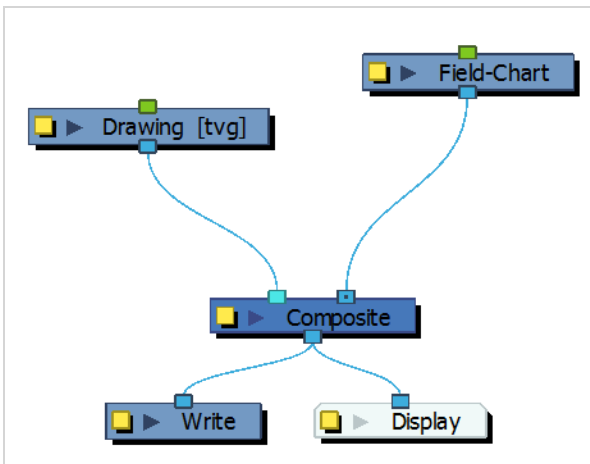

The Field Chart node displays a traditional animation field chart, which allows you to position elements in the Camera view. The Field Chart node doesn't export. If you want to export a field chart, use the Grid node—see [Grid Node on page 655](#).

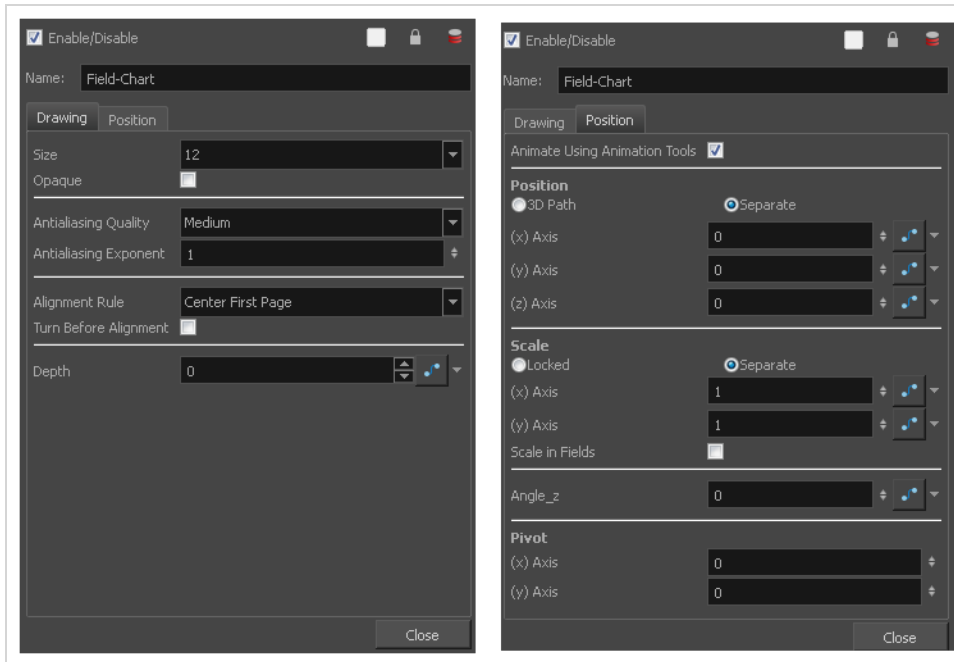

## Field Chart Properties



Parameter	Description
Name	Allows you to change the name given to the node.
<b>Drawing</b>	
Size	Adjusts the number of units in the grid (field chart). The grid size will always be a 4:3 ratio, as per traditional animation standards. The grid is available in 12 or 16 fields.
Opaque	Inserts a white background behind the grid and covers everything else behind it. By default, you can see through the grid.
Antialiasing	<p><b>Antialiasing Quality:</b> The smoothness (antialiasing) setting used to make the crisp vector contours appear smooth.</p> <ul style="list-style-type: none"> <li>• <b>None - No Transparency:</b> Disables antialiasing, renders semi-transparent pixels either fully opaque or fully transparent, and fills single-pixel gaps with an opaque pixel to avoid generating out-of-place gaps when lines intersect each other.</li> <li>• <b>Low:</b> Disables antialiasing, but renders transparency.</li> <li>• <b>Medium Low:</b> Renders vector artwork with basic antialiasing.</li> </ul>

	<ul style="list-style-type: none"> <li>• <b>Medium:</b> Renders vector shapes with improved antialiasing. Bitmap texture fills will appear blurred.</li> <li>• <b>High:</b> Renders vector shapes with improved antialiasing, without blurring bitmap texture fills.</li> </ul> <div data-bbox="565 373 1429 577" style="border: 1px solid #add8e6; padding: 10px; margin: 10px 0;">  <b>TIP</b>        It is recommended to leave this setting to <b>High</b> unless you are working on a pencil test, or another type of scene where rendering speed is more important than rendering quality.     </div> <div data-bbox="565 604 1429 877" style="border: 1px solid #add8e6; padding: 10px; margin: 10px 0;">  <b>TIP</b>        If the production requires exporting line art without antialiasing to colour them in a third-party software, it is recommended to use the <b>None - No Transparency</b> setting. This setting automatically fills one-pixel gaps created by crisp lines intersecting each other, which would otherwise need to be filled manually in the third-party software.     </div> <p><b>Antialiasing Exponent:</b> Determines how much the artwork is scaled up to apply antialiasing onto it. A higher value will result in sharper edges, and a lower value will result in softer edges. Typical values range between 0 and 3. Higher values may be attempted but may result in overly crisp outlines. Negative values will cause the outlines to appear blurry.</p>
Alignment Rule	<p>The alignment rule selections are intended to deal with drawings that were created on paper of a different size or orientation from the default alignment rule (set up in the Scene Settings dialog box) or imported bitmap images. The drawings are then scaled to match the Harmony alignment rectangle. Note that alignment rules are not based on the camera frame, but on the scene frame. Refer to the Fundamentals Guide to learn more about scene alignment and scene settings.</p> <ul style="list-style-type: none"> <li>• <b>Left:</b> The default alignment for drawings; aligns the drawings to the left side of the scene's alignment rectangle. Harmony scales the drawings to match their height to the alignment rectangle of the scene.</li> <li>• <b>Right:</b> Aligns the drawings to the right side of the alignment rectangle. Harmony scales the drawings to match their height to the height of the alignment rectangle of the scene.</li> <li>• <b>Top:</b> Aligns the drawings to the top of the alignment rectangle. Harmony scales the drawings to match their widths to the width of the alignment rectangle of the scene.</li> <li>• <b>Bottom:</b> Aligns the drawings to the bottom of the alignment rectangle. Harmony scales the drawings to match their widths to the width of the alignment rectangle of the scene.</li> </ul>

	<ul style="list-style-type: none"> <li>• <b>Centre Fit:</b> Centers the drawings.</li> <li>• <b>Centre Fill:</b> Centers the drawings and then scales them so the width or height fills the available space.</li> <li>• <b>Centre LR:</b> Aligns the drawings in the left-right centre of the alignment rectangle. Harmony scales the drawings to match their height to the height of the alignment rectangle of the scene.</li> <li>• <b>Centre TB:</b> Aligns the drawings in the top-bottom centre of the alignment rectangle. Harmony scales the drawings to match their widths to the width of the alignment rectangle of the scene.</li> <li>• <b>Stretch:</b> Scales the drawings so they fit within the alignment rectangle of the scene. This is particularly useful for images that you will manipulate with a Quadmap node. If the drawings in the Quadmap node do not have the same aspect ratio as the alignment rectangle of the scene (from the Scene Settings dialog box), the handles on the quadmap will not appear on the corners of the image, making it difficult to manipulate the quadmap. In this case, you would set the drawing layer of the quadmap images to Stretch to make the handles appear on the corner of the image. This can have the effect of distorting the images, but it is not an issue with images that will be distorted through the Quadmap node anyways.</li> <li>• <b>As Is:</b> Leaves the drawings aligned as they are.</li> <li>• <b>Centre First Page:</b> Aligns the centre of the first part of a standard pan cel with the centre of the field chart.</li> </ul>
Turn Before Alignment	<p><b>Turn Before Alignment:</b> Rotates the drawings in the selected element 90 degrees to the left before scaling and aligning them according to the alignment rule, and before performing any offset, rotation or scaling for the element or peg. This and the Alignment Rule are intended for drawings that were created on paper of a different size or orientation than the other paper in the scene, and requires alignment so they are treated accurately.</p>
Depth	<p>Overrides the order of cables in the node system to determine the forward/backward order in which this element is rendered. The Z position value overrides the depth value.</p>
<b>Position</b>	
Animate Using Animation Tools	<p>By default, the grid can be animated using the same parameters as a peg, but you can disable this feature so the field chart remains in place. You can connect it to a peg to animate it or move it.</p> <p>When this option is deselected, you cannot move the layer in the Camera view using the Transform and Advanced tools. This prevents you from accidentally displacing or modifying a layer.</p>

Position	<p><b>3D Path:</b> Use a 3D path to position the element. A 3D path uses a single function to define the position on the X, Y and Z axes. This function is made of control points linked by a curvilinear path, making the movement follow a natural curve. The pace and ease of the movement is determined by a single velocity function.</p> <p><b>Separate:</b> Positions the element using separate functions for the X, Y and Z axes. This allows to control the direction and pace of the movement across all three axes separately. Unless ease is applied to the axes, the trajectory of the element will follow straight lines going between each keyframe.</p> <p><b>Path:</b> If the 3D Path option is selected, this field allows you to create or select the 3D Path function used to position the element.</p> <p><b>Path (x) Axis:</b> The position of the element on the East-West axis, in fields.</p> <p><b>Path (y) Axis:</b> The position of the element on the South-North axis, in fields.</p> <p><b>Path (z) Axis:</b> The position of the element in the Back-Front axis, in fields.</p> <p><b>Velocity:</b> If the 3D Path option is selected, this function is used to control the pace at which the element moves towards each control point in the 3D Path function, on all three axes simultaneously.</p>
Scale	<p><b>Locked:</b> Uses a single scale parameter to scale the element, preserving its proportions.</p> <p><b>Separate:</b> Uses a separate parameter to scale the element on the X and Y axis, as well as on the Y axis if the element is 3D-enabled, allowing to stretch or squash the element.</p> <p><b>(x) Axis:</b> The horizontal scale factor. The default value is 1.</p> <p><b>(y) Axis:</b> The vertical scale factor. The default value is 1.</p> <p><b>(z) Axis:</b> The depth scale factor for 3D-enabled elements. The default value is 1.</p> <p><b>Scale in Fields:</b> With this option enabled, the scale factor is based on the amount of fields in the scene. For example, to shrink one of the dimensions of an element to half its original size, the scale factor would normally be set to 0.5. If this option is enabled and the amount of fields in the scene is 12, then the scale factor to shrink the element by half would be 6.</p>
Angle Z	<p>Lets you type in a degree value for the rotation angle. Note that you can enter values greater than 360 and -360 degrees. If you enter 720, the object will rotate twice.</p>
Pivot	<p><b>(x) Axis:</b> The horizontal position of the pivot point of the element relative to the pivot point of the drawing, in fields.</p> <p><b>(y) Axis:</b> The vertical position of the pivot point of the element relative to the pivot point of the drawing, in fields.</p>

## Gradient Node

The Gradient node is similar to a Colour Card in which it fills all of the space in the stage, except that instead of filling it with a solid colour, it fills it with a configurable gradient. A gradient is a colour that tapers into another colour. The Gradient node can generate linear or radial gradient, between colours with or without transparency. The colours as well as the start and end points of the gradient in the stage can be configured and animated.



The Gradient node covers the entire camera frame and beyond. You do not need to scale it up or down. It will automatically cover an infinite zone. You simply need to connect it behind your scene's elements. You can connect it in front of some elements you want to cover. By default, the Gradient has a Z ordering value of 0. When you select the Gradient node, the Camera view displays yellow triangles to indicate that it's selected.

## Connection

Being a generator, the Gradient node does not need an input image. It generates a gradient on its own, based on its parameters alone.

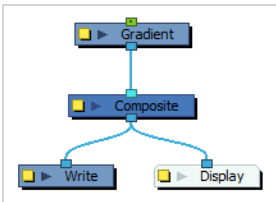

Just like Element nodes, Gradient nodes can be hooked to a peg, allowing you to easily move, rotate, scale and animate the gradient.

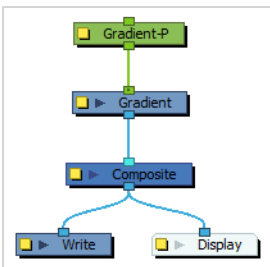



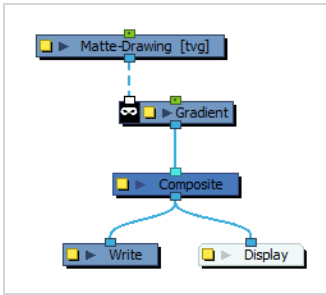

Optionally, the Gradient node can be connected to a matte image. In this case, the gradient will only be applied over the opaque areas of the matte.



## Controls

If you want to control the gradient's orientation and points position in the Camera view, you can use the Control command to display the points and move them.

### How to control the gradient in the Camera view

1. In the Tools toolbar, select the Transform  tool.
2. In the Timeline or Node view, select the Gradient node.
3. Do one of the following:
  - In the Camera toolbar, click on the Show Control  button.
  - From the top menu, select **View > Show > Control**.

The starting and ending points of the gradient will appear in the Camera view, like so:

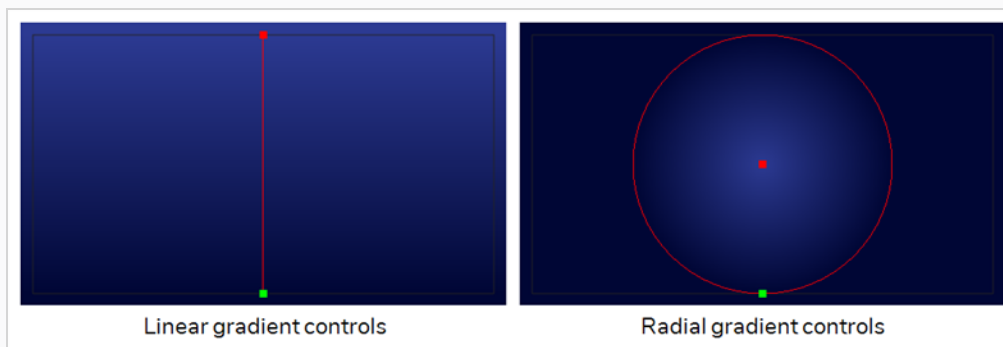

4. Click and drag on one of the points to change its position.

## Layer Properties

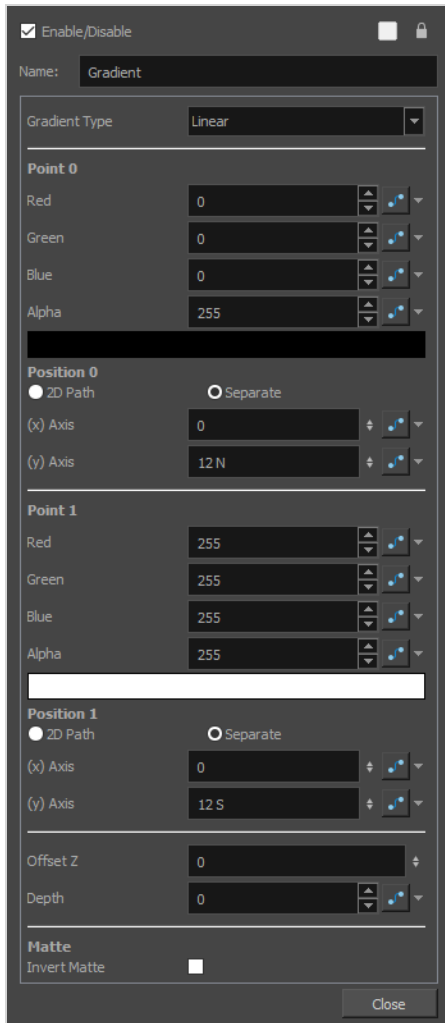

Use the Gradient property editor to modify the values of the gradient and the position of its output.

Parameter	Description
Gradient Type	<p>Allows you to select between the following types of gradient:</p> <ul style="list-style-type: none"> <li>• <b>Linear:</b> Lines of colour are drawn perpendicular to the axis between point 0 and point 1.</li> </ul>

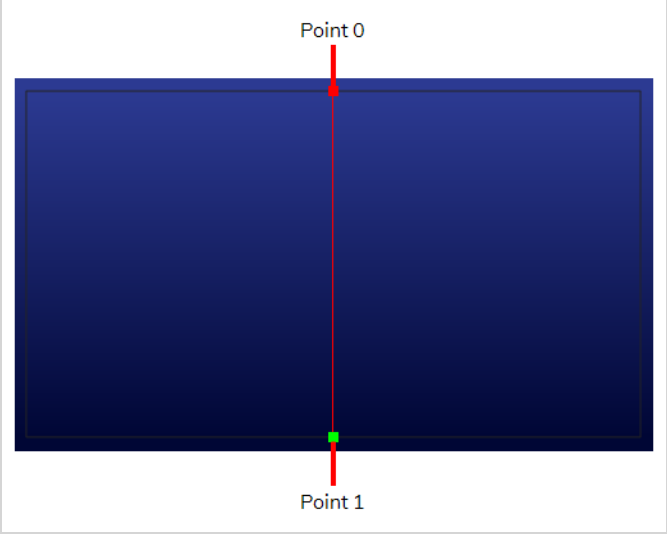
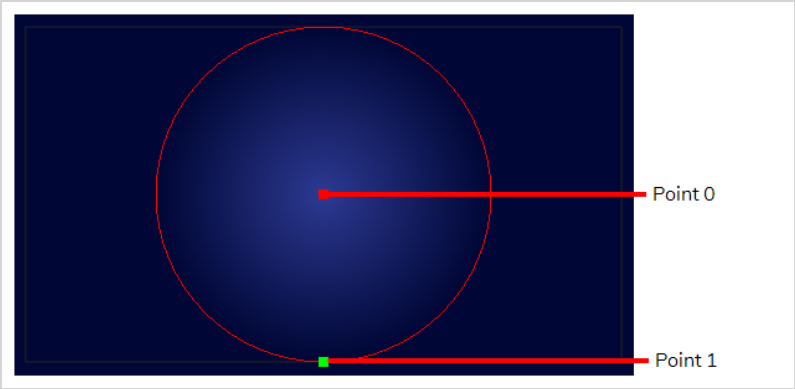
	 <ul style="list-style-type: none"> <li>• <b>Radial:</b> Circles of colour are drawn with point 0 as their center, with a ray progressing between point 0 and point 1.</li> </ul> 
<b>Point 0</b>	
Colour	<p>The colour of point 0. The gradient will start with this colour and taper to the colour of point 1.</p> <ul style="list-style-type: none"> <li>• <b>Red:</b> The value of red in the colour.</li> <li>• <b>Green:</b> The value of green in the colour.</li> <li>• <b>Blue:</b> The value of blue in the colour.</li> <li>• <b>Alpha:</b> The opacity of the colour.</li> </ul>
Position 0	<p>The position of point 0 in the stage. The gradient will start from this position and end at the position of point 1.</p> <p>If you want to animate the point, you can choose which type of function to use to store the animation.</p>

	<ul style="list-style-type: none"> <li>• <b>2D Path:</b> The horizontal and vertical position are on the same function. This makes the point move in a curvilinear trajectory between each keyframe.</li> <li>• <b>Separate:</b> The horizontal and vertical position are on separate functions. This makes the point move in a straight line between each keyframe and it allows you to modulate the trajectory differently on each axis.</li> </ul>
(x) Axis	The position of point 0 on the x-axis.
(z) Axis	The position of point 0 on the y-axis.
<b>Point 1</b>	
Colour	<p>The colour of point 1. The gradient will start with the colour in point 0 and taper to this colour.</p> <ul style="list-style-type: none"> <li>• <b>Red:</b> The value of red in the colour.</li> <li>• <b>Green:</b> The value of green in the colour.</li> <li>• <b>Blue:</b> The value of blue in the colour.</li> <li>• <b>Alpha:</b> The opacity of the colour.</li> </ul>
Position 1	<p>The position of point 1 in the stage. The gradient will start from the position of point 0 and end in this position.</p> <p>If you want to animate the point, you can choose which type of function to use to store the animation.</p> <ul style="list-style-type: none"> <li>• <b>2D Path:</b> The horizontal and vertical position are on the same function. This makes the point move in a curvilinear trajectory between each keyframe.</li> <li>• <b>Separate:</b> The horizontal and vertical position are on separate functions. This makes the point move in a straight line between each keyframe and it allows you to modulate the trajectory differently on each axis.</li> </ul>
(x) Axis	The position of point 1 on the x-axis.
(z) Axis	The position of point 1 on the y-axis.
<b>Position</b>	

---

Offset Z	The position of the Gradient layer on the z-axis.
Depth	This parameter can be used to determine whether the gradient displays behind or in front of elements with the same position on the z-axis. Elements and Colour Cards also have a depth parameter.
<b>Matte</b>	
Invert Matte	If an image is connected to the Gradient node's matte port, by default, the gradient is only applied on the opaque areas of the matte. If this parameter is enabled, the gradient is applied to the transparent areas of the matte instead.

## Grid Node

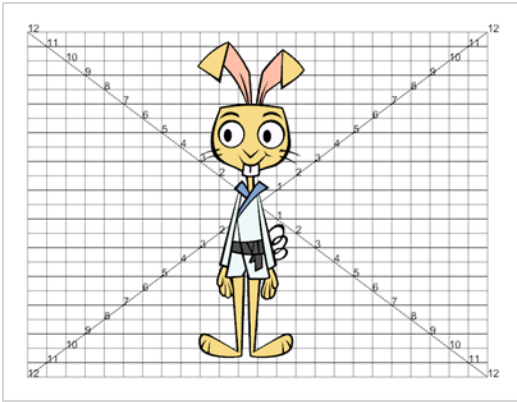

The Grid node displays a grid, in field chart unit, which allows you to position elements in the Camera view.

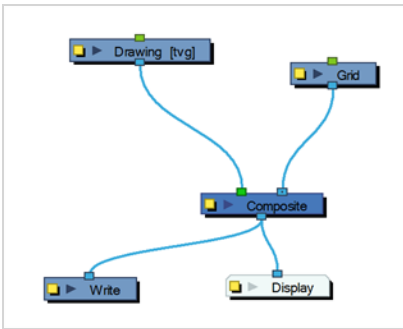

## Grid Properties

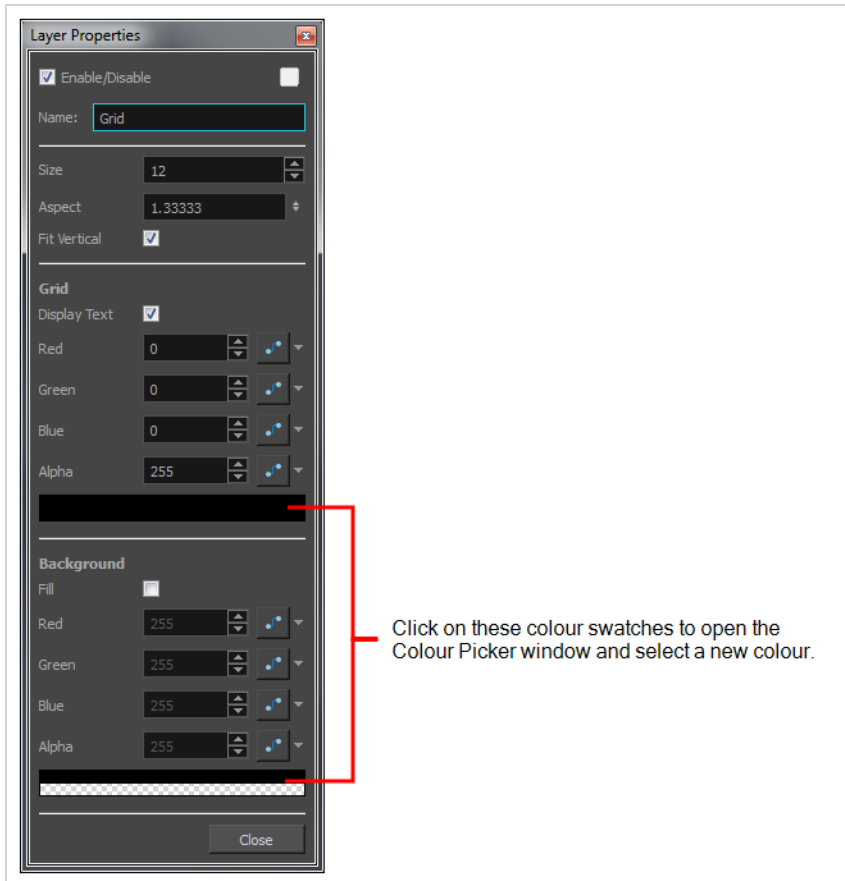

Parameter	Description
Name	Allows you to change the name given to the node.
Size	Adjusts the amount of units in the grid (field chart). The grid size will always be a 4:3 ratio, as per traditional animation standards, but will adjust the camera frame width. You can change the grid to adjust to the camera frame by deselecting the Fit Vertical option.

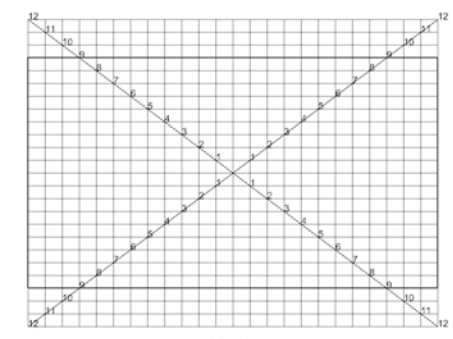
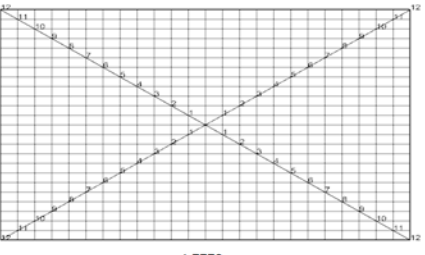
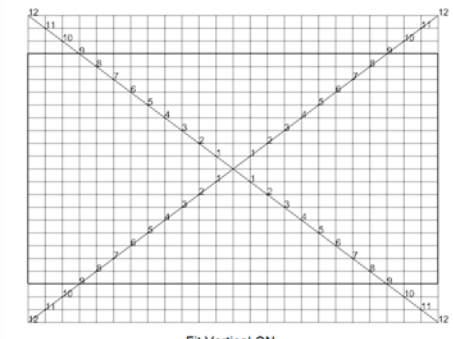
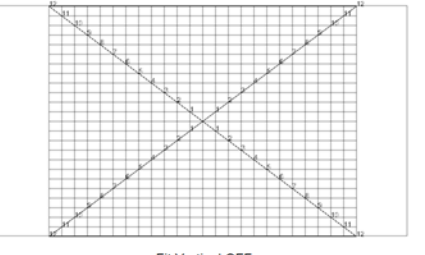
<p>Aspect</p>	<div style="display: flex; justify-content: space-around; align-items: center;">   </div> <p style="text-align: center;">4.3 ratio <span style="margin-left: 200px;">1.7778</span></p> <p>The grid size default format is 4:3 ratio, as per traditional animation standards, but will adjust the camera frame width. You can change the grid ratio by entering a new ratio. To find your scene ratio, select <b>Scene &gt; Scene Settings</b>.</p>
<p>Fit Vertical</p>	<div style="display: flex; justify-content: space-around; align-items: center;">   </div> <p style="text-align: center;">Fit Vertical ON <span style="margin-left: 200px;">Fit Vertical OFF</span></p> <p>Makes the grid size adjust the camera width or height.</p>
<p>Display Text</p>	<p>Turns the display of numbers on or off.</p>
<p>Fill</p>	<p>Makes the grid's background opaque. Nothing behind will be shown. You can also click on the colour swatch to open the Colour Picker window and select a background colour.</p>
<p>RGBA</p>	<p>The colour and alpha values of the corresponding point. You can also click on the colour swatch to open the Colour Picker window and select a grid or background colour. Default values: 0,0,0 and 255, 255, 255.</p>
<p>Colour Swatch</p>	<p>Opens the Colour Picker window in which you can specify the colour.</p>



## Lens Flare Node

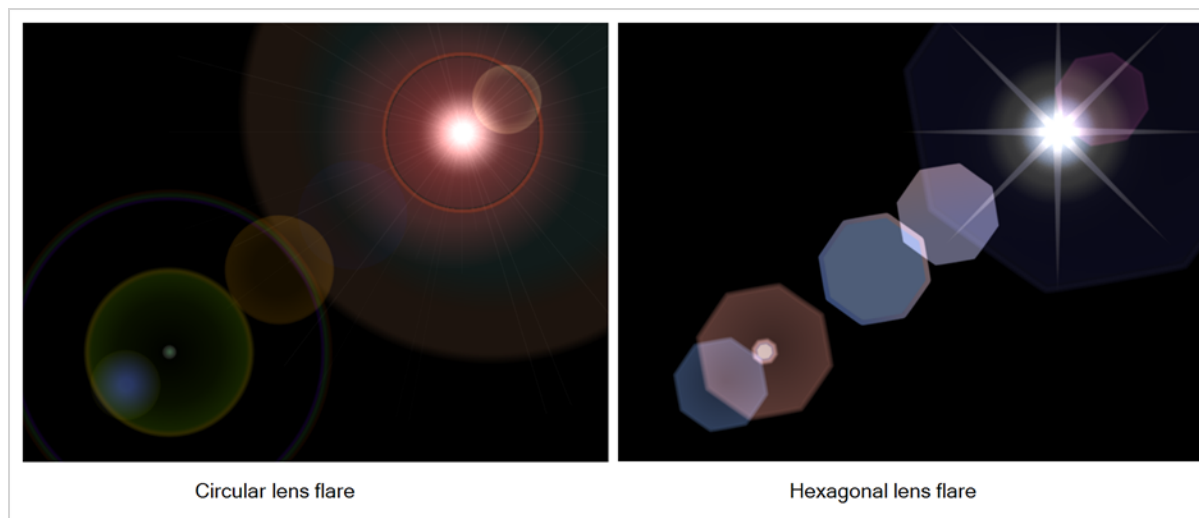

The Lens Flare effect simulates the refraction caused by shining a bright light into a camera lens. The shape of the lens flare can be circular or hexagonal.

For detailed video tutorials and sample scenes by Adam Phillips, see:

<https://www.toonboom.com/resources/video-tutorials/chapter/adam-phillips-harmony-effects>

Here is how a typical lens flare can be set up:

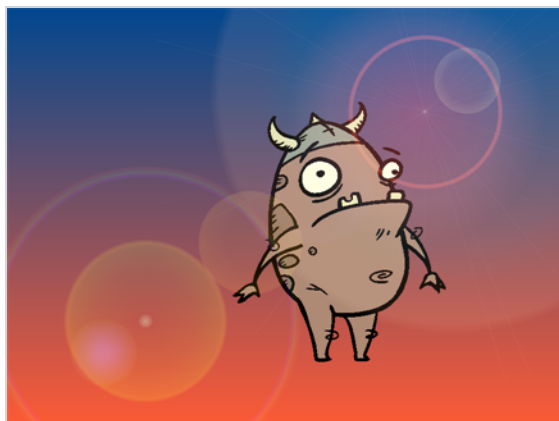

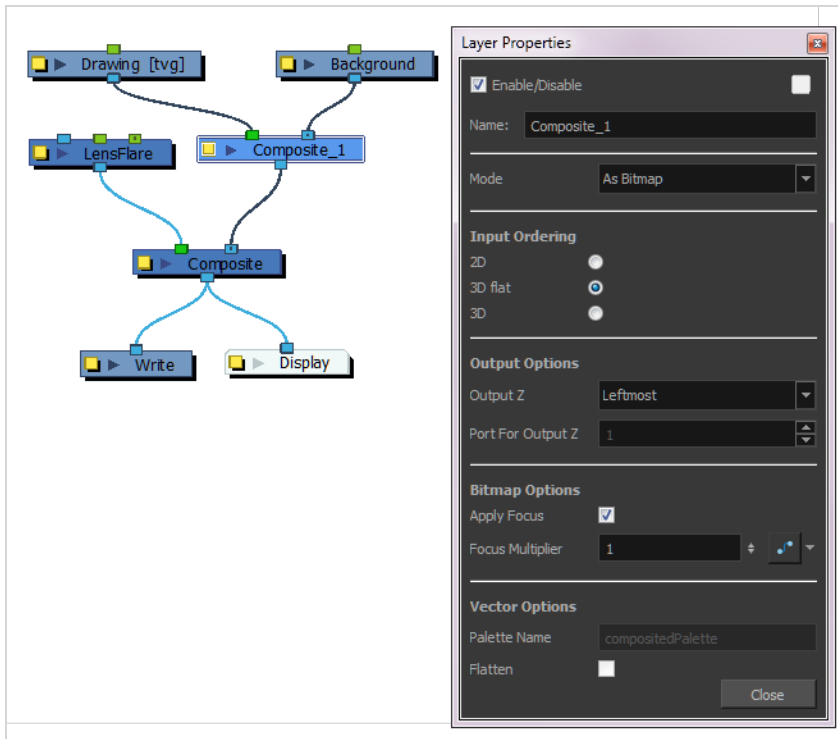

## Lens Flare Properties

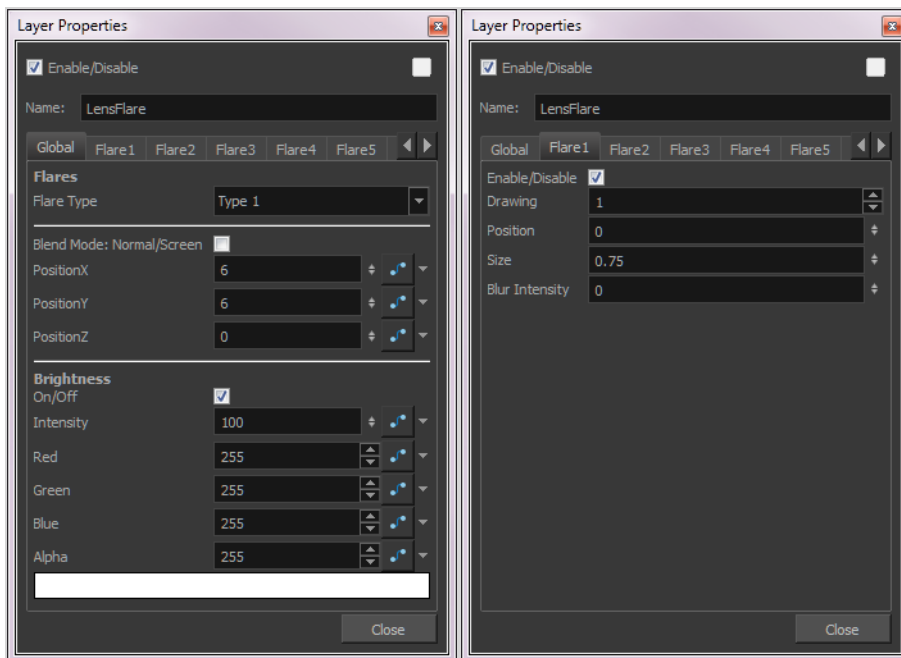

Parameter	Description
Flares	

Flare Type	<p>Custom: Lets you use your own custom art or drawing.</p> <p>Type 1: Circular lens flare.</p> <p>Type 2: Hexagonal lens flare.</p>
Blend Mode: Normal/Screen	<p>Lets you apply a normal or screen blending mode to the image.</p> <p><b>Normal:</b> When selected, this operation will not create any blending mode effect.</p> <p><b>Screen:</b> When deselected, this operation multiplies the inverted colour of the blending element with the image. This lightens the colour of the overlapping area. Screen is the default blending mode.</p>
Position X, Y, Z	Lets you precisely orient the flare in the x, y, and z axes.
<b>Brightness</b>	
Intensity	The strength of the lens flare.
Red	Red values of the image.
Green	Green values of the image.
Blue	Blue values of the image.
Alpha	Alpha values of the image.
Colour Swatch	Opens the Colour Picker where you can specify the colour of the main flare.
<b>Flare 1–10</b>	Lets you create custom lens flares by associating them with specific drawings. You can create up to 10 different flares.
	<p><b>Drawing:</b> Lets you specify a drawing to use for the flare.</p> <p><b>Position:</b> The position of the flare.</p> <p><b>Size:</b> The size of the flare.</p> <p><b>Blur Intensity:</b> The strength of the flare.</p>

## Turbulent Noise Node

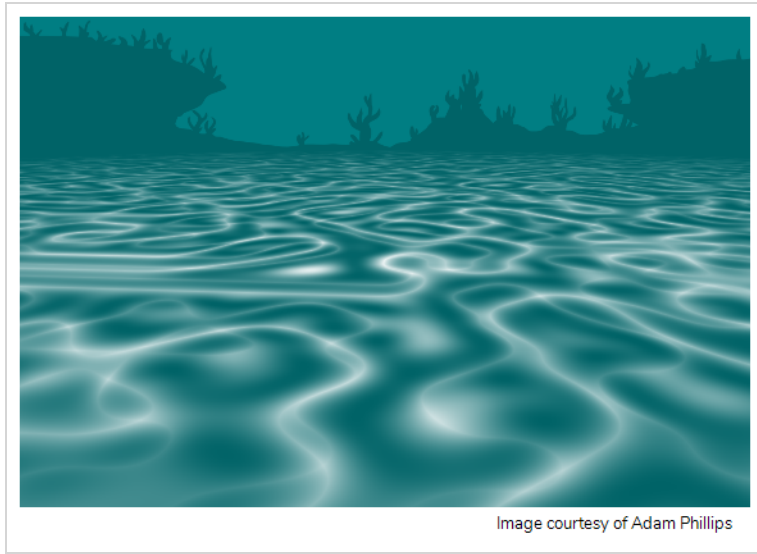

The Turbulent Noise effect uses Perlin noise to create greyscale noise for organic-looking backgrounds, displacement maps and textures. Among other things, it can be used to simulate fluid effects like clouds, fire, lava, steam, flowing water, or vapour. The Turbulent Noise effect models turbulent systems with smaller noise features moving more quickly than larger noise features. The Turbulent Noise effect creates smooth animations and takes less time to render than other noise or grain effects.

For detailed video tutorials and sample scenes by Adam Phillips, see:

<https://www.toonboom.com/resources/video-tutorials/chapter/adam-phillips-harmony-effects>

## Connection

Being a generator, the Turbulent Noise node does not require an input image. It generates noise using its Layer Properties. However, its default settings will only output solid black.

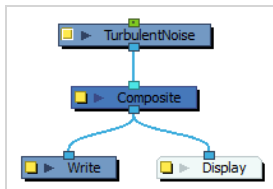

The Turbulent Noise node can be hooked to a peg, allowing you to transform and animate the effect.

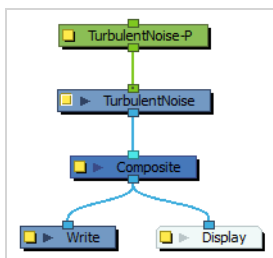

**NOTE**

In the example above, it is hooked to a Quadmap to simulate a perspective effect.

Optionally, a Turbulent Noise node can also be connected to a matte image. In this case, the noise will only fill the shape of the matte.

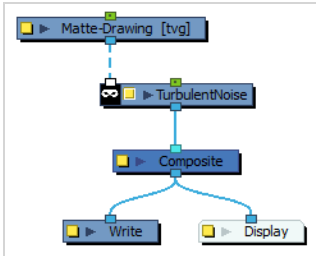

## Layer Properties

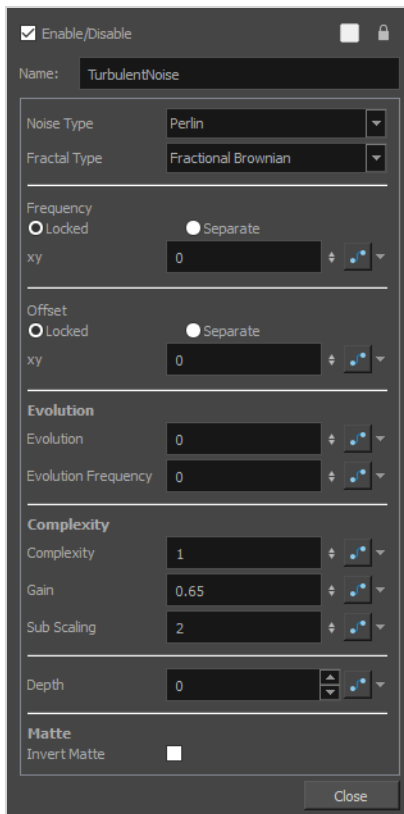

Parameter	Description
Enable/Disable	Allows you to enable or disable the node. When disabled, a node has no visible effect on the rendered image, nor on the preview in the Camera, Perspective, Side and Top views.

Parameter	Description
Colour Swatch	Sets the colour of the layer in the Timeline view and of the node in the Node view.
Name	Allows you to enter a name for the node.
Noise Type	<p>The algorithm used to generate the noise:</p> <ul style="list-style-type: none"> <li>• <b>Perlin:</b> Creates pseudo random patterns. The greyscale contains a continuity between different tones of grey.</li> <li>• <b>Simplex:</b> Creates a more contrasted noise pattern with more variation than Perlin. There is a smooth variation of intensity.</li> <li>• <b>Sinusoidal:</b> Creates a repeated wavelike pattern.</li> <li>• <b>Sub Scaling:</b> Applies Perlin noise twice. The second noise is added where dark areas appear in the original. The frequency of the second iteration is higher so the noise is smaller.</li> <li>• <b>Rocky:</b> Uses the Perlin pattern but converts the very high and low values to more moderate values. For example, the whites become light greys and the blacks become dark greys.</li> <li>• <b>Small Bumps:</b> Uses the Perlin pattern. The transitional grey areas between blacks and whites become inverted so they look like dark lines. The extremes, black and white areas, become whitish.</li> </ul>
Frequency	The density of displacement appearing in the noise. A higher value produces a greater amount of displacement in a given area; a lower value produces a smaller amount.
Offset	Moves the entire image.
Locked	Applies parameter value while retaining the X and Y ratio.
Separate	Allows you to apply different parameter values to X and Y.
xy	When locked, applies parameter values to both X and Y. When separated, allows you to apply different value to X and Y.
Evolution	Determines the displacement pattern over time.
Evolution Frequency	This factor makes the complexity iterations animate or transform at a higher speed. In other words, the second, third, etc. passes, controlled by the Complexity

Parameter	Description
	parameter, will mutate faster than the main one.
Complexity	<p>The number of noise layers that make up the noise. Each successive layer has a higher frequency, resulting in a smaller noise effect. You can have up to seven passes. Increasing this number increases the depth and amount of detail in the noise. Use Complexity with Sub Scaling when the value is 1 or greater.</p> <div data-bbox="565 541 1429 680" style="border: 1px solid #c8e6c9; padding: 5px;">  <b>NOTE</b>            Increasing the Complexity results in longer rendering times.         </div>
Gain	Controls the amount of opacity present in the iteration of noise. This also affects the layer when using Sub Scaling. With a value of 0, you will not see the sub noise. A value of 1 will show the sub noise just as strong as the main one. For example, with water ripples, a higher amount of Gain will reveal more ripple or subripples.
Sub Scaling:	The factor by which the main noise is modified at each iteration of complexity. A value of 1 make the two noises identical. A value of 2 makes the sub noise twice as small. The next iteration would be 4 times smaller. Values must be greater than 1.
Depth	This value determines the composition order when the Z value of two elements is the same.
<b>Matte</b>	
Invert Matte	If the Turbulent Noise node is connected to a matte image, by default, the noise will only fill the opaque areas of the matte. If this parameter is enabled, the noise will fill the transparent areas of the matte instead.

## Group Nodes

The nodes found in the group category are used to organize the Node view by grouping nodes and providing input and output ports for these groups.

<b>Group Node</b> .....	<b>666</b>
<b>Multi-Port-In Node</b> .....	<b>667</b>
<b>Multi-Port-Out Node</b> .....	<b>668</b>



## Group Node

The Group node is the node containing all the layers in a group. In the Timeline view, a Group node appears as a layer that you can expand or collapse to display or hide the layers it contains in the layer list. In the Node view, a Group appears as a node that can be entered by clicking on the arrow in the right end of the node.

## Multi-Port-In Node

A Multi-Port-In node is added by default in a new Group node. Use it to add one or more input ports to the Group node so that you can process an image through the nodes in the Group node.

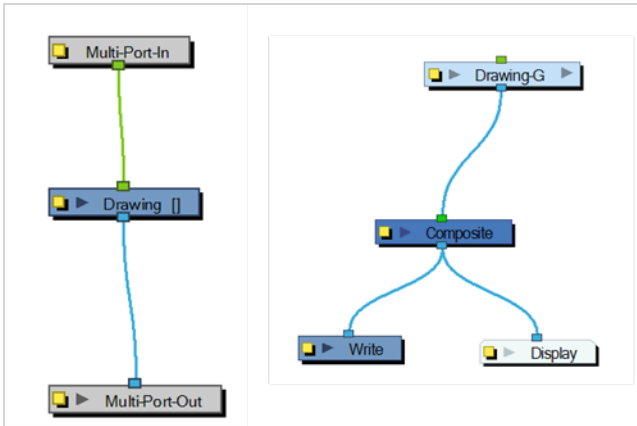

When you plug an element to a Multi-Port-In node, an input port appears at the top of the Group node. You can add additional ports to the nodes as needed.

Pass your cursor over the Group node input port to see the name of the Port Image In node that it connects to. You will notice that the Group node in these examples has no output port. It requires a Multi-Port-Out node to output data from its network.

A Multi-Port-In is automatically added when you create a group.

Use the Multi-Port-In editor to rename the node.

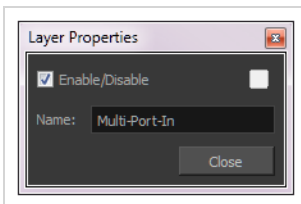

## Multi-Port-Out Node

A Multi-Port-Out node is added in a new Group node by default. Use it to add output ports to the Group node so that you can output the result of the group operation to the rest of the network. After you plug an element to a Multi-Port-Out node, an output port appears on the bottom of your Group node. You can add additional output ports as needed.

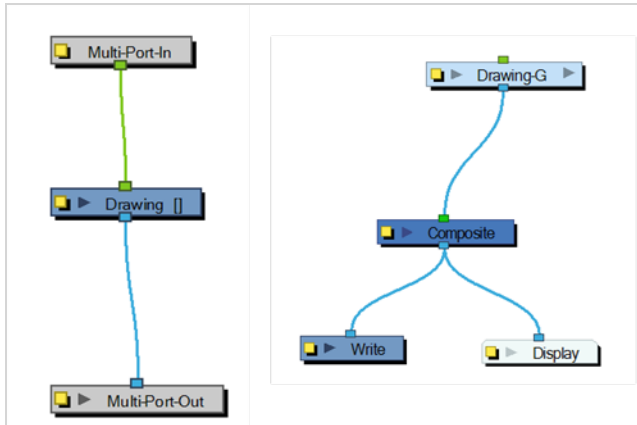

A Multi-Port-Out is automatically added when you create a group.

Use the Multi-Port-Out editor to rename the node in the network.

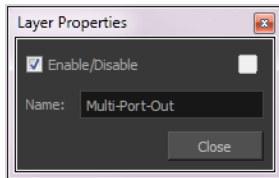

## Miscellaneous Nodes

The nodes found in the Miscellaneous category are various nodes used to either add notes to the Node view, use external scripts or previous and hide elements in OpenGL and Render view.

<b>External Node</b> .....	<b>670</b>
<b>Master Controller Node</b> .....	<b>673</b>
<b>Note Node</b> .....	<b>679</b>
<b>OpenGL Bypass Node</b> .....	<b>680</b>
<b>OpenGL-Cache-Lock Node</b> .....	<b>682</b>
<b>Render Preview Node</b> .....	<b>685</b>
<b>Script Node</b> .....	<b>686</b>
<b>Visibility Node</b> .....	<b>689</b>

## External Node

Use the External node to process images through external programs and input the resulting images back into the network. Note that not all programs work with the External node.

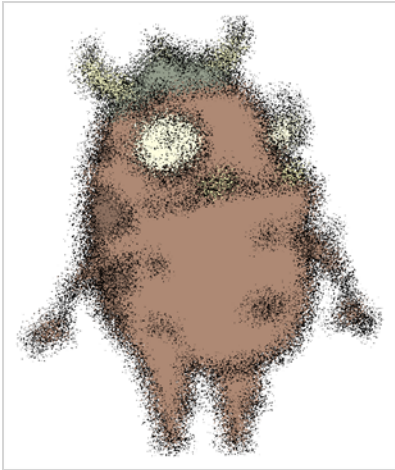

Using the External node lets you avoid having to export your animation to another software to do some processing over it and then bringing it back to Harmony. This way, you can modify your scene and animation as much as you want and still use the effects or render process from a third-party software.



### NOTE

Harmony also supports OpenFX plugins.

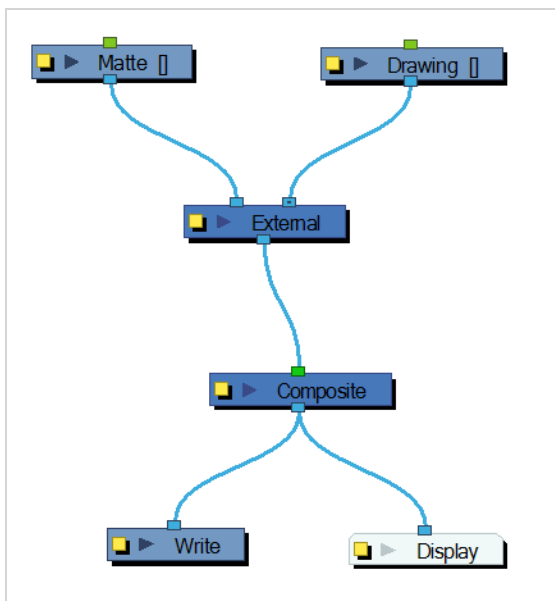

The External node writes input files to temporary files on the system. It then calls the external program, which will process the input images. If two images are input into the node, the program must composite them

together to produce one output image. Finally, the file produced by the external program is read back into the network.

The command is sent to the external program in the following format:

**program\_name file\_1 file\_2 output\_file numerical\_param extension**

Use the External editor to control the program that is launched by the node, the files that it reads, and the file that it outputs into the network.

```
Version: ImageMagick 6.3.0 11/06/06 Q16 http://www.imagemagick.org
Copyright: Copyright (C) 1999-2006 ImageMagick Studio LLC
Usage: mogrify [options ...] file [ [options ...] file ...]
Where options include:
-adaptive-blur geometry      adaptively blur pixels; decrease effect near edges
-adaptive-resize geometry    adaptively resize image with data dependent triangulation
-adaptive-sharpen geometry  adaptively sharpen pixels; increase effect near edges
-affine matrix               affine transform matrix
-annotate geometry text    annotate the image with text
-antialias                  remove pixel-aliasing
-authenticate value         decrypt image with this password
-auto-orient                automatically orient image
-background color           background color
-bias value                 add bias when convolving an image
```

In this example, the ImageMagick 6.3 software was used without a matte connection.

Use the External editor to write down the parameters matching the chosen external program.

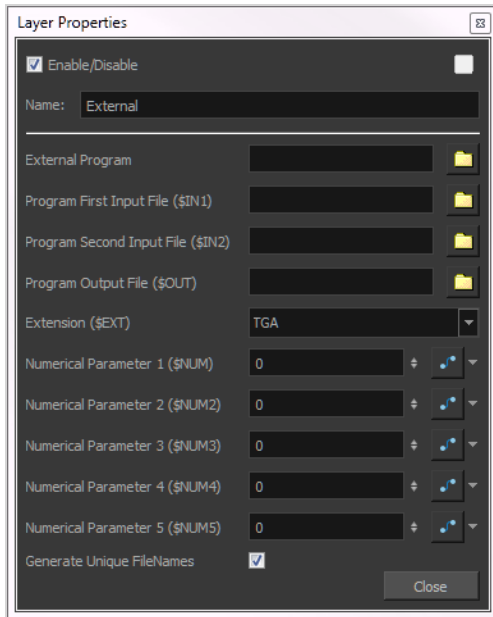

### External Properties

Parameter	Description
External Program	The name of the program launched by the External node. This field can include a full or relative path to the executable file. If no path is entered, the user's path is searched to locate the program.

	<p>Enter the command directly into this field.</p> <p>For example:</p> <pre><b>mogrify -spread \$NUM \$IN1</b></pre> <p>Where:</p> <p><b>mogrify:</b> Is the name of the program</p> <p><b>spread:</b> Is the option to be applied,</p> <p><b>\$NUM</b> and <b>\$IN1:</b> Are the numerical parameter and first input file variable declared in the External node.</p>
Program First Input File (\$IN1)	The name and location of the temporary file that Harmony will write to the file system for the external program to read. It must not include the dot or the extension; the External node will add these based on the Extension field.
Program Second Input File (\$IN2)	When processing two files through this node (such as an image and a matte), this is the name and location of the second temporary file that Harmony writes to the file system for the external program to read. It must not include the dot or the extension; the External node will add these based on the Extension field.
Program Output File (\$OUT)	The name and location of the temporary file that the external program will write to the file system so that Harmony can read it back into the network.
Extension (\$EXT)	The file type that will be processed by the external program.
Numerical Parameter(\$NUM)	A value passed to the external program as a file processing option. It can be attached to a function curve to change over time.
The program files are temporary files that are overwritten at each frame as the node is executed. They are only meant to temporarily store the image that is being processed at each frame.	
Generate Unique FileNames	If this option is enabled, the temporary output file will have a unique identification number added to its name to avoid any file override if another scene or External script is rendered at the same time. It could be possible to have an override when two scenes using the External nodes are rendered in batch processing.

## Master Controller Node

The master controller node is a special kind of script node that allows you to create visual widgets that you can display in the Camera view, and script to programmatically affect a character rig when manipulated by the user.

For information and examples on how to use the Master Controller node, refer to the *Master Controller* subsection of the *Rigging* chapter of the *User Guide*.

## Connection

The Master Controller does not need to be connected to a node in order to work, unless it is scripted to affect nodes that are connected to it.

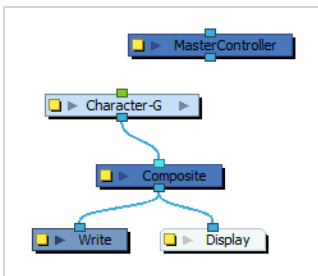

If a Master Controller is connected to a node, the node system it is connected to should ultimately end up connected to a Display node in order for the Master Controller to work.

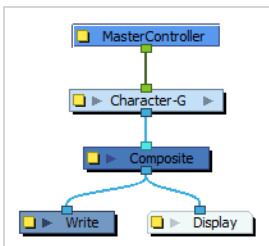

If you configure the Master Controller's first (rightmost) input port to be a transformation (peg) input port, you can connect a peg to the Master Controller, and use this peg to move its widget around in the Camera view, allowing you to easily set the widget's default position in the scene.

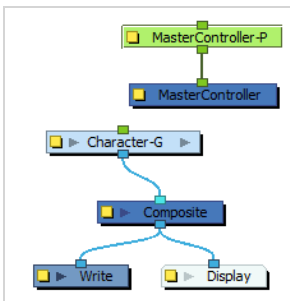







**IMPORTANT**

A Master Controller node must have at least one output port to function, even if this port is not connected to anything.

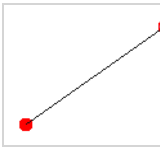
## Controls

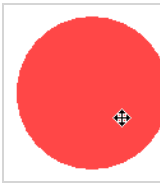
The Master Controller can be scripted to display any one of the following kinds of controls in the Camera view:

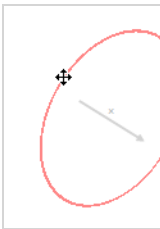
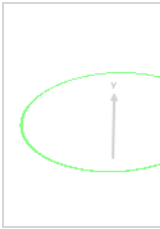
Control	Appearance	Description
Slider		A slider that allows the user to slide a handle up or down. When manipulated, it provides a value between its minimum and maximum values.
2D Line Display		Displays a line going between two 2D Point widgets, make a "bone" type manipulator that can be moved by either end.
2D Point		A point that the user can freely drag around the stage. When manipulated, it provides its position.
3D Rotation		A 3D sphere that the user can rotate in all directions. When manipulated, it provides an object with a rotation angle for each axis.

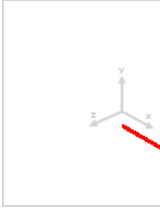
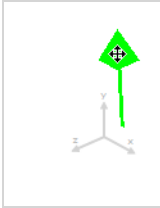
Control	Appearance	Description
X Rotation		<p>A circle that can be rotated around the x-axis. When manipulated, it provides a rotation angle.</p>
Y Rotation		<p>A circle that can be rotated around the y-axis. When manipulated, it provides a rotation angle.</p>
Z Rotation		<p>A circle that can be rotated around the z-axis. When manipulated, it provides a rotation angle.</p>
X Translation		<p>An arrow that can be dragged along the x-axis. When manipulated, it provides an offset.</p>
Y Translation		<p>An arrow that can be dragged along the y-axis. When manipulated, it provides an offset.</p>

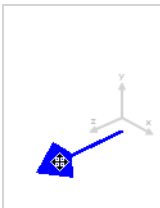
Control	Appearance	Description
Z Translation		An arrow that can be dragged along the z-axis. When manipulated, it provides an offset.

## Scripting Interface

To see the reference for the scripting interface used by the Script node, see the Scripting Interface reference guide, which is packaged with Harmony and can be found on the following location on your system:



- Windows: `C:\Program Files (x86)\Toon Boom Animation\Toon Boom Harmony 16.0 Premium\help\script\index.html`
- macOS (Harmony Stand Alone): `/Applications/Toon Boom Harmony 16.0 Premium/tba/help/script/index.html`
- macOS (Harmony Server): `/Applications/Toon Boom Harmony 16.0 Premium Network/tba/help/script/index.html`
- GNU/Linux: `/usr/local/ToonBoomAnimation/harmonyPremium_16.0/help/script/index.html`

## Layer Properties

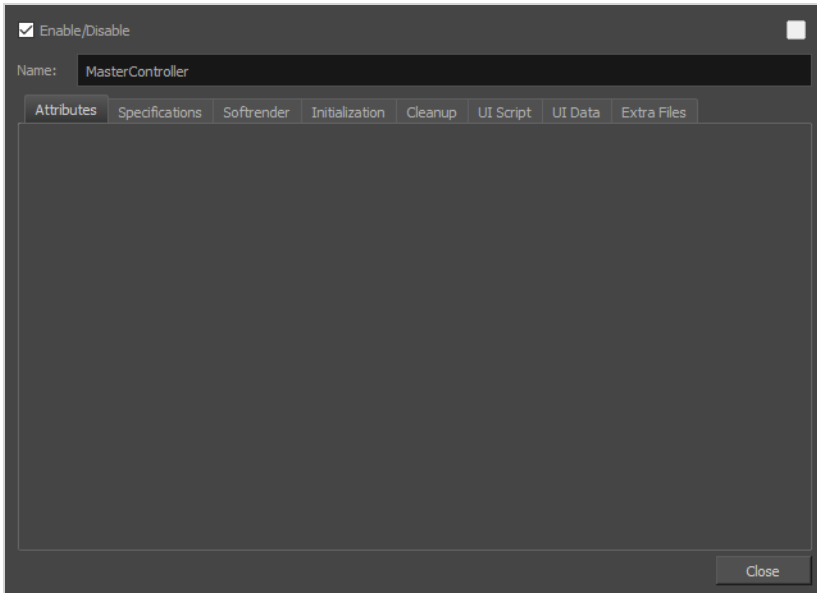
The Master Controller node is essentially a Script node with an extra layer of functionality in its scripting interface. Hence, its layer properties are very similar to that of the Script node. However, its most important tab is the **UI Script** tab. The script in this tab is executed when the layer is selected and the user clicks on the  Show Control button in the Camera toolbar. This is where you can define which widget the node displays, and what happens when the user manipulates the widget.



Parameter	Description
Name	Allows you to enter a name for the node.
<b>Tabs</b>	
Attributes	This tab allows you to set values for the attributes defined in the Specifications tab.
Specifications	<p>This tab allows you to define the attributes as well as the input and output ports for the Master Controller.</p> <p>The Master Controller supports the following types of attributes:</p> <ul style="list-style-type: none"> <li>• bool</li> <li>• int</li> <li>• double</li> <li>• String</li> <li>• Text</li> <li>• Colour</li> <li>• Position2d</li> <li>• Position3d</li> </ul> <p>The Master Controller supports the following types of ports:</p> <ul style="list-style-type: none"> <li>• Image</li> </ul>

Parameter	Description
	<ul style="list-style-type: none"> <li>• Peg</li> </ul>
Softrender	<p>This tab allows you to write or link to a script that will be executed when rendering the node.</p> <div data-bbox="565 470 1429 638" style="border: 1px solid #c8e6c9; padding: 10px;"> <p> <b>NOTE</b></p> <p>Scripts in this tab are ignored by the Master Controller node. The Softrender tab is only executed by Script nodes.</p> </div>
Initialization	<p>This tab allows you to write or link to a script that will be executed when loading the scene.</p>
Cleanup	<p>This tab allows you to write or link to a script that will be executed when closing the scene.</p>
UI Script	<p>This tab allows you to write or link to a script that will be executed when using the Show Control command while the node is selected. This is where widgets and their functionalities should be defined.</p>
Extra Files	<p>This tab allows you to define folders or files from root directory of the scene that should be preserved when creating templates or saving the scene in a different location. Any asset, such as external scripts, user interface files, data files or images that the Master Controller requires should be listed in this tab.</p> <div data-bbox="565 1281 1429 1793" style="border: 1px solid #c8e6c9; padding: 10px;"> <p> <b>NOTES</b></p> <ul style="list-style-type: none"> <li>• To add Extra Files to the Extra Files attribute, click on the  Function button right of the Extra Files field to create the Extra Files attribute, then click on it again to open a dialog box in which you can type the file path of each file or folder that you want to copy with the Master Controller, with one file path per line.</li> <li>• File paths must use forward slashes (/) and must be relative to the scene directory. They can point to files or folders. For example, if you want to copy everything in the <b>scripts</b> sub-directory of your scene with your Master Controller, you can simply add <b>scripts</b> to the list.</li> </ul> </div>

## Note Node

The Note node allows you to record any textual information that is relevant to your project. You can add comments, suggestions or reminders. You can add Note nodes anywhere in the network, including groups.

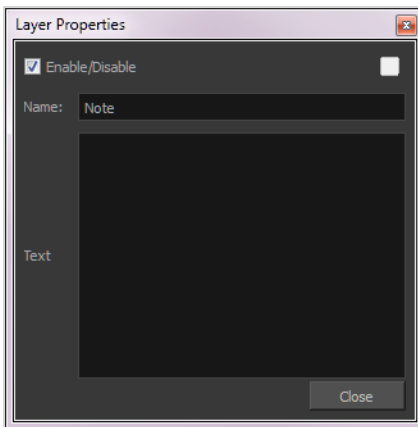
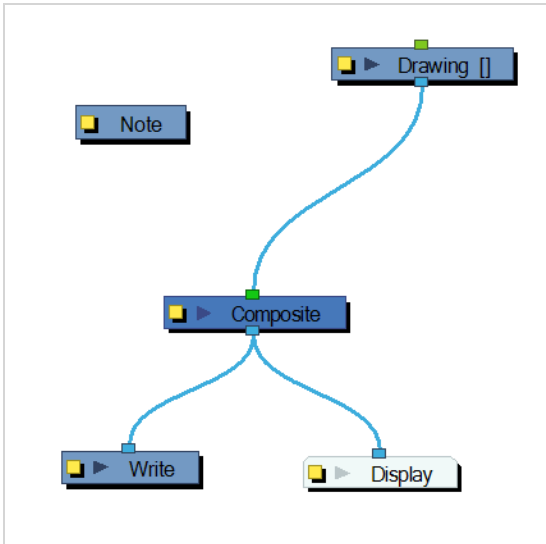

## OpenGL Bypass Node

The OpenGL Bypass node can be used to define what is displayed in the OpenGL preview of the Camera view separately from what appears in the final rendered image. This can be used to help with performance when working on a scene or during playback. The OpenGL preview can be made to only display elements that are important to the animator as they are working on the scene, making the generation of the OpenGL preview a lot less demanding for Harmony, without affecting the rendered image.

### Connection

The OpenGL Bypass node has two input ports and one output port. What is connected to the left input port displays in the OpenGL preview, and what is connected to the right input port appears in the rendered image.

#### How to connect an OpenGL Bypass node

1. Identify a part of the scene's node system that adds a lot of unnecessary load to the OpenGL preview.
2. If that part of the node system is not connected to a composite, add a Composite node and connect all the elements of that area to this composite. This will be the *render composite*.
3. Connect the OpenGL Bypass node under the render composite through its right input port.
4. Create another composite. This will be the *preview composite*.
5. Connect only the parts of the node system that are useful to the animator to the preview composite.
6. Connect the preview composite to the left input port of the OpenGL Bypass node.

In the following example the scene includes a background, a character (which is rigged to be cut by part of the background), a drop shadow, light and shadow effects, a node system deformed by a Quadmap to make a computer or television screen effect, a snowstorm particle system and an overlay. All of these elements are connected to a composite that is connected to the right port of the OpenGL Bypass. Connected to the left port of the OpenGL Bypass is a composite that is only connected to the character without the cutter, the background, and the content of the screen without the Quadmap deformation, which would typically be all the animator needs to work on the scene.

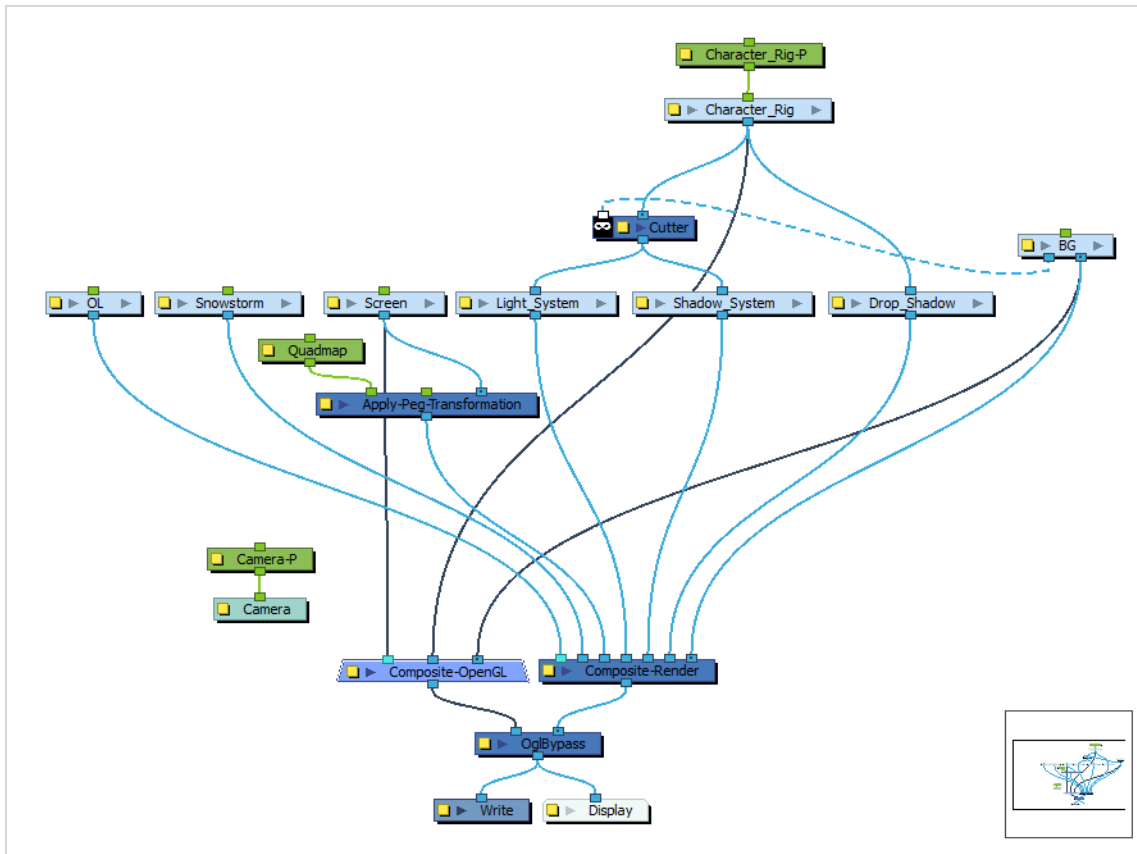

**NOTE**

This example showcases the OpenGL Bypass node being used for the scene's main composite. It is also possible to use it for very precise areas of a node system, such as individual body parts of a character, as long as they are linked together by a composite.

## Properties

Parameter	Description
Name	Allows you to enter a name for the node.



## OpenGL-Cache-Lock Node

The OpenGL Cache Lock node can significantly increase the performance of Harmony when working in heavy scenes with many characters, very complex rigs or an otherwise heavy node system.

Without the OpenGL-Cache-Lock node, Harmony must regenerate the OpenGL preview displayed in the Camera view every time an element is changed or manipulated from scratch. This means it has to process every node in the scene's node system all over again. Although the OpenGL preview is optimized for quick real-time rendering, a complex enough node system can make this process slow enough that each action done on the scene causes a delay, ultimately making working on heavy scenes excessively time-consuming.

A typical way to circumvent this is to temporarily disable elements in the scene that are not being worked on. For example, an animator working on a scene with several characters can disable the characters they are not working on at the time, and can also temporarily disable the scene's background and props, so that only the elements they need to manipulate are visible which reduces the load on OpenGL previewing.

The purpose of the OpenGL-Cache-Lock is to obtain virtually the same benefit in performance without having to hide any element in the scene. When connected under a node system, this node creates a cache of the OpenGL preview of the elements it is connected to. Every time a change is made to any element in the scene and the OpenGL preview must be refreshed, the OpenGL-Cache-Lock node checks if the change affects one of the elements it is connected to. If it does not, it will simply output the cached image for the preview, saving Harmony the burden of regenerating the preview for these elements.

Hence, in the previous example, an OpenGL-Cache-Lock node could be connected under the main composite of each character. Harmony would then cache the preview of each character separately, and would only regenerate the preview of a character when one of its parts is manipulated or modified. The animator would not need to disable any characters as Harmony will keep re-using the cached previews of the characters they are not currently working on.



### NOTE

The OpenGL Cache Lock node only affects the way the OpenGL preview is generated and has no effect on the actual rendered image.

## Connection

The OpenGL-Cache-Lock node must be connected under elements or composites that should be cached separately for the OpenGL preview. Typically, this means adding an OpenGL-Cache-Lock node under elements that will be animated individually. In the example below, an OpenGL-Cache-Lock node can be connected under the main composite of each character. But for a scene with very complex character rigs, an OpenGL-Cache-Lock node could also be connected under composites for each limb of the character, for their torso, for their head, etc.

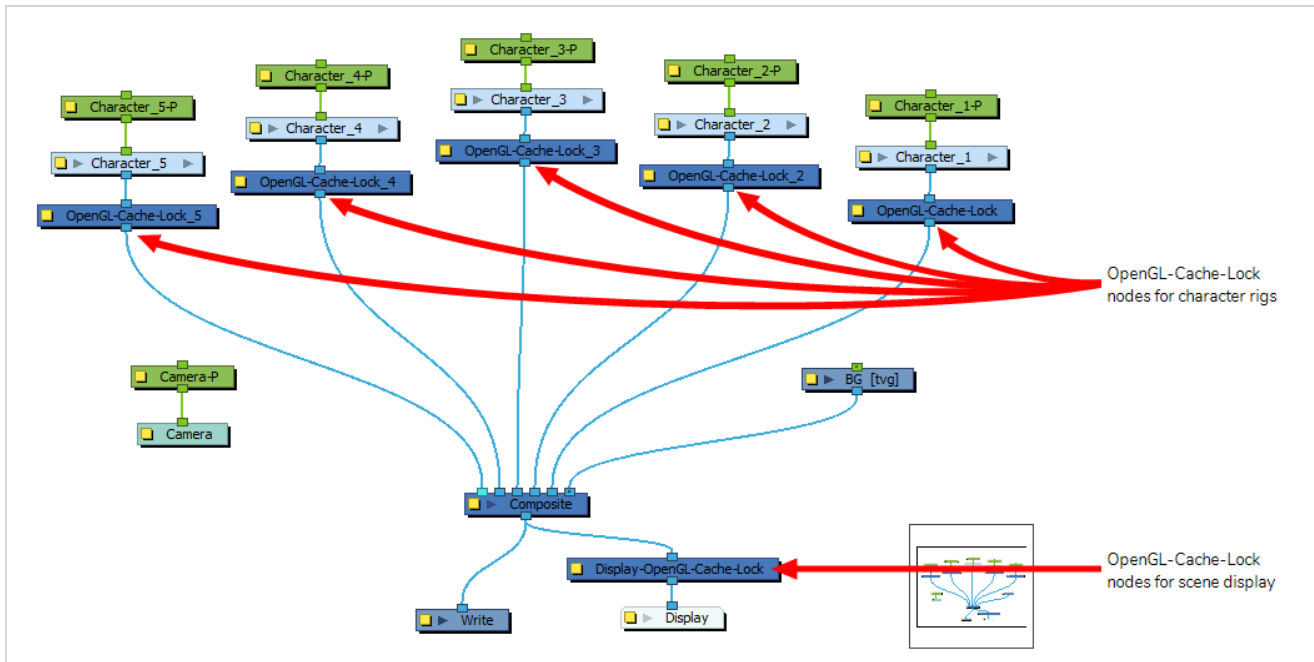

An OpenGL-Cache-Lock node can also be connected between the scene's main composite and its main display. This can help with performance when zooming in, panning and rotating the scene. Harmony will use the cached preview while zooming in, panning or rotating, and will only regenerate the preview half a second after the operation is done.





### IMPORTANT

The OpenGL-Cache-Lock node must be used with some caution:

- If the user begins zooming in, rotating or panning the Camera view, the preview will not regenerate immediately. Rather, it will regenerate half a second after the user releases is done. During that short delay, because the preview cached by the OpenGL-Cache-Lock is a bitmap image and that it does not extend the borders of the Camera view, zoomed-in areas will appear pixelated, and areas that are brought from outside of the Camera view's borders by zooming out or panning will appear blank until the preview is regenerated.
- It is important not to add too many OpenGL-Cache-Lock nodes, and to only use them for complex node systems. If a scene has too many OpenGL-Cache-Lock nodes and that they are used on node systems that are too simple, the caching overhead as well as the need to composite all the different caches is liable to cause more load on Harmony than it would save.
- Likewise, whether adding an OpenGL-Cache-Lock node under layout elements such as backgrounds, underlays and overlays will enhance performance depends on how complex they are. For example, a single vector drawing layer might benefit from an OpenGL-Cache-Lock if it has an exceptionally high amount of detail. Otherwise, the performance gain for a few drawing layers is unlikely to surpass the incurred caching overhead. You should use them with discretion with such elements, and test whether they cause a noticeable improvement or decrease in performance.

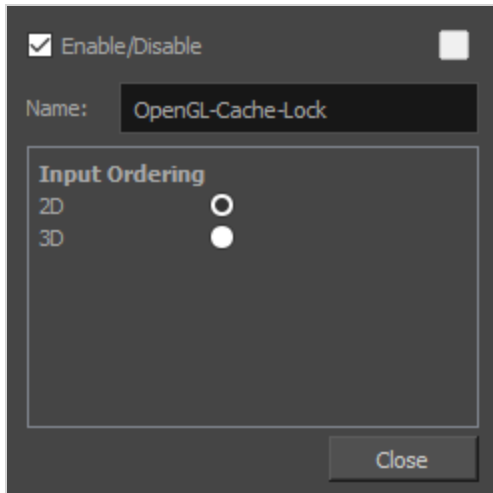
## Properties



Parameter	Description
Name	Allows you to enter a name for the node.
Input Ordering	<p>Determines the way the elements connected to the OpenGL-Cache-Lock node are ordered in the preview:</p> <ul style="list-style-type: none"> <li>• <b>2D:</b> Elements connected to the node will appear flattened together. Their apparent position on the Z axis relative to other elements in the scene will be the one of the foremost element.</li> <li>• <b>3D:</b> Elements will appear in their appropriate order based on their position on the Z axis relative to other elements in the scene.</li> </ul> <div style="border: 1px solid green; padding: 5px; margin-top: 10px;"> <p> <b>NOTE</b> This only affects the way elements are displayed in the OpenGL preview. The OpenGL-Cache-Lock node does not affect the way elements are rendered in the final render.</p> </div>

## Render Preview Node

To adjust the effect's visual controls in OpenGL mode, from the Node Library view, drag a Render Preview node to the Node view. Connect it between the effect and the Composite nodes.

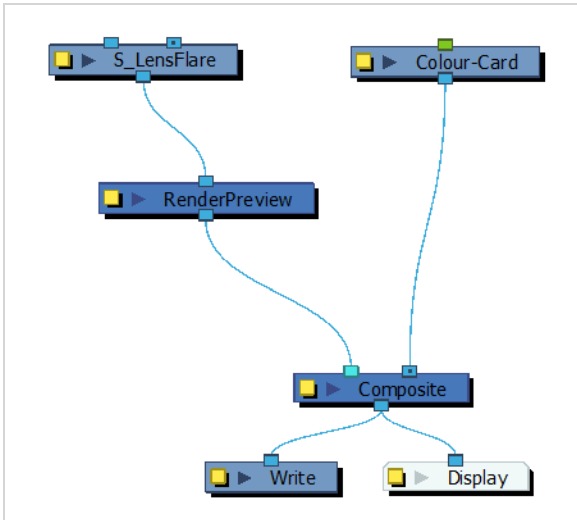

## Script Node

You can use the script node to create a custom node that processes peg and image information from other nodes using the Harmony scripting interface.

### Connection

By default, the Script node has one image input port and one image output port, which do not have any purpose until you add scripts to it.

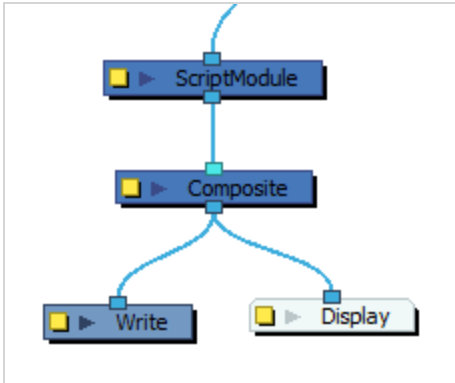

The Script node can be configured to have as many input and output ports as needed. Each port can be configured to carry image information or transformation (peg) information.

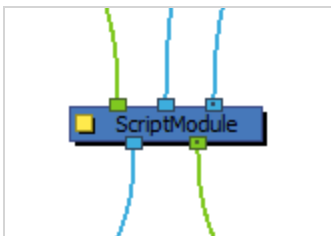

### Scripting Interface

For a reference on the modules and methods available in the scripting interface used by the Script node, refer to the Script Node reference guide, which is packaged with Harmony and can be found on the following location on your system:



- Windows: `C:\Program Files (x86)\Toon Boom Animation\Toon Boom Harmony 16.0 Premium\help\scriptmodule\index.html`
- macOS (Harmony Stand Alone): `/Applications/Toon Boom Harmony 16.0 Premium/tba/help/scriptmodule/index.html`
- macOS (Harmony Server): `/Applications/Toon Boom Harmony 16.0 Premium Network/tba/help/scriptmodule/index.html`
- GNU/Linux: `/usr/local/ToonBoomAnimation/harmonyPremium_16.0/help/scriptmodule/index.html`

## Layer Properties

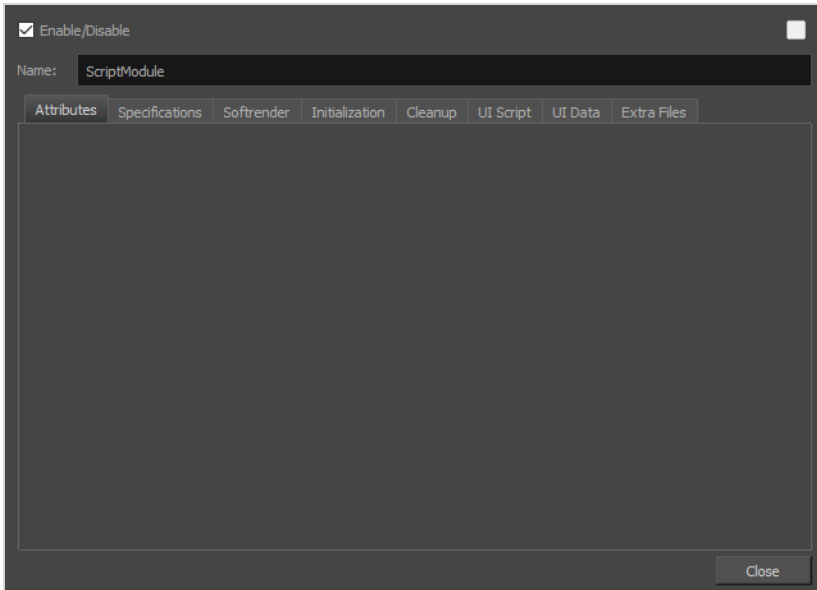
The layer properties of a Script Node allow you to configure which properties and ports it has, to set values for the properties you added to it, to link it to files and to script its behaviour in various events.



Parameter	Description
Name	Allows you to enter a name for the node.
<b>Tabs</b>	
Attributes	This tab allows you to set values for the attributes defined in the Specifications tab.
Specifications	<p>This tab allows you to define the attributes as well as the input and output ports for the Script node.</p> <p>The Script node supports the following types of attributes:</p> <ul style="list-style-type: none"> <li>• bool</li> <li>• int</li> <li>• double</li> <li>• String</li> <li>• Text</li> <li>• Colour</li> <li>• Position2d</li> </ul>

Parameter	Description
	<ul style="list-style-type: none"> <li>• Position3d</li> </ul> <p>The Script node supports the following types of ports:</p> <ul style="list-style-type: none"> <li>• Image</li> <li>• Peg</li> </ul>
Softrender	This tab allows you to write or link to a script that will be executed when rendering the node.
Initialization	This tab allows you to write or link to a script that will be executed when loading the scene.
Cleanup	This tab allows you to write or link to a script that will be executed when closing the scene.
UI Script	This tab allows you to write or link to a script that will be executed when using the Show Control command while the node is selected.
Extra Files	<p>This tab allows you to define folders or files from root directory of the scene that should be preserved when creating templates or saving the scene in a different location. Any asset, such as external scripts, user interface files, data files or images that the Script node requires should be listed in this tab.</p> <div style="border: 1px solid #c8e6c9; padding: 10px; margin-top: 10px;"> <p> <b>NOTES</b></p> <ul style="list-style-type: none"> <li>• To add Extra Files to the Extra Files attribute, click on the  Function button right of the Extra Files field to create the Extra Files attribute, then click on it again to open a dialog box in which you can type the file path of each file or folder that you want to copy with the Master Controller, with one file path per line.</li> <li>• File paths must use forward slashes (/) and must be relative to the scene directory. They can point to files or folders. For example, if you want to copy everything in the <b>scripts</b> sub-directory of your scene with your Master Controller, you can simply add <b>scripts</b> to the list.</li> </ul> </div>

## Visibility Node

The Visibility node lets you control whether an item is visible in OpenGL mode versus the Soft Render mode in the Camera view. If the Soft Render option is not enabled, the layer will not be exported.

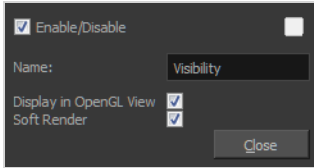

## Visibility Properties

Parameter	Description
Display in OpenGL View	Displays your render in OpenGL mode.
Soft Render	



## Move Nodes

The nodes found in the Move category are used to animate layers as well as camera motions.

<b>Apply Image Transformation Node</b> .....	<b>691</b>
<b>Apply Peg Transformation Node</b> .....	<b>694</b>
<b>Camera Node</b> .....	<b>698</b>
<b>OrthoLock Node</b> .....	<b>700</b>
<b>Peg Node</b> .....	<b>702</b>
<b>Shake Node</b> .....	<b>704</b>
<b>Transform-Loop Node</b> .....	<b>708</b>
<b>Quadmap Node</b> .....	<b>711</b>
<b>Quake Node</b> .....	<b>714</b>

## Apply Image Transformation Node

The Apply Image Transformation effect is mainly used when you want to pan an object out of the camera frame and that object has an effect such as a Glow or a Blur on it. When you use a peg or the Apply Peg Transformation node to translate an object such as the sun out of the camera frame, as soon as the sun starts to go outside of the camera frame, the sun's circle is cropped and the blur is applied on the shape left over. This also means that when the sun is completely out of the frame, the Blur is not calculated anymore and the Blur pops out.

To prevent this from happening, you must use the Apply Image Transformation node to pan the sun out.

The Apply Image Transformation node applies the panning transformation once the full drawing of the sun is blurred, once the image is composited. Here is an example of this network:

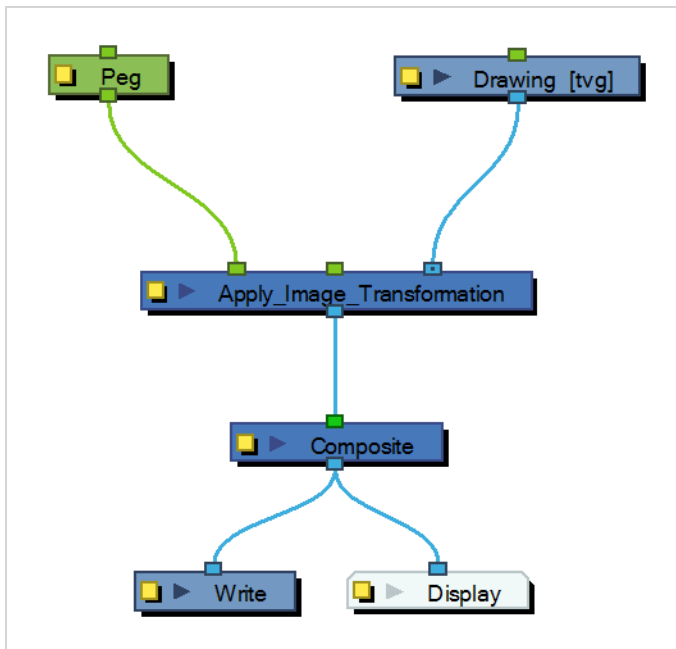

Here is how to connect the Blur effect for a sun panning out:

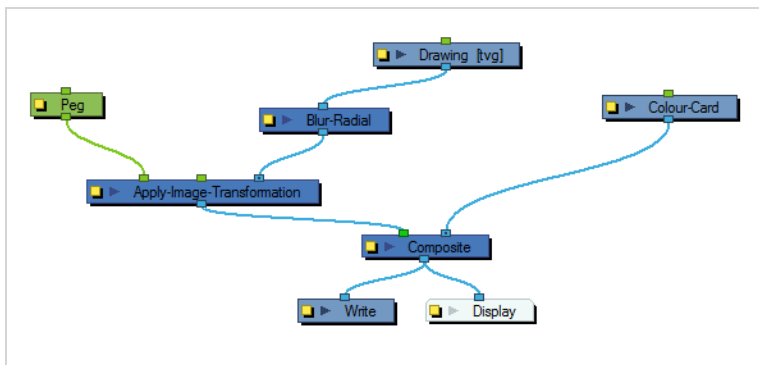

Here is the visual result of the blurred sun:

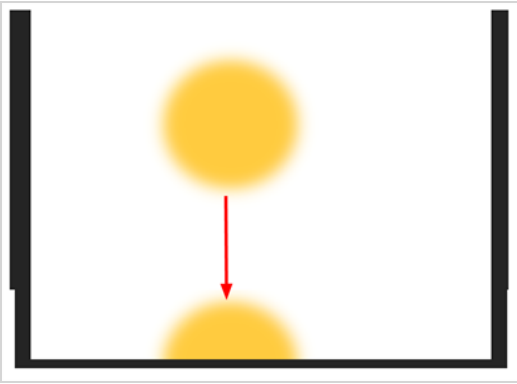

Look at the following example to understand better why using the Apply Image Transformation instead of a regular peg or the Apply Peg Transformation node.

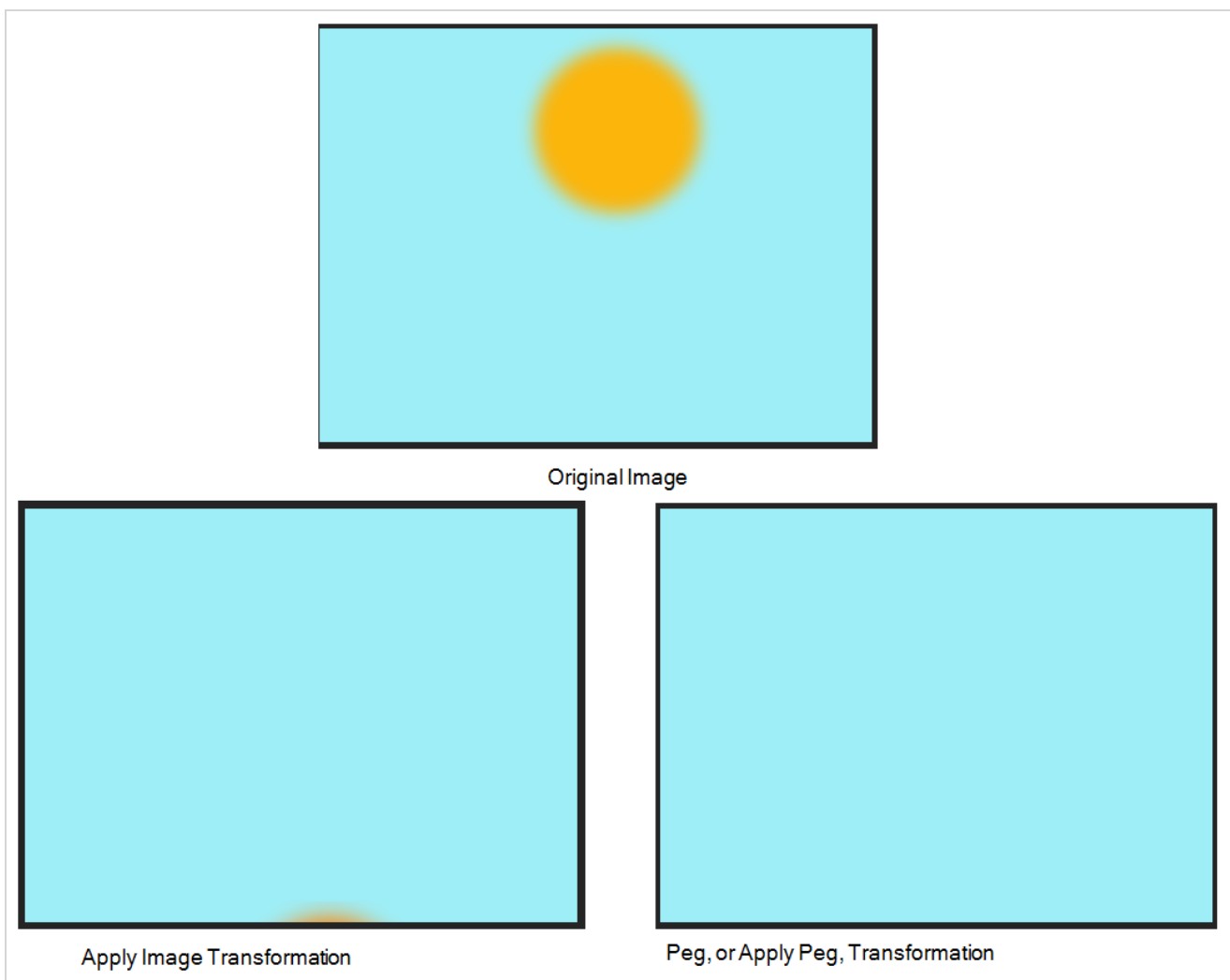

The normal rendering behaviour is to crop the image before applying the effects. When planning a sunset using either a Peg or the Apply Peg Transformation node, as soon as the drawing of the sun is out of the camera frame, the drawing is cropped and there is no image left to blur. This means that the glowing edge pops out of the camera instead of panning out gradually. Using the Apply Image Transformation node, the

image is blurred before being panned out, so this means that even once the drawing is out of the camera frame, its glowing edge will still show until the drawing is far enough from the camera border. This way, there is no pop when panning out blurred objects.

Use the Apply Image Transformation editor to change the name of the node.

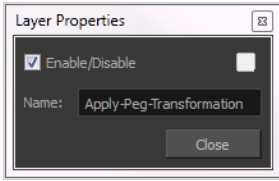

## Apply Peg Transformation Node

Use the Apply Peg Transformation node to apply a transformation coming from a Peg, Ortholock, or Quadmap node on a single node or a group of nodes. When using the drawing layer's No Clipping option, you can use this node to apply all Camera and Peg transformations once all of the effects and nodes connected above the drawing node are calculated.



You can use this effect node to create a simple highlight on a cut-out puppet or use the No Clipping option available in the drawing layer.

The No Clipping option, found under the drawing Layer Properties' Advanced tab is used when you do not want to crop your images before all effects are applied to your drawing. No camera motion or peg transformation will be applied to your drawing until you connect an Apply Peg Transformation.

The advantage of this node is that you can create a second output of your image or puppet and offset it, scale it or apply any kind of transformation on it.

The transformations set in the Peg, Ortholock, or Quadmap node connected to the Apply Peg Transformation node are applied **BEFORE** the image is composited.

Here is an example of how to connect the Apply Peg Transformation node:

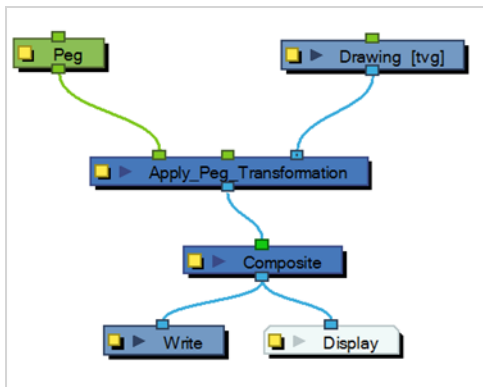

The transformation set in the Peg node from the example above is applied before the image is composited, which is the equivalent of the following network:

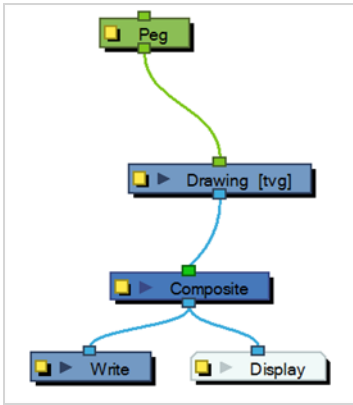

In the following images you can see the result of the transformation without the Apply Peg Transformation node and with it:

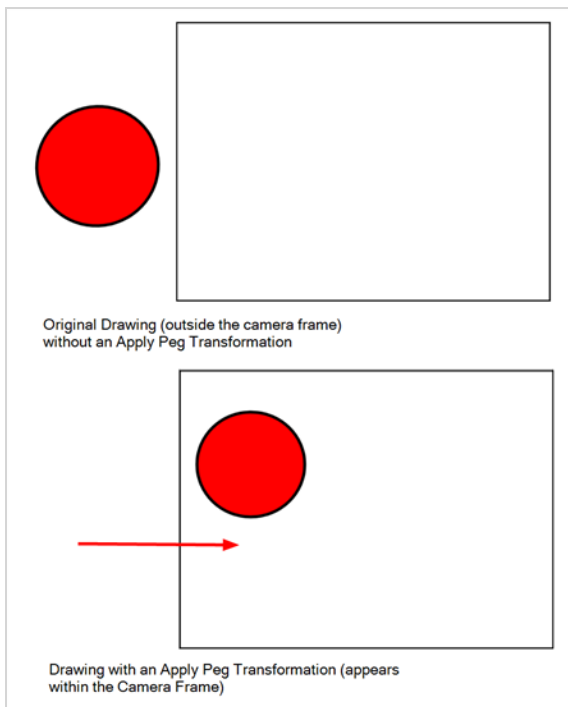

Using the Apply Peg Transformation you can apply transformation on drawings that are outside the camera frame and make them appear inside the frame.

If you are using the Apply Image Transformation node to create a drop-down shadow for a character, it will work correctly so long as the character is not going outside of the camera frame or that the drawing connected in it is a **VECTOR** drawing. The reason is the Apply Image Transformation node applies the transformation once the drawing is rendered, moved by its own set of Pegs, motion paths and quadmap and cropped to the camera frame size. This crop operation does not occur if the drawing is a vector drawing (\*.TVG). Although, as soon as the drawing is passed through an effect node or a bitmap type Composite node, the drawing is turned into a bitmap image and gets cropped.

So, if you offset a bitmap half inside and half outside the camera frame, the outside part is cropped out and then moved by the Apply Image Transformation node. A part of the original drawing is cut. You need to use the

Apply Peg Transformation node for the transformation to be applied before the image is processed and cropped.

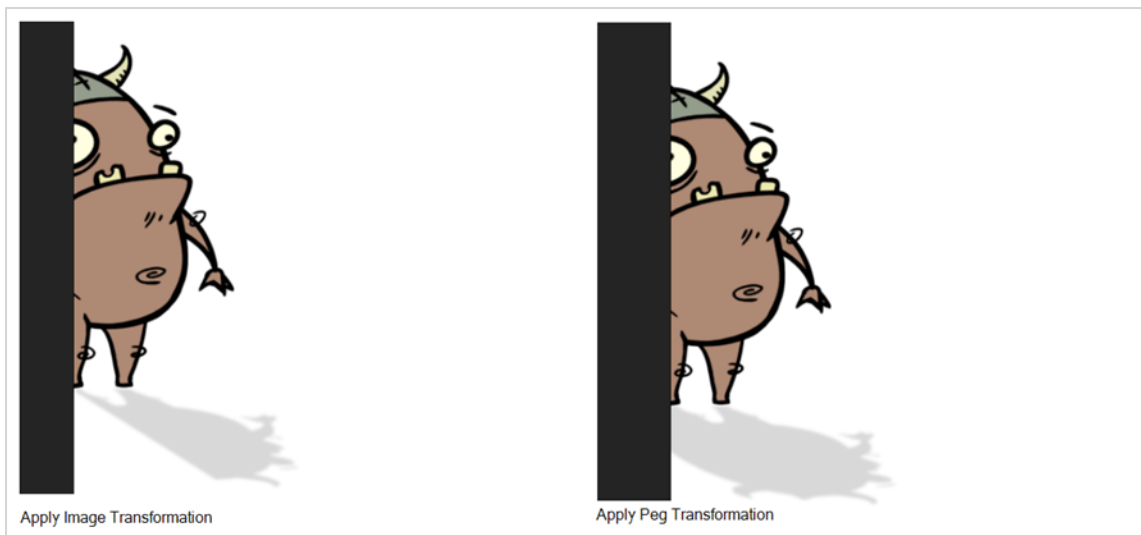
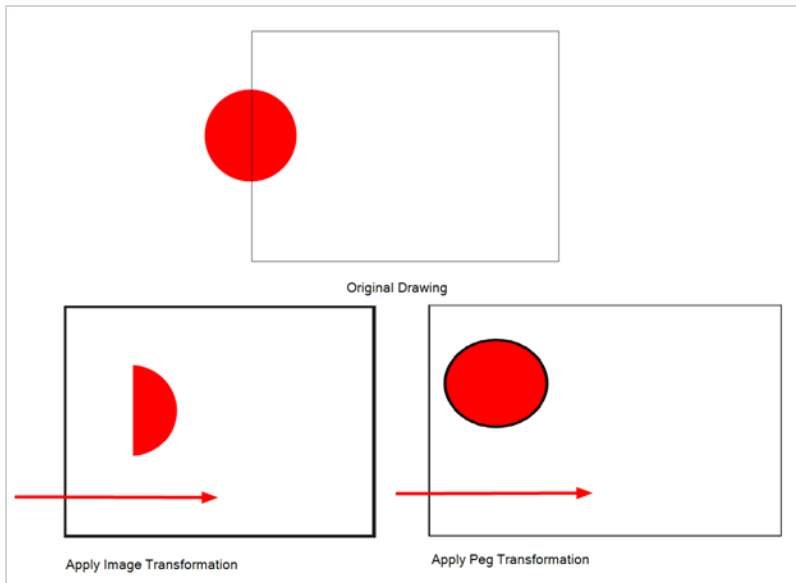

## Advanced Apply Peg Transformation

You can use the Apply Peg Transformation's middle port to apply the transformation you connected to the node after one of the Peg or Quadmap connected above the drawing node.

In the following example, two pegs were added to control the different motions on independent trajectories:

- Peg-Translation
- Peg-Scale

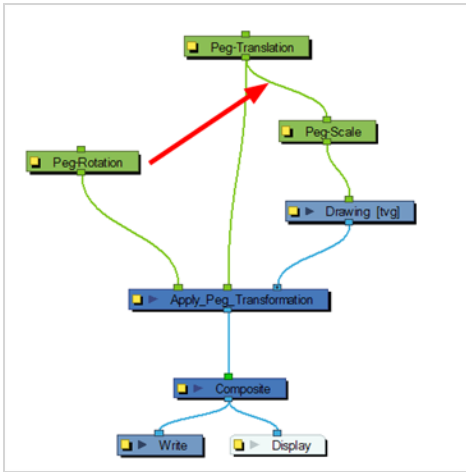

When there is no Apply Peg Transformation node, the Peg-Translation is the first trajectory to affect the drawing node. Then, once the translation is applied, the Scale trajectory affects the drawing node.

When using an Apply Peg Transformation node without using the middle port, the Peg-Rotation connected in the APT node is applied at the top of everything. The order in which the trajectories are applied to the drawing node is:

1. Peg-Rotation
2. Peg-Translation
3. Peg-Scale

When the Peg-Translation is connected in the Apply Peg Transformation's middle port, the Peg-Rotation is applied after the Peg-Translation and before the Peg-Scale. This means that the translation is done before the rotation instead of the rotation before the translation.

The order in which the trajectories are applied to the drawing node is:

1. Peg-Translation
2. Peg-Rotation
3. Peg-Scale

Use the Apply Peg Transformation editor to rename the node.

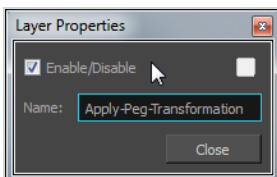



## Camera Node

You can setup the camera position by entering coordinates and values in the Layer Properties view.

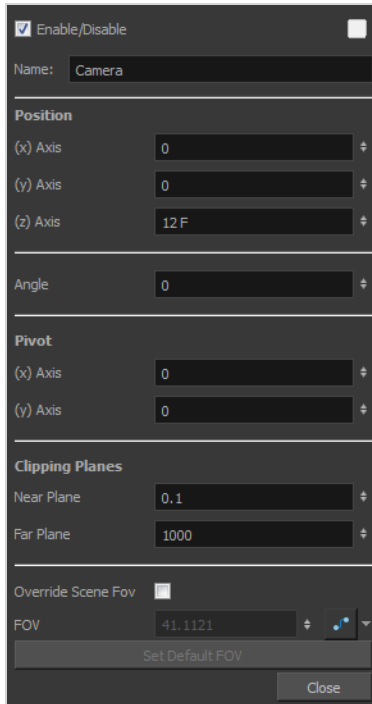

Parameter	Description
Enable/Disable	Turns the camera layer on or off.
Change Track Colour	The Change Track Colour button lets you change the colour of the exposed frames; this helps you to quickly locate a layer in the Timeline view. Click the Change Track Colour button to open the Select Colour window and choose a new colour. You can modify the colour for any type of layer, such as group, peg, drawing, and effects.
Name	Displays the current layer name. You can rename the layer by typing in a new layer name.
Position	Displays the current position of the camera layer using X-axis (East/West), Y-axis (North/South) and Z-axis (Forward/Backward) coordinates. To reposition your camera frame, type in the new values corresponding to the desired position coordinates. You can also use the up and down arrows to set the value of each field.
Angle	Displays the current rotation value. To set a new rotation position, type in a new angle value. You can also use the up and down arrows to set the new angle value.

Pivot	Displays the current position of the rotation pivot of the camera layer. The camera will perform a rotation taking the position of the pivot as its angle centre. By default, the pivot is set at the centre of the camera frame. To reposition the pivot point, enter new X and Y coordinates values in the appropriate field. To see the pivot's position, the Rotate tool must be selected.
Clipping Planes	You can change the near and far clipping planes of the camera. The near plane is the point on the camera cone where the camera is located. The far clipping plane is the far end of the camera cone. Nothing outside that range is visible. This is useful when dealing with 3D elements and 3D sets. For example, the camera can be looking inside a 3D box or room and you might want the foreground wall to not obstruct the view of the interior. By default, the near clipping plane is set to 1 field and the far clipping plane is set to 1000 fields.
Override Scene FOV	Enable the FOV field in which you can type in a new field-of-view value.
FOV	Displays the current field-of-view default value. When enabled, you can type in a new zoom value for your camera frame. You can also use the up and down arrows to set the new zoom value.  Click on the Create Function button to animate the camera zoom value.
Set Default FOV	Resets the custom zoom value to its default value.

## OrthoLock Node

When you create a 3D camera move in your scene, notice that layers are treated as flat objects. That is, animation layers that are supposed to face the camera at all times will look like a flat sheet of rotating paper.



Use the Ortholock layer when mixing flat animation layers with a set built in 3D. Ortholock forces your drawing layer to always follow the Camera angle. It does not follow its position or zooming level, only the rotation. This prevents drawings from being distorted by the camera motion.

## Connection

The OrthoLock node can be connected as a parent of the drawing or drawings which you want to face the camera.

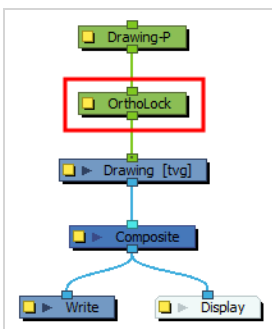

## Layer Properties

Parameter	Description
Enable/Disable	Allows you to enable or disable the node. When disabled, a node has no visible effect on the rendered image, nor on the preview in the Camera, Perspective, Side and Top views.
Colour Swatch	Sets the colour of the layer in the Timeline view and of the node in the Node view.

Parameter	Description
Name	Allows you to enter a name for the node.
Rotation Axis	<p>The axes on which to rotate the input image to keep facing the camera.</p> <ul style="list-style-type: none"><li>• <b>X and Y Axes:</b> The drawing will be rotated on the x and y axes to keep facing the camera regardless of its position in the 3D space.</li><li>• <b>X Axis Only:</b> The drawing will be rotated on the x-axis when the camera is rotated in the x-axis. The drawing will keep facing the camera if it moves to a low or high angle view, but not if it moves around it while staying on the ground.</li><li>• <b>Y Axis Only:</b> The drawing will be rotated on the y-axis when the camera is rotated on the y-axis. The drawing will keep facing the camera if it moves around it while staying on the ground, but not if it moves to a low or high angle view.</li></ul>
Max Angle	<p>The maximum angle at which the drawings can appear to be relative to the camera angle, on both the x and y axes, in either direction.</p> <p>For example, at the default setting, 0, the input image will always be facing the camera. If however you set this parameter to 30°, you can rotate the camera around the drawing up to 30° in either direction and the drawing will appear in perspective, but past 30°, the drawing will appear to rotate to keep its angle relative to the camera.</p>

## Peg Node

Find below a description of all the Peg node parameters.

### Transformation Tab

Parameter	Description
Enable 3D	Displays additional parameters for working with 3D objects.
Position	<p><b>3D Path:</b> Use a 3D path to position the element. A 3D path uses a single function to define the position on the X, Y and Z axes. This function is made of control points linked by a curvilinear path, making the movement follow a natural curve. The pace and ease of the movement is determined by a single velocity function.</p> <p><b>Separate:</b> Positions the element using separate functions for the X, Y and Z axes. This allows to control the direction and pace of the movement across all three axes separately. Unless ease is applied to the axes, the trajectory of the element will follow straight lines going between each keyframe.</p> <p><b>Path:</b> If the 3D Path option is selected, this field allows you to create or select the 3D Path function used to position the element.</p> <p><b>Path (x) Axis:</b> The position of the element on the East-West axis, in fields.</p> <p><b>Path (y) Axis:</b> The position of the element on the South-North axis, in fields.</p> <p><b>Path (z) Axis:</b> The position of the element in the Back-Front axis, in fields.</p> <p><b>Velocity:</b> If the 3D Path option is selected, this function is used to control the pace at which the element moves towards each control point in the 3D Path function, on all three axes simultaneously.</p>
Scale	<p><b>Locked:</b> Uses a single scale parameter to scale the element, preserving its proportions.</p> <p><b>Separate:</b> Uses a separate parameter to scale the element on the X and Y axis, as well as on the Z axis if the element is 3D-enabled, allowing to stretch or squash the element.</p> <p><b>(x) Axis:</b> The horizontal scale factor. The default value is 1.</p> <p><b>(y) Axis:</b> The vertical scale factor. The default value is 1.</p> <p><b>(z) Axis:</b> The depth scale factor for 3D-enabled elements. The default value is 1.</p> <p><b>Scale in Fields:</b> With this option enabled, the scale factor is based on the amount of fields in the scene. For example, to shrink one of the dimensions of an element to half its original size, the scale factor would normally be set to 0.5. If this option is enabled and the amount of fields in the scene is 12, then the scale factor to shrink the element by half would be 6.</p>

	<p><b>Ignore Parent Scaling:</b> When this option is enabled, any scaling value applied to a parent layer is ignored in the current layer. This can be handy in cut-out rigs when you need to scale an arm without affecting the forearm.</p>
Rotation	<p><b>Angle z:</b> Lets you type in a degree value for the rotation angle. Note that you can enter values greater than 360 and -360 degrees. If you enter 720, the object will rotate twice.</p>
Skew	<p><b>Skew:</b> Lets you type in a degree value between -90 to 90 for the skew angle.</p>
Pivot	<p><b>(x) Axis:</b> The horizontal position of the pivot point of the element relative to the pivot point of the drawing, in fields.</p> <p><b>(y) Axis:</b> The vertical position of the pivot point of the element relative to the pivot point of the drawing, in fields.</p>

## Shake Node

T-H16NEW-004-001

The Shake node allows you to generate a fully animated, fully customizable shake animation, which can be used to create camera shakes or to make an element in your scene shake.

The Shake node is a more advanced version of the Quake node. Among many enhancements, you can make each shaking motion interpolate over several frames by reducing its Frequency parameter, and you can make each movement hold for 2 or more frames, if needed, by increasing its Step parameter. Additionally, you can configure each big shaking motion to have several smaller shaking motion across it, to make a more erratic looking shaking movement.

## Connection

Just like a peg, you can connect the Shake node as a parent of the element you want it to move. Hence, if you want to shake an element in your scene, connect the Shake node as a parent of that element.

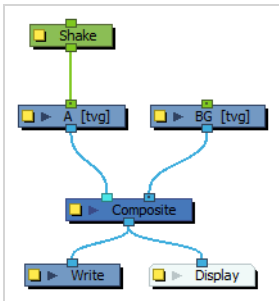

To create a Camera shake, connect the Shake node as a parent of the scene's Camera node.

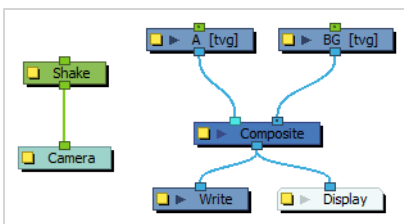

Like pegs, Shake nodes can be connected in chain, either with other Shake nodes or with other Move-type nodes, such as Peg nodes.

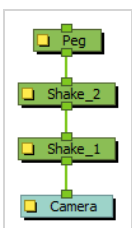

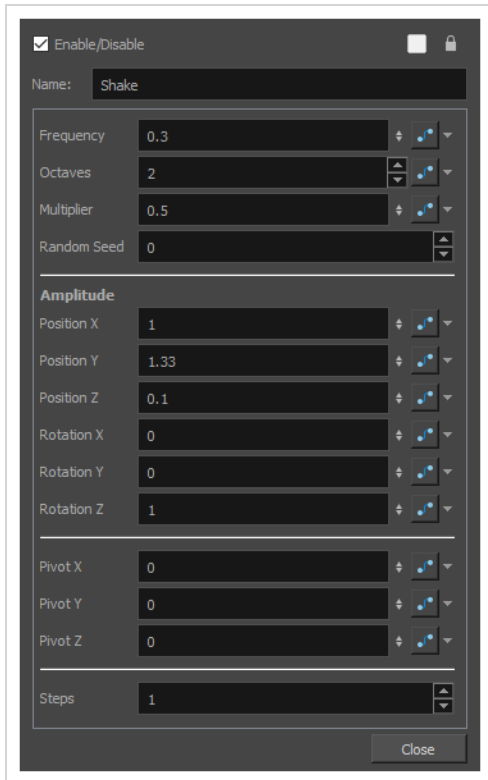

## Layer Properties



Parameter	Description
Name	Allows you to change the name given to the node.
Frequency	<p>The speed of the big vibrations. This field takes a decimal value between 0 and 1. At 1, each vibration only takes a single frame. At 0.5, each vibration takes 2 frames, etc.</p> <p>When set to 0, the Shake node produces no vibration. You can animate this parameter to control when the Shake node has an effect and when it doesn't, as well as to increase or decrease the speed of the shake.</p>
Octaves	With the Octave parameter, you can add smaller vibrations to the big vibrations, making for a more erratic, forceful shake. This parameters takes an integer, which determines the amount of smaller vibrations to add to each big vibration.

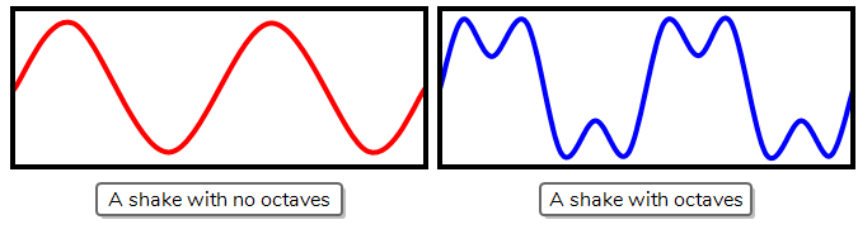

Parameter	Description
	
Multiplier	<p>The strength of the smaller vibrations, relative to the big vibrations. This is set to 0.5 by default, which means smaller vibrations will have, at most, half the amplitude of big vibrations.</p>
Random Seed	<p>This parameter determines the pattern of random motions it uses to simulate shaking. There is no wrong value for this parameter. Entering any value will simply make it use a different random pattern.</p> <p>If you have two or more Shake nodes in your scene and they have the same Random Seed value, their shaking will be similar, if not exactly the same, as it will be based on the same pattern of random motions. Hence, you might need to assign different Random Seed values to all of your Shake nodes to make sure their motion pattern feels different.</p> <p>You should also assign a different Random Seed value to each Shake node if they make a shaking motion that goes on throughout several scenes so that it doesn't look like the motion pattern is repeating itself.</p> <p>You can also change the value of this parameter just to make the Shake node use a different shake pattern, and see if you can find a pattern that fits your expectations better.</p>
<b>Amplitude</b>	
Position X	The maximum distance, in fields, to shake left or right.
Position Y	The maximum distance, in fields, to shake up or down.
Position Z	The maximum distance, in fields, to shake closer to or further from the camera.
Rotation X	The maximum angle, in degrees, to shake around the horizontal axis.
Rotation Y	The maximum angle, in degrees, to shake around the vertical axis.

Parameter	Description
Rotation Z	The maximum angle, in degrees, to shake clockwise or counterclockwise.
<b>Pivot</b>	
Pivot X	The horizontal offset of the pivot point, in fields, relative to its default horizontal position.
Pivot Y	The vertical offset of the pivot point, in fields, relative to its default vertical position.
Pivot Z	<p>The offset of the pivot point on the z-axis, in fields, relative to its default position on the z-axis.</p> <div data-bbox="565 814 1429 1180" style="border: 1px solid #c8e6c9; padding: 10px;"> <p> <b>NOTES</b></p> <ul style="list-style-type: none"> <li>• The position of the pivot is used for rotations in the shaking motions.</li> <li>• The pivot of the Shake node is positioned in the centre by default. However, if an element connected under it has the Use Embedded Pivots property set to Apply Embedded Pivot on Parent Peg, the default pivot position of the Shake node will be the same as the pivot of that element.</li> </ul> </div>
<b>Steps</b>	
Steps	The amount of frames to hold each movement. By default, this is set to 1, which means the Shake node will move each frame. You can set this to 2 or 3 if you animate on twos or threes, so that the motions of the Shake node match the pace of your animation.

## Transform-Loop Node

The Transform-Loop node allows you to automatically loop a transformation applied by a peg onto its element, so that you do not have to copy and paste this animation over and over again throughout your scene. This is especially useful if you need to repeat the pan animation of a looping background.

The Transform-Loop node will take the animation that is fed to it by its parent node, for a given frame range, and repeat this animation onto its child node throughout the entire scene. It can automatically detect the range of frames to repeat, or you can manually set this range. It can loop the animation in three ways:

- **Repeat** will simply repeat the animation as is, going from the start all the way to the end, and instantly playing it again from the start.

When the Transform-Loop node repeats the animation, it skips the first frame of the animation. This is useful when using looping backgrounds. Typically, with a looping background, the first frame of the looping animation looks exactly like the last frame of the looping animation. Hence, skipping the first frame avoids having two frames that look exactly the same when the animation loops, making a smooth infinite loop.

- **Ping-Pong** plays the animation, then plays it again backward, then forward again, etc.
- **Repeat and Offset** repeats the transformation, but also accumulates the effect of the transformation. Hence, if the animation is, for example, of a ball bouncing once towards the right, then the Transform-Loop node will make it bounce further and further towards the right until it exits the camera field.

## Connection

The Transform-Loop node repeats the transformations that are sent to it from its top (input) port, and outputs the looped transformation through its bottom (output) port.

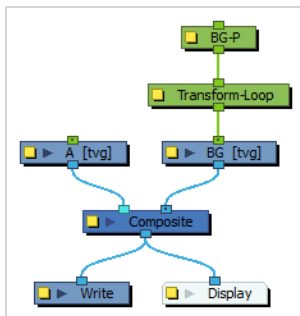

The Transform-Loop node repeats the transformations from all the nodes connected directly or indirectly to its top (input) port, not just the one connected right above it.

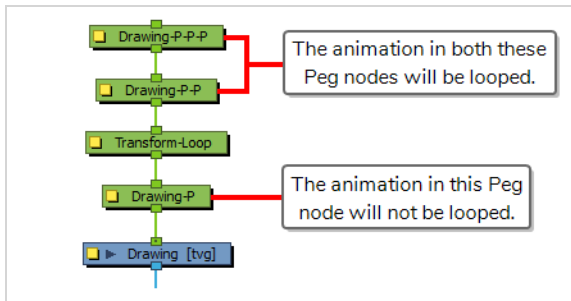

## Layer Properties

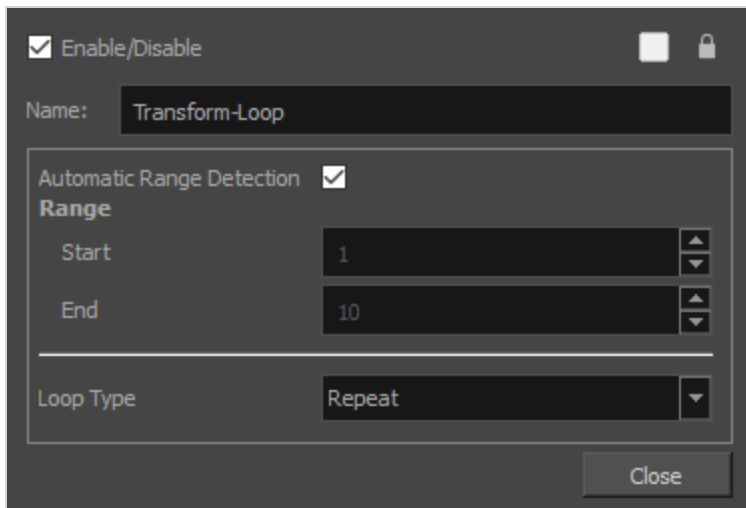

Parameter	Description
Name	Allows you to change the name given to the node.
Automatic Range Detection	<p>Automatically sets the range of the animation to loop based on the animation in its parent peg. It will start the range at the first keyframe in the parent peg, and end it at the last keyframe in the parent peg.</p> <div style="border: 1px solid green; padding: 10px; margin-top: 10px;"> <p><b>NOTE</b></p> <p>If there are several peg nodes connected in a chain to the top port of the Transform-Loop node, it will loop the animation of all these Peg nodes combined. However, it will only use the keyframes in the node right above it to determine the range of animation to loop. In this case, you have to disable Automatic Range Detection and set the range manually to make sure the Transform-Loop node repeats all of the animation you want it to repeat.</p> </div>
Range	The range of animation frames to loop.

Parameter	Description
	<ul style="list-style-type: none"> <li>• <b>Start:</b> The number of the first frame of the animation that the Transform-Loop node should loop.</li> <li>• <b>End:</b> The number of the last frame of the animation that the Transform-Loop node should loop.</li> </ul>
Loop Type	<p>The way the Transform-Loop node should loop the animation:</p> <ul style="list-style-type: none"> <li>• <b>Repeat</b> will simply repeat the animation as is, going from the start all the way to the end, and instantly playing it again from the start.</li> </ul> <p>When the Transform-Loop node repeats the animation, it skips the first frame of the animation. This is useful when using looping backgrounds. Typically, with a looping background, the first frame of the looping animation looks exactly like the last frame of the looping animation. Hence, skipping the first frame avoids having two frames that look exactly the same when the animation loops, making a smooth infinite loop.</p> <ul style="list-style-type: none"> <li>• <b>Ping-Pong</b> plays the animation, then plays it again backward, then forward again, etc.</li> <li>• <b>Repeat and Offset</b> repeats the transformation, but also accumulates the effect of the transformation. Hence, if the animation is, for example, of a ball bouncing once towards the right, then the Transform-Loop node will make it bounce further and further towards the right until it exits the camera field.</li> </ul>

# Quadmap Node

T-COMP2-010-001

The Quadmap transformation layer lets you deform the shape of an element. For example, you can use it to create a drop-shadow effect on an element.



You can edit the Quadmap visually in the Camera view.

## How to edit the Quadmap in the Camera view

1. In the Timeline view, click the Add Layer **+** button and select **Quadmap**.
2. Connect the drawing you want to deform to the Quadmap.
  - In the Node view, add a Quadmap node and connect to the drawing element node that you want the effect to act on.

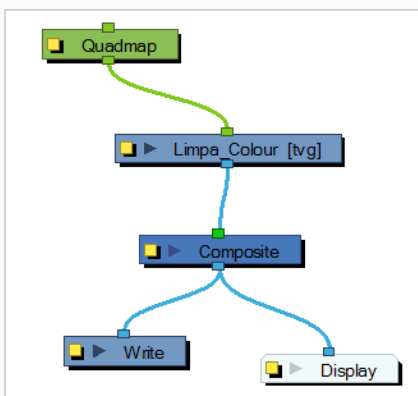
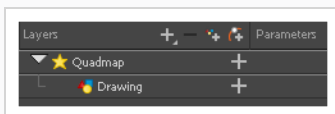

3. In the Tools toolbar, disable the Animate mode to change the value for the Quadmap over the entire duration of the element.
4. In the Timeline view, click on the Quadmap layer to select it.
5. From the top menu, select **View > Show > Control** or press **Shift + F11**.

The quadmap handles appear around the element in the window. There is also a pivot point at the centre of the quadmap frame that you can reposition.

- In the Camera view window, use the Transform tool to move the points on the quadmap. Shift + click to select multiple points.

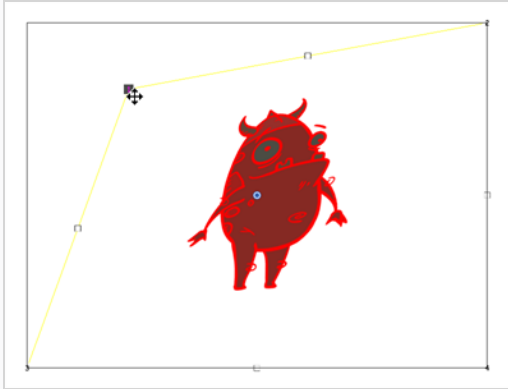

### TIP

The position of the points can be animated. To do this, open the Quadmap node layer properties and create functions for each of the coordinates.

## Properties

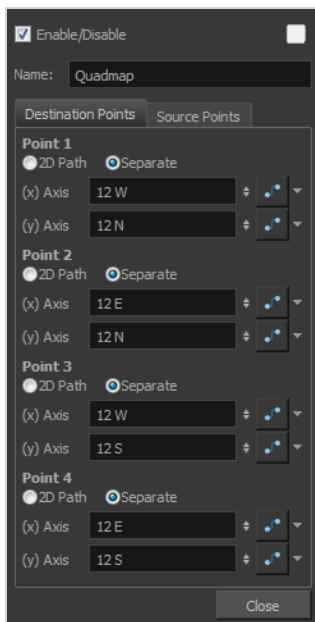

Parameter	Description
-----------	-------------

Name	Allows you to change the name given to the node.
2D Path	Changes the X and Y values simultaneously and control the velocity of the change.
Separate	Changes the X and Y values separately. Each one can be attached to separate function curves.



## Quake Node

The Quake node allows you to create a very common camera move, the camera shake. Using the Quake node, you can generate an automated quake instead of manually entering random keyframes. This way, you can simulate the shock of something heavy falling on the ground, like an earthquake or a strong vibration.

### How to use the Quake node to create a camera shake

1. From the Node Library view, drag a **Quake** node to the Node view.
2. If you do not have a Camera node already, drag one from the Node Library view to the Node view.
3. Connect the Quake node to the Camera node.

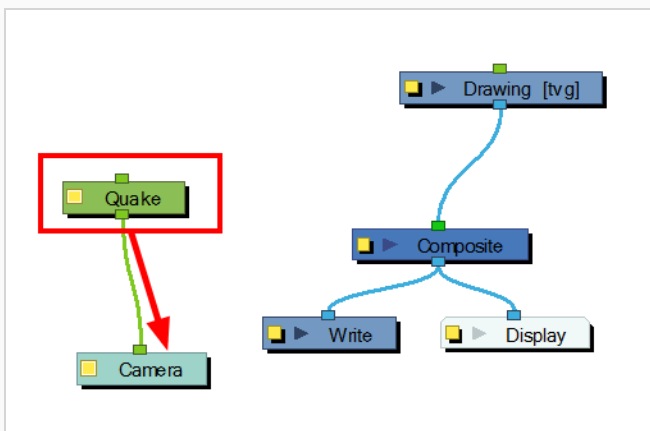

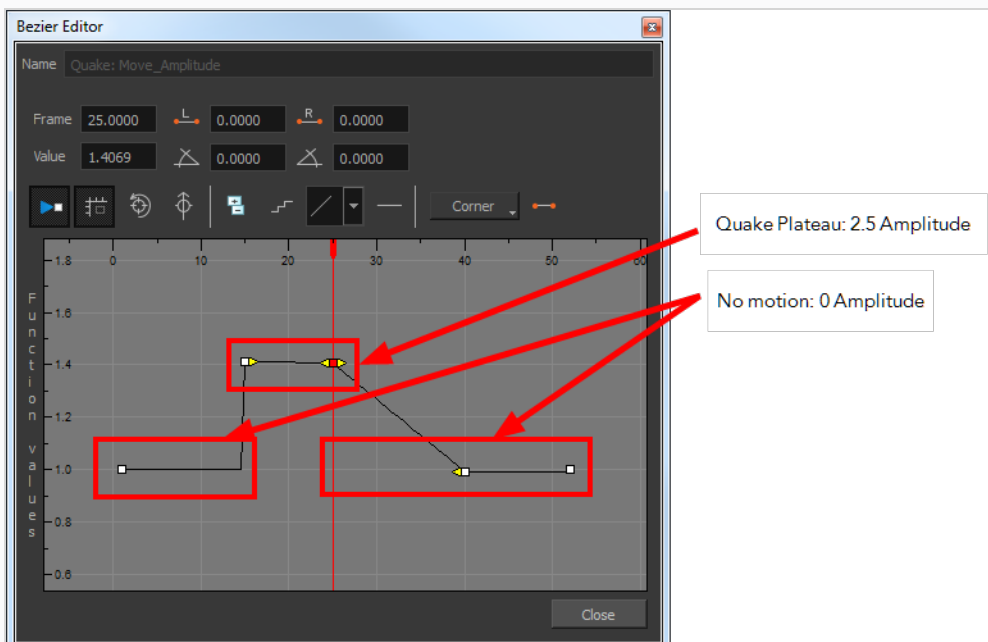

4. Click on the Quake node's yellow square properties button to open the Quake properties.
5. In the Quake properties window, adjust the properties.

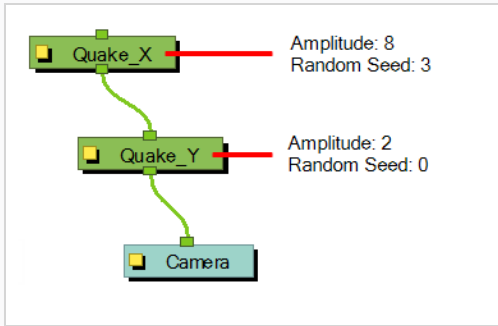

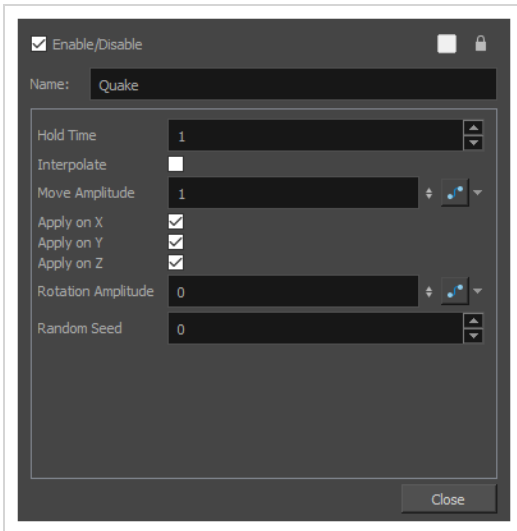

## Layer Properties



Parameter	Description
Name	Allows you to change the name given to the node.
Hold Time	Allows you to enter the number of frames you want one of the quake vibrations (position) to hold for. Most camera shakes are done in a single frame (1) or double frame (2).
Interpolate	An interpolation is generated between the random values. Instead of jumping to the next position, it will slowly progress forwards to the next position. It is the same principle as stop-motion keyframes and motion keyframes.
Move Amplitude	This is the strength of the quake. The higher the value, the stronger the quake. If the value is set to 0, there will be no motion. To have the motion start and stop at a specific frame during the scene, you can create a function curve and animate the amplitude over time. Simply click the Function  button to generate the

	function, then click on it again to open the Function editor.
Apply on X, Y, Z	Applies the quake to the X, Y and Z-axis.
Rotation Amplitude	When the value is higher than 0, a rotating quake is applied. The higher the value, the stronger the quake.
Random Seed	<p>This parameter determines the pattern of random motions it uses to simulate shaking. There is no wrong value for this parameter. Entering any value will simply make it uses a different random pattern.</p> <p>If you have two or more Quake nodes in your scene and they have the same Random Seed value, their shaking will be similar, if not exactly the same, as it will be based on the same pattern of random motions. Hence, you might need to assign different Random Seed values to all of your Quake nodes to make sure their motion pattern feel different.</p> <p>You should also assign a different Random Seed value to each Quake node if they make a shaking motion that goes on throughout several scenes so that it doesn't look like the motion pattern is repeating itself.</p> <p>You can also change the value of this parameter just to make the Quake node use a different shake pattern, and see if you can find a pattern that fits your expectations better.</p>

## Output Nodes

The nodes found in the Output category are used to control the image outputted in the various views as well as during the rendering process.

<b>Crop Node</b> .....	<b>718</b>
<b>Display Node</b> .....	<b>721</b>
<b>Multi-Layer Write Node</b> .....	<b>722</b>
<b>Scale Output Node</b> .....	<b>726</b>
<b>Write Node</b> .....	<b>728</b>
Image Formats for Rendering Write Nodes .....	733

## Crop Node

To output two files with different aspect ratios, such as 16:9 and 4:3, you can use the Crop node. This node is used to crop the final image in order to discard excess information without distorting the render.

If you want to export your scene in a resolution that is smaller than your scene's resolution and which does not have the same aspect ratio, you should use a Scale-Output node to shrink the output, but preserve the scene's proportions, then a Crop node to adjust the output to fit the desired aspect ratio.

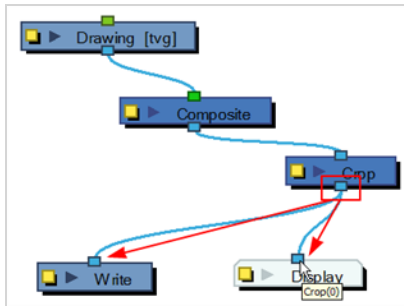

Find below the Crop node properties.

## Cropping Tab

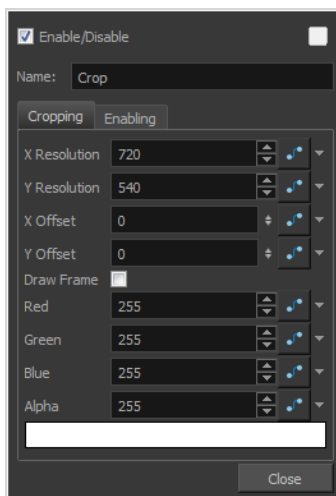

Parameter	Description
X Resolution	This is the X (width) value in pixel of the resolution to crop the final image to.
Y Resolution	This is the Y (height) value in pixel of the resolution to crop the final image to.
X Offset	This is the X (horizontal) offset value in pixel to move the crop box to in the final image.

Y Offset	This is the Y (vertical) offset value in pixel to move the crop box to in the final image.
Draw Frame	Enable the Draw Frame option if, instead of cropping the images, you prefer to have Harmony draw a frame over the rendered scene.
Red, Green, Blue, Alpha	These are the RGBA values used for the frame colour if you enabled the Draw Frame option.
Colour Swatch	Displays the selected colour for the frame to draw. You can click on the Colour Swatch to open the Colour Picker dialog and select a colour for the frame.

## Enabling Tab

Using the options in the Enabling tab, you can set up some Crop nodes to only be enabled if the scene is rendered at a specific resolution. This is mostly useful on Harmony Server, as Harmony Server allows you select the resolution at which to render a scene when sending a scene for rendering by the Harmony database's render farm.

This can be useful if you want your scene to render differently depending on the resolution in which you render it. For example, you could have a storyboard thumbnail in a small corner of your scene, and a crop node that connects between your scene's main Composite node and your Write node. Then, by setting up this Crop node to only be enabled when the scene is rendered at the storyboard thumbnail's resolution, you can decide whether your scene will render its animation or its storyboard by deciding whether to render at the scene's resolution or the storyboard thumbnail's resolution.

This option allows you to filter with either resolution presets, or by specifying the width and height of the chosen resolution in pixels. You can hence create custom resolution presets named after the Crop node's purpose, to make it easier to choose the resolution when rendering a scene.

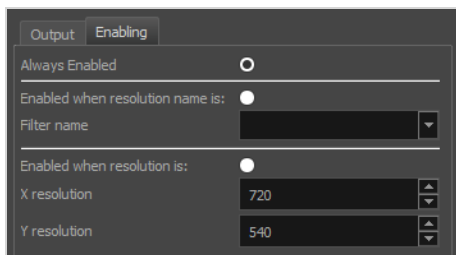

Parameter	Description
Always Enabled	Makes this Crop node render every time the scene is rendered. This is the default option.

---

Enabled when Resolution Name is	Makes this Crop node render only when the scene is rendered at the specified resolution preset.
Filter Name	Select the resolution preset at which to render the scene to activate this Crop node.
Enabled when Resolution is	Make this Crop node render only when the scene is rendered at the resolution with the specified width and height, in pixels.
X Resolution	The width (in pixels) of the resolution at which to render the scene to activate this Crop node.
Y Resolution	The height (in pixels) of the resolution at which to render the scene to activate this Crop node.

## Display Node

The Display node is an important node; it is used by the export and views to display your scene, primarily the Camera and Timeline views. By default, a scene's node system always has a Display node which can be used to show your entire scene, a single node or a group of nodes through a Composite or Group node. You might use it to see one single character as you animate it, debug your node system as you create complex effects or export your complete scene or a portion of it.

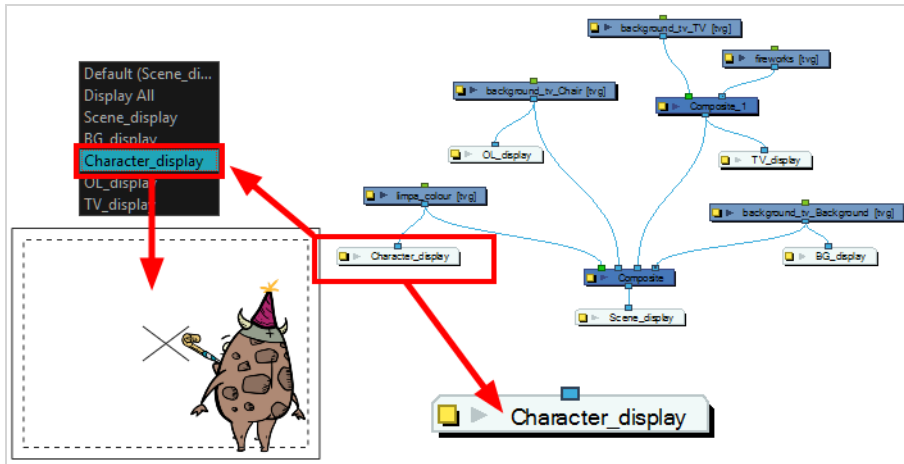



## Multi-Layer Write Node

The Multi-Layer Write node allows you to export Photoshop Document (.psd) or OpenEXR (.exr) files with multiple layers inside them. It works just like a Write node, except that it takes several input images instead of just one, and each input image is used to generate one of the layers of the image files it outputs when rendering.



### NOTE

To learn more about the Write node, see [Write Node on page 728](#).

## Connection

Like the Write node, the Multi-Layer Write node only takes input images. Its output is stored in image files when your scene is rendered. However, contrary to the Write node, the Multi-Layer Write node takes several input images.

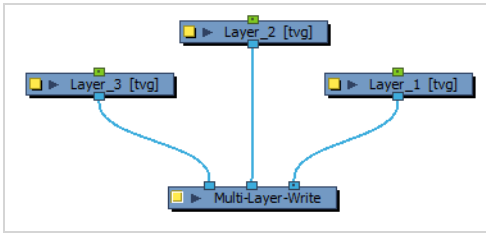

Each image connected to the Multi-Layer Write node will be used to make one of the layers of the image files the node creates. The image connected to the rightmost port will be the bottom layer, and the image connected to the leftmost port will be the top layer.

## Layer Properties

### Inputs Tab

The Inputs tab displays a list of the elements connected to the node's input ports. The input ports are listed from right to left. The layers listed in this list are ordered from the bottommost layer to the topmost layer. Hence, the layer appearing at the top of the list will be the bottom layer.

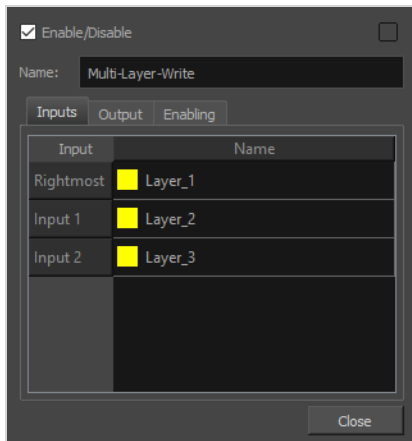

The layers will be named in the output file as they appear in the Name column. By default, each layer is named after their respective input node. If you prefer, you can customize the name of each layer. Simply double-click on a layer's name to be prompted to type a new name.

A coloured square appears to the left of each name to indicate whether the name is based on the node or is a custom name. If the square is **yellow**, the name is based on the node. If it is **green**, it is a custom name. Once a layer name has been customized, it will no longer automatically update based on the connected node's name.

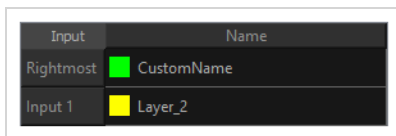

## Output Tab

The output tab can be used to configure the path, file naming pattern and file type of images exported by the Multi-Layer Write node.

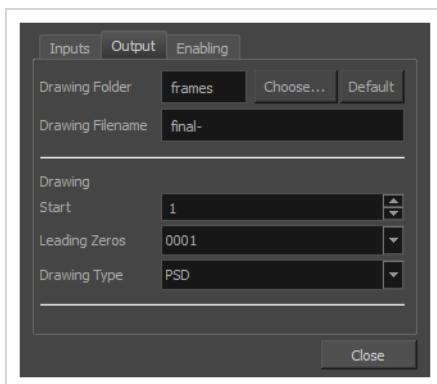

Parameter	Description
Drawing Folder	The path to the folder in which to save the rendered frames. This path can be absolute or relative to the scene's folder. For example, the default path for rendered frames is <b>frames</b> , which means the images are saved in the <b>frames</b>

Parameter	Description
	subfolder of the scene folder. If you want to select an absolute path, you can click on the <b>Choose</b> button at the right of the text field and select the folder in which your scenes should export their frames. You can also click on the <b>Default</b> button to set the export path to the default value.
Drawing Filename	The prefix for the file name of each exported frame. Frames will be named with this value, followed by the frame number and their image type extension. It is recommended to leave the hyphen (-) at the end of the prefix to separate the prefix from the frame number.
Drawing	
Start	Select the starting number for the image sequence.
Leading Zeros	Select the number of digits you want to see after the sequence prefix.
Drawing Type	Allows you to select the image type in which to export the frames. You can choose between the following file types: <ul style="list-style-type: none"> <li>• <b>PSD:</b> A multi-layer Photoshop Document (.psd) file.</li> <li>• <b>EXR:</b> A multi-layer OpenEXR (.exr) file, compressed in ZIPS format, which compresses the image in blocks of 16 scanlines.</li> <li>• <b>EXR_ZIP_1LINE:</b> A multi-layer OpenEXR (.exr) file, compressed in ZIP1 format, which compresses the image in blocks of 1 scanline.</li> </ul>

## Enabling Tab

You can create several Write nodes for a single scene and, by default, when a scene is rendered, all of its Write nodes will perform their render. However, using the options in the Enabling tab, you can set up some Write nodes to only perform their render if the scene is rendered at a specific resolution. This is mostly useful on Harmony Server, as Harmony Server allows you select the resolution at which to render a scene when sending a scene for rendering by the Harmony database's render farm.

A good example of how this can be useful is if your scene has storyboard thumbnails in the corner, and a Write node connected to a composite that crops the picture to only include the storyboard thumbnail, so that your scene can export both the final animation and the animated storyboard when rendered. You can set up your scene's main Write node to only work when exporting the scene at the scene's original resolution, and the storyboard thumbnails Write node to only work when exporting at the desired resolution for an animated storyboard.

This option allows you to filter with either resolution presets, or by specifying the width and height of the chosen resolution in pixels. You can hence create custom resolution presets named after their Write node's purpose, to make it easier to choose the resolution when rendering a scene.

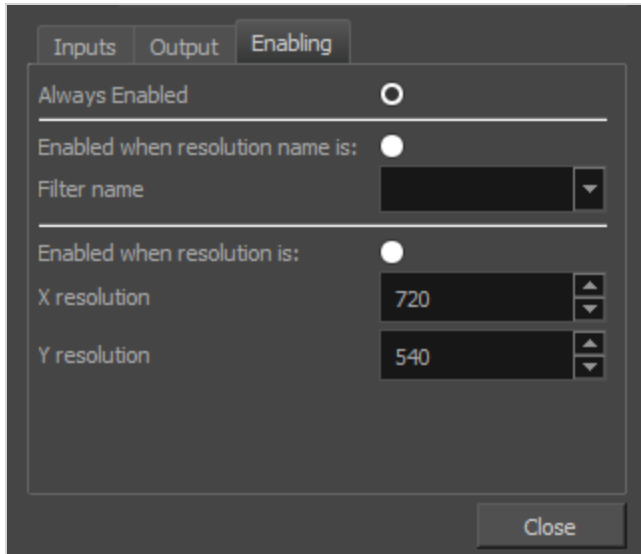

Parameter	Description
Always Enabled	Makes this Write node render every time the scene is rendered. This is the default option.
Enabled when Resolution Name is	Makes this Write node render only when the scene is rendered at the specified resolution preset.
Filter Name	Select the resolution preset at which to render the scene to activate this Write node.
Enabled when Resolution is	Make this Write node render only when the scene is rendered at the resolution with the specified width and height, in pixels.
X Resolution	The width (in pixels) of the resolution at which to render the scene to activate this Write node.
Y Resolution	The height (in pixels) of the resolution at which to render the scene to activate this Write node.

## Scale Output Node

Once your Write nodes are connected, you need some Scale-Output nodes to change the resolution output of the Write node without changing the scene settings. For example, if you export in a high resolution and a low resolution, you need one Scale-Output node.



### NOTE

If you use a Scale-Output node to scale up the image, it will look pixelated. If you want to export a scene in multiple resolutions, you should set your scene's resolution to be the highest resolution in which you want to render, and use Scale-Output nodes to scale down the output.

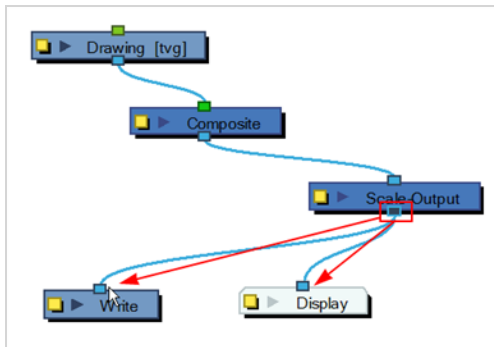

Find below the Scale-Output node properties.

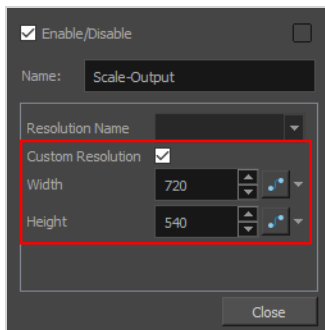

Parameter	Description
Resolution Name	Select one of the existing resolution preset from the list to indicate the resolution you want the finale images to be scaled at. Always make sure the selected resolution is smaller than the scene setting one.
Custom Resolution	Enable this option to set a resolution that is not available in the Resolution preset list.
Width	X (horizontal) value in pixels of the resolution to scale the images down to.

Height	Y (vertical) value in pixels of the resolution to scale the images down to.
--------	---

## Write Node

The Write node is the node that is used by Harmony to render a scene. When rendering a scene, Harmony renders the image information sent to the Write node, and outputs it using the parameters in the Write node's layer properties.

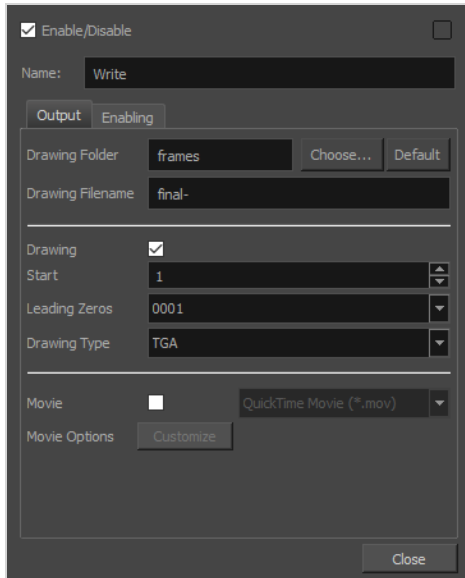

The Node view allows you to branch out and merge elements of your scene in specific ways. By default, a scene has a Write node connected to its main composite, meaning all of the scene's elements are rendered. However, a Write node can be connected to any node in your scene that outputs image information, even a drawing or an effect. A scene's renders are based on the image information that is sent to its Write node, and nothing else. Hence, you can control exactly what gets rendered, which is especially useful if you want to have elements in your scene that are only visible in the Camera view, such as a storyboard overlay or a camera guide, without having them appear in the renders.

You can also set up a scene to create multiple renders by connecting several Write nodes to it. Your Write nodes can be connected to different elements of your scene, which allows you to create separate renders for different parts of your Node view every time your scene is rendered. For example, a scene can have a Write node for rendering the scene without any annotations, so that render can be used in post production, and another one for rendering the scene with its storyboard and annotations for reviewing. A scene can also have multiple Write Nodes connected to the same composite, which can allow you to render the same image in multiple file formats or locations at the same time.

Each Write node can be configured to export individual frames as image files, a video file, or both simultaneously.



### NOTE

For a list of the available image formats for the Drawing Type parameter, see [Image Formats for Rendering Write Nodes on page 733](#).

## Layer Properties

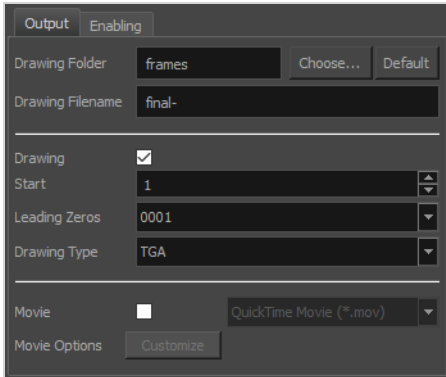

### Output Tab

The output tab can be used to configure whether the Write node creates individual frame images, a movie file, or both. Further more, you can configure the path, file naming pattern and file type of frames exported by the Write node, as well as the path, file name and encoding options of the movie file created by the Write node.



Parameter	Description
Drawing Folder	The path to the folder in which to save the rendered frames. This path can be absolute or relative to the scene's folder. For example, the default path for rendered frames is <b>frames</b> , which means the images are saved in the <b>frames</b> subfolder of the scene folder. If you want to select an absolute path, you can click on the <b>Choose</b> button at the right of the text field and select the folder in which your scenes should export their frames. You can also click on the <b>Default</b> button to set the export path to the default value.
Movie Folder	Only available when the <b>Movie</b> option is enabled. The folder in which to export the movie file. You can click <b>Choose</b> to the right of the text field to browse for the directory where you want the movie to be exported, or click <b>Default</b> to set the export path to the default value. You can also type a path relative to the scene's directory. For example, the default value is <b>frames</b> , which exports the movie to the scene's <b>frames</b> subdirectory.
Drawing Filename	The prefix for the file name of each exported frame. Frames will be named with this value, followed by the frame number and their image type extension. It is recommended to leave the hyphen (-) at the end of the prefix to separate the prefix from the frame number.
Movie Filename	Only available when the Movie option is enabled. The name of the movie file to export. Do not enter the file's extension.

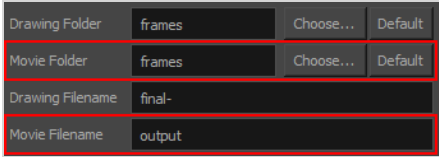

Drawing	Select this option to create an image sequence.
Start	Select the starting number for the image sequence.
Leading Zeros	Select the number of digits you want to see after the sequence prefix.
Drawing Type	The image format in which the rendered frames will be saved.
Movie	<p>Select this option to create a QuickTime movie. When enabled, the Movie Folder and the Movie Filename fields appear among the Drawing Folder and Drawing Filename fields.</p> 
Video Format	<p>The drop down list to the right of the <b>Movie</b> option. Allows you to select one of the following formats:</p> <ul style="list-style-type: none"> <li>• <b>Quick Time Movie (*.mov)</b>: Available on Windows, macOS and GNU/Linux.</li> <li>• <b>Windows Media Video (*.wmv)</b>: Available on Windows only.</li> </ul> <div style="border: 1px solid green; padding: 10px; margin-top: 10px;"> <p> <b>NOTE</b></p> <p>On Windows and macOS, <a href="#">Apple QuickTime</a> must be installed in order to export QuickTime movies. On GNU/Linux, Harmony uses a more limited, open source QuickTime-compatible library which does not require additional software.</p> </div>
Movie Options	<p>Click the <b>Customize</b> button to open the movie settings dialog box and change the video and audio compression settings for the movie to export.</p> <ul style="list-style-type: none"> <li>• If the selected export format is QuickTime Movie (*.mov), this will open the QuickTime movie settings dialog box—see <a href="#">QuickTime Movie Settings Dialog Box</a>.</li> <li>• If the selected export format is Windows Media Video (*.wmv), this will open the Windows Media Video settings dialog box—see <a href="#">Windows Media Video Settings Dialog Box</a>.</li> </ul> <p>This option appears on Windows and macOS only.</p>
Video Options	Click the <b>Customize</b> button to open the QuickTime video settings dialog box and

	<p>change the video compression settings for the movie to export—see <a href="#">OpenQuickTime Video Options Dialog Box</a>.</p> <p>This option appears on GNU/Linux only.</p>
Sound Option	<p>Click the <b>Customize</b> button to open the QuickTime video settings dialog box and change the audio compression settings for the movie to export—see <a href="#">OpenQuickTime Sound Options Dialog Box</a>.</p> <p>This option appears on GNU/Linux only.</p>

## Enabling Tab

You can create several Write nodes for a single scene and, by default, when a scene is rendered, all of its Write nodes will perform their render. However, using the options in the Enabling tab, you can set up some Write nodes to only perform their render if the scene is rendered at a specific resolution. This is mostly useful on Harmony Server, as Harmony Server allows you select the resolution at which to render a scene when sending a scene for rendering by the Harmony database's render farm.

A good example of how this can be useful is if your scene has storyboard thumbnails in the corner, and a Write node connected to a composite that crops the picture to only include the storyboard thumbnail, so that your scene can export both the final animation and the animated storyboard when rendered. You can set up your scene's main Write node to only work when exporting the scene at the scene's original resolution, and the storyboard thumbnails Write node to only work when exporting at the desired resolution for an animated storyboard.

This option allows you to filter with either resolution presets, or by specifying the width and height of the chosen resolution in pixels. You can hence create custom resolution presets named after their Write node's purpose, to make it easier to choose the resolution when rendering a scene.

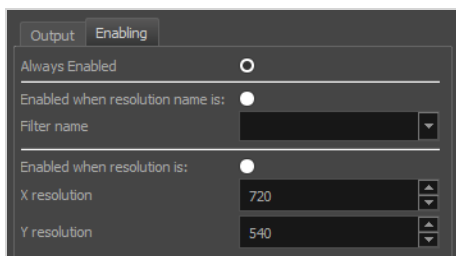

Parameter	Description
Always Enabled	Makes this Write node render every time the scene is rendered. This is the default option.
Enabled when Resolution Name is	Makes this Write node render only when the scene is rendered at the specified resolution preset.

---

Filter Name	Select the resolution preset at which to render the scene to activate this Write node.
Enabled when Resolution is	Make this Write node render only when the scene is rendered at the resolution with the specified width and height, in pixels.
X Resolution	The width (in pixels) of the resolution at which to render the scene to activate this Write node.
Y Resolution	The height (in pixels) of the resolution at which to render the scene to activate this Write node.

## Image Formats for Rendering Write Nodes

To export an image sequence, you must to adjust a few settings in the Write node's properties. The most important one is the Drawing Type parameter, which determines the image format in which individual frames are exported.

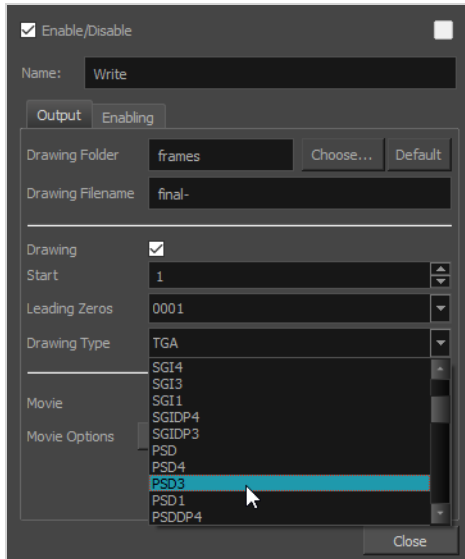



Most available formats are named after their file extension, but some also contain suffixes indicating how they're encoded. For example, while PNG is exported with three colour channels—red, green and blue—and encoded at 8 bits per channel by default, PNG4DP is a variant of PNG with four channels—red, green, blue and alpha (transparency)—as well as double precision, which means each colour channel is encoded in 16 bits instead of 8 bits.

Here is a list of all the image formats supported for rendering with Write nodes in Harmony

Format	Specification	Description
TVG		<p><b>Toon Boom Vector Graphic (*.tvg)</b></p> <p>Toon Boom's proprietary format for storing vector drawings.</p> <div style="border: 1px solid green; padding: 10px; margin-top: 10px;"> <p> <b>NOTE</b></p> <p>To export TVG files, your Write node must be connected to a vector drawing layer or to a vector composite node. The exported TVG files will contain the vector and bitmap drawing information, but will ignore effects and deformations.</p> </div>

TGA	Full colour	<p><b>Truevision TGA/TARGA (*.tga)</b></p> <p>A standard image format with lossless compression and support for transparency.</p> <p>TGA files use more disk space than PNG files, but rendering in TGA is faster.</p>
TGA1	Greyscale	
TGA3	Full colour	
TGA4	Full colour with transparency	
SGI	Full colour / 8 bits per channel	<p><b>Silicon Graphics Image (*.sgi)</b></p> <p>A highly capable format with lossless compression as well as support for double precision and transparency.</p>
SGI1	Greyscale / 8 bits per channel	
SGI3	Full colour / 8 bits per channel	
SGI4	Full colour with transparency / 8 bits per channel	
SGIDP	Full colour / 16 bits per channel	
SGIDP3	Full colour / 16 bits per channel	
SGIDP4	Full colour with transparency / 16 bits per channel	
PSD	Full colour / 8 bits per channel	<p><b>Photoshop Document (*.psd)</b></p> <p>An Adobe Photoshop proprietary format used for image editing.</p> <p>PSD files exported by Harmony contain a single background layer with the rasterized image.</p>
PSD1	Greyscale / 8 bits per channel	
PSD3	Full colour / 8 bits per channel	

PSD4	Full colour with transparency / 8 bits per channel	
PSDDP	Full colour / 16 bits per channel	
PSDDP1	Greyscale / 16 bits per channel	
PSDDP3	Full colour / 16 bits per channel	
PSDDP4	Full colour with transparency / 16 bits per channel	
YUV		<p><b>Y'UV frame (*.yuv)</b></p> <p>A legacy format optimized for NTSC television. The image information is encoded in the Y'UV color space, which means Luma (Y') and Chrominance (UV).</p> <div style="border: 1px solid #c8e6c9; padding: 10px; margin-top: 10px;"> <p> <b>NOTE</b></p> <p>YUV images must be exported in NTSC resolution (720 x 540), or they will not be legible.</p> </div>
PAL		<p><b>PAL frame (*.pal)</b></p> <p>A legacy format optimized for PAL television.</p> <div style="border: 1px solid #c8e6c9; padding: 10px; margin-top: 10px;"> <p> <b>NOTE</b></p> <p>PAL images must be exported in PAL resolution (768 x 576), or they will not be legible.</p> </div>
SCAN		<p><b>Toon Boom Scan Files (*.scan)</b></p> <p>A Toon Boom proprietary format used by Scan to store scanned image information along with its registration (peg) information. SCAN files are in greyscale.</p>
PNG	Full colour / 8 bits per	<b>Portable Network Graphics (*.png)</b>

	channel	<p>A highly portable image format with high lossless compression as well as support for transparency and double-precision. PNG is typically used for Web applications, graphical user interfaces and image sharing.</p> <p>Rendering in PNG takes more time than rendering in TGA or in uncompressed image formats, but saves a lot of disk space.</p>
PNG4	Full colour with transparency / 8 bits per channel	
PNGDP	Full colour / 16 bits per channel	
PNGDP3	Full colour / 16 bits per channel	
PNGDP4	Full colour with transparency / 16 bits per channel	
JPG		<p><b>Jpeg (*.jpg)</b></p> <p>A very compact image format with lossy compression. It is typically used for Web pages and photo sharing. Because it does not preserve image quality, it is recommended to never render in Jpeg format unless you are exporting stills for a Web page or are making quick render tests.</p>
BMP	Full colour	<p><b>Bitmap (*.bmp)</b></p> <p>A standard uncompressed image format commonly used on Microsoft operating systems.</p>
BMP4	Full colour with transparency	
OPT	Full colour	<p><b>Toon Boom OPT image (*.opt)</b></p> <p>A legacy Toon Boom proprietary format that stores raw image data with lossless compression.</p>
OPT1	Greyscale	
OPT3	Full colour	
OPT4	Full colour with transparency	
VAR		<p><b>Toon Boom VAR image (*.var)</b></p> <p>A legacy Toon Boom proprietary format that stores raw image data with lossless compression in greyscale.</p>

TIF		<p><b>Tagged Image File Format (*.tiff)</b></p> <p>An image format with many compression and encoding settings. It is often used for image exchange in visual arts and publishing.</p> <p>TIFF images exported by Harmony are uncompressed, encoded on a per-pixel (interleaved) basis in PC byte order.</p>
DPX	8 bits per channel / Full color / RGB channel order	<p><b>Digital Picture Exchange (*.dpx)</b></p> <p>A professional photo format that supports various different approaches to storing colour information, which can be used for storing, exchanging and editing raw information recorded by cameras. It is commonly used in film production.</p>
DPX3_8	8 bits per channel / Full color / RGB channel order	
DPX3_10	10 bits per channel / Full color / RGB channel order	
DPX3_12	12 bits per channel / Full color / RGB channel order	
DPX3_16	16 bits per channel / Full color / RGB channel order	
DPX3_10_INVERTED_CHANNELS	10 bits per channel / Full color / BGR channel order	
DPX3_12_INVERTED_CHANNELS	12 bits per channel / Full color / BGR channel order	
DPX3_16_INVERTED_CHANNELS	16 bits per channel / Full color / BGR channel order	
EXR		



	<p>transparent, the color and depth information of pixels further back is stored along with it. If your scene has multiplane or 3D elements, this format can be used for compositing your animation with other graphical elements in 3D animation software.</p>
PDF	<p><b>Portable Document File (*.pdf)</b></p> <p>Typically, PDF files are used to store, archive, share and print documents. However, Harmony uses the PDF format for its capability to store bitmap images and vector graphics.</p> <p>If the write node is connected to a vector drawing layer or to a vector composite, the exported PDF files will contain the image as a vector graphic. It will ignore bitmap layers, effects and deformations. Otherwise, the PDF files will contain the rendered image as a bitmap.</p>
DTEX	<p><b>Deep Texture (*.dtx)</b></p> <p>A commonly used deep image format. Each pixel in an DTEX file is exported with its Z-depth information. Additionally, if a pixel is semi-transparent, the color and depth information of pixels further back is stored along with it. If your scene has multiplane or 3D elements, this format can be used for compositing your animation with other graphical elements in 3D animation software.</p> <div data-bbox="688 1058 1429 1297" style="border: 1px solid #c8e6c9; padding: 10px; margin-top: 10px;"> <p> <b>NOTE</b></p> <p>Exporting in Deep Texture requires RenderMan to be installed on the machine and the path to RenderMan properly configured in Harmony. For more information, see the <a href="#">Setting 3D Renderer Paths</a> topic of the User Guide.</p> </div>

## Particle Nodes

You can access the Particle effects through the Node Library view. The Particle category contains all the nodes needed to build various Particle effect systems.

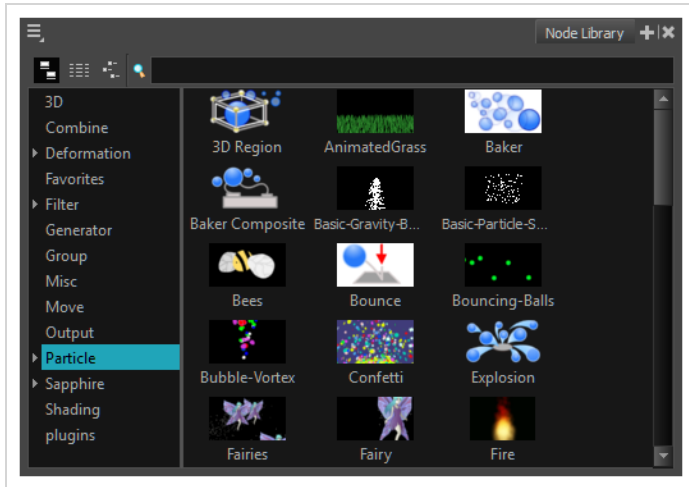

This section explains each node's purpose, its layer properties and how to adjust these properties.

<b>3D Region</b> .....	<b>741</b>
<b>Baker</b> .....	<b>743</b>
<b>Baker Composite</b> .....	<b>746</b>
<b>Bounce</b> .....	<b>747</b>
<b>Explosion</b> .....	<b>749</b>
<b>Gravity</b> .....	<b>751</b>
<b>Image Fracture</b> .....	<b>753</b>
<b>Kill</b> .....	<b>759</b>
<b>Move Particles</b> .....	<b>761</b>
<b>Orbit</b> .....	<b>763</b>
<b>Planar Region</b> .....	<b>766</b>
<b>Random</b> .....	<b>769</b>
<b>Region Composite</b> .....	<b>770</b>
<b>Repulse</b> .....	<b>771</b>
<b>Rotation Velocity</b> .....	<b>772</b>
<b>Sink</b> .....	<b>775</b>
<b>Size</b> .....	<b>776</b>

<b>Sprite Emitter</b> .....	<b>778</b>
<b>System Composite</b> .....	<b>788</b>
<b>Velocity</b> .....	<b>789</b>
<b>Visualizer</b> .....	<b>792</b>
<b>Vortex</b> .....	<b>794</b>
<b>Wind-Friction</b> .....	<b>796</b>

## 3D Region

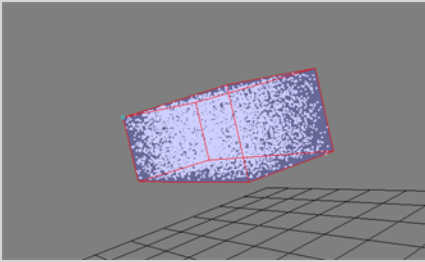

The 3D Region effect lets you define the 3D region, which can take many forms, such as a sphere, cone, cylinder or box. The 3D Region node acts in contrast to the Planer Region node, which generates and emits particles from a 2D plane.

You can connect a 3D Region to a Sprite-Emitter to define the region from which particles are generated. It could also be connected to a Bounce node to define a region against which particles bounce. If connected to a Sink node, it will define a region where the particles will disappear.

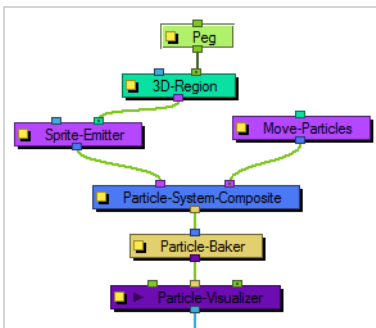

### How to preview the 3D Region

1. From the top menu, select **View > Show > Control** or press Shift + F11 (Windows/Linux) or ⌘ + F11 (macOS).

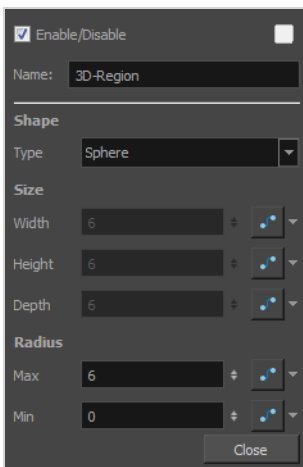

## 3D Region Properties

Parameter	Description
Name	Allows you to change the name given to the node.
Shape	<p>Choose a shape for the 3D Region by clicking on the Type drop-down menu and selecting either Box, Cylinder, Cones, Sphere or Image.</p> <p>If you select Image, you must connect the node of a vector drawing or a vectorized bitmap image to the left port (blue node) of the 3D Region node. The particles will then be emitted from that image's shape. Don't forget that you can rotate your vector drawing in 3D space by enabling the 3D option in its Layer Properties.</p>
Size	<p>Enter different values into the Width, Height and Depth fields to change the dimensions of the 3D Region's selected shape. Depending on the shape selected, some fields may be greyed-out if they are not applicable. You can also modify the shape with the Transform Tool by grabbing the control handles (turquoise squares) in the Camera or Perspective views. You can also change the dimensions of the region over time by click on the function button at the end of each field.</p>
Radius	<p>Enter different values in the Max or Min fields to change the inner or outer radius of applicable shapes, such as a cylinder, cone or sphere. You can also change the radii by grabbing the control handles (turquoise squares) in the Camera or Perspective views. The radii of the region can be changed over time by clicking the function button at the end of each field.</p>

# Baker

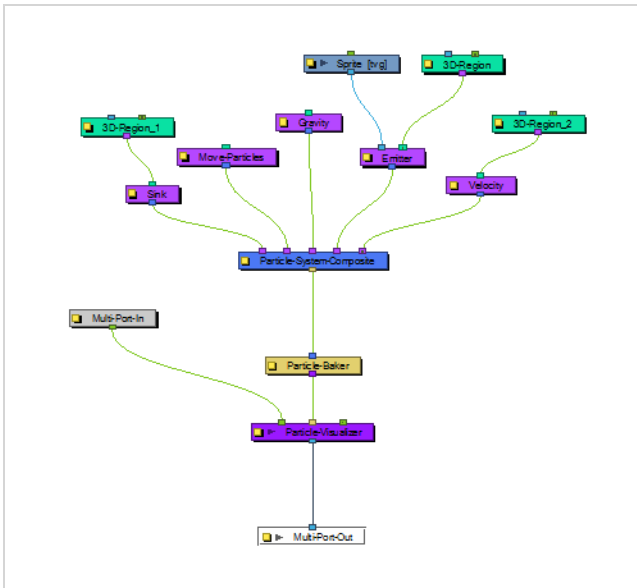

The Baker effect, also known as *Particle-Baker*, lets you make decisions about the particle system's position, angle, number, etc. in the same way that a baker would make decisions about the ingredients that go into baking a cake. The Baker performs the particle simulation, combining all the ingredients specified to get the final result. The Baker must always be connected to the Particle-Visualizer.

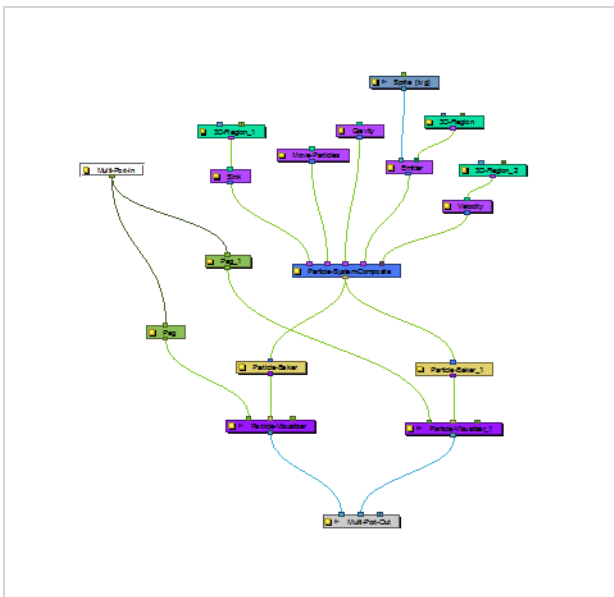

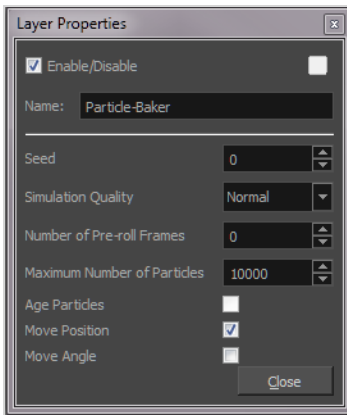

## Particle Baker Properties

Parameter	Description
Name	Allows you to change the name given to the node.
Seed	Allows you to apply a random effect to the particle system. There may be times when you want to copy the particle system to two different locations on your screen. You can take the out-port of the Particle System Composite node, and plug this into two separate Bakers and Visualizers. Then you could move one system over by attaching a peg into the left side of one Visualizer. This makes the two systems look exactly the same. Add a random Seed to make them look different.
Simulation Quality	Defines how many simulation steps per frame are performed. The lowest quality creates one step per frame. Raising the quality will divide the simulation time and create two or more steps of simulation for each frame. This increases the computation time, but also increases the quality of the result.
Number of Pre-roll Frames	Allows you to select a start position in the particle effect sequence, other than the start (generation) of the sequence. This allows you to start the particle effect part-way through its cycle, even if it starts on frame 1 of your project. An example of when this parameter might come in handy is when you want it to be already raining at the start of your scene. If you don't change the number of Pre-roll Frames, it will always start to rain at the beginning of the scene.
Maximum Number of Particles	Lets you put a limit on the number of particles that will be created; particles will stop being generated once this number is reached.
Age Particles	Tracks how long a particle has existed in its cycle from the time of its inception. Knowing a particles "age" means you can tack other parameters onto its life span, such as having the particle start to disappear or change colour at a certain

	time.age.
Move Position	Allows the particles to move position, otherwise the particles cannot flow in a specified direction. This option also exists in the Move Particles node. You do not always need a Move Particles node; this is why this option exists in the Baker. This option is also useful when your Move Particles node is cut off by a sink—see <a href="#">Sink on page 775</a> .
Move Angle	Allow particles to flow from different angles. This option also exists in the Move Particles node. You do not always need a Move Particles node; this is why this option exists in the Baker. This option is also useful for when your Move Particles node is cut off by a sink—see <a href="#">Sink on page 775</a> .



## Baker Composite

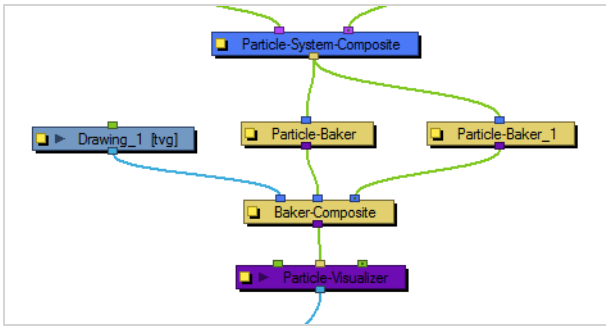

The Baker Composite effect is used to composite more than one Particle-Baker, as well as any other elements that need to be combined before they pass through the Particle Visualizer.

# Bounce

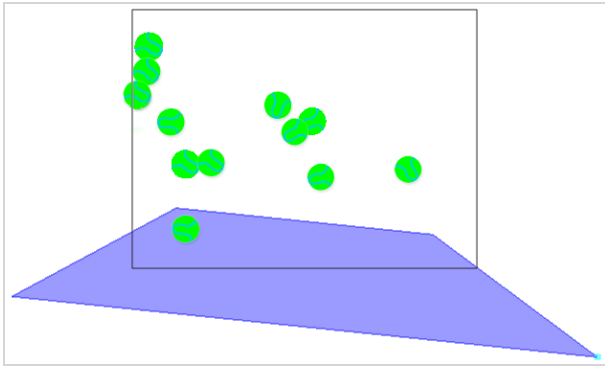

The Bounce effect lets you to make particles bounce off a surface with realistic physical modelling. This node should have a region connected to it, and that region will act as a bounce plane so when any particle hits it, it will bounce off at the correct angle.

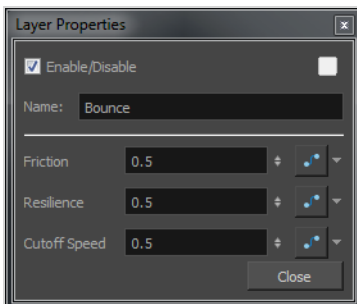
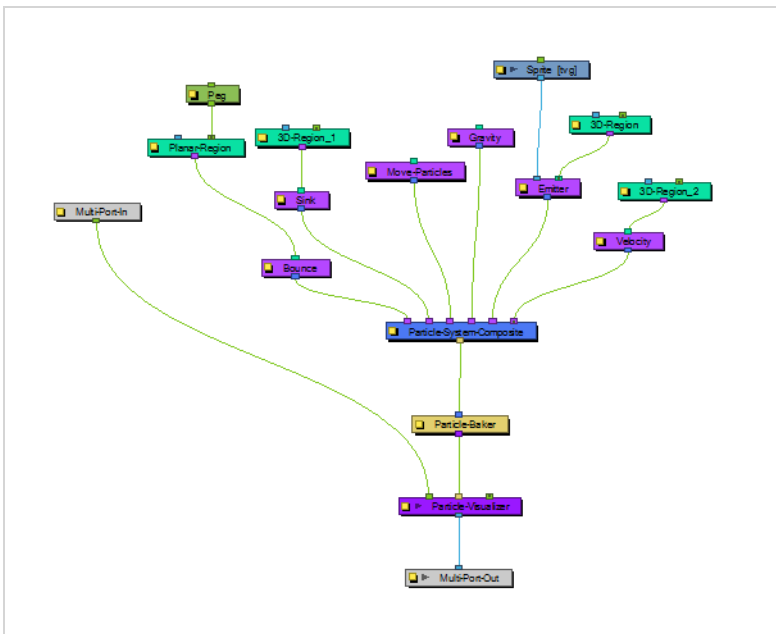

## Bounce Properties

Parameter	Description
Name	Allows you to change the name given to the node.
Trigger	An on/off switch using binary code. 1 = on, 0 = off.
Friction	Enter a value in this field to increase the amount of friction each particle experiences as it makes contact with the planar surface. A positive value creates more friction and slows the particle down. A negative value lessens the friction and makes the surface appear more slippery.
Resilience	Increases or decreases the bounciness of the particle. A value of zero causes the particle to hit the planar surface once and slide off any downward facing angle. A positive value, even by decimal increments, causes the particle to become bouncy. A negative value deadens the effect, the same way a lack of Region would.
Cutoff Speed	Increasing this value widens the bounce arc. If the connected Planar Region is completely flat, a value of zero will cause the particle to bounce up and down in place. A tilted plane in the direction of the bounce will also widen the arc.

## Explosion

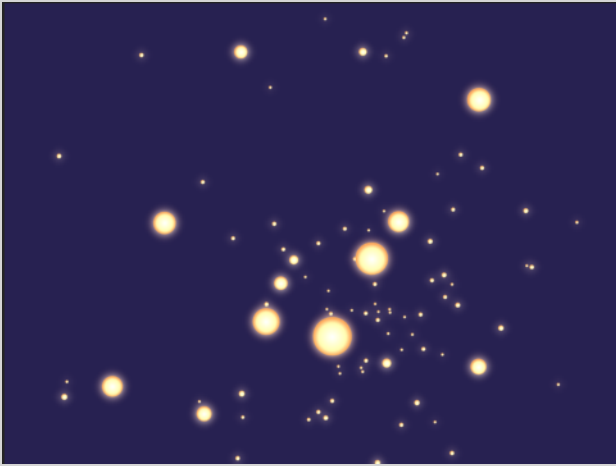

The Explosion effect lets you create an explosion. As it is an Action node, it should be connected to the Particle System Composite after the Sprite Emitter. As the explosion occurs, the particles will burst rapidly away from the centre of the explosion (the centre of the defined Region), then gradually slow down.

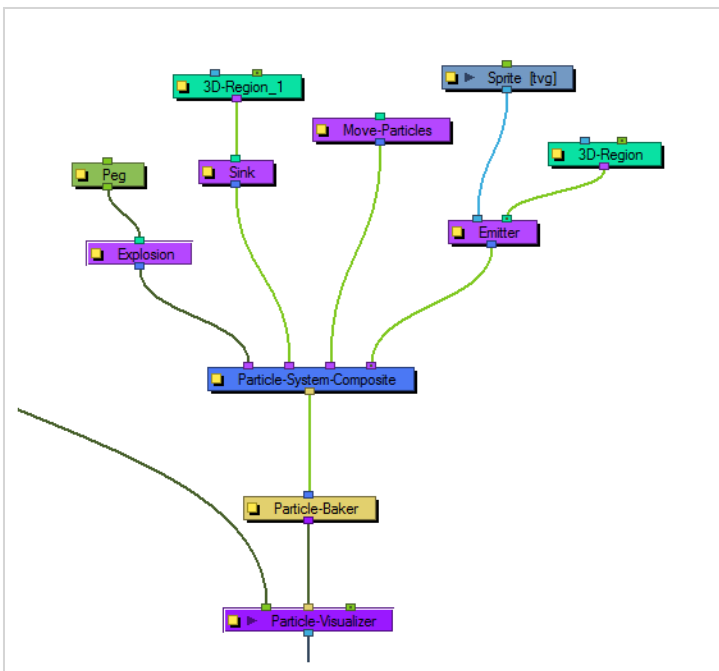

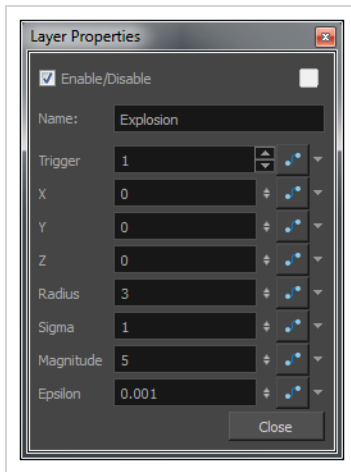

## Explosion Properties

Parameter	Description
Name	Allows you to change the name given to the node.
Trigger	An on/off switch using binary code. 1 = on, 0 = off.
Coordinates	Use the X, Y and Z fields to enter different position values to move the particle system around in 3D space. You can also connect a Peg node to the Explosion to manipulate its position with the Transform or Move tool.
Radius	Defines the surface of an invisible sphere. As the explosion occurs, the exploded particles inside the boundaries of this sphere will be effected by the force of the explosion, while the particles that eventually pass through will remain unaffected.
Sigma	The higher the Sigma value, the longer it takes for the particles to completely disappear, even if the initial explosion seems to occur just as rapidly.
Magnitude	Defines the magnitude of the explosion. The greater the magnitude, the faster the particles break up.
Epsilon	This value works in opposition to the Sigma value. The higher the value, the slower the initial explosion occurs. If the value is high (an integer value) then larger particles remain suspended for a longer period of time from the initial explosion and takes a while to gradually break down. A smaller (decimal) value breaks the particles down to smaller forms more rapidly from the time of the initial explosion.

:

# Gravity

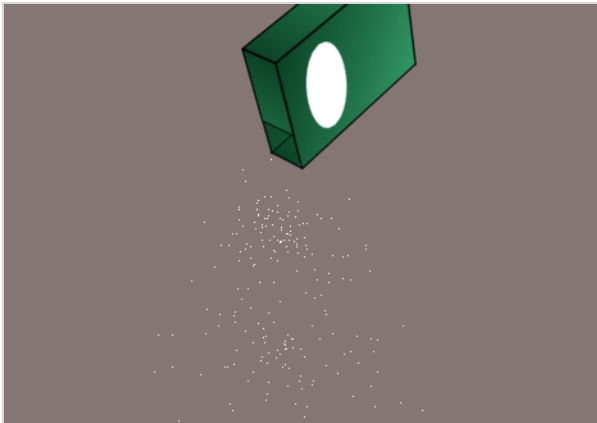

The Gravity effect lets you define the gravity of the particle system.

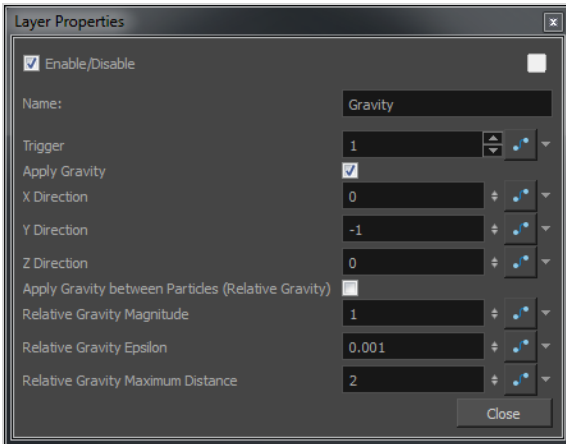
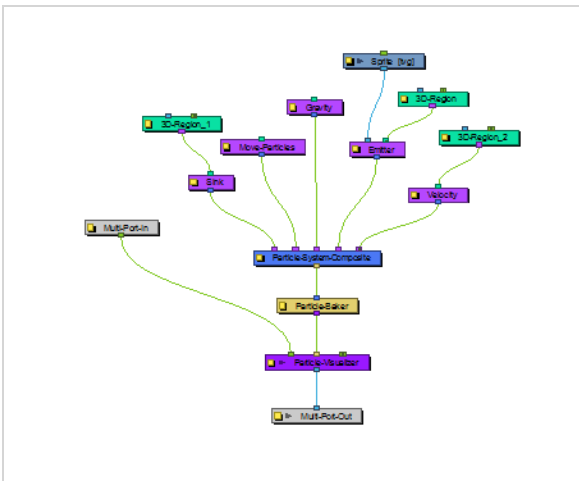

## Gravity Properties

Parameter	Description
-----------	-------------

Name	Allows you to change the name given to the node.
Trigger	An on/off switch using binary code. 1 = on, 0 = off.
Apply Gravity	Forces the particle system to adhere to the force of gravity. Values must be entered into the Direction fields, along with enabling this option, in order for it to work. If this option is not selected, the particle system will explode outwards from its origin point.
X Direction	Directs the particle stream to the left or right (along the X-axis). A value of 1 forces the particle stream to the right, while a value of -1 forces the particle stream to the left.
Y Direction	Directs the particle stream up or down (along the Y-axis). A value of 1 forces the particle stream to flow upwards, while a value of -1 forces the particle stream to flow downwards.
Z Direction	Directs the particle stream forwards or backwards (along the Z-axis). A value of 1 forces the particle stream to flow forwards, while a value of -1 forces the particle stream to flow backwards.
Apply Gravity between Particles (Relative Gravity)	Applies gravity between each particle, taking their masses into account. The mass of the particle can be specified at emission time via the Sprite or Image Emitter.
Relative Gravity Magnitude	Adjust the amount of gravity applied between particles.
Relative Gravity Epsilon	The acceleration falls off the further the particles get from each other. When the particles are very close to each other, the acceleration becomes very high, so you should define a small region around the particles so they never actually touch.
Relative Gravity Maximum Distance	Adjusts the radius beyond which particles do not affect each other.

## Image Fracture

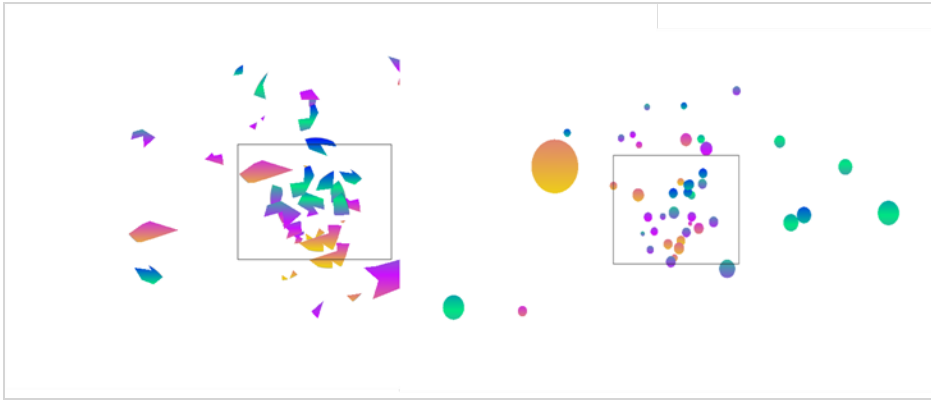

The Image Fracture effect breaks an image into pieces. This effect requires two image objects: the image to be cut and the shape of the cut pieces (matte). The image to be cut can be anything from a vector drawing to a bitmap image to an entire scene's composite—effects and all. The image to be cut should be hooked to the Image Fracture's right port.

The matte should be flattened if you want it to work like a cookie cutter (hollow shape with a frame) and can be composed of brush or pencil lines. It can also be a solid shape, many solid filled shapes, and even many solid filled overlapping shapes. When the matte is made of overlapping pieces, the cut image will be multiplied at those zones to break apart in multiple layers. The matte drawing should be hooked to the Image Fracture's left port.

The two image objects overlap perfectly when combined in the Image Fracture. This means that you must take the 12 by 12 field into account when judging the scale and proportion of these objects. If the matte does not overlap a part of the image, that part of the image will not be cut. The matte does not have to be a continuous shape. It could be three separate circles, which would then be cut and pulled away from the image.

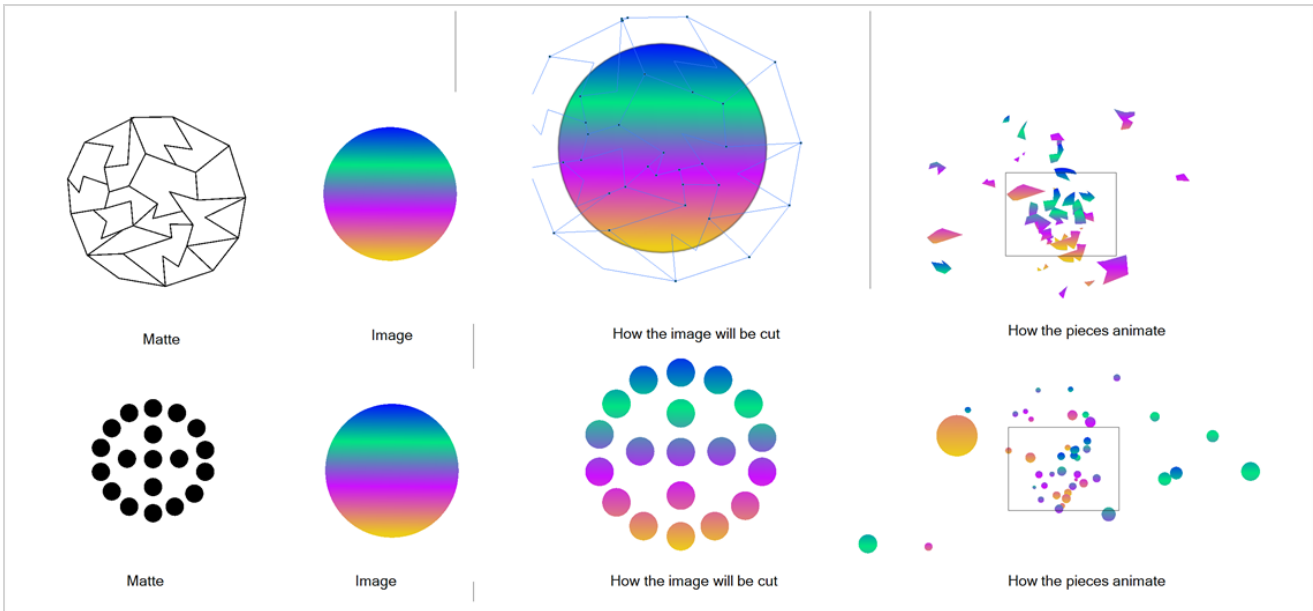



**NOTE**

You can display the grid and use the Light Table feature in the Drawing view while drawing or scaling the image and matte to ensure that they're the correct size relative to one another.

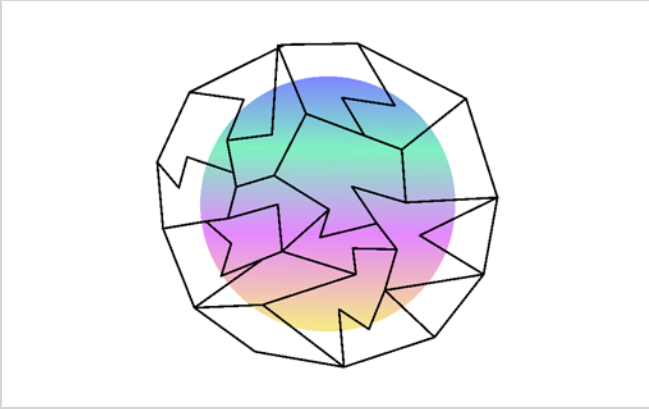

Here's an example of a node structure with the Image Fracture effect:

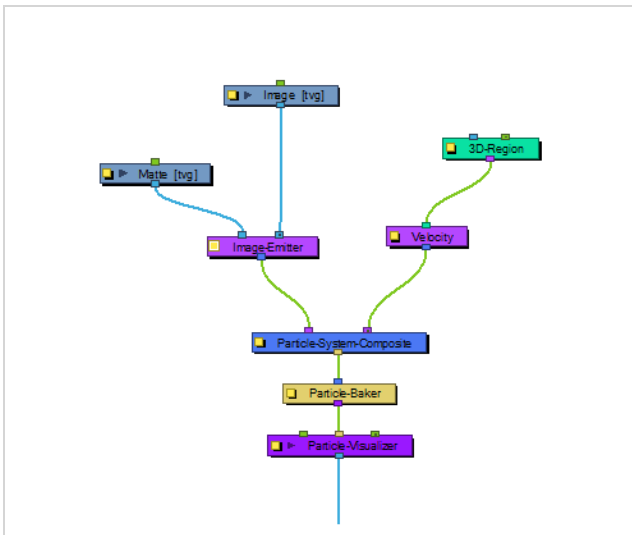

## Image Fracture Properties

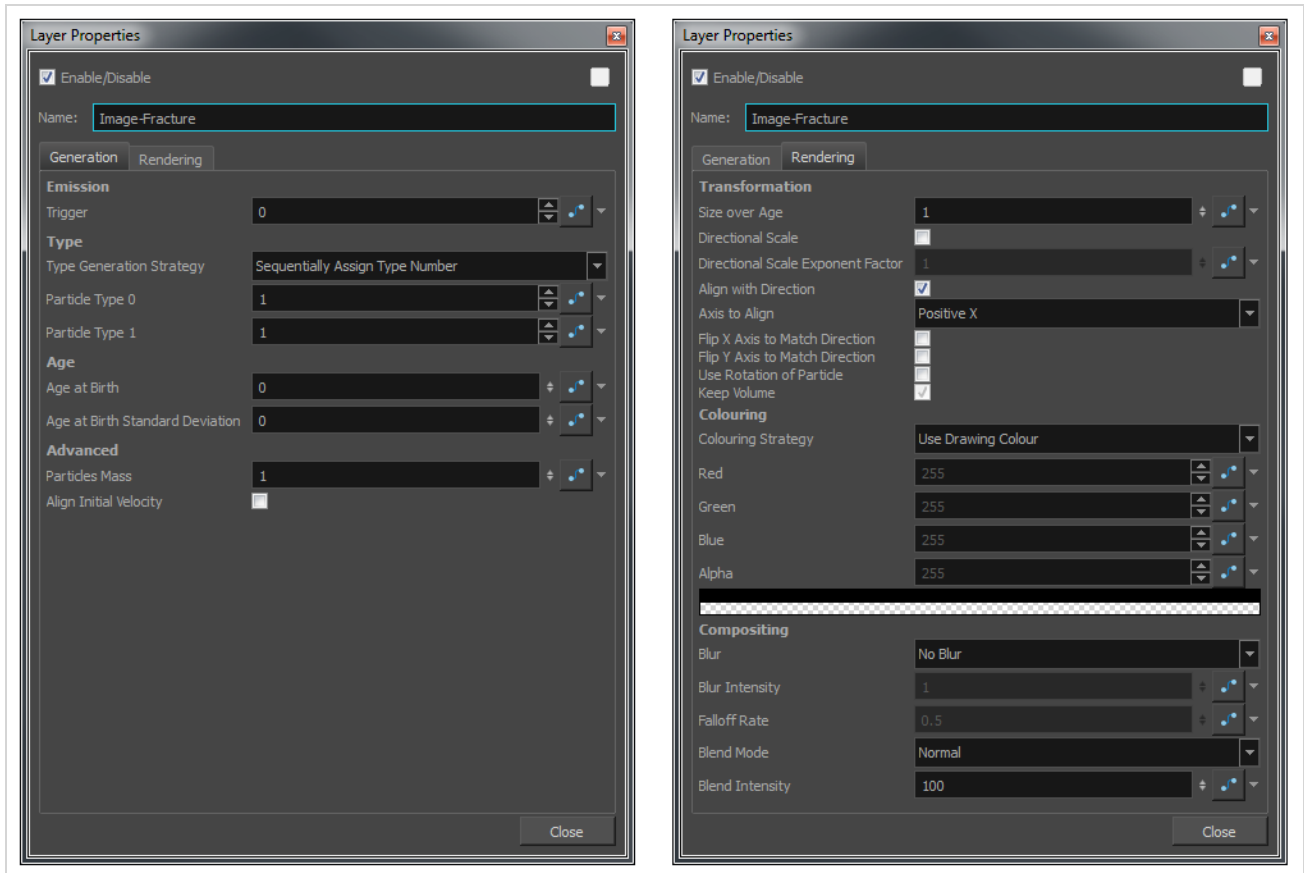

## Generation Tab

Parameter	Description
<b>Emission</b>	
Trigger	An on/off switch using binary code. 1 = on, 0 = off.
Type	You may want to design a variety of different drawings that will vary the appearance of the particle system. In this case, you should put each drawing on its own cell in the drawing layer. Each drawing will then be a new type of particle.
Type Generation Strategy	Lets you sequentially or randomly assign a type (moving from one drawing to the next).
Particle Type 0	This is the frame number of the first drawing. If you have a 5-frame cycle that starts on frame 1, you would put a 1 here.

Particle Type 1	This is the frame number of the last drawing. If you have a 5-frame cycle that starts on frame 1, you would put 5 here.
<b>Age</b>	
Age at Birth	A different start frame number can be entered in this field. This means that a particle can start with a different drawing than the drawing on frame 1.
Age at Birth Standard Deviation	Allows a random deviation for the birth of the particles. If you have a five-frame cycle that starts on frame 1, but you want the particles to be a random type, then you may want to set the Age and Birth to 3 with a standard deviation of 2. That means the particles will randomly be born at any frame from 1 to 5.
<b>Advanced</b>	
Particles Mass	Defines a mass for the particles which will affect how the particles interact with gravity.
Align Initial Velocity	Aligns the initial velocity with the region from which the particles are being emitted. If you are emitting from a sphere, the particles will all start out moving away from the centre of the sphere.

## Rendering Tab

Parameter	Description
<b>Transformation</b>	
Size over Age	Lets you determine the size of the particle as it ages. Attach a function to this attribute if you would like to, for example, have the particles get smaller as time goes on.
Directional Scale	Scales the particle in the direction of its movement.
Directional Scale Exponent Factor	Sets an exponent here for how much you would like that particle to scale.
Align with Direction	Aligns the particle in the direction of its movement.
Axis to Align	Select the axis that you want to align. This axis refers to the axis of the Drawing

	grid from the Drawing node plugged into the emitter.
Flip X Axis to Match Direction	You may want to have the particle align to the X direction of movement. You can see this property being used in the Lemmings example.
Flip Y Axis to Match Direction	Similar to flipping the X axis, you may want to flip the Y axis of a drawing to match the direction of the particle movement.
Use Rotation of Particle	Enables rotation on the particle.
Keep Volume	When you choose to do a Directional Scale, this will automatically maintain the volume of the particle by squashing it proportionally to how much it stretches as a result of the directional scale.
<b>Colouring</b>	
Colouring Strategy	Lets you choose how to define the colour of the particle.
Use Drawing Colour	The particle remains the same colour as it was drawn with.
Map RGB Based on Age	Attach a function to this to vary the Red, Green, and Blue values of the particle as it ages.
Map RGBA Based on Age	Attach a function to this to vary the Red, Green, Blue, and Alpha values of the particle as it ages.
Apply Opacity Based on Age	Keeps the original RGB values from the drawing, but vary the Alpha (Opacity) according to a function that you define here.
Map RGB Based on Frame	Changes the Red, Green, and Blue values of the particles based on the frame. Changing based on the frame means that ALL particles will change colour on that frame, regardless of their age.
Map RGBA Based on Frame	Changes the Red, Green, Blue, and Alpha values of all particles on a given frame by attaching a function.
Apply Opacity Based on Frame	Uses the original RGB values from your drawing, but varies the Alpha (Opacity) of the particles on a certain frame by attaching a function to this.
Red, Blue, Green, Alpha	This is where you can attach functions to the Red, Blue, Green and Alpha values.

	You can also click on the colour swatch to adjust the colour.
<b>Compositing</b>	
Blur	Lets you attach a function to define how you want the particles to blur based on the age, frame or camera distance of each particle. There are low and high quality blurs. Also, you can attach a function to define how all particles should be blurred.
Blur Intensity	Lets you set a value or attach a function to animate the blur according to the type of blur that was defined from the drop-down list.
Falloff Rate	<p>The distance where the blur fades from the edge of the image. Select a value between 0 and 1.</p> <p>A falloff rate of 0 causes the blur to fade out slowly, distributing the blur evenly from the edge of the drawing to the farthest edge of the blur.</p> <p>A falloff rate of 1 causes the blur to fade out quickly so that the blur is heaviest at the edge of the drawing.</p>
Blend Mode	Defines a blend mode for the particles to get cool effects.
Blend Intensity	This is a percentage of how opaque you want the particles to be blended. 50 = 50% transparent. 100 = opaque.

## Kill

The Kill effect lets you determine when particles disappear.

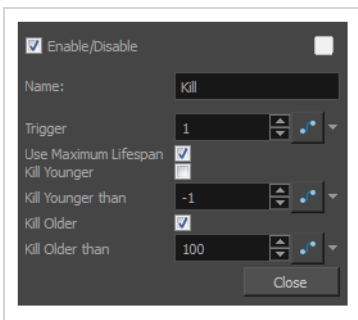
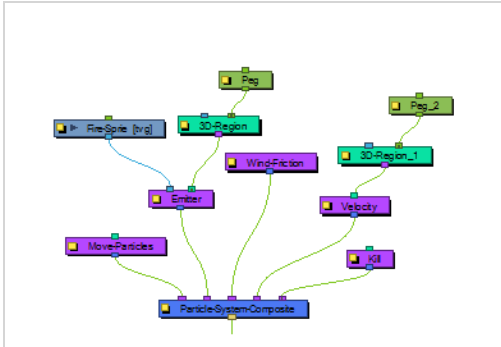

## Kill Properties

Parameter	Description
Name	Allows you to change the name given to the node.
Trigger	An on/off switch using binary code. 1 = on, 0 = off.
Use Maximum Lifespan	Makes particles disappear when they reach their maximum lifespan.
Kill Younger	<p>To use this parameter, you must attach a function to this property because if you select this option at time 0, you will never see any particles. If you set Kill Younger to 10, at time 0, there will be no particles older than 10, so you will never see any particles.</p> <p>It may be useful to have the particles animating over time, and at some point in time, you may want to kill all the younger particles. An example would be an animation where the particles change from blue to yellow. At every frame, new particles are generated, and the particles that already exist age. Then you would add an explosion that kills all particles younger than 10 frames. It would kill all the blue particles, leaving only the yellow particles.</p>

Kill Younger Than	This is where you can animate the effect for Kill Younger.
Kill Older	Makes particles disappear when they reach a certain level of maturity.
Kill Older Than	Lets you set the age at which particles disappear.

## Move Particles

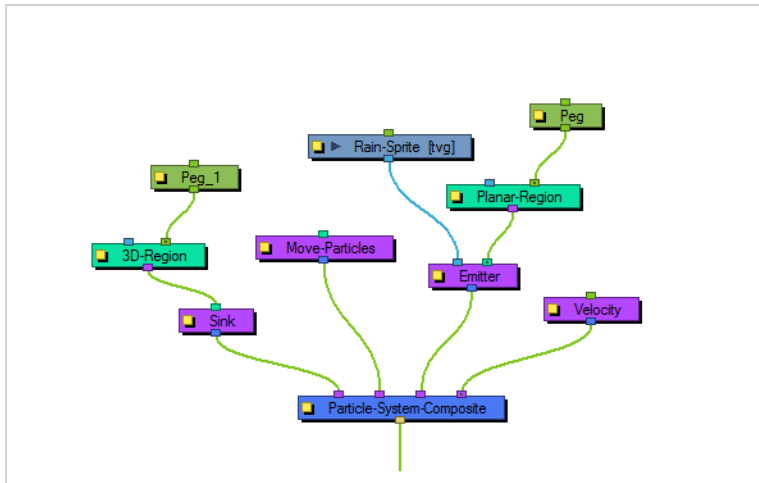

The Move Particles effect lets you determine whether the particles are stationary (like grass) or moving (like rain), and you can animate this function on and off.

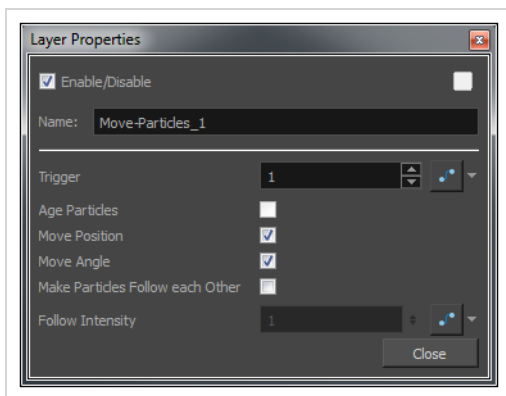

## Move Particles Properties

Parameter	Description
Trigger	An on/off switch using binary code. 1 = on, 0 = off.
Age Particles	<p>Ages the particles. Note that if you select the Move Position and Move Angle, then the particles will age implicitly. If you do not want the particles to move, but still want them to age, deselect Move Position and Move Angle, and select Age Particles.</p> <p>The Age Particles parameter also exists in the Baker, however whatever happens in the Baker happens after everything else in the particle system. So, if for example you have a Kill node, it will kill the particles before they age. You probably want to age the particles before you determine whether to kill them. Therefore, if you have a Kill node, make sure to age the particles in your Move node before you kill them.</p>



	<p>If you age the particles both in the Move and Baker node, then the particles will age twice on that frame instead of once.</p>
Move Position	<p>Lets you enable movement on the particles. There is also a Move Particles option in the Baker. If it's deselected in the Baker and in the Move node, the particles will not move; they will simply generate in place and stay there. If the option is selected on the Baker, the particles will move. But if you need the particles to interact with another Action, say a Sink, then you want the particles to move before they reach the sink. This is why you have a separate Move node, so you can place this Move before (to the right of) the Sink in your particle system composite.</p>
Move Angle	<p>Like the Move Position, this enables the rotation of particles in the particle system.</p>
Move Particles Follow Each Other	<p>Allows one particle to follow another particle, through an attraction between the particles. This is particularly useful when you want to create a snake-like effect, where the particles are animating across the screen and following each other.</p>
Follow Intensity	<p>Lets you adjust the strength of the attraction between particles following each other.</p>

## Orbit

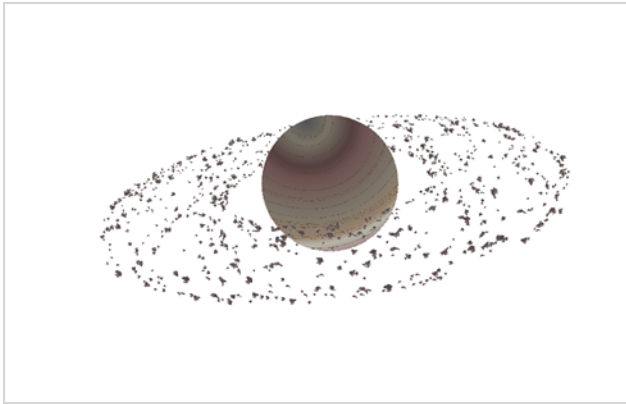

The Orbit effect lets you define an axis the particles will be attracted to and orbit around. You can place a Peg layer into the orbit to move the position of the orbit without adjusting the parameters in the Layer Properties.

Fine-tuning the Orbit effect can take a bit of finesse because the orbit takes into account the velocity of the particles, and uses this to determine whether:

- The particle will orbit around the axis
- The particle will be influenced but eventually escape
- The particle will hardly be influenced at all.

This is just like how gravity between astral bodies works in space. Here are some examples of how having the orbit in the wrong place can give some cool (but perhaps not useful) effects:

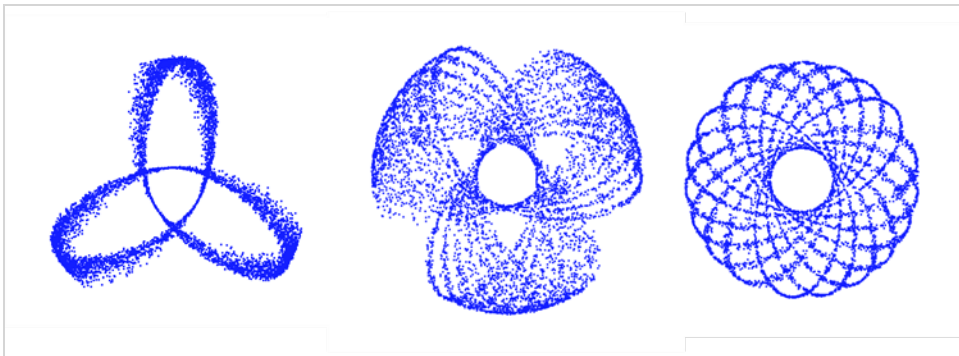

You will also want to make sure that your initial velocity is varied, so use an interpolated speed and set two different values. That way, there will be a spread between them. If not, then you will get the effects as shown above.

Also, you should use the Peg layer to move the position of the Orbit node around until you find the right spot to get the look you're trying to achieve. It also helps to set some pre-roll frames on your Baker to get things ramped-up before you start to manipulate the position of the Orbit node.

Here's an example of what a typical node structure with an Orbit node looks like:

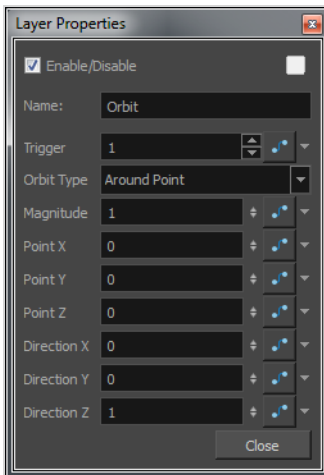
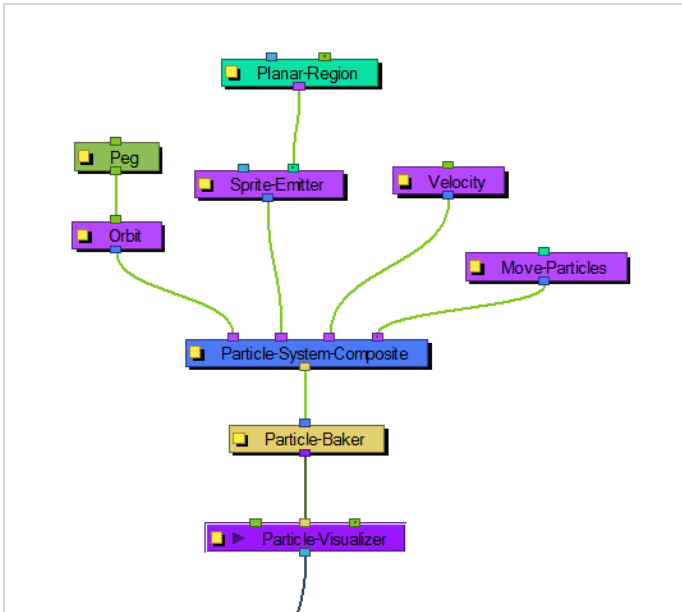

## Orbit Properties

Parameter	Description
Name	Allows you to change the name given to the node.
Trigger	An on/off switch using binary code. 1 = on, 0 = off.
Orbit Type	Lets you select the type of Orbit you want to use. For most scenarios, like asteroids orbiting a planet, a point will suffice. If you want to rotate around an axis instead, choose between the X, Y, Z axes or set up your own custom axis.
Magnitude	Adjust the amount that the acceleration of each particle will be adjusted. The

	higher the value, the more the particle will accelerate towards the orbit. A magnitude of 0.001 is a good number to use for this. When the magnitude is set too high, the particles will simply fly out into space.
Point X	Defines the X position of the centre of the Orbit. You may also leave this at 0 and use a peg to move the position of the Orbit node.
Point Y and Z	Defines the Y and Z position of the centre of the Orbit.
Direction X	Defines the X component of the axis of rotation for the orbit. This is only taken into account if you choose to set up a custom axis. If this is set to 1, and Y and Z are set to 0, then the axis will be going in the same direction as the X axis. If the X component is set to 1, and the Y component is also set to 1, then the axis will be at a 45 degree angle between the two.
Direction Y and Z	Defines the Y and Z components of the axis of rotation for the orbit.

## Planar Region

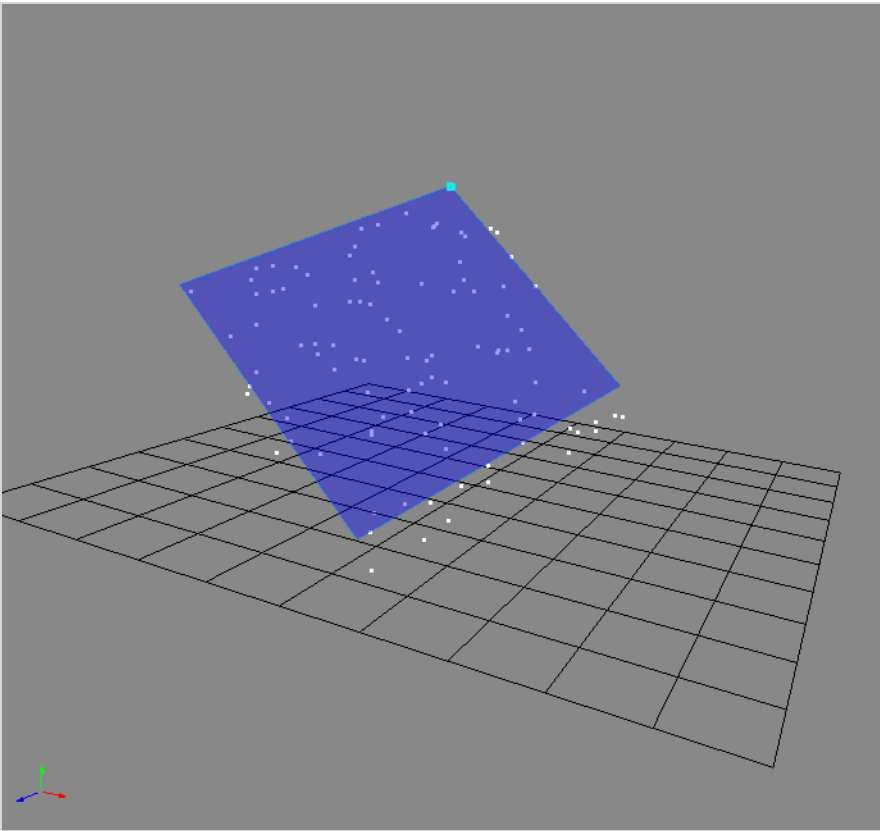

Like the 3D region, this determines a region that you can use as a source or as a bounce plane, but instead of a 3D region, it's a 2D plane. Connect a peg to the right in-port to adjust the position of the plane.

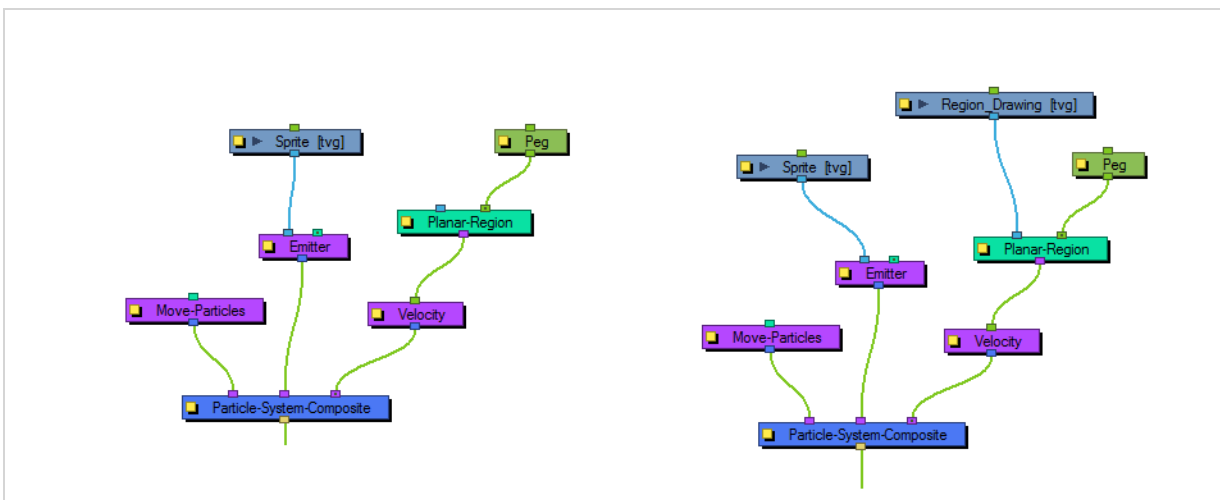

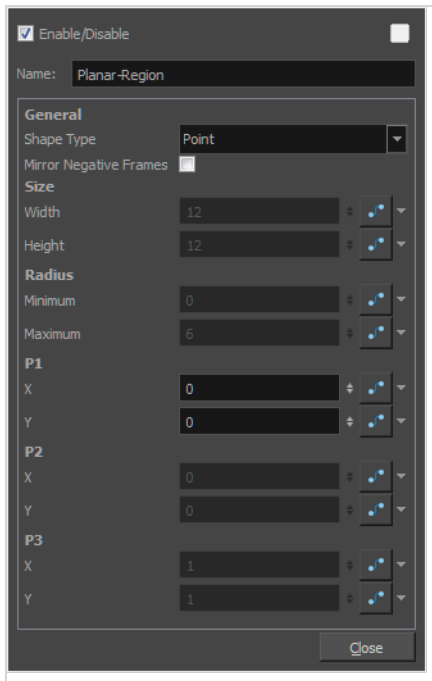

## Planar Region Properties

Parameter	Description
Name	Allows you to change the name given to the node.
Shape Type	<p>Lets you define the shape of the plane. The parameters that you can adjust below will be greyed out depending on the shape type you choose. Each shape can be adjusted from the Camera view using the Transform tool by selecting the Planar Region and then selecting <b>View &gt; Show &gt; Control</b>.</p> <p><b>Rectangle:</b> The width and height on a rectangle.</p> <p><b>Disc:</b> The point (the centre) of the disk. You can also adjust values for the minimum and maximum radius. A minimum radius of 0 will simply be a circle.</p> <p><b>Triangle:</b> The three points of the triangle independently.</p> <p><b>Line:</b> The two points on a line.</p> <p><b>Point:</b> The position of one single point.</p> <p><b>Image:</b> If you choose to use the Image option, then you should use the left in-port of the Planar-Region to connect a drawing layer that can be used as a mask.</p>
Mirror Negative Frames	Mirrors the input peg transformation to generate positions for frames before the scene begins.

Size	<b>Width:</b> The width of a rectangular region. <b>Height:</b> Adjust the height of a rectangular region.
Radius	<b>Minimum:</b> The minimum radius on a disc region. <b>Maximum:</b> Adjust the maximum radius on a disc region.
P1	<b>X:</b> The X position of Point 1. Point 1 could refer to the point on a triangle, line, or point. <b>Y:</b> The Y position of Point 1.
P2	<b>X:</b> The X position of Point 2. Point 2 could refer to the point on a triangle or line. <b>Y:</b> The Y position of Point 2.
P3	<b>X:</b> The X position of Point 3. Point 3 refers to a point on a triangle. <b>Y:</b> The Y position of Point 3.

## Random

The Random effects lets you put a random seed on some qualities like acceleration, speed, rotation speed, and position. There's also a Seed value in the Baker, but you may only want to make one particular aspect of the system random. This effect gives you control over the randomness of a particular property.

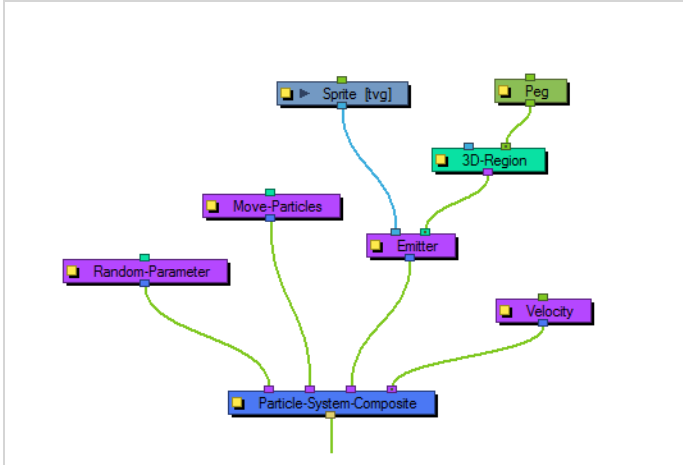

## Random Properties

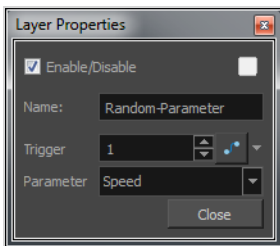

Parameter	Description
Name	Allows you to change the name given to the node.
Trigger	An on/off switch using binary code. 1 = on, 0 = off.
Parameter	Lets you choose a parameter to make random: None, Acceleration, Speed, Rotation Speed, and Position.



## Region Composite

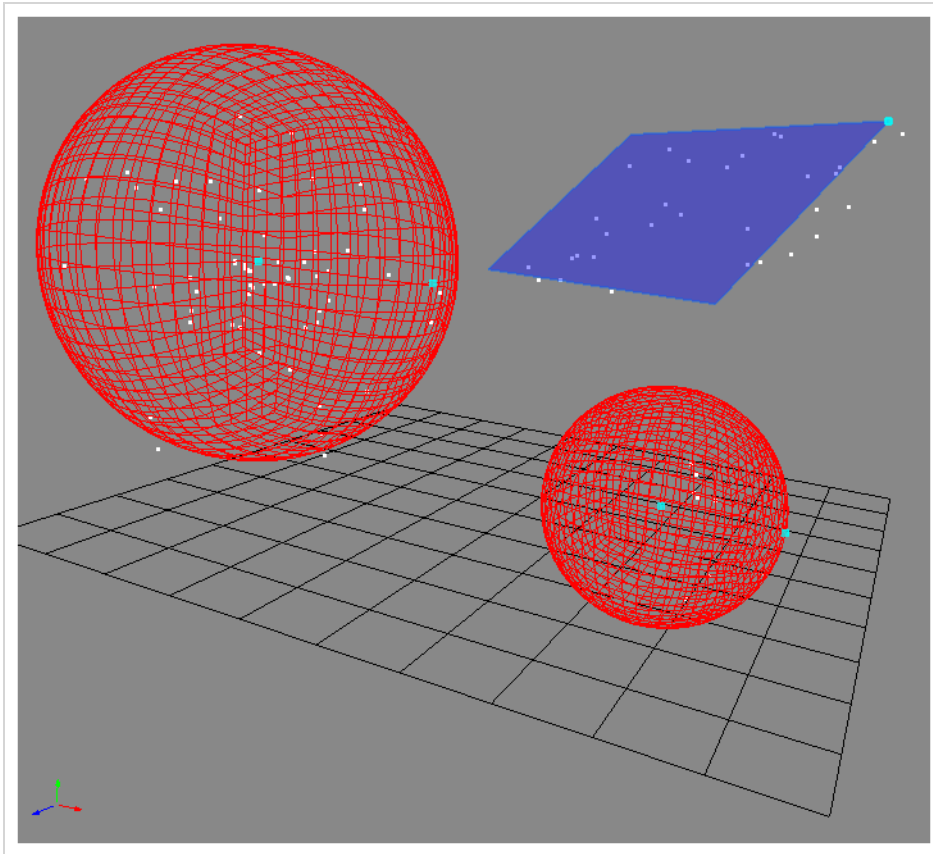

The Region Composite effect lets you composite multiple regions, 3D regions or planar regions. You may want to emit particles from multiple regions in the same particle system.

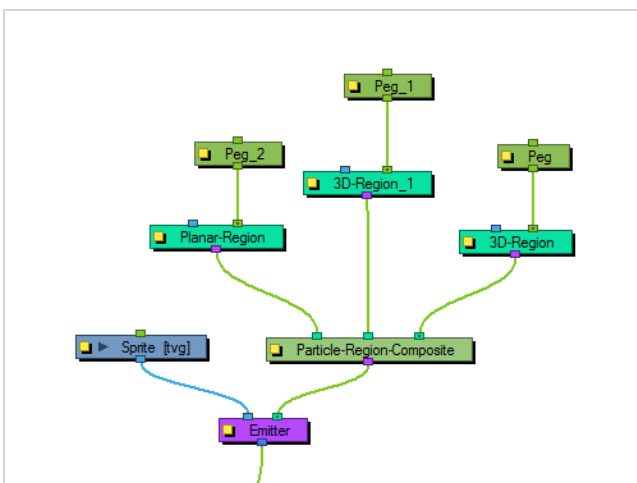

## Repulse

The Repulse effect repulses a particle around a region, but is different than the Bounce node as it is repelled before it physically hits the region.

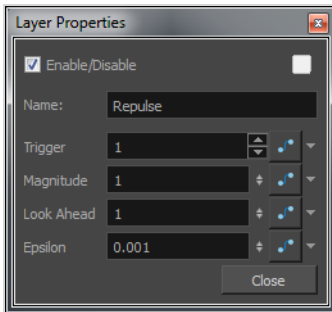
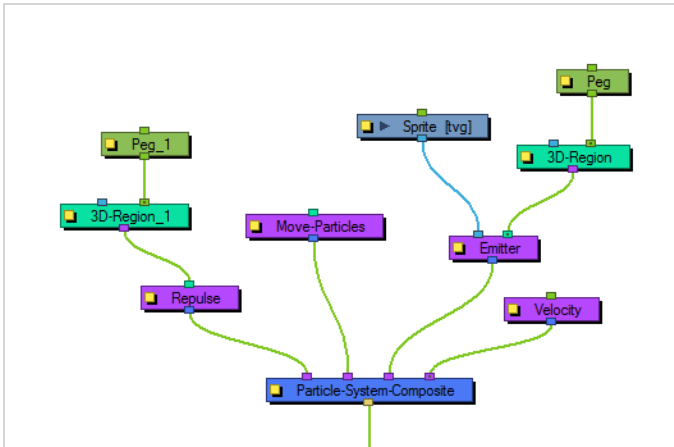

## Repulse Properties

Parameter	Description
Name	Allows you to change the name given to the node.
Trigger	An on/off switch using binary code. 1 = on, 0 = off.
Magnitude	This value should be between 0 and 2. The higher the value, the more drastically the particles will be repulsed.
Look Ahead	Determines how far ahead of the particle's current position to see whether there's an obstacle coming. This value should be between 0 and 100.
Epsilon	Affects how quickly the effect of the repulse wears off. The smaller the number, the longer the effect lasts. This value should be between 0.1 and 0.0001.

## Rotation Velocity

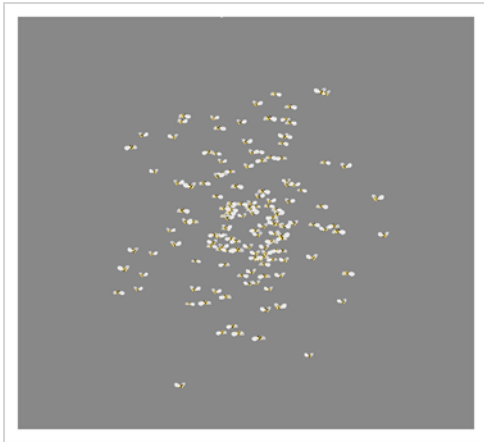

The Rotation Velocity effect lets you define the initial rotational velocity of the particles. The values that you set up for this node refer to each individual particle's drawing axes. This means that if you choose to rotate around the X-axis, it will rotate around each particle's local X-axis as defined by its drawing plane.

The rotational velocity should be set before you emit the particles, such as to the right, so the velocity is taken into account when the particles are created.

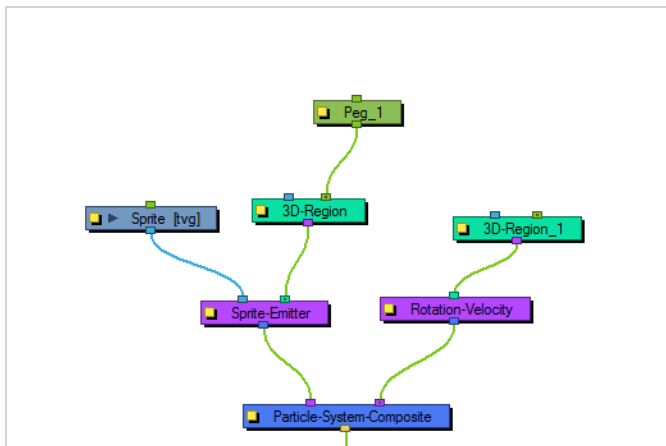

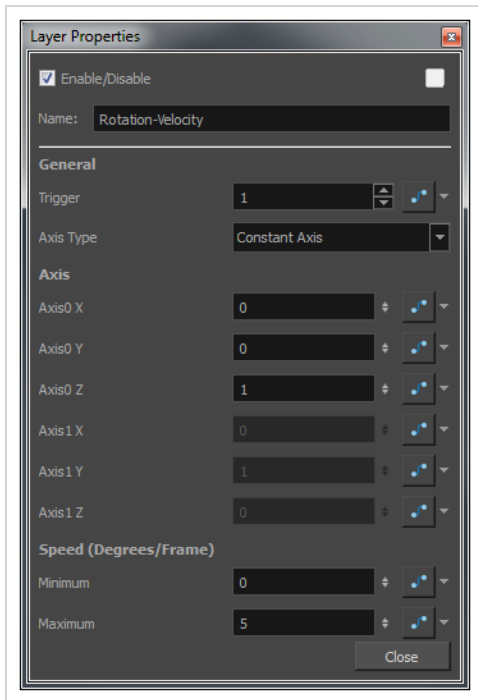

## Rotation Velocity Properties

Parameter	Description
Name	Allows you to change the name given to the node.
General	<p><b>Trigger:</b> An on/off switch using binary code. 1 = on, 0 = off.</p> <p><b>Axis Type:</b> Lets you select the type of axis to use.</p> <ul style="list-style-type: none"> <li>• <b>Use Input Shape:</b> Uses a region to define the rotational axis of the particles. The axis of each particle's rotation will be perpendicular to the plane that particle is created on.</li> <li>• <b>Constant Axis:</b> If you choose to rotate the particles around a constant axis, then each particle will rotate around the same axis. This axis will then be defined as Axis0.</li> <li>• <b>Interpolated Axis:</b> If you choose to rotate the particles around an interpolated axis, that means each particle will have its own rotational velocity which lies somewhere between Axis0 and Axis1.</li> </ul>
Axis	<p><b>Axis0 X:</b> Defines the X component of Axis0. If you set the X to 1, and the Y and Z to 0, then the particle will rotate around its X-axis as defined by its drawing plane. If you set X to 1 and also Y to 1, then it will rotate around an axis that is 45 degrees between X and Y.</p> <p><b>Axis0 Y:</b> Defines the Y component of Axis0.</p>

	<p><b>Axis0 Z:</b> Defines the Z component of Axis0.</p> <p><b>Axis1 X:</b> Defines the X component of Axis1. This applies only when you have selected an Interpolated axis.</p> <p><b>Axis1 Y:</b> Defines the Y component of Axis1.</p> <p><b>Axis1 Z:</b> Defines the Z component of Axis1.</p>
Speed (Degrees/Frame)	<p><b>Minimum:</b> The minimum initial rotation that a particle can have, in degrees per frame.</p> <p><b>Maximum:</b> The maximum initial rotation that a particle can have, in degrees per frame.</p>

## Sink

The Sink effect causes particles to disappear when outside the region that is plugged into the sink. It can also be inverted, so the particles disappear when they enter the region instead.

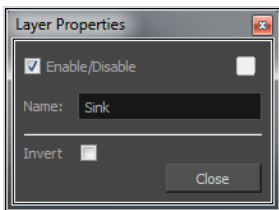
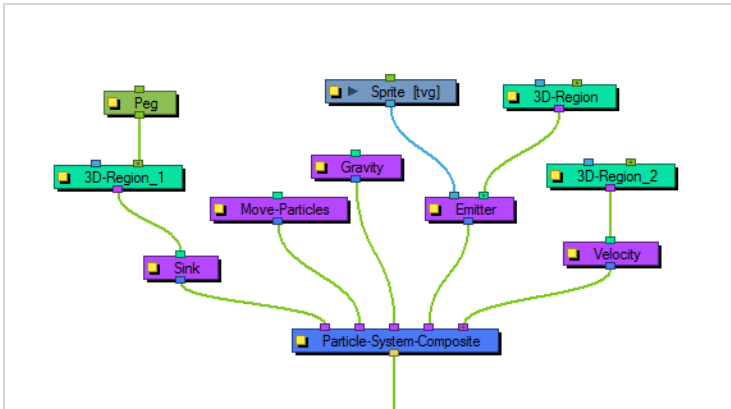

## Sink Properties

Parameter	Description
Name	Allows you to change the name given to the node.
Invert	The default behaviour of the sink is for particles to disappear when they depart the region. When inverted, the particles disappear when they enter the region instead.

## Size

The Size effect lets you animate the size of the particles.

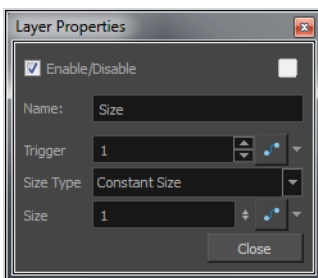
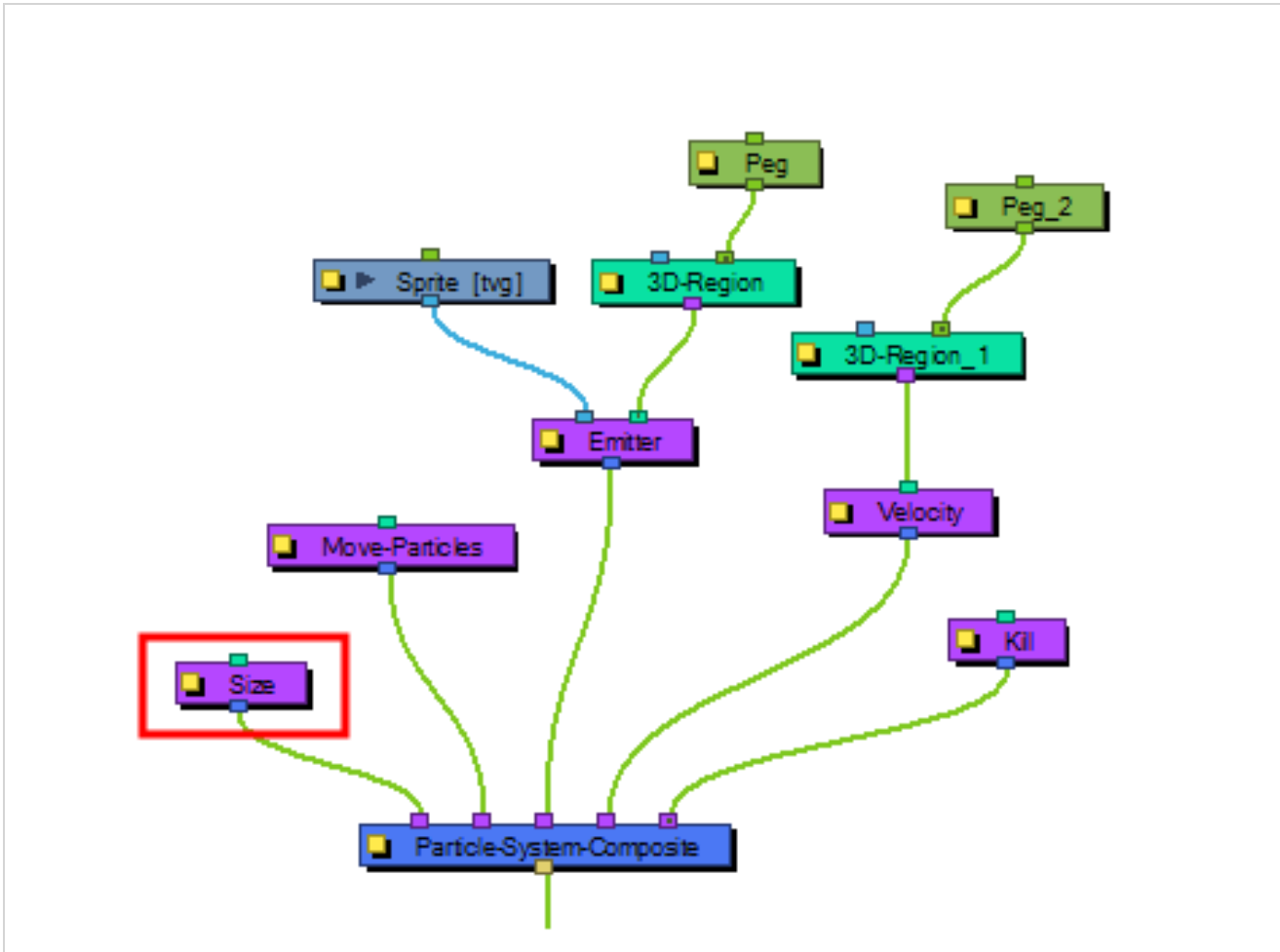

## Size Properties

Parameter	Description
Name	Allows you to change the name given to the node.

Trigger	An on/off switch using binary code. 1 = on, 0 = off.
Size Type	Lets you select a type for the size. If you choose Constant Size, then all particles will be animated to have the same size. If you choose Input Shape instead, then you must input a Region into the in-port of the Size node. It will use this region to determine the size of the particles.
Size	Lets you adjust the size of the particles.

:

:



## Sprite Emitter

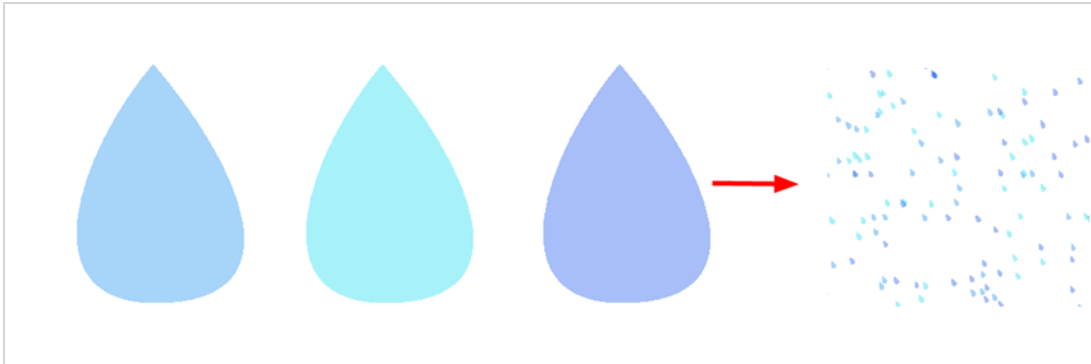

The Sprite Emitter effect is an all-purpose emitter. You can plug it into a drawing layer to generate particles that look like your drawing layer. You could also just output dot particles if you have no image layer connected. There are many parameters to control how particles are emitted.

## Sprite Emitter Properties

### Generation Tab

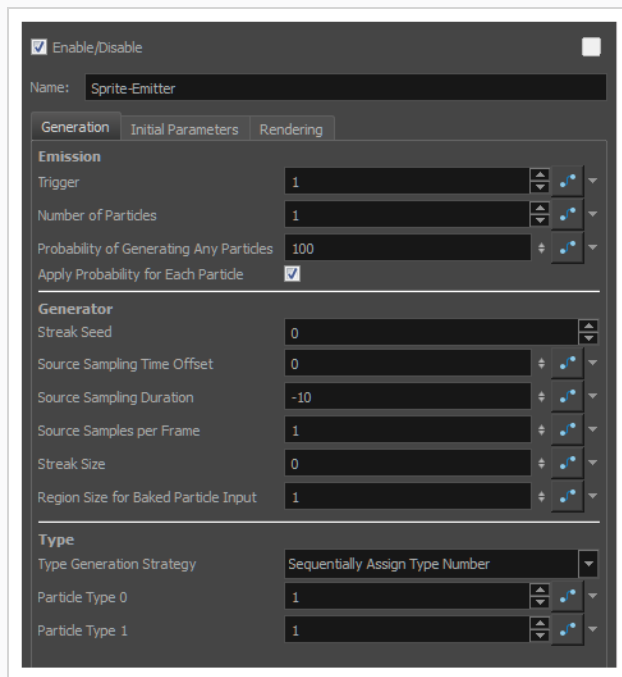

Parameter	Description
Emission	<b>Trigger:</b> An on/off switch using binary code. 1 = on, 0 = off.

	<p><b>Number of Particles:</b> This is where you can define how many particles will be emitted on each frame.</p>
	<p><b>Probability of Generating Any Particles:</b> This is a probability percentage between 0 and 100. If the probability is set to 100%, it will generate the Number of Particles specified. If you set the percentage to 50%, then there's only a 50% chance that it will generate the number of particles set in the Number of Particles. You can play with this value to add random spacing to the generation of particles.</p>
Generator	<p><b>Streak Seed:</b> The number of streaks to generate.</p> <p><b>Source Sampling Time Offset:</b> Sets the streak start at a different time to offset its position.</p> <p><b>Source Sampling Duration:</b> This parameter is the key to generating streaks. If set to 0, the behaviour is the same as before. If set to -10 for example, it will sample the input region (in this example the Planar-Region) 10 frames in the past. If in this mode, the Number of Particles parameter is the number of streaks to generate. If you want to generate five streaks for example, you need to set the Streak Size to a value different than 0, otherwise all the streaks will be at the same spot.</p> <p><b>Source Samples Per Frame:</b> The number of subdivisions for each frame. A value of 1 generates a particle for each frame. A value of 16 generates a particle on each 1/16th of a frame.</p> <p><b>Streak Size:</b> The radius of the sphere used for sampling the offset of the streak.</p> <p><b>Region Size for Baked Particle Input:</b> The Baked Particle Input property refers to when you use a Baker as an input to a Sprite Emitter. You can do this when you want to generate particles from other particles. When you do this, you have the option of setting a sphere around the source particle from which the new particle system will generate particles. That is the region which is referred to in this value. If you look at the following example, you'll see that the purple smiley faces are generating smaller green, blue, and yellow smiley faces. This is done by plugging the Baker from the purple smiley faces into the Sprite Emitter of the other smiley faces. See the following images:</p>

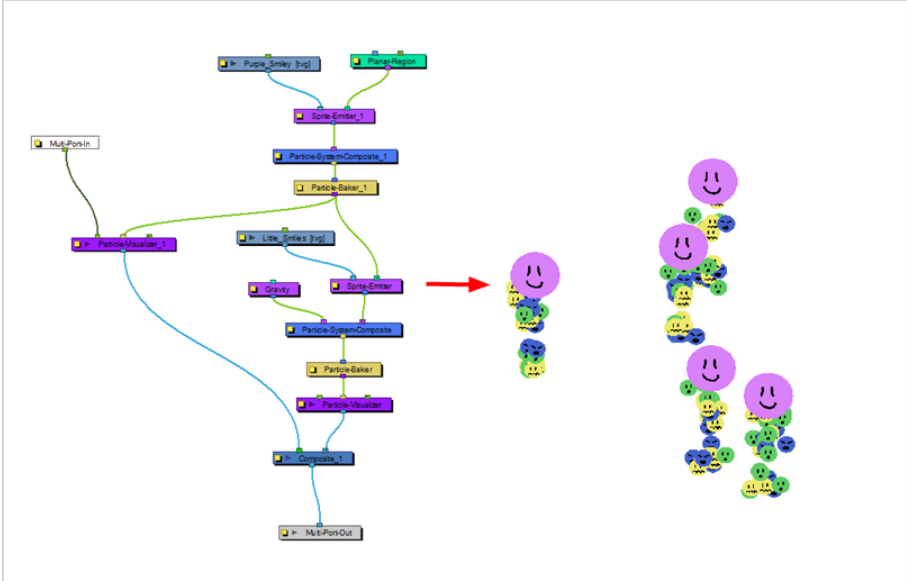
	
Type	<p>You may want to design a variety of different drawings that will vary the appearance of your particle system. To do this, you should put each drawing on its own cell in the drawing layer. Each drawing will then be a new Type of particle.</p> <p><b>Type Generation Strategy:</b></p> <p>Lets you sequentially or randomly assign a type (moving from one drawing to the next).</p> <p><b>Particle Type 0:</b></p> <p>This is the frame number of the first drawing. If you have a 5-frame cycle that starts on frame 1, you would put a 1 here.</p> <p><b>Particle Type 1:</b></p> <p>This is the frame number of the last drawing. If you have a 5-frame cycle that starts on frame 1, you would put 5 here.</p>

## Initial Parameters Tab

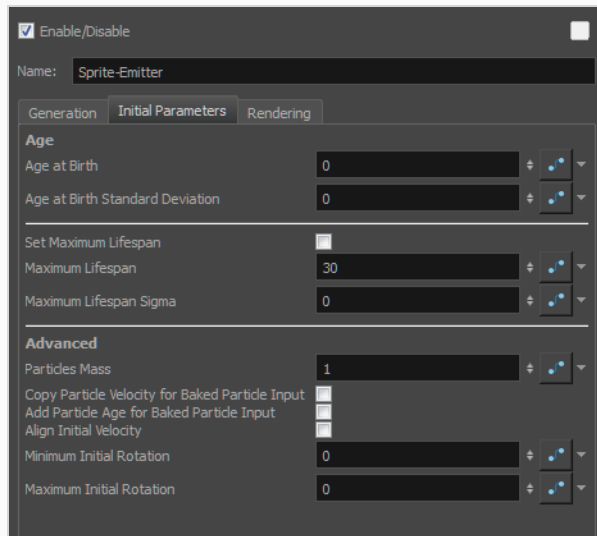

Parameter	Description
Age	<p><b>Age at Birth:</b> A different start frame number can be entered in this field. This means that a particle can start with a different drawing than the drawing that you have on frame 1.</p> <p><b>Age at Birth Standard Deviation:</b> Allows a random deviation for the birth of the particles. If you have a 5-frame cycle that starts on frame 1, but you want the particles to be of a random type, then you may want to set the Age and Birth to 3 with a standard deviation of 2. That means that particles will randomly be born at any frame from 1 to 5.</p>
	<p><b>Set Maximum Lifespan:</b> Makes particles die automatically.</p> <p><b>Maximum Lifespan:</b> This is how long the particle will exist before dying.</p> <p><b>Maximum Lifespan Sigma:</b> The lifespan variation of particles. If set to 0, all particles will have the same lifespan. A larger value means that particle lifespans will be distributed over a larger range.</p>
Advanced	<p><b>Particles Mass:</b> Define a mass for the particles. This mass will affect how the particles interact with gravity.</p> <p><b>Copy Particle Velocity for Baked Particle Input:</b> If you select this option, the velocity of the parent system will be applied to the child system when a Baker is used as the region for a Sprite Emitter.</p> <p><b>Add Particle Age for Baked Particle Input:</b> If you select this option, the age of the</p>

parent system will be inherited by the child system when a Baker is used as the region for a Sprite Emitter.

**Align Initial Velocity:** This aligns the initial velocity with the region from which the particles are being emitted. If you are emitting from a sphere, then the particles will all start out moving away from the centre of the sphere.

**Minimum Initial Rotation:** Define a minimum rotation in degrees that the particle can have when it is generated. There is also a separate Rotation-Velocity node in which you can define this parameter.

**Maximum Initial Rotation:** Define a maximum rotation in degrees that the particle can have when it is generated.

## Rendering Tab

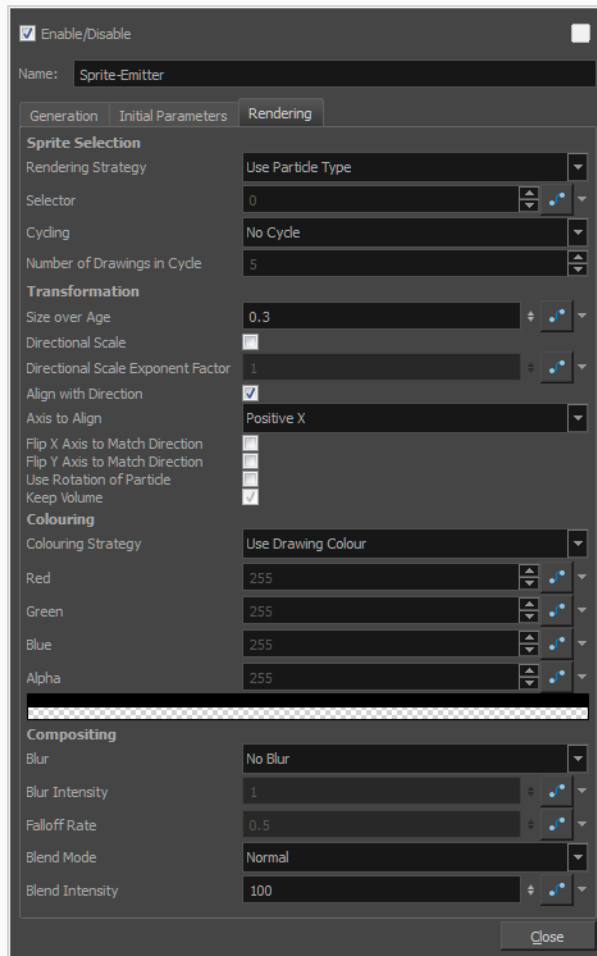

Parameter

Description

Sprite Selection

**Rendering Strategy:** Select a method to determine the particle type defined for each particle that is created.

- **Render as Dot:** Renders each particle as a dot. This is useful mainly for previewing the effects of your particle system without using the drawing layer (sprite).
- **Use Frame Number:** As the frame number increases, the type of particle will change to match the frame number. This means that ALL particles in the system will change together as the frame number changes. If you only have a few drawings, then you may want to enable Cycling to cycle those drawings.
- **Use Frame Number as Index in Selector:** When you select this option, you can use the Selector to animate the Frame Number it uses over time. So, instead of taking the current frame as the Frame Number, you can write your own function instead. For example, if you animate the selector so that at frame 1, it starts out at 2, then 8 frames later you add another keyframe to set the value to 4. Between frame 1 and frame 8, the particles will all change type together from what they look like on frame 2 to what they look like on frame 4.
- **Use Particle Type:** Each particle that is generated will look like the Particle Type that was assigned on the Generation tab. For example, if you use a value of 1 for Particle Type 0, and 6 for Particle Type 1, then each particle will be assigned a type from 1 to 6. This type corresponds to the drawing that appears on the sprite on that frame number. So if you have a drawing layer called Sprite that is plugged into the left in-port of the Emitter, it will look for the drawings in cells 1 to 6 of Sprite to assign those drawings to each particle.
- **Use Particle Type as Index in Selector:** This option allows you to use the Selector to manually create a function that assigns how many of which particle will be created.

For example, you can set the Particle Type to go from 1 to 100 in the Generation tab. Then use the Selector to remap the particle types to a certain drawing. So for example you could create five drawings, labelled 1 to 5, and use the selector to create mainly 1s, no 2s, a few 3s, 4s, and a very few 5s. What it's doing is looking at the X-axis to find what the particle "type" is, then looking at the Y-axis to find out which drawing to assign to that "type." When you use 1 to 100 as a type, then when you're setting the values, they act as a percentage.

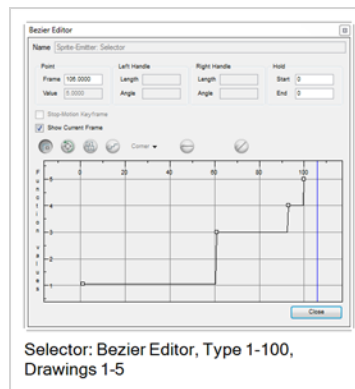
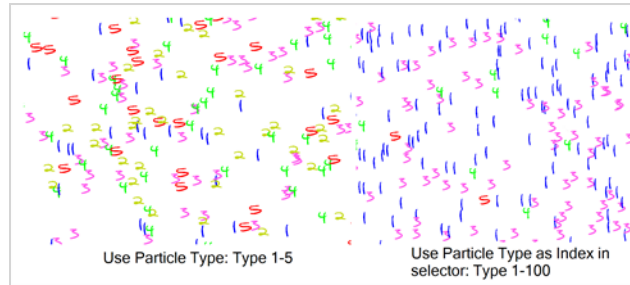

Selector: Bezier Editor, Type 1-100, Drawings 1-5

- **Use Age:** As the particle ages, it will change appearance from what appears on the Sprite's first drawing to the subsequent drawings. This means that each particle can have its appearance animated as it gets older.
- **Use Age as Index in Selector:** You can animate the Selector to change how a particle ages over time. For example, if you have a Sprite with six drawings on it, you might want to animate it so it changes from drawing 1, on frame 1, to drawing 2, on frame 10, then drawing 3 on frame 14, drawing 4 on frame 16, drawing 5 on frame 17, etc. so the particle rapidly ages. This allows you to change the timing of the aging dynamically through the selector, instead of having to modify the exposure of the cells on the Sprite.

**Selector:** Animates the Selector in conjunction with the Rendering Strategy to adjust the parameters that control the particle's appearance at birth and over time.

**Cycling:** If you're using rendering strategies like Frame Number or Age, you may want to cycle the drawings. For example, if you are using Frame Number, but you've only got 5 frames worth of drawings in your Sprite, then if you use "No Cycle," your Particles will disappear after frame 5. You can choose to cycle Normally (1-2-3-4-5-1-2-3-4-5) or Back and Forth (1-2-3-4-5-4-3-2-1).

**Number of Drawings in Cycle:** Lets you indicate how many frames from your Sprite you'd like to cycle.

Transformation	<p><b>Size over Age:</b> Lets you determine the size of the particle as it ages. Attach a function to this attribute if you want to, for example, have the particles get smaller as time goes on.</p> <p><b>Directional Scale:</b> Scales the particle in the direction of its movement.</p> <p><b>Directional Scale Exponent Factor:</b> Sets an exponent here for how much you want that particle to scale.</p> <p><b>Align with Direction:</b> Aligns the particle in the direction of its movement.</p> <p><b>Axis to Align:</b> Select the axis that you want to align. This axis refers to the axis of the Drawing grid from the Drawing node plugged into the emitter.</p> <p><b>Flip X Axis to Match Direction:</b> You may want to have the particle align to the X direction of movement. You can see this property being used in the Lemmings example.</p> <p><b>Flip Y Axis to Match Direction:</b> Similar to flipping the X axis, you may want to flip the Y axis of a drawing to match the direction of the particle movement..</p> <p><b>Use Rotation of Particle:</b> Enables rotation on the particle.</p> <p><b>Keep Volume:</b> When you choose to do a Directional Scale, this will automatically maintain the volume of the particle by squashing it proportionally to how much it stretches as a result of the directional scale.</p>
Colouring	<p><b>Colouring Strategy:</b> Lets you choose how to define the colour of the particle.</p> <ul style="list-style-type: none"> <li>• <b>Use Drawing Colour:</b> The particle remains the same colour as it was drawn with.</li> <li>• <b>Map RGB Based on Age:</b> Attach a function to this to vary the Red, Green, and Blue values of the particle as it ages.</li> <li>• <b>Map RGBA Based on Age:</b> Attach a function to this to vary the Red, Green, Blue, and Alpha values of the particle as it ages.</li> <li>• <b>Apply Opacity Based on Age:</b> Keeps the original RGB values from the drawing, but vary the Alpha (Opacity) according to a function that you define here.</li> <li>• <b>Map RGB Based on Frame:</b> Changes the Red, Green, and Blue values of the particles based on the frame. Changing based on the frame means that ALL particles will change colour on that frame, regardless of their age.</li> <li>• <b>Map RGBA Based on Frame:</b> Changes the Red, Green, Blue, and Alpha values of all particles on a given frame by attaching a function.</li> <li>• <b>Apply Opacity Based on Frame:</b> Uses the original RGB values from your drawing, but varies the Alpha (Opacity) of the particles on a certain frame by attaching a function to this.</li> </ul>



	<p><b>Red, Blue, Green, Alpha:</b> This is where you can attach functions to the Red, Blue, Green and Alpha values. You can also click on the colour swatch to adjust the colour.</p>
Compositing	<p><b>Blur:</b> Lets you determine the Blur to apply to the particles.</p> <ul style="list-style-type: none"> <li>• <b>No Blur:</b> No blur will be applied to the particles.</li> <li>• <b>Directional Blur Based on Age:</b> Attaches a function to define how you want the particles to blur based on the age of each particle. The particle will blur in the direction of movement.</li> <li>• <b>Directional Blur Based on Frame:</b> Attaches a function to define how all particles should be blurred at a particular frame. The particle will blur in the direction of movement.</li> <li>• <b>Low Quality Radial Blur Based on Age:</b> Attaches a function to define how you want the particles to blur based on the age of each particle. This will be a low quality blur.</li> <li>• <b>Low Quality Radial Blur Based on Frame:</b> Attaches a function to define how all particles should be blurred at a particular frame. This will be a low quality blur.</li> <li>• <b>Low Quality Radial Blur Based on Camera Distance:</b> Defines how you want the particles to blur based on their distance from the camera. This is a low quality blur.</li> <li>• <b>High Quality Radial Blur Based on Age:</b> Attaches a function to define how you want the particles to blur based on the age of each particle. This is a high quality blur.</li> <li>• <b>High Quality Radial Blur Based on Frame:</b> Attaches a function to define how all particles should be blurred at a particular frame. This is a high quality blur.</li> <li>• <b>High Quality Radial Blur Based on Camera Distance:</b> Defines how you want the particles to blur based on their distance from the camera. This is a high quality blur.</li> </ul> <p><b>Blur Intensity:</b> Lets you set a value or attach a function to animate the blur according to the type of blur that was defined from the drop-down list.</p> <p><b>Falloff Rate:</b> The distance where the blur fades from the edge of the image. Select a value between 0 and 1. A falloff rate of 0 causes the blur to fade out slowly, distributing the blur evenly from the edge of the drawing to the farthest edge of the blur. A falloff rate of 1 causes the blur to fade out quickly so that the blur is heaviest at the edge of the drawing.</p> <p><b>Blend Mode:</b> Defines a blend mode for the particles to get cool effects.</p> <p><b>Blend Intensity:</b> This is a percentage of how opaque you want the particles to be blended. 50 = 50% transparent. 100 = opaque.</p>

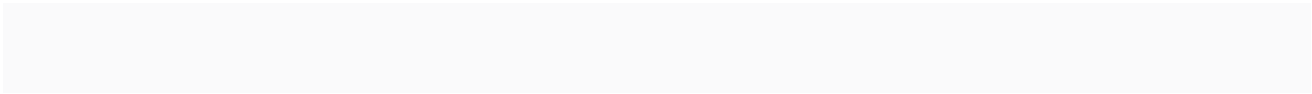

## System Composite

The System Composite node is where you connect all the "Actions" of your particle system. An action includes any of the light-purple nodes, like Gravity, Emitters, and velocity parameters. All of the "Actions" help to define the behaviour of the particle system.

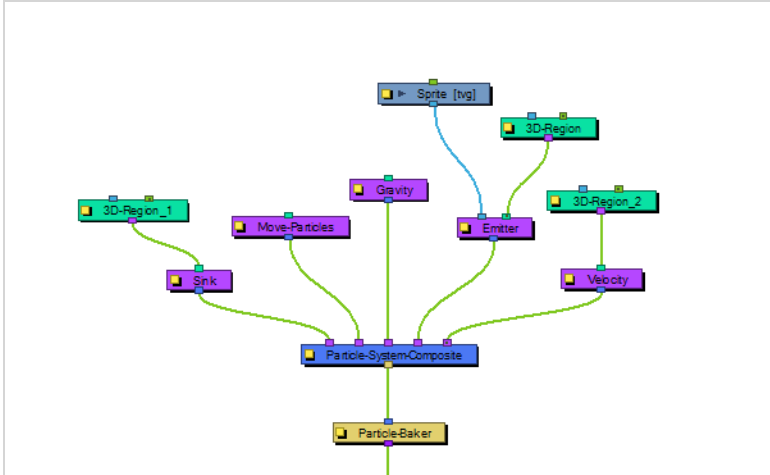

# Velocity

The Velocity effect defines the initial velocity of the particles that are emitted in the particle system. You can select this node and select **View > Show > Control** to display the manipulation handles to help you set the parameters of this node. Use your Transform tool to modify the manipulation handles in the Camera or Perspective view.

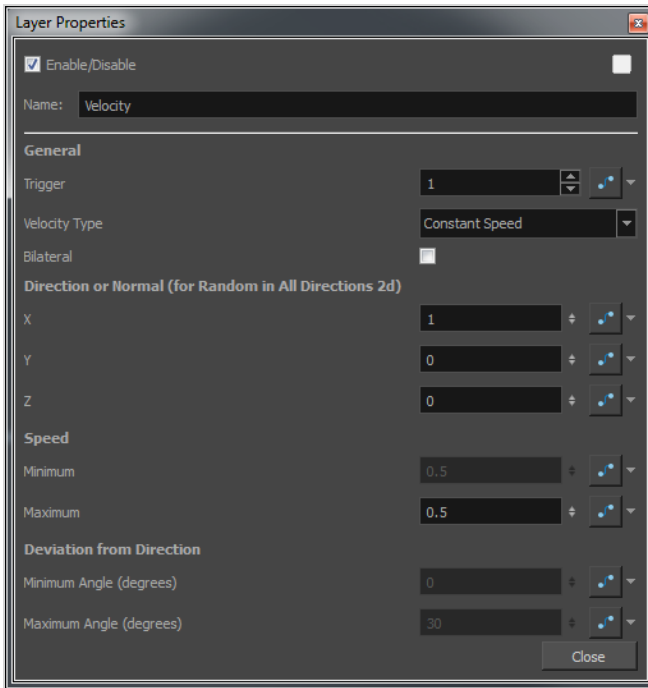
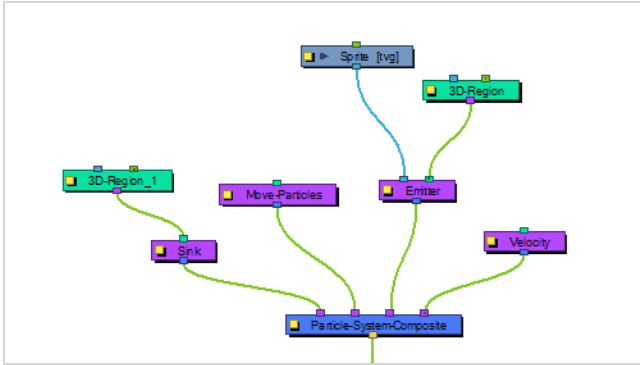

## Velocity Properties

Parameter	Description
General	<b>Trigger:</b> Is an on/off switch using binary code, where 1 = on, while 0 = off.
	<b>Velocity Type</b>

	<ul style="list-style-type: none"> <li>• <b>Use Input Shape:</b> If you plug a Region into the in-port of the Velocity node, it will take the shape of this region to determine the initial velocity of the particles. They will take a velocity that is perpendicular to the surface of the shape.</li> <li>• <b>Constant Speed:</b> Sets a constant speed for the initial velocity of the particles.</li> <li>• <b>Interpolated Speed:</b> Each particle is assigned an initial speed that is somewhere between the two values set for Interpolated Speed.</li> <li>• <b>Random in All Directions 2D:</b> All particles will be assigned a random velocity in any direction on a 2D plane.</li> <li>• <b>Random in All Directions 3D:</b> All particles will be assigned a random velocity in any direction.</li> <li>• <b>Random in Cone:</b> Particles will be assigned an initial velocity anywhere in the shape of a cone.</li> <li>• <b>Random in 2D-Pie:</b> Particles will be assigned an initial velocity anywhere in the shape of a pie slice on a 2D plane.</li> </ul>
Direction of Normal (for Random in all Directions 2D)	<p><b>Bilateral:</b> Generates positive and negative velocities in a given direction. For example, you can generate particles with cone-shaped velocity, (e.g. a bazooka firing) going only in the forward direction, but you can also generate velocities in the opposite direction.</p> <p>Lets you input values for the perpendicular direction for the Random property in All Directions 2D.</p> <p><b>X:</b> Sets a value between 0 and 1 to determine how much influence the X-axis has over the direction of the normal. For example, if the X value is set to 1, and Y and Z are set to 0, then the perpendicular (normal) will be going in the X direction. If X is set to 1, and Y is also set to 1, then the axis will be 45 degrees, halfway between X and Y. Feel free to use the Manipulation Handles for the velocity node by selecting the Velocity node and then selecting <b>View &gt; Show &gt; Control</b>. This will allow you to use the Transform tool in the Camera View or the Perspective View to set the appropriate values.</p> <p><b>Y:</b> Set a value between 0 and 1 to determine how much influence the Y-axis has over the direction of the normal.</p> <p><b>Z:</b> Set a value between 0 and 1 to determine how much influence the Z-axis has over the direction of the normal.</p>
Speed	<p><b>Minimum:</b> There are some speeds that are constant, and some that are a range of values between a minimum and maximum. Set the minimum speed here.</p> <p><b>Maximum:</b> Set the maximum speed for interpolated speeds.</p>

Deviation from Direction	<p><b>Minimum Angle:</b> This is used for Cone and Pie shapes. Put a non-zero value here if you want there to be a hole in the middle of your cone or pie.</p> <p><b>Maximum Angle:</b> Set the maximum angle for your cone or pie here.</p>
--------------------------	--

## Visualizer

The Particle-Visualizer effect renders and flattens the particle system down to a single plane. You can plug a peg module into the left port to animate the position of the whole particle system. Plugging a peg into the right port will move the depth where the flat plane is generated, so you can move it behind or in front of various other drawing layers in your scene. You can even have two Visualizers with pegs in the right in-ports that are at different depths to display some particles in front of and some particles behind a character or drawing in the scene.

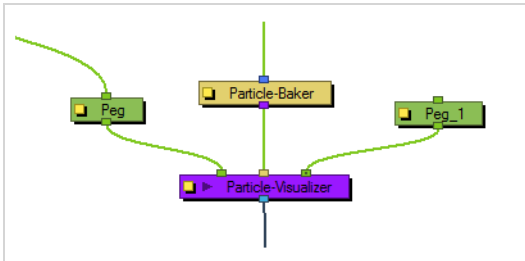

### Visualizer Properties

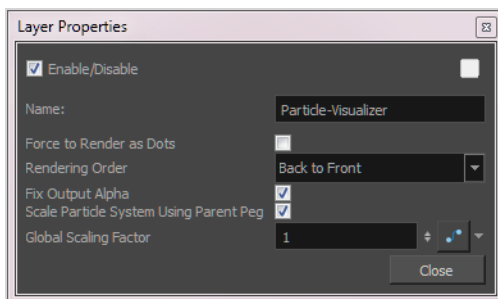

Parameter	Description
Force Render as Dots	Temporarily renders your system as Dots when previewing a simulation. All drawings are ignored and the system is forced to render as dots. <b>Note:</b> You can also use the option <b>View &gt; Particle &gt; Show Particles</b> as Dots in OpenGL. When enabled, the particles will always be displayed as dots in the OpenGL preview mode to make playback speed faster for heavy scenes.
Rendering Order	Lets you set the order in which you want the particles to appear in the render. <b>Back to Front:</b> Added particles will appear behind existing particles. <b>Front to Back:</b> Added particles will appear in front of existing particles. <b>Oldest to Youngest:</b> Older particles will appear behind younger particles. <b>Youngest to Oldest:</b> Older particles will appear in front of younger particles. <b>Ascending Types:</b> Lower types will appear behind higher types. <b>Descending Types:</b> Lower types will appear in front of higher types.

Fix Output Alpha	This is an important option when using some filters like Screen or Multiply in the Blend Mode that can be specified in the Rendering tab of the Emitter. When working with premultiplied images, if the alpha is not fixed in the visualizer, you may see some unusual artifacts.
Scale Particle System Using Parent Peg	Respects the scaling of a particle system so you can position and resize it as you like. Old scenes with particle system will still work as this option is disabled.
Global Scaling Factor	Lets you set the scaling factor for particle system.



## Vortex

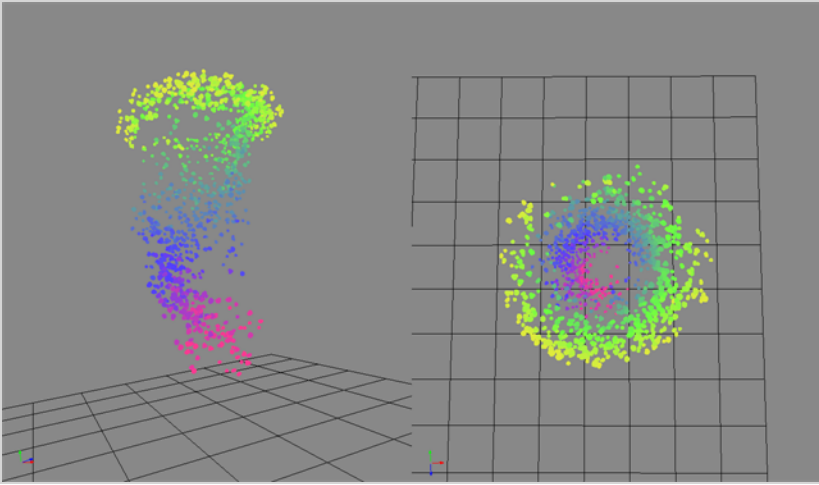

The Vortex effect allows you to define an axis as a vortex, so the particles will spin around this axis.

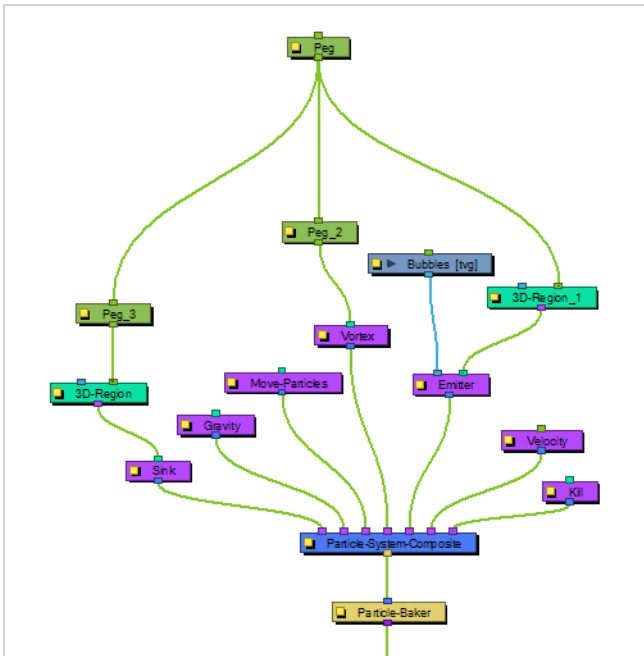

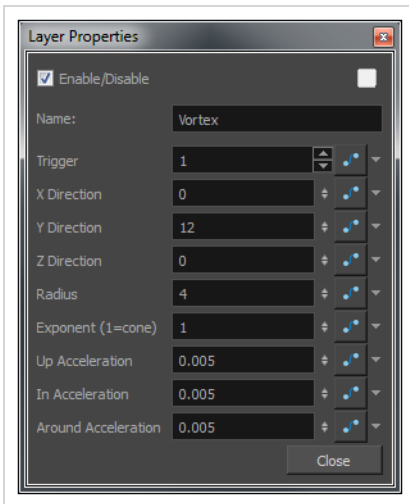

## Vortex Properties

Parameter	Description
Trigger	An on/off switch using binary code, where 1 = on and 0 = off.
X Direction	Defines the X portion of the axis of rotation for the Vortex.
Y Direction	Defines the Y portion of the axis of rotation for the Vortex.
Z Direction	Defines the Z portion of the axis of rotation of the Vortex.
Radius	Defines the radius at the top of the vortex.
Exponent (1=cone)	Defines a curve that gives the Vortex a certain silhouette. 1 forms a cone, greater than 1 curves inward.
Up Acceleration	Defines the vertical acceleration of the particles that are inside the Vortex.
In Acceleration	Defines the inward acceleration of particles that are outside the Vortex.
Around Acceleration	Defines the acceleration around the vortex of particles that are inside the Vortex.

## Wind-Friction

The Wind-Friction effect lets you define the amount of wind in the scene, and animate the wind over time.

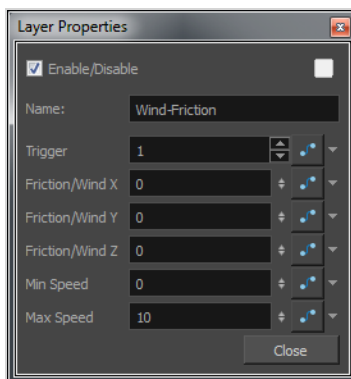
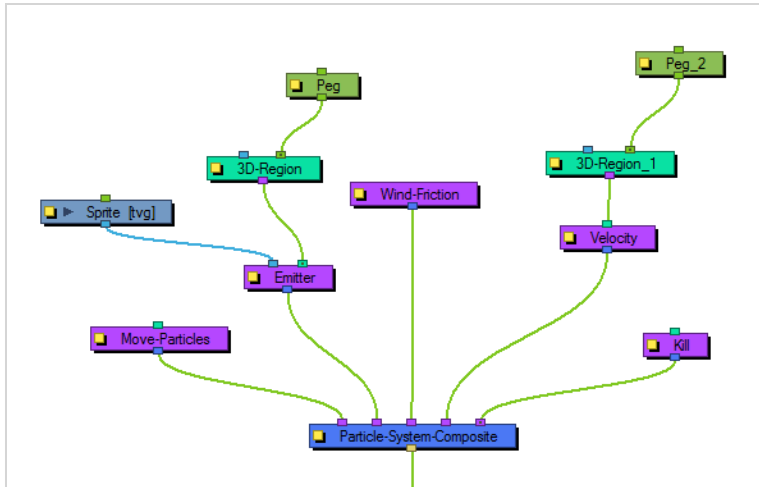

## Wind-Friction Properties

Parameter	Description
Trigger	An on/off switch using binary code, where 1 = on and 0 = off.
Friction/Wind X, Y, Z	Defines the amount that the wind will dampen or increase the speed of the particles in the X, Y or Z direction.
Min Speed	The minimum speed of particles that will be affected by the wind. Particles moving slower than this will not be affected
Max Speed	The maximum speed of particles that will be affected by the wind. Particles moving faster than this will not be affected.

## Shading Nodes

Harmony provides you with a wide series of parameters to customize your light shading effects.

<b>Light Position Node</b> .....	<b>798</b>
<b>Light Shader Node</b> .....	<b>800</b>
<b>Normal Map Node</b> .....	<b>803</b>
<b>Normal Map Converter Node</b> .....	<b>807</b>
<b>Tone Shader Node</b> .....	<b>809</b>
<b>Volume Object Node</b> .....	<b>813</b>

## Light Position Node

The Light Position node is the actual light source interacting with all the defined volume objects. You can set its position in relation to the objects and animate it over time. All volumes will react according to the light's motion.

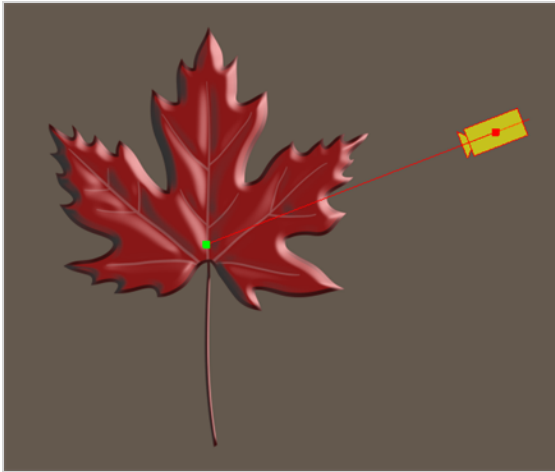

This is not where you set the light type or colour. You'll be adjusting these in the Light Shader and Tone Shader nodes.

## Light Position Properties

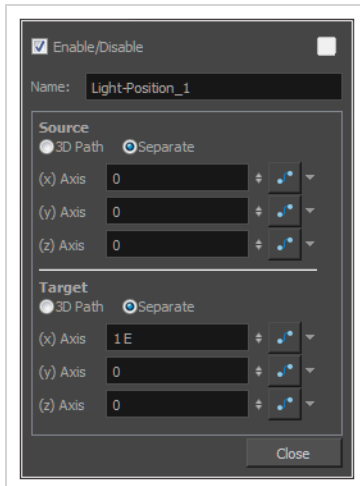

Parameter	Description
Source	Lets you control the value of the light source.
Target	The point or direction at which the light is pointing
	<b>3D Path:</b> Lets you use a 3D path when animating the light.

	<b>Separate:</b> Lets you enter separate values for the X, Y and Z axes.
	<b>(x) Axis:</b> Lets you type in a new East/West coordinate corresponding to the desired position.
	<b>(y) Axis:</b> Lets you type in a new North/South coordinate corresponding to the desired position.
	<b>(z) Axis:</b> Lets you type in a new Forward/Backward coordinate corresponding to the desired position.

## Light Shader Node

The Light Shader node lets you adjust the highlight parameters, such as the colour, to create the desired ambiance. You can animate most parameters over time to create a mood change, sunset or any other type of light transition. The beveling height and smoothing is set in the Normal Map node.

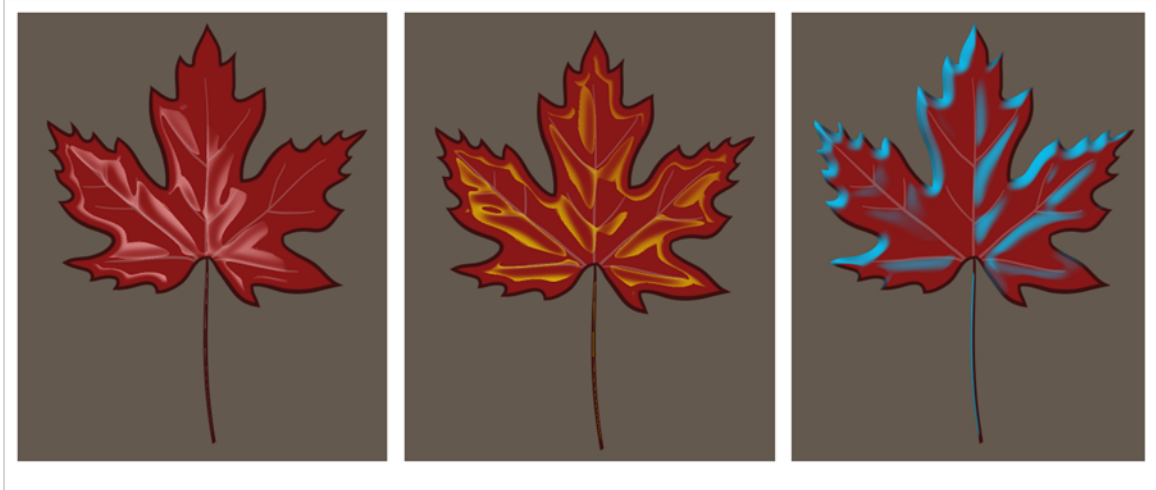

## Light Shader Properties

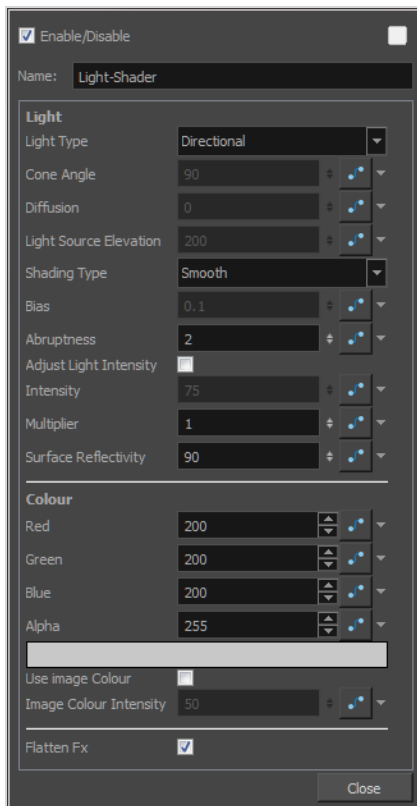

Parameter	Description
-----------	-------------

Name	Allows you to change the name given to the node.
<b>Light</b>	
Light Type	<p><b>Directional:</b> A light that is parallel in the scene. Each “beam” of light follows the direction defined by the light source and target, and point in the same direction. This type of light is used when the light source is far away or very big, like the sun.</p> <p><b>Point:</b> A light that illuminates everything around it. Its “beam” of light will go in all directions like a fire.</p> <p><b>Spot:</b> A light that forms a conical shape like a flashlight.</p>
Cone Angle	The value that defines the light’s cone angle. This option is only accessible with the Light Type set to Spot.
Diffusion	Lets you play with the diffusion of the light on the surface of the drawing. In other words, it is the edge softness. This option is only accessible with the Light Type set to Spot.
Light Source Elevation	Defines the height of the spotlight. This option is only accessible when the Light Type set to Spot or Point.
Shading Type	<p>Smooth: The light and tone fx will have smooth edges.</p> <p>Sharp: The light and tone fx will have sharp edges.</p>
Bias	<p>Define the polarization of the light.</p> <p>When the Shade type is set to Smooth, it defines the width of the light’s smooth zone.</p> <p>When the Shade type is set to Sharp, the Bias defines the antialiasing on the edge of the highlight or tone zone. But,if the Shade type is set to Sharp, the Bias option need a small value such as 0.1 or 0.2. The exponent will be able to compensate the limitation of this small value.</p>
Abruptness	This is a multiplier value of the Bias option. It will define how quick the polarization of the light will change from a value to another.
Adjust Light Intensity	Lets you adjust the light intensity.
Intensity	Lets you set the strength of the light.



Multiplier	Multiplies the value of the Intensity option.
Surface Reflectivity	This option is useful for exaggerating the light on the edge of the 3D geometry. The closer an edge is to the light source, the more intense the light will be.
<b>Colour</b>	
Red/Green/Blue/Alpha	The colour and transparency of the Colour Card. You can also attach these parameters to function columns to change their values over time. Click the colour swatch to open the Colour Picker window and select a colour.
Colour Swatch	Opens the Colour Picker window in which you can specify the colour.
Use Image Colour	Lets you use the colour of the drawing in a lighter or darker colour for the highlight and tone fx.
Image Colour Intensity	Lets you blend the colour of the light with the image colour.
Flatten Fx	This is useful when there are several highlight and tone fx, one over the other, but are supposed to be merged together. Sometimes, shadows and lights look better when they do not overlap.

## Normal Map Node

The Normal Map node lets you centralize all Volume Object nodes and chisel out the shading 3D geometry (bevel height, smoothing, carving, etc.). It could be described as carving a bas relief. You only need one Normal Map node per light shading effect and, in general, only one per scene.

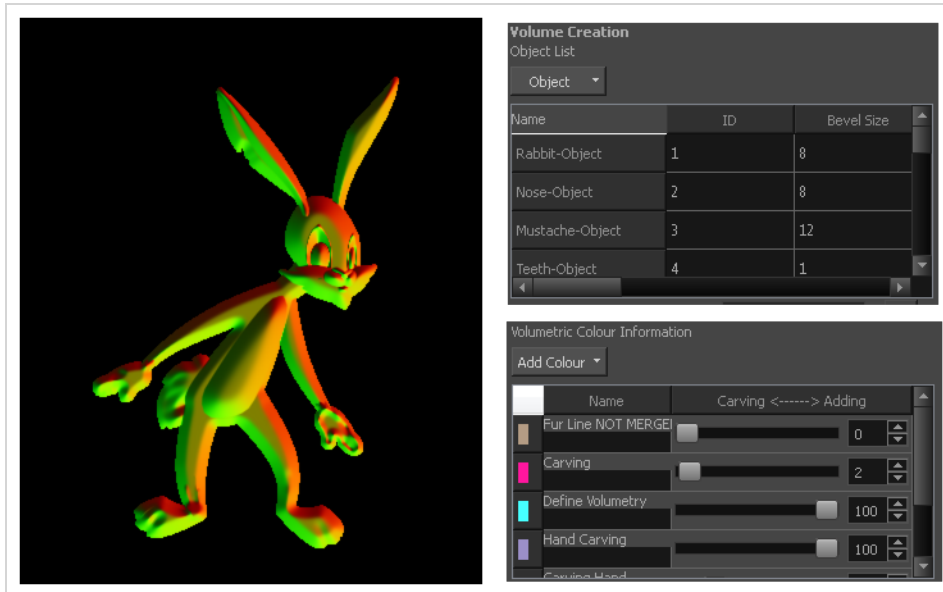

A normal map can be used to create other effects. If you're working with an OpenFX plugin or other plugin requiring a normal map, you can use the Normal Map Converter node to translate the Harmony normal map to a format supported by your plugin. The Normal Map Converter node has been optimized to work with GenArts® plugins, but you also have the ability to use it on custom plugins..

## Normal Map Properties

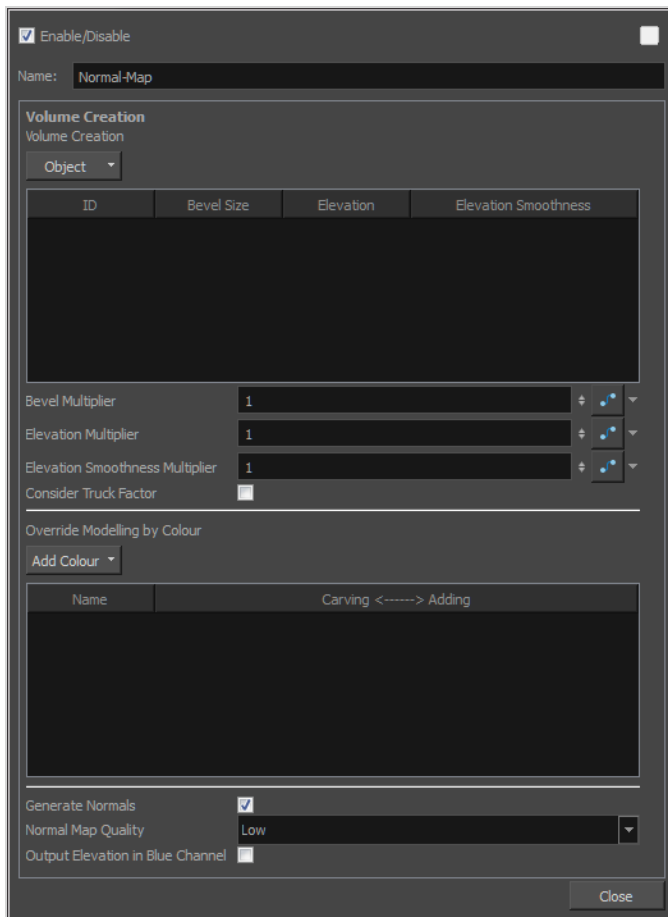

Parameter	Description
Volume Creation	Lists all the different volume object IDs are listed. This is where you can define the basic volumetric shape of each Volume Object node connect to the Normal Map.
Object	<p>Let you add or remove Volume Object nodes that are connected to the Normal Map node.</p> <p><b>Add All Defined Objects:</b> Adds all Volume Object nodes connected to the Normal Map node.</p> <p><b>Remove Selected Objects:</b> Removes all Volume Object nodes from the Volume Creation list.</p>
Name	The name that was previously set ineach Volume Object node. This information can be really helpful when there are many volume objects listed. With a good name, it is easy to discover what the ID number is related to. When you hover over this column, a tooltip appears listing all volume objects with the same ID.

In the following image, the tooltip indicates that three copies were made from FootR-Object. By keeping the same name, you can easily see that each time you see a Volume Object named "FootR-Object", the ID will be the same.

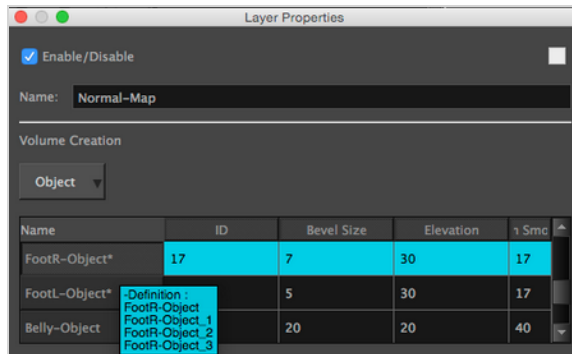

In the second example, a specific name was created for each volume object, even if they have the same ID. That way, it is easy to find a specific nodenode when searching for an element with the Search tool in the NetworkNode view.

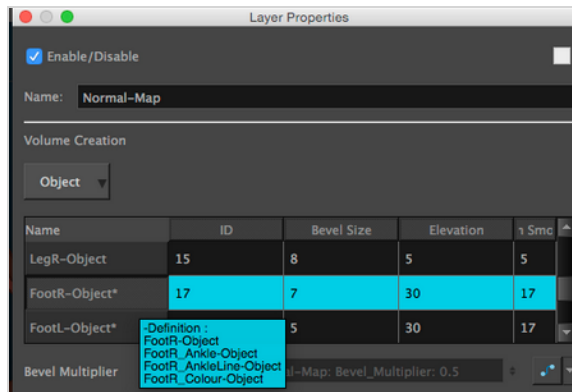

ID

The identity number that was previously set in the volume object nodenode appears here. The tooltip in the ID column lists all drawing elements that are connected to the volume object with this identity number.

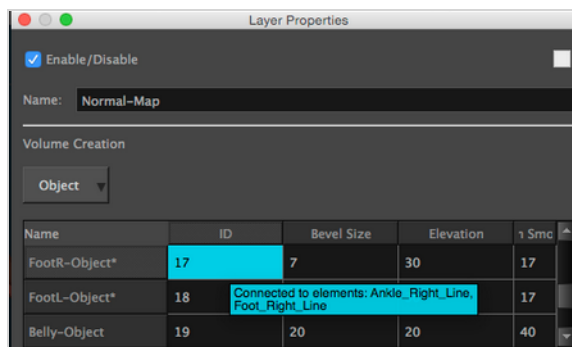

Bevel Size

Defines the size of the bevel on the contour of all the drawings related to a specific ID number

Elevation	Defines the elevation of a specific volume object. The higher the value, the more the volumetry of this Volume Object resembles a conical or pyramidal shape.
Elevation Smoothness	Complementary to the Elevation column. Instead of keeping a conical or pyramidal shape, the shape will be smoothed to create a sphere or a bump shape. The edge will be round instead of sharp.
Bevel Multiplier	A multiplier of the Bevel Size value in the board. This affects every object listed.
Elevation Multiplier	A multiplier of the Elevation value in the board. This affects every object listed.
Elevation Smoothness Multiplier	A multiplier of the Elevation Smoothness value in the list. This affects every object listed.
Consider Truck Factor	Keeps the same ratio for the Light Shading system when the camera zooms in or out. This parameter cannot work properly if the size of the drawing, with a volume object nodenode, is changed on the drawing itself. In other words, if the animation is directly created on the drawing layer.
<b>Override Modelling by Colour</b>	
Add Colour	Lets you add or remove any colour that will affect the Adding/ Carving options in the list beneath. When you select this button, each colour palette in the scene is listed and all their swatches are displayed.
Swatches	The first column of the Override Modelling by Colour board is the Swatches. This column does not have a name. When you select a colour swatch from the Add Colour list, the colour swatch appears at the beginning of the list.
Generate Normals	Activates or deactivates the generation of the Normal Map.
Normal Map Quality	Lets you change the Quality of the Normal Map from low to high.
Output Elevation in Blue Channel	When selected, the Elevation is calculated and appears in the soft render mode. When deselected, the object ID appears in the soft render mode. Because it is connected to the blue channel of a drawing, the result will only affect the blue channel.

## Normal Map Converter Node

The normal map will carve and emboss a flat plane using vectors. The X, Y and Z coordinates of the normal map vectors are stored in RGB values to convert the 3D aspect into a visual result and use it to create various effects, such as light reflections (light shading). The X value is stored in the Red channel. The Y value is stored in the Green channel. The Z value is stored in the Blue channel.



### NOTE

Note that not all normal map formats are supported.

The Normal Map Converter uses the following formula per channel:

- **value \* (+/- length) + offset**
- **\* +/- depending if inverse is set to true ("- " if true)**

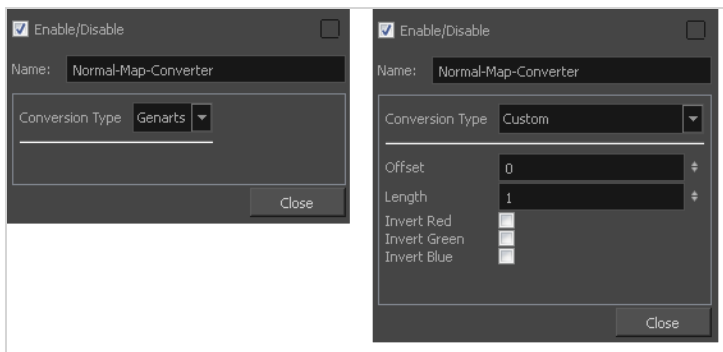

Parameter	Description
Conversion Type	By default, the conversion type is set to Genarts. If you work with a different manufacturer and want to adjust the parameters, set the conversion type to Custom.
Offset	Offsets the original position of the vector. You need to read the plugin documentation to know the offset you need to use. You must use the same offset value as the manufacturer is using. By default the offset is set to 0.
Length	The Normal Map Converter normalizes Harmony vectors to 1. By default the length value is set to 1. If your plugin requires shorter or longer vectors, enter a value smaller or greater than 1. It will multiply the vector length.
Invert Red	Inverts the red value (x). If your value is 125, the invert setting will transform it to -125.

---

Invert Green	Inverts the green value (y). If your value is 125, the invert setting will transform it to -125.
Invert Blue	Inverts the blue value (z). If your value is 125, the invert setting will transform it to -125.

## Tone Shader Node

The Tone Shader node lets you adjust the tone parameters, such as the colour, to create the desired ambiance. You can animate most parameters over time to create shade transitions. The beveling height and smoothing is set in the Normal Map node.





## Tone Shader Properties

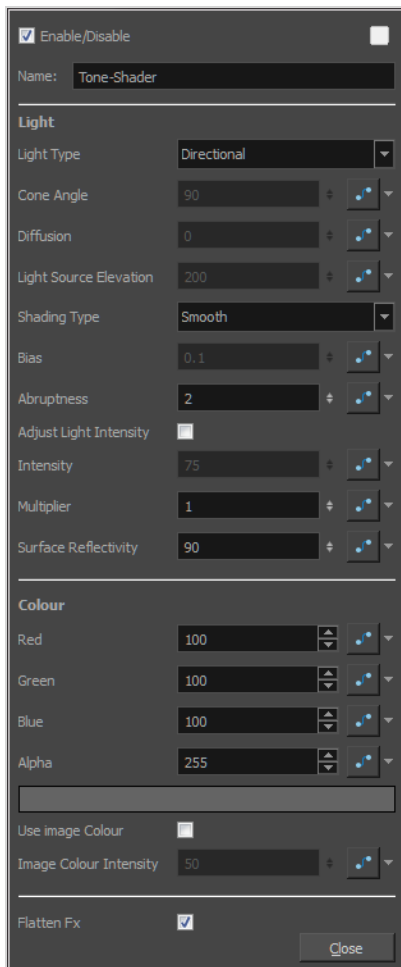

Parameter	Description
Name	Allows you to change the name given to the node.
<b>Light</b>	
Light Type	<p><b>Directional:</b> A light that is parallel in the scene. Each “beam” of light follows the direction defined by the light source and target, and point in the same direction. This type of light is used when the light source is far away or very big, like the sun.</p> <p><b>Point:</b> A light that illuminates everything around it. Its “beam” of light will go in all directions like a fire.</p> <p><b>Spot:</b> A light that forms a conical shape like a flashlight.</p>
Cone Angle	The value that defines the light’s cone angle. This option is only accessible with

	the Light Type set to Spot.
Diffusion	Lets you play with the diffusion of the light on the surface of the drawing. In other words, it is the edge softness. This option is only accessible with the Light Type set to Spot.
Light Source Elevation	Defines the height of the spotlight. This option is only accessible when the Light Type set to Spot or Point.
Shading Type	Smooth: The light and tone fx will have smooth edges. Sharp: The light and tone fx will have sharp edges.
Bias	Define the polarization of the light. When the Shade type is set to Smooth, it defines the width of the light's smooth zone. When the Shade type is set to Sharp, the Bias defines the antialiasing on the edge of the highlight or tone zone. But,if the Shade type is set to Sharp, the Bias option need a small value such as 0.1 or 0.2. The exponent will be able to compensate the limitation of this small value.
Abruptness	This is a multiplier value of the Bias option. It will define how quick the polarization of the light will change from a value to another.
Adjust Light Intensity	Lets you adjust the light intensity.
Intensity	Lets you set the strength of the light.
Multiplier	Multiplies the value of the Intensity option.
Surface Reflectivity	This option is useful for exaggerating the light on the edge of the 3D geometry. The closer an edge is to the light source, the more intense the light will be.
<b>Colour</b>	
Red/Green/Blue/Alpha	The colour and transparency of the Colour Card. You can also attach these parameters to function columns to change their values over time. Click the colour swatch to open the Colour Picker window and select a colour.
Colour Swatch	Opens the Colour Picker window in which you can specify the colour.

---

Use Image Colour	Lets you use the colour of the drawing in a lighter or darker colour for the highlight and tone fx.
Image Colour Intensity	Lets you blend the colour of the light with the image colour.
Flatten Fx	This is useful when there are several highlight and tone fx, one over the other, but are supposed to be merged together. Sometimes, shadows and lights look better when they do not overlap.

## Volume Object Node

The Volume Object node lets you define a volume zone the light will interact with.

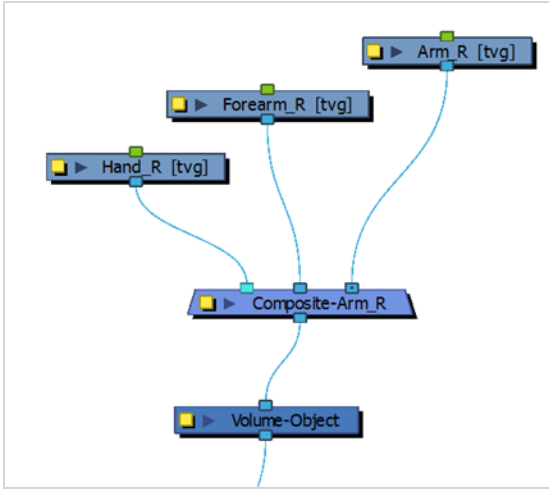

If there is a single drawing on which you want to apply shading, you only need one Volume Object node. For cut-out characters, you will require more as you will define which should be different volumes. For example, you could decide that the arm, forearm, and hand will form one shape for the light to hit and create a highlight. You could then define the body as a separate volume. If you use different Volume Object nodes on the arm pieces, you will get odd carvings and bumps where the joints overlap. Before adding light shading to your rig, you should analyze how the parts will interact with one another.

All the Volume Object nodes in your structure will be gathered in the Normal Map node where you can define the parameter for each volume.

## Volume Object Properties

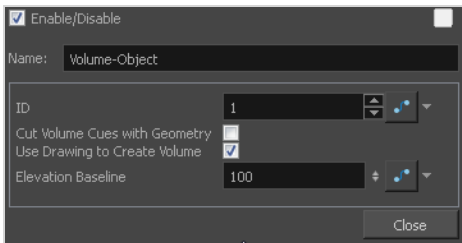

Parameter	Description
Name	With the light shading feature, the naming of the nodes becomes important. Since there isn't any limitation on the number of Volume Object nodes that can be added to a node structure, it's quite important to give a good name to each Volume Object node. These names will later appear in the Normal Map node, in the Volume Creation section.

ID	<p>This is the identity number you assign to a drawing or a group of drawings that will be represented in the same volume once it is generated by the Normal Map node. This ID is also in the Normal Map node, where a list of all Volume Objects is applied.</p>
Cut Volume Cues with Geometry	<p>When this option is not selected, Harmony cuts the 3D geometry (shading bas relief) of the drawing after it has been generated by the Normal Map node.</p> <p>Some nodes, such as filters, can affect the shape or colour of the drawing. Those nodes will be processed and recognized by the Normal Map node. Therefore, it is possible to limit the 3D geometry only on a part of the drawing, but not all of it. The 3D geometry follows the edge of the entire drawing and will not be affect by the filters.</p>
Use Drawing to Create Volume	<p>During the generation created by the Normal Map node, the shape of the drawing or group of drawings identified with the same ID will be recognized to create the volume. When this option is selected, the Light Shader and Tone Shader effect appear inside the contour of those drawings.</p>
Elevation Baseline	<p>The baseline defines how much you can add or carve the Volume Object. The drawing or group of drawings connected to this Volume Object node share the same baseline value. Because this setting is closely tied to the adding/curving option called Intensity (0-100) (accessible in the Volumetric Colour Information of the Normal Map node), both places need to have some parameters set. Playing only with the Geometry Intensity won't change anything if there aren't any parameters set in the Normal Map node.</p>

## Plugin Nodes

There are 2 plug-in node effects available in Harmony:

- Brightness-Contrast—see [Brightness Contrast Node](#) on page 522
- Sparkle

## Sparkle

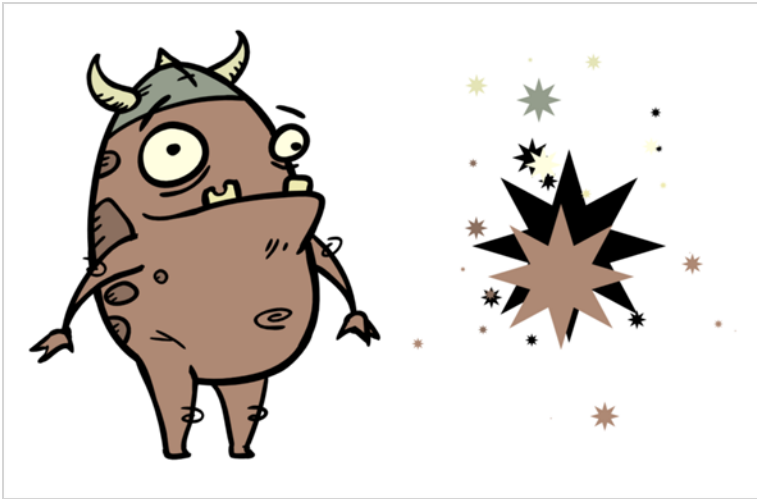

The Sparkle effect transforms a vector drawing into sparkles. You have a high degree of control over the appearance of the sparkles.

The sparkle effect can only be used with vector drawings. If the sparkle effect node is attached to a composite, verify that the Composite editor is set to Vector Flatten Output.

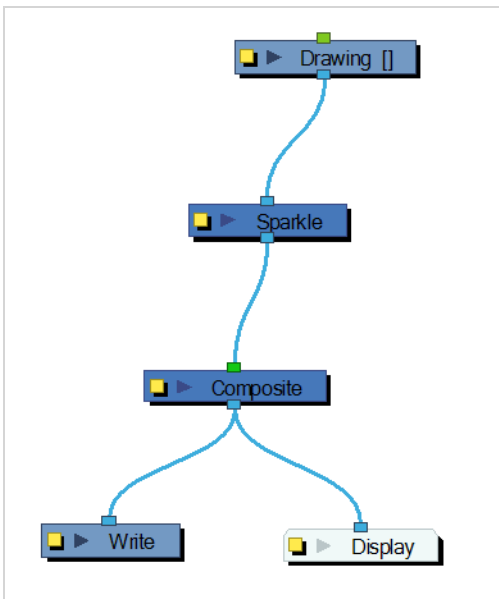

Use the Sparkle editor to modify how the Sparkle node creates the sparkle effect. You can also use Bezier and Ease function curves to change the values of factors over time.

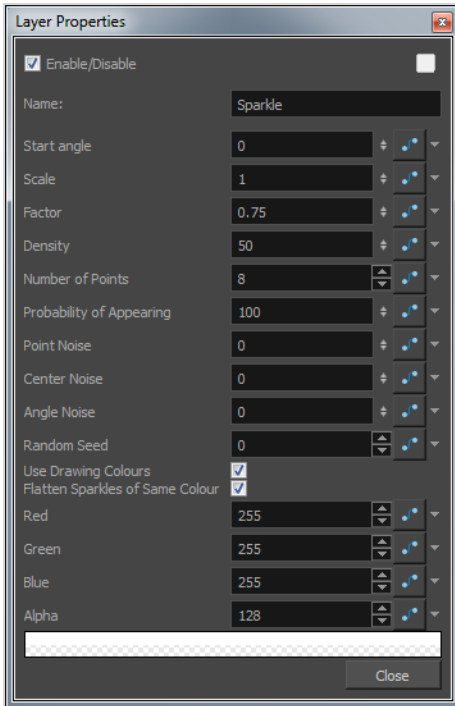

## Sparkle Properties

Parameter	Description
Start Angle	Enter a value between -360 and 360 to indicate the angle of rotation of each sparkle.
Scale	Sparkles are determined by the size of the bounding box of the coloured areas in the drawing. Enter the multiple to use to scale the sparkle size.
Factor	Enter a value between 0.1 and 1 to determine how pointy the sparkle is. A value closer to 0 will result in a more pointed sparkle. A value closer to 1 will result in a more rounded sparkle.
Density	Adjusts the density level.
Number of Points	Enter the number of points you want each sparkle to have.
<b>Probability of Appearing</b>	Enter the percentage of possibility that sparkles will be displayed. Enter 100 to always show sparkles. Enter 0 to always hide sparkles.
Point Noise	Enter a value between 0.1 and 1 to indicate the amount by which points in a sparkle will distort.



---

Centre Noise	Enter a value between 0.1 and 1 to indicate the amount by which the angles between each point in a sparkle will distort.
Angle Noise	Enter a value between 0.1 and 1 to indicate the amount by which the Start Angle in a sparkle will distort.
Random Seed	Enter a positive integer value that will be used to determine the sparkle pattern.
Use Drawing Colours	Select this option to use the colour attributes of the drawing for the sparkle colour. When this selection is disabled (default setting), the colour values will be used as they are entered in the editor.
Flatten Sparkles of Same Colour	Flatten all drawings of the same colour into a single layer.
Red/Green/Blue/Alpha	In the RGBA fields, enter the values to use for the sparkle colour.

## Selection Preset Note Node

The Selection Preset Note node appears in the Node view after an initial Selection Preset is created.

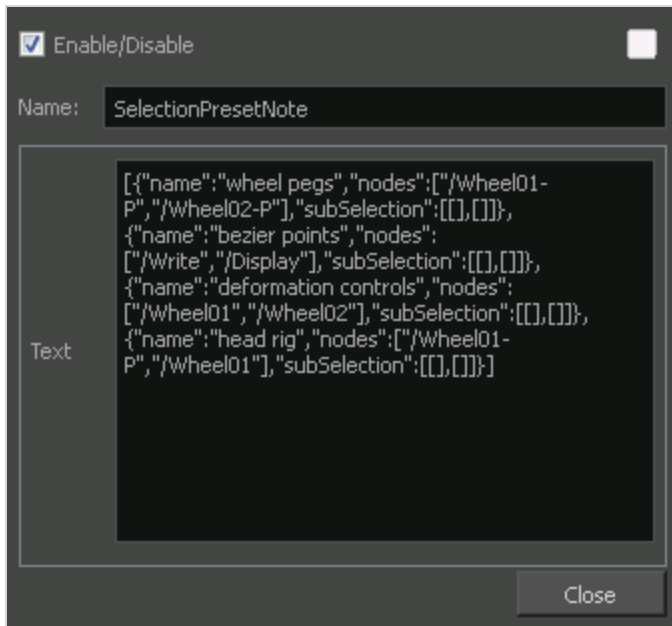

## Selection Preset Note Properties

Parameter	Description
Enable/Disable	Checking this option enables the node. Unchecking this option disables the node.
Track Colour	Click on this swatch to open the Select Colour window. Select a colour and click OK to mark the node with the selected colour. 
Name	Allows you to change the name given to the node.
Text	Displays the code text for the Selection Presets list that can be found in the Selection Presets window.

Close	Closes the Properties window.
-------	-------------------------------

## Sound Layer

When you select a sound layer in the Timeline view, the options related to that layer appear in the Layer Properties view.

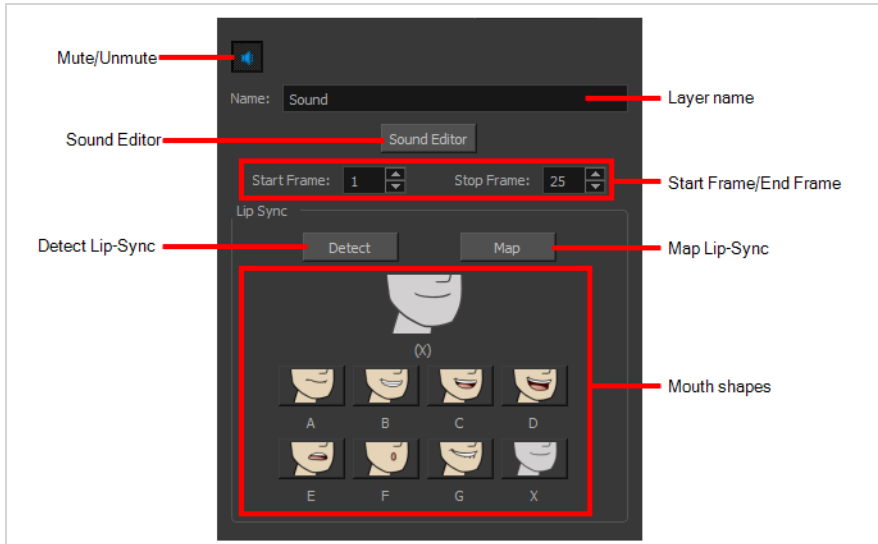

If you double-click on a sound layer in the Timeline view, or in a sound column in the Xsheet view, the Sound Element Editor dialog will open. This dialog allows you to fine-tune the sound track's lip sync, start time, stop time and volume.

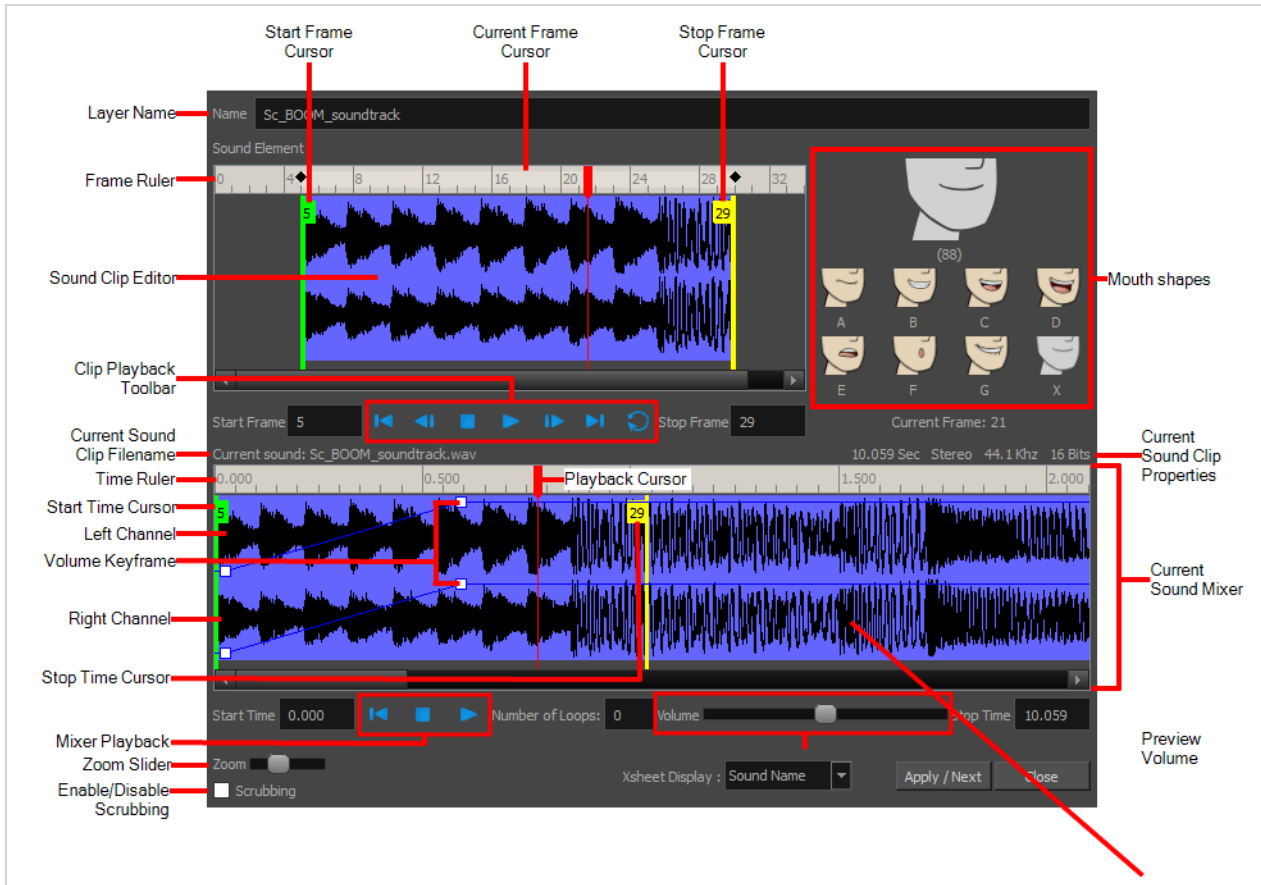

**NOTE**

Contrary to all other layers, sound layers are not represented by nodes in the Node view.



# Chapter 4: Tools Properties

Harmony has a wide variety of drawing and manipulation tools and each one of them has a series of options and modes available in the Tool Properties view. This section covers these options.

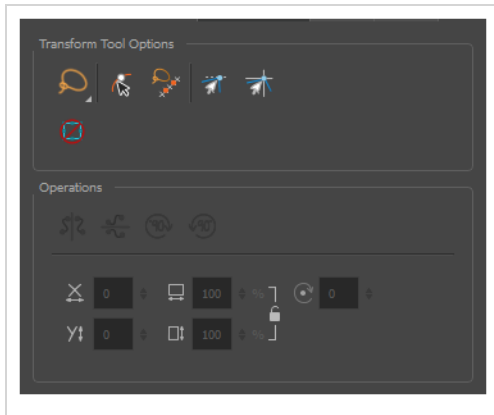

Brush Tool Properties .....	826
Centerline Editor Tool Properties .....	847
Close Gap Tool Properties .....	849
Contour Editor Tool Properties .....	850
Cutter Tool Properties .....	854
Drawing Pivot Tool Properties .....	858
Dropper Tool Properties .....	860
Edit Gradient/Texture Tool Properties .....	861
Ellipse Tool Properties .....	862
Envelope Tool Properties .....	871
Eraser Tool Properties .....	874
Ink Tool Properties .....	893
Inverse Kinematics Tool Properties .....	895
Line Tool Properties .....	898
Morphing Tool Properties .....	908
Paint Tool Properties .....	912
Pencil Tool Properties .....	919
Pencil Editor Tool Properties .....	929
Perspective Tool Properties .....	934

Polyline Tool Properties .....	937
Rectangle Tool Properties .....	945
Reposition All Drawings Tool Properties .....	954
Rigging Tool Properties .....	956
Select Tool Properties .....	959
Shift and Trace Tool Properties .....	971
Smooth Editor Tool Properties .....	974
Stroke Tool Properties .....	976
Text Tool Properties .....	978
Transform Tool Properties .....	981
Zoom Tool Properties .....	984



## Brush Tool Properties

The Brush tool allows you to draw by creating shapes based on your drawing strokes and filling them with colour or textures. When used with a tablet, it is pressure sensitive, just like a real life brush.

### How to access the Brush tool properties

1. In the Tools toolbar, select the Brush  tool.

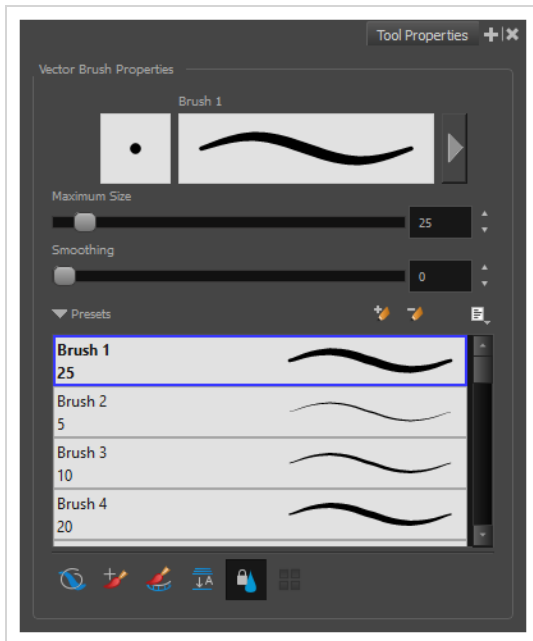

The tool's properties are displayed in the Tool Properties view.



## Brush Properties

The following properties affect the brush's size, smoothing and other properties for the drawing style of your brush. Those properties can be saved into brush presets for later use.





Property	Description
Preview Area	The Preview area lets you see a preview of the stroke your drawing tool will make. 
Brush Properties Dialog	The arrow button right of the preview area opens the Brush Properties dialog.

Property	Description
	 <p>While the Tool Properties view only gives you access to a few of the brush properties, a list of brush presets and other drawing options, the Brush Properties dialog gives you access to all the available options for your brush's tip and texture. For more information on the Brush Properties dialog, see the <a href="#">Brush Properties Dialog</a> section below.</p>
Maximum Size	<p>Defines the maximum width of brush strokes.</p> <p>If the tool is used with a pressure sensitive pen tablet, the width of the stroke will vary between its maximum size and minimum size depending on the amount of pressure used. If used with a mouse, the width of the stroke will always be its maximum size.</p>
Smoothing	<p>Defines the number of control points added to the centre line. The fewer the control points the smoother (but less faithful) the line.</p> <div data-bbox="527 982 1429 1119" style="border: 1px solid #90EE90; padding: 5px;">  <p><b>NOTE</b> This option is only available when drawing on a vector layer.</p> </div>
Flow	<p>Lets you set the opacity for each instance of the brush tip that gets printed into your canvas. Contrary to the Opacity parameter, the flow parameter has a cumulative effect. This means that a lower flow will make your brush strokes more transparent towards its extremities and more opaque in its center. Your stroke's flow will also accumulate if you draw over it. By default, your brush's flow varies with the amount of pressure you put on your tablet pen.</p> <div data-bbox="527 1417 1429 1585" style="border: 1px solid #90EE90; padding: 5px;">  <p><b>NOTE</b> This option is only displayed in the Tool Properties view when drawing on a bitmap layer.</p> </div>
Opacity	<p>The Opacity parameter are where Lets you set the opacity of your brush strokes. Contrary to the Flow parameter, the Opacity parameter is non-cumulative. Your whole brush stroke's opacity will not exceed the Opacity parameter. By default, the Opacity parameter varies depending on the amount of pressure you put on your tablet pen.</p>

Property	Description
	<div style="border: 1px solid #c8e6c9; padding: 10px;">  <p><b>NOTE</b></p> <p>This option is only displayed in the Tool Properties view when drawing on a bitmap layer.</p> </div>

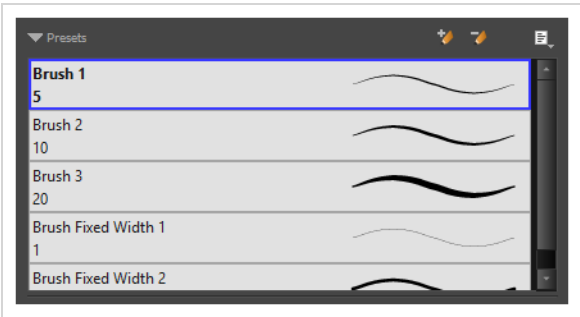
## Brush Presets







These options allow you to select, create and manage brush presets.







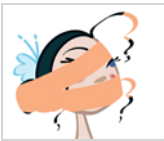

Icon	Property	Description
	Presets list	<p>By default, Harmony has preloaded brush presets. You can also create your own brush presets by configuring your brush, then saving its properties into a new preset. It is also possible to export and import brush presets.</p> 
	New Brush Preset	Creates a new preset based on the current tool properties.
	Delete Brush	Deletes the currently selected preset.
	Brush Presets Menu	<p>Open a menu that contains the following options:</p> <ul style="list-style-type: none"> <li>• <b>New Brush Preset:</b> Creates a new preset based on the current tool properties.</li> <li>• <b>Delete Brush:</b> Deletes the currently selected preset.</li> <li>• <b>Rename Brush:</b> Allows you to rename the currently selected preset.</li> <li>• <b>Import Brushes:</b> Allows you to import brush presets exported from Harmony.</li> </ul>

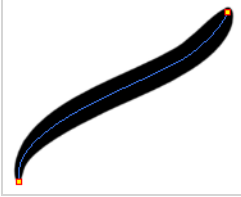
		<ul style="list-style-type: none"> <li>• <b>Export Brushes:</b> Allows you to export your brush presets into an <code>.xml</code> file.</li> <li>• <b>Small Thumbnail:</b> Displays presets in a grid of small thumbnails with a preview of their tip.</li> <li>• <b>Large Thumbnail:</b> Displays presets in a grid of big thumbnails, with their name and a preview of their tip.</li> <li>• <b>Stroke View:</b> Displays presets in a list, with their name and a preview of a stroke done with each preset.</li> </ul>
--	--	--

## Drawing Options

These options affect the way your drawing strokes are added to your artwork.

Icon	Property	Description
	Draw Behind	<p>When enabled, your brush strokes will appear behind the existing artwork.</p>  <p>The orange stroke was drawn over the black stroke, then put underneath it.</p> <div style="border: 1px solid green; padding: 5px; margin-top: 10px;">  <p><b>NOTE</b> Your brush stroke will temporarily appear over your artwork as you draw it, until you release the mouse cursor or tablet pen.</p> </div>
	Repaint Brush	<p>When enabled, your brush strokes will only repaint existing artwork and will not add colour to empty areas. If you repaint semi-transparent artwork, your artwork will not become more opaque than it already is.</p> 
	Automatically Create Colour Art	<p>As you draw in the Line Art layer, the Automatically Create Colour Art option instantly creates the corresponding strokes in the Colour Art layer.</p>

		 <div data-bbox="649 422 1429 560" style="border: 1px solid green; padding: 5px;">  <p><b>NOTE</b> This option is only available when drawing on a vector layer.</p> </div>
	Auto-Flatten Mode	<p>By default, when drawing on a vector layer, each new stroke is created as a separate drawing object, which can be edited independently from other parts of the artwork. When enabled, the Auto-Flatten option automatically merges strokes into existing artwork.</p> <div data-bbox="649 787 1429 955" style="border: 1px solid green; padding: 5px;">  <p><b>NOTE</b> This option is only available when drawing on a vector layer. When drawing on a bitmap layer, artwork is always flattened.</p> </div>
	Respect Protected Colour	<p>In the Colour view, it is possible to make some of the colours in your palettes protected from change. When enabled, the Respect Protected Colour option will prevent the brush tool from drawing over areas filled with a protected colour.</p> <div data-bbox="649 1182 1429 1381" style="border: 1px solid green; padding: 5px;">  <p><b>NOTE</b> This option is only available when drawing on a vector layer. When drawing on a bitmap layer, colour is not linked to your palettes and cannot be protected.</p> </div>
	Use Stored Colour Gradient	<p>The Use Stored Colour Gradient option can be used when painting with a gradient colour to always position the gradient in the same way it was stored, making it consistent across brush strokes. You can store a gradient by selecting a zone painted with a gradient with the Select tool, then clicking on Store Colour Gradient  in the Tool Properties view.</p> <div data-bbox="649 1648 1429 1787" style="border: 1px solid green; padding: 5px;">  <p><b>NOTE</b> This option is only available when drawing on a vector layer.</p> </div>

## Brush Properties Dialog

Brushes have an extensive set of options and properties that are not displayed in the Tool Properties view, but rather, in a dialog you can access from it. To open the Brush Properties dialog, click on the arrow button right of the stroke display area.



The Brush Properties dialog has five different tabs, minus the Smoothing tab if you are working on a bitmap layers. Below is detailed information about the options available in each tab:

- [Tip Tab](#) on page 831
- [Smoothing Tab](#) on page 836
- [Transparency Tab](#) on page 837
- [Dual Tip Tab](#) on page 840
- [Paper Texture Tab](#) on page 844

### Tip Tab

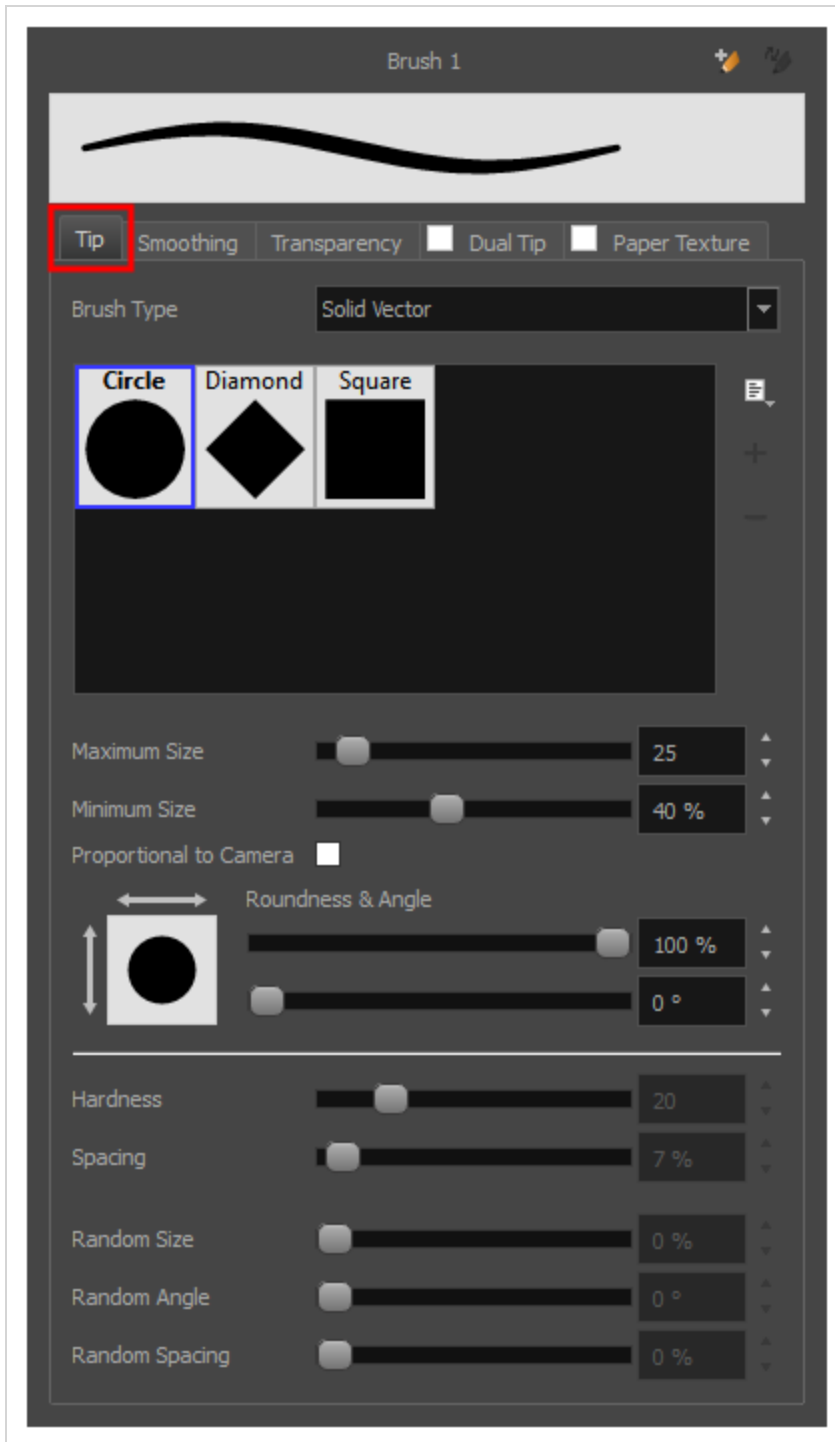

The Tip tab allows you to configure the shape, size, hardness and spacing of your brush tip.



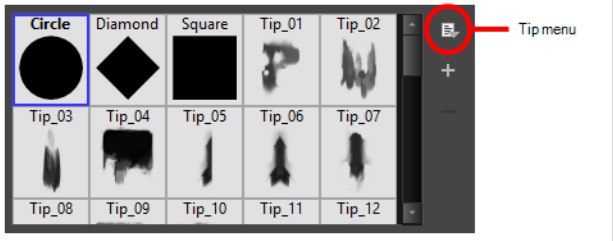

Property	Description
Brush Type	<p>Allows you to select between one of the following brush types:</p> <ul style="list-style-type: none"> <li>• <b>Solid Vector Brush:</b> Creates vector shapes filled with a solid colour. Makes artwork lightweight, scalable and easy to tweak. Since this kind of brush can only create solid colour shapes, solid vector brushes have a</li> </ul>

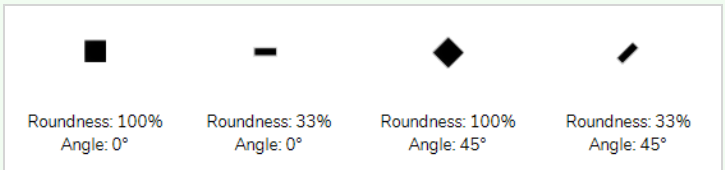
	<p>limited set of options including size, roundness, angle, centerline smoothing and contour smoothing.</p> <ul style="list-style-type: none"> <li>• <b>Textured Vector Brush:</b> Creates vector shapes filled with a texture. This gives you access to bitmap brush tips, paper textures, transparency and several other options.</li> </ul> <div data-bbox="570 411 1430 611" style="border: 1px solid green; padding: 10px; margin-top: 10px;"> <p> <b>NOTE</b></p> <p>This option is not available when working on a bitmap layer. With bitmap layers, brushes are always textured, and textured brush options are always available.</p> </div>
<p>Brush Tip Library</p>	<div data-bbox="570 667 1190 926" style="border: 1px solid gray; padding: 5px; margin-bottom: 10px;">  </div> <p>This is where you select the shape of the brush tip. By default it is round. Note that some tips are designed to have semitransparent areas, even when the maximum brush opacity is set to 100%.</p> <p>To create a custom brush tip, you must prepare the file ahead of time, either in Harmony or in a third-party software, such as Adobe Photoshop. Colour is not supported and transparency is not supported in the traditional sense. Black appears as 100% opaque, white appears as 100% transparent and all the shades of grey in between appear as varying degrees of semitransparency. A range of file formats are supported—.jpeg, .png, .tif, .psd, .tga to name a few. Alpha channels are disregarded on import. It is recommended that your file be between 100 x 100 pixels and 400 x 400 pixels.</p> <p>You can also import brush tips that you exported from Harmony, so you can share them with colleagues.</p>
<p>Minimum and Maximum Size</p>	<p>The minimum and maximum sizes of your drawing tool produce the thick and thin effect on your stroke. This works with the pressure sensitivity of a pen tablet.</p> <ul style="list-style-type: none"> <li>• <b>Maximum Size:</b> Defines the maximum width of the stroke.</li> <li>• <b>Minimum Size:</b> Defines the minimum width of the stroke in relation to and as a percentage of the maximum size.</li> </ul>

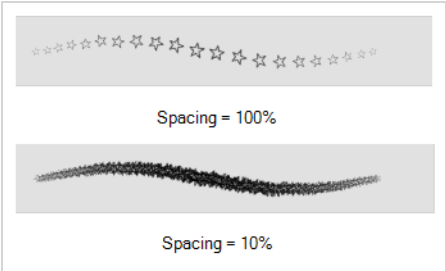
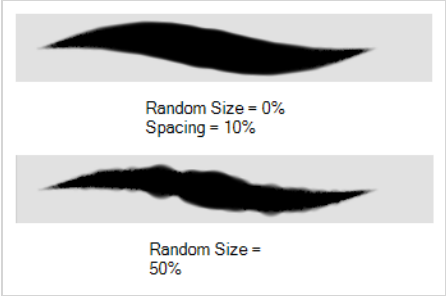

	<div data-bbox="570 191 1430 390" style="border: 1px solid #c8e6c9; padding: 10px;">  <p><b>NOTE</b></p> <p>Setting the Minimum Size value to 100% eliminates the possibility of creating width variation on your stroke. In other words, you would be forcing a uniform line width using the Maximum Size value.</p> </div>				
Proportional to Camera	<p>If you check this option, the size of the brush will be adjusted to the position of the camera on the z-axis. This means that if the camera is zoomed in on the scene, the brush will be proportionally smaller so that it appears the same size in the rendered image. Likewise, if the camera is zoomed out, the brush will be proportionally bigger.</p>				
Roundness and Angle	<p>The Roundness and Angle parameters allow you to change the shape and orientation of the tip.</p> <ul style="list-style-type: none"> <li>• <b>Roundness:</b> The vertical scaling to apply to the tip. Reducing this setting squashes the tip vertically, allowing you to turn round or square tips into flat tips.</li> <li>• <b>Angle:</b> The angle at which to rotate the brush tip, counterclockwise.</li> </ul> <div data-bbox="570 957 1430 1318" style="border: 1px solid #c8e6c9; padding: 10px;"> <div data-bbox="597 984 657 1052" style="float: left; margin-right: 10px;"></div> <p><b>NOTE</b></p> <p>The squashing is not relative to the angle—if the tip is rotated, the squashing will still be done relative to the tip's original orientation.</p> <div style="text-align: center; margin-top: 10px;">  <table style="width: 100%; margin-top: 5px;"> <tr> <td style="text-align: center;">Roundness: 100% Angle: 0°</td> <td style="text-align: center;">Roundness: 33% Angle: 0°</td> <td style="text-align: center;">Roundness: 100% Angle: 45°</td> <td style="text-align: center;">Roundness: 33% Angle: 45°</td> </tr> </table> </div> </div>	Roundness: 100% Angle: 0°	Roundness: 33% Angle: 0°	Roundness: 100% Angle: 45°	Roundness: 33% Angle: 45°
Roundness: 100% Angle: 0°	Roundness: 33% Angle: 0°	Roundness: 100% Angle: 45°	Roundness: 33% Angle: 45°		
Hardness	<p>The hardness value corresponds to the softness of the brush tip's edges. The lower the value, the softer the tip edge. The higher the value, the sharper the tip edge. Be aware that some brush tips are not 100% opaque, so they will always appear somewhat soft, even at 100% hardness.</p> <div data-bbox="570 1539 899 1696" style="border: 1px solid #ccc; padding: 5px; margin-top: 10px;">  <p style="text-align: center; margin-top: 5px;">100% Hardness      10% Hardness</p> </div>				
Spacing	<p>Defines the amount of space between each stamp of the brush. A value of 100% sets the stamp marks edge to edge, if there is no white space around the shape. The larger the value, the greater the space between marks. A really large value can make the brush stroke appear as a string of individual marks. Conversely, a</p>				

	<p>small spacing value will give the appearance of a fluid brush stroke.</p> <p>Spacing is only evident when making a continuous stroke.</p> 
<p>Randomness</p>	<p>The Randomness parameters let you create a varied brush stroke. Refining these options can give your stroke a lovely, non-mechanical look.</p>
<p>Random Size</p>	<p>You can create variation between the thick and thin of your brush stroke just by setting the Maximum and Minimum Size values. If you add randomness to the mix, pressure sensitivity from your drawing tablet will still be applied. Light pressure will create random values around the minimum, while heavy pressure will create random values closer to the maximum. The larger the percentage, the larger the range of random variation.</p>  <div data-bbox="570 1325 1430 1560" style="border: 1px solid green; padding: 10px; margin-top: 10px;"> <p> <b>NOTE</b></p> <p>Setting the Minimum Size to 100% eliminates the possibility of creating width variation on your stroke, whether you are applying randomness or not. Therefore, you would be forcing a uniform line width using the Maximum Size value.</p> </div>
<p>Random Angle</p>	<p>Sets the range for random rotation around the set Angle value. For example, if the Angle is set to 45° and the Random Angle set to 10°, the software will choose values between 40°–50° (plus or minus 5 degrees, equaling a total of 10 degrees).</p>

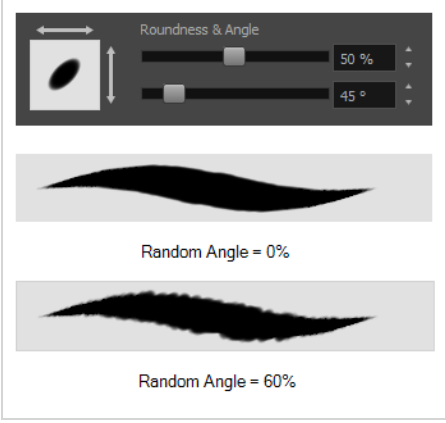
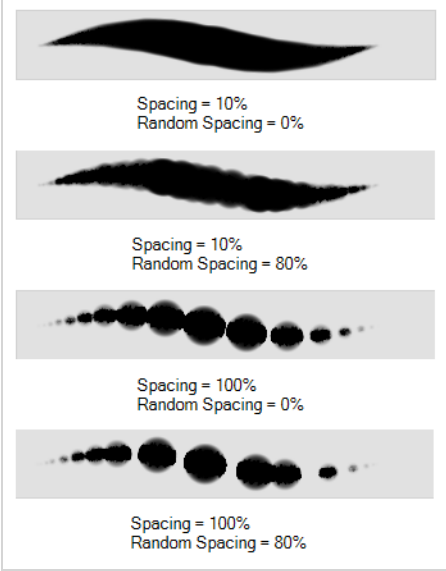
	
Random Spacing	<p>Sets the range for random spacing around the set Spacing value. For example, if the Spacing is set to 50% and the Random Spacing is set to 10%, then Harmony will choose values between 45%–55% (plus or minus 5 percent, equaling a total of 10 percent).</p> 

## Smoothing Tab

The Smoothing tab contains options to configure how Harmony should automatically smooth your brush strokes as you paint.

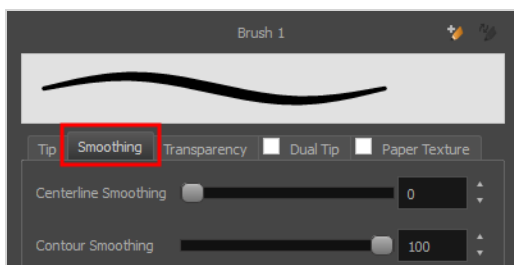



**NOTE**

The Smoothing tab is only available when working on a vector layer, as bitmap layers do not support smoothing.

Property	Description
Centerline Smoothing	Defines the amount of smoothing Harmony should perform on your brush stroke's direction, curves and corners. A higher setting will prevent your line from being shaky, but is liable to reduce drawing precision and turn sharp angles into curves.
Contour Smoothing	Defines the amount of smoothing Harmony should perform on outer contour of the brush stroke. A higher setting will round sharp corners and reduce the amount of control points for the resulting vector shape.

## Transparency Tab

The Transparency tab allows you to decide if your brush has antialiasing as well as to set its flow and opacity settings.

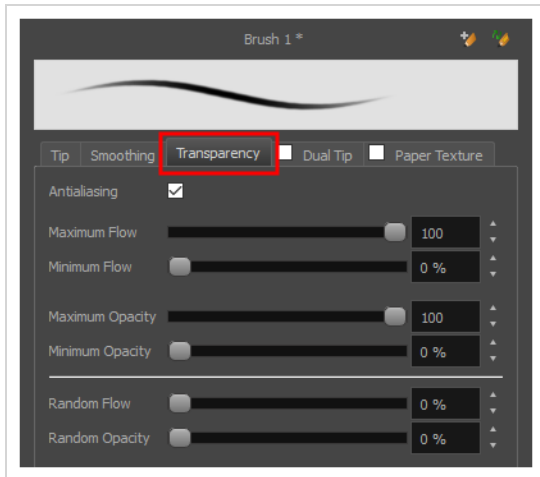



**NOTE**

The Transparency tab's options are only available on vector layers if the **Brush Type** option of the **Tip** tab is set to **Textured Vector Brush**. On bitmap layers, those options are always available.

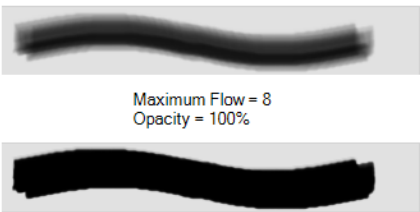
Property	Description
Antialiasing	Enabled by default. This option causes the contours of the brush strokes to

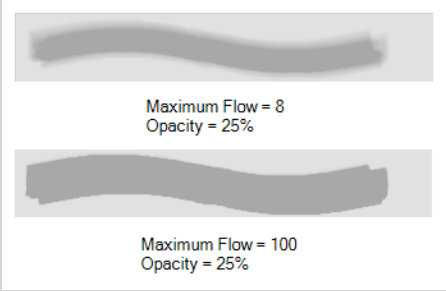
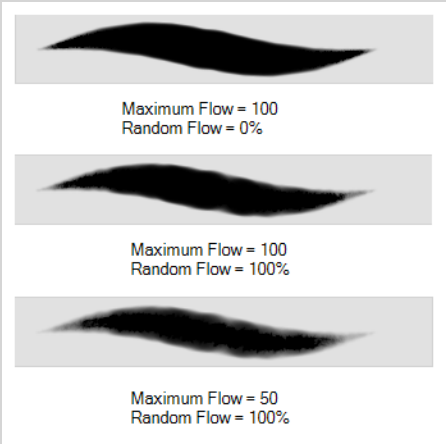
	<p>blend with the surrounding colours, to create an illusion of smoothness otherwise not possible due to the picture resolution.</p> <p>If antialiasing is disabled, the brush's texture will only render fully transparent or fully opaque pixels. Disabling this option can be useful if you need your outlines to be very crisp, if you want to make pixel art or if you need your brush strokes to render in solid colors with no variation, which makes them easier to repaint or process in third party software.</p> <div data-bbox="573 485 1430 621" style="border: 1px solid green; padding: 5px;">  <p><b>NOTE</b> When disabled, all other options in the Transparency tab are disabled.</p> </div>
Maximum and Minimum Flow	<p>The Maximum and Minimum Flow parameters let you set the range for the rate at which paint flows from your brush. The analogy works better with a pen. The greater the flow, the more ink comes out, hence the more consistent the colour and texture of the line. If the flow is light, then the colour and texture of the line may look spotty. This feature works with the pressure sensitivity of a pen tablet.</p> <ul style="list-style-type: none"> <li>• <b>Maximum Flow:</b> Sets the maximum rate at which colour and texture are applied as you create a fluid stroke.</li> <li>• <b>Minimum Flow:</b> Sets the minimum rate at which colour and texture are applied as you create a fluid stroke. It is defined as a percentage of the Maximum Flow value. If the Minimum Flow value is set to 100%, then tablet pressure sensitivity will no longer be applicable. The flow will be set to the constant rate of the Maximum Flow value.</li> </ul> <div data-bbox="573 1161 1016 1451" style="border: 1px solid gray; padding: 10px;">  </div>
Maximum Opacity and Minimum Opacity	<p>The Maximum and Minimum Opacity parameters are where you set the opacity range for a brush mark. This works with the pressure sensitivity of a pen tablet.</p> <ul style="list-style-type: none"> <li>• <b>Maximum Opacity:</b> Sets the transparency limit of the brush mark when the pressure is heavy.</li> <li>• <b>Minimum Opacity:</b> Sets the transparency limit of the brush mark when the pressure is very light. It is defined as a percentage of the Maximum Opacity value. If the Minimum Opacity value is set to 100%, then tablet pressure sensitivity will no longer be applicable. The opacity will be set to the constant rate of the Maximum Opacity value.</li> </ul>

	
<p>Randomness</p>	<p>The Randomness parameter lets you set the range for the randomness of the flow and opacity. This works with the pressure sensitivity of a pen tablet.</p>
<p>Randomness Flow</p>	<p>You can create variation in the flow of your brush stroke just by setting the Maximum and Minimum Flow values. If you add randomness to the mix, pressure sensitivity from your drawing tablet will still be applied. Light pressure will create random values around the minimum, while heavy pressure will create random values closer to the maximum. The larger the percentage, the larger the range of random variation.</p>  <div data-bbox="573 1388 1430 1619" style="border: 1px solid green; padding: 10px;"> <p> <b>NOTE</b></p> <p>Setting the Minimum Flow value to 100% eliminates the possibility of creating flow variation on your stroke, whether you are applying randomness or not. That is, you would be forcing a uniform flow using the Maximum Flow value.</p> </div>
<p>Random Opacity</p>	<p>You can create variation in the opacity of your brush stroke just by setting the Maximum and Minimum Opacity values. If you add randomness to the mix, pressure sensitivity from your drawing tablet will still be applied. Light pressure will create random values around the minimum, while heavy pressure will create random values closer to the maximum. The larger the percentage, the larger the range of random variation.</p>

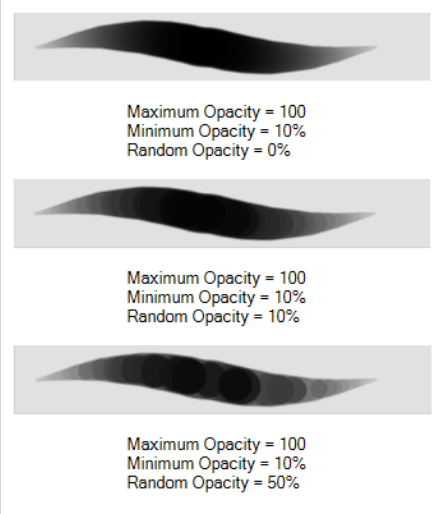

Maximum Opacity = 100  
Minimum Opacity = 10%  
Random Opacity = 0%

Maximum Opacity = 100  
Minimum Opacity = 10%  
Random Opacity = 10%

Maximum Opacity = 100  
Minimum Opacity = 10%  
Random Opacity = 50%

 **NOTE**  
Setting the Minimum Opacity value to 100% eliminates the possibility of creating opacity variation on your stroke, whether you are applying randomness or not. That is, you would be forcing a uniform opacity using the Maximum Opacity value.

## Dual Tip Tab

The Dual Tip tab lets you set the parameters for creating a dual tip brush. The primary bitmap brush tip and the dual tip always work together. You can set the parameters for the primary tip in the Tip tab and those for the dual tip in the Dual Tip tab. The Blend mode you select determines how the tips are combined.

By default, the Blend Mode is set to Multiply and the Random Angle to 360°.

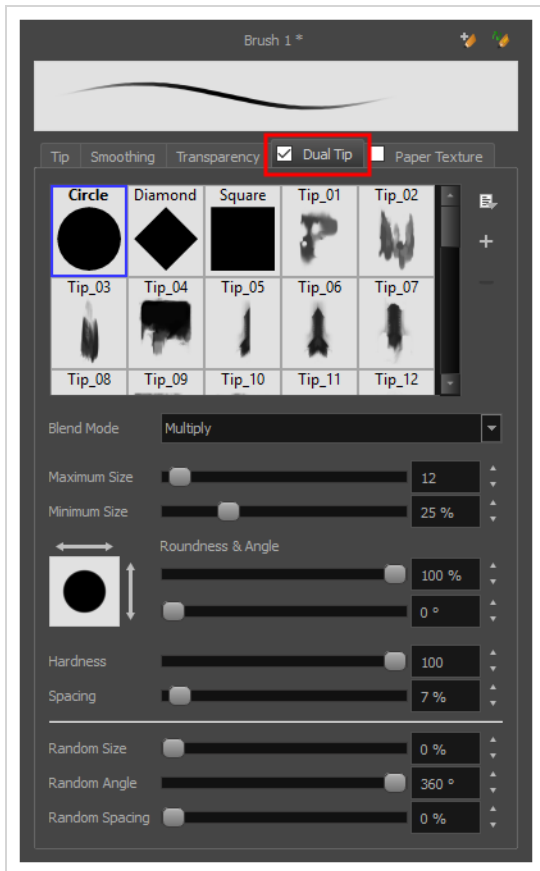

**NOTE**

To use a Dual Tip, you must enable option by checking the checkbox inside the **Dual Tip** tab. Additionally, if you are working on a vector layer, the **Brush Type** option of the Tip tab must be set to **Textured Vector Brush**.

Property	Description
Enable/Disable	The checkbox inside the tab allows you to decide whether or not your brush uses a dual tip. If this checkbox is unchecked, the options in the Dual Tip tab will be disabled.
Blend Mode	The Blend modes let you decide how the primary tip and the dual tip are combined.
Multiply	This is the default blend mode. When the two brush tips are combined in this mode, they essentially cut each other out in overlapping areas, where one or both tips have an area of 100% transparency. The less opaque the brush tips are, the lighter their combination.

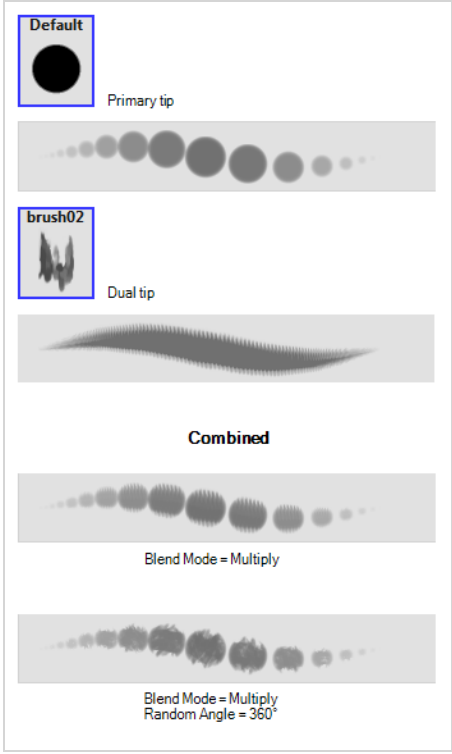

Property	Description
	 <p>Default Primary tip</p> <p>brush02 Dual tip</p> <p>Combined</p> <p>Blend Mode = Multiply</p> <p>Blend Mode = Multiply Random Angle = 360°</p>
Colour Dodge	<p>In this mode, the primary tip cuts out the shape of the dual tip. Where the tip shapes overlap, within the boundaries of the primary shape, the colour and opacity appear darker.</p>

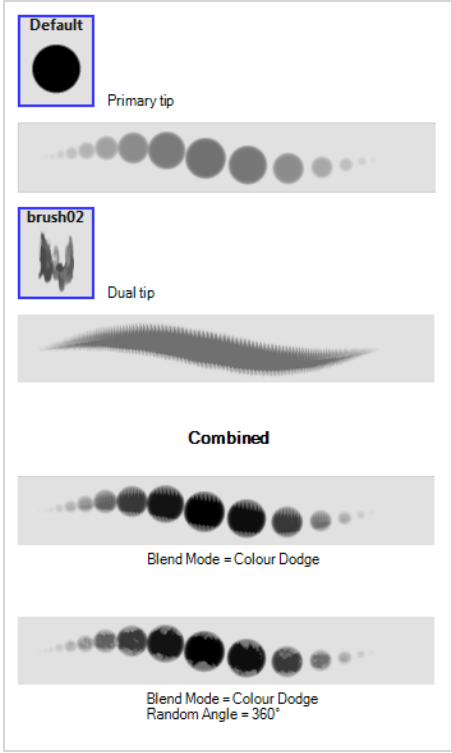
Property	Description
	 <p>The diagram illustrates the 'Combine' brush mode. It shows two individual brush tips: a solid black circle labeled 'Default' with 'Primary tip' and a dual-pointed brush labeled 'brush02' with 'Dual tip'. Below these are stroke examples. The 'Combined' section shows a stroke where the two tips are overlaid, with 'Blend Mode = Colour Dodge'. A second example shows the same stroke with 'Blend Mode = Colour Dodge' and 'Random Angle = 360°', resulting in a more textured, multi-colored appearance.</p>
Combine	<p>This mode treats the two tips as two different and separate brushes that have the same colour and follow the same path.</p>

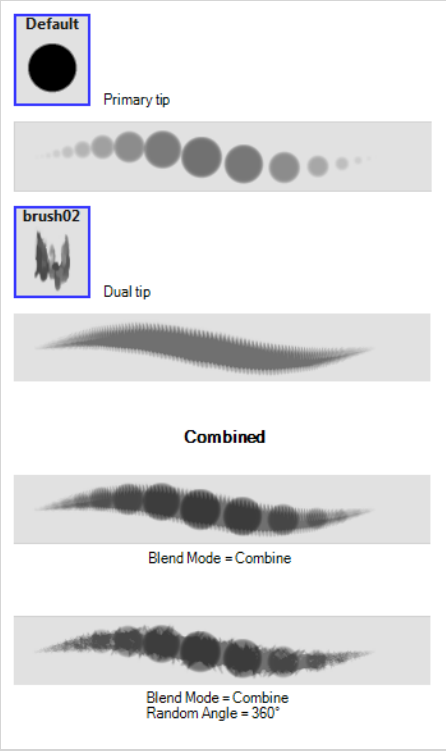
Property	Description
	 <p>The diagram illustrates different brush tip configurations and their combinations. It is organized into three main sections:</p> <ul style="list-style-type: none"> <li><b>Default:</b> Shows a 'Primary tip' represented by a solid black circle. Below it is a horizontal row of circles of varying sizes, representing a gradient or soft edge.</li> <li><b>brush02:</b> Shows a 'Dual tip' represented by two small, dark, irregular shapes. Below it is a horizontal, wavy, feathered stroke.</li> <li><b>Combined:</b> Shows two examples of the 'Default' and 'brush02' strokes combined.       <ul style="list-style-type: none"> <li>The first example is labeled 'Blend Mode = Combine' and shows the two strokes overlapping horizontally.</li> <li>The second example is labeled 'Blend Mode = Combine' and 'Random Angle = 360°' and shows the two strokes overlapping at various angles.</li> </ul> </li> </ul>

## Paper Texture Tab

The Paper Texture tab lets you configure a paper-like texture for your brush. You can also add textures by importing image files, or import paper textures that were previously exported from Harmony.

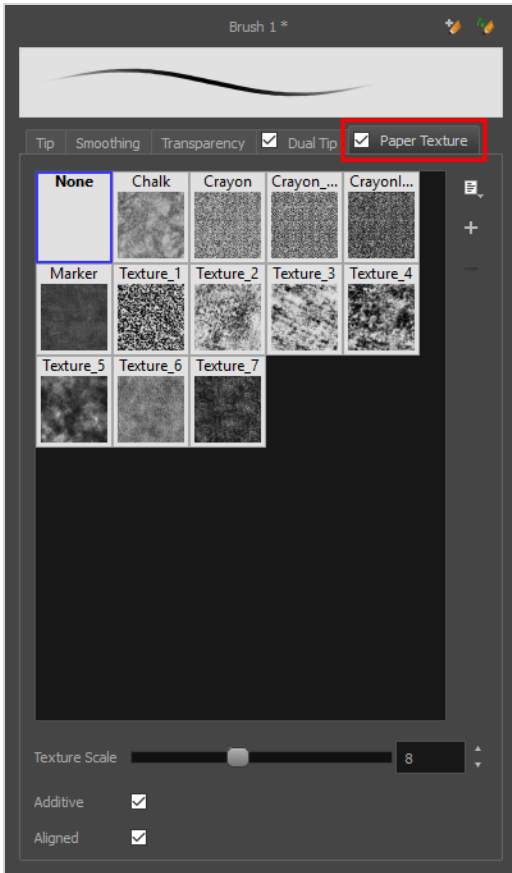

**NOTE**

To use a Paper Texture, you must enable option by checking the checkbox inside the **Paper Texture** tab. Additionally, if you are working on a vector layer, the **Brush Type** option of the Tip tab must be set to **Textured Vector Brush**.

Property	Description
Enable/Disable	The checkbox inside the tab allows you to decide whether or not your brush uses a paper texture. If this checkbox is unchecked, the options in the Paper Texture tab will be disabled.
Texture Scale	Increase or decreases the size of the paper texture.
Additive	This option layers the texture on top of itself as you scribble overlapping lines in one continuous stroke. If this option is turned off, areas of overlapping lines from a single, continuous stroke will appear the same, in terms of darkness and texture, as non-overlapping areas.

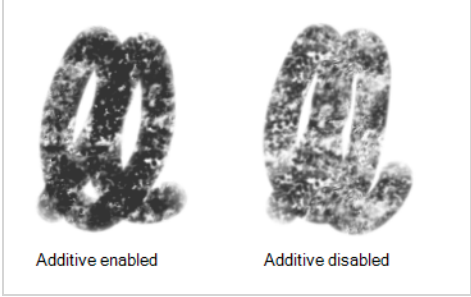
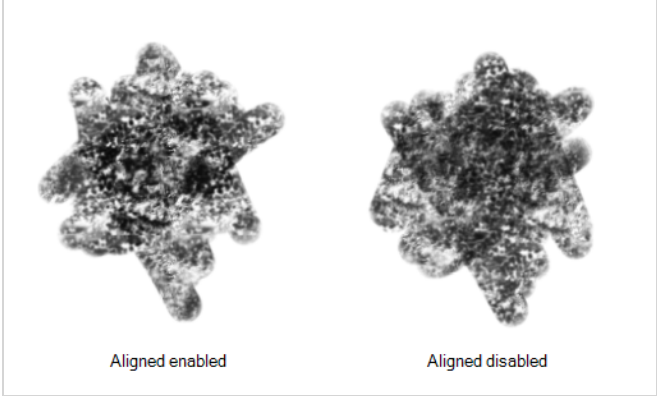
Property	Description
	 <p data-bbox="553 533 678 552">Additive enabled</p> <p data-bbox="781 533 906 552">Additive disabled</p>
Aligned	<p data-bbox="522 648 1419 783">This option defines the way separate, overlapping strokes behave. If this option is enabled, the paper texture's position does not change with each sweep of the brush. If this option is disabled, each sweep of the brush produces a different texture position. The texture orientation always stays the same.</p>  <p data-bbox="630 1161 755 1180">Aligned enabled</p> <p data-bbox="943 1161 1068 1180">Aligned disabled</p>

## Centerline Editor Tool Properties





The Centerline Editor tool allows you to edit brush strokes by their centreline rather than by their contour. This makes it easier to tweak the tips, curves and corners of brush strokes. The purpose of this tool is to make it as easy to edit brush strokes as it is to edit pencil lines with the Contour Editor tool.

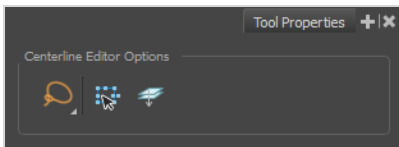

### How to access the Centerline Editor tool properties

1. In the Tools toolbar, select the Centerline Editor  tool.
2. The tool's properties are displayed in the Tool Properties view.

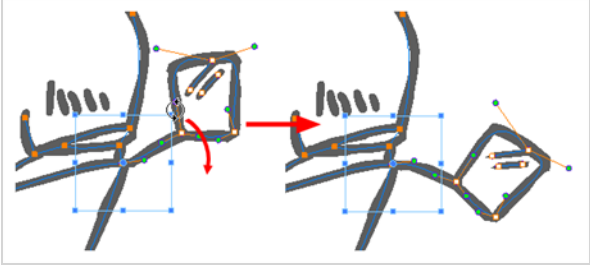

## Tool Options

Icon	Property	Description
	Selection Mode	<p>Allows you to choose the method to visually select multiple elements:</p> <ul style="list-style-type: none"> <li>•  <b>Lasso:</b> Allows you to select multiple elements by drawing a lasso around them with your mouse.</li> <li>•  <b>Marquee:</b> Allows you to select multiple elements by drawing a rectangle around them. This is faster, as you only need to drag your mouse from one corner of the rectangle to its opposite corner, but it may not be as precise as you want.</li> </ul> <div style="border: 1px solid #add8e6; padding: 10px; margin-top: 10px;"> <p> <b>TIP</b> You can press and hold the Alt key to temporarily use the other selection mode.</p> </div>
	Show Centerline Editor Controls	<p>When enabled, selecting several control points will make a manipulator bounding box appear. You can use this manipulator to scale and rotate the selection of points.</p>

Icon	Property	Description
		
	Apply to Line and Colour Art	<p>Allows you to perform drawing operations on both the Line Art and Colour Art layers of your drawing simultaneously.</p> <div data-bbox="738 716 1430 884" style="border: 1px solid green; padding: 5px;"><p> <b>NOTE</b> If you have Overlay and Underlay Art layers enabled, they will also be affected when this option is enabled.</p></div>

## Close Gap Tool Properties

The paint tool requires the area you attempt to fill to be closed in order to know exactly what area of your artwork must be filled. However, it is common for artists to accidentally leave small gaps in their artwork.

The Close Gap tool allows you to quickly close small gaps in a shape by creating an invisible stroke connecting two extremities of the gap. You can then fill the area using the Paint tool, as this invisible stroke will be taken in account to determine the outline of the shape to fill.



### TIP

You do not need to use the Close Gap tool with precision. If you draw a crude stroke near the gap you want to close, the tool will automatically detect the two closest line extremities and will draw an invisible straight line connecting them, closing the gap between them.



### How to access the Close Gap tool properties

1. In the Tools toolbar, select the Close Gap  tool.

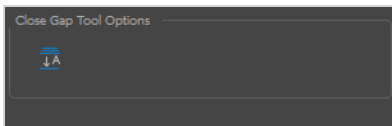
The tool's properties are displayed in the Tool Properties view.



## Tool Options

Icon	Property	Description
	Auto Flatten	<p>The Close Gap tool creates an invisible drawing stroke to close the shape. Enabling this option will merge the stroke into the artwork instead of adding the stroke on top of it.</p> <div style="border: 1px solid green; padding: 10px; margin-top: 10px;"> <p> <b>NOTE</b></p> <p>The area you close with the Close Gap tool will be fillable regardless of whether or not this option is enabled.</p> </div>



## Contour Editor Tool Properties

The Contour Editor lets you reshape vector shapes, brush strokes and lines in your drawings.

Artwork in Harmony is made of vector shapes. Vector shapes are defined by points, the lines joining the points together (contours) and the curve vectors, represented by Bezier handles, which make the curve of said lines.

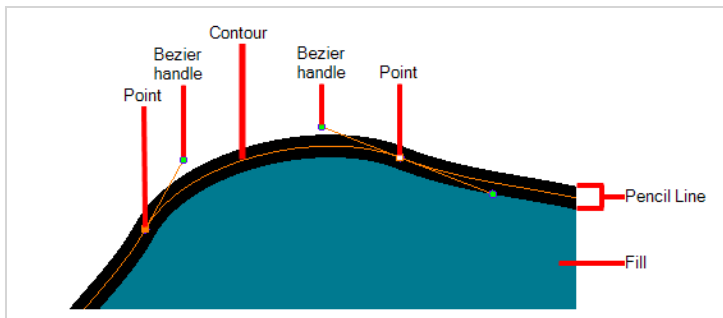

The Contour Editor tool allows you to select a contour or point, and change the position of points, add and remove points from the shape, rotate, lengthen and shorten curve handles to influence the curve of contours between those points, or drag contours between points to change their curve directly.



### How to access the Contour Editor tool properties



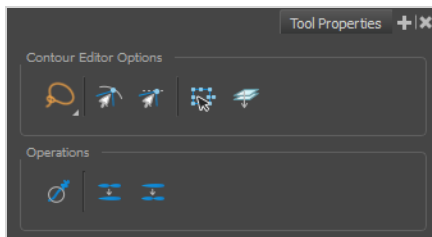





1. In the Tools toolbar, select the Contour Editor  tool.

The tool's properties are displayed in the Tool Properties view.

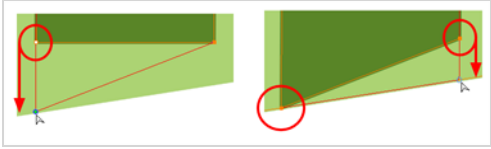

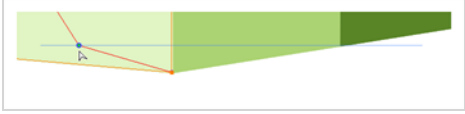

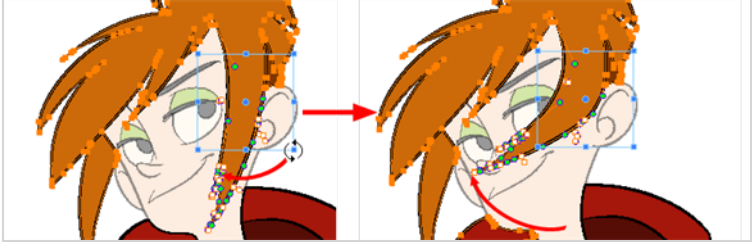

## Tool Modes

Icon	Property	Description
	Selection Mode	<p>Allows you to choose the method to visually select multiple elements:</p> <ul style="list-style-type: none"> <li>•  <b>Lasso:</b> Allows you to select multiple elements by drawing a lasso around them with your mouse.</li> <li>•  <b>Marquee:</b> Allows you to select multiple elements by drawing a rectangle around them. This is faster, as you only need to drag your mouse from one corner of the rectangle to</li> </ul>

Icon	Property	Description
		<p>its opposite corner, but it may not be as precise as you want.</p> <div data-bbox="683 342 1430 512" style="border: 1px solid #add8e6; padding: 10px;"> <p> <b>TIP</b> You can press and hold the ALT key to temporarily use the other selection mode.</p> </div>
	<p>Snap to Contour</p>	<p>Snaps your selection or point to any line you position it on. As soon as you move it close enough to another line, your point or selection will snap to it.</p> 
	<p>Snap and Align</p>	<p>Snaps the selected anchor point to any existing line while displaying temporary rulers as a guide that you can also snap your anchor point to.</p> 
	<p>Show Contour Editor Controls</p>	<p>When enabled, selecting several control points will make a manipulator bounding box appear. You can use this manipulator to scale and rotate the selection of points.</p> 
	<p>Apply to Line and Colour Art</p>	<p>Allows you to perform drawing operations on both the Line Art and Colour Art layers of your drawing simultaneously.</p>

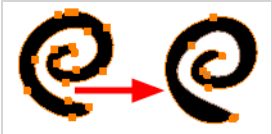
Icon	Property	Description
		<div style="border: 1px solid #c8e6c9; padding: 10px;">  <p><b>NOTE</b> If you have Overlay and Underlay Art layers enabled, they will also be affected when this option is enabled.</p> </div>

## Operations

Icon	Property	Description
	Smooth Selection	<p>The Smooth operation lets you smooth out selected drawing strokes and remove extra points.</p>  <div style="border: 1px solid #bbdefb; padding: 10px; margin-top: 10px;">  <p><b>TIP</b> You can also smooth the selection by selecting <b>Drawing&gt; Optimize &gt; Smooth</b> from the top menu or by pressing Alt + Shift + S.</p> </div>
 	Split Pencil Line Join Pencil Lines	<p>When drawing with the Polyline tool, your drawing has an even line thickness. You can use the Pencil Editor to adjust the thickness point by point, but if you want to adjust it quicker, you can use the Split Pencil Line and Point Pencil Lines options to create segments and apply a pencil stencil to your drawing. Note that if you did not join the pencil lines on your polyline stroke, the segments between the points will act as separated segments.</p>

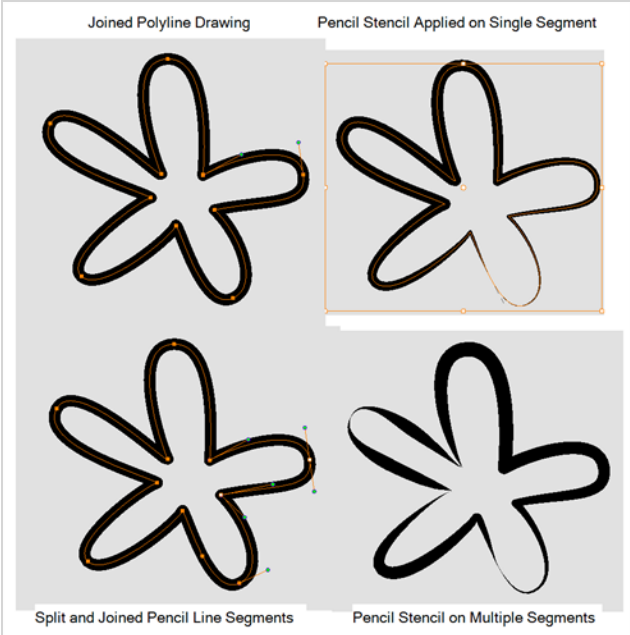
Icon	Property	Description
		 <p>The diagram illustrates four different ways to apply a pencil stencil to a star-shaped drawing:</p> <ul style="list-style-type: none"> <li><b>Joined Polyline Drawing:</b> Shows a star shape composed of multiple line segments joined at their endpoints. Small blue and green handles are visible at the junctions.</li> <li><b>Pencil Stencil Applied on Single Segment:</b> Shows the same star shape with a single segment highlighted by an orange rectangular selection box. A pencil icon is positioned over the segment, indicating the application of a pencil stencil effect.</li> <li><b>Split and Joined Pencil Line Segments:</b> Shows the star shape with several segments highlighted by orange selection boxes. A pencil icon is positioned over one of the segments, indicating the application of a pencil stencil effect to multiple segments.</li> <li><b>Pencil Stencil on Multiple Segments:</b> Shows the star shape with a thick, solid black stroke applied to all segments, representing the final result of applying a pencil stencil to multiple segments.</li> </ul>

## Cutter Tool Properties

The Cutter tool lets you cut out part of a drawing so that you can transform it, copy it or delete it.





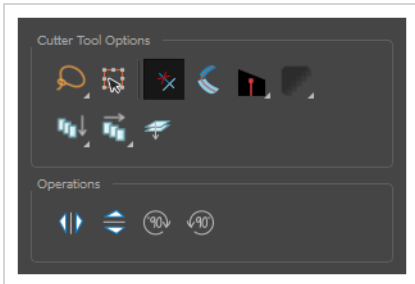

### How to access the Cutter tool properties





1. In the Tools toolbar, select the Cutter  tool.





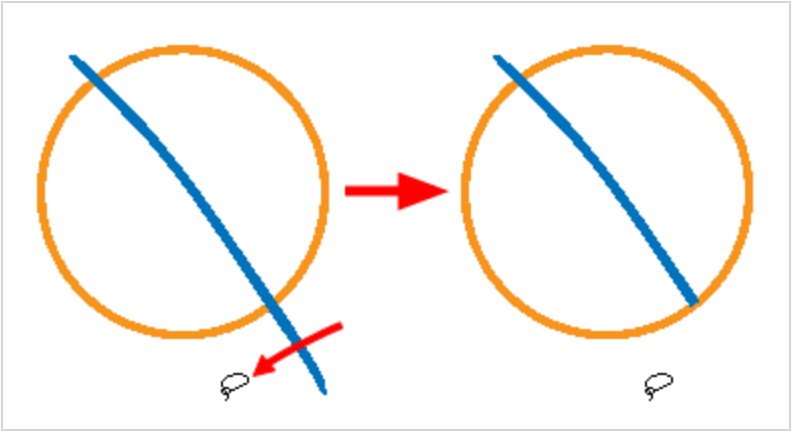

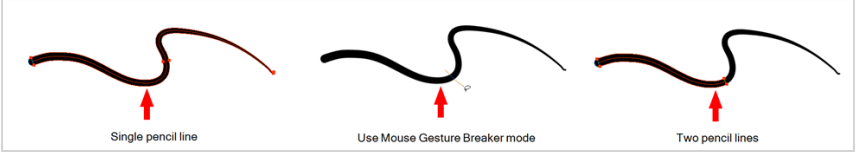

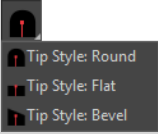

The tool's properties are displayed in the Tool Properties view.



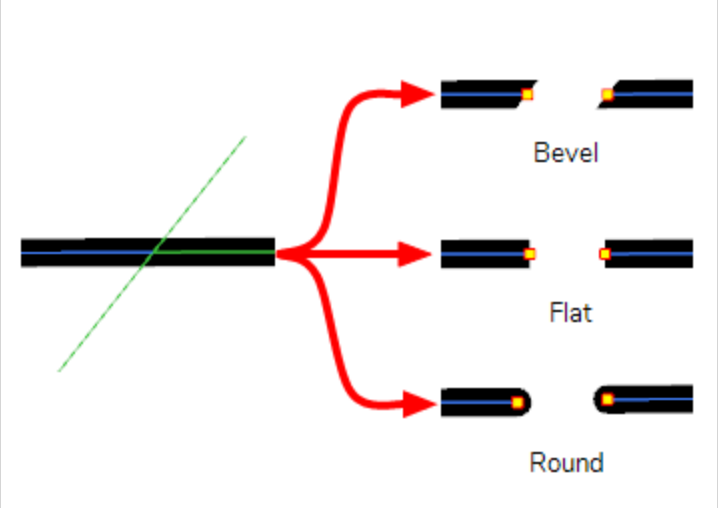





## Tool Options





Icon	Property	Description
	Selection Mode	<p>Allows you to choose the method to visually select multiple elements:</p> <ul style="list-style-type: none"> <li>•  <b>Lasso:</b> Allows you to select multiple elements by drawing a lasso around them with your mouse.</li> <li>•  <b>Marquee:</b> Allows you to select multiple elements by drawing a rectangle around them. This is faster, as you only need to drag your mouse from one corner of the rectangle to its opposite corner, but it may not be as precise as you want.</li> </ul> <div style="border: 1px solid #0070C0; padding: 5px; margin-top: 10px;"> <p> <b>TIP</b> You can press and hold the Alt key to temporarily use the other selection mode.</p> </div>
	Easy Drag	When enabled, you can drag the selection by clicking anywhere inside its bounding box. By default, you must click on the artwork in the selection to be able to drag it.
	Use Mouse Gesture	When this option is enabled along with the Lasso  selection type, quickly drawing a line with the Cutter tool over a line segment in your artwork will instantly delete it. This can be useful if you want to use the Cutter tool to

Icon	Property	Description
		<p>quickly clean up your artwork.</p>  <div data-bbox="584 798 1429 1060" style="border: 1px solid green; padding: 5px;"> <p> <b>NOTE</b>                      This option will only work when using the Cutter tool on separate brush or pencil strokes. Hence, it is important not to flatten your artwork if you intend to use this option to clean up your drawings. This option has no effect on bitmap layers as the artwork in bitmap layers is always flattened.</p> </div>
	<p>Use Mouse Gesture Breaker Mode</p>	<p>When using the Lasso selection type, the Use Mouse Gesture Breaker Mode option lets you draw an invisible stroke on a pencil line to cut it in two individual objects. Once a pencil line is cut with this option, you will be able to select the two portions independently with either the Cutter tool, Pencil Editor tool or Select tool.</p>  <div data-bbox="584 1501 1429 1648" style="border: 1px solid green; padding: 5px;"> <p> <b>NOTE</b>                      This option only works with pencil lines.</p> </div>
	<p>Tip Style</p>	<p>When cutting through pencil lines, this option decides what kind of pencil line tips to put at the extremities of the remaining pencil line segments, where they were cut.</p>

Icon	Property	Description
		 <p>By default, this is set to Bevel , which will leave the tip of the pencil line cut at the same angle as your cutter stroke. If you prefer, you can make pencil lines that you split with the Cutter tool have Flat  or Round  tips instead.</p> 
	Antialiasing	<p>When working on bitmap artwork, enabling this will smooth the edges of the artwork you cut out, so that they do not appear pixelated.</p> <div data-bbox="586 1251 1430 1388" style="border: 1px solid green; padding: 5px;"> <p> <b>NOTE</b> This option is only available with bitmap layers.</p> </div>
	Apply to Visible Drawing Layers	<p>This option allows you to select which layers the tool should affect. It can be toggled on or off. When toggled on, it has two different modes. You can select a mode by clicking and holding on the button.</p> <ul style="list-style-type: none"> <li>• <b>Off:</b> When this button is toggled off, the tool only works on the currently selected layers. If several layers are selected, the tool will work on all these layers simultaneously.</li> <li>•  <b>Apply to Visible Drawing Layers:</b> The tool will work on all the visible layers in the Camera view.</li> <li>•  <b>Apply to Synced Drawing Layers:</b> If the currently selected layer is synced with another layer, the tool will work on both the current layer and its synced layer.</li> </ul>

Icon	Property	Description
		<div style="border: 1px solid green; padding: 5px;">  <b>NOTE</b>            This option only works in the Camera view.         </div>
	Apply to All Frames	<p>This option allows you to determine which drawings in the current layer the tool should affect. It can be toggled on or off. When toggled on, it has two different modes. You can select a mode by clicking and holding on the button.</p> <ul style="list-style-type: none"> <li>• <b>Off:</b> When this button is toggled off, the tool only works on the drawing in the current frame.</li> <li>•  <b>Apply to All Frames:</b> The tool will work on every exposed drawing in the selected layer simultaneously.</li> <li>•  <b>Apply to Onion Skin Range:</b> The tool will work on every drawing displayed in the Onion Skin. Onion Skin must be enabled for this option to work.</li> </ul>
	Apply to Line and Colour Art	<p>Allows you to perform drawing operations on both the Line Art and Colour Art layers of your drawing simultaneously.</p> <div style="border: 1px solid green; padding: 5px;">  <b>NOTE</b>            If you have Overlay and Underlay Art layers enabled, they will also be affected when this option is enabled.         </div>

## Operations

Icon	Property	Description
	Flip Horizontal	Flips the current selection horizontally.
	Flip Vertical	Flips the current selection vertically.
	Rotate 90 Degrees CW	Rotates the current selection 90 degrees clockwise.
	Rotate 90 Degrees CCW	Rotates the current selection 90 degrees counter-clockwise.







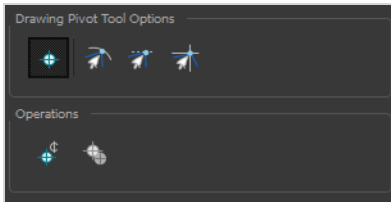



## Drawing Pivot Tool Properties

The Drawing Pivot tool lets you set the pivots on your character. You can set the drawing pivots on drawings and symbols.

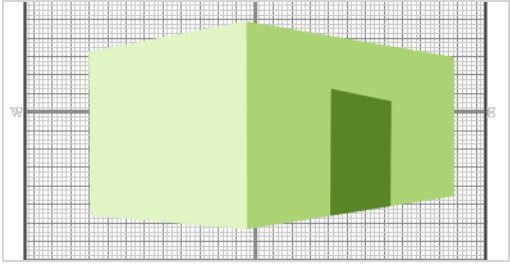

## Tool Options

Icon	Property	Description
	Setting the Drawing Pivot for Symbols on All Frames	<p>The Set the Pivot for Symbol on All Frames option is enabled by default. When you set a drawing pivot on a symbol, all of its cells use the same drawing pivot. This means you do not have to set a drawing pivot on all frames. Once you set it, it is done.</p> <p>If you prefer to set a different drawing pivot for a series of cells, you can deselect the option and set your pivots on each cell or cell range.</p> <div style="border: 1px solid green; padding: 5px; margin-top: 10px;"> <p> <b>NOTE</b></p> <p>If you have already set several different pivots on your symbol's cells and selected the Set the Pivot for Symbol on All Frames option, once you set a new pivot on the same symbol, all of its pivots will be reset and will use your new pivot.</p> </div>
	Snap to Contour	Snaps your selection or point to any line you position it on. As soon as you move it close enough to another line, your point or selection will snap to it.
	Snap and Align	Snaps the selected anchor point to any existing line while displaying temporary rulers as a guide that you can also snap your anchor point to.
	Snap to Grid	Snaps your selection following the currently enabled grid.

		
	<p>Reset Pivot</p>	<p>When you click the Reset Pivot option, the drawing pivot of the selected drawing or symbol is reset to the centre of the Camera view.</p>
	<p>Copying Pivot on Parent Symbol</p>	<p>When you import new extra drawings, such as hands and mouths, you can use the drawing pivot that was set on your drawings and report them to the symbol's cells. Use the Copy Pivot to Parent Symbol command for this.</p> <div data-bbox="854 884 1430 1245" style="border: 1px solid green; padding: 10px;"> <p> <b>NOTE</b></p> <p>When you copy drawing pivots to the parent symbol, there is no link between the drawings' pivots and the symbol's pivots. If you modify the drawing pivot later, it will not link to the symbol. You would need to perform the operation again. If you need to modify the symbol's pivots, you can do it directly on the symbol's cells.</p> </div>

## Dropper Tool Properties

The Dropper tool allows you to pick a colour from your drawing without going to the Colour view.



### NOTE



The following options will only have an effect when picking colours from a bitmap layer, as they affect the colour that gets picked. When working on a vector layer, you can only pick colours that are available in one of the palettes in your scene. Therefore, the colour you pick will always be exactly the colour that was used to fill the shape or stroke you clicked on.

### How to access the Dropper tool properties

1. In the Tools toolbar, select the Dropper  tool.

The tool's properties are displayed in the Tool Properties view.



Icon	Property	Description
	Sample All Layers	By default, the Dropper tool picks the colour from the active drawing layer only. This means that if the colour is semi-transparent, it will still only take the colour from the active layer, along with its transparency, and ignore the colours from layers behind it.  With this option enabled, the Dropper tool will pick the colour as it appears on the screen instead, allowing you to pick colours that are the result of several layers composited together.
	Do Not Pick Transparency	By default, the Dropper tool picks the colour's alpha value as well as its colour values. When enabled, the colour picked will always have an alpha value of 255.

## Edit Gradient/Texture Tool Properties

The Edit/Gradient Texture tool allows you to move, rotate and scale a gradient or texture fill within the shape it fills, without modifying the shape itself.

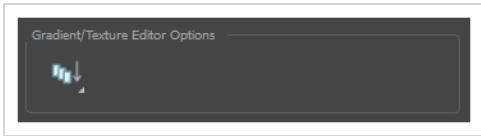





### How to access the Edit Gradient/Texture tool properties

1. In the Tools toolbar, select the Edit Gradient/Texture  tool.

The tool's properties are displayed in the Tool Properties view.

## Tool Options

Icon	Property	Description
	Apply to Visible Drawing Layers	<p>This option allows you to select which layers the tool should affect. It can be toggled on or off. When toggled on, it has two different modes. You can select a mode by clicking and holding on the button.</p> <ul style="list-style-type: none"> <li>• <b>Off:</b> When this button is toggled off, the tool only works on the currently selected layers. If several layers are selected, the tool will work on all these layers simultaneously.</li> <li>•  <b>Apply to Visible Drawing Layers:</b> The tool will work on all the visible layers in the Camera view.</li> <li>•  <b>Apply to Synced Drawing Layers:</b> If the currently selected layer is synced with another layer, the tool will work on both the current layer and its synced layer.</li> </ul> <div data-bbox="584 1457 1429 1591" style="border: 1px solid green; padding: 5px;"> <p> <b>NOTE</b> This option only works in the Camera view.</p> </div>

## Ellipse Tool Properties

The Ellipse tool allows you to quickly draw an ellipse or a circle.

### How to access the Ellipse tool properties

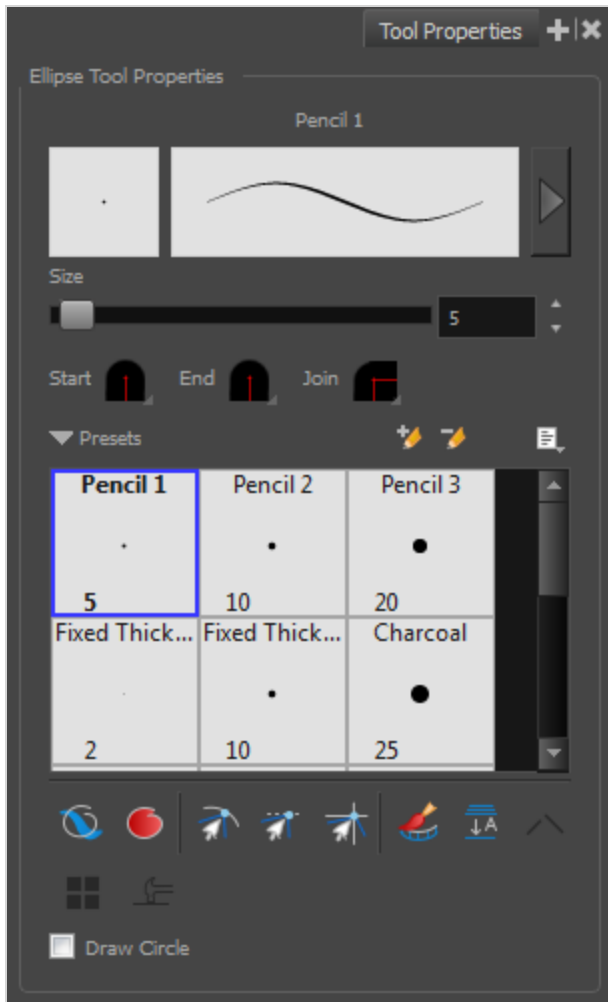

1. In the Tools toolbar, select the Ellipse  tool.

The tool's properties are displayed in the Tool Properties view.



## Pencil Properties

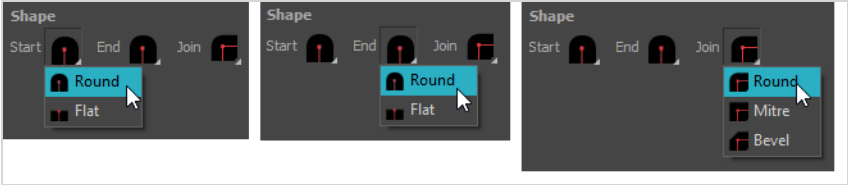

Just like other shape tools, this tool creates pencil lines. Hence, its tool properties are similar to the ones of the Pencil tool and it can be used with pencil presets.

Property	Description
Preview Area	<p>The Preview area lets you see a preview of the stroke your drawing tool will make.</p> 
Pencil Properties Dialog	<p>The arrow button right of the preview area opens the Pencil Properties dialog.</p>  <p>While the Tool Properties view only gives you access to a few of the pencil properties, a list of pencil presets and other drawing options, the Pencil Properties dialog gives you access to all the available options for your pencil's shape and texture. For more information on the Pencil Properties dialog, see the <a href="#">Pencil Properties Dialog on page 867</a> section below.</p>
Size	<p>Defines the width of the pencil line used to draw the shape.</p>
Shape	<p>You can adjust the start, end, and join style of a pencil line.</p>  <ul style="list-style-type: none"> <li>• <b>Start:</b> Lets you select the style of the start tip, which is the first tip you drew. You can choose between Round or Flat style.</li> <li>• <b>End:</b> Lets you select the style of the end tip, which is the last tip you drew. You can choose between Round or Flat style.</li> <li>• <b>Join:</b> Lets you select the joint style. The joints are where the line curves abruptly. You could also define the Join style as the corner style. You can choose between Round, Mitre and Bevel style.</li> </ul>

## Pencil Presets











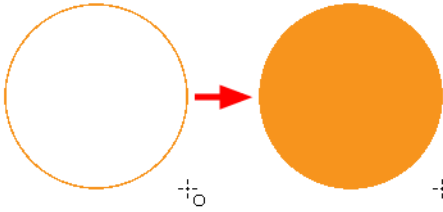

These options allow you to select, create and manage pencil presets.

Icon	Property	Description
	Presets list	Harmony provides a variety of pencil presets and thickness stencils and









Icon	Property	Description
		<p>also lets you create and save your own. It is a good idea to create and save pencils with precise sizes and parameters when you draw for efficiency and consistency.</p> <p>A thickness stencil saves the thickness information across the length of the line. When drawing with a thickness stencil, the pressure sensitivity of the tablet is discarded. A thickness stencil can be used while drawing, or applied afterwards.</p> <p>You also have the possibility to apply different textures to your lines by either using the default presets or to import your own.</p> <p>You can export the pencil presets that you have created and import those that others have created. This is a good way for you and project collaborators to keep a consistent look for the project.</p>
	New Brush Preset	Creates a new preset based on the current tool properties.
	Delete Brush Preset	Deletes the currently selected preset.
	Brush Presets Menu	<p>Open a menu that contains the following options:</p> <ul style="list-style-type: none"> <li>• <b>New Brush Preset:</b> Creates a new preset based on the current tool properties.</li> <li>• <b>Delete Brush:</b> Deletes the currently selected preset.</li> <li>• <b>Rename Brush:</b> Allows you to rename the currently selected preset.</li> <li>• <b>Import Brushes:</b> Allows you to import brush presets exported from Harmony.</li> <li>• <b>Export Brushes:</b> Allows you to export your brush presets into an <b>.xml</b> file.</li> <li>• <b>Small Thumbnail:</b> Displays presets in a grid of small thumbnails with a preview of their tip.</li> <li>• <b>Large Thumbnail:</b> Displays presets in a grid of big thumbnails, with their name and a preview of their tip.</li> <li>• <b>Stroke View:</b> Displays presets in a list, with their name and a preview of a stroke done with each preset.</li> </ul>

## Drawing Options

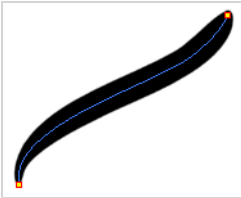
These options affect the way your shape is added to your artwork.

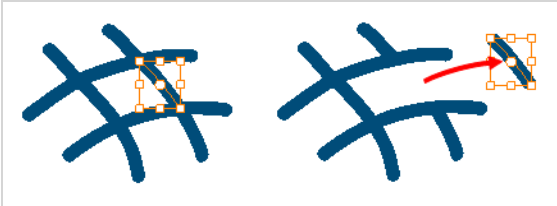
Icon	Property	Description
	<p>Draw Behind</p>	<p>When enabled, your brush strokes will appear behind the existing artwork.</p> <div data-bbox="634 338 1105 533" style="border: 1px solid gray; padding: 5px;">  <p>The orange stroke was drawn over the black stroke, then put underneath it.</p> </div> <div data-bbox="634 569 1430 741" style="border: 1px solid green; padding: 5px; background-color: #e0f2f1;"> <p> <b>NOTE</b></p> <p>Your brush stroke will temporarily appear over your artwork as you draw it, until you release the mouse cursor or tablet pen.</p> </div>
	<p>Auto Fill</p>	<p>When enabled, the shape you draw is automatically filled with the selected colour. By default, drawing a shape only creates its outlines.</p> <div data-bbox="634 888 1127 1134" style="border: 1px solid gray; padding: 5px;">  </div> <div data-bbox="634 1169 1430 1453" style="border: 1px solid blue; padding: 5px; background-color: #e0f2f1;"> <p> <b>TIP</b></p> <p>By default the pencil line and its fill will be the same colour. If you want to select different colours for the pencil line and its fill, you can click on the Unlock Three Colours  button in the Colour view, then select different colours for Brush strokes , Pencil lines  and Paint fills .</p> </div>
	<p>Snap to Contour</p>	<p>When enabled, while you're drawing, the mouse cursor will snap to the nearby contours of the artwork in your drawing.</p>
	<p>Snap and Align</p>	<p>When enabled, while you're drawing, the mouse cursor will automatically align to the rectangular bounding boxes of other strokes and shapes in your drawing.</p>
	<p>Snap to Grid</p>	<p>When enabled, while you're drawing, the mouse cursor will snap against the intersecting points of the grid.</p>



Icon	Property	Description
		<div data-bbox="634 285 1430 457" style="border: 1px solid #add8e6; padding: 10px;">  <b>TIP</b>            To display the grid, select <b>View &gt; Grid &gt; Show Grid</b> from the top menu or press <b>Ctrl + '</b>.         </div>
	Automatically Create Colour Art	<p>As you draw in the Line Art layer, the Automatically Create Colour Art option instantly creates the corresponding strokes in the Colour Art layer.</p> 
	Auto Flatten Mode	<p>By default, when drawing on a vector layer, each new stroke is created as a separate drawing object, which can be edited independently from other parts of the artwork. When enabled, the Auto-Flatten option automatically merges strokes into existing artwork.</p>  <div data-bbox="634 1272 1430 1507" style="border: 1px solid #90ee90; padding: 10px;">  <b>NOTE</b>            Using the Select tool, you can use select and remove a segment of flattened pencil lines. Overlapping pencil lines drawn with the Auto-Flatten mode are essentially cut into segments by the overlap and can be treated as individual lines.         </div>
	Use Stored Colour Gradient	<p>The Use Stored Colour Gradient option can be used when painting with a gradient colour to always position the gradient in the same way it was stored, making it consistent across brush strokes. You can store a gradient by selecting a zone painted with a gradient with the Select tool, then clicking on Store Colour Gradient  in the Tool Properties view.</p>
	Draw Circle	<p>When checked, the shape you draw will be of equal width and height, making it a perfect circle.</p>

Icon	Property	Description
		 <b>TIP</b> You can also draw a circle by holding the Shift key while drawing.

## Pencil Properties Dialog

The Ellipse tool draws the same type of line as the Pencil tool. Hence, you can configure the Ellipse tool's lines using the Pencil Properties dialog, which you can open by clicking on the arrow button right of the stroke display area in the Tool Properties view.



## Size and Smoothness Tab

The Size and Smoothness tab allows you to select your pencil's size, its smoothing parameters as well as the shape of its tips and corners.

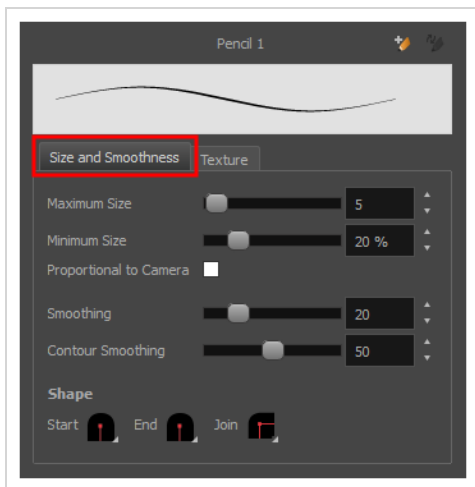

Property	Description
Maximum Size	Defines the maximum size of the pencil line. If the tool is used with a pressure sensitive pen tablet, the width of the stroke will vary between its maximum size and minimum size depending on the amount of pressure used. If used with a mouse, the width of the stroke will always be its maximum size.
Minimum Size	Defines the minimum size of your stroke as a percentage of the maximum size. If you

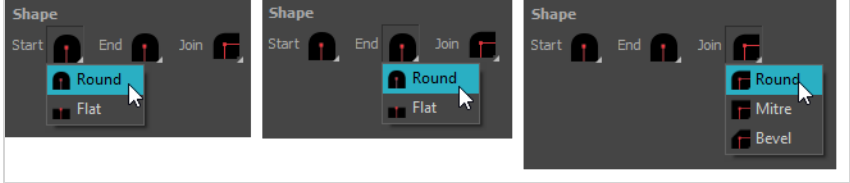
Property	Description
	do not have pressure sensitivity from a pen table, the minimum size value will be ignored.
Proportional to Camera	If you check this option, the size of the pencil will be adjusted to the position of the camera on the z-axis. This means that if the camera is zoomed in on the scene, the pencil will be proportionally smaller so that it appears the same size in the rendered image. Likewise, if the camera is zoomed out, the pencil will be proportionally bigger.
Smoothing	Defines the number of control points added to the centre line. The fewer the control points the smoother (but less faithful) the line.
Contour Smoothing	Defines the number of points on the contour share of your stroke. This will smooth out the bumps and waves on your contour shape of your brush strokes.
Shape	<p>You can adjust the start, end, and join style of a pencil line.</p>  <ul style="list-style-type: none"> <li>• <b>Start:</b> Lets you select the style of the start tip, which is the first tip you drew. You can choose between Round or Flat style.</li> <li>• <b>End:</b> Lets you select the style of the end tip, which is the last tip you drew. You can choose between Round or Flat style.</li> <li>• <b>Join:</b> Lets you select the joint style. The joints are where the line curves abruptly. You could also define the Join style as the corner style. You can choose between Round, Mitre and Bevel style.</li> </ul>

## Texture Tab

In the Pencil Properties view, the Texture tab allows you to select a pencil texture from the currently selected pencil texture palette to use with the Pencil tool. You can also add, remove or rename textures, save the current pencil texture palette as the default one, or import the pencil texture palette into your scene.

The pencil texture palette used in the Texture tab of the Pencil Properties dialog is the one selected in the Colour view. You can select a pencil texture palette by selecting it from the pencil texture palette list in the Colour view—see [Colour View on page 1058](#).

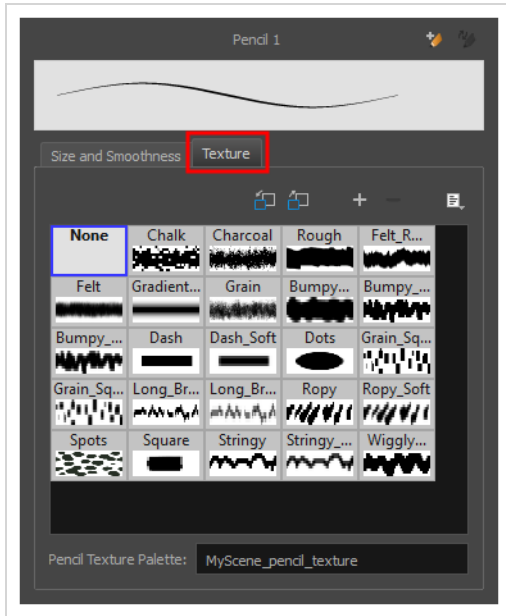

Icon	Property	Description
	Use as Default Pencil Texture Palette	Sets the currently selected pencil texture palette as the default pencil texture palette in your user preferences. The default pencil texture palette is added to every scene you create in Harmony. The palette is copied in your preferences, so it will be added to your new scenes in the exact state it is when you make it the default pencil texture palette.
	Reload Default Texture Palette	Imports the default pencil texture palette as a new pencil texture palette into your scene's palette list, and selects it as the current pencil texture palette.
	New Texture	Allows you to import an image file into a new pencil texture swatch in the current pencil texture palette. The pencil texture's effect on your pencil line will be based on the image's transparency channel, and will follow your pencil lines on its horizontal axis.
	Delete Texture	Deletes a pencil texture swatch from the current pencil texture palette.
	Rename Texture	Renames the selected pencil texture swatch in the current pencil texture palette.
	Pencil Texture List	Displays the pencil textures in the current pencil texture palette and allows you to select one to use with the Pencil tool.
	Pencil Texture Palette	Displays the name of the currently selected pencil texture palette, for





---



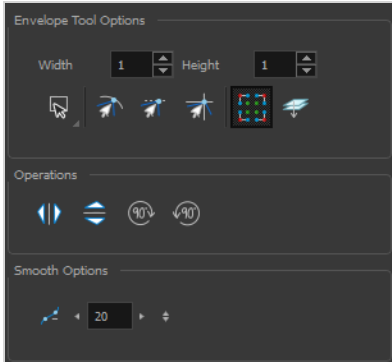

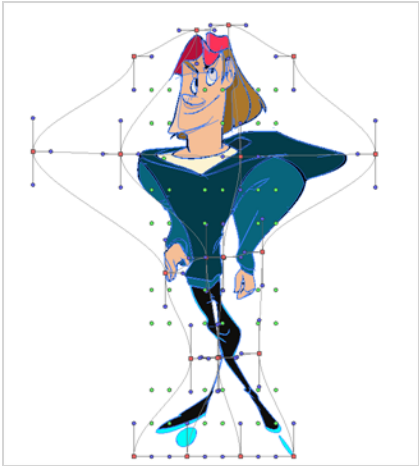



Icon	Property	Description
		reference. To select a different pencil texture palette, you must select it in the Colour view—see <a href="#">Colour View on page 1058</a> .





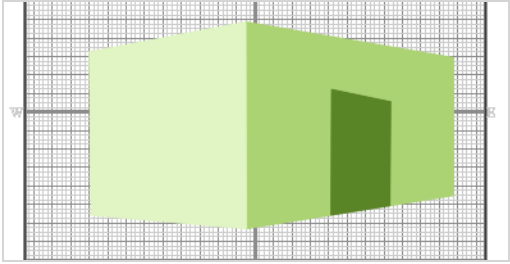

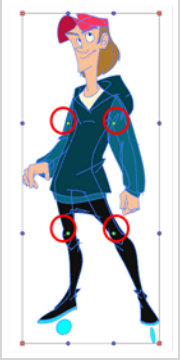
# Envelope Tool Properties

Selecting the Envelope tool displays its properties and options in the Tool Properties view.



Icon	Tool Name	Description
	Width and Height	<p>Increase the width and height values to add more columns and rows to the deformation grids.</p> 
	Lasso	<p>Sets the selection mode to Lasso, which allows you to select multiple items by drawing a lasso around them.</p> <div style="border: 1px solid #4a86e8; padding: 10px; margin-top: 10px;"> <p> <b>TIP</b> When this option is enabled, you can press and hold the ALT key to temporarily use Marquee mode.</p> </div>
	Marquee	<p>Sets the selection mode to Marquee, which allows you to select multiple items by drawing a rectangle around them.</p>

		 <b>TIP</b> When this option is enabled, you can press and hold the Alt key to temporarily use Lasso mode.
	Snap to Contour	Snaps your selection or point to any line you position it on. As soon as you move it close enough to another line, your point or selection will snap to it.
	Snap and Align	Snaps the selected anchor point to any existing line while displaying temporary rulers as a guide that you can also snap your anchor point to.
	Snap to Grid	Snaps your selection following the currently enabled grid. 
	Show Advanced Controls	To display more controls, you can click on the Show Advanced Controls button. 
	Apply to Line and Colour Art	Allows you to perform drawing operations on both the Line Art and Colour Art layers of your drawing simultaneously.

		<div style="border: 1px solid green; padding: 5px;">  <p><b>NOTE</b> If you have Overlay and Underlay Art layers enabled, they will also be affected when this option is enabled.</p> </div>
	Flip Horizontal	Flips the current selection horizontally.
	Flip Vertical	Flips the current selection vertically.
	Rotate 90 Degrees CW	Rotates the current selection 90 degrees clockwise.
	Rotate 90 Degrees CCW	Rotates the current selection 90 degrees counter-clockwise.
	Smooth	You can modify the central line smoothness of your line using this option. This parameter smooths the deformed lines. Increasing the value will result in a smoother line with fewer control points. The more you increase the value, the less details and curves you will get. Use the left and right arrows to increment the value by one full unit. Use the Up - Down slider to quickly increment the value.



## Eraser Tool Properties

The Eraser tool allows you to erase artwork by drawing eraser strokes over it. When using the Eraser tool with a tablet, it is pressure sensitive, like with the Brush and Pencil tool.

### How to access the Eraser tool properties

1. In the Tools toolbar, select the Eraser  tool.

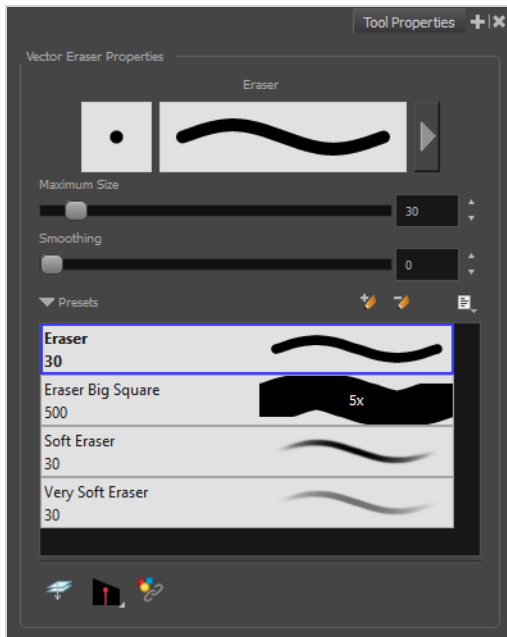

The tool's properties are displayed in the Tool Properties view.



## Eraser Properties



The way the Eraser tool is configured is almost identical to the way the Brush tool is configured.

Property	Description
Stroke Preview Area	<p>The Preview area lets you see a preview of the stroke your drawing tool will make.</p> 
Eraser Properties Dialog	<p>The arrow button right of the display area opens the Eraser Properties dialog, which gives you access to all the parameters and options for your eraser. The Tool Properties view only gives you access to a few of the eraser properties, a list of eraser presets and options for the Eraser tool that are not related to the eraser properties. For more</p>

Property	Description
	<p>information on the Eraser Properties dialog, see the <a href="#">Eraser Properties Dialog</a> section below.</p> 
Maximum Size	<p>Defines the maximum size of the eraser.</p> <p>If the tool is used with a pressure sensitive pen tablet, the width of the stroke will vary between its maximum size and minimum size depending on the amount of pressure used. If used with a mouse, the width of the stroke will always be its maximum size.</p>
Smoothing	<p>Defines the number of control points added to the centre line. The fewer the control points the smoother (but less faithful) the line.</p>
Flow	<p>Lets you set the opacity for each instance of the eraser tip that gets erased from your artwork. Contrary to the Opacity parameter, the flow parameter has a cumulative effect. This means that a lower flow will make your eraser strokes less effective towards its extremities and more effective in its center. Your stroke's flow will also accumulate if you draw over it. By default, your eraser's flow varies with the amount of pressure you put on your tablet pen.</p> <div data-bbox="500 1108 1430 1283" style="border: 1px solid #c8e6c9; padding: 10px;"> <p> <b>NOTE</b> This option is only displayed in the Tool Properties view when drawing on a bitmap layer.</p> </div>
Opacity	<p>The Opacity parameter are where Lets you set the opacity of your brush strokes. Contrary to the Flow parameter, the Opacity parameter is non-cumulative. Your whole brush stroke's opacity will not exceed the Opacity parameter. By default, the Opacity parameter varies depending on the amount of pressure you put on your tablet pen.</p> <div data-bbox="500 1507 1430 1682" style="border: 1px solid #c8e6c9; padding: 10px;"> <p> <b>NOTE</b> This option is only displayed in the Tool Properties view when drawing on a bitmap layer.</p> </div>



## Eraser Presets



These options allow you to select, create and manage eraser presets.

Icon	Property	Description
	Presets list	By default, Harmony has preloaded eraser presets. You can also create your own eraser presets by configuring your eraser, then saving its properties into a new preset. It is also possible to export and import eraser presets.
	New Brush Preset	Creates a new preset based on the current tool properties.
	Delete Brush	Deletes the currently selected preset.
	Rename Brush	Allows you to rename the currently selected preset.
	Import Brushes	Allows you to import brush presets exported from Harmony.
	Export Brushes	Allows you to export your brush presets into an <b>.xml</b> file.
	Small Thumbnail	Displays presets in a grid of small thumbnails with a preview of their tip.
	Large Thumbnail	Displays presets in a grid of big thumbnails, with their name and a preview of their tip.
	Stroke View	Displays presets in a list, with their name and a preview of a stroke done with each preset.

## Erasing Options

These options affect the way your eraser strokes are applied to your artwork.

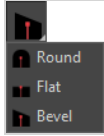
Icon	Property	Description
	Apply to Line and Colour Art	<p>Allows you to perform drawing operations on both the Line Art and Colour Art layers of your drawing simultaneously.</p> <div style="border: 1px solid green; padding: 10px; margin-top: 10px;"> <p> <b>NOTE</b> If you have Overlay and Underlay Art layers enabled, they will also be affected when this option is enabled.</p> </div>

Icon	Property	Description
	Tip Style	<p>If you erase the end of a pencil line or erase a pencil line through the centre, new line tips are created. Use the Tip Style option to customize the shape of the tips of the pencil lines that are trimmed by the Eraser tool.</p>  <p>By default, this option is set to <b>Bevel</b> , which will leave the end of the pencil line cut at the same angle as the eraser stroke</p>
	Apply to Synced Drawing Layers	If the currently selected layer is synced with another layer, the tool will work on both the current layer and its synced layer.

## Eraser Properties Dialog

Erasers have an extensive set of options and properties that are not displayed in the Tool Properties view, but rather, in a dialog you can access from it. To open the Eraser Properties dialog, click on the arrow button right of the stroke display area.



The Eraser Properties dialog has five different tabs, minus the Smoothing tab if you are working on a bitmap layers. Below is detailed information about the options available in each tab:



- [Tip Tab on page 877](#)
- [Smoothing Tab on page 882](#)
- [Transparency Tab on page 883](#)
- [Dual Tip Tab on page 886](#)
- [Paper Texture Tab on page 890](#)



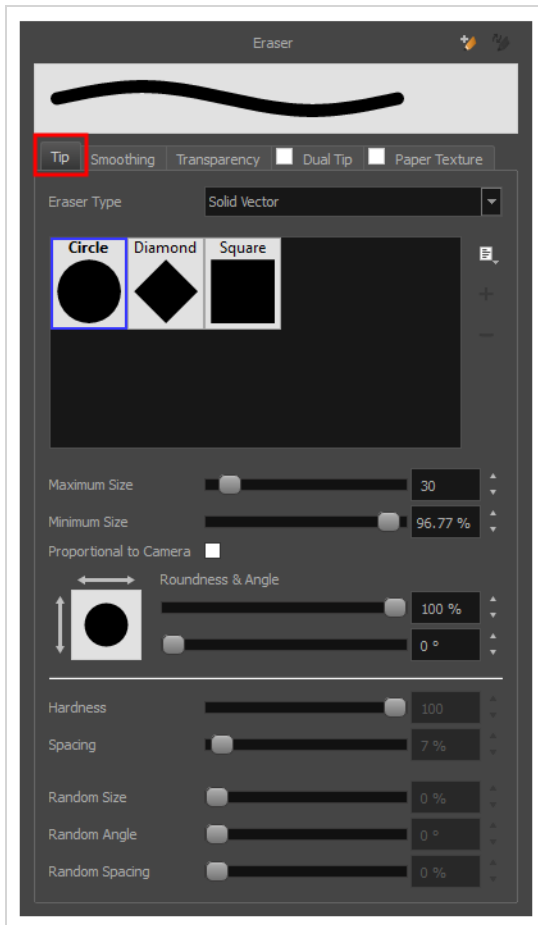

## Tip Tab

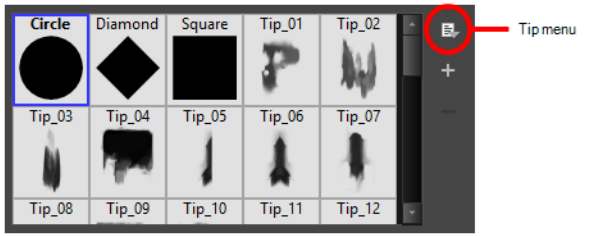

The Tip tab allows you to configure the shape, size, hardness and spacing of your eraser tip.



Property	Description
Eraser Type	<p>Allows you to select between one of the following eraser types:</p> <ul style="list-style-type: none"> <li>• <b>Solid Vector:</b> Simply cuts out the eraser stroke's shape from the vector artwork. A solid vector eraser always completely erase the artworks leaving hard seams.</li> <li>• <b>Textured Eraser:</b> Allows to configure the eraser with the same options as with a textured brush. A textured eraser will decrease the opacity of bitmap textures in textured brush strokes if it doesn't completely erase it. If it completely erases a brush stroke, it will cut out the erased part from the vector artwork.</li> <li>• <b>Textured, Preserve Vector:</b> Like a Textured Eraser, except that it will not cut out from the vector shapes, even if it fully erases pixels in a textured brush stroke's texture.</li> </ul>

Property	Description
	<div data-bbox="505 285 1430 548" style="border: 1px solid #c8e6c9; padding: 10px; margin-bottom: 10px;">  <b>NOTE</b>                      Textured erasers only work as expected on textured brush strokes. Using a Textured eraser on a solid vector brush stroke or on a pencil line will only cut the eraser stroke's shape out of it. If you use a Textured, Preserve Vector type eraser on a solid vector shape or on a pencil line, the eraser will not erase anything.                 </div> <div data-bbox="505 579 1430 747" style="border: 1px solid #c8e6c9; padding: 10px;">  <b>NOTE</b>                      This option is not available when working on a bitmap layer. With bitmap layers, erasers are always textured, and textured eraser options are always available.                 </div>
Eraser Tip Library	<div data-bbox="505 804 1122 1058" style="border: 1px solid #ccc; padding: 5px; margin-bottom: 10px;">  </div> <p>This is where you select the shape of the eraser tip. By default, it is round. Note that some tips are designed to have semitransparent areas, even when the maximum eraser opacity is set to 100%.</p> <p>To create a custom eraser tip, you must prepare the file ahead of time, either in Harmony or in a third-party software, such as Adobe Photoshop. Colour is not supported and transparency is not supported in the traditional sense. Black appears as 100% opaque, white appears as 100% transparent and all the shades of grey in between appear as varying degrees of semitransparency. A range of file formats are supported—jpeg, .png, .tif, .psd, .tga to name a few. Alpha channels are disregarded on import. It is recommended that your file be between 100 x 100 pixels and 400 x 400 pixels.</p> <p>You can also import eraser tips that you exported from Harmony, so you can share them with colleagues.</p>
Minimum and Maximum Size	<p>The minimum and maximum sizes of your drawing tool produce the thick and thin effect on your stroke. This works with the pressure sensitivity of a pen tablet.</p> <ul style="list-style-type: none"> <li>• <b>Maximum Size:</b> Defines the maximum width of the stroke.</li> <li>• <b>Minimum Size:</b> Defines the minimum width of the stroke in relation to and as a percentage of the maximum size.</li> </ul>

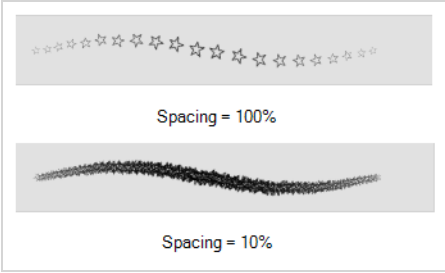
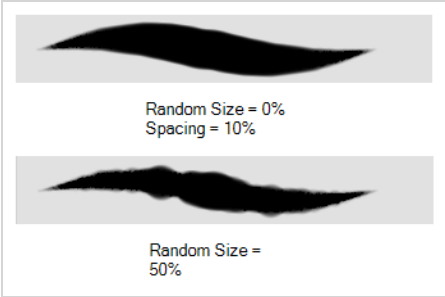
Property	Description
	<div data-bbox="505 283 1430 485" style="border: 1px solid #c8e6c9; padding: 10px;">  <p><b>NOTE</b></p> <p>Setting the Minimum Size value to 100% eliminates the possibility of creating width variation on your stroke. In other words, you would be forcing a uniform line width using the Maximum Size value.</p> </div>
Proportional to Camera	<p>If you check this option, the size of the eraser will be adjusted to the position of the camera on the z-axis. This means that if the camera is zoomed in on the scene, the eraser will be proportionally smaller so that it appears the same size in the rendered image. Likewise, if the camera is zoomed out, the eraser will be proportionally bigger.</p>
Roundness and Angle	<p>The Roundness and Angle parameters allow you to change the shape and orientation of the tip.</p> <ul style="list-style-type: none"> <li>• <b>Roundness:</b> The vertical scaling to apply to the tip. Reducing this setting squashes the tip vertically, allowing you to turn round or square tips into flat tips.</li> <li>• <b>Angle:</b> The angle at which to rotate the brush tip, counterclockwise.</li> </ul> <div data-bbox="505 1016 1430 1377" style="border: 1px solid #c8e6c9; padding: 10px;">  <p><b>NOTE</b></p> <p>The squashing is not relative to the angle—if the tip is rotated, the squashing will still be done relative to the tip's original orientation.</p> <div data-bbox="613 1167 1330 1339" style="border: 1px solid #ccc; padding: 10px; text-align: center;">  <p>Roundness: 100%    Roundness: 33%    Roundness: 100%    Roundness: 33%</p> <p>Angle: 0°            Angle: 0°            Angle: 45°            Angle: 45°</p> </div> </div>
Hardness	<p>The Hardness and Spacing parameters allow you to change the softness and spacing of the marks made by the eraser tip. You can preview the hardness and spacing at the top of the Eraser Properties window, stroke preview area.</p> <p>The hardness value corresponds to the softness of the eraser tip's edges. The lower the value, the softer the tip edge. The higher the value, the sharper the tip edge. Be aware that some eraser tips are not 100% opaque, so they will always appear somewhat soft, even at 100% hardness.</p> <div data-bbox="505 1724 834 1881" style="border: 1px solid #ccc; padding: 10px; text-align: center;">  <p>100% Hardness      10% Hardness</p> </div>

Property	Description
Spacing	<p>Defines the amount of space between each stamp of the eraser. A value of 100% sets the stamp marks edge to edge, if there is no white space around the shape. The larger the value, the greater the space between marks. A really large value can make the eraser stroke appear as a string of individual marks. Conversely, a small spacing value will give the appearance of a fluid brush stroke.</p> <p>Spacing is only evident when making a continuous stroke.</p> 
Randomness	<p>The Randomness parameters let you create a varied bitmap eraser stroke. Refining these options can give your stroke a lovely, non-mechanical look.</p>
Random Size	<p>You can create variation between the thick and thin of your eraser stroke just by setting the Maximum and Minimum Size values. If you add randomness to the mix, pressure sensitivity from your drawing tablet will still be applied. Light pressure will create random values around the minimum, while heavy pressure will create random values closer to the maximum. The larger the percentage, the larger the range of random variation.</p>  <div data-bbox="505 1564 1429 1795" style="border: 1px solid green; padding: 10px;"> <p> <b>NOTE</b></p> <p>Setting the Minimum Size to 100% eliminates the possibility of creating width variation on your stroke, whether you are applying randomness or not. Therefore, you would be forcing a uniform line width using the Maximum Size value.</p> </div>
Random Angle	<p>Sets the range for random rotation around the set Angle value. For example, if the</p>

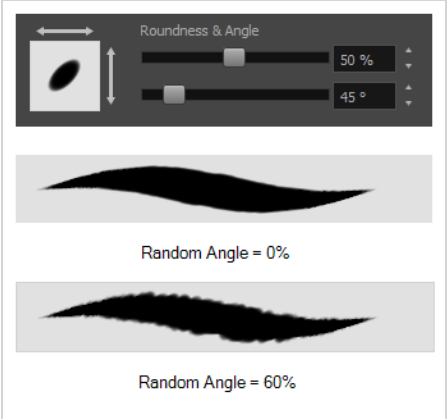
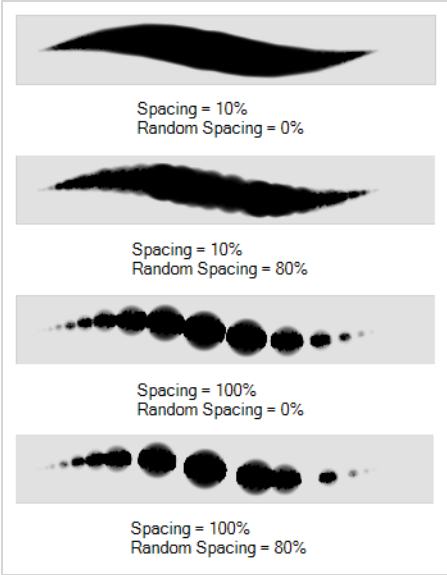

Property	Description
	<p>Angle is set to 45° and the Random Angle set to 10°, the software will choose values between 40°–50° (plus or minus 5 degrees, equaling a total of 10 degrees).</p> 
Random Spacing	<p>Sets the range for random spacing around the set Spacing value. For example, if the Spacing is set to 50% and the Random Spacing is set to 10%, then Harmony will choose values between 45%–55% (plus or minus 5 percent, equaling a total of 10 percent).</p> 

## Smoothing Tab

The Smoothing tab contains options to configure how Harmony should automatically smooth your eraser strokes as you paint.

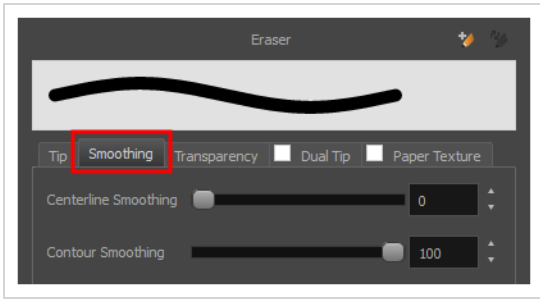

**NOTE**

The Smoothing tab is only available when working on a vector layer, as bitmap layers do not support smoothing.

Property	Description
Centerline Smoothing	Defines the amount of smoothing Harmony should perform on your eraser stroke's direction, curves and corners. A higher setting will prevent your line from being shaky, but is liable to reduce drawing precision and turn sharp angles into curves.
Contour Smoothing	Defines the amount of smoothing Harmony should perform on outer contour of the eraser stroke. A higher setting will round sharp corners and reduce the amount of control points for the resulting vector shape.

## Transparency Tab

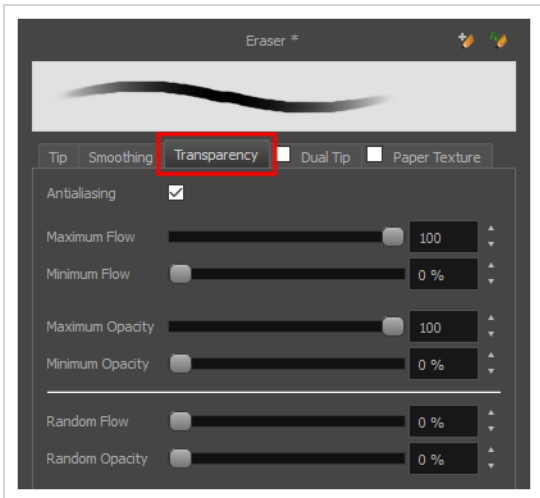

The Transparency tab allows you to decide if your eraser has antialiasing as well as to set its flow and opacity settings.



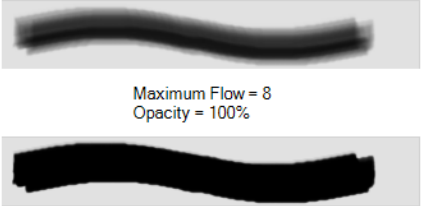

**NOTE**

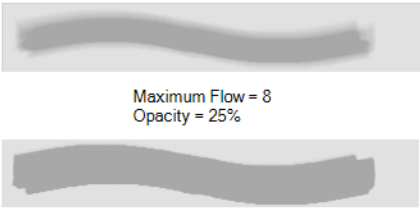
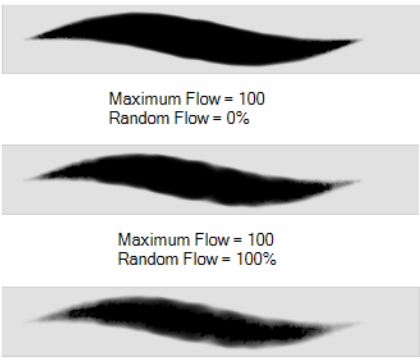
The Transparency tab's options are only available on vector layers if the **Eraser Type** option of the Tip tab is set to **Textured Vector** or **Textured, Preserve Vector**.. On bitmap layers, those options are always available.

Property	Description
Antialiasing	<p>Enabled by default. This option causes the contours of the eraser strokes to blend with the surrounding colours, to create an illusion of smoothness otherwise not possible due to the picture resolution.</p> <p>If antialiasing is disabled, the eraser will either fully erase pixels or leave them intact.</p> <div data-bbox="574 758 1430 894" style="border: 1px solid green; padding: 5px;">  <p><b>NOTE</b> When disabled, all other options in the Transparency tab are disabled.</p> </div>
Maximum and Minimum Flow	<p>The Maximum and Minimum Flow parameters let you set the range for the rate at which your eraser's effect flows. The greater the flow, the more consistent the effect is. If the flow is light, then the effect may look spotty. This feature works with the pressure sensitivity of a pen tablet.</p> <ul style="list-style-type: none"> <li>• <b>Maximum Flow:</b> Sets the maximum rate at which colour and texture are applied as you create a fluid stroke.</li> <li>• <b>Minimum Flow:</b> Sets the minimum rate at which colour and texture are applied as you create a fluid stroke. It is defined as a percentage of the Maximum Flow value. If the Minimum Flow value is set to 100%, then tablet pressure sensitivity will no longer be applicable. The flow will be set to the constant rate of the Maximum Flow value.</li> </ul> <div data-bbox="574 1402 1016 1692" style="border: 1px solid gray; padding: 10px; text-align: center;">  </div>
Maximum Opacity and Minimum Opacity	<p>The Maximum and Minimum Opacity parameters are where you set the opacity range for an eraser mark. This works with the pressure sensitivity of a pen tablet.</p> <ul style="list-style-type: none"> <li>• <b>Maximum Opacity:</b> Sets the transparency limit of the eraser mark when the pressure is heavy.</li> </ul>

Property	Description
	<ul style="list-style-type: none"> <li> <b>Minimum Opacity:</b> Sets the transparency limit of the eraser mark when the pressure is very light. It is defined as a percentage of the Maximum Opacity value. If the Minimum Opacity value is set to 100%, then tablet pressure sensitivity will no longer be applicable. The opacity will be set to the constant rate of the Maximum Opacity value.                     </li> </ul> <div data-bbox="573 480 1016 770" style="border: 1px solid gray; padding: 10px; margin: 10px 0;">  <p style="text-align: center;">Maximum Flow = 8 Opacity = 25%</p> <p style="text-align: center;">Maximum Flow = 100 Opacity = 25%</p> </div>
Randomness	<p>The Randomness parameter lets you set the range for the randomness of the flow and opacity. This works with the pressure sensitivity of a pen tablet.</p>
Randomness Flow	<p>You can create variation in the flow of your eraser stroke just by setting the Maximum and Minimum Flow values. If you add randomness to the mix, pressure sensitivity from your drawing tablet will still be applied. Light pressure will create random values around the minimum, while heavy pressure will create random values closer to the maximum. The larger the percentage, the larger the range of random variation.</p> <div data-bbox="573 1199 1016 1640" style="border: 1px solid gray; padding: 10px; margin: 10px 0;">  <p style="text-align: center;">Maximum Flow = 100 Random Flow = 0%</p> <p style="text-align: center;">Maximum Flow = 100 Random Flow = 100%</p> <p style="text-align: center;">Maximum Flow = 50 Random Flow = 100%</p> </div> <div data-bbox="573 1677 1430 1913" style="border: 1px solid green; padding: 10px; margin: 10px 0;"> <p> <b>NOTE</b></p> <p>Setting the Minimum Flow value to 100% eliminates the possibility of creating flow variation on your stroke, whether you are applying randomness or not. That is, you would be forcing a uniform flow using the Maximum Flow value.</p> </div>

Property	Description
Random Opacity	<p>You can create variation in the opacity of your eraser stroke just by setting the Maximum and Minimum Opacity values. If you add randomness to the mix, pressure sensitivity from your drawing tablet will still be applied. Light pressure will create random values around the minimum, while heavy pressure will create random values closer to the maximum. The larger the percentage, the larger the range of random variation.</p> <div data-bbox="574 516 1013 1029" style="border: 1px solid gray; padding: 10px; margin: 10px 0;">  <p style="text-align: center; margin: 5px 0;">Maximum Opacity = 100 Minimum Opacity = 10% Random Opacity = 0%</p> <p style="text-align: center; margin: 5px 0;">Maximum Opacity = 100 Minimum Opacity = 10% Random Opacity = 10%</p> <p style="text-align: center; margin: 5px 0;">Maximum Opacity = 100 Minimum Opacity = 10% Random Opacity = 50%</p> </div> <div data-bbox="574 1066 1430 1297" style="border: 1px solid green; padding: 10px; margin: 10px 0; background-color: #e0f2f1;"> <p> <b>NOTE</b></p> <p>Setting the Minimum Opacity value to 100% eliminates the possibility of creating opacity variation on your stroke, whether you are applying randomness or not. That is, you would be forcing a uniform opacity using the Maximum Opacity value.</p> </div>

## Dual Tip Tab

The Dual Tip tab lets you set the parameters for creating a dual tip eraser. The primary bitmap eraser tip and the dual tip always work together. You can set the parameters for the primary tip in the Tip tab and those for the dual tip in the Dual Tip tab. The Blend mode you select determines how the tips are combined.

By default, the Blend Mode is set to Multiply and the Random Angle to 360°.

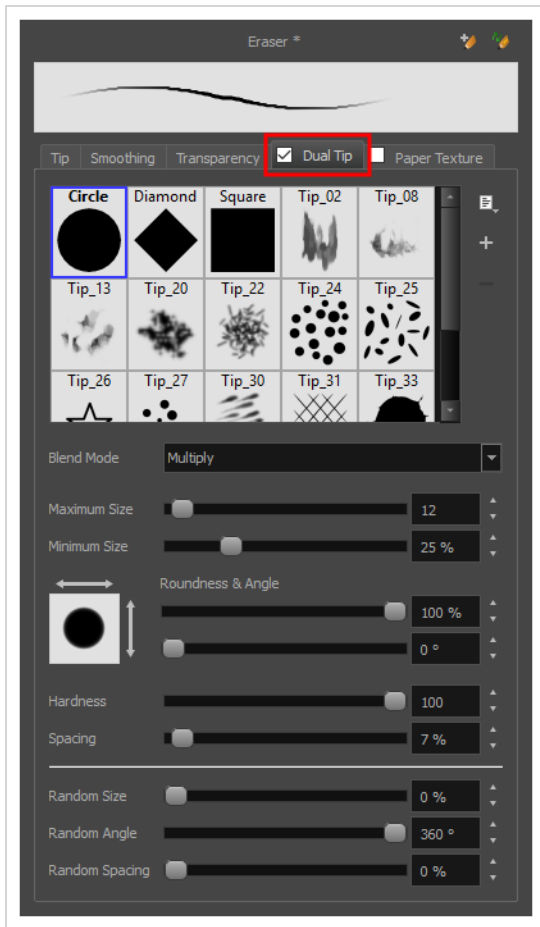

**NOTE**

To use a Dual Tip, you must enable option by checking the checkbox inside the **Dual Tip** tab. Additionally, if you are working on a vector layer, the **Eraser Type** option of the Tip tab must be set to **Textured Vector** or **Textured, Preserve Vector**.

Tool Name	Description
Enable/Disable	The checkbox inside the tab allows you to decide whether or not your eraser uses a dual tip. If this checkbox is unchecked, the options in the Dual Tip tab will be disabled.
Blend Mode	The Blend modes let you decide how the primary tip and the dual tip are combined.
Multiply	This is the default blend mode. When the two eraser tips are combined in this mode, they essentially cut each other out in overlapping areas, where one or both tips have an area of 100% transparency. The less opaque the eraser tips are, the lighter their combination.

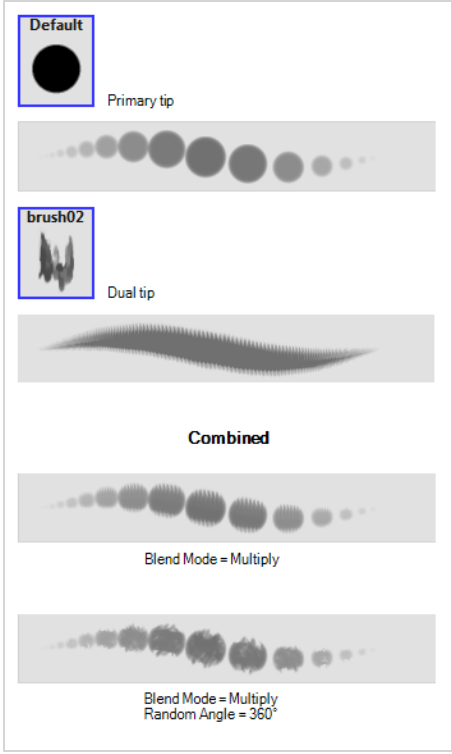
Tool Name	Description
	 <p>Default Primary tip</p> <p>brush02 Dual tip</p> <p>Combined</p> <p>Blend Mode = Multiply</p> <p>Blend Mode = Multiply Random Angle = 360°</p>
Colour Dodge	<p>In this mode, the primary tip cuts out the shape of the dual tip. Where the tip shapes overlap, within the boundaries of the primary shape, the colour and opacity appear darker.</p>

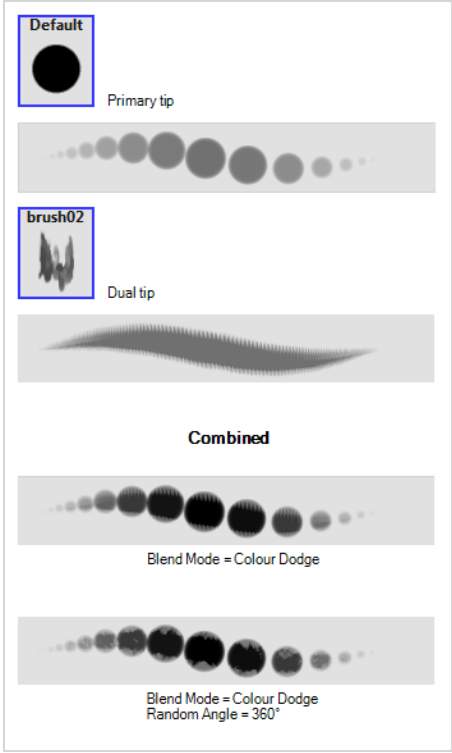
Tool Name	Description
	 <p>The image displays four examples of brush configurations and their resulting strokes:</p> <ul style="list-style-type: none"> <li><b>Default:</b> Labeled "Primary tip", showing a single black circular tip and a horizontal stroke of circles of varying sizes.</li> <li><b>brush02:</b> Labeled "Dual tip", showing two black circular tips and a wavy horizontal stroke.</li> <li><b>Combined:</b> Labeled "Blend Mode = Colour Dodge", showing two overlapping black circular tips and a horizontal stroke where the two tips' effects are combined.</li> <li><b>Combined:</b> Labeled "Blend Mode = Colour Dodge" and "Random Angle = 360°", showing two overlapping black circular tips and a horizontal stroke where the two tips' effects are combined with random orientations.</li> </ul>
Combine	<p>This mode treats the two tips as two different and separate erasers that have the same colour and follow the same path.</p>

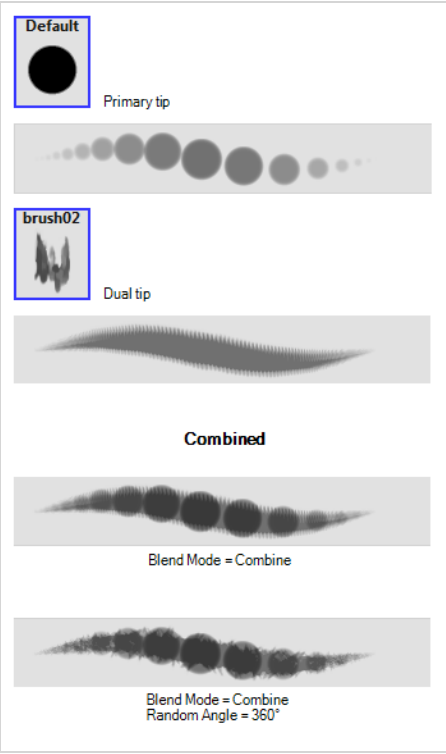

Tool Name	Description
	 <p>The diagram illustrates three brush tip configurations within a white rectangular frame:</p> <ul style="list-style-type: none"> <li><b>Default:</b> A single black circle tip, labeled "Primary tip". Below it is a horizontal row of circles of varying sizes, with the largest in the center, fading to smaller sizes at both ends.</li> <li><b>brush02:</b> Two black, pointed tips facing each other, labeled "Dual tip". Below it is a horizontal, wavy, feathered brush stroke.</li> <li><b>Combined:</b> A row of circles of varying sizes, similar to the "Default" row, but with a textured, grainy appearance. Below it is a horizontal, wavy, feathered brush stroke with a similar textured appearance. The text "Blend Mode = Combine" is centered below the stroke.</li> <li>Below the "Combined" stroke, the text "Blend Mode = Combine" and "Random Angle = 360°" is displayed.</li> </ul>

## Paper Texture Tab

The Paper Texture tab lets you configure a paper-like texture for your eraser. You can also add textures by importing image files, or import paper textures that were previously exported from Harmony.

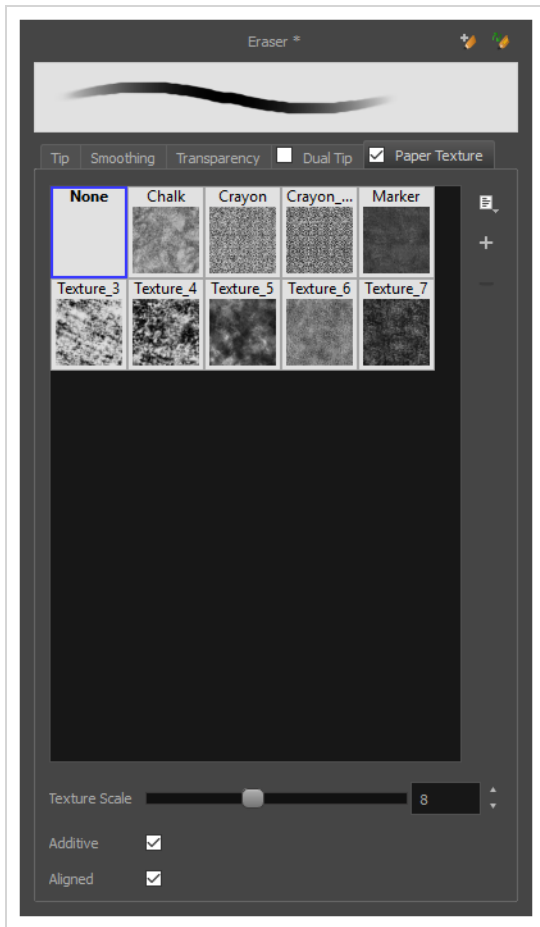

**NOTE**

To use a Paper Texture, you must enable option by checking the checkbox inside the **Paper Texture** tab. Additionally, if you are working on a vector layer, the **Eraser Type** option of the Tip tab must be set to **Textured Vector** or **Textured, Preserve Vector**.



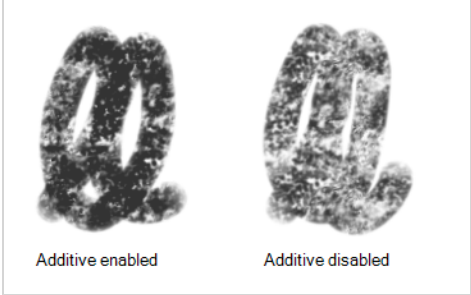
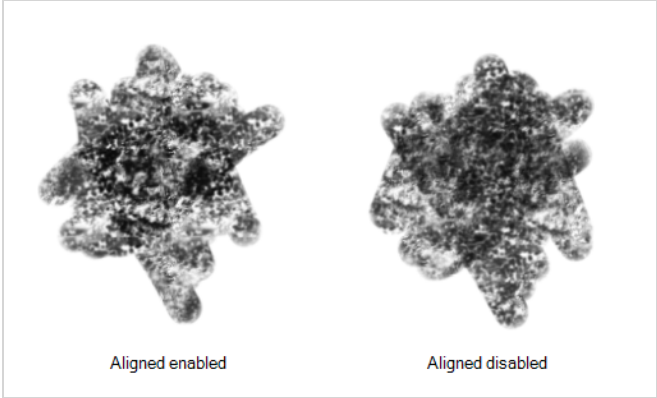



Property	Description
Enable/Disable	The checkbox inside the tab allows you to decide whether or not your eraser uses a paper texture. If this checkbox is unchecked, the options in the Paper Texture tab will be disabled.
Texture Scale	Increase or decreases the size of the paper texture.
Additive	This option layers the texture on top of itself as you scribble overlapping lines in one continuous stroke. If this option is turned off, areas of overlapping lines from a single, continuous stroke will appear the same, in terms of darkness and texture, as non-overlapping areas.

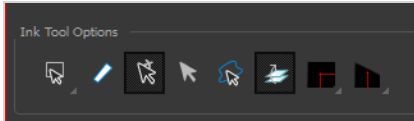





Property	Description
	 <p data-bbox="553 533 678 552">Additive enabled</p> <p data-bbox="781 533 911 552">Additive disabled</p>
Aligned	<p data-bbox="522 653 1422 783">This option defines the way separate, overlapping strokes behave. If this option is enabled, the paper texture's position does not change with each sweep of the eraser. If this option is disabled, each sweep of the eraser produces a different texture position. The texture orientation always stays the same.</p>  <p data-bbox="630 1142 748 1161">Aligned enabled</p> <p data-bbox="943 1142 1062 1161">Aligned disabled</p>

## Ink Tool Properties

When you select the Ink tool, its properties and options appear in the Tool Properties view.

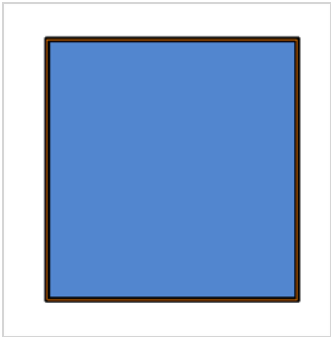

Icon	Tool Name	Tool
	Lasso	<p>Sets the selection mode to Lasso, which allows you to select multiple items by drawing a lasso around them.</p> <div style="border: 1px solid #0070C0; padding: 5px;"> <p> <b>TIP</b> When this option is enabled, you can press and hold the Alt key to temporarily use Marquee mode.</p> </div>
	Marquee	<p>Sets the selection mode to Marquee, which allows you to select multiple items by drawing a rectangle around them.</p> <div style="border: 1px solid #0070C0; padding: 5px;"> <p> <b>TIP</b> When this option is enabled, you can press and hold the Alt key to temporarily use Lasso mode.</p> </div>
	Show Inkable Lines	<p>Highlights all pencil lines (no brush strokes) on the selected layer. Pencil line segments that are already inked with the selected swatch colour from the colour palette are also not highlighted.</p>
	Be Smart on Connecting Lines	<p>As you hover and move the cursor across intersecting pencil lines, the path that you create will be highlighted. When you click on your mouse or stylus the highlighted segments are inked. With this option disabled, all the intersecting segments that your cursor comes near will be highlighted and become part of the selection, even if they were not situated in the direction of the chosen path.</p>

		 <b>NOTE</b> This option only works if the Ink tool is in Hover mode.
	Select Mode	Use this mode instead of the Hover Mode. In the Hover Mode, any potentially inkable pencil line will have its central vector line highlighted as the Ink tool's cursor hovers over it. Use Ctrl (Windows/Linux) or ⌘ (macOS) to toggle between the two modes.
	Select Newly Painted, Repainted, and Unpainted Contours/Lines	In the Paint tool properties, this option keeps a selection highlighted around the latest painted zone after using the Paint, Repaint, Unpaint, or Paint Unpainted tool. 
	Raise	As you ink the pencil line, the segment will be moved on top of the other intersecting strokes. Disable this option for the line to be sent behind. Hold down the Alt key to perform the opposite operation as you ink.
	Mitre	As you hover over two perpendicular or nearly perpendicular segments, a highlighted path with a corner is created. Clicking on these highlighted segments inks both segments and makes them appear as a single stroke with a corner or bend. Options include: As Is, Round, Miter, and Bevel.
	Tip Style	Lets you customize the edge of the Ink tool. Options include: Round, Flat, and Bevel.

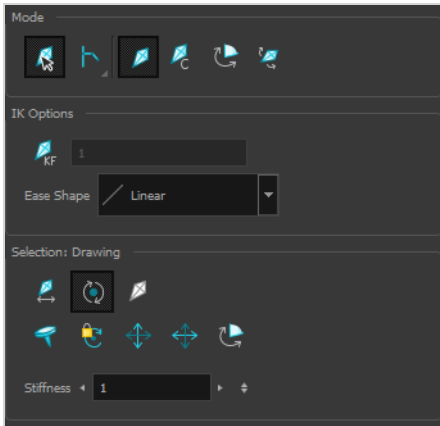

## Inverse Kinematics Tool Properties

The IK tool has a series of different modes and options available in the Tool Properties view.



### Mode

Mode	Button	Description
Bone Selection		<p>Enabled by default, this mode lets you click on any bone in a character and move it without having to select the actual layer.</p> <p>When you disable this mode, you cannot move any bone except the selected one. This allows you to grab and rotate the selected part from many angles and locations. You can click completely outside the character and move the pieces.</p>
Chain		<ul style="list-style-type: none"> <li> <b>Simple Chain Mode:</b> This is the default mode and will only allow for the movement of parts attached to a single chain up to the point of intersection. A single chain is a straight line with no secondary chain attached.</li> <li> <b>Direct Chain Mode:</b> This mode allows you to move parts up a simple secondary chain to a principle chain, as long as translation movement is possible (the principle chain is attached to its own peg), but will ignore all secondary chains. A direct chain is a single chain which goes directly to the core.</li> <li> <b>All Chain Mode:</b> This mode allows you to move all parts attached to all chains in the IK skeleton. All chains are attached and move simultaneously when one part is moved.</li> </ul>
IK Manipulation		<p>The main working mode for the IK tool. Enable this mode when you want to animate and position a puppet.</p> <p>Ctrl + click (Windows/Linux) or ⌘ + click (macOS) on a body part to</p>

		select it. You do not need to select a part to be able to move it.
Apply IK Constraints		Lets you correct a part's position on a series of frames. For example, if the character's foot is sinking into the floor, you can correct its position and angle over a series of frames.
Edit Min/Max Angle		Lets you set a rotation restriction on some of your parts, such as elbows, knees and ankles.
Bone Editing		Lets you fix the bone orientation on extremities, such as hands and feet.

## IK Options

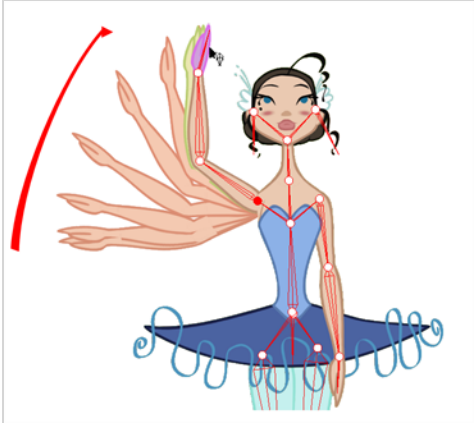
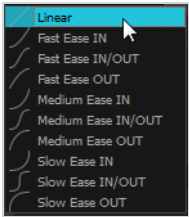
Parameter	Description
IK Keyframe	Used in combination with the IK Constraints mode, this option determines the starting frame of the constraint you will apply.
Ease Shape	<div data-bbox="561 1031 1032 1451" data-label="Image">  </div> <p>While animating with the IK tool and before doing a movement, set an easing preset so the motion is not so mechanical.</p> <p>Before moving the part, select a preset from the Ease Shape menu:</p> <div data-bbox="561 1625 748 1839" data-label="Image">  </div> <p>If you select a new preset in the list and move the part again on the same</p>

	keyframe, the easing will automatically update.
--	---

## Selection

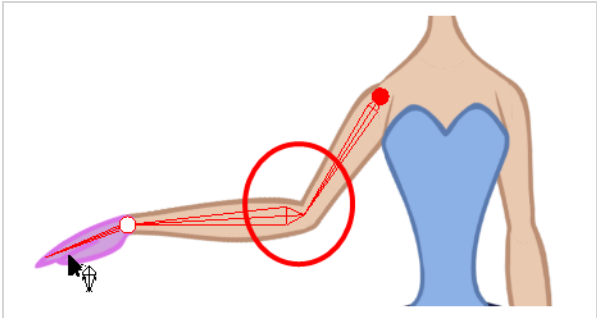
Parameter	Description
Enable Translation If Top of Hierarchy	 <p>Used only on master pegs. This option is useful when you have this particular situation: You want the character to do a perfect split (sitting down with the legs at right angles to the body or at the sides with the torso facing forwards), then the hip will need to translate and not just rotate on the spot. And since IK is all about rotation, you would select the hip layer and enable the translation option.</p>
Enable Rotation	 <p>This option is enabled by default. The pivot disappears but you can still see the bone. When this option is disabled, the selected part cannot be rotated and will remain in the same position. You can use this option to simulate an arm in a plaster cast.</p>
Exclude from IK	This option lets you exclude certain parts of the puppet from the IK influence, such as the eyes and mouth.
IK Nails	These options let you temporarily fix a part of a character to a spot either in translation or rotation, or enable maximum and minimum angle usage.
Stiffness	When a certain part is selected, you can apply a stiffness value to it. A different stiffness value can be set to each body part individually. The greater the stiffness, the more difficult it is to make that part rotate, thereby rendering it stiff while the other parts continue to move freely on their joints.



## Line Tool Properties

The Line tool allows you to quickly draw a line segment by dragging the mouse from its starting point to its end point.

### How to access the Line tool properties

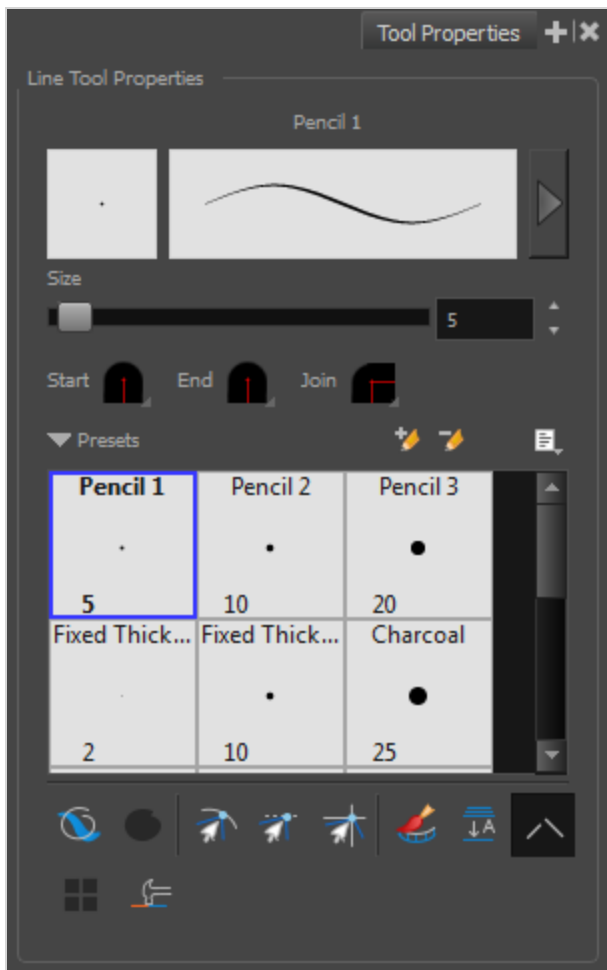

1. In the Tools toolbar, select the Line  tool.

The tool's properties are displayed in the Tool Properties view.



## Pencil Properties

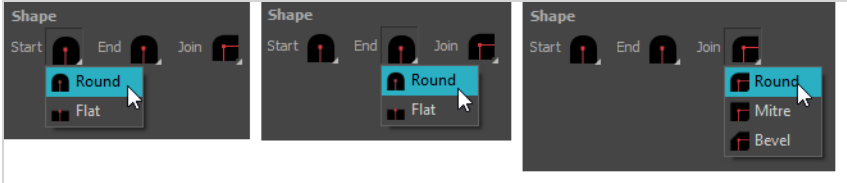

Just like other shape tools, this tool creates pencil lines. Hence, its tool properties are similar to the ones of the Pencil tool and it can be used with pencil presets.

Tool Name	Description
Preview Area	<p>The Preview area lets you see a preview of the stroke your drawing tool will make.</p> 
Pencil Properties Dialog	<p>The arrow button right of the preview area opens the Pencil Properties dialog.</p>  <p>While the Tool Properties view only gives you access to a few of the pencil properties, a list of pencil presets and other drawing options, the Pencil Properties dialog gives you access to all the available options for your pencil's shape and texture. For more information on the Pencil Properties dialog, see the <a href="#">Pencil Properties Dialog</a> section below.</p>
Size	<p>Defines the width of the pencil line used to draw the line.</p>
Shape	<p>You can adjust the start, end, and join style of a pencil line.</p>  <ul style="list-style-type: none"> <li>• <b>Start:</b> Lets you select the style of the start tip, which is the first tip you drew. You can choose between Round or Flat style.</li> <li>• <b>End:</b> Lets you select the style of the end tip, which is the last tip you drew. You can choose between Round or Flat style.</li> <li>• <b>Join:</b> Lets you select the joint style. The joints are where the line curves abruptly. You could also define the Join style as the corner style. You can choose between Round, Mitre and Bevel style.</li> </ul>

## Pencil Presets









These options allow you to select, create and manage pencil presets.





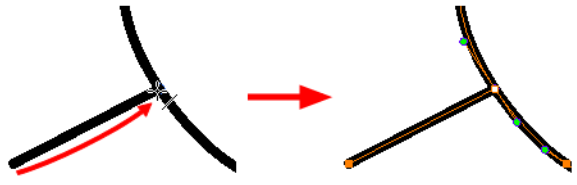

Icon	Property	Description
	Presets list	Harmony provides a variety of pencil presets and thickness stencils and



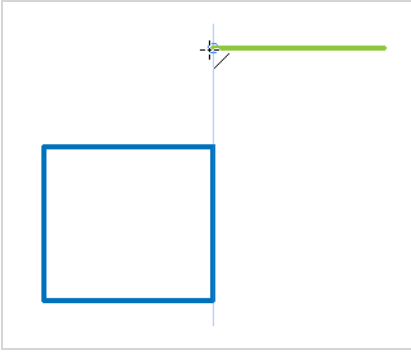

Icon	Property	Description
		<p>also lets you create and save your own. It is a good idea to create and save pencils with precise sizes and parameters when you draw for efficiency and consistency.</p> <p>A thickness stencil saves the thickness information across the length of the line. When drawing with a thickness stencil, the pressure sensitivity of the tablet is discarded. A thickness stencil can be used while drawing, or applied afterwards.</p> <p>You also have the possibility to apply different textures to your lines by either using the default presets or to import your own.</p> <p>You can export the pencil presets that you have created and import those that others have created. This is a good way for you and project collaborators to keep a consistent look for the project.</p>
	New Brush Preset	Creates a new preset based on the current tool properties.
	Delete Brush Preset	Deletes the currently selected preset.
	Brush Presets Menu	<p>Open a menu that contains the following options:</p> <ul style="list-style-type: none"> <li>• <b>New Brush Preset:</b> Creates a new preset based on the current tool properties.</li> <li>• <b>Delete Brush:</b> Deletes the currently selected preset.</li> <li>• <b>Rename Brush:</b> Allows you to rename the currently selected preset.</li> <li>• <b>Import Brushes:</b> Allows you to import brush presets exported from Harmony.</li> <li>• <b>Export Brushes:</b> Allows you to export your brush presets into an <b>.xml</b> file.</li> <li>• <b>Small Thumbnail:</b> Displays presets in a grid of small thumbnails with a preview of their tip.</li> <li>• <b>Large Thumbnail:</b> Displays presets in a grid of big thumbnails, with their name and a preview of their tip.</li> <li>• <b>Stroke View:</b> Displays presets in a list, with their name and a preview of a stroke done with each preset.</li> </ul>

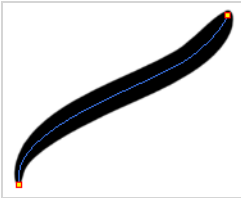

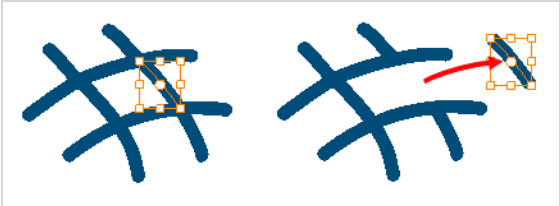
## Drawing Options

These options affect the way your drawing strokes are added to your artwork.

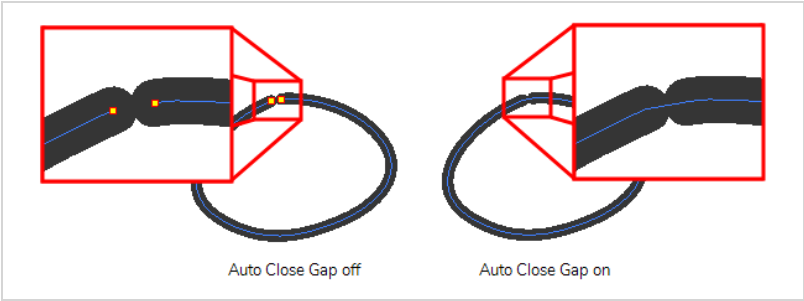
Icon	Tool Name	Description
	<p>Draw Behind</p>	<p>When enabled, your brush strokes will appear behind the existing artwork.</p> <div data-bbox="634 338 1105 533" style="border: 1px solid gray; padding: 5px;">  <p>The orange stroke was drawn over the black stroke, then put underneath it.</p> </div> <div data-bbox="634 569 1430 739" style="border: 1px solid green; padding: 5px; background-color: #e0f2f1;"> <p> <b>NOTE</b></p> <p>Your brush stroke will temporarily appear over your artwork as you draw it, until you release the mouse cursor or tablet pen.</p> </div>
	<p>Snap to Contour</p>	<p>When enabled, while you're drawing, the mouse cursor will automatically snap to the nearby contours of existing artwork, allowing you to draw shapes that connect with other parts of your drawing.</p> <div data-bbox="634 926 1247 1129" style="border: 1px solid gray; padding: 5px;">  </div> <div data-bbox="634 1171 1430 1478" style="border: 1px solid green; padding: 5px; background-color: #e0f2f1;"> <p> <b>NOTE</b></p> <p>If you draw a line with the Line tool and make its tip snap to a contour or another control point in your artwork, they will be locked together. You can then manipulate both simultaneously using the Contour Editor  tool. You can also separate two drawing strokes that have been snapped together by selecting one of them with the Select  tool and moving it away.</p> </div>
	<p>Snap and Align</p>	<p>When enabled, while you're drawing, the mouse cursor will automatically align with the edges of strokes and shapes in your artwork, allowing you to draw shapes that align with parts of your drawing.</p>

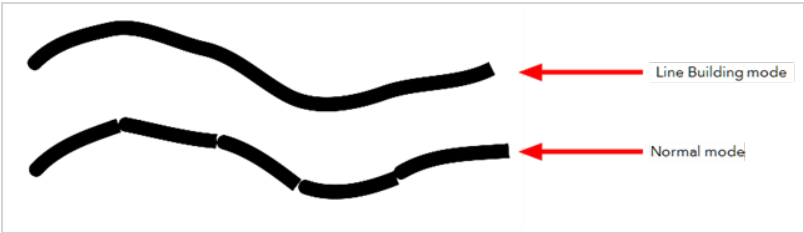
Icon	Tool Name	Description
		
	Snap to Grid	<p>When enabled, while you're drawing, the mouse cursor will snap against the intersecting points of the grid.</p> <div data-bbox="634 793 1430 968" style="border: 1px solid #add8e6; padding: 10px;"> <p> <b>TIP</b> To display the grid, select <b>View &gt; Grid &gt; Show Grid</b> from the top menu or press <b>Ctrl + '</b>.</p> </div>
	Automatically Create Colour Art	<p>As you draw in the Line Art layer, the Automatically Create Colour Art option instantly creates the corresponding strokes in the Colour Art layer.</p> 
	Auto-Flatten Mode	<p>By default, when drawing on a vector layer, each new stroke is created as a separate drawing object, which can be edited independently from other parts of the artwork. When enabled, the Auto-Flatten option automatically merges strokes into existing artwork.</p> 

Icon	Tool Name	Description
		<div style="border: 1px solid #c8e6c9; padding: 10px; margin: 10px 0;">  <p><b>NOTE</b></p> <p>Using the Select tool, you can use select and remove a segment of flattened pencil lines. Overlapping pencil lines drawn with the Auto-Flatten mode are essentially cut into segments by the overlap and can be treated as individual lines.</p> </div>
	<p>Auto-Close Gap</p>	<p>When enabled, small gaps between the pencil lines you draw will be closed by an invisible stroke to make sure your shapes are closed and that they can be filled with the Paint tool.</p> <p>When drawing contours with pencil lines, the centreline is used to determine whether or not the contour is closed, but the visible tips of the pencil line will extend a bit beyond the tips of its centreline, making it possible to have shapes that appear closed, but are not really. This can prevent the shape from being filled with the Paint tool. Enabling this option when drawing with the Pencil or Line tool will prevent you from leaving invisible gaps in your contours.</p> <div style="text-align: center; margin-top: 20px;">  <p>Auto Close Gap off      Auto Close Gap on</p> </div>
	<p>Line Building Mode</p>	<p>The Line Building mode is very useful when drawing long lines and curves in small increments with pencil lines or the Line tool. As the pencil lines are central vector lines, it may be difficult to align the line tips perfectly to create a uniform stroke and close all gaps.</p> <p>In this mode, you can draw lines in small increments and the tips are merge into one single stroke.</p> <div style="text-align: center; margin-top: 20px;">  <p>Line Building mode      Normal mode</p> </div>

Icon	Tool Name	Description
		<div style="border: 1px solid green; padding: 10px; background-color: #e6f2e6;">  <b>NOTE</b>            This mode only works with pencil lines or the line tool.         </div>
	Use Stored Colour Gradient	The Use Stored Colour Gradient option can be used when painting with a gradient colour to always position the gradient in the same way it was stored, making it consistent across brush strokes. You can store a gradient by selecting a zone painted with a gradient with the Select tool, then clicking on Store Colour Gradient  in the Tool Properties view.

## Pencil Properties Dialog

Since the Line tool draws pencil lines, you can use the Pencil Properties dialog to customize the type of lines it draws. To open the Pencil Properties dialog, click on the arrow button right of the stroke display area.

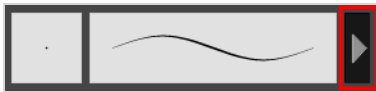

## Size and Smoothness Tab

The Size and Smoothness tab allows you to select your pencil's size, its smoothing parameters as well as the shape of its tips and corners.

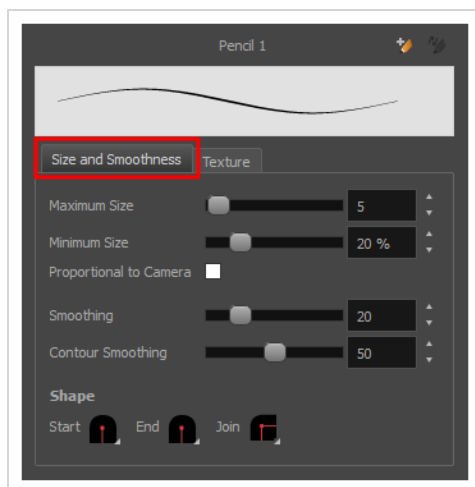

Property	Description
Maximum Size	Defines the maximum size of the pencil line. If the tool is used with a pressure

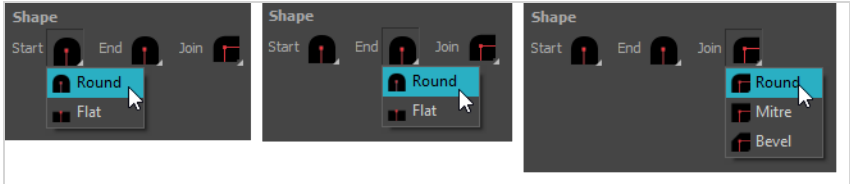
Property	Description
	sensitive pen tablet, the width of the stroke will vary between its maximum size and minimum size depending on the amount of pressure used. If used with a mouse, the width of the stroke will always be its maximum size.
Minimum Size	Defines the minimum size of your stroke as a percentage of the maximum size. If you do not have pressure sensitivity from a pen table, the minimum size value will be ignored.
Proportional to Camera	If you check this option, the size of the pencil will be adjusted to the position of the camera on the z-axis. This means that if the camera is zoomed in on the scene, the pencil will be proportionally smaller so that it appears the same size in the rendered image. Likewise, if the camera is zoomed out, the pencil will be proportionally bigger.
Smoothing	Defines the number of control points added to the centre line. The fewer the control points the smoother (but less faithful) the line.
Contour Smoothing	Defines the number of points on the contour share of your stroke. This will smooth out the bumps and waves on tour contour shape of your brush strokes.
Shape	<p>You can adjust the start, end, and join style of a pencil line.</p>  <ul style="list-style-type: none"> <li>• <b>Start:</b> Lets you select the style of the start tip, which is the first tip you drew. You can choose between Round or Flat style.</li> <li>• <b>End:</b> Lets you select the style of the end tip, which is the last tip you drew. You can choose between Round or Flat style.</li> <li>• <b>Join:</b> Lets you select the joint style. The joints are where the line curves abruptly. You could also define the Join style as the corner style. You can choose between Round, Mitre and Bevel style.</li> </ul>

## Texture Tab

In the Pencil Properties view, the Texture tab allows you to select a pencil texture from the currently selected pencil texture palette to use with the Pencil tool. You can also add, remove or rename textures, save the current pencil texture palette as the default one, or import the pencil texture palette into your scene.



The pencil texture palette used in the Texture tab of the Pencil Properties dialog is the one selected in the Colour view. You can select a pencil texture palette by selecting it from the pencil texture palette list in the Colour view—see [Colour View on page 1058](#).

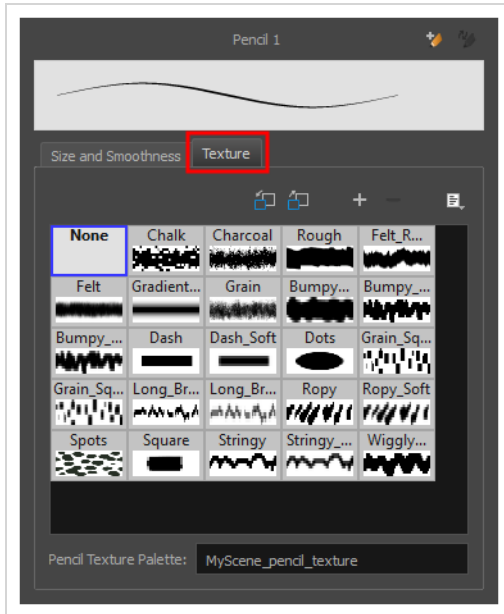





Icon	Property	Description
	Use as Default Pencil Texture Palette	Sets the currently selected pencil texture palette as the default pencil texture palette in your user preferences. The default pencil texture palette is added to every scene you create in Harmony. The palette is copied in your preferences, so it will be added to your new scenes in the exact state it is when you make it the default pencil texture palette.
	Reload Default Texture Palette	Imports the default pencil texture palette as a new pencil texture palette into your scene's palette list, and selects it as the current pencil texture palette.
	New Texture	Allows you to import an image file into a new pencil texture swatch in the current pencil texture palette. The pencil texture's effect on your pencil line will be based on the image's transparency channel, and will follow your pencil lines on its horizontal axis.
	Delete Texture	Deletes a pencil texture swatch from the current pencil texture palette.
	Rename Texture	Renames the selected pencil texture swatch in the current pencil texture palette.



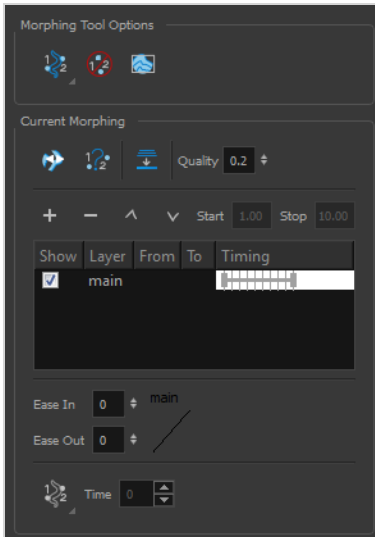

Icon	Property	Description
	Pencil Texture List	Displays the pencil textures in the current pencil texture palette and allows you to select one to use with the Pencil tool.
	Pencil Texture Palette	Displays the name of the currently selected pencil texture palette, for reference. To select a different pencil texture palette, you must select it in the Colour view—see <a href="#">Colour View on page 1058</a> .

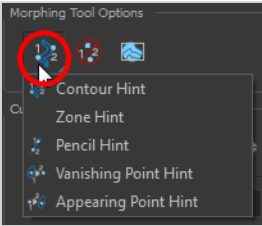
## Morphing Tool Properties

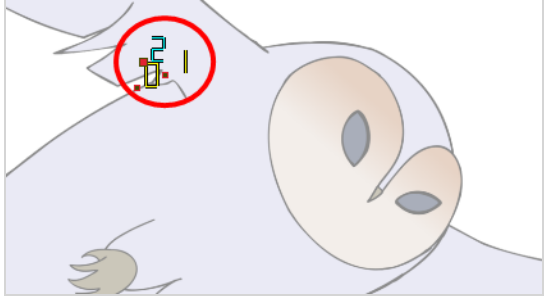

As you create and adjust your morphing sequences, you will often use the Tool Properties view. Using this view allows you to do things such as toggle between your key drawings, adjust the easing or select a hint type.

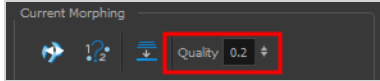

Icon	Tool Name	Description
	Hint Type	<p>The Hint Type drop-down menu allows you to select the correct hint to remedy any problem areas in your drawing.</p>  <p>You can have more than one hint type in your drawings. You can mix all of the hint types in your morphing sequence.</p>
	Do not Pick Transparency	<p>The Hide Hints button temporarily hides the hint points from the key drawings. Use this option when you have a series of hint points hiding some lines you would like to see.</p>

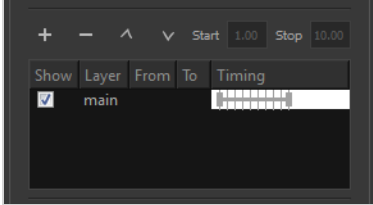
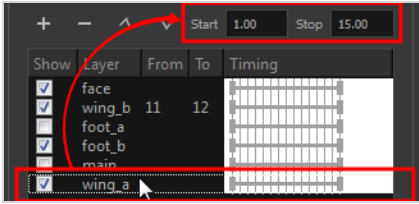
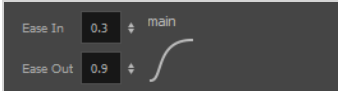
		
	Show Morphing in Place	The Show Morphing In Place option is used with morphing layers. Enabling this option prevents the currently selected morphing layer from being shown on top of the others and maintains the correct layer ordering.
	Suggest Hints	The Suggest Hints option is used to automatically set hint points on key drawings as a help tool. If you're not sure where to set hints, you can use this option. It will set the main hints which you can then fine tune.
	Switch Between Drawings	The Switch Between Drawings button is used to toggle Toggles between the two key drawings in your morphing sequence. This option is useful while setting hints. You can use the default keyboard shortcut F4 to toggle between your drawings.
	Flatten	The Flatten option is used when you have to morph a sequence with a semi-transparent or transparent colour in it.
	Quality	<p>The Quality setting is used to make the lines of the morphed drawings smoother. Adjust this parameter when you are doing an extreme close up of your animation.</p> 
	Morphing Layers	The Morphing Layers option is used when working with morphing layers. You can add, remove and manage your different morphing layers in this space.

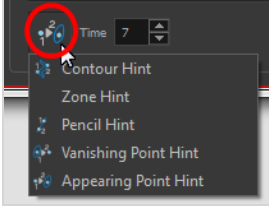
		 <p>To create new drawings, double-click on the blank area under the <b>From</b> section to create the source drawing and the <b>To</b> section for the destination drawing and type a different value than the ones used for the main layer.</p>
+	Add Layer	Adds a new Morphing layer.
-	Delete Layer	Deletes the selected Morphing layer.
^	Move Up	Moves the new layer up in the stack.
v	Move Down	Moves the new lower up in the stack.
	Start	<p>Indicates the start frame of the selected Morphing layer.</p> 
	Stop	Indicates the end frame of the selected Morphing layer.
	Ease in and Ease out	<p>The Easing option is used to adjust the starting and ending velocity of your morphing sequence so that the motion is smooth and not mechanical.</p> <p>You can adjust the Ease In and Ease Out value by dragging your cursor up and down or typing a new value. The values go from -1.0 to 1.0.</p> 

	<p>Convert Hints</p>	<p>The Convert Hints option is used to switch the type of the selected hint points. This option is useful when you position hints and then realize they are not the right type. You can select them and convert them to the correct type instead of deleting them and setting new ones.</p>  <p>Use the Morphing tool to select the hints and then convert them by going to the Tool Properties view and selecting the new hint type from the Convert Hints drop-down menu.</p>
	<p>Time</p>	<p>The Time field is used to set the timing on Appearing Point and Vanishing Point hints. These hints are used to set the trajectory of appearing and vanishing objects, With the Time field, select your Appearing Point or Vanishing Point hint and type the frame number on which the object will start its appearing or vanishing animation.</p> 

## Paint Tool Properties

The Paint tool allows you to fill closed areas of your drawing with the selected colour.





### How to access the Paint tool properties

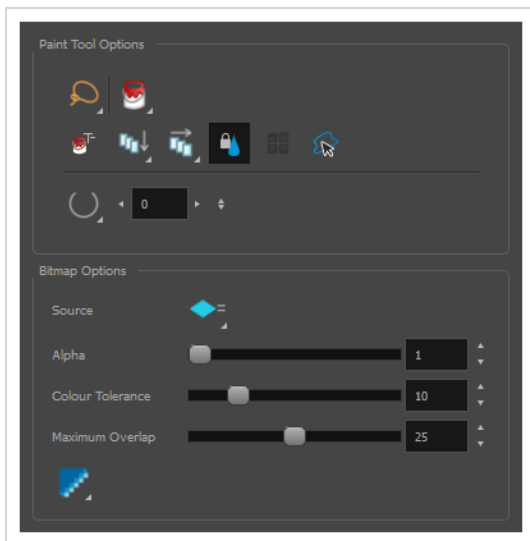









1. In the Tools toolbar, select the Paint , Paint Unpainted , Repaint  or Unpaint  tool.

The tool's properties are displayed in the Tool Properties view.









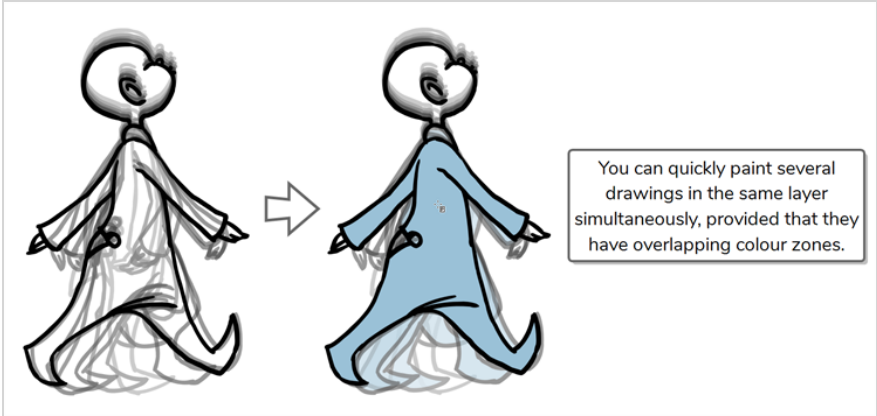

## Paint Tool Options

Icon	Property	Description
	Selection Mode	<p>Allows you to choose the method to visually select multiple elements:</p> <ul style="list-style-type: none"> <li>•  <b>Lasso:</b> Allows you to select multiple elements by drawing a lasso around them with your mouse.</li> <li>•  <b>Marquee:</b> Allows you to select multiple elements by drawing a rectangle around them. This is faster, as you only need to drag your mouse from one corner of the rectangle to its opposite corner, but it may not be as precise as you want.</li> </ul> <div style="border: 1px solid #0070C0; padding: 5px; margin-top: 10px;"> <p> <b>TIP</b> You can press and hold the Alt key to temporarily use the other selection mode.</p> </div>

Icon	Property	Description
	<p>Paint Mode</p>	<p>The Paint tool has four different modes:</p> <ul style="list-style-type: none"> <li>  <b>Paint:</b> Paints or repaints selected zones, whether or not they are already filled.         </li> <li>  <b>Paint Unpainted:</b> Only paints empty zones, and does not repaint zones that are already filled with colour.         </li> <li>  <b>Repaint:</b> Only paints zones that are already filled with colour, and does not fill empty zones.         </li> <li>  <b>Unpaint:</b> Removes colour from the selected zone, replacing it with transparency.         </li> </ul>
	<p>Paint and Remove Textures</p>	<p>The Paint and Remove Texture option is used when you vectorized images as greyscale texture style. An image vectorized as texture is a mix of bitmap filling encapsulated in a vector-based frame. Painting a textured zones with the Paint tool will change the tint of the textured lines. Painting the textured zones using the Paint and Remove Texture option transforms the bitmap filling into a 100% vector based zone and fills it with a solid colour.</p> 
	<p>Apply to Visible Drawing Layers</p>	<p>This option allows you to select which layers the tool should affect. It can be toggled on or off. When toggled on, it has two different modes. You can select a mode by clicking and holding on the button.</p> <ul style="list-style-type: none"> <li> <b>Off:</b> When this button is toggled off, the tool only works on the currently selected layers. If several layers are selected, the tool will work on all these layers simultaneously.         </li> <li>  <b>Apply to Visible Drawing Layers:</b> The tool will work on all the visible layers in the Camera view.         </li> <li>  <b>Apply to Synced Drawing Layers:</b> If the currently selected layer is synced with another layer, the tool will work on both the current layer and its synced layer.         </li> </ul> <div style="border: 1px solid green; padding: 10px; margin-top: 10px;"> <p> <b>NOTE</b> This option only works in the Camera view.</p> </div>

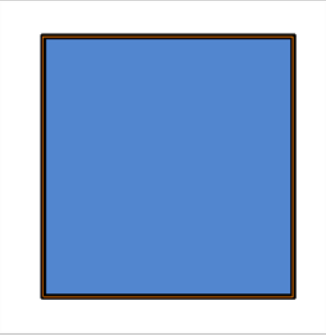

Icon	Property	Description
	Apply to All Frames	<p>This option allows you to determine which drawings in the current layer the tool should affect. It can be toggled on or off. When toggled on, it has two different modes. You can select a mode by clicking and holding on the button.</p> <ul style="list-style-type: none"> <li>• <b>Off:</b> When this button is toggled off, the tool only works on the drawing in the current frame.</li> <li>•  <b>Apply to All Frames:</b> The tool will work on every exposed drawing in the selected layer simultaneously.</li> <li>•  <b>Apply to Onion Skin Range:</b> The tool will work on every drawing displayed in the Onion Skin. Onion Skin must be enabled for this option to work.</li> </ul> <div data-bbox="561 716 1433 1129" style="border: 1px solid black; padding: 10px; margin-top: 10px;">  </div>
	Respect Protected Colour	<p>The Respect Protected Colour option is enabled by default. In your Colour view, you can protect some colour swatches to avoid repainting or unpainting the zones linked to that swatch.</p> <p>If you disable this option the Paint tool will not follow the protect colour rule and will repaint or unpaint the protected colours on your drawings until you enable the option again.</p>
	Use Stored Colour Gradient	<p>When you paint a zone with a gradient or textured colour swatch, the gradient or texture's position is set relative to the size of the zone you are painting. If you want the Paint tool to use a particular size and position, you must first store your desired position and size using the Select tool and then enable the Use Stored Colour Gradient option in the Paint tool properties.</p>





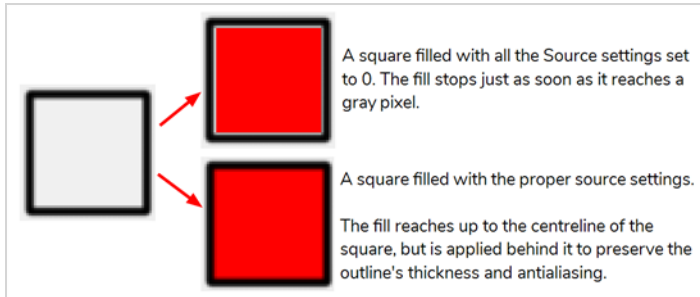

Icon	Property	Description
		
	<p>Select Newly Painted, Repainted, and Unpainted Contours/Lines</p>	<p>In the Paint tool properties, this option keeps a selection highlighted around the latest painted zone after using the Paint, Repaint, Unpaint, or Paint Unpainted tool.</p> 
	<p>Close Gap</p>	<p>By default, if you attempt to fill a shape that has a small gap in its contour, the Paint tool will not be able to fill the shape. This option allows you to make the Paint tool automatically add a stroke to close the shape when it detects a small gap between two strokes in the shape.</p> <p>The Close Gap setting can be set to a value between 0 and 10. This determines the maximum size of a gap to close, in pixels. You can also use one of the following presets:</p> <ul style="list-style-type: none"> <li>• <input type="radio"/> <b>No Close Gap:</b> Sets the Close Gap setting to 0, disabling the feature.</li> <li>• <input type="radio"/> <b>Close Small Gap:</b> Sets the Close Gap setting to 2, making the Paint tool close gaps that are barely visible.</li> <li>• <input type="radio"/> <b>Close Medium Gap:</b> Sets the Close Gap setting to 4, making the Paint tool close gaps that are somewhat visible.</li> <li>• <input type="radio"/> <b>Close Large Gap:</b> Sets the Close Gap setting to 8, making the Paint tool close gaps that are easy to notice.</li> </ul>

## Bitmap Options



Since bitmap drawings are made of pixels instead of shapes, and that the outlines of shapes in bitmap drawings are often feathered, it can be complicated to figure out exactly the area the Paint tool must fill when trying to fill a zone in a bitmap drawing. For example, if the Paint tool only replaces pixels with the exact same colour as the one you click on with the selected colour, it will leave a small gap near the outlines of the shape.



The following settings determine how the Paint tool figures out the area it must fill. When any of these settings are increased, the Paint tool's tolerance for colour or alpha differences increases and it will a bigger area that it otherwise would.

Icon	Property	Description
	Source	<p>Allows you to select which art layer to use in order to determine the fillable zone. By default, this is set to Current Art , which means the layer you are filling will be used to determine the fillable zone. However, if you want to keep your colour art on the Colour Art layer and the line art on the Line Art layer, you can set the Source to Line Art , and then use the Paint tool on the Colour Art layer. The Paint tool will use the artwork in the Line Art layer to determine the area to fill with colour, but will still add this colour to the Colour Art layer.</p> <p>This property has the following options:</p> <ul style="list-style-type: none"> <li>•  <b>Current Art:</b> Bases the zone to fill on the current art layer.</li> <li>•  <b>Line Art:</b> Bases the zone to fill on the Line Art layer, regardless of which layer you are painting on.</li> <li>•  <b>Colour Art:</b> Bases the zone to fill on the Colour Art layer, regardless of which layer you are painting on.</li> </ul>
--	Alpha	<p>The alpha threshold that separates opaque and transparent zones. When filling a "transparent" zone, the paint tool will apply the colour under semi-transparent pixels, making them opaque. Then filling an "opaque" zone, the paint tool will replace the colour of semi-transparent pixels without affecting their transparency.</p> <p>If you want to repaint lineart or shapes that have no outlines, you can do</p>

Icon	Property	Description
		<p>so by decreasing this setting completely. This will make it fill any pixel that isn't 100% transparent, so it will paint your outlines completely. However, if you're using this method to repaint outlines, they must not be filled yet for this method to work.</p> <p>If you want to paint transparent zones that have dirt or semi-transparent spots, you can increase this setting to make the Paint tool paint behind them instead of around them.</p> <div data-bbox="657 577 1429 808" style="border: 1px solid #c8e6c9; padding: 10px;"> <p> <b>NOTE</b></p> <p>Raising this setting too high may cause the paint tool to ignore outlines that are not 100% opaque, which can cause it to think the shape is not closed. Hence, it might fail to find a zone to fill and not do anything.</p> </div>
--	Colour Tolerance	<p>The amount of tolerance the paint tool has for changes in colour when filling an area. Raising this setting will allow the paint tool to fill over areas that have some variations in colour, but may cause it to fill beyond the areas you meant to paint.</p>
--	Maximum Overlap	<p>The maximum amount of pixels beyond the fillable zone that the Paint tool can fill.</p> <p>When this setting is set to any value above zero, the paint tool will fill the zone until it finds a pixel that is a different colour, value or transparency as the one you clicked on. Then, it will start filling pixels beyond that point, up until it filled the amount of pixels in the Maximum Overlap setting.</p> <p>If it lands outside of a fillable zone before it reached the maximum overlap, it will stop filling at that point. However, if it lands into another fillable zone before reaching its maximum overlap, it will fill that zone as well. Therefore, if you're filling shapes inside other shapes, you have to set this setting to the approximate width of your outlines. Setting it higher will make the colour spill beyond the zone you clicked on and fill the zone outside of it, and setting it lower is liable to leave a small gap between the fill and the outlines.</p>

Icon	Property	Description
		<div data-bbox="657 283 1429 672" style="border: 1px solid #c8e6c9; padding: 10px;">  <p><b>NOTE</b></p> <p>When you fill a zone with overlap, Harmony tries to detect and preserve the outlines of your shape. This is easy to do when filling a transparent shape, or when repainting a shape made of solid outlines and a solid fill. However, if you are trying to repaint an already painted zone, it may fail to detect your outlines and may repaint over them if the colour of your outlines or inside the shape isn't consistent. Therefore, it is highly recommended to avoid repainting painted zones as much as possible when working with bitmap layers.</p> </div>
	Antialiasing	<p>When enabled, the outlines of the fill will be smoothed so that they do not look pixelated.</p> <div data-bbox="657 829 1429 1029" style="border: 1px solid #c8e6c9; padding: 10px;">  <p><b>NOTE</b></p> <p>The effect of this setting will not be visible if you fill all the way to the outlines, as the Paint tool will preserve the antialiasing of existing outlines when filling up to them.</p> </div>

## Pencil Tool Properties

The Pencil tool allows you to draw simple contour lines that are defined by their centerline and their thickness.

When you select the Pencil tool, the Tool Properties view displays the different Pencil modes that control how the pencil line is drawn.

### How to access the Pencil tool properties

1. In the Tools toolbar, select the Pencil  tool.

The tool's properties are displayed in the Tool Properties view.

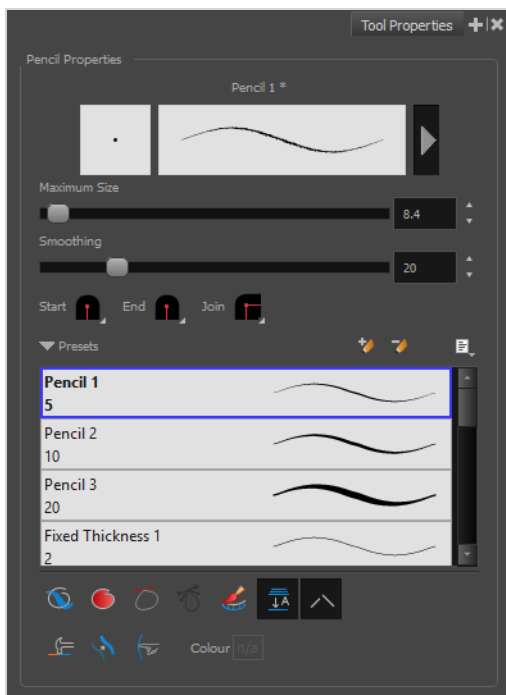

## Pencil Properties

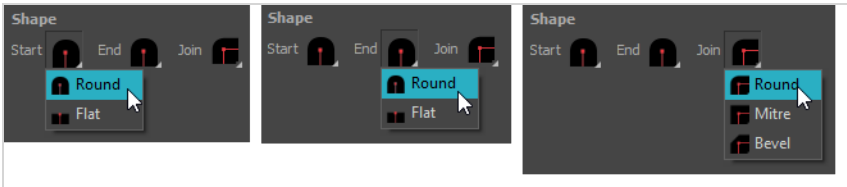

The following properties affect the pencil's size, smoothing, shape and other properties for the drawing style of your pencil. Those properties can be saved into pencil presets for later use.

Property	Description
Preview Area	<p>The Preview area lets you see a preview of the stroke your drawing tool will make.</p> 

Property	Description
Pencil Properties Dialog	<p>The arrow button right of the preview area opens the Pencil Properties dialog.</p>  <p>While the Tool Properties view only gives you access to a few of the pencil properties, a list of pencil presets and other drawing options, the Pencil Properties dialog gives you access to all the available options for your pencil's shape and texture. For more information on the Pencil Properties dialog, see the <a href="#">Pencil Properties Dialog</a> section below.</p>
Maximum Size	<p>Defines the maximum width of the pencil line.</p> <p>If the tool is used with a pressure sensitive pen tablet, the width of the stroke will vary between its maximum size and minimum size depending on the amount of pressure used. If used with a mouse, the width of the stroke will always be its maximum size.</p>
Smoothing	<p>Defines the number of control points added to the centre line. The fewer the control points the smoother (but less faithful) the line.</p>
Shape	<p>You can adjust the start, end, and join style of a pencil line.</p>  <ul style="list-style-type: none"> <li>• <b>Start:</b> Lets you select the style of the start tip, which is the first tip you drew. You can choose between Round or Flat style.</li> <li>• <b>End:</b> Lets you select the style of the end tip, which is the last tip you drew. You can choose between Round or Flat style.</li> <li>• <b>Join:</b> Lets you select the joint style. The joints are where the line curves abruptly. You could also define the Join style as the corner style. You can choose between Round, Mitre and Bevel style.</li> </ul>

## Pencil Presets











These options allow you to select, create and manage pencil presets.



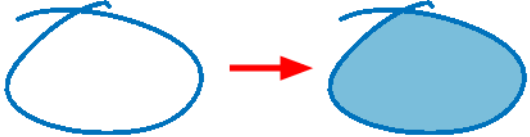



Icon	Property	Description
	Presets list	<p>Harmony provides a variety of pencil presets and thickness stencils and also lets you create and save your own. It is a good idea to create and save pencils with precise sizes and parameters when you draw for efficiency and consistency.</p> <p>A thickness stencil saves the thickness information across the length of the line. When drawing with a thickness stencil, the pressure sensitivity of the tablet is discarded. A thickness stencil can be used while drawing, or applied afterwards.</p> <p>You also have the possibility to apply different textures to your lines by either using the default presets or to import your own.</p> <p>You can export the pencil presets that you have created and import those that others have created. This is a good way for you and project collaborators to keep a consistent look for the project.</p>
	New Brush Preset	Creates a new preset based on the current tool properties.
	Delete Brush Preset	Deletes the currently selected preset.
	Brush Presets Menu	<p>Open a menu that contains the following options:</p> <ul style="list-style-type: none"> <li>• <b>New Brush Preset:</b> Creates a new preset based on the current tool properties.</li> <li>• <b>Delete Brush:</b> Deletes the currently selected preset.</li> <li>• <b>Rename Brush:</b> Allows you to rename the currently selected preset.</li> <li>• <b>Import Brushes:</b> Allows you to import brush presets exported from Harmony.</li> <li>• <b>Export Brushes:</b> Allows you to export your brush presets into an <code>.xml</code> file.</li> <li>• <b>Small Thumbnail:</b> Displays presets in a grid of small thumbnails with a preview of their tip.</li> <li>• <b>Large Thumbnail:</b> Displays presets in a grid of big thumbnails, with their name and a preview of their tip.</li> <li>• <b>Stroke View:</b> Displays presets in a list, with their name and a preview of a stroke done with each preset.</li> </ul>

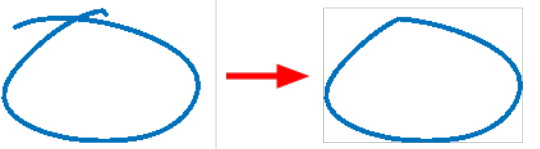

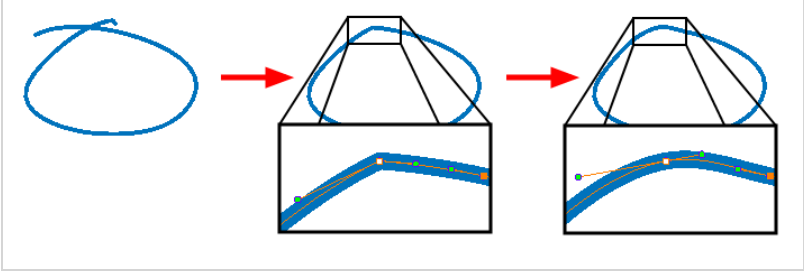

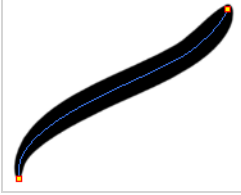

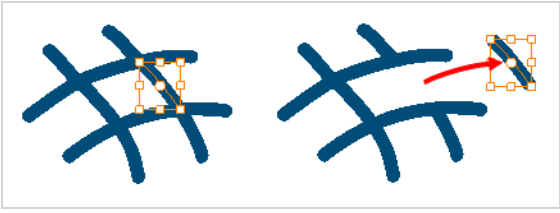

## Drawing Options

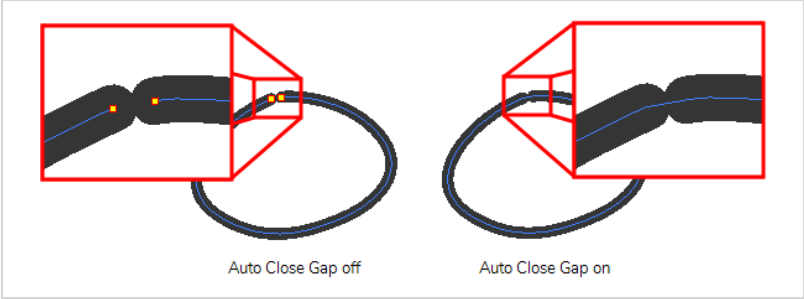
These options affect the way your drawing strokes are added to your artwork.

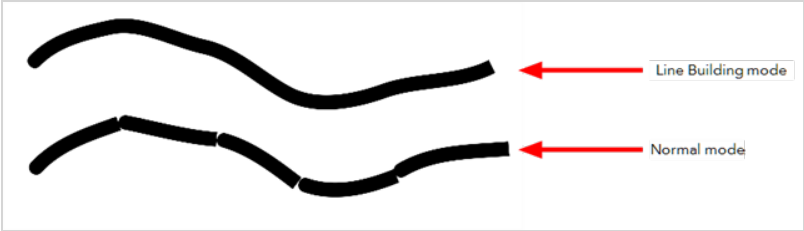
Icon	Property	Description
	Draw Behind	<p>When enabled, your brush strokes will appear behind the existing artwork.</p> <div data-bbox="634 478 1105 674">  <p>The orange stroke was drawn over the black stroke, then put underneath it.</p> </div> <div data-bbox="634 709 1430 884" style="border: 1px solid green; padding: 5px;"> <p> <b>NOTE</b></p> <p>Your brush stroke will temporarily appear over your artwork as you draw it, until you release the mouse cursor or tablet pen.</p> </div>
	Auto Fill	<p>When enabled, drawing a closed shape will automatically fill it with the currently selected Paint colour.</p> <div data-bbox="634 1031 1211 1209">  </div> <div data-bbox="634 1251 1430 1528" style="border: 1px solid blue; padding: 5px;"> <p> <b>TIP</b></p> <p>By default the pencil line and its fill will be the same colour. If you want to select different colours for the pencil line and its fill, you can click on the Unlock Three Colours  button in the Colour view, then select different colours for Brush strokes , Pencil lines  and Paint fills .</p> </div>
	Trim Extra Lines	<p>When enabled, drawing a closed shape will automatically remove the outstanding lines.</p> <div data-bbox="634 1682 1195 1839">  </div>

Icon	Property	Description
	<p>Align Handles After Trim</p>	<p>When the Trim Extra Lines option is enabled, enable this option to make the point where the beginning and end of the stroke meet into a smooth curve rather than a hard corner.</p> 
	<p>Automatically Create Colour Art</p>	<p>As you draw in the Line Art layer, the Automatically Create Colour Art option instantly creates the corresponding strokes in the Colour Art layer.</p> 
	<p>Auto Flatten</p>	<p>By default, when drawing on a vector layer, each new stroke is created as a separate drawing object, which can be edited independently from other parts of the artwork. When enabled, the Auto-Flatten option automatically merges strokes into existing artwork.</p>  <div data-bbox="634 1507 1430 1738" style="border: 1px solid green; padding: 5px; margin-top: 10px;"> <p> <b>NOTE</b></p> <p>Using the Select tool, you can select and remove a segment of flattened pencil lines. Overlapping pencil lines drawn with the Auto-Flatten mode are essentially cut into segments by the overlap and can be treated as individual lines.</p> </div>
	<p>Auto-Close Gap</p>	<p>When enabled, small gaps between the pencil lines you draw will be closed by an invisible stroke to make sure your shapes are closed and that they can be filled with the Paint tool.</p>

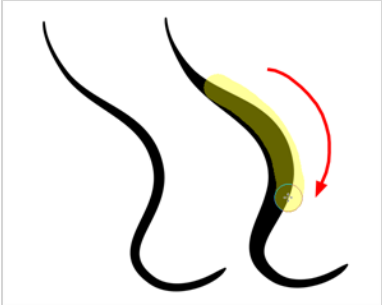
Icon	Property	Description
		<p>When drawing contours with pencil lines, the centreline is used to determine whether or not the contour is closed, but the visible tips of the pencil line will extend a bit beyond the tips of its centreline, making it possible to have shapes that appear closed, but are not really. This can prevent the shape from being filled with the Paint tool. Enabling this option when drawing with the Pencil or Line tool will prevent you from leaving invisible gaps in your contours.</p> 
	<p>Line Building Mode</p>	<p>The Line Building mode is very useful when drawing long lines and curves in small increments with pencil lines or the Line tool. As the pencil lines are central vector lines, it may be difficult to align the line tips perfectly to create a uniform stroke and close all gaps.</p> <p>In this mode, you can draw lines in small increments and the tips are merge into one single stroke.</p>  <div data-bbox="634 1470 1433 1608" style="border: 1px solid green; padding: 5px;"> <p> <b>NOTE</b> This mode only works with pencil lines or the line tool.</p> </div>
	<p>Auto Adjust Thickness</p>	<p>The Auto Adjust Thickness tool is useful when you want to render a portion of a line thicker. When tracing a drawing on paper, you will often go back to a section of a curve to make it thicker to add dynamism to the line. Using the Auto Adjust Thickness tool, you can draw highlight strokes over the section to make thicker. Once you release the pen or mouse, the line becomes thicker following the shape and curve of the original stroke. This way is much faster and smoother than using the Pencil Editor tool.</p>

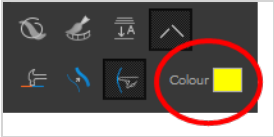
Icon	Property	Description
		<p>You do not have to add extra points and adjust the position and Bezier handles.</p>  <p>The default overlay colour is light yellow. If this colour is difficult to see because of the background or drawing colour, you can adjust the colour.</p>
	<p>Line Pushing Mode</p>	<p>The Line Pushing Mode option lets you draw highlight strokes over existing pencil lines. You can reshape the curves. Depending how you draw the pushing stroke over your line, the highlighted section will be reshaped in one direction or the other.</p> <p>The default overlay colour is light yellow. If this colour is difficult to see because of the background or drawing colour, you can adjust the colour.</p>
	<p>Colour</p>	<p>You can change the colour of the temporary strokes that appear in the drawing space when using the Line Pushing Mode or the Auto Adjust Thickness option by clicking on the Colour swatch and selecting a new colour in the Colour Picker dialog.</p> 

## Pencil Properties Dialog

Pencils have extra parameters which are not accessible from the Tool Properties view. To open the Pencil Properties dialog, click on the arrow button right of the stroke display area.

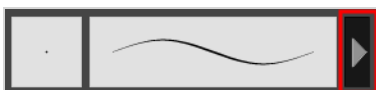

## Size and Smoothness Tab

The Size and Smoothness tab allows you to select your pencil's size, its smoothing parameters as well as the shape of its tips and corners.

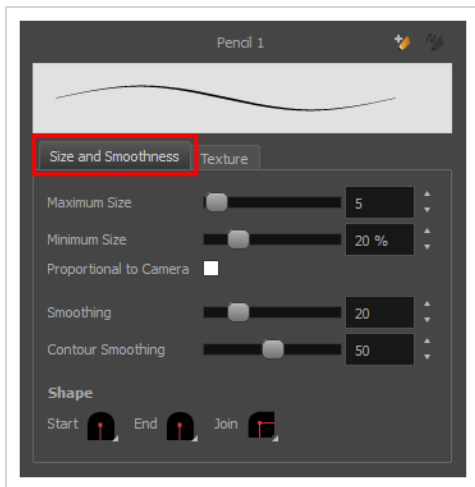

Property	Description
Maximum Size	Defines the maximum size of the pencil line. If the tool is used with a pressure sensitive pen tablet, the width of the stroke will vary between its maximum size and minimum size depending on the amount of pressure used. If used with a mouse, the width of the stroke will always be its maximum size.
Minimum Size	Defines the minimum size of your stroke as a percentage of the maximum size. If you do not have pressure sensitivity from a pen table, the minimum size value will be ignored.
Proportional to Camera	If you check this option, the size of the pencil will be adjusted to the position of the camera on the z-axis. This means that if the camera is zoomed in on the scene, the pencil will be proportionally smaller so that it appears the same size in the rendered image. Likewise, if the camera is zoomed out, the pencil will be proportionally bigger.
Smoothing	Defines the number of control points added to the centre line. The fewer the control points the smoother (but less faithful) the line.
Contour Smoothing	Defines the number of points on the contour share of your stroke. This will smooth out the bumps and waves on your contour shape of your brush strokes.
Shape	You can adjust the start, end, and join style of a pencil line.

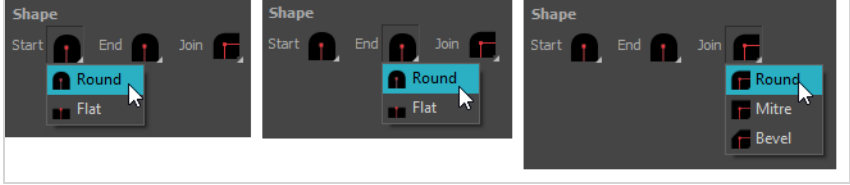



Property	Description
	 <ul style="list-style-type: none"> <li>• <b>Start:</b> Lets you select the style of the start tip, which is the first tip you drew. You can choose between Round or Flat style.</li> <li>• <b>End:</b> Lets you select the style of the end tip, which is the last tip you drew. You can choose between Round or Flat style.</li> <li>• <b>Join:</b> Lets you select the joint style. The joints are where the line curves abruptly. You could also define the Join style as the corner style. You can choose between Round, Mitre and Bevel style.</li> </ul>

## Texture Tab

In the Pencil Properties view, the Texture tab allows you to select a pencil texture from the currently selected pencil texture palette to use with the Pencil tool. You can also add, remove or rename textures, save the current pencil texture palette as the default one, or import the pencil texture palette into your scene.

The pencil texture palette used in the Texture tab of the Pencil Properties dialog is the one selected in the Colour view. You can select a pencil texture palette by selecting it from the pencil texture palette list in the Colour view—see [Colour View on page 1058](#).





Icon	Property	Description
	Use as Default Pencil Texture Palette	Sets the currently selected pencil texture palette as the default pencil texture palette in your user preferences. The default pencil texture palette is added to every scene you create in Harmony. The palette is copied in your preferences, so it will be added to your new scenes in the exact state it is when you make it the default pencil texture palette.
	Reload Default Texture Palette	Imports the default pencil texture palette as a new pencil texture palette into your scene's palette list, and selects it as the current pencil texture palette.
	New Texture	Allows you to import an image file into a new pencil texture swatch in the current pencil texture palette. The pencil texture's effect on your pencil line will be based on the image's transparency channel, and will follow your pencil lines on its horizontal axis.
	Delete Texture	Deletes a pencil texture swatch from the current pencil texture palette.
	Rename Texture	Renames the selected pencil texture swatch in the current pencil texture palette.
	Pencil Texture List	Displays the pencil textures in the current pencil texture palette and allows you to select one to use with the Pencil tool.
	Pencil Texture Palette	Displays the name of the currently selected pencil texture palette, for reference. To select a different pencil texture palette, you must select it in the Colour view—see <a href="#">Colour View on page 1058</a> .



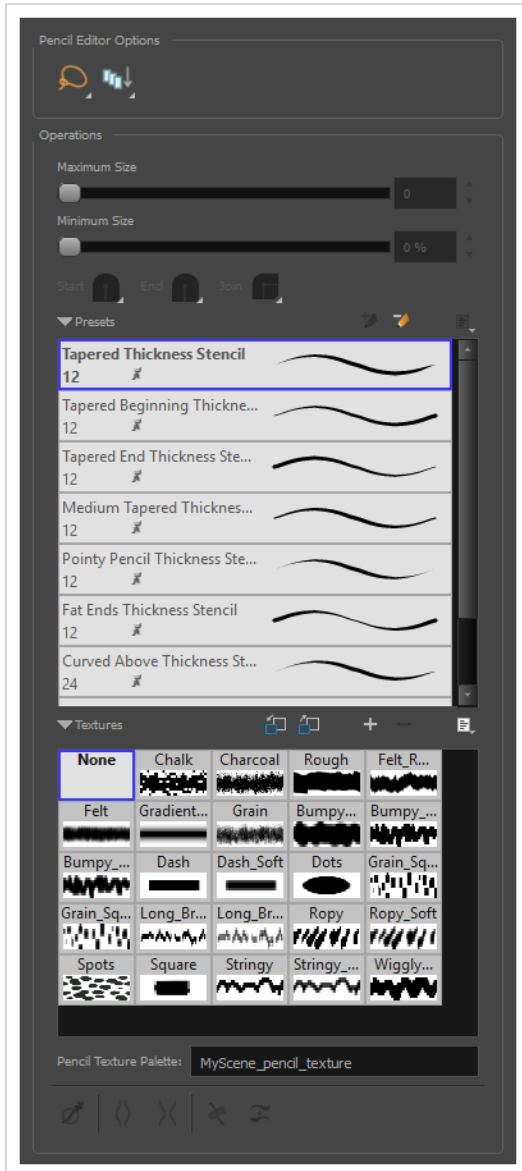

## Pencil Editor Tool Properties





When you select the Pencil Editor tool, its properties and options appear in the Tool Properties view.









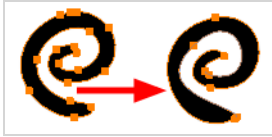

Icon	Tool Name	Description
	Selection Mode	<p>Allows you to choose the method to visually select multiple elements:</p> <ul style="list-style-type: none"> <li>  <b>Lasso:</b> Allows you to select multiple elements by drawing a lasso around them with your mouse.         </li> <li>  <b>Marquee:</b> Allows you to select multiple elements by drawing a rectangle around them. This is faster, as you only need to drag your mouse from one corner of the rectangle to its opposite corner, but it may not be as precise as you want.         </li> </ul>

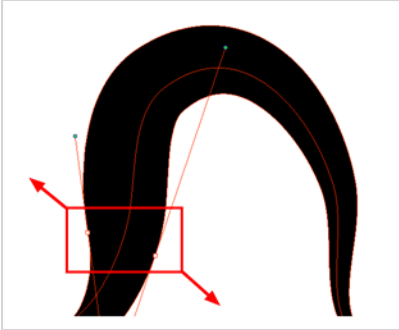

		<div data-bbox="673 210 738 283" style="display: inline-block; vertical-align: middle;">  </div> <p><b>TIP</b></p> <p>You can press and hold the Alt key to temporarily use the other selection mode.</p>
	<p>Apply to Visible Drawing Layers</p>	<p>This option allows you to select which layers the tool should affect. It can be toggled on or off. When toggled on, it has two different modes. You can select a mode by clicking and holding on the button.</p> <ul style="list-style-type: none"> <li>• <b>Off:</b> When this button is toggled off, the tool only works on the currently selected layers. If several layers are selected, the tool will work on all these layers simultaneously.</li> <li>•  <b>Apply to Visible Drawing Layers:</b> The tool will work on all the visible layers in the Camera view.</li> <li>•  <b>Apply to Synced Drawing Layers:</b> If the currently selected layer is synced with another layer, the tool will work on both the current layer and its synced layer.</li> </ul> <div data-bbox="673 913 738 987" style="display: inline-block; vertical-align: middle;">  </div> <p><b>NOTE</b></p> <p>This option only works in the Camera view.</p>

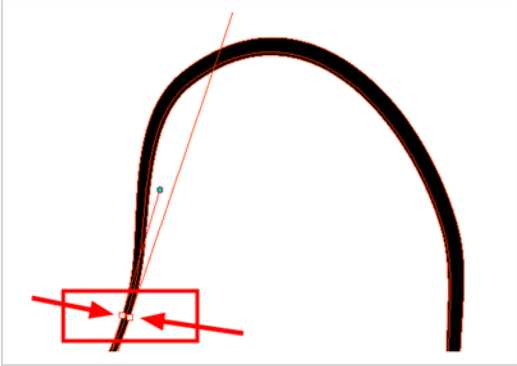
		<ul style="list-style-type: none"> <li>• <b>Join:</b> Lets you select the joint style. The joints are where the line curves abruptly. You could also define the Join style as the corner style. You can choose between Round, Mitre and Bevel style.</li> </ul>
	Presets	<p>Harmony provides a variety of pencil presets and thickness stencils and also lets you create and save your own. It is a good idea to create and save pencils with precise sizes and parameters when you draw for efficiency and consistency.</p> <p>A thickness stencil saves the thickness information across the length of the line. When drawing with a thickness stencil, the pressure sensitivity of the tablet is discarded. A thickness stencil can be used while drawing, or applied afterwards.</p> <p>You also have the possibility to apply different textures to your lines by either using the default presets or to import your own.</p> <p>You can export the pencil presets that you have created and import those that others have created. This is a good way for you and project collaborators to keep a consistent look for the project.</p>
	New Brush	Allows to create a new preset from the selected pencil line.
	Delete Brush	Deletes the currently selected preset.
	Rename Brush	Allows you to rename the currently selected preset.
	Small Thumbnail, Large Thumbnail, and Stroke View	Allows you to display the presets as small square thumbnails, large square thumbnails or a list of stroke preview.
	Use as Default Pencil Texture Palette	Sets the currently selected pencil texture palette as the default pencil texture palette in your user preferences. The default pencil texture palette is added to every scene you create in Harmony. The palette is copied in your preferences, so it will be added to your new scenes in the exact state it is when you make it the default pencil texture palette.
	Reload Default Texture Palette	Imports the default pencil texture palette as a new pencil texture palette into your scene's palette list, and selects it as the current pencil texture palette.
	New Texture	Adds a new custom pencil texture to the list.
	Delete Texture	Deletes a texture preset from the list.

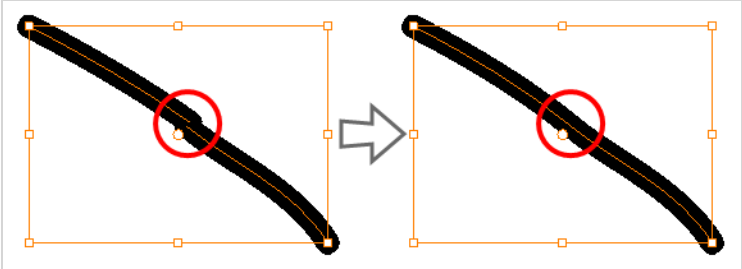
	Rename Texture	Renames the selected texture to keep the list organized.
	Presets	Harmony provides a variety of pencil texture presets and also lets you create and save your own.
	Pencil Texture Palette	Displays the colour palette assigned to hold the pencil textures. Use the Colour View menu to assign a new palette.
	Smooth Selection	<p>The Smooth operation lets you smooth out selected drawing strokes and remove extra points.</p>  <div style="border: 1px solid #add8e6; padding: 10px; margin-top: 10px;">  <b>TIP</b>  You can also smooth the selection by selecting <b>Drawing &gt; Optimize &gt; Smooth</b> from the top menu or by pressing <b>Alt + Shift + S</b>. </div>
	Pump Pencil Pressure	<p>The Pump Pencil Pressure option is used to increase the line thickness of a selected area on a pencil line.</p> 
	Deflate Pencil Pressure	<p>The Deflate Pencil Pressure option is used to decrease the line thickness of a selected area on a pencil line.</p>

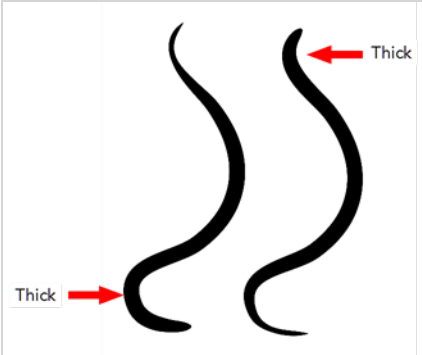
		
	<p>Merge Pencil Lines</p>	<p>Because pencil lines are defined by their centre lines, two pencil lines that brush against each other may not actually make a closed shape, even if they appear closed. If you select several pencil lines that are close together, you can use this button to close the small gaps between these pencil lines and make them into a single pencil line.</p> 
	<p>Reverse Pencil Thickness</p>	<p>The Reverse Pencil Thickness option inverts the thick and thin section on a selected pencil line. This option will take the thickest size on the line and apply it to the thinnest, and it will apply the thinnest to the thickest.</p> 

## Perspective Tool Properties





The perspective tool allows you to deform artwork by creating a rectangular bounding box around it and allowing you to manipulate any of the four corners. The selected artwork will be deformed to fit the shape you make by simulating a perspective effect.



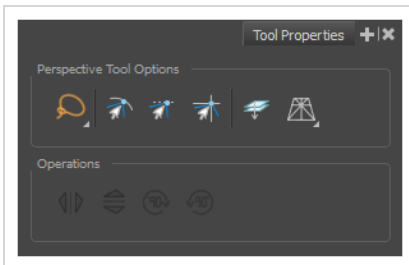





### How to access the Perspective tool properties





1. In the Tools toolbar, select the Perspective  tool.

The tool's properties are displayed in the Tool Properties view.

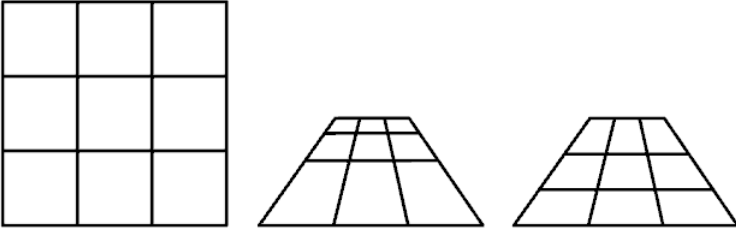

Icon	Tool Name	Description
<b>Perspective Tool Options</b>		
	Selection Mode	<p>Allows you to choose the method to visually select multiple elements:</p> <ul style="list-style-type: none"> <li>•  <b>Lasso:</b> Allows you to select multiple elements by drawing a lasso around them with your mouse.</li> <li>•  <b>Marquee:</b> Allows you to select multiple elements by drawing a rectangle around them. This is faster, as you only need to drag your mouse from one corner of the rectangle to its opposite corner, but it may not be as precise as you want.</li> </ul> <div style="border: 1px solid #0070C0; padding: 5px; margin-top: 10px;"> <p> <b>TIP</b> You can press and hold the Alt key to temporarily use the other selection mode.</p> </div>
	Snap to Contour	<p>When enabled, while moving a selection, the mouse cursor (along with the selection) will snap against the nearby points and contours of your artwork, allowing you to snap parts of your artwork together.</p>

Icon	Tool Name	Description
	Snap and Align	<p>When enabled, while moving a selection, the rectangular bounding box of the selection will snap to the rectangular bounding box of any other drawing stroke in the drawing, allowing you to align drawing strokes laterally.</p>
	Snap to Grid	<p>When enabled, while moving a selection, the mouse cursor will snap against the intersecting points of the grid.</p> <div data-bbox="657 577 1429 751" style="border: 1px solid #add8e6; padding: 5px;"> <p> <b>TIP</b> To display the grid, select <b>View &gt; Grid &gt; Show Grid</b> from the top menu or press Ctrl + '.</p> </div>
	Apply to Line and Colour Art	<p>Allows you to perform drawing operations on both the Line Art and Colour Art layers of your drawing simultaneously.</p> <div data-bbox="657 905 1429 1079" style="border: 1px solid #90ee90; padding: 5px;"> <p> <b>NOTE</b> If you have Overlay and Underlay Art layers enabled, they will also be affected when this option is enabled.</p> </div>
	Deformation Mode	<p>Allows you to select between one of the two following deformation modes:</p> <ul style="list-style-type: none"> <li>•  <b>Perspective:</b> Deforms the selection by simulating a perspective effect.</li> <li>•  <b>Lattice:</b> Deforms the selection by simply making the artwork fit the bounding box, without applying a perspective effect.</li> </ul> <p>The difference between both modes becomes easier to understand if you apply a transformation to a drawing of a grid to make it look like it's laid down on a surface:</p> <div data-bbox="657 1533 1429 1831" style="border: 1px solid #ccc; padding: 10px; text-align: center;">  <p>Original shape      Deformed with Perspective Mode      Deformed with Lattice Mode</p> </div>

Icon	Tool Name	Description
<b>Operations</b>		
	Flip Horizontal	Flips the selection horizontally.
	Flip Vertical	Flips the selection vertically.
	Rotate 90 CW	Rotates the selection 90° clockwise.
	Rotate 90 CCW	Rotates the selection 90° counterclockwise.

## Polyline Tool Properties

The Polyline tool allows you to draw complex lines or shapes by defining each point and their Bezier handles one by one.

### How to access the Polyline tool properties

1. In the Tools toolbar, select the Polyline  tool.

The tool's properties are displayed in the Tool Properties view.

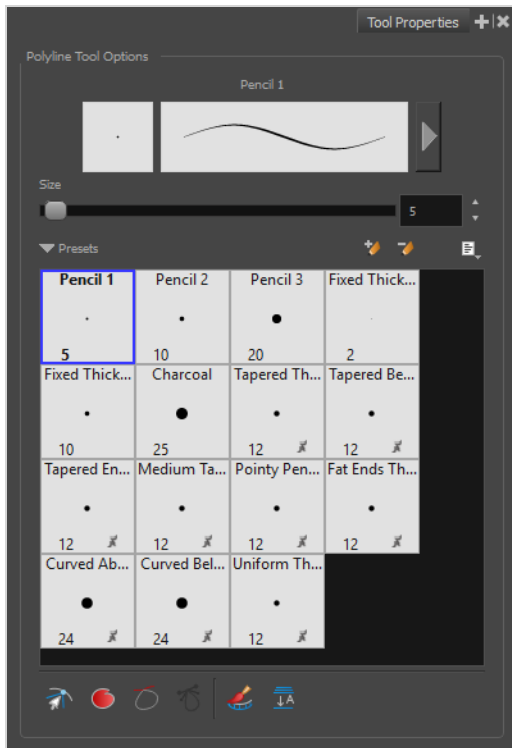

## Pencil Properties



Just like other shape tools, this tool creates pencil lines. Hence, its tool properties are similar to the ones of the Pencil tool and it can be used with pencil presets.

Icon	Property	Description
	Preview Area	<p>The Preview area lets you see a preview of the stroke your drawing tool will make.</p> 







	Pencil Properties Dialog	<p>The arrow button right of the preview area opens the Pencil Properties dialog.</p>  <p>While the Tool Properties view only gives you access to the pencil size, a list of pencil presets and other drawing options, the Pencil Properties dialog gives you access to all the available options for your pencil's shape and texture. For more information on the Pencil Properties dialog, see the <a href="#">Polyline Tool Properties</a> section below.</p>
	Size	Defines the width of the pencil line used to draw the shape.





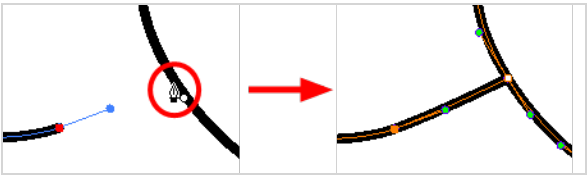



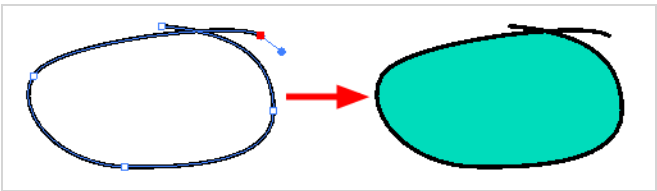



## Pencil Presets

Icon	Property	Description
	Presets list	<p>Harmony provides a variety of presets and also lets you create and save your own. It is a good idea to create and save pencils with precise sizes and parameters when you draw and design for efficiency and consistency.</p> <p>All tools using pencil lines share the same preset list. Therefore, the Polyline, Line, Rectangle, Ellipse, and Pencil tools share the same preset list.</p>
	New Preset	Creates a new preset based on the current tool properties.
	Delete Preset	Deletes the currently selected preset.
	Presets Menu	Gives access to more options for managing presets.
	Rename Brush	Allows you to rename the currently selected preset.
	Import Brushes	Allows you to import brush presets exported from Harmony.
	Export Brushes	Allows you to export your brush presets into an <b>.xml</b> file.
	Small Thumbnail	Displays presets in a grid of small thumbnails with a preview of their tip.

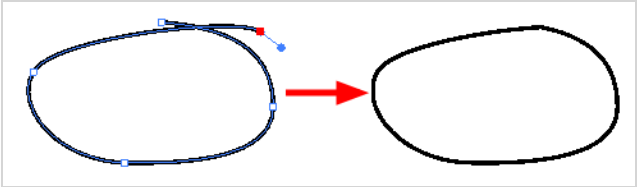
	Large Thumbnail	Displays presets in a grid of big thumbnails, with their name and a preview of their tip.
	Stroke View	Displays presets in a list, with their name and a preview of a stroke done with each preset.

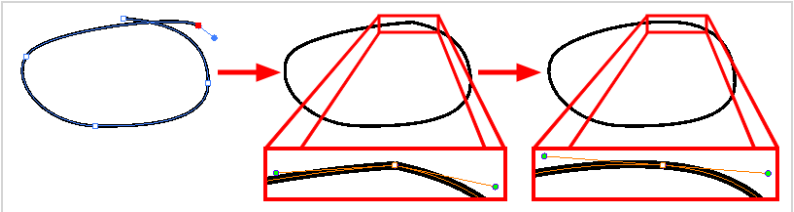
## Drawing Options

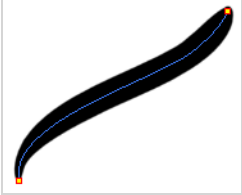
Icon	Property	Description
	Snap to Contour	<p>When this option is enabled, clicking close to a contour in your drawing will add the point to that contour. The line you are building will be linked to that contour.</p>  <p>If this option is disabled, attempting to click on existing contours will always create a point very close to that contour, but not exactly on it. Therefore, it is necessary to enable this mode if you want to create lines that branch from into existing contours in your drawing.</p> <div style="border: 1px solid #c8e6c9; padding: 10px; margin-top: 10px;"> <p> <b>NOTE</b></p> <p>If you draw a line with the Line tool and make its tip snap to a contour or another control point in your artwork, they will be locked together. You can then manipulate both simultaneously using the Contour Editor  tool. You can also separate two drawing strokes that have been snapped together by selecting one of them with the Select  tool and moving it away.</p> </div>
	Auto Fill	<p>When enabled, drawing a closed shape will automatically fill it with the currently selected Paint colour.</p> 

		<div data-bbox="672 216 743 285" style="display: inline-block; vertical-align: middle;">  </div> <p><b>TIP</b></p> <p>By default the pencil line and its fill will be the same colour. If you want to select different colours for the pencil line and its fill, you can click on the Unlock Three Colours  button in the Colour view, then select different colours for Brush strokes , Pencil lines  and Paint fills .</p>
	Trim Extra Lines	<p>When enabled, drawing a closed shape will automatically remove the outstanding lines.</p> 
	Align Handles After Trim	<p>When the Trim Extra Lines option is enabled, enable this option to make the point where the beginning and end of the stroke meet into a smooth curve rather than a hard corner.</p> 
	Automatically Create Colour Art	<p>As you draw in the Line Art layer, the Automatically Create Colour Art option instantly creates the corresponding strokes in the Colour Art layer.</p> 
	Auto-Flatten Mode	<p>By default, when drawing on a vector layer, each new stroke is created as a separate drawing object, which can be edited independently from other parts of the artwork. When enabled, the Auto-Flatten option automatically merges strokes into existing artwork.</p>

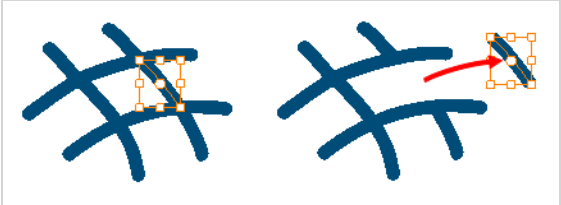



**NOTE**

Using the Select tool, you can use select and remove a segment of flattened pencil lines. Overlapping pencil lines drawn with the Auto-Flatten mode are essentially cut into segments by the overlap and can be treated as individual lines.

## Pencil Properties Dialog

The Polyline tool draws the same type of line as the Pencil tool. Hence, you can configure the Polyline tool's lines using the Pencil Properties dialog, which you can open by clicking on the arrow button right of the stroke display area in the Tool Properties view.

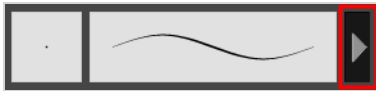

## Size and Smoothness Tab

The Size and Smoothness tab allows you to select your pencil's size, its smoothing parameters as well as the shape of its tips and corners.

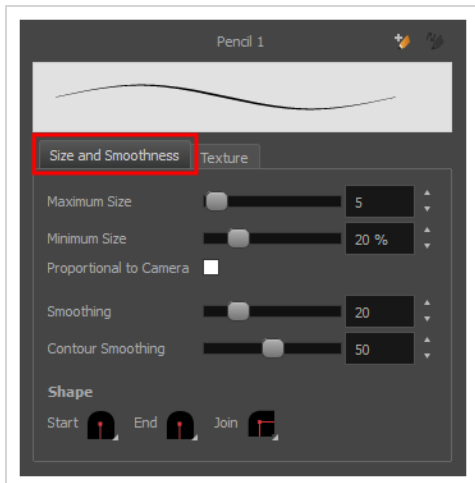

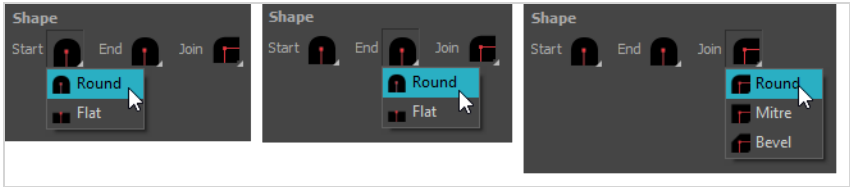



Property	Description
Maximum Size	Defines the maximum size of the pencil line. If the tool is used with a pressure sensitive pen tablet, the width of the stroke will vary between its maximum size and minimum size depending on the amount of pressure used. If used with a mouse, the width of the stroke will always be its maximum size.
Minimum Size	Defines the minimum size of your stroke as a percentage of the maximum size. If you do not have pressure sensitivity from a pen table, the minimum size value will be ignored.
Proportional to Camera	If you check this option, the size of the pencil will be adjusted to the position of the camera on the z-axis. This means that if the camera is zoomed in on the scene, the pencil will be proportionally smaller so that it appears the same size in the rendered image. Likewise, if the camera is zoomed out, the pencil will be proportionally bigger.
Smoothing	Defines the number of control points added to the centre line. The fewer the control points the smoother (but less faithful) the line.
Contour Smoothing	Defines the number of points on the contour share of your stroke. This will smooth out the bumps and waves on tour contour shape of your brush strokes.
Shape	<p>You can adjust the start, end, and join style of a pencil line.</p>  <ul style="list-style-type: none"> <li>• <b>Start:</b> Lets you select the style of the start tip, which is the first tip you drew. You can choose between Round or Flat style.</li> <li>• <b>End:</b> Lets you select the style of the end tip, which is the last tip you drew. You can choose between Round or Flat style.</li> <li>• <b>Join:</b> Lets you select the joint style. The joints are where the line curves abruptly. You could also define the Join style as the corner style. You can choose between Round, Mitre and Bevel style.</li> </ul>

## Texture Tab

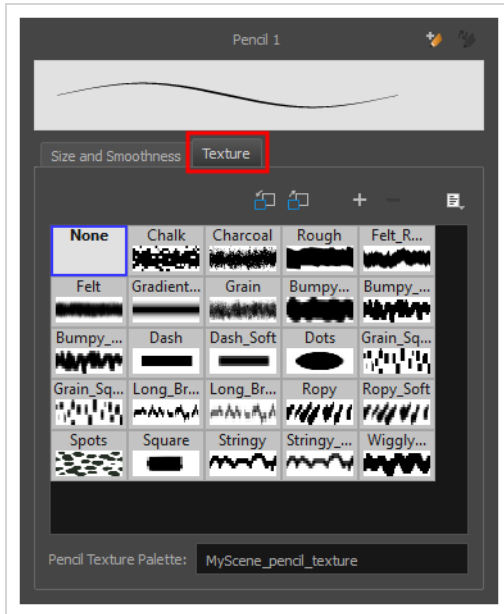
In the Pencil Properties view, the Texture tab allows you to select a pencil texture from the currently selected pencil texture palette to use with the Pencil tool. You can also add, remove or rename textures, save the current pencil texture palette as the default one, or import the pencil texture palette into your scene.

The pencil texture palette used in the Texture tab of the Pencil Properties dialog is the one selected in the Colour view. You can select a pencil texture palette by selecting it from the pencil texture palette list in the Colour view—see [Colour View on page 1058](#).



Icon	Property	Description
	Use as Default Pencil Texture Palette	Sets the currently selected pencil texture palette as the default pencil texture palette in your user preferences. The default pencil texture palette is added to every scene you create in Harmony. The palette is copied in your preferences, so it will be added to your new scenes in the exact state it is when you make it the default pencil texture palette.
	Reload Default Texture Palette	Imports the default pencil texture palette as a new pencil texture palette into your scene's palette list, and selects it as the current pencil texture palette.
	New Texture	Allows you to import an image file into a new pencil texture swatch in the current pencil texture palette. The pencil texture's effect on your pencil line will be based on the image's transparency channel, and will follow your pencil lines on its horizontal axis.
	Delete Texture	Deletes a pencil texture swatch from the current pencil texture palette.
	Rename Texture	Renames the selected pencil texture swatch in the current pencil texture palette.

Icon	Property	Description
	Pencil Texture List	Displays the pencil textures in the current pencil texture palette and allows you to select one to use with the Pencil tool.
	Pencil Texture Palette	Displays the name of the currently selected pencil texture palette, for reference. To select a different pencil texture palette, you must select it in the Colour view—see <a href="#">Colour View on page 1058</a> .

**NOTE**

L

## Rectangle Tool Properties

The Rectangle tool allows you to quickly draw a rectangle or a square.

### How to access the Rectangle tool properties

1. In the Tools toolbar, select the Rectangle  tool.

The tool's properties are displayed in the Tool Properties view.

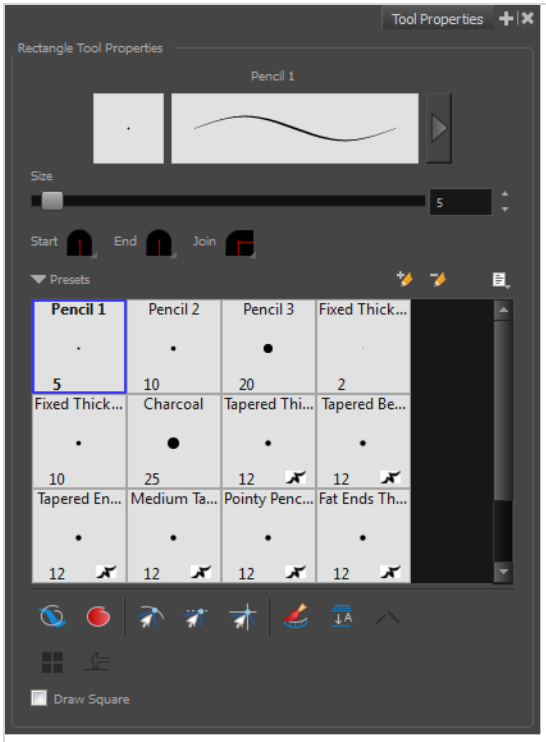

## Pencil Properties

Just like other shape tools, this tool creates pencil lines. Hence, its tool properties are similar to the ones of the Pencil tool and it can be used with pencil presets.

Property	Description
Preview Area	The Preview area lets you see a preview of the stroke your drawing tool will make. 
Pencil Properties	The arrow button right of the preview area opens the Pencil Properties dialog.



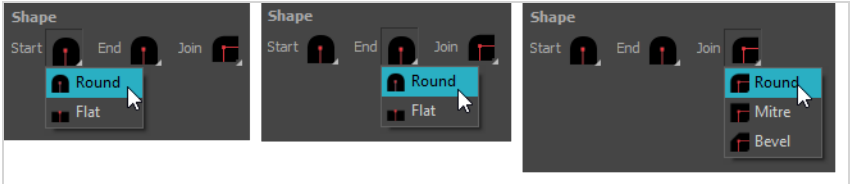





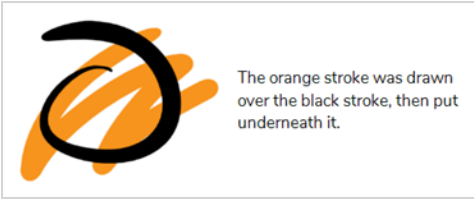



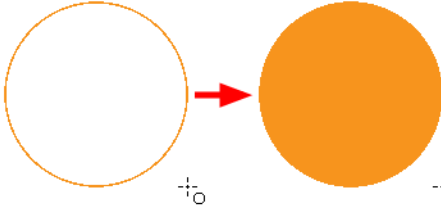







Property	Description
Dialog	 <p>While the Tool Properties view only gives you access to a few of the pencil properties, a list of pencil presets and other drawing options, the Pencil Properties dialog gives you access to all the available options for your pencil's shape and texture. For more information on the Pencil Properties dialog, see the <a href="#">Pencil Properties Dialog on page 950</a> section below.</p>
Size	Defines the width of the pencil line used to draw the shape.
Shape	<p>You can adjust the start, end, and join style of a pencil line.</p>  <ul style="list-style-type: none"> <li>• <b>Start:</b> Lets you select the style of the start tip, which is the first tip you drew. You can choose between Round or Flat style.</li> <li>• <b>End:</b> Lets you select the style of the end tip, which is the last tip you drew. You can choose between Round or Flat style.</li> <li>• <b>Join:</b> Lets you select the joint style. The joints are where the line curves abruptly. You could also define the Join style as the corner style. You can choose between Round, Mitre and Bevel style.</li> </ul>

## Drawing Options

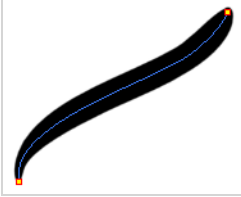
These options affect the way your shape is added to your artwork.

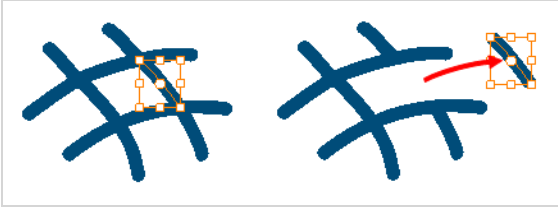

Icon	Property	Description
	Draw Behind	<p>When enabled, your brush strokes will appear behind the existing artwork.</p>  <p>The orange stroke was drawn over the black stroke, then put underneath it.</p>

Icon	Property	Description
		<div data-bbox="634 283 1430 453" style="border: 1px solid #c8e6c9; padding: 10px;">  <b>NOTE</b>                      Your brush stroke will temporarily appear over your artwork as you draw it, until you release the mouse cursor or tablet pen.                 </div>
	<p>Auto Fill</p>	<p>When enabled, the shape you draw is automatically filled with the selected colour. By default, drawing a shape only creates its outlines.</p> <div data-bbox="634 600 1127 848" style="border: 1px solid #ccc; padding: 10px; text-align: center;">  </div> <div data-bbox="634 884 1430 1167" style="border: 1px solid #bbdefb; padding: 10px;">  <b>TIP</b>                      By default the pencil line and its fill will be the same colour. If you want to select different colours for the pencil line and its fill, you can click on the Unlock Three Colours  button in the Colour view, then select different colours for Brush strokes , Pencil lines  and Paint fills .                 </div>
	<p>Snap to Contour</p>	<p>When enabled, while you're drawing, the mouse cursor will snap to the nearby contours of the artwork in your drawing.</p>
	<p>Snap and Align</p>	<p>When enabled, while you're drawing, the mouse cursor will automatically align to the rectangular bounding boxes of other strokes and shapes in your drawing.</p>
	<p>Snap to Grid</p>	<p>When enabled, while you're drawing, the mouse cursor will snap against the intersecting points of the grid.</p> <div data-bbox="634 1612 1430 1787" style="border: 1px solid #bbdefb; padding: 10px;">  <b>TIP</b>                      To display the grid, select <b>View &gt; Grid &gt; Show Grid</b> from the top menu or press <b>Ctrl + `</b>.                 </div>
	<p>Automatically Create Colour Art</p>	<p>As you draw in the Line Art layer, the Automatically Create Colour Art option instantly creates the corresponding strokes in the Colour Art layer.</p>

Icon	Property	Description
		
	Auto Flatten Mode	<p>By default, when drawing on a vector layer, each new stroke is created as a separate drawing object, which can be edited independently from other parts of the artwork. When enabled, the Auto-Flatten option automatically merges strokes into existing artwork.</p>  <div data-bbox="634 951 1430 1184" style="border: 1px solid #c8e6c9; padding: 10px; margin-top: 10px;"> <p> <b>NOTE</b></p> <p>Using the Select tool, you can use select and remove a segment of flattened pencil lines. Overlapping pencil lines drawn with the Auto-Flatten mode are essentially cut into segments by the overlap and can be treated as individual lines.</p> </div>
	Use Stored Colour Gradient	<p>The Use Stored Colour Gradient option can be used when painting with a gradient colour to always position the gradient in the same way it was stored, making it consistent across brush strokes. You can store a gradient by selecting a zone painted with a gradient with the Select tool, then clicking on Store Colour Gradient  in the Tool Properties view.</p>
	Draw Square	<p>When checked, the shape you draw will be of equal width and height, making it a perfect square.</p> <div data-bbox="634 1577 1430 1713" style="border: 1px solid #bbdefb; padding: 10px; margin-top: 10px;"> <p> <b>TIP</b></p> <p>You can also draw a square by holding the Shift key while drawing.</p> </div>

## Pencil Presets

These options allow you to select, create and manage pencil presets.

Icon	Property	Description
	Presets list	<p>Harmony provides a variety of pencil presets and thickness stencils and also lets you create and save your own. It is a good idea to create and save pencils with precise sizes and parameters when you draw for efficiency and consistency.</p> <p>A thickness stencil saves the thickness information across the length of the line. When drawing with a thickness stencil, the pressure sensitivity of the tablet is discarded. A thickness stencil can be used while drawing, or applied afterwards.</p> <p>You also have the possibility to apply different textures to your lines by either using the default presets or to import your own.</p> <p>You can export the pencil presets that you have created and import those that others have created. This is a good way for you and project collaborators to keep a consistent look for the project.</p>
	New Brush Preset	Creates a new preset based on the current tool properties.
	Delete Brush Preset	Deletes the currently selected preset.
	Brush Presets Menu	<p>Open a menu that contains the following options:</p> <ul style="list-style-type: none"> <li>• <b>New Brush Preset:</b> Creates a new preset based on the current tool properties.</li> <li>• <b>Delete Brush:</b> Deletes the currently selected preset.</li> <li>• <b>Rename Brush:</b> Allows you to rename the currently selected preset.</li> <li>• <b>Import Brushes:</b> Allows you to import brush presets exported from Harmony.</li> <li>• <b>Export Brushes:</b> Allows you to export your brush presets into an <code>.xml</code> file.</li> <li>• <b>Small Thumbnail:</b> Displays presets in a grid of small thumbnails with a preview of their tip.</li> <li>• <b>Large Thumbnail:</b> Displays presets in a grid of big thumbnails, with their name and a preview of their tip.</li> <li>• <b>Stroke View:</b> Displays presets in a list, with their name and a preview of a stroke done with each preset.</li> </ul>

## Pencil Properties Dialog

The Rectangle tool draws the same type of line as the Pencil tool. Hence, you can configure the Rectangle tool's lines using the Pencil Properties dialog, which you can open by clicking on the arrow button right of the stroke display area in the Tool Properties view.

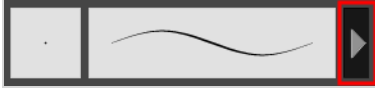

## Size and Smoothness Tab

The Size and Smoothness tab allows you to select your pencil's size, its smoothing parameters as well as the shape of its tips and corners.

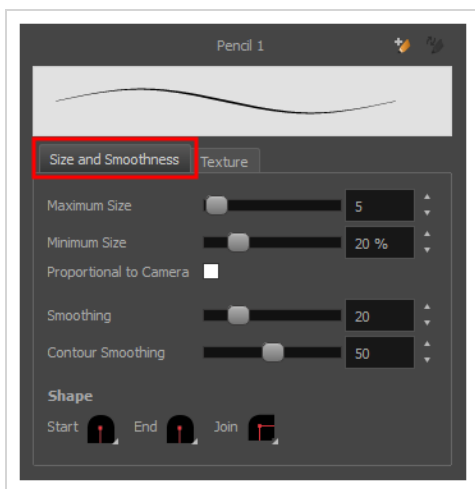

Property	Description
Maximum Size	Defines the maximum size of the pencil line. If the tool is used with a pressure sensitive pen tablet, the width of the stroke will vary between its maximum size and minimum size depending on the amount of pressure used. If used with a mouse, the width of the stroke will always be its maximum size.
Minimum Size	Defines the minimum size of your stroke as a percentage of the maximum size. If you do not have pressure sensitivity from a pen table, the minimum size value will be ignored.
Proportional to Camera	If you check this option, the size of the pencil will be adjusted to the position of the camera on the z-axis. This means that if the camera is zoomed in on the scene, the pencil will be proportionally smaller so that it appears the same size in the rendered image. Likewise, if the camera is zoomed out, the pencil will be proportionally bigger.

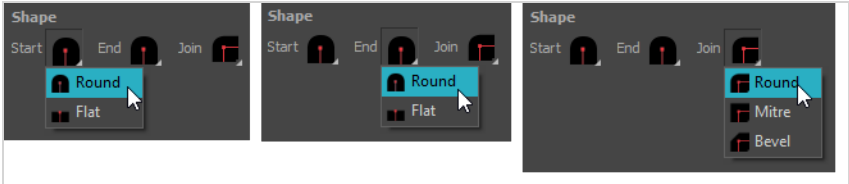



Property	Description
Smoothing	Defines the number of control points added to the centre line. The fewer the control points the smoother (but less faithful) the line.
Contour Smoothing	Defines the number of points on the contour share of your stroke. This will smooth out the bumps and waves on your contour shape of your brush strokes.
Shape	<p>You can adjust the start, end, and join style of a pencil line.</p>  <ul style="list-style-type: none"> <li>• <b>Start:</b> Lets you select the style of the start tip, which is the first tip you drew. You can choose between Round or Flat style.</li> <li>• <b>End:</b> Lets you select the style of the end tip, which is the last tip you drew. You can choose between Round or Flat style.</li> <li>• <b>Join:</b> Lets you select the joint style. The joints are where the line curves abruptly. You could also define the Join style as the corner style. You can choose between Round, Mitre and Bevel style.</li> </ul>

## Texture Tab

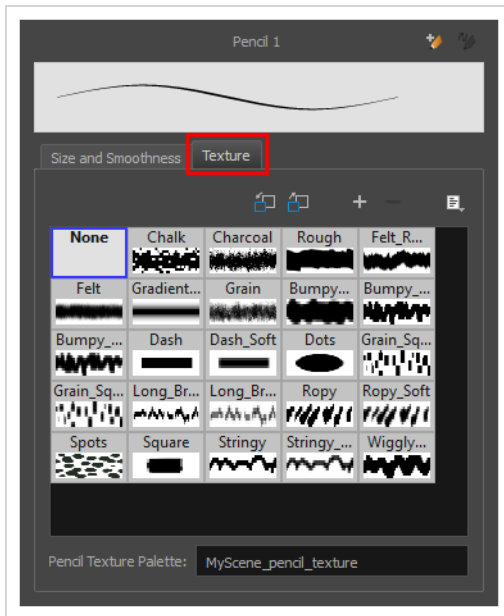
In the Pencil Properties view, the Texture tab allows you to select a pencil texture from the currently selected pencil texture palette to use with the Pencil tool. You can also add, remove or rename textures, save the current pencil texture palette as the default one, or import the pencil texture palette into your scene.

The pencil texture palette used in the Texture tab of the Pencil Properties dialog is the one selected in the Colour view. You can select a pencil texture palette by selecting it from the pencil texture palette list in the Colour view—see [Colour View on page 1058](#).



Icon	Property	Description
	Use as Default Pencil Texture Palette	Sets the currently selected pencil texture palette as the default pencil texture palette in your user preferences. The default pencil texture palette is added to every scene you create in Harmony. The palette is copied in your preferences, so it will be added to your new scenes in the exact state it is when you make it the default pencil texture palette.
	Reload Default Texture Palette	Imports the default pencil texture palette as a new pencil texture palette into your scene's palette list, and selects it as the current pencil texture palette.
	New Texture	Allows you to import an image file into a new pencil texture swatch in the current pencil texture palette. The pencil texture's effect on your pencil line will be based on the image's transparency channel, and will follow your pencil lines on its horizontal axis.
	Delete Texture	Deletes a pencil texture swatch from the current pencil texture palette.
	Rename Texture	Renames the selected pencil texture swatch in the current pencil texture palette.
	Pencil Texture List	Displays the pencil textures in the current pencil texture palette and allows you to select one to use with the Pencil tool.
	Pencil Texture Palette	Displays the name of the currently selected pencil texture palette, for

Icon	Property	Description
		reference. To select a different pencil texture palette, you must select it in the Colour view—see <a href="#">Colour View on page 1058</a> .



## Reposition All Drawings Tool Properties

When you use the Reposition All Drawings tool, its properties and options appear in the Tool Properties view.

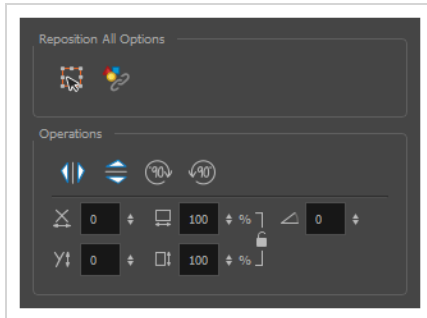

### Tool Options

Icon	Option	Description
	Easy Drag	When enabled, you can drag the selection by clicking anywhere inside its bounding box. By default, you must click on the artwork in the selection to be able to drag it.
	Apply to Synced Drawing Layers	If the currently selected layer is synced with another layer, the tool will work on both the current layer and its synced layer.

### Operations

Icon	Option	Description
	Flip Horizontal	Flips the current selection horizontally.
	Flip Vertical	Flips the current selection vertically.
	Rotate 90 Degrees CW	Rotates the current selection 90 degrees clockwise.
	Rotate 90 Degrees CCW	Rotates the current selection 90 degrees counter-clockwise.
	Offset X and Y	Use the Offset X and Offset Y operation fields to enter specific values and precisely reposition the selected shape.

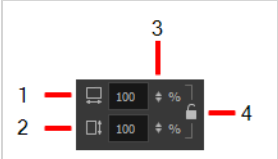
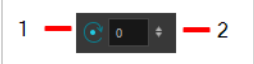
Icon	Option	Description
		 <ol style="list-style-type: none"> <li>1. <b>X:</b> Type a value in this field to reposition your selection along the X-axis.</li> <li>2. <b>Y:</b> Type a value in this field to reposition your selection along the Y-axis.</li> <li>3. <b>Up/Down arrows:</b> Use the up and down arrows to modify the value in the X or Y value field.</li> </ol>
	<p>Width and Height</p>	<p>Use the Width and Height operation fields to enter specific values to resize the selected shape with precision.</p>  <ol style="list-style-type: none"> <li>1. <b>Width:</b> Type a value in this field to resize the width of your selection.</li> <li>2. <b>Height:</b> Type a value in this field to resize the height of your selection.</li> <li>3. <b>Up/Down arrows:</b> Use the up and down arrows to modify the value in the Width or Height fields.</li> <li>4. <b>Lock icon:</b> Click the lock icon to lock or unlock the ratio between the Width and Height values.</li> </ol>
	<p>Angle</p>	<p>The Angle operation lets you to enter specific values and accurately rotate the selected shape.</p>  <ol style="list-style-type: none"> <li>1. <b>Angle:</b> Type a degree value in this field to rotate your selection.</li> <li>2. <b>Up/Down arrows:</b> Use the up and down arrows to modify the value in the Angle value field.</li> </ol>

## Rigging Tool Properties

In the Tool Properties view, you can customize not only the behaviour of the tool but also the settings of the deformers that you will create.

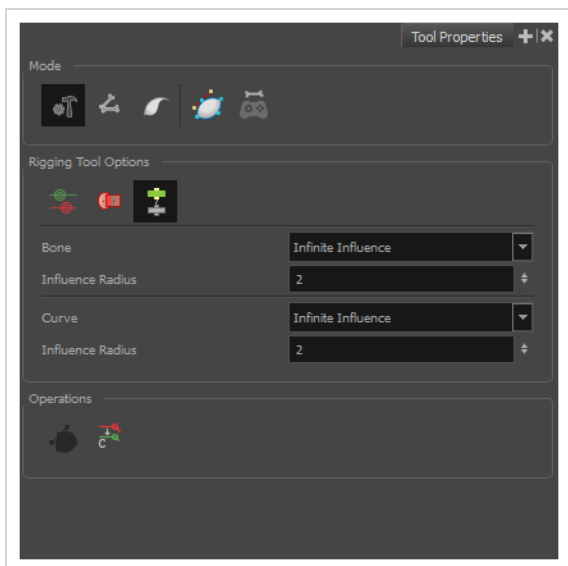



### Mode



Name	Button	Description
Automatic Mode		Sets the Rigging tool to automatically create a Bone or Curve deformer, corresponding to the movement of the cursor in the Camera view.
Bone Mode		Sets the Rigging tool to create Bone deformers.
Curve Mode		Sets the Rigging tool to create Curve deformers.
Envelope Mode		Sets the Rigging tool to create Envelope deformers.
Game Bone Mode		Sets the Rigging tool to create Game Bone deformers.

### Options

Parameter	Button	Description
Show All Manipulators		Lets you immediately see the resting position in red (Setup) and

(Show All Controls)		the animated position in green.
Show All Regions of Influence		Lets you visualize the area within which the art will be influenced by the deformation effect—see <a href="#">Rigging Tool Properties on page 956</a> .
Automatically Create Group when Creating a New Deformation Rig		This option automatically creates a deformation group connected to the input port of the selected element. This group includes all the necessary deformation nodes you created.
Bone and Curve Zone of Influence		The Zone of Influence setting used as the default when creating an articulation, bone deformer or curve deformer using the Rigging tool.
		<b>Zero Influence:</b> The Zone of Influence does not exist. No deformation will happen.
		<b>Infinite Influence:</b> This is the default option and is the most commonly used. The Zone of Influence has no boundary and covers the whole element to which the deformer is linked and its children, excluding areas that are already part of another elliptic or shaped Zone of Influence. The Infinite Influence zone will extend from the centre of your skeleton to infinity, working perpendicularly to the skeleton.
		<b>Elliptic Influence:</b> The Zone of Influence boundary is defined by an elliptical shape; its size can be customized using the Bone, or Articulation or Curve node properties or by using the Transform tool. The Elliptic Influence will most likely be used on a bitmap picture you want to deform.
		<b>Shaped Influence:</b> The Zone of Influence boundary is defined by a shape which you can customize using the Transform tool. The Shaped Influence will most likely be used on a bitmap picture you want to deform.
		<b>Influence Radius:</b> This value is the size of the influence zone. The default value is 2.

## Operations

Name	Button	Description
Convert Elliptic Zone of Influence to Shape		<p>After you have created a deformation chain using Elliptic as the Zone of Influence type, you can select your deformer and click on this button to convert it to a Shaped type. Control points will appear around the shape making it easy to customize. You can also convert the Elliptic zone of influence to a shape. Select <b>Animation &gt; Deformation &gt; Convert Elliptic Deformation ROI to Shape</b>. This will create a much smaller initial zone of influence than if you were to convert it directly to a shape.</p>
Reset Deform (Reset Current Keyframe)		<p>Copies the resting position of the deformation skeleton to the current frame.</p>

## Select Tool Properties

The Select tool lets you select strokes and apply basic transformations such as repositioning, rotating, scaling or skewing, using the different handles of the bounding box.

If you have text or pencil lines selected with the Select tool, their properties will display in the Tool Properties view, allowing you to make changes to your selection.





### How to access the Select tool properties

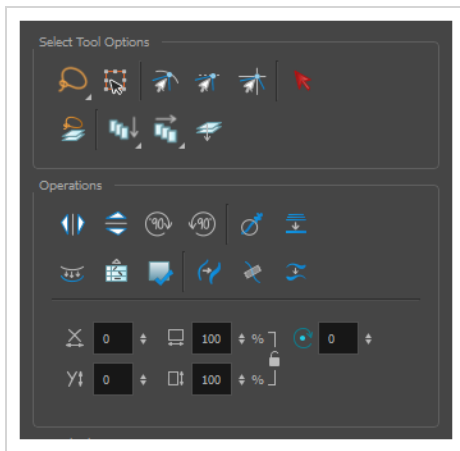





1. In the Tools toolbar, select either the Select  tool.



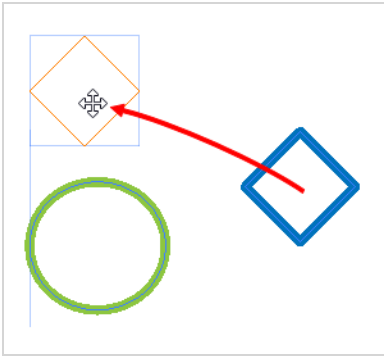

The tool's properties are displayed in the Tool Properties view.







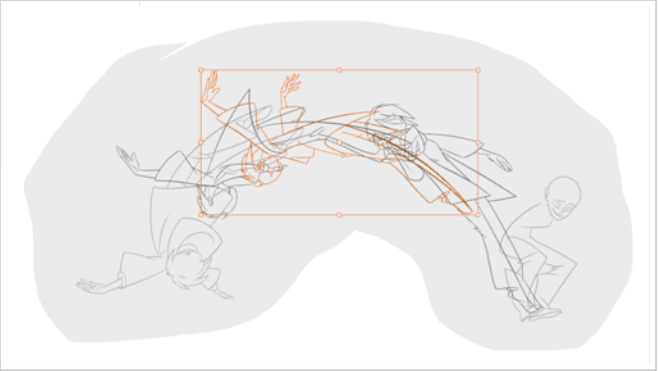

## Tool Options



Icon	Property	Description
	Selection Mode	<p>Allows you to choose the method to visually select multiple elements:</p> <ul style="list-style-type: none"> <li>•  <b>Lasso:</b> Allows you to select multiple elements by drawing a lasso around them with your mouse.</li> <li>•  <b>Marquee:</b> Allows you to select multiple elements by drawing a rectangle around them. This is faster, as you only need to drag your mouse from one corner of the rectangle to its opposite corner, but it may not be as precise as you want.</li> </ul> <div style="border: 1px solid #add8e6; padding: 10px; margin-top: 10px;"> <p> <b>TIP</b> You can press and hold the Alt key to temporarily use the other selection mode.</p> </div>

Icon	Property	Description
	Easy Drag	When enabled, you can drag the selection by clicking anywhere inside its bounding box. By default, you must click on the artwork in the selection to be able to drag it.
	Snap to Contour	When enabled, while moving a selection, the mouse cursor (along with the selection) will snap against the nearby points and contours of your artwork, allowing you to snap parts of your artwork together.
	Snap and Align	<p>When enabled, while moving your selection, the rectangular bounding box of the selection will align with the rectangular bounding boxes of other strokes and shapes in your artwork.</p> 
	Snap to Grid	<p>When enabled, while moving a selection, the mouse cursor will snap against the intersecting points of the grid.</p> <div data-bbox="643 1249 1430 1423" style="border: 1px solid #add8e6; padding: 10px;"> <p> <b>TIP</b> To display the grid, select <b>View &gt; Grid &gt; Show Grid</b> from the top menu or press <b>Ctrl + '</b>.</p> </div>
	Select by Colour	When enabled, clicking on a coloured zone in your artwork will instantly select all the zones that are filled with the same colour.



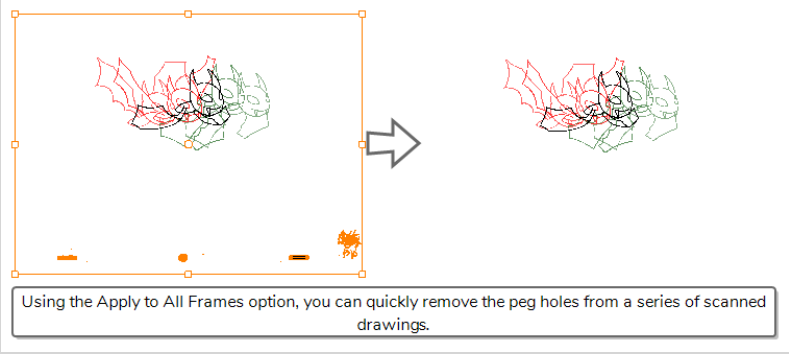

Icon	Property	Description
		 <div data-bbox="646 730 1430 968" style="border: 1px solid green; padding: 5px;"> <p> <b>NOTE</b></p> <p>Only the zones painted with the <b>same colour swatch</b> in your palette will be selected. If another zone is coloured with the exact same colour, but not the same colour swatch, it will not be selected.</p> </div>
	<p>Permanent Selection</p>	<p>Allows you maintain a selection while editing multiple drawings. Once this option is enabled, the selection zone made using the Select tool will remain as you navigate through drawings of the same layer and drawings from other drawing layers.</p> 
	<p>Apply to Visible Drawing Layers</p>	<p>This option allows you to select which layers the tool should affect. It can be toggled on or off. When toggled on, it has two different modes. You can select a mode by clicking and holding on the button.</p> <ul style="list-style-type: none"> <li>• <b>Off:</b> When this button is toggled off, the tool only works on the currently selected layers. If several layers are selected, the tool will work on all these layers simultaneously.</li> <li>•  <b>Apply to Visible Drawing Layers:</b> The tool will work on all the</li> </ul>









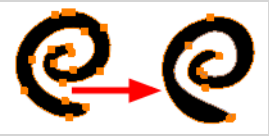

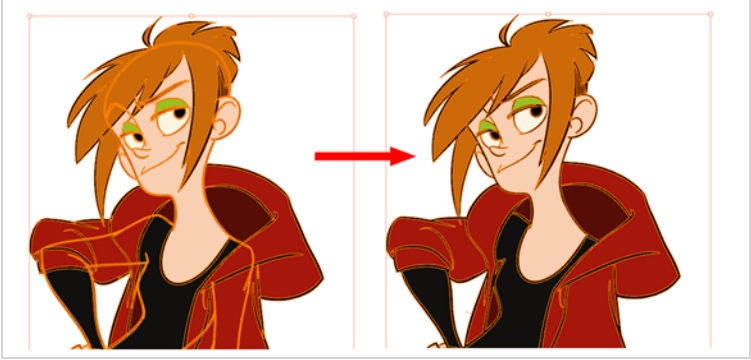



Icon	Property	Description
		<p>visible layers in the Camera view.</p> <ul style="list-style-type: none"> <li>  <b>Apply to Synced Drawing Layers:</b> If the currently selected layer is synced with another layer, the tool will work on both the current layer and its synced layer. </li> </ul> <div data-bbox="646 464 1390 852" style="border: 1px solid #ccc; padding: 5px; text-align: center;">  </div> <div data-bbox="646 894 1430 1031" style="border: 1px solid #90EE90; padding: 5px; margin-top: 10px;">  <b>NOTE</b>  This option only works in the Camera view. </div>
	Apply to All Frames	<p>This option allows you to determine which drawings in the current layer the tool should affect. It can be toggled on or off. When toggled on, it has two different modes. You can select a mode by clicking and holding on the button.</p> <ul style="list-style-type: none"> <li> <b>Off:</b> When this button is toggled off, the tool only works on the drawing in the current frame. </li> <li>  <b>Apply to All Frames:</b> The tool will work on every exposed drawing in the selected layer simultaneously. </li> <li>  <b>Apply to Onion Skin Range:</b> The tool will work on every drawing displayed in the Onion Skin. Onion Skin must be enabled for this option to work. </li> </ul>



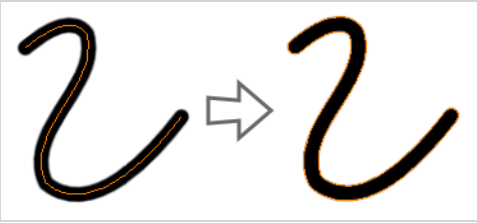

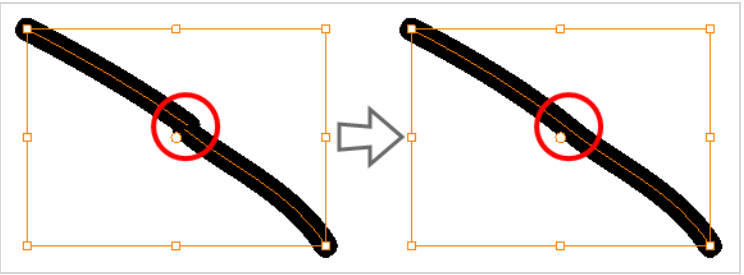
Icon	Property	Description
		
	<p>Apply to Line and Colour Art</p>	<p>Allows you to perform drawing operations on both the Line Art and Colour Art layers of your drawing simultaneously.</p> <div style="border: 1px solid green; padding: 5px; margin-top: 10px;"> <p> <b>NOTE</b> If you have Overlay and Underlay Art layers enabled, they will also be affected when this option is enabled.</p> </div>

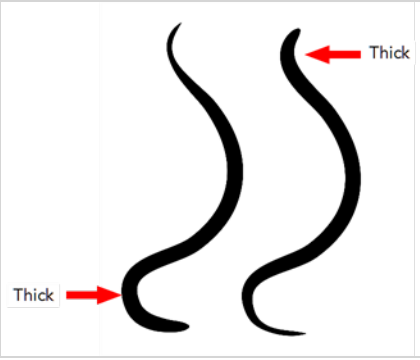
## Operations

Icon	Property	Description
	<p>Flip Horizontal</p>	<p>Flips the current selection horizontally.</p>
	<p>Flip Vertical</p>	<p>Flips the current selection vertically.</p>
	<p>Rotate 90 Degrees CW</p>	<p>Rotates the current selection 90 degrees clockwise.</p>
	<p>Rotate 90 Degrees CCW</p>	<p>Rotates the current selection 90 degrees counter-clockwise.</p>
	<p>Smooth</p>	<p>Smooth out selected drawing strokes and remove extra points.</p> 

Icon	Property	Description
	Flatten	<p>Merges drawing objects and brush strokes into a single layer. If you draw new lines to fix a drawing or line with many brush strokes, it can be useful to flatten them all into a single shape. By default, lines are drawn one on top of each other. If you intend to repaint the lines or modify their shape, it will be easier if they are flattened.</p> 
	Create Colour Art from Line Art	<p>Lets you use the outline you traced on one of the four embedded layers (line art, colour art, overlay, underlay) and create invisible strokes to paint your drawings on separate layers. This provides more inking and painting flexibility.</p> <p>You can also configure this option to create the invisible strokes on any of the four embedded layers.</p>
	Distribute to Layers	<p>The Distribute to Layers option is used to separate the selected art strokes and send them to new drawing layers. In the Camera view, once you have drawn your artwork, you can select the strokes you want to distribute using the Select tool and click on the Distribute to Layers button; you can also select <b>Drawing &gt; Distribute to Layers</b>. It will automatically take every stroke from the drawing selection made in the Camera view and separate them into a different layer for each. If an artwork is composed of several strokes, you must group them using <b>Edit &gt; Group &gt; Group</b> before using the Distribute to Layers option. This option cannot be done from the Drawing view.</p>
	Store Colour Gradient	<p>Use the Store Colour Gradient operation to record the selected gradient's position. This reuses the stored position of the gradient when drawing new brush lines or painting colour zones. Enable the Use Stored Colour Gradient  option in the Paint or Brush Tool Properties view to do this.</p>
	Pencil to Brush	<p>Converts the selected centre line pencil strokes into contour strokes brush lines.</p>



Icon	Property	Description
		
	<p>Merge Pencil Lines</p>	<p>Because pencil lines are defined by their centre lines, two pencil lines that brush against each other may not actually make a closed shape, even if they appear closed. If you select several pencil lines that are close together, you can use this button to close the small gaps between these pencil lines and make them into a single pencil line.</p>  <div style="border: 1px solid green; padding: 5px; margin-top: 10px;"> <p> <b>NOTE</b> Points must be close enough to be merged. If there is a large gap between the lines, they will not be merged.</p> </div>
	<p>Reverse Pencil Thickness</p>	<p>The Reverse Pencil Thickness option inverts the thick and thin section on a selected pencil line. This option will take the thickest size on the line and apply it to the thinnest, and it will apply the thinnest to the thickest.</p> 
	<p>Offset X</p>	<p>Lets you enter a value to reposition the selection along the X-axis.</p>

Icon	Property	Description
	Offset Y	Lets you enter a value to reposition the selection along the Y-axis.
	Width	Lets you enter a value to resize the width of the selection.
	Height	Lets you enter a value to resize the height of the selection.
	Lock	Locks or unlocks the ratio between the Width and Height values.
	Angle	Lets you enter specific values to rotate the selection. A positive value rotates the selection counter clockwise and a negative value rotates the selection clockwise.

## Pencil Selection

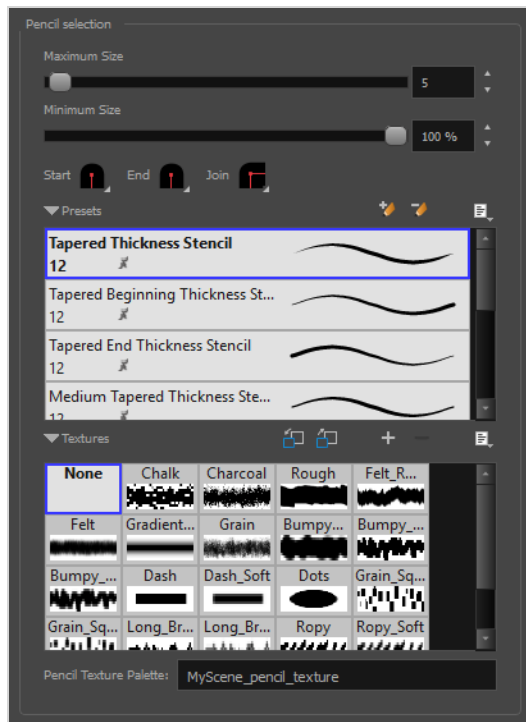
If the selection contains pencil lines, the Pencil Selection section appears at the bottom of the Tool Properties view, allowing you to adjust the properties of those pencil lines.

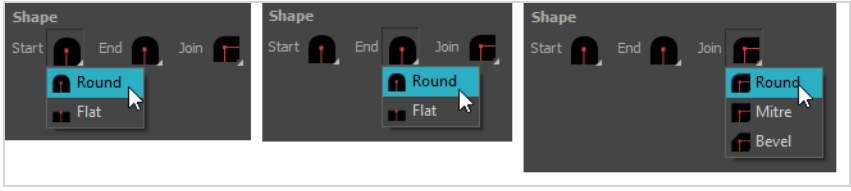

Property	Description
Maximum Size	Adjusts the size of the parts of the pencil lines that are the thickest. Parts of the pencil lines that are between the minimum and maximum sizes will be adjusted proportionally.
Minimum Size	Adjusts the size of the parts of the pencil lines that are the thinnest. Parts of the pencil lines that are between the minimum and maximum sizes will be adjusted proportionally.
Pencil Line Shape	<p>You can adjust the start, end, and join style of a pencil line.</p>  <ul style="list-style-type: none"> <li>• <b>Start:</b> Lets you select the style of the start tip, which is the first tip you drew. You can choose between Round or Flat style.</li> <li>• <b>End:</b> Lets you select the style of the end tip, which is the last tip you drew. You can choose between Round or Flat style.</li> <li>• <b>Join:</b> Lets you select the joint style. The joints are where the line curves abruptly. You could also define the Join style as the corner style. You can choose between Round, Mitre and Bevel style.</li> </ul>
Pencil Stencils	<p>Allows you to apply one of the available line thickness stencils to the selected pencil lines. Stencils set the width of a pencil lines all along its length. You can use one of the preloaded presets, or create your own pencil stencils.</p> 
Adding Texture to a Pencil Line	Pencil lines support texture. Once a pencil line is drawn, you can apply a preset texture or load your own. Textures are independent from pencil stencils.

## Text Selection







If your selection include text boxes created with the Text tool, a Text Selection section will appear at the bottom of the Tool Properties view, allowing you to adjust the formatting of the whole text box.

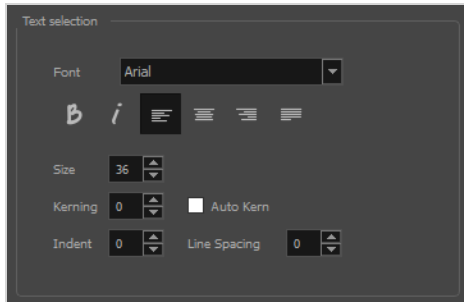



### TIP

You can also adjust the formatting of parts of the text in the text box using the Text tool—see [Text Tool Properties](#) on page 978.



Icon	Property	Description
	Font	Lets you select the font in which to display the text. 
	Bold	Makes the selected text bold. 
	Italic	Makes the selected text italic. 
	Align Left	Aligns the text in the selected text box to the left.

Icon	Property	Description
		<div data-bbox="659 285 954 525" style="border: 1px solid black; padding: 5px;"> <p>LOREM IPSUM DOLOR SIT AMET,                      CONSECTETUR ADIPISCING                      ELIT. AENEAN VESTIBULUM,                      METUS AC FERMENTUM                      PORTTITOR, ODIO TURPIS                      PORTTITOR NIBH, ID                      CONSEQUAT MAGNA LIGULA ET                      ELIT. CURABITUR SOLLICITUDIN                      ELIT AC LOREM MOLLIS ACC                      UMSAN.</p> </div>
	Align Center	<p>Aligns the text in the selected text box to the centre.</p> <div data-bbox="659 663 938 867" style="border: 1px solid black; padding: 5px;"> <p>LOREM IPSUM DOLOR SIT AMET,                      CONSECTETUR ADIPISCING                      ELIT. AENEAN VESTIBULUM,                      METUS AC FERMENTUM                      PORTTITOR, ODIO TURPIS                      PORTTITOR NIBH, ID                      CONSEQUAT MAGNA LIGULA ET                      ELIT. CURABITUR SOLLICITUDIN                      ELIT AC LOREM MOLLIS ACC                      UMSAN.</p> </div>
	Align Right	<p>Aligns the text in the selected text box to the right.</p> <div data-bbox="659 993 915 1192" style="border: 1px solid black; padding: 5px;"> <p>LOREM IPSUM DOLOR SIT AMET,                      CONSECTETUR ADIPISCING                      ELIT. AENEAN VESTIBULUM,                      METUS AC FERMENTUM                      PORTTITOR, ODIO TURPIS                      PORTTITOR NIBH, ID                      CONSEQUAT MAGNA LIGULA ET                      ELIT. CURABITUR SOLLICITUDIN                      ELIT AC LOREM MOLLIS ACC                      UMSAN.</p> </div>
	Justify	<p>Makes the text in the selected text box take all the horizontal space by adjusting the spacing between each word. Text that use a single line and text in the last line of a paragraph is aligned to the left.</p> <div data-bbox="659 1388 927 1591" style="border: 1px solid black; padding: 5px;"> <p>LOREM IPSUM DOLOR SIT AMET,                      CONSECTETUR ADIPISCING                      ELIT. AENEAN VESTIBULUM,                      METUS AC FERMENTUM                      PORTTITOR, ODIO TURPIS                      PORTTITOR NIBH, ID                      CONSEQUAT MAGNA LIGULA ET                      ELIT. CURABITUR SOLLICITUDIN                      ELIT AC LOREM MOLLIS ACC                      UMSAN.</p> </div>
	Size	<p>Allows you to set the size of the selected text.</p> <div data-bbox="659 1717 1089 1839" style="border: 1px solid black; padding: 5px;"> <p>small text <b>big text</b></p> </div>

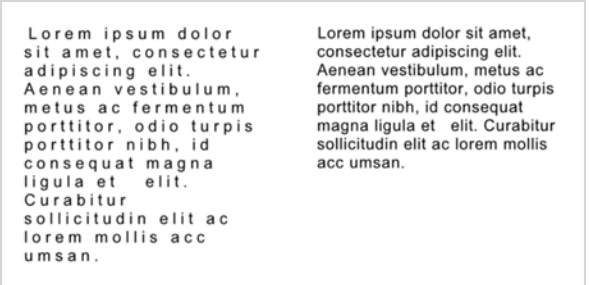
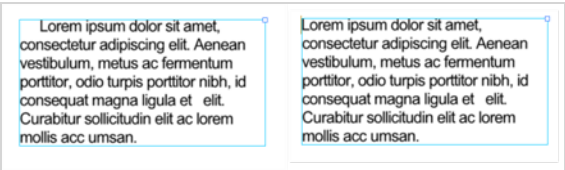
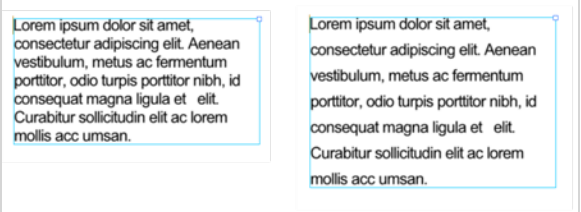

Icon	Property	Description
	Kerning	<p>Allows you to increase or decrease the spacing between each character.</p>  <p>       Lorem ipsum dolor sit amet, consectetur adipiscing elit. Aenean vestibulum, metus ac fermentum porttitor, odio turpis porttitor nibh, id consequat magna ligula et elit. Curabitur sollicitudin elit ac lorem mollis acc umsan.     </p>
	Auto Kern	<p>Sets the kerning automatically based on the font's predefined standard.</p>
	Indent	<p>Allows you to increase or decrease the indentation of the first line of text in each paragraph.</p>  <p>       Lorem ipsum dolor sit amet, consectetur adipiscing elit. Aenean vestibulum, metus ac fermentum porttitor, odio turpis porttitor nibh, id consequat magna ligula et elit. Curabitur sollicitudin elit ac lorem mollis acc umsan.     </p>
	Line Spacing	<p>Increases or decreases the space between each line of text.</p>  <p>       Lorem ipsum dolor sit amet, consectetur adipiscing elit. Aenean vestibulum, metus ac fermentum porttitor, odio turpis porttitor nibh, id consequat magna ligula et elit. Curabitur sollicitudin elit ac lorem mollis acc umsan.     </p>

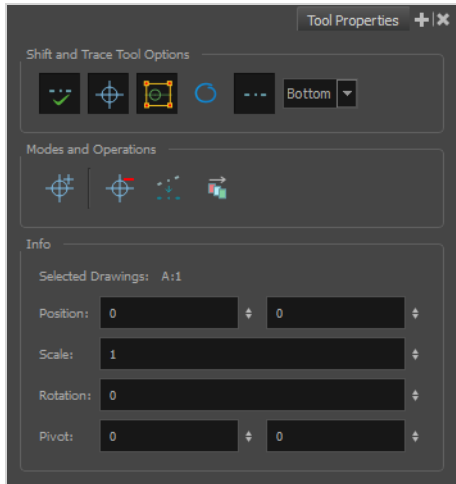

## Shift and Trace Tool Properties

The Shift and Trace tool allows you to temporarily move, rotate and scale drawings, then trace over them in other drawings, using Onion Skin to keep the outlines of the shifted drawings in your drawing space. Contrary to Shift and Trace with the Drawing Desk, you can use the Shift and Trace tool in the Camera view.











### How to access the Shift and Trace Tool Properties

1. Do one of the following:

- In the Tools toolbar, double-click on the Hand  tool and select Shift and Trace  in the pop-up menu.
- In the top menu, select **Drawing > Drawing Tools > Shift and Trace**.

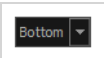
The Shift and Trace tool properties appear in the Tool Properties view.

Icon	Tool Name	Description
<b>Shift and Trace Tool Options</b>		
	Enable/Disable Shift and Trace	Enabled by default. When disabled, drawings that were repositioned, rotated or scaled with the Shift and Trace tool appear in their original position.
	Display Cross Hair	Enabled by default. When disabled, cross hairs added with the Shift and Trace tool are invisible.
	Show manipulators for shift and	Enabled by default. This displays the manipulator allowing you to rotate and scale drawings for Shift and Trace, as well as to re-position their pivot point. When hidden, you can only shift drawings laterally.



Icon	Tool Name	Description
	trace	
	Show the outline of the selected shift and trace drawing	When enabled, the contours of each brush stroke for the current drawing will appear highlighted in cyan.
	Show/Hide Pegs	Enabled by default. When using the Shift and Trace tool, peg holes are displayed at the bottom of every drawing to help keep track of how offset drawings are from their original position and from each other. You can also click and drag on the left or right peg hole of a drawing to rotate it around the centre peg hole. When disabled, those peg holes are hidden.
	Peg Position	Allows you to select on which edge of the drawings to display peg holes. By default, they are displayed at the bottom of the drawings.
<b>Modes and Operations</b>		
	Set Add Cross Hair Mode	When selected, clicking on the drawing will add a cross hair where you click. Cross hairs are marks that appear on the same location on every drawing in the current layer and which move when you offset a drawing with the Shift and Trace tool, and they appear in the Onion Skin rendition of neighbouring drawings as well. This allows you to keep track of how offset each drawing is.
	Remove All Cross Hair	Removes all the cross hairs created for shift and trace.
	Reset Selected Drawings Shift Position	Undoes all transformations done with the Shift and Trace tool on the selected drawings, resetting them to their original position, angle and scale.
	Reset All Drawings Shift Position	Undoes all transformations done with the Shift and Trace tool on all drawings, resetting them to their original position, angle and scale.
<b>Info</b>		
Selected Drawings	The element name and drawing name of the currently selected drawing.	

Icon	Tool Name	Description
Position		The offset of the current drawing from its original position on the x and y axes, in fields, when moved with the Shift and Trace tool.
Scale		The Shift and Trace scale factor of the currently selected drawing, when scaled with the Shift and Trace tool.
Rotation		The Shift and Trace rotation angle of the currently selected drawing, in degrees, counterclockwise, when rotated with the Shift and Trace tool.
Pivot		The offset, in fields, of the current drawing's pivot point from its centre, on the x and y axes. The pivot point is the point from which drawings are rotated and scaled.

## Smooth Editor Tool Properties

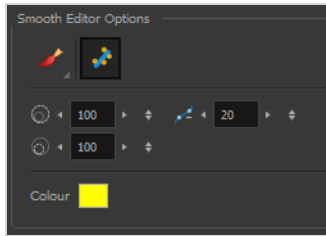
When you select the Smooth Editor tool, its properties and options appear in the Tool Properties view.

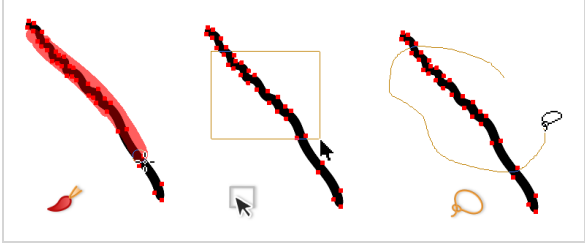



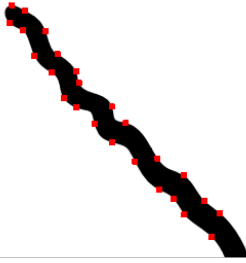
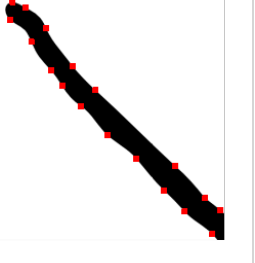
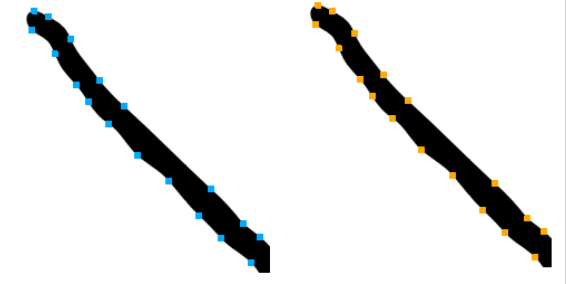



Icon	Tool Name	Description
	Smoothing Style	<p>The Smoothing Style options allow you to smooth a portion of your drawing by tracing a smoothing stroke over the zone to optimize or by selecting an area of the drawing with the Marquee or Lasso.</p> <p>Note that by default, the Smooth Editor tool colour is yellow, it was changed to orange for screen grab clarity.</p> 
	Show Control Points	<p>The Show Control Points option allows you to show or hide the Bezier points around lines. When the Bezier points are displayed, you can see the result of your smoothing and the number of points left on the curve. When it is turned off, only the original artwork is displayed.</p>
	Minimum Size and Maximum Size	<p>This is where you set the minimum and maximum sizes of your drawing tool which will produce the thick and thin effect on your stroke. This works with the pressure sensitivity of a pen tablet.</p> <p>This options is available while using the Brush Smoothing  style.</p> <ul style="list-style-type: none"> <li>• <b>Maximum and Minimum Size:</b> Defines the</li> </ul>

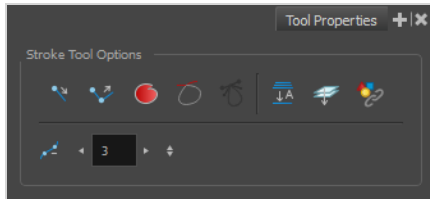

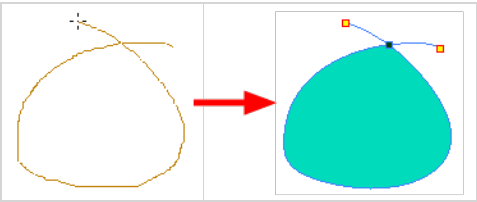



		<p>maximum and minimum width of the stroke.</p> <ul style="list-style-type: none"> <li>• <b>Up/Down arrows:</b> Use the up and down arrows to set the minimum and maximum size value.</li> </ul>
	<p>Smoothness</p>	<p>The Smoothness impacts the strength of the smoothing result. The higher the value, the more points are removed and the smoother the curve. The Smoothness range is from 0 to 100; the default value is 20.</p> <div style="display: flex; justify-content: space-around;"> <div data-bbox="852 604 1117 926">  <p>Smoothness = 2</p> </div> <div data-bbox="1170 604 1435 926">  <p>Smoothness = 10</p> </div> </div>
	<p>Colour</p>	<p>You can modify the colour of the control points displayed on the artwork while working with the Smooth Editor tool by double-clicking on the colour swatch.</p> <div data-bbox="852 1159 1435 1461">  </div>

## Stroke Tool Properties

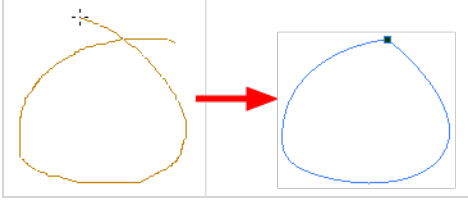
When you select the Stroke tool, its properties and options appears in the Tool Properties view.

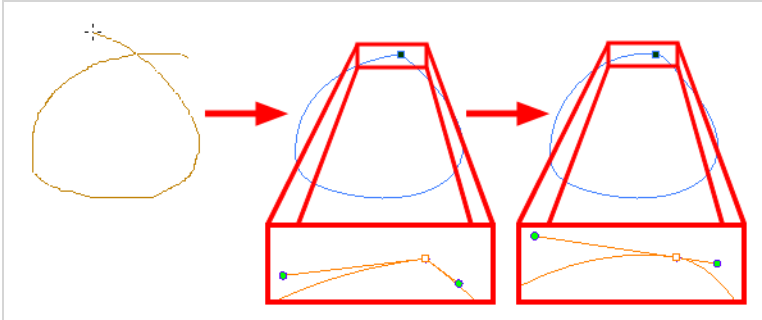

Icon	Tool Name	Description
	Draw Stroke as Straight Lines	Enable the Draw Stroke as Straight Lines option if you want the new strokes you draw to be a perfect straight line. Disable the option if you want the stroke to follow the mouse gesture.
	Connect Line Ends	Enable the Connect Line Ends option if you want the start or end point of your new stroke to connect to your existing strokes to make sure no gaps are left in your drawing.
	Auto Fill	<p>When enabled, drawing a closed shape will automatically fill it with the currently selected Paint colour.</p>  <div style="border: 1px solid #0070C0; padding: 10px; margin-top: 10px;"> <p> <b>TIP</b></p> <p>By default the pencil line and its fill will be the same colour. If you want to select different colours for the pencil line and its fill, you can click on the Unlock Three Colours  button in the Colour view, then select different colours for Brush strokes , Pencil lines  and Paint fills .</p> </div>
	Trim Extra Lines	When enabled, drawing a closed shape will automatically remove the outstanding lines.

		
	<p>Align Handles After Trim</p>	<p>When the Trim Extra Lines option is enabled, enable this option to make the point where the beginning and end of the stroke meet into a smooth curve rather than a hard corner.</p> 
	<p>Auto-Flatten Mode</p>	<p>By default, when drawing on a vector layer, each new stroke is created as a separate drawing object, which can be edited independently from other parts of the artwork. When enabled, the Auto-Flatten option automatically merges strokes into existing artwork.</p>
	<p>Apply to Line and Colour Art</p>	<p>Allows you to perform drawing operations on both the Line Art and Colour Art layers of your drawing simultaneously.</p> <div style="border: 1px solid green; padding: 10px; margin-top: 10px;"> <p> <b>NOTE</b> If you have Overlay and Underlay Art layers enabled, they will also be affected when this option is enabled.</p> </div>
	<p>Apply to Synced Drawing Layers</p>	<p>If the currently selected layer is synced with another layer, the tool will work on both the current layer and its synced layer.</p>
	<p>Smoothness</p>	<p>You can modify the central line smoothness of your line using this option. This parameter smooths the initial movement of your line. Increasing the value will result in a smoother line with fewer control points. Use the left and right arrows to increment the value by one full unit. Use the Up - Down slider to quickly increment the value.</p>



## Text Tool Properties

The Text tool lets you add text fields to your project, in which you can type text, then adjust its formatting using various fonts and text attributes.





With the Text tool selected, you can select text within text boxes you created and change the formatting of the selection. You can also select and manipulate text boxes using the Select tool, and change the formatting of the entire text box in the Select tool properties.



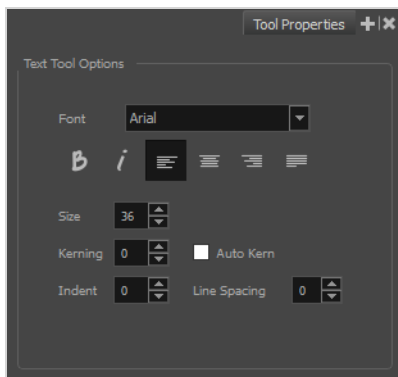

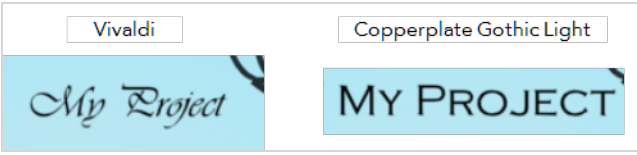

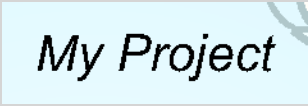

### How to access the Text tool properties

- In the Tools toolbar, select the Text **T** tool.

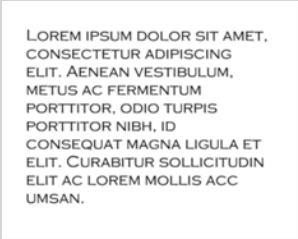
The tool's properties are displayed in the Tool Properties view.

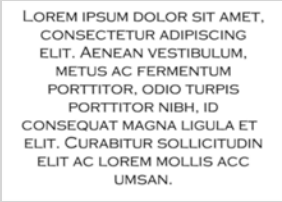

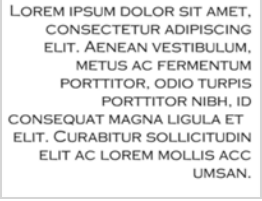
Icon	Property	Description
	Font	Lets you select the font in which to display the text. 
	Bold	Makes the selected text bold. 
	Italic	Makes the selected text italic.

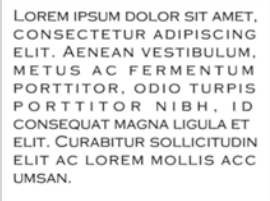

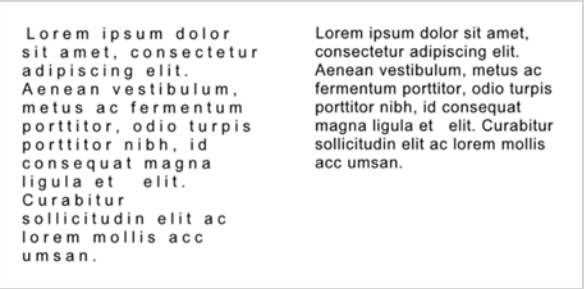
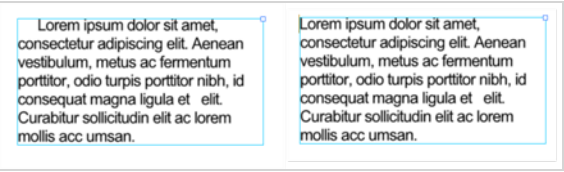
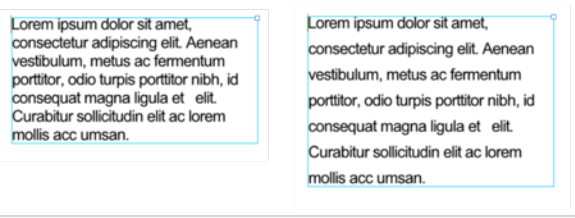



Icon	Property	Description
		
	Align Left	<p>Aligns the text in the selected text box to the left.</p> 
	Align Center	<p>Aligns the text in the selected text box to the centre.</p> 
	Align Right	<p>Aligns the text in the selected text box to the right.</p> 
	Justify	<p>Makes the text in the selected text box take all the horizontal space by adjusting the spacing between each word. Text that use a single line and text in the last line of a paragraph is aligned to the left.</p> 

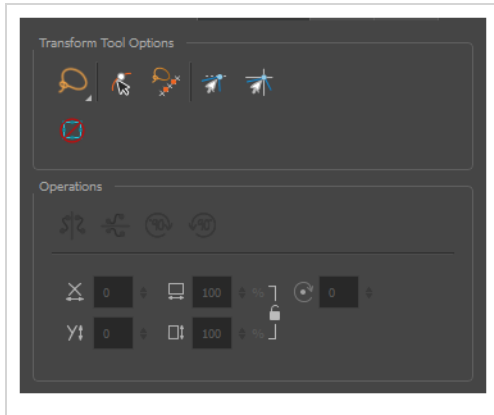







Icon	Property	Description
	Size	<p>Allows you to set the size of the selected text.</p> 
	Kerning	<p>Allows you to increase or decrease the spacing between each character.</p> 
	Auto Kern	<p>Sets the kerning automatically based on the font's predefined standard.</p>
	Indent	<p>Allows you to increase or decrease the indentation of the first line of text in each paragraph.</p> 
	Line Spacing	<p>Increases or decreases the space between each line of text.</p> 

## Transform Tool Properties

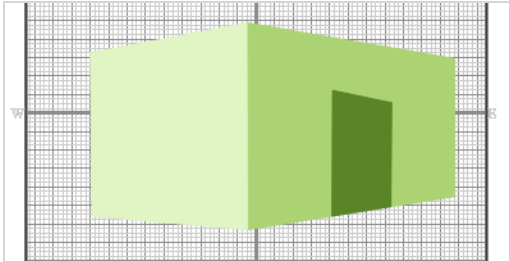
When selecting the Transform tool, several options are available in the Tool Properties view.



Icon	Tool Name	Description
	Lasso	<p>Sets the selection mode to Lasso, which allows you to select multiple items by drawing a lasso around them.</p> <div style="border: 1px solid #4F81BD; padding: 10px; margin-top: 10px;"> <p> <b>TIP</b> When this option is enabled, you can press and hold the Alt key to temporarily use Marquee mode.</p> </div>
	Marquee	<p>Sets the selection mode to Marquee, which allows you to select multiple items by drawing a rectangle around them.</p> <div style="border: 1px solid #4F81BD; padding: 10px; margin-top: 10px;"> <p> <b>TIP</b> When this option is enabled, you can press and hold the Alt key to temporarily use Lasso mode.</p> </div>
	Peg Selection Mode	<p>In the Camera view, the Peg Selection Mode limits the selection to peg layers instead of drawing layers. This mode is useful when you have created a character rig using peg layers for each drawing. That way, you do not accidentally select the drawing layer when you want to animate on the peg.</p> <p>When disabled, the Transform tool selects the drawing layers.</p>
	Control Selection Mode	<p>When enabled, you can select several control points in the Camera view by drawing a lasso or marquee around them. By default, drawing a lasso or marquee in the Camera view will select layers in</p>

		<p>the area.</p> <div style="border: 1px solid green; padding: 5px; margin-top: 10px;">  <b>NOTE</b>  This option works with curve and envelope deformation points as well as Animated Matte Generator control points. </div>
	Snap and Align	Snaps the selected anchor point to any existing line while displaying temporary rulers as a guide that you can also snap your anchor point to.
	Snap to Grid	Snaps your selection following the currently enabled grid.  
	Hide Manipulator Controls	The Hide Manipulator Controls button lets you hide the bounding box and manipulator controls from the Camera view when an element is selected.
	Flip Horizontal	Flips the current selection horizontally.  You can also select <b>Animation &gt; Flip &gt; Flip Horizontal</b> from the top menu or press 4 or 5.
	Flip Vertical	Flips the current selection vertically.  You can also select <b>Animation &gt; Flip &gt; Flip Vertical</b> from the top menu or press 4 or 5.
	Rotate 90 Degrees CW	Rotates the current selection 90 degrees clockwise.
	Rotate 90 Degrees CCW	Rotates the current selection 90 degrees counter-clockwise.
	Offset X ad Y	Use the Offset X and Offset Y operation fields to enter specific values and precisely reposition the selected shape.

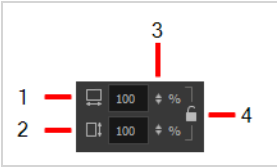
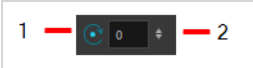
		 <ol style="list-style-type: none"> <li>1. <b>X:</b> Type a value in this field to reposition your selection along the X-axis.</li> <li>2. <b>Y:</b> Type a value in this field to reposition your selection along the Y-axis.</li> <li>3. <b>Up/Down arrows:</b> Use the up and down arrows to modify the value in the X or Y value field.</li> </ol>
	<p>Width and Height</p>	<p>Use the Width and Height operation fields to enter specific values to resize the selected shape with precision.</p>  <ol style="list-style-type: none"> <li>1. <b>Width:</b> Type a value in this field to resize the width of your selection.</li> <li>2. <b>Height:</b> Type a value in this field to resize the height of your selection.</li> <li>3. <b>Up/Down arrows:</b> Use the up and down arrows to modify the value in the Width or Height fields.</li> <li>4. <b>Lock icon:</b> Click the lock icon to lock or unlock the ratio between the Width and Height values.</li> </ol>
	<p>Angle</p>	<p>The Angle operation lets you to enter specific values and accurately rotate the selected shape.</p>  <ol style="list-style-type: none"> <li>1. <b>Angle:</b> Type a degree value in this field to rotate your selection.</li> <li>2. <b>Up/Down arrows:</b> Use the up and down arrows to modify the value in the Angle value field.</li> </ol>

## Zoom Tool Properties

The Zoom tool lets you zoom in and out of the Camera, Drawing, Side and Top views. You can also use it to reset the zoom level.



### How to access the Zoom tool properties

1. In the Tools toolbar, select the Zoom  tool.

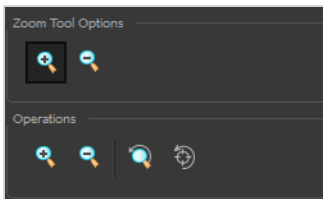



The tool's properties are displayed in the Tool Properties view.



## Tool Options

Icon	Parameter	Description
	Zoom In Mode	Use the mouse cursor to zoom in to the Camera or Drawing view.
	Zoom Out Mode	Use the mouse cursor to zoom out of the Camera or Drawing view.

## Operations

Icon	Parameter	Description
	Perform Zoom In	Zoom in the Camera or Drawing view. The keyboard shortcut is 2.
	Perform Zoom Out	Zoom out the Camera or Drawing view. The keyboard shortcut is 1.
	Reset Zoom	Restores the current zoom level to 100%.
	Reset View	Restores the original display by resetting any pan, rotation or zoom actions.





# Chapter 5: Toolbars

Harmony contains toolbars which, by default, are located at the top of the interface. Some views also have a toolbar which you can reposition to suit your work style. You can show or hide toolbars, as well as customize it with the tools you use most often and hide the ones you don't.

Top Toolbars .....	988
Advanced Animation Toolbar .....	989
Art Layer Toolbar .....	991
Control Point Toolbar .....	993
Coordinate Toolbar .....	995
Deformation Toolbar .....	996
Display Toolbar .....	1001
Easy Flipping Toolbar .....	1002
Edit Toolbar .....	1003
File Toolbar .....	1004
Flip Toolbar .....	1005
Game Toolbar .....	1006
Mark Drawing Toolbar .....	1007
Master Controller Toolbar .....	1008
Mini Playback Toolbar .....	1009
Onion Skin Toolbar .....	1010
Playback Toolbar .....	1012
Scripting Toolbar .....	1015
Shift and Trace Toolbar .....	1016
Tool Presets Toolbar .....	1018
Tools Toolbar .....	1019
Workspace Toolbar .....	1025
View Toolbars .....	1026
3D Graph View Toolbar .....	1027
Animated Matte Generator Toolbar .....	1028
Script Editor Toolbar .....	1031

Timeline View Toolbar .....	1036
Xsheet View Toolbar .....	1038

## Top Toolbars

Harmony has a series of toolbars that are added by default at the top of the interface. These toolbars can be moved on the sides of the interface as well as within specific views.

All top toolbars can be added through the top menu **Windows > Toolbars > desired toolbar**.

<b>Advanced Animation Toolbar</b> .....	<b>989</b>
<b>Art Layer Toolbar</b> .....	<b>991</b>
<b>Control Point Toolbar</b> .....	<b>993</b>
<b>Coordinate Toolbar</b> .....	<b>995</b>
<b>Deformation Toolbar</b> .....	<b>996</b>
<b>Display Toolbar</b> .....	<b>1001</b>
<b>Easy Flipping Toolbar</b> .....	<b>1002</b>
<b>Edit Toolbar</b> .....	<b>1003</b>
<b>File Toolbar</b> .....	<b>1004</b>
<b>Flip Toolbar</b> .....	<b>1005</b>
<b>Game Toolbar</b> .....	<b>1006</b>
<b>Mark Drawing Toolbar</b> .....	<b>1007</b>
<b>Master Controller Toolbar</b> .....	<b>1008</b>
<b>Mini Playback Toolbar</b> .....	<b>1009</b>
<b>Onion Skin Toolbar</b> .....	<b>1010</b>
<b>Playback Toolbar</b> .....	<b>1012</b>
<b>Scripting Toolbar</b> .....	<b>1015</b>
<b>Shift and Trace Toolbar</b> .....	<b>1016</b>
<b>Tool Presets Toolbar</b> .....	<b>1018</b>
<b>Tools Toolbar</b> .....	<b>1019</b>
<b>Workspace Toolbar</b> .....	<b>1025</b>

## Advanced Animation Toolbar

The Advanced Animation toolbar contains tools to position and animate layers. The Scale, Translate and Rotate tools can be used to reposition the permanent pivot position of a layer. Unlike the Transform tool, each tool in the Advanced Animation toolbar performs a single operation, either rotate, scale, translate or scale in relation to the camera distance.



### How to access the Advance Animation toolbar

1. Select **Windows > Toolbars > Advanced Animation**.

Icon	Tool Name	Description
	Translate	Lets you move the selected element along the X and Y axes.
	Rotate	Turns a selected element around its pivot point.
	Scale	Increases or decreases the size of a selected element. You can scale an object up to make it larger or down to make it smaller. Press Shift to scale the element while maintaining its proportions.
	Skew	Slants the selected element.
	Maintain Size	Keeps elements the same size aspect ratio in the Camera view as you move them towards or away from the camera.
	Spline Offset	Lets you reposition the visual trajectory without offsetting or modifying your animation. By default, the trajectory is located at 0,0,0 fields. If your elements were drawn in a different location than the centre of the drawing area, it will look like the trajectory is not aligned with your drawing. Also, if you have several elements attached to one trajectory, you might want your trajectory to be at a different location to represent the group's motion better.

---

	Reposition Drawing	Lets you reposition, scale, rotate or skew all drawing strokes on every drawing included in a layer.
---	--------------------	--

## Art Layer Toolbar

The Art Layer toolbar lets you access the art layers. By default, only the Line Art and Colour Art are displayed. A drawing is composed of two layers, a line layer and a colour layer. The colour layer is always placed under the line layer. These layers are accessible in the Drawing or Camera view (using drawing tools). When you view the final drawing, you will see the final composition of the lines and colours, not two separate layers.

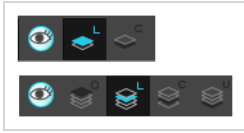

You can draw and paint in all layers. If you prefer to work in a single layer, everything can be done in the Line Art layer.

You can change your preferences to enable the advanced use of layers and have access to four layers instead of two:

- Overlay
- Line Art
- Colour Art
- Underlay

### How to access the Art Layer toolbar





1. Select **Windows > Toolbars > Art Layer**.

### How to enable the Support Overlay and Underlay Arts option

1. Select **Edit > Preferences** ( Windows/Linux ) or **Harmony Premium > Preferences** ( macOS ).
2. In the Preferences dialog box, select the **Advanced** tab.
3. In the Advanced Options section, select the **Support Overlay and Underlay Arts** option.
4. Click **OK**.

Icon	Tool Name	Description
	Preview Line Art and Colour Art	Displays all Art layers.

---

	Overlay Art	Makes the Overlay Art layer current.
	Line Art	Makes the Line Art layer current.
	Colour Art	Makes the Colour Art layer current.
	Underlay Art	Makes the Underlay Art layer current.

# Control Point Toolbar

The Control Point toolbar displays parameters when you select a keyframe or control point in the Camera, Timeline or Xsheet view. You can edit keyframes and control point parameters, such as the continuity, bias, tension and lock-in-time.

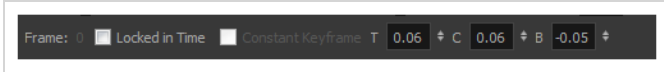

## How to access the Control Point toolbar

1. Select **Windows > Toolbars > Control Point**.

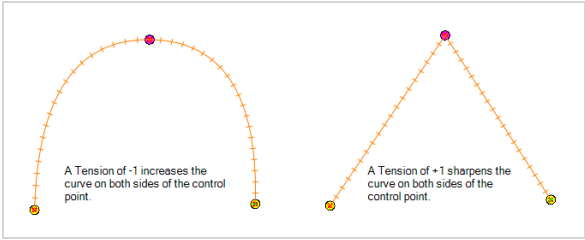
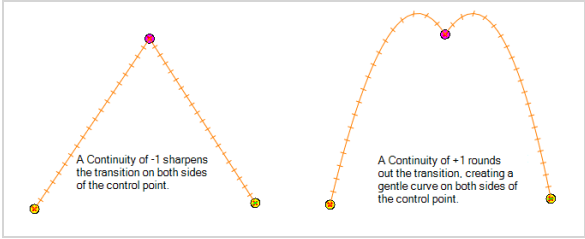
Icon	Tool Name	Description
	Frame	Indicates the current frame.
	Locked in Time	Locks a control point in time, making it a keyframe.
	Constant Keyframe	Removes any interpolation and keeps the keyframe value constant up to the next keyframe.
T	Tension	Controls how sharply the path bends as it passes through a control point or keyframe. 
C	Continuity	Controls the smoothness of a transition between the segments joined by a point. 

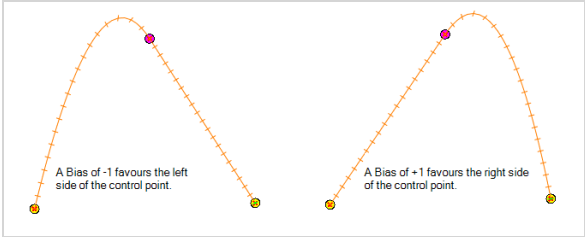

B	Bias	<p>Controls the slope of the path so it flows towards one side of the motion point or the other.</p>  <p>A Bias of -1 favours the left side of the control point.</p> <p>A Bias of +1 favours the right side of the control point.</p>
---	------	--

## Coordinate Toolbar

T-ANIMCO2-001-001

The Coordinate toolbar displays parameters of keyframes or control points in the Camera, Timeline or Xsheet view. You can edit keyframes and control point parameters, such as the position, scale and rotation coordinates.



For tasks related to this toolbar, see [Coordinates and Control Points View on page 1066](#).

### How to access the Coordinate toolbar

1. Select **Windows > Toolbars > Coordinate**.

Parameter	Description
Translation	The translation fields display the X, Y and Z translation values of the selected layer. You can enter precise values to set the first frame and last frame position of a layer. By default the Z value field is disabled. It will automatically become active when the 3D option is enabled.
Scale	The scale fields display the X, Y and Z scaling values of the selected layer. You can enter precise values to set the first frame and last frame size of a layer. By default the Z value field is disabled. It will automatically become active when the 3D option is enabled.
Rotation	The rotation fields display the X, Y and Z rotation values of the selected layer. You can enter precise values to set the first frame and last frame rotation of a layer. By default the Z value field is disabled. It will automatically become active when the 3D option is enabled.
Skew	The skew field displays skew value of the selected object. You can enter a precise value to set the skew of the object.

## Deformation Toolbar



T-RIG-007-009



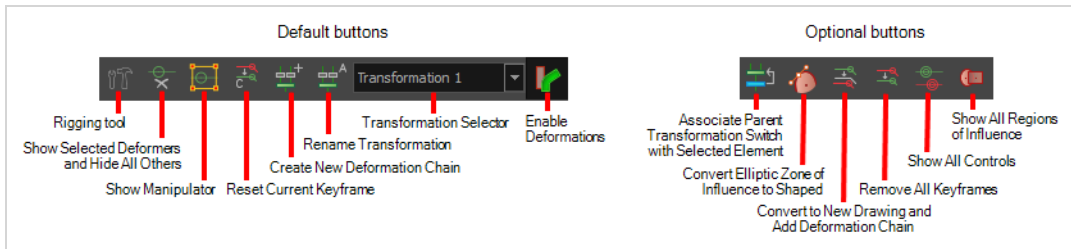

The Deformation toolbar contains the various tools and options used to create a deformation rig. This toolbar is displayed in the default interface.



By default, the Deformation toolbar only contains the essential options. If you right-click on the toolbar and select **Customize**, you can add additional buttons.



## Default Buttons

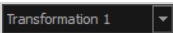





Icon	Tool Name	Description
	Rigging Tool	The Rigging tool is used to create either a Bone or Curve deformation chain. You also use it to set up the resting position.  To learn more about the Rigging tool's properties, see <a href="#">Rigging Tool Properties on page 956</a> .
	Show Selected Deformation Chains and Hide All Others	Displays the deformer manipulators for the selected drawings or selected deformers in the Camera view, and hides all other deformer manipulators.
	Show Manipulator	When several points from a curve or envelope deformation chain are selected, this displays a manipulator bounding box around them. Using this manipulator, you can move, rotate and scale the selected points together.

		
	<p>Reset Current Keyframe</p>	<p>The Reset Current Keyframe copies the resting position, the original setup of your skeleton before undergoing any deformation, to your current frame. Once you have created a deformation chain, you can use the Rigging tool to adjust the position and appearance of the rig to fit the element. When the skeleton is in place, you can use the Reset Current Keyframe button to reset the current frame position to the resting position.</p>
	<p>Create New Deformation Chain</p>	<p>The Create New Deformation Chain option allows you to create a new deformation chain on a same character. For example, if you have drawings for the different views of your puppet (front, profile, back, etc.), you can use this feature to setup a new set of chains for each angle without having to create completely different puppets.</p>
	<p>Rename Transformation</p>	<p>The Rename Transformation option allows you to give specific names to your different transformation chains. By default, chains are named Transformation plus the number of the chain, such as Transformation 2. You can rename these to identify them easier, such as front, side, back, and so on.</p>
	<p>Transformation Selector</p>	<p>The Transformation Selector drop-down menu allows you to assign an existing chain to a set of drawings. For example you might want to reuse the front deformation chains for another series of drawing.</p> <p>When creating a new drawing, the Default Transformation is assigned. While on the new drawing frames, from the drop-down menu, select a different chain to automatically assign it.</p>

	<p>Enable Deformations</p>	<p>The Enable Deformations button allows you to display your drawings in their original state or with deformations while creating additional drawings. Depending on the artwork you need to create, you might need to refer to the other images either deformed or in their original position.</p> <div data-bbox="854 428 1430 695" style="border: 1px solid green; padding: 5px;"> <p> <b>NOTE</b></p> <p>Disabling deformations is only a display mode. Although drawings will not appear deformed in the Camera view, even in Render View mode, they will still be deformed in the rendered images.</p> </div>
	<p>Associate Parent Transformation Switch with Selected Element</p>	<p>Matches the drawing name and drawing location path in the Transformation Switch node's Properties with the drawing name and drawing location path found in the Drawing Layer's Properties. For this button to work, a drawing node connect to a deformation group, with a Transformation Switch inside, must be selected.</p>

## Optional Buttons

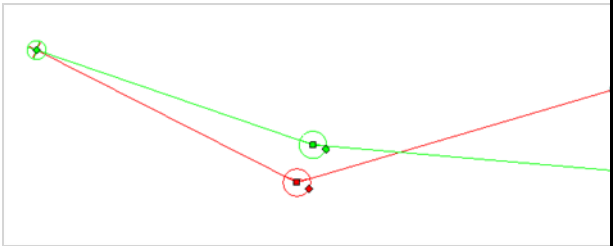
Icon	Tool Name	Description
	<p>Convert Elliptic Zone of Influence to Shape</p>	<p>After you have created a deformation chain using Elliptic as the Zone of Influence type, you can select your deformer and click on this button to convert it to a Shaped type. Control points will appear around the shape making it easy to customize. You can also convert the Elliptic zone of influence to a shape. Select <b>Animation &gt; Deformation &gt; Convert Elliptic Deformation ROI to Shape</b>. This will create a much smaller initial zone of influence than if you were to convert it directly to a shape.</p>

		<div style="border: 1px solid green; padding: 5px;">  <p><b>NOTE</b></p> <p>You can also convert the Elliptic zone of influence to a shape. Select <b>Animation &gt; Deformation &gt; Convert Elliptic Deformation ROI to Shape</b>. This will create a much smaller initial zone of influence than if you were to convert it directly to a shape.</p> </div>
	<p>Convert to New Drawing and Add Deformation Chain</p>	<p>Takes the pose/drawing and the deformer of the selected frame and converts it to a new pose/drawing with the corresponding deformer.</p>
	<p>Remove All Keyframes</p>	<p>The Remove All Keyframes option removes all keyframes on the selected deformation chain.</p>
	<p>Show All Controls</p>	<p>The Show All Controls button lets you visualize the resting position in red (Setup mode) and the active position (Animation) in green at the same time</p> 
	<p>Show All Regions of Influence</p>	<p>The Show All Regions of Influence button displays all regions of influence in the deformer's in your project. Note that the deformer's controls must be visible in order for its zones of Influence to show. The regions will not be displayed when a deformer's zone of Influence is set to Infinite or Zero.</p> 

		 <b>NOTE</b> Region of influences are not available for Game Bone deformers.
--	--	---

## Display Toolbar

The Display toolbar lets you select the different Display nodes available in the node system.



When your scene does not have a Display node, it is automatically set to Display All which uses the Timeline view ordering and shows floating nodes from the Node view. You can also set your scene to use Display All using the Display toolbar.



### NOTE

If you try to add a peg or other transformation layer in the Timeline view without having a layer selected, an error message will display. Make sure to change to Display All. The peg layer will be floating in the Node view and will not be visible in the Timeline view. The Timeline view shows only layers that are connected to the Composite node.

If you switch to Display All, you run the risk of not realizing when you have floating nodes that are not connected to your composite. For this reason, it is not recommended to work in Display All mode.

### How to access the Display toolbar

1. Select **Windows > Toolbars > Display**.



## Easy Flipping Toolbar

T-LAY-003-007

The Easy Flipping toolbar lets you rapidly flip through drawings in the Drawing view as is done with paper drawings. In order for the features in this toolbar to work, you must be in the Drawing view.

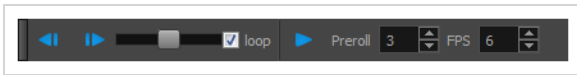

### How to access the Easy Flipping toolbar

1. Select **Windows > Toolbars > Easy Flipping**.

Icon	Tool Name	Description
	Previous Drawing	Displays the previous drawing of your animation.
	Next Drawing	Displays the next drawing of your animation.
	Slider	Lets you flip forwards or backwards through your drawings by moving the slider.
	Loop	Displays drawings in the first frame after you reach the last frame of your animation.
	Easy Flip	Automatically flips through the drawings based on the FPS.
	Preroll	Sets the number of drawings to be flipped through before the starting drawing. The starting drawing is determined by the position of the red playhead in the Timeline view.
	FPS	Sets the speed of playback in the units of frames per second.

## Edit Toolbar

The Edit toolbar contains common operations such as Copy, Paste, Cut, Undo and Redo. These options can also be found in the Edit menu.



### How to access the Edit toolbar

1. Select **Windows > Toolbars > Edit**.

Icon	Tool Name	Description
	Undo	Removes the last change made to your project. Harmony supports multiple undo, so you can undo changes you made in the order you made them.
	Redo	Redoes an operation you have undone. This command is active only after you use the Undo command.
	Cut	Removes selected objects. You can then paste the object or its properties to another object.
	Copy	Copies selected objects and properties.
	Paste	Places an object you cut or copied into the location you select in a view.
	Create Symbol	Creates a symbol from selected drawing elements in the Drawing or Camera view, nodes in the Node view, or a layer or cells in the Timeline view.

## File Toolbar

The File toolbar contains the common file operations such as New, Save and Open. These options can also be found in the File menu.



### How to access the File toolbar

1. Select **Windows > Toolbars > File**.

Icon	Tool Name	Description
	New (Harmony Stand Alone)	Creates a new scene while closing any scene already open. The New Scene dialog box opens, asking for directory, name, and resolution information.
	Open	Displays the Open Scene dialog box where you can browse for a scene file. You can open a new scene from the current one and the previous scene will close.
	Save	Saves all changes made to the opened scene, drawings, palettes, and palette lists.
	Save As	<p>Saves the current file with a different name and at a different location.</p> <p>Saves the current state of a scene as another scene. The Save As window prompts you for a new name and a different location for this scene before saving it. This will create a complete scene directory for the new scene.</p> <div style="border: 1px solid green; padding: 5px; margin-top: 10px;">  <p><b>NOTE</b> The scene name <b>cannot</b> exceed 23 characters.</p> </div>
	Import Images	Imports bitmap images which you can choose to vectorize.







## Flip Toolbar

The Flip toolbar lets you determine the type of drawing to include in your flipping selection. You can flip through the key, breakdown or in-between drawings individually, or view a combination.



### How to access the Easy Flipping toolbar

1. Select **Windows > Toolbars > Easy Flipping**.

Icon	Tool Name	Description
	Show Key Drawings	Displays key drawings when flipping through drawings.
	Show Breakdown Drawings	Displays breakdown drawings when flipping through drawings.
	Show In-between Drawings	Displays in-between drawings when flipping through drawings.
	Show Retake Key Drawings	Displays retake key drawings when flipping through drawings.
	Show Retake Breakdown Drawings	Displays breakdown retake drawings when flipping through drawings.
	Show Retake In-between Drawings	Displays retake in-between drawings when flipping through drawings.



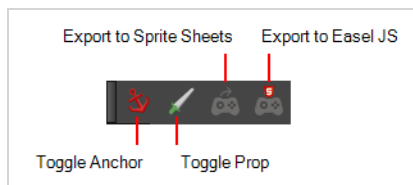

## Game Toolbar

The Game toolbar contains tools for setting anchors and props, as well as exporting to sprite sheets and Easel JS.



### How to access the Game toolbar

1. Select **Windows > Toolbars > Game**.

Icon	Tool Name	Description
	Toggle Anchor	Adds the Anchor parameter to the selected layer.
	Toggle Prop	Adds the Prop parameter to the selected layer.
	Export to Sprite Sheets	Opens the Export to Sprite Sheets window where you can export your animation as sprite sheets .
	Export to Easel JS	Opens the Export to Easel JS window where you can export your animation as Easel JS.







## Mark Drawing Toolbar

The Mark Drawing toolbar lets you identify drawings such as key, breakdown and in-between. The drawing identification feature can help the animator stay well organized and save time when identifying key, breakdown or in-between drawings in the Xsheet and Timeline views.



### How to access the Mark Drawing toolbar

1. Select **Windows > Toolbars > Mark Drawings**.

Icon	Tool Name	Description
	Mark as Key Drawing	Identifies the selected drawing as a key drawing.
	Mark as Breakdown Drawing	Identifies the selected drawing as a breakdown drawing.
	Mark as In-between Drawing	Identifies the selected drawing as an in-between drawing.
	Mark as Retake Key Drawing	Identifies the selected drawing as a key retake drawing.
	Mark as Retake Breakdown Drawing	Identifies the selected drawing as a breakdown retake drawing.
	Mark as Retake In-between Drawing	Identifies the selected drawing as a in-between retake drawing.

## Master Controller Toolbar

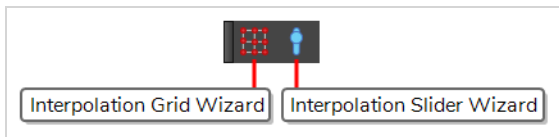

T-RIG3-008-002

The Master Controller toolbar allows you to launch one of the wizards that are packaged with Harmony which can be used to generate Master Controller widgets.



### How to access the Master Controller toolbar

1. Do one of the following:
  - In the top menu, select **Windows > Toolbars > Master Controller**.
  - Right-click on any existing toolbar and select **Master Controller**.

Icon	Tool Name	Description
	Interpolation Grid Wizard	Opens the Interpolation Grid wizard, which allows you to create a 2D point widget Master Controller that can pose your rig, or part of your rig, according to a grid of preset poses—see <a href="#">Interpolation Grid Wizard Dialog Box on page 104</a> .
	Interpolation Slider Wizard	Opens the Interpolation Slider wizard, which allows you to create a slider widget Master Controller that can pose your rig, or part of your rig, according to a line-up of 2 or more poses—see <a href="#">Interpolation Slider Wizard Dialog Box on page 111</a> .

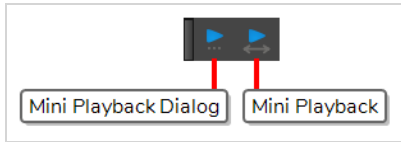

## Mini Playback Toolbar

The Mini Playback toolbar allows you to quickly preview a short span of animation starting a few frames before the current frame and ending a few frames after the current frame, at a customizable frame rate.



### How to add the Mini Playback toolbar to your workspace

1. Do one of the following:
  - In the top menu, select **Windows > Toolbars > Mini Playback**.
  - Right-click on any existing toolbar and select **Mini Playback**.

Icon	Tool Name	Description
	Mini Playback Dialog	Open the Mini Playback dialog. This dialog allows you to set the amount of frames before and after the current frame to playback when using Mini Playback, to set the speed of Mini Playback and to start Mini Playback.
	Mini Playback	Begins Mini Playback using the last settings entered in the Mini Playback dialog. By default, Mini Playback will play 5 frames before and after the current frame, at the scene's frame rate.





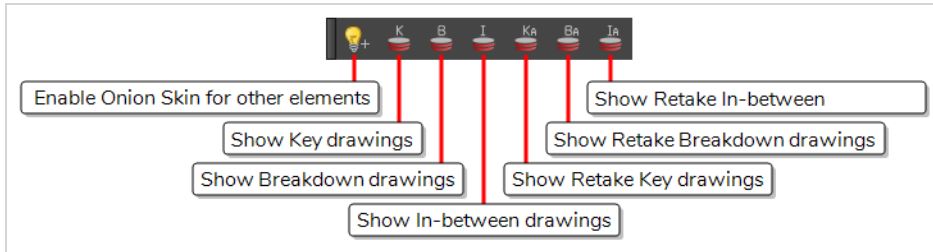

## Onion Skin Toolbar



The Onion Skin toolbar contains a few options that can be used with Onion Skin. Specifically, you can use it to quickly toggle the Enable Onion Skin for other elements option, as well as to only display drawings with specific markers in the Onion Skin.



### How to access the Onion Skin toolbar

1. Select **Windows > Toolbars > Onion Skin**.





Icon	Tool Name	Description
	Enable Onion Skin in Other Elements	In the Drawing View, when the Light Table is enabled, making other layers visible alongside the current layer, this will make the Onion Skin for other visible layers appear alongside the Onion Skin for the current layer. Drawings for elements above the current layer will appear in blue, and drawings for elements below will appear in yellow.  <div style="border: 1px solid green; padding: 5px;"><b>NOTE</b> The drawings from other elements that get displayed in the Onion Skin are the drawings that are exposed at the same time as the drawings displayed in the current layer's Onion Skin.</div>
	Show Key Drawings	Only displays drawings marked as key drawings in the Onion Skin.
	Show Breakdown Drawings	Only displays drawings marked as breakdowns in the Onion Skin.
	Show In-between Drawings	Only displays drawings with no marker in the Onion Skin. Drawings with no marker are considered in-betweens.
	Show Retake Key Drawings	Only displays drawings marked as retake key drawings in the Onion Skin.



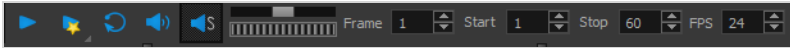

Icon	Tool Name	Description
	Show Retake Breakdown Drawings	Only displays drawings marked as retake breakdowns in the Onion Skin.
	Show Retake In-between Drawings	Only displays drawings marked as retake in-betweens in the Onion Skin.



## Playback Toolbar

The Playback toolbar lets you play back animation and sound. Use it to scrub the sound to create your lip-sync, loop the playback, navigate through frames, and change the playback range and speed.



Name	Button	Description
Play		Plays the scene in the Camera or Drawing view.  You can also select <b>Play &gt; Play</b> or <b>Stop</b> from the top menu.
Render and Play		Renders your scene's frames, then opens the rendered frames in Play for playback.  This allows you to preview your scene's animation in real time, with the effects rendered and with no risk of slowdown.  You can click and hold this button to switch its mode to <b>Record and Play</b> or <b>Test SWF Movie</b> .
Record and Play		Exports your scene as it appears in the Camera view into a movie file, then opens it in your workstation's default video player.  This allows you to preview your animation without any risk of slowdown, but it does not preview the effects in your scene. However, it is much faster than Render and Play.
Test SWF Movie		Quickly exports your scene as a Flash Movie (.swf), then opens it in your workstation's default web browser.
Enable Loop		If pressed, your scene will repeat indefinitely when playing. Otherwise, it will stop when the end is reached.  You can also select <b>Play &gt; Loop</b> from the top menu.

<p>Enable Sound</p>		<p>When pressed, your scene's soundtrack will play during playback.</p> <p>You can also select <b>Play &gt; Enable Sound</b> from the top menu.</p>
<p>Enable Sound Scrubbing</p>		<p>When pressed, you will hear a sample of your scene's soundtrack at the current frame when moving your scene's playhead in the Timeline view.</p> <p>This allows you to easily situate where the action is relative to the sound track.</p> <p>You can also select <b>Play &gt; Enable Sound Scrubbing</b>.</p>
<p>Jog Frames</p>		<p>Allows you to quickly play your scene forward or backward to preview your animation.</p> <p>Moving the handle towards the right will play your scene forward, while moving it towards the left will play your scene backward.</p> <p>The closer to the edge you move the handle, the faster the playback will be, allowing you to dose the speed at which your scene is played. When the handle is at the edge, your scene will play at its actual framerate.</p> <p>Once the head is released, it returns to the middle and playback stops.</p>
<p>Frame</p>		<p>Lets you manually enter the current frame number, setting the playhead's position.</p>
<p>Start</p>		<p>Let's you manually enter the number of the first frame to play during playback.</p> <div data-bbox="933 1545 1429 1751" style="border: 1px solid #add8e6; padding: 10px;"> <p> <b>TIP</b></p> <p>You can also click on <b>Start</b> (just left of the input field) to quickly set the Start frame to the current frame.</p> </div>
<p>Stop</p>		<p>Let's you manually enter the number of the first frame to play during playback.</p>

		 <b>TIP</b> You can also click on <b>Stop</b> (just left of the input field) to quickly set the Stop frame to the current frame.
FPS (Frames per second)		<p>Lets you set the amount of frames that should be played during every second of playback, which is how the playback speed is determined.</p>  <b>NOTE</b> This does not change the frames per second setting in your scene's resolution settings.



## Scripting Toolbar

The scripting toolbar allows you to create buttons that run functions in your scripts. You can add one button for each function you want to be able to run, and clicking on the button will instantly run the script function your linked it to.



### How to add the Scripting toolbar to your workspace

1. Do one of the following:
  - In the top menu, select **Windows > Toolbars > Scripting**.
  - Right-click on any existing toolbar and select **Scripting**.

Icon	Tool Name	Description
	Manage Scripts	Opens the Scripts Manager dialog box where you can add scripts and functions to your Scripting toolbar.
	Stop Script	Stops the execution of a script launched from the Scripting toolbar.

## Shift and Trace Toolbar

The Shift and Trace toolbar allows you to temporarily move, rotate and scale drawings, then trace over them in other drawings using Onion Skin. Contrary to Shift and Trace with the Drawing Desk, you can use the Shift and Trace toolbar in the Camera view.

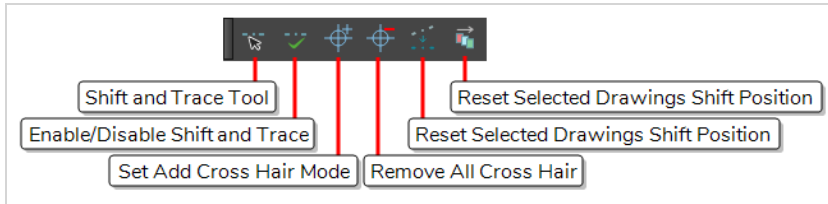





### How to access the Shift and Trace toolbar



- Do one of the following:
  - In the top menu, select **Windows > Toolbar > Shift and Trace**.
  - Right-click on any existing toolbar and select **Shift and Trace**.



#### NOTE

You can also select the Shift and Trace  tool from the Tools toolbar, under the pop-up menu of the Hand  tool. When the Shift and Trace tool is active, all the commands in the Shift and Trace toolbar are available in the Tool Properties view.

Icon	Tool Name	Description
	Shift and Trace Tool	<p>Enables the Shift and Trace tool, with which you can temporarily offset, rotate and scale drawings.</p> <p>The transformations done on drawings with the Shift and Trace tool are only meant to allow you to trace these drawings, and can be undone at any time to reset the drawings back to their intended position.</p> <p>Selecting the Shift and Trace tool also enables Shift and Trace and Onion Skin.</p>
	Enable/Disable Shift and Trace	Enabled by default. When disabled, drawings that were repositioned, rotated or scaled with the Shift and Trace tool appear in their original position.
	Set Add Cross Hair Mode	<p>When selected, clicking on the drawing will add a cross hair where you click.</p> <p>Cross hairs are marks that appear on the same location on every drawing in the current layer and which move when you offset a drawing with the Shift and Trace tool, and they appear in the Onion Skin rendition of neighbouring drawings as</p>

Icon	Tool Name	Description
		well. This allows you to keep track of how offset each drawing is.
	Remove All Cross Hair	Removes all the cross hairs created for shift and trace.
	Reset Selected Drawings Shift Position	Undoes all transformations done with the Shift and Trace tool on the selected drawings, resetting them to their original position, angle and scale.
	Reset All Drawings Shift Position	Undoes all transformations done with the Shift and Trace tool on all drawings, resetting them to their original position, angle and scale.





## Tool Presets Toolbar

The Tool Presets toolbar lets you create new tool presets and manage them.



### How to access the Tool Presets toolbar

1. Select **Windows > Toolbars > Tool Presets**.

Icon	Tool Name	Description
	New Tool Preset	Creates a new tool preset from the current tool settings.
	Manage Presets	Opens the Manage Tool Preset dialog box where you can update, organize, and delete existing presets.

## Tools Toolbar

The Tools toolbar contains the main tools you need to work in Harmony. In the default workspace, this toolbar is located on the left-most side of the interface. A small triangle at the lower-right corner of a tool indicates that additional tools can be selected in a pop-up menu. To access these tools, either click and hold on the tool button, or select the tool then click on it again.

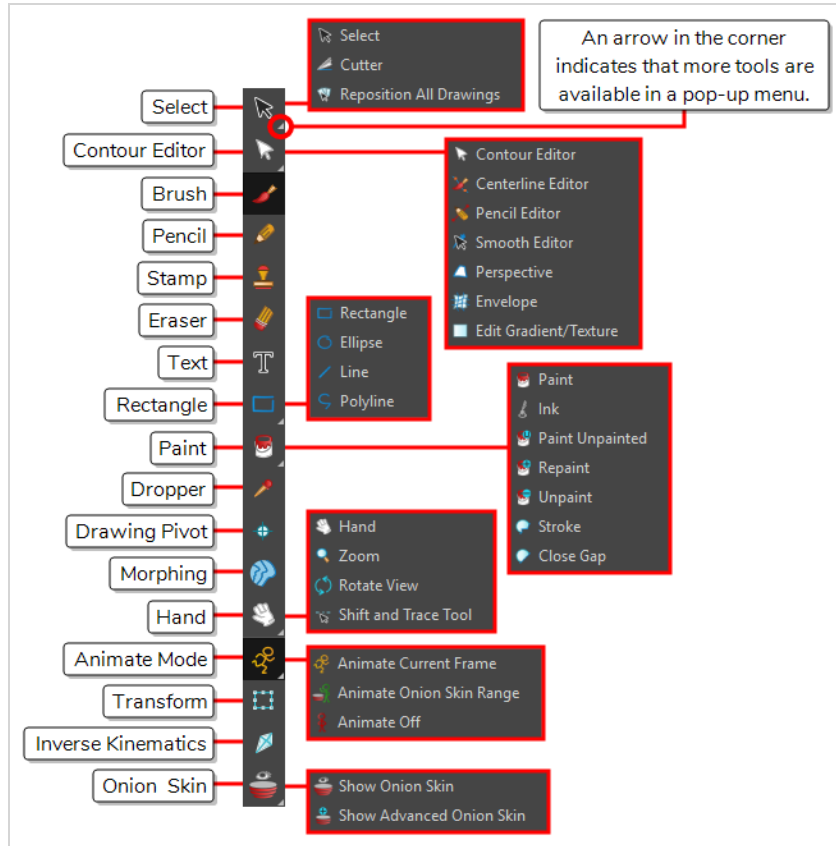

By default, the Tools toolbar displays several of its tools in pop-up menus that must be opened. It is possible to make the Tools toolbar display every tool in its individual button instead by enabling the Flat Tools Toolbar preference. This makes the selection of tools quicker. However, because there is not enough vertical space to display all tools, some tools will be hidden from the Tools toolbar by default. Which tools are displayed in the Tools toolbar when Flat Tools Toolbar is enabled can be customized. The order in which tools are listed in Flat Tools Toolbar mode can also be customized.

### How to make every tool in the Tools toolbar display in buttons rather than pop-up menus

1. Do one of the following:

- Select **Edit > Preferences** (Windows/Linux) or **Harmony Premium > Preferences** (macOS).

- Press **Ctrl + U** (Windows/Linux) or **⌘ + U** (macOS).
2. Select the **General** tab.
  3. In the Options section, select the **Flat Tool Toolbar** option.

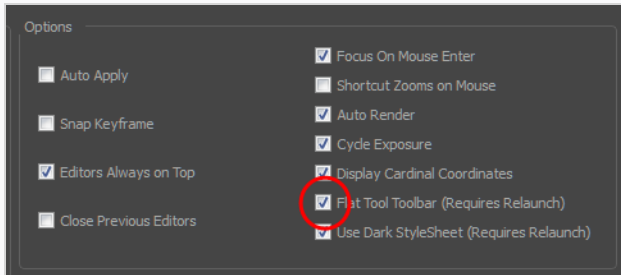

4. Click **OK** and restart Harmony.

## How to customize which tools are displayed in the Tools toolbar when it is in Flat mode

1. Right-click on the Tools toolbar and select **Customize**.



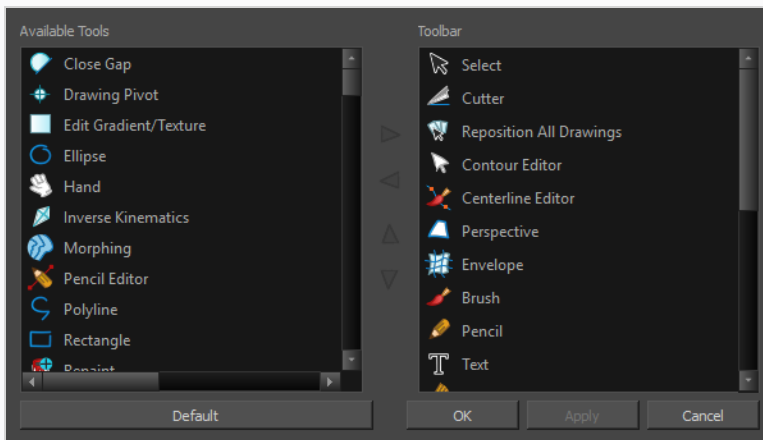











The Toolbar Manager dialog appears.



















2. In the Available Tools list, select each tool that you want to add to the Tools toolbar, then click on the Add the selected tool to the toolbar **►** button.
3. In the Toolbar list, select each tool that you want to remove from the Tools toolbar, then click on the Remove the selected tool from the toolbar **◄** button.



Tool Name	Icon	Description
Select		Allows you to select and reposition, scale, rotate and skew brush strokes, pencil lines, shapes and other parts of your artwork.

Cutter		Allows you to cut a part of your artwork, then reposition, scale, rotate and skew it.
Reposition All Drawings		Allows you to reposition, scale, rotate and skew all drawings in the current layer.
Contour Editor		Allows you to edit the vector contours of brush strokes, pencil lines and shapes in your artwork. You can add, remove, tweak and move vector points, move the Bezier handles of the vector points as well as deform vector outlines.
Centerline Editor		Allows you to tweak and deform a brush stroke by manipulating the points at the centre of its line rather than its contour.
Pencil Editor		Allows you to adjust the thickness of a pencil line at its different points and corners, tweak the shape of its extremities and scale its texture.
Smooth Editor		Allows you to optimize contours and lines by removing its extra points, making them easier to edit.
Perspective		Allows you to deform artwork by applying a perspective effect on it.
Envelope		Allows you to deform and warp artwork by moving points and tweaking lines in a grid.
Edit Gradient/Texture		Allows you to adjust the position, angle and size of gradients and textures in a colour zone.
Brush		A pressure-sensitive tool for creating a contour shape with a thick and thin line effect, as if created with a paint brush.
Pencil		A pressure-sensitive tool for drawing outlines. Pencil lines are made of central vector lines, making them easier to tweak and edit than brush strokes.
Text		Allows you to add text and to format it.
Eraser		A pressure-sensitive tool for erasing parts of a drawing.

Paint		Allows you to fill colour zones with a colour or texture.
Ink		Allows you to recolour pencil lines with precision by changing the colour of one segment at a time.
Paint Unpainted		Allows you to quickly fill empty zones in your artwork with a colour or texture, leaving filled zones unchanged.
Repaint		Allows you to quickly repaint painted zones in your artwork. Empty zones will remain empty.
Unpaint		Allows you to empty filled colour zones of their colour and texture.
Stroke		Allows you to create invisible lines that can serve as colour zones that can be filled, or close the gaps in existing colour zones.
Close Gap		Allows you to close open shapes so that they can be filled with the Paint tool. By drawing a stroke near a small gap in a shape, this tool will create a small invisible stroke connecting the two closest points around the gap.
Line		Draws a straight line segment going from one point to the other.
Rectangle		Draws a rectangle.
Ellipse		Draws an ellipse.
Polyline		Allows you to draw shapes, segmented lines or complex curved lines by clicking to create each point in the sequence of line segments.
Dropper		Allows you to select a colour by clicking on a colour in your artwork.
Drawing Pivot		Allows you to position the pivot on a drawing layer by clicking where you want its location to be.
Morphing		Allows you to create and configure a morphing sequence, which will automatically generate the in-betweens between two drawings in the

		current layer.
Hand		Allows you to pan the Camera and Drawing views.
Zoom		Allows you zoom in and out of the Camera and Drawing views.
Rotate View		Lets you rotate the Camera and Drawing views just like with a real animation disc.
Shift and Trace		Allows you to temporarily move drawings so you can trace over them in other drawings using Onion Skin.
Animate Current Frame		When this option is selected, every time you use the  Transform,  Advanced Animation or  Inverse Kinematic tools to manipulate an element in your scene, the position of the element will be stored in a keyframe at the current frame. This allows you to animate elements in your scene without creating keyframes manually.
Animate Onion Skin Range		When this option is selected, if you use the  Transform or  Advanced Animation tools to make transformations to an element in your scene, the transformations will be stored as keyframes at the beginning and at the end of the current Onion Skin range, as well as on every existing keyframe in-between. This can be useful if you want to reposition an element that you have already animated, but only during a specific range of frames, which you can define by enabling Onion Skin and setting the Onion Skin range to cover that range of frames.
Animate Off		When this option is selected, if you use the  Transform or  Advanced Animation tools to make transformation to an element in your scene, the transformations will affect the element throughout the whole scene. This can be useful if you want to reposition an element after you have already animated it.
Transform		Allows you to select drawing layers and position, rotate, scale and skew them.
Inverse Kinematics		Allows you to pose a character model by pulling on its extremities, such as hands and feet, and have the other connected limbs follow. Can be used on any piece connected in a hierarchy.

---

Onion Skin		Displays the previous and next frames of an animation. Useful when animating cut-out characters.
Advanced Onion Skin		Enables Advanced Onion Skin, a more flexible kind of Onion Skin that can be easily configured using the Onion Skin view.

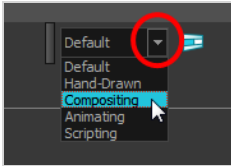

## Workspace Toolbar

The Workspace toolbar lets you load other workspaces. The first time you start Harmony, the default workspace is loaded. Other workspaces are available such as the Hand-Drawn Animation and Compositing workspaces; these display different views and toolbars. You can access these workspaces and any you create, from the Windows menu and the Workspace toolbar.



### How to access the Workspace toolbar

1. Select **Windows > Toolbars > Workspace**.

Icon	Tool Name	Description
	Workspace List	Allows you to select an existing workspace.
	Workspace Manager	Opens the Workspace Manager where you can organize, display, and remove workspace from your list.
	Save Workspace	When the Automatically Save Workspace preference is disabled, the Save Workspace button becomes available. This allows you to manually save your new workspace configuration.



---

## View Toolbars

Harmony has a series of view specific toolbars that are only available in a given view. These toolbars can be moved only within their view.

All view toolbars can be added, as long as the view is visible, through the top menu **Windows > Toolbars > desired toolbar**.

<b>3D Graph View Toolbar</b> .....	<b>1027</b>
<b>Animated Matte Generator Toolbar</b> .....	<b>1028</b>
<b>Script Editor Toolbar</b> .....	<b>1031</b>
<b>Timeline View Toolbar</b> .....	<b>1036</b>
<b>Xsheet View Toolbar</b> .....	<b>1038</b>

## 3D Graph View Toolbar

The 3D Graph toolbar works in conjunction with the elements in the 3D Graph view.



### How to access the 3D Graph toolbar

1. With the 3D Graph view open in your workspace, do one of the following:
  - From the top menu, select **Windows > Toolbars > 3D Graph**.
  - Right-click on the top area of the 3D Graph view and select **3D Graph**.



#### NOTE

This toolbar is for use with the 3D Graph view. For more information on this view, see [3D Graph View on page 1042](#).

Icon	Functionality	Description
	Enable Subnode	Enables the selected subnode, making it and all its enabled children visible. You can also enable a selection of multiple subnodes.
	Disable Subnode	Disables the selected subnode, making it and all its children invisible. You can also disable a selection of multiple subnodes.
	Make Properties Available	When the 3D model is connected to a Subnode Animation node, this will add the properties (ie: position, angle, scale) of the selected subnode to the Subnode Animation node's list of properties in the Timeline view. This is useful if you want to add keyframes to a subnode before animating it or if you want to outline which subnodes should be animated and which ones should not.
	Add 3D Kinematic Output	Creates a 3D Kinematic Output node and connects it under the 3D Model's Subnode Animation node. This 3D Kinematic Output node will be configured to use the currently selected subnode's animation. You can then connect this 3D Kinematic Output node to an element in your scene to apply the selected subnode's animation to that element.

## Animated Matte Generator Toolbar

The Animated Matte Generator toolbar displays by default at the top of the Animated Matte Generator view, adding some extra functionalities for editing and animating Animated Matte Generator nodes.

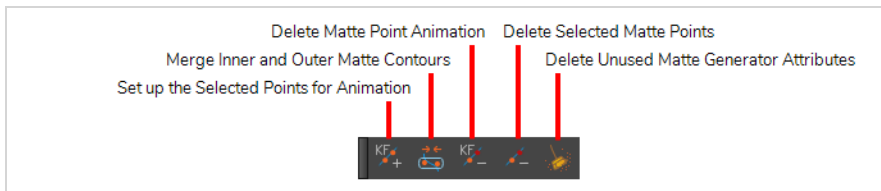

### How to access the Animated Matte Generator toolbar



1. Add the Animated Matte Generator view to your workspace by doing one of the following:
  - From the top-right corner of any currently visible view, click the Add View **+** button and select **Animated Matte Generator**.
  - From the top menu, select **Windows > Animated Matte Generator**.
2. Click on the Animated Matte Generator to set the focus on it.
3. In the top menu, select **Windows > Toolbars > Animated Matte Generator**.







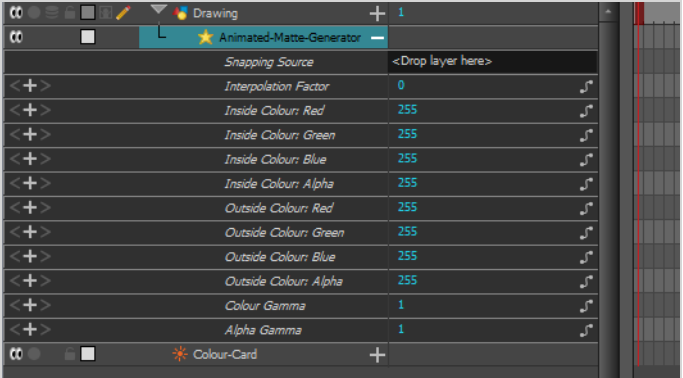
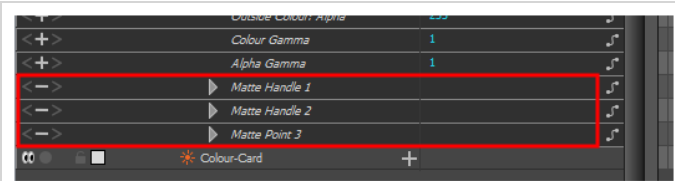
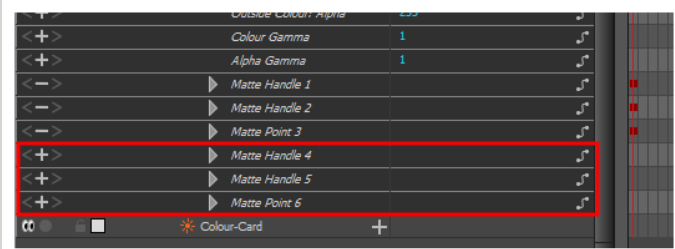

#### NOTE

This toolbar is for the Animated Matte Generator view. For information about the options and functionalities of the Animated Matte Generator view, see [Animated Matte Generator View on page 1044](#).

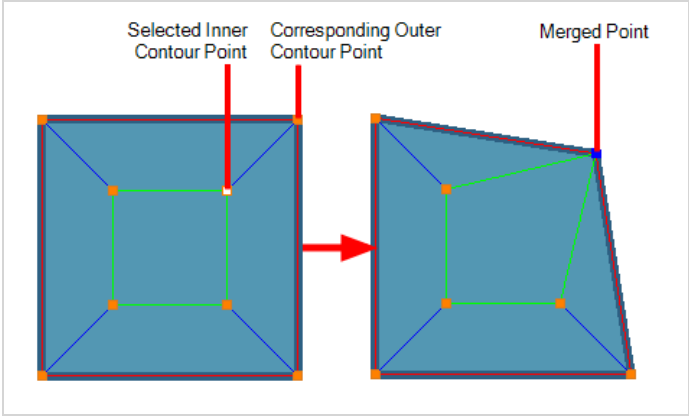
Icon	Functionality	Description
	Set up the Selected Points for Animation	<p>Adds the attribute for the position and handles of the selected matte point(s) to the list of visible attributes for the Animated Matte Generator node in the Timeline view.</p> <p>If you expand the parameters of an Animated Matte Generator toolbar in the Timeline view, by default, you will see its interpolation factor and its colour properties, which are animatable, but you will not see the attributes of each of the control points of the matte contours.</p>

Icon	Functionality	Description
		 <p>Attributes for a point are automatically added to the node's list of attributes if you animate the point in the Camera view. A keyframe is created at the same time for these attributes, to record the point's position.</p>  <p>By moving one of the matte's points in the Camera view, attributes for that point and its handles are added to the list and a keyframe is created for these attributes.</p> <p>You can use this button to add the attributes of the currently selected control points in the matte contour to the list of attributes of the Animated Matte Generator node in the Timeline view, without requiring you to animate them first.</p>  <p>By selecting another point and clicking on the Set up the Selected Points for Animation button, attributes for the point and its handles are added to the list without creating keyframes for them.</p> <p>This can serve as an indication to animators as to which control points they are supposed to animate and which ones should be left in their default position.</p>
	<p>Merge Inner and Outer Matte Contours</p>	<p>By default, the points in the animated matte generator's outer contour and their corresponding points from the inner contour</p>

Icon	Functionality	Description
		<p>are locked together, allowing you to animate a single matte instead of two mattes. If you disable one of the contours by toggling off the Outer Contour  or Inner Contour  visibility buttons in the Animated Matte Generator view, you can animate the other contour's points separately from the hidden contour, which causes the points to be separated. This command puts separated contour points from the inner and outer contours in the same position, and locks them back together, as they were initially.</p> 
	Delete Matte Point Animation	Deletes every keyframe in the scene for the selected matte points, as well as their attributes in the Timeline view. This resets the selected points to their original position and makes them static throughout the scene.
	Delete Selected Matte Point	<p>Deletes the selected matte control points from the contour.</p> <div data-bbox="748 1360 1433 1598" style="border: 1px solid green; padding: 10px;"> <p> <b>NOTE</b></p> <p>If a point from one of the two contours is deleted, the corresponding point from the other contour will also be deleted. It is not possible to have a different amount of points on a matte's inner and outer contours.</p> </div>
	Delete Unused Matte Generator Attributes	This cleans up the list of attributes for the Animated Matte Generator layer in the Timeline view by removing attributes that have been created for points that no longer exist. For example, points that were created for a drawing that was deleted, or for a part of a drawing that was erased or modified.



## Script Editor Toolbar

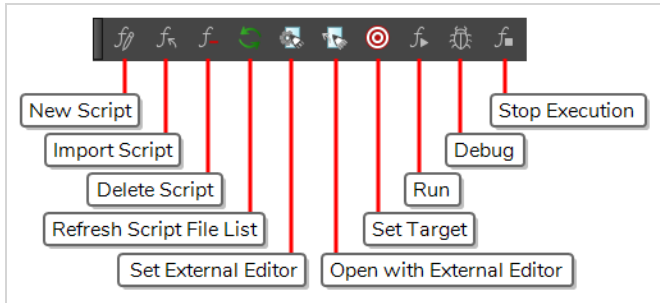

The Script Editor toolbar gives you quick access to some commonly used commands for editing and testing scripts in the Script Editor view—see [Script Editor View](#) on page 1106.









### How to access the Script Editor toolbar











1. Add the Script Editor view to your workspace by doing one of the following:
  - In the top-right corner of an existing view, click on the **+** Add View button and select Script Editor.
  - In the top menu, select **Windows > Script Editor**.
2. Click on the Script Editor view to set the focus on it.
3. In the top menu, select **Windows > Toolbars > Script Editor**.

Icon	Button	Description
	New Script	<p>Creates a new script. When you click on this button, you are first prompted to type in a name for the script. Then, you will be prompted to select which location to save the script in:</p> <ul style="list-style-type: none"> <li>• <b>User:</b> Saves the script to a directory in your user preferences directory. You will be able to run and edit the script from any scene as long as you are logged in as the same user.</li> </ul> <div style="border: 1px solid green; padding: 10px; margin: 10px 0;"> <p> <b>NOTE</b></p> <p>If you are using Harmony Stand Alone, the script will be saved to the preferences for your account on your computer. If you are using Harmony Server, the script will be saved to the preferences for your Harmony database user.</p> </div> <ul style="list-style-type: none"> <li>• <b>Global:</b> If you are using Harmony Server, select this option to save the script to the Harmony database's global script directory. Anyone who is logged in to the database will be able to edit and run this script.</li> </ul>

Icon	Button	Description
		<ul style="list-style-type: none"> <li>• <b>Environment:</b> If you are using Harmony Server, select this option to save the script to the current scene's environment. Anyone will be able to edit and run the script as long as they are working on a scene inside this environment.</li> <li>• <b>Job:</b> If you are using Harmony Server, select this option to save the script to the current scene's job. Anyone will be able to edit and run the script as long as they are working on a scene inside this job.</li> <li>• <b>Scene:</b> Save the script to the scene's <b>scripts</b> sub-folder. Anyone will be able to edit and run the script when working on this specific scene.</li> <li>• <b>System Variable:</b> Save the script to the directory in the <b>TOONBOOM_GLOBAL_SCRIPT_LOCATION</b> environment variable. This option is only available if this environment variable is set.</li> </ul> <div data-bbox="558 789 1430 932" style="border: 1px solid green; padding: 5px;">  <p><b>NOTE</b> For more information on script locations, see <a href="#">Script list on page 1106</a>.</p> </div>
	Import Script	<p>Allows you to import a script from your machine into Harmony. When you click on this button, you are prompted to browse for and select a script on your file system. Then, you are prompted to select which location to import the script in:</p> <ul style="list-style-type: none"> <li>• <b>User:</b> Saves the script to a directory in your user preferences directory. You will be able to run and edit the script from any scene as long as you are logged in as the same user.</li> </ul> <div data-bbox="639 1247 1430 1482" style="border: 1px solid green; padding: 5px;">  <p><b>NOTE</b> If you are using Harmony Stand Alone, the script will be saved to the preferences for your account on your computer. If you are using Harmony Server, the script will be saved to the preferences for your Harmony database user.</p> </div> <ul style="list-style-type: none"> <li>• <b>Global:</b> If you are using Harmony Server, select this option to save the script to the Harmony database's global script directory. Anyone who is logged in to the database will be able to edit and run this script.</li> <li>• <b>Environment:</b> If you are using Harmony Server, select this option to save the script to the current scene's environment. Anyone will be able to edit and run the script as long as they are working on a scene inside this environment.</li> <li>• <b>Job:</b> If you are using Harmony Server, select this option to save the script to the current scene's job. Anyone will be able to edit and run the script as long as they are working on a scene inside this job.</li> </ul>

Icon	Button	Description
		<ul style="list-style-type: none"> <li>• <b>Scene:</b> Save the script to the scene's <b>scripts</b> sub-folder. Anyone will be able to edit and run the script when working on this specific scene.</li> <li>• <b>System Variable:</b> Save the script to the directory in the <b>TOONBOOM_GLOBAL_SCRIPT_LOCATION</b> environment variable. This option is only available if this environment variable is set.</li> </ul> <div data-bbox="558 506 1430 800" style="border: 1px solid #c8e6c9; padding: 10px; margin-top: 10px;"> <p> <b>NOTES</b></p> <ul style="list-style-type: none"> <li>• When you import a script, any user interface (.ui) or icon (.png) file that is in the same directory and has the same filename as the script will also be imported.</li> <li>• For more information on script locations, see <a href="#">Script Editor View</a> on page 1106.</li> </ul> </div>
	Delete Script	<p>Deletes the selected script.</p> <div data-bbox="558 919 1430 1251" style="border: 1px solid #c8e6c9; padding: 10px; margin-top: 10px;"> <p> <b>NOTES</b></p> <ul style="list-style-type: none"> <li>• You cannot delete a script if it is in the Application Resources location, as those are scripts that are installed with Harmony.</li> <li>• If you delete a script that was originally in Application Resources but which you copied to another location so you could make changes to it, the original version of the script in the Application Resources folder will be restored to the list.</li> </ul> </div>
	Refresh Script File List	<p>Refresh the list of scripts in the Script Editor. If there are new scripts in your user preferences or your scene's scripts sub-folder, click on this button to be able to open them in the Script Editor.</p>
	Set External Editor	<p>Allows you to type in the path and name for your preferred text editing software.</p> <div data-bbox="558 1528 1430 1860" style="border: 1px solid #c8e6c9; padding: 10px; margin-top: 10px;"> <p> <b>NOTES</b></p> <ul style="list-style-type: none"> <li>• On macOS, only typing the name of your preferred text editing software is enough if that application supports the AppleScript Open Document protocol.</li> <li>• On Windows and GNU/Linux, unless your text editor is in your system's <b>PATH</b> environment variable, you will have to type in the full path to the editor.</li> </ul> </div>















Icon	Button	Description
	Open with External Editor	Opens the selected script in the chosen external text editing software.
	Set Target	<p>Prompts you to select which script and which function to use with the  Run and  Debug buttons.</p> <div data-bbox="560 512 1429 842" style="border: 1px solid green; padding: 10px;"> <p> <b>NOTES</b></p> <ul style="list-style-type: none"> <li>You can set the entire script as the target by selecting the <b>&lt;Nothing&gt;</b> function from the functions list.</li> <li>You cannot link an entire script to a toolbar button. Only functions within scripts can be added as toolbar buttons. Therefore, running or debugging an entire script rather than one of its functions should be done for testing purposes only.</li> </ul> </div>
	Run	<p>Runs the target script and function.</p> <div data-bbox="560 961 1429 1339" style="border: 1px solid green; padding: 10px;"> <p> <b>NOTES</b></p> <ul style="list-style-type: none"> <li>If you have not set a target script and function, you will be prompted to set one when you click on this button.</li> <li>You can set or change the target script and function by clicking on the  Set Target button.</li> <li>If you are editing <b>&lt;&lt;&lt;Sandbox&gt;&gt;&gt;</b>, this button will simply run what you typed into the sandbox, regardless of whether another target is set.</li> </ul> </div>
	Debug	<p>Open the target script and function in the Qt Script Debugger, in which you can test and debug the function.</p> <div data-bbox="560 1495 1429 1873" style="border: 1px solid green; padding: 10px;"> <p> <b>NOTES</b></p> <ul style="list-style-type: none"> <li>If you have not set a target script and function, you will be prompted to set one when click on this button.</li> <li>You can set or change the target script and function by clicking on the  Set Target button.</li> <li>If you are editing <b>&lt;&lt;&lt;Sandbox&gt;&gt;&gt;</b>, this button will simply debug what you typed into the sandbox, regardless of whether another target is set.</li> </ul> </div>





Icon	Button	Description
	Stop Execution	If a script is currently running, this interrupts its execution.

## Timeline View Toolbar

The 3D Graph toolbar works in conjunction with the elements in the 3D Graph view.



Button	Name	Description
	Set Ease Type	
	Create Empty Drawing	
	Duplicate Drawing	
	Insert Keyframe	
	Delete Keyframes	
	Set Motion Keyframe	
	Set Stop-Motion Keyframe	
	Go to Previous Keyframe	
	Go to Next Keyframe	
	Add Key Exposure	
	Delete Key Exposure	
	Centre On Selection	
	Set Ease for Multiple Parameters	
	Create Keyframes On	Opens the Create Keyframes On dialog box, where you can set the options to create a new keyframe every x number of frames.

	Fill Empty Cells	
	Paste Mode: All Drawing Attributes	
	Paste Mode: Keyframes Only	
	Paste Mode: Exposures Only	
	Add Prefix or Suffix	

## How to access the Timeline view toolbar

You can add the Timeline view toolbar to the Timeline view by:

- Going to the top menu and selecting **Windows > Toolbars > Timeline view**.
- right-clicking on the space at the top of the Timeline view and selecting **Timeline view**.

## Xsheet View Toolbar

The Xsheet toolbar contains the common timing operations such as Add Column, Delete Column, Clone Column, and so on. These options can also be found in the top menu.

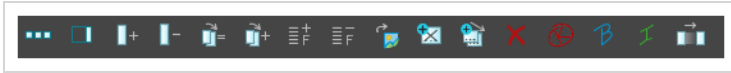



## Chapter 6: Views

The Harmony interface is composed of different views, each one designed for a specific purpose. You can modify the location of the views by adding a new view as a tab or as a window. You can also swap the location of a view.

When a view is active, a red rectangle appears around the view. Keyboard shortcuts and top menu options are associated with the active view. If a menu option is greyed out, it means it does not apply to the layer, drawing or other type of selection or the option does not apply to the active view.

3D Graph View .....	1042
Animated Matte Generator View .....	1044
Camera View .....	1051
Colour View .....	1058
Coordinates and Control Points View .....	1066
Drawing View .....	1069
Drawing Substitutions View .....	1072
Function View .....	1074
Guides View .....	1077
Integrated Help View .....	1080
Layer Properties View .....	1081
Library View .....	1083
Master Controller View .....	1086
Message Log View .....	1088
Metadata Editor View .....	1089
Model View .....	1091
Node View .....	1092
Node Library View .....	1094
Onion Skin View .....	1097
Perspective View .....	1103
Script Editor View .....	1106
Side View .....	1111
Timeline View .....	1113
Tool Properties View .....	1123

Top View .....	1124
Xsheet View .....	1126



## 3D Graph View

When a 3D model is selected, the 3D Graph view allows you to view a list of the subnodes composing the 3D model, arranged in their hierarchy. You can select a subnode from the list. When a subnode is selected, you can manipulate it with the Transform tool, disable or enable it.

If your 3D model is connected to a Subnode Animation node, you can select this Subnode Animation node and use the 3D Graph view to select and animate a subnode, to add its properties to the Subnode Animation's properties in the Timeline view, or connect a subnode to a 3D Kinematic Output node to it so that its animation can be applied to another element.

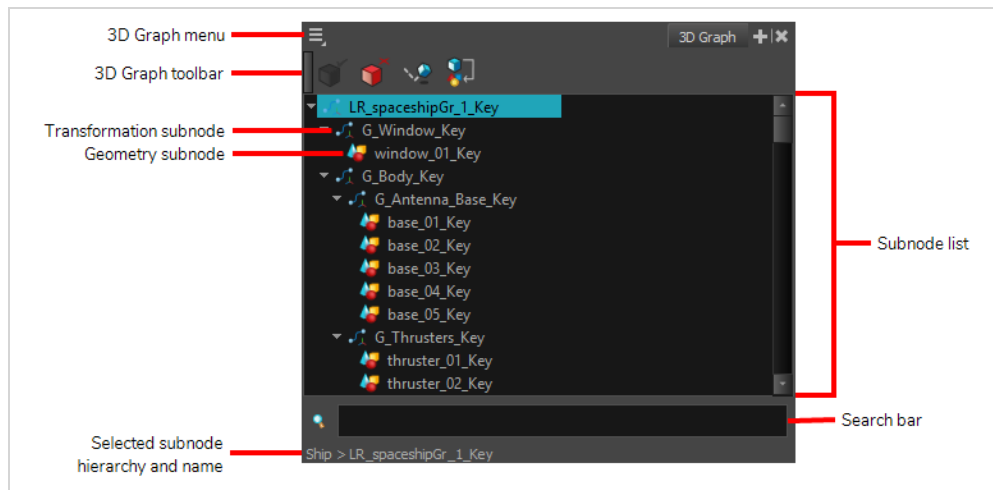



### How to access the 3D Graph view

Do one of the following:

- From the top menu, select **Windows > 3D Graph**.
- From any of the other views, click the Add View **+** button and select **3D Graph**.

Section	Description
3D Graph menu	Access commands through this menu—see <a href="#">3D Graph View Menu</a> .
3D Graph toolbar	See <a href="#">3D Graph View Toolbar</a> .
Subnode list	Lists the selected 3D model's subnodes in a tree hierarchy and allows you to select a subnode.

	<div style="border: 1px solid #c8e6c9; padding: 10px;">  <p><b>NOTE</b></p> <p>Subnodes preceded with a  icon are transformation subnodes which are only used to affect the position, size and angle of its child subnodes. Subnodes preceded with a  are geometry subnode, which actually contain a visible part of the 3D model.</p> </div>
<p>Selected subnode hierarchy and name</p>	<p>Displays the subnode's parent hierarchy followed by the subnode's name.</p>
<p>Search bar</p>	<p>Allows you to filter and search for subnodes. Typing anything in the field will make the subnode list only display subnodes that contain the typed text string in their name, along with their parents.</p>

## Animated Matte Generator View

The Animated Matte Generator view allows you to configure and animate the matte created by a Animated-Matte-Generator node. It also allows you to quickly add Animated-Matte-Generator templates to your Node view.

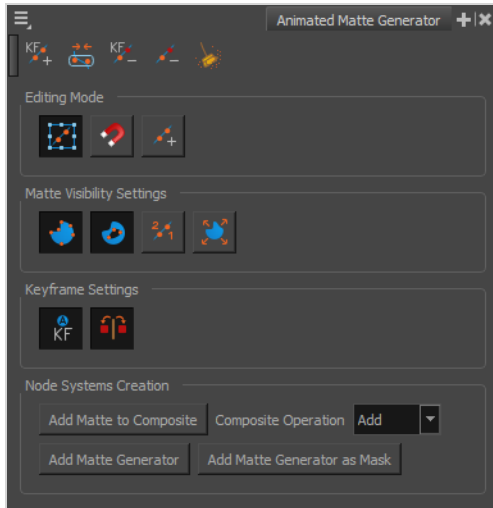

### How to access the Animated Matte Generator view

1. Do one of the following:
  - From the top-right corner of any currently visible view, click the Add View **+** button and select **Animated Matte Generator**.
  - From the top menu, select **Windows > Animated Matte Generator**.



### How to display the Animated Matte Generator controls and enable the Animated Matte Generator view options





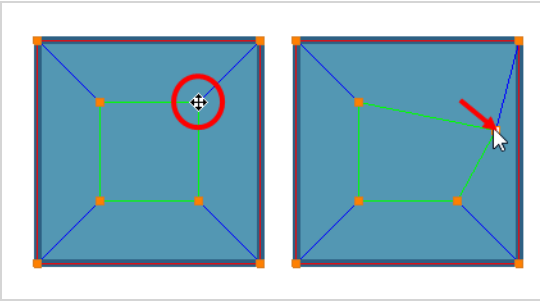

1. In the Tools toolbar, select the Transform tool or press Shift + T.
2. In the Timeline or Node view, select the Animated Matte Generator node you wish to configure or animate.
3. In the Camera view toolbar, click on Show Controls  or press Shift + F11.

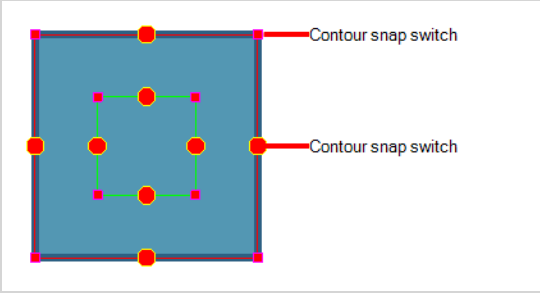
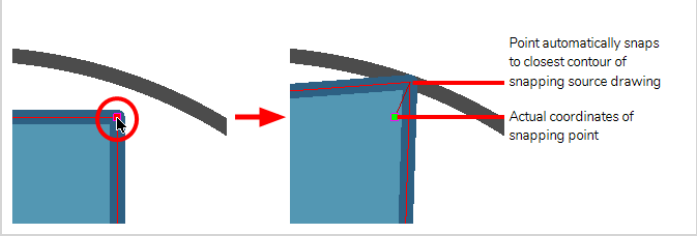

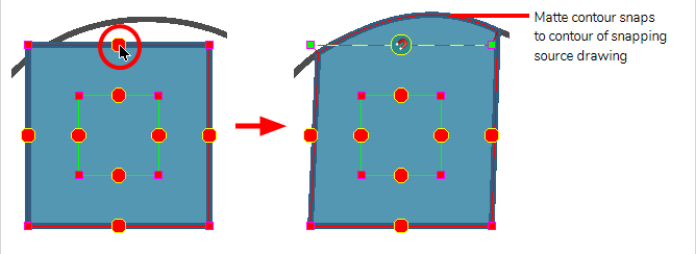

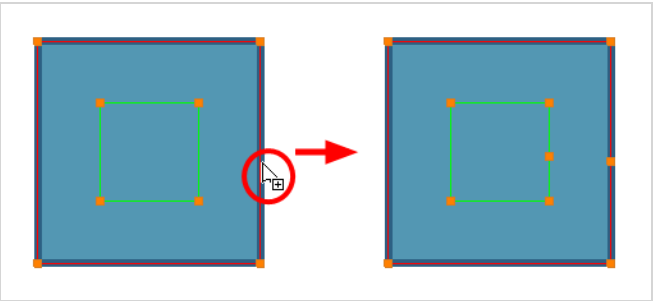







#### NOTE

The Animated Matte Generator view also has its own toolbar. For information on the buttons in this toolbar, see [Animated Matte Generator Toolbar](#)

Icon	Functionality	Description
Editing Mode		
	<p>Define Matte Point</p>	<p>Allows you to manipulate the matte's contour points by dragging them in the Camera view. Use this mode to edit and animate your matte.</p> 
	<p>Set to Snap</p>	<p>If the Animated Matte Generator node is connected to a snapping source drawing, this allows you to define which points and contours of the matte should snap to the contours of the snapping source drawing, by clicking on them.</p>  <p>If you click on a point in this mode, it will be set to snap to the nearest contour of the snapping source drawing.</p>  <p>If you click on a contour in this mode, the contour will be set to snap to the nearest contour of the snapping source drawing, and will be made to match its curve. Both points on either end of that contour will also be set to snap to the snapping source drawing.</p>

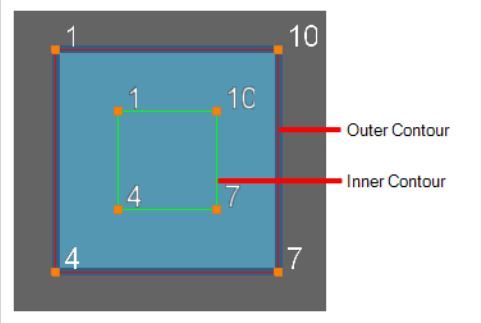
		 <p>Points and contours that are configured to snap will snap to the closest point or contour they can find in the snapping source, provided that they are at a reasonable distance from their actual coordinates. This distance can be adjusted by changing the Drag-to-Snap Distance parameter in the Animated Matte Generator's layer properties.</p>
	<p>Add Matte Point</p>	<p>Allows you create a point on the contour of the map by clicking on one of the matte's contour where you want the point to be created.</p>  <div data-bbox="743 1205 1430 1440" style="border: 1px solid green; padding: 5px;"> <p> <b>NOTE</b> Adding a matte point to one of the matter's contours will also add a point to the matte's other contour. It is not possible to have a different amount of points on a matte's inner and outer contours.</p> </div> <div data-bbox="743 1465 1430 1667" style="border: 1px solid green; padding: 5px;"> <p> <b>NOTE</b> Contrary to tools like the Contour Editor, you cannot use a keyboard shortcut to click and add a point to a matte contour.</p> </div>
<p>Matte Visibility Settings</p>		
	<p>Outer Contour</p>	<p>When enabled, the matte's Outer Contour and its controls display in the Camera view, and the Outer Contour can be modified.</p>

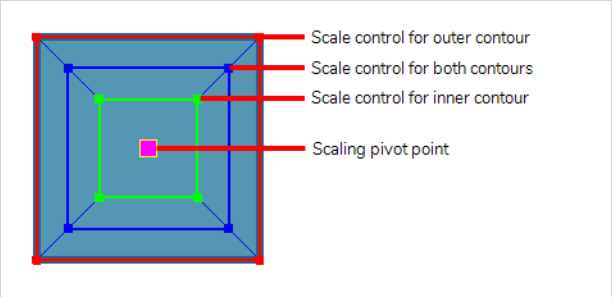
		<div data-bbox="743 189 1432 453" style="border: 1px solid #add8e6; padding: 10px;">  <p><b>TIP</b></p> <p>You can hold Alt while pressing this button to quickly enable the outer contour and disable the inner contour simultaneously. You can also hold Shift while pressing any of the Matte Visibility Settings buttons to quickly enable all matte visibility settings.</p> </div>
	<p>Inner Contour</p>	<p>When enabled, the matte's Inner Contour and its controls display in the Camera view, and the Inner Contour can be modified.</p> <div data-bbox="743 609 1432 940" style="border: 1px solid #90ee90; padding: 10px;">  <p><b>NOTE</b></p> <p>A matte always has an <i>outer contour</i> and an <i>inner contour</i>. By default, both contours are merged together, having the same shape and points, allowing you to animate them simultaneously as if the matte had a single contour. You can separate the points of the inner and outer contours by hiding one of the contours and making modifications on the other contour.</p> </div> <div data-bbox="743 970 1432 1272" style="border: 1px solid #90ee90; padding: 10px;">  <p><b>NOTE</b></p> <p>When two contour points are separated, you can lock them back together by selecting them and clicking on the Merge Inner and Outer Matte Contour  button of the Animated Matte Generator toolbar or by moving one of the points close to its corresponding point until they snap together.</p> </div> <div data-bbox="743 1302 1432 1566" style="border: 1px solid #add8e6; padding: 10px;">  <p><b>TIP</b></p> <p>You can hold Alt while pressing this button to quickly enable the inner contour and disable the contour simultaneously. You can also hold Shift while pressing any of the Matte Visibility Settings buttons to quickly enable all matte visibility settings.</p> </div>
	<p>Point Id</p>	<p>When enabled, the identification number of each of the matte's points display in the Camera view. These numbers are used to track which point of the outer contour are matched with which points of the inner contour.</p>

		 <p><b>TIP</b> You can hold Shift while pressing any of the Matte Visibility Settings buttons to quickly enable all matte visibility settings.</p>
	<p>Scaling Controls</p>	<p>When enabled, moving one of the control points of the matte contours will scale the entire matte. A purple square will appear in the middle of the matte's contour. Moving this square will change the position of the pivot point used for scaling the contour.</p>  <p><b>TIP</b> You can hold Shift while pressing any of the Matte Visibility Settings buttons to quickly enable all matte visibility settings.</p>
<p>Keyframe Settings</p>		
	<p>Auto Key on All Points</p>	<p>By default, when a matte control point is moved in the Camera view, a keyframe is created for that point and its handles. With this option enabled, a keyframe will be created for all the points in the matte and all of their handles.</p>

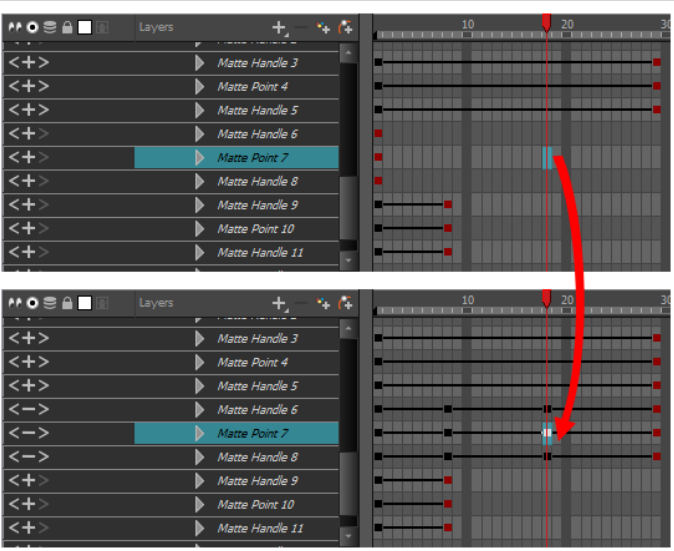
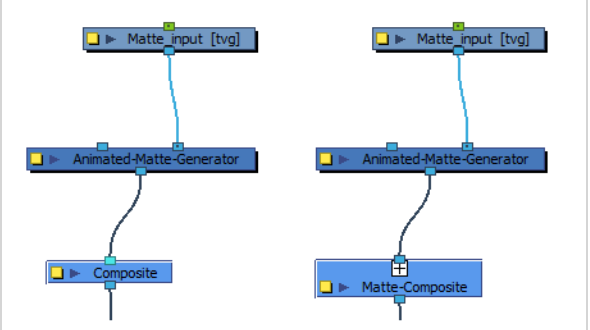
	<p>Fix Adjacent Keyframes</p>	<p>When moving a control point, this will look for keyframes on other control points right before and after the current frame and, if it finds any, it will create keyframes for the control point being moved at these frames. This ensures that animating without the Auto Key on All Points option does not create overlapping animation for control points, but does not create unnecessary keyframes.</p>  <p>When matte point 7 is moved, a keyframe is created at the current frame, but also at frame 8, because matte point 10 has a keyframe at frame 8, and also at frame 29, because matte point 4 has a keyframe at frame 29. This prevents overlapping animation.</p>
<p>Node Systems Creation</p>		
	<p>Add Matte to Composite</p>	<p>If a Composite or Matte-Composite node is selected in the Node view, this creates an Animated Matte Generator template with an empty matte drawing layer in the Node view, then connects the newly created Animated-Matte-Generator node to the selected composite.</p> 
	<p>Composite Operation</p>	<p>When using the Add Matte to Composite option on a Matte</p>

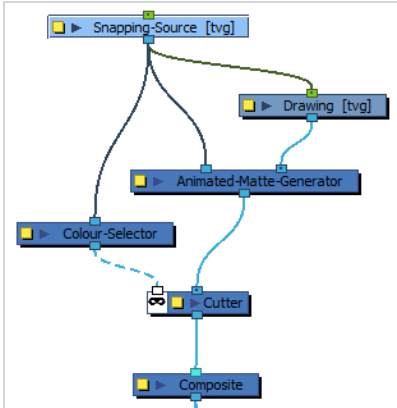
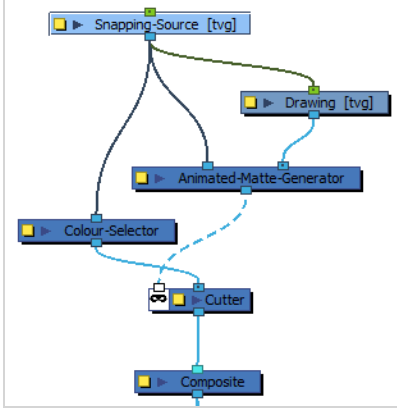

		<p>Composite node, this determines whether the Animated Matte Generator node being created will be connected to the selected Matte Composite node in <b>Add</b>, <b>Subtract</b> or <b>Intersect</b> mode.</p>
	<p>Add Matte Generator</p>	<p>This creates an Animated Matte Generator template in the Node view which includes a Matte drawing layer, an Animated Matte Generator node, a Colour Selector and a Cutter.</p>  <p>If a drawing layer is selected when clicking this button, it will be connected as the peg of the Matte drawing layer, and as the input of the Colour Selector node.</p>
	<p>Add Matte Generator as Mask</p>	<p>This creates a similar template to the one created by the Add Matte Generator button, except that the Animated-Matte-Generator node created by this option is connected to the matte port of the Cutter node, and the Colour-Selector node connected to the selected layer is connected to the input port of the Cutter node.</p> 

## Camera View

The Camera view is the centre of operations in Harmony. In this view, you can draw, paint, animate, set up your scene, manipulate objects, open symbols and preview your animation.

The Camera view also has a top and bottom toolbar that you can use to navigate in the view, change the display mode or go up your symbol hierarchy.

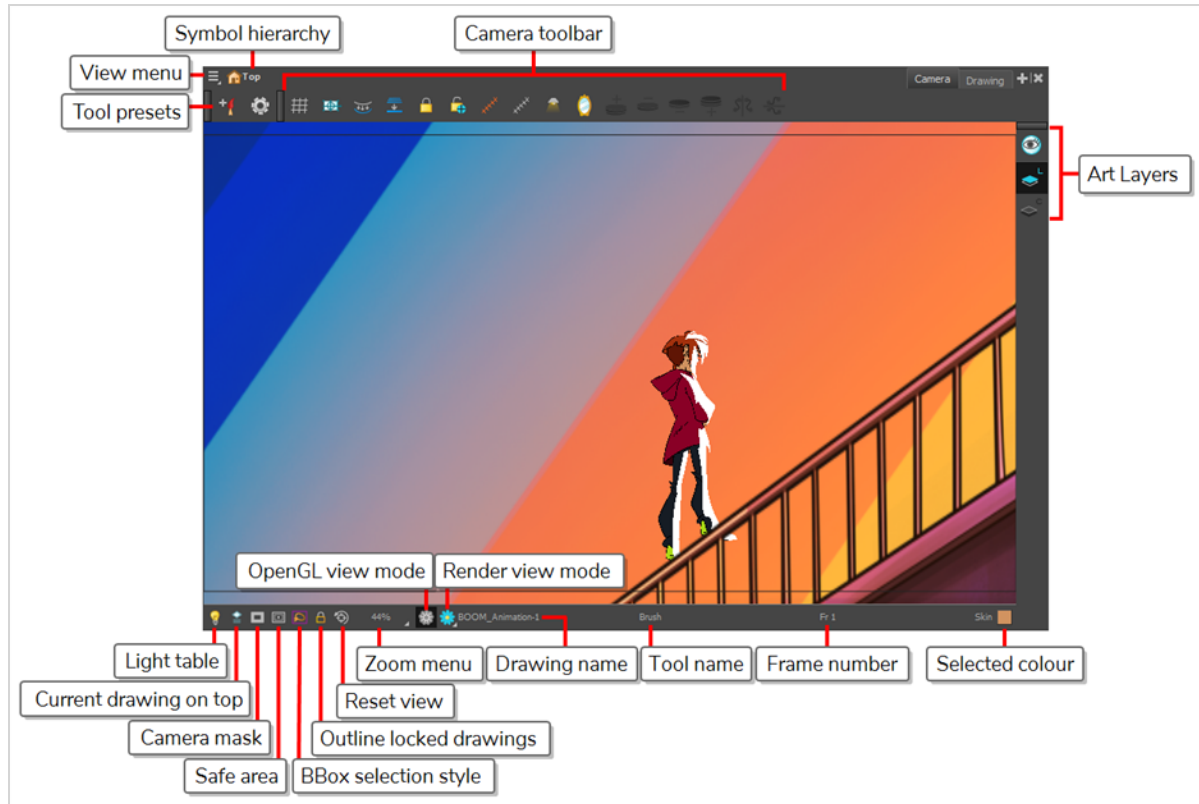











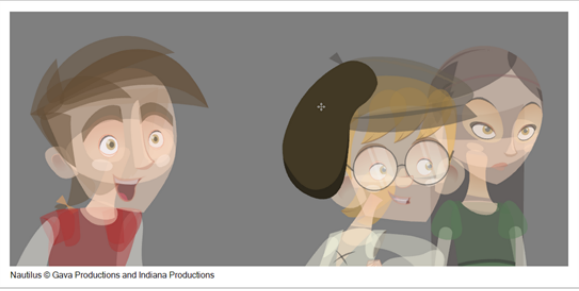

### How to access the Camera view



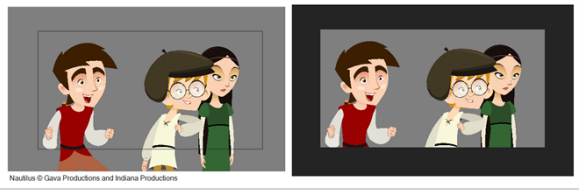

Do one of the following:



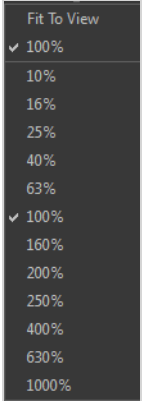

- From the top menu, select **Windows > Camera**.
- From any of the other views, click the Add View **+** button and select **Camera**.

Icon	Section	Description
	View Menu	The View menu contains all the tools and options that you can use in the Camera view to draw, animate or set up the scene.

	Editing Stack	<p>The Editing Stack menu displays the names of the symbols and their hierarchy when you are editing a symbol. You can click on the different names to go back up to the different parent symbols or the top/current project.</p>
	Camera View Toolbar	<p>The Camera View toolbar contains all the tools and options you can use in the Camera view to draw, animate or set up the scene. The toolbar can be displayed or hidden by right-clicking on it and selecting or deselecting the Camera View toolbar.</p>
	Light Table	<p>When you have a drawing layer or drawing selected, the Light Table button allows you to fade the colours of the other layers so you can see the current artwork better as you edit with a drawing tool. Note that the light table does not work when using a layer editing tool, such as the Transform tool.</p>  <p><small>Nautilus © Gava Productions and Indiana Productions</small></p>
	Current Drawing on Top	<p>When this button is enabled, the drawing that you are currently editing with a drawing tool is temporarily displayed in front of all the other elements. The actual scene is not modified.</p>  <p><small>Nautilus © Gava Productions and Indiana Productions</small></p>
	Camera Mask	<p>The Camera Mask button shows or hides Displays a black mask around the scene's frame to avoid seeing the unnecessary artwork. This option is handy when you're animating and setting up the scene. It allows you to see your scene's composition better.</p>

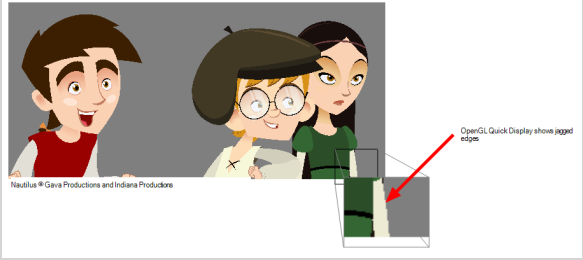
		<p>You can also access this from the top menu by selecting <b>View &gt; Show &gt; Camera Mask</b>.</p> 
	<p>Safe Area</p>	<p>The Safe Area button shows or hides Displays the TV safety zone and the centre of the camera frame. The safe area adapts to the scene resolution, as well as the safety zone and frame's centre.</p> <p>You can also access this feature from the top menu by selecting <b>View &gt; Show &gt; Safe Area</b>.</p> 
	<p>BBox Selection Style</p>	<p>When you select an object in the Camera view with the Transform tool, a bounding box always appears around the object and the artwork is tinted in fuchsia, red or yellow. Enabling this option will only keep the bounding box and remove the colour tint.</p> 
	<p>Outline Locked Drawings</p>	<p>Drawings that are locked in the Timeline view (cannot be selected in the Camera view) are displayed as wireframes.</p>

		
	<p>Reset View</p>	<p>The Reset View button resets any panning, zooming or rotation done in the Camera view and returns the display to the initial settings. You can also press Shift + M.</p>
	<p>Zoom Menu</p>	<p>The Zoom menu lets you enlarge or reduce the Camera or Drawing view display.</p> <p>To make the camera frame size always match the size of your view, select the <b>Fit to View</b> option. Click the drop-down arrow and select a zoom level or press 1 and 2.</p> 
	<p>OpenGL View Mode</p>	<p>The OpenGL View Mode button switches the Camera view to fast display, letting you see your animation play in real time. The OpenGL display requires less memory. The final look of your effects is not shown in the OpenGL View Mode. You must switch to the Render View Mode to see your effects.</p>

		
	<p>Render View Mode</p>	<p>The Render View Mode button switches the Camera view to a fully rendered display showing the final image of the current frame. If a modification is done to your current frame or if you move to a different frame, click the <b>Update Preview</b> button to update the display if your preview does not update automatically. The Render View Mode display lets you see the final look of your frames including effects and antialiasing. You cannot play back your scene in Render View Mode. To see your scene fully rendered and to play it back, you must press the Render and Play button in the Playback toolbar.</p> 
	<p>Matte View Mode</p>	<p>The Matte View Mode button switches the Camera view to a matte display showing the alpha channel of the elements in your scene. The transparency level ranges from 0 to 100 percent. Zero percent is completely transparent and represented by black and 100 percent is completely opaque and represented by white. Everything in between these extremes has a transparency level somewhere between 1 and 99 percent and is represented in various shades of grey.</p> <ul style="list-style-type: none"> <li>To access the Matte View mode, click on the Render View button and select Matte View from the drop-down menu.</li> </ul>

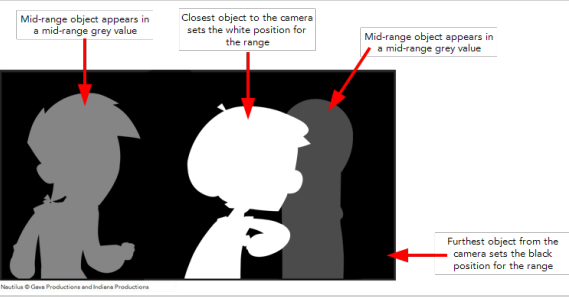
		 <p>Nautilus © Garra Productions and Indiana Productions</p>
<p>Z</p>	<p>Depth View Mode</p>	<p>The Depth View mode displays images in a relative white to black gradient scale. The object(s) closest to the camera are displayed in white and the object(s) furthest from the camera are displayed in black. If the position of the last object changes along the z-axis, that object will still remain black, so long as it retains its position as the object the farthest back. It does not matter where that object is in 3D space, it just matters what its position is relative to the other object in the same space. The objects closest and farthest from the camera set the range of the white to black scale. All the other objects fall somewhere in between.</p>  <p>Nautilus © Garra Productions and Indiana Productions</p> <ul style="list-style-type: none"> <li>To access the Depth View mode, click on the Render View button and select Depth View from the drop-down menu.</li> </ul>
	<p>Drawing Name</p>	<p>The Drawing Name field displays the name of the selected drawing, as well as the layer containing it. If the cell does not contain any drawing, an <b>Empty Cell</b> text is shown in the field.</p>
	<p>Tool Name</p>	<p>The Tool Name field displays the name of the selected tool. If you temporarily override a drawing tool using a keyboard shortcut, the tool's name will be highlighted in red. You can temporarily override a tool by holding its keyboard shortcut without the Alt key. For</p>

		<p>example, the Select tool shortcut is Alt + S. If you hold down the S key, you will switch to the Select tool. When you release the key, you will return to the tool you were using.</p>
	Frame Number	<p>The Frame Number field displays the number of the current frame.</p>
	Selected Colour	<p>The colour swatch displays the currently selected colour in the Colour view.</p>



## Colour View

The Colour view is where you create colours and palettes and import existing palettes into your project. The Colour view is also necessary for drawing, painting and creating colour styling.

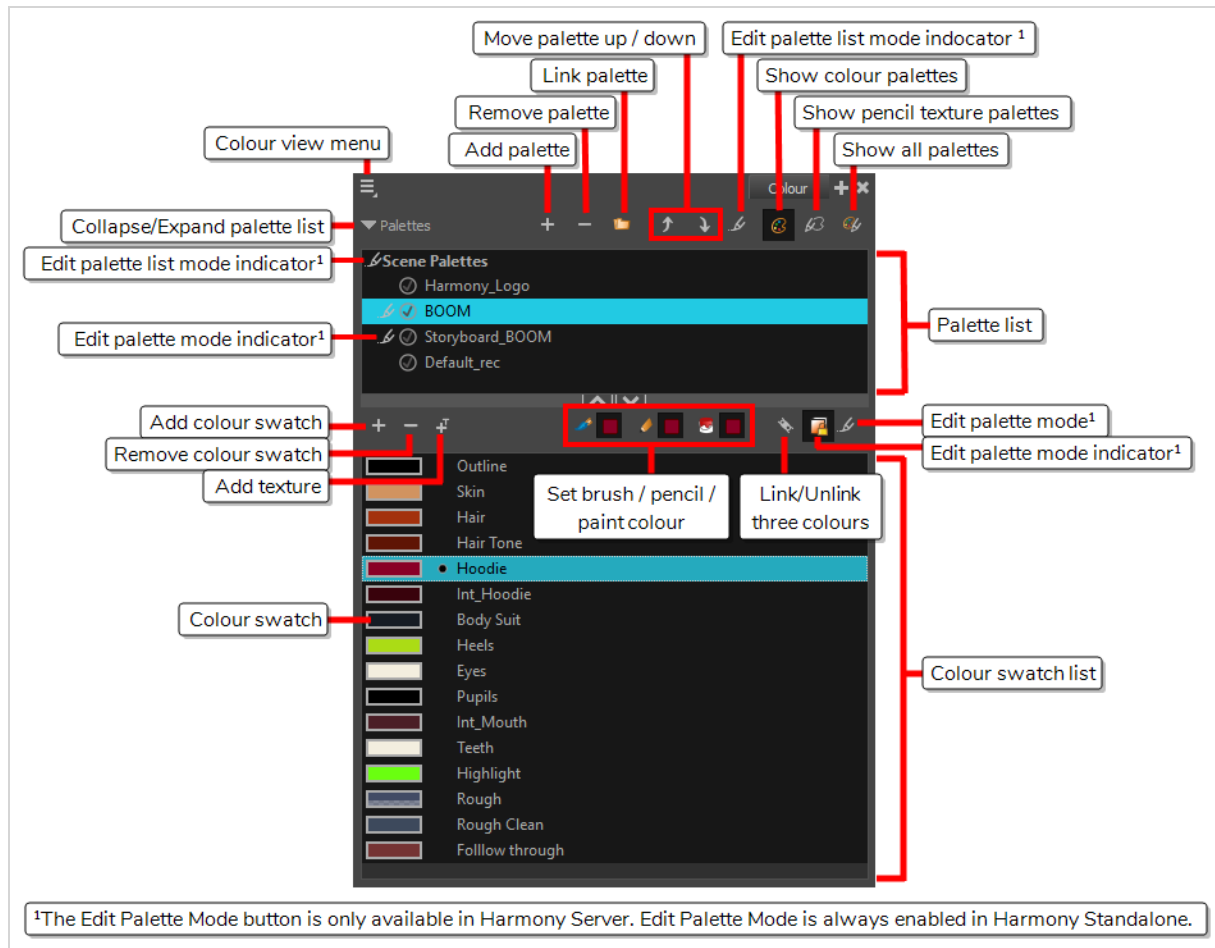







### How to access the Colour view





Do one of the following:

- From the top menu, select **Windows > Colour**.
- From any of the other views, click the Add View **+** button and select **Colour**.





### Palette List Panel

Icon	Option	Description
	View Menu	The View menu contains all the commands and options that you can use in the Colour view to manage colours and palettes.



	Collapse/Expand Palette List	Allows you to show or hide your palette list and its options. By default, the palette list is displayed, but you may want to hide it if you are working with a single palette and want to allow more vertical space for the colour swatch list.
	Add Palette	Allows you to create a new palette.
	Remove Palette	<p>Deletes the currently selected palette. If the colour swatch is used in your project, zones painted with colour swatches which have been deleted will turn red, easily identifying them so you can repaint them with another colour swatch.</p> 
	Link Palette	<p>Allows you to add a palette from a different location, be it in a scene, job, environment or even an element to your palette list. The palette will be linked to its original location rather than copied to your scene's folder. Hence, if you make changes to the original palette, it will affect the colour of elements in your scene.</p> <p>If you want to import a palette as a copy into your scene's palette library, right-click on your palette list and select <b>Import</b>. You can also link to a palette in any location on your machine or network by selecting <b>Link to External</b>.</p>
	Order Palette List	<p>Moves palettes further up or down the palette list.</p> <p>If a palette has been cloned, the highest palette among the original palette and its clone(s) will be used by Harmony. This can be overridden by using a Colour-Override effect—see <a href="#">Colour-Override Node on page 540</a>.</p>
	Edit Palette List Mode Indicator	In Harmony Server, this icon appears when you have the modifying rights on your scene's palette list. While several users can work on a scene at the same time, only one user may have the right to modify a palette list at any given time.









		<div style="border: 1px solid green; padding: 10px;">  <p><b>NOTE</b> In Harmony Stand Alone, you can always modify your scene's palette list. On Harmony Server, you must unlock your palette list before making modifications to it.</p> </div>
	Show Colour Palettes	Shows only colour palettes in the palette list. This is the default option.
	Show Pencil Texture Palettes	Shows only pencil texture palettes in the palette list.
	Show All Palettes	Shows both colour and pencil texture palettes in the palette list.

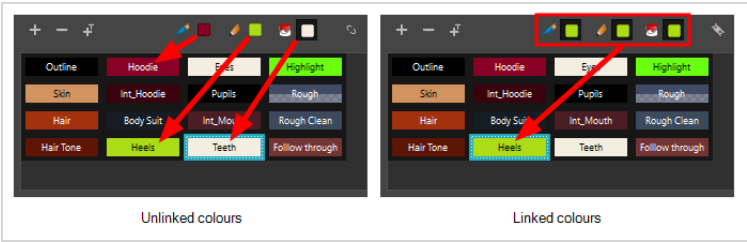

## Palette List

Icon	Description
	In Harmony Server, this indicates that you have the rights to modify the palette.
	Indicates that the palette is stored at the same level as its palette list. For example, a palette that is stored in the scene's palette library and which is listed in the scene's palette list, or a palette that is stored in an element's palette library and which is listed in that same element's palette list.
	Indicates that the palette file is stored in an external location, such as a different scene, an element in a different scene, a job other than the scene's job, an environment other than the scene's environment, or a custom location on your file system or network. This means the palette is liable to be missing if it is moved from its original location, or if the scene is exported from the database into an offline scene or to a different database.
	This indicates that the palette is stored at a higher level than its palette list, making it a shared palette. For example, a palette in your scene's palette list that is stored in the palette library of the scene's job or environment, or a palette in an element's palette list that is stored in the palette library of the scene.
	Indicates a potentially dangerous situation. For example, a palette file that is stored in one of the scene's element folders, but which is added to your scene's palette list. The whole scene can use the palette, but since it's stored inside an element, deleting that element will make your whole scene lose access to that palette.

## Colour Swatch List Panel

Icon	Option	Description
+	Add Colour	Adds a new colour swatch to the bottom of your colour list.
-	Remove Colour	<p>The Remove Colour button lets you delete the currently selected colour swatches. If the colour swatch is used in your project, and confirmation dialog will appear prompting you to confirm that you want to delete the colour. Zones painted with colour swatches which have been deleted will turn red, easily identifying them so you can repaint them with another colour swatch.</p> 
+	Add Texture	<p>Allows you to import a bitmap image as a texture, which can be painted with just like a colour. When used with the Brush or Paint tools, bitmap textures are tiled inside the shape they fill. The scaling and position of the texture inside their shape can be tweaked with the Edit Gradient/Texture tool. When used with the Pencil tool or one of the Shape tools, a bitmap texture will follow the pencil line's direction.</p> 

	Set Current Brush Colour	When enabled, the colour you select in the colour view will be selected for the Brush tool.
	Set Current Pencil Colour	When enabled, the colour you select in the colour view will be selected for the Pencil tool, as well as other tools that create pencil lines, such as the Line, Rectangle, Ellipse and Polyline tools.
	Set Current Paint Colour	When enabled, the colour you select in the colour view will be selected for the Paint tool.
	Link/Unlink Three Colours	<p>When enabled, the colour you select will be selected for all drawing tools. When disabled, you can select individual colours for the Brush, Pencil and Paint tools.</p> 
	Edit Palette Mode	<p>In Harmony Server, this allows you to get the modifying rights to the selected palettes.</p> <p>Since several people can work on any given scene at the same time, and a palette can be shared between scenes, palettes may be loaded in read-only mode when opening a scene on a Harmony database. Then, an user would only be able to edit a palette by first activating Edit Palette Mode. This prevents several users from making changes on the palette at the same time, since a user cannot activate Edit Palette Mode on a palette that is already being edited by someone else. This also prevents users from accidentally making modifications on important palettes.</p>
	Edit Palette Mode Indicator	<p>In Harmony Server, this icon appears when you have the modifying rights on the currently selected palette.</p> <div data-bbox="690 1600 1432 1770" style="border: 1px solid green; padding: 10px;"> <p> <b>NOTE</b></p> <p>In Harmony Stand Alone, you can always modify your palettes.</p> </div>
	Colour Swatch Name	Each colour swatch available in the Colour view can have its own name, making it easy to identify which colour is used to paint what

		<p>part of your character or background.</p>  <div style="border: 1px solid green; padding: 5px; margin-top: 10px;"> <p><b>NOTE</b></p> <p>Two colours can have the same name. Harmony identifies colours by an identification number.</p> </div>
	<p>Colour Swatch</p>	<p>Also referred to as <i>colour pots</i>, the colour swatch is the actual colour information for a colour in your palette. It is represented by a rectangle displaying the colour in the list.</p> 

## Colour Editor Panel

The Colour Editor panel is an optional panel in the Colour view which can be enabled to edit your colour swatches on the go.

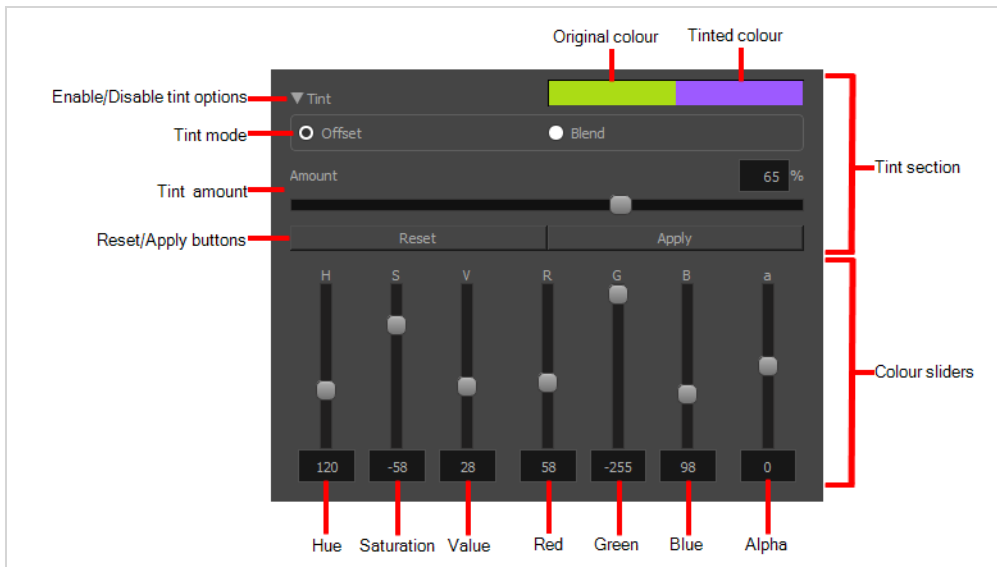

## How to enable the Colour Editor panel

1. Do one of the following:

- Right-click on the palettes list, then select **Colour Editor**.
- Click on the View Menu  button and select **Palettes > Colour Editor**.

Option	Description
Enable/Disable Tint Options	<p>This collapses or expands the Tint section of the Colour Editor panel.</p> <p>When tint options are enabled, the Colour Editor panel can be used to add a tint to the colour. This means that all sliders start with a value of 0 and that the new colour will be calculated relative to the old colour, using the algorithm chosen in the Tint Mode option. As you change the values of the colour sliders, the colour in your palette is not updated immediately. Rather, it is only updated when you click on the Apply button.</p> <p>When Tint options are disabled, the Colour Editor panel only has colour sliders, and those sliders start out with the values of the selected colour. Changing the value of any of the colour sliders immediately updates the colour in your palette with the new value.</p>
Tint Mode	<p>Allows you to select how the colour will be modified by the tint:</p> <ul style="list-style-type: none"> <li>• <b>Offset:</b> The chosen tint's colour values will be added to the selected colour's values to make the new colour. You can choose negative values if you wish to subtract from the selected colour's values.</li> <li>• <b>Blend:</b> The selected colour will be blended with the selected tint, resulting in the average between the selected colour and the tint.</li> </ul>
Reset	<p>In tint mode, this sets all the colour sliders to their neutral value, leaving the selected colour unchanged.</p>
Apply	<p>In tint mode, this applies the tint to the selected colour. Note that when tint mode is not enabled, changes to the selected colour are automatically applied.</p>
H (Hue)	<p>Sets the hue of the colour or tint.</p>
S (Saturation)	<p>Sets the saturation level of the colour or tint.</p>
V (Value)	<p>Sets the value of the colour or tint.</p>

R (Red)	Sets the red value of the colour or tint.
G (Green)	Sets the green value of the colour or tint.
B (Blue)	Sets the blue value of the colour or tint.
a (Alpha)	Sets the alpha (transparency) value of the colour or tint.



## Coordinates and Control Points View

The Coordinates and Control Points view displays the parameters of keyframes or control points selected in the Camera, Timeline or Xsheet view. You can also see the same information in the Coordinate and Control Point toolbars.

In this view, you can edit keyframes and control point parameters, such as the position, continuity, bias, tension and lock-in-time.

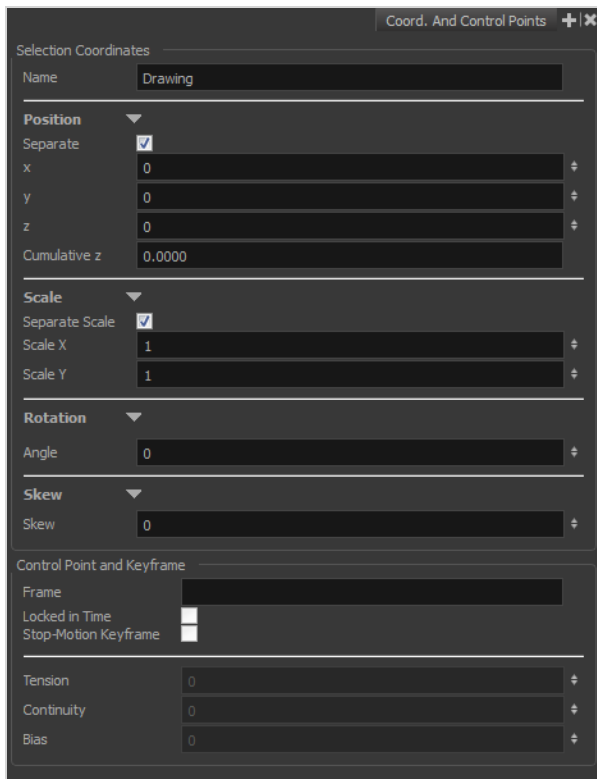

### How to access the Coordinates and Control Points view

Do one of the following:

- From the top menu, select **Windows > Coordinates and Control Points**.
- From any of the other views, click the Add View **+** button and select **Coordinates and Control Points**.

Parameter	Description
Name	The name of the function curve to which the select point is linked.
Position	

Separate	Modifies modify the X, Y and Z coordinates independently. When this option is deselected, all three parameters are linked. If one is deleted, all others will also be deleted.
Cumulative Z	When a layer is parented to other layers that are moved forward or backward on the Z-axis, the currently selected layer's Z position value may not be accurate since its parent will also have an offset on the Z-axis. The Cumulative Z value is a compilation of all the Z-axis offsets to give the real Z-axis offset value related to the (0,0) centre.
Scale	
Separate Scale	Modifies the width and height values independently. When this option is selected, the width and height are locked to the same value, forcing the scale to be on a 1:1 ratio. If the option is deselected, you have the ability to squash and stretch your layer at will.
Rotation	
Angle	The rotation angle value from the permanent pivot of the element.
Skew	
Skew	This is the skewing value.
Control Point and Keyframe	
Frame	The frame at which the select point is set.
Locked in Time	Indicates whether the point is locked to a specific frame (keyframe) or only locked to a specific position and the curve can flow through it freely as other points are being added, moved, or adjusted (control point).
Stop-Motion Keyframe	When this option is selected, the keyframe is set as a stop-motion point. This means that there is no automatic interpolation created between the selected point and the next one. The layer will maintain its position until the animation reaches the frame of the next point and will then jump to the new position. Deselect this option to generate interpolation and get the layer to progressively move to the next position.
Tension	Controls how sharply the path bends as it passes through a control point or

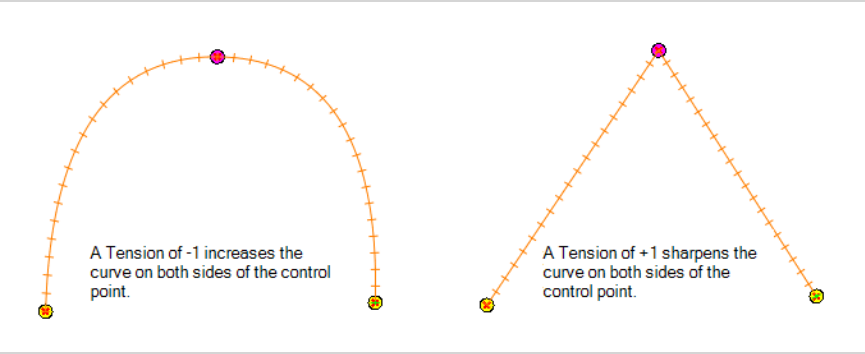
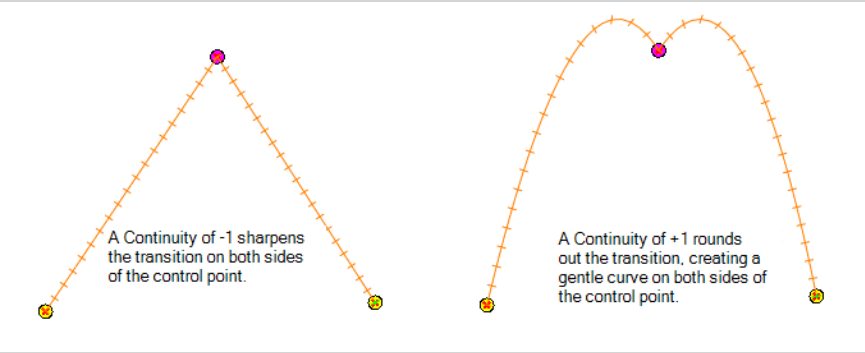
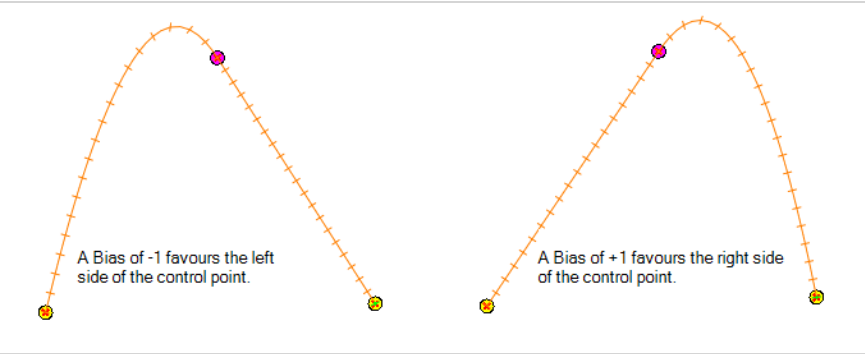
	<p>keyframe.</p> 
Continuity	<p>Controls the smoothness of a transition between the segments joined by a point.</p> 
Bias	<p>Controls the slope of the path so it flows towards one side of the motion point or the other.</p> 

## Drawing View

In Harmony, you can draw in both the Drawing or Camera views. Although the two views are similar, there are some differences when it comes to drawing.

Only the selected drawing is displayed by default in the Drawing view. You can use features, such as the light table to display the current drawing of all the enabled layers of your scene in washed-out colours, or the Onion Skin to display the previous and next drawings of the currently selected drawing layer.

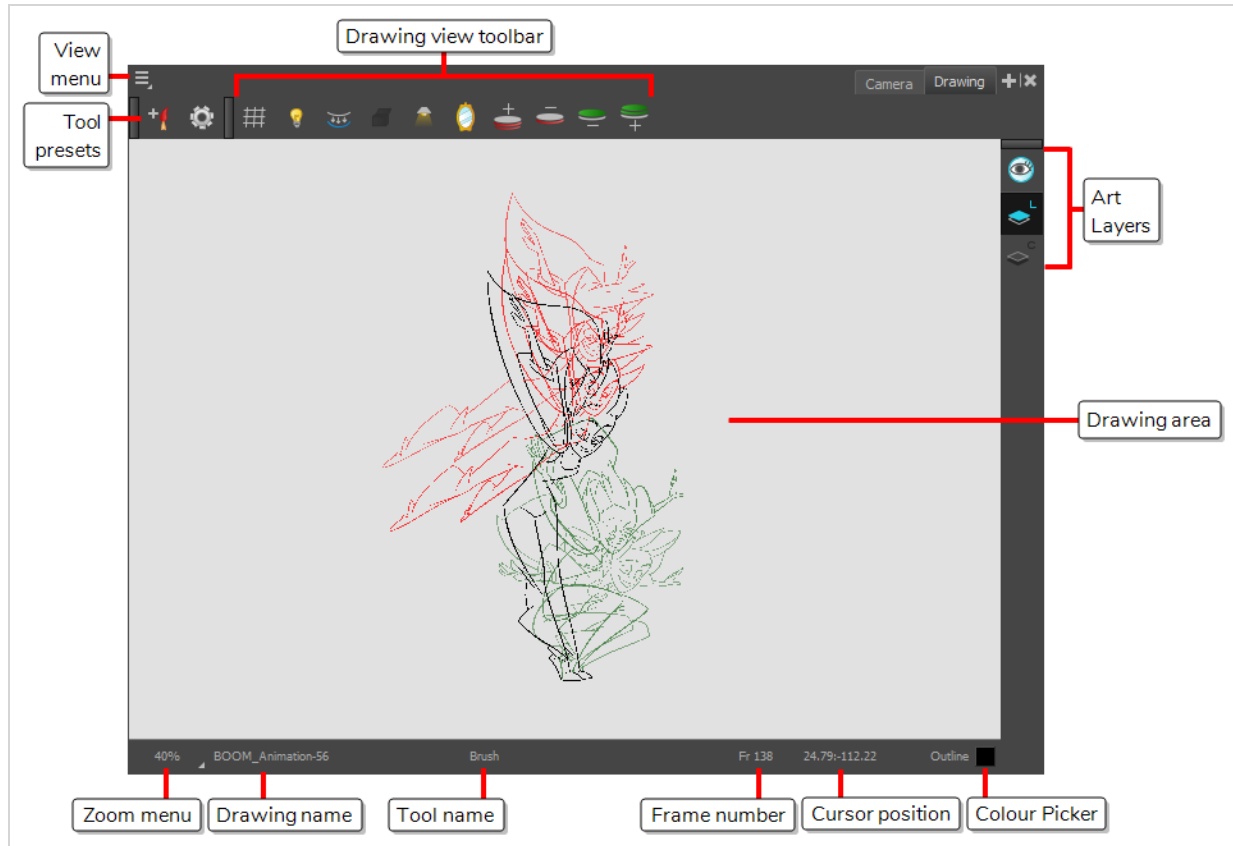

### How to access the Drawing view

Do one of the following:

- From the top menu, select **Windows > Drawing** .
- From any of the other views, click the Add View **+** button and select **Drawing**.

Icon	Section	Description
	View Menu	The View menu contains all the tools and options that

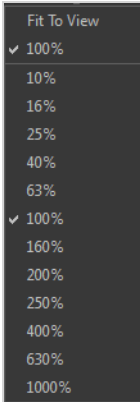
		you can use in the Drawing view to draw, animate and paint.
	Drawing Area	This is the main space in the Drawing view. It is where you draw and where the drawings are displayed.
	Zoom Menu	<p>The Zoom menu lets you enlarge or reduce the Camera or Drawing view display.</p> <p>To make the camera frame size always match the size of your view, select the <b>Fit to View</b> option. Click the drop-down arrow and select a zoom level or press 1 and 2.</p> 
	Drawing Name	The Drawing Name field displays the name of the selected drawing, as well as the layer containing it. If the cell does not contain any drawing, an <b>Empty Cell</b> text is shown in the field.
	Tool Name	The Tool Name field displays the name of the selected tool. If you temporarily override a drawing tool using a keyboard shortcut, the tool's name will be highlighted in red. You can temporarily override a tool by holding its keyboard shortcut without the Alt key. For example, the Select tool shortcut is Alt + S. If you hold down the S key, you will switch to the Select tool. When you release the key, you will return to the tool you were using.
	Frame Number	This field displays the current frame of the animation you are working on.
	Cursor Coordinates	This indicates the position of the your pointer in the

		drawing area.
	Colour Picker	The Colour Picker allows you to select a colour for drawing.

## Drawing Substitutions View

T-H16NEW-002-001

The Drawing Substitutions view allows you to quickly swap which drawing is exposed on the selected layer at the current frame.

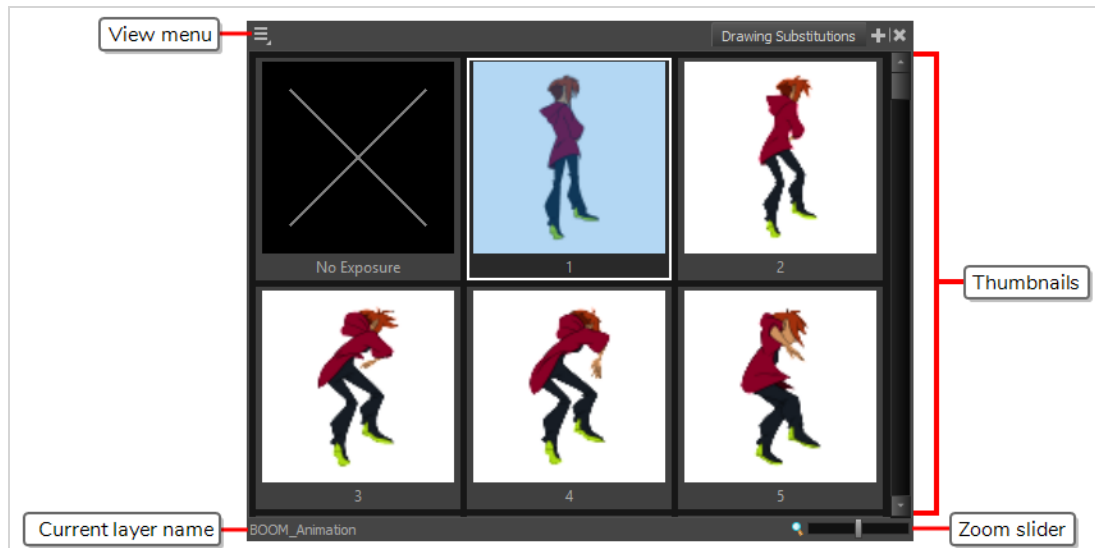

### How to access the Drawing Substitutions view

1. Do one of the following
  - From the top menu, select **Windows > Drawing Substitutions**.
  - In the top-right corner of any view, click on the **+** Add View button and select **Drawing Substitutions**.

Section	Description
View Menu	<p>Opens a menu with the <b>Create Key Exposure</b> option. This option can be enabled or disabled. It determines what happens when you set the drawing in the current frame to the same drawing as the drawing in the previous frame.</p> <ul style="list-style-type: none"> <li>• When enabled, the exposure of the drawing at the current frame will be separated from the drawing in the previous frame with a key exposure.</li> <li>• When disabled, the exposure of the current frame will be merged with the exposure of the previous frame.</li> </ul>

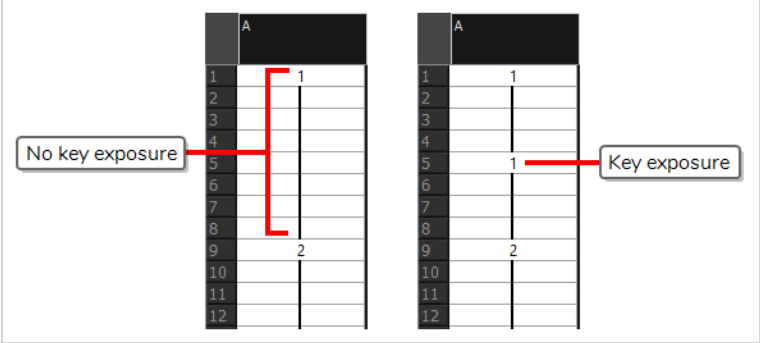
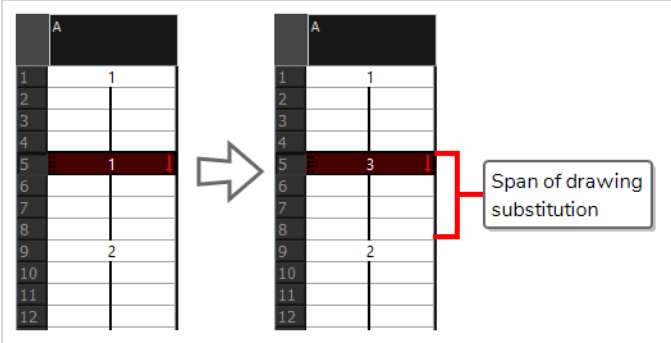
Section	Description
	 <p>The diagram illustrates two vertical grids representing drawing exposure. Each grid has 12 rows and a column labeled 'A'. In the left grid, a red bracket spans rows 1 through 4, with a callout box labeled 'No key exposure'. In the right grid, a red line points to row 5, with a callout box labeled 'Key exposure'.</p>
<p>Thumbnails</p>	<p>Allows you to select the drawing to be exposed at the current frame. This will also replace the drawing for all subsequent frames during which the current drawing is exposed.</p>  <p>The diagram shows two thumbnail grids. The first grid has row 5 highlighted in dark red with the number '1'. An arrow points to the second grid where row 5 is highlighted in dark red with the number '3'. A red bracket in the second grid spans rows 5 to 6, with a callout box labeled 'Span of drawing substitution'.</p>
<p>Current layer name</p>	<p>The name of the currently selected layer. The drawings in the thumbnails list are the drawings currently stored in this layer.</p>
<p>Zoom slider</p>	<p>Allows you to change the size of the thumbnails.</p>



## Function View

The Function view lets you edit function curves and parameters. It contains a visual graph for adding, removing, and editing keyframes, as well as adjusting the velocity. The Function view allows you to display multiple functions in the background as a reference.

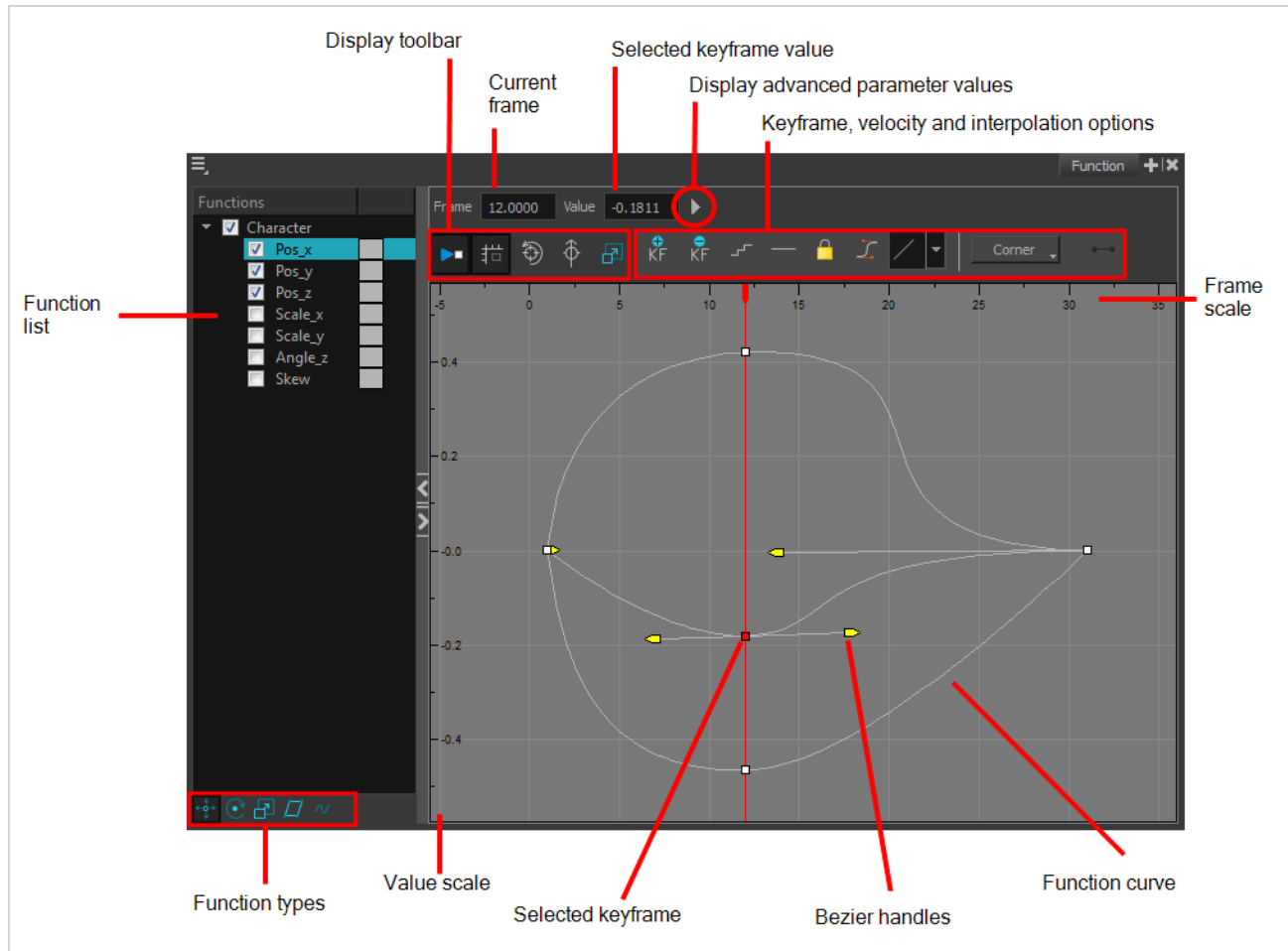

### How to access the Function view

Do one of the following:

- From the top menu, select **Windows > Function**.
- From any of the other views, click the Add View **+** button and select **Function**.

### How to display functions in the Function view

1. Open the Function view.

The Function view is blank until you select the layer containing the functions you want to display.

2. To display a function in the Function view, click on the layer containing the functions to adjust in the Timeline view.
3. To select the functions you want to edit, select them in the Function list.

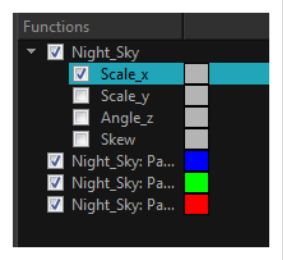
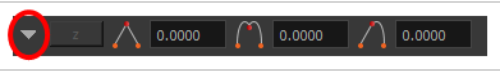
Parameter	Description
Function List	 <p>When selecting a layer in the Timeline view, all the corresponding functions are displayed (if any). Select the functions you want to see and edit, and hide the ones you don't.</p>
Display Toolbar	<p>Allows you to modify how the editing area is displayed. You can hide the grid, disable the synchronization with the current frame, reset the zoom level and normalize the function display by stacking them one over the other to compare them regardless of their value range.</p>
Current Frame	<p>Displays the current scene frame.</p>
Selected Keyframe Value	<p>Displays the value of the selected keyframe.</p>
Display Advanced Parameter Values	 <p>Displays the Projection, Bias, Tension and Continuity parameters to adjust the curve around the selected keyframe.</p>
Keyframe, Velocity and Interpolation Options	<p>This toolbar lets you add and delete keyframes, adjust the velocity curve, adjust the segments to motion or stop-motion keyframes and set the velocity to create steps instead of a constant progression.</p>
Function Types	<p>This toolbar lets you click on the different function types to enable or disable all the listed functions of that type.</p>
Value Scale	<p>Displays the value range for the displayed editing area. It can be referenced to know the value of a keyframe.</p>

---





Selected Keyframe	The selected keyframe is displayed in red. When selected, the keyframe values are displayed in the corresponding fields.
Bezier Handles	The Bezier handles let you adjust the ease in and ease out of each keyframe. The more the handle is pulled out horizontally, the slower the animation will be. The more the handle is pulled out vertically, the faster the animation will be.
Function Curve	The thin line going from keyframe to keyframe is the actual curve. The section of a curve located between two keyframes is called a segment.
Frame Scale	The Frame Scale displays the frame range for the displayed editing area. It can be referenced to know the current frame of a keyframe.



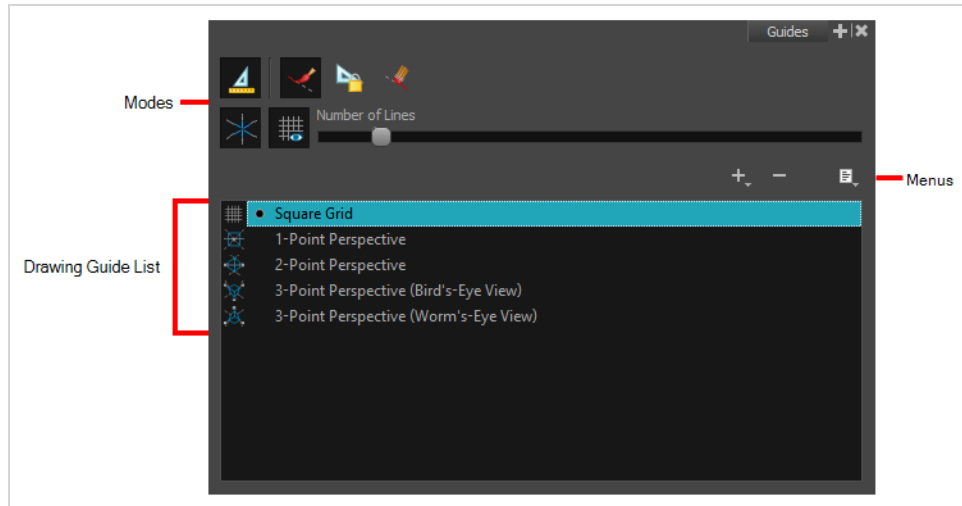



## Guides View

The Guides view enables you to manage drawing guides for a given storyboard panel. Use Drawing Guides to assist you in creating a drawing with perspective.

Guides can be added, selected, renamed, deleted, cut, copied, pasted and reordered. Guides can also be exported to a file and re-imported later.

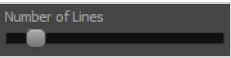

Icon	Name	Description
Options		
	Enable Guide	Enables or disables drawing guides.
	Align with Guide	<p>When enabled:</p> <ul style="list-style-type: none"> <li>The Brush, Pencil, Line and (optionally) Eraser tools are constrained by the Drawing Guide to draw/erase straight lines only.</li> </ul> <p>When disabled:</p> <ul style="list-style-type: none"> <li>The drawing tools are not constrained by the Drawing Guide, allowing you to do freehand strokes. The guide acts as a visual aid only.</li> </ul>
	Lock Guide	Locks the editing of a Drawing Guide to prevent its accidental modification while drawing.
	Enable Guide with Eraser	Toggles the use of Drawing Guides with the Eraser tool.

Icon	Name	Description
	Full Cursor Display	<p>When enabled:</p> <ul style="list-style-type: none"> <li>• Drawing Guide axes extend to the edge of the drawing area.</li> </ul> <p>When disabled:</p> <ul style="list-style-type: none"> <li>• Drawing Guide axes are short.</li> <li>• Drawing Guide axes disappear while drawing a stroke.</li> </ul>
	Show Reference Lines	Toggles the display of a visual reference consisting of lines that converge towards the vanishing point(s).
	Number of Lines	<p>Adjusts the amount of reference lines to display.</p> 
<b>Guides List</b>		
	New Guide	<p>Allows you to add a guide to the scene's guides list. You can add a guide of one of the following types:</p> <ul style="list-style-type: none"> <li>• Square grid</li> <li>• 1-point perspective</li> <li>• 2-point perspective</li> <li>• 3-point perspective (bird's eye view)</li> <li>• 3-point perspective (worm's eye view)</li> </ul>
	Delete Guide	Deletes the selected Drawing Guide(s) from the scene's guides list.
	Guides View Menu	Opens a menu with the following commands:
	Rename Guide	Renames the selected Drawing Guide.
	Cut	Cuts the selected Drawing Guide(s) from the list and adds it to the clipboard.
	Copy	Copies the selected Drawing Guide(s) to the clipboard.

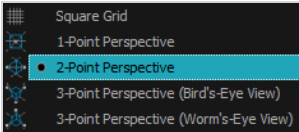
Icon	Name	Description
	Paste	Pastes Drawing Guide(s) from the clipboard to the scene's guides list. Pasted guides are inserted under the selected guide.
	Import Guides	Imports Drawing Guides from a source file and inserts them at the bottom of the scene's guides list. Duplicate guides are filtered out to avoid cluttering the list.
	Export Selected Guides	Exports the selected Drawing Guide(s) to a destination file.
	Drawing Guides List	<p>Displays the scene's list of guides and allows you to select which guide to display and use.</p> 

## Integrated Help View

Use the Integrated Help when you are unsure about what a certain menu item is or the function of a specific preference in the Preferences panel.

If you keep the Integrated Help window open for the entire duration of your work session, then you can use the forward and backward arrows to scroll through a history of the help information that you called up during your session.

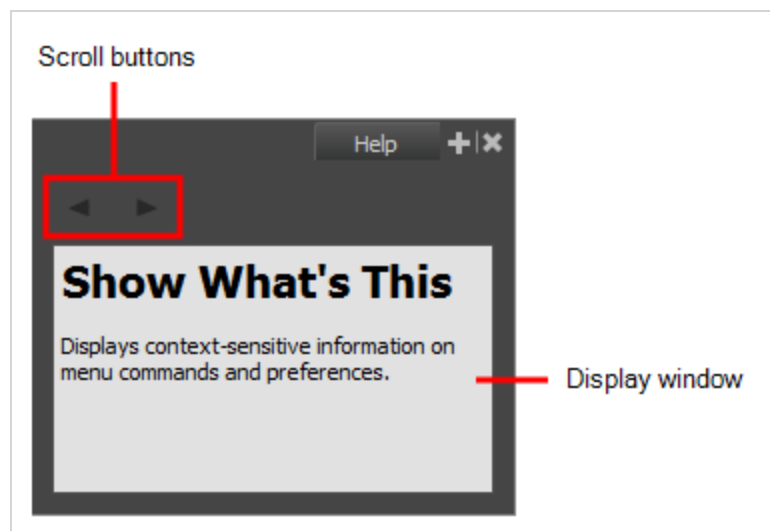

### How to access the Integrated Help view

1. Do one of the following:
  - From the top menu, select **Windows > Integrated Help**.
  - From any of the other views, click the Add View **+** button and select **Integrated Help**.

## Layer Properties View

The Layer Properties editor or view lets you adjust the properties of a layer in the Timeline view or a node in the Node view. The Layer Properties can be viewed as a floating window or as a view (docked).

Each layer has its own set of properties that can be modified, including effect and peg layers. Display the Layer Properties editor or view if you want to modify some of the layer's properties, such as the name or the antialiasing quality.



### NOTE

To know more about the parameters displayed in the Layer Properties view, see [Nodes / Layers](#).

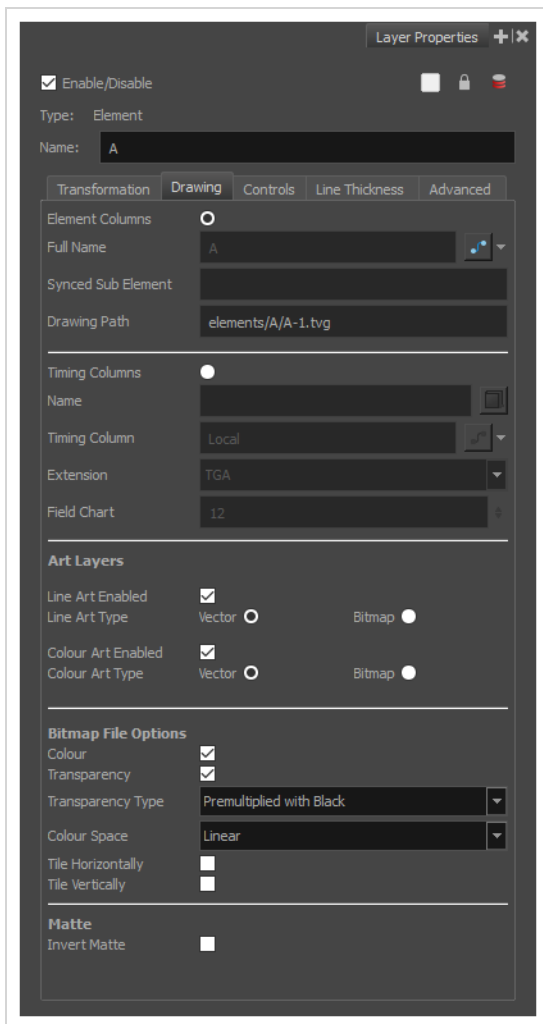

### How to access the Layer Properties view

Do one of the following:



- From the top menu, select **Windows > Layer Properties**.
- From any of the other views, click the Add View **+** button and select **Layer Properties**.

### How to access the Layer Properties editor

- Double-click on a layer in the Timeline view or a node in the Node view.
- Right-click on a layer in the Timeline view or a node in the Node view and select **Layer Properties**.
- Select a layer in the Timeline view or a node in the Node view and press Shift + E.

## Library View

The Library view is used to store elements such as animation, drawings, backgrounds and character models so as to reuse in different scenes and projects. You can also use the Library view to create and store symbols, as well as to store and import images, sound files and 3D models.

To reuse elements from a scene in other scenes, you must create a template so that you can import it into different scenes. Templates can contain anything from a single drawing to a whole scene structure. You can create a template by creating it in a scene, then copying the elements you want in your template into a library. The resulting template is structured like a mini-scene that contains only the elements you copied into it. A template does not have any dependencies on the scene it was originally created in. Hence, it can safely be imported in any other scene.

Additionally, the Library view's Drawing Substitution panel allows you to quickly change the current frame's exposure to one of the existing drawings in a layer. This is especially useful for animating a cut-out character's mouths, hands, eyelids and other such body parts which typically contain several drawings to choose from.

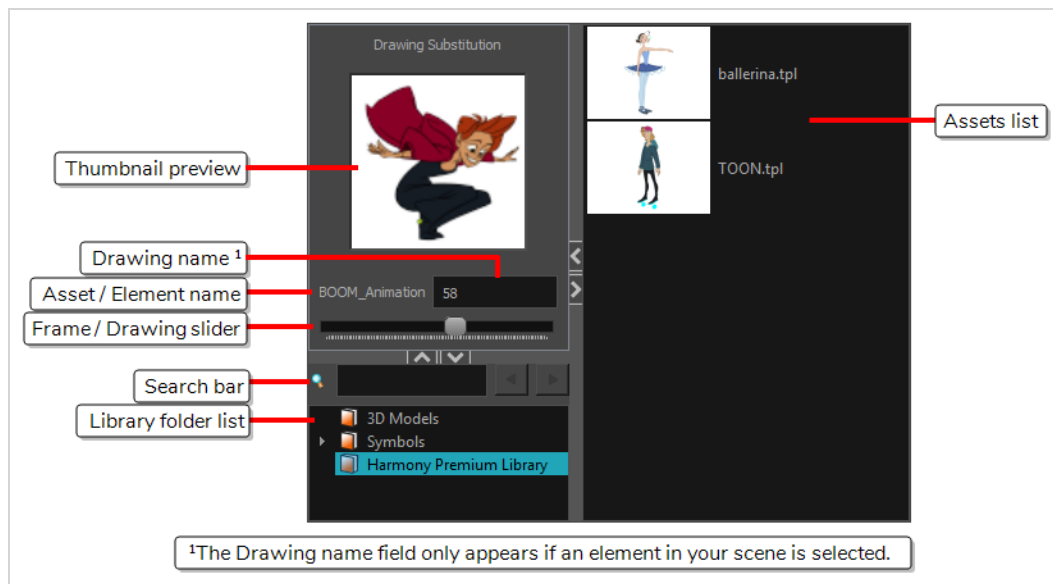

### How to access the Library view

Do one of the following:

- From the top menu, select **Windows > Library**.
- From any of the other views, click the Add View **+** button and select **Library**.

Icon	Section	Description
	View Menu	The Library menu lets you access commands related to the Library view, importing .swf movies and Illustrator files, add a new folder, and refresh

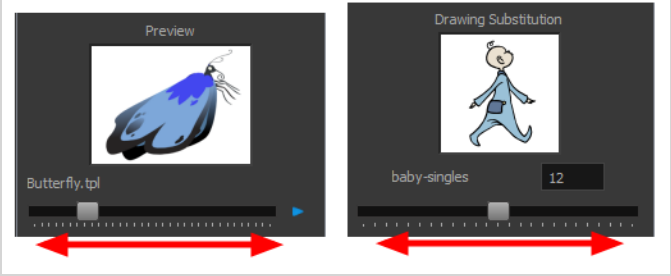
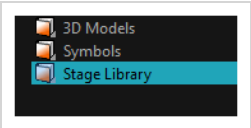
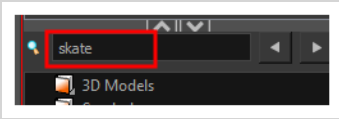
Icon	Section	Description
		the library's content.
	Preview Window	<p>The Preview window lets you see the content of the currently selected template or symbol in the Template/Symbol list.</p> 
	Preview Playback	<p>The Preview Playback button lets you play back the content of the selected template or symbol if it contains more than one frame. Press the Play button to play back the preview.</p>
	Library Folder List	<p>The Library Folder List displays all the folders linked to the Library view.</p>  <p>There are two default folders:</p> <ul style="list-style-type: none"> <li>• <b>Symbols:</b> This folder is the only folder containing symbols. You can organize it by adding subfolders inside.</li> <li>• <b>Harmony Premium Library:</b> This is a default folder found on the hard drive in your user documents. This folder can contain templates, but no symbols.</li> </ul> <p>You can link new library folders to the Library view and organize them with subfolders.</p>
	Library Search tool	<p>When working on a movie or series, you will probably end up with many templates and symbols in your library. Using the Search tool, you can quickly find the templates and symbols in your folders.</p> 

Icon	Section	Description
	Template/Symbol List	The Template/Symbol list displays the templates or symbols contained in the selected library folder. You can display the templates by right-clicking the symbols' thumbnails and selecting <b>View &gt; Thumbnails</b> .

## Master Controller View

T-RIG3-008-008

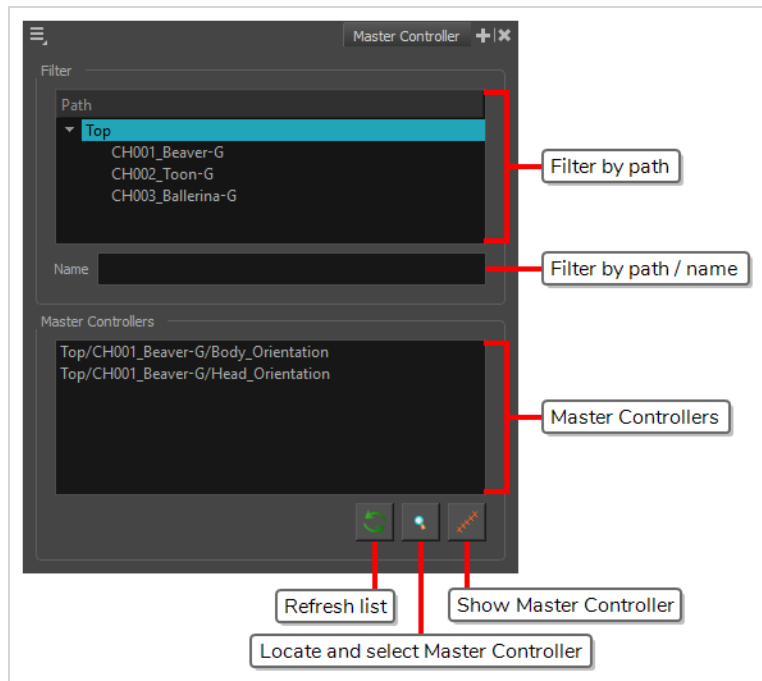

The Master Controller view allows you to quickly find, select and display Master Controllers in the current scene.



### How to add the Master Controller view to your workspace

- Do one of the following:
  - In the top-right corner of an existing view, click on **+** Add View and select **Master Controller**.
  - In the top menu, select **Windows > Master Controller**.

Icon	Section	Description
<b>Filter</b>		
	Path	Allows you to select a group in the current scene. When a group is selected, only the Master Controllers within that group will be listed in the Master Controllers list. This can be useful if you have several characters and only want the list of Master Controllers for a specific character.

Icon	Section	Description
	Name	Allows you to filter the Master Controllers in the Master Controllers list by their path or name. When you type something in this field, only the Master Controllers that contain the text you typed in their full path including their name will be listed in the Master Controllers list.
<b>Master Controllers</b>		
	Master Controllers	<p>Allows you to select one of the Master Controllers in your scene. This list displays the Master Controllers in your scene with their full path in the group hierarchy. Groups in the hierarchy are separated by forward slashes (/).</p> <p>If a group is selected in the Path list, only the Master Controllers within this group will appear in the list. If anything is typed in the Name field, only Master Controllers with this text in their full path including their name will appear in the list. Otherwise, all the Master Controllers in your scene are listed.</p>
	Refresh List	Refreshes the Path list if there are any changes in the name or hierarchy of groups in your scene, as well as the Master Controllers list if there are any changes in the Master Controllers in your scene.
	Locate and Select Master Controller	If a Master Controller is selected in the Master Controllers list, clicking on this button will select the actual Master Controller node. It will also make the Node View navigate instantly to and focus on that Master Controller node.
	Show Master Controller	If a Master Controller is selected in the Master Controllers list, clicking on this button will display its widget in the Camera view.

## Message Log View

The Message log view displays information gathered during a render task, such as which frames and at what time they were each rendered. The view also contains a list of the colour recovery operations.

```

Message Log
T: 17:04:39.202 Color recovery disabled - 1 colors not found in palette list [C:/toon Boom
Projects/Harmony/HAR11/TB_magazine/Guru_Nautilus/Ale/_LINEUP_/elements/fundilhos]
T: 17:04:39.206 Color recovery disabled - 1 colors not found in palette list [C:/toon Boom
Projects/Harmony/HAR11/TB_magazine/Guru_Nautilus/Ale/_LINEUP_/elements/piru]
T: 17:04:39.212 Missing palette [C:/toon Boom Projects/Harmony/HAR11/TB_magazine/Guru_Nautilus/Ale/_LINEUP_/jobs/Digital/palette-
library/STILPEN_JOV_01.plt]
T: 17:04:39.214 Color recovery disabled - 2 colors not found in palette list [C:/toon Boom
Projects/Harmony/HAR11/TB_magazine/Guru_Nautilus/Ale/_LINEUP_/elements/fivela.632]
T: 17:04:48.323 Color recovery for palette list [C:/toon Boom Projects/Harmony/HAR11/TB_magazine/Guru_Nautilus/Ale/_LINEUP_]
T: 17:04:48.323 14 colors recovered and 0 palettes loaded
T: 17:04:48.323 Colors: [Pele.01] [New 12] [New 15] [Arma.02] [New 14] [Pele.01b] [New 0] [Bracelete] [Cinto.02] ...

T: 17:16:53.626 Missing palette [C:/toon Boom Projects/Harmony/HAR11/TB_magazine/Guru_Nautilus/Ale/_LINEUP_/jobs/Digital/palette-
library/STILPEN_JOV_01.plt]
T: 17:16:53.789 Missing palette [C:/toon Boom Projects/Harmony/HAR11/TB_magazine/Guru_Nautilus/Ale/_LINEUP_/jobs/Digital/palette-
library/PUOK_01.plt]
T: 17:16:53.153 Missing palette [C:/toon Boom Projects/Harmony/HAR11/TB_magazine/Guru_Nautilus/Ale/_LINEUP_/jobs/Digital/palette-
library/CRIS_01.plt]
T: 17:16:53.299 Missing palette [C:/toon Boom Projects/Harmony/HAR11/TB_magazine/Guru_Nautilus/Ale/_LINEUP_/jobs/Digital/palette-
library/CRIS_01.plt]
T: 17:16:53.378 Missing palette [C:/toon Boom Projects/Harmony/HAR11/TB_magazine/Guru_Nautilus/Ale/_LINEUP_/jobs/Digital/palette-
library/CRIS_01.plt]
T: 17:16:53.383 Missing palette [C:/toon Boom Projects/Harmony/HAR11/TB_magazine/Guru_Nautilus/Ale/_LINEUP_/jobs/Digital/palette-
library/CRIS_01.plt]
T: 17:16:53.602 Missing palette [C:/toon Boom Projects/Harmony/HAR11/TB_magazine/Guru_Nautilus/Ale/_LINEUP_/jobs/Digital/palette-
library/STILPEN_JOV_01.plt]
T: 17:17:25.094 Color recovery disabled - 1 colors not found in palette list [C:/toon Boom
Projects/Harmony/HAR11/TB_magazine/Guru_Nautilus/Ale/_LINEUP_/elements/Lingua.409]
T: 17:17:25.095 Color recovery disabled - 1 colors not found in palette list [C:/toon Boom
Projects/Harmony/HAR11/TB_magazine/Guru_Nautilus/Ale/_LINEUP_/elements/Coxa.475]
T: 17:17:25.095 Color recovery disabled - 1 colors not found in palette list [C:/toon Boom
Projects/Harmony/HAR11/TB_magazine/Guru_Nautilus/Ale/_LINEUP_/elements/Nariz.01]
T: 17:17:25.119 Color recovery for palette list [C:/toon Boom Projects/Harmony/HAR11/TB_magazine/Guru_Nautilus/Ale/_LINEUP_]
T: 17:17:25.119 3 colors recovered and 0 palettes loaded
T: 17:17:25.120 Colors: [Boca.01] [Calca.01a] [Pele.01b]

T: 17:17:25.120 Rendering frame 1
T: 17:17:27.194 Rendering frame 2
T: 17:17:27.207 Rendering frame 3
T: 17:17:27.350 Rendering frame 4
T: 17:17:28.518 Color recovery for palette list [C:/toon Boom
Projects/Harmony/HAR11/TB_magazine/Guru_Nautilus/Ale/_LINEUP_/elements/Orelha.357]
T: 17:17:28.519 1 colors recovered and 0 palettes loaded
T: 17:17:28.519 Colors: [Pele.03]

```

### How to access the Message Log view

Do one of the following:

- From the top menu, select **Windows > Message Log**.
- From any of the other views, click the Add View **+** button and select **Message Log**.

## Metadata Editor View

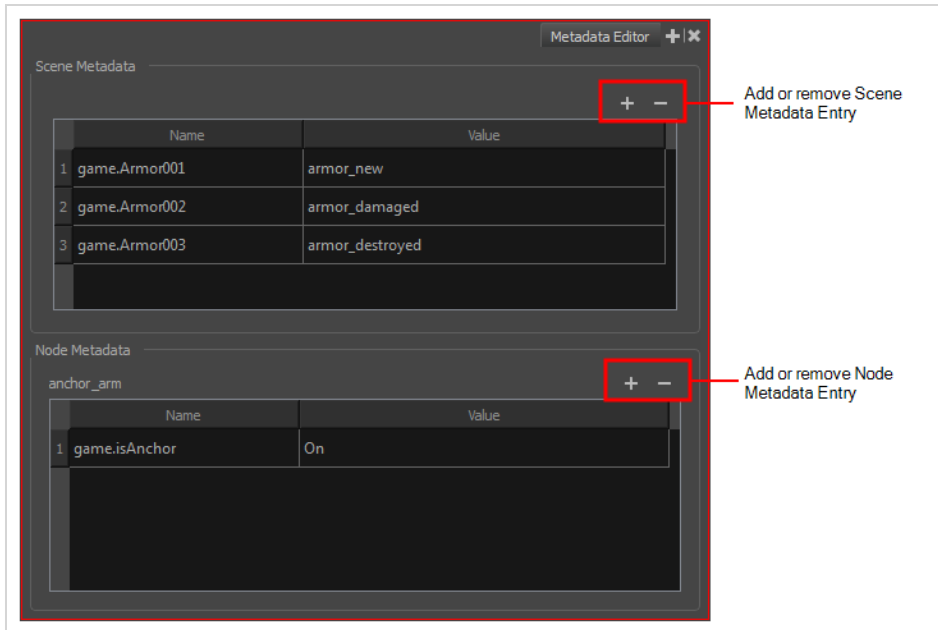

The Metadata Editor view lets you access the information of the props and anchors to be exported to Unity.



### NOTE

Because the Unity game engine does not support Unicode characters, it is recommended to avoid using it in scenes intended for games.

### How to access the Metadata Editor view

- In the top-right corner of a view, click the Add View **+** button and select **Metadata Editor**.
- In the top menu, select **Windows > Metadata Editor**.

Parameter	Description
Scene Metadata	This is a list of optional parameters you can create in a scene project to be exported to Unity. It will not have any incentive towards your scene assets, but can help developers know what to do with the assets contained in your Harmony scene.
	Once in Unity, scene Metadata will appear in Inspector view > Metadata when the Asset is selected in the Hierarchy view.
	<b>Name:</b> Name of the Scene entry. (e.g. game.Armor001)



	<p><b>Value:</b> This can be anything that describes the state of an object. You could, for example, have three different stages of armour: new, damaged and destroyed.</p>
Node Metadata	<p>Displays only the props and anchors held inside your selection. If nothing is selected, no information will display. Name and value appear in this box as well. Name will show you the associated .tvg name and value will be set as either On or Off, depending on whether you want the connection to be set as active or not.</p> <p>Once in Unity, scene Metadata will appear in the Hierarchy view.</p>
	<p><b>Name:</b> Name of the selected anchor or prop. (e.g. game.isAnchor). Notice that it differs from the drawing layer name on the top-left corner of the Node Metadata section.</p>
	<p><b>Value:</b> Can be set to be active (On) or inactive (Off).</p>

**NOTE**

For any anchor or prop information created within the Metadata Editor, the naming convention must always use the prefix "game.". The term "game." is recognized automatically by Unity as a metadata information. For example: `game.Armor001`.

## Model View

T-ANIMPA-004-004

Once you have a fully painted drawing, you can use it as a colour model and load it in the Model view. This drawing can be used and loaded in any of your Harmony scenes.

Once a drawing is loaded in the Model view, you can use the Dropper  tool to select a colour from the model and use it to paint in the Camera or Drawing view without having to pick the colour from the colour palette.



### How to access the Model view

Do one of the following:

- From the top menu, select **Windows > Model**.
- From any of the other views, click the Add View  button and select **Model**.

Icon	Section	Description
	View Menu	The View menu contains all the tools and options that you can use to manage models.
	Model View Toolbar	The Model View toolbar contains all the tools and options you can use in the Model view to navigate through and manage models.

## Node View

T-HFND-010-002

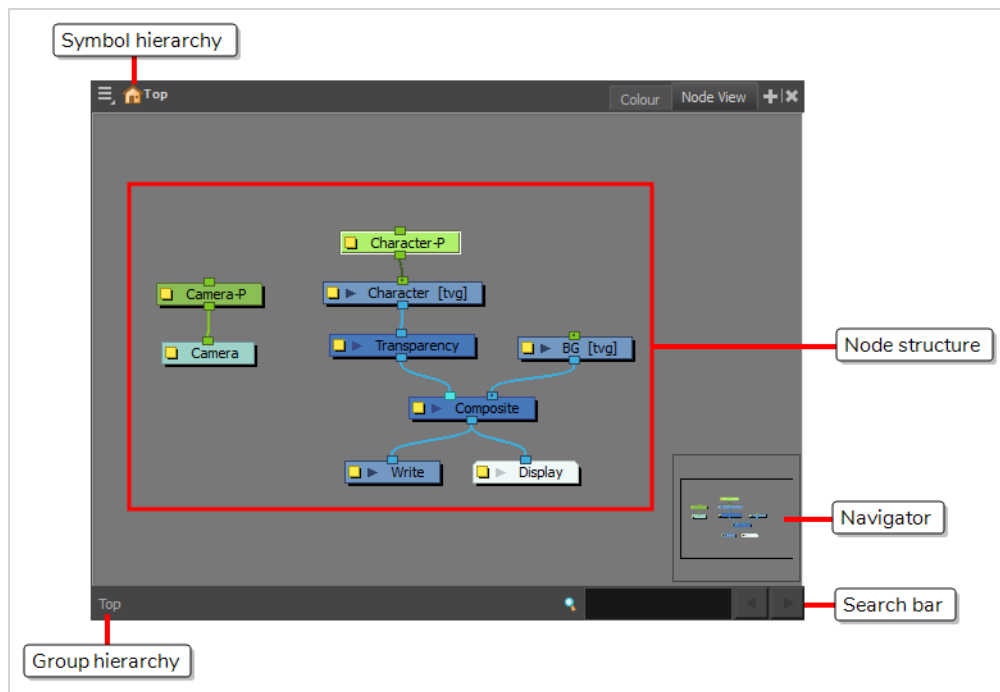

In the Node view, you can connect effects and compositing nodes to form a network, also known as a node system. This view is very useful for rigging puppets, creating advanced effects and having a clear view of complex scenes. The organization and order of the nodes determines the flow of data during the compositing process and how your animation elements will be composited.



### How to access the Node view

Do one of the following:

- From the top menu, select **Windows > Node View**.
- From any of the other views, click the Add View **+** button and select **Node**.

Icon	Section	Description
	View Menu	The View menu contains all the tools and options that you can use to manage the node system.
	Editing Stack	The Editing Stack menu displays the names of the symbols and their hierarchy when you are editing a symbol. You can click on the different names to go back up to the different parent symbols or the

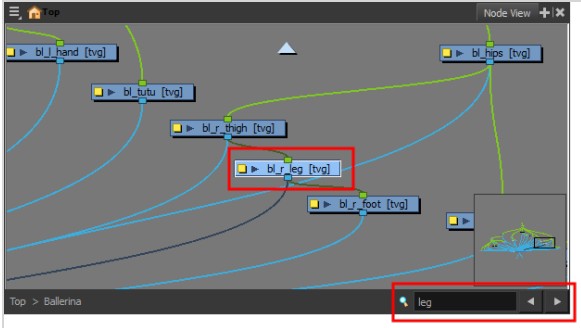
		top/current project.
	Node System	The main area of the Node view is where you can add and organize different nodes to represent a scene.
	Navigator	The Navigator view lets you pan the visible area to move quickly through extensive node sets.
	Search Toolbar	<p>The Search toolbar lets you find and match a node in the project. The search is not case-sensitive. Once you have entered characters in the search field, press Enter/Return to validate and find the pattern in the node names. If successful, the node is selected and centred in the view. If many instances are found, use the Previous and Next buttons to cycle through each node.</p>  <p>The screenshot shows a Node View window titled 'Node View' with a search toolbar at the bottom. The search field contains the text 'leg'. A red box highlights the search field and the 'leg' text. Another red box highlights the 'bl_r_leg [tvg]' node in the node hierarchy, which is selected and centered in the view. The node hierarchy includes 'bl_l_hand [tvg]', 'bl_tutu [tvg]', 'bl_r_high [tvg]', 'bl_r_leg [tvg]', and 'bl_r_foot [tvg]'. The search toolbar also has 'Previous' and 'Next' buttons.</p>
	Group Navigation	When entering a group, the Group Navigation allows you to navigate back to the top and see the hierarchy of the group in which you are.

## Node Library View

T-HFND-010-003

To add effects or other types of nodes to the Node view, you must first find them in the Node Library view.

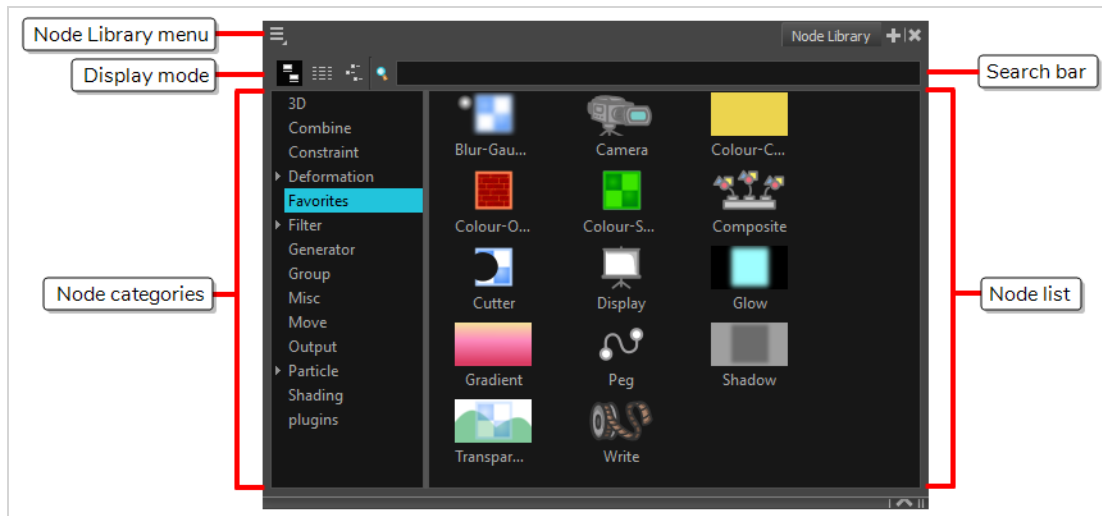

When you create a new project in Harmony, the default node system that appears in the Node view looks similar to the one below.

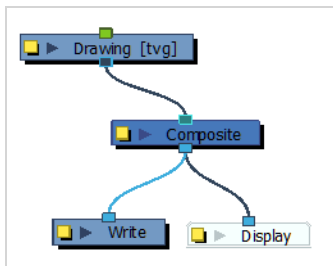

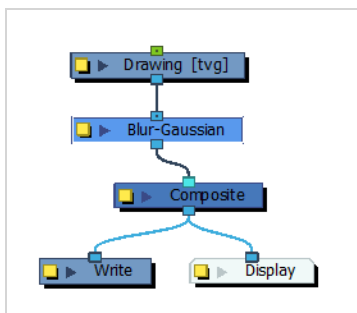

Notice how layers are connected to your scene's composite. For an effect to work, it must be connected as an intermediary between a layer and its composite, as if it was made to filter the layer's drawing information before it reaches the composite.



### How to access the Node Library view

Do one of the following:

- From the top menu, select **Windows > Node Library View**.
- From any of the other views, click the Add View **+** button and select **Node Library View**.

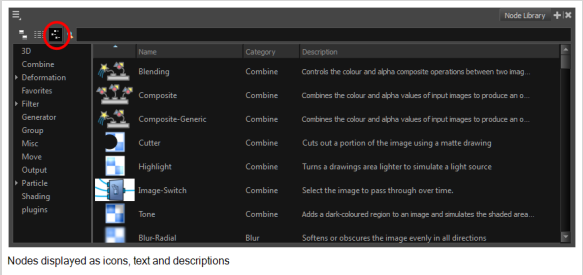
Icon	Section	Description
	View Menu	The View menu contains all the tools and options that you can use to manage the Node Library.
	Node Library View Toolbar	<p>In the Node Library View toolbar, you can change how the nodes are displayed. You can display nodes as icons, as a textual list or as icons with their names and a description.</p>   <p>Nodes displayed as icons, text and descriptions</p>
	Node Categories	The Node Library view is conveniently divided into several categories retaining the related nodes.
	<b>Category</b>	<b>Description</b>
	3D	Nodes related to working with 3D models within Harmony.
	Combine	Nodes for combining images.
	Deformation	Nodes needed for building a deformation chain, as well as advanced effects such as Fold and Auto Muscle. The Deformation category is divided into the Bone and Distort categories.
	Favorites	Nodes most commonly used. To add nodes to the Favorites category, select any node from any other section and drag it onto the Favorites category.

	Filter	Effect nodes, such as blurs. This category is subdivided into the following categories: Adjust, Blur, Colour Correct, Isolate and Stylize.
	Generator	Nodes that create an image, such as a gradient or colour.
	Group	Nodes for grouping, like Group nodes and Multi-Port-In nodes.
	Misc	Various nodes including External, Note, Script and Visibility.
	Move	Nodes for changing elements over time, like Peg nodes, as well as certain transformations.
	Output	Output (Export) nodes such as Crop, Display, Scale-Output and Write nodes.
	Particle	Nodes needed to construct complex particle systems. This category includes a series of examples of particle effects and is subdivided into the following categories: Basic, Examples and Modifier.
	Plugins	Plugin nodes.
	Shading	Nodes for light shading.

## Onion Skin View

The Onion Skin view allows you to quickly configure onion skin. Using this view, you can choose the colour of previous and next drawings, which kind of marked drawings to display and whether to measure the span of onion skin per frame or per drawing. When using Advanced Onion Skin, you can also use this view to pick which drawings are included in the Onion Skin, as well as the opacity of the drawings relative to how far they are from the current frame.

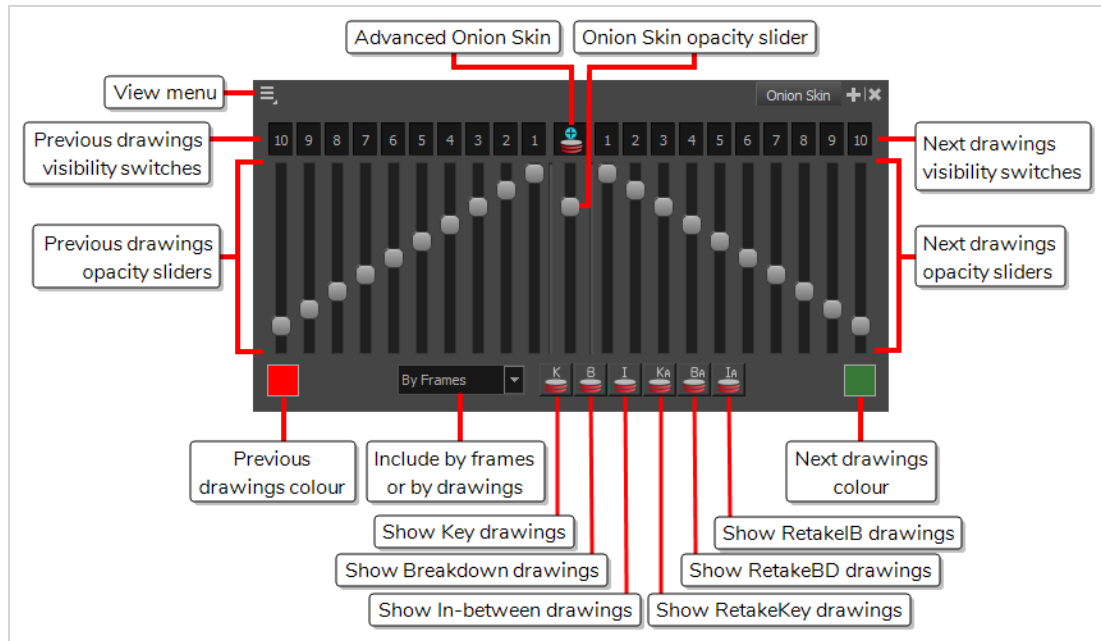

### How to access the Onion Skin view

1. Do one of the following:

- In the top-right corner of a view, click on the **+** Add View button and select **Onion Skin**.
- In the top menu, select **Windows > Onion Skin**.

The Onion Skin view is added to your workspace.

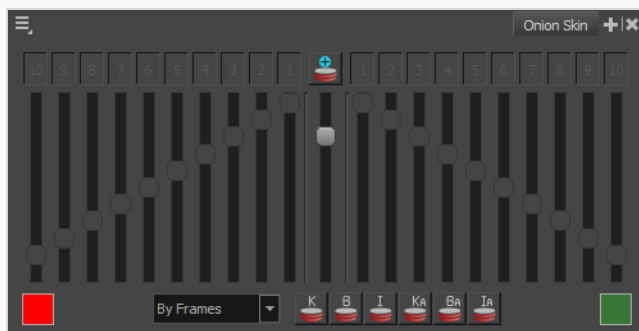





A lot of the controls in the Onion Skin view are only accessible when using Advanced Onion Skin.







## How to enable Advanced Onion Skin



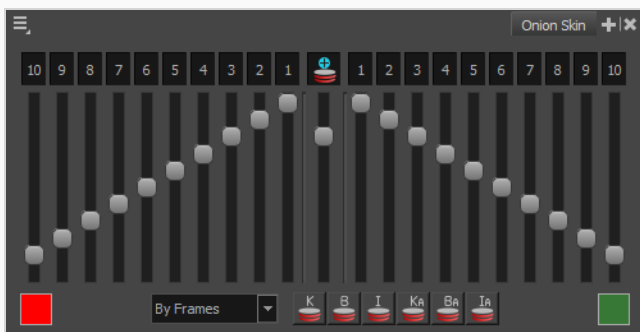

1. Do one of the following:



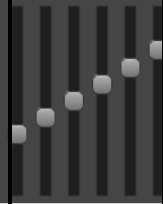
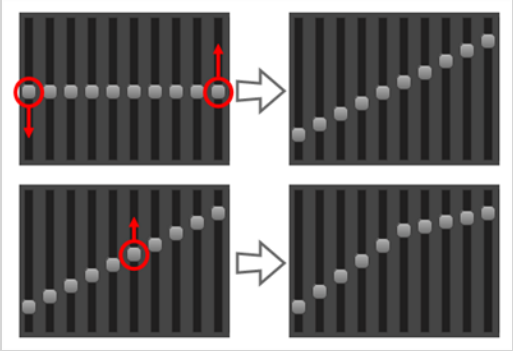

- In the Tools toolbar, double-click on  Onion Skin and select  **Advanced Onion Skin**.
- In the Onion Skin view, click on the  Advanced Onion Skin button.
- In the top-left corner of the Onion Skin view, open the  View Menu and select **Advanced Onion Skin**.

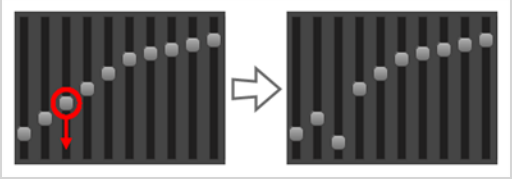



The controls for the Advanced Onion Skin are now accessible in the Onion Skin view.





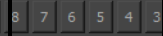

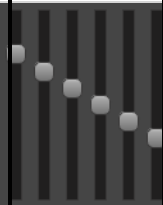
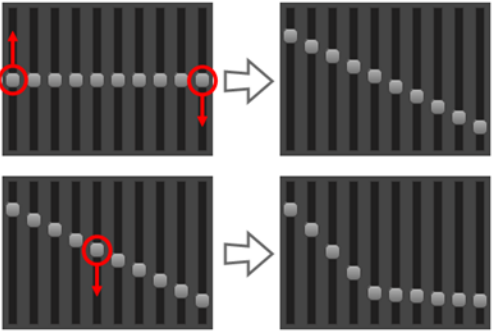

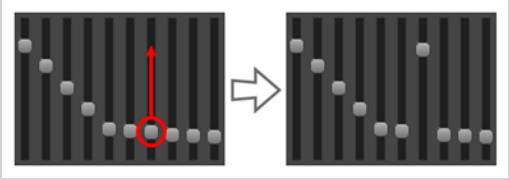

User Interface	Section	Description
	View Menu	Open the Onion Skin view menu, which contains extra options for Advanced Onion Skin—see <a href="#">Onion Skin View Menu</a> on page 304
<b>Previous Drawings Settings</b>		
	Previous drawings visibility switches	<p>Allows you to select which drawings before the current frame to include in the Onion Skin. A drawing that is toggled on will be visible in the Onion Skin, and a drawing that is toggled up will be excluded from it. You can select a range of drawings, or include and exclude specific drawings individually.</p> <div style="border: 1px solid #add8e6; padding: 10px; margin-top: 10px;"> <p> <b>TIP</b></p> <p>You can quickly select or deselect a range of drawings by clicking and holding on one drawing, then dragging the mouse cursor over the other drawings you want to toggle.</p>  </div>

User Interface	Section	Description
	<p>Previous drawings opacity sliders</p>	<p>Allows you to adjust the opacity scale of drawings before the current frame. Each slider represents the opacity of one drawing.</p> <p>By default, moving one of these sliders will move the other sliders so that the opacity remain on a graded scale. In this case, you can start by adjusting the opacity on one end, the opacity on another end and then, if you want, adjust one of the sliders in-between to make a segmented progression.</p>  <p>You can disable this behaviour by unchecking the <b>Link Sliders</b> option in the  View Menu in the top-left corner of the Onion Skin view. This option is enabled by default. When disabled, you can adjust the opacity of each drawing independently.</p> 
	<p>Previous drawings colour</p>	<p>Allows you to select the colour in which to display the drawings before the current frame.</p>
<p><b>Onion Skin Settings</b></p>		
	<p>Advanced Onion Skin</p>	<p>Enables Advanced Onion Skin. Advanced Onion Skin allows you to select, on the fly, which drawings to include in your Onion Skin, even if those drawings are not consecutive drawings, as well as the opacity scales for the drawings before and after the current frame.</p> <p>The controls for selecting which drawings to display in the Onion Skin as well as their opacity sliders are only accessible when Advanced Onion Skin is enabled. Otherwise, when using regular Onion Skin, the opacity of drawings in the Onion Skin is determined by the Onion Skin settings in the Preferences</p>

User Interface	Section	Description
		<p>dialog. The amount of drawings to include in the Onion Skin is set using the Onion Skin Add / Reduce One Previous Drawing and Onion Skin Add / Reduce One Next Drawing commands, available in the Camera and Drawing toolbars as well as in View &gt; Onion Skin in the top menu.</p>
	<p>Onion skin opacity slider</p>	<p>Allows you to set the overall opacity of all the drawings in the Onion Skin.</p>
	<p>Include by frames or by drawings</p>	<p>Allows you to select whether the drawings to include in the Onion Skin are selected by frame or by drawing.</p> <ul style="list-style-type: none"> <li> <b>By Frames:</b> Selects the drawings to display in the Onion Skin by their frame number relative to the current frame. For example, if the Onion Skin is set to include 2 drawings before and after the current frame, it will include the drawings up to two frames before and up to two frames after the current frame, even if those drawings are the same as the one in the current frame. This is more useful for cut-out animation as it allows you to position a drawing relative to its position in adjacent frames. </li> </ul> <div data-bbox="691 1192 1430 1329" style="border: 1px solid #c8e6c9; padding: 5px; margin: 10px 0;"> <p> <b>NOTE</b> This option only works in the Camera view.</p> </div> <ul style="list-style-type: none"> <li> <b>By Drawings:</b> Selects the drawings to display in the Onion Skin by the amount of different drawings before and after the current frame. For example, if the Onion Skin is set to include 2 drawings before and after the current frame, this will display the nearest two different drawings before and after the drawing in the current frame in the Onion Skin, even if those drawings are further than 2 frames away from the current frame. This is more useful for frame-by-frame animation. </li> </ul> <div data-bbox="691 1667 1430 1866" style="border: 1px solid #c8e6c9; padding: 5px; margin: 10px 0;"> <p> <b>NOTE</b> When this option is enabled, the handles allowing you to adjust the extent of the Onion Skin in the Timeline view are not available.</p> </div>

User Interface	Section	Description
Next Drawings Settings		
	Next drawings visibility switches	<p>Allows you to select which drawings after the current frame to include in the Onion Skin. A drawing that is toggled on will be visible in the Onion Skin, and a drawing that is toggled up will be excluded from it. You can select a range of drawings, or include and exclude specific drawings individually.</p> <div data-bbox="613 579 1430 926" style="border: 1px solid #add8e6; padding: 10px;"> <p> <b>TIP</b></p> <p>You can quickly select or deselect a range of drawings by clicking and holding on one drawing, then dragging the mouse cursor over the other drawings you want to toggle.</p>  </div>
	Next drawings opacity sliders	<p>Allows you to adjust the opacity scale of drawings after the current frame. Each slider represents the opacity of one drawing.</p> <p>By default, moving one of these sliders will move the other sliders so that the opacity remain on a graduated scale. In this case, you can start by adjusting the opacity on one end, the opacity on another end and then, if you want, adjust one of the sliders in-between to make a segmented progression.</p> <div data-bbox="613 1234 1130 1587" style="border: 1px solid #ccc; padding: 10px;">  </div> <p>You can disable this behaviour by unchecking the <b>Link Sliders</b> option in the  View Menu in the top-left corner of the Onion Skin view. This option is enabled by default. When disabled, you can adjust the opacity of each drawing independently.</p>

User Interface	Section	Description
		
	Next drawings colour	Allows you to select the colour in which to display the drawings after the current frame.
<b>Marked Drawings Settings</b>		
	Show Key drawings in Onion Skin	Only displays drawings marked as key drawings in the Onion Skin.
	Show Breakdown drawings in Onion Skin	Only displays drawings marked as breakdowns in the Onion Skin.
	Show In-between drawings in Onion Skin	Only displays drawings with no marker in the Onion Skin. Drawings with no marker are considered in-betweens.
	Show RetakeKey drawings in Onion Skin	Only displays drawings marked as retake key drawings in the Onion Skin.
	Show RetakeBD drawings in Onion Skin	Only displays drawings marked as retake breakdowns in the Onion Skin.
	Show RetakeIB drawings in Onion Skin	Only displays drawings marked as retake in-betweens in the Onion Skin.

# Perspective View

T-HFND-008-016

The Perspective view is used during scene setup. It allows you to see a multiplane scene’s orientation. The Perspective view is similar to a 3D display, as it lets you rotate the scene through all possible angles to understand the spacing between the elements. You can also position and rotate your layers and the camera inside the 3D display to achieve some 3D setup and camera moves.

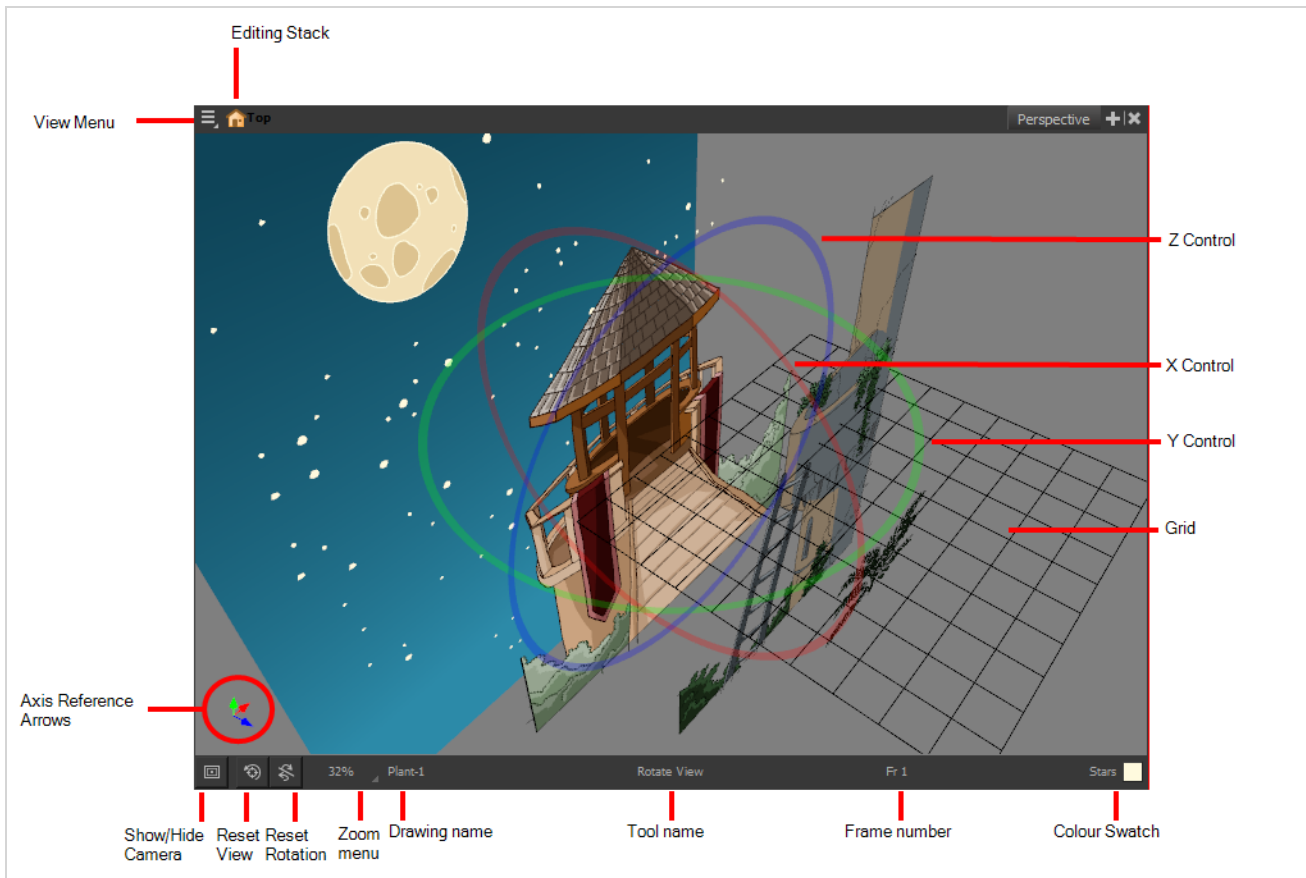





## How to access the Perspective view

Do one of the following:

- From the top menu, select **Windows > Perspective**.
- From any of the other views, click the Add View **+** button and select **Perspective**.

Icon	Section	Description
	View Menu	The View menu contains all the tools and options that you can use to work in the Perspective view.

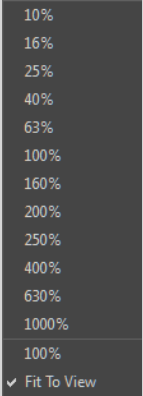
	Editing Stack	The Editing Stack menu displays the names of the symbols and their hierarchy when you are editing a symbol. You can click on the different names to go back up to the different parent symbols or the top/current project.
	X Control	The red circle rotates the view on its X axis.
	Y Control	The green circle rotates the view on its Y axis.
	Z Control	The blue circle rotates the view on its Z axis.
	Grid	This is a perspective (3D) grid reference.
	Axis Reference Arrows	The axis reference arrows let you maintain your orientation when navigating in the Perspective view.
	Show/Hide Camera	Shows or hides camera frame in the Perspective view.
	Reset View	Resets the pan, rotation, and zoom of the Perspective view.
	Reset Rotation	Resets the rotation of the Perspective view.
	Zoom Menu	<p>This field displays the current zoom level in the Perspective view. You can use the Zoom level drop-down menu to select a specific zoom level from the list. Zoom levels from 2.5% to 6400% are available; you can also select Fit To View to automatically use a zoom level that lets you see all your scene layers and information in the Perspective view at once.</p> 

	Layer Name	This field displays the currently selected layer and drawing name.
	Tool Name	This field displays the currently selected tool.
	Frame Number	This field displays the currently selected frame of your animation.
	Colour Swatch	This field displays the currently selected colour in the palette.



## Script Editor View

The Scripting view allows you to edit scripts to run in Harmony directly from the application. It displays a list of available scripts, from which you can select an existing script, edit it, test it and save it. The Script Editor will highlight the syntax of your script for easy reading.

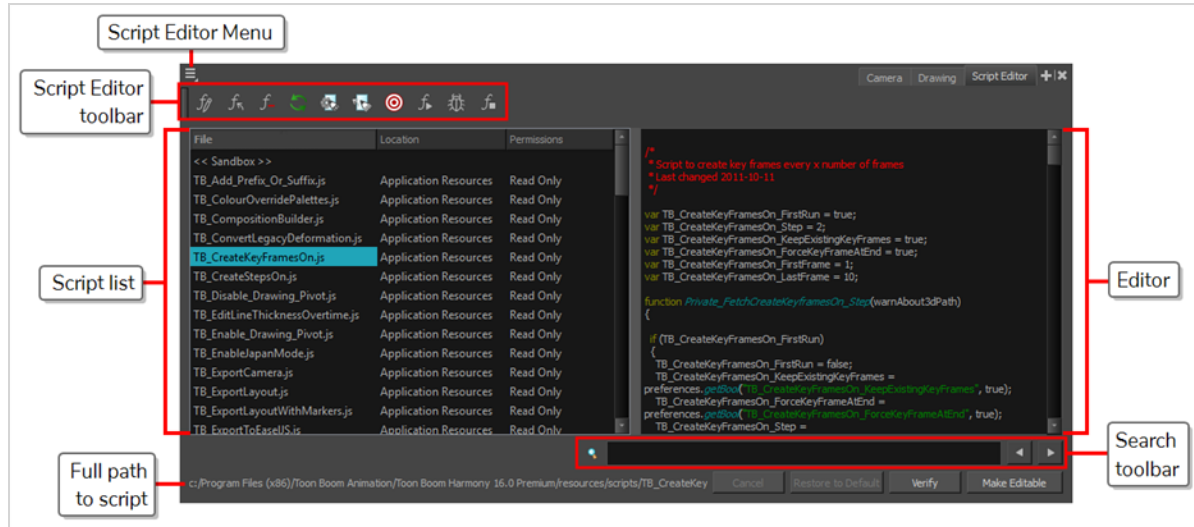

### How to access the Script Editor view

Do one of the following:

- From the top menu, select **Windows > Script Editor**.
- From any of the other views, click the Add View **+** button and select **Script Editor**.

Parameter	Description
Script Editor menu	The menu for this view—see <a href="#">Script Editor View Menu</a> on page 312.
Script Editor toolbar	The toolbar for this view—see <a href="#">Script Editor Toolbar</a> on page 1031.
Script list	<p>The list of script files available as well as their location and their read and write permissions. Selecting a script in this list will open it in the editor.</p> <p>The file list has three columns: <b>File</b>, <b>Location</b> and <b>Permissions</b>.</p> <ul style="list-style-type: none"> <li>• The <b>File</b> column indicates the filename of each script.</li> </ul>

**NOTE**

The << **Sandbox** >> item at the top of the list does not correspond to an actual script file. It is a temporary container to type and test code, and its content cannot be saved.

- The **Location** of the script can be one of the following:
  - **Application Folder:** Scripts that are packaged and installed with Harmony. By default, you cannot edit these scripts until you select them and click on Make Editable, at which point you are prompted to copy the script to a location from which you can edit them.

Scripts in the Application Resources folder are in the following location:

- **Windows:** `C:\Program Files (x86)\Toon Boom Animation\Toon Boom Harmony 16.0 Premium\Resources\scripts`
- **macOS (Stand Alone):** `/Applications/Toon Boom Harmony 16.0 Premium/tba/resources/scripts`
- **macOS (Server):** `/Applications/Toon Boom Harmony 16.0 Premium Network/tba/resources/scripts`
- **GNU/Linux:** `/usr/local/ToonBoomAnimation/harmonyPremium_16.0/resources/scripts`
- **User:** Scripts that are saved in your user preferences. Those scripts can be edited and executed from any scene, provided that you are logged in as the same user.

In Harmony Stand Alone, scripts in the User folder are in the following location:

- **Windows:** `C:\Users\[user_name]\AppData\Roaming\Toon Boom Animation\Toon BoomHarmonyPremium\1600-scripts`
- **macOS:** `/Users/[user_name]/Library/Preferences/Toon Boom Animation/Toon BoomHarmonyPremium/1600-scripts`
- **GNU/Linux:** `/home/[user_name]/Toon Boom Animation/Toon BoomHarmonyPremium/1600-scripts`

In Harmony Server, scripts in the User folder are in the following location:

`/USA_DB/users/[username]/HarmonyPremium/1600-scripts`

- **Scene:** Scripts in the `scripts` sub-folder of the currently open scene. These scripts can only be edited and executed when the current scene is open.
- **Job (Harmony Server only):** When using Harmony Server, these are the scripts saved in the directory of the current scene's job. These scripts can be edited and executed by any user when any scene that is part of this job is open.

Scripts in the Job folder can be found in the following location:

`/USA_DB/jobs/[job_name]`

- **Environment (Harmony Server only):** When using Harmony Server, these are scripts saved in the directory of the current scene's environment. These scripts can be edited

and executed by any user when any scene that is part of this environment is open.

Scripts in the Environment folder can be found in the following location:

`/USA_DB/environments/[environment name]`

- **Global (Harmony Server only):** Scripts in the Harmony database's scripts directory. These scripts can be edited by any user when any scene in the database is open.

Scripts in the Global folder can be found in the following location:

`/USA_DB/scripts`

- **System Variable:** Scripts inside the directory set in the `TOONBOOM_GLOBAL_SCRIPT_LOCATION` environment variable, if this variable is set. These scripts can be edited and executed by anyone on your workstation.



#### NOTE

When two or more scripts with the same file name exist in different locations, Harmony will give priority to a single one of these scripts. The script given priority will be the one listed in the Script Editor and the one executed if it is associated to a toolbar button.

Which script is prioritized is determined by the order of priority of script locations. From highest priority to lowest priority, the order goes as follows:

**User > Scene > System Variable > Job > Environment > Global  
> Application Resources**

An exception to this rule is if you have a script with the same name in both the scene folder and your user preferences. In this case, both versions of the script will be listed and you will be able to edit both.



- The **Permissions** of the script can be one of the following:
  - **Read Only:** You cannot edit the script in the Script Editor and save your changes.



#### NOTES

- If the script's location is the Application Resources folder, it will always be Read Only to prevent you from making changes to scripts packaged with Harmony. However, you can click on the **Make Editable** button below the script editor to make a copy of the script in your user preferences folder, after which you can make changes to this copy.
- If the script is in any other location and is Read Only, then it is likely that a network administrator made the script or the folder containing the script read-only to prevent other users from making unwanted changes to it.

- **Read/Write:** You can edit the script in the Script Editor and save your changes.

<p>Editor</p>	<p>A text field in which you can edit the selected script.</p> <div data-bbox="362 247 1430 426" style="border: 1px solid green; padding: 5px;">  <p><b>NOTE</b> If the selected script is in the Application Resources folder, you will not be able to edit it until you click on the <b>Make Editable</b> button.</p> </div>
<p>Search toolbar</p>	<p>Allows you to type in a keyword and search for this keyword within the script. You can use the ► Next button to go to the next instance of the keyword and the ◀ Previous button to go to the previous instance.</p>
<p>Cancel</p>	<p>If you have made any changes to your script that you have not yet saved, this discards those changes and reloads the saved version.</p>
<p>Restore to Default</p>	<p>If the selected script is a script that was packaged with Harmony, and which you copied to your User folder, to the Scene folder or to the Job, Environment or Global folder to make changes to it, you can click on this button to delete this copy of this script and resume using the original version of the script that is packaged with Harmony instead.</p> <div data-bbox="362 940 1430 1081" style="border: 1px solid red; padding: 5px;">  <p><b>IMPORTANT</b> This will permanently delete your version of the script and any changes you have made to it.</p> </div>
<p>Verify</p>	<p>Verifies that the script has no syntax error.</p>
<p>Make Editable</p>	<p>If the currently selected script is in the Application Resources folder, you cannot edit it. By clicking on this button, the script can be copied to a location where you can edit it.</p> <p>When you click on this button, you are prompted to choose whether to copy in either of these locations:</p> <ul style="list-style-type: none"> <li>• <b>User:</b> Saves the script to a directory in your user preferences directory. You will be able to run and edit the script from any scene as long as you are logged in as the same user.</li> </ul> <div data-bbox="441 1503 1430 1707" style="border: 1px solid green; padding: 5px;">  <p><b>NOTE</b> If you are using Harmony Stand Alone, the script will be saved to the preferences for your account on your computer. If you are using Harmony Server, the script will be saved to the preferences for your Harmony database user.</p> </div> <ul style="list-style-type: none"> <li>• <b>Global:</b> If you are using Harmony Server, select this option to save the script to the Harmony database's global script directory. Anyone who is logged in to the database will be able to edit and run this script.</li> <li>• <b>Environment:</b> If you are using Harmony Server, select this option to save the script to the</li> </ul>

	<p>current scene's environment. Anyone will be able to edit and run the script as long as they are working on a scene inside this environment.</p> <ul style="list-style-type: none"> <li>• <b>Job:</b> If you are using Harmony Server, select this option to save the script to the current scene's job. Anyone will be able to edit and run the script as long as they are working on a scene inside this job.</li> <li>• <b>Scene:</b> Save the script to the scene's <b>scripts</b> sub-folder. Anyone will be able to edit and run the script when working on this specific scene.</li> <li>• <b>System Variable:</b> Save the script to the directory in the <b>TOONBOOM_GLOBAL_SCRIPT_LOCATION</b> environment variable. This option is only available if this environment variable is set.</li> </ul> <div data-bbox="362 625 1430 848" style="border: 1px solid #90EE90; padding: 10px;">  <p><b>NOTES</b></p> <ul style="list-style-type: none"> <li>• This button will be greyed out if the script is in any location other than Application Resources and is read only.</li> <li>• For more information on these locations, refer to <a href="#">Script list on page 1106</a>.</li> </ul> </div>
Save	<p>Saves the modifications you made to the script.</p> <p>This button replaces the Make Editable button after you have used the Make Editable button to copy the script to a location from which you can edit it.</p>

## Side View

T-HFND-008-015

The Side view is used mainly for multiplane scenes and to position elements in 3D space. It allows you to see a scene's stage from the side. This lets the camera cone and spacing between the elements to be seen.

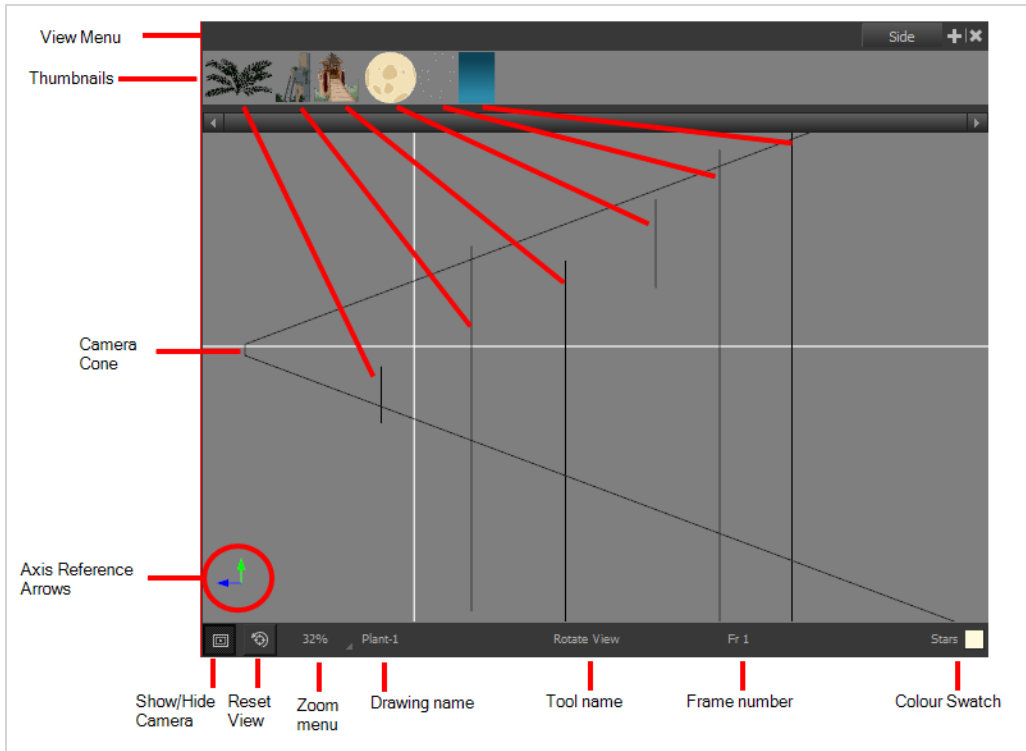



### How to access the Side view

Do one of the following:

- From the top menu, select **Windows > Side**.
- From any of the other views, click the Add View **+** button and select **Side**.

Icon	Section	Description
	View Menu	The View menu contains all the tools and options that you can use to work in the Side view.
	Thumbnails	A thumbnail of each drawing layer in the scene. The order of the thumbnail images is based on each element's FB position in the scene space. You can see a representation of the FB position of each layer in the

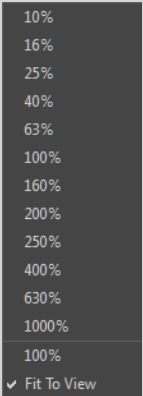
		camera cone.
	Camera Cone	The camera cone represents the camera's position and field-of-view (FOV).
	Axis Reference Arrows	The axis reference arrows let you maintain your orientation when navigating in the view.
	Show/Hide Camera	Shows or hides camera frame in the Perspective view.
	Reset View	Resets the pan, rotation, and zoom of the Perspective view.
	Zoom Menu	<p>This field displays the current zoom level in the Perspective view. You can use the Zoom level drop-down menu to select a specific zoom level from the list. Zoom levels from 2.5% to 6400% are available; you can also select Fit To View to automatically use a zoom level that lets you see all your scene layers and information in the Perspective view at once.</p> 
	Layer Name	This field displays the currently selected layer and drawing name.
	Tool Name	This field displays the currently selected tool.
	Frame Number	This field displays the currently selected frame of your animation.
	Colour Swatch	This field displays the currently selected colour in the palette.

# Timeline View

T-HFND-006-002

To set your animation timing, you will mostly work with the Timeline and Xsheet views. It's extremely useful to become familiar with the Timeline view, how it works, and its interface.

The Timeline view is the main view used when adjusting the timing of drawings, adding keyframes and ordering layers. The Timeline view displays layers, effects, sounds, keyframe values, scene length, layer names, drawings, keyframes, timing, and frames.

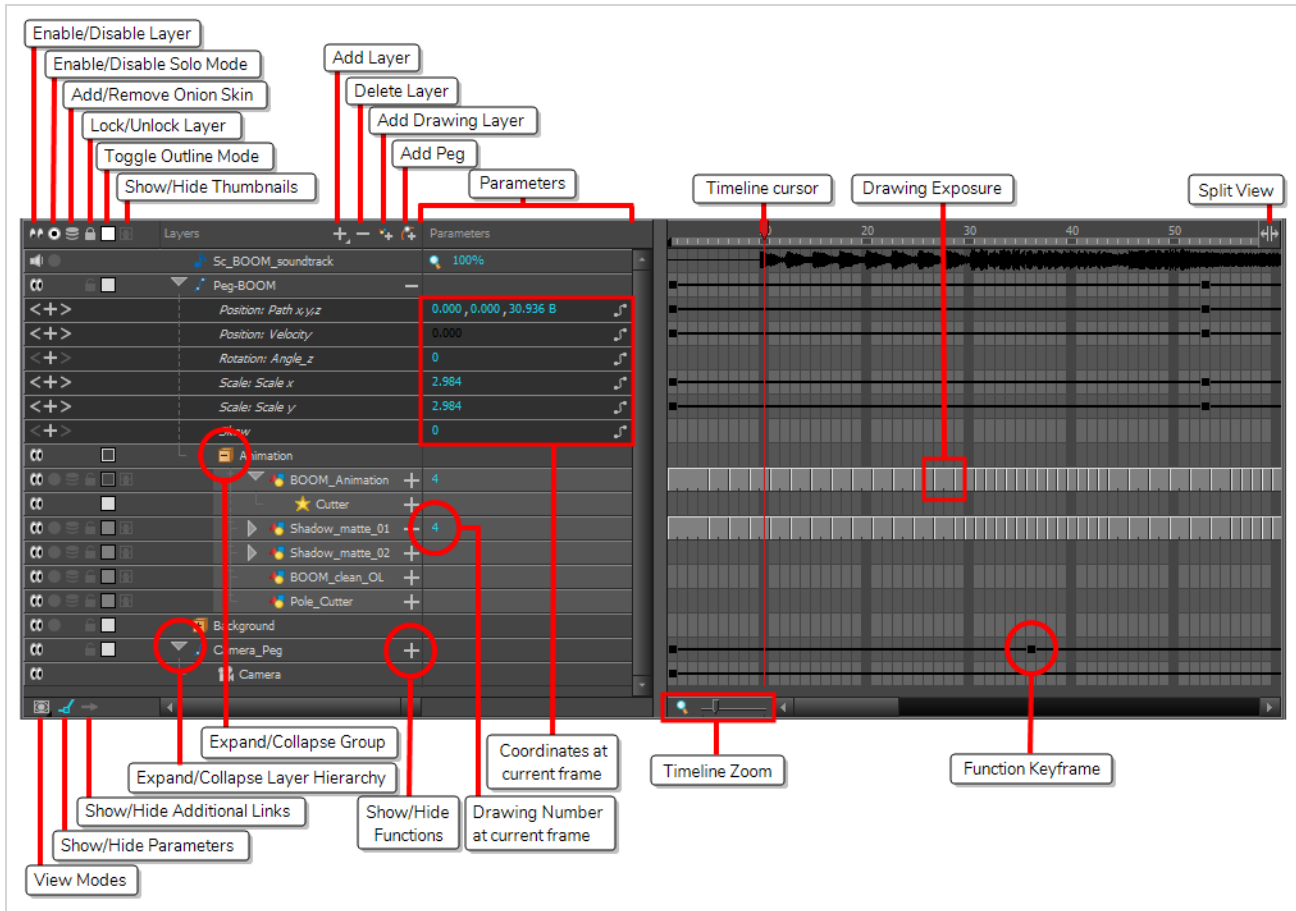

The Timeline view allows you to read your timing from left to right. It represents the scene's elements in their simplest form. You can also see the layers and their names, as well as the drawing's exposure. The drawing name is displayed when you place your pointer over the drawing's exposure.

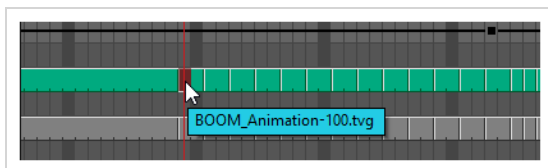











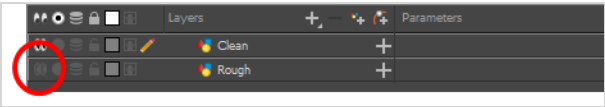
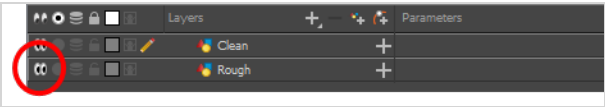







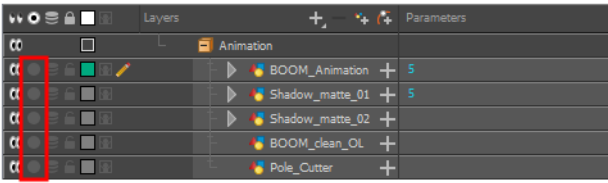
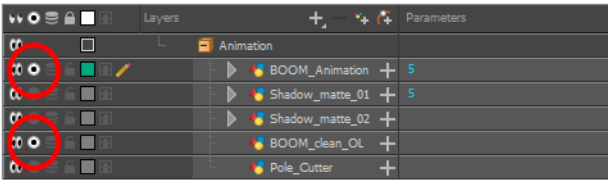

## How to access the Timeline view

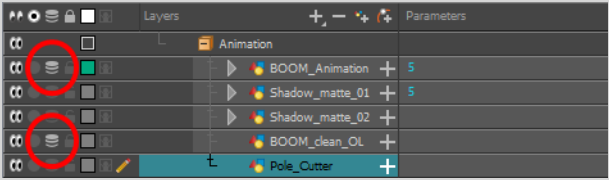

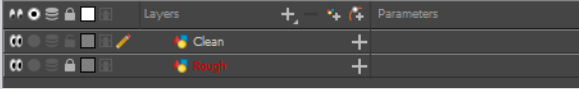

Do one of the following:

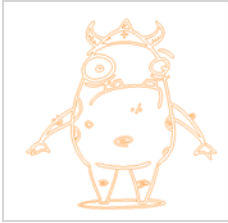
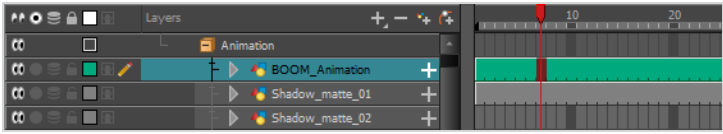



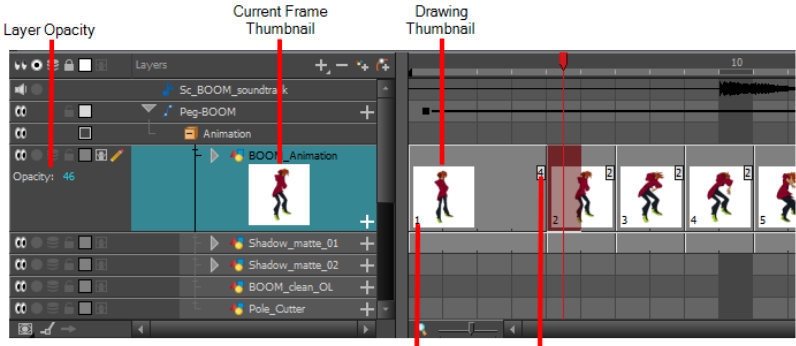



- From the top menu, select **Windows > Timeline**.
- From any of the other views, click the Add View **+** button and select **Timeline**.





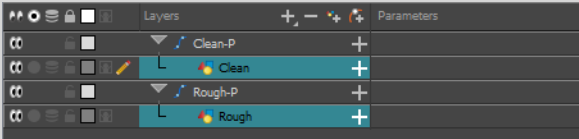

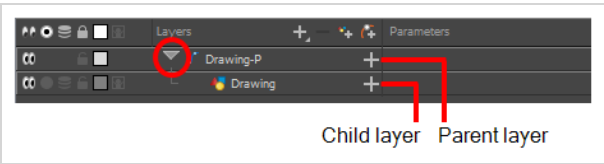

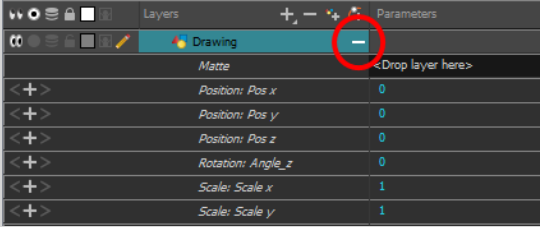

Icon	Section	Description
	View Menu	The View menu contains all the tools and options that you can use to manage models.
	Enable/Disable Layer	<p>The Enable/Disable All button lets you enable or disable layers. Disabling a layer makes the scene behave as if it didn't exist, including when rendering the scene. For example:</p> <ul style="list-style-type: none"> <li>• A disabled drawing layer will be invisible.</li> <li>• A disabled sound layer will be mute.</li> <li>• A disabled peg layer will not affect the position of its child layers.</li> </ul> <p>To disable a layer, click the layer's Enable/Disable button or press D.</p>  <p>To enable a layer, click the layer's Enable/Disable button or press A.</p>  <div style="border: 1px solid green; padding: 5px; margin-top: 10px;"> <p> <b>NOTE</b> Next to sound layers, the Enable/Disable layer button will look like this: .</p> </div> <div style="border: 1px solid blue; padding: 5px; margin-top: 10px;"> <p> <b>TIP</b> You can enable or disable all layers by clicking on the Enable or disable all layers  button in the top row.</p> </div>
	Enable/Disable Solo Mode	Solo mode allows you to only view specific layers in the Camera view and hide all others. When solo mode is enabled on one layer, only this layer will











		<p>be visible. If solo mode is enabled on several layers, and only these layers will be visible. If solo mode is not enabled on any layer, all enabled layers will be visible.</p> <p>You can also use solo mode on sound tracks. If solo mode is enabled on any sound tracks, only those sound tracks will play during playback.</p> <div data-bbox="613 405 1243 642">  <p>All layers are visible in the Camera view</p> </div> <div data-bbox="613 674 1243 911">  <p>Only layers with the Solo icon activated are currently visible in the Camera view.</p> </div> <div data-bbox="613 947 1430 1150" style="border: 1px solid #0070C0; padding: 10px;"> <p> <b>TIP</b></p> <p>When some layers are in solo mode, you can disable or re-enable solo mode on all layers that have it enabled by clicking on the Toggle solo mode on or off  button in the top row.</p> </div>
	<p>Add to/Remove from Onion Skin</p>	<p>For when the Onion Skin option is enabled, this allows you to enable or disable Onion Skin on specific layers.</p> <div data-bbox="613 1297 1218 1476">  </div> <div data-bbox="613 1514 1430 1682" style="border: 1px solid #0070C0; padding: 10px;"> <p> <b>TIP</b></p> <p>To activate the general Onion Skin preview, in the Tools toolbar, click the Onion Skin button</p> </div>
	<p>Lock/Unlock Layer</p>	<p>The Lock/Unlock Layer button lets you prevent the selection or editing of a layer in the Camera view. To select some of the layers without selecting others, in the Timeline view, lock the layers you do not want to select. When a layer is locked, its name is displayed in red.</p>



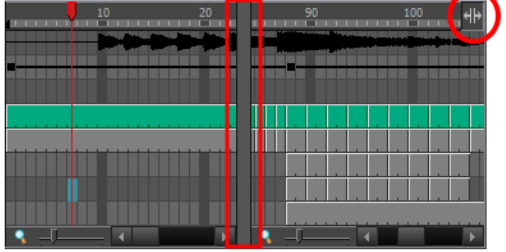



		 <p>In the top menu, there is a series of locking options. Select <b>Animation &gt; Lock</b> &gt; select one of the following:</p> <ul style="list-style-type: none"> <li>• <b>Lock:</b> Locks the currently selected element.</li> <li>• <b>Unlock:</b> Unlocks the currently selected element.</li> <li>• <b>Lock All:</b> Locks all the elements in the Camera view.</li> <li>• <b>Unlock All:</b> Unlocks all the elements in the Camera view.</li> <li>• <b>Lock All Others:</b> Locks all the elements in the Camera view except the currently selected one.</li> </ul>
	<p>Toggle Outline Mode / Change Track Colour</p>	<p>Each drawing layer has a little colour swatch that has two functionalities:</p> <ul style="list-style-type: none"> <li>• <b>Single-clicking</b> a layer's colour swatch toggles Outline mode on or off. Outline mode makes the layer display as nothing but the outlines of its vector shapes in the Camera view, allowing you to see the drawing's shape without it blocking the view of layers behind it.</li> </ul>  <ul style="list-style-type: none"> <li>• <b>Double-clicking</b> the layer's colour swatch opens a colour picker dialog that allows you to change the layer's track colour. The track colour displays in the layer's track in the Timeline view, allowing you to give special visibility to specific layers. It also determines the colour of the layer's outlines if it's in outline mode.</li> </ul> 
	<p>Show/Hide Thumbnails</p>	<p>Expands the layer to display a thumbnail of the drawing in the current frame, as well as for each drawing in the timeline.</p>

		<div data-bbox="613 191 1430 459" style="border: 1px solid green; padding: 10px; margin-bottom: 10px;">  <p><b>NOTE</b></p> <p>By default, the timeline's zoom level does not allow enough horizontal space to fully display the thumbnails of drawings exposed for one or two frames only. To see the thumbnails for drawings with short exposure, you must increase the timeline's zoom level—see <a href="#">Timeline Zoom</a> on page 1122.</p> </div> <div data-bbox="613 485 1430 879" style="border: 1px solid gray; padding: 10px; margin-bottom: 10px;">  </div> <p>When a drawing layer is in Show Thumbnails mode:</p> <ul style="list-style-type: none"> <li>• An exposure indicator appears at the right of each exposed drawing in the timeline, indicating the amount of frames the drawing spans over.</li> <li>• An Opacity parameter appears to the left of the layer, allowing you to set the layer's opacity level.</li> </ul> <div data-bbox="613 1186 1430 1360" style="border: 1px solid blue; padding: 10px;">  <p><b>TIP</b></p> <p>You can show or hide thumbnails for all drawing layers by clicking on the Show/Hide All Thumbnails  button in the top row.</p> </div>
	<p>Opacity</p>	<p>Allows you to set the opacity level of the layer. Click and drag the value left or right to decrease or increase the layer's opacity.</p> <div data-bbox="613 1518 1430 1686" style="border: 1px solid green; padding: 10px; margin-top: 10px;">  <p><b>NOTE</b></p> <p>This parameter only displays for drawing layers that are in Show Thumbnails mode.</p> </div>
	<p>Active Drawing Layer Indicator</p>	<p>This icon appears next to the active drawing layer, which is the layer you draw on when using drawing tools.</p>

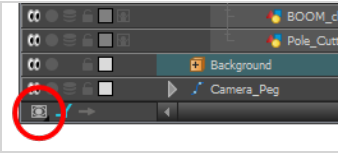

		<div style="border: 1px solid #c8e6c9; padding: 10px;">  <p><b>NOTE</b></p> <p>The active drawing layer is not always the selected layer. For example, if you select a drawing layer, then a peg layer, the peg layer will be the selected layer, but the active drawing layer will remain the last drawing layer you selected, until you select another drawing layer.</p> </div>
	<p>Add Layer</p>	<p>The Add Layers button lets you add new layers to the Timeline view. When you click the Add Layers button, a menu appears displaying the most commonly used layer types so that you can quickly add them to your scene. If you need to add other types of layers, you must use the Node view and the Node library.</p>
	<p>Delete</p>	<p>The Delete Layers button lets you delete the currently selected layers in the Timeline view.</p>
	<p>Add Drawing Layer</p>	<p>The Add Drawing Layer button lets you automatically add a new drawing layer to the Timeline view. By default, the layer is named <b>Drawing</b>.</p>
	<p>Add Peg</p>	<p>The Add Peg button lets you add a peg layer to the timeline. If several layers are selected, a peg is added and parented to each layer.</p> 
	<p>Expand/Collapse</p>	<p>The Expand/Collapse button is used to display the children layers of a parent layer. Once a layer is parented to another layer, it is indented to the right and the Collapse/Expand Children button appears on the parent layer allowing you to show or hide the child layer.</p> 
	<p>Show/Hide Functions</p>	<p>The Show/Hide Functions button lets you display the functions embedded in each layer. The functions are the different coordinates and values used to record a layer's parameters at each frame. This information is stored on the function curves using keyframes.</p> <p>If the layer can be connected to another layer, for example to use a drawing</p>

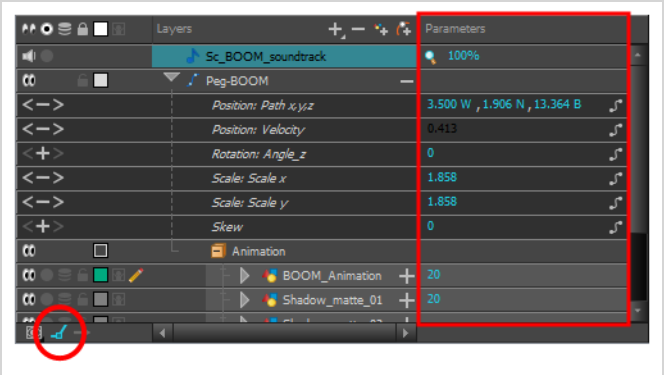
		<p>layer as a matte, expanding a layer's functions will also list its possible connections. You can connect layers by dragging and dropping a layer onto another layer's connection.</p> 
	<p>Add/Remove Keyframe</p>	<p>Adds a keyframe at the current frame of the selected function or removes the keyframe at the current frame of the selected function, if there is one already.</p> <div data-bbox="613 709 1430 846" style="border: 1px solid #c8e6c9; padding: 10px;"> <p> <b>NOTE</b> This button only displays for function layers.</p> </div>
	<p>Previous Keyframe</p>	<p>Moves the timeline cursor to the previous keyframe on the selected function.</p> <div data-bbox="613 968 1430 1104" style="border: 1px solid #c8e6c9; padding: 10px;"> <p> <b>NOTE</b> This button only displays for function layers.</p> </div>
	<p>Next Keyframe</p>	<p>Moves the timeline cursor to the next keyframe on the selected function.</p> <div data-bbox="613 1220 1430 1356" style="border: 1px solid #c8e6c9; padding: 10px;"> <p> <b>NOTE</b> This button only displays for function layers.</p> </div>
	<p>Function Menu</p>	<p>Displays the Function menu, which allows you to create a new function for the function layer, or to link it to an existing shared function.</p> <div data-bbox="613 1514 1430 1692" style="border: 1px solid #c8e6c9; padding: 10px;"> <p> <b>NOTE</b> This button only displays for functions layers, in the Parameters column—see <a href="#">Show/Hide Parameters on page 1121</a>.</p> </div>
	<p>Function Keyframe</p>	<p>A frame where the value for one or more of the layer's functions is preset. The position of each layers in key poses for digital animation is recorded in function keyframes. You can grab and move function keyframes as well as copy, cut, paste and delete them.</p>

		<div data-bbox="613 191 1430 564" style="border: 1px solid #add8e6; padding: 10px;">  <p><b>TIP</b></p> <p>If you have a keyframe and a drawing selected simultaneously, and you wish to delete the keyframe without deleting the drawing's exposure by doing one of the following:</p> <ul style="list-style-type: none"> <li>• In the Timeline toolbar, click on the Delete Keyframe  button.</li> <li>• Press F7.</li> <li>• From the top menu, select <b>Animation &gt; Delete Keyframe</b></li> </ul> </div> <div data-bbox="613 594 1430 768" style="border: 1px solid #90ee90; padding: 10px; margin-top: 10px;">  <p><b>NOTE</b></p> <p>If a collapsed layer has children that have function keyframes, you will see a white square  instead.</p> </div>
	<p>Split</p>	<p>The Split button lets you split the Timeline view in two sections, allowing you to see two different portions of the Timeline view. This can be useful if you need to often switch between two specific points of a lengthy scene.</p> <div data-bbox="613 951 1135 1243" style="border: 1px solid #ccc; padding: 5px; text-align: center;">  </div>
	<p>Drawing Exposure</p>	<p>In the Timeline view, when a drawing is exposed, it is represented by a grey block that extends from the first frame it is exposed to the last frame it is exposed.</p> <div data-bbox="613 1438 813 1472" style="border: 1px solid #ccc; padding: 2px; text-align: center;">  </div>
	<p>View Modes</p>	<p>Lets you choose between different view modes allowing you to decide which layers are listed in the Timeline view. This can be useful if you're working on a scene with a lot of layers, and you only want layers you will be working on to appear in the Timeline view so as to declutter it. The following view modes are available:</p> <ul style="list-style-type: none"> <li>• Normal View Mode  will show all the layers that are connected to your scene's display node.</li> <li>• Selection Only Mode  will hide all the layers that are not currently selected, leaving only the currently selected layers in the Timeline</li> </ul>

		<p>view.</p> <ul style="list-style-type: none"> <li>View Tagged Layers  will only show layers which you have tagged.</li> </ul>  <div style="border: 1px solid #4F81BD; padding: 10px; margin-top: 10px;"> <p> <b>TIP</b></p> <p>You can tag a layer by doing one of the following:</p> <ul style="list-style-type: none"> <li>Right click on the layer and select <b>Tag &gt; Timeline Tag</b>.</li> <li>Open the Timeline view menu  and select <b>Edit &gt; Tag &gt; Timeline Tag</b>.</li> </ul> </div>
	<p>Show/Hide Parameters</p>	<p>Shows or hides the Parameters column, right of the Layers column. The Parameters column displays information on the layer at the current frame, depending on the type of layer it is:</p> <ul style="list-style-type: none"> <li>If the layer is a drawing, it displays the name of the drawing at the current frame.</li> <li>If the layer is a function, it displays the value of the function at the current frame.</li> <li>If the layer is a sound track, it displays the sound track's volume.</li> </ul>  <p>Using the mouse, you can drag the parameter left and right to change its value. This is especially useful for quickly changing a drawing's exposure at the current frame.</p>
	<p>Show/Hide Additional Links</p>	<p>Shows or hides the Additional Links column. The Additional Links column displays layers that are connected under the layer, but for other purposes than being the parent of those layers. For example, if a layer is used as the matte of an effect, the effect will be displayed in that layer's Additional Links.</p>

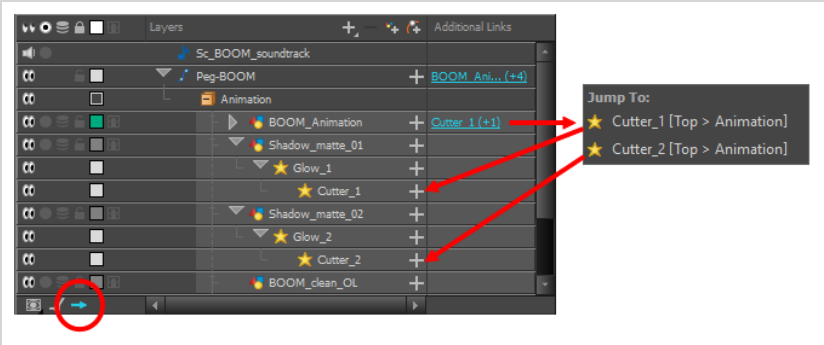

		<p>If more than one layers are in a layer's Additional Links, only the first of these layers will be displayed, followed by the amount of extra linked layers there are.</p> <p>By clicking on the Additional Links, you can open a menu listing the linked layers, and click on one of these layers to navigate to it.</p> <p>In the following example, the BOOM_Animation layer is used as the matte of Cutter_1 and Cutter_2:</p> 
	<p>Timeline Zoom</p>	<p>Reduces or increases the width of frames in the Timeline view. Move the slider right to increase the width or left to reduce it. You can also press 2 to zoom in and 1 to zoom out when the Timeline view is focused on.</p> <p>If you want to reset the Timeline view's zoom, click on the Timeline Zoon  icon left of the slider.</p>

# Tool Properties View

T-HFND-004-002

The Tool Properties view contains the most common options and operations related to the currently selected tool. When you select a tool from the Tools toolbar, the Tool Properties view updates.

For example, if you choose the Select tool, the Tool Properties view will display the options and operations related to it, such as Snap to Contour, Apply to All Drawings, Flip Horizontal, and Flatten.

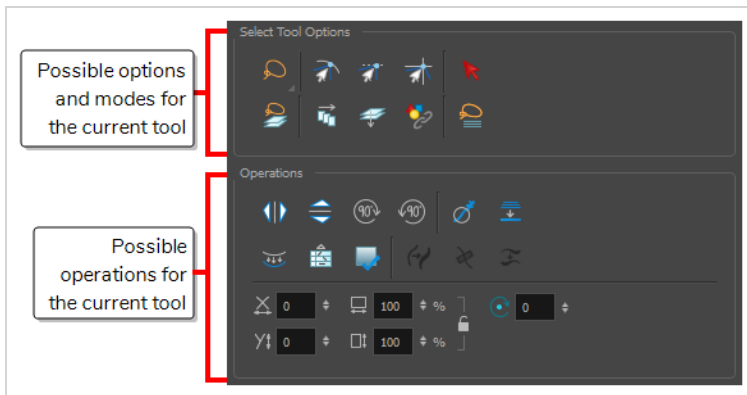

## NOTE

To learn more about the options appearing in the Tool Properties view, see [Tools Properties on page 824](#).

## How to access the Tool Properties view

Do one of the following:

- From the top menu, select **Windows > Tool Properties**.
- From any of the other views, click the Add View **+** button and select **Tool Properties**.

## Top View

T-HFND-008-014

The Top view is used mainly for multiplane scenes and to position elements in 3D space. It allows you to see the scene's stage from above. This lets the camera cone and the spacing between the elements be seen.

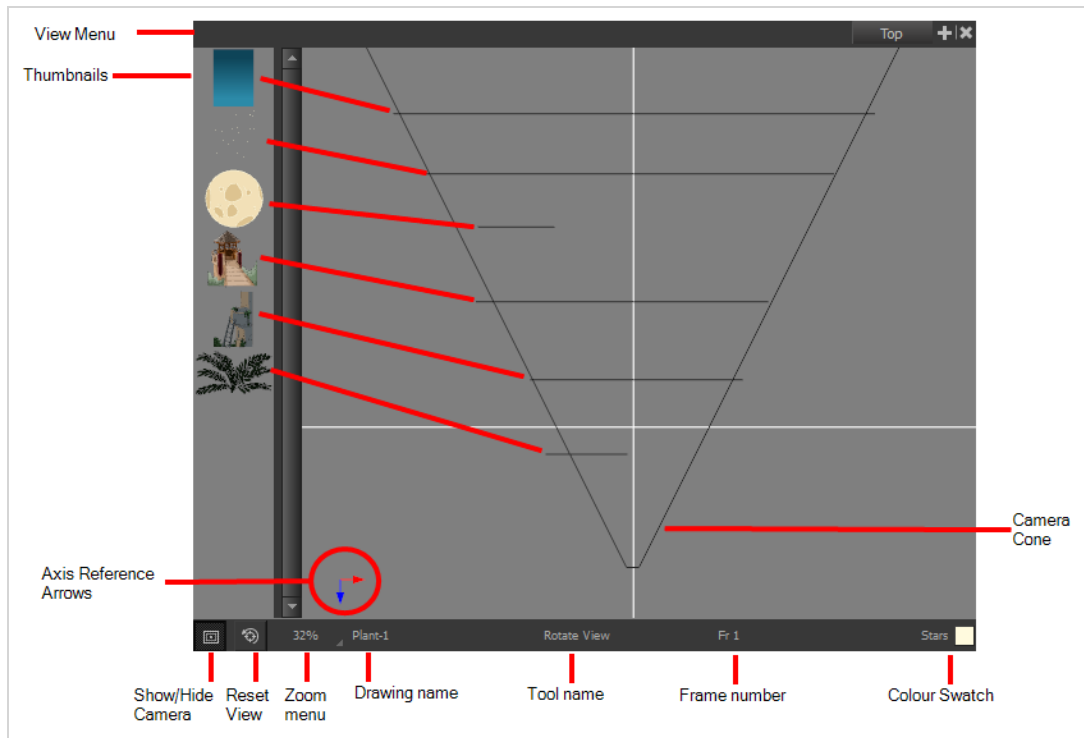



### How to access the Top view

Do one of the following:

- From the top menu, select **Windows > Top**.
- From any of the other views, click the Add View **+** button and select **Top**.

Icon	Section	Description
	View Menu	The View menu contains all the tools and options that you can use to work in the Side view.
	Thumbnails	A thumbnail of each drawing layer in the scene. The order of the thumbnail images is based on each element's FB position in the scene space. You can see a representation of the FB position of each layer in the camera cone.

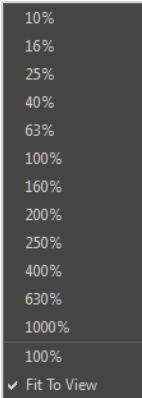
	Camera Cone	The camera cone represents the camera's position and field-of-view (FOV).
	Axis Reference Arrows	The axis reference arrows let you maintain your orientation when navigating in the view.
	Show/Hide Camera	Shows or hides camera frame in the Perspective view.
	Reset View	Resets the pan, rotation, and zoom of the Perspective view.
	Zoom Menu	<p>This field displays the current zoom level in the Perspective view. You can use the Zoom level drop-down menu to select a specific zoom level from the list. Zoom levels from 2.5% to 6400% are available; you can also select Fit To View to automatically use a zoom level that lets you see all your scene layers and information in the Perspective view at once.</p> 
	Layer Name	This field displays the currently selected layer and drawing name.
	Tool Name	This field displays the currently selected tool.
	Frame Number	This field displays the currently selected frame of your animation.
	Colour Swatch	This field displays the currently selected colour in the palette.

## Xsheet View

T-HFND-006-003

The Xsheet view lets you read the timing vertically by displaying it in a grid, with each drawing layer represented by a column, each frame of your scene represented by a row, and each exposed drawing displayed by its name in the cells. It is meant to work like a traditional animation exposure sheet.

Using the functions panel, you can also view the functions and keyframes of the motion paths for the selected column, with the value of those functions for each frame listed in the cells.

Contrary to the Timeline view, the Xsheet view does not display pegs, effects or layer hierarchy. Hence, it is optimized for traditional and paperless animation, whereas the Timeline view is optimized for digital or cut-out animation.

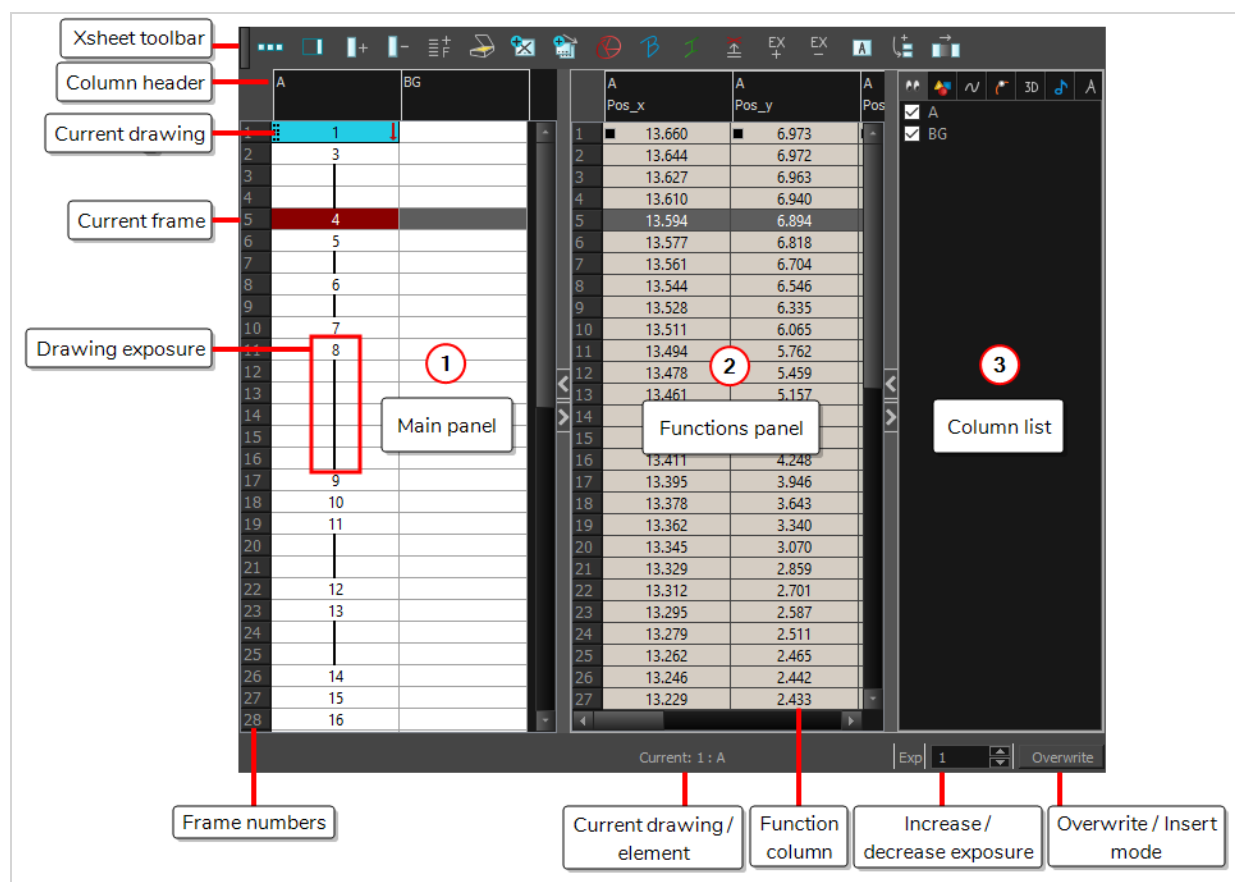

### How to access the Xsheet view

Do one of the following:

- From the top menu, select **Windows > Xsheet**.
- From any of the other views, click the Add View **+** button and select **Xsheet**.

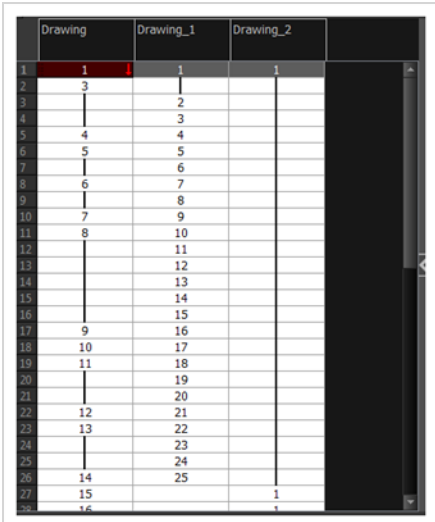
Icon	Section	Description
	View Menu	The View menu contains all the tools and options that you can use to manage columns and timing.
	View Toolbar	The view toolbar contains all the tools and options you can use in the Xsheet view to manage columns and timing.
	Xsheet Main Section	<p>The Xsheet view has three sections. By default, only the main section is visible. It displays the drawing layers, also known as <i>drawing columns</i>.</p>  <p>When using advanced compositing and animation techniques, unconnected functions (motion paths) also appear in the main section. Unconnected functions mean that some motion paths are not attached to any particular layer.</p> <p>When you reconnect functions to a layer, they are still visible in the main section.</p>

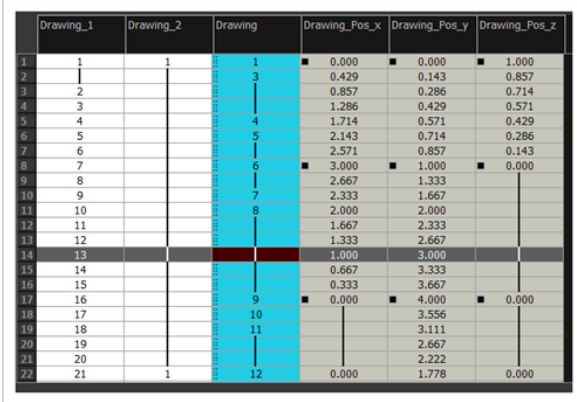
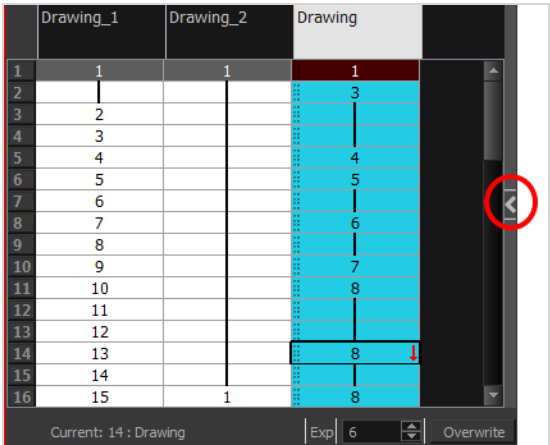
		
	<p style="text-align: center;">Functions Section</p>	<p>The Functions section is used for more advanced techniques. This section displays the functions (paths) related to the selected layer in the Timeline view. By default, the Functions section is hidden.</p> <p>In the Xsheet view, click the Expand button located on the right side of the main section. Click on the same button to collapse it. You can also use the Show Column List button in the Xsheet View toolbar. If you select a drawing column in the main section of the Xsheet view, the function columns will not be displayed. You must select the layer from the Timeline view.</p> 
	<p style="text-align: center;">Column List Section</p>	<p>The Column List section allows you to show and hide columns in the Xsheet view. When you hide a layer in the Xsheet view, it is also disabled in the Timeline view.</p>

		<div data-bbox="852 189 1144 472" data-label="Image"> </div>
--	--	--



		<div data-bbox="852 504 1429 640" data-label="Text"> <p>You can use the Column List to hide individual columns or hide an entire column type (drawing or function) from the Xsheet view. By default, the Functions section is hidden.</p> <p>In the Xsheet view, click the Expand button on the right side of the main section to show the Functions section. Click on the same button to collapse it. You can also use the Show Column List  button in the Xsheet toolbar.</p> <p>Go to the Xsheet view menu and select <b>View &gt; Show Column List</b>. Click the Expand button on the right side of the Functions section to display the Column List section.</p> </div> <div data-bbox="852 1029 1380 1438" data-label="Image"> </div>
--	--	---

		<div data-bbox="852 1512 1429 1648" data-label="Text"> <p>Each column available in the Xsheet view has a header displaying the column's name. The column's name is the same as the corresponding timeline layer. If you rename one or the other, they will both be renamed.</p> <p>A quick access menu is available when you right-click. This menu contains the command affecting an entire column such as renaming, changing the default colour, or deleting a column.</p> <p>The tooltip that appears when you hover at the top of each Xsheet column shows the folder path to the</p> </div>
--	--	--

		<div data-bbox="519 1690 690 1722" data-label="Text"> <p>Column Header</p> </div>
--	--	---

		<div data-bbox="852 1512 1429 1900" data-label="Text"> <p>Each column available in the Xsheet view has a header displaying the column's name. The column's name is the same as the corresponding timeline layer. If you rename one or the other, they will both be renamed.</p> <p>A quick access menu is available when you right-click. This menu contains the command affecting an entire column such as renaming, changing the default colour, or deleting a column.</p> <p>The tooltip that appears when you hover at the top of each Xsheet column shows the folder path to the</p> </div>
--	--	--

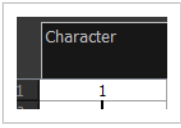
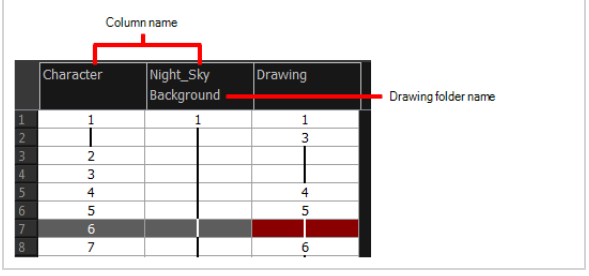
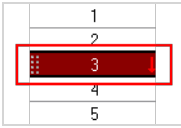

		<p>source drawings for that column.</p>  <p>In Harmony, the column header shows the layer's name and the name of the drawing folder to which it is linked. If the name of the layer is the same as the drawing folder, the drawing folder's name will not be displayed. For example; when you link a Timing column to a certain element (and thereby the Element's folder). To modify the name of the element folder independently from the column and layer name, you must select the Advanced Element Mode option preference in the Advanced tab of the Preferences dialog box.</p> 
	<p>Current Drawing</p>	<p>A drawing selected in dark red indicates that the drawing is currently displayed in the Drawing and Camera views. The current drawing selection is not linked to the drawing displayed in the Camera view since drawings from each visible layer are displayed at once.</p> 
	<p>Current Frame</p>	<p>The darker frame appearing in the Xsheet view represents the current frame.</p> 
	<p>Drawing Exposure</p>	<p>In the drawing columns, you can see the drawing names and their exposure. You can use any alphanumeric symbol to name your drawing. When a</p>

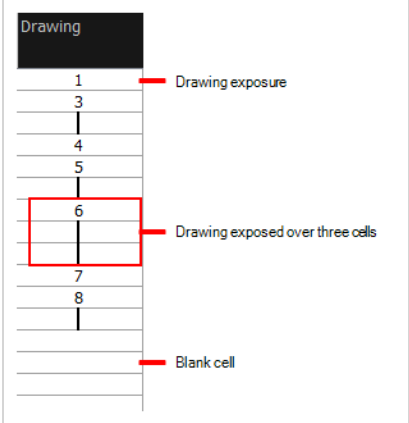
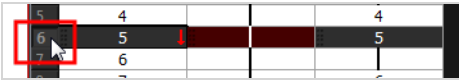
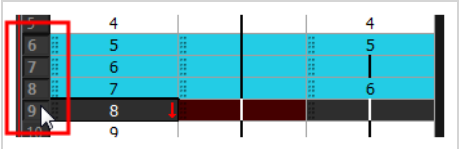
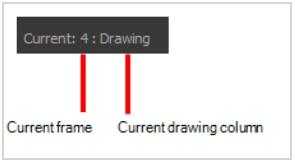
		<p>drawing is exposed over more than one cell, a vertical black line is displayed to indicate the continuity of the exposure. When there is no drawing in a cell, the cell will be blank.</p> 
	<p>Frame Numbers</p>	<p>On the left side of the Xsheet view, the frame numbers are shown indicating where you are. These read vertically instead of being displayed horizontally as they are in the Timeline view.</p> <ul style="list-style-type: none"> <li>To go to a particular frame, click the frame number.</li> </ul>  <ul style="list-style-type: none"> <li>To select an entire range of frames, click and drag a selection downwards.</li> </ul> 
	<p>Current Frame Display</p>	<p>At the bottom-right of the Xsheet view, you can see the current frame number, as well as the column containing the drawing currently displayed in the Drawing view.</p> 

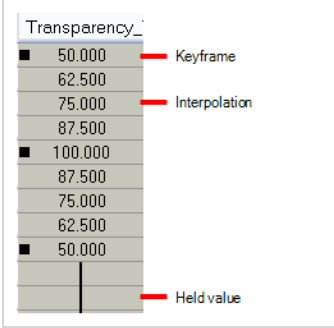
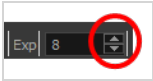
	<p>Functions Column</p>	<p>The functions columns are displayed in the Functions section of the Xsheet view. They represent the motion and rotation you applied to a drawing layer. Only the function columns related to the selected layer are displayed.</p> <p>A function column can also be related to an effect. Selecting the effect layer shows you the corresponding function column in the Xsheet view.</p> <p>The function columns display the position value or effect value on each cell. If there is a keyframe on a cell, a black square is displayed. Holding the same value for several frames displays a vertical black line.</p> 
	<p>Increase/Decrease Exposure</p>	<p>You can quickly increase or decrease the exposure of the selected cell by clicking on the up and down arrows in the Increase/Decrease Exposure field.</p> 
	<p>Overwrite/Insert Modes</p>	<p>The Overwrite/Insert button allows you to decide the way the values are inserted into the Xsheet.</p>