

Harmony20

Premium

Toon Boom Harmony 20 Premium Reference Guide



TOON BOOM ANIMATION INC.

4200 St.Laurent Blvd, Suite 1020
Montreal, Quebec, Canada
H2W 2R2

+1 514 278 8666

contact@toonboom.com
toonboom.com

Legal Notices

Toon Boom Animation Inc.
4200 Saint-Laurent, Suite 1020
Montreal, Quebec, Canada
H2W 2R2

Tel: +1 514 278 8666

Fax: +1 514 278 2666

toonboom.com

Disclaimer

The content of this document is the property of Toon Boom Animation Inc. and is copyrighted. Any reproduction in whole or in part is strictly prohibited.

The content of this document is covered by a specific limited warranty and exclusions and limit of liability under the applicable License Agreement as supplemented by the special terms and conditions for Adobe®Flash® File Format (SWF). For details, refer to the License Agreement and to those special terms and conditions.

Trademarks

Toon Boom® is a registered trademark. Harmony™ and the Toon Boom logo are trademarks of Toon Boom Animation Inc. All other trademarks of the property of their respective owners.

Publication Date

03-11-2021

Copyright © 2021 Toon Boom Animation Inc., a Corus Entertainment Inc. company. All rights reserved.

Table of Contents

Table of Contents	2
Introduction	16
Chapter 1: Dialog Boxes	18
Add Column Dialog Box	22
Add Drawing Layer Dialog Box	25
Add Frames Dialog Box	27
Add Prefix or Suffix Dialog Box	29
Add Synced Drawing Layer Dialog Box	30
Advanced Save Dialog Box	32
Attribute Information Dialog Box	37
Auto-Matte Dialog Box	40
Close Gaps Dialog Box	41
Column Properties Dialog Box	42
Column Types Dialog Box	44
Configure Line Art to Colour Art Dialog Box	45
Convert to Synced Drawing Layer Dialog Box	47
Create Cycle Dialog Box	48
Create Drawing from Drawing Selection Dialog Box	49
Create Function Step On Dialog Box	50
Create Palette Dialog Box	53
Create Palette from Selection Dialog Box	54
Database Selector Dialog Box	56
Deformer On Deformer Wizard Dialog Box	58
Edit Default Paste Preset Dialog Box	61
Edit Exposure Paste Preset Dialog Box	63
Element Manager Dialog Box	65
Envelope Creator Dialog Box	67
Export Layout Image Dialog Box	72
Export OpenGL Frames Dialog Box	75

Export Soundtracks Dialog Box	87
Export to Animated GIF Dialog Box	89
Export to Easel JS Dialog Box	92
Export to Flash Movie Dialog Box	95
Export to Video Dialog Box	97
Export to Sprite Sheet Dialog Box	103
Expression Dialog Box	106
Extend Exposure Dialog Box	108
Fill Cells Randomly Dialog Box	109
Fill Exposure Using Render Changes Dialog Box	110
Fill Selection Dialog Box	113
Function Wizard Dialog Box	114
Master Controller Grid Wizard Dialog Box	121
Import 3D Models Dialog Box	128
Import Images Dialog Box	130
Manage Local Cache Dialog Box	137
Manage Pre-Render Cache Dialog Box	139
Manage Tool Presets Dialog Box	141
Marker Dialog Box	143
Mini Playback Dialog Box	145
Movie Options Dialog Box (macOS)	146
QuickTime Movie Settings Dialog Box (Windows)	151
New Scene Dialog Box	156
New Tool Preset Dialog Box	158
Onion Skin and Light Table Transparency Dialog Box	160
Palette Browser Dialog Box	161
Palette Operations Dialog Box	164
Paste Preset Dialog Box	166
Paste Special Dialog Box	168
Pen Pressure Feel Dialog Box	173

Pose Copier Dialog Box	176
Preferences Dialog Box	178
Recolour Drawings Dialog Box	182
Remove Dirt Dialog Box	184
Remove Frames Dialog Box	185
Remove Hair Dialog Box	187
Render 3D Model Dialog Box	188
Render Write Nodes Dialog Box	193
Save Dialog Box	197
Scene Settings Dialog Box	199
Scripts Manager Dialog Box	212
Select Colour Dialog Box	214
Selection Presets Dialog Box	216
Sequence Fill Dialog Box	219
Set Ease for Multiple Parameters Dialog Box	221
Set Ease on Keyframes Dialog Box	223
Master Controller Slider Wizard Dialog Box	225
Show Hidden Columns Dialog Box	228
OpenQuickTime Sound Options Dialog Box (GNU/Linux)	230
QuickTime Sound Settings Dialog Box (Windows)	235
QuickTime Standard Video Compression Settings Dialog Box (Windows)	241
Tint Offset/Blend Dialog Box	249
Toolbar Manager Dialog Box	250
Vectorization Parameters Dialog Box	251
Versions Dialog Box	260
OpenQuickTime Video Options Dialog Box (GNU/Linux)	261
Windows Media Video Settings Dialog Box (Windows)	266
Xsheet Column Width Dialog Box	270
Chapter 2: Menus	272
Main Menus	274

Animation Menu	275
Drawing Menu	285
Edit Menu	293
File Menu	297
Help Menu	301
Insert Menu	303
Play Menu	305
Scene Menu	307
View Menu	309
Windows Menu	316
View Menus	318
3D Graph View Menu	319
Camera View Menu	321
Colour View Menu	338
Drawing View Menu	341
Function View Menu	354
Library View Menu	356
Model View Menu	358
Node View Menu	360
Node Library View Menu	365
Onion Skin View Menu	366
Perspective View Menu	368
Script Editor View Menu	374
Side View Menu	379
Timeline View Menu	384
Top View Menu	389
Xsheet View Menu	394
Chapter 3: Nodes / Layers	404
3D Nodes	411
3D Kinematic Output Node	412

Flatten Node	415
Render Maya Batch Node	417
Subnode Animation Node	422
Z Buffer Smoothing Node	426
Combine Nodes	428
Blending Node	429
Composite Node	435
Composite-Generic Node	440
Cutter Node	446
Highlight Node	448
Image Switch Node	452
Matte-Composite Node	454
Tone Node	457
Transformation Switch Node	461
Constraint Nodes	463
Constraint Switch Node	465
Dynamic Spring Node	468
Multi-Points Constraint Node	473
Static Transformation Node	476
Three-Points Constraint Node	479
Transformation Gate Node	482
Transformation Limit Node	484
Two-Points Constraint Node	490
Deformation Nodes	496
Articulation Node	497
Auto Fold Node	500
Auto Muscle Node	502
Bone Nodes	506
Curve Node	510
Deformation Composite Node	514

Deformation Root Node	517
Deformation Scale Node	518
Deformation Switch Node	523
Deformation Uniform Scale Node	525
Deformation Wave Node	527
Fold Node	530
Game Bone Node	534
Glue Node	536
Kinematic Output Node	538
Mesh Warp Node	539
Offset Node	543
Point Kinematic Output Node	545
Connections	546
Refract	552
Stick Node	554
Turbulence Node	556
Weighted Deform Node	560
Filter Nodes	564
Anti-Flicker Node	566
Auto-Patch Node	568
Bloom Node	570
Blur-Box Node	574
Blur-Directional Node	577
Connection	578
Layer Properties	579
Blur-Gaussian Node	581
Blur-Radial Node	584
Blur-Radial-Zoom Node	586
Blur-Variable Node	590
Brightness Contrast Node	592

Channel Selector Node	594
Channel Swap Node	596
Chroma-Keying Node	598
Colour Banding Node	604
Colour Art Node	607
Colour Curves Node Properties	609
Colour Fade Node	614
Palette Overrides	615
Individual Colour Overrides	617
Colour Levels Node	621
Colour-Override Node	624
Colour-Scale Node	629
Colour Selector Node	631
Contrast Node	634
Dither Node	636
Focus Node	638
Focus Multiplier Node	641
Gamma Node	643
Glow Node	646
Grain Node	650
Greyscale Node	652
Hue-Saturation Node	654
Increase Opacity Node	661
Layer Selector Node	664
Line Art Node	667
Luminance Threshold Node	669
Matte-Blur Node	672
Matte-Resize Node	675
Median Node	677
Motion Blur Node	680

Motion-Blur-Legacy Node	684
Negate Node	687
Overlay Layer Node	689
Pixelate Node	691
Remove Transparency Node	693
RGB Difference Keyer Node	695
Shadow Node	700
Transparency Node	703
Underlay Layer Node	705
Generator Nodes	708
Animated Matte Generator Node	709
Burn-In Node	720
Colour-Card Node	724
Element / Drawing Node	727
Connection	728
Field Chart Node	745
Gradient Node	750
Grid Node	756
Lens Flare Node	759
Turbulent Noise Node	762
Group Nodes	766
Group Node	767
Multi-Port-In Node	768
Multi-Port-Out Node	769
Miscellaneous Nodes	770
External Node	771
Master Controller Node	774
Note Node	780
OpenGL Bypass Node	781
OpenGL-Cache-Lock Node	783

Pre-Render Cache Node	786
Connection	787
Render Preview Node	790
Script Node	791
Visibility Node	794
Move Nodes	795
Apply Image Transformation Node	796
Apply Peg Transformation Node	799
Camera Node	803
OrthoLock Node	805
Peg Node	807
Shake Node	809
Transform-Loop Node	813
Quadmap Node	816
Quake Node	819
Output Nodes	822
Crop Node	823
Display Node	826
Multi-Layer Write Node	827
Scale Output Node	831
Write Node	833
Particle Nodes	847
3D Region	849
Baker	851
Baker Composite	854
Bounce	855
Explosion	857
Gravity	859
Image Fracture	861
Kill	867

Move Particles	869
Orbit	871
Planar Region	874
Random	878
Region Composite	879
Repulse	880
Rotation Velocity	881
Sink	884
Size	885
Sprite Emitter	887
System Composite	897
Velocity	898
Visualizer	901
Vortex	903
Wind-Friction	905
Shading Nodes	906
Ambient Occlusion Node	907
Cast Shadow Node	911
Light Position Node	918
Light Shader Node	920
Light Shader Properties - Surface Light Tab	924
Normal Map Node	925
Normal Map Converter Node	929
Shape Curve Node	931
Shape Line Node	934
Shape Render Node	936
Surface Map Node	939
Layer Properties	940
Surface Normal Node	943
Tone Shader Node	945

Tone Share Properties - Surface Light tab	948
Volume Object Node	949
Plugin Nodes	951
Sparkle	952
Selection Preset Note Node	955
Sound Layer	956
Chapter 4: Tools Properties	958
Brush Tool Properties	960
Centerline Editor Tool Properties	981
Close Gap Tool Properties	983
Colour Eyedropper Tool Properties	984
Contour Editor Tool Properties	985
Cutter Tool Properties	990
Drawing Pivot Tool Properties	995
Edit Gradient/Texture Tool Properties	997
Ellipse Tool Properties	998
Envelope Tool Properties	1008
Eraser Tool Properties	1011
Ink Tool Properties	1032
Inverse Kinematics Tool Properties	1034
Line Tool Properties	1037
Morphing Tool Properties	1049
Node Caching Toolbar	1053
Paint Tool Properties	1054
Pencil Tool Properties	1061
Pencil Editor Tool Properties	1072
Perspective Tool Properties	1077
Polyline Tool Properties	1080
Rectangle Tool Properties	1088
Reposition All Drawings Tool Properties	1098

Rigging Tool Properties	1100
Select Tool Properties	1103
Shift and Trace Tool Properties	1115
Smooth Editor Tool Properties	1118
Stamp Tool Properties	1120
Stroke Tool Properties	1128
Text Tool Properties	1130
Transform Tool Properties	1133
Zoom Tool Properties	1137
Chapter 5: Toolbars	1138
Workspace Toolbars	1140
Advanced Animation Toolbar	1141
Art Layer Toolbar	1143
Control Point Toolbar	1145
Coordinate Toolbar	1147
Deformation Toolbar	1148
Display Toolbar	1153
Easy Flipping Toolbar	1154
Edit Toolbar	1155
File Toolbar	1156
Flip Toolbar	1158
Game Toolbar	1159
Mark Drawing Toolbar	1160
Master Controller Toolbar	1161
Mini Playback Toolbar	1163
Node Caching Toolbar	1164
Onion Skin Toolbar	1165
Pen Settings Toolbar	1167
Playback Toolbar	1170
Scripting Toolbar	1173

Shift and Trace Toolbar	1174
Tool Presets Toolbar	1176
Tools Toolbar	1177
Workspace Toolbar	1183
View Toolbars	1184
3D Graph View Toolbar	1185
Animated Matte Generator Toolbar	1186
Script Editor Toolbar	1189
Timeline View Toolbar	1194
Xsheet View Toolbar	1199
Chapter 6: Views	1200
3D Graph View	1202
Animated Matte Generator View	1204
Camera View	1211
Colour View	1220
Coordinates and Control Points View	1228
Drawing View	1231
Drawing Substitutions View	1234
Function View	1236
Guides View	1239
Integrated Help View	1243
Layer Properties View	1244
Library View	1246
Master Controller View	1249
Message Log View	1251
Metadata Editor View	1252
Model View	1254
Node View	1256
Node Library View	1258
Onion Skin View	1261

Perspective View	1267
Script Editor View	1270
Side View	1275
Timeline View	1277
Tool Properties View	1287
Top View	1288
Xsheet View	1290

Introduction

Harmony has several commands, dialog boxes, and buttons. The Reference section lists all of them along with the matching definition. To understand how to use these functions in a production context, read the User guide.

In the Reference guide, you will learn about the various parameters available in dialog boxes, menus, nodes, toolbars, views, and windows.

The Preferences guide provides additional details about each individual preference.

Chapter 1: Dialog Boxes

Dialog boxes contain controls such as options and lists through which you can carry out a particular command or task. For example, in the Scene Settings dialog box, you must indicate the resolution and alignment. A typical dialog box looks as follows:

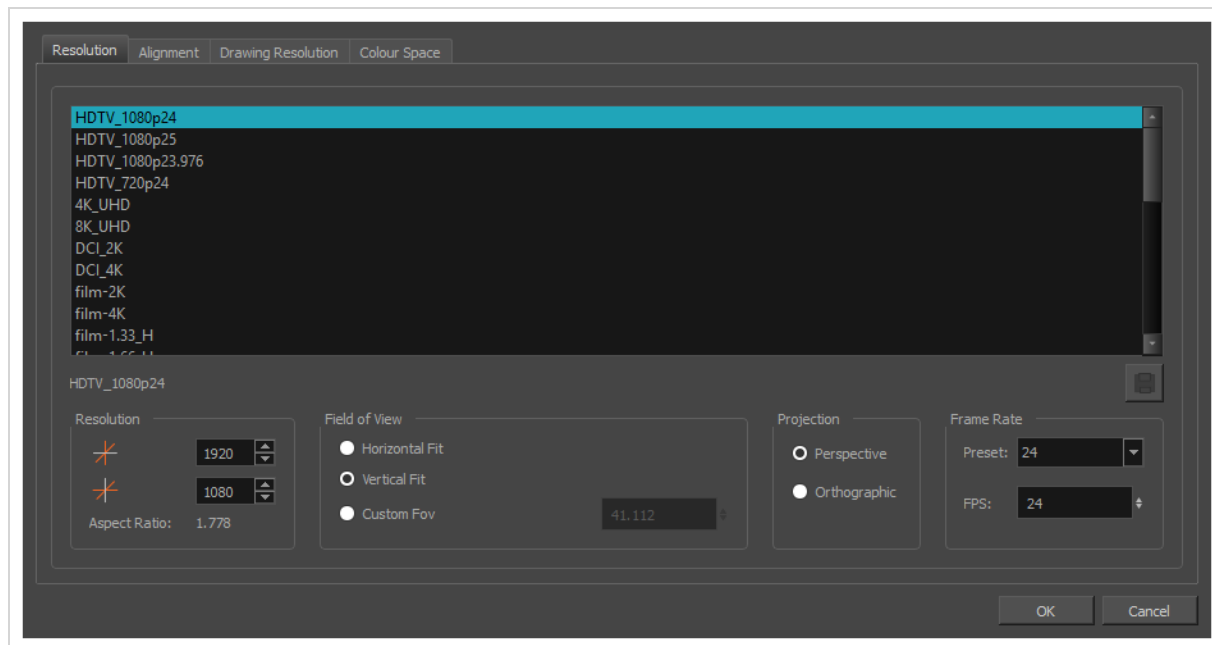

Add Column Dialog Box	22
Add Drawing Layer Dialog Box	25
Add Frames Dialog Box	27
Add Prefix or Suffix Dialog Box	29
Add Synced Drawing Layer Dialog Box	30
Advanced Save Dialog Box	32
Attribute Information Dialog Box	37
Auto-Matte Dialog Box	40
Close Gaps Dialog Box	41
Column Properties Dialog Box	42
Column Types Dialog Box	44
Configure Line Art to Colour Art Dialog Box	45
Convert to Synced Drawing Layer Dialog Box	47
Create Cycle Dialog Box	48
Create Drawing from Drawing Selection Dialog Box	49

Create Function Step On Dialog Box	50
Create Palette Dialog Box	53
Create Palette from Selection Dialog Box	54
Database Selector Dialog Box	56
Deformer On Deformer Wizard Dialog Box	58
Edit Default Paste Preset Dialog Box	61
Edit Exposure Paste Preset Dialog Box	63
Element Manager Dialog Box	65
Envelope Creator Dialog Box	67
Export Layout Image Dialog Box	72
Export OpenGL Frames Dialog Box	75
Export Soundtracks Dialog Box	87
Export to Animated GIF Dialog Box	89
Export to Easel JS Dialog Box	92
Export to Flash Movie Dialog Box	95
Export to Video Dialog Box	97
Export to Sprite Sheet Dialog Box	103
Expression Dialog Box	106
Extend Exposure Dialog Box	108
Fill Cells Randomly Dialog Box	109
Fill Exposure Using Render Changes Dialog Box	110
Fill Selection Dialog Box	113
Function Wizard Dialog Box	114
Master Controller Grid Wizard Dialog Box	121
Import 3D Models Dialog Box	128
Import Images Dialog Box	130
Manage Local Cache Dialog Box	137
Manage Pre-Render Cache Dialog Box	139
Manage Tool Presets Dialog Box	141
Marker Dialog Box	143

Mini Playback Dialog Box	145
Movie Options Dialog Box (macOS)	146
QuickTime Movie Settings Dialog Box (Windows)	151
New Scene Dialog Box	156
New Tool Preset Dialog Box	158
Onion Skin and Light Table Transparency Dialog Box	160
Palette Browser Dialog Box	161
Palette Operations Dialog Box	164
Paste Preset Dialog Box	166
Paste Special Dialog Box	168
Pen Pressure Feel Dialog Box	173
Pose Copier Dialog Box	176
Preferences Dialog Box	178
Recolour Drawings Dialog Box	182
Remove Dirt Dialog Box	184
Remove Frames Dialog Box	185
Remove Hair Dialog Box	187
Render 3D Model Dialog Box	188
Render Write Nodes Dialog Box	193
Save Dialog Box	197
Scene Settings Dialog Box	199
Scripts Manager Dialog Box	212
Select Colour Dialog Box	214
Selection Presets Dialog Box	216
Sequence Fill Dialog Box	219
Set Ease for Multiple Parameters Dialog Box	221
Set Ease on Keyframes Dialog Box	223
Master Controller Slider Wizard Dialog Box	225
Show Hidden Columns Dialog Box	228
OpenQuickTime Sound Options Dialog Box (GNU/Linux)	230

QuickTime Sound Settings Dialog Box (Windows)	235
QuickTime Standard Video Compression Settings Dialog Box (Windows)	241
Tint Offset/Blend Dialog Box	249
Toolbar Manager Dialog Box	250
Vectorization Parameters Dialog Box	251
Versions Dialog Box	260
OpenQuickTime Video Options Dialog Box (GNU/Linux)	261
Windows Media Video Settings Dialog Box (Windows)	266
Xsheet Column Width Dialog Box	270

Add Column Dialog Box

The Add Column dialog box lets you add a column in the Xsheet view.

By default, when you create a new scene, there is one drawing column in the Xsheet view and one corresponding drawing layer in the Timeline view.

You can add an element for each drawing and it will appear as a column in the Xsheet view, a layer in the Timeline view, and a node in the Node view.

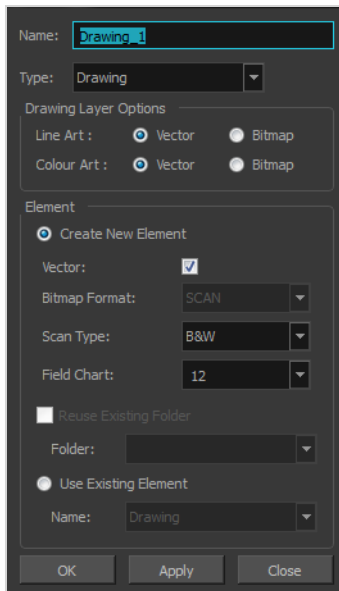

How to access the Add Column dialog box

1. Do one of the following:
 - In the Xsheet menu, select **Columns > Add Columns**.
 - Click the Add Columns + button.
 - Press Shift + C.



NOTE

The Add Column dialog box contains additional parameters for working with elements which will only display if you set advanced preferences. To do this, press Ctrl + U (Windows/Linux) or ⌘ + U (macOS) to open the Preferences dialog box. Select the **Advanced** tab, then select the **Advanced Element Mode** option and click **OK**.

Parameter	Description
-----------	-------------

Name	Lets you give the new column a meaningful name.
Type	Lets you select a type of column to create. Choices include: Drawing, Timing, Sound, 3D Path, 3D Rotation, Bezier Curve, Ease Curve, Expression and Annotation.
Drawing Layer Options	
Line Art	Creates a vector or bitmap drawing column in the Line Art layer.
Colour Art	Creates a vector or bitmap drawing column in the Colour Art layer.
Element	
Create New Element	Creates an independent column with its own drawing folder.
Vector	Select this option if you want the layer to contain vector drawings. Deselect this option if you want the layer to contain bitmap images. Most of the time, the Vector option will be enabled.
Bitmap Format	Lets you select the type of bitmap image to insert in the column. Select SCAN from the list if you are planning to scan drawings using the Toon Boom Harmony Premium Scan module.
Scan Type	If you chose SCAN from the Bitmap Format list, select the kind of scanning you want to achieve.
Field Chart	When importing traditional animation, lets you indicate the size of paper on which the animation or background was drawn. If you are not using perforated animation paper, leave the 12 field default value as is.
Reuse Existing Element	Links your column to an existing folder within the Element folder of your scene.
Folder	Lets you select the folder to which you want to link your new column.
Use Existing Element	Uses drawings from an existing column in the new column. Both columns will be attached to the same set of drawings, but their timing will remain independent from one another. If you modify one of the drawings, it will be modified in both columns. This is the same principle as the Clone column.

Name	Lets you select the column to which you want to link your new column.
Add and Close	Adds the selected type of layers to the Timeline view and corresponding column in the Xsheet view and closes the dialog box. The names of the layers/columns are automatically numbered incrementally.
Add	Adds the selected type of layers to the Timeline view and corresponding column in the Xsheet view. The dialog box remains open for you to add as many layers/columns as needed. The names of the layers/columns are automatically numbered incrementally.
Close	Closes the dialog box.

Add Drawing Layer Dialog Box

The Add Drawing Layer dialog box lets you add a drawing layer to your project.

By default, when you create a new scene, there is one drawing column in the Xsheet view and one corresponding drawing layer in the Timeline view.

You can add an element for each drawing and it will appear as a column in the Xsheet view, a layer in the Timeline view, and a node in the Node view.

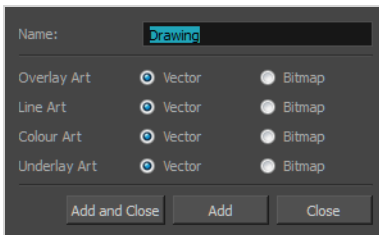
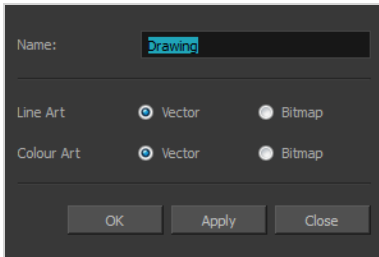

How to access the Add Drawing Layer dialog box

1. Do one of the following:
 - In the Timeline view, click the Add Drawing Layer  button.
 - From the top menu, select **Insert > Drawing**.
 - Press Ctrl + R (Windows/Linux) or ⌘ + R (macOS).

Parameter	Description
Name	Lets you give the new layer a meaningful name.
Overlay Art	Creates a vector or bitmap drawing layer in the Overlay Art layer.
Line Art	Creates a vector or bitmap drawing layer in the Line Art layer.
Colour Art	Creates a vector or bitmap drawing layer in the Colour Art layer.

Underlay Art	Creates a vector or bitmap drawing layer in the Underlay Art layer.
Add and Close	Adds the selected type of layers to the Timeline view and corresponding column in the Xsheet view and closes the dialog box. The names of the layers/columns are automatically numbered incrementally.
Add	Adds the selected type of layers to the Timeline view and corresponding column in the Xsheet view. The dialog box remains open for you to add as many layers/columns as needed. The names of the layers/columns are automatically numbered incrementally.
Close	Closes the dialog box.

Add Frames Dialog Box

The Add Frames dialog box allows you to add a given amount of frames at a specific point in your scene. The new frames are added to every layer in your scene and will offset all the keyframes and drawings after the insertion point.

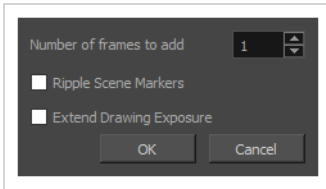

How to access the Add Frames dialog box

1. In the Timeline or Xsheet view, select a frame or a range of frames.

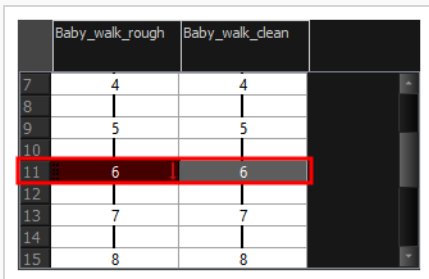
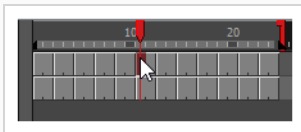

2. Do one of the following:

- From the top menu, select **Scene > Frame > Add Frames at Start, Add Frames at End, Add Frames Before Selection** or **Add Frames After Selection**.
- In the Xsheet view, right-click and select **Frame > Add Frames at Start, Add Frames at End, Add Frames Before Selection** or **Add Frames After Selection**.
- In the Xsheet toolbar, click the  Add Frames button to add frames after your selection.
- Press **Ctrl + G** (Windows/Linux) or **⌘ + G** (macOS) to add frames before the selection, or **Ctrl + H** to add frames after the selection.

The Add Frames dialog box appears.

Parameter	Description
Number of frames to add	The amount of frames to add.

Parameter	Description
Ripple Scene Markers	<p>If checked, scene markers after the insertion point will be offset forward to remain synchronized with the keyframes and drawings in your scene. If unchecked, scene markers will remain in place while everything else after the insertion point is offset.</p>
Extend Drawing Exposure	<p>If checked, drawings that are exposed just before the insertion point will be exposed throughout the added frames. If unchecked, no drawing will be exposed in the added frames.</p> <div data-bbox="565 615 1430 751" style="border: 1px solid green; padding: 5px;"> NOTE This option has no effect when adding frames at the start of the scene.</div>

Add Prefix or Suffix Dialog Box

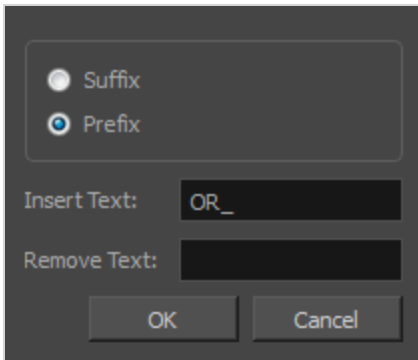

The Add Prefix or Suffix dialog box lets you add or remove a prefix or suffix for a multi-layer or multi-node selection.

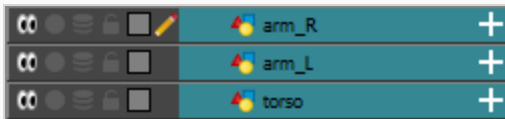

How to access the Add Prefix or Suffix dialog box

1. In the Network or Timeline view, select all the nodes or layers to rename or press Ctrl + A (Windows/Linux) or ⌘ + A (macOS).



2. In the Scripting toolbar, click the Add Prefix or Suffix Script  button. If the Scripting toolbar is not visible, you can display it by selecting **Windows > Toolbars > Scripting** from the top menu. If the Add Prefix or Suffix Script  button is not visible in the Scripting toolbar.

The Add Prefix or Suffix dialog box opens.

Parameter	Description
Suffix	Allows you put a defined set of characters (letters, numbers, symbols) after the pre-existing layer or node name.
Prefix	Allows you put a defined set of characters (letters, numbers, symbols) before the pre-existing layer or node name.
Insert Text	Enter a set of characters to be added to the selected layers or nodes.
Remove Text	Enter a set of characters to be removed from the selected layers or nodes.

Add Synced Drawing Layer Dialog Box

The Add Synced Drawing Layer dialog box lets you add a drawing layer to your project that will automatically be synced with the currently selected layer.

Depending on whether the Support Overlay and Underlay Arts option was selected in the Advanced tab of the Preferences panel, the Add Synced Drawing Layer dialog box may look one of two ways.

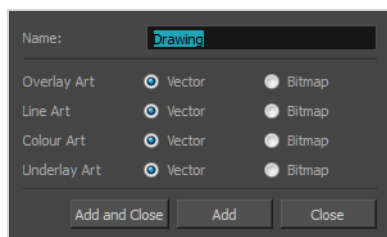
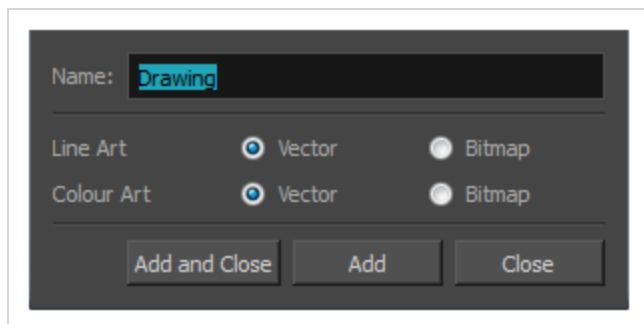

How to access the Add Synced Drawing Layer dialog box

1. In the Timeline view, right-click on the drawing layer you would like to sync with another layer.
2. From the right-click menu, select **Add Synced Drawing Layer**.

Parameter	Description
Name	Lets you give the new layer a meaningful name.
Overlay Art	Creates a vector or bitmap drawing layer in the Overlay Art layer.
Line Art	Creates a vector or bitmap drawing layer in the Line Art layer.
Colour Art	Creates a vector or bitmap drawing layer in the Colour Art layer.
Underlay Art	Creates a vector or bitmap drawing layer in the Underlay Art layer.

Add and Close	Adds the selected type of layers to the Timeline view and corresponding column in the Xsheet view and closes the dialog box. The names of the layers/columns are automatically numbered incrementally.
Add	Adds the selected type of layers to the Timeline view and corresponding column in the Xsheet view. The dialog box remains open for you to add as many layers/columns as needed. The names of the layers/columns are automatically numbered incrementally.
Close	Closes the dialog box.

Advanced Save Dialog Box

In Harmony Server, the Advanced Save dialog box lets you save the scene as a new version, overwrite an existing version, set a new current version, display a list of modified drawings, colour palettes, and modified colour palette lists.

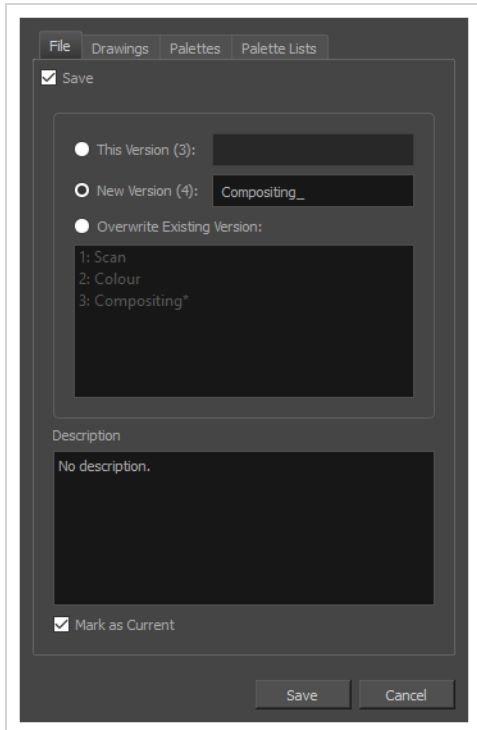

How to access the Advanced Save dialog Box

1. Make sure that you have the necessary rights to save the current scene version. If you do not, you can acquire the rights by selecting **File > Rights to Modify Scene Version** or **Rights to Modify Scene** from the top menu.
2. From the top menu, select **File > Advanced Save**.

The Advanced Save dialog appears.

File Tab

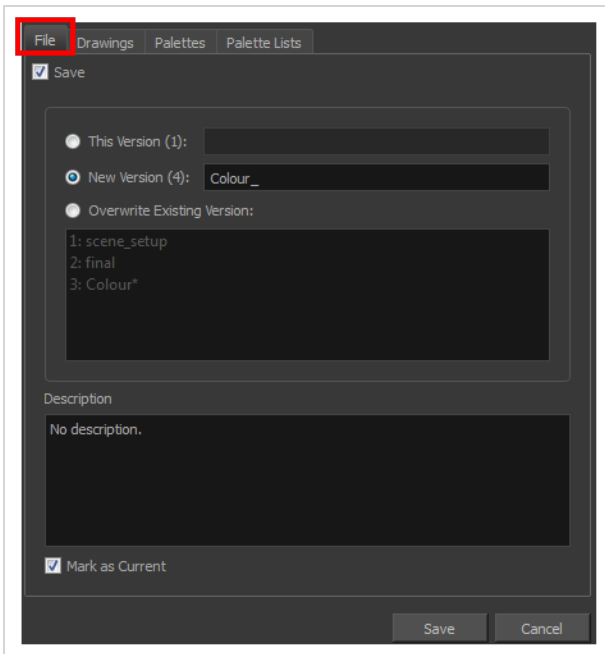

Parameter	Description
Save	<ul style="list-style-type: none"> ▶ Enable this option if you want to save the modifications made to the current scene. ▶ Deselect the Save option if you only want to save specific components of your scene listed in the Drawings, Palettes or Palette Lists tabs. This will disable all option in the File tab.
This Version (number)	Saves the current version of the scene. You can rename the current version by typing a new name into the field.
New Version (number)	Saves the current scene as a new version. You can name this new version by typing a name into the field.
Overwrite Existing Version	Lets you select an existing version of your scene from the list to overwrite it.
Description	Use this field to add or edit an existing description for the scene version you want to save.
Mark as Current	Lets you set this scene version as the current one. This version will be automatically selected as the default current version when the scene is selected in the Database Selector dialog box

Drawings (Harmony Server only)

The Drawings tab lists the modified drawings.

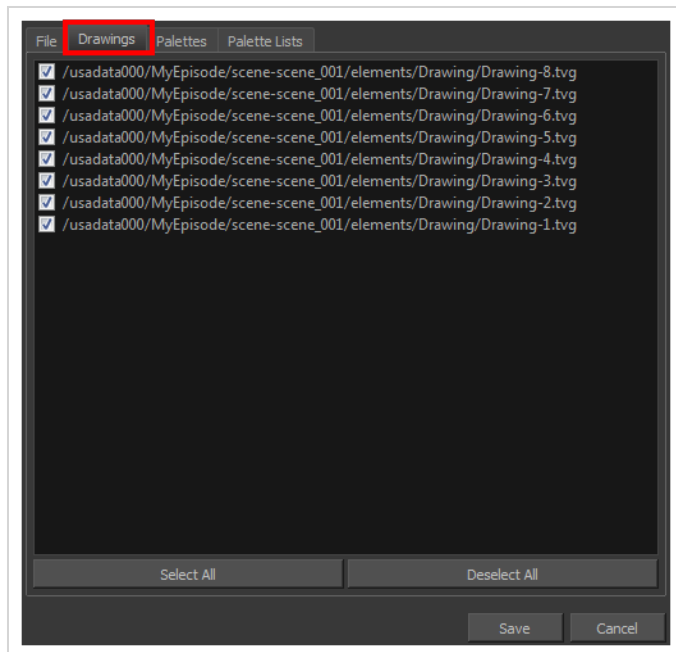

Parameter	Description
Drawing list	Lets you select the modified drawings to save, and deselect the ones you do not want to save.
Select All	Selects all modified drawings in list.
Deselect All	Deselects all modified drawings in the list.

Palettes Tab

The Palette tab lists the modified colour palettes.

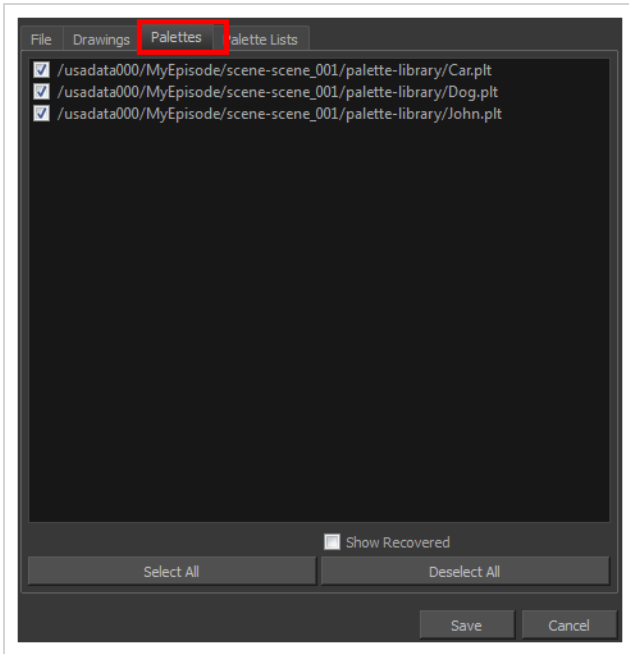

Parameter	Description
Colour Palette list	Lets you select the colour palette to save, and deselect the ones you do not want to save.
Show Recovered	Displays the recovered palettes in the list of modified palettes.
Select All	Selects all modified colour palettes in the palette list.
Deselect All	Deselects all modified colour palettes in the palette list.

Palette Lists Tab

The Palette Lists tab lists all the modified colour palette lists.

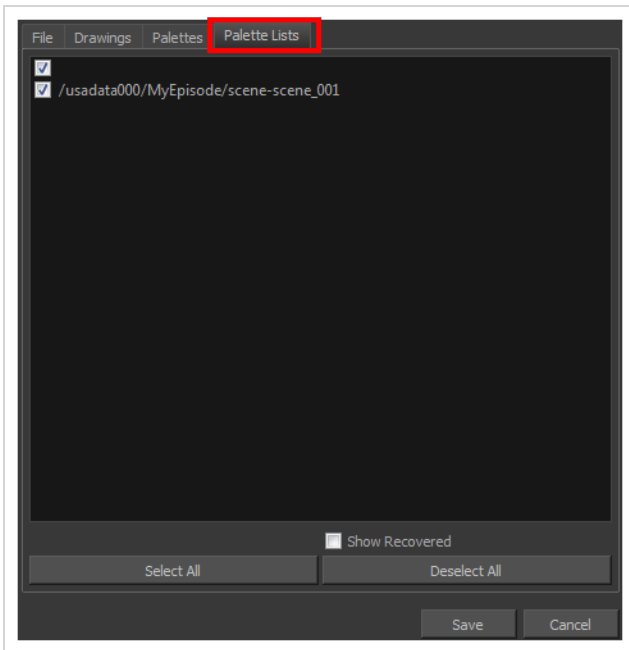



Parameter	Description
Palette Lists	Lets you select the modified palette list to save, and deselect the ones you do not want to save.
Show Recovered	Displays the recovered palettes in the list of modified palettes.
Select All	Selects all modified palette lists in the list.
Deselect All	Deselects all modified palette lists in the list.

Attribute Information Dialog Box

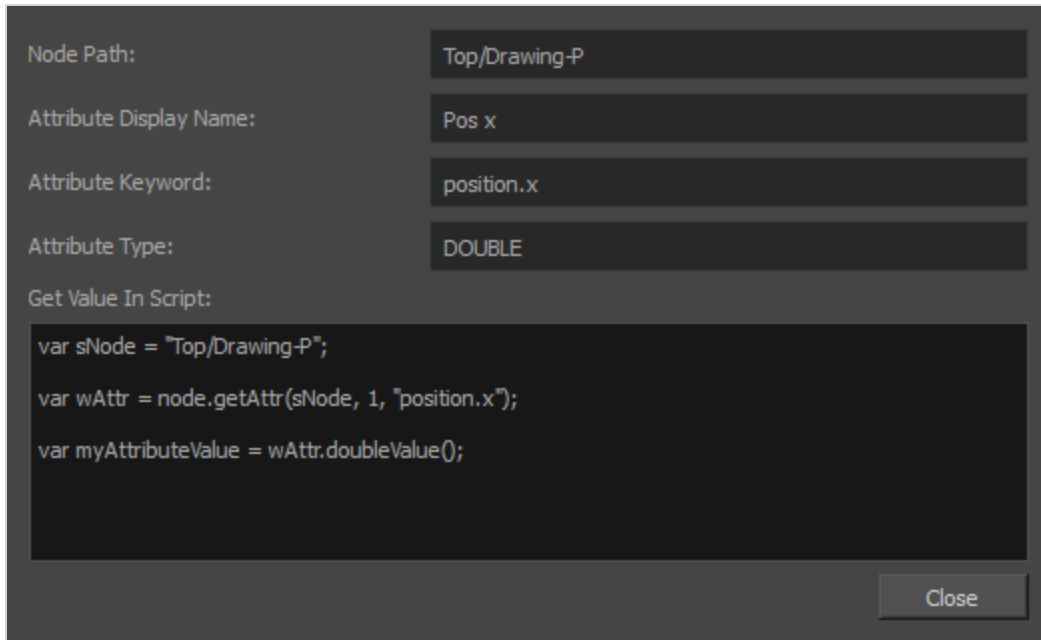
The Attribute Information dialog box displays information for accessing a specific attribute in a specific node through the Harmony scripting interface.



How to access the Attribute Information Dialog Box

1. In the top-left corner of the Node view, click on the  Menu button and select **View > Show Attribute Information**.
2. In the Node view, locate the node which you want to manipulate through scripting.
3. Click on the  Layer Properties button for this node.

The Layer Properties dialog for this node appears. Right of each attribute is a  Show Attribute Information button.

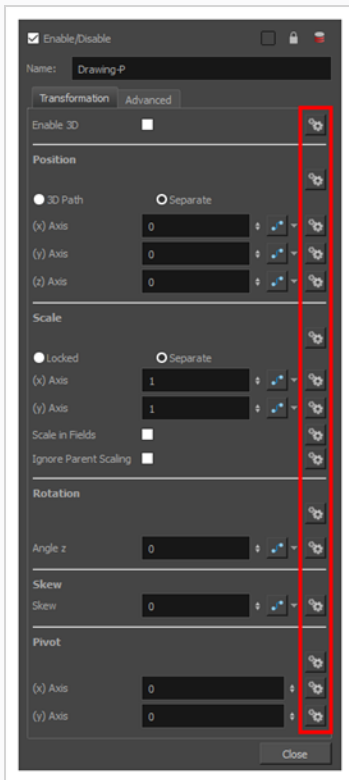

- Click on the  Show Attribute Information button next to the attribute which you want to access through scripting.

The Attribute Information dialog appears and displays information on the attribute, as well as a sample script to access the attribute.

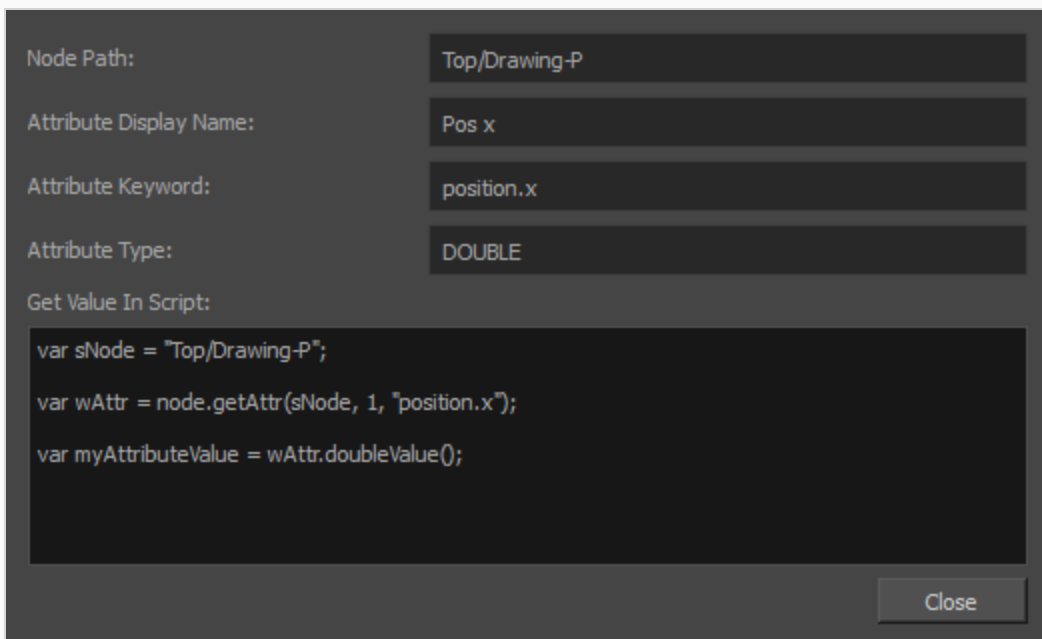

Parameter	Description
Node Path	The path to access the node in your scene's node system. This path is the hierarchy of groups in which the node is located, and always starts with Top , which represents the root of the scene's group hierarchy. For example, if the node is named master-P and is inside a group named CH001_MyCharacter in the scene's root, its path would be Top/CH001_MyCharacter/master-P .
Attribute Display Name	The user friendly name of the attribute. This name cannot be used in the Harmony scripting interface.
Attribute Keyword	The actual name of the attribute in the Harmony scripting interface.
Attribute Type	The type of the attribute.
Get Value in Script	A sample script to access the attribute and store its value in a variable.

Auto-Matte Dialog Box

The Auto-Matte dialog box lets you generate a matte for a drawing.

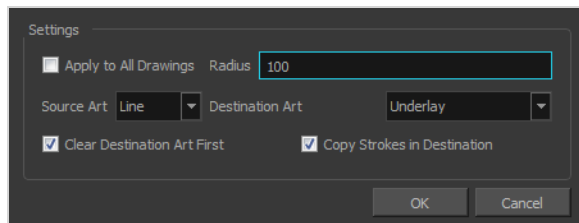

How to access the Auto Matte dialog box

1. In the Camera or Drawing view, select the drawing you want to create a matte for.
2. Do one of the following:
 - From the top menu, select **Drawing > Generate Auto-Matte**.
 - In the Camera or Drawing menu, select **Drawing > Generate Auto-Matte**.

Parameter	Description
Settings	
Apply to all Drawings	Creates a matte for all the drawings included in layer.
Radius	Lets you increase or decrease the radius value depending on the precision or roughness of your line. Use a lower value, the closer to your lines' contours the matte will be shaped. The higher the value, the looser the matte will be shaped.
Source Art	Lets you select the layer from which you want the matte created: Line Art, Colour Art, Underlay or Overlay .
Destination Art	Lets you select the layer on which you want the matte to be created: Line Art, Colour Art, Underlay or Overlay .
Clear Destination Art First	Deletes existing artwork on the destination layer before adding a matte to it.
Copy Strokes in Destination	Copies the contour of your lines as invisible lines in the matte drawing. This is useful if you need to reuse the lines later.

Close Gaps Dialog Box

The Close Gaps dialog box lets you close up drawing areas that not are closed. This may sometimes happen when painting. You can close small gaps in a drawing by creating small, invisible strokes between the two closest points to close the colour zone. You do not need to trace directly over the gap. You can draw it a few millimeters away. The two closest points automatically close the gap.

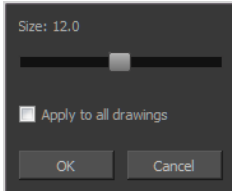

How to access the Close Gaps dialog box

1. Select **View > Show > Show Strokes** or press K to see a preview of the result.
2. To flatten the strokes you draw, click the Auto-Flatten  button in the Tool Properties view.
3. Select **Drawing > Clean Up > Close Gaps** or press Shift + F10 (Windows/Linux only).

The Close Gaps dialog box opens.

Parameter	Description
Size	Lets you set the size of the gap you want to be closed.
Apply to all drawings	Closes all gaps in the drawing of the selected layer.

Column Properties Dialog Box

The Column Properties dialog box lets you add, delete or modify elements (drawing folders) in your scene.

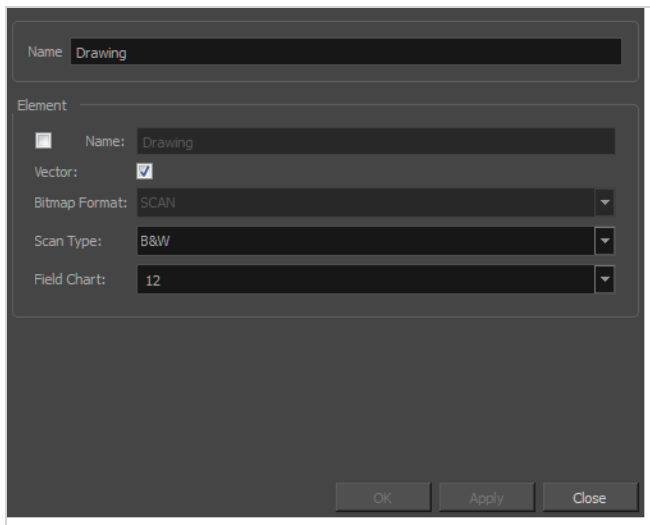

How to access the Drawing dialog box

1. In the Xsheet view, double-click on a column name. Do not click on the drawing folder name that the column is linked to (this also appears in the column header just below the column name).

Parameter	Description
Name	Type in a new name in this field to create an element or to rename the selected element.
Element	
Name	Type in a new name in this field to create an element or to rename the selected element.
Vector	Select this option if the new element is a vector drawing or if you want to enable the parameters on the selected element in the Elements list.
Bitmap Format	Lets you select the file format of the bitmap layer.
Scan Type	If you're planning to scan elements with the Toon Boom Harmony Premium Scan module, select the scan type from the list.

Field Chart	If you're importing traditional animation, select the size of the paper on which the animation was drawn.
-------------	---

Column Types Dialog Box

The Columns Types dialog box lets you show or hide columns in the exposure sheet.

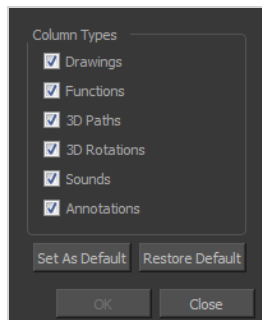

How to access the Columns Types dialog box

1. In the Xsheet view, select **View > Column Types Manager**.

The Column Types dialog box opens.

Parameter	Description
Column Types	Lets you select the types of columns to display in the Xsheet view.
Save as Default	Makes these new settings the default ones used each time you start Harmony.
Restore Default	Returns the settings to their defaults.

Configure Line Art to Colour Art Dialog Box

The Configure Line Art to Colour Art dialog box lets you modify settings for the Line Art and Colour Art layers.

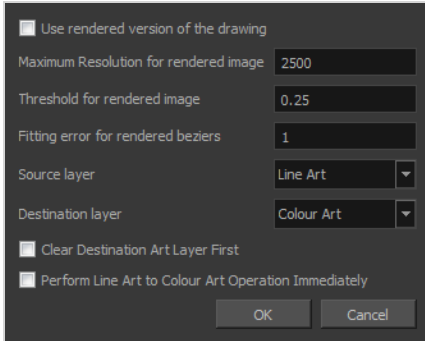

How to access the Configure Line Art to Colour Art dialog box

1. In the Tools toolbar, select the Select tool.
2. In the Tool Properties view, hold down the Shift key and click on the Create Colour Art from Line Art button.

Parameter	Description
Use rendered version of the drawing	Renders the drawing and vectorize it to calculate the position of the centreline that will produce the colour art stroke.
Maximum Resolution for rendered image	The size of the rendered image.
Threshold for rendered image	The value of grey processed to create the rendered vectorized arts.
Fitting error for rendered Beziers	This value represents how precise the fitting of the colour art zone in relation to the line art will be.
Source layer	Lets you select the layer (Line Art, Colour Art, Underlay or Overlay) you want the colour art to be created from.
Destination layer	Lets you select the layer (Line Art, Colour Art, Underlay or Overlay) you want the colour art to be created on.
Clear Destination Art Layer First	Deletes the content before the colour art is added. This is useful when you already have artwork on the destination layer.

Perform Line Art to Colour Art Operation Immediately	Performs the Create Colour Art from Line Art command when you click OK.
---	--

Convert to Synced Drawing Layer Dialog Box

The Sync Layer feature allows for drawings to be separated on different layers, but to have the same timing.

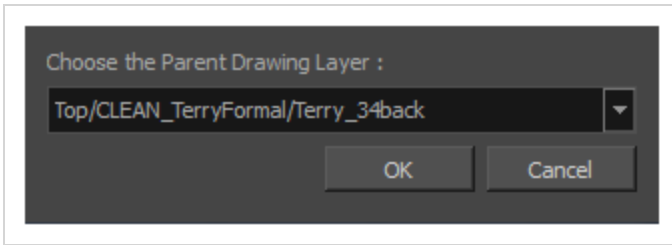

How to access the Convert to Synced Drawing Layer dialog box

1. right-click on a drawing layer you would like to sync with another layer.
2. From the right-click menu, select **Sync Layers With**.

In the Choose the Parent Drawing Layer drop-down list, with the exception of the selected layer, every layer in your scene is listed.

3. To sync a layer with your currently selected layer, from the drop-down list, select a parent drawing layer and click OK. The child layer immediately updates to the parent layer's timing.

Create Cycle Dialog Box

The Create Cycle dialog box lets you create cycles from a series of drawings and exposures.

When you create a drawing cycle, all the repeated drawings are linked to the same original files. When modify, repaint, or correct a drawing named “1” for example, all drawings named “1” are updated simultaneously. In order to modify a drawing independently from its other exposures, you must duplicate the drawing.

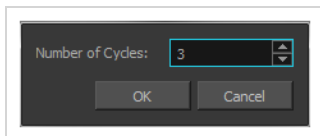

How to access the Create Cycle dialog box

1. In the Timeline or Xsheet view, select the cell range to loop.

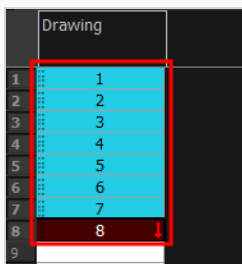
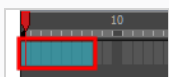

2. In the Timeline toolbar, click the Create Cycle  button (you may have to customize the toolbar to display it).

The Create Cycle dialog box opens.

Parameter	Description
Number of Cycles	Lets you specify the number of cycles, including the current selection.

Create Drawing from Drawing Selection Dialog Box

The Create Drawing from Drawing Selection dialog box lets you cut a part of a drawing and send it to a new or existing layer.

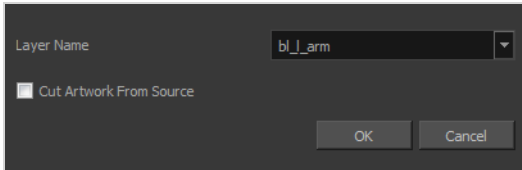

How to access the Create Drawing from Drawing Selection dialog box

1. From the top menu, select **Edit > Create Drawing From Drawing Selection** or press F9 (Windows/Linux) or ⌘ + F9 (macOS).

The Create Drawing From Drawing Selection dialog box opens.



Parameter	Description
Layer Name	Lets you enter a name for the layer using the naming convention you established.
Cut Artwork From Source	Lets you cut the selected artwork from the model.

Create Function Step On Dialog Box

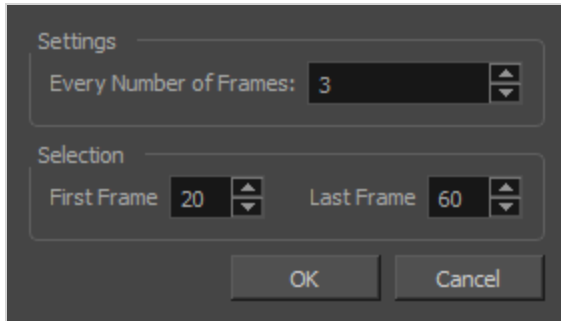
The Create Function Step On dialog box lets you hold the same value over a selected number of frames for multiple parameters (pos x, scale y, etc.). This works well when you are animating drawings on 2s or 3s, for example, and you want to hold the same value for a function over those two or three frames.



How to access the Create Function Step On dialog box

1. Add the Scripting toolbar to your interface:
 - Go to the top menu and select **Windows > Toolbars > Scripting**.
 - right-click on the empty space near the top of the interface and from the quick-access menu selecting **Scripting**.
 - right-click on the empty space near the top of a view and from the quick-access menu selecting **Scripting**.
2. In the Scripting toolbar, click on the Manage Scripts  button to open the Scripts Manager window.
3. In the Scripts Manager, in the Files section, select the file **TB_CreateStepsOn.js**.
The functions associated with that file appear in the Functions section.
4. In the Functions section, select **TB_CreateStepsOn**.
The Add script to toolbar  button becomes active.

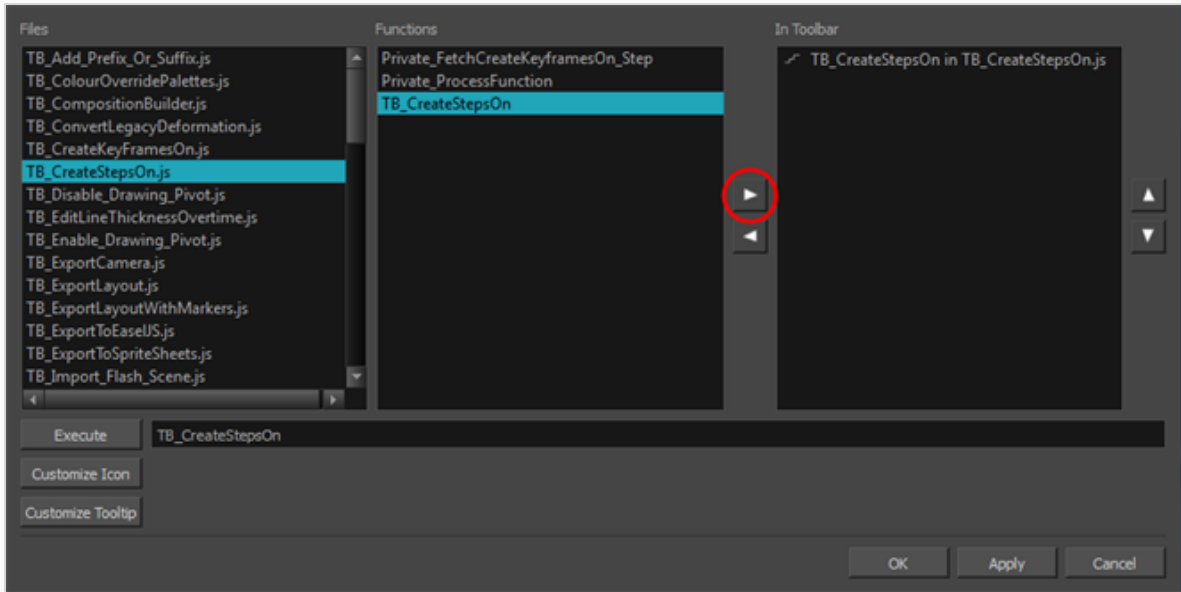

5. Click on the Add script to toolbar ▷ button.
The TB_CreateStepsOn script button is added to the Scripting toolbar.
6. Click **Apply**.
7. Click **OK**.
8. In the Timeline view, select the layer whose parameter values you would like to hold.
9. In the Scripting toolbar, click on the TB_CreateStepsOn script button.

The Create Function Step On dialog box appears.

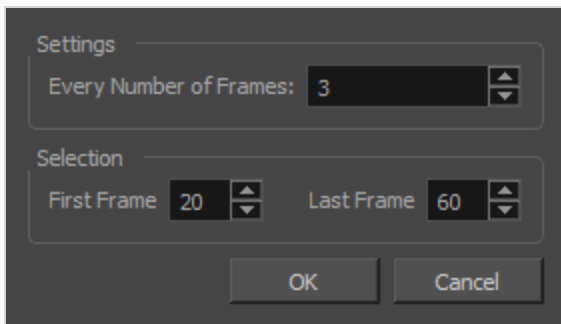

Parameter	Description
Settings	
Every Number of Frames	Enter in the number of frames you would like to hold your functions.

Selection	
First Frame	Enter in the frame number of where you would like the stepped holds to start. The playhead location determines the lowest value you can enter for the first frame. You need to move the playhead to frame one if you would like to set frame one as the lowest possible starting value.
Last Frame	Enter in the frame number of where you would like the stepped holds to stop.

Create Palette Dialog Box

The Create Palette dialog box allows you to create a colour palette for your scene. Palettes created with this dialog box are added to your scene's palette list, and stored in your scene's **palette-library** subdirectory.

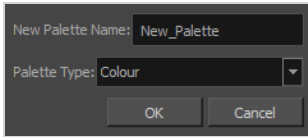

NOTE

If you have the Advanced Palette Lists preference enabled, the dialog will also have a palette browser, which allows you to decide where the palette is stored and whether to add it to the scene or the element's palette list—see [Palette Browser Dialog Box on page 161](#).

How to access the Create Palette dialog box

1. Do one of the following:
 - In the Colour View, click the New Palette **+** button over the palette list.
 - From the Colour view menu, select **Palettes > New**

Parameter	Description
New Palette Name	Allows you to type in the name of the palette to create.
Palette Type	Allows you choose the palette type to create: <ul style="list-style-type: none"> • Colour: A colour palette can contain colours, gradients and bitmap textures. • Pencil Texture: A pencil texture palette can contain textures to apply as transparency filters to pencil lines, in combination to their line colour, to create various styles of pencil lines.

Create Palette from Selection Dialog Box

The Create Palette from Selection dialog box allows you to create a palette that contains all the colours used by all the drawings in the selected drawing layers.

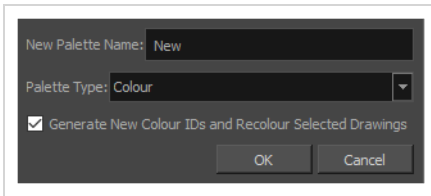

This can be useful, for example, if the colour design for a character model or rig, a background or another kind of asset was made using several different palettes, and you need to consolidate all of the colours used by the asset into its own dedicated palette.



NOTES

- The Create Palette from Selection dialog uses the colours in all the drawings in the selected layers, even drawings that are not exposed.
- For tasks related to this dialog box, see the User Guide.

How to access the Create Palette from Selection dialog box

1. In the Timeline, Xsheet, Camera or Node view, select one or more drawing layers.
2. In the top-left corner of the Colour view, open the  View Menu and select **Palettes > New Palette from Selected Drawings**.

Parameter	Description
New Palette Name	Allows you to type in the name of the palette to create.
Palette Type	Allows you choose one of the type of palette to create: <ul style="list-style-type: none"> • Colour: Creates a palette containing all the colours, gradients and bitmap textures used in the selected drawing layers. • Pencil Texture: Creates a palette containing all the pencil textures used in the selected drawing layers.
Generate New Colour IDs and Recolour Selected Drawings	By default, the Create Palette from Selection dialog box generates the palette by copying the colour swatches used in the selected drawings from their original palette into a new palette, along with their colour ID. This means that the colour swatches in the generated palette will use the same colour IDs as the ones in the original palettes.

If you select this option, Harmony will generate a palette with new colour IDs, and will replace the old colour IDs in your artwork with the new ones. This will usually have no visible effect, and will prevent the swatches in the new palette from having the same colour IDs as the swatches you originally used to colour your artwork. When two palettes have a swatch with the same colour ID, Harmony uses the swatch from the top-most palette in the palette list.



NOTE

If your artwork uses Colour-Override effects, the colour IDs used by these Colour-Override will not be replaced with the new colour IDs, making the Colour-Override ineffective unless you reconfigure them manually. Hence, you should avoid using this parameter if you are consolidating the palette of a character rig that uses a lot of Colour-Overrides.

Database Selector Dialog Box

The Database Selector dialog box lets you connect to your studio's central database when working on Harmony Server.



NOTE

When you connect to the database, you cannot create new scenes directly from Harmony. The available scenes must have been already created using the Control Center module.

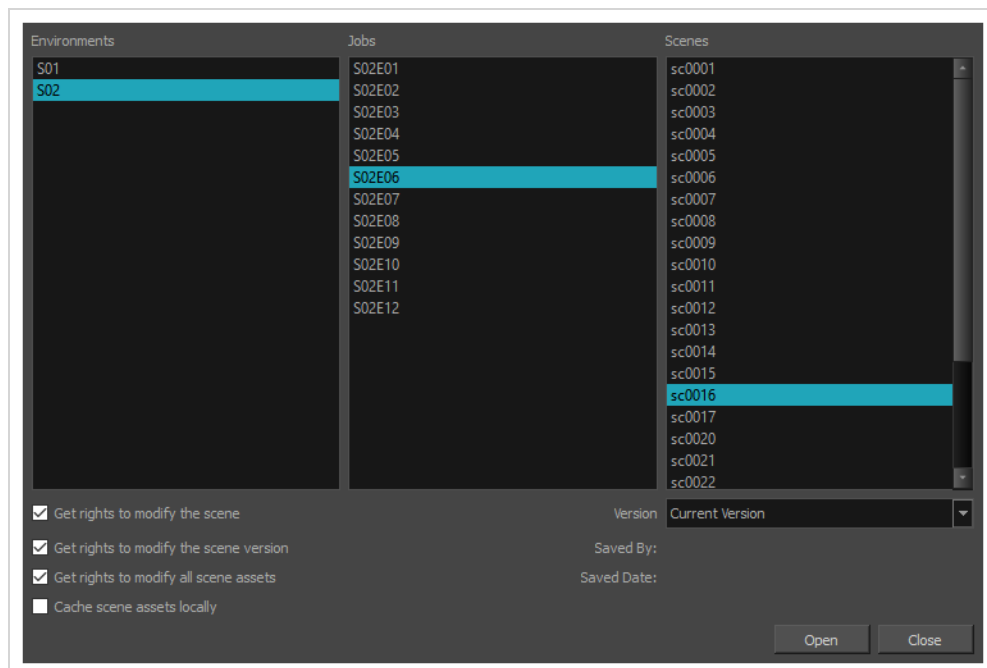

How to access the Database Selector dialog box

1. Start Harmony
2. In the log-in dialog, select **Connect to Database**.
3. In the **User Name** field, type in your Harmony Server username.
4. Click on **OK**.

The Database Selector dialog box opens.

Parameter	Description
Environments	Lets you select the scene's environment (project, movie).

Jobs	Lets you select the scene's job (episode, sequence).
Scenes	Lets you select the scene.
Get rights to modify the scene	Allows you to modify the selected version of the scene as well as to manage and overwrite other versions. Other users will not be able to open a different version of the scene until you close the scene.
Get rights to modify the scene version	Allows you to modify the currently selected scene version only. Unless the Get rights to modify the scene option is also checked, you will not be able to change other versions of the scene. This allows other users to modify different versions of the scene while you are working on the selected version.
Get rights to modify all scene assets	Automatically gets the rights to modify all of the scene's assets, locking other users from making changes to them until you close the scene. This means that you will have the rights to modify all the scene's versions, drawings, palettes, its palette list, but not its library folder. If this option is unchecked, drawings and palettes will be locked unless you unlock them manually. This can allow another user to work on the scene's drawings and palettes in Paint while you are working on the scene's timing or staging in Harmony.
Cache scene assets locally	<p>Downloads the scene's drawings to your computer before opening the scene. Harmony will then load the drawings from your computer during the session, instead of loading them from their original location over the network. This can significantly increase performance, especially with resource-heavy scenes.</p> <p>When you save your scene, the updated drawings will be uploaded automatically to the database, so you do not have to re-upload them manually.</p> <div data-bbox="565 1297 1430 1465" style="border: 1px solid green; padding: 5px;">  <p>NOTE If this option is checked, it may take a while to download all of the scene's assets when opening a particularly heavy scene.</p> </div>
Version	If you saved different versions of a scene, this lets you select one to open.

Deformer On Deformer Wizard Dialog Box

The Deformer on Deformer Wizard dialog box allows you to create a Curve deformer over an Envelope deformer, so that the Curve deformer deforms the Envelope deformer, which in turn deforms the drawing it is attached to.

Simply creating a Curve deformer over or under an Envelope deformer does not achieve the expected results, as both deformers end up acting as a single chain that both deform the drawing, and manipulating one deformer does not offset the other deformer's points. This usually results in a deformation system that is unwieldy and which doesn't produce a good image.

With the Deformer on Deformer Wizard, it is possible to create a functional Curve deformer over an existing Envelope deformer. The Deformer on Deformer Wizard accomplishes this by converting the Curve deformer into a Master Controller. This Master Controller, while looking like a regular Curve deformer, will actually deform the Envelope deformation chain it is rigged to, rather than the drawing itself. The Envelope deformation chain will in turn deform the drawing.

This allows you to combine the ability of an Envelope deformer to make tweaks to the outer shape of a drawing with the ability of a Curve deformer to easily animate the centreline of a drawing.

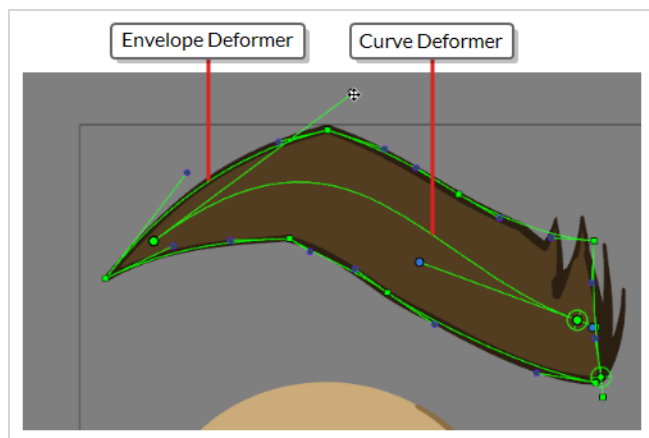

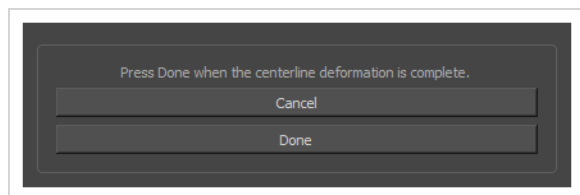

Before you use the Deformer on Deformer Wizard, you must already have created the Envelope deformer for the drawing using the **RT** Rigging tool. Then, you must select the group containing the Envelope deformer in the Node View and open the Deformer on Deformer Wizard.



The Deformer on Deformer Wizard only has two buttons: **Cancel** and **Done**. This is because it works by observing while you build the Curve deformer over the Envelope deformer. As you create Curve deformation points, it generates the nodes and connections required to create a Deformer on Deformer system. When you're done building the Curve deformer, you can click on **Done** to finalize the conversion of the Curve deformer

into a Deformer on Deformer system. Then, your Curve deformer will be able to deform the Envelope deformer your rigged it to.

So, in summary, to use the Deformer on Deformer Wizard, you must follow these steps:

1. Create your drawing.
2. Create the Envelope deformation chain for your drawing, as you normally would, using the  Rigging tool.
3. Select the Envelope deformation chain your created.
4. Open the Deformer on Deformer Wizard.
5. While the Wizard is open, create a Curve deformation chain using the  Rigging tool. You can move the Wizard aside and keep working on your scene while it is open.
6. Once you created your Curve deformer, click on **Done** in the wizard.

And that's it. Your Curve deformer will be converted to a Deformer on Deformer system, which will be able to work with the Envelope deformer you created prior.

How to access the Deformer on Deformer Wizard

1. Add the Master Controller toolbar to your workspace by doing one of the following:
 - Right-click on an existing toolbar and select **Master Controller**.
 - In the top menu, select **Windows > Toolbars > Master Controller**.

The Master Controller toolbar appears.

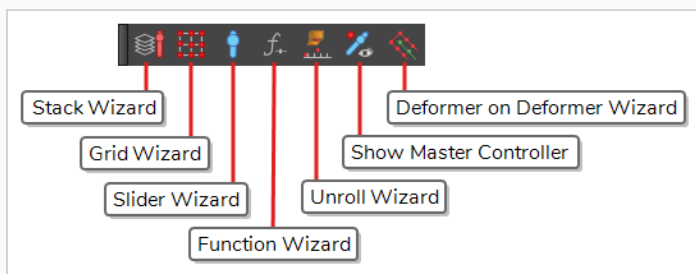

2. In the Node View or the Timeline view, select the group for the Envelope deformer over which you want to create a Curve deformer.

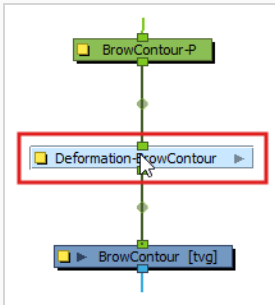

3. In the Master Controller toolbar, click the  Deformer on Deformer button.

The Deformer on Deformer Wizard appears. The  Rigging tool is also automatically selected in the Deformation toolbar.

Button	Description
Cancel	Cancels the creation of a Deformer on Deformer. This undoes changes to the Node View that were made while using the wizard.
Done	Once you are done creating the Curve deformer, click on Done to finalize the Deformer on Deformer system. After this, the Curve deformer you created will be converted to a Master Controller that is able to deform the Envelope deformer you created prior.

Edit Default Paste Preset Dialog Box

The Edit Default Paste Preset dialog box lets you modify settings for the keyframe and exposure paste presets, as well as setting the defaults.

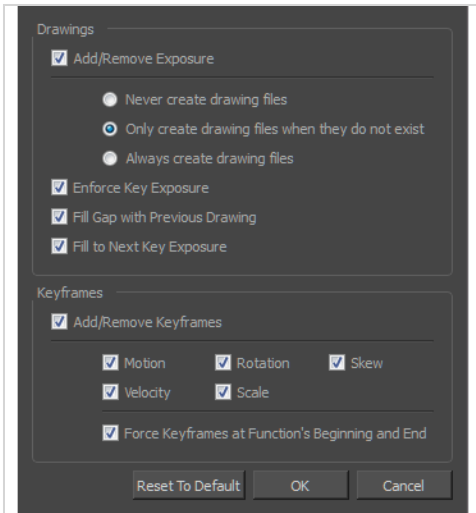

How to access the Edit Default Paste Preset dialog box

1. From the Timeline menu, select **Edit > Modify Paste Presets > All** or **Key Frame** or **Exposure**.

Parameter	Description
Drawings	
Add/Remove Exposure	Never create drawing files: When adding exposures to a drawing layer, drawing files will not be created.
	Only create drawing files when they do not exist: When adding exposures to a drawing layer, new drawings will be created only when drawings with the same name do not already exist in the destination.
	Always create drawing files: When adding exposures to a drawing layer, new drawings will always be created. If drawing files with the same name already exist, Harmony will create a new name for the drawing.
Enforce Key Exposure	If there are key exposures that exist on copied drawings, they are preserved when pasting. No key exposures are added. This is the default behavior when pasting.

Fill Gap with Previous Drawing	Fills selected area in the Xsheet or Timeline view with the previous drawing.
Fill to Next Key Exposure	Fills selected area till the next key exposure.
Keyframes	
Add/Remove Keyframes	Motion: Copies the properties of the selected motion keyframe to the new frame.
	Velocity: Copies the properties of the selected velocity keyframe to the new frame.
	Rotation: Copies the properties of the selected rotation keyframe to the new frame.
	Scale: Copies the properties of the selected scale keyframe to the new frame.
	Skew: Copies the properties of the selected skew keyframe to the new frame.
	Force Keyframes at Function's Beginning and End: Adds a keyframe to the beginning and end of the pasted function, reproducing the source function.

Edit Exposure Paste Preset Dialog Box

The Edit Exposure Paste Preset dialog box lets you reuse key exposures as you animate.

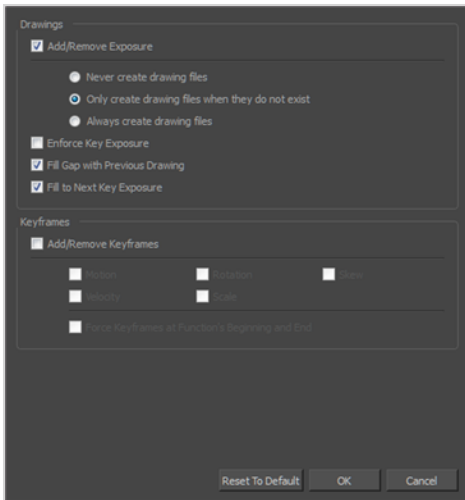

How to access the Edit Exposure Paste Preset dialog box

1. From the Timeline view menu, select **Edit > Modify Paste Presets > Exposure**.

The Edit Exposure Paste Preset dialog box opens.

Parameter	Description
Drawings	
Add/Remove Exposure	Never create drawing files: When adding exposures to a drawing layer, drawing files will not be created.
	Only create drawing files when do they do not exist: When adding exposures to a drawing layer, new drawings will be created only when drawings with the same name do not already exist in the destination.
	Always create drawing files: When adding exposures to a drawing layer, new drawings will always be created. If drawing files with the same name already exist, Harmony will create a new name for the drawing.
Enforce Key Exposure	Creates a key exposure on the same drawing.
Fill Gap with Previous Drawing	Fills selected area in the Xsheet or Timeline view with the previous drawing.

Fill to Next Key Exposure	Fills selected area till the next key exposure.
Keyframes	
Add/Remove Keyframes	Motion: Copies the properties of the selected motion keyframe to the new frame.
	Velocity: Copies the properties of the selected velocity keyframe to the new frame.
	Rotation: Copies the properties of the selected rotation keyframe to the new frame.
	Scale: Copies the properties of the selected scale keyframe to the new frame.
	Skew: Copies the properties of the selected skew keyframe to the new frame.
	Force Keyframes at Function's Beginning and End: Adds a keyframe to the beginning and end of the pasted function, reproducing the source function.
Reset to Default	Return all values to their defaults.

Element Manager Dialog Box

The Element Manager window lets you Open the Element Manager window where you can add, delete or modify elements (drawing folders) in your scene. If you have drawing folders that are not linked to a column in your scene, use the Element Manager to delete them if needed. See [xref Reference > Windows > Element Manager](#).

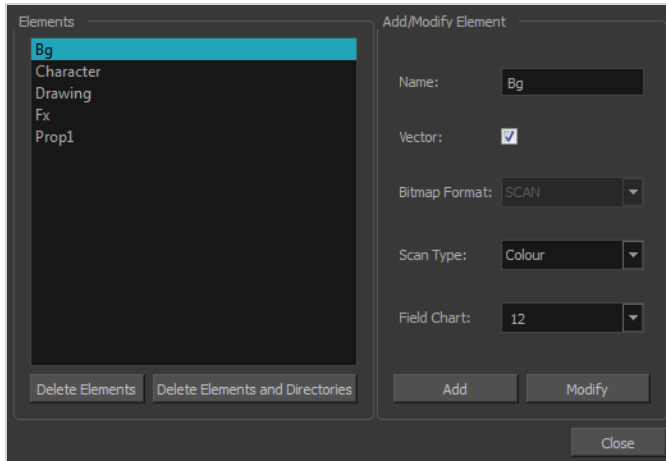

How to access the Element Manager window

1. From the top menu, select **Scene > Element Manager**.

Parameter	Description
Elements	
Delete Elements	Deletes the selected elements.
Delete Elements and Directories	Deletes the selected layer and its directories (drawing folder).
Add/Modify Element	
Name	Type in a new name in this field to create an element or to rename the selected element.
Vector	Select this option if the new element is a vector drawing or if you want to enable the parameters on the selected element in the Elements list.

Bitmap Format	Lets you select the file format of the bitmap layer.
Scan Type	If you're planning to scan elements with the Toon Boom Harmony Premium Scan module, select the scan type from the list.
Field Chart	If you're importing traditional animation, select the size of the paper on which the animation was drawn.
Add	Creates a new element with the current parameters entered in the Add/Modify Element section.
Modify	Applies the parameter changes made to the selected element.

Envelope Creator Dialog Box

The Envelope Creator Dialog box allows you to procedurally generate a curve or envelope deformation chain based on the artwork in the current layer. The deformation chain can be made to wrap around the outer shape of the artwork or to go through its centre line. It will be created as a parent of the current layer, allowing you to use it to deform and animate the artwork in the layer instantly after creating it.

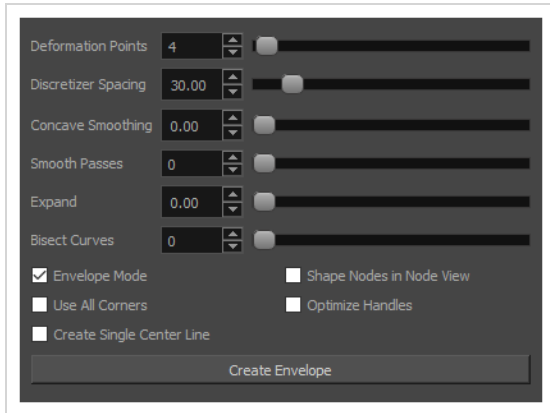

How to access the Envelope Creator dialog box

1. Select the node or layer for which you want to create a deformation chain.
2. In the top menu, select **Animation > Envelope Creator > Create Envelope**.

The Envelope Creator dialog appears.

Parameters

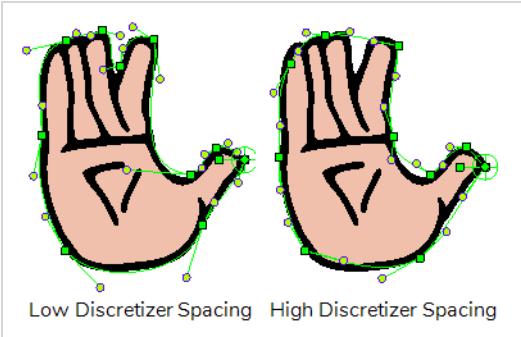
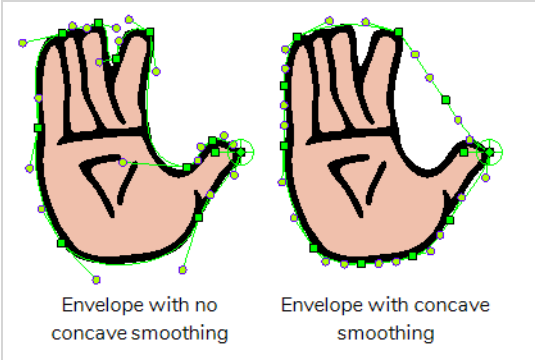

Parameter	Description
Deformation Points	<p>The amount of deformation points to create in the deformation chain. The higher the amount of points, the more faithful to the outer shape of your artwork the deformation chain will be, but the harder it will be to animate.</p> <p>Envelope with 4 deformation points Envelope with 8 deformation points</p>

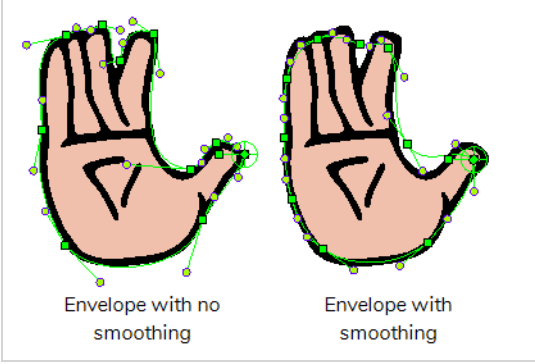
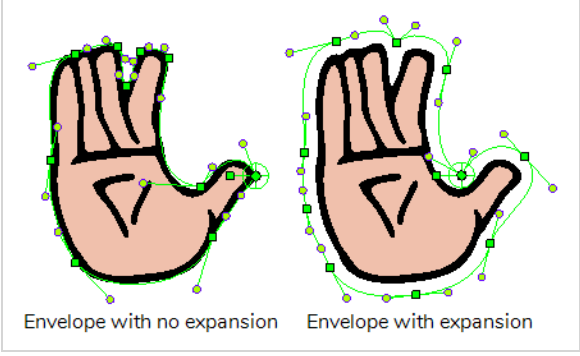
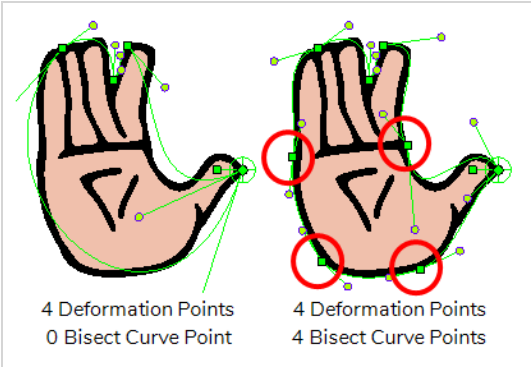
Parameter	Description
	<div style="border: 1px solid #add8e6; padding: 10px;">  TIP You can enable the Use All Corners option to let the Envelope Creator calculate how many points to create based on the amount of corners in your artwork. </div>
Discretizer Spacing	<p>The scale at which the Envelope Creator analyzes the drawing's details. A lower setting will cause the shape of the envelope to match the contours of the drawing more closely, but may cause the Envelope Creator to hang when generating an envelope and to generate points for small dents and bumps in the contour of the artwork. A higher setting will allow the Envelope Creator to ignore subtle details in the contour which would not be useful for the deformation chain.</p> <div style="text-align: center;">  <p>Low Discretizer Spacing High Discretizer Spacing</p> </div>
Concave Smoothing	<p>Smooths out the concavities of the envelope. Increasing this parameter makes the concave corners in the envelope moved away from the centre of the envelope, making the shape of the envelope closer to a convex shape. The position of convex corners is not affected by this parameter.</p> <div style="text-align: center;">  <p>Envelope with no concave smoothing Envelope with concave smoothing</p> </div>
Smooth Passes	The amount of smoothing applied to the corners and angles in the shape of the deformation chain.

Parameter	Description
	 <p style="text-align: center;">Envelope with no smoothing Envelope with smoothing</p>
Expand	<p>Expands the outer shape of the envelope. This ensures that the contours of the artwork are inside the envelope instead of meshing with it.</p>  <p style="text-align: center;">Envelope with no expansion Envelope with expansion</p>
Bisect Curves	<p>The amount of extra points to add over the segments of the deformation chain. While points added with the Deformation Points parameter are laid out to match the corners of the shape, the points added with the Bisect Curves setting are added to the middle of the segments between those points.</p> <p>This parameter determines the total amount of Bisect Curves points to add to the whole envelope. Those points are distributed along the envelope, with priority given to longer segments. An extremely long segment may have several Bisect Curves points added to it, like in this example:</p>  <p style="text-align: center;">4 Deformation Points 4 Deformation Points 0 Bisect Curve Point 4 Bisect Curve Points</p>

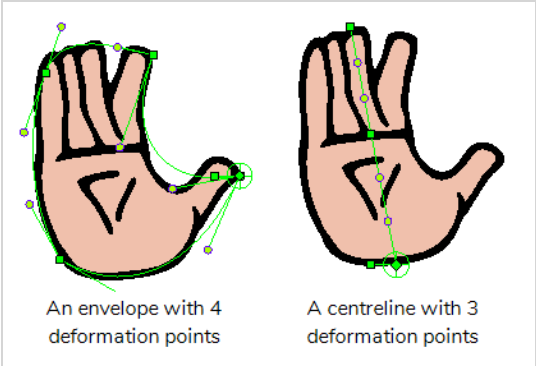
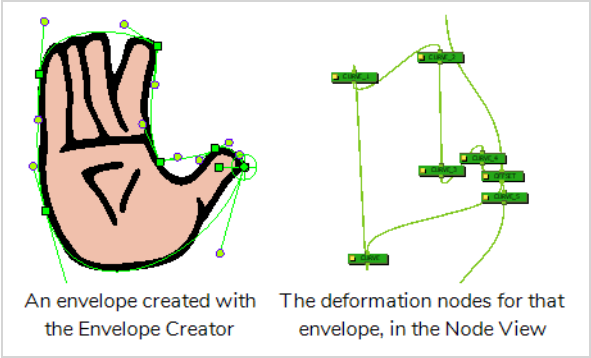
Options

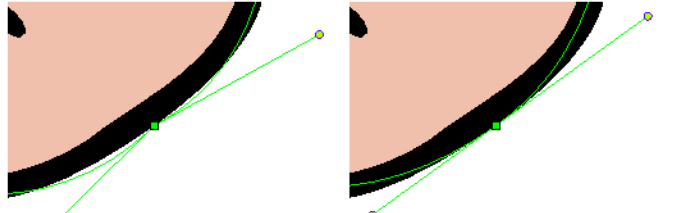
Parameter	Description
Envelope Mode	By default, the Envelope Creator will generate a Curve type deformation chain. This means that the first point in the chain is not used to deform the artwork, but rather, to offset the deformation chain and move the drawing. With Envelope mode enabled, the first point in the deformation chain has the same purposes as all the other points, which is to deform the drawing.
Use All Corners	When enabled, this ignores the Deformation Points parameter and creates a deformation point for each corner the Envelope Creator detects in the shape of the artwork.
Create Single Center Line	<p>When enabled, this creates a deformation chain that goes through the centre line of the artwork, instead of going around the outer contour of the artwork.</p>  <p>An envelope with 4 deformation points A centreline with 3 deformation points</p>
Shape Nodes in Node View	<p>Lays out the deformation nodes in the node view so that they resemble the shape of the deformation chain, allowing you to visually identify which deformation node corresponds to which deformation point in the chain.</p>  <p>An envelope created with the Envelope Creator The deformation nodes for that envelope, in the Node View</p>
Optimize Handles	When the envelope has very wide angle corners, the Bezier handles for these points may be almost aligned, but not exactly. With this option enabled, Bezier handles that are almost aligned will be automatically aligned.

Parameter	Description
	<div data-bbox="360 285 1062 611" style="border: 1px solid gray; padding: 5px; margin-bottom: 10px;">  <p data-bbox="394 541 683 594">Bezier handles for a wide angle corner</p> <p data-bbox="721 541 1036 594">With the Optimize Handles option, these Bezier handles are aligned.</p> </div> <div data-bbox="360 646 1430 911" style="border: 1px solid green; padding: 10px; background-color: #e0f2f1;"> <p data-bbox="386 674 448 741"></p> <p data-bbox="467 680 542 707">NOTE</p> <p data-bbox="467 728 1390 879">When two Bezier handles for a point are aligned, the point does not act as a corner, but rather as a control point for the curve of the shape. Rotating a handle that is aligned with the opposite handle also rotates the opposite handle, making sure that the point does not become a corner. You can rotate one of the handles independently from the other by holding the Alt key.</p> </div>

Buttons

Parameter	Description
Create Envelope	Automatically generates a deformation chain around the artwork in the current layer, using the parameters in this dialog box. The deformation chain will be placed as a parent of the current layer.

Export Layout Image Dialog Box

The Export Layout Image dialog box allows you to export your drawings as bitmap images matching the scene resolution size, taking camera motions into account, to paint them in an external bitmap editing software.

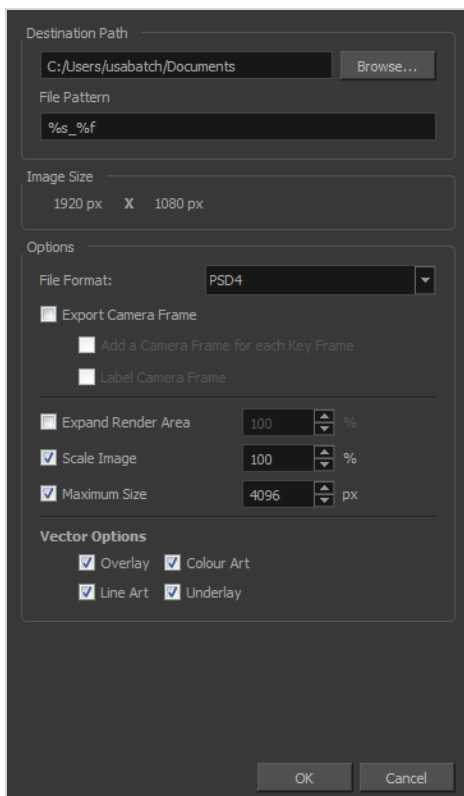

Access Method

1. From the top menu, select one of the following:
 - **File > Export > Layout Image** to export all the elements in your scene to the layout .psd file.
 - **File > Export > Layout Image from Selection** to export only the selected elements.

The Export Layout Image dialog box opens.

Parameter	Description
Destination Path	Use the Browse button to select a location to save your layout and name the resulting .psd file.
File Pattern	Automatically puts the name of the scene and/or the frame number in the name of the file you create.

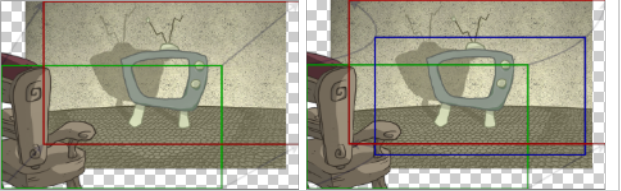
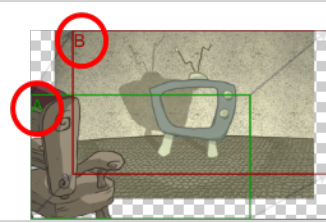
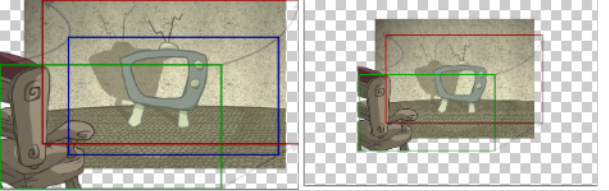
<p>Image Size</p>	<p>The size of the .psd image file that will be exported. The resulting image will be 72 dpi as the standard television resolution and its size in pixel will fit your scene resolution settings. i.e HDTV, NTSC, PAL, etc. Note that if you have a camera movement going over the normal camera frame limit, for example a pan, the image will be bigger.</p>
<p>Options</p>	<p>File Format: Lets you select the format to export your layout.</p> <p>Export Camera Frame: Prints the first and last camera frame of each scene into the exported layout images. If exporting in .psd format, the camera frames will be printed on a separate layer.</p> <p>Add a Camera Frame for Each Keyframe: If a scene contains a camera movement with more than two keyframes, this prints each camera keyframe into the layout.</p>  <p>Label Camera Frame: Adds the camera position label in the top-left corner of each camera frame. Camera frames are labeled with a letter of the alphabet indicating their respective order.</p> 
	<p>Expand Render Area: Expands the area to render into the layouts. By default, only the area of the scene that is covered by the camera is rendered, and exported layout images are cropped at the edges of the camera frames. If enabled, this option adds space around the render area and captures extra details outside the camera frames. By default, the render area is expanded by 10%. You can use the input field to the right of the option to change this ratio.</p>  <p>Scale Image: Ensures that when a camera close-up is included in a scene, the exported image is larger so that the closest camera frame is at least the size of the chosen image size. This way, the layout does not appear pixelated when zooming in on the closest camera frame. If disabled, the size of the exported images will be</p>

	<p>based off the chosen Base Image Size and Expand Render Area options.</p> <p>Maximum Size: If the Scale Image Up to Smallest Camera Frame option is enabled, this ensures images do not get scaled up too much. If enabled, images will be limited to 4096 pixels in width and height by default.</p>
	<p>Vector Options</p> <p>If you export one or more vector-based drawing layers in your layout image, you have the option to export only the drawing layers you want. Enable or disable the following options to export or prevent the export of the corresponding art layers.</p> <p>Overlay: Exports the art in the Overlay layer of the drawings to be exported to the layout image.</p> <p>Line Art: Exports the art in the Line layer of the drawings to be exported to the layout image.</p> <p>Colour Art: Exports the art in the Colour layer of the drawings to be exported to the layout image.</p> <p>Underlay: Exports the art in the Underlay layer of the drawings to be exported to the layout image.</p>

Export OpenGL Frames Dialog Box

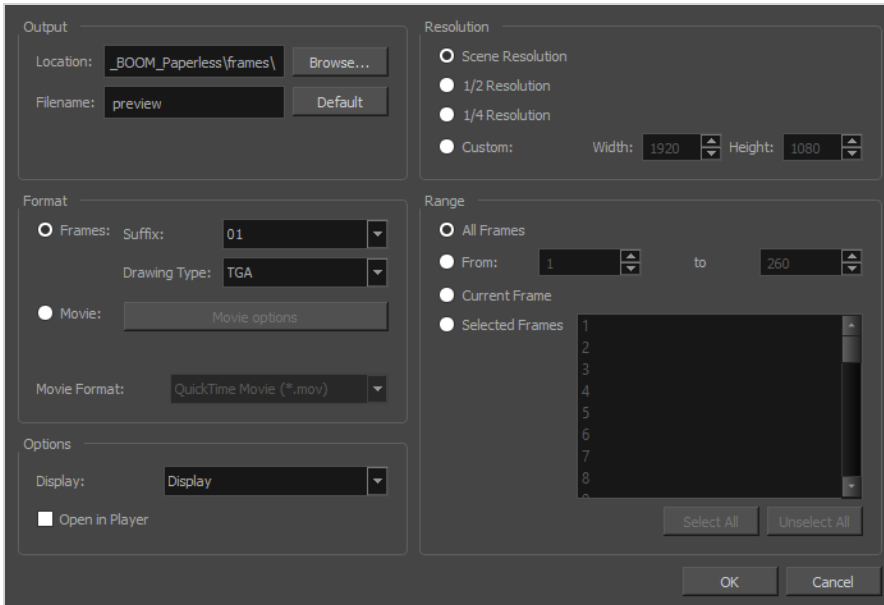

The Export OpenGL Frames dialog box allows you to export your scene as a sequence of images as they appear in the OpenGL View mode of the Camera view. This means they are exported without effects, antialiasing and proper compositing. This allows you to quickly preview the animation in your scene without having to wait through the full rendering process.





How to access the Export to OpenGL Frames dialog box

1. In the top menu, select **File > Export > OpenGL Frames**.

Parameter	Description
Output	
Location	The directory in which to export the frames or movie file. You can click Browse... to open a dialog allowing you to navigate your file system and select a directory.
Filename	The name of the file to export. If you are exporting frames, the file name of each frame will start with this value, followed by the number of the frame.
Format	

Parameter	Description																						
Frames	Exports each frame as an individual image file.																						
Suffix	Allows you to select the number of digits in the number used to identify each frame.																						
Drawing Type	<table border="1"> <thead> <tr> <th>Format</th> <th>Specification</th> <th>Description</th> </tr> </thead> <tbody> <tr> <td>TVG</td> <td></td> <td> <p>Toon Boom Vector Graphic (*.tvg)</p> <p>Toon Boom's proprietary format for storing vector drawings. TVG images contain vector shape, colour and texture information.</p> <div style="border: 1px solid green; padding: 5px; margin-top: 10px;"> <p> NOTE</p> <p>To export TVG files, your Write node must be connected to a vector drawing layer or to a vector composite node. The exported TVG files will contain the vector and bitmap drawing information, but will ignore effects and deformations.</p> </div> </td> </tr> <tr> <td>TGA</td> <td>Full colour</td> <td rowspan="4"> <p>Truevision TGA/TARGA (*.tga)</p> <p>A standard image format with lossless compression and support for transparency.</p> <p>TGA files use more disk space than PNG files, but rendering in TGA is faster.</p> </td> </tr> <tr> <td>TGA1</td> <td>Greyscale</td> </tr> <tr> <td>TGA3</td> <td>Full colour</td> </tr> <tr> <td>TGA4</td> <td>Full colour with transparency</td> </tr> <tr> <td>SGI</td> <td>Full colour / 8 bits per channel</td> <td rowspan="3"> <p>Silicon Graphics Image (*.sgi)</p> <p>A highly capable format with lossless compression as well as support for double precision and transparency.</p> </td> </tr> <tr> <td>SGI1</td> <td>Greyscale / 8 bits per channel</td> </tr> <tr> <td>SGI3</td> <td>Full colour /</td> </tr> </tbody> </table>	Format	Specification	Description	TVG		<p>Toon Boom Vector Graphic (*.tvg)</p> <p>Toon Boom's proprietary format for storing vector drawings. TVG images contain vector shape, colour and texture information.</p> <div style="border: 1px solid green; padding: 5px; margin-top: 10px;"> <p> NOTE</p> <p>To export TVG files, your Write node must be connected to a vector drawing layer or to a vector composite node. The exported TVG files will contain the vector and bitmap drawing information, but will ignore effects and deformations.</p> </div>	TGA	Full colour	<p>Truevision TGA/TARGA (*.tga)</p> <p>A standard image format with lossless compression and support for transparency.</p> <p>TGA files use more disk space than PNG files, but rendering in TGA is faster.</p>	TGA1	Greyscale	TGA3	Full colour	TGA4	Full colour with transparency	SGI	Full colour / 8 bits per channel	<p>Silicon Graphics Image (*.sgi)</p> <p>A highly capable format with lossless compression as well as support for double precision and transparency.</p>	SGI1	Greyscale / 8 bits per channel	SGI3	Full colour /
	Format	Specification	Description																				
	TVG		<p>Toon Boom Vector Graphic (*.tvg)</p> <p>Toon Boom's proprietary format for storing vector drawings. TVG images contain vector shape, colour and texture information.</p> <div style="border: 1px solid green; padding: 5px; margin-top: 10px;"> <p> NOTE</p> <p>To export TVG files, your Write node must be connected to a vector drawing layer or to a vector composite node. The exported TVG files will contain the vector and bitmap drawing information, but will ignore effects and deformations.</p> </div>																				
	TGA	Full colour	<p>Truevision TGA/TARGA (*.tga)</p> <p>A standard image format with lossless compression and support for transparency.</p> <p>TGA files use more disk space than PNG files, but rendering in TGA is faster.</p>																				
	TGA1	Greyscale																					
	TGA3	Full colour																					
	TGA4	Full colour with transparency																					
	SGI	Full colour / 8 bits per channel	<p>Silicon Graphics Image (*.sgi)</p> <p>A highly capable format with lossless compression as well as support for double precision and transparency.</p>																				
SGI1	Greyscale / 8 bits per channel																						
SGI3	Full colour /																						

Parameter	Description		
	Format	Specification	Description
		8 bits per channel	
	SGI4	Full colour with transparency / 8 bits per channel	
	SGIDP	Full colour / 16 bits per channel	
	SGIDP3	Full colour / 16 bits per channel	
	SGIDP4	Full colour with transparency / 16 bits per channel	
	PSD	Full colour / 8 bits per channel	<p>Photoshop Document (*.psd)</p> <p>An Adobe Photoshop proprietary format used for image editing.</p> <p>PSD files exported by Harmony contain a single background layer with the rasterized image.</p> <div data-bbox="816 1556 1398 1787" style="border: 1px solid green; padding: 5px;"> <p> NOTE</p> <p>PSD files exported from Harmony are tagged with their colour space information in their metadata, except for PSD files exported in greyscale.</p> </div>
	PSD1	Greyscale / 8 bits per channel	
	PSD3	Full colour / 8 bits per channel	
	PSD4	Full colour with transparency / 8 bits per channel	







Parameter	Description		
	Format	Specification	Description
	PSDDP	Full colour / 16 bits per channel	
	PSDDP1	Greyscale / 16 bits per channel	
	PSDDP3	Full colour / 16 bits per channel	
	PSDDP4	Full colour with transparency / 16 bits per channel	
	YUV	<p>Y'UV frame (*.yuv)</p> <p>A legacy format optimized for NTSC television. The image information is encoded in the Y'UV color space, which means Luma (Y') and Chrominance (UV).</p> <div data-bbox="813 1245 1398 1446" style="border: 1px solid #c8e6c9; padding: 5px;"> <p> NOTE</p> <p>YUV images must be exported in NTSC resolution (720 x 540), or they will not be legible.</p> </div>	
	PAL	<p>PAL frame (*.pal)</p> <p>A legacy format optimized for PAL television.</p> <div data-bbox="813 1614 1398 1816" style="border: 1px solid #c8e6c9; padding: 5px;"> <p> NOTE</p> <p>PAL images must be exported in PAL resolution (768 x 576), or they will not be legible.</p> </div>	



Parameter	Description					
	<table border="1"> <thead> <tr> <th data-bbox="423 283 602 373">Format</th> <th data-bbox="602 283 786 373">Specification</th> <th data-bbox="786 283 1430 373">Description</th> </tr> </thead> </table>			Format	Specification	Description
Format	Specification	Description				
SCAN		<p>Toon Boom Scan Files (*.scan)</p> <p>A Toon Boom proprietary format used by Scan to store scanned image information along with its registration (peg), resolution and field chart metadata. SCAN files are in gresyscale.</p>				
PNG	Full colour / 8 bits per channel	<p>Portable Network Graphics (*.png)</p> <p>A highly portable image format with high lossless compression as well as support for transparency and double-precision. PNG is typically used for Web applications, graphical user interfaces and image sharing.</p> <p>Rendering in PNG takes more time than rendering in TGA or in uncompressed image formats, but saves a lot of disk space.</p> <div data-bbox="813 1108 1398 1310" style="border: 1px solid green; padding: 5px; margin-top: 10px;"> <p> NOTE</p> <p>PNG files exported from Harmony are tagged with their colour space information in their metadata.</p> </div>				
PNG4	Full colour with transparency / 8 bits per channel					
PNGDP	Full colour / 16 bits per channel					
PNGDP3	Full colour / 16 bits per channel					
PNGDP4	Full colour with transparency / 16 bits per channel					
JPG		<p>Jpeg (*.jpg)</p> <p>A very compact image format with lossy compression. It is typically used for Web pages and photo sharing. Because it does not preserve image quality, it is recommended to never render in Jpeg format unless you are exporting stills for a Web page or are making quick render tests.</p>				

Parameter	Description		
	Format	Specification	Description
	BMP	Full colour	Bitmap (*.bmp) A standard uncompressed image format commonly used on Microsoft operating systems.
	BMP4	Full colour with transparency	
	OPT	Full colour	Toon Boom Optimized image (*.opt) A legacy Toon Boom proprietary format that stores bitmap image data with lossless compression. It supports transparency.
	OPT1	Greyscale	
	OPT3	Full colour	
	OPT4	Full colour with transparency	
	VAR		Toon Boom Variable Header image (*.var) A legacy Toon Boom proprietary format that stores greyscale bitmap image data with lossless compression.
	TIF		Tagged Image File Format (*.tiff) An image format with many compression and encoding settings. It is often used for image exchange in visual arts and publishing. TIFF images exported by Harmony are uncompressed, encoded on a per-pixel (interleaved) basis in PC byte order.
	DPX	8 bits per channel / Full color / RGB channel order	Digital Picture Exchange (*.dpx) A professional photo format that supports various different approaches to storing colour information, which can be used for storing, exchanging and editing raw information recorded by cameras. It is commonly used in film production.
	DPX3_8	8 bits per channel / Full color / RGB channel order	

Parameter	Description																										
	<table border="1"> <thead> <tr> <th data-bbox="427 285 602 373">Format</th> <th data-bbox="602 285 786 373">Specification</th> <th data-bbox="786 285 1430 373">Description</th> </tr> </thead> <tbody> <tr> <td data-bbox="427 373 602 590">DPX3_10</td> <td data-bbox="602 373 786 590">10 bits per channel / Full color / RGB channel order</td> <td data-bbox="786 373 1430 1906"></td> </tr> <tr> <td data-bbox="427 590 602 806">DPX3_12</td> <td data-bbox="602 590 786 806">12 bits per channel / Full color / RGB channel order</td> <td data-bbox="786 590 1430 1906"></td> </tr> <tr> <td data-bbox="427 806 602 1022">DPX3_16</td> <td data-bbox="602 806 786 1022">16 bits per channel / Full color / RGB channel order</td> <td data-bbox="786 806 1430 1906"></td> </tr> <tr> <td data-bbox="427 1022 602 1239">DPX3_10_INVERTED_CHANNELS</td> <td data-bbox="602 1022 786 1239">10 bits per channel / Full color / BGR channel order</td> <td data-bbox="786 1022 1430 1906"></td> </tr> <tr> <td data-bbox="427 1239 602 1455">DPX3_12_INVERTED_CHANNELS</td> <td data-bbox="602 1239 786 1455">12 bits per channel / Full color / BGR channel order</td> <td data-bbox="786 1239 1430 1906"></td> </tr> <tr> <td data-bbox="427 1455 602 1671">DPX3_16_INVERTED_CHANNELS</td> <td data-bbox="602 1455 786 1671">16 bits per channel / Full color / BGR channel order</td> <td data-bbox="786 1455 1430 1906"></td> </tr> <tr> <td data-bbox="427 1671 602 1906">EXR</td> <td data-bbox="602 1671 786 1906">16 lines Zip compression</td> <td data-bbox="786 1671 1430 1906"> <p>OpenEXR (*.exr)</p> <p>A highly capable deep image format. Each pixel in an EXR file is exported with its Z-depth information. Additionally, if a pixel is semi-transparent, the color and depth information of pixels further back is stored along with it. If your scene</p> </td> </tr> </tbody> </table>	Format	Specification	Description	DPX3_10	10 bits per channel / Full color / RGB channel order		DPX3_12	12 bits per channel / Full color / RGB channel order		DPX3_16	16 bits per channel / Full color / RGB channel order		DPX3_10_INVERTED_CHANNELS	10 bits per channel / Full color / BGR channel order		DPX3_12_INVERTED_CHANNELS	12 bits per channel / Full color / BGR channel order		DPX3_16_INVERTED_CHANNELS	16 bits per channel / Full color / BGR channel order		EXR	16 lines Zip compression	<p>OpenEXR (*.exr)</p> <p>A highly capable deep image format. Each pixel in an EXR file is exported with its Z-depth information. Additionally, if a pixel is semi-transparent, the color and depth information of pixels further back is stored along with it. If your scene</p>		
Format	Specification	Description																									
DPX3_10	10 bits per channel / Full color / RGB channel order																										
DPX3_12	12 bits per channel / Full color / RGB channel order																										
DPX3_16	16 bits per channel / Full color / RGB channel order																										
DPX3_10_INVERTED_CHANNELS	10 bits per channel / Full color / BGR channel order																										
DPX3_12_INVERTED_CHANNELS	12 bits per channel / Full color / BGR channel order																										
DPX3_16_INVERTED_CHANNELS	16 bits per channel / Full color / BGR channel order																										
EXR	16 lines Zip compression	<p>OpenEXR (*.exr)</p> <p>A highly capable deep image format. Each pixel in an EXR file is exported with its Z-depth information. Additionally, if a pixel is semi-transparent, the color and depth information of pixels further back is stored along with it. If your scene</p>																									
			<p>OpenEXR (*.exr)</p> <p>A highly capable deep image format. Each pixel in an EXR file is exported with its Z-depth information. Additionally, if a pixel is semi-transparent, the color and depth information of pixels further back is stored along with it. If your scene</p>																								

Parameter	Description		
	Format	Specification	Description
			<p>has multiplane or 3D elements, this format can be used for compositing your animation with other graphical elements in 3D animation software.</p> <div data-bbox="816 527 1398 926" style="border: 1px solid green; padding: 5px;"> <p> NOTES</p> <ul style="list-style-type: none"> • OpenEXR files exported from Harmony are tagged with the white point and primaries coordinates for their colour space. • OpenEXR files are always exported by Harmony always have 1 line Zip compression if they contain a 3D image. </div>
	EXR_ZIP_1LINE	1 line Zip compression	
	PDF	<p>Portable Document File (*.pdf)</p> <p>Typically, PDF files are used to store, archive, share and print documents. However, Harmony uses the PDF format for its capability to store bitmap images and vector graphics.</p> <p>If the write node is connected to a vector drawing layer or to a vector composite, the exported PDF files will contain the image as a vector graphic. It will ignore bitmap layers, effects and deformations. Otherwise, the PDF files will contain the rendered image as a bitmap.</p>	
	DTEX	<p>Deep Texture (*.dtx)</p> <p>A commonly used deep image format. Each pixel in an DTEX file is exported with its Z-depth information. Additionally, if a pixel is semi-transparent, the color and depth information of pixels further back is stored along with it. If your scene has multiplane or 3D elements, this format can be used for compositing your animation with other graphical elements in 3D animation software.</p>	

Parameter	Description						
	<table border="1" data-bbox="427 285 1430 737"> <thead> <tr> <th data-bbox="427 285 602 373">Format</th> <th data-bbox="602 285 786 373">Specification</th> <th data-bbox="786 285 1430 373">Description</th> </tr> </thead> <tbody> <tr> <td data-bbox="427 373 602 737"></td> <td data-bbox="602 373 786 737"></td> <td data-bbox="786 373 1430 737"> <div data-bbox="813 405 1398 705" style="border: 1px solid #c8e6c9; padding: 10px;">  <p>NOTE Exporting in Deep Texture requires RenderMan to be installed on the machine and the path to RenderMan properly configured in Harmony. For more information, see the Setting 3D Renderer Paths topic of the User Guide.</p> </div> </td> </tr> </tbody> </table>	Format	Specification	Description			<div data-bbox="813 405 1398 705" style="border: 1px solid #c8e6c9; padding: 10px;">  <p>NOTE Exporting in Deep Texture requires RenderMan to be installed on the machine and the path to RenderMan properly configured in Harmony. For more information, see the Setting 3D Renderer Paths topic of the User Guide.</p> </div>
Format	Specification	Description					
		<div data-bbox="813 405 1398 705" style="border: 1px solid #c8e6c9; padding: 10px;">  <p>NOTE Exporting in Deep Texture requires RenderMan to be installed on the machine and the path to RenderMan properly configured in Harmony. For more information, see the Setting 3D Renderer Paths topic of the User Guide.</p> </div>					
<p>Movie</p>	<p>Exports the frames into a movie file.</p>						
<p>Movie options</p>	<p>Opens the movie settings dialog box for your selected video format, in which you can set the video and audio compression settings for your video file:</p> <ul style="list-style-type: none"> • QuickTime Movie (*.mov) on Windows: Movie Options Dialog Box (macOS), • QuickTime Movie (*.mov) on macOS: QuickTime Movie Settings Dialog Box (Windows) • Windows Media Video (*.wmv): Windows Media Video Settings Dialog Box (Windows) <div data-bbox="427 1178 1430 1318" style="border: 1px solid #c8e6c9; padding: 10px;">  <p>NOTE This button is available on Windows and macOS only.</p> </div>						
<p>Video options</p>	<p>Opens the video settings dialog box, which allows you to set the video compression settings for your video file—see OpenQuickTime Video Options Dialog Box (GNU/Linux).</p> <div data-bbox="427 1472 1430 1612" style="border: 1px solid #c8e6c9; padding: 10px;">  <p>NOTE This button is available on GNU/Linux only.</p> </div>						
<p>Sound options</p>	<p>Opens the audio settings dialog box, which allows you to set the audio compression settings for your video file—see OpenQuickTime Sound Options Dialog Box (GNU/Linux).</p> <div data-bbox="427 1766 1430 1906" style="border: 1px solid #c8e6c9; padding: 10px;">  <p>NOTE This button is available on GNU/Linux only.</p> </div>						

Parameter	Description
Movie Format	<p>Allows you to choose one of the following movie formats:</p> <ul style="list-style-type: none"> • QuickTime Movie (*.mov): The Apple QuickTime format. This is the default export format and is recommended for its portability, and also because it allows you to choose among several video codecs. <div data-bbox="505 470 1430 1066" style="border: 1px solid #c8e6c9; padding: 10px; margin: 10px 0;"> <p> NOTES</p> <ul style="list-style-type: none"> • On Windows, Apple QuickTime must be installed to allow Harmony to export QuickTime movies. You can configure the export of QuickTime movies to use any codec that is compatible with QuickTime, including H.264, MPEG-4 and Animation. • On macOS, Harmony uses Apple AVFoundation to export QuickTime movies, which allows you to export using codecs such as H.264, Apple ProRes 422 and Apple ProRes 4444, among others. • If you are looking to export a QuickTime movie with transparency, be sure to choose a codec that supports encoding with an alpha channel. • On GNU/Linux, Harmony uses the OpenQuickTime library to export QuickTime movies. This only allows you to export videos in non-proprietary formats such as Motion-JPEG, Photo JPEG, PNG or Uncompressed (RGB). </div> <ul style="list-style-type: none"> • H.264/MPEG-4 (*.mov) : A simple movie format that uses the H.264 codec, which is supported by most web browsers. <div data-bbox="505 1192 1430 1684" style="border: 1px solid #c8e6c9; padding: 10px; margin: 10px 0;"> <p> NOTES</p> <ul style="list-style-type: none"> • Using this format does not require additional software. However, if this is the first time you export a movie in H.264/MPEG-4 format, you will be prompted to download the OpenH264 library from Cisco. Simply click Yes when prompted, and Harmony will automatically download the library, then export the movie. • There are no encoding options for this format. • This format supports resolutions of up to 4096×2304. Each dimension must be a multiple of 16 pixels. • Audio exported in this format is encoded in PCM 16-bit stereo, 22.05 kHz. </div> <ul style="list-style-type: none"> • Windows Media Video (*.wmv): The native format for Windows Media Player.

Parameter	Description
	<div style="border: 1px solid #c8e6c9; padding: 10px; margin-bottom: 10px;">  <p>NOTES</p> <ul style="list-style-type: none"> Windows Media Video (.wmv) files can only be exported on Windows. Video players and editors on non-Windows systems can generally not open Windows Media Video (.wmv) files. </div> <ul style="list-style-type: none"> Flash (.swf) Image sequence in Jpeg (.jpg), Targa (.tga) or Portable Network Graphics (.png) format.
Options	
Open in Player	<p>If checked, the exported images or movie will be opened after the export is finished:</p> <ul style="list-style-type: none"> If you are exporting frames, they will be opened in the Play application. If you are exporting a movie, it will be opened in your operating system's movie player.
Resolution	<p>Allows you to specify a resolution to export in, relative to your scene's actual resolution:</p> <ul style="list-style-type: none"> Same as Scene Resolution: Exports a movie in the same resolution as your scene's resolution. 3/4 of Scene Resolution: Exports a movie at 75% of the scene's width and height. 1/2 of Scene Resolution: Exports a movie at 50% of the scene's width and height. 1/4 of Scene Resolution: Exports a movie at 25% of the scene's width and height. Custom: Allows you specify the preferred resolution of your exported video file, in pixels, in the Width and Height fields.
Range	<p>Allows you to specify the range of frames in your scene to export:</p> <ul style="list-style-type: none"> All Frames: Exports all the frames in your scene. From / to: Allows you to specify the frame range to export using the two input fields to the right. The first input field is for specifying the first frame to export, and the second one is for specifying the last frame to export. All the frames in-between, including the ones specified, will be exported. Current Frame: Exports the current frame only. Selected Frames: Allows you to select which frames to export. You can enable or disable exporting a specific frame by clicking on it. You can also toggle exporting a range of frames by clicking and dragging over that range in the list.

Parameter	Description
OK	Exports OpenGL frames with the selected settings and closes the dialog box.
Cancel	Closes the dialog box without exporting anything.

Export Soundtracks Dialog Box

The Export Soundtracks dialog box lets you export a sound file to use it in another application, such as an editing software. Harmony allows you to export sound files as a merged soundtrack or as a series of individual files. The exported soundtracks are generated as *.wav files.

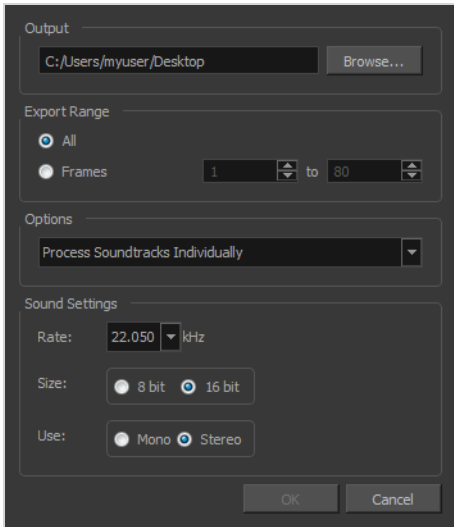

How to access the Export Soundtracks dialog box

1. From the top menu, select **File > Export > Soundtrack**.

The Export Soundtracks dialog box opens.

Parameter	Description
Output	Lets you specify the location in which the file will be exported.
Export Range	
All	Exports the sound over all the frames of your scene.
Frames	Sets the start and end frames in the corresponding fields on the right.
Options	
Process Soundtracks Individually	Each soundtrack from all layers is exported as individual files.

Merge All Soundtracks	One single file is created, combining all the sound files you imported in your scene. Note that it will only use the sound files in the selected frame range set in the Export Range section. If you selected to export all the frames, all the sound files will be processed.
Sound Settings	
Rate	Lets you set the rate of the soundtrack.
Size	Lets you export the soundtrack at 8 or 16 bits.
Use	Lets you export the soundtrack as mono or stereo.

Export to Animated GIF Dialog Box

Using the Export to Animated GIF dialog box, you can export your scene, or an excerpt of it, as an animated GIF image.

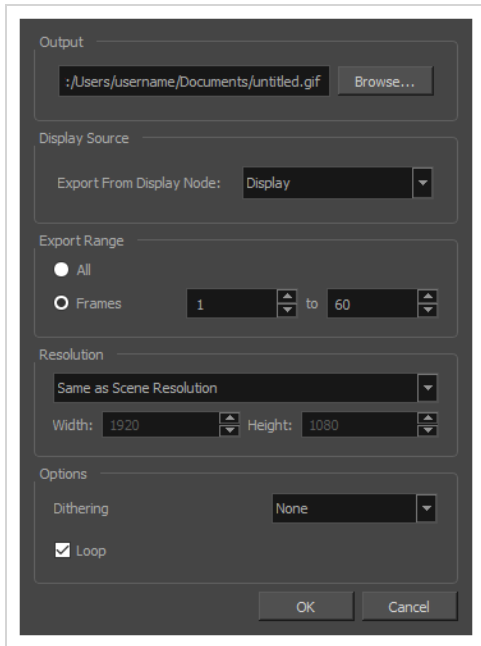

Animated GIFs are a portable format commonly used for exchanging short animations and clips on the web. They can be played in any web browser and in many image viewers.

Animated GIFs are a convenient sharing format, but they are not a publishing format. They are not as optimized for fast download and playback as movie files, cannot contain audio and, most importantly, can only contain up to 256 different colours throughout the entire animation. Hence, if your animation contains textures or gradients, it is likely to lose quality when exported as an animated GIF, as Harmony will have to limit the amount of different colours used in the exported image.



NOTE



For steps on how to use the Export to Animated GIF dialog box, see the User Guide.

How to access the Export to Animated GIF dialog box

1. In the top menu, select **File > Export > Animated GIF**.

The Export to Animated GIF dialog box appears.

Parameter	Description
Output	
Output	The full path and file name of the GIF file to export.
Browse	Opens a dialog allowing you to browse to the desired export directory and enter the desired file name.
Display Source	
Export from Display Node	<p>Allows you to select the display node from which to render your scene.</p> <div style="border: 1px solid green; padding: 10px; margin-top: 10px;"> <p> NOTE</p> <p>If there is no Display node in your scene, the only available option will be Display All. This renders all the nodes in your scene, including ones that are not connected to anything. You can add other Display nodes to your scene and connect them under specific parts of your scene to be able to render these parts only.</p> </div>
Export Range	
All	Exports all the frames in your scene.
Frames	Allows you to specify a range of frames to render.
Resolution	
Resolution list	<p>Lets you specify a resolution to export in relative to your scene's actual resolution:</p> <ul style="list-style-type: none"> • Same as Scene Resolution: Exports a movie in the same resolution as your scene's resolution. • 3/4 of Scene Resolution: Exports a movie at 75% of the scene's width and height. • 1/2 of Scene Resolution: Exports a movie at 50% of the scene's width and height. • 1/4 of Scene Resolution: Exports a movie at 25% of the scene's width and height. • Custom: Allows you specify the preferred resolution of your exported video file, in pixels, in the Width and Height fields.

Parameter	Description
Width	If you selected the Custom resolution, use this field to specify the width, in pixels, of the exported movie.
Width	If you selected the Custom resolution, use this field to specify the height, in pixels, of the exported movie.
Options	Options
Dithering	<p>Since GIF images can only have up to 256 colours, you have the option to add dithering to the rendered image. Dithering blends pixels of different colours where the image contains gradients to simulate colours that do not exist in the GIF image's colour palette.</p> <ul style="list-style-type: none"> • None: No dithering will be applied. Each pixel rendered is rendered with the colour in the palette that is the closest to its actual colour.  <ul style="list-style-type: none"> • Diffusion: Blends pixels in irregular patterns to blend pixels and simulate the colour as closely as possible.  <ul style="list-style-type: none"> • Pattern: Blends pixels in regular checkered patterns to simulate the colour without created clusters of pixels. 
Loop	If this option is checked, the exported GIF animation will loop when previewed in web browsers and other image viewers that support animated GIFs. Otherwise, it will only play once and stop.

Export to Easel JS Dialog Box

The Export to Easel JS window lets you flatten an image sequence of your animation. Even if you have a fully rigged puppet or a single drawing layer with your animation sequence, the outcome will still be a flattened output of each frame, grouped together in your sprite sheet. This allows for more flexibility and freedom of work as you have access to any tools or effect modules you want to use. However, this can result in heavier files depending on the length, complexity and export size of your animation.

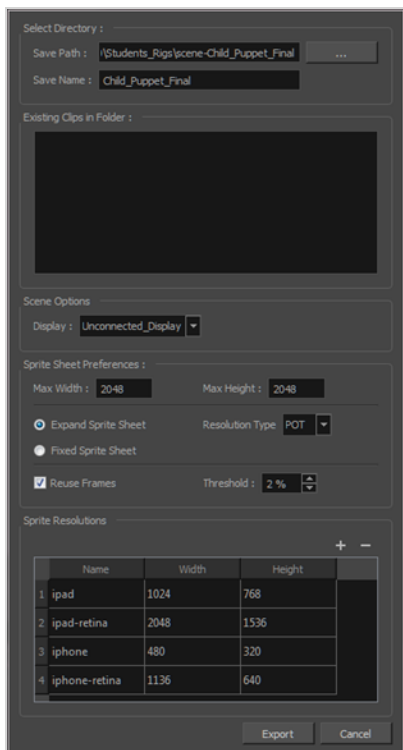

How to access the Export to Easel JS window

1. Select **Windows > Toolbars > Game**.

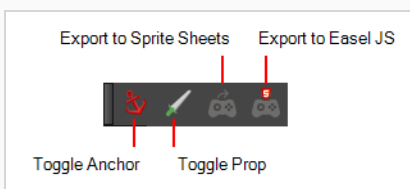

2. Click the Export to Easel JS  button.

Parameter	Description
Select Directory	

Save Path	The folder path where you want to save your export.
Save Name	The folder name in which you will save your export. This will also be the name of your asset in Unity. Your scene file name will be used as the clip name.
Existing Clips in Folder	Displays the clips in the folder.
Scene Options	
Display	Here, you must select the Display of your character. This is the one that will be used to render out all of the information attached to that Display node. If the Unconnected_Display option is selected, all of the visual information in your scene will be rendered out.
Sprite Sheet Preferences	
Max Width	This is a value, in pixels, for the maximum width and height the exported sprite sheet should be. By default, both values are set to 2048 pixels.
Max Height	
Expand Sprite Sheet	Uses the minimum size necessary up until it reaches the maximum resolution.
Fixed Sprite Sheet	Creates a texture of the specified size (Max Width and Max Height) even if it does not fill it up completely by all the drawings in your scene.
Resolution Type	<p>POT: Exports to sprite sheets with sizes that are a power of 2. For example: 1024 x 1024. This is optimized for many graphics cards, but consumes more memory.</p> <p>NPOT: Some game engines are optimized specifically to render to non powers of two, so that it will avoid those numbers. Example: 1000 x 1000.</p>
Reuse Frames	This option works in tandem with the Threshold option. The export will compare the drawings in your project to reuse a maximum of similar drawings and reduce the amount of information found in the sprite sheet, making it lighter. The export will omit the creation of new drawings if the difference is less than the threshold percentage.
Threshold	Calculates the differences between multiple drawings. A 2% threshold will prevent the creation of a new drawing if the drawing is too similar to an existing drawing. For instance, with a 2% threshold, and my drawing is 100 pixels big, only 2 of those pixels need to be different from my other drawing in order to

	create a new one. The higher the threshold, the fewer similar drawings you will have.
Sprite Resolutions	Size of the render of the individual sprite, when it exports each drawing out.

Export to Flash Movie Dialog Box

The Export to Flash Movie dialog box lets you export your animation as a Flash (.swf) movie.

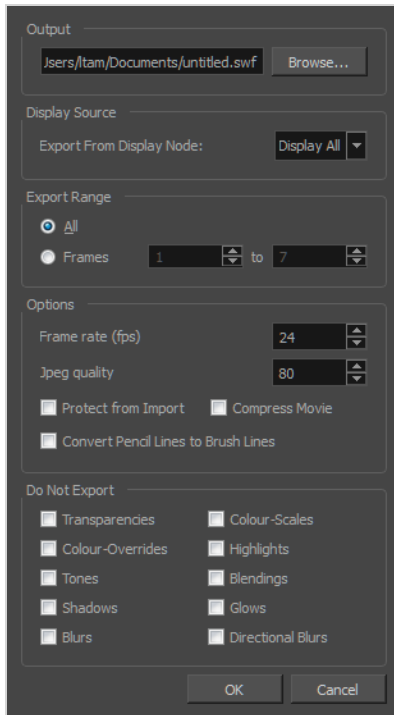

How to access the Export to Flash Movie dialog box

1. From the top menu, select **File > Export > SWF**.

The Export to Flash Movie (.swf) dialog box opens.

Parameter	Description
Output	Lets you specify the location in which the file will be exported.
Display Source	Lets you select a Display node to read from in the Export From Display Node menu.
Export Range	
All	Exports all the frames of your movie.
Frames	Export a frame range which you specify

Options	
Frame Rate	Lets you enter a Frame rate (fps). By default, it will be set to match the fps of your Harmony project. If you choose a lower frame rate, your export playback will be faster than your actual project. The reverse is also true for a higher frame rate.
Jpeg Quality	<p>Lets you select a JPEG quality:</p> <ul style="list-style-type: none"> ▶ 100 = Full quality ▶ 50 = Average quality at about 1/5th of the size. ▶ 25 = Medium quality where loss of high image resolution starts to occur. ▶ 10 = Low quality where “macro-blocking” or large pixelation become obvious. ▶ 1 = Lowest quality where there is extreme loss of colour and detail and the image becomes nearly unrecognizable.
Protect from Import	Prevents the movie from being imported into another application.
Convert Pencil Lines to Brush Lines	Retains the thickness of pencil lines.
Compress Movie	Compresses the movie for a lighter format. The movie may lose some quality, but the file will be lighter.
Do Not Export	<p>Lets you select the effects you do NOT want to be rendered in the SWF movie.</p> <div style="border: 1px solid green; padding: 10px; margin-top: 10px;"> <p> NOTE</p> <p>Certain Harmony effects are not listed in this section as they are not compatible and therefore not available for SWF export. These effects will not appear in the SWF render.</p> </div>

Export to Video Dialog Box

The Export to Video dialog box lets you export your animation as a movie file.

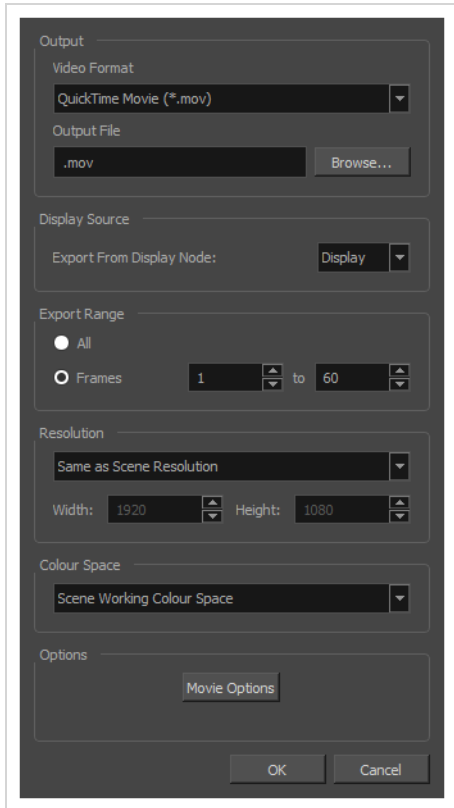

If you added burn-in information to your scene, it will be included in your exported file—see [Burn-In Node on page 720](#).

How to access the Export to QuickTime Movie dialog box

1. From the top menu, select **File > Export > Movie**.

Parameter	Description
Output	
Video Format	<p>Allows you to choose one of the following movie formats:</p> <ul style="list-style-type: none"> • QuickTime Movie (*.mov): The Apple QuickTime format. This is the default export format and is recommended for its portability, and also because it allows you to choose among several video codecs.



NOTES

- On Windows, [Apple QuickTime](#) must be installed to allow Harmony to export QuickTime movies. You can configure the export of QuickTime movies to use any codec that is compatible with QuickTime, including H.264, MPEG-4 and Animation.
- On macOS, Harmony uses Apple AVFoundation to export QuickTime movies, which allows you to export using codecs such as H.264, Apple ProRes 422 and Apple ProRes 4444, among others.
- If you are looking to export a QuickTime movie with transparency, be sure to choose a codec that supports encoding with an alpha channel.
- On GNU/Linux, Harmony uses the OpenQuickTime library to export QuickTime movies. This only allows you to export videos in non-proprietary formats such as Motion-JPEG, Photo JPEG, PNG or Uncompressed (RGB).



- **H.264/MPEG-4 (*.mov)** : A simple movie format that uses the H.264 codec, which is supported by most web browsers.





NOTES

- Using this format does not require additional software. However, if this is the first time you export a movie in H.264/MPEG-4 format, you will be prompted to download the OpenH264 library from Cisco. Simply click **Yes** when prompted, and Harmony will automatically download the library, then export the movie.
- There are no encoding options for this format.
- This format supports resolutions of up to 4096×2304. Each dimension must be a multiple of 16 pixels.
- Audio exported in this format is encoded in PCM 16-bit stereo, 22.05 kHz.

- **Windows Media Video (*.wmv)**: The native format for Windows Media Player.

	<div style="border: 1px solid #c8e6c9; padding: 10px; margin-bottom: 10px;">  <p>NOTES</p> <ul style="list-style-type: none"> • Windows Media Video (.wmv) files can only be exported on Windows. • Video players and editors on non-Windows systems can generally not open Windows Media Video (.wmv) files. </div> <ul style="list-style-type: none"> • Flash (.swf) • Image sequence in Jpeg (.jpg), Targa (.tga) or Portable Network Graphics (.png) format.
<p>Output file</p>	<p>The full path and file name of the movie file to export.</p>
<p>Browse</p>	<p>Opens a dialog allowing you to browse to the desired export directory and enter the desired filename.</p>
<p>Display Source</p>	
<p>Export from Display Node</p>	<p>Lets you select the display node from which to render your scene.</p> <div style="border: 1px solid #c8e6c9; padding: 10px; margin-top: 10px;">  <p>NOTE</p> <p>If there is no Display node in your scene, the only available option will be Display All. This renders all the nodes in your scene, including ones that are not connected to anything. You can add other Display nodes to your scene and connect them under specific parts of your scene to be able to render these parts only.</p> </div>
<p>Export Range</p>	
<p>All</p>	<p>Exports all the frames in your scene.</p>
<p>Frames</p>	<p>Allows you to specify the frame range to export using the two input fields to the right. The first input field is for specifying the first frame to export, and the second one is for specifying the last frame to export. All the frames in-between, including the ones specified, will be exported.</p>
<p>Resolution</p>	
<p>Resolution list</p>	<p>Allows you to specify a resolution to export in, relative to your scene's actual</p>

	<p>resolution:</p> <ul style="list-style-type: none"> • Same as Scene Resolution: Exports a movie in the same resolution as your scene's resolution. • 3/4 of Scene Resolution: Exports a movie at 75% of the scene's width and height. • 1/2 of Scene Resolution: Exports a movie at 50% of the scene's width and height. • 1/4 of Scene Resolution: Exports a movie at 25% of the scene's width and height. • Custom: Allows you specify the preferred resolution of your exported video file, in pixels, in the Width and Height fields.
Width / Height	<p>Lets you specify the width and height of video file you wish to export, in pixels. To preserve your scene's aspect ratio, changing the value of the Width or Height field will automatically update the other field with a proportional value.</p>
Colour Space	<p>The colour space in which to render your movie. The rendered frames will be converted from your scene's working colour space to the selected colour space.</p> <p>The following colour spaces are supported in Harmony:</p> <ul style="list-style-type: none"> • Scene Working Colour Space: The same colour space as the one selected in the Colour Space tab of the Scene Settings dialog. • Linear: The same primaries and white point as sRGB and Rec. 709, but with no gamma transfer curve applied to the colour values. This colour space is useful for compositing intermediary images that are meant to be rendered in sRGB or Rec. 709. • Display P3: A colour space commonly used for digital projection. It has the same primaries as DCI-P3, the same white point as sRGB and the same gamma transfer curve as sRGB. • Display P3 Linear: The same as Display P3, except with no gamma transfer curve. This colour space is useful for compositing intermediary images that are meant to be rendered in Display P3. • Rec. 709: The colour space used for HDTV. It has the same primaries and white point as sRGB, but has a different gamma transfer curve. • Rec. 709 2.4: The same colour space as Rec. 709 or sRGB, except with a gamma transfer curve of 2.4. This colour space exists because some editing systems use a gamma transfer curve of 2.4 instead of the standard gammae curve for Rec. 709. • Rec. 2020: A colour space used for Ultra High Definition TV (UHDTV).

	<p>It has a complex gamma transfer curve and primaries that cover more of the human-perceivable colour space than other colour spaces, especially in the area of human-perceivable greens.</p> <ul style="list-style-type: none"> • Rec. 2020 2.4: The same colour space as Rec. 2020, except with a simple gamma transfer curve of 2.4. This colour space exists because some editing systems use a gamma transfer curve of 2.4 instead of the standard gamma curve for Rec. 2020. • Rec. 2020 Linear: The same colour space as Rec. 2020, except with no gamma transfer curve. This colour space is useful for compositing intermediary images that are meant to be rendered in Rec. 2020. • sRGB: A colour space typically used for standard computer monitors. It has the same primaries and white point as Rec. 709, but has a different gamma transfer curve.
Options	
<p>Movie Options</p>	<p>Opens the movie settings dialog box for your selected video format, in which you can set the video and audio compression settings for your video file:</p> <ul style="list-style-type: none"> • QuickTime Movie (*.mov) on Windows: Movie Options Dialog Box (macOS), • QuickTime Movie (*.mov) on macOS: QuickTime Movie Settings Dialog Box (Windows) • Windows Media Video (*.wmv): Windows Media Video Settings Dialog Box (Windows) <div data-bbox="597 1220 1430 1356" style="border: 1px solid #c8e6c9; padding: 10px; margin-top: 10px;"> <p> NOTE This button is available on Windows and macOS only.</p> </div>
<p>Video Options</p>	<p>Opens the video settings dialog box, which allows you to set the video compression settings for your video file—see OpenQuickTime Video Options Dialog Box (GNU/Linux).</p> <div data-bbox="597 1549 1430 1686" style="border: 1px solid #c8e6c9; padding: 10px; margin-top: 10px;"> <p> NOTE This button is available on GNU/Linux only.</p> </div>
<p>Sound Options</p>	<p>Opens the audio settings dialog box, which allows you to set the audio compression settings for your video file—see OpenQuickTime Sound Options Dialog Box (GNU/Linux).</p>



NOTE

This button is available on GNU/Linux only.

Export to Sprite Sheet Dialog Box

The Export to Sprite Sheets window exports to multiple resolutions, generating multiple .xml files and one or multiple sprite sheets depending on how many sprite resolutions you defined.

This saves different animations of the same character into the same name. For example, if there's an idle, run, and jump animation, these should all share the same Save Name. You can think of it as the overall collection of animations. Inside are the different saved scene versions whose drawings you can reuse for all the animations in that character set. Each scene version will be displayed as an item in the list.

When you export an animation, only the drawings used in that scene are exported. All the drawings are exported individually first and then atlased together into a sprite sheet.

If you saved multiple animations to the same Save Name (i.e. SpaceDuck: run, idle), then it will reatlas the sprite sheet to include all the drawings from all the animations in that folder, creating a new animation file, but reusing the same skeleton.

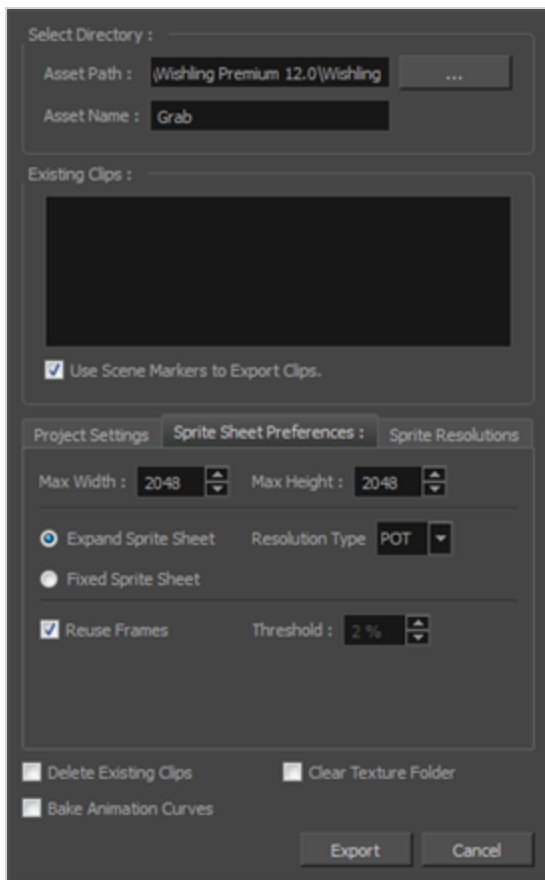

How to access the Export to Sprite Sheets window

1. Select **Windows > Toolbars > Game**.

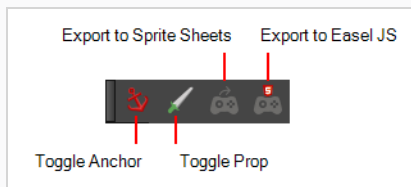

2. Click the Export to Sprite Sheets  button.

Parameter	Description
Select Directory	
Asset Path	The folder path where you want to save your export.
Asset Name	The folder name in which you will save your export. This will also be the name of your asset in Unity. Your scene file name will be used as the clip name.
Existing Clips in Folder	
Preview Window	Displays a list of pre-existing clips in the same export folder location, most likely exported there from a previous time.
Use Scene Markers to Export Clips	Uses scene markers to define the export range, instead of exporting the entire scene.
Project Settings	
Unit Scale	Lets you change the scale when exporting to Unity to accommodate the size of the export without it affecting the Harmony scene. This helps you resize assets properly for Unity without having to resize them in Harmony. The basic scale is one Animation Field for one Unity unit.
Preset	Lets you select the unit conversion from Harmony to Unity, by selecting one of 4 presets. Note: a field is a unit of measure in traditional animation grid.
Sprite Sheet Preferences	
Max Width	This is a value, in pixels, for the maximum width and height the exported sprite sheet should be. By default, both values are set to 2048 pixels.

Max Height	Makes linear values for interpolation. This increases the amount of memory used but frees up the calculation so it is not done on the fly.
Expand Sprite Sheet	Uses the minimum size necessary up until it reaches the maximum resolution.
Fixed Sprite Sheet	Creates a texture of the specified size (Max Width and Max Height) even if it does not fill it up completely by all the drawings in your scene.
Resolution Type	<p>POT: Exports to sprite sheets with sizes that are a power of 2. For example: 1024 x 1024. This is optimized for many graphics cards, but consumes more memory.</p> <p>NPOT: Some game engines are optimized specifically to render to non powers of two, so that it will avoid those numbers. Example: 1000 x 1000.</p>
Reuse Frames	This option works in tandem with the Threshold option. The export will compare the drawings in your project to reuse a maximum of similar drawings and reduce the amount of information found in the sprite sheet, making it lighter. The export will omit the creation of new drawings if the difference is less than the threshold percentage.
Threshold	Calculates the differences between multiple drawings. A 2% threshold will prevent the creation of a new drawing if the drawing is too similar to an existing drawing. For instance, with a 2% threshold, and my drawing is 100 pixels big, only 2 of those pixels need to be different from my other drawing in order to create a new one. The higher the threshold, the fewer similar drawings you will have.
Sprite Resolutions	Size of the render of the individual sprite, when it exports each drawing out.
Delete Existing Clips	Select this option to delete any pre-existing clips in the export location.
Bake Animation Curves	Makes linear values for interpolation. This increases the amount of memory used but frees up the calculation so it is not done on the fly.
Clear Texture Folder	Removes any information from the texture folder within the Harmony file. This has no incidence towards the Unity export but contributes to a lighter Harmony file.

Expression Dialog Box

In Harmony, you can use expressions to automate the calculation of effect values based on the values in another function. An expression is a mathematical formula that allows you to manipulate the value in the source function to create new values for the destination effect.

The Expression dialog box is where you write expressions. It's a simple text editor that can handle incomplete or invalid JS programs although they will not be evaluated. Harmony can save and load invalid JS programs.

The Expression editor evaluates the current script at the current global frame and reports any errors or returns the numerical result of the program.

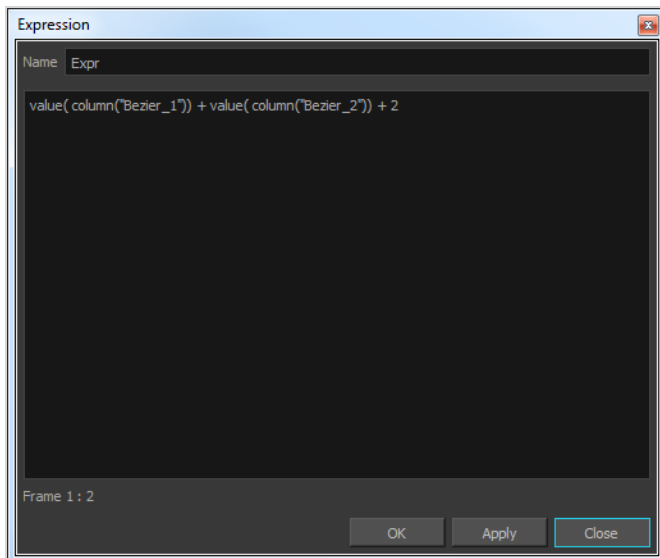

How to access the Expression dialog box

1. In the Xsheet view menu, select **Columns > Add Columns** or press Shift + C.

The Add Column dialog box opens.

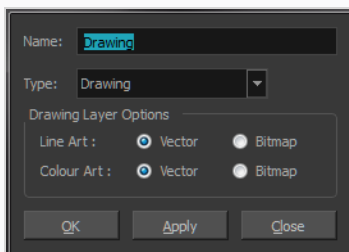

2. In the Name field, type a name for the column.
3. From the Type menu, select **Expression** and click **OK**.
4. Double-click on the column's header to open the Expression dialog box.

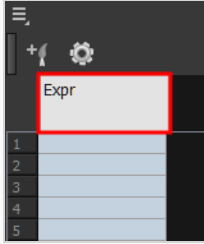

The Expression dialog box opens.

Parameter	Description
Name	Indicates the name of the expression column in the Xsheet. You can edit this name.
Description field	Area in which you can type in expressions.

Extend Exposure Dialog Box

The Extend Exposure dialog box lets you extend the exposure of a selected cell in the Timeline or Xsheet.

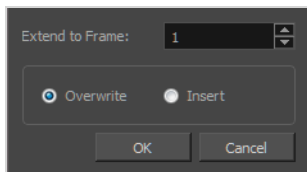

How to access the Extend Exposure dialog box

1. Select a cell and do one of the following:
 - From the top menu, select **Animation > Cell > Extend Exposure**.
 - Press F5.

The Extend Exposure dialog box opens.

Parameter	Description
Extend to Frame	Lets you enter the frame up to which you want to extend the exposure. You can expose the drawing in the frames and replace the drawings that were originally there or move the subsequent frames forward in time.
Overwrite	Lets you expose the drawing in the frames and replace the drawings that were orginally there.
Insert	Lets you expose the drawing in the frames and move the subsequent frames forward in the Timeline view.

Fill Cells Randomly Dialog Box

The Fill Cells Randomly dialog box lets you fill in random values over a selection. You can give a maximum and a minimum value and create a range for Harmony to choose the random values from. The selection can be over one cell or a cell range in one column or more or an entire column or many entire columns.

How to access the Fill Cells Randomly dialog box

- Do one of the following:
 - Select **Animation > Cell > Fill Cells Randomly**.
 - In the Xsheet view, click the Fill Cells Randomly  button (you may have to customize the toolbar to display it).

The Fill Cells Randomly dialog box opens.

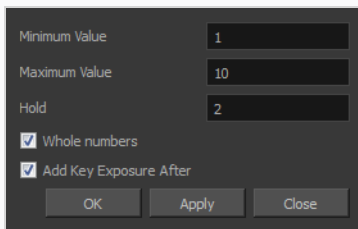

Parameter	Description
Minimum Value	The lowest value to be used in the randomized exposure or keyframe value.
Maximum Value	The highest value to be used in the randomized exposure or keyframe value.
Hold	The exposure holding value.
Whole Numbers	If you are applying this to a drawing column, this option lets you avoid having decimal points.
Add Key Exposure After	Inserts a key exposure on the frame following the last cell of the selection.

Fill Exposure Using Render Changes Dialog Box

The Fill Exposure Using Render Changes dialog box lets you detect if a threshold of changes has occurred between two consecutive images and then expose the affected textures for further processing. It can be used for example to change the texture on a characters shirt only when the shape of the shirt is changed significantly from the previous frame. This avoids unnecessary repetitive texture changes on every frame.



How to access the Fill Exposure Using Render Changes dialog box

1. In the Timeline view, select the textures or live-action sequence.

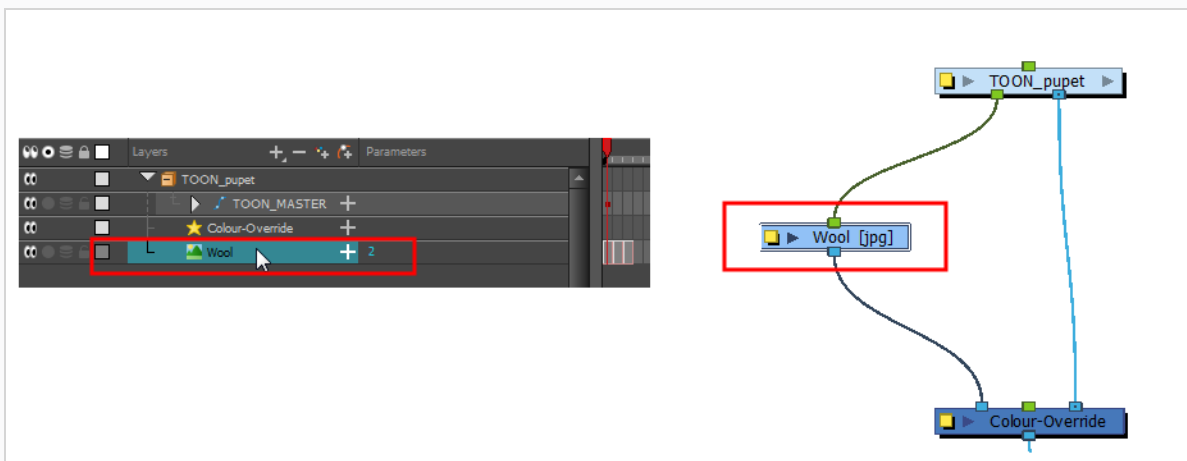

2. From the top menu, select **Scene > Default Display > desired Display node**.
3. From the top menu, select **Animation > Exposure Fill > Using Render Change**.

Wait while Harmony creates a low resolution render of the images to preview.

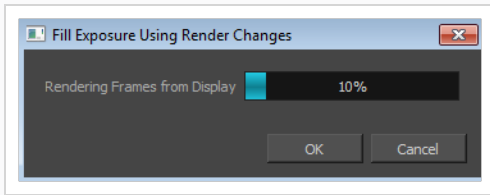

4. In the Fill Exposure Using Render Changes window, use the Frame slider to view the motion change analysis.
5. Based on your style preference, adjust the parameters to assign when the texture exposure changes will occur. You can adjust the type of filter to use for the motion detection, as well as threshold values to indicate what will be considered a big enough motion variation for an exposure change.

Parameter	Description
Changes Detection Settings	Frame: Use the slider to see when a change is necessary. A red edge indicates there is a large enough motion for the texture to change.
	Use: Lets you use either the Red, Green, Blue, or Alpha channel, or Luminance difference between frames to analyze the motion changes. The Alpha channel is selected by default as it is the most commonly used parameter.
	Pixel Value Change Threshold: The percentage of change in a pixel to be considered different from one frame to another. The higher the value, the more change is required when comparing two images in order for a new texture to be used.
	Area Change Threshold: The percentage of non-empty pixels that must change from one frame to another to be considered different.
Fill Settings	These settings let you change the exposure. You can also decide on how many images you want to cycle.
	First/Last Frame: Lets you set the first and last frame for the exposure change. You can set this for the entire scene or for part of the scene (frames 20 to 32 for example).
	Number of Drawings in Cycle: Lets you set of the number of drawings to include in the cycle.

	<p>First Drawing Used in Cycle: Lets you set the first drawing used in the cycle. Your drawings must be named using numeric values only, or number values with a prefix or suffix. It cannot only be letters.</p>
	<p>Drawing Name Prefix: Adds a prefix before the number. For example, texture_01, texture_02 and so on.</p>
	<p>Drawing Name Suffix: Adds a suffix after the number. For example, 01_texture, 02_texture and so on.</p>

Fill Selection Dialog Box

The Fill Selection dialog box lets you fill the same value over an entire selection. The selection can be over one cell, a cell range in one column, a cell range over many columns, an entire column, or many columns. You can use numbers, words, letters, or any alphanumeric value.

How to access the Fill Selection dialog box

1. In the Timeline or Xsheet view, select a cell range.

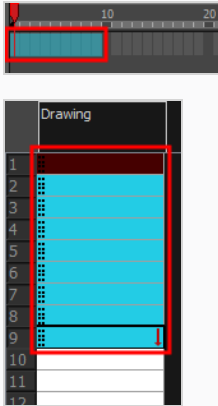

1. Do one of the following:

- From the top menu, select **Animation > Cell > Fill Selection**.
- In the Xsheet toolbar, click the Fill Selection  button. Note that you may have to add this button to your toolbar by right-clicking on it and selecting **Customize**.
- Press Ctrl + T (Windows/Linux) or ⌘ + T (macOS).

The Fill Selection dialog box opens.

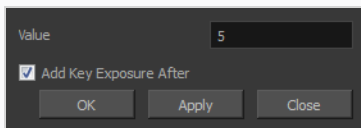

Parameter	Description
Value	This is the value to be used in the filled selection.
Add Key Exposure After	Inserts a key exposure on the frame following the last cell of the selection.

Function Wizard Dialog Box

The Function Wizard dialog box allows you to easily create Master Controller widgets that are programmed to control specific attributes in a node. It works by letting you select a type of widget, a type of operation, one or several nodes and the node attribute to control, and generates a fully functional Master Controller node that controls the selected attribute in the selected nodes.

The Function Wizard automatically generates the script to make your Master Controller work, so you don't need to have scripting knowledge to use this wizard. However, it also allows you to customize the script it generates from within the wizard. Hence, users who are familiar with Harmony scripting can easily change or expand the capacities of the Master Controller they're creating. They can use this wizard to create a "basic" Master Controller and use it as a foundation to develop a much more complex Master Controller. Users who are less familiar with scripting can also look at the script generated to learn how scripting with Master Controllers works.

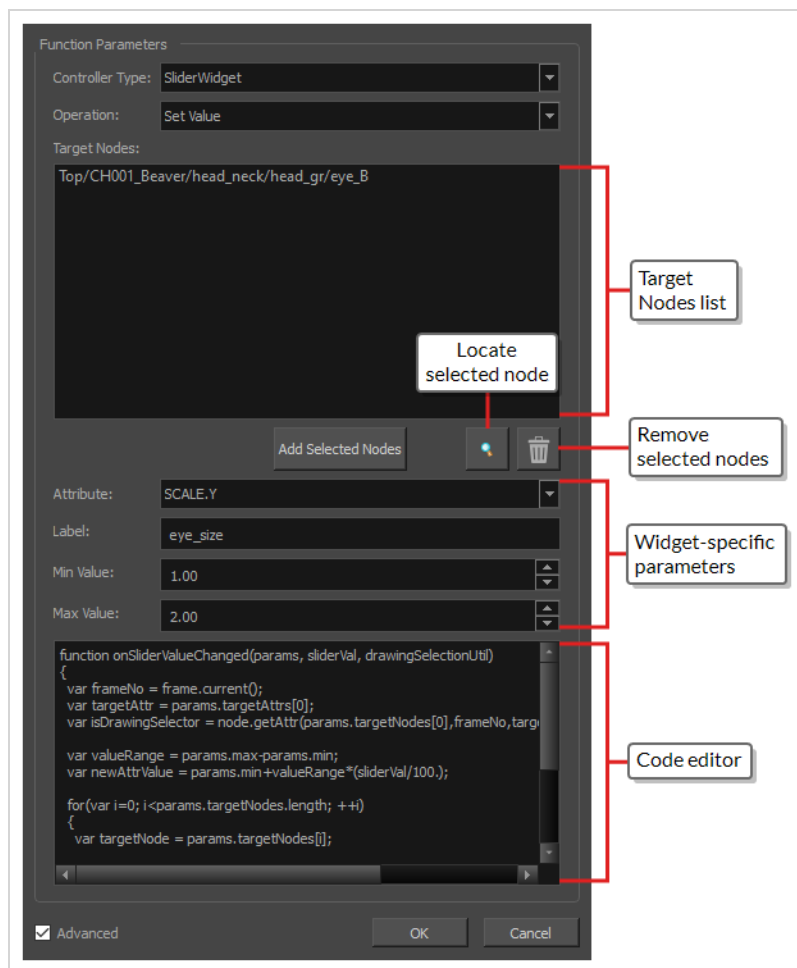

To use the Function Wizard, you must first identify and select a node for which you want to create a widget. The resulting widget, which will appear in the Camera View, can be configured to perform the following operations:

- Control the value of one of a node’s numerical (scalar) attributes (e.g., horizontal position, vertical position, etc.)
- Control the value of one of a node’s 2D (vector) attributes (e.g., position, scale, etc.)
- Toggle whether a node is enabled or disabled
- Show or hide the controls for a node
- Show or hide the deformation controls for a deformation chain

How to access the Function Wizard



1. Add the Master Controller toolbar to your workspace by doing one of the following:
 - Right-click on an existing toolbar and select **Master Controller**.
 - In the top menu, select **Windows > Toolbars > Master Controller**.

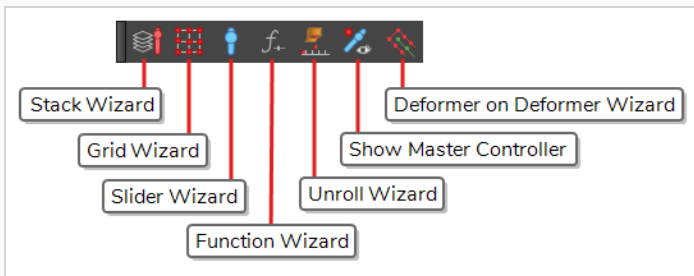

The Master Controller toolbar appears.



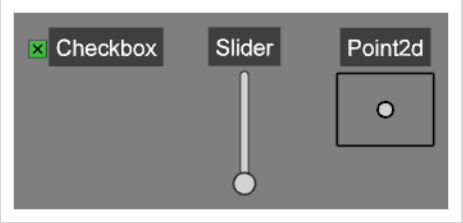

2. In the Node or Timeline view, select the nodes that you want to control with a Master Controller.
3. In the Master Controller toolbar, click the f_+ Function Wizard button.

Icon	Parameter	Description
	Controller Type	<p>The type of Master Controller widget to create. The Function Wizard can generate a widget of the following types:</p> <ul style="list-style-type: none"> • Checkbox: A simple controller that has two states: checked or unchecked. The user can toggle its state by clicking on it. • Slider: A controller consisting of a point that can be moved vertically within a range. It returns a value based on where the point is positioned within that range. • Point2d: A controller consisting of a point that can be moved horizontally and vertically within a rectangle. It returns the position of the point within that rectangle, in x and y coordinates.

Icon	Parameter	Description
		
	Operation	<p>The operation to execute on the selected nodes, on their selected attribute, when the user manipulates the widget. Depending on the selected controller types, the following operations are available:</p> <ul style="list-style-type: none"> • CheckboxWidget: <ul style="list-style-type: none"> • Toggle Attribute: Toggles one of the boolean attributes of the target nodes to true or false, depending on whether the checkbox is checked or unchecked. • Show/Hide Node Controls: Toggles whether the controls for the target nodes are visible in the Camera view. • Enable/Disable Nodes: Toggles whether the target nodes are enabled or disabled. Disabled nodes have no effect on the rendered image. For example, disabled Element nodes are invisible, disabled Peg nodes do not offset the elements attached under them, and disabled effect nodes output their input image as-is, without applying an effect to it. • Show/Hide Deformers: Toggles whether the controls for the deformers in the target nodes are visible in the Camera view. • Point2dWidget: <ul style="list-style-type: none"> • Set Value: Sets the value of an attribute for the target nodes based on the X and Y coordinates of the 2D point within its bounding box. <div style="border: 1px solid green; padding: 10px; margin: 10px 0;"> <p> NOTES</p> <p>In the case of Point2d widgets, the target attribute must be a vector-type attribute, which means it must have X and Y child attributes, so that these child attributes can be set to the value of the X and Y coordinates of the 2D point.</p> <p>For example, a 2D point widget can be used to manipulate the position or the scale of a Peg or Element node, as those attributes have X and Y child attributes.</p> </div> <ul style="list-style-type: none"> • SliderWidget: <ul style="list-style-type: none"> • Set Value: Sets the value of a numerical attribute for the targets nodes, based on the position of the point within the slider. Contrary to Point2D

Icon	Parameter	Description
		<p>widgets, the Slider widget can manipulate any single numerical (scalar) attribute for the target nodes.</p>
	<p>Target Nodes</p>	<p>The list of nodes that the Master Controller will affect. When you open the Function Wizard, this list is automatically filled with the currently selected nodes in your scene. The list of target nodes can be edited using the buttons just below it.</p> <div data-bbox="505 541 1430 1136" style="border: 1px solid #c8e6c9; padding: 10px;"> <p> NOTES</p> <ul style="list-style-type: none"> • If multiple nodes of different types are added to the Target Nodes list, only attributes that are common to all the target nodes can be manipulated. As such, it is recommended to only add nodes of the same type to the Target Nodes list. <p>For example, if you add both Peg and Element nodes to the Target Nodes list, you will not be able to manipulate their position with your Master Controller, as the position attribute for a Peg is named POSITION, whereas the position attribute for an Element is named OFFSET. Hence, they are not considered the same attribute.</p> <ul style="list-style-type: none"> • If multiple nodes are added to the Target Nodes list, the first node in the list will serve as the “master” node. This means that the widget’s state or position will remain synchronized to the value of the first node’s target attribute. </div>
	<p>Add Selected Nodes</p>	<p>Adds the nodes that are currently selected in the scene, whether from the Timeline view, Node View or Camera view, to the list of Target Nodes in the Function Wizard.</p>
	<p>Locate Selected Node</p>	<p>Instantly navigates, in the Node View, to the node that is currently selected in the Target Nodes list, and selects it.</p>
	<p>Remove Node</p>	<p>Remove the nodes that are selected in the Target Nodes list from the Target Nodes list.</p>
<p>Slider widget parameters</p> <div data-bbox="193 1696 760 1887" style="border: 1px solid #ccc; padding: 5px; background-color: #f0f0f0;"> <p>Attribute: SCALE.Y</p> <p>Label: eye_size</p> <p>Min Value: 1.00</p> <p>Max Value: 2.00</p> </div>		

Icon	Parameter	Description
	Attribute	<p>Allows you to select which attribute in the target nodes that the slider widget will control. This drop-down will display all numerical (scalar) attributes available for the selected nodes.</p> <div data-bbox="505 415 1430 615" style="border: 1px solid #c8e6c9; padding: 10px;"> <p> NOTE If several nodes of different types (i.e.: Peg, element, effect, composite, etc.) are in the Target Nodes list, only attributes that are common to all the target nodes will be available.</p> </div>
	Label	<p>The label text to display over the widget, to make it easy to identify in the Cameras view.</p> <p>This value is also used to name the Master Controller node that will be created. The Master Controller node will be named mc_ followed by the name in the Label, with spaces replaced by underscores (_).</p>
	Min Value	The value returned by the slider when it is set to its lowest position.
	Max Value	The value returned by the slider when it is set to its highest position.
<p>Point2d widget parameters</p> <div data-bbox="196 1163 760 1430" style="border: 1px solid #ccc; padding: 5px;"> <p>Attribute: OFFSET</p> <p>Label: eye_position</p> <p>XMin: -1.000</p> <p>YMin: -1.000</p> <p>XMax: 1.000</p> <p>YMax: 1.000</p> </div>		
	Attribute	<p>Allows you to select which attribute in the target nodes that the slider widget will control. This drop-down will display all vector-type attributes available for the selected nodes. Vector-type attributes are attributes that have X and Y sub-attributes, which can be set to the X and Y coordinates of the 2D point as it is manipulated.</p> <div data-bbox="505 1671 1430 1871" style="border: 1px solid #c8e6c9; padding: 10px;"> <p> NOTE If several nodes of different types (i.e.: Peg, element, effect, composite, etc.) are in the Target Nodes list, only attributes that are common to all the target nodes will be available.</p> </div>

Icon	Parameter	Description
	Label	<p>The label text to display over the widget, to make it easy to identify in the Cameras view.</p> <p>This value is also used to name the Master Controller node that will be created. The Master Controller node will be named mc_ followed by the name in the Label, with spaces replaced by underscores (_).</p>
	XMin	The value returned by the 2D point widget for the X coordinate when it is at its leftmost position.
	XMax	The value returned by the 2D point widget for the X coordinate when it is at its rightmost position.
	YMin	The value returned by the 2D point widget for the Y coordinate when it is at its bottommost position.
	YMax	The value returned by the 2D point widget for the Y coordinate when it is at its topmost position.
<p>Checkbox widget parameters</p> 		
	Attribute	<p>Allows you to select which attribute in the target nodes that the checkbox widget will toggle. This drop-down will display all boolean-type attributes available for the selected nodes.</p> <p>This drop-down will be greyed out if you selected an operation that toggles something other than an attribute, such as Enable/Disable Nodes, Show/Hide Node Controls and Show/Hide Deformers.</p> <div data-bbox="505 1528 1430 1822" style="border: 1px solid green; padding: 10px; margin-top: 10px;"> <p>NOTES</p> <ul style="list-style-type: none"> • This drop-down will be greyed out if the Operation parameter is set to something other than Toggle Attribute. • If several nodes of different types (i.e.: Peg, element, effect, composite, etc.) are in the Target Nodes list, only attributes that are common to all the target nodes will be available. </div>
	Label	The label text to display over the widget, to make it easy to identify in the Cameras

Icon	Parameter	Description
		<p>view.</p> <p>This value is also used to name the Master Controller node that will be created. The Master Controller node will be named mc_ followed by the name in the Label, with spaces replaced by underscores (_).</p>
Additional parameters		
	Function Code	<p>The function that is executed when the Master Controller widget is manipulated.</p> <p>This script can be edited within the Function Wizard, and any changes you make to the script will actually be carried over to the Master Controller that the wizard will create. Hence, not only this field allows you to learn what the code for a basic Master Controller looks like, it can also allow you to create Master Controllers that have more complex effects than what is supported by the Function Wizard.</p> <div data-bbox="505 848 1430 1052" style="border: 1px solid #add8e6; padding: 10px;"> <p> TIP You can also modify this code at any time after you created your Master Controller. To make changes to this code, simply open the Layer Properties for the Master Controller node, and then select the UI Script tab.</p> </div>
	Advanced	<p>By default, several of the target node's attributes are hidden in the Attribute drop-down so as to avoid cluttering it. In Advanced mode, all of the target node's attributes that are compatible with your Master Controller widget will be listed in the Attribute drop-down, giving you more options for which attribute of the target node the Master Controller will manipulate.</p>

Master Controller Grid Wizard Dialog Box

T-HSCP-003-006

The Master Controller Grid Wizard dialog box allows you to create a 2D point-type Master Controller widget which can be used to position a character model based on a grid of poses.

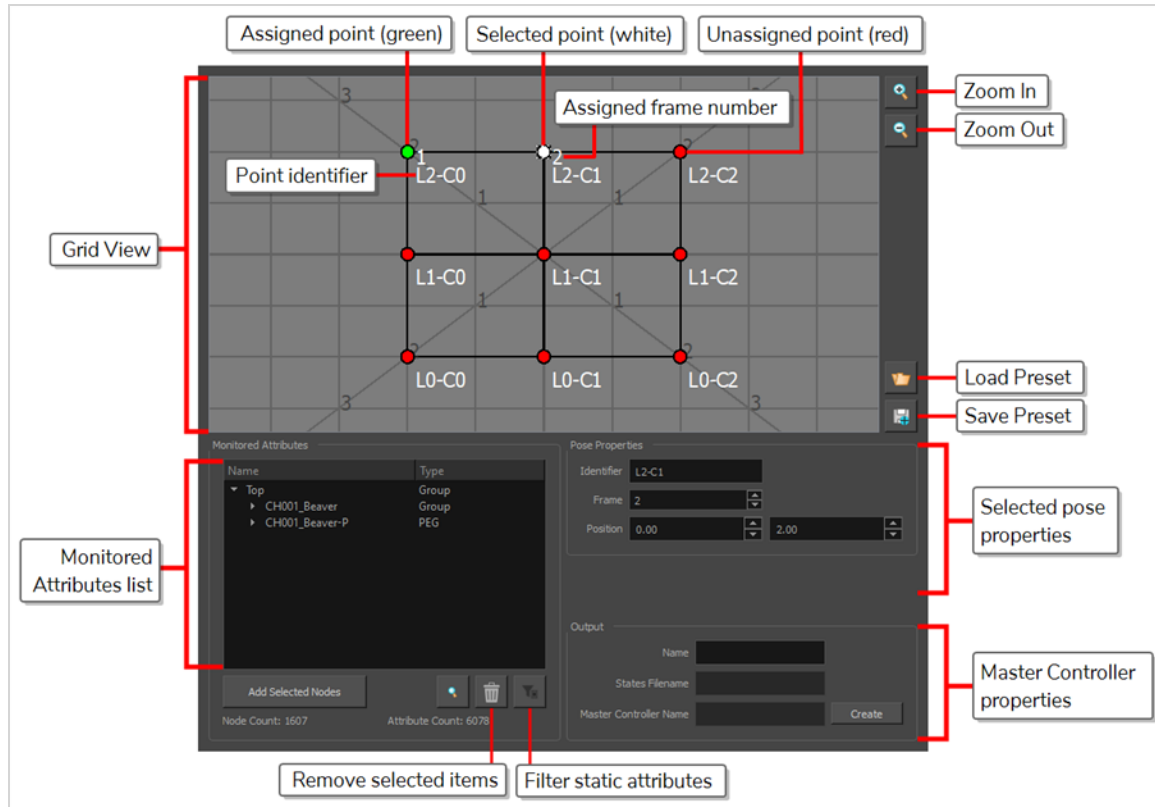

To use the Interpolation Wizard, you must first create enough poses to make a grid of poses. For example, key poses of a character's head looking in every direction can be laid out in a grid:

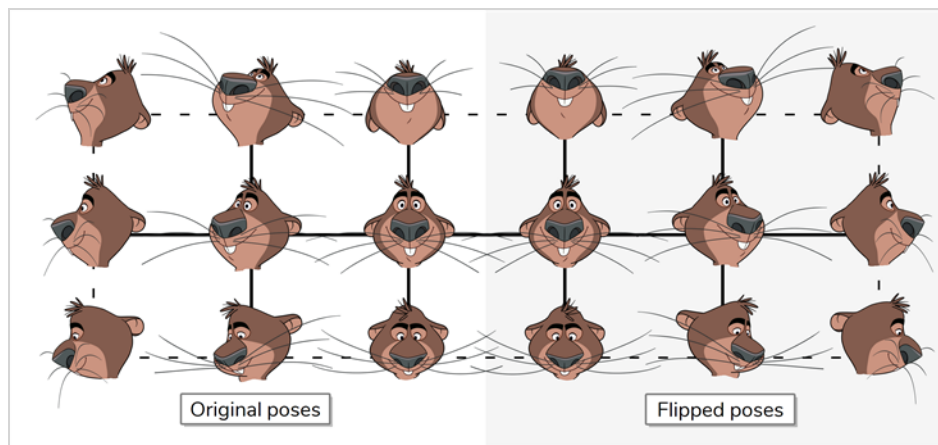

Once you've done that, you need to select the layers and/or groups you want your Master Controller to control which, in this case, would be all the layers making the character's head. Then, you can open the Grid Wizard.

The Wizard will start out by displaying the Load Preset dialog, in which you can specify the vertical and horizontal size of your grid in the **Key Poses** fields.

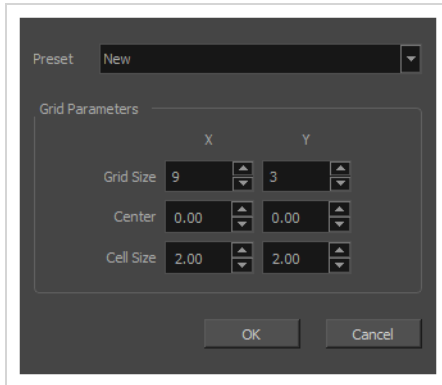

Optionally, you can also select its centre point and the size of its cells in the **Center** and **Cell size** fields. The coordinates used for the center position and cell size are based on a 4:3, 12 fields traditional animation grid. You display one over your character as a reference by adding a Grid node to your scene—see [Grid Node](#).

Then, the Grid Wizard dialog will generate a grid with the specified size in the specified position and with the specified cell size. Each point in the grid will be represented by a **red** dot. You must select each of these dots and associate them with the frame number containing the pose you want the point to represent. Once a point is associated to a pose, it becomes **green**.

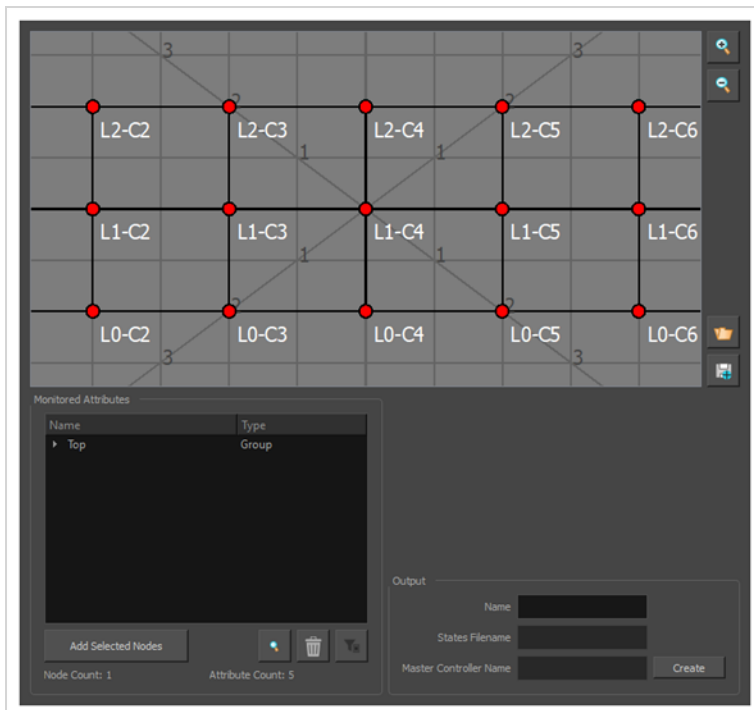

When you click on **Create**, this grid of poses will be stored in a pose database and a 2D point Master Controller will be created. This Master Controller will use this pose database to change your character's pose when you move the 2D point around in the Camera view.

How to access the Grid Wizard

1. Do one of the following to add the Master Controller toolbar to your workspace:

- Right-click on an existing toolbar and select **Master Controller**.
- In the top menu, select **Windows > Toolbars > Master Controller**.

The Master Controller toolbar appears.

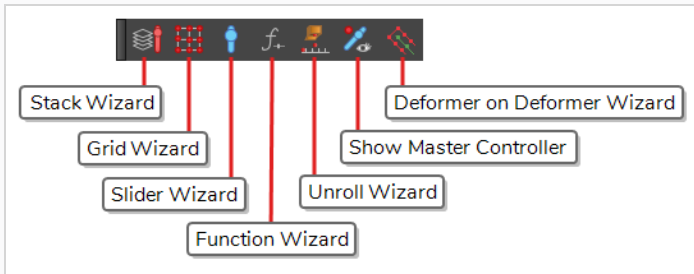

1. In the Timeline view, select the layers and groups you want your Master Controller to control.

 **NOTE**
If you select a group, all of the layers inside it will be added to the list of layers your Master Controller will control.



2. In the Master Controller toolbar, click on the  Grid Wizard button.



Grid Parameters Dialog Parameters



Parameter	Description
Preset	Allows you to select and load a grid preset you previously created. If you have not created any, you can ignore this drop-down and set up a new grid in the fields below.
Key Poses	The numbers of columns and rows with which to create the grid of poses. The product of these two amounts is the amount of poses you will need to provide to the Grid Wizard.
Center	The coordinates of the centre of the grid, relative to the centre of the scene, in horizontal and vertical fields.
Cell Size	The size of each cell in the grid, in horizontal and vertical fields.

Parameter	Description
OK	Dismisses the Grid Parameters dialog box and creates the grid with the selected parameters in the Grid Wizard dialog box, so that you can start configuring the points in the grid.

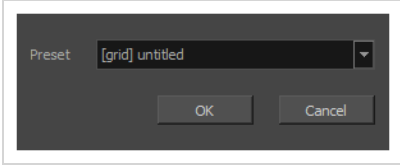
Grid Wizard Dialog Parameters

Icon	Parameter	Description
Grid		
	Grid View	<p>Displays the grid of poses.</p> <p>Each point in the grid is represented by a coloured dot:</p> <ul style="list-style-type: none"> • Red dots are dots that need to be assigned to a pose (frame number). • Green dots are dots that are already assigned to a pose (frame number). <p>You must fill each point in the grid with poses, until they are all green, before you can create your Master Controller.</p> <p>To fill a point, simply click on it to select it. This will make the Select Frame dialog appear, in which you can type in the frame number to associate the point to.</p> <p>Selecting a point makes the State Properties section of the dialog appear. In this section, you can change the identifier and the frame number of the point, and you can also modify its position in the grid.</p> <p>The grid is laid out over a standard 12 fields 4:3 animation grid. This grid is the same grid that displays in the Camera view if you add a Grid node to your scene. Hence, by adding a Grid node to your scene, you can use it as a reference to align the grid with specific areas in the scene.</p> <p>You can pan around the grid view by clicking and dragging on it.</p>
	Zoom In	Zooms into the grid view.
	Zoom Out	Zooms out of the grid view.

Icon	Parameter	Description
	<p>Load Preset</p>	<p>Opens the Load Preset dialog. In this dialog, you can load a grid preset, or create a new grid.</p>  <p>To load an existing preset, select it in the Preset drop-down. To create a new grid from scratch, select New in the Preset drop-down instead.</p> <p>If you click OK, the selected grid will be loaded into the Grid Wizard, replacing the current grid and discarding any work you put on it. If you click Cancel, you can resume working on the currently loaded grid.</p>
	<p>Save Preset</p>	<p>Saves the current grid and all of its properties as a grid preset. This allows you to quickly reload the current grid's size, its centre point, its cell size, as well as each point's assigned frame and other properties into the Grid Wizard later, when you want to create another 2D point widget. This can be very useful if you create several character models in different scenes, with the same poses at the same frames.</p> <p>You can select a grid preset to use in the Grid Parameters dialog that appears when you open the Grid Wizard.</p>
<p>Monitored Attributes</p>		
	<p>Attribute List</p>	<p>The list of nodes (ie: layers, pegs, deformation points, etc.) that will be affected by the Master Controller. If you expand any of the listed nodes, you will find the list of attributes (ie: position, angle, scale, etc.)</p> <p>The list is structured in a group/node/attributes hierarchy, with Top representing the root of your scene. By expanding a group, you will find all of the nodes inside that group. By expanding a node, you will find all of its attributes.</p>
	<p>Add Selected Nodes</p>	<p>If you first select groups nodes in the Timeline or Node view, you can click on this button to add these nodes' attributes to the Monitored Attributes list. This allows you to add more nodes to the list of nodes that will be controlled by the Master Controller.</p>

Icon	Parameter	Description
		<p>If you select a group, this button will add the group as well as every node inside that group to the Monitored Attributes list.</p>
	<p>Remove Selected Items</p>	<p>Removes the groups, nodes or attributes that are currently selected in the Monitored Attributes list from the Monitored Attributes list. This allows you to remove nodes from the list of nodes that will be controlled by the Master Controller.</p> <p>If you select a group, this button will remove the group as well as every node inside that group from the Monitored Attributes list.</p> <p>If you select specific attributes in a node, this button will only remove these attributes from the Monitored Attributes list, and will leave the other attributes in the list. This allows you to make the Master Controller only control specific attributes for a node and ignore others.</p>
	<p>Filter Static Attributes</p>	<p>Remove every attribute that does not change across any of the poses added to the grid. This will optimize the performance of the Master Controller as well as reduce the amount of storage space it uses without impacting its functionality.</p> <div data-bbox="695 1060 1430 1234" style="border: 1px solid green; padding: 5px; margin-top: 10px;"> <p> NOTE This option can only be used once you have filled your entire grid with poses.</p> </div>
	<p>Node Count</p>	<p>The amount of nodes (layers, pegs, deformation points, etc.) that will be controlled by the Master Controller.</p>
	<p>Attribute Count</p>	<p>The amount of attributes (position, angle, scale, etc.) that will be controlled by the Master Controller.</p>
<p>Pose Properties</p>		
	<p>Identifier</p>	<p>Allows you to type in a custom label for the currently selected point.</p>
	<p>Frame</p>	<p>Allows you to view and update the frame number (pose) associated with the currently selected point.</p>
	<p>Position</p>	<p>Allows you to update the position of the selected point on the grid,</p>

Icon	Parameter	Description
		<p>in horizontal and vertical field coordinates.</p> <p>By default, all points in the grid are created to be at an equal distance from one another. By using these fields to edit the position of points, you can make a fully customized grid.</p>
Output		
	Name	Allows you to enter the name for the Master Controller node that will be created at the end of the process.
	States Filename	<p>Displays the name of the corresponding states file name, based on the Master Controller node name.</p> <p>The attribute values of the associated poses are recorded in an external file. When the Master Controller node is created, the matching states file is created.</p>
	Master Controller Name	Displays the complete Master Controller node name including the mc_ prefix.
	Create	Generate the Master Controller and its database of poses.

Import 3D Models Dialog Box

Use the Import 3D Models dialog box to import 3D models into Harmony.

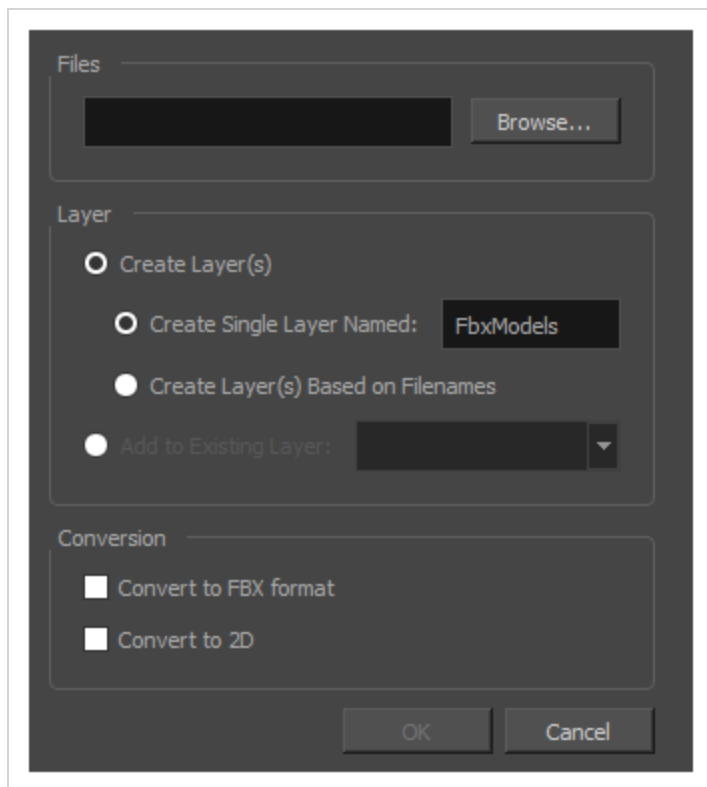

How to open the Import 3D Models dialog box

1. From the top menu, select **File > Import > 3D Models**.

The Import 3D Models dialog box opens.

Parameter	Description
Files	
Browse	Lets you locate and select 3D model file formats from a location on your computer or a location accessible from your computer (network, server, etc.).
Layer	
Create Layers(s)	This option is selected by default. A new layer will be created for the selected 3D model files for the import. You have two choices:

Create Single Layer Named	Creates a new layer for your 3D model that you can name. Name the new layer immediately by entering a name into the provided field.
Create Layer(s) Based on Filenames	Creates a layer based on each unique filename prefix. For example, the filenames a-1.obj, a-2.obj and b-1.obj will create layers named "a" and "b", where "a" has two 3D models and "b" has one. When creating a single layer from these three filenames, all three models will be imported to the new layer.
Add to Existing Layer	Imports the selected files to an existing layer in the scene. Once this option is selected the adjacent drop-down list becomes active. Select an existing layer name from the drop-down list. Note that if you select a vector layer, it will encapsulate the 3D model inside a symbol.
Conversion	
Convert to FBX format	Check this option if your file isn't already a Filmbox (. fbx) file and you would like it to be. This format incorporates all associated files, such as the texture files.
Convert to 2D	Check this option if you want to render the 3D model into a 2D image and import it into a bitmap layer instead of as a 3D object. You will be prompted to select the position and angle from which to render the 3D model, as well as to apply geometrical transformations to it before rendering it—see Render 3D Model Dialog Box on page 188.

Import Images Dialog Box

T-HFND-007-011

The Import Images dialog box lets you import bitmap images and vectorize them, making the images editable. Then you can use a variety of drawing tools to edit the image. Or you can always keep the original bitmap image as is.

Also, you can choose to import bitmap images on bitmap or vector layers depending on your project..

How to open the Import Images dialog box

1. Do one of the following:

- From the top menu, select **File > Import > Images**.
- In the File toolbar, click the Import Images  button.
- In the Xsheet view, right-click anywhere in the frame area and select **Import > Images**.

The Import Images dialog box opens.

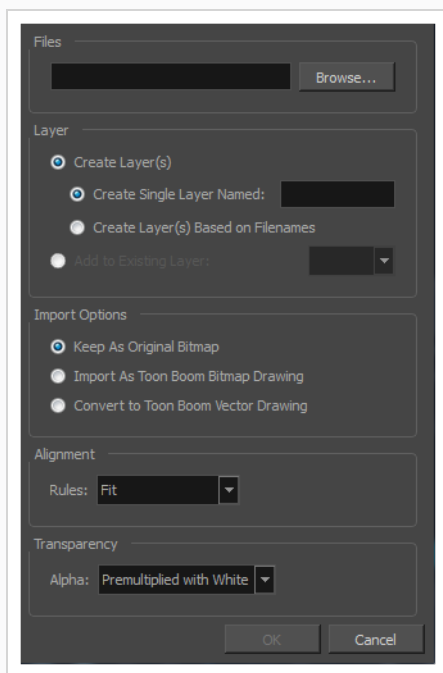

Parameter	Description
Files	

Browse	Lets you find and select images on your computer.
Layer	
Create Layers(s)	Create layers for imported images.
Create Single Layer Named	Creates a new layer with the specified name and imports the images into it.
Create Layer(s) Based on Filenames	Creates a layer based on each unique filename prefix. For example, if you import three files named a-1.tga, a-2.tga and b-1.tga, this will create two layers, one named "a" and one named "b". Layer "a" will contain the two first images and "b" will contain the third one.
Add to Existing Layer	Imports the images into the specified layer. Note that you can only import into layers that are compatible with your import options. For example, if you're importing images as vector drawings, you can only import them into vector drawing layers.
Import Options	Depending on how you choose to import images, the Alignment section offers different options.
Keep as Original Bitmap	Retains an imported image as a bitmap. In the Alignment section, decide on the size and placement of your image within the camera frame. Depending on the Scene Settings (the height and width in pixels that you chose for your project), an image that you import may get scaled to the point where all its individual pixels become visible.
Import as Toon Boom Bitmap Drawing	Imports a drawing into a vector layer where you can edit the image using the drawing tools.
Convert to Toon Boom Vector Drawing	Imports a drawing and converts it to a Toon Boom vector drawing.
Alignment (Keep As Original Bitmap)	
Rules	<p>Fit:</p> <p>Adjusts the image's size to fit completely within the scene's field, both vertically and horizontally, making sure the entire image is visible.</p> <p>If the image's orientation is portrait, then it will adjust the image's height to fit the</p>

field's height, without affecting the image's aspect ratio:

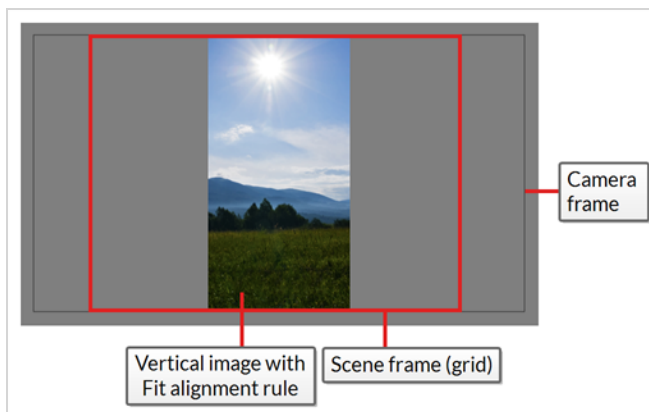

If the image orientation is landscape, then it will adjust the image's width to fit the field's width, without affecting the image's aspect ratio:

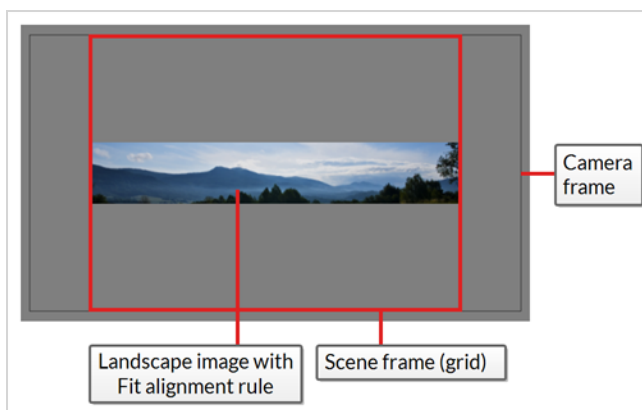

Pan:

This has the opposite effect to the fit parameter. The image's smallest dimension will be made to fit the scene frame's matching dimension, and the image's largest dimension will be adjusted proportionally, making the image fill the entire scene field, and bleed past its boundaries if its aspect ratio does not match the field's aspect ratio. This option can be used to import a panning background image, also referred to as a pan.

If the image's orientation is portrait, it will adjust the image's width to fit the field's width, without affecting its aspect ratio:

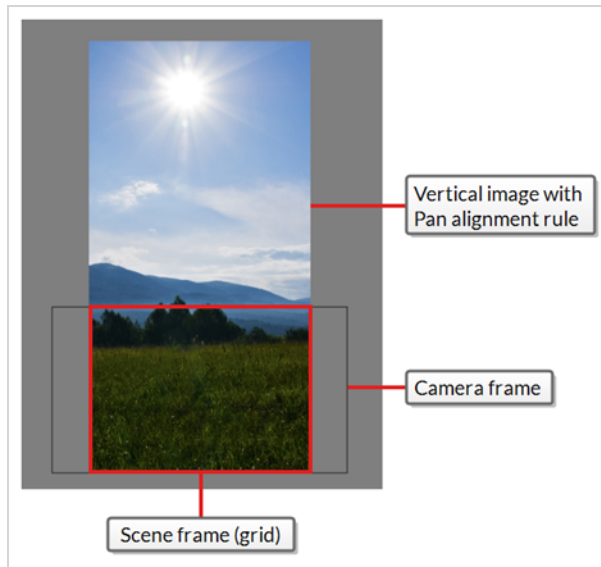

If the image's orientation is landscape, it will adjust the image's height to fit the field's height, without affecting its aspect ratio:

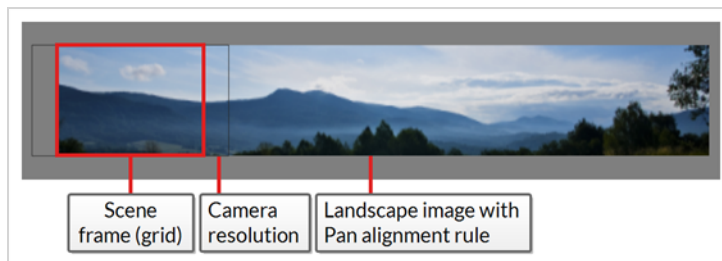

This has the opposite effect to the fit parameter. The image's smallest dimension will be made to fit the scene frame's matching dimension, and the image's largest dimension will be adjusted proportionally, making the image fill the entire scene field, and bleed past its boundaries if its aspect ratio does not match the field's aspect ratio. This option can be used to import a panning background image, also referred to as a pan.

If the image's orientation is portrait, it will adjust the image's width to fit the field's width, without affecting its aspect ratio:

Project Resolution: Scales the image to fit the scene's resolution, making each pixel in the image take one pixel in the scene's field. For example, if the image's dimensions in pixels are half of the scene's resolution in pixels, then the image's dimensions will appear to be half of the scene field's dimensions.

Alignment (Import as Toon Boom Bitmap Drawing)

Rules

Horizontal Fit:

Adjusts the image's size so that its width matches the scene's width, without affecting its aspect ratio.

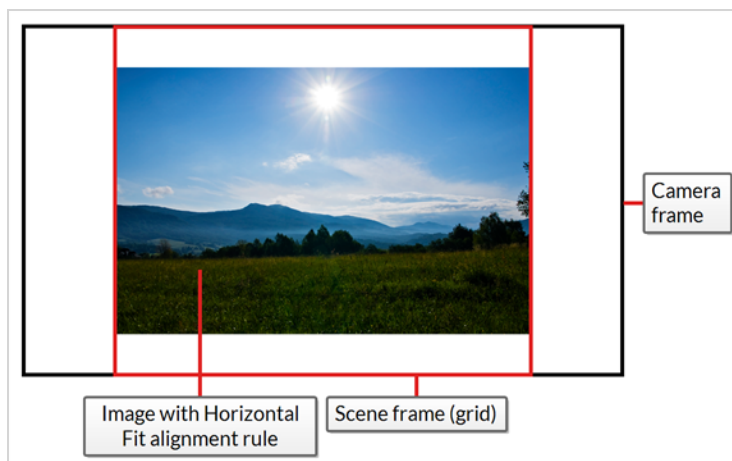

Vertical Fit:

Adjusts the image's size so that its height matches the scene's height, without affecting its aspect ratio.

frame (grid) resolution Pan alignment rule

This has the opposite effect to the fit parameter. The image's smallest dimension will be made to fit the scene frame's matching dimension, and the image's largest dimension will be adjusted proportionally, making the image fill the entire scene field, and bleed past its boundaries if its aspect ratio does not match the field's aspect ratio. This

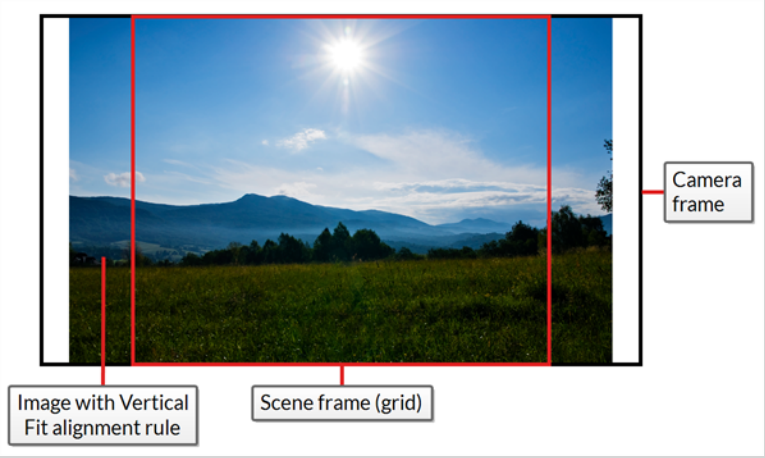
	 <p>The diagram shows a landscape image of a field and mountains under a bright sun. A red rectangular frame is overlaid on the image, labeled 'Image with Vertical Fit alignment rule'. A white rectangular frame is overlaid on the red one, labeled 'Scene frame (grid)'. A label 'Camera frame' points to the right edge of the red frame.</p> <p>Actual Size: Imports the image in its actual size, without adjusting its size relative to the scene's resolution. For example, if the image's dimensions in pixels are half of the scene's resolution in pixels, then the image's dimensions will appear to be half of the scene field's dimensions.</p>
<p>Transparency</p>	
<p>Alpha</p>	<p>Premultiplied with White: The colour values of semi-transparent pixels in the image have been encoded so that the more transparent they are, the closer to white they are. When an image that is premultiplied with white is loaded in a software that does not support transparency, it appears blended with a white background. Select this to make Harmony reverse this premultiplication so that the image blends properly with other visual elements in your scene.</p> <p>Premultiplied with Black: The colour values of semi-transparent pixels in the image have been encoded so that the more transparent they are, the closer to black they are. When an image that is premultiplied with black is loaded in a software that does not support transparency, it appears blended with a black background. Select this to make Harmony reverse this premultiplication so that the image blends properly with other visual elements in your scene.</p> <p>Straight: The colour of semi-transparent pixels in the image is encoded independently from their transparency. When an image that is not premultiplied is loaded in a software that does not support transparency, semi-transparent pixels simply appear fully opaque, making its edges appear pixelated.</p> <p>Clamp Colour to Alpha: This is the same as Premultiplied with Black, except that it also prevents the colour values for a given pixel from being higher than that pixel's alpha value. This option is only useful if you are working with images that are supposed to be premultiplied with black, but where the colour values of pixels have been increased without their alpha values being adjusted accordingly.</p>

Vectorization	
Black and White	Vectorizes drawings with a solid black line. This creates a 100% vector-based drawing and paints it with the Vectorized Line colour swatch from your scene's palette.
Grey	Vectorizes the image as a mix of vector contour and greyscale bitmap filling. Lines keep the texture from the scan, and the white of the paper becomes transparent.
New Preset	Lets you create a new preset.
Delete Preset	Lets you delete any preset in the list.
Edit Preset	Lets you edit the vectorization parameters for the selected preset.

Manage Local Cache Dialog Box

The Manage Local Cache dialog box displays a list of all the Harmony Server scenes for which you have cached drawings. In this dialog, you can check if the drawings you have in a scene's cache match the drawings in the database server, you can delete unused caches and you can change the directory in which scene data is cached.

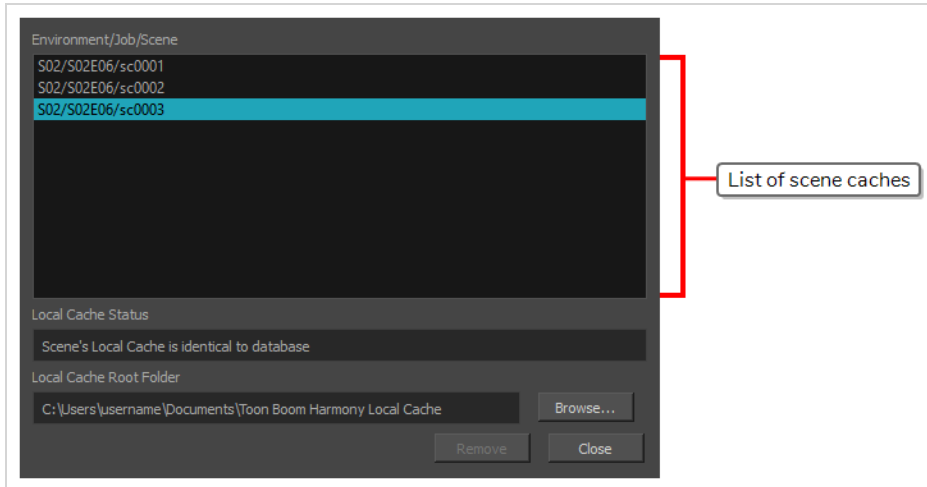

NOTE



A scene's data is cached on your computer when you check the **Cache scene assets locally** option in the Database Selector before opening the scene—see [Database Selector Dialog Box](#) on page 56.

How to access the Manage Local Cache dialog box

1. In the top menu, select **File > Manage Local Caches**.

The Manage Local Caches dialog appears.

Parameter	Description
List of scene caches	<p>The list of caches stored on your computer. There is one item for each scene for which there is cached data. Each item is identified by the scene's environment, followed by its job, then its name, in this format:</p> <p style="text-align: center;">Environment/Job/Scene</p> <p>If you select a scene cache in the list, the Manage Local Caches dialog will compare the drawings that are cached on your computer to the drawings in the actual scene in the database, and report if they are identical or not in the Local Cache Status field.</p>
Local	If you select a cache, the Manage Local Cache dialog will analyze whether the data in the selected

Parameter	Description
Cache Status	<p>cache matches the data in the actual scene in the Harmony Server database.</p> <p>If it displays Scene's Local Cache is identical to the database, then the drawings in the selected cache on your computer are identical to the drawings in the corresponding scene in the database, meaning that your cache and that the database are up to date.</p> <p>If it displays Scene's Local Cache is different than database, then some drawings in the selected cache on your computer are different from the drawings in the corresponding scene in the database. This usually means one of the following:</p> <ul style="list-style-type: none"> • If the selected cache is the cache of the currently opened scene and you just saved your scene, Harmony may still be uploading the updated drawings to the database. In this case, you can close the dialog, wait a few seconds, and reopen it to see if Harmony is done uploading the drawings. If it is, it will report that the cache is identical to the database. • If this is not the cache of the currently opened scene, it is likely that the database scene has been changed by someone else since the last time you opened it. That would mean that the database version is more up to date than your cache. This is not a problem, as next time you open the scene, your cache will be updated.
Local Cache Root Folder	Indicates where scene caches are stored on your computer. By default, scene caches are stored in a folder named Toon Boom Harmony Local Cache, inside your Documents folder.
Browse	<p>Allows you to change the folder where caches are downloaded when you open a scene.</p> <div data-bbox="360 1205 1430 1409" style="border: 1px solid #c8e6c9; padding: 10px; margin-top: 10px;">  <p>NOTE</p> <p>The caches that are currently stored on your machine will not be moved to their new location. Hence, when you change the local cache root folder, the list of scene caches will become empty until you open a scene.</p> </div>
Remove	<p>Deletes the selected scene cache from your computer.</p> <div data-bbox="360 1524 1430 1696" style="border: 1px solid #c8e6c9; padding: 10px; margin-top: 10px;">  <p>NOTE</p> <p>This button is greyed out if the selected scene cache is for the currently opened scene, as this cache is currently in use by Harmony.</p> </div>
Close	Closes the dialog.

Manage Pre-Render Cache Dialog Box

When a scene contains more than one Pre-render Cache node, it is possible to manage every or some Pre-render Cache nodes at the same time.

How to access the Manage Pre-render Cache dialog box

1. In the top menu, select **Scene > Manage Pre-render Cache**.

The Manage Pre-render Cache dialog box opens.

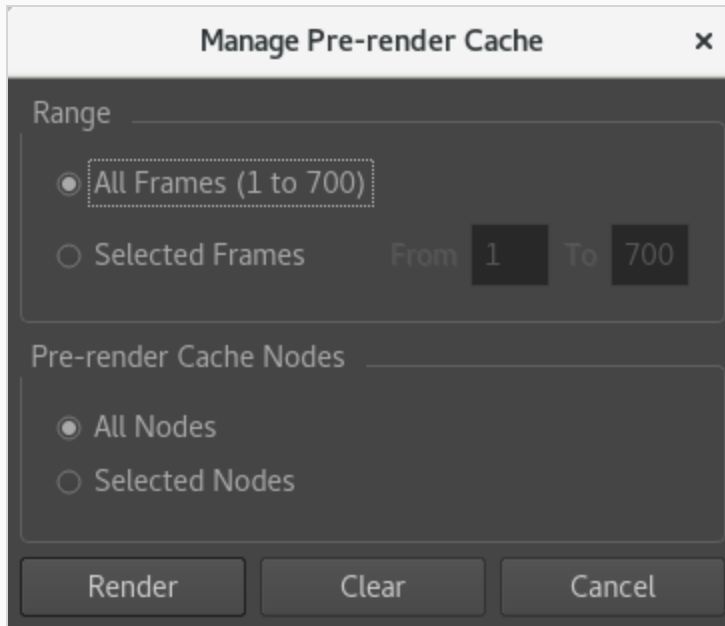

How to manage all Pre-render Cache nodes at the same time

1. In the top menu, select **Scene > Manage Pre-render Cache**.
2. Define the range of the frames that need to be managed.
3. Select **All Nodes**.
4. Do one of the following:
 - Click on the Render button to render every Pre-render Cache node.
 - Click on the Clear button to clear the cache of every Pre-render Cache node.

How to manage some Pre-render Cache nodes at the same time

1. In the Camera view, select every Pre-render Cache node that you want to manage.
2. In the top menu, select **Scene > Manage Pre-render Cache**.
3. Define the range of the frames that need to be managed.
4. Select **Selected Nodes**.
5. Do one of the following:
 - Click on the Render button to render all selected Pre-render Cache nodes.
 - Click on the Clear button to clear the cache of all selected Pre-render Cache nodes.



NOTE

It is also possible to open the Manage Pre-render Cache dialog box by using the Pre-render Cache shortcut available under the General shortcut category.

Parameter	Description
Range	<p>All Frames: Select All Frames if you want to pre-render the entire scene.</p> <p>Selected Frames: Select Selected Frames if you want to render a part of your scene. Then, in the field to the left, type in the first frame of the sequence you want to export, and in the other field, the last frame of the sequence you want to render.</p>
Pre-render Cache Nodes	<p>All Nodes: Select All Frames if you want to clear or render the cache of every Pre-render Cache node.</p> <p>Selected Nodes: Select Selected Nodes if you want to render the cache on the Pre-render Cache nodes that were previously selected in the Node view.</p>
Render	Renders the frames into cache images within the prerender.db folder of the current Pre-render Cache node. Those images will be rendered as .rpng files.
Clear	Removes every cache image rendered within the prerender.db folder of the current Pre-render Cache node.

Manage Tool Presets Dialog Box

The Tool Presets window lets you create new tool presets and manage them.

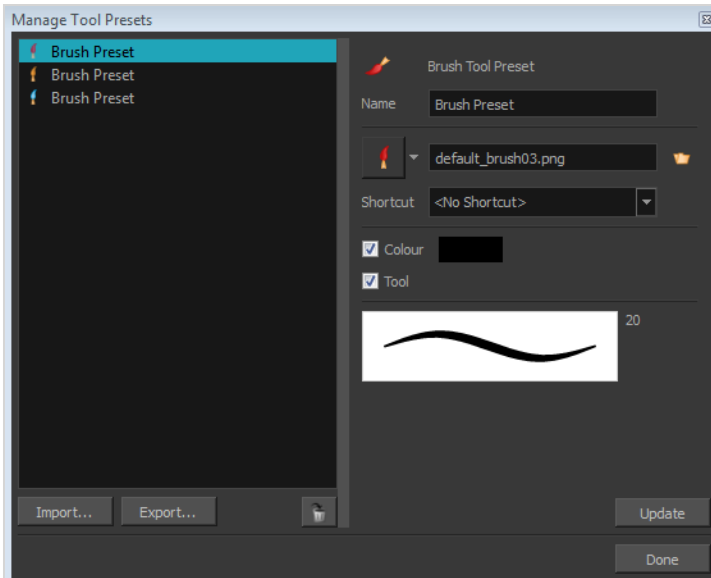

How to access the Manage Tool Presets window

- Do one of the following:
 - From the top menu, select **Windows > Toolbars > Tool Presets**.
 - Right-click an empty area below the top menu and select **Tool Presets**.

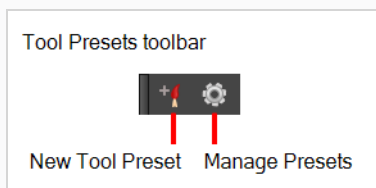

- In the Tool Presets toolbar, click the Manage Presets button.

Parameter	Description
Icon	Lets you select a preset to manage.
Import	Lets you import an existing preset.
Export	Lets you export a preset for use in other projects.

Delete	Removes the preset from the list of tool presets.
Name	Lets you change the name of the preset.
Icon list	Lets you select an icon for the preset.
Folder icon	Lets you select an image for the preset.
Shortcut	Lets you assign a keyboard shortcut to the new preset.
Colour	Saves the current colour into the tool preset.
Tool	If you disable this option, only the colour will be associated. You could, for example, set three different colours with shortcuts not associated with any tool. The colour preset would then work on any selected tool. Selecting the brush tool was only a vehicle to get into the New Tool Preset dialog box.
Update	After adjusting the settings for a preset, the current properties are applied to the presets, as well as any other changes you made in the Manage Tool Presets window.

Marker Dialog Box

The Timeline Scene Marker dialog box lets you create and manage scene markers in the Timeline view.

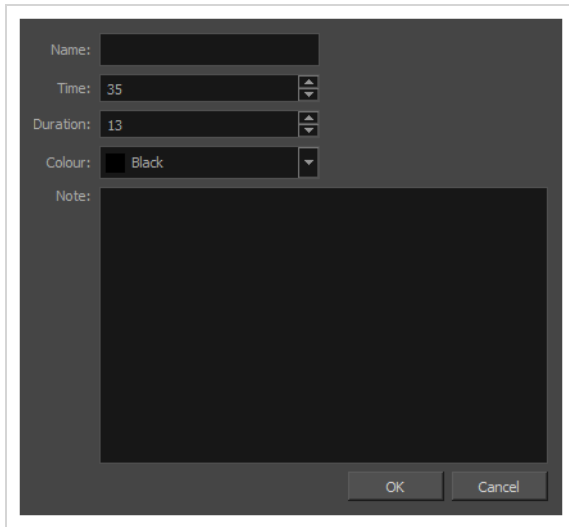

Scene markers are visual indicators displayed at the top of the Timeline view in the frame counter area. You can use it to denote anything relevant to your work. You can indicate the frames you want to clean up, a change in action, an impact, or where you intend to apply an effect. You can also add a note to a scene marker. If you hold the mouse cursor over a scene marker, its name, starting frame, duration and note will be displayed in the tool tip box.

How to access the Timeline Scene Marker dialog box

1. In the Timeline view, do one of the following:
 - If you want to create a scene marker at a single frame, select that frame on any layer.
 - If you want to create a scene marker that spans over several frames, select this range of frame on any layer.
2. Right-click on the ruler at the top of the Timeline view and, in the context menu, select **Scene Markers > Create Scene Marker**.



**NOTE**

If your scene already contains scene markers, you can also open this dialog box by clicking on a scene marker to select it, then right-clicking anywhere on the timeline ruler and selecting **Scene Markers > Edit** in the contextual menu.

Parameter	Description
Name	The name of the marker.
Time	The frame number at which the marker starts.
Duration	<p>The amount of frames during which the marker spans.</p> <div data-bbox="565 829 1429 997" style="border: 1px solid #add8e6; padding: 5px;"> <p> TIP You can set the duration to zero to make a marker that just points at the starting frame.</p> </div>
Colour	Allows you to select a colour for the scene marker.
Note	Allows you to type a description for the scene marker.

Mini Playback Dialog Box

The Mini Playback dialog box allows you to configure and start Mini Playback. Mini Playback allows you to quickly preview a short span of animation starting a few frames before the current frame and ending a few frames after the current frame, at a customizable frame rate.

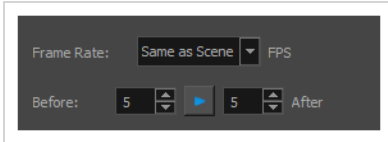

How to access the Mini Playback dialog

- Do one of the following:
 - In the top menu, select **Play > Mini Playback**.
 - In the Mini Playback toolbar, click on the  Mini Playback Dialog button.

Icon	Parameter	Description
	Frame Rate	The speed at which Mini Playback should play your animation. By default, it is set to Same as Scene to play at the same pace as your scene's frame rate. Otherwise, you can choose among a set of commonly used frame rates.
	Before	The amount of frames before the current frame at which to start Mini Playback.
	Play	Starts Mini Playback. Playback will start at the amount of frames in the Before field before the current frame, and end at the amount of frames in the After field after the current frame, at the frame rate in the Frame Rate drop-down.
	After	The amount of frames after the current frame at which to end Mini Playback.

Movie Options Dialog Box (macOS)

The Movie Options dialog box allows you to configure the video and audio settings when exporting a movie in QuickTime Movie (.mov) format on macOS.

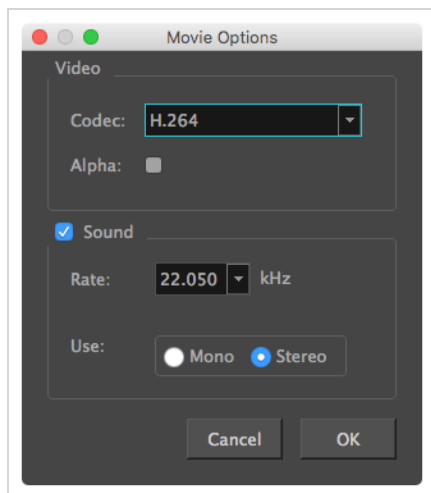

NOTES

- For tasks related to this dialog box, refer to the User Guide.
- This dialog can only be accessed on macOS.

How to access the Movie Settings dialog box from the Export Movie dialog

1. From the top menu, select **File > Export > Movie**.

The Export Movie dialog box appears.

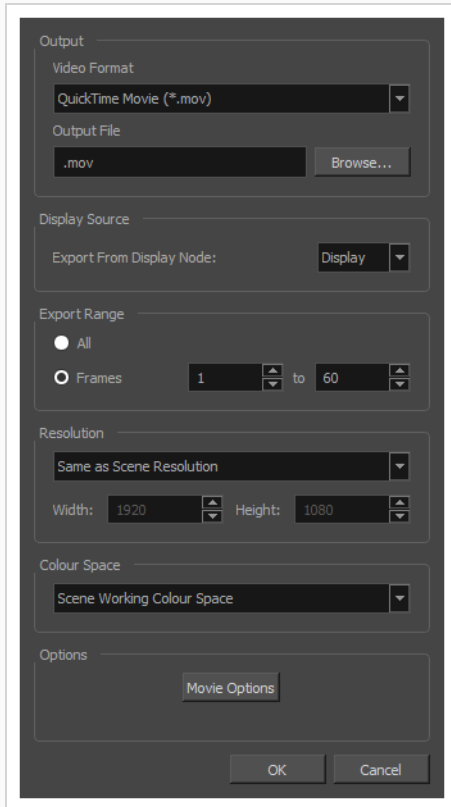

2. In the **Movie Format** drop-down, select **QuickTime Movie (*.mov)**.
3. Click on the **Movie Options** button.

How to access the Movie Settings dialog box from the Export OpenGL Frames dialog

1. In the top menu, select **File > Export > OpenGL Frames**.
The Export OpenGL Frames dialog box appears.

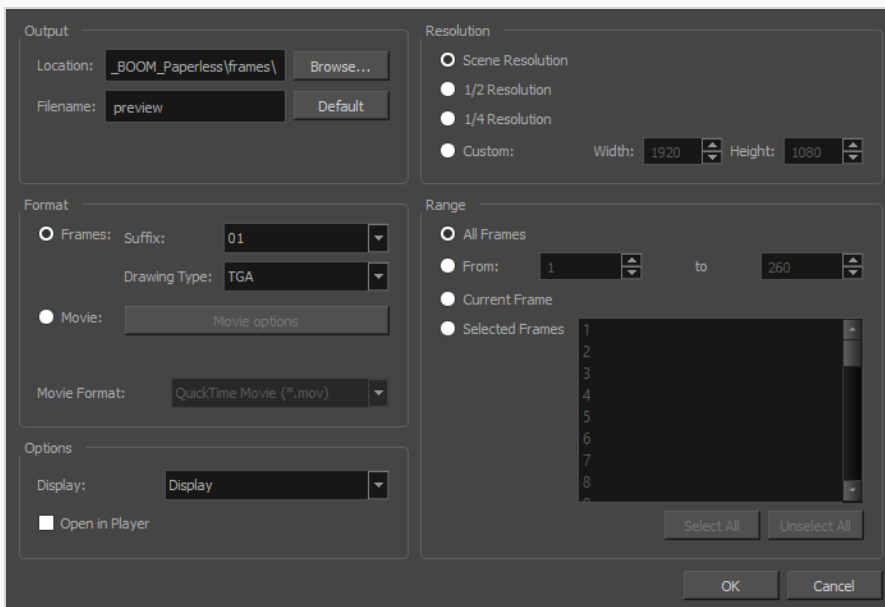

2. In the **Format** section, select **Movie**.
3. In the **Movie Format** drop-down, select **QuickTime Movie (*.mov)**.
4. Click on the **Movie Options** button.

How to access the Movie Settings dialog box from the Write node Layer Properties

1. In the Node view, locate your scene's Write node.
2. Open the Write node's Layer Properties by doing one of the following:
 - Click on the yellow square  at the left end of the Write node.

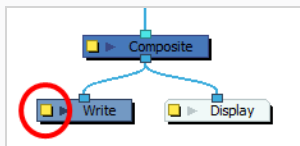

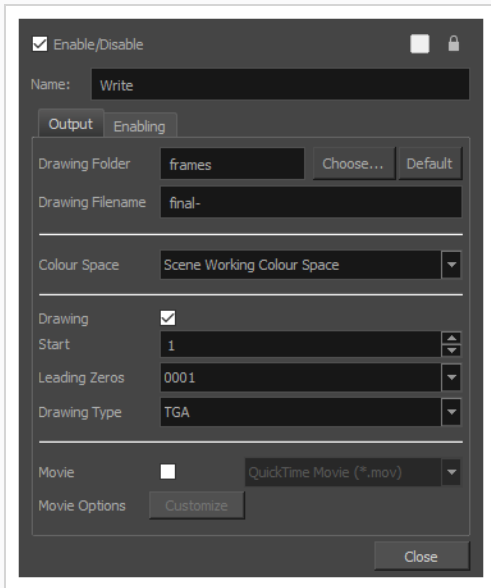

- Right-click on the Write node, then select **Layer Properties**.

The Write node's Layer Properties dialog appears.



3. In the Write node's Layer Properties, enable the **Movie** option.
 1. To the right of the Movie check box, open the drop-down menu and select **QuickTime Movie (*.mov)**.
 2. To the right of **Movie Options**, click **Customize**.

Parameter	Description
Video	
Codec	<p>Allows you to select which algorithm to use to compress the video data. The following video codecs are supported:</p> <ul style="list-style-type: none"> • H.264: A very effective lossy compression algorithm that is commonly supported by web browsers and media players. • H.265: Same compression quality as H.264, but with a smaller compression size. This is useful for videos intended for the web and mobile devices. Not supported on all major browsers or operating systems. • Apple ProRes 422: A nearly lossless compression algorithm commonly used for video editing on Apple systems. This codec is optimized for preserving video quality, but not for publishing or streaming. • Apple ProRes 422 HQ: Preserves visual quality at the same high level as Apple ProRes 4444 but for 4:2:2 image sources (cleaner footage for things like green screening). Heavier than Apple ProRes 422 for real-time editing performance. • Apple ProRes 422 LT: A more highly compressed codec than Apple ProRes 422, with

Parameter	Description
	<p>roughly 70 percent of the data rate and 30 percent smaller file sizes. This codec is perfect for environments with limited storage capacity and data rates.</p> <ul style="list-style-type: none"> • Apple ProRes 422 Proxy: An even more highly compressed codec than Apple ProRes 422 LT, intended for use in offline workflows that require low data rates but full-resolution video. • Apple ProRes 4444: A nearly lossless compression algorithm commonly used for video editing on Apple systems. Compared to Apple ProRes 422, this codec preserves more colour detail and supports transparency. However, it results in heavier file sizes.
Alpha	<p>Check this option if you want to export a video with transparency.</p> <div data-bbox="399 720 1429 892" style="border: 1px solid #c8e6c9; padding: 10px;">  NOTE This option is only available when exporting with the Apple ProRes 4444 codec. Other codecs do not support transparency. </div>
Sound	<p>Uncheck this checkbox if you want to export a movie without an audio track.</p>
Rate	<p>Allows you to select the sample rate, or frequency, in which to export the audio track for the movie.</p> <div data-bbox="399 1140 1429 1339" style="border: 1px solid #c8e6c9; padding: 10px;">  NOTE Harmony cannot export audio at a higher sample rate than 22.050 kHz. If you select a higher sample rate, your project's audio will be upsampled, which means it will take more disc space without increasing in quality. </div>
Use	<p>Allows you to select whether to export the movie's audio track using the Mono or Stereo channel mode.</p> <div data-bbox="399 1497 1429 1665" style="border: 1px solid #c8e6c9; padding: 10px;">  NOTE Stereo sound has a separate track for the left and right speakers, whereas mono sound only has a single audio track for all speakers. </div>

QuickTime Movie Settings Dialog Box (Windows)

The Movie Settings dialog box allows you to configure the video and audio compression settings when exporting a QuickTime Movie (.mov) file.

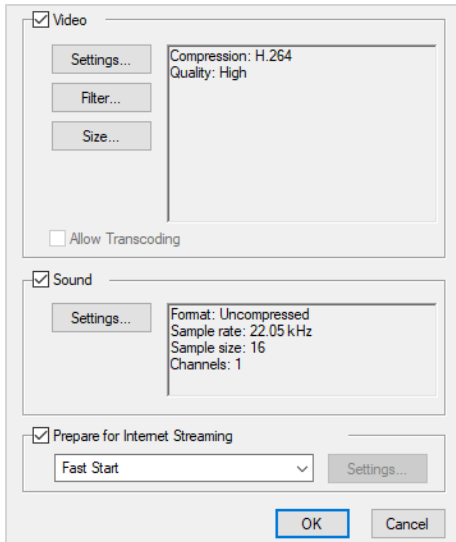

NOTES

- For tasks related to this dialog box, refer to the User Guide.
- This dialog can only be accessed on Windows and requires [Apple QuickTime](#) to be installed.

How to access the QuickTime Movie Settings dialog box from the Export Movie dialog

1. From the top menu, select **File > Export > Movie**.

The Export Movie dialog box appears.

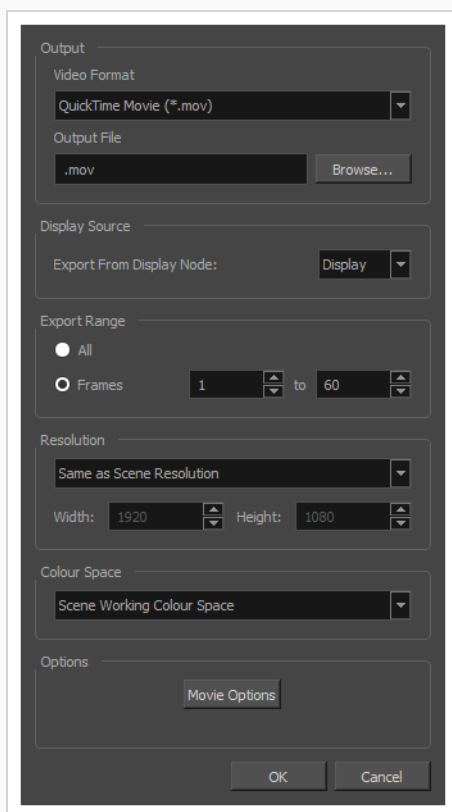

2. In the **Movie Format** drop-down, select **QuickTime Movie (*.mov)**.
3. Click on the **Movie Options** button.

How to access the QuickTime Movie Settings dialog box from the Export OpenGL Frames dialog

1. In the top menu, select **File > Export > OpenGL Frames**.

The Export OpenGL Frames dialog box appears.

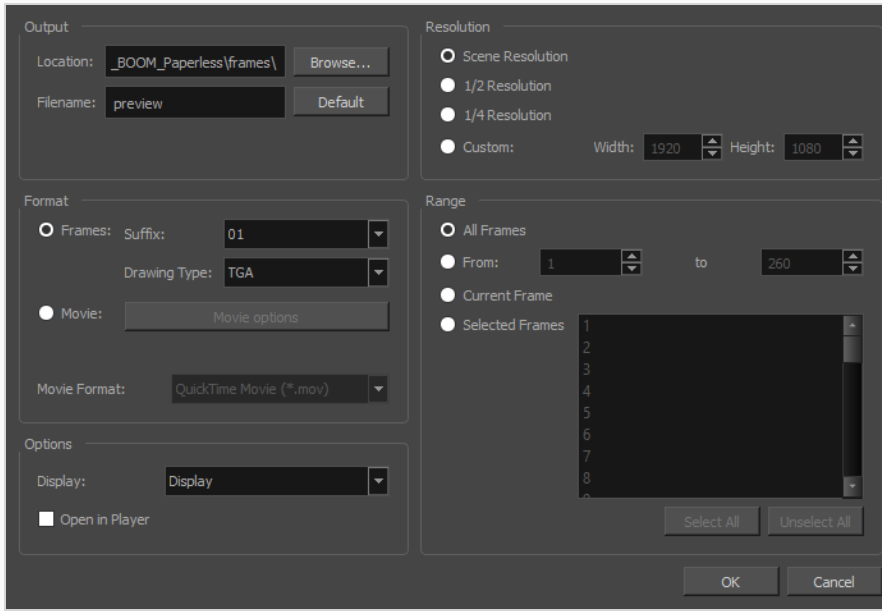

2. In the **Format** section, select **Movie**.
3. In the **Movie Format** drop-down, select **QuickTime Movie (*.mov)**.
4. Click on the **Movie Options** button.

How to access the QuickTime Movie Settings dialog box from the Write node Layer Properties

1. In the Node view, locate your scene's Write node.
2. Open the Write node's Layer Properties by doing one of the following:
 - Click on the yellow square  at the left end of the Write node.

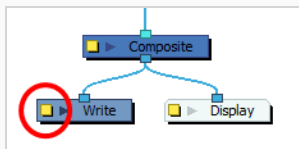

- Right-click on the Write node, then select **Layer Properties**.

The Write node's Layer Properties dialog appears.

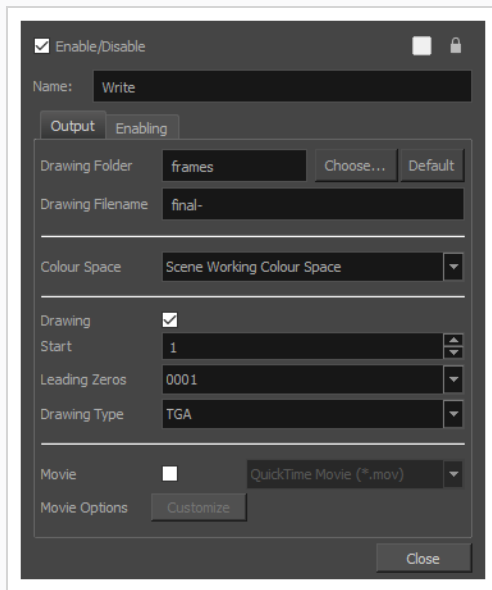

3. In the Write node's Layer Properties, enable the **Movie** option.
 1. To the right of the Movie check box, open the drop-down menu and select **QuickTime Movie (*.mov)**.
 2. To the right of **Movie Options**, click **Customize**.

Parameter	Description
Video	
Settings	Opens the Standard Video Compression Settings dialog box. This is where you can set the video compression settings for the movie you will export—see QuickTime Standard Video Compression Settings Dialog Box (Windows) on page 241.
Filter	Opens the Choose Video Filter dialog box, where you can select from a range of filters to apply to your video export.
Size	Opens the Export Size Settings dialog box. This dialog is available because of the way the Apple QuickTime interface is designed, but its settings are not taken in account by Harmony. The size of the exported video is determined by Harmony.
Sound	

Settings	Opens the Sound Settings dialog box. This is where you can you set the sound compression settings for the movie you will export—see QuickTime Sound Settings Dialog Box (Windows) on page 235.
Prepare for Internet Streaming	<p>If this option is enabled, the video will be optimized to start playing while it is downloading, as videos do in web browsers and web-based streaming applications.</p> <ul style="list-style-type: none">• Fast Start: The video plays as soon as enough data required to start playback has been downloaded.• Fast Start - Compressed Header: Same as Fast Start, except the header is compressed for an even faster start. Requires QuickTime 3.0 or later.• Hinted Streaming: Allows you to optimize the movie file for streaming through QuickTime Server Software. Click on the Settings button to configure how hints are created in your movie file.

New Scene Dialog Box

The New Scene window lets you create a new scene.

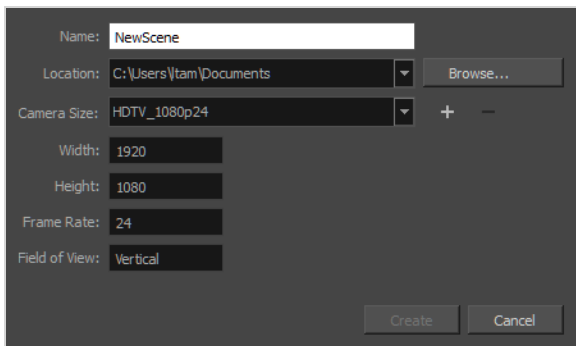

How to access the New Scene window

1. Do one of the following:
 - From the top menu, select **File > New**.
 - In the File toolbar, click the New  button.
 - Press **Ctrl + N** (Windows/Linux) or **⌘ + N** (macOS).

The New Scene dialog box opens.

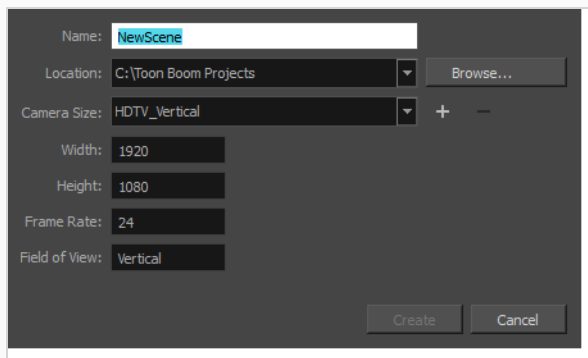

Parameter	Description
Name	Lets you type in a name for the new scene.
Location	Lists the locations you used most frequently for storing scenes.
Browse	Opens a browser in which you can specify a location for the new scene that is not listed in the Location list.

Camera Size	Opens a list of resolutions.
+ (Create Custom Resolution)	Opens the New Resolution window in which you can create a custom resolution that is added to the Camera Size list.
- (Delete Custom Resolution)	Lets you remove a custom resolution from the Camera Size list.
Width	Indicates the width of the resolution you chose from the Camera Size list.
Frame Rate	Indicates the frame rate of the resolution you chose from the Camera Size list.

New Tool Preset Dialog Box

The New Tool Preset dialog box lets you create new tool presets and manage them.

Tool presets let you save a variety of settings and are very efficient for accessing the tools you use most often. That way, the tool is already set with the desired properties, such as colour, line thickness, whether to enable Draw Behind or Auto Flatten mode, and so on. You can create presets for these tools and many more: Brush, Pencil, Eraser, Rectangle, Ellipse, and Line.

The difference between a tool preset and a brush preset is that when you save a tool preset, you have the option of saving the colour and assigning a shortcut, which you cannot do with brush presets.

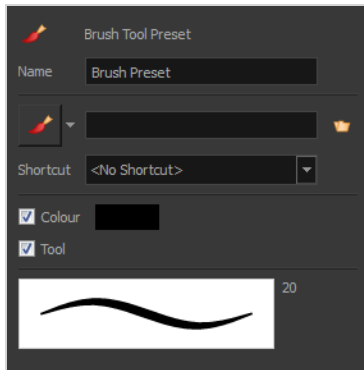

How to access the New Tool Preset dialog box

1. Do one of the following:

- From the top menu, select **Windows > Toolbars > Tool Presets**.
- Right-click an empty area below the top menu and select **Tool Presets**.

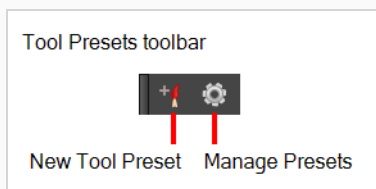

2. In the Tool Presets toolbar, click the New Tool Preset button.

Parameter	Description
Name	Lets you give the preset a meaningful name.
Icon list	Lets you select an icon for the preset.

Folder icon	Lets you select an image for the preset.
Shortcut	Lets you assign a keyboard shortcut to the preset.
Colour	Saves the current colour into the tool preset.
Tool	If you disable this option, only the colour will be associated. You could, for example, set three different colours with shortcuts not associated with any tool. The colour preset would then work on any selected tool. Selecting the brush tool was only a vehicle to get into the New Tool Preset dialog box.

Onion Skin and Light Table Transparency Dialog Box

T-ANIMPA-006-009

This dialog box lets you adjust the Onion Skin and Light table transparency parameters.

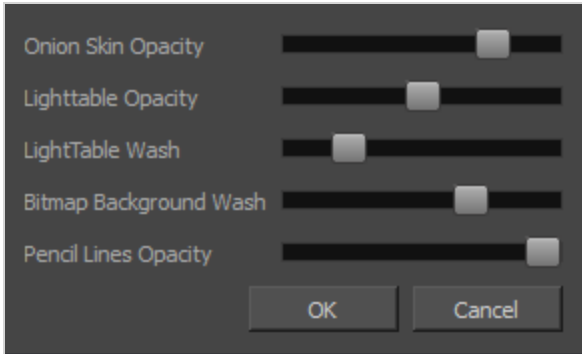

How to access the Onion Skin and Light Table Transparency dialog box

- In the Drawing view toolbar, click on the Top Light  button to open the Onion Skin and Light Table Transparency dialog box.

Command	Description
Onion Skin Opacity	Sets the maximum opacity value for the onion skin opacity display. Moving the slider all the way to the left = 0% opacity. Moving the slider all the way to the right = 100% opacity.
Lighttable Opacity	Sets the maximum opacity value for the light table display. Moving the slider all the way to the left = 0% opacity. Moving the slider all the way to the right = 100% opacity.
LightTable Wash	Sets the washed-out value for the light table display. Moving the slider all the way to the left = 0% opacity. Moving the slider all the way to the right = 100% opacity.
Bitmap Background Wash	Sets the maximum opacity value for the background wash. Moving the slider all the way to the left = 0% opacity. Moving the slider all the way to the right = 100% opacity. Only works for bitmap layers.
Pencil Lines Opacity	Sets the maximum opacity value for central vector lines (lines made by the Pencil or Shape tools). Moving the slider all the way to the left = 0% opacity. Moving the slider all the way to the right = 100% opacity.

Palette Browser Dialog Box

The Palette Browser dialog allows you to decide the level of palette list and palette storage to use when you want to create, clone, link to or import a palette.

This dialog only appears if you have the Advanced Palette Lists preference enabled, which is disabled by default. When Advanced Palette Lists mode is disabled, Harmony automatically stores palettes in a scene's palette list, inside the scene's **palette-library** subdirectory.

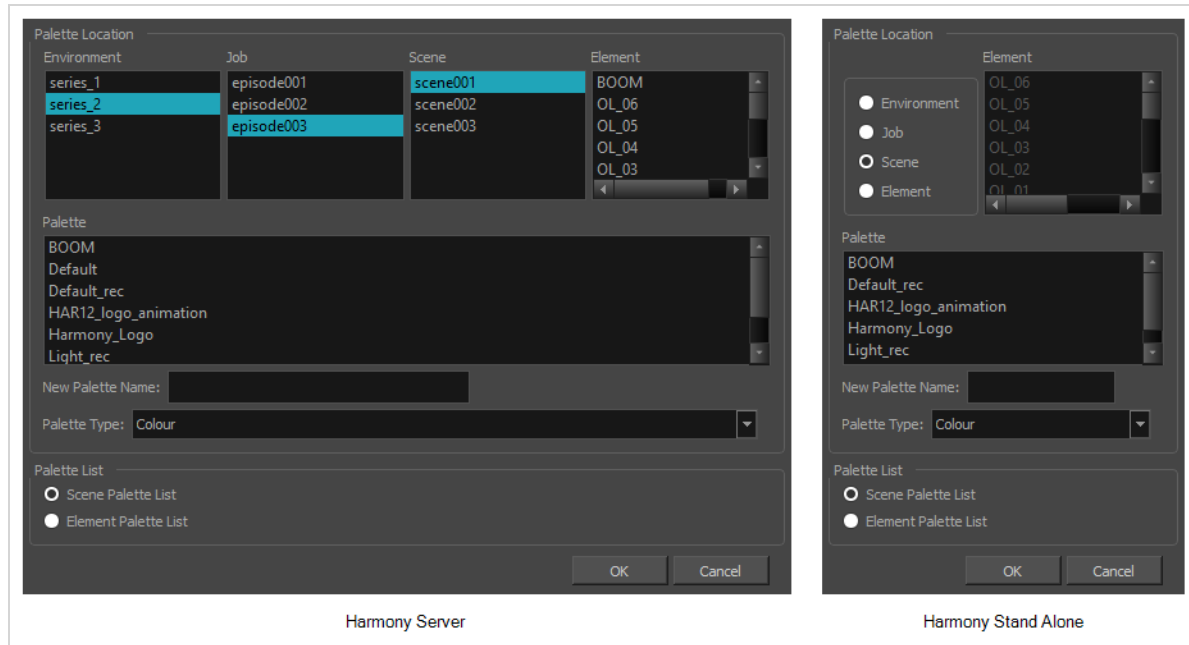

How to access the Palette Browser dialog box

1. Start Harmony and log in.
2. Close the Database Selector dialog box.
3. From the top menu, select **Tools > Palette Operations**.
4. In the Palette Operations dialog box that opens, select the palette you want to clone at the location and level in which it was stored.
5. Click **Clone**.

Parameter	Description
Palette Location	This allows you to browse for the physical location of the palette file in your database. If you are using Harmony Stand Alone, you can still select the scene's own job or

	<p>environment as a location. Stand alone scenes have a provisional job and environment storage space inside the scene's directory. The files in these storage spaces can be imported into a database scene's actual job and environment when importing the scene to a Harmony database. If you never intend to use Harmony Server, you should keep your palettes inside your scene or element's palette libraries.</p>
Environment	<p>Stores the palette file in the selected environment's palette library. Environments are typically used to contain a whole production, series or feature film.</p> <ul style="list-style-type: none"> • In Harmony Server, this stores the palette in <code>/USA_DB/environments/[environment name]/palette-library</code>. • In Harmony Stand Alone, this stores the palette inside the scene's directory, under <code>environments/Digital/palette-library</code>.
Job	<p>Stores the palette file in the selected job's palette library. Jobs are typically used to contain episodes in a series, or any set of scenes that is intended to be put in the same sequence.</p> <ul style="list-style-type: none"> • In Harmony Server <code>/USA_DB/jobs/[job name]/palette-library</code>. • In Harmony Stand Alone, this stores the palette inside the scene's directory, under <code>jobs/Digital/palette-library</code>.
Scene	<p>Stores the palette file in the selected scene's palette library, which is the palette-library subdirectory of the scene's directory.</p>
Element	<p>Stores the palette file inside the selected element's palette library. This library is located inside the scene's directory, under <code>elements/[element name]/palette-library</code>.</p>
Palette	<p>This lists the existing palettes in the selected location.</p>
New Palette Name	<p>If you are creating or cloning a palette, use this field to enter the palette file's name. The palette will be listed under this name in your palette list. On your file system, it will be named after its palette name, followed by the extension <code>.plt</code>.</p>
Palette Type	<p>When creating a palette, you can choose between the following palette types:</p> <ul style="list-style-type: none"> • Colour: A colour palette can contain colours, gradients and bitmap textures. • Pencil Texture: A pencil texture palette can contain textures to apply as transparency filters to pencil lines, in combination to their line colour, to create various styles of pencil lines.

Palette List	This allows you to decide if you want the palette to be added to your scene's palette list, or to the currently selected element's palette list.
Scene Palette List	Adds the palette to the scene's palette list. Palettes in the scene's palette list are available to all the elements in your scene. This is especially useful if you are doing digital animation, where character models can be made of many layers that need to use the same palette.
Element Palette List	Adds the palette to the currently selected element's palette list. Palettes in an element's palette list can only be used by the drawings in this element, and will only be listed in the Colour view when this element is selected. This can be useful if you are doing traditional animation, where each character is usually drawn on a single layer, and you want each layer to have its own palette.

Palette Operations Dialog Box

When you start Toon Boom Harmony Premium connected to the database, you can access the Palette Operations dialog box which lets you clone, rename, or delete palettes in your database, without having to open a scene or browse the database's file system in your operating system's shell.

In Harmony, palettes are individual `*.plt` files that can be copied, transferred and stored. When a palette is created from Harmony, it needs to be stored somewhere. By default, the palette file is stored in the scene directory in a palette-library folder unless you specify a different location.

There are four locations where you can find palette-library folders: Element, Scene, Job and Environment.

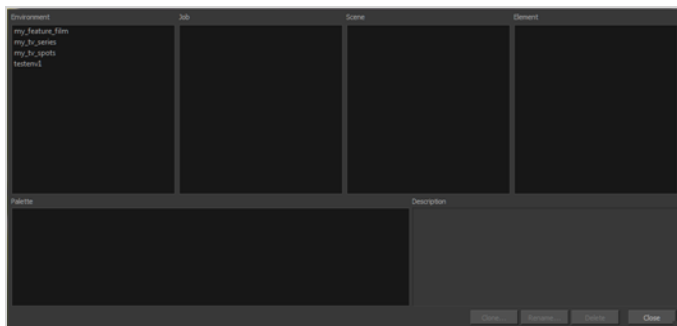

How to access the Palette Operations dialog box

1. Start Harmony and log in.
2. Close the Database Selector dialog box.
3. From the top menu, select **Tools > Palette Operations**.

Parameter	Description
Environment	The production, project, feature film or series.
Job	The episode and sequence from each environment.
Scene	The scenes from each job.
Element	The layers and columns in each scene.
Palette	The scene palettes.
Description	Notes, if any, of the project.

Clone	Opens the Palette Browser dialog box from which you can select the level in which to store the palette file.
Rename	Lets you rename a palette.
Delete	<p>Lets you delete a palette.</p> <div data-bbox="565 470 1430 638" style="border: 1px solid #c8e6c9; padding: 10px;">  <p>NOTE It is not recommended to disable the warning message that appears when you are attempting to delete a palette as this operation cannot be undone.</p> </div>
Close	Closes the Palette Operations dialog box.

Paste Preset Dialog Box

When pasting key frames and exposures, you can modify the existing presets to your liking. There are three presets you can modify: the default presets for both key frames and exposures, key frames only and exposures only.

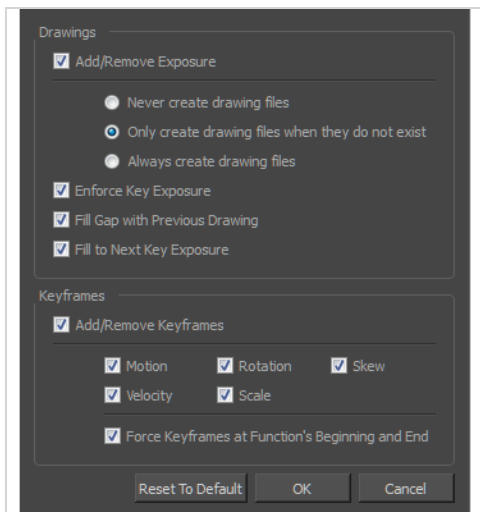

Parameter	Description
Drawings	
Add/Remove Exposure	Never create drawing files: When adding exposures to a drawing layer, drawing files will not be created.
	Only create drawing files when they do not exist: When adding exposures to a drawing layer, new drawings will be created only when drawings with the same name do not already exist in the destination.
	Always create drawing files: When adding exposures to a drawing layer, new drawings will always be created. If drawing files with the same name already exist, Harmony will create a new name for the drawing.
Enforce Key Exposure	If there are key exposures that exist on copied drawings, they are preserved when pasting. No key exposures are added. This is the default behavior when pasting.
Fill Gap with Previous Drawing	Fills selected area in the Xsheet or Timeline view with the previous drawing.
Fill to Next Key Exposure	Fills selected area till the next key exposure.

Keyframes	
Add/Remove Keyframes	Motion: Copies the properties of the selected motion keyframe to the new frame.
	Velocity: Copies the properties of the selected velocity keyframe to the new frame.
	Rotation: Copies the properties of the selected rotation keyframe to the new frame.
	Scale: Copies the properties of the selected scale keyframe to the new frame.
	Skew: Copies the properties of the selected skew keyframe to the new frame.
	Force Keyframes at Function's Beginning and End: Adds a keyframe to the beginning and end of the pasted function, reproducing the source function.

Paste Special Dialog Box

The Paste Special dialog box lets you determine how templates and symbols are imported in the Timeline view.

When you import a template in the Timeline view, all layers are created as well as drawings and keyframes. You can choose to import only the keyframes without the drawings or import only the drawings that are not already in your layers. You can adjust the behaviour using the Paste Special dialog box. When you import a symbol in your scene, its full length is exposed by default. If you import a symbol in the Timeline view's left side, all the frames will be exposed. However, if you import it into an existing layer, you can use the Paste Special dialog box to adjust the import behaviour to fit your requirements. Once you set the parameters, Harmony will reuse them each time you import a symbol in the Timeline view's right side until you set new parameters.

How to access the Paste Special dialog box

1. In the Library view, select the symbol or template to import.
2. Do one of the following:
 - While holding down the Alt key, click and drag on the template, then drop it on the Timeline view, over the layer and at the frame where you want to paste it.
 - Press Ctrl + C (Windows/Linux) or ⌘ + C (macOS). Then, in the Timeline view, click on the frame where you want to paste the template and press Ctrl + B (Windows/Linux) or ⌘ + B (macOS)

The Paste Special dialog box opens.

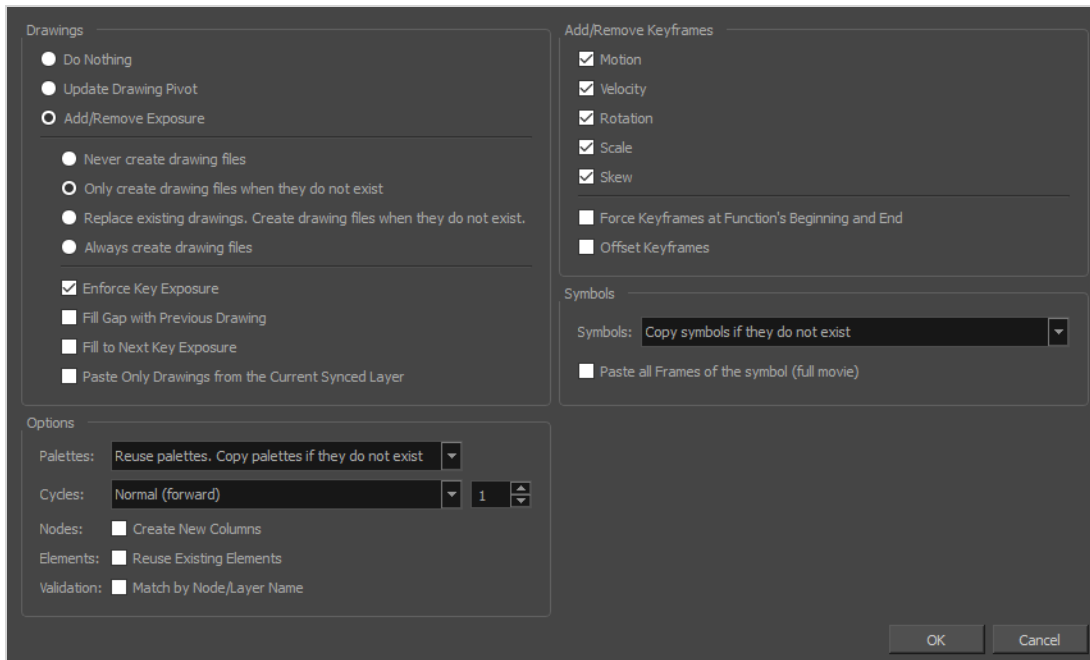

Parameter	Description
Drawings	
Do Nothing	Does not create or overwrite drawings.
Update Drawing Pivot	Revises the drawing pivot in the destination to use the same drawing pivot as the first drawing in the template. If you have a range of drawings selected in the destination, the pivot points of all selected drawings will be updated.
Add/Remove Exposure	<p>Never create drawing files: When adding exposures to a drawing layer, drawing files will not be created.</p>
	<p>Only create drawing files when they do not exist: When adding exposures to a drawing layer, new drawings will be created only when drawings with the same name do not already exist in the destination.</p>
	<p>Replace existing drawings. Create drawing files when they do not exist: Replace drawings with the same names to update a scene with new modified drawings and preserve the animation.</p> <p>Tip: If you don't want to lose the existing animation when pasting a template, such as when placing new drawings after the animation, then delete the template's animation. It will still have updated the drawings but not override the existing animation.</p>
	<p>Always create drawing files: When adding exposures to a drawing layer, new drawings will always be created. If drawing files with the same name already exist, Harmony will create a new name for the drawing.</p>
	<p>Enforce Key Exposure: If there are key exposures that exist on copied drawings, they are preserved when pasting. No key exposures are added. This is the default behavior when pasting.</p>
	<p>Fill Gap with Previous Drawing: Fills selected area in the Xsheet or Timeline view with the previous drawing.</p>
	<p>Fill to Next Key Exposure: Fills selected area till the next key exposure.</p>
	<p>Paste all frames of the symbol (full movie): When enabled, the Paste Special command exposes all the symbol's frames instead of only the first one.</p>

Symbols	
Copy symbols if they do not exist	This is the default setting for this operation and will prevent Symbols in an Action template from being copied.
Duplicate symbols	Creates a duplicate of the symbol instead of linking the Symbol instance to the original one. The new Symbol is created in the Library.
Paste all Frames of the symbol (full movie)	When enabled, the Paste Special command exposes all the symbol's frames instead of only the first one.
Add Remove/Keyframes	
Motion	Copies the properties of the selected motion keyframe to the new frame.
Velocity	Copies the properties of the selected velocity keyframe to the new frame.
Rotation	Copies the properties of the selected rotation keyframe to the new frame.
Scale	Copies the properties of the selected scale keyframe to the new frame.
Skew	Copies the properties of the selected skew keyframe to the new frame.
Force Keyframes at Function's Beginning and End	Adds a keyframe to the beginning and end of the pasted function, reproducing the source function.
Offset Keyframes	When pasting functions, offsets keyframes from the function's last frame value by the values in the pasted function. This will continue the progression of a function instead of repeating the values.
Options	
Palettes	<p>Do nothing: Does not create, overwrite, merge or link palettes.</p> <p>Reuse palettes. Copy palettes if they do not exist: Palettes in the destination drawings are left as they are.</p> <p>Copy and overwrite existing palettes: Overwrites destination palettes with the palettes from the source drawings.</p>

	<p>Copy and create new palette files: Creates new palette files, placing them at the same relative environment and scene level as the source. If the palettes in the templates were stored at the environment level of the source scene, the paste operation will place the palettes in the environment level of the destination scene.</p> <p>Copy and create new palette files in element folder: Creates new palette files in the element folders of the destination scene, rather than in the same relative job or environment.</p> <p>Copy palette and merge colours. Add new colours only: Adds new colours to the destination palettes and ignores colours that are the same in the two palettes.</p> <p>Copy palettes and update existing colours: Adds new colours to the destination palette and updates duplicate colours in the destination with colour values from the source.</p> <p>Link to original palettes (colour model): Links the colour palettes in the destination scene to the palettes in the source. Use this to link drawings to the palettes in a colour model.</p> <p>Copy scene palettes and merge colours. Add new colours only: Adds new colours to the destination scene palettes and ignores colours that are the same in the two palettes.</p> <p>Copy scene palettes and update existing colours: Adds new colours to the destination scene palette and updates duplicate colours in the destination with the colour values from the source.</p>
Cycles	<p>Normal (forward): Pastes your selection as is, starting with the first cell and ending with the last.</p> <p>Reverse: Pastes your selection in reverse, starting with the last cell and ending with the first.</p> <p>Forward > Reverse: Pastes your selection as a yo-yo, starting with the first cell, going to the last one and ending with the first cell.</p> <p>Reverse > Forward: Pastes your selection as a reverse yo-yo, starting with the last cell, going to the first one and ending with the last cell.</p>
Nodes	<p>Create New Columns: A new column is created when you copy and paste nodes from the Node view or layer in the Timeline view. If the layers are linked to function curves, the function curves, drawings and timing will be duplicated.</p>
Elements	<p>Reuse existing elements: Lets you paste existing elements without creating new ones. This should be used only when pasting within versions of the same scene.</p>
Validation	<p>Match by Node/Layer Name: When pasting a template with a hierarchy onto another hierarchy, this option looks to match the pasting elements with the same layer or node name, rather than the same hierarchical structure. This means that</p>

	even if the two hierarchies are different, a new pose of a character's body part will still be pasted on the correct body part layer, as long as both layers are named the same.
--	--

Pen Pressure Feel Dialog Box

The Pen Pressure Feel dialog box allows you to configure how Harmony processes the pressure you put on your drawing tool to apply it to the size of your drawing tool.

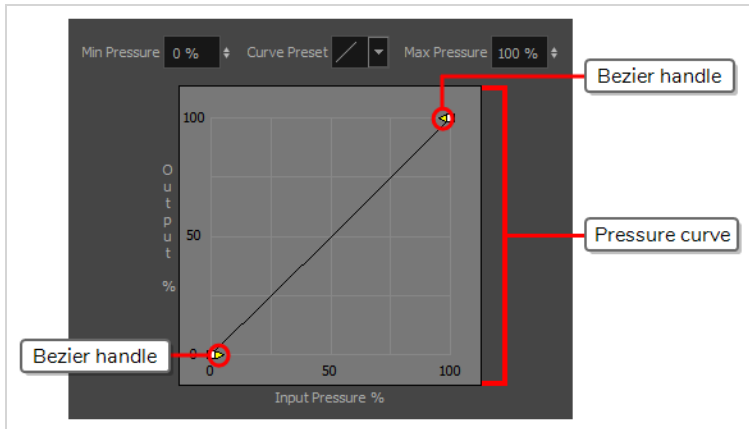

By default, Harmony applies the pressure you put on your pen to your tool in a linear fashion. That is, if you put 25% of the maximum pressure on your pen, your tool's size will be 25% of the way between its minimum and maximum size. If you put 75% of the maximum pressure on your pen, your tool's size will be 75% of the way between its minimum and maximum size.

However, you may find that it would feel more natural, or that it would make it easier to control the size of your drawing strokes, if Harmony interpreted the pressure you put on your pen differently. For example, you may want Harmony to make your brush strokes small unless you put a lot of pressure on your pen, or you may want Harmony to make your brush strokes big unless you put very little pressure on your pen. This is where the Pen Pressure Feel dialog box comes in handy.



NOTE

For information on how to use the Pen Pressure Feel dialog, refer to the User Guide.

How to access the Pen Pressure Feel dialog

1. Add the Pen Settings toolbar to your workspace by doing one of the following:
 - In the top menu, select **Windows > Toolbars > Pen Settings**.
 - Right-click on any existing toolbar and, in the context menu, select **Pen Settings**.

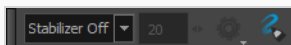

2. In the Pen Settings toolbar, click on the  Pen Pressure Feel button.

The Pen Pressure Feel dialog appears.

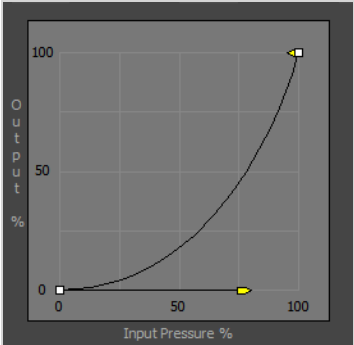
Parameter	Description
Min Pressure	<p>The percentage of your pen's maximum pressure you must apply before Harmony registers that you are drawing. If you increase this setting, you can lightly brush your tablet with your pen without drawing, and you must apply a certain amount of pressure on it to draw.</p> <p>For example, if you set this to 15%, you can apply up to 15% of your pen's maximum pressure without actually drawing. If you apply exactly 15% of your pen's maximum pressure, Harmony will draw a stroke in your tool's minimum size.</p> <p>By default, this is set to 0%, which means that just brushing the tablet with your pen will draw in your tool's minimum size. You can increase this setting up to 25%.</p>
Curve Preset	<p>Allows you to instantly apply a curve preset to the pressure curve below.</p>
Max Pressure	<p>The percentage of your pen's maximum pressure at which point your drawing tool should draw in its maximum size.</p> <p>For example, if you set this to 80%, your drawing tool will draw in its maximum size if you apply 80% of your tablet pen's maximum pressure.</p> <p>By default, this is set to 100%, which means you have to press your tablet pen all the way to draw in your drawing tool's maximum size. You can decrease this setting down to 75%.</p>
Pressure Curve	<p>This curve determines how to process the amount of pressure you apply to your tablet pen into your drawing tool's size.</p> <p>By default, it is linear, meaning that the amount of pressure you put on your tablet pen is directly applied to the size of your drawing tool. By moving the two Bezier handles between the extremities of the curve, you can change the curve's shape.</p> <ul style="list-style-type: none"> If you make an ease-in curve like the one below, the size of your drawing strokes will tend to be closer to the minimum size of your drawing tool, unless you apply a lot of pressure on your tablet pen.  <ul style="list-style-type: none"> If you make an ease-out curve like the one below, the size of your drawing strokes will tend to be closer to the maximum size of your drawing tool, unless you apply very little pressure on your tablet pen.

Parameter	Description
	<div data-bbox="440 285 792 630" data-label="Figure"> <p>The graph shows a coordinate system with 'Input Pressure %' on the x-axis (0 to 100) and 'Output %' on the y-axis (0 to 100). A curve starts at (0,0) and rises with a concave-up shape, reaching (100,100). A yellow arrow points to the curve at approximately 25% input pressure, and another yellow arrow points to the curve at approximately 75% input pressure.</p> </div> <ul style="list-style-type: none"> <li data-bbox="412 661 1429 798"> <p>If you make an ease-in-ease-out curve like the one below, the size of your drawing strokes will tend to be closer to the minimum size of your drawing tool when applying light pressure, and to be closer to the maximum size of your drawing tool when applying more pressure, but it will rarely be the median between the minimum and the maximum size.</p> <div data-bbox="440 823 792 1167" data-label="Figure"> <p>The graph shows a coordinate system with 'Input Pressure %' on the x-axis (0 to 100) and 'Output %' on the y-axis (0 to 100). A curve starts at (0,0) and rises with a concave-down shape, reaching (100,100). A yellow arrow points to the curve at approximately 25% input pressure, and another yellow arrow points to the curve at approximately 75% input pressure.</p> </div> <ul style="list-style-type: none"> <li data-bbox="412 1199 1429 1302"> <p>If you make an ease-out-ease-in curve like the one below, the size of your drawing strokes will tend to be closer to median between the minimum and maximum size of your drawing tool, unless you apply very little or a lot of pressure on your tablet pen.</p> <div data-bbox="440 1325 792 1669" data-label="Figure"> <p>The graph shows a coordinate system with 'Input Pressure %' on the x-axis (0 to 100) and 'Output %' on the y-axis (0 to 100). An S-shaped curve starts at (0,0), passes through (50,50), and ends at (100,100). Yellow arrows point to the curve at approximately 25% and 75% input pressure.</p> </div>

Pose Copier Dialog Box

T-RIG3-007-007

The pose copier contains many buttons and other information to facilitate the insertion of poses in the animation.

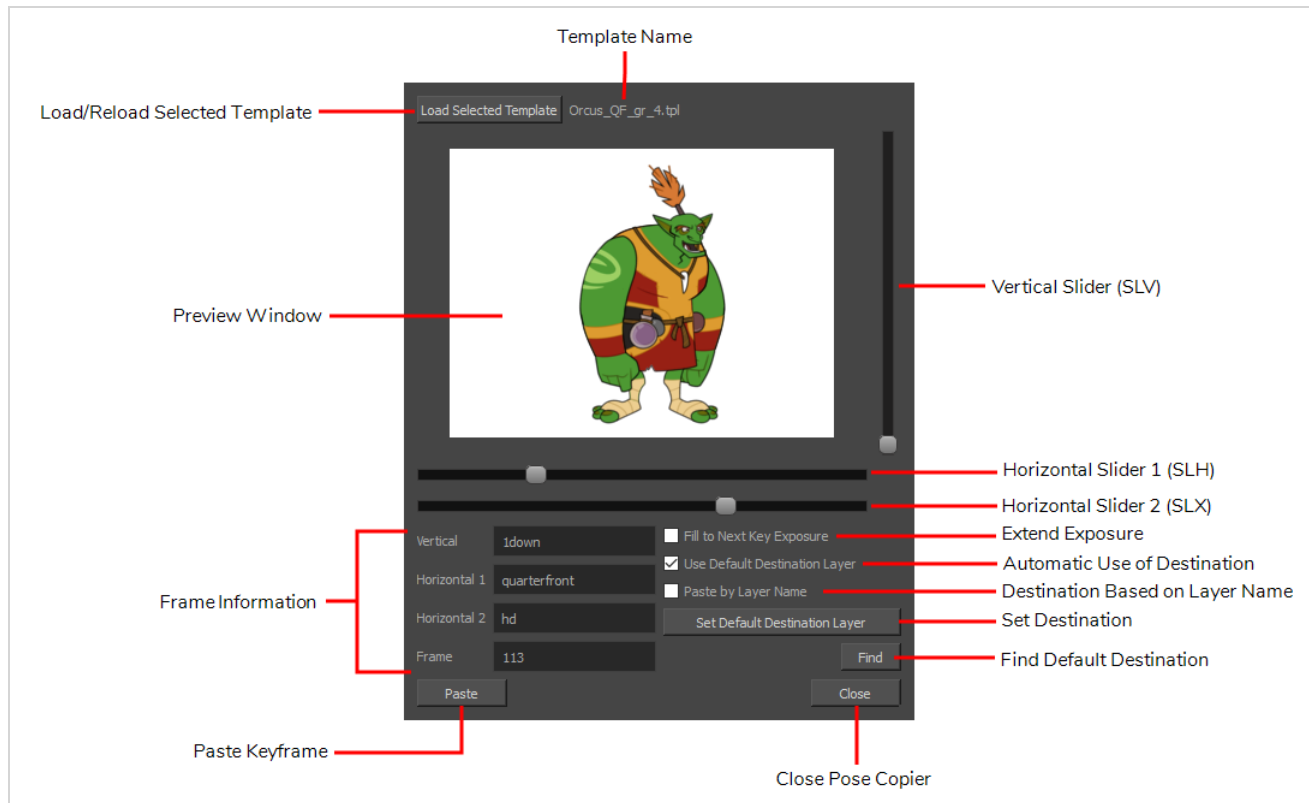

Parameter	Description
Preview Window	Based on master template's generated thumbnails, previews currently selected frames.
Load Selected Template	Updates the template with the newly selected template.
Template Name	Name of the currently selected template.
Vertical Slider (SLV)	Linked to the slv- node of the node system.
Horizontal Slider 1 (SLH)	Linked to the slh- node of the node system. Default slider for the pose copier if no guide layers are created.

Horizontal Slider 2 (SLX)	Linked to the slx- node of the node system.
Fill to Next Key Exposure	Having this option checked will automatically extend the exposure of the pasted frame up to the next key.
Use Default Destination Module	When enabled, the pasted keys will automatically refer to the destination defined in the option Set Default Destination Module.
Paste by Layer Name	When this option is checked the pasted layers will look for the individual layer name instead of matching the hierarchy of the template.
Set Default Destination Module	Instead of selecting the destination every time, the layer set as default destination will automatically paste the keys onto those layers.
Find	This will center on the default destination in the timeline.
Paste	Paste the current position of the pose copier onto the destination.
Vertical	Currently selected frame on the vertical slider. (based on frame name in slv-node)
Horizontal 1	Currently selected frame on the horizontal slider 1. (based on frame name in slh-node)
Horizontal 2	Currently selected frame on the horizontal slider 2. (based on frame name in slx-node)
Frame	Frame number of the selected frame within the master template.

Preferences Dialog Box

The Preferences dialog box allows you to adjust preferences to suit your workflow and your production's needs.

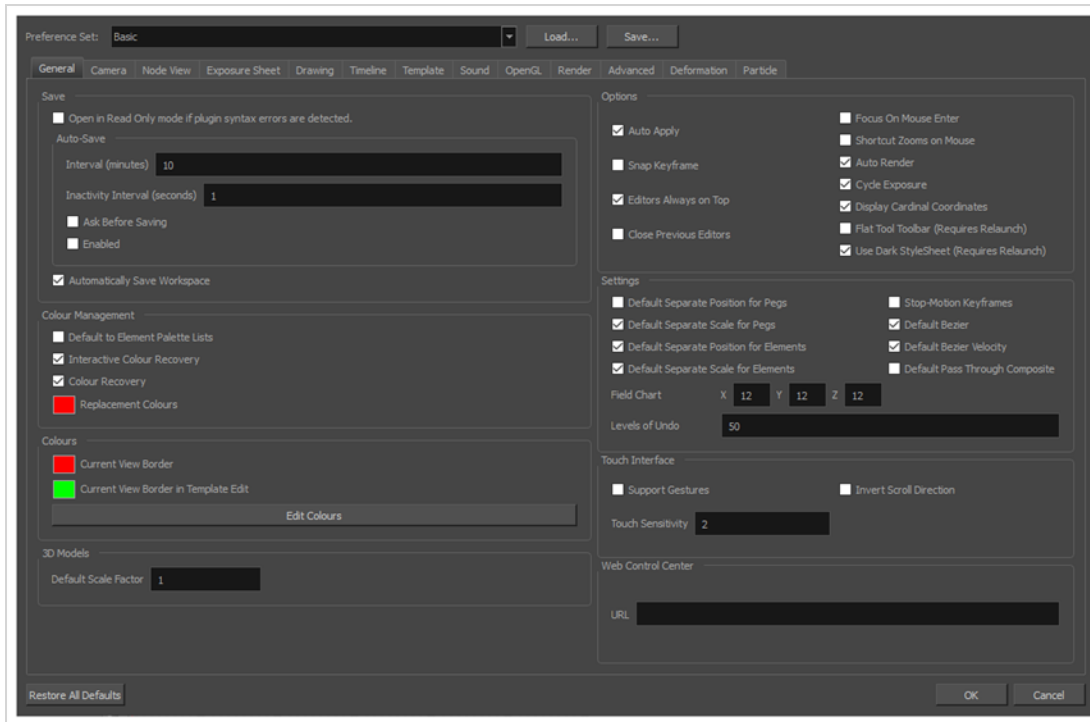

NOTE

For a list of all the preferences as well as their functionality, refer to the Preferences guide.

How to open the Preferences dialog box

- Do one of the following:
 - Windows or GNU/Linux:**
 - In the top menu, select **Edit > Preferences**.
 - Press **Ctrl + U**.
 - macOS:**
 - In the top menu, select **Harmony Premium > Preferences**.
 - Press **⌘ + U**.

Parameter	Description						
Preference Set	<p>This drop-down allows you to select among one of the available preference presets.</p> <p>The different preference presets have a lot of settings in common. The following table lists how each preset differs for specific preferences:</p>						
	Tab / Location	Preference	Preference Set				
			Basic	Compositing	Cutout Animation	Paperless Animation	Rigging
	General	Focus on Mouse Enter	Off	On	On	On	On
		Default pass Through Composite	Off	Off	On	Off	On
		Default Separate Position for Pegs	Off	Off	On	Off	On
		Stop-Motion Keyframes	Off	Off	On	Off	On
	Timeline	Reduce Indentation	Off	On	On	Off	On
		Drawing Substitution: Create Key Exposure	On	Off	Off	Off	On
	Advanced	Support Overlay and Underlay Arts	Off	On	On	Off	On

Parameter	Description																																																					
	<table border="1"> <thead> <tr> <th data-bbox="358 317 516 562" rowspan="2">Tab / Location</th> <th data-bbox="516 317 695 562" rowspan="2">Preference</th> <th colspan="5" data-bbox="695 317 1430 407">Preference Set</th> </tr> <tr> <th data-bbox="695 407 805 562">Basic</th> <th data-bbox="805 407 980 562">Compositing</th> <th data-bbox="980 407 1135 562">Cutout Animation</th> <th data-bbox="1135 407 1289 562">Paperless Animation</th> <th data-bbox="1289 407 1430 562">Rigging</th> </tr> </thead> <tbody> <tr> <td data-bbox="358 562 516 682"></td> <td data-bbox="516 562 695 682">Advanced Display</td> <td data-bbox="695 562 805 682">Off</td> <td data-bbox="805 562 980 682">On</td> <td data-bbox="980 562 1135 682">Off</td> <td data-bbox="1135 562 1289 682">Off</td> <td data-bbox="1289 562 1430 682">On</td> </tr> <tr> <td data-bbox="358 682 516 802"></td> <td data-bbox="516 682 695 802">Advanced Palette List</td> <td data-bbox="695 682 805 802">Off</td> <td data-bbox="805 682 980 802">On</td> <td data-bbox="980 682 1135 802">On</td> <td data-bbox="1135 682 1289 802">On</td> <td data-bbox="1289 682 1430 802">On</td> </tr> <tr> <td data-bbox="358 802 516 951"></td> <td data-bbox="516 802 695 951">Advanced Element Mode</td> <td data-bbox="695 802 805 951">Off</td> <td data-bbox="805 802 980 951">On</td> <td data-bbox="980 802 1135 951">Off</td> <td data-bbox="1135 802 1289 951">Off</td> <td data-bbox="1289 802 1430 951">Off</td> </tr> <tr> <td data-bbox="358 951 516 1199"></td> <td data-bbox="516 951 695 1199">Element Node Animate Using Animation Tools</td> <td data-bbox="695 951 805 1199">On</td> <td data-bbox="805 951 980 1199">On</td> <td data-bbox="980 951 1135 1199">Off</td> <td data-bbox="1135 951 1289 1199">On</td> <td data-bbox="1289 951 1430 1199">Off</td> </tr> <tr> <td data-bbox="358 1199 516 1381">Pencil Tool Properties</td> <td data-bbox="516 1199 695 1381">Auto Close Gap</td> <td data-bbox="695 1199 805 1381">On</td> <td data-bbox="805 1199 980 1381">On</td> <td data-bbox="980 1199 1135 1381">On</td> <td data-bbox="1135 1199 1289 1381">On</td> <td data-bbox="1289 1199 1430 1381">Off</td> </tr> </tbody> </table>							Tab / Location	Preference	Preference Set					Basic	Compositing	Cutout Animation	Paperless Animation	Rigging		Advanced Display	Off	On	Off	Off	On		Advanced Palette List	Off	On	On	On	On		Advanced Element Mode	Off	On	Off	Off	Off		Element Node Animate Using Animation Tools	On	On	Off	On	Off	Pencil Tool Properties	Auto Close Gap	On	On	On	On	Off
Tab / Location	Preference	Preference Set																																																				
		Basic	Compositing	Cutout Animation	Paperless Animation	Rigging																																																
	Advanced Display	Off	On	Off	Off	On																																																
	Advanced Palette List	Off	On	On	On	On																																																
	Advanced Element Mode	Off	On	Off	Off	Off																																																
	Element Node Animate Using Animation Tools	On	On	Off	On	Off																																																
Pencil Tool Properties	Auto Close Gap	On	On	On	On	Off																																																
Save...	Allows you to export your current preference settings as an XML file, which you can import later.																																																					
Load...	Allows you to browse for and import a preference file that was exported with the Save... button.																																																					
Preference Tabs	<p>Where you can browse for and change preferences.</p> <div data-bbox="358 1686 1430 1822" style="border: 1px solid #c8e6c9; padding: 10px;">  NOTE For a list of all the preferences as well as their functionality, refer to the Preferences guide. </div>																																																					
Restore	Restores all your preferences to their default setting for the selected preference set.																																																					

Parameter	Description
All Defaults	
OK	Commits your changes to the preferences and closes the dialog.
Cancel	Undoes your changes to the preferences and closes the dialog.

Recolour Drawings Dialog Box

The Recolour Drawing dialog box allows you to replace all instances of a colour or texture in drawings with a different colour or texture swatch in one of the scene's palettes. This replaces the colours or textures in the drawings without requiring you to modify the palettes. You can use this dialog to perform colour replacement in the current drawing, in all the drawings in one or several layers or in all drawings in your scene.

This dialog will replace the colour or texture that is currently selected in the Colour view with the colour or texture that you select inside the dialog.

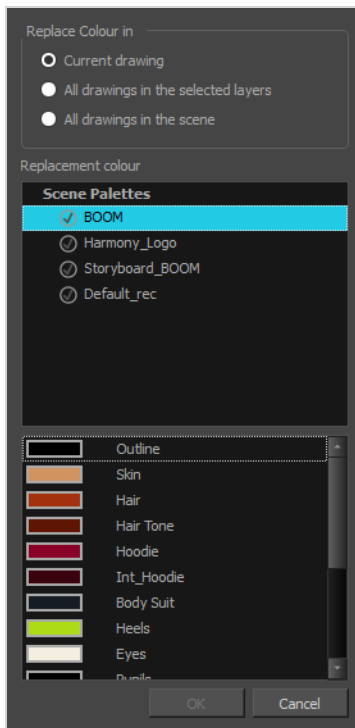

How to access the Recolour Drawings dialog

1. In the Colour view, select the colour or texture swatch you want to replace by doing one of the following:
 - Select the palette in which the colour or texture swatch is located, then select the swatch you wish to replace.
 - If the drawing in the Camera or Drawing view contains the colour or texture you want to replace, select the Colour Eyedropper  tool in the Tools toolbar, then click on that colour or texture in the drawing. The Colour view will automatically select that colour or texture's palette as well as that colour or texture's swatch.

2. Do one of the following:

- Right-click on the swatches list, then select **Recolour Drawings**.
- Open the Colour view menu , then select **Colours > Recolour Drawings**.

Parameter	Description
Replace Colour In	<p>Allows you to select which drawings will be affected by the colour replacement:</p> <ul style="list-style-type: none"> • Current drawing: Replaces the selected colour in the currently selected drawing only. • All drawings in the currently selected layers: Replaces the selected colour in all the drawings in the layer that is currently selected in the Timeline, Xsheet or Node view. <div data-bbox="643 793 1430 930" style="border: 1px solid #c8e6c9; padding: 10px; margin: 10px 0;">  NOTE This option can work with several drawing layers selected. </div> <ul style="list-style-type: none"> • All drawings in the scene: Replaces the selected colour in every drawing in the current scene.
Replacement Colour	<p>Allows you to select the palette and colour or texture swatch to replace the selected colour or texture with.</p>

Remove Dirt Dialog Box

The Remove Dirt dialog box lets you select small dots and hairs on a drawing for removal.

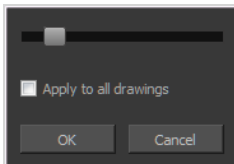

When paper drawings are passed through a scanner, there can be some hair and dirt scattered across them. These lines and dots need to be cleaned. Harmony provides different tools to help get rid of them quickly.

How to access the Remove Dirt dialog box

1. Do one of the following:
 - From the top menu, select **Drawing > Clean Up > Remove Dirt**.
 - From the Camera or Drawing View menu, select **Drawing > Clean Up > Remove Dirt**.
 - Press Shift + D.

Parameter	Description
Slider	<p>Lets you adjust the amount of detail removed from the layer.</p> <p>Raising the Remove Dirt level will select bigger dots. When selecting larger dots, be careful not to lose small details like pupils and nostrils. Once you have chosen the level, you can apply it to the current drawing or the entire animation sequence. This is a quick way to get rid of most dirt and dust.</p> <p>During this process, the dirt that will be removed is highlighted in red.</p>
Apply to all drawings	Applies the operation to all drawings in the layer.

Remove Frames Dialog Box

The Add Frames dialog box allows you to remove a range of frames from your scene. All the keyframes and the exposed drawings in the removed range will be deleted, and the keyframes and exposed drawings after the removed range will be offset backwards, so as to close the gap.

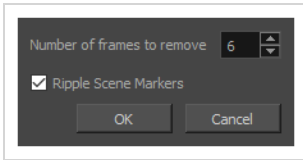

How to access the Remove Frames dialog box

1. In the Timeline or Xsheet view, select a frame or a range of frames.



2. Do one of the following:
 - From the top menu, select **Scene > Frame > Remove Selected Frames**.
 - In the Xsheet view, right-click and select **Frame > Remove Selected Frames**.

The Add Frames dialog box appears.

Parameter	Description
Number of frames to remove	The amount of frames to remove. The range of frame that will be removed starts from the selected frame—or the first selected frame, if a range of frames is selected—and ends after the selected number of frames.

Parameter	Description
	By default, this is set to the amount of selected frames.
Ripple Scene Markers	If checked, scene markers after the removed frames will be offset backward to remain synchronized with the keyframes and drawings in your scene. If unchecked, scene markers will remain in place while everything else after the removed frames is offset.

Remove Hair Dialog Box

The Remove Hair dialog box lets you remove any small strokes created in the Colour Art layer from very thick lines or filled zones. Increasing the Remove Hair level value will select larger strokes for removal from the drawing.

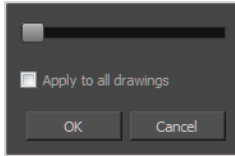

When paper drawings are passed through a scanner, there can be some hair and dirt scattered across them. These lines and dots need to be cleaned. Harmony provides different tools to help get rid of them quickly.

How to access the Remove Hair dialog box

1. In the Timeline or Xsheet view, select the drawing containing the drawing to clean.
2. From the top menu, select **View > Show > Show Strokes** to display the invisible lines or press K.
3. In the top menu, select **Drawing > Clean Up > Remove Hair**.

Parameter	Description
Slider	Lets you adjust the number of length of hairs selected.
Apply to all drawings	Applies the operation to all drawings in the layer.

Render 3D Model Dialog Box

The Render 3D Model dialog box allows you to render a 3D model into a 2D bitmap layer. In this dialog, you can pick the point of view and angle from which the model is rendered, as well as apply geometrical transformations to the model before rendering it.

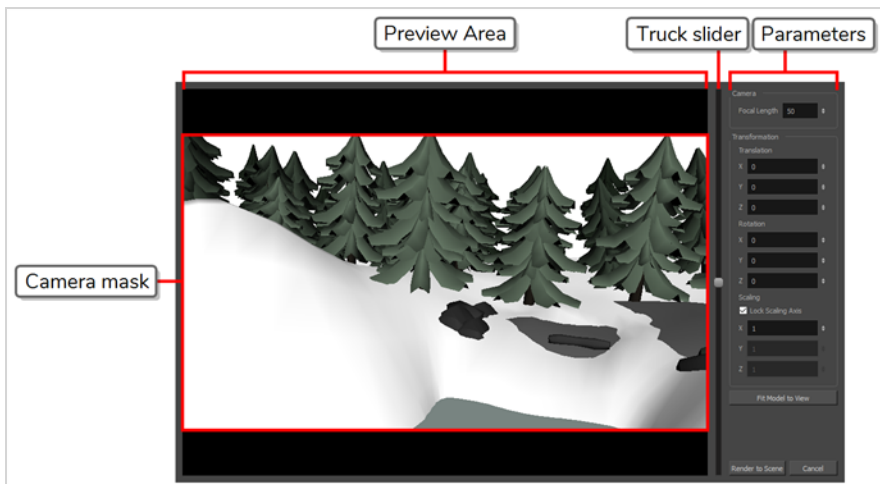

NOTE

For information on how to use this dialog, see the User Guide.

How to access the Render 3D Model dialog box

1. In Harmony, select **File > Import > 3D Models**.

The Import 3D Models dialog box opens.

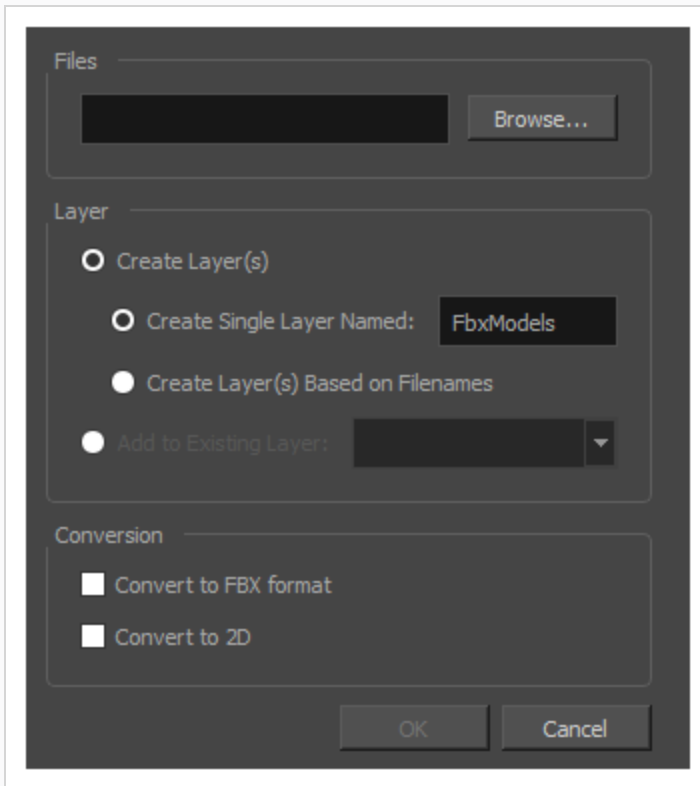

2. In the **Files** field, click on **Browse**.

An Open dialog appears.

3. Browse to and select your 3D model, then click on **Open**.

**NOTE**

If you want to import a 3D model as a rendered 2D image, you can only import a single 3D model at a time.

**NOTE**



You can only import .osb, .3ds, .obj, .fbx, .abc and .dae type 3D models.

4. In the Import 3D Models dialog, check the **Convert to 2D** checkbox.
5. Click on **OK**.

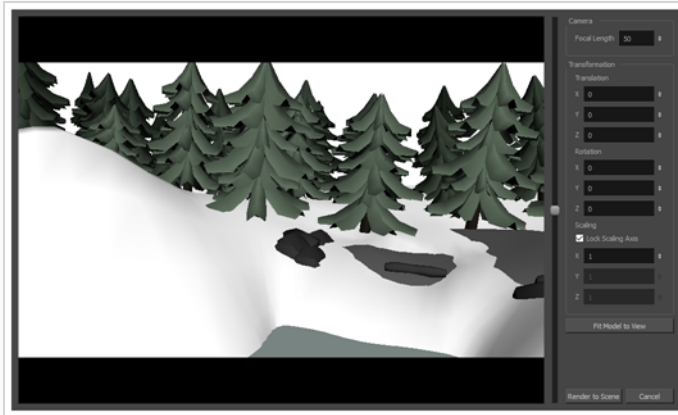
The Render 3D Model dialog appears.

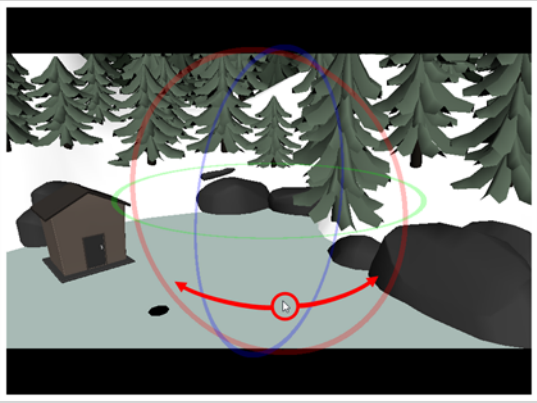

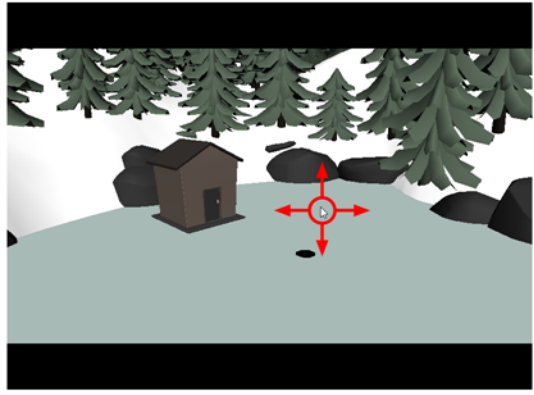
Parameter	Description
Preview Area	<p>The preview area displays the 3D model as it will be rendered in the scene. Black bars display around the area to mark parts of the areas that are outside of the camera frame.</p> <p>In this area, you can:</p> <ul style="list-style-type: none"> • Either click and drag on the vertical slider to the right or scroll the mouse wheel up or down to adjust the distance between the camera and the model. • Hold Ctrl + Shift (Windows/Linux) or ⌘ + Shift (macOS), then click and drag on the preview area to rotate the camera.  <ul style="list-style-type: none"> • Hold Spacebar, then click and drag on the preview area to pan the camera laterally.

Parameter	Description
	
Camera	
Focal Length	<p>The angle of the camera cone used to render the 3D model. A wide angle will render the model with less perspective, and a narrow angle will render it with exaggerated perspective.</p> <div data-bbox="451 940 1429 1142" style="border: 1px solid #c8e6c9; padding: 10px;"> <p> NOTE Increasing this setting will also decrease the perceived size of the 3D model, and decreasing it will increase its perceived size. You must then adjust the camera's distance from the model or the model's scaling to compensate.</p> </div>
Transformation	
Translation	<p>The position of the 3D model relative to the center of the stage:</p> <ul style="list-style-type: none"> • X: The horizontal position of the 3D model, from west to east. • Y: The vertical position of the 3D model, from south to north. • Z: The position of the 3D model relative to the camera, from near to far.
Rotation	<p>The angle of the 3D model relative to its default angle:</p> <ul style="list-style-type: none"> • X: The rotation angle of the model around the horizontal axis. • Y: The rotation angle of the model around the vertical axis. • Z: The rotation angle of the model around the z-axis.
Scaling	<p>The size of the 3D model relative to its default size:</p> <ul style="list-style-type: none"> • Lock Scaling Axis: When enabled, you can use the X scaling field to set the scaling of the 3D model on all axes, preserving its proportions.

Parameter	Description
	<ul style="list-style-type: none">• X: The horizontal scaling of the model.• Y: The vertical scaling of the model.• Z: The scaling of the model on the z-axis.
Fit Model to View	Click on this button to automatically adjust the model's Truck, Translation X and Translation Y parameters so that the model fits inside the camera field and is positioned in its centre.
Render to Scene	Rasterize the 3D model into a bitmap layer and add it to the current panel.
Cancel	Dismiss this dialog and do not import the 3D model.

Render Write Nodes Dialog Box

The Render Write Nodes dialog box lets you configure your scene to render locally or sent it to a render farm so other computers can render your scenes while you continue working on your station.

In Harmony Stand Alone, the Render Write Nodes dialog box will look as follows:

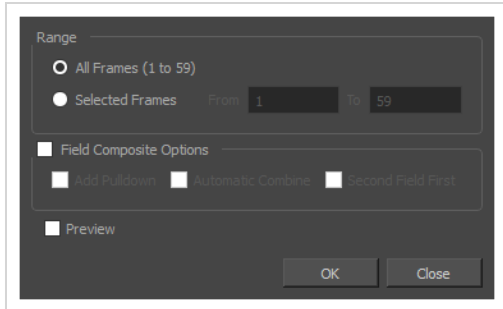

In Harmony Server, the Render Write Nodes dialog box will have an additional section, **Batch Composite Options**, which allows to set parameters for the server's batch rendering service:

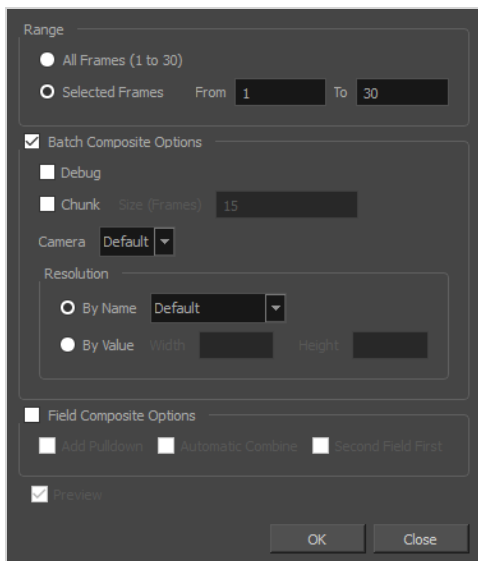

There are two approaches to rendering a scene in Harmony Server:

- **Local Rendering** is done directly by your machine in your Harmony session. Hence, it uses your machine's resources and will prevent you from working on the scene until the render is done. You will see the render progress in real time and will be able to preview the results right after it's finished.
- **Batch Rendering** is done by sending a scene to the server's render queue so it can be processed by the render farm. This allows you to keep working on your scene while the render is being done. The rendering progress can be monitored in Control Center and, when finished, the results can be previewed in Play. Batch Rendering gives you access to additional rendering options.

In either case, the render will be output in the same folder and in the same file formats, as those are determined by the scene's Write nodes. However, batch rendering supports additional options, such as rendering in chunks, or in different resolutions than the scene's resolution.

How to access the Render Write Nodes dialog box

1. Do one of the following:

- From the top menu, select **File > Export > Render Write Nodes**.
- Press **Ctrl + Shift + Y** (Windows/Linux) or **⌘ + Shift + Y** (macOS).

The Render Write Nodes dialog box opens.

Parameter	Description
Range	
All Frames	Sends all the frames in the scene to be rendered.
Selected Frames	Sends the specified range of frames to be rendered.
Batch Composite Options	Check this to send the scene to batch rendering and unlock batch rendering options. Otherwise, the scene will be rendered locally.
Debug	Instructs the batch rendering service to log debug information. When this is checked, the machine that processes the render will have more information about the compositing process in its batch rendering service's log.
Chunk	When checked, this splits the render job sent to the server's render queue into several smaller render jobs, allowing it to be processed by several machines in the render farm. Note that this only affects Frame renders. If the render includes a movie file, the movie will still be exported as a single file once all the frames have been rendered.
Size (Frames)	Specifies the amount of frames each chunk will include. For example, when rendering a 50 frames scene by chunks of 30, this will make the first render job render frames 1 to 30, and the second render job render frames 31 to 50.
Camera	If you created a scene with several Camera nodes, this allows you to specify which one to use for the render.
Resolution	This allows you to set the width and height of the rendered images or movie, either: By Name: Allows you to select between Default or one of the available resolution presets. If Default is selected, the scene will be rendered in its own resolution.

	<p>By Value: Allows you to set the width and height of the rendered images in pixels.</p>																		
<p>Field Composite Options</p>																			
<p>Add Pulldown</p>	<p>Renders using the 3:2 pull-down technique. Every odd-numbered frame will be rendered on 3 images, and every even-numbered frame will be rendered on 2 images.</p> <p>The exported images will be named in pairs to indicate that they are to be combined together. Therefore, the exported frames will follow this scheme:</p> <table border="1" data-bbox="561 623 1216 1413"> <thead> <tr> <th>Exported Image File</th> <th>Rendered Frame</th> </tr> </thead> <tbody> <tr> <td>final-0001-f1.tga</td> <td>Frame 1 of the scene</td> </tr> <tr> <td>final-0001-f2.tga</td> <td>Frame 1 of the scene</td> </tr> <tr> <td>final-0002-f1.tga</td> <td>Frame 1 of the scene</td> </tr> <tr> <td>final-0002-f2.tga</td> <td>Frame 2 of the scene</td> </tr> <tr> <td>final-0003-f1.tga</td> <td>Frame 2 of the scene</td> </tr> <tr> <td>final-0003-f2.tga</td> <td>Frame 3 of the scene</td> </tr> <tr> <td>final-0004-f1.tga</td> <td>Frame 3 of the scene</td> </tr> <tr> <td>final-0004-f2.tga</td> <td>Frame 3 of the scene</td> </tr> </tbody> </table> <p>This makes a scene animated in 24 frames per second output in 60 images per second. Hence, once the paired images are combined, this will make a 30 frames per second render.</p>	Exported Image File	Rendered Frame	final-0001-f1.tga	Frame 1 of the scene	final-0001-f2.tga	Frame 1 of the scene	final-0002-f1.tga	Frame 1 of the scene	final-0002-f2.tga	Frame 2 of the scene	final-0003-f1.tga	Frame 2 of the scene	final-0003-f2.tga	Frame 3 of the scene	final-0004-f1.tga	Frame 3 of the scene	final-0004-f2.tga	Frame 3 of the scene
Exported Image File	Rendered Frame																		
final-0001-f1.tga	Frame 1 of the scene																		
final-0001-f2.tga	Frame 1 of the scene																		
final-0002-f1.tga	Frame 1 of the scene																		
final-0002-f2.tga	Frame 2 of the scene																		
final-0003-f1.tga	Frame 2 of the scene																		
final-0003-f2.tga	Frame 3 of the scene																		
final-0004-f1.tga	Frame 3 of the scene																		
final-0004-f2.tga	Frame 3 of the scene																		
<p>Automatic Combine</p>	<p>Combines each pair of images rendered with Pulldown by interlacing them together.</p>																		
<p>Second Field First</p>	<p>By default, when images rendered with Pulldown are combined, the first image in a pair is rendered on odd lines (referred to as the first field), and the second is rendered on even lines (referred to as the second field). This does the opposite: The second image in a pair is rendered on odd lines and the first one is rendered on even lines.</p>																		

Preview	When rendering locally, this opens the rendered image sequence in Play immediately after the render is done.
---------	--

Save Dialog Box

The Save dialog box appears when you save a scene for the first time in Harmony Server.

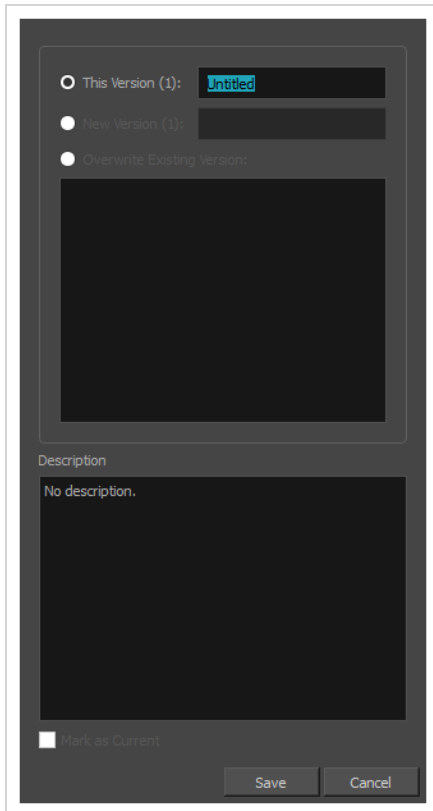

How to access the Save dialog Box

1. Make sure you have the necessary rights to save the current scene version. If you do not, you can acquire the rights by selecting **File > Rights to Modify Scene Version** or **Rights to Modify Scene** in the top menu.
2. Do one of the following:
 - In the top menu, select **File > Save**.
 - In the File toolbar, click on the  Save button.
 - Press **Ctrl + S** (Windows/Linux) or **⌘ + S** (macOS).

When saving the scene for the first time, the Save dialog box opens, prompting you to name the version.

Parameter	Description
-----------	-------------

This Version	Allows you to enter the name of the current version.
Description	Enter a short description of the current version.

Scene Settings Dialog Box

The Scene Settings dialog box lets you select settings for the resolution of your scene, its alignment and the resolution of bitmap drawings and textured brush strokes.

You are already required to select resolution and alignment settings when creating a scene, but those settings can also be modified later using the Scene Settings dialog box.

How to access the Scene Settings dialog box

1. In the top menu, select **Scene > Scene Settings**.

The Scene Settings dialog box opens.

Resolution Tab

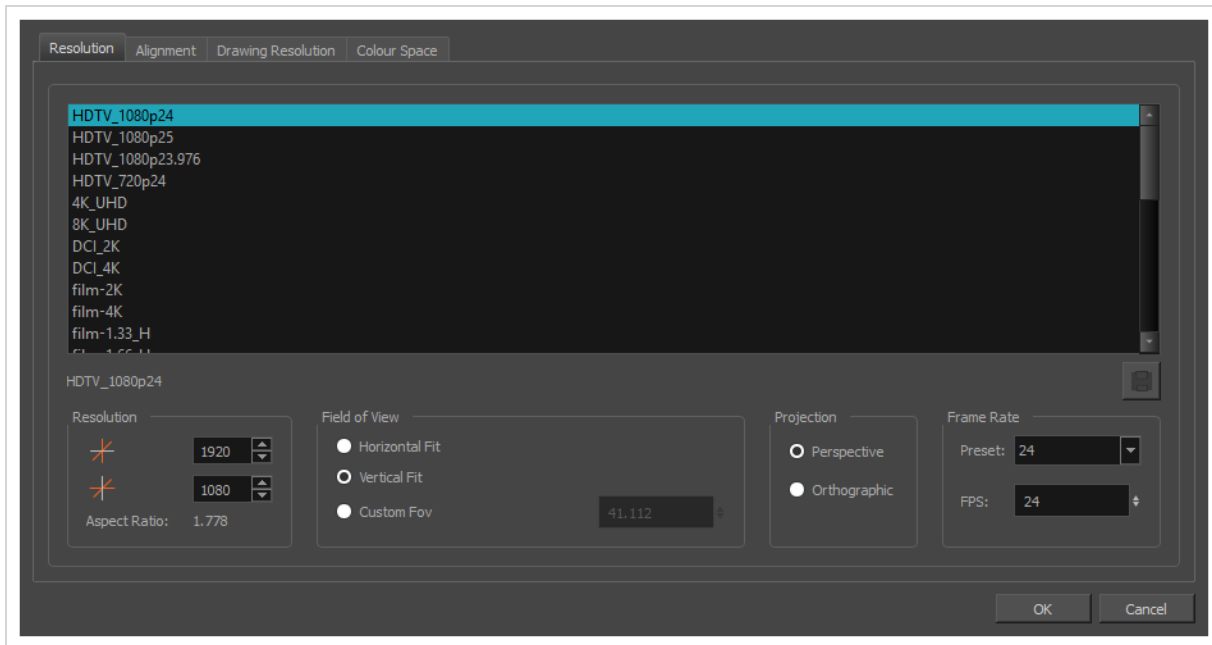



The resolution tab allows you to set the width and height of your scene in pixels, the angle of the field of view and the way elements are projected across the depth of your scene.

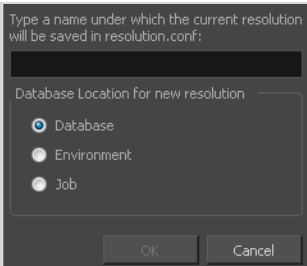

Icon	Parameter	Description
	Resolution Presets	<p>You can select your project's resolution (camera frame size) from this preset list.</p> <ul style="list-style-type: none"> • HDTV_1080p24: The standard definition for high definition television at 24 frames per second, mostly used in the Americas and some Asian countries that used the NTSC standard for analogue television.

Icon	Parameter	Description
		<ul style="list-style-type: none"> • HDTV_1080p25: The standard definition for high definition television at 25 frames per second, usually for broadcasting in European, African, Asian and Australian countries that used the PAL or SECAM standard for analogue television. • HDTV_1080p23.976: The standard definition for high definition television at 23.976 frames per second. This is useful if the remainder of your pipeline uses the 23.976 framerate for legacy reasons. • HDTV_720p24: The former standard high definition resolution at 24 frames per second. • 4K_UHD: A standard ultra HD (4K) format for television productons. 4K implies that the width of the image is of, give or take, 4000 pixels. • 8K_UHD: A standard ultra HD (8K) format for television productions. 8K implies that the width of the image is of, give or take, 8000 pixels. • DCI_2K: A standard HD format for cinema. • DCI_4K: A standard ultra HD (4K) format for cinema. • film-2K: A standard HD format for film projectors with a low aspect ratio. • film-4K: A standard ultra HD (4K) format for film projectors with a low aspect ratio. • film-1.33_H: The standard resolution for the academy film format that conforms to the standard 4:3 aspect ratio. • film-1.66_H: The standard resolution for widescreen film format that conforms to the 16:9 aspect ratio. • film-1.66_V: The standard resolution for widescreen film format, but with a vertical field of view. • Cineon: The standard format for 35 mm Kodak/Cineon film. • NTSC: The standard resolution and framerate for analogue standard definition televisions in most of the Americas (except Brazil, Paraguay, Uruguay and Argentina), Japan, Taiwan, South Korea, the Philippines and Myanmar. • PAL: The standard resolution and framerate for analogue standard definition televisions in Europe, Africa, Australia, most of Asia, Brazil, Uruguay and Argentina. • 2160p-240p: A series of standard widescreen presets named after their resolution heights.

Icon	Parameter	Description
		<ul style="list-style-type: none"> • low: A resolution based on NTSC with half of its standard dimensions. • Web_Video: A legacy format for web streaming. • Game_512: A preset for the gaming pipeline, with a square canvas. • Game_512_Ortho: Like Game_512, except with Orthographic projection so that elements moved on the Z axis do not appear smaller or bigger. • WebCC_Preview: The preset used by WebCC to render previews of scenes in a Harmony Server database. • HDTV: The standard definition for high definition television at 24 frames per second, with a horizontal fit field of view. • HDTV_Vertical: The standard definition for high definition television at 24 frames per second, with a vertical fit field of view.
	Selected Resolution Preset	Displays the name of the selected resolution preset just below the presets list. If you have made any changes to the resolution since selecting a preset, this will display "(custom)".
	Save Resolution Setting	<p>Allows you to save the current resolution settings as a new preset. If you have a resolution preset selected, this button is only available if you have made changes to the resolution since selecting the preset. You will be prompted to type in the name of the new resolution preset. If using Harmony Server, you will also be asked to select in which part of the database you want the preset to be saved.</p> 
	Resolution	The resolution of the scene defines the width and height of the canvas in pixels. By default, the scene will be rendered in this resolution. If using bitmap layers or textured brush strokes, the definition of the pixels in your artwork will also be based on the scene's resolution.

Icon	Parameter	Description
	Scene Width	The width of the resolution for the scene, in pixels.
	Scene Height	The width of the resolution for the scene, in pixels.
	Aspect Ratio	Displays the ratio between the horizontal and vertical dimensions of the scene. For example, if the scene width and height are the same value, this ratio equals 1. The standard aspect ratio for widescreen televisions is 1.777. For legacy displays, it is 1.333.
	Field of View	<p>The angle of the field of view, which determines the size of the camera cone as well as the way the field grid used to position elements is adjusted to fit the scene.</p> <ul style="list-style-type: none"> • Horizontal Fit: The field of view is automatically adjusted so that the field grid and camera cone fit the horizontal length of the scene. • Vertical Fit: The field of view is automatically adjusted so that the field grid and camera cone fits the vertical length of the scene. • Custom FOV: Enter the angle of the field of view manually. A greater angle will make a wider camera cone and smaller fields. A smaller angle will mean a more narrow camera cone and bigger fields.

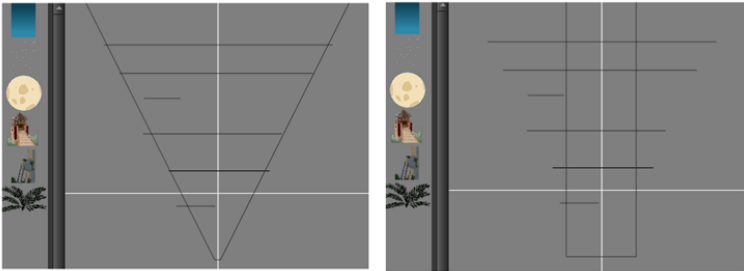
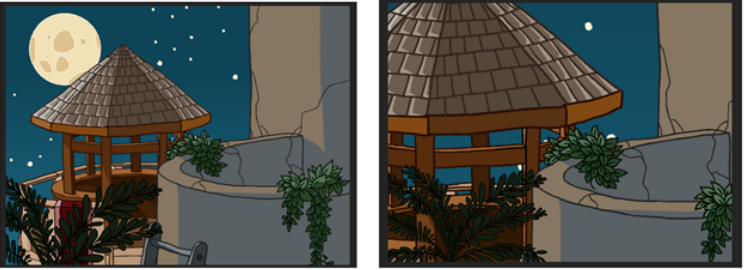
Icon	Parameter	Description
		<div style="border: 1px solid #c8e6c9; padding: 10px;">  <p>NOTES</p> <ul style="list-style-type: none"> • Objects in Harmony are positioned in fields, based on a traditional animation grid which, by default, extends to 12 fields from the center in each direction, and which has 4:3 proportions by default. In a scene with 4:3 proportions, this grid fits the camera field perfectly. However, since most scenes have an aspect ratio of 16:9, the grid does not fit the camera field perfectly. If the field of view is Horizontal Fit, the grid's width will match the scene's width, but will extend beyond its vertical edges. If the field of view is Vertical Fit, the grid's height will match the scene's height, will not extends to its horizontal edges. • To avoid distorting elements, the field of view angle is applied directly to the vertical axis, and the one applied on the horizontal axis is calculated proportionally to the aspect ratio of the scene. • The field of view may affect the way 3D-rotated elements and 3D objects are rendered. If too wide, objects may appear distorted when seen from an angle. If too low, objects may seem flat and may lack foreshortening. </div>
	Projection	<p>The Projection settings allows you to modify the type of camera your scene is using. You can either use a perspective camera (regular camera) or orthographic camera (no perspective).</p> <ul style="list-style-type: none"> • Perspective: Objects placed closer to the camera will be displayed bigger and objects placed further away will be displayed smaller. Elements that are 3D-rotated as well as 3D objects will be rendered in a realistic perspective. • Orthographic: The size of objects does not depend on their position on the Z-axis. Moving an element forward or backward will not change its apparent size, only its order relative to other elements. 3D-rotated elements and 3D objects will have no foreshortening. This option is more often useful when using Harmony for gaming, and more information about this option is available in the Gaming guide. This option can also be useful if you don't need any perspective in your project and want to use the Z-axis to order elements, or if you want to

Icon	Parameter	Description
		<div data-bbox="753 283 1430 485" style="border: 1px solid #add8e6; padding: 10px;">  <p>TIP In order to create scenes with the Orthographic camera by default, you need to create a new custom scene resolution.</p> </div> <div data-bbox="672 512 1433 835" style="border: 1px solid #ccc; padding: 10px; margin-top: 10px;">  <div style="display: flex; justify-content: space-around; margin-top: 5px;"> Perspective camera Orthographic camera </div> </div> <div data-bbox="672 869 1433 1192" style="border: 1px solid #ccc; padding: 10px; margin-top: 10px;">  <div style="display: flex; justify-content: space-around; margin-top: 5px;"> Perspective camera Orthographic camera </div> </div>
	Frame Rate	<p>The amount of animation frames to play each second. Increasing the FPS will make your animation play faster, and decreasing it will make it play slower.</p> <ul style="list-style-type: none"> • Preset: Allows you to select a frame rate for your scene among one of many commonly used preset frame rates. • FPS: Allows you to type in the frame rate for your scene. <div data-bbox="672 1530 1430 1797" style="border: 1px solid #90ee90; padding: 10px; margin-top: 10px;">  <p>NOTE The standard framerate for film production is 24 frames per second. However, televisions in some countries play at 25 frames per second. Some productions may use 23.976 frames per second to preserve compatibility with legacy standard displays.</p> </div>

Alignment Tab

The alignment tab is used to determine the aspect ratio, the position and the size of the field grid used to position elements in the scene.

In Harmony are positioned in *fields*, a unit used in traditional animation which traditionally ranges from 0 to 12 followed by a cardinal direction, and in which 0,0 is the center of the scene.

The default Alignment setting in Harmony is based on such a traditional 4:3 drawing grid. In a scene with an aspect ratio of 4:3, this means that positioning an element 12 fields in any direction will make it reach one of the edges of the camera field. For example, 12 North is the vertical position of the upper edge of the camera field, and 12 East is the horizontal position of the right edge of the camera field.

However, since the most commonly used scene resolutions have an aspect ratio of 16:9, and the default grid is in a 4:3 proportion, the grid used to position element will not be in the same proportions as the camera field. The way this is handled is determined by the Field of View setting in the Resolution tab. If your field of view is set to Horizontal fit, the field grid will be made to fit the scene horizontally, and stretch beyond the vertical edges of the scene. This means that 12 East will still be the right edge of the screen, but the position of the upper edge of the scene will be about 9.36 North. Likewise, if the field of view is set to Vertical Fit, the upper edge of the field will be at 12 North, but the right edge will be at about 16 East.

Some artists or studios may prefer to use a square fields grid, where fields have the same size horizontally and vertically.

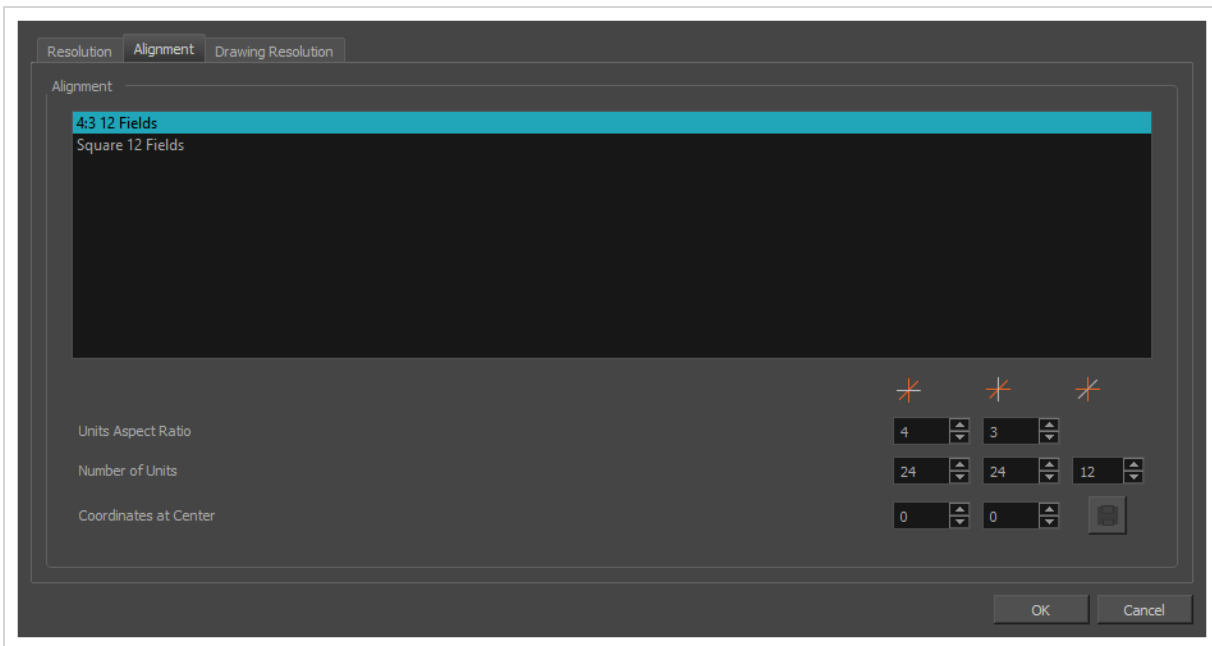

Parameter	Description
Alignment	The list of alignment presets. By default, Harmony has these two alignment presets:

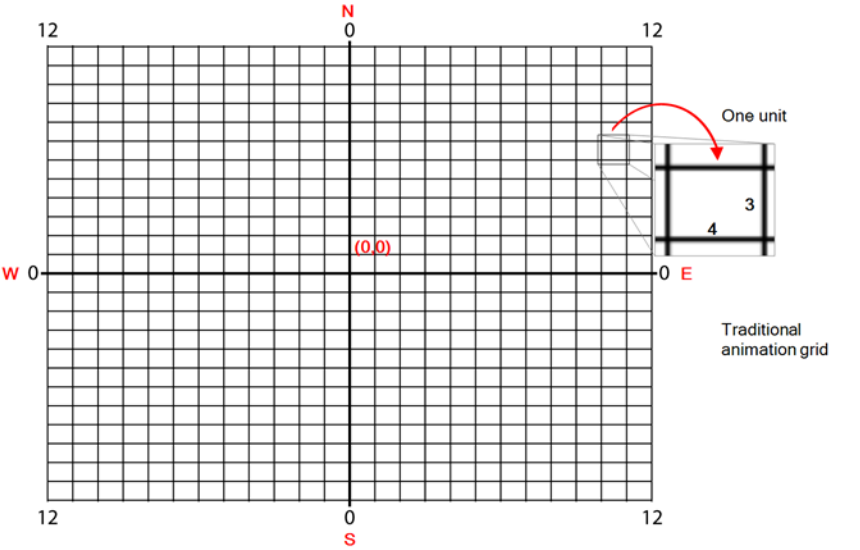
Parameter	Description
	<ul style="list-style-type: none"> • 4:3 12 Fields: Defines the units of your project to have a 4:3 ratio and sets up 12 of these units to run both vertically and horizontally in four cardinal quarters (NW, NE, SW, SE). This is the default setting, and it corresponds to an animation grid used in traditional animation. Hence, coordinates based on a traditional animation grid can be entered in Harmony as is to position elements where they are expected to be. • Square 12 Fields: Defines the units of your project to have a 1:1 or square ratio and sets up 12 units to run both vertically and horizontally in four cardinal quarters (NW, NE, SW, SE). <div data-bbox="565 646 1430 890" style="border: 1px solid green; padding: 10px; margin-top: 10px;"> <p> NOTE</p> <p>When the Grid is displayed in the Camera and Drawing view, it is always based on the 4:3 12 Fields alignment preset, regardless of your scene's alignment setting. To display the grid, from the top menu, select View > Grid > Show Grid.</p> </div>
Units Aspect Ratio	<p>The aspect ratio of each field. This describes the proportional difference between the width and the height of the field. By default, it is set to 4:3, which means the width of each field will take 4 unites of length for each 3 units the height of the field takes. In other words, the width of a field is $1.\overline{333}$ times its height. If set to, for example, 1:1, the fields will be perfectly square.</p> <div data-bbox="565 1142 1430 1745" style="border: 1px solid gray; padding: 10px; margin-top: 10px;"> <p>Alignment Presets</p>  </div>
Number of Units	<p>The number of fields the grid should have in each direction. In the Number of Units fields, enter the number of horizontal, vertical and depth units for your scene's grid.</p>

Parameter	Description
	<p>The grid is a specific size based on the scene's resolution and field of view angle. Changing the amount of units for each direction will not change the size of the grid, but rather, the size of the units. Hence, if an element is offset at 3 North, 4 East, and you change the number of horizontal and vertical units from 24 to 12, the element will become offset twice as far from the centre as it originally was.</p> <p>The third setting in this field determines the amount of units across the Z axis. This determines how far each unit will take an element further or closer to the camera when moved on the Z-axis. By default, the grid has 12 fields across the Z-axis, which is half the amount of fields on the X and Y axes by default. Hence, each field on the Z-axis is worth exactly twice the length of a field on the horizontal axis.</p> <p>Animators who are familiar with traditional animation method will understand the default setting of 24 units horizontal by 24 units vertical as it corresponds to a traditional animation grid.</p>
Coordinates at Centre	<p>The offset for the centre of the fields grid. The centre of the fields grid is where elements are positioned by default, when they themselves are at coordinates 0,0. To change the centre, you must enter its offset from the actual centre of the grid in fields. For example, if your fields grid is 24 x 24, and you want the centre to be at the top-left corner, you should enter -12,-12.</p>
Save	<p>Saves your current Alignment settings and be able to select them later from the list.</p>

**TIP**

If you prefer working in pixel-based positions, you must set the aspect ratio of your units to be the same as the aspect ratio of your scene resolution, set the horizontal number of units to the width of your scene in pixels, the vertical number of units to the height of your scene in pixels, and the depth number of units to the width of your scene in pixels. This way, each unit will translate to exactly 1 pixel, in all directions.

**NOTE**

Each layer also has an alignment rule, which determines how it is positioned relative to the fields grid. By default, it is set to "Centre First Page". However, this alignment rule is made to be compatible to 4:3 fields grids. Hence, if you change your scene's alignment rules, your layers will be offset. To avoid this issue, change the alignment rules of your layers to "Centre" via the Advanced tab of the Layer Properties view.

Drawing Resolution Tab

The drawing resolution tab is used to set the pixel density of bitmap drawings as well as of bitmap textures in textured brush strokes in vector drawings. Also, it is used to set the size of the canvas for bitmap drawings relative to the size of the scene.



NOTE

These settings are applied to newly created drawings in the scene, but not to existing drawings in your scene. To change the pixel density of existing vector drawings, you must select **Drawing > Change Vector Drawing Brush Resolution** from the top menu. To change the pixel density and canvas size of existing bitmap drawings, you must select **Drawing > Change Bitmap Drawing Resolution** from the top menu.



NOTE

You can change the default drawing resolution settings for new scenes in the Drawing tab of the Preferences dialog.

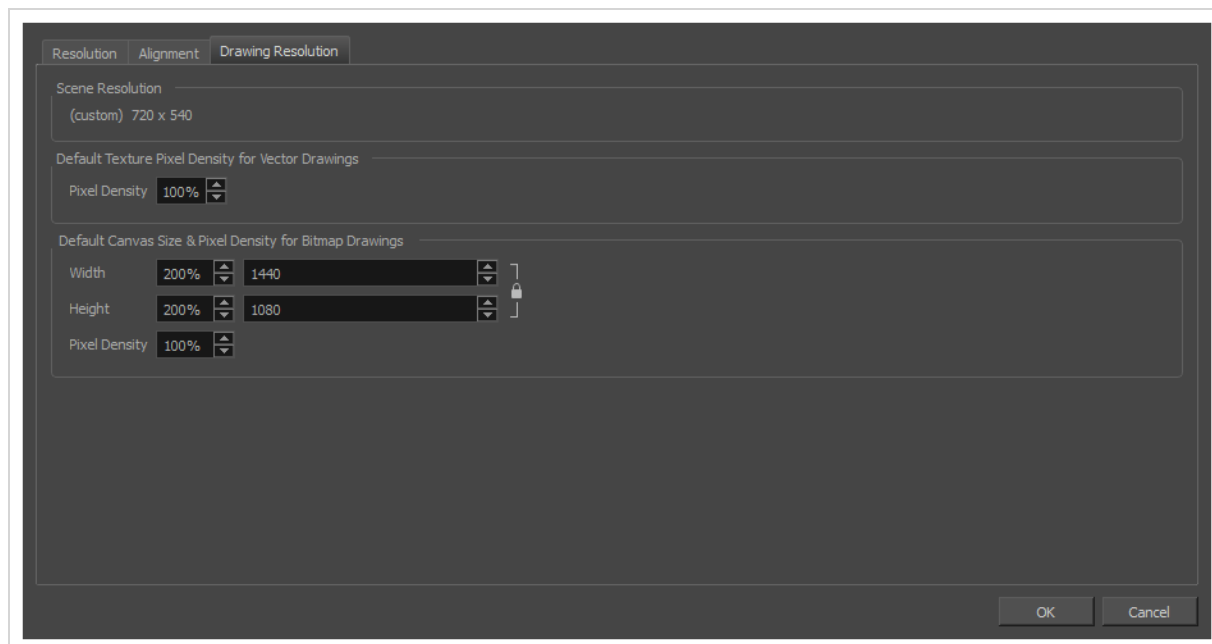

Parameter	Description
Scene Resolution	This indicates the currently selected scene resolution preset and its dimensions in pixels.
Default Texture Density for Vector Drawings	Pixel Density: Determines the amount of pixels to store in textured brush strokes

Parameter	Description
	for each pixel that displays when the drawing is not zoomed in or scaled up. For example, at 100%, zooming in or scaling up textured brush strokes will make them lose texture quality. If set to 200%, textured brush strokes can be zoomed in or scaled up until they're twice their original size without losing picture quality.
Default Canvas Size and Pixel Density for Bitmap Drawings	<p>Width: The default width of the canvas when creating drawings in a bitmap drawing layer. The percentage is relative to the width of the scene. Its default value, 200%, makes the width of the canvas twice the width of the stage.</p> <p>Height: The default height of the canvas when creating drawings in a bitmap drawing layer. The percentage is relative to the height of the scene. Its default value, 200%, makes the height of the canvas twice the height of the stage.</p> <p>Pixel Density: Determines the amount of pixels to store for each pixel that displays on the screen when the drawing is not zoomed in or scaled up. For example, at 100%, zooming in or scaling up a bitmap drawing will make it lose picture quality. If set to 200%, bitmap drawings can be zoomed in or scaled up until they're twice their original size without losing picture quality.</p>

Colour Space

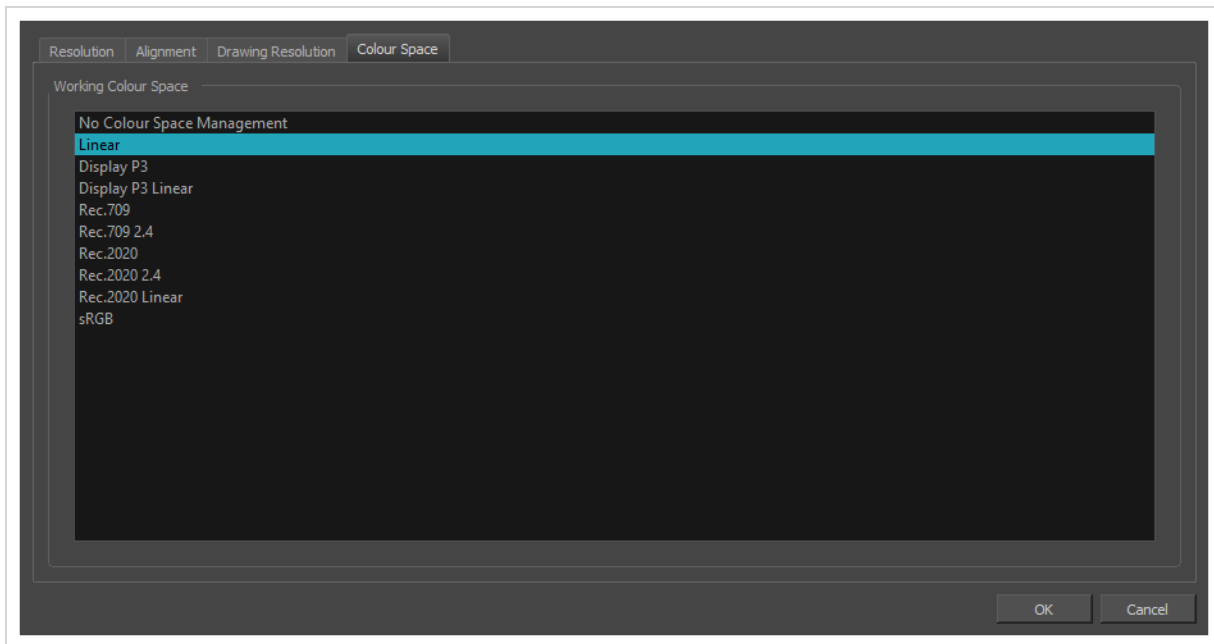

Parameter	Description
Working Colour	The working colour space of a project is the one used internally by Harmony. It is also the default colour space used for decoding the colours in drawing layers as well as for exporting images and

Parameter	Description
Space	<p>movies. However, those can be configured to be different from the project colour space if needed.</p> <p>The following colour spaces are available in Harmony:</p> <ul style="list-style-type: none"> • No Colour Space Management: No colour space conversion will be done in the entire project, even if you set the colour space for your drawing layers or for rendering your scene. • Linear: The same primaries and white point as sRGB and Rec. 709, but with no gamma transfer curve applied to the colour values. This colour space is useful for compositing intermediary images that are meant to be rendered in sRGB or Rec. 709. • Display P3: A colour space commonly used for digital projection. It has the same primaries as DCI-P3, the same white point as sRGB and the same gamma transfer curve as sRGB. • Display P3 Linear: The same as Display P3, except with no gamma transfer curve. This colour space is useful for compositing intermediary images that are meant to be rendered in Display P3. • Rec. 709: The colour space used for HDTV. It has the same primaries and white point as sRGB, but has a different gamma transfer curve. • Rec. 709 2.4: The same colour space as Rec. 709 or sRGB, except with a gamma transfer curve of 2.4. This colour space exists because some editing systems use a gamma transfer curve of 2.4 instead of the standard gamma curve for Rec. 709. • Rec. 2020: A colour space used for Ultra High Definition TV (UHDTV). It has a complex gamma transfer curve and primaries that cover more of the human-perceivable colour space than other colour spaces, especially in the area of human-perceivable greens. • Rec. 2020 2.4: The same colour space as Rec. 2020, except with a simple gamma transfer curve of 2.4. This colour space exists because some editing systems use a gamma transfer curve of 2.4 instead of the standard gamma curve for Rec. 2020. • Rec. 2020 Linear: The same colour space as Rec. 2020, except with no gamma transfer curve. This colour space is useful for compositing intermediary images that are meant to be rendered in Rec. 2020. • sRGB: A colour space typically used for standard computer monitors. It has the same primaries and white point as Rec. 709, but has a different gamma transfer curve. <p>By default, your drawing layers are read in the same colour space as your project, and your rendered frames are created in the same colour space as your project as well. However, if the colour space for the project is different from the colour space used for drawing layers and from the colour space used for rendering your scene, the project colour space serves as the “intermediary” colour space.</p> <p>This means that, in the process of rendering your scene, your drawing layers are converted from their colour space to the project’s colour space, after which they are composited together along with your scene’s visual effects, and finally the rendered image is converted to the colour space selected for rendering your scene.</p> <p>Hence, from a compositing perspective, it is recommended to set your project’s workspace to the linear variant of the colour space used for your drawing layers and for rendering your scene. Working</p>

Parameter	Description																					
	<p>this way ensures that calculations made on the colour values for compositing visual elements effects are not affected by the colour space's gamma curve. The following is a table of recommended colour space configurations:</p> <table border="1" data-bbox="362 411 1429 1026"> <thead> <tr> <th data-bbox="362 411 764 499">Drawing Layer Colour Space</th> <th data-bbox="764 411 1076 499">Project Colour Space</th> <th data-bbox="1076 411 1429 499">Rendering Colour Space</th> </tr> </thead> <tbody> <tr> <td data-bbox="362 499 764 588">sRGB</td> <td data-bbox="764 499 1076 588">Linear</td> <td data-bbox="1076 499 1429 588">sRGB</td> </tr> <tr> <td data-bbox="362 588 764 676">Rec. 709</td> <td data-bbox="764 588 1076 676">Linear</td> <td data-bbox="1076 588 1429 676">Rec. 709</td> </tr> <tr> <td data-bbox="362 676 764 764">Rec. 709 2.4</td> <td data-bbox="764 676 1076 764">Linear</td> <td data-bbox="1076 676 1429 764">Rec. 709 2.4</td> </tr> <tr> <td data-bbox="362 764 764 852">Rec. 2020</td> <td data-bbox="764 764 1076 852">Rec. 2020 Linear</td> <td data-bbox="1076 764 1429 852">Rec. 2020</td> </tr> <tr> <td data-bbox="362 852 764 940">Rec. 2020 2.4</td> <td data-bbox="764 852 1076 940">Rec. 2020 Linear</td> <td data-bbox="1076 852 1429 940">Rec. 2020 2.4</td> </tr> <tr> <td data-bbox="362 940 764 1026">Display P3</td> <td data-bbox="764 940 1076 1026">Display P3 Linear</td> <td data-bbox="1076 940 1429 1026">Display P3</td> </tr> </tbody> </table>	Drawing Layer Colour Space	Project Colour Space	Rendering Colour Space	sRGB	Linear	sRGB	Rec. 709	Linear	Rec. 709	Rec. 709 2.4	Linear	Rec. 709 2.4	Rec. 2020	Rec. 2020 Linear	Rec. 2020	Rec. 2020 2.4	Rec. 2020 Linear	Rec. 2020 2.4	Display P3	Display P3 Linear	Display P3
Drawing Layer Colour Space	Project Colour Space	Rendering Colour Space																				
sRGB	Linear	sRGB																				
Rec. 709	Linear	Rec. 709																				
Rec. 709 2.4	Linear	Rec. 709 2.4																				
Rec. 2020	Rec. 2020 Linear	Rec. 2020																				
Rec. 2020 2.4	Rec. 2020 Linear	Rec. 2020 2.4																				
Display P3	Display P3 Linear	Display P3																				

Scripts Manager Dialog Box

The Scripts Manager dialog allows you to create buttons in the Scripting toolbar. Each button you create can run a specific function in one of your scripts. You can also choose an icon and a tool tip for the button, if you want.

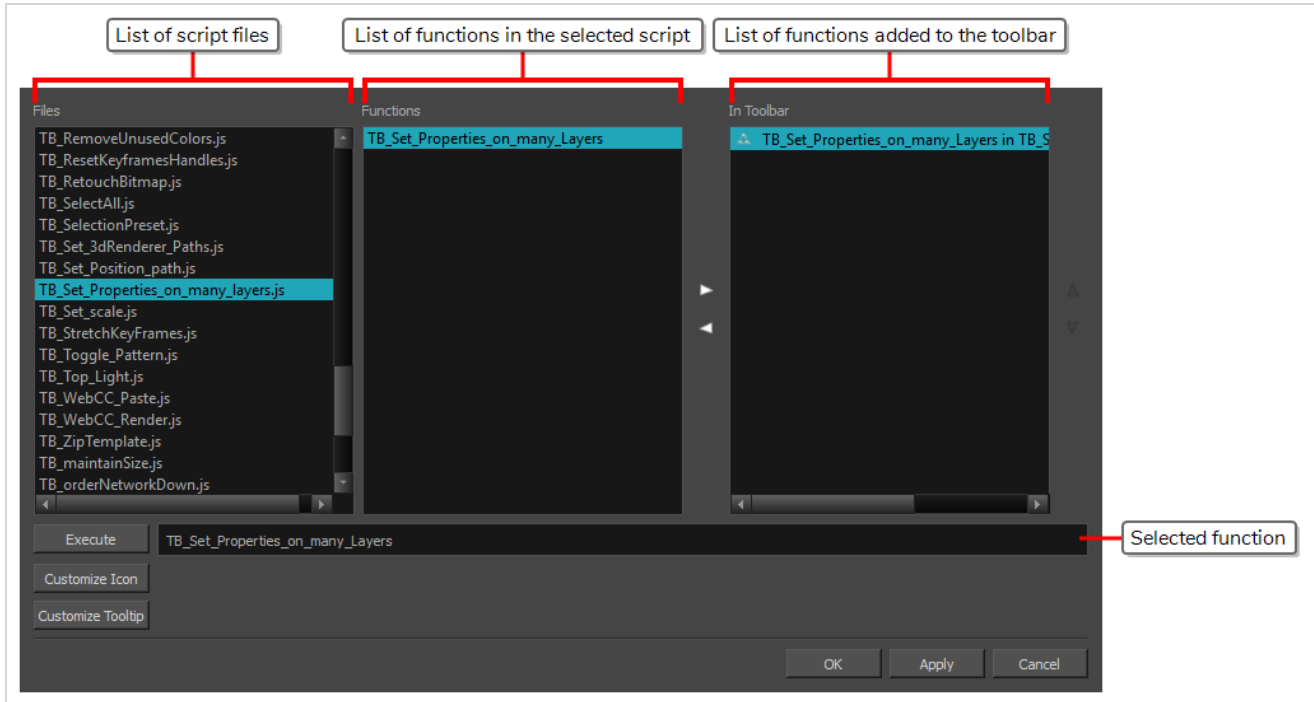

NOTE

For tasks related to this dialog box, see the User Guide.

How to access the Scripts Manager Dialog Box

1. Add the Scripting toolbar to your workspace by doing one of the following:
 - In the top menu, select **Windows > Toolbars > Scripting**.
 - Right-click on any existing toolbar and select **Scripting**.
2. In the Scripting toolbar, click on the  Manage Scripts button.

The Scripts Manager dialog box opens.

Parameter	Description
Files	A list of the available JavaScript files.

Functions	A list of the available functions for the selected script.
In Toolbar	The list of script functions already added to the Scripting toolbar.
Execute	<p>Runs the selected function.</p> <div data-bbox="565 432 1430 569" style="border: 1px solid #0070C0; padding: 5px;"> TIP Press Esc to interrupt the execution of the script.</div>
Customize Icon	Allows you to select an icon for the toolbar button. Clicking on this button will open an Open dialog prompting you to browse for and select a .png , .jpg , .xpm or .svg file.
Customize Tooltip	Allows you to type in a custom tooltip for the toolbar button.

Select Colour Dialog Box

The Select Colour dialog box lets you set the colour of layers and columns. Using colours for layers and columns helps to differentiate them visually, making them easy to identify. The colours you choose will be reflected in the Node view.

You can select a colour by choosing from a basic set of colours, using the colour wheel or by specifying the HSV or RGB values. Once you have selected a colour, you can adjust its intensity and save it as a custom colour that you can reuse.

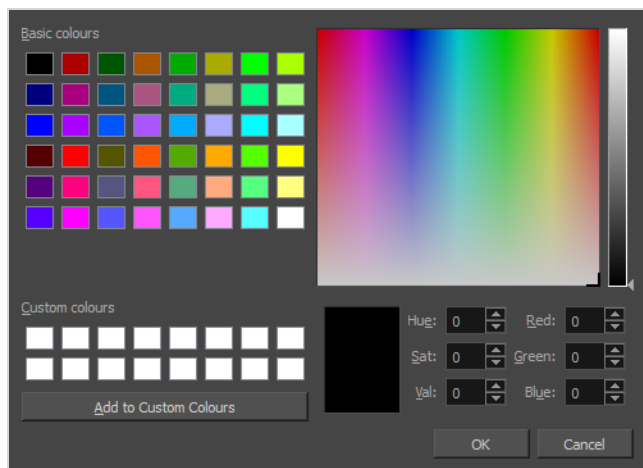

How to access the Select Colour dialog box in the Timeline view

1. In the Timeline view, click the Change Track Colour  button of the layer you want to modify.

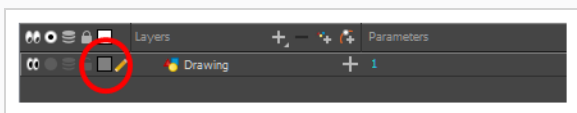

The Select Colour dialog box opens.

How to access the Select Colour dialog box in the Xsheet view

1. In the Xsheet view, select one or more columns to modify.
2. Right-click on the column's header and select **Colour > Change Columns Colour**.

The Select Colour dialog box opens.

Parameter	Description
-----------	-------------



Basic colours	A basic set of colours to choose from.
Custom colours	Displays the custom colours you previously stored using the Add to Custom Colours button.
Add to custom colours	Lets you add the selected colour to the Custom colours list above.
Colour wheel	Lets you select a colour by dragging the T-shaped pointer.
Value slider	Once you select a colour, you can drag the slider to change the intensity and see it previewed in the Colour Preview window below..
Colour Preview	Displays the colour you are currently selecting. To apply the colour, click OK.
Hue, Saturation, Value	Lets you set the hue (colour), saturation (amount of colour) and brightness (value) of the colour.
Red, Green, Blue	Lets you set the red, green and blue values.

Selection Presets Dialog Box

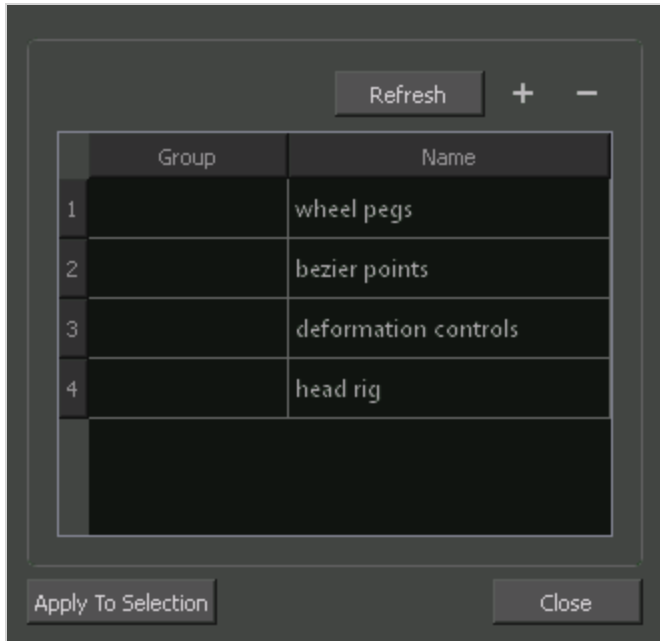

As you're animating, you might find that you are constantly selecting the same pegs, drawing layers, bezier points on a deformation envelope, part of a character rig, etc. You can create a preset that automatically selects any defined element or group of elements.



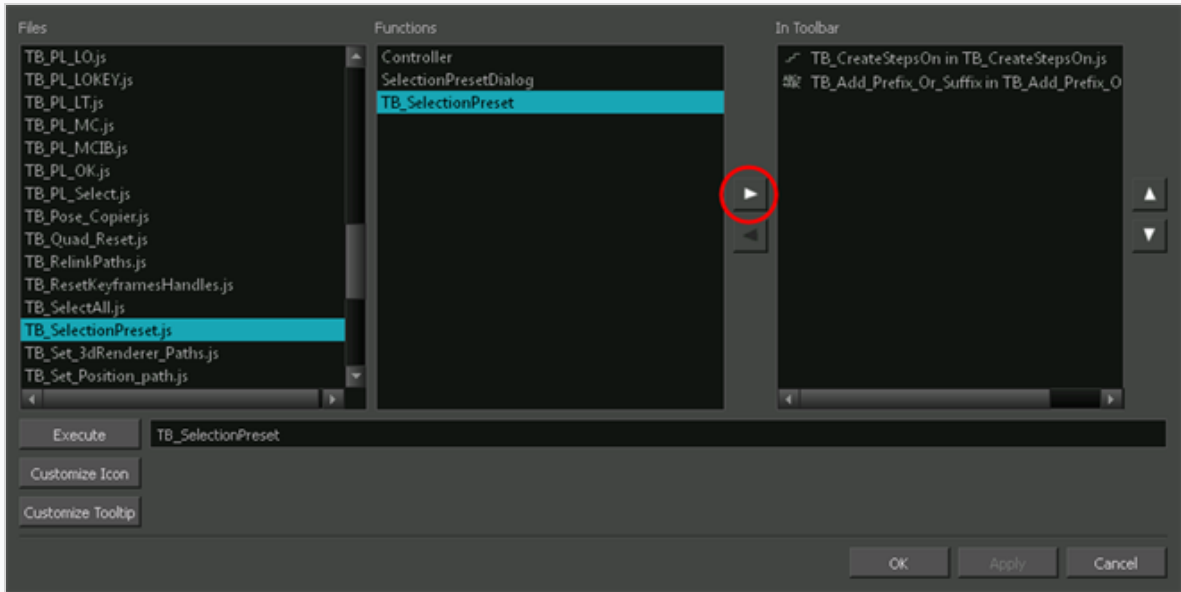

How to access the Selection Presets dialog box

1. Add the Scripting toolbar to your interface:
 - Go to the top menu and select **Windows > Toolbars > Scripting**.
 - right-click on the empty space near the top of the interface and from the quick-access menu selecting **Scripting**.
 - right-click on the empty space near the top of a view and from the quick-access menu selecting **Scripting**.
2. In the Scripting toolbar, click on the Manage Scripts  button to open the Scripts Manager window.
3. In the Scripts Manager, in the Files section, select the file **TB_SelectionPreset.js**.
The functions associated with that file appear in the Functions section.
4. In the Functions section, select **TB_SelectionPreset**.
The Add script to toolbar  button becomes active.



5. Click on the Add script to toolbar  button.
The TB_SelectionPreset script  button is added to the Scripting toolbar.
6. Click **Apply**.
7. Click **OK**.
8. In the Scripting toolbar, click on the TB_SelectionPreset  button.
The Selection Presets window opens.

Parameter	Description
Refresh	Removes any highlighted zones from the Group column.
 Add Selection Preset	Opens the Save Selection As Preset dialog box. After entering a name for the new preset and clicking OK, a new Selection Preset is added to the Selection Presets list. Note: before clicking on the Add button, make a selection in your scene of the elements for which you wish to create a Selection Preset.
 Delete Selection Preset	Deletes the selected Selection Preset from the list.
Group	Double-click in this area, next to the Selection Preset you wish to use, to select the elements defined by the preset.
Name	Displays the name of the preset.

Apply to Selection	Selects the elements defined by the selected preset from the Name list.
Close	Closes the Selection Presets window.

Sequence Fill Dialog Box

The Sequence Fill dialog box lets you create a numbered sequence over a selection. The sequence can be forward, backward, single, double or higher increment, as a cycle, and so on. The selection can be over one cell or a cell range in one column or more or an entire column or many entire columns.

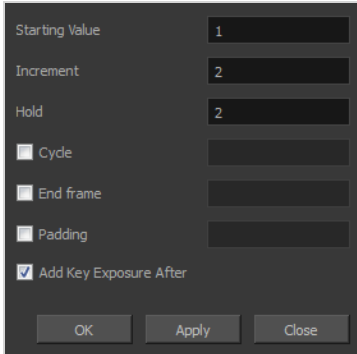

How to access the Sequence Fill dialog box

1. In the Timeline or Xsheet view, select a cell range.

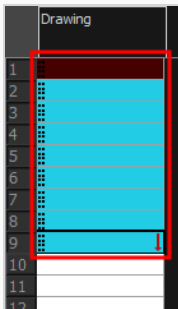

2. Do one of the following:
 - From the top menu, select **Animation > Cell > Sequence Fill**.
 - In the Timeline view, right-click and select **Exposure > Sequence Fill**.
 - In the Xsheet toolbar, click the Sequence Fill  button (you may have to customize the toolbar to display it).
 - Press Ctrl + M (Windows/Linux) or ⌘ + M (macOS).

The Sequence Fill dialog box opens.

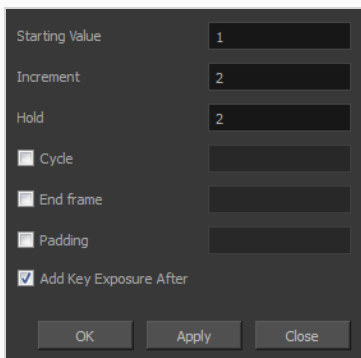

Parameter	Description
Starting Value	The first number in the sequence.
Increment	Lets you type the number by which the drawing number will increase from frame to frame. For example, an increment of 1 gives you: 1-2-3-4 ; an increment of 2 gives you: 1-3-5-7 ; and -2 gives you this: 8-6-4-2 .
Hold	The exposure holding value.
Cycle	Enable this option to cycle the values and enter the number of cycles in the Cycle field.
End Frame	Enable this option to stop the fill at a specific frame within the selection. Indicate the frame number in the End Frame field.
Padding	Enable this option to add a 0 padding before the drawing name. In the Padding field, enter as many hash symbols (#) as digit you want in your drawing name, including the value itself.
Add Key Exposure After	Inserts a key exposure on the frame following the last cell of the new fill selection.

Set Ease for Multiple Parameters Dialog Box

The Edit Set Ease for Multiple Parameters dialog box lets you apply ease to multiple functions and keyframes. You can display the function curve and modify the Bezier or Ease curve.

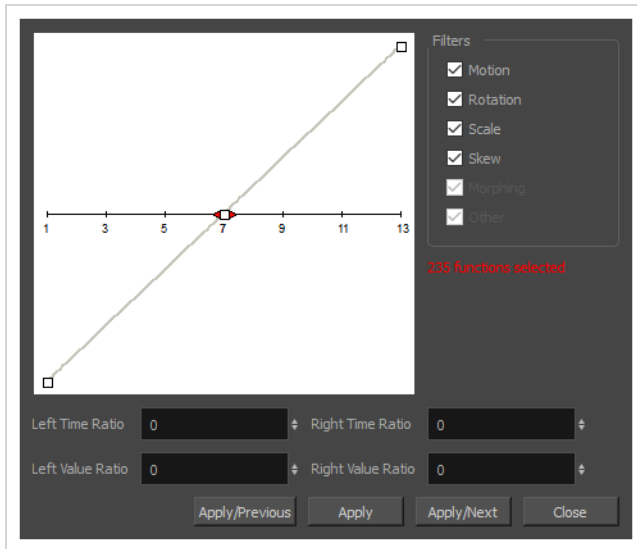

How to access the Set Ease for Multiple Parameters dialog box

1. In the Timeline view, select a keyframe on one or more layers.

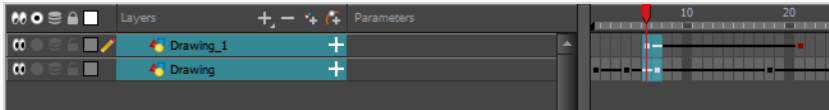

2. Do one of the following:
 - In the Timeline view, right-click and select **Set Ease For Multiple Parameters**.
 - In the Timeline toolbar, click the Set Ease For Multiple Parameters  button.

The Set Ease For Multiple Parameters dialog box opens.

Parameter	Description
Filters	
Motion	Motion: Applies the easing parameters to the selected Position X, Position Y, Position Z and 3D Path functions.
	Rotation: Applies the easing parameters to the selected Angle functions.

Parameter	Description
	Scale: Applies the easing parameters to the selected Scale functions.
	Skew: Applies the easing parameters to the selected Skew functions.
	Morphing: Applies the easing parameters to the selected Morphing Velocity functions. Note that it applies to the Morphing velocity function found in the Layer Properties window, not the basic morphing ease in the Tool Properties view.
	Other: Applies the easing parameters to all the other the selected functions, such as all functions created to animate effect parameters.
Left and Right Time Ratio	Lets you type the percentage value corresponding to the length of time you want the easing to last. Stay between 0% and 100%. If you go beyond 100%, your motion will overshoot.
Left and Right Value Ratio	Lets you type the percentage value of how strong you want the easing out to be. Stay between 0% and 100%. If you go beyond 100%, your motion will overshoot.
Apply/Previous	Applies the easing parameters to the selected keyframes and then selects the previous keyframe in the timeline.
Apply	Applies the easing parameters to the selected keyframes.
Apply/Next	Applies the easing parameters to the selected keyframes and then selects the next keyframe in the timeline.
Close	Close the dialog box. If you did not apply the modifications, they will be cancelled.

Set Ease on Keyframes Dialog Box

The Set Ease on Keyframes dialog box allows you to quickly change the percentage of ease before and after a selection of keyframes.

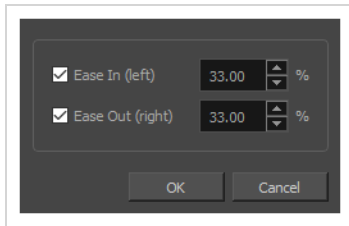

This dialog box is designed to quickly adjust the “time ratio” of the ease on your animations. To give you a better idea of its effect, select a keyframe and open the Set Ease for Multiple Parameters dialog box. This dialog box allows you to adjust the ease of your animations using Bezier handles. Moving the Bezier handle laterally changes the time ratio of the ease, and moving it vertically changes its value ratio—see [Set Ease for Multiple Parameters Dialog Box on page 221](#).

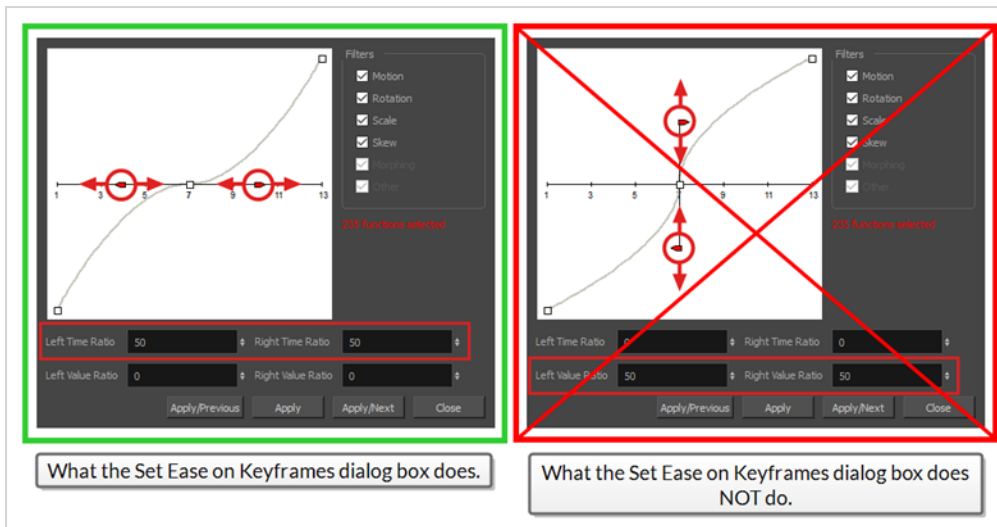

How to access the Set Ease on Keyframes dialog box

1. In the Timeline view, select one or several animation keyframes.
2. In the Timeline toolbar, click on the Set Ease on Selected Keyframes button.

The Set Ease on Keyframes dialog box appears.

Parameter	Description
Ease In (left)	Allows you to adjust the ease left of the selected keyframes. <ul style="list-style-type: none"> • If the checkbox is unchecked, the ease left of the selected keyframes will be unchanged.

Parameter	Description
	<ul style="list-style-type: none">• If the checkbox is checked, the ease left of the selected keyframes will be set to the percentage in the input-field right of the checkbox.
Ease Out (right)	<p>Allows you to adjust the ease right of the selected keyframes.</p> <ul style="list-style-type: none">• If the checkbox is unchecked, the ease right of the selected keyframes will be unchanged.• If the checkbox is checked, the ease right of the selected keyframes will be set to the percentage in the input-field right of the checkbox.
OK	Applies the selected changes and closes the dialog box.
Cancel	Closes the dialog box without making any changes.

Master Controller Slider Wizard Dialog Box

The Master Controller Slider Wizard dialog allows you to generate a slider-type Master Controller widget which can be used to position a character model based on a range of two or more key poses.

To use the Slider Wizard, all you need to do is to provide it with a selection of layers and/or groups (ie: a character rig, or part of a character rig) as well as a range of frames. The Slider Wizard dialog will store all the poses for the selected layers in the selected range of frames in a file, and generate a Slider widget which, when manipulated by the user, is scripted to apply one of these poses, or an intermediary between two of these poses, onto these layers.

A good example of how this dialog can be used is by creating poses of your characters in key angles (ie: front, 3/4 front, side, 3/4 back and back, as well as the flipped versions of these angles), and creating a slider made to interpolate between all these poses. If done properly, and provided that all the poses provided can be interpolated, the result will be a slider widget that can be used to pose the character in any angle.

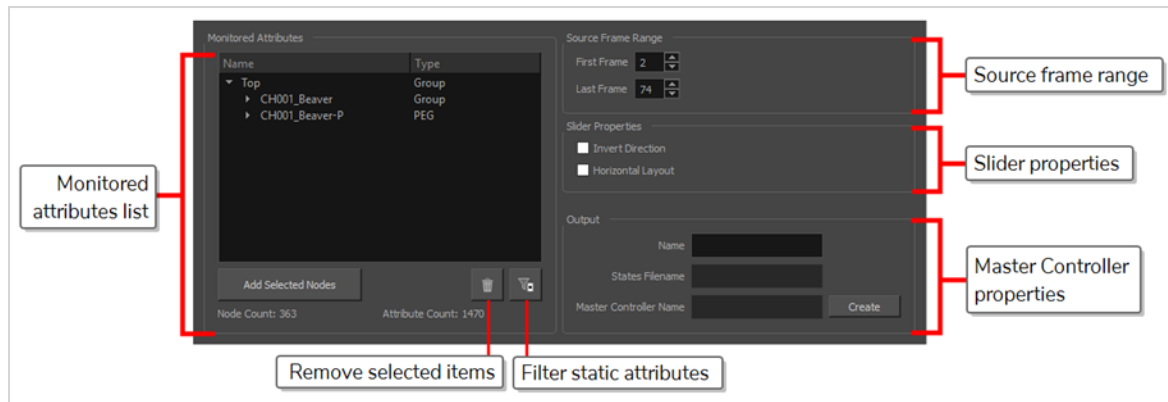

How to access the Slider Wizard

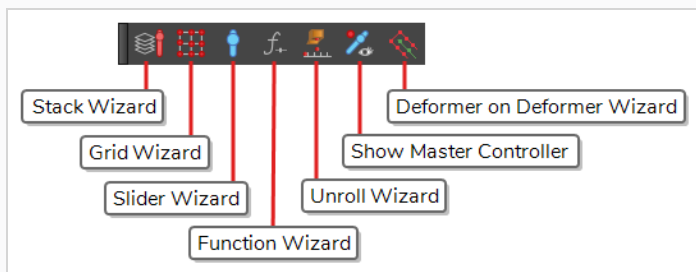

1. Do one of the following to add the Master Controller toolbar to your workspace:
 - Right-click on an existing toolbar and select **Master Controller**.
 - In the top menu, select **Windows > Toolbars > Master Controller**.

The Master Controller toolbar appears.



1. In the Timeline view, select a range of frames.
2. In the Master Controller toolbar, click on the  Slider Wizard button.

Icon	Parameter	Description
Source Frame Range		
	First Frame	The frame number of the first frame in the selection.
	Last Frame	The frame number of the last frame in the selection.
Slider Properties		
	Invert Direction	By default, the slider will interpolate from the first pose to the last pose by sliding the handle from bottom to top, or from left to right if the Horizontal Layout option is checked. If this option is checked, the slider will interpolate from the first pose to the last pose by sliding the handle from the top to the bottom, or from right to left.
	Horizontal Layout	By default, the slider will slide on a vertical axis. If this option is checked, it will slide on a horizontal axis.
Monitored Attributes		
	Attribute List	<p>The list of nodes (ie: layers, pegs, deformation points, etc.) that will be affected by the Master Controller. If you expand any of the listed nodes, you will find the list of attributes (ie: position, angle, scale, etc.)</p> <p>The list is structured in a group/node/attributes hierarchy, with Top representing the root of your scene. By expanding a group, you will find all of the nodes inside that group. By expanding a node, you will find all of its attributes.</p>
	Add Selected Nodes	<p>If you first select groups nodes in the Timeline or Node view, you can click on this button to add these nodes' attributes to the Monitored Attributes list. This allows you to add more nodes to the list of nodes that will be controlled by the Master Controller.</p> <p>If you select a group, this button will add the group as well as every node inside that group to the Monitored Attributes list.</p>

Icon	Parameter	Description
	Remove Selected Items	<p>Removes the groups, nodes or attributes that are currently selected in the Monitored Attributes list from the Monitored Attributes list. This allows you to remove nodes from the list of nodes that will be controlled by the Master Controller.</p> <p>If you select a group, this button will remove the group as well as every node inside that group from the Monitored Attributes list.</p> <p>If you select specific attributes in a node, this button will only remove these attributes from the Monitored Attributes list, and will leave the other attributes in the list. This allows you to make the Master Controller only control specific attributes for a node and ignore others.</p>
	Filter Static Attributes	Remove every attribute that does not change during the selected frame range. This will optimize the performance of the Master Controller as well as reduce the amount of storage space it uses without impacting its functionality.
	Node Count	The amount of nodes (layers, pegs, deformation points, etc.) that will be controlled by the Master Controller.
	Attribute Count	The amount of attributes (position, angle, scale, etc.) that will be controlled by the Master Controller.
Output		
	Name	Allows you to type in a base name for your Master Controller.
	States Filename	Displays the path and name of the file where the poses database will for the Master Controller will be stored. This path is relative to the scene directory.
	Master Controller Name	Displays the name of the Master Controller node that will be added to your scene. This is the name of your Master Controller the prefix mc_ .
	Create	Generate the Master Controller and its database of poses.

Show Hidden Columns Dialog Box

The Show Hidden Columns dialog box lets you display all the columns contained in the exposure sheet. It can be used to hide individual columns.

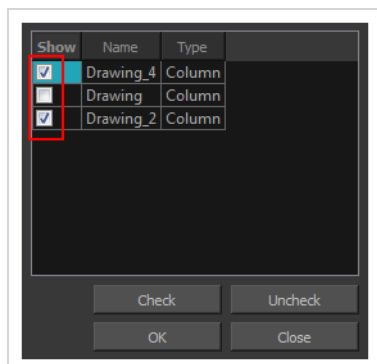

How to access the Show Hidden Columns dialog box

1. In the Xsheet view, do one of the following:

- Click the thick grey line that represents a hidden column.
- Right-click on the column header and select **Show Hidden Columns**.
- Press Alt + Shift + H.

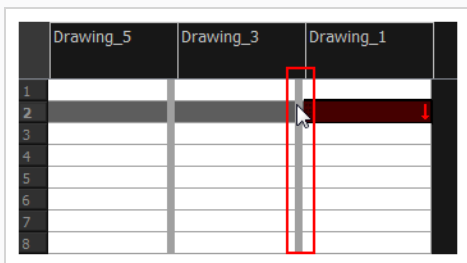

The Show Hidden Columns dialog box opens.

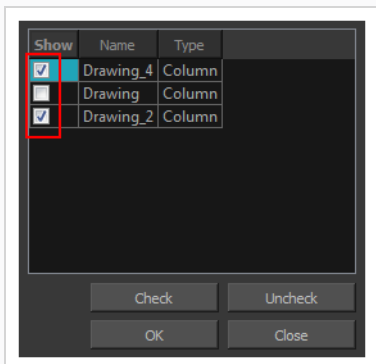

Parameter	Description
Show	Lets you select the hidden columns to display in the Xsheet view.
Name	Name of the drawing.
Type	Indicates the column type such as column, timing, and expression.
Check	Selects all columns.
Uncheck	Deselects all selected columns.

OpenQuickTime Sound Options Dialog Box (GNU/Linux)

The OpenQuickTime Sound Options dialog box (titled MediaSettings) allows you to configure the audio compression settings when exporting a QuickTime movie on Linux.

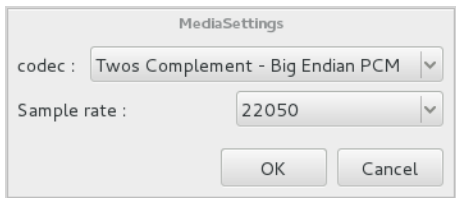

On GNU/Linux, Harmony uses the OpenQuickTime framework to export QuickTime movies. This framework uses its own user interfaces to allow you to configure the video and audio compression settings for a movie. Because OpenQuickTime only comes bundled with non-proprietary codecs, its compression options are limited.



NOTES

- For tasks related to this dialog box, refer to the User Guide.
- This dialog can only be accessed on GNU/Linux.

How to access the OpenQuickTime Sound Options dialog box from the Export Movie dialog

1. From the top menu, select **File > Export > Movie**.

The Export Movie dialog box appears.

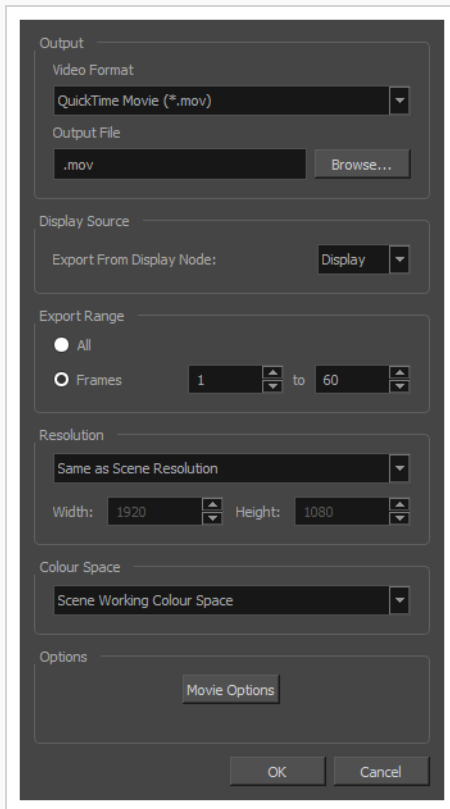

2. In the **Movie Format** drop-down, select **QuickTime Movie (*.mov)**.
3. Click on the **Sound Options** button.

How to access the OpenQuickTime Sound Options dialog box from the Export OpenGL Frames dialog

1. In the top menu, select **File > Export > OpenGL Frames**.

The Export OpenGL Frames dialog box appears.

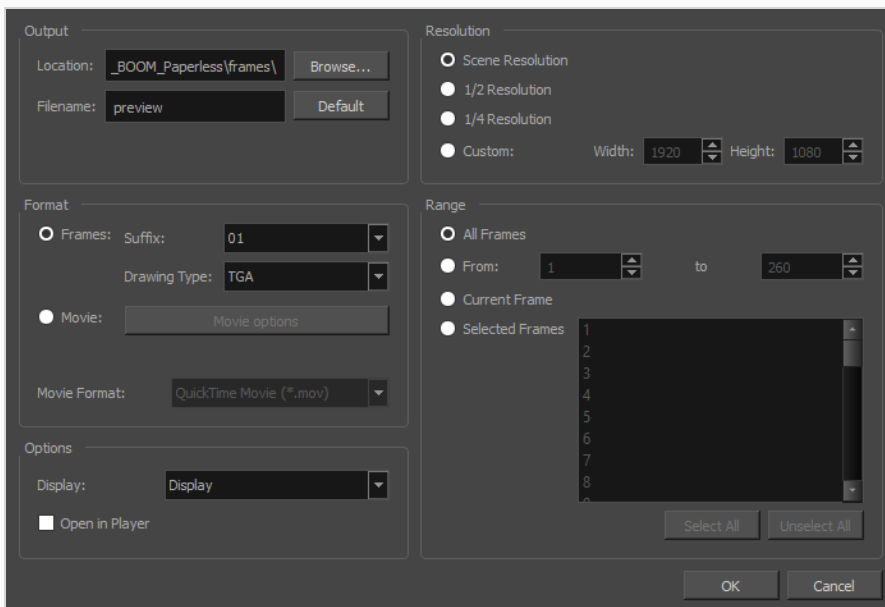

2. In the **Format** section, select **Movie**.
3. In the **Movie Format** drop-down, select **QuickTime Movie (*.mov)**.
4. Click on the **Sound Options** button.

How to access the OpenQuickTime Sound Options dialog box from the Write node Layer Properties

1. In the Node view, locate your scene's Write node.
2. Open the Write node's Layer Properties by doing one of the following:
 - Click on the yellow square  at the left end of the Write node.

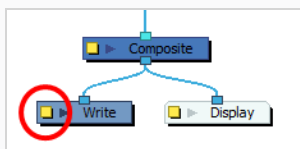

- Right-click on the Write node, then select **Layer Properties**.

The Write node's Layer Properties dialog appears.

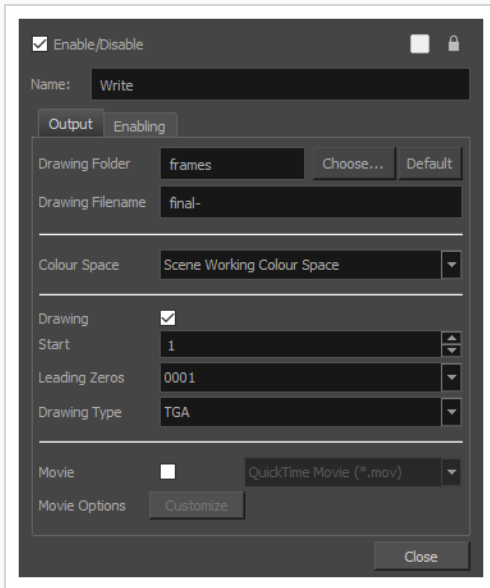

3. In the Write node's Layer Properties, enable the **Movie** option.
 1. To the right of the Movie check box, open the drop-down menu and select **QuickTime Movie (*.mov)**.
 2. To the right of **Sound Options**, click **Customize**.

Parameter	Description
codec	<p>Lets you select a codec. By default, the following codecs will be available:</p> <ul style="list-style-type: none"> • A-Law 2:1: This codec uses logarithms to compress audio data. The resulting audio stream requires half the disk space of uncompressed audio data, but is of noticeably lower quality. • IMA 4:1: This codec compresses audio data to require a quarter of the disk space required for uncompressed audio data. It is not supported by a lot of software. • Twos Complement - Little Endian PCM: A standard uncompressed audio codec. • Twos Complement - Big Endian PCM: A legacy standard uncompressed audio codec. This codec may be compatible with older editing interfaces. • (mu)-Law 2:1: Similarly to A-Law, this codec uses logarithms to compress audio data. The resulting audio stream requires half the disk space of uncompressed audio data, but is of noticeably lower quality.

	 NOTE It is recommended to leave this option to its default value, Twos Complement - Little Endian PCM , as it is commonly used for storing uncompressed audio. Other encoding formats are likely to sacrifice audio quality for negligible savings in disk space.
Sample rate	The sample rate at which to export your scene's audio. The only available option is 22050 Hz, as it is the sample rate used internally by Harmony.

QuickTime Sound Settings Dialog Box (Windows)

The Sound Settings dialog box allows you to set the audio compression settings when you want to export a QuickTime Movie (.mov) file.

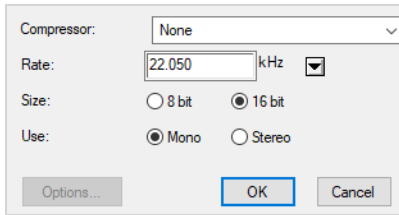

NOTES

- For tasks related to this dialog box, refer to the User Guide.
- This dialog can only be accessed on Windows and requires [Apple QuickTime](#) to be installed.

How to access the QuickTime Sound Settings dialog box from the Export Movie dialog

1. From the top menu, select **File > Export > Movie**.

The Export Movie dialog box appears.

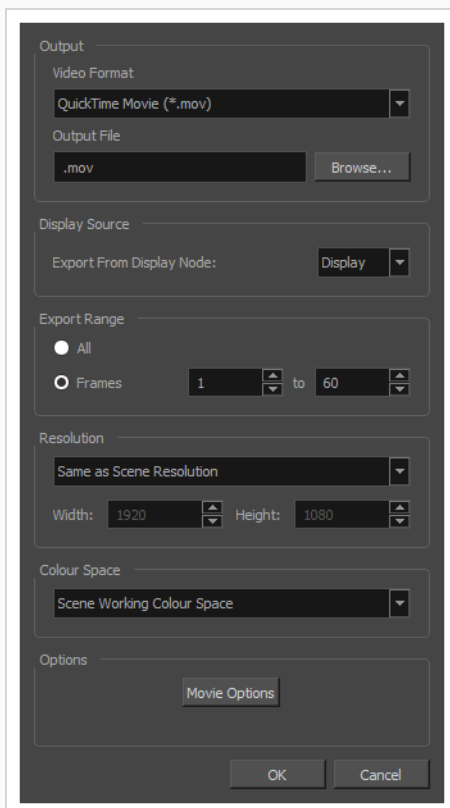

2. In the **Movie Format** drop-down, select **QuickTime Movie (*.mov)**.
3. Click on the **Movie Options** button.

The QuickTime Movie Settings dialog box appears.

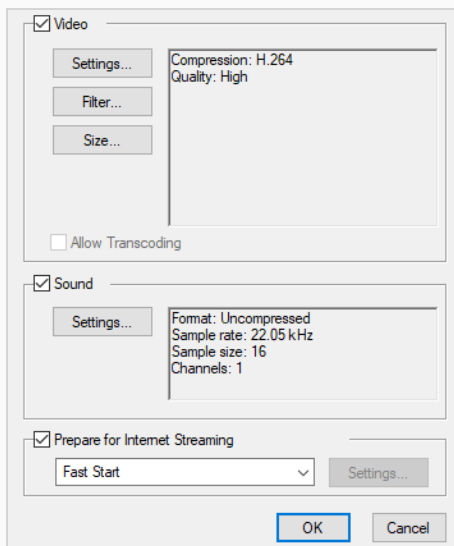

4. In the **Sound** section, click **Settings**.

How to access the QuickTime Sound Settings dialog box from the Export OpenGL Frames dialog

1. In the top menu, select **File > Export > OpenGL Frames**.

The Export OpenGL Frames dialog box appears.

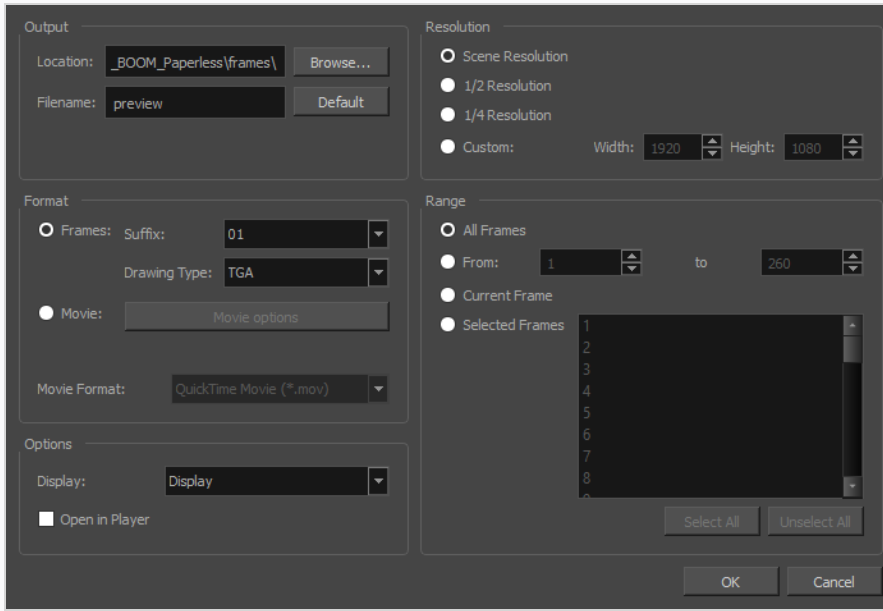

2. In the **Format** section, select **Movie**.
3. In the **Movie Format** drop-down, select **QuickTime Movie (*.mov)**.
4. Click on the **Movie Options** button.

The QuickTime Movie Settings dialog box appears.

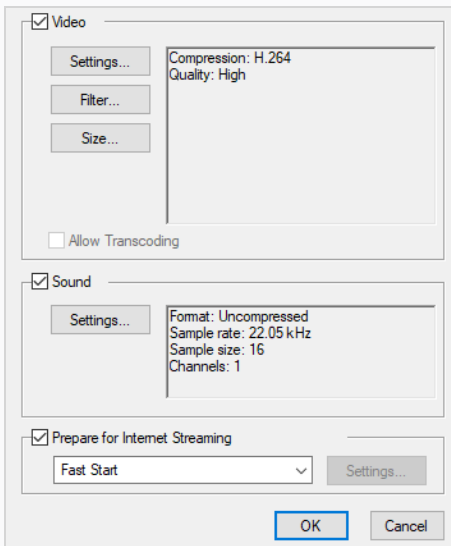

5. In the **Sound** section, click **Settings**.

How to access the QuickTime Sound Settings dialog box from the Write node Layer Properties

1. In the Node view, locate your scene's Write node.
2. Open the Write node's Layer Properties by doing one of the following:
 - Click on the yellow square  at the left end of the Write node.

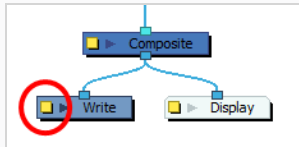

- Right-click on the Write node, then select **Layer Properties**.

The Write node's Layer Properties dialog appears.

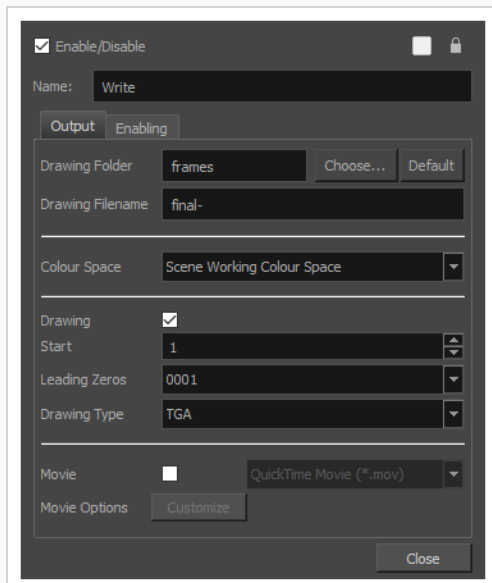



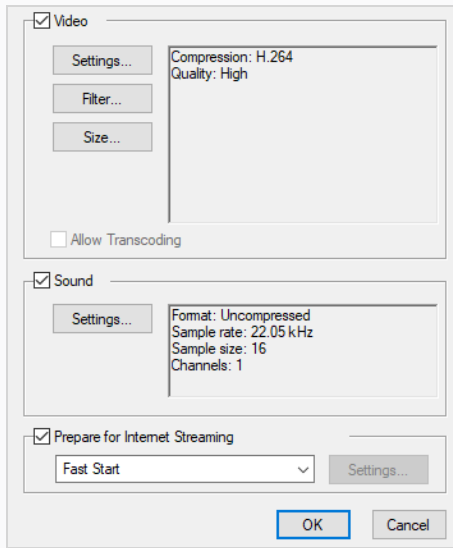

3. In the Write node's Layer Properties, enable the **Movie** option.
 1. To the right of the Movie check box, open the drop-down menu and select **QuickTime Movie (*.mov)**.
 2. To the right of **Movie Options**, click **Customize**.

The QuickTime Movie Settings dialog box appears.



3. In the **Sound** section, click **Settings**.

Parameter	Description
Compressor	<p>Allows you to select the compression algorithm to use to compress the movie's audio track.</p> <div data-bbox="565 1066 1430 1241" style="border: 1px solid green; padding: 5px;"> <p> NOTE It is recommended to leave this setting to None, as other formats are likely to sacrifice audio quality for negligible savings in disk space.</p> </div>
Rate	<p>Allows you to select the sample rate, or frequency, in which to export the audio track for the movie.</p> <div data-bbox="565 1392 1430 1591" style="border: 1px solid green; padding: 5px;"> <p> NOTE Harmony cannot export audio at a higher sample rate than 22.050 kHz. If you select a higher sample rate, your project's audio will be upsampled, which means it will take more disc space without increasing in quality.</p> </div>
Size	<p>Allows you to select the bit depth in which to encode the audio track. This determines the amount of precision to record each wavelength in the audio track.</p>

Parameter	Description
	<div data-bbox="565 285 1429 487" style="border: 1px solid #c8e6c9; padding: 10px;"> NOTE The standard bit depth is 16-bit. If you choose 8-bit, the amount of disk space the audio track of your movie file requires will be halved, but the audio quality will be significantly lower.</div>
Use	<p data-bbox="565 550 1429 613">Allows you to select whether to export the movie's audio track using the Mono or Stereo channel mode.</p> <div data-bbox="565 646 1429 814" style="border: 1px solid #c8e6c9; padding: 10px;"> NOTE Stereo sound has a separate track for the left and right speakers, whereas mono sound only has a single audio track for all speakers.</div>

QuickTime Standard Video Compression Settings Dialog Box (Windows)

The Standard Video Compression Settings dialog box allows you to configure the video compression settings when exporting a QuickTime Movie (.mov) file.

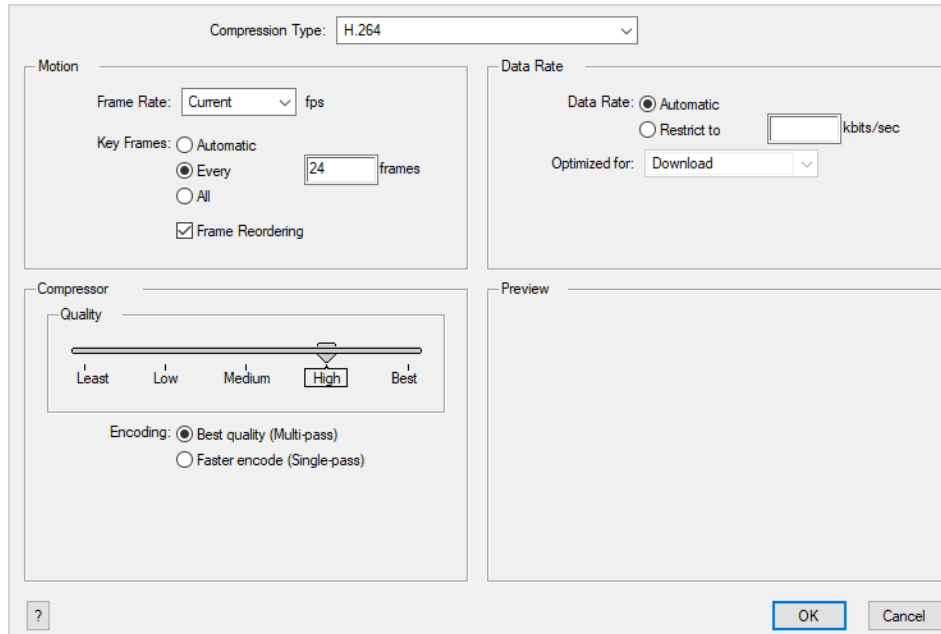

NOTES

- For tasks related to this dialog box, refer to the User Guide.
- This dialog can only be accessed on Windows and requires [Apple QuickTime](#) to be installed.

How to access the QuickTime Standard Video Compression Settings dialog box from the Export Movie dialog

1. From the top menu, select **File > Export > Movie**.

The Export Movie dialog box appears.

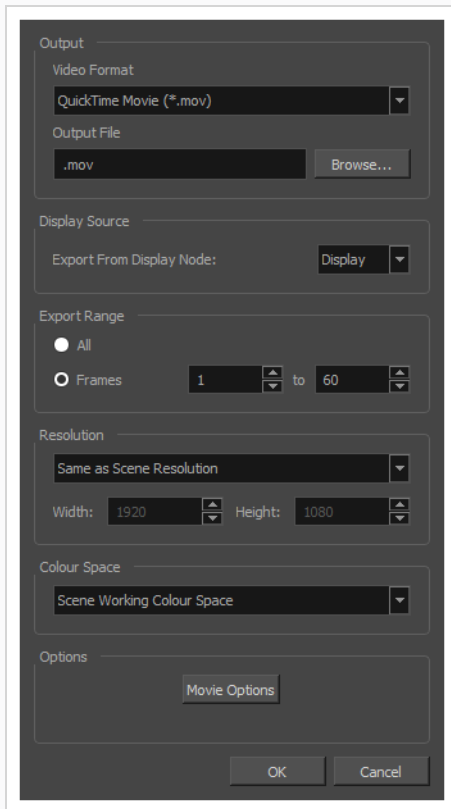

2. In the **Movie Format** drop-down, select **QuickTime Movie (*.mov)**.
3. Click on the **Movie Options** button.

The QuickTime Movie Settings dialog box appears.

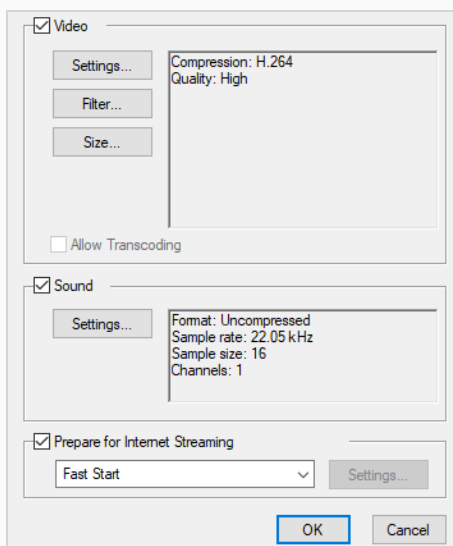

4. In the **Video** section, click **Settings**.

How to access the QuickTime Standard Video Compression Settings dialog box from the Export OpenGL Frames dialog

1. In the top menu, select **File > Export > OpenGL Frames**.

The Export OpenGL Frames dialog box appears.

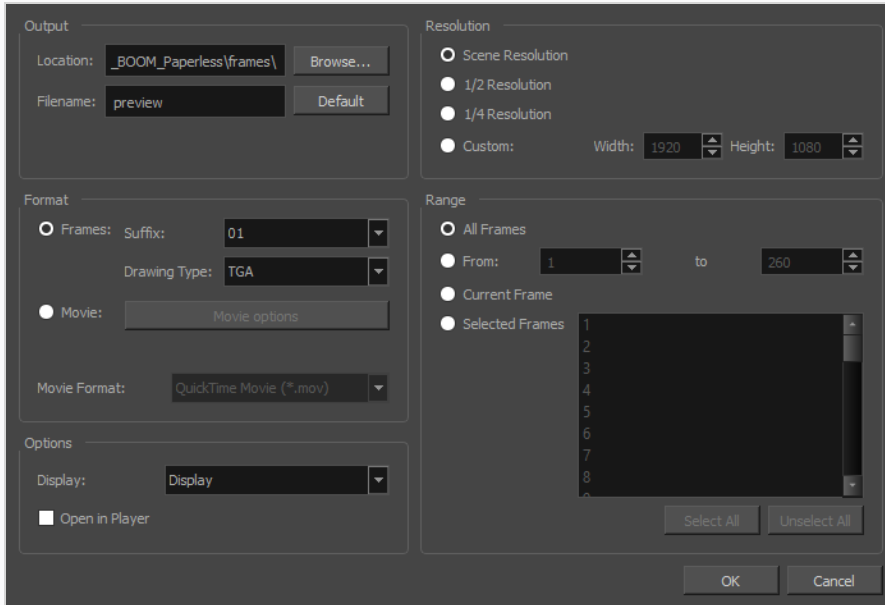

2. In the **Format** section, select **Movie**.
3. In the **Movie Format** drop-down, select **QuickTime Movie (*.mov)**.
4. Click on the **Movie Options** button.

The QuickTime Movie Settings dialog box appears.

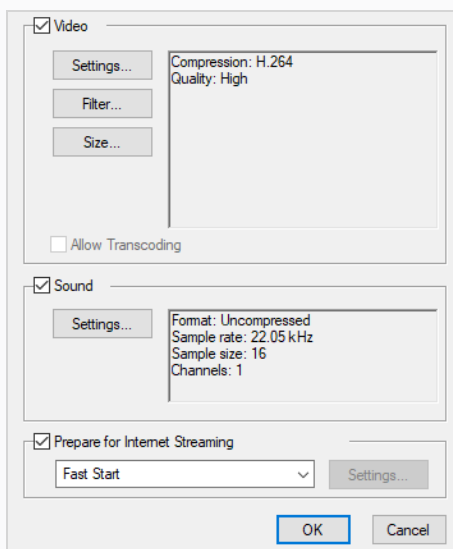

5. In the **Video** section, click **Settings**.

How to access the QuickTime Standard Video Compression Settings dialog box from the Write node Layer Properties

1. In the Node view, locate your scene's Write node.
2. Open the Write node's Layer Properties by doing one of the following:
 - Click on the yellow square  at the left end of the Write node.

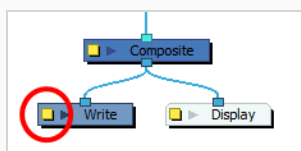

- Right-click on the Write node, then select **Layer Properties**.

The Write node's Layer Properties dialog appears.

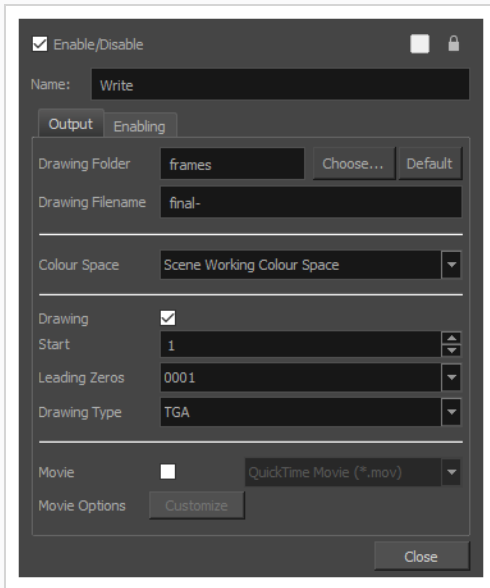



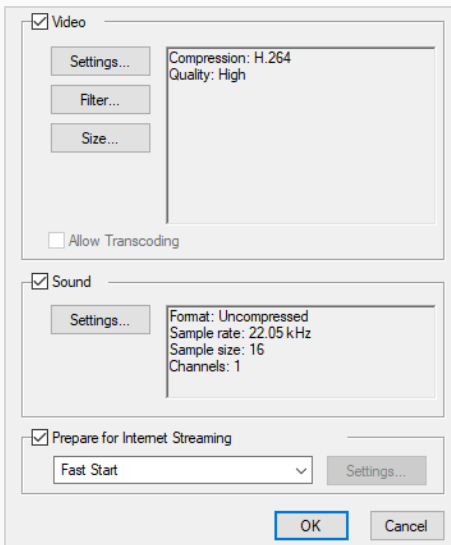

3. In the Write node's Layer Properties, enable the **Movie** option.
 1. To the right of the Movie check box, open the drop-down menu and select **QuickTime Movie (*.mov)**.
 2. To the right of **Movie Options**, click **Customize**.

The QuickTime Movie Settings dialog box appears.



3. In the **Video** section, click **Settings**.

Parameter	Description
Compression Type	<p>Allows you to select the codec to use to compress the video stream of your movie. It is recommended to use one of the following codecs, depending on your usage scenario:</p> <ul style="list-style-type: none"> • H.264: A very effective lossy compression algorithm that is commonly supported by web browsers and most media players. • MPEG-4 Video: A very effective lossy compression algorithm that is commonly supported by media players, but less so by web browsers. • Animation: A high quality compression algorithm that is commonly used for media interchange and video editing. <div data-bbox="565 682 1429 1012" style="border: 1px solid #add8e6; padding: 10px;">  <p>TIPS</p> <ul style="list-style-type: none"> • You can export a video with transparency by selecting the Animation codec and setting the Depth setting to Millions of Colors+. • You can export a video with virtually lossless compression by selecting the Animation codec and setting Quality setting to Best. </div>
Motion	
Frame Rate	The amount of frames per second for the video stream. Leave this setting to Current to use your project's frame rate.
Key Frames	<p>Some codecs compress the video by recording a limited amount of keyframes, which are frames in which the entire picture is encoded, pixel by pixel and, in-between, recording <i>deltas</i>, which are frames that are only defined by their difference with the previous frame. This significantly reduces the size of the movie file. However, the less keyframes a movie has, the more it is likely to encounter decoding errors, and the harder it is for players to scrub or jump to a specific time in the video. This option allows you to decide when keyframes are inserted in the video stream.</p> <p>Automatic: Lets the encoder decide when keyframes should be inserted.</p> <p>Every ... frames: Allows you to set the exact interval, in frames, at which keyframes should be inserted.</p> <p>All: Encodes every frame as a keyframe. This option will significantly impact file size, but will make it easier to scrub through the video without causing any rendering error.</p>

Parameter	Description
	<div data-bbox="565 285 1429 487" style="border: 1px solid #c8e6c9; padding: 10px;">  NOTE If you are using the H.264 codec, you must set the Key Frames option to All, or you will get an error message when you confirm the compression settings. </div>
Frame Reordering	Encodes frames in a different order than the one at which they are meant to be displayed. This allows for more efficient compression, but may not be compatible with some players.
Compressor	
Depth	<p>Allows you to set the colour depth for your video. A lower colour depth will reduce the size of the video stream but will have significant impacts on picture quality.</p> <div data-bbox="565 932 1429 1104" style="border: 1px solid #bbdefb; padding: 10px;">  TIP Set this to Millions of Colors+ if you want to export a video with transparency. </div>
Quality	Lets you choose a quality setting for the video compression. A higher quality setting will increase the size of the movie file, but will look better. A lower quality setting will reduce the size of the movie file, but will cause blurriness and compression artifacts to appear in the picture.
Scan Mode / Interlaced	<p>Allows you to choose between the following scan modes:</p> <ul style="list-style-type: none"> • Interlaced: Frames are encoded starting with their odd-numbered scanlines, then their even-numbered scanlines. • Progressive: Frames are encoded whole, from the highest scanline to the lowest scanline. <div data-bbox="565 1604 1429 1772" style="border: 1px solid #c8e6c9; padding: 10px;">  NOTE Some codecs will display a drop-down allowing you to select Interlaced or Progressive, while others will simply have an Interlaced checkbox. </div>
Aspect Ratio	<p>Allows you to select one of the following aspect ratios:</p> <ul style="list-style-type: none"> • 4:3: For output on standard definition displays.

Parameter	Description
	<ul style="list-style-type: none"> • 16:9: For output to widescreen displays.
Filter	<p>When exporting with the PNG compression type, this determines the algorithm with which each pixel is encoded relative to other pixels. Leaving this option to Best will export in the most space-efficient filter, without compromising picture quality. Picking a filter may increase rendering speed a bit, at the expense of some disk space.</p>
Data Rate	
Automatic	Lets the encoder use the optimal bit rate for your compression settings.
Restrict To	<p>Allows you to specify the encoding bit rate.</p> <div data-bbox="565 852 1430 1020" style="border: 1px solid #c8e6c9; padding: 10px;"> <p> NOTE This setting will override other compression settings, so that the specified bit rate is respected.</p> </div>
Optimized For	<p>Optimize the encoding to be responsive depending on the intended viewing method:</p> <ul style="list-style-type: none"> • CD/DVD-ROM: Optimizes the bit rate for a video that will be played using an optical disc player. • Download: Optimizes the bit rate for a file that is going to be downloaded, then viewed from the user's hard drive. • Streaming: Optimized the bit rate for a video that will be streamed from the web and played as the video is being downloaded.

Tint Offset/Blend Dialog Box

You can offset, blend, or mix the colours in a colour palette using the sliders and increasing the Amount value.

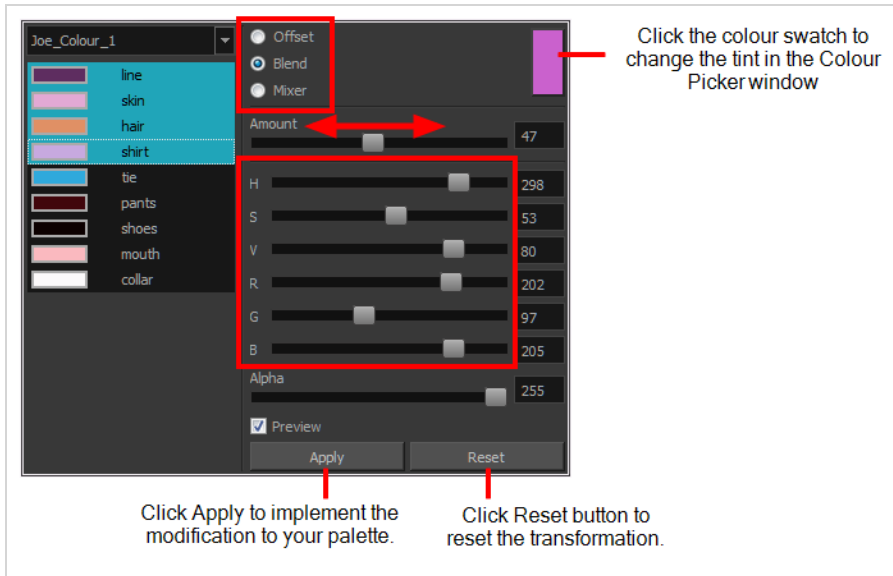

How to access the Tint Offset/Blend dialog box

1. From the Colour View menu, select **Palettes > Tint Panel** or right-click and select **Tint Panel**.

The Blend/Offset Tint panel opens.

Parameter	Description
Offset	Offsets the selected colours by the adjustments made using the HSB and RGB sliders. Use the Amount slider to adjust the degree of offset. Use the Alpha slider to adjust the opacity of the selected colour.
Blend	Blends the selected colours with the colour swatch in the top-right corner. Use the Amount slider to adjust the degree of blend. A blend of 100% turns the selected colours into the same colour as the swatch. Adjusting the HSB and RGB sliders affect the swatch colour, which in turn affects the selected colours on the left. Use the Alpha slider to adjust the opacity of the swatch.
Mixer	Select a Base and Tint colour to form a third colour swatch. Use the slider just beneath to mix the Base and Tint colours by different amounts. This will affect the mixed swatch whether it is selected or not. Select either the Tint or Base swatch and use the HSB and RGB sliders to adjust its colour. This will affect the mixed swatch colour, which in turn affects the selected colours on the left.

Toolbar Manager Dialog Box

The Toolbar Manager dialog box lets you customize the toolbar in any of the views. You can add your favourite tools to a toolbar for an efficient workflow.

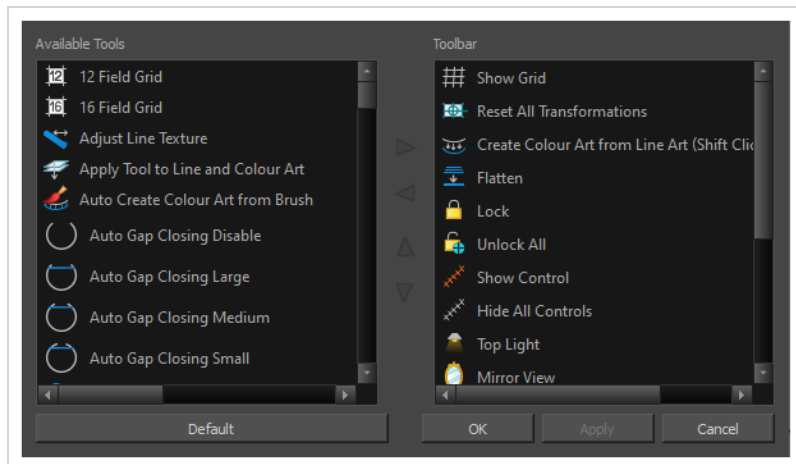

How to access the Toolbar Manager dialog box

1. Right-click on a toolbar in any view and select **Customize**. Note that the menu will not appear if you right-click on a disabled icon.

Parameter	Description
Available Tools	Displays the complete list of tools available for customizing a toolbar.
Toolbar	Displays a list of the tools currently available on the toolbar.
Default	Restores the toolbar with its default items.

Vectorization Parameters Dialog Box

The Vectorization Parameters dialog box lets you vectorize pencil drawings, along with any red, blue or green pencil marks you may have used to indicate highlights and shadows. The drawing will be vectorized into pure red, blue, green and black (RGB values), while creating colour art zones wherever lines connect. After painting in your tones and highlights, change your pure RGB colours to transparent (0 Alpha) in the Colour Picker window and watch the indicator colour zone lines disappear.

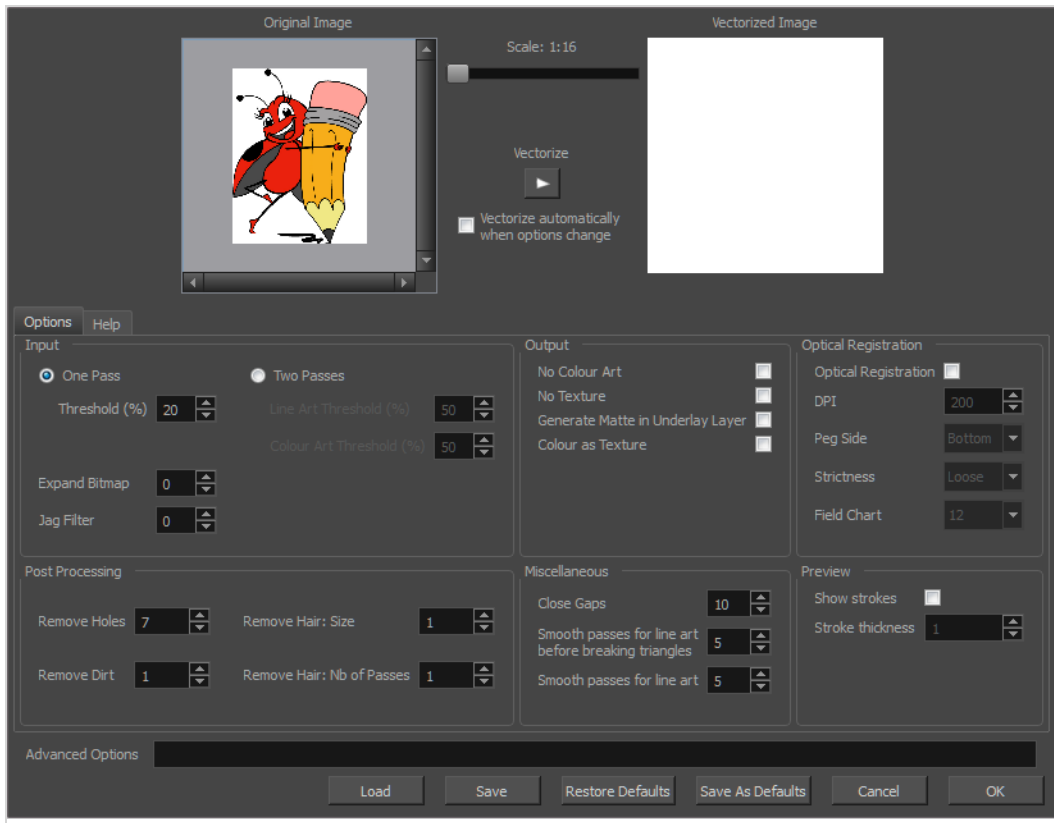

How to open the Vectorization Parameters dialog box

1. From the top menu, select **File > Import > From Scanner**.
You can also open it from any other import option that allows you to customize the vectorization parameters (i.e. from the scanner).
2. In the Scan Drawings window, do the following:
 - In the Layer section, decide on the layer options.
 - In the Import Options section, select the **Convert to Toon Boom Vector Drawing** option
 - Click **Preview**.
3. In the Vectorization section, click the Vectorization Parameters  button.

Options Tab

The Options tab contains the main vectorization settings. More settings are available in the Help tab.



Parameter	Description
Input	The input filters are applied to the bitmap image before it is vectorized.
One Pass	One threshold value is applied to both the Line and Colour Art. For drawings with distinct vector-style lines of mattes, you only need one pass.
Two Passes	Applies a different threshold value to each layer. For greyscale drawings, you may want to perform the vectorization process twice to apply different threshold values to the Line and Colour Art layers.
Threshold	Determines which values in the scanned image are considered part of the Line and Colour Art layer and what will be eliminated from the vectorized drawing; 0% is white and 100% is black. The threshold is between these two values.
Expand Bitmap	Lets you enter a value to scale the bitmap to detect small variations in the line. Use this option if you scanned a greyscale image and want to preserve small variations in the texture to apply to the line art.
Jag Filter	Lets you enter a value to scale back the bitmap to remove some of the line's roughness. This is useless when you have a drawing that appears quite rough; the Jag filter will eliminate excess strokes in the final drawing.
Line Art Threshold (%)	Determines which values in the scanned image are considered part of the Line Art layer and what will be eliminated from the vectorized drawing; 0% is white and 100% is black. The threshold is between these two values.

Colour Art Threshold (%)	Determines which values in the scanned image are considered part of the Colour Art layer and what will be eliminated from the vectorized drawing; 0% is white and 100% is black. The threshold is between these two values.
Output	The output filters are applied during the vectorization process.
No Colour Art	Does not generate filling zones in the Colour Art layer.
No Texture	Does not generate texture in the Line Art layer in the final images. Select this option to create solid lines in the final line art.
Generate Matte in Underlay Layer	Creates an opaque zone behind your drawing's lines to avoid seeing through the layers.
Colour as Texture	Converts colour values into a texture layer.
Optical Registration	The optical registration options are used to automatically align drawings based on the position of the peg holes on the animation paper. The peg holes must appear in the scanned drawings for the optical registration to work.
DPI	Lets you enter the dots-per-inch value of your image. You must enter the same value as the DPI used to scan the image.
Peg Side	Lets you select the position of the peg holes on your drawings. Identify whether they are on the top, bottom, left or right.
Strictness	Determines how exact the location of the peg holes must be for the software to recognize them. There are two values to choose from: Strict: The peg holes must be in a tightly defined area to be recognized. Loose: The peg holes can be recognized somewhere in a larger area. This is the recommended setting.
Field Chart	Lets you indicate the size of the animation paper, 12 or 16.
Post Processing	The Post Processing filters are applied to the final vector images.
Remove Holes	Removes holes of a specified value that might make painting difficult.
Remove Dirt	Removes stray marks and dirt of a specified value. Try a value around 500.

Remove Hair Size	Removes small strokes that have no line art.
Remove Hair: Number of Passes	The number of times the drawing will be analyzed to identify hair marks.
Miscellaneous	
Close Gaps	Closes gaps in the Colour Art so you can paint it.
Smooth Passes for Line Art Before Breaking Triangles	The number of times the smoothing operation runs before creating the triangles that break lines in the drawing. If unnecessary triangles are appearing in the drawing, increase this value.
Smooth Passes for Line Art	The number of times the smoothing operation is performed after the triangles have been created. This further smooths the line art.
Preview	
Show Strokes	Shows the strokes in the Vectorized Image panel.
Stroke Thickness	Shows the size of the strokes.

Help Tab

The Help tab contains the most advanced vectorization settings which you type in the Advanced Option fields at the bottom of the Vectorization Parameters dialog box.

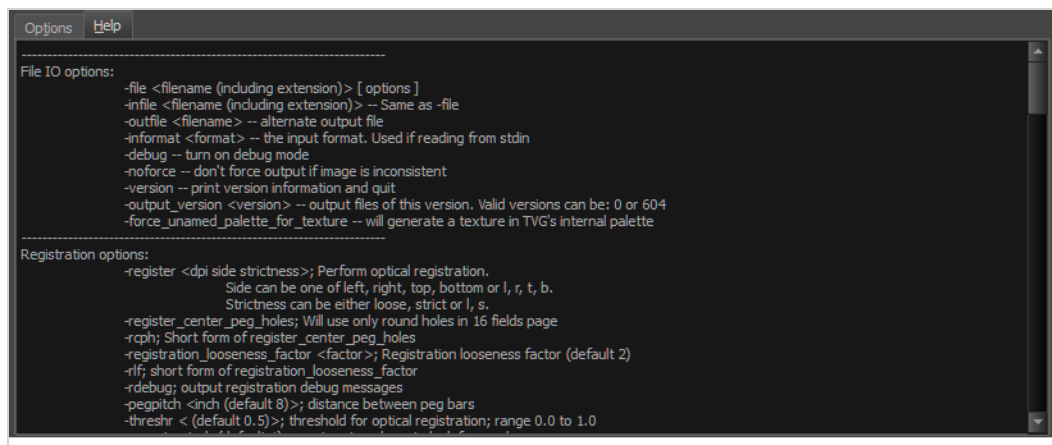

```

Options Help
-----
File IO options:
-file <filename (including extension)> [ options ]
-infile <filename (including extension)> -- Same as -file
-outfile <filename> -- alternate output file
-informat <format> -- the input format. Used if reading from stdin
-debug -- turn on debug mode
-noforce -- don't force output if image is inconsistent
-version -- print version information and quit
-output_version <version> -- output files of this version. Valid versions can be: 0 or 604
-force_unnamed_palette_for_texture -- will generate a texture in TVG's internal palette

Registration options:
-register <dpi side strictness>; Perform optical registration.
    Side can be one of left, right, top, bottom or l, r, t, b.
    Strictness can be either loose, strict or l, s.
-register_center_peg_holes; Will use only round holes in 16 fields page
-rcph; Short form of register_center_peg_holes
-registration_looseness_factor <factor>; Registration looseness factor (default 2)
-rlf; short form of registration_looseness_factor
-rdebug; output registration debug messages
-pegpitch <inch (default 8)>; distance between peg bars
-threshr <(default 0.5)>; threshold for optical registration; range 0.0 to 1.0

```

File IO Options

-file <filename (including extension)> [options]

- infile** <filename (including extension)>; same as -file
- outfile** <filename>; alternate output file
- informat** <format>; the input format. Used if reading from stdin
- debug**; turn on debug mode
- noforce**; don't force output if image is inconsistent
- version**; print version information and quit
- output_version** <version>; output files of this version. Valid versions can be: 0 or 604
- force_unnamed_palette_for_texture**; will generate a texture in TVG's internal palette

Registration Options

- register** <dpi side strictness>; perform optical registration.
 - Side can be one of left, right, top, bottom or l, r, t, b.
 - Strictness can be either loose, strict or l, s.
- register_center_peg_holes**; will use only round holes in 16 fields page
- rcph**; short form of register_center_peg_holes
- registration_looseness_factor** <factor>; registration looseness factor (default 2.000000)
- rff**; short form of registration_looseness_factor
- rdebug**; output registration debug messages
- pegpitch** <inch (default 8.000000)>; distance between peg bars
- threshr** <(default 0.500000)>; threshold for optical registration; range 0.0 to 1.0
- rmargin** <inch (default 1)>; region size where to look for peg bars
- peg_distance_from_center** <inch (default 5.25)>; peg distance from centre of the image
- pdfc**; short form of -peg_distance_from_center
- out_peg_position** <side (default same)>; wanted position of the peg on the drawing.
 - Can be one of right, left, top, bottom (or r, l, t, b) or same.
 - A rotation will be performed if it is different from the side passed to -register.
- output_peg_matrix**; output the peg transformation matrix on standard output.
- scanner_calibrate**; <(default 1.0000 1.0000) > x and y scale factors to be applied to scanner image.

Filtering Options

- pixel** <pixel_shape (default '4x3')>; Valid values: 4x3

-**gap** <worldUnits (default 10)>; close gaps up to this big

-**pencil**; generate line art only

-**keep_dirt**; don't filter out dirt

-**thresh** <threshold (default 0.2)>; range 0.0 to 1.0

-**rmv_hairs** <worldUnits (default 1)> <passes (default 1)>

- remove hairs of size smaller than "size" in "passes" passes

-**rmv_holes** <area (default 7)>; remove holes smaller than "area"

-**rmv_dirt** <area (default 1)>; remove dirt smaller than "area"

- try values between 100 and 500 for rmv_holes and rmv_dirt. The area is in world units squared

-**rmv_triangles** <worldUnits (default 30.000000)>; remove triangles at "pixels"

- distance from each other. Use -no_break to remove all triangles

-**no_texture**; don't generate textured strokes

-**color_as_texture**; will vectorize the alpha channel and put the RGB colour in a textured colour

-**noclosegap**; disable all gap closing algorithms

-**no_break**; disable the breaking of line art

-**jag_filter** <pixels (default 0)>; expand the pixels in the vectorization bitmap

-**expand_bitmap** <pixels (default 0)>; expand the pixels in the vectorization bitmap

-**fit_errorc** <error (default 1.000000)>; fitting error for the colour art

-**fit_errorl** <error (default 1.000000)>; fitting error for the line art

-**smoothl** <passes (default 1)>; number of smooth passes for line art

-**smoothc** <passes (default 1)>; number of smooth passes for colour art

-**first_smooth** <passes (default 0)>; number of smooth passes for line art before breaking triangles

-**first_smoothl** <passes (default 0)>; number of smooth passes for line art before breaking triangles

-**first_smoothc** <passes (default 0)>; number of smooth passes for line art in colour art pass (needs -2pass)

-**2pass**; specify two sets of parameters; one for line art "l", one for colour art "c"

- (-thresh, -rmv_holes and -rmv_dirt will be overridden by -threshl, threshc, -rmv_holesl, -rmv_holesc, -rmv_dirtl and -rmv_dirtc)

-**threshl** <threshold for line art (default 0.5)>; range 0.0 to 1.0

-**threshc** <threshold for color art (default 0.5)>; range 0.0 to 1.0

-**jag_filterl** <pixels (default 0)>; expand the pixels in the vectorization bitmap for line art

- jag_filterc** <pixels (default 0)>; expand the pixels in the vectorization bitmap for colour art
- expand_bitmapl** <pixels (default 0)>; expand the pixels in the vectorization bitmap for line art
- expand_bitmapc** <pixels (default 0)>; expand the pixels in the vectorization bitmap for colour art
- rmv_holesl** <area (default 7)>; remove line art holes smaller than "area"
- rmv_holesc** <area (default 7)>; remove colour art holes smaller than "area"
- rmv_dirtl** <area (default 1)>; remove line art dirt smaller than "area"
- rmv_dirtc** <area (default 1)>; remove colour art dirt smaller than "area"
- try values between 100 and 500 for `rmv_holesl`, `rmv_holesc`, `rmv_dirtl` and `rmv_dirtc`. The values are in world units squared
- margins** <inch (default 0.25)>; remove margin around bitmap
- top_margin** <inch (default 0.25)>; remove margin at top of bitmap
- bottom_margin** <inch (default 0.25)>; remove margin at bottom of bitmap
- left_margin** <inch (default 0.25)>; remove margin at left of bitmap
- right_margin** <inch (default 0.25)>; remove margin at right of bitmap
- remove_peg_bars**; remove the peg bar holes
- field_size** <fields (default 12 or use value in scan file)>; set the drawing to this field size
- fs**; short hand for `-field_size`
- peg_bar_size** <inch (default 1)>; the size of the peg bar region
- noframe**; do not put a frame around the colour art
- frame_fields** <default -1.000000>; put a frame of the specified dimension around the colour art
- downscale_input** <default 1>; downscale the raw input by this integer factor
- downscale_texture** <default 1>; downscale the output texture by this integer factor
- buildmatte**; generate a matte on underlay for line test
- buildmatte_colourart**; generate a matte on colour art for line test

**NOTE**

-`buildmatte` and `-buildmatte_colourart` are mutually exclusive

-**copystrokes**; copy original strokes when building matte.

Options for bitmap that has no registration information

- pixel_margins** <inch (default 0)>; remove margin around bitmap

- top_pixel_margin** <inch (default 0)>; remove margin at top of bitmap
- bottom_pixel_margin** <inch (default 0)>; remove margin at bottom of bitmap
- left_pixel_margin** <inch (default 0)>; remove margin at left of bitmap
- right_pixel_margin** <inch (default 0)>; remove margin at right of bitmap
- dpi** <(default -1)>; dpi information of input bitmap

RGB Keying Options

- rgb**; generate separate zones for red, green and blue lines
- rgb_alpha** <value (default 255)>; generate red, green and blue colour with alpha of this value
- no_red**; ignore red colour in vectorization
- no_green**; ignore green colour in vectorization
- no_blue**; ignore blue colour in vectorization
- flatten**; flatten the drawing after generating colours
- rmv_rgb_dirt** <threshold area default 0.0>; remove red, green and blue regions smaller than area
- expand_bitmap_rgb** <pixels (default 0)>; expand the pixels in the vectorization bitmap for rgb
- threshrgb** <value> <threshold for rgb vectorization default 0.200000>;
- threshsv** <saturation threshold default 0.500000> <value threshold default 0.500000>; thresholds on saturation and value to consider a pixel to be grey

Colour Vectorization Options

- color_vectorize**; perform a colour vectorization
- file2** <colour art filename>; specify the colour art bitmap
- penstyle** <center alpha (0.0-20.0)> <edge alpha (0.0-20.0)> <gamma (0-10)><centre pressure effect (0.0-1.0)> <edge pressure effect (0.0-1.0)><texture bitmap downscaling (0.2-20)> <texture bitmap file (valid filename or "" if no file)>; generate brush texture for the line art
- pressure_variation** <strategy (0, 1 or 2)> <min pressure (0.0-1.0)> <max pressure (0.0-1.0)> <max variation (0.0-1.0)>; specify a pressure strategy for the centre line.
- blur_radius** <pixels (default 0)>; blur the penstyle texture generated
- color_contour_smooth_passes** <times (default 3)>; perform number of smooth passes on contour before computing texture
- ccsp** <times (default 3)>; short for -color_contour_smooth_passes
- color_rmv_holesl** <world units (default 0.000000)>; remove holes of this size when computing texture
- color_fill_holesl** <world units (default 0.000000)>; fill holes of this size for colour line art

Bubble Usage (implemented only for colour vectorization's line art)

-**create_bubbles**; add bubbles into the LineArt. Implemented for colour vectorization only

-**bubble_gap** <value (default 3)>; max number of colour art points between 2 bubbles

-**bubble_length** <value (default 10)>; max number of circles in a bubble

-**min_radius** <value (default 1.5000)>; min radius of a circle in a bubble relative to the line thickness (must be >= 1.0)

-**max_radius** <value (default 3.5000)>; max radius of a circle in a bubble relative to the line thickness (must be >= 1.0)

-**uniform_gap**; the space between bubbles is constant

4 Colour Vectorization

-**4colours** [key:value] ... [key:value] ; The key value list can be empty. The list of keys is:

rgbdiff:value ; between [0.0-1.0] or [0-255]

dark:value ; between [0.0-1.0] or [0-255]

grey:value ; between [0.0-1.0] or [0-255]

white:value ; between [0.0-1.0] or [0-255]

dirt:value ; dirt area. 200 is a good value

rt:value ; between [0.0-1.0] or [0-255]

gt:value ; between [0.0-1.0] or [0-255]

bt:value ; between [0.0-1.0] or [0-255]



NOTE

There must be no space between the colon and the key/value. For example: -4colours rgbdiff:20 dark:20 grey:120 white:250 dirt:200 rt:240 gt:240 bt:240

Versions Dialog Box

The Versions window lets you delete any unnecessary versions of scenes when working with Harmony Server. When working with multiple versions of a scene, you may want to clean up the database by deleting the ones you no longer need.

How to access the Versions window

1. Make sure you have the necessary rights. If you do not, select **File > Rights to Modify Scene**.
2. Select **File > Manage Versions**.

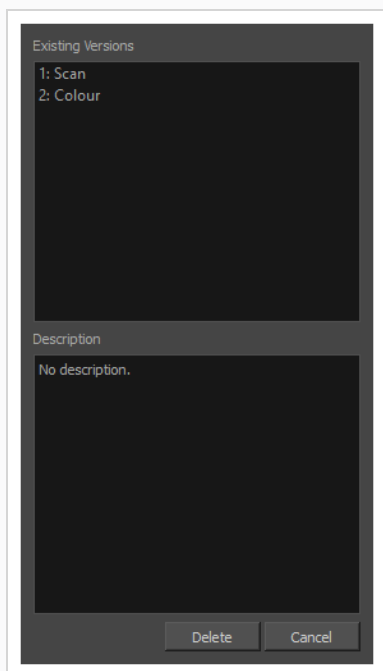

Parameter	Description
Existing Versions	Displays the different versions of a scene that you can delete.
Description	Displays information about the selected version.
Delete	Removes the selected version of a scene. <div style="border: 1px solid red; padding: 5px; margin-top: 10px;">  IMPORTANT This operation cannot be undone. </div>

OpenQuickTime Video Options Dialog Box (GNU/Linux)

The OpenQuickTime Video Options dialog box (titled MediaSettings) allows you to configure the video compression settings when exporting a QuickTime movie on Linux.

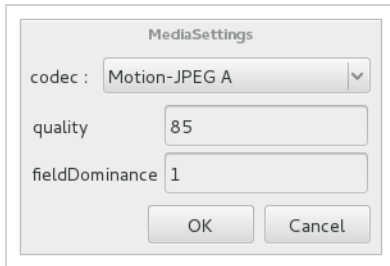

On GNU/Linux, Harmony uses the OpenQuickTime framework to export QuickTime movies. This framework uses its own user interfaces to allow you to configure the video and audio compression settings for a movie. Because OpenQuickTime only comes bundled with non-proprietary codecs, its compression options are limited.



NOTES

- For tasks related to this dialog box, refer to the User Guide.
- This dialog can only be accessed on macOS.

How to access the OpenQuickTime Video Options dialog box from the Export Movie dialog

1. From the top menu, select **File > Export > Movie**.

The Export Movie dialog box appears.

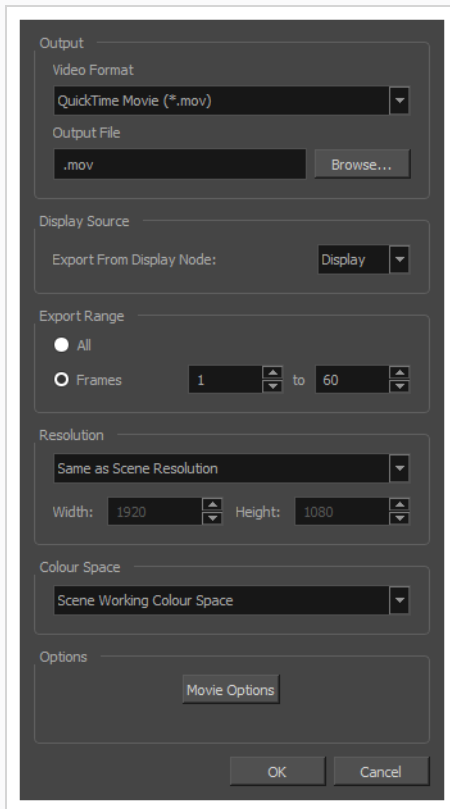

2. In the **Movie Format** drop-down, select **QuickTime Movie (*.mov)**.
3. Click on the **Video Options** button.

How to access the OpenQuickTime Video Options dialog box from the Export OpenGL Frames dialog

1. In the top menu, select **File > Export > OpenGL Frames**.

The Export OpenGL Frames dialog box appears.

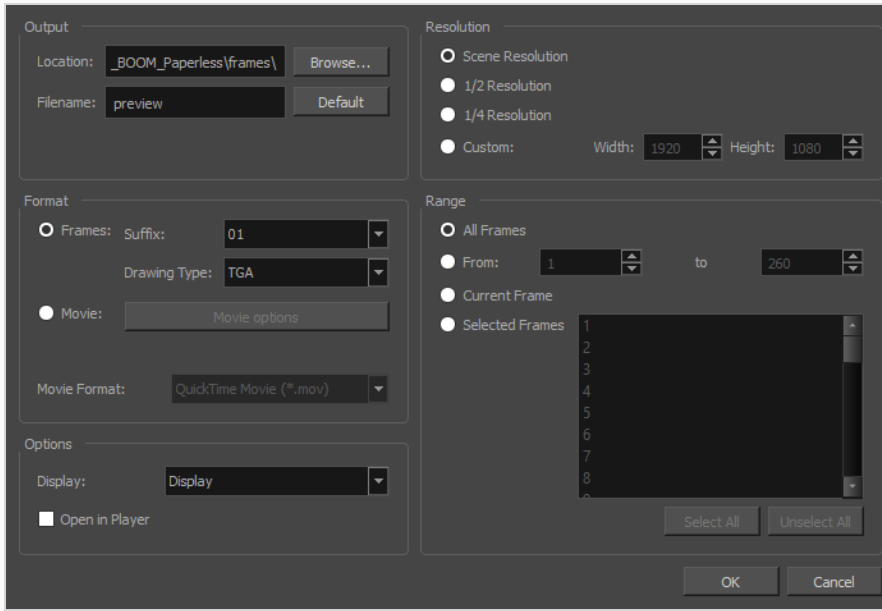

2. In the **Format** section, select **Movie**.
3. In the **Movie Format** drop-down, select **QuickTime Movie (*.mov)**.
4. Click on the **Video Options** button.

How to access the OpenQuickTime Video Options dialog box from the Write node Layer Properties

1. In the Node view, locate your scene's Write node.
2. Open the Write node's Layer Properties by doing one of the following:
 - Click on the yellow square  at the left end of the Write node.

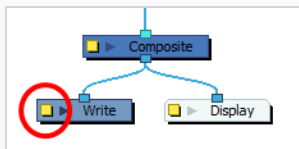

- Right-click on the Write node, then select **Layer Properties**.

The Write node's Layer Properties dialog appears.

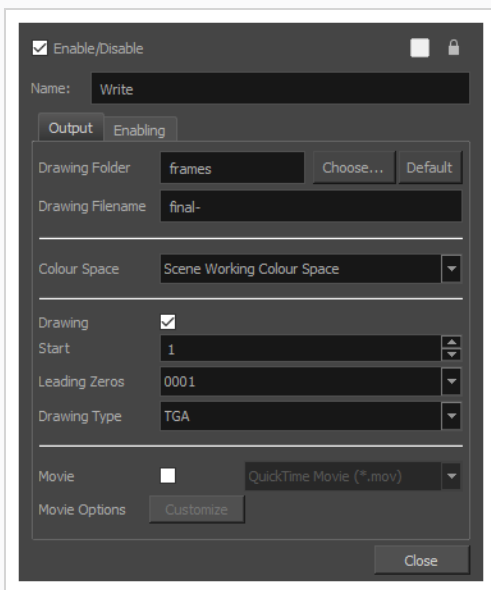

3. In the Write node's Layer Properties, enable the **Movie** option.
 1. To the right of the Movie check box, open the drop-down menu and select **QuickTime Movie (*.mov)**.
 2. To the right of **Video Options**, click **Customize**.

Parameter	Description
codec	<p>Allows you to select a video compression algorithm. By default, the following codecs are available:</p> <ul style="list-style-type: none"> • Motion-JPEG A: A very portable codec that performs lossy JPEG compression and interlaces the frames. Motion-JPEG A compression is less efficient than Photo JPEG in terms of quality and file size, but may be a more portable alternative for software that does not support Photo JPEG. • Photo JPEG: Encodes the movie as a sequence of JPEG images. JPEG images have lossy compression. This is the most efficient codec for file size. • Portable Network Graphics (PNG): Encodes the movie as a sequence of PNG images. PNG images have lossless compression. • Tag Image File Format (TIFF): Encodes the movie as a sequence of uncompressed TIFF images. This codec is lossless. • Uncompressed (RGB): Encodes the movie as uncompressed bitmap data. This codec is lossless.

	<div style="border: 1px solid green; padding: 10px;">  <p>NOTE Portable Network Graphics (PNG) and Photo JPEG are the only codecs in this list that are natively supported by both Harmony and GNOME's Totem Video Player. Other codecs may require additional software to play on GNU/Linux workstations.</p> </div>
quality	When using a JPEG-based codec, this allows you to set the JPEG compression quality. By default, this will be set to 85. Possible values range from 0 to 100. The higher the quality, the more disk space the resulting video file will take.
fieldDominance	For codecs with interlacing. This is set to 1 by default. If set to 1, the first field will be encoded on odd frames, and the second field will be encoded on even frames. If set to 2, the first field will be encoded on even frames, and the second field will be encoded on odd frames.
compression	The amount of lossless compression to perform when exporting in PNG format. PNG compression is lossless, but higher compression settings will take longer to encode and decode.
packbits	For movies encoded in TIFF. When enabled, this option adds extra lossless compression to the encoding.
lendian	For movies encoded in TIFF. When enabled, the video data is encoded in little endian byte order, instead of big endian.

Windows Media Video Settings Dialog Box (Windows)

The WMV Settings dialog box allows you to configure the video and audio settings when exporting a movie in Windows Media Video (.wmv) format.

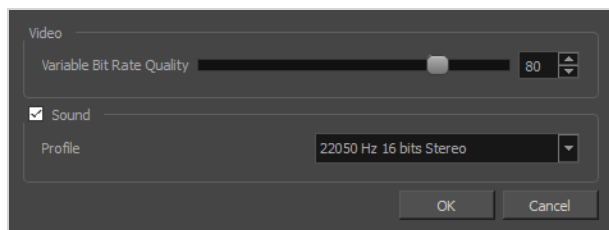

NOTES

- For tasks related to this dialog box, refer to the User Guide.
- This dialog can only be accessed on Windows.

How to access the WMV Options dialog box from the Export Movie dialog

1. From the top menu, select **File > Export > Movie**.

The Export Movie dialog box appears.

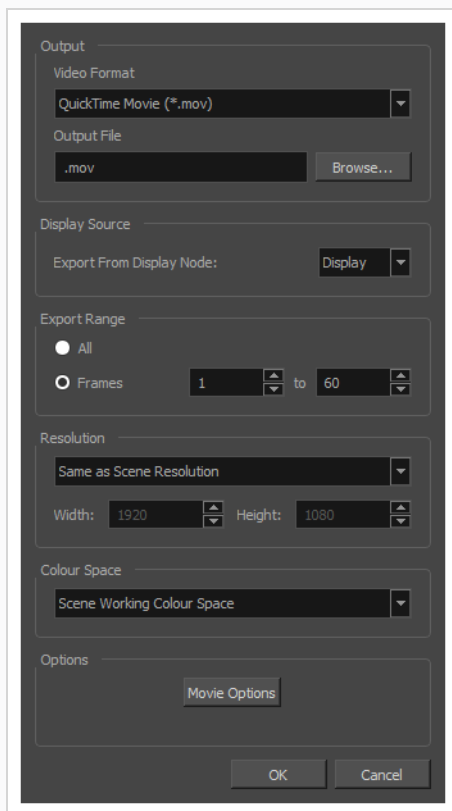

2. In the **Movie Format** drop-down, select **Windows Media Video (*.wmv)**.
3. Click on the **Movie Options** button.

How to access the WMV Options dialog box from the Export OpenGL Frames dialog

1. In the top menu, select **File > Export > OpenGL Frames**.

The Export OpenGL Frames dialog box appears.

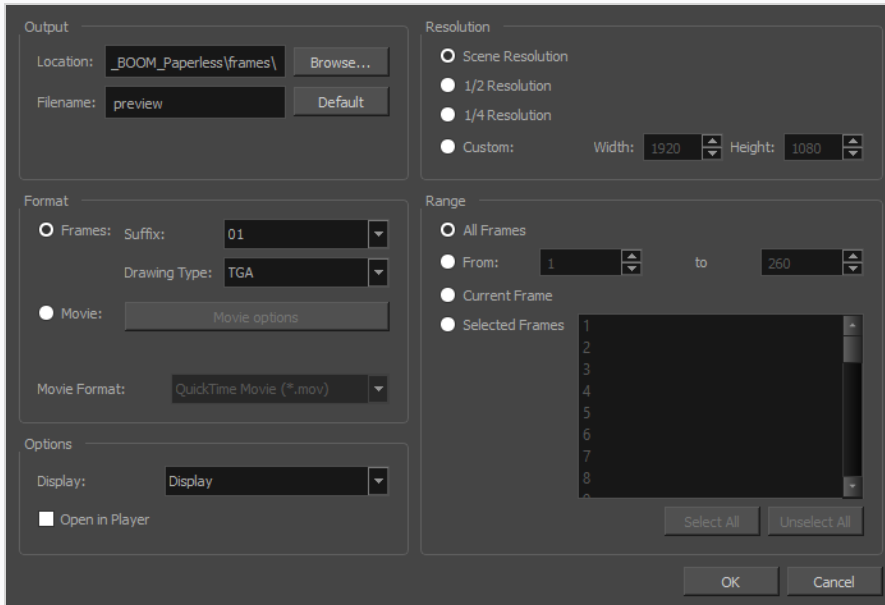

2. In the **Format** section, select **Movie**.
3. In the **Movie Format** drop-down, select **Windows Media Video (*.wmv)**.
4. Click on the **Movie Options** button.

How to access the WMV Options dialog box from the Write node Layer Properties

1. In the Node view, locate your scene's Write node.

2. Open the Write node's Layer Properties by doing one of the following:

- Click on the yellow square  at the left end of the Write node.

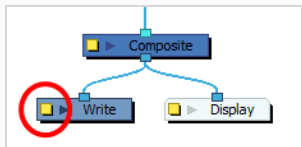

- Right-click on the Write node, then select **Layer Properties**.

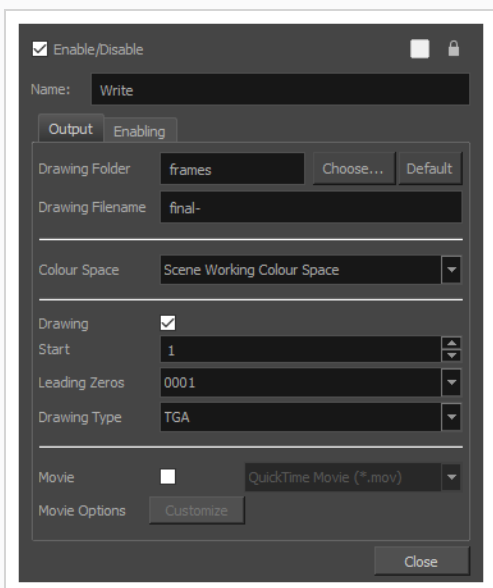

The Write node's Layer Properties dialog appears.



3. In the Write node's Layer Properties, enable the **Movie** option.

1. To the right of the Movie check box, open the drop-down menu and select **Windows Media Video (*.wmv)**.
2. To the right of **Movie Options**, click **Customize**.

Parameter	Description
Video	
Variable Bit Rate Quality	Allows you choose a quality setting ranging from 5 to 100 for the video stream. The higher the quality of the export, the larger the resulting file.
Sound	Uncheck this checkbox if you want to export a movie without an audio track.

	<div data-bbox="565 191 1430 390" style="border: 1px solid #c8e6c9; padding: 10px;">  <p>NOTE The Sound section of this dialog is not available if you are exporting an EDL/AAF/XML sequence, as this type of export creates video files with no audio track and export sound clips in separate sound files.</p> </div>
<p style="text-align: center;">Profile</p>	<p>Allows you to select one of the preset combinations of audio sample rates, sample sizes and channel modes for the audio stream:</p> <ul style="list-style-type: none"> • Sample rate: Available sample rates are 8000 Hz, 16000 Hz, 22050 Hz and 44100 Hz. The higher the sample rate, the better the audio quality. <div data-bbox="643 636 1430 867" style="border: 1px solid #c8e6c9; padding: 10px;">  <p>NOTE Harmony cannot export audio at a higher sample rate than 22.050 kHz. If you select a higher sample rate, your project's audio will be upsampled, which means it will take more disc space without increasing in quality.</p> </div> <ul style="list-style-type: none"> • Sample size: Also known as bit depth, this determines the amount of precision used to record each wavelength in the audio track. The standard size is 16-bit. If you choose 8-bit, the amount of disk space the audio track of your movie file requires is halved, but the audio quality will be significantly lower. <div data-bbox="643 1098 1430 1272" style="border: 1px solid #c8e6c9; padding: 10px;">  <p>NOTE Exporting in 8-bit audio requires Apple QuickTime to be installed.</p> </div> <ul style="list-style-type: none"> • Channel mode: Available channel modes are Stereo and Mono. Stereo sound has a separate audio track for the left and the right speakers, whereas mono sound uses a single track for all speakers.

Xsheet Column Width Dialog Box

The Xsheet Column Width dialog box lets modify the width of a column in the Xsheet view and use it as the default column width.

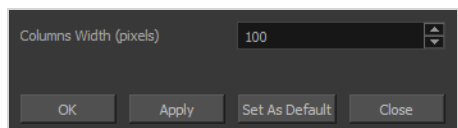

How to access the Xsheet Column Width Dialog Box

1. In the Xsheet view, select a column.
2. From the Xsheet menu, select **View > Set Columns Width**.

The Xsheet Column Width dialog box opens.

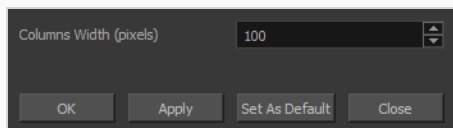

Parameter	Description
Columns Width (pixels)	Lets you set the width of the selected columns (in pixels).
Apply	Applies the value you entered to the selected column without closing the dialog box.
Set As Default	Uses the value you entered as the default for all columns in the Xsheet.

Chapter 2: Menus

The Menus section covers all the menu entries available in Harmony. There are several types of menus in Harmony: main menus, quick-access menus and view menus. Menus contains most of the functions available. They may also have a toolbar button or keyboard shortcut equivalent.

Main Menu	274
Animation Menu	275
Drawing Menu	285
Edit Menu	293
File Menu	297
Help Menu	301
Insert Menu	303
Play Menu	305
Scene Menu	307
View Menu	309
Windows Menu	316
View Menus	318
3D Graph View Menu	319
Camera View Menu	321
Colour View Menu	338
Drawing View Menu	341
Function View Menu	354
Library View Menu	356
Model View Menu	358
Node View Menu	360
Node Library View Menu	365
Onion Skin View Menu	366
Perspective View Menu	368
Script Editor View Menu	374
Side View Menu	379
Timeline View Menu	384

Top View Menu	389
Xsheet View Menu	394

Main Menu

The top menu contains most of the commands available in Harmony. Depending on the view you're working in and the selected element, some commands are available and others not. The top menu is always located at the very top of the interface.

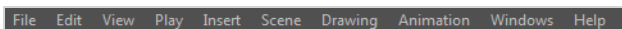
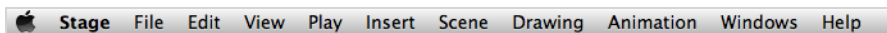

On macOS, there is also a Harmony Premium category that contains the following commands: Preferences, About, and Quit.







Animation Menu	275
Drawing Menu	285
Edit Menu	293
File Menu	297
Help Menu	301
Insert Menu	303
Play Menu	305
Scene Menu	307
View Menu	309
Windows Menu	316

Animation Menu

The Animation menu lets you access tools, adjust animation timing, set deformation, morphing and IK parameters, lock or unlock layers, and select elements in the Xsheet and Timeline views.

How to access the Animation menu

- At the top of the interface, select **Animation**.

Command	Description
Animate	
Animate Current Frame	When this option is selected, every time you use the  Transform,  Advanced Animation or  Inverse Kinematic tools to manipulate an element in your scene, the position of the element will be stored in a keyframe at the current frame. This allows you to animate elements in your scene without creating keyframes manually.
Animate Onion Skin Range	When this option is selected, if you use the  Transform or  Advanced Animation tools to make transformations to an element in your scene, the transformations will be stored as keyframes at the beginning and at the end of the current Onion Skin range, as well as on every existing keyframe in-between. This can be useful if you want to reposition an element that you have already animated, but only during a specific range of frames, which you can define by enabling Onion Skin and setting the Onion Skin range to cover that range of frames.
Animate Off	When this option is selected, if you use the  Transform or  Advanced Animation tools to make transformation to an element in your scene, the transformations will affect the element throughout the whole scene. This can be useful if you want to reposition an element after you have already animated it.
Stop-Motion Keyframe	Converts the selected keyframes to stop-motion keyframes. Between a stop-motion keyframe and the next keyframe, Harmony does not generate any animation and the element remains static until the next keyframe.
Delete Keyframe	Deletes the selected keyframes.

Tools	
Transform	Allows you to select drawing layers and position, rotate, scale and skew them.
Inverse Kinematics	Allows you to pose a character model by pulling on its extremities, such as hands and feet, and have the other connected limbs follow. Can be used on any piece connected in a hierarchy.
Translate	Lets you move the selected element along the X and Y axes.
Rotate	Turns a selected element around its pivot point.
Scale	Increases or decreases the size of a selected element. You can scale an object up to make it larger or down to make it smaller. Press Shift to scale the element while maintaining its proportions.
Skew	Slants the selected element.
Maintain Size	Keeps elements the same size aspect ratio in the Camera view as you move them towards or away from the camera.
Spline Offset	Lets you reposition the visual trajectory without offsetting or modifying your animation. By default, the trajectory is located at 0,0,0 fields. If your elements were drawn in a different location than the centre of the drawing area, it will look like the trajectory is not aligned with your drawing. Also, if you have several elements attached to one trajectory, you might want your trajectory to be at a different location to represent the group's motion better.
Reposition Drawing	Lets you reposition, scale, rotate or skew all drawing strokes on every drawing included in a layer.
Cell	
Increase Exposure	Adds one more exposure to a selected cell; repeating this action adds an extra cell each time. This is an efficient way to extend a drawing's exposure and is always set in Insert mode. Increasing an exposure pushes the existing exposure forward.
Decrease Exposure	Decreases exposure of a selected cell by one; repeating this action

	decreases one exposure adds an extra cell each time. This is an efficient way to shorten a drawing's exposure. Decreasing an exposure pulls in the existing exposure.
Set Exposure to	Lets you set the exposure to 1, 2, 3 or a custom exposure.
Extend Exposure	Lets you enter the frame up to which you want to extend the exposure. You can expose the drawing in the frames and replace the drawings that were originally there or move the subsequent frames forward in time.
Add Key Exposure	Adds a key exposure to the selected cell.
Remove Key Exposure	Removes key exposures from the selected cells.
Remove Duplicate Key Exposure	<p>When working with drawings to adjust the timing of a mouth in a lipsync, for example, and forcing the use of specific key exposures, unnecessary key exposures will be created. You can delete these duplicates without affecting the rest of the drawing. The first drawing of the selection will be used for the range.</p> <div style="border: 1px solid green; padding: 5px; margin-top: 10px;">  <p>NOTE Duplicate key exposures may occur when pasting with the Enforce Key Exposure option selected.</p> </div>
Fill Empty Cells	Fills the empty frames in the selection with the exposure just before. For example, if you select a range of frame that starts with an exposed drawing and then ends with empty cells, all of the empty cells in the selection will be filled with the exposed drawing just before the empty cells.
Insert Blank Cell	Adds an empty cell between other cells.
Clear Exposure	Removes the exposure from the selected cell.
Clear Exposure and Pull	Replaces the exposure from the selected cell with exposures that follow it.
Fill Selection	Lets you fill the same value over an entire selection. The selection can be over one cell, a cell range in one column, a cell range over many columns, an entire column, or many columns. You can use numbers,

	words, letters, or any alphanumeric value.
Sequence Fill	Lets you create a numbered sequence over a selection. The sequence can be forward, backward, single, double or higher increment, as a cycle, and so on. The selection can be over one cell or a cell range in one column or more or an entire column or many entire columns.
Fill Cells Randomly	Lets you fill in random values over a selection. You can give a maximum and a minimum value and create a range for Harmony to choose the random values from. The selection can be over one cell or a cell range in one column or more or an entire column or many entire columns.
Hold Exposure	Lets you expose a drawing for three, four, or five cells and so on.
Deformation	
Set Curves and Offsets Independent from Parent	When you transfer a curve's position to its parent offset, first you must to set curves and offsets independent from parent.
Transfer Curve Values to Offset	Lets you transfer all of the information from first curve deformer to its parent Offset node. This is useful for a legacy scene created using Curve deformations where the Offset's position has been placed far away from the drawing to make sure it doesn't affect the drawing's deformation. You can bring back the offset and give it the first curve's position. The Envelope deformation lets you animate the offset of each curve separately. The offset no longer needs to be placed far away.
Convert Elliptic Deformation ROI to Shape	After you have created a deformation chain using Elliptic as the Zone of Influence type, you can select your deformer and click on this button to convert it to a Shaped type. Control points will appear around the shape making it easy to customize. You can also convert the Elliptic zone of influence to a shape. Select Animation > Deformation > Convert Elliptic Deformation ROI to Shape . This will create a much smaller initial zone of influence than if you were to convert it directly to a shape.
Convert Deformed Drawing to Drawings	Convert deformation animations to drawing sequences, so you can adjust the drawings using the drawing tools. You may also want to change the timing and set it on double frames instead of single frame.
Convert to New Drawing and Add Deformation Chain	Takes the pose/drawing and the deformer of the selected frame and converts it to a new pose/drawing with the corresponding deformer.

Envelope Creator	
Create Envelope	<p>Opens the Envelope Creator dialog, which allows you to automatically generate a deformation chain based on the artwork in the current layer.</p> <p>Among other things, the Envelope Creator dialog allows you to set the parameters for the amount of deformation points in the envelope as well as its shape and type.</p>
Draw Envelope	<p>Opens the Envelope Drawer dialog, which allows you to draw a deformation chain in the Camera view using a mouse or pen tablet. The deformation chain will be created as a parent of the current layer.</p> <p>Among other things, the Envelope Drawer dialog allows you to set the parameters for the amount of deformation points are created and how the shape of your drawing is processed.</p>
Exposure Fill	
Using Render Change	<p>Modifies the timing (exposure) of the selected layer, lets you adjust the parameters to assign when the texture exposure changes will occur. You can adjust the type of filter to use for the motion detection, as well as threshold values to indicate what will be considered a big enough motion variation for an exposure change.</p>
Master Controller	
Launch Stack Wizard	<p>Opens the Master Controller Stack Wizard, which allows you to create a Master Controller that combines a 2D point widget and a slider. The 2D point widget can be used to rotate part of your rig in any direction, used a grid of preset poses, and the slider can be used to switch between different grids of poses.</p>
Launch Grid Wizard	<p>Opens the Master Controller Grid Wizard, which allows you to create a Master Controller with a 2D point widget that can be used to rotate part of your rig in any direction, using a grid of preset poses—see Master Controller Grid Wizard Dialog Box on page 121.</p>
Launch Slider Wizard	<p>Opens the Master Controller Slider Wizard, which allows you to create a Master Controller with a slider widget which can be used to change the pose of part or all of your rig, based on a line-up of 2 or more poses—see Master Controller Slider Wizard Dialog Box on page 225.</p>

Morphing	
Create Morphing	Allows you to create and configure a morphing sequence, which will automatically generate the in-betweens between two drawings in the current layer.
Insert Morphing Key Drawing	Creates a morphing keyframe from a selected morphing frame.
Delete Morphing	Once a cell is selected in a morphing sequence, deletes the entire sequence between the two keyframes.
Convert Morphing to Drawing	Lets you convert your morphing inbetweens to real drawings you can edit. This is useful when manually editing a morphing sequence or if you prefer to have animation timing in double frame (on twos) instead of single frame (on ones).
Contour Hint	<p>The Contour Hint point is used on the colour fill zone and brush lines; in other words, on Contour vectors. It allows you to control the line thickness and contour position. Also, if a contour is not animated correctly, you can use hints to correct the animation. For example, if a flag is not waving properly.</p> <p>When adding a Contour Hint point, make sure to place it far enough away from the contour so you can see it snap to the contour.</p> <p>Contour Hint points are yellow.</p>
Zone Hint	<p>The Zone Hint point is used on a colour zone to control the proximity rule. The Zone Hint is placed in the centre of the colour zone. Sometimes a colour zone is not associated with the corresponding one by default. For example, in a splash animation there are many water droplets that are the same colour. Harmony automatically morphs the droplet to the nearest one. This is not always the one you may have predicted. A Zone Hint will force a colour zone to morph with another one.</p> <p>Zone Hint points are cyan in colour.</p>
Pencil Hint	<p>A Pencil Hint point is used to control a pencil line, also known as central vector. It can be used on drawings that were done using the Pencil, Polyline, Ellipse, Line and Rectangle tools. Like the Contour Hint, the Pencil Hint snaps to the central vector. Make sure to place it far enough away from the line so you will see it snap when you move it.</p> <p>Pencil Hint points are magenta in colour.</p>

Appearing Point Hint	<p>An Appearing Point Hint is used to control the trajectory of an appearing shape. A shape will appear in the destination drawing when there is no corresponding shape in the source drawing. If you do not place an Appearing Point Hint to control the point of appearance, the shape will appear from its centre and expand outwards.</p> <p>Appearing Point Hint points are violet in colour.</p>
Vanishing Point Hint	<p>A Vanishing Point Hint is used to control the trajectory of a vanishing shape. A shape will vanish from the source drawing when there is no corresponding shape in the destination drawing. If you do not place a Vanishing Point Hint to control the point of disappearance, the shape will vanish into its centre.</p> <p>Vanishing Point Hint points are green in colour.</p>
Switch Between Morphing Key Drawings	<p>Toggles between the two key drawings in your morphing sequence. This option is useful while setting hints. You can use the default keyboard shortcut F4 to toggle between your drawings.</p>
Go to First Frame	<p>Goes to the first frame of your morphing sequence.</p>
Go to Previous Frame	<p>Goes to the previous frame of the selected frame in the morphing sequence.</p>
Go to Next Frame	<p>Goes to the next frame of the selected frame in the morphing sequence.</p>
Go to Last Frame	<p>Goes to the last frame of your morphing sequence.</p>
Suggest Hints	<p>Automatically sets hint points on key drawings as a help tool. If you're not sure where to set hints, you can use this option. It will set the main hints which you can then fine tune.</p>
Hide Hints	<p>Temporarily hides the hint points from the key drawings. Use this option when you have a series of hint points hiding some lines you would like to see.</p>
IK Constraints	
Set IK Nail	<p>Blocks the X, Y and Z positions.</p>
Set IK Hold Orientation	<p>Blocks the angle.</p>

Set IK Hold X	Blocks only the X position.
Set IK Hold Y	Blocks only the Y position.
Remove All Constraints	Removes all nails except the minimum and maximum angles.
Lip-Sync	
Change Mouth Shape to	Lets you change the mouth shape to one of the following: A, B, C, D, E, F, G, X.
Auto Lip-Sync Detection	Generates a sound detection for lip-sync.
Map Lip-Sync	Automatically maps drawings in an element to the mouth chart you have generated for a sound. This can save time when you are lip-synching a voice track.
Flip	
Flip Horizontal	Flips the selection horizontally.
Flip Vertical	Flips the selection vertically.
Flip Scale X	Once your drawing layer is rotated, the original horizontal and vertical axes change. The Flip Scale X and Flip Scale Y will perform a flip on your drawing layer following its original axis. Remembers the original X-axis of the layer and flips the element following it.
Flip Scale Y	Remembers the original Y-axis of the layer and flips the element following it.
Linear Motion	Switches between a linear and curved corner.
Lock in Time	Indicates whether the point is locked to a specific frame (keyframe) or only locked to a specific position and the curve can flow through it freely as other points are being added, moved, or adjusted (control point).
No Z Dragging	Keeps the Z value constant when you drag a character using the Transform or Translate tool.

Substitute Drawing Previous	Replaces the drawing or cell's symbol on the current frame by the previous drawing.
Substitute Drawing Next	Replaces the drawing or cell's symbol on the current frame by the next drawing.
Go to Previous Keyframe	Goes to the previous keyframe.
Go to Next Keyframe	Goes to the next keyframe.
Select Previous Keyframe /Point	Select the previous keyframe/point.
Select Next Keyframe /Point	Select the next keyframe/point.
Select Child Skipping Effects	Lets you select the first element parented to the selected peg element in the Timeline view skipping effects in the hierarchy.
Select Child	Lets you select the first element parented to the selected peg element in the Timeline view.
Select Children	Lets you select all elements parented to the selected peg element in the Timeline view.
Select Group Content	Selects all of the contents of the group.
Select Parent Skipping Effects	Lets you select the parent of the selected element in the Timeline view skipping effects in the hierarchy.
Select Parent	Lets you select the parent of the selected element in the Timeline view.
Select Previous Sibling	Lets you select the previous element (above current element) in the Timeline view.
Select Next Sibling	Lets you select the next element (below current element) in the Timeline view.
Lock	
Lock	Locks one or a multiple selection of layers.

Unlock	Unlocks one or a multiple selection of locked layers.
Lock All	Locks all the layers in the Timeline view.
Unlock All	Unlocks all the layers in the Timeline view.
Lock All Others	Locks every layer except the selected ones.
Reset	Returns the value of the selected element to the initial value of the active tool. For example, if the Rotate tool is active, the transformation angle will be reset to 0 and if the Transform tool is active, all the transformation values will be reset.
Reset All	Resets all transformations on the current frame in a selected layer. Your keyframe will remain, but all the values will return to the starting value. All transformations are reset regardless of the tool you're using.
Reset All Except Z	Resets all transformations on the current frame except the Z position. This is useful when doing cut-out animation. Cut-out puppets often have a particular Z ordering for the different views of a character. You might want to reset the transformation, but not necessarily the Z position.

Drawing Menu

The Drawing menu lets you access many tools related to drawing, painting, dirt removal, optimizing strokes, and more.

How to access the Drawing menu

- At the top of the interface, select **Drawing**.

Command	Description
Drawing Tools	Allows you to select one of the drawing tools available in Harmony.
Select	Allows you to select and reposition, scale, rotate and skew brush strokes, pencil lines, shapes and other parts of your artwork.
Contour Editor	Allows you to edit the vector contours of brush strokes, pencil lines and shapes in your artwork. You can add, remove, tweak and move vector points, move the Bezier handles of the vector points as well as deform vector outlines.
Centerline Editor	Allows you to tweak and deform a brush stroke by manipulating the points at the centre of its line rather than its contour.
Pencil Editor	Allows you to adjust the thickness of a pencil line at its different points and corners, tweak the shape of its extremities and scale its texture.
Cutter	Allows you to cut a part of your artwork, then reposition, scale, rotate and skew it.
Smooth Editor	Allows you to optimize contours and lines by removing its extra points, making them easier to edit.
Perspective	Allows you to deform artwork by applying a perspective effect on it.
Envelope	Allows you to deform and warp artwork by moving points and tweaking lines in a grid.
Reposition All Drawings	Allows you to reposition, scale, rotate and skew all drawings in the current layer.
Drawing Pivot	Allows you to position the pivot on a drawing layer by clicking where you want its location to be.

Brush	A pressure-sensitive tool for creating a contour shape with a thick and thin line effect, as if created with a paint brush.
Pencil	A pressure-sensitive tool for drawing outlines. Pencil lines are made of central vector lines, making them easier to tweak and edit than brush strokes.
Text	Allows you to add text and to format it.
Eraser	A pressure-sensitive tool for erasing parts of a drawing.
Colour Eyedropper	Allows you to select a colour by clicking on a colour in your artwork.
Pencil Texture Eyedropper	Allows you to select a pencil texture by clicking on a textured pencil line.
Morphing	Allows you to create and configure a morphing sequence, which will automatically generate the in-betweens between two drawings in the current layer.
Line	Draws a straight line segment going from one point to the other.
Rectangle	Draws a rectangle.
Ellipse	Draws an ellipse.
Polyline	Allows you to draw shapes, segmented lines or complex curved lines by clicking to create each point in the sequence of line segments.
Paint	Allows you to fill colour zones with a colour or texture.
Ink	Allows you to recolour pencil lines with precision by changing the colour of one segment at a time.
Repaint Brush	Like the Brush tool, but only paints over existing brush strokes.
Close Gap	Allows you to close open shapes so that they can be filled with the Paint tool. By drawing a stroke near a small gap in a shape, this tool will create a small invisible stroke connecting the two closest points around the gap.



Stroke	Allows you to create invisible lines that can serve as colour zones that can be filled, or close the gaps in existing colour zones.
Edit Gradient/Texture	Allows you to adjust the position, angle and size of gradients and textures in a colour zone.
Hand	Allows you to pan the Camera and Drawing views.
Zoom	Allows you zoom in and out of the Camera and Drawing views.
Rotate View	Lets you rotate the Camera and Drawing views just like with a real animation disc.
Shift and Trace	Allows you to temporarily move drawings so you can trace over them in other drawings using Onion Skin.
Clean Up	
Remove Dirt	Opens the Remove Dirt dialog box where you can specify the number and size of dots removal from a selected drawing.
Remove Hair	Opens the Remove Hair dialog box where you can specify the number and length of hairs for removal from a selected drawing. This removes any small strokes created in the Colour Art layer from very thick lines or filled zones. Increase the value to select larger strokes for removal from the drawing.
Close Gaps	Closes small gaps in a drawing by creating small, invisible strokes between the two closest points to close the colour zone. You do not need to trace directly over the gap. You can draw it a few millimeters away. The two closest points automatically close the gap.
Remove Art Inside Selection	Removes any art inside a selection. It is recommended that you clean your Colour Art level as well. If you have a stroke accumulation in the Colour Art, it can result in large output files, especially if you work in high definition resolutions.
Remove Art Inside Selection on All Drawings	Removes any art inside all drawings selected with the Permanent Selection option in the Select tool.
Remove Art Outside Selection	Removes any art existing outside a selection. It is recommended that you clean the Colour Art level as well. If you have a stroke accumulation in the Colour Art, it can result in large output files, especially if you work in high-definition resolutions.

Remove Art Outside Selection on All Drawings	Removes any art outside all drawings selected with the Permanent Selection option in the Select tool.
Paint	
<div style="border: 1px solid green; padding: 10px;">  NOTE The Paint commands require you to use the Permanent Selection option in the Select tool so you can maintain a selection over multiple drawings. </div>	
Unpaint Selection	Unpaints any art existing inside a selection.
Unpaint Selection on All Drawings	Unpaints all art contained inside a selection on all the drawings within the same layer.
Unpaint Outside Selection	Unpaints any art existing outside a selection. If no selection have been drawn using the Select tool, the entire drawing will be unpainted.
Unpaint Outside Selection on All Drawings	Unpaints all art outside a selection on all the drawings within the same layer.
Repaint Selection	Repaints any art inside a selection.
Repaint Selection on All Drawings	Repaints any art inside a selection on all the drawings contained within the same layer.
Repaint Outside Selection	Repaints any art outside a selection. If no selection has been drawn using the Select tool, the entire drawing will be repainted.
Repaint Outside Selection on All Drawings	Repaints any art outside a selection on all the drawings contained within the same layer.
Convert	

Pencil Lines to Brush Strokes	Converts the selected centreline pencil strokes into contour strokes brush lines.
Brush Strokes to Pencil Lines	Converts selected contour strokes into centreline pencil strokes. The brush stroke thickness will be lost.
Strokes to Pencil Lines	Converts the selected invisible line to a pencil line.
Break Apart Text Layers	Text is treated as a single drawing object. This separates the text so each character becomes an individual drawing object you can select and modify independently.
Optimize	
Flatten	Merges drawing objects and brush strokes into a single layer. If you draw new lines to fix a drawing or line with many brush strokes, it can be useful to flatten them all into a single shape. By default, lines are drawn one on top of each other. If you intend to repaint the lines or modify their shape, it will be easier if they are flattened.
Smooth	Smooths selected drawing strokes and removes extra points.
Create Contour Strokes	Adds a permanent invisible line around a shape that was drawn directly in Harmony. This allows you to unpaint lines with the Paint tool but maintain the shape of the lines, should you need to repaint later.
Remove Contour Strokes	Remove any permanently invisible lines that were created while scanning and vectorizing drawings or manually adding contour strokes. This is useful for removing the intersection triangles created during vectorization.
Remove Extra Strokes	Removes strokes inside painted area. This option only works after the painted drawing is flattened.
Optimize	Reduces the number of layers, such as overlapping brush strokes, in the selected drawing objects. Drawing objects will only be flattened and optimized if the selected objects do not change the appearance of the final image when they are merged.
Crop Brush Textures	Crops an unnecessarily large texture bitmap that lies unseen beneath the vector contour of a textured line. This often occurs when you cut and paste textured lines from one drawing into another. If you cut a portion from a textured line and paste it into a different drawing, Harmony pastes the entire unseen texture bitmap from the source drawing into the new one, even if you only took a small portion of the source

	<p>drawing. Using the Crop Brush Texture command will crop away extraneous texture that does not touch the vector area. If there are many textured lines in your scene, this will greatly reduce the file size.</p>
<p>Reduce Drawing Texture Resolution</p>	<p>When you import and vectorize as texture (colour) a high resolution image, the size of your drawing can be heavy. You can reduce the size and resolution of the textures in a drawing.</p>
<p>Transform</p>	
<p>Flip Horizontal</p>	<p>Flips the current selection horizontally.</p>
<p>Flip Vertical</p>	<p>Flips the current selection vertically.</p>
<p>Rotate 90 CW</p>	<p>Rotates the current selection 90 degrees clockwise.</p>
<p>Rotate 90 CCW</p>	<p>Rotates the current selection 90 degrees counter-clockwise.</p>
<p>Rotate 180</p>	<p>Rotates the current selection 180 degrees.</p>
<p>Arrange</p>	
<p>Bring to Front</p>	<p>Moves the selected art to the front (on top).</p>
<p>Bring Forward</p>	<p>Moves the selected art one level forward (closer to the front).</p>
<p>Send Backward</p>	<p>Moves the selected art one level lower (behind).</p>
<p>Send to Back</p>	<p>Moves the selected art behind everything (bottom / back).</p>
<p>Create Empty Drawing</p>	<p>Creates a drawing in the selected cell, replacing any drawing that may already be exposed in that cell and the following ones until it meets another drawing, key exposure or a blank cell.</p>
<p>Duplicate Drawings</p>	<p>Creates a duplicate of the selected drawing in the layer. The duplicate drawing will be exposed at the selected frame instead of the original drawing. Hence, this command allows you to instantly start working on a duplicate of the current drawing and retain the original.</p>

	 <p>NOTE</p> <p>When duplicating a drawing, the exposure at the selected cell is replaced with the new drawing, up until the next key exposure.</p>
Delete Selected Drawings	Permanently removes selected drawings. Once you save your project, these drawings cannot be recovered.
Rename Drawing	Lets you give a selected drawing a new name.
Rename Drawing with Prefix	Lets you rename a drawing sequence with a prefix, which can be quite useful for cut-out puppet breakdown and deformation animation. This applies to any deformation work done in pre-Harmony 12 versions.
Rename by Frame	Lets you rename a series of drawings relative to their frame position. This is useful in hand-drawn animation.
Select Strokes with Current Colour	Lets you select drawing elements and painted areas with the same colour as the currently selected colour in your colour palette.
Distribute to Layers	<p>Every selected stroke in the Camera view is placed on separate layers; one layer per stroke. If artwork is composed of several strokes, you must group them to put them on the same layer.</p> <p>This operation cannot be done in the Drawing view.</p>
Create Colour Art from Line Art	<p>Lets you use the outline you traced on one of the four embedded layers (line art, colour art, overlay, underlay) and create invisible strokes to paint your drawings on separate layers. This provides more inking and painting flexibility.</p> <p>You can also configure this option to create the invisible strokes on any of the four embedded layers.</p>
Create Breaking Triangles	<p>Useful for brush strokes, creates triangular breaks at natural line intersections. These intersections are the probable locations where colour line breaks may occur, such as where a sleeve meets a hand.</p> <p>This makes it easier to soft trace lines in different colours when there are flattened or unflattened clean brush strokes.</p>
Generate Auto-Matte	Fills colour based on currently selected colour swatch on different drawing layers (overlay, underlay) so overlapping lines are more visible during a line test.

Adjust Line Texture Opacity	Lets you adjust the contrast and opacity of textured lines in a drawing.
Change Vector Drawing Brush Resolution	<p>Allows you to change the pixel density of textured brush strokes in vector drawings in your scene.</p> <div style="border: 1px solid #c8e6c9; padding: 10px;">  NOTE When you create a new vector drawing, its pixel density for textured brush strokes is based on the settings in the Drawing Resolution tab of the Scene Settings dialog. </div>
Change Bitmap Drawing Resolution	<p>Allows you to change the pixel density and canvas size of existing bitmap drawings in your scene.</p> <div style="border: 1px solid #c8e6c9; padding: 10px;">  NOTE When you create a new bitmap drawing, its canvas size and pixel density are based on the settings in the Drawing Resolution tab of the Scene Settings dialog. </div>
Previous Drawing	When a cell is selected in the Timeline or Xsheet view, displays the previous drawing.
Next Drawing	When a cell is selected in the Timeline or Xsheet view, displays the next drawing.
Previous Layer	When a cell is selected in the Timeline or Xsheet view, displays the previous layer.
Next Layer	<p>Once a cell is selected in the Timeline or Xsheet view, you can navigate between the drawings, frames, and layers. Displays the previous drawing, next drawing, previous layer or next layer.</p> <p>When a cell is selected in the Timeline or Xsheet view, displays the next layer.</p>
Colour Protection	
Toggle Current Colour Protection	Temporarily enables/disables the Colour Protection feature so you can quickly correct wrongly inked or painted areas under protected colour without readjusting the Current Colour Protection option.
Respect Colour Protection	In the Colour view, you can protect a colour swatch to avoid repainting or unpainting the zones linked to that swatch. If you using the Paint tool and this option is deselected, you will repaint or unpaint the protected colours on your drawings until you enable the option again.

Edit Menu

The Edit menu lets you repeat and undo actions, cut/copy/paste selected objects, select and manipulate objects, work with symbols, and access the Preferences dialog box.

How to access the Edit menu

- From the top menu, select **Edit**.

Command	Description
Undo	Removes the last change made to your project. Harmony supports multiple undo, so you can undo changes you made in the order you made them.
Redo	Redoes an operation you have undone. This command is active only after you use the Undo command.
Cut	Removes selected objects. You can then paste the object or its properties to another object.
Copy	Copies selected objects and properties.
Paste	Places an object you cut or copied into the location you select in a view.
Paste Special	Opens the Paste Special dialog box which lets you determine how templates and symbols are imported in the Timeline view. There are advanced paste options for drawings, timings, keyframes, layers, as well as palettes and symbols.
Paste Special Again	Pastes new drawings with the previous Paste Special settings.
Paste Cycle	Cycles a portion of an animation. You can increase or decrease the number of cycles to paste and select a type of cycle: Normal, Reverse, Forward-Reverse and Reverse-Forward.
Paste Reverse	Reverses the timing of drawings or keyframes in range of selection after copying.

Delete	Removes selected objects.
Select All	Selects all drawing objects in the current drawing window in the Drawing, Timeline and Camera views. This helps you manage multiple objects as one when moving them.
Deselect All	Deselects all selected objects in the Drawing and Camera views.
Invert Selection	Deselects the currently selected items and selects all other items that were not selected. For example, if some lines are selected in a drawing, this command will deselect them and select any other lines in the drawing that were not selected.
Auto-Apply	Automatically applies changes you make to a property window or dialog box. Harmony applies the modification automatically and displays the result in the Camera view. When working on a heavy scene, it is useful to turn off this option. If you want to always work in Auto-Apply mode, you can deselect the Auto-Apply option in the Preferences dialog box (General tab). Then, each time you start Harmony, the Auto-Apply mode will be off. You must click the Apply button to see any modifications.
Create Symbol	Creates a symbol from selected drawing elements in the Drawing or Camera view, nodes in the Node view, or a layer or cells in the Timeline view.
Open Merge Editor	Lets you bring together (merge) the layer or drawings from different versions of the same scene.
Expand Symbol	<p>Extracts a symbol's contents and places it on the root timeline. Its contents will be copied and inserted into the root timeline. The symbol will not be removed from the Timeline view once it is expanded.</p> <p>The symbol's layers will be parented to it in case you created motions and transformations on the drawing layer that contain the symbol. Breaking the hierarchy could result in the loss of any scaling and animation you may have created.</p>
Expand Selected Symbol in Groups	Expands a symbol within a group to avoid crowding the timeline with a series of layers. When you expand the symbols, the layers will be contained in a group node that you can expand to see the content.
Duplicate Selected Symbol	Creates a duplicate of a selected symbol. If other symbols are nested

	inside the new symbol, they are not duplicated. If you modify them, the original and other instances will also be modified.
Create Drawing from Drawing Selection	Breaks a character into its main body parts. There is no need to create any layers prior to this process. Make sure your model is well centered and sized in the Camera view.
Clone: Drawings Only	Creates a copy of the drawings in the selected layer in the Timeline view or column in the Xsheet view. The timing is not copied.
Clone: Drawings and Timing	Creates a copy of the drawings and their timings in the selected layer in the Timeline view or column in the Xsheet view.
Duplicate	Duplicates a layer to have a copy of the drawings that are independent from the original ones, as well as an independent timing (exposure). When you need the drawings to be modified independently, you will want to duplicate the layer instead of cloning it.
Merge	There are two methods of merging drawings. <ul style="list-style-type: none"> You can merge selected drawings in adjacent elements. The columns and layers will be left intact, and each new merged drawing will reside in the frames of the left-most column or lower layer. You can merge elements. All drawings will be merged. Unused columns and layers will be deleted, but the original drawing files are still accessible.
Group	
Group	Groups selected drawing objects in the Camera or Drawing view.
Ungroup	Ungroups a selected group of drawing objects in the Camera or Drawing view.
Group Selected Layers	Groups selected layers in the Timeline view or nodes selected in the Node view.
Ungroup Selected Layers	Ungroups a selected group in the Timeline or Node views.
Move to Parent Group	Moves selected nodes in the Node view up to the parent group level, maintaining all connections.

Edit Drawing Mode	When the Auto-Get Rights to Modify Drawings option is selected in the Preferences dialog box (General tab), the system automatically gets the rights to modify drawings when you select a drawing. Otherwise, you must manually get the rights to modify drawings.
Edit Palette List Mode	When the Auto-Get Rights to Modify Palette option is selected in the Preferences dialog box (General tab), the system automatically gets the rights to modify palettes and palette lists when you select a colour from a palette. Otherwise, you must manually get the rights to modify a palette or palette list.
Get Rights to Modify Drawing	Manually releases the rights to modify a selected drawing.
Release Rights to Modify Drawing	Manually releases rights to modify a selected drawing.
Force Release Rights to Modify Drawing	This option is always available even if the Get Rights to Modify All Scene Assets option is not selected in the Database Selector dialog box.
Preferences	Opens the Preferences dialog box where you can set your preferences for Harmony.



File Menu

The File menu lets you open, close, save, scan, print, and import and export files.

How to access the File menu

- From the top menu, select **File**.

Command	Description
New	Creates a new scene while closing any scene already open. The New Scene dialog box opens, asking for directory, name, and resolution information.
Open	Displays the Open Scene dialog box where you can browse for a scene file. You can open a new scene from the current one and the previous scene will close.
Open Recent	Displays a list of the most recently opened scenes.
Clear	Clears the list of recently opened scenes.
Close	Closes the currently opened scene, but does not close the Harmony application.
Save	Saves all changes made to the opened scene, drawings, palettes, and palette lists.
Advanced Save	Lets you do the following: <ul style="list-style-type: none"> • Save the scene as the current version. • Save different versions representing different stages of the production of your scene. • Save different versions representing different scene setups. • Choose specific assets that you want to save, such as drawings or palettes.
Rights to Modify Scene Version	Allows you to modify the selected version of the scene as well as to manage and overwrite other versions. Other users will not be able to open a different version of the scene until you close the scene.
Rights to Modify Scene	Allows you to modify the currently selected scene version only. Unless the Get rights to modify the scene option is also checked, you will not be able to change other versions of the scene. This allows other users to modify different versions of the scene while you are working on the selected version.

Read Changed Drawings	<p>Determines which drawing files have been modified on disk since you loaded them. All updated drawings will be reloaded.</p> <div data-bbox="451 285 1430 424" style="border: 1px solid #90EE90; padding: 5px;">  NOTE Reloading a locked drawing will discard unsaved changes. </div>
Manage Versions	Allows you to manage all the versions of the current scene.
Manage Local Cache	Opens the Manage Local Cache dialog, in which you can see all the Harmony Server database scenes that were cached locally, delete unused caches and check if the data in a scene's cache matches the data on the database server.
Save As	<p>Saves the current file with a different name and at a different location.</p> <p>Saves the current state of a scene as another scene. The Save As window prompts you for a new name and a different location for this scene before saving it. This will create a complete scene directory for the new scene.</p> <div data-bbox="451 919 1430 1058" style="border: 1px solid #90EE90; padding: 5px;">  NOTE The scene name cannot exceed 23 characters. </div>
Save as New Version	Saves the current scene as another version. The Save Version dialog box prompts you to give a name for this new version. This will create a new .xstage file in your current project directory.
Back Up Scene	Backs up the current scene to a location you choose.
Update Database Scene	Updates your database with only the changes you made to the scene. To do this, you must enter your host name and host port in the Preferences dialog box, General tab.
Download Database Changes	If any changes were made to the scene you downloaded, you can perform an update by downloading these changes, which will be integrated into your scene.
Remove Unused Files	Removes the unused palettes from the scene list.
Import	
From Scanner	Imports drawings from a TWAIN scanner.

Images	Imports bitmap images which you can choose to vectorize.
3D Models	Once you have exported a model using a 3D authoring software, you can import it and integrate it in your 2D animation scene. You have the possibility to convert your 3D models to *.osb files upon import to Harmony and save them as such. This will allow Harmony to render 3D files with the associated textures without the need to copy them manually (as long as the auxiliary files are linked correctly and named appropriately on your disk).
Link to Images	Links to images stored on a centralizer server when working with Harmony Server.
Movie	Lets you convert a QuickTime movie to an image sequence and audio file.
Sound	Lets you import sound files into your project.
Colour Model	Lets you import TVG drawing file into your project. Once imported, it is display in the Model view for use as a colour model which you can load into any Harmony scene.
SWF, Illustrator Files to Library	Lets you import SWF files into your project.
Export	
Movie	Exports animation as a QuickTime movie.
Render Write Nodes	Renders all the Write nodes in a node structure. When working with Harmony Server, you can send your scene to batch processing and to a render farm.
Soundtrack	Exports a sound file as a merged soundtrack or series of individual files. The exported soundtracks are generated as *.wav files.
SWF	Exports a Flash movie file. Harmony supports exporting Flash movie files with a limited subset of vector and bitmap effects, the latter which can be previewed in Render View  mode.
OpenGL Frames	Exports OpenGL frames (fast display mode) for a quick screen renders of a scene that contain no transparency channel. Heavier scenes containing 3D, multiple effects and camera

	moves can be fairly long to export.
Layout Image	Exports all the elements in your scene to a layout .psd file.
Layout Image from Selection	Exports only the selected elements to a layout .psd file.
Print	
Xsheet	Prints the exposure sheet so you can take it to your animation table, provide a copy to the animator, or create your Xsheet skeleton directly in Harmony.
Node View	Prints the Node view for reference purposes.
Quit	Closes the application.

Help Menu

The Help menu lets you display the Harmony documentation, Welcome screen and end user license agreement, as well as access the Toon Boom website, and identify the product name and version number.

How to access the Help menu

- At the top of the interface, select **Help**.

Command	Description
Online Help	Opens the Harmony Help system, complete with instructions on how to use the system. This requires an internet connection.
Getting Started	Opens the Harmony Getting Started Guide (in PDF format) in a browser window. Requires Acrobat Reader.
Toon Boom on the Web	Opens the Toon Boom website, which features a Support and Community > Forum section.
Customer Experience Improvement Program	<p>The Customer Experience Improvement Program allows Toon Boom to collect usage information. The data does not contain any personally identifiable information and cannot be used to identify you. The data will consist of a basic hardware description, a project summary and usage information. The information is used only for software improvement purposes, as well as for sharing with third parties for the same reason.</p> <p>This program is enabled by default but is voluntary. If you prefer not to participate, you can opt out when you first launch the software, by using a global preference, or by a command line argument.</p>
About	Identifies the product name and version number.
Show Welcome Screen	Displays the Harmony Welcome screen.
Show End User License Agreement	Displays the End User License Agreement.
Debug Mode	When enabled, information is logged in the Message Log view about the preview generated in the Camera view, each time the preview is refreshed. In OpenGL preview mode, summary information is logged about the amount of nodes to process and the time it takes to generate

the preview. In Render Preview mode, detailed information about each composite and effect that is processed is logged.

Additionally, this option makes the Node view display information on each of its node about the amount of time a node must be processed to generate the OpenGL preview, and the total amount of time (in milliseconds) it takes for the node to process all its ingoing connections.

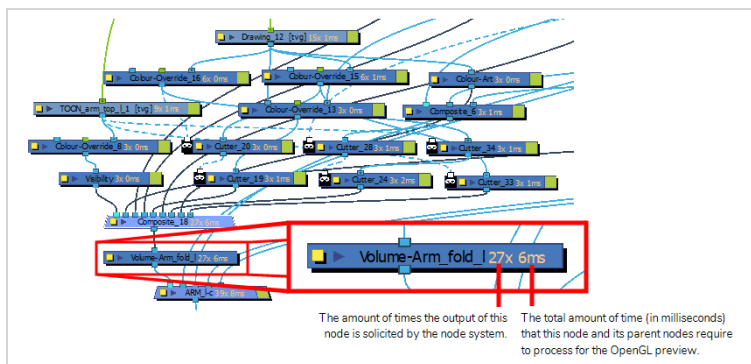

This can be useful if the complexity of a scene is impacting application performance, as it may help you identify the parts of your node system that have the most impact on the time it takes to generate the preview.



NOTE

The time indicated is cumulative from the top-down. This means a child node will always indicate that it takes at least as much time to process as its parent.

Shortcuts

Displays the complete list of keyboard shortcuts for Harmony.

Insert Menu

The Insert menu lets you create empty symbols in the Library view, different types of layers in the Timeline view, keyframes and control points.

How to access the Insert menu

- At the top of the interface, select **Insert**.

Command	Description
Create Empty Symbol in Library	Creates an empty symbol in the Library view to which you can edit (add content).
Bone	Adds a new Bone layer to the Timeline view.
Camera	Adds a new Camera layer to the Timeline view.
Colour-Card	Adds a new Colour-Card layer to the Timeline view.
Drawing	Adds a new Drawing layer to the Timeline view and a column in the Xsheet view.
Game Bone	Adds a new Game Bone layer to the Timeline and Node views.
Group	Adds a new Group layer to the Timeline and Node views.
Kinematic Output	Adds dd a new Kinematic Output layer to the Timeline and Node views.
Peg	Adds a new Peg layer to the Timeline and Node views.
Quadmap	Adds a new Quadmap layer to the Timeline and Node views.
Particle	
Basic Particle System	Adds a new layer with a basic particle system in the Timeline and Node views.

Basic Gravity-based System	Adds a new layer with a basic gravity-based particle system in the Timeline view.
Keyframe	Adds a keyframe to the selected cell in the Timeline view.
Keyframe and Duplicate Drawing	Adds a keyframe to the selected drawing layer cell in the Timeline view and creates a duplicate of the drawing, which sits on top of the original drawing.
Position Keyframe	Adds a position keyframe whereby keyframes will only be added on the X, Y and Z parameters of the selected layer. Keyframes are not added on the Angle, Scale and Skew parameters.
Control Point	Adds a control point to the trajectory of the selected element or peg in the Camera view when the element or peg is in a 3D path. Note that you must have a 3D path in the peg portion in order to add a control point.

Play Menu

The Play menu lets you play back animation and sound. Use it to scrub the sound to create your lip-sync, loop the playback, navigate through frames, and change the playback range and speed.

How to access the Play menu

- At the top of the interface, select **Play**.

Command	Description
Play	Plays the scene in the Camera or Drawing view.
Render and Play	<p>Renders your scene's frames, then opens the rendered frames in Play for playback.</p> <p>This allows you to preview your scene's animation in real time, with the effects rendered and with no risk of slowdown.</p>
Record and Play	<p>Exports your scene as it appears in the Camera view into a movie file, then opens it in your workstation's default video player.</p> <p>This allows you to preview your animation without any risk of slowdown, but it does not preview the effects in your scene. However, it is much faster than Render and Play.</p> <p>This button automates the usage of the Export OpenGL Frames dialog see</p>
Test SWF Movie	Quickly exports your scene as a Flash Movie (.swf), then opens it in your workstation's default web browser.
Stop	Stops playback.
Mini Playback	Open the Mini Playback dialog. This dialog allows you to set the amount of frames before and after the current frame to playback when using Mini Playback, to set the speed of Mini Playback and to start Mini Playback.
Start Mini Playback	Begins Mini Playback using the last settings entered in the Mini Playback dialog. By default, Mini Playback will play 5 frames before and after the current frame, at the scene's frame rate.

Playback Speed	Opens the Set New Frame Rate dialog box where you can set the frame rate at which the playback plays.
Loop	If pressed, your scene will repeat indefinitely when playing. Otherwise, it will stop when the end is reached.
Enable Sound	Turns on sound during playback.
Enable Sound Scrubbing	Turns on sound scrubbing during playback.
Start Frame	Opens the Set Playback Start Frame dialog box , in which you can enter the frame number from which to start playback.
Stop Frame	Opens the Set Playback Stop Frame dialog box, in which you can set the frame number at which to stop playback.
First Frame	Moves the red playhead to the first frame.
Previous Frame	Moves the red playhead to the previous frame.
Next Frame	Moves the red playhead to the next frame.
Last Frame	Moves the red playhead to the last frame.
Go to Frame	Opens the Go to Frame dialog box where you can enter the frame number on which the red playhead to be positioned in the Timeline view.
Enable Playback	
Top View	Plays back your animation in the Top view.
Side View	Plays back your animation in the Side view.
Perspective View	Plays back your animation in the Perspective view.

Scene Menu

The Scene menu lets you set the scene length, add frames to the scene, view different displays of the scene, set render options, access the Scene Settings dialog box and Elements Manager window, and verify the drawing and palette files in your project.

How to access the Scene menu

- At the top of the interface, select **Scene**.

Command	Description
Scene Length	Lets you set the length of the scene in frames.
Frame	
Add Frames at Start	Adds the number of frames you specify to the beginning of the scene.
Add Frames at End	Adds the number of frames you specify to the end of the scene.
Add Frames Before Selection	Adds the number of frames you specify before or after your selection.
Add Frames After Selection	
Remove Selected Frames	Deletes the selected frames from your scene.
Camera	
Default Camera	Lets you select a camera. If you only add one camera to your scene, you will only see Default Camera in your list.
Default Display	
Display All	Shows the contents of a specific Display node, updating the contents of the Camera, Top, Side, Perspective, and Timeline views.
Display	
Scene Settings	Opens the Scene Settings dialog box where you can set the resolution, alignment, bitmap resolution and many other parameters.

Render	
Auto Render	Automatically recalculates the preview image whenever you modify a parameter. If your scene is heavy and you do not want the preview rendered automatically, deselect the Auto-Render option and do the preview update manually. Note that this will slow down Harmony as it takes resources to update every frame.
Auto Render Write	Renders a frame each time the current frame is changed. You must have a Write node in your node structure to use this command.
Recalculate All	Refreshes the node structure and rerenders the display when the Camera view is in render mode.
Recalculate Selected	Refreshes the node structure and rerenders the display of selected elements when the Camera View is in render mode.
Cancel Preview Render	Cancels a render that was started.
Element Manager	Opens the Element Manager window where you can add, delete or modify elements (drawing folders) in your scene. If you have drawing folders that are not linked to a column in your scene, use the Element Manager to delete them if needed. See xref Reference > Windows > Element Manager .
Check Files	Verifies the integrity of the drawing and palette files in your project.

View Menu



The View menu lets you manipulate the view by zooming, panning, or rotating. You can also display the grid and change its size, use the onion skin feature to help with drawing, and set the preview resolution.

How to access the View menu





- At the top of the interface, select **View**.





Command	Description
Toggle Full Screen	<p>Cycles through the following display modes:</p> <ul style="list-style-type: none"> • Normal Full-Screen: The main application window becomes full screen. • View Full-Screen: The selected view becomes full screen and all other views are collapsed. • Normal: The main application window is restored to its original size and collapsed views are expanded.
Zoom In	Zooms in the view.
Zoom Out	Zooms out the view.
Rotate View CW	Rotates the Camera view 30 degrees clockwise, like an animation table.
Rotate View CCW	Rotates the Camera view 30 degrees counter-clockwise, like an animation table.
Mirror View	Temporarily flips the Camera or Drawing view horizontally, allowing you to view and edit your artwork as if it was being mirrored.
Reset Zoom	Resets the view's zoom to its default position.
Reset Rotation	Resets the view's rotation to its default position.
Reset Pan	Resets the view's pan to its default position.
Reset View	Resets the view to its default position.

Next Colour	Goes to the next colour in the Colour view.
Previous Colour	Goes to the previous colour in the Colour view.
Grid	
Show Grid	Displays the grid.
Grid Outline Only	Displays the outline of the grid only.
Underlay	Displays the grid under the drawing elements.
Overlay	Displays the grid over the drawing elements.
Square Grid	Displays a standard square grid.
12 Field Grid	Displays a 12-field size grid.
16 Field Grid	Displays a 16-field size grid.
Onion Skin	
Show Onion Skin	Lets you preview the previous and next drawings. By default, the previous drawings appear in a shade of red and the next drawings are displayed with a shade of green. You can change these colours in the Preferences dialog box.
Add to Onion Skin	Adds a series of selected elements to the onion skin preview.
Remove from Onion Skin	Removes a series of selected elements from the onion skin preview.
Remove Unselected from Onion Skin	Removes all elements except the ones selected from the onion skin preview.
Add All to Onion Skin	Adds all of the scene's elements to the onion skin preview.
Remove All from Onion Skin	Removes all of the scene's elements from the onion skin preview.

<p>Onion Skinning by Frames</p>	<p>Selects the drawings to display in the Onion Skin by their frame number relative to the current frame. For example, if the Onion Skin is set to include 2 drawings before and after the current frame, it will include the drawings up to two frames before and up to two frames after the current frame, even if those drawings are the same as the one in the current frame. This is more useful for cut-out animation as it allows you to position a drawing relative to its position in adjacent frames.</p> <div data-bbox="680 499 1427 638" style="border: 1px solid #c8e6c9; padding: 5px;">  <p>NOTE This option only works in the Camera view.</p> </div>
<p>Onion Skinning by Drawings</p>	<p>Selects the drawings to display in the Onion Skin by the amount of different drawings before and after the current frame. For example, if the Onion Skin is set to include 2 drawings before and after the current frame, this will display the nearest two different drawings before and after the drawing in the current frame in the Onion Skin, even if those drawings are further than 2 frames away from the current frame. This is more useful for frame-by-frame animation.</p> <div data-bbox="680 968 1427 1171" style="border: 1px solid #c8e6c9; padding: 5px;">  <p>NOTE When this option is enabled, the handles allowing you to adjust the extent of the Onion Skin in the Timeline view are not available.</p> </div>
<p>No Previous Drawing</p>	<p>Removes the previous drawing's onion skin and displays only the next drawing.</p>
<p>Previous Drawing</p>	<p>Displays the previous drawing.</p>
<p>Previous Two Drawings</p>	<p>Displays the previous two drawings.</p>
<p>Previous Three Drawings</p>	<p>Displays the previous three drawings.</p>
<p>No Next Drawing</p>	<p>Do not show the onion skin for all of the next drawings.</p>
<p>Next Drawing</p>	<p>Show the onion skin for the next drawing.</p>
<p>Next Two Drawings</p>	<p>Show the onion skin for the next two drawings.</p>

Next Three Drawings	Show the onion skin for the next three drawings.
Reduce One Previous Drawing	Reduces the number of previous visible drawings by one.
Add One Previous Drawing	Adds one drawing to the number of previous visible drawings.
Reduce One Next Drawing	Reduces the number of next visible drawings by one.
Add One Next Drawing	Adds one drawing to the number of next visible drawings.
Light Table	Turns on the light table so you can see the previous and subsequent active layers in washed-out colours. It is useful for seeing the other layers when designing, animating or cleaning up your animation.
Backlight	Produces a silhouette effect by changing the drawing's coloured areas into a single dark, solid colour. Use this to verify the completeness of the ink and paint process. Any unpainted zones can be seen as the light shows through the unpainted areas of the silhouetted drawing.
Show	
Symbol Pivot	Displays a symbol's pivot. The Symbol pivot is similar to the Drawing pivot. Each symbol cell can have its own pivot and act the same as the Drawing pivot. The Symbol pivot can also be referred to as embedded pivot. Inside a symbol, each drawing can have its own pivot.
Safe Area	Displays the TV safety zone and the centre of the camera frame. The safe area adapts to the scene resolution, as well as the safety zone and frame's centre.
Camera Mask	Displays a black mask around the scene's frame to avoid seeing the unnecessary artwork. This option is handy when you're animating and setting up the scene. It allows you to see your scene's composition better.
Control	Displays the controls of the selected element.
Current Drawing on Top	Displays the selected drawing on top of everything while you draw. By enabling this option, each time you select a drawing tool, the selected drawing is displayed in front of everything in the Camera view. The Timeline and Node view ordering remain unchanged. You only need to

	enable this option once, it is not necessary to do it each time you select a drawing tool.
Outline Locked Drawings	Displays drawing that are locked in the Timeline view (cannot be selected in the Camera view) as wireframes.
Show Strokes	Displays the strokes in your drawings so that the invisible lines stand out.
Show Strokes with Colour Wash	Displays strokes with washed-out colours.
Hide All Controls	Hides the controls of the selected element.
Deformation	
Show Current Deformers and Hide All Others	Shows all current deformers and hides all other manipulators displayed in the Camera view.
Alignment Guides	Alignment Guides
Show Alignment Guides	<p>When enabled, alignment guides will be visible in the Camera and Drawing views.</p> <p>This is enabled by default. Disabling this option will hide and disable alignment guides, meaning that animation and drawing tools will not snap to them, even if the  Snap to Alignment Guides option is enabled in the Tool Properties view.</p>
Lock Alignment Guides	It is possible to reposition alignment guides in the current panel by dragging them using the  Transform tool. Enabling this option will lock the alignment guides in their current position, allowing you to manipulate layers and artwork in your scene without accidentally moving alignment guides.
Clear Alignment Guides	Removes all the alignment guides from your scene.
New Horizontal Alignment Guide	<p>Adds a horizontal alignment guide to the middle of the stage.</p> <div style="border: 1px solid #0070C0; padding: 10px; margin-top: 10px;"> <p> TIP You can move the alignment guide from its default position using the  Transform tool or the  Select tool.</p> </div>

New Vertical Alignment Guide	<p>Adds a vertical alignment guide to the middle of the stage.</p> <div data-bbox="678 247 1429 424" style="border: 1px solid #0070C0; padding: 10px;">  TIP You can move the alignment guide from its default position using the  Transform tool or the  Select tool. </div>
Particle	
Show Particles as Dots in OpenGL	Displays the particles as dots in the OpenGL preview mode. This makes the playback speed faster for a heavy scene.
Preview Manager	Opens the Preview Manager where you can set options for the quality of previews, and clearing and updating the cache.
Preview Resolution	
Same as Scene Resolution	Lets you choose a resolution for previewing a scene.
3/4 of Scene Resolution	
1/2 of Scene Resolution	
1/3 of Scene Resolution	
1/4 of Scene Resolution	
Custom	Lets you select a resolution from a list of presets or enter X and Y values for a custom preview resolution.
Bitmap File Quality	<p>Lets you increase or decrease the preview quality of raw bitmap images. By default, bitmap files imported in Harmony will display in a low resolution in the Camera view to avoid hindering performance.</p> <div data-bbox="678 1633 1429 1869" style="border: 1px solid #0070C0; padding: 10px;">  TIP You can change the default resolution in which bitmap files are displayed in the Camera view by changing the Small Bitmap Resolution preference located in the Camera tab of the Preferences dialog. </div>



NOTE

This only affects the way bitmap images display in the OpenGL preview of the scene in the Camera view. The preview quality of bitmap images does not affect the final render.

Windows Menu

The Windows menu lets you customize your workspace to suit your working style, save it as a new workspace, and load it from the Workspace toolbar. You can also show or hide the different toolbars and views in Harmony.

How to access the Windows menu

- From the top menu, select **Windows**.

Command	Description
Restore Default Workspace	Returns modified workspaces to their original default layout if you do not like the current modifications or inadvertently closed some windows.
Workspace	
Workspace Manager	Opens the Workspace Manager where you can modify, create, delete, rename and reorder your workspaces.
Save Workspace	Saves the current workspace along with any modifications you made.
Save Workspace As...	Saves the workspace as a new version to avoid overwriting the current one.
Workspace	Lets you open workspaces designed specifically for animating, compositing, hand drawing, scripting and the default workspace.
Toolbars	Allows you to add or remove toolbars from your workspace. <div data-bbox="678 1451 1430 1625" style="border: 1px solid #c8e6c9; padding: 10px; margin-top: 10px;">  <p>NOTE For information on the different toolbars in Harmony, see Toolbars.</p> </div>
Camera	Shows or hides the Camera view.
Colour	Shows or hides the Colour view.
Coord. and Control Points	Shows or hides the Coordinates and Control Points view.

Drawing	Shows or hides the Drawing view.
Function	Shows or hides the Function view.
Layer Properties	Shows or hides the Layer Properties view.
Library	Shows or hides the Library view.
Message Log	Shows or hides the Message Log view.
Model	Shows or hides the Model view.
Node Library	Shows or hides the Library view.
Node View	Shows or hides the Node view.
Perspective	Shows or hides the Perspective view.
Side	Shows or hides the Side view.
Timeline	Shows or hides the Timeline view.
Tool Properties	Shows or hides the Tool Properties view.
Top	Shows or hides the Top view.
Xsheet	Shows or hides the Xsheet view.
3D Graph	Shows or hides the 3D Graph view.
Integrated Help	Shows or hides the Integrated Help view.
Metadata Editor	Shows or Hides the Metadata Editor view.
Script Editor	Shows or hides the Script Editor view.

View Menus

A view menu contains commands specifically related to that view.

How to access a view menu

1. In the top-left corner of a view, click the Menu  button.

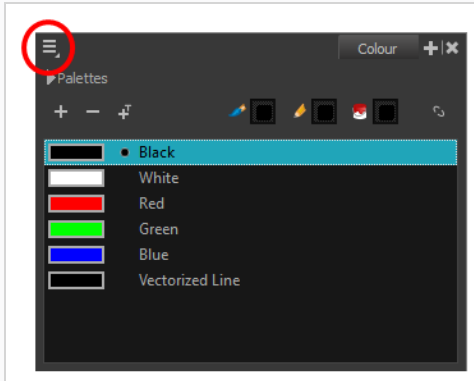



3D Graph View Menu	319
Camera View Menu	321
Colour View Menu	338
Drawing View Menu	341
Function View Menu	354
Library View Menu	356
Model View Menu	358
Node View Menu	360
Node Library View Menu	365
Onion Skin View Menu	366
Perspective View Menu	368
Script Editor View Menu	374
Side View Menu	379
Timeline View Menu	384
Top View Menu	389
Xsheet View Menu	394

3D Graph View Menu

The 3D Graph View menu lets you access commands related to the 3D Graph view, such as selecting different subnodes, disabling and enabling subnodes and inserting the 3D Kinematic Output node.

How to access the 3D Graph menu

- In the upper-left corner of the 3D Graph view, click the menu  button.

Command	Description
Edit	
Copy Subnode Name	<p>Copies the name of the currently selected subnode. This can be useful if you need to enter the name of a subnode in the properties of a 3D Kinematic Output node.</p> <div style="border: 1px solid #00a0e3; padding: 10px; margin-top: 10px;"> <p> TIP You can also automatically create a 3D Kinematic Output node with the selected subnode's name in its properties by selecting the subnode in the 3D Graph view, then clicking on Add 3D Kinematic Output  in the 3D Graph toolbar.</p> </div>
Select All	Selects all the listed subnodes.
Deselect All	Deselects all the subnodes.
Select Child Subnodes	Changes the selection to the first subnode that is a child of the currently selected subnode.
Select Parent Subnode	Changes the selection to the parent of the currently selected subnode.
Select Next Sibling Subnode	Changes the selection to the subnode just below the currently selected subnode in the list, provided that they have the same parent.
Select Previous Sibling Subnode	Changes the selection to the subnode just above the currently selected subnode in the list, provided that they have the same parent.
Subnodes	

Enable	Enables the selected subnode, making it and all its enabled children visible. You can also enable a selection of multiple subnodes.
Disable	Disables the selected subnode, making it and all its children invisible. You can also disable a selection of multiple subnodes.
Insert	
Make Properties Available	When the 3D model is connected to a Subnode Animation node, this will add the properties (ie: position, angle, scale) of the selected subnode to the Subnode Animation node's list of properties in the Timeline view. This is useful if you want to add keyframes to a subnode before animating it or if you want to outline which subnodes should be animated and which ones should not.
3D Kinematic Output	Creates a 3D Kinematic Output node and connects it under the 3D Model's Subnode Animation node. This 3D Kinematic Output node will be configured to use the currently selected subnode's animation. You can then connect this 3D Kinematic Output node to an element in your scene to apply the selected subnode's animation to that element.
Extended Mode	Displays non-key subnodes in the subnode list. By default, those nodes are hidden because they are not useful for animation and they can significantly bloat up the subnode list. However, it may be useful to have access to these nodes in order to debug issues with the visibility of parts of your 3D model.

Camera View Menu

The Camera View menu lets you do many things in the Camera view, including selecting and editing objects in different views, changing the display, setting morphing parameters, accessing tools and many more.

How to access the Camera menu

- In the upper-left corner of the Camera view, click the menu  button.

Command	Description
Edit	
Cut	Removes selected objects. You can then paste the object or its properties to another object.
Copy	Copies selected objects and properties.
Paste	Places an object you cut or copied into the location you select in a view.
Delete	Removes selected objects.
Select All	Selects all drawing objects in the current drawing window in the Drawing, Timeline and Camera views. This helps you manage multiple objects as one when moving them.
Deselect All	Deselects all selected objects in the Drawing and Camera views.
Select Strokes With Current Colour	Selects all the strokes that are filled with the colour or texture that's currently selected in the Colour view.
Select Strokes With Current Pencil Texture	Selects all the pencil lines that use the pencil line texture that's currently selected in the Colour view.
Invert Selection	Deselects the currently selected items and selects all other items that were not selected. For example, if some lines are selected in a drawing, this command will deselect them and select any other lines in the drawing that were not selected.
Select Child Skipping	Lets you select the first element parented to the selected peg element in the



Effects	Timeline view skipping effects in the hierarchy.
Select Child	Lets you select the first element parented to the selected peg element in the Timeline view.
Select Children	Lets you select all elements parented to the selected peg element in the Timeline view.
Select Parent Skipping Effects	Lets you select the parent of the selected element in the Timeline view skipping effects in the hierarchy.
Select Parent	Lets you select the parent of the selected element in the Timeline view.
Select Previous Sibling	Lets you select the previous element (above current element) in the Timeline view.
Select Next Sibling	Lets you select the next element (below current element) in the Timeline view.
Group	Group: Groups selected drawing objects in the Camera or Drawing view.
	Ungroup: Ungroups a selected group of drawing objects in the Camera or Drawing view.
View	
Navigation	Zoom In: Zooms in the view.
	Zoom Out: Zooms out the view.
	Rotate View CW: Rotates the Camera view 30 degrees clockwise, like an animation table.
	Rotate View CCW: Rotates the Camera view 30 degrees counter-clockwise, like an animation table.
	Reset Zoom: Resets the view's zoom to its default position.
	Reset Rotation: Resets the view's rotation to its default position.

	<p>Reset Pan: Resets the view's pan to its default position.</p>
	<p>Reset View: Resets the view to its default position.</p>
Switch to Colour Art	Displays the Colour Art layer. When switching art layers, you can edit the selected layer without affecting the other one.
Preview Line Art and Colour Art	Displays all Art layers.
Open GL View	Switches the Camera view to fast display, letting you see your animation play in real time. The OpenGL display requires less memory. The final look of your effects is not shown in the OpenGL View Mode. You must switch to the Render View Mode to see your effects.
Render View	Switches the Camera view to a fully rendered display showing the final image of the current frame. If a modification is done to your current frame or if you move to a different frame, click the Update Preview button to update the display if your preview does not update automatically. The Render View Mode display lets you see the final look of your frames including effects and antialiasing. You cannot play back your scene in Render View Mode. To see your scene fully rendered and to play it back, you must press the Render and Play button in the Playback toolbar.
Matte View	Switches the Camera view to a matte display showing the alpha channel of the elements in your scene. The transparency level ranges from 0 to 100 percent. Zero percent is completely transparent and represented by black and 100 percent is completely opaque and represented by white. Everything in between these extremes has a transparency level somewhere between 1 and 99 percent and is represented in various shades of grey.
Grid	Show Grid: Displays the grid.
	Grid Outline Only: Displays the outline of the grid only.
	Underlay: Displays the grid under the drawing elements.
	Overlay: Displays the grid over the drawing elements.
	Square Grid: Displays a standard square grid.

	<p>12 Field Grid: Displays a 12-field size grid.</p>
	<p>16 Field Grid: Displays a 16-field size grid.</p>
Onion Skin	<p>Show Onion Skin: Lets Lets you preview the previous and next drawings. By default, the previous drawings appear in a shade of red and the next drawings are displayed with a shade of green. You can change these colours in the Preferences dialog box.</p>
	<p>Add to Onion Skin: Adds Adds a series of selected elements to the onion skin preview.</p>
	<p>Remove from Onion Skin: Removes Removes a series of selected elements from the onion skin preview.</p>
	<p>Remove Unselected from Onion Skin: Removes Removes all elements except the ones selected from the onion skin preview.</p>
	<p>Add All to Onion Skin: Adds Adds all of the scene's elements to the onion skin preview.</p>
	<p>Remove All from Onion Skin: Removes Removes all of the scene's elements from the onion skin preview.</p>
	<p>Onion Skinning by Drawing:</p>
	<p>No Previous Drawing:</p>
	<p>Previous Drawing: Displays the previous drawing.</p>
	<p>Previous Two Drawings: Displays the previous two drawings.</p>
	<p>Previous Three Drawings: Displays the previous three drawings.</p>
	<p>No Next Drawing: Displays no next drawing.</p>
	<p>Next Drawing: Displays the next drawing.</p>
	<p>Next Two Drawings: Displays the next two drawings.</p>

	Next Three Drawings: Displays the next three drawings.
	Reduce One Previous Drawing: Reduces the number of previous visible drawings by one.
	Add One Previous Drawing: Adds one drawing to the number of previous visible drawings.
	Reduce One Next Drawing: Reduces the number of next visible drawings by one.
	Add One Next Drawing: Adds one drawing to the number of next visible drawings.
Light Table	Turns on the light table so you can see Turns on the light table so you can see the previous and subsequent active layers in washed-out colours. It is useful for seeing the other layers when designing, animating or cleaning up your animation.
Backlight	Produces Produces a silhouette effect by changing the drawing's coloured areas into a single dark, solid colour. Use this to verify the completeness of the ink and paint process. Any unpainted zones can be seen as the light shows through the unpainted areas of the silhouetted drawing.
Show	Symbol Pivot: Displays a symbol's pivot. The Symbol pivot is similar to the Drawing pivot. Each symbol cell can have its own pivot and act the same as the Drawing pivot. The Symbol pivot can also be referred to as <i>embedded pivot</i> . Inside a symbol, each drawing can have its own pivot.
	Safe Area: Displays Displays the TV safety zone and the centre of the camera frame. The safe area adapts to the scene resolution, as well as the safety zone and frame's centre.
	Camera Mask: Displays Displays a black mask around the scene's frame to avoid seeing the unnecessary artwork. This option is handy when you're animating and setting up the scene. It allows you to see your scene's composition better.
	Control: Displays the controls of the selected element.
	BBox Selection Style: Lets you change the display style of selected elements to a bounding box style. This removes the default overlay highlight and leaves only the bounding box around the selected element.

	<p>Outline Locked Drawings: Drawings that are locked in the Timeline view (cannot be selected in the Camera view) are displayed as wireframes.</p>
	<p>Show Current Drawing on Top: Displays Displays the selected drawing on top of everything while you draw. By enabling this option, each time you select a drawing tool, the selected drawing is displayed in front of everything in the Camera view. The Timeline and Node view ordering remain unchanged. You only need to enable this option once, it is not necessary to do it each time you select a drawing tool.</p>
	<p>Show Strokes: Displays the strokes in your drawings so that the invisible lines stand out.</p>
	<p>Show Strokes with Colour Wash: Displays strokes with washed-out colours.</p>
	<p>Highlight Selected Colour:</p>
	<p>Show Scan Information: Displays a status bar showing the scanning information at the bottom of the Drawing and Camera view.</p>
Hide All Controls	Hides the controls of the selected element.
Render Current Frame	Renders only the current frame.
Auto Render	Automatically recalculates the preview image whenever you modify a parameter. If your scene is heavy and you do not want the preview rendered automatically, deselect the Auto-Render option and do the preview update manually. Note that this will slow down Harmony as it takes resources to update every frame.
Layer Properties	Displays the Layer Properties window of the selected layer in the Timeline view.
Preview Manager	Opens the Preview Manager where you can set options for the quality of previews, and clearing and updating the cache.
Bitmap File Quality	Let's you increase or decrease the preview quality of raw bitmap images. By default, bitmap files imported in Harmony will display in a low resolution in the Camera view to avoid hindering performance.

	<div data-bbox="558 191 1430 390" style="border: 1px solid #4a90e2; padding: 10px; margin-bottom: 10px;">  <p>TIP You can change the default resolution in which bitmap files are displayed in the Camera view by changing the Small Bitmap Resolution preference located in the Camera tab of the Preferences dialog.</p> </div> <div data-bbox="558 420 1430 619" style="border: 1px solid #7ed321; padding: 10px;">  <p>NOTE This only affects the way bitmap images display in the OpenGL preview of the scene in the Camera view. The preview quality of bitmap images does not affect the final render.</p> </div>
<p>Drawing</p>	
<p>Clean Up</p>	<p>Remove Dirt: Opens the Remove Dirt dialog box where you can specify the number and size of dots removal from a selected drawing.</p> <p>Remove Hair: Opens the Remove Hair dialog box where you can specify the number and length of hairs for removal from a selected drawing. This removes any small strokes created in the Colour Art layer from very thick lines or filled zones. Increase the value to select larger strokes for removal from the drawing.</p> <p>Close Gaps: Closes small gaps in a drawing by creating small, invisible strokes between the two closest points to close the colour zone. You do not need to trace directly over the gap. You can draw it a few millimeters away. The two closest points automatically close the gap.</p> <p>Remove Art Inside Selection: Removes any art inside a selection. It is recommended that you clean your Colour Art level as well. If you have a stroke accumulation in the Colour Art, it can result in large output files, especially if you work in high definition resolutions.</p> <p>Remove Art Inside Selection On All Drawings: Removes any art inside all drawings selected with the Permanent Selection option in the Select tool.</p> <p>Remove Art Outside Selection: Removes any art existing outside a selection. It is recommended that you clean the Colour Art level as well. If you have a stroke accumulation in the Colour Art, it can result in large output files, especially if you work in high-definition resolutions.</p> <p>Remove Art Outside Selection On All Drawings: Removes any art outside all drawings selected with the Permanent Selection option in the Select tool.</p>

Paint	Unpaint Selection: Unpaints any art existing inside a selection.
	Unpaint Selection on All Drawings: Unpaints all art contained inside a selection on all the drawings within the same layer.
	Unpaint Outside Selection: Unpaints any art existing outside a selection. If no selection have been drawn using the Select tool, the entire drawing will be unpainted.
	Unpaint Outside Selection on All Drawings: Unpaints all art outside a selection on all the drawings within the same layer.
	Repaint Selection: Repaints any art inside a selection.
	Repaint Selection on All Drawings: Repaints any art inside a selection on all the drawings contained within the same layer.
	Repaint Outside Selection: Repaints any art outside a selection. If no selection has been drawn using the Select tool, the entire drawing will be repainted.
	Repaint Outside Selection on All Drawings: Repaints any art outside a selection on all the drawings contained within the same layer.
Convert	Pencil Lines to Brush Strokes: Converts the selected centreline pencil strokes into contour strokes brush lines.
	Brush Strokes to Pencil Lines: Converts selected contour strokes into centreline pencil strokes. The brush stroke thickness will be lost.
	Strokes to Pencil Lines: Converts the selected invisible line to a pencil line.
	Brush Apart Text Layers: Text is treated as a single drawing object. This separates the text so each character becomes an individual drawing object you can select and modify independently.
Optimize	Flatten: Merges Merges drawing objects and brush strokes into a single layer. If you draw new lines to fix a drawing or line with many brush strokes, it can be useful to flatten them all into a single shape. By default, lines are drawn one on top of each other. If you intend to repaint the lines or modify their shape, it will be easier if they are flattened.

	<p>Smooth: Smooths selected drawing strokes and removes extra points.</p>
	<p>Create Contour Strokes: Adds a permanent invisible line around a shape that was drawn directly in Harmony. This allows you to unpaint lines with the Paint tool but maintain the shape of the lines, should you need to repaint later.</p>
	<p>Remove Contour Strokes: Remove any permanently invisible lines that were created while scanning and vectorizing drawings or manually adding contour strokes. This is useful for removing the intersection triangles created during vectorization.</p>
	<p>Remove Extra Strokes: Removes strokes inside painted area. This option only works after the painted drawing is flattened.</p>
	<p>Optimize: Reduces Reduces the number of layers, such as overlapping brush strokes, in the selected drawing objects. Drawing objects will only be flattened and optimized if the selected objects do not change the appearance of the final image when they are merged.</p>
	<p>Crop Brush Textures: Crops Crops an unnecessarily large texture bitmap that lies unseen beneath the vector contour of a textured line. This often occurs when you cut and paste textured lines from one drawing into another. If you cut a portion from a textured line and paste it into a different drawing, Harmony pastes the entire unseen texture bitmap from the source drawing into the new one, even if you only took a small portion of the source drawing. Using the Crop Brush Texture command will crop away extraneous texture that does not touch the vector area. If there are many textured lines in your scene, this will greatly reduce the file size.</p>
	<p>Reduce Drawing Texture Resolution: When you import and vectorize as texture (colour) a high resolution image, the size of your drawing can be heavy. You can reduce the size and resolution of the textures in a drawing.</p>
<p>Arrange</p>	<p>Bring to Front: Moves the selected art to the front (on top).</p>
	<p>Bring Forward: Moves the selected art one level forward (closer to the front).</p>
	<p>Send Backward: Moves the selected art one level lower (behind).</p>
	<p>Send to Back: Moves the selected art behind everything (bottom / back).</p>

Transform	Flip Horizontal: Flips the current selection horizontally.
	Flip Vertical: Flips the current selection vertically.
	Rotate 90 CW: Rotates the current selection 90 degrees clockwise.
	Rotate 90 CCW: Rotates the current selection 90 degrees counter-clockwise.
	Rotate 180: Rotates the current selection 180 degrees.
Create Empty Drawing	Creates a drawing in the selected cell, replacing any drawing that may already be exposed in that cell and the following ones until it meets another drawing, key exposure or a blank cell.
Duplicate Drawings	<p>Creates a duplicate of the selected drawing in the layer. The duplicate drawing will be exposed at the selected frame instead of the original drawing. Hence, this command allows you to instantly start working on a duplicate of the current drawing and retain the original.</p> <div style="border: 1px solid green; padding: 5px; margin-top: 10px;">  <p>NOTE When duplicating a drawing, the exposure at the selected cell is replaced with the new drawing, up until the next key exposure.</p> </div>
Delete Selected Drawings	Permanently removes selected drawings. Once you save your project, these drawings cannot be recovered.
Rename Drawing	Lets you give a selected drawing a new name.
Create Colour Art From Line Art	<p>Lets you use the outline you traced on one of the four embedded layers (line art, colour art, overlay, underlay) and create invisible strokes to paint your drawings on separate layers. This provides more inking and painting flexibility.</p> <p>You can also configure this option to create the invisible strokes on any of the four embedded layers.</p>
Generate Auto-Matte	<p>Automatically creates a matte from a selected drawing or all drawings on a layer.</p> <p>Opens the auto-Matte dialog box where you can set the radius of the lines depending on how precise or rough your line is.</p> <p>You can also select the source and destination layers from which the matte will be created.</p>

Adjust Line Texture Opacity	Lets you adjust the contrast and opacity of textured lines in a drawing.
Change Bitmap Drawing Resolution	Lets you Lets you change the resolution of bitmap art for individual drawings. You can reduce the resolution of your bitmap file as well as increase it. Be careful because enlarging the bitmap resolution on an existing drawing will result in a loss of quality.Harmony will perform a pixel smoothing pass (resampling) and create additional pixels to avoid losing too much quality, but only to a certain extent. This feature is very useful when you need to have a full resolution of a bitmap image (such as imported bitmaps as .psd or .tga for the background) for tracing to create a matte directly in Harmony.By default, Harmony creates small thumbnail images when imported as bitmap in order to increase performance by using a small thumbnail image instead of using the original large size bitmap for animation work in Harmony. This will make difficult to view details or trace due to the low resolution (blurry). This option temporary increases the resolution of bitmaps up to their original bitmap resolution to make tracing easier.
Previous Drawing	Once a cell is selected in the Timeline or Xsheet view, you can navigate between the drawings, frames, and layers. Displays the previous drawing, next drawing, previous layer or next layer. Displays the previous drawing, next drawing, previous layer or next layer.
Next Drawing	
Previous Layer	
Next Layer	
Colour Protection	Toggle Current Colour Protection: Temporarily enables/disables the Colour Protection feature so you can quickly correct wrongly inked or painted areas under protected colour without readjusting the Current Colour Protection option.
	Respect Colour Protection: In the Colour view, you can protect a colour swatch to avoid repainting or unpainting the zones linked to that swatch. If you using the Paint tool and this option is deselected, you will repaint or unpaint the protected colours on your drawings until you enable the option again.
Drawing Tools	
Select	Allows you to select and reposition, scale, rotate and skew brush strokes, pencil lines, shapes and other parts of your artwork.
Contour Editor	Allows you to edit the vector contours of brush strokes, pencil lines and shapes in your artwork. You can add, remove, tweak and move vector points, move the Bezier handles of the vector points as well as deform vector outlines.

Centerline Editor	Allows you to tweak and deform a brush stroke by manipulating the points at the centre of its line rather than its contour.
Pencil Editor	Lets you modify the thick and thin contour of a pencil line (basically a central vector shape). Shape control points along the central spine allow you to adjust the stroke curve and position.
Cutter	Allows you to cut a part of your artwork, then reposition, scale, rotate and skew it.
Smooth Editor	Allows you to optimize contours and lines by removing its extra points, making them easier to edit.
Perspective	Allows you to deform artwork by applying a perspective effect on it.
Envelope	Allows you to deform and warp artwork by moving points and tweaking lines in a grid.
Reposition All Drawings	Allows you to reposition, scale, rotate and skew all drawings in the current layer.
Drawing Pivot	Allows you to position the pivot on a drawing layer by clicking where you want its location to be.
Brush	A pressure-sensitive tool for creating a contour shape with a thick and thin line effect, as if created with a paint brush.
Pencil	A pressure-sensitive tool for drawing outlines. Pencil lines are made of central vector lines, making them easier to tweak and edit than brush strokes.
Text	Allows you to add text and to format it.
Eraser	A pressure-sensitive tool for erasing parts of a drawing.
Colour Eyedropper	Allows you to select a colour by clicking on a colour in your artwork.
Pencil Texture Eyedropper	Allows you to select a pencil texture by clicking on a textured pencil line.
Morphing	Allows you to create and configure a morphing sequence, which will automatically generate the in-betweens between two drawings in the current

	layer.
Line	Draws a straight line segment going from one point to the other.
Rectangle	Draws a rectangle.
Ellipse	Draws an ellipse.
Polyline	Allows you to draw shapes, segmented lines or complex curved lines by clicking to create each point in the sequence of line segments.
Paint	Allows you to fill colour zones with a colour or texture.
Ink	Allows you to recolour pencil lines with precision by changing the colour of one segment at a time.
Repaint Brush	Lets you repaint existing brush strokes. The new brush strokes will be cropped to fit in existing artwork.
Close Gap	Allows you to close open shapes so that they can be filled with the Paint tool. By drawing a stroke near a small gap in a shape, this tool will create a small invisible stroke connecting the two closest points around the gap.
Stroke	Allows you to create invisible lines that can serve as colour zones that can be filled, or close the gaps in existing colour zones.
Edit Gradient/Texture	Allows you to adjust the position, angle and size of gradients and textures in a colour zone.
Hand	Allows you to pan the Camera and Drawing views.
Zoom	Allows you zoom in and out of the Camera and Drawing views.
Rotate View	Lets you rotate the Camera and Drawing views just like with a real animation disc.
Animation	
Insert Keyframe	Adds a keyframe on the selected cell in the Timeline view.

Insert Control Point	Adds a control point to a 3D path function.
Set Stop-Motion Keyframe	Converts the selected keyframes to stop-motion keyframes. Between a stop-motion keyframe and the next keyframe, Harmony does not generate any animation and the element remains static until the next keyframe.
Set Motion Keyframe	Converts the selected keyframes to motion keyframes. With motion keyframes, Harmony generates the interpolation between the motion keyframe and the next keyframe. This means that a value for each frame between the keyframes is calculated by Harmony to progress from the value of the previous keyframe to the value of the next keyframe.
Flip	Flips the position of an element on its axis.
Set Ease for Multiple Parameters	Lets you set the ease in and ease out on multiple functions and keyframes. This opens the Set Ease For Multiple Parameters where you can modify the Bezier or Ease curve. You can apply easing parameters to a certain type of function only, such as rotation or scale.
Linear Motion	Transforms a curved path to a linear path removing tension, bias, and continuity.
Lock in Time	Indicates whether the point is locked to a specific frame (keyframe) or only locked to a specific position and the curve can flow through it freely as other points are being added, moved, or adjusted (control point).
No Z Dragging	Keeps the Z value constant when you drag a character using the Transform or Translate tool.
Substitute Drawing Previous	Replaces the drawing or cell's symbol on the current frame by the next drawing.
Substitute Drawing Next	
Select Previous Keyframe/Point	Select the previous keyframe/point.
Select Next Keyframe/Point	

Lock	Locks a layer so it cannot be selected in the Camera view.
Reset	Returns Returns the value of the selected element to the initial value of the active tool. For example, if the Rotate tool is active, the transformation angle will be reset to 0 and if the Transform tool is active, all the transformation values will be reset.
Reset All	Resets Resets all transformations on the current frame in a selected layer. Your keyframe will remain, but all the values will return to the starting value. All transformations are reset regardless of the tool you're using.
Reset All Except Z	Resets Resets all transformations on the current frame except the Z position. This is useful when doing cut-out animation. Cut-out puppets often have a particular Z ordering for the different views of a character. You might want to reset the transformation, but not necessarily the Z position.
Animation Tools	
Transform	Allows you to select drawing layers and position, rotate, scale and skew them.
Translate	Lets you move the selected element along the X and Y axes.
Rotate	Turns a selected element around its pivot point.
Scale	Increases or decreases the size of a selected element. You can scale an object up to make it larger or down to make it smaller. Press Shift to scale the element while maintaining its proportions.
Maintain Size	Keeps elements the same size aspect ratio in the Camera view as you move them towards or away from the camera.
Skew	Slants the selected element.
Reposition Drawing	Lets you reposition, scale, rotate or skew all drawing strokes on every drawing included in a layer.
Spline Offset	Lets you Lets you reposition the visual trajectory without offsetting or modifying your animation. By default, the trajectory is located at 0,0,0 fields. If your elements were drawn in a different location than the centre of the drawing area, it will look like the trajectory is not aligned with your drawing. Also, if you have several elements attached to one trajectory, you might want your trajectory to be at a different location to represent the group's motion better.

Inverse Kinematic Tool	Allows you to pose a character model by pulling on its extremities, such as hands and feet, and have the other connected limbs follow. Can be used on any piece connected in a hierarchy.
IK Constraints	
Set IK Nail	Blocks the X, Y and Z positions.
Set IK Hold Orientation	Blocks the angle.
Set IK Hold X	Blocks only the X position.
Set IK Hold Y	Blocks only the Y position.
Set IK Min Angle	Sets limitations on the angle parameter to prevent the puppet from bending too far.
Set IK Max Angle	
Remove All Constraints	Removes all nails except the minimum and maximum angles.
Morphing	
Morphing	Allows you to create and configure a morphing sequence, which will automatically generate the in-betweens between two drawings in the current layer.
Contour Hint	<p>The Contour Hint point is used on the colour fill zone and brush lines; in other words, on Contour vectors. It allows you to control the line thickness and contour position. Also, if a contour is not animated correctly, you can use hints to correct the animation. For example, if a flag is not waving properly.</p> <p>When adding a Contour Hint point, make sure to place it far enough away from the contour so you can see it snap to the contour.</p> <p>Contour Hint points are yellow.</p>
Zone Hint	<p>The Zone Hint point is used on a colour zone to control the proximity rule. The Zone Hint is placed in the centre of the colour zone. Sometimes a colour zone is not associated with the corresponding one by default. For example, in a splash animation there are many water droplets that are the same colour. Harmony</p>

	<p>automatically morphs the droplet to the nearest one. This is not always the one you may have predicted. A Zone Hint will force a colour zone to morph with another one.</p> <p>Zone Hint points are cyan in colour.</p>
Pencil Hint	<p>A Pencil Hint point is used to control a pencil line, also known as <i>central vector</i>. It can be used on drawings that were done using the Pencil, Polyline, Ellipse, Line and Rectangle tools. Like the Contour Hint, the Pencil Hint snaps to the central vector. Make sure to place it far enough away from the line so you will see it snap when you move it.</p> <p>Pencil Hint points are magenta in colour.</p>
Vanishing Point Hint	<p>A Vanishing Point Hint is used to control the trajectory of a vanishing shape. A shape will vanish from the source drawing when there is no corresponding shape in the destination drawing. If you do not place a Vanishing Point Hint to control the point of disappearance, the shape will vanish into its centre.</p> <p>Vanishing Point Hint points are green in colour.</p>
Appearing Point Hint	<p>An Appearing Point Hint is used to control the trajectory of an appearing shape. A shape will appear in the destination drawing when there is no corresponding shape in the source drawing. If you do not place an Appearing Point Hint to control the point of appearance, the shape will appear from its centre and expand outwards.</p> <p>Appearing Point Hint points are violet in colour.</p>
Switch Between Morphing Key Drawings	<p>Toggles Toggles between the two key drawings in your morphing sequence. This option is useful while setting hints. You can use the default keyboard shortcut F4 to toggle between your drawings.</p>
Suggest Hints	<p>Automatically sets Automatically sets hint points on key drawings as a help tool. If you're not sure where to set hints, you can use this option. It will set the main hints which you can then fine tune.</p>
Hide Hints	<p>Temporarily Temporarily hides the hint points from the key drawings. Use this option when you have a series of hint points hiding some lines you would like to see.</p>

Colour View Menu

The Colour View menu lets you access commands related to the Colour view such as creating new palettes, adding new colour swatches, and displaying the Tint panel.

How to access the Colour menu

- In the upper-left corner of the Colour view, click the menu  button.

Command	Description
Palettes	
New	Creates a new colour palette. By default, Toon Boom Harmony Premium is set to the Basic mode. For simple productions, it is recommended to use the Basic mode. This setting stores the palettes automatically for you and saves them at the Scene level. When you use the Advanced Palette Lists mode, you can decide at which level you want to store your palettes: Environment, Job, Scene, or Element.
Link	Lets you access other palettes created in the project and link them to your scene.
Link to External	Lets you you link an external palette to your scene without copying it in your project.
Import	Imports a colour palette located on your hard drive.
Remove	Removes the selected palette from the palette list.
Remove and Delete on Disk	Removes the selected palette from the palette list and deletes the palette file from the disk.
Rename	Lets you give the selected colour palette a new name.
Duplicate	Creates a copy of the original palette, using the same names and colour values, but has a different ID and is independent from the original palette. This ensures that both the duplicate and original palettes are completely independent.
Clone	Creates a copy of the master palette. The colours in each palette have the same properties. The colours have the same identification number pointing to the same

	colour zones, but they can have different names and RGBA values.
Pencil Texture Palette	Displays the colour palette containing the pencil line textures.
Move Up	Moves the selected colour palette up one level.
Move Down	Moves the selected colour palette down one level.
Colour Editor	Opens the Colour Editor where you can pick and edit colour swatches.
Tint Panel	Opens the Tint panel where you can modify a series of colours to blend a tint in them or offset their RGBA values.
Current Palette Overrides	When clone palettes are present in the palette list, by default, priority is given to the palette that is the highest in the palette list to decide which colours to apply to drawings. With this option enabled, priority is given to the currently selected palette. Selecting any of the clone palettes will make drawings use colours from the selected palette instead.
Display Colour Values	Display the colour values beside their colour swatches in the palette list.
Colours	
Cut	Cuts the selected colour swatch from the palette.
Copy	Copies the selected colour swatch which you can paste in a different palette.
Copy Colour ID	Copies a colour swatch's colour ID so you can keep a reference file of colour IDs or use them with custom plug-ins. Example of a colour ID: 075cf5b552401130 .
Paste Colour Values	Pastes the colour value of the copied swatch over an existing colour swatch.
Paste As New Colours	Creates a new colour swatch from the colour value of the copied swatch.
Paste As Clones	Pastes a copied colour to a new palette as a clone of the original one. Both colour use the same colour ID. They have to be in different palettes.

New	Creates a new colour swatch from the colour swatch that was last selected.
Edit	Opens the Colour Picker window in which you can edit the selected colour swatch.
Delete	Deletes the selected colour swatch from the palette.
New Texture	Lets you add a bitmap colour swatch to your palette. You can load photos and textures and paint your drawings with it. The bitmap image must be a .tga or .psd file format.
Edit Texture	Opens the browser to replace the texture used in a textured colour swatch. All zones using the swatch will be updated with the new texture.
Scale Down Texture	Lets you set a new maximum texture size or scaling factor.
New Default Colour	Creates a new colour using the default colour set in the preferences.
Protect Colour	Locks a selected colour, so if you ever paint over it accidentally, the work already done will not be affected. You can also block the filling colours if you painted all of the animation in Line Art and plan to repaint the lines.
Swatch Mode	Displays the colour swatches with its corresponding name inside the swatch. When this option is not selected, the names of the colour swatches are displayed beside the swatch.
Independent Bitmap Colour	Bitmap colour selection is independent from the vector colour selection.
Bitmap Colour Sliders	
RGB	Displays the colour picking sliders as RGB (red, green, blue).
HSV	Displays the colour picking sliders as HSV (hue, saturation, value).

Drawing View Menu

The Drawing View menu lets you access tools, set morphing parameters, lock or unlock layers, and select elements in the Drawing view.

How to access the Drawing menu

- In the upper-left corner of the Drawing view, click the menu  button.

Command	Description
Edit	
Cut	Removes selected objects. You can then paste the object or its properties to another object.
Copy	Copies selected objects and properties.
Paste	Places an object you cut or copied into the location you select in a view.
Delete	Removes selected objects.
Select All	Selects all drawing objects in the current drawing window in the Drawing, Timeline and Camera views. This helps you manage multiple objects as one when moving them.
Deselect All	Deselects all selected objects in the Drawing and Camera views.
Select Stroke With Current Colour	Selects all the strokes that are filled with the colour or texture that's currently selected in the Colour view.
Select Strokes With Current Pencil Texture	Selects all the pencil lines that use the pencil line texture that's currently selected in the Colour view.
Invert Selection	Deselects the currently selected items and selects all other items that were not selected. For example, if some lines are selected in a drawing, this command will deselect them and select any other lines in the drawing that were not selected.
View	

Zoom In	Zooms in the view.
Zoom Out	Zooms out the view.
Reset Zoom	Resets the view's zoom to its default position.
Rotate View CW	Rotates the Camera view 30 degrees clockwise, like an animation table.
Rotate View CCW	Rotates the Camera view 30 degrees counter-clockwise, like an animation table.
Reset Rotation	Resets the view's rotation to its default position.
Reset Pan	Resets the view's pan to its default position.
Reset View	Resets the view to its default position.
Switch to Colour Art	Displays the Colour Art layer. When switching art layers, you can edit the selected layer without affecting the other one.
Preview Line Art and Colour Art	Displays all Art layers.
Grid	Show Grid: Displays the grid.
	Grid Outline Only: Displays the outline of the grid only.
	Underlay: Displays the grid under the drawing elements.
	Overlay: Displays the grid over the drawing elements.
	Square Grid: Displays a standard square grid.
	12 Field Grid: Displays a 12-field size grid.
	16 Field Grid: Displays a 16-field size grid.
Onion Skin	Show Onion Skin: Lets Lets you preview the previous and next drawings. By

	<p>default, the previous drawings appear in a shade of red and the next drawings are displayed with a shade of green. You can change these colours in the Preferences dialog box.</p>
	<p>Show Centre Line:</p>
	<p>No Previous Drawing: Displays no previous drawing.</p>
	<p>Previous Drawing: Displays the previous drawing.</p>
	<p>Previous Two Drawings: Displays the previous two drawings.</p>
	<p>Previous Three Drawings: Displays the previous three drawings.</p>
	<p>No Next Drawing: Displays no next drawing.</p>
	<p>Next Drawing: Displays the next drawing.</p>
	<p>Next Two Drawings: Displays the next two drawings.</p>
	<p>Next Three Drawings: Displays the next three drawings.</p>
	<p>Reduce One Previous Drawing: Reduces the number of previous visible drawings by one.</p>
	<p>Add One Previous Drawing: Adds one drawing to the number of previous visible drawings.</p>
	<p>Reduce One Next Drawing: Reduces the number of next visible drawings by one.</p>
	<p>Add One Next Drawing: Adds one drawing to the number of next visible drawings.</p>
Light Table	<p>Turns on the light table so you can see the previous and subsequent active layers in washed-out colours. It is useful for seeing the other layers when designing, animating or cleaning up your animation.</p>
Backlight	<p>Produces a silhouette effect by changing the drawing's coloured areas into a single dark, solid colour. Use this to verify the completeness of the ink and paint process. Any unpainted zones can be seen as the light shows through the</p>

	unpainted areas of the silhouetted drawing.
Show	
Show Strokes	Displays the strokes in your drawings so that the invisible lines stand out.
Show Strokes with Colour Wash	Displays strokes with washed-out colours.
Highlight Selected Colour	Identify a selected colour swatch used in a drawing.
Show Morphing Key Drawing Thumbnail	When using the Morphing tools, this displays the source or destination drawing as a reference in the bottom corner of the Drawing view.
Show Scan Information	Displays a status bar showing the scanning information at the bottom of the Drawing and Camera view.
Desk	
No Thumbnail	Changes the size of the drawing desk thumbnails.
Small Thumbnail	
Medium Thumbnail	
Large Thumbnail	
Remove Selected Drawing	Clears selected drawing from drawing desk.
Remove All Drawings	Clears all drawing from drawing desk.
Drawing	
Clean Up	Remove Dirt: Opens the Remove Dirt dialog box where you can specify the number and size of dots removal from a selected drawing.

	<p>Remove Hair: Opens the Remove Hair dialog box where you can specify the number and length of hairs for removal from a selected drawing. This removes any small strokes created in the Colour Art layer from very thick lines or filled zones. Increase the value to select larger strokes for removal from the drawing.</p>
	<p>Close Gaps: Closes small gaps in a drawing by creating small, invisible strokes between the two closest points to close the colour zone. You do not need to trace directly over the gap. You can draw it a few millimeters away. The two closest points automatically close the gap.</p>
	<p>Remove Art Inside Selection: Removes any art inside a selection. It is recommended that you clean your Colour Art level as well. If you have a stroke accumulation in the Colour Art, it can result in large output files, especially if you work in high definition resolutions.</p>
	<p>Remove Art Inside Selection On All Drawings: Removes any art inside all drawings selected with the Permanent Selection option in the Select tool.</p>
	<p>Remove Art Outside Selection: Removes any art existing outside a selection. It is recommended that you clean the Colour Art level as well. If you have a stroke accumulation in the Colour Art, it can result in large output files, especially if you work in high-definition resolutions.</p>
	<p>Remove Art Outside Selection On All Drawings: Removes any art outside all drawings selected with the Permanent Selection option in the Select tool.</p>
<p>Paint</p>	<p>Unpaint Selection: Unpaints any art existing inside a selection.</p>
	<p>Unpaint Selection on All Drawings: Unpaints all art contained inside a selection on all the drawings within the same layer.</p>
	<p>Unpaint Outside Selection: Unpaints any art existing outside a selection. If no selection have been drawn using the Select tool, the entire drawing will be unpainted.</p>
	<p>Unpaint Outside Selection on All Drawings: Unpaints all art outside a selection on all the drawings within the same layer.</p>
	<p>Repaint Selection: Repaints any art inside a selection.</p>
	<p>Repaint Selection on All Drawings: Repaints any art inside a selection on all the drawings contained within the same layer.</p>

	<p>Repaint Outside Selection: Repaints any art outside a selection. If no selection has been drawn using the Select tool, the entire drawing will be repainted.</p>
	<p>Repaint Outside Selection on All Drawings: Repaints any art outside a selection on all the drawings contained within the same layer.</p>
Convert	<p>Pencil Lines to Brush Strokes: Converts the selected centreline pencil strokes into contour strokes brush lines.</p>
	<p>Brush Strokes to Pencil Lines: Converts selected contour strokes into centreline pencil strokes. The brush stroke thickness will be lost.</p>
	<p>Strokes to Pencil Lines: Converts the selected invisible line to a pencil line.</p>
	<p>Brush Apart Text Layers: Text is treated as a single drawing object. This separates the text so each character becomes an individual drawing object you can select and modify independently.</p>
Optimize	<p>Flatten: Merges Merges drawing objects and brush strokes into a single layer. If you draw new lines to fix a drawing or line with many brush strokes, it can be useful to flatten them all into a single shape. By default, lines are drawn one on top of each other. If you intend to repaint the lines or modify their shape, it will be easier if they are flattened.</p>
	<p>Smooth: Smooths selected drawing strokes and removes extra points.</p>
	<p>Create Contour Strokes: Adds a permanent invisible line around a shape that was drawn directly in Harmony. This allows you to unpaint lines with the Paint tool but maintain the shape of the lines, should you need to repaint later.</p>
	<p>Remove Contour Strokes: Remove any permanently invisible lines that were created while scanning and vectorizing drawings or manually adding contour strokes. This is useful for removing the intersection triangles created during vectorization.</p>
	<p>Remove Extra Strokes: Removes strokes inside painted area. This option only works after the painted drawing is flattened.</p>
	<p>Optimize: Reduces Reduces the number of layers, such as overlapping brush strokes, in the selected drawing objects. Drawing objects will only be flattened and optimized if the selected objects do not change the appearance of the final image when they are merged.</p>

	<p>Crop Brush Textures: Crops Crops an unnecessarily large texture bitmap that lies unseen beneath the vector contour of a textured line. This often occurs when you cut and paste textured lines from one drawing into another. If you cut a portion from a textured line and paste it into a different drawing, Harmony pastes the entire unseen texture bitmap from the source drawing into the new one, even if you only took a small portion of the source drawing. Using the Crop Brush Texture command will crop away extraneous texture that does not touch the vector area. If there are many textured lines in your scene, this will greatly reduce the file size.</p>
	<p>Reduce Drawing Texture Resolution:</p> <p>When you import and vectorize as texture (colour) a high resolution image, the size of your drawing can be heavy. You can reduce the size and resolution of the textures in a drawing.</p>
Arrange	<p>Bring to Front: Moves the selected art to the front (on top).</p>
	<p>Bring Forward: Moves the selected art one level forward (closer to the front).</p>
	<p>Send Backward: Moves the selected art one level lower (behind).</p>
	<p>Send to Back: Moves the selected art behind everything (bottom / back).</p>
Transform	<p>Flip Horizontal: Flips the current selection horizontally.</p>
	<p>Flip Vertical: Flips the current selection vertically.</p>
	<p>Rotate 90 CW: Rotates the current selection 90 degrees clockwise.</p>
	<p>Rotate 90 CCW: Rotates the current selection 90 degrees counter-clockwise.</p>
	<p>Rotate 180: Rotates the current selection 180 degrees.</p>
Create Empty Drawing	<p>Creates Creates a drawing in the selected cell, replacing any drawing that may already be exposed in that cell and the following ones until it meets another drawing, key exposure or a blank cell.</p>
Duplicate Drawings	<p>Creates a duplicate of the selected drawing in the layer. The duplicate drawing will be exposed at the selected frame instead of the original drawing. Hence, this command allows you to instantly start working on a duplicate of the current drawing and retain the original.</p>

	 NOTE When duplicating a drawing, the exposure at the selected cell is replaced with the new drawing, up until the next key exposure.
Delete Selected Drawings	Permanently removes selected drawings. Once you save your project, these drawings cannot be recovered.
Rename Drawing	Lets you give a selected drawing a new name.
Create Colour Art From Line Art	<p>Lets you use the outline you traced on one of the four embedded layers (line art, colour art, overlay, underlay) and create invisible strokes to paint your drawings on separate layers. This provides more inking and painting flexibility.</p> <p>You can also configure this option to create the invisible strokes on any of the four embedded layers.</p>
Generate Auto-Matte	<p>Automatically creates a matte from a selected drawing or all drawings on a layer.</p> <p>Opens the auto-Matte dialog box where you can set the radius of the lines depending on how precise or rough your line is.</p> <p>You can also select the source and destinatin layers from which the matte will be created.</p>
Adjust Line Texture Opacity	Lets you adjust the contrast and opacity of textured lines in a drawing.
Change Bitmap Drawing Resolution	<p>Lets you Lets you change the resolution of bitmap art for individual drawings. You can reduce the resolution of your bitmap file as well as increase it. Be careful because enlarging the bitmap resolution on an existing drawing will result in a loss of quality. Harmony will perform a pixel smoothing pass (resampling) and create additional pixels to avoid losing too much quality, but only to a certain extent. This feature is very useful when you need to have a full resolution of a bitmap image (such as imported bitmaps as .psd or .tga for the background) for tracing to create a matte directly in Harmony. By default, Harmony creates small thumbnail images when imported as bitmap in order to increase performance by using a small thumbnail image instead of using the original large size bitmap for animation work in Harmony. This will make difficult to view details or trace due to the low resolution (blurry). This option temporary increases the resolution of bitmaps up to their original bitmap resolution to make tracing easier.</p>

Previous Drawing	Once a cell is selected in the Timeline or Xsheet view, you can navigate between the drawings, frames, and layers. Displays the previous drawing, next drawing, previous layer or next layer. Displays the previous drawing, next drawing, previous layer or next layer.
Next Drawing	
Previous Layer	
Next Layer	
Colour Protection	Toggle Current Colour Protection: Temporarily enables/disables the Colour Protection feature so you can quickly correct wrongly inked or painted areas under protected colour without readjusting the Current Colour Protection option.
	Respect Colour Protection: In the Colour view, you can protect a colour swatch to avoid repainting or unpainting the zones linked to that swatch. If you using the Paint tool and this option is deselected, you will repaint or unpaint the protected colours on your drawings until you enable the option again.
Drawing Tools	
Select	Allows you to select and reposition, scale, rotate and skew brush strokes, pencil lines, shapes and other parts of your artwork.
Contour Editor	Allows you to edit the vector contours of brush strokes, pencil lines and shapes in your artwork. You can add, remove, tweak and move vector points, move the Bezier handles of the vector points as well as deform vector outlines.
Centerline Editor	Allows you to tweak and deform a brush stroke by manipulating the points at the centre of its line rather than its contour.
Pencil Editor	Lets you modify the thick and thin contour of a pencil line (basically a central vector shape). Shape control points along the central spine allow you to adjust the stroke curve and position.
Cutter	Allows you to cut a part of your artwork, then reposition, scale, rotate and skew it.
Smooth Editor	Allows you to optimize contours and lines by removing its extra points, making them easier to edit.
Perspective	Allows you to deform artwork by applying a perspective effect on it.

Envelope	Allows you to deform and warp artwork by moving points and tweaking lines in a grid.
Reposition All Drawings	Allows you to reposition, scale, rotate and skew all drawings in the current layer.
Drawing Pivot	Allows you to position the pivot on a drawing layer by clicking where you want its location to be.
Brush	A pressure-sensitive tool for creating a contour shape with a thick and thin line effect, as if created with a paint brush.
Pencil	A pressure-sensitive tool for drawing outlines. Pencil lines are made of central vector lines, making them easier to tweak and edit than brush strokes.
Text	Allows you to add text and to format it.
Eraser	A pressure-sensitive tool for erasing parts of a drawing.
Colour Eyedropper	Allows you to select a colour by clicking on a colour in your artwork.
Pencil Texture Eyedropper	Allows you to select a pencil texture by clicking on a textured pencil line.
Morphing	Allows you to create and configure a morphing sequence, which will automatically generate the in-betweens between two drawings in the current layer.
Line	Draws a straight line segment going from one point to the other.
Rectangle	Draws a rectangle.
Ellipse	Draws an ellipse.
Polyline	Allows you to draw shapes, segmented lines or complex curved lines by clicking to create each point in the sequence of line segments.
Paint	Allows you to fill colour zones with a colour or texture.

Ink	Allows you to recolour pencil lines with precision by changing the colour of one segment at a time.
Repaint Brush	Lets you repaint existing brush strokes. The new brush strokes will be cropped to fit in existing artwork.
Close Gap	Allows you to close open shapes so that they can be filled with the Paint tool. By drawing a stroke near a small gap in a shape, this tool will create a small invisible stroke connecting the two closest points around the gap.
Stroke	Allows you to create invisible lines that can serve as colour zones that can be filled, or close the gaps in existing colour zones.
Edit Gradient/Texture	Allows you to adjust the position, angle and size of gradients and textures in a colour zone.
Hand	Allows you to pan the Camera and Drawing views.
Zoom	Allows you zoom in and out of the Camera and Drawing views.
Rotate View	Lets you rotate the Camera and Drawing views just like with a real animation disc.
Morphing	
Morphing	Allows you to create and configure a morphing sequence, which will automatically generate the in-betweens between two drawings in the current layer.
Contour Hint	<p>The Contour Hint point is used on the colour fill zone and brush lines; in other words, on Contour vectors. It allows you to control the line thickness and contour position. Also, if a contour is not animated correctly, you can use hints to correct the animation. For example, if a flag is not waving properly.</p> <p>When adding a Contour Hint point, make sure to place it far enough away from the contour so you can see it snap to the contour.</p> <p>Contour Hint points are yellow.</p>
Zone Hint	<p>The Zone Hint point is used on a colour zone to control the proximity rule. The Zone Hint is placed in the centre of the colour zone. Sometimes a colour zone is not associated with the corresponding one by default. For example, in a splash animation there are many water droplets that are the same colour. Harmony</p>

	<p>automatically morphs the droplet to the nearest one. This is not always the one you may have predicted. A Zone Hint will force a colour zone to morph with another one.</p> <p>Zone Hint points are cyan in colour.</p>
Pencil Hint	<p>A Pencil Hint point is used to control a pencil line, also known as central vector. It can be used on drawings that were done using the Pencil, Polyline, Ellipse, Line and Rectangle tools. Like the Contour Hint, the Pencil Hint snaps to the central vector. Make sure to place it far enough away from the line so you will see it snap when you move it.</p> <p>Pencil Hint points are magenta in colour.</p>
Vanishing Point Hint	<p>A Vanishing Point Hint is used to control the trajectory of a vanishing shape. A shape will vanish from the source drawing when there is no corresponding shape in the destination drawing. If you do not place a Vanishing Point Hint to control the point of disappearance, the shape will vanish into its centre.</p> <p>Vanishing Point Hint points are green in colour.</p>
Appearing Point Hint	<p>An Appearing Point Hint is used to control the trajectory of an appearing shape. A shape will appear in the destination drawing when there is no corresponding shape in the source drawing. If you do not place an Appearing Point Hint to control the point of appearance, the shape will appear from its centre and expand outwards.</p> <p>Appearing Point Hint points are violet in colour.</p>
Switch Between Morphing Key Drawings	<p>Toggles Toggles between the two key drawings in your morphing sequence. This option is useful while setting hints. You can use the default keyboard shortcut F4 to toggle between your drawings.</p>
Go to First Frame	<p>Goes to the first frame of your morphing sequence.</p>
Go to Previous Frame	<p>Goes to the previous frame of the selected frame in the morphing sequence.</p>
Go to Next Frame	<p>Goes to the next frame of the selected frame in the morphing sequence.</p>
Go to Last Frame	<p>Goes to the last frame of your morphing sequence.</p>
Suggest Hints	<p>Automatically sets Automatically sets hint points on key drawings as a help tool. If you're not sure where to set hints, you can use this option. It will set the main hints which you can then fine tune.</p>

Hide Hints	Temporarily Temporarily hides the hint points from the key drawings. Use this option when you have a series of hint points hiding some lines you would like to see.
------------	---

Function View Menu

The Functions View menu lets you do many things in the Camera view, including selecting and editing objects in different views, changing the display, setting morphing parameters, accessing tools and many more.

How to access the Function menu

- In the upper-left corner of the Function view, click the menu  button.

Command	Description
Edit	
Cut	Removes selected objects. You can then paste the object or its properties to another object.
Copy	Copies selected objects and properties.
Paste	Places an object you cut or copied into the location you select in a view.
Delete	Removes selected objects.
Select Next Keyframe	Selects the next keyframe.
Select Previous Keyframe	Selects the previous keyframe.
Select Left Handle	Selects the left handle of the selected keyframe.
Select Right Handle	Selects the right handle of the selected keyframe.
Select All	Selects all objects in the Function view. This helps you manage multiple objects as one.
Deselect All	Deselects all selected objects in the Function view.
View	

Show Current Frame	Displays the current frame
Toggle Grid	Enables the display of the grid.
Reset Zoom	Resets the view's zoom to its default position.
Reset Pan	Resets the view's pan to its default position.
Reset View	Resets the view to its default position.
Function List	
Auto Load Selection	
Clear	
Load Selection	
Add Selection	
Remove Selection	
Show	Show Motion:
	Show Rotation:
	Show Scale:
	Show Skew:
	Show Other:

Library View Menu

The Library View menu lets you access commands specific to the Library view, such as opening a Library or getting the rights to modify a library folder.

How to access the Library menu

- In the upper-left corner of the Library view, click the menu  button.

Command	Description
View	
List	Displays the contents of the selected folder as a list.
Thumbnails	Displays the contents of the selected folder as a thumbnails.
Details	Displays the details of the selected file.
Generate Thumbnails	Creates a thumbnail to display in the preview window.
Edit	
New Symbol	<p>Creates a new symbol from a drawing or part of a drawing in the Drawing or Camera view, a layer in the Timeline view, or a node in the Node view.</p> <p>If your selection is in the Timeline or Node view, the new symbol appears in the Symbol folder. The current selection is not replaced by the new symbol. The new symbol only appears in the library. You must drag it into your scene to use it.</p> <p>If your selection is in the Drawing or Camera view, the new symbol appears in the Symbol folder and in the Timeline view as a new layer.</p>
Cut	Cuts the selected file in the Library view.
Copy	Copies the selected file in the Library view.
Paste	Pastes the selected file in the Library view.
Delete	Deletes the selected file in the Library view.

Delete Thumbnails	Deletes any thumbnails that were generated for display in the preview window.
Edit Symbol	Places you inside the symbol where you can edit it. To return to the project's timeline, click the Top  button in the Camera view's top-left corner, press Ctrl + Shift + E (Windows/Linux) or ⌘ + Shift + E (macOS).
Remove Unused Files	Removes any files not in use in the selected template.
Rename Template	Lets you rename a selected template.
Import Files	Imports vector files such as AI, PDF, and SWF. You requires the right to modify the library in which you want to import the files.
Folders	
New Folder	Creates a new folder in the Library view. Before you can create a new folder, you must have the right to modify the folder in which you are creating the new folder.
Refresh	Updates the view and its contents.
Open Library	Lets you open a library on your computer.
Close Library	Unlinks a library folder from your library list.

Model View Menu

The Model View menu lets you load models and view them in different ways, as well as access some drawing tools.

How to access the Model menu

- In the upper-left corner of the Model view, click the menu  button.

Command	Description
Previous Model	Shows the previous model loaded in the Model view.
Next Model	Shows the next model loaded in the Model view.
Import Model	Imports a TVG drawing as a model in the Model view.
Use Current Drawing as Model	Loads the currently selected drawing in the scene as a model in the Model view.
Load Default Models	Loads TVG drawings placed in a custom models folder located in the scene folder.
Clear Model	Removes the model from the Model view.
Zoom In	Zooms in the view.
Zoom Out	Zooms out the view.
Reset Zoom	Resets the view's zoom to its default position.
Reset Pan	Resets the view's pan to its default position.
Reset View	Resets the view to its default position.
Rotate View CW	Rotates the Camera view 30 degrees clockwise, like an animation table.
Rotate View CCW	Rotates the Camera view 30 degrees counter-clockwise, like an animation table.

Reset Rotation	Resets the view's rotation to its default position.
Select	Activates the Select tool. This tools is also available on the Tools toolbar.
Cutter Selection	Allows to cut a section of the model to paste it in your scene.
Dropper	Activates the Colour Eyedropper tool. This tools is also available on the Tools toolbar.
Zoom	Activates the Zoom tool. This tools is also available on the Tools toolbar.

Node View Menu

The Node View menu lets you organize the nodes according to how you like to work and the nodes you use most often. You can easily add categories and subcategories, remove categories you don't use, and rename categories.

How to access the Node menu

- In the upper-left corner of the Node view, click the menu  button.

Command	Description
File	
Print	Lets you print the contents of the Node view. You must be connected to a printer.
Edit	
Cut	Removes selected objects. You can then paste the object or its properties to another object.
Copy	Copies selected objects and properties.
Paste	Places an object you cut or copied into the location you select in a view.
Paste Special	Lets you copy and paste selected drawings into a different layer or paste the selection in the same layer to duplicate the drawings.
Paste Special Again	Pastes new drawings with the previous Paste Special settings.
Delete	Removes selected objects.
Select All	Selects all drawing objects in the current drawing window in the Drawing, Timeline and Camera views. This helps you manage multiple objects as one when moving them.
Deselect All	Deselects all selected objects in the Drawing and Camera views.
Invert Selection	Deselects the currently selected items and selects all other items that were not

	selected. For example, if some lines are selected in a drawing, this command will deselect them and select any other lines in the drawing that were not selected.
Layer Properties	Shows or hides the Layer Properties view.
Recalculate Selected	Refreshes the node structure and rerenders the display of selected elements when the Camera View is in render mode.
Recalculate All	Refreshes the node structure and rerenders the display when the Camera view is in render mode.
Tag	You can tag elements in the Timeline or Node views to view only those elements. When you tag elements, an asterisk appears beside the item in the Timeline view. Once your elements are tagged and you have switched over to View Tagged Layers mode, the Timeline view will display only tagged elements. The red bar on the left of the layers indicates you are in this view mode.
	Timeline Tag: Tags selected elements in the Timeline or Node views.
	Timeline Untag: Untags selected layer in the Timeline view.
	Timeline Untag All: Untags all tagged elements.
	Timeline Untag All Others: Untags all elements except the selected one.
Auto Render Write	Renders a frame each time the current frame is changed. You must have a Write node in your node structure to use this command.
Select Child Skipping Effects	Lets you select the first element parented to the selected peg element in the Timeline view skipping effects in the hierarchy.
Select Child	Lets you select the first element parented to the selected peg element in the Timeline view.
Select Group Content	Select contents within the group node.
Select Children	Lets you select all elements parented to the selected peg element in the Timeline view.
Select Parent	Lets you select the parent of the selected element in the Timeline view skipping

Skipping Effects	effects in the hierarchy.
Select Parent	Lets you select the parent of the selected element in the Timeline view.
Select Previous Sibling	Lets you select the previous element (above current element) in the Timeline view.
Select Next Sibling	Lets you select the next element (below current element) in the Timeline view.
View	
Zoom In Node View	Zooms in the view.
Zoom Out Node View	Zooms out the view.
Reset Zoom	Resets the view's zoom to its default position.
Centre on Selection	Centre the display of the Node view on the selected node. This is useful when you have many nodes in the Node view, you may find it hard to locate which one is selected.
Reset Pan	Resets the view's pan to its default position.
Reset View	Resets the view to its default position.
Show All Nodes	Display all nodes.
Editor	Display the Layer Properties editor of the selected node.
Publish Attribute Node	To quickly access parameters for nodes that are grouped, you can select your most common parameters to modify and make them appear in the group Layer Properties editor. This way, you can access them directly without having to enter the group every time.
Show Selected Thumbnails	Displays the thumbnails of selected nodes.
Hide All Thumbnails	Hides all the thumbnails of selected nodes.

Navigator	Hide Navigator: Hides the navigator.
	Top Right: Places the navigator in the top-right corner of the Node view.
	Top Left: Places the navigator in the top-left corner of the Node view.
	Bottom Right: Places the navigator in the bottom-right corner of the Node view.
	Bottom Left: Places the navigator in the top-left corner of the Node view.
Cable Style	Line: Use straight lines to show the connections between nodes.
	Bezier: Use curved (Bezier) lines to show the connections between nodes.
Nodes	
Enable	Activate the selected node.
Disable	Deactivate the selected node.
Enable All	Activate all nodes.
Disable All Others	Deactivates all nodes except for those those selected. This operation only affects the current level layers. It does not affect the nested nodes within a group. Deactivated nodes appear in red.
Clone Selected Nodes: Drawings and Timing	Creates a copy of the selected element that is linked to the original. If a drawing is modified in the original or cloned layer, both will be updated. However, cloned layers can have different timings.
Clone Selected Nodes: Drawings Only	When you clone a node, it does not automatically connect itself to the Composite node of your scene. You can clone the drawings only or both the drawings and timing.
Duplicate Selected Nodes	Creates an independent copy of the selected element. This useful when you need to modify the element independently, including the timing (exposure). Changes to the original element do not propagate to the duplicate.
Group Selection	Creates a simple group from your selection. The resulting group displays the same number of connections as elements in the group.

Group Selection with Composite	Group a selection.
Ungroup	Ungroups the selected group of nodes.
Move to Parent Group	Moves selected nodes up to the parent group level.
Exit Group	Exits the group.
Clear Published Attributes	Removes the most common parameters you selected for quick access in the Layer Properties editor of a group.
Insert	
Composite	Adds a Composite node to the Node view.
Display	Adds a Display node to the Node view.
Drawing	Opens the Add Drawing Layer dialog box where you can specify the type of layer to add.
Group	Adds a Group node to the Node view.
Parent Peg	Adds a new peg to the timeline as a parent of the selected layer.
Peg	Adds a Peg node to the Node view.
Effects	Lets you add effects from these categories: 3D, Combine, Deformation, Favourites, Filter, Generator, Group, Misc, Move, Output, Particle, Sapphire, Shading and Plugins.
Backdrop	Adds a backdrop to the Node view. Backdrops are a way to work with complex node systems that let you associate a selected set of nodes by colour.

Node Library View Menu

The Node Library View menu lets you organize the nodes according to how you like to work and the nodes you use most often. You can easily add categories and subcategories, remove categories you don't use, and rename categories.

How to access the Node Library menu

- In the upper-left corner of the Node Library view, click the menu  button.

Command	Description
New Category	Adds a new category to the list of categories to which you can organize nodes according to how you like to work and the nodes you use most often.
Rename Category	Renames an existing category.
Remove Category	Remove a category you no longer need.
Remove Node	Removes a node from a category.
Refresh	Updates the view and its contents.



Onion Skin View Menu

The Onion Skin view menu contains extra options for controlling the Advanced Onion Skin. It is accessible via the Onion Skin view—see [Onion Skin View on page 1261](#).

How to access the Onion Skin view menu

1. In the top-left corner of the Onion Skin view, click on the  View Menu button.

Command	Description
Advanced Onion Skin	<p>Enables Advanced Onion Skin. Advanced Onion Skin allows you to select, on the fly, which drawings to include in your Onion Skin, even if those drawings are not consecutive drawings, as well as the opacity scales for the drawings before and after the current frame.</p> <p>The controls for selecting which drawings to display in the Onion Skin as well as their opacity sliders are only accessible when Advanced Onion Skin is enabled. Otherwise, when using regular Onion Skin, the opacity of drawings in the Onion Skin is determined by the Onion Skin settings in the Preferences dialog. The amount of drawings to include in the Onion Skin is set using the Onion Skin Add / Reduce One Previous Drawing and Onion Skin Add / Reduce One Next Drawing commands, available in the Camera and Drawing toolbars as well as in View > Onion Skin in the top menu.</p>
Original Colors	Displays the onion skin using the actual colours of the drawings.
Coloured	Displays the onion skin using the colours selected for the previous and next drawings in the Onion Skin view.
Coloured Outlines	Displays the onion skin using the colours selected for the previous and next drawings, but only as outlines instead of filled shapes.
Onion Skin by Frames	<p>Selects the drawings to display in the Onion Skin by the amount of different drawings before and after the current frame. For example, if the Onion Skin is set to include 2 drawings before and after the current frame, this will display the nearest two different drawings before and after the drawing in the current frame in the Onion Skin, even if those drawings are further than 2 frames away from the current frame. This is more useful for frame-by-frame animation.</p> <div style="border: 1px solid green; padding: 10px; margin-top: 10px;">  NOTE When this option is enabled, the handles allowing you to adjust the extent of the Onion Skin in the Timeline view are not available. </div>
Onion	Selects the drawings to display in the Onion Skin by the amount of different drawings before and

Command	Description
Skin by Drawings	<p>after the current frame. For example, if the Onion Skin is set to include 2 drawings before and after the current frame, this will display the nearest two different drawings before and after the drawing in the current frame in the Onion Skin, even if those drawings are further than 2 frames away from the current frame. This is more useful for frame-by-frame animation.</p> <div data-bbox="358 451 1429 621" style="border: 1px solid #c8e6c9; padding: 10px;">  <p>NOTE When this option is enabled, the handles allowing you to adjust the extent of the Onion Skin in the Timeline view are not available.</p> </div>
Apply Colour Wash	<p>Displays onion skins with a lighter, less saturated colour. The further away the drawing is from the current frame, the more washed its colour appears.</p> <div data-bbox="358 774 1429 945" style="border: 1px solid #c8e6c9; padding: 10px;">  <p>NOTE The minimum and maximum colour wash values for Onion Skin can be customized in the Drawing tab of the Preferences dialog.</p> </div>
Enable Onion Skin for Other Elements	<p>In the Drawing View, when the Light Table is enabled, making other layers visible alongside the current layer, this will make the Onion Skin for other visible layers appear alongside the Onion Skin for the current layer. Drawings for elements above the current layer will appear in blue, and drawings for elements below will appear in yellow.</p> <div data-bbox="358 1169 1429 1339" style="border: 1px solid #c8e6c9; padding: 10px;">  <p>NOTE The drawings from other elements that get displayed in the Onion Skin are the drawings that are exposed at the same time as the drawings displayed in the current layer's Onion Skin.</p> </div>
Link Sliders	<p>When enabled, the opacity sliders in the Onion Skin view will move simultaneously as you adjust one of them, so that the opacity levels for previous and next drawings progresses from the opacity level of the first drawing to the opacity level of the last drawing.</p> <p>When this mode is enabled, you can adjust the first and last sliders for previous or next drawings, then, optionally, adjust a single one of the sliders in-between to create a segmented progression.</p> <p>However, if you want to make the opacity of Onion Skin drawings to vary in any way that is more complex, you must disable this option.</p>

Perspective View Menu











The Perspective View menu lets you select and edit elements, manipulate the view during scene setup, set parameters for animation and access animation tools.

How to access the Perspective menu

- In the upper-left corner of the Perspective view, click the menu  button.

Command	Description
Edit	
Cut	Removes selected objects. You can then paste the object or its properties to another object.
Copy	Copies selected objects and properties.
Paste	Places an object you cut or copied into the location you select in a view.
Delete	Removes selected objects.
Select All	Selects all drawing objects in the current drawing window in the Drawing, Timeline and Camera views. This helps you manage multiple objects as one when moving them.
Deselect All	Deselects all selected objects in the Drawing and Camera views.
Invert Selection	Deselects the currently selected items and selects all other items that were not selected. For example, if some lines are selected in a drawing, this command will deselect them and select any other lines in the drawing that were not selected.
Select Child Skipping Effects	Lets you select the first element parented to the selected peg element in the Timeline view skipping effects in the hierarchy.
Select Child	Lets you select the first element parented to the selected peg element in the Timeline view.
Select Children	Lets you select all elements parented to the selected peg element in the

	Timeline view.
Select Parent Skipping Effects	Lets you select the parent of the selected element in the Timeline view skipping effects in the hierarchy.
Select Parent	Lets you select the parent of the selected element in the Timeline view.
Select Previous Sibling	Lets you select the previous element (above current element) in the Timeline view.
Select Next Sibling	Lets you select the next element (below current element) in the Timeline view.
View	
Zoom In	Zooms into the view, towards the view's pivot point, up to 80,000%.
Zoom Out	Zooms out of the view, away from the view's pivot point, up to 1%.
Move Forward	Moves infinitely forward into the view, using the direction set by the current position and angle of rotation.
Move Backward	Moves infinitely backwards out of the view, using the direction set by the current position and angle of rotation.
Reset Zoom	Resets the view's zoom to its default position.
Reset Pan	Resets the view's pan to its default position.
Reset View	Resets the view to its default position.
Face Selected to Draw	Resets any rotations made and brings the selected object to the center of the view. Displaying the drawing object at this perspective is intended to facilitate drawing on the object.
Look at Selected	Resets view to have the selected object at the center, without resetting the rotation angles or zoom.
Layer Properties	Shows or hides the Layer Properties view.

Light Table	Turns on the light table so you can see the previous and subsequent active layers in washed-out colours. It is useful for seeing the other layers when designing, animating or cleaning up your animation.
Camera Cone	Displays the camera cone.
Control	Displays the controls of the selected element.
Hide All Controls	Hides the controls of the selected element.
Enable Playback	Plays back your animation in the Perspective view.
Animation	
Animate	
Animate Current Frame	When this option is selected, every time you use the  Transform,  Rotate,  Advanced Animation or  Inverse Kinematic tools to manipulate an element in your scene, the position of the element will be stored in a keyframe at the current frame. This allows you to animate elements in your scene without creating keyframes manually.
Animate Onion Skin Range	When this option is selected, if you use the  Transform or  Rotate,  Advanced Animation tools to make transformations to an element in your scene, the transformations will be stored as keyframes at the beginning and at the end of the current Onion Skin range, as well as on every existing keyframe in-between. This can be useful if you want to reposition an element that you have already animated, but only during a specific range of frames, which you can define by enabling Onion Skin and setting the Onion Skin range to cover that range of frames.
Animate Off	When this option is selected, if you use the  Transform or  Rotate,  Advanced Animation tools to make transformation to an element in your scene, the transformations will affect the element throughout the whole scene. This can be useful if you want to reposition an element after you have already animated it.
Insert Keyframe	Adds a keyframe to the currently selected frame in the Timeline view.
Insert Control Point	Adds a control point to the motion path at the currently selected frame. This control point does not appear in the Timeline, but can be used to reshape the

	<p>motion path. In order for this command to work, layers must be set to 3D Path.</p>
Set Stop-Motion Keyframe	<p>Converts the selected keyframes to stop-motion keyframes. Between a stop-motion keyframe and the next keyframe, Harmony does not generate any animation and the element remains static until the next keyframe.</p>
Set Motion Keyframe	<p>Converts the selected keyframes to motion keyframes. With motion keyframes, Harmony generates the interpolation between the motion keyframe and the next keyframe. This means that a value for each frame between the keyframes is calculated by Harmony to progress from the value of the previous keyframe to the value of the next keyframe.</p>
Flip	<p>Flip Horizontal: Flips the current selection horizontally.</p>
	<p>Flip Vertical: Flips the current selection vertically.</p>
	<p>Flip Scale X: Once your drawing layer is rotated, the original horizontal and vertical axes change. The Flip Scale X and Flip Scale Y will perform a flip on your drawing layer following its original axis. Remembers the original X-axis of the layer and flips the element following it.</p>
	<p>Flip Scale Y: Remembers the original Y-axis of the layer and flips the element following it.</p>
Set Ease for Multiple Parameters	<p>Opens the Set Ease for Multiple Parameters dialog box where you can change the velocity of selection functions.</p>
Linear Motion	<p>Straightens out the motion path on either sides of the selected control point.</p>
Lock in Time	<p>Indicates whether the point is locked to a specific frame (keyframe) or only locked to a specific position and the curve can flow through it freely as other points are being added, moved, or adjusted (control point).</p>
No Z Dragging	<p>Locks the Z value when you're animating in 3D space. This means you can only reposition your object along the x and y axes.</p>
Substitute Drawing Previous	<p>Replaces the drawing or cell's symbol on the current frame by the next drawing.</p>
Substitute Drawing Next	

Select Previous Keyframe /Point	Select the previous keyframe/point.
Select Next Keyframe /Point	Select Next Keyframe /Point
Lock	Lock: Locks Locks one or a multiple selection of layers.
	Unlock: Unlocks Unlocks one or a multiple selection of locked layers.
	Lock All: Locks Locks all the layers in the Timeline view.
	Unlock All: Unlocks Unlocks all the layers in the Timeline view.
	Lock All Others: Locks Locks every layer except the selected ones.
Reset	Returns Returns the value of the selected element to the initial value of the active tool. For example, if the Rotate tool is active, the transformation angle will be reset to 0 and if the Transform tool is active, all the transformation values will be reset.
Reset All	Resets Resets all transformations on the current frame in a selected layer. Your keyframe will remain, but all the values will return to the starting value. All transformations are reset regardless of the tool you're using.
Reset All Except Z	Resets Resets all transformations on the current frame except the Z position. This is useful when doing cut-out animation. Cut-out puppets often have a particular Z ordering for the different views of a character. You might want to reset the transformation, but not necessarily the Z position.
Animation Tools	
Transform	Allows you to select drawing layers and position, rotate, scale and skew them.
Translate	Lets you move the selected element along the X and Y axes.
Rotate	Turns a selected element around its pivot point.
Scale	Increases or decreases the size of a selected element. You can scale an object up to make it larger or down to make it smaller. Press Shift to scale the

	element while maintaining its proportions.
Maintain Size	Keeps elements the same size aspect ratio in the Camera view as you move them towards or away from the camera.
Skew	Slants the selected element.
Reposition Drawing	Lets you reposition, scale, rotate or skew all drawing strokes on every drawing included in a layer.
Spline Offset	Lets you Lets you reposition the visual trajectory without offsetting or modifying your animation. By default, the trajectory is located at 0,0,0 fields. If your elements were drawn in a different location than the centre of the drawing area, it will look like the trajectory is not aligned with your drawing. Also, if you have several elements attached to one trajectory, you might want your trajectory to be at a different location to represent the group's motion better.



Script Editor View Menu



The Script Editor view menu gives you access to all of the commands needed for editing and testing scripts in the Script Editor view—see [Script Editor View on page 1270](#).



How to access the Script Editor view menu

1. Add the Script Editor view to your workspace by doing one of the following:
 - In the top-right corner of an existing view, click on the **+** Add View button and select Script Editor.
 - In the top menu, select **Windows > Script Editor**.
2. In the top-left corner of the Script Editor view, click on the  Menu button.

Button	Description
File	<p>Creates a new script. When you click on this button, you are first prompted to type in a name for the script. Then, you will be prompted to select which location to save the script in:</p> <ul style="list-style-type: none"> • User: Saves the script to a directory in your user preferences directory. You will be able to run and edit the script from any scene as long as you are logged in as the same user. <div data-bbox="574 1241 1430 1474" style="border: 1px solid green; padding: 10px; margin: 10px 0;"> <p> NOTE If you are using Harmony Stand Alone, the script will be saved to the preferences for your account on your computer. If you are using Harmony Server, the script will be saved to the preferences for your Harmony database user.</p> </div> <ul style="list-style-type: none"> • Global: If you are using Harmony Server, select this option to save the script to the Harmony database's global script directory. Anyone who is logged in to the database will be able to edit and run this script. • Environment: If you are using Harmony Server, select this option to save the script to the current scene's environment. Anyone will be able to edit and run the script as long as they are working on a scene inside this environment. • Job: If you are using Harmony Server, select this option to save the script to the current scene's job. Anyone will be able to edit and run the script as long as they are working on a scene inside this job. • Scene: Save the script to the scene's scripts sub-folder. Anyone will be able to
New Script	

Button	Description
	<p>edit and run the script when working on this specific scene.</p> <ul style="list-style-type: none"> • System Variable: Save the script to the directory in the <code>TOONBOOM_GLOBAL_SCRIPT_LOCATION</code> environment variable. This option is only available if this environment variable is set. <div data-bbox="495 468 1430 611" style="border: 1px solid #c8e6c9; padding: 10px; margin-top: 10px;">  <p>NOTE For more information on script locations, see Script list on page 1270.</p> </div>
<p>Import Script</p>	<p>Allows you to import a script from your machine into Harmony. When you click on this button, you are prompted to browse for and select a script on your file system. Then, you are prompted to select which location to import the script in:</p> <ul style="list-style-type: none"> • User: Saves the script to a directory in your user preferences directory. You will be able to run and edit the script from any scene as long as you are logged in as the same user. <div data-bbox="574 926 1430 1157" style="border: 1px solid #c8e6c9; padding: 10px; margin-top: 10px;">  <p>NOTE If you are using Harmony Stand Alone, the script will be saved to the preferences for your account on your computer. If you are using Harmony Server, the script will be saved to the preferences for your Harmony database user.</p> </div> <ul style="list-style-type: none"> • Global: If you are using Harmony Server, select this option to save the script to the Harmony database's global script directory. Anyone who is logged in to the database will be able to edit and run this script. • Environment: If you are using Harmony Server, select this option to save the script to the current scene's environment. Anyone will be able to edit and run the script as long as they are working on a scene inside this environment. • Job: If you are using Harmony Server, select this option to save the script to the current scene's job. Anyone will be able to edit and run the script as long as they are working on a scene inside this job. • Scene: Save the script to the scene's <code>scripts</code> sub-folder. Anyone will be able to edit and run the script when working on this specific scene. • System Variable: Save the script to the directory in the <code>TOONBOOM_GLOBAL_SCRIPT_LOCATION</code> environment variable. This option is only available if this environment variable is set.

Button	Description
	<div data-bbox="495 283 1429 577" style="border: 1px solid #c8e6c9; padding: 10px;">  <p>NOTES</p> <ul style="list-style-type: none"> • When you import a script, any user interface (.ui) or icon (.png) file that is in the same directory and has the same filename as the script will also be imported. • For more information on script locations, see Script Editor View on page 1270. </div>
Delete Script	<p>Deletes the selected script.</p> <div data-bbox="495 697 1429 1029" style="border: 1px solid #c8e6c9; padding: 10px;">  <p>NOTES</p> <ul style="list-style-type: none"> • You cannot delete a script if it is in the Application Resources location, as those are scripts that are installed with Harmony. • If you delete a script that was originally in Application Resources but which you copied to another location so you could make changes to it, the original version of the script in the Application Resources folder will be restored to the list. </div>
Refresh Script File List	<p>Refresh the list of scripts in the Script Editor. If there are new scripts in your user preferences or your scene's scripts sub-folder, click on this button to be able to open them in the Script Editor.</p>
Editor	
Set External Editor	<p>Allows you to type in the path and name for your preferred text editing software.</p> <div data-bbox="495 1400 1429 1732" style="border: 1px solid #c8e6c9; padding: 10px;">  <p>NOTES</p> <ul style="list-style-type: none"> • On macOS, only typing the name of your preferred text editing software is enough if that application supports the AppleScript Open Document protocol. • On Windows and GNU/Linux, unless your text editor is in your system's PATH environment variable, you will have to type in the full path to the editor. </div>
External Editor	<p>Opens the selected script in the chosen external text editing software.</p>

Button	Description
Play/Debug	
Set Target	<p>Prompts you to select which script and which function to use with the Run and Debug commands.</p> <div data-bbox="496 470 1430 800" style="border: 1px solid #90EE90; padding: 10px;"> <p> NOTES</p> <ul style="list-style-type: none"> • You can set the entire script as the target by selecting the <Nothing> function from the functions list. • You cannot link an entire script to a toolbar button. Only functions within scripts can be added as toolbar buttons. Therefore, running or debugging an entire script rather than one of its functions should be done for testing purposes only. </div>
Run	<p>Runs the target script and function.</p> <div data-bbox="496 919 1430 1249" style="border: 1px solid #90EE90; padding: 10px;"> <p> NOTES</p> <ul style="list-style-type: none"> • If you have not set a target script and function, you will be prompted to set one when you select this command. • You can set or change the target script and function by selecting Set Target from this menu. • If you are editing <<<Sandbox>>>, this button will simply run what you typed into the sandbox, regardless of whether another target is set. </div>
Debug	<p>Open the target script and function in the Qt Script Debugger, in which you can test and debug the function.</p> <div data-bbox="496 1415 1430 1745" style="border: 1px solid #90EE90; padding: 10px;"> <p> NOTES</p> <ul style="list-style-type: none"> • If you have not set a target script and function, you will be prompted to set one when you select this command. • You can set or change the target script and function by selecting Set Target from this menu. • If you are editing <<<Sandbox>>>, this button will simply debug what you typed into the sandbox, regardless of whether another target is set. </div>
Stop	<p>If a script is currently running, this interrupts its execution.</p>

Button	Description
Help	
Scripting Interface Documentation	<p>Opens the reference documentation for the Harmony scripting interface in a web browser.</p> <div data-bbox="495 470 1429 640" style="border: 1px solid #c8e6c9; padding: 10px;"> NOTE This documentation is installed with Harmony and does not require Internet access.</div>



Side View Menu





The Side View menu lets you position elements in 3D space, set parameters for animation and access animation tools—see [Side View on page 1275](#).

How to access the Side menu

- In the upper-left corner of the Side view, click the menu  button.

Command	Description
Edit	
Cut	Removes selected objects. You can then paste the object or its properties to another object.
Copy	Copies selected objects and properties.
Paste	Places an object you cut or copied into the location you select in a view.
Delete	Removes selected objects.
Select All	Selects all drawing objects in the current drawing window in the Drawing, Timeline and Camera views. This helps you manage multiple objects as one when moving them.
Deselect All	Deselects all selected objects in the Drawing and Camera views.
Invert Selection	Deselects the currently selected items and selects all other items that were not selected. For example, if some lines are selected in a drawing, this command will deselect them and select any other lines in the drawing that were not selected.
Select Child Skipping Effects	Lets you select the first element parented to the selected peg element in the Timeline view skipping effects in the hierarchy.
Select Child	Lets you select the first element parented to the selected peg element in the Timeline view.
Select Children	Lets you select all elements parented to the selected peg element in the Timeline view.

Select Parent Skipping Effects	Lets you select the parent of the selected element in the Timeline view skipping effects in the hierarchy.
Select Parent	Lets you select the parent of the selected element in the Timeline view.
Select Previous Sibling	Lets you select the previous element (above current element) in the Timeline view.
Select Next Sibling	Lets you select the next element (below current element) in the Timeline view.
View	
Zoom In	Zooms in the view.
Zoom Out	Zooms out the view.
Reset Zoom	Resets the view's zoom to its default position.
Reset Pan	Resets the view's pan to its default position.
Reset View	Resets the view to its default position.
Layer Properties	Shows or hides the Layer Properties view.
Camera Cone	Displays the camera cone.
Control	Displays the controls of the selected element.
Hide All Controls	Hides the controls of the selected element.
Enable Playback	Plays back your animation in the Perspective view.
Animation	
Animate	
Animate Current Frame	When this option is selected, every time you use the  Transform,  Advanced Animation or  Inverse Kinematic tools to manipulate an

	<p>element in your scene, the position of the element will be stored in a keyframe at the current frame. This allows you to animate elements in your scene without creating keyframes manually.</p>
<p>Animate Onion Skin Range</p>	<p>When this option is selected, if you use the  Transform or  Advanced Animation tools to make transformations to an element in your scene, the transformations will be stored as keyframes at the beginning and at the end of the current Onion Skin range, as well as on every existing keyframe in-between. This can be useful if you want to reposition an element that you have already animated, but only during a specific range of frames, which you can define by enabling Onion Skin and setting the Onion Skin range to cover that range of frames.</p>
<p>Animate Off</p>	<p>When this option is selected, if you use the  Transform or  Advanced Animation tools to make transformation to an element in your scene, the transformations will affect the element throughout the whole scene. This can be useful if you want to reposition an element after you have already animated it.</p>
<p>Insert Keyframe</p>	<p>Adds a keyframe to the selected cell in the Timeline view.</p>
<p>Insert Control Point</p>	
<p>Set Stop-Motion Keyframe</p>	<p>Converts the selected keyframes to stop-motion keyframes. Between a stop-motion keyframe and the next keyframe, Harmony does not generate any animation and the element remains static until the next keyframe.</p>
<p>Set Motion Keyframe</p>	<p>Converts the selected keyframes to motion keyframes. With motion keyframes, Harmony generates the interpolation between the motion keyframe and the next keyframe. This means that a value for each frame between the keyframes is calculated by Harmony to progress from the value of the previous keyframe to the value of the next keyframe.</p>
<p>Flip</p>	<p>Flip Horizontal: Flips the current selection horizontally.</p>
	<p>Flip Vertical: Flips the current selection vertically.</p>
	<p>Flip Scale X: Once your drawing layer is rotated, the original horizontal and vertical axes change. The Flip Scale X and Flip Scale Y will perform a flip on your drawing layer following its original axis. Remembers the original X-axis of the layer and flips the element following it.</p>
	<p>Flip Scale Y: Remembers the original Y-axis of the layer and flips the element</p>

	following it.
Set Ease for Multiple Parameters	Opens the Set Ease for Multiple Parameters dialog box where you can change the velocity of selection functions.
Linear Motion	Transforms a curved path to a linear path removing tension, bias, and continuity.
Lock in Time	Indicates whether the point is locked to a specific frame (keyframe) or only locked to a specific position and the curve can flow through it freely as other points are being added, moved, or adjusted (control point).
No Z Dragging	Keeps the Z value constant when you drag a character using the Transform or Translate tool.
Substitute Drawing Previous	Replaces the drawing or cell's symbol on the current frame by the next drawing.
Substitute Drawing Next	
Select Previous Keyframe /Point	Select the previous keyframe/point.
Select Next Keyframe /Point	Select Next Keyframe /Point
Lock	Lock: Locks one or a multiple selection of layers.
	Unlock: Unlocks one or a multiple selection of locked layers.
	Lock All: Locks all the layers in the Timeline view.
	Unlock All: Unlocks all the layers in the Timeline view.
	Lock All Others: Locks every layer except the selected ones.
Reset	Returns the value of the selected element to the initial value of the active tool. For example, if the Rotate tool is active, the transformation angle will be reset to 0 and if the Transform tool is active, all the transformation values will be reset.

Reset All	Resets Resets all transformations on the current frame in a selected layer. Your keyframe will remain, but all the values will return to the starting value. All transformations are reset regardless of the tool you're using.
Reset All Except Z	Resets Resets all transformations on the current frame except the Z position. This is useful when doing cut-out animation. Cut-out puppets often have a particular Z ordering for the different views of a character. You might want to reset the transformation, but not necessarily the Z position.
Animation Tools	
Transform	Allows you to select drawing layers and position, rotate, scale and skew them.
Translate	Lets you move the selected element along the X and Y axes.
Rotate	Turns a selected element around its pivot point.
Scale	Increases or decreases the size of a selected element. You can scale an object up to make it larger or down to make it smaller. Press Shift to scale the element while maintaining its proportions.
Maintain Size	Keeps elements the same size aspect ratio in the Camera view as you move them towards or away from the camera.
Reposition Drawing	Lets you reposition, scale, rotate or skew all drawing strokes on every drawing included in a layer.
Spline Offset	Lets you Lets you reposition the visual trajectory without offsetting or modifying your animation. By default, the trajectory is located at 0,0,0 fields. If your elements were drawn in a different location than the centre of the drawing area, it will look like the trajectory is not aligned with your drawing. Also, if you have several elements attached to one trajectory, you might want your trajectory to be at a different location to represent the group's motion better.

Timeline View Menu

The Timeline View menu lets you modify layers, keyframe and timing.

How to access the Timeline menu

- In the upper-left corner of the Timeline view, click the menu  button.

Parameter	Description
Import	
From Scanner	Imports drawings from a TWAIN scanner.
Images	Imports bitmap images which you can choose to vectorize.
Sounds	Lets you import sound files into your project.
Edit	
Cut cells from Xsheet	Removes selected objects. You can then paste the object or its properties to another object.
Copy cells from Xsheet	Copies selected objects and properties.
Paste	Places an object you cut or copied into the location you select in a view.
Paste Special	Lets you copy and paste selected drawings into a different layer or paste the selection in the same layer to duplicate the drawings.
Paste Special Again	Pastes new drawings with the previous Paste Special settings.
Paste Cycle	Cycles a portion of an animation. You can increase or decrease the number of cycles to paste and select a type of cycle: Normal, Reverse, Forward-Reverse and Reverse-Forward.
Paste Reverse	Reverses the timing of drawings or keyframes in range of selection after copying.

Delete	Removes selected objects.
Modify Paste Presets	Lets you modify existing presets when pasting keyframes and exposures. There are three presets you can modify: the default presets for both key frames and exposures, key frames only and exposures only.
Select All	Selects all drawing objects in the current drawing window in the Drawing, Timeline and Camera views. This helps you manage multiple objects as one when moving them.
Deselect All	Deselects all selected objects in the Drawing and Camera views.
Invert Selection	Deselects the currently selected items and selects all other items that were not selected. For example, if some lines are selected in a drawing, this command will deselect them and select any other lines in the drawing that were not selected.
Select Synced Layers	Selects all the layers synced to the selected layer. The selected layer must be a synced in order for this option to be enabled.
Select Child Skipping Effects	Lets you select the first element parented to the selected peg element in the Timeline view skipping effects in the hierarchy.
Select Child	Lets you select the first element parented to the selected peg element in the Timeline view.
Select Children	Lets you select all elements parented to the selected peg element in the Timeline view.
Select Parent Skipping Effects	Lets you select the parent of the selected element in the Timeline view skipping effects in the hierarchy.
Select Parent	Lets you select the parent of the selected element in the Timeline view.
Select Previous Sibling	Lets you select the previous element (above current element) in the Timeline view.
Select Next Sibling	Lets you select the next element (below current element) in the Timeline view.
Lock	Lock: Locks one or a multiple selection of layers.

	<p>Unlock: Unlocks Unlocks one or a multiple selection of locked layers.</p>
	<p>Lock All: Locks Locks all the layers in the Timeline view.</p>
	<p>Unlock All: Unlocks Unlocks all the layers in the Timeline view.</p>
	<p>Lock All Others: Locks Locks every layer except the selected ones.</p>
Tag	<p>Timeline Tag: You can tag elements in the Timeline or Node views to view only those elements. When you tag elements, an asterisk appears beside the item in the Timeline view. Once your elements are tagged and you have switched over to View Tagged Layers mode, the Timeline view will display only tagged elements. The red bar on the left of the layers indicates you are in this view mode.</p>
	<p>Timeline Untag: Untags selected layer in the Timeline view.</p>
	<p>Timeline Untag All: Untags all tagged elements.</p>
	<p>Timeline Untag All Others: Untags all elements except the selected one.</p>
Scene Markers	<p>Mark Current Frame: Places a scene marker on the current frame on which the playhead is parked. The marker appears in the frame counter area of the Timeline view. You can customize the colour of the scene marker and add text to display as a tooltip when you hover over the marker—see .</p>
	<p>Create Scene Marker: Creates a scene marker from a selected frame range in the frame counter area of the Timeline view.</p>
	<p>Edit Scene Marker: Lets you edit an existing scene marker.</p> <p>NOTE: It's important to select the <u>entire</u> length of the scene marker, otherwise the Timeline Scene Marker dialog box will not open for editing.</p>
	<p>Delete Scene Marker: Removes an existing scene marker.</p>
Share Functions	<p>Lets you share an existing function curve. By default, all function curves can only be used and modified using their original parameter. If you want another layer or parameter to use the same function curve, you must share it.</p>
View	

Cycle to Next View Mode	Displays the new view mode.
Normal View Mode	Displays the Normal view mode, the default in the Timeline view. It shows everything connected to the chosen display. In this mode, anything not connected to the currently set default display will not be shown in the Timeline view. This also means that you cannot add certain elements to the Timeline view, as by default, when added they are not connected to any display or composite node. An example of such an element is a peg.
Selection Only Mode	Displays only elements currently selected in the Camera or Node view. This makes it easier to concentrate on one or a few elements at a time.
View Tagged Layers	<p>Lets you see only elements which have been assigned a Tagged status. An item that has been tagged will appear in the Timeline view with a small asterisk beside its name.</p> <p>Once your elements are tagged and you have switched over to View Tagged Layers mode, the Timeline view will display only tagged elements. The red bar on the left of the layers indicates you are in this view mode. While in this mode, the asterisks are not displayed beside the tagged elements.</p>
Show Functions	
Centre on Selection	Scrolls the layers list to the currently selected layer. This is useful if you want to select a layer in the Camera view, then manipulate its timing Timeline view.
Change Track Colour	Opens the colour picker window to modify the colour of the selected layer.
Default Track Colour	Resets the layer colour.
Collapse/Expand	Toggles between expanding and collapsing all parent layers in the Timeline view.
Collapse All	Collapses all parented layers in the Timeline view.
Expand All	Expands all parented layers in the Timeline view.
Set Tempo Marker	Lets you set a marker that synchronizes your animation with a musical score. This lets you reproduce the FPB (Frames Per Beat) and use the tempo signature as tempo markers. The Xsheet view lets you pace your animation according to the tempo or beat of the soundtrack music or to any rhythmic sound, such as the ticking of a clock or water leaking from a spout. See .

Layers	
Add Synced Drawing Layer	Creates a new drawing layer whose timing is synced immediately with the currently selected drawing layer.
Sync Layer With	Opens the Convert to Synced Drawing Layer dialog box. In this dialog box, every other drawing layer in the project can be selected, parented and have its timing synced to the currently selected layer.
Unsync Layer	Unsyncs the parent layer of a synced pairing, when the child layer is selected.





Top View Menu



The Top View menu lets you position elements in 3D space, set parameters for animation and access animation tools—see [Top View](#) on page 1288.

How to access the Top menu

- In the upper-left corner of the Top view, click the menu  button.

Command	Description
Edit	
Cut Drawing Object	Removes selected objects. You can then paste the object or its properties to another object.
Copy Drawing Object	Copies selected objects and properties.
Paste	Places an object you cut or copied into the location you select in a view.
Delete Drawing Object	Removes selected objects.
Select All	Selects all drawing objects in the current drawing window in the Drawing, Timeline and Camera views. This helps you manage multiple objects as one when moving them.
Deselect All	Deselects all selected objects in the Drawing and Camera views.
Invert Selection	Deselects the currently selected items and selects all other items that were not selected. For example, if some lines are selected in a drawing, this command will deselect them and select any other lines in the drawing that were not selected.
Select Child	Lets you select the first element parented to the selected peg element in the Timeline view.
Select Children	Lets you select all elements parented to the selected peg element in the Timeline view.
Select Parent	Lets you select the parent of the selected element in the Timeline view.

Select Previous Sibling	Lets you select the previous element (above current element) in the Timeline view.
Select Next Sibling	Lets you select the next element (below current element) in the Timeline view.
View	
Zoom In	Zooms in the view.
Zoom Out	Zooms out the view.
Reset Zoom	Resets the view's zoom to its default position.
Reset Pan	Resets the view's pan to its default position.
Reset View	Resets the view to its default position.
Layer Properties	Shows or hides the Layer Properties view.
Camera Cone	Displays the camera cone.
Control	Displays the controls of the selected element.
Hide All Controls	Hides the controls of the selected element.
Enable Playback	Plays back your animation in the Perspective view.
Animation	
Animate	
Animate Current Frame	When this option is selected, every time you use the  Transform,  Advanced Animation or  Inverse Kinematic tools to manipulate an element in your scene, the position of the element will be stored in a keyframe at the current frame. This allows you to animate elements in your scene without creating keyframes manually.
Animate Onion Skin	When this option is selected, if you use the  Transform or  Advanced Animation tools to make transformations to an element in your scene,

Range	the transformations will be stored as keyframes at the beginning and at the end of the current Onion Skin range, as well as on every existing keyframe in-between. This can be useful if you want to reposition an element that you have already animated, but only during a specific range of frames, which you can define by enabling Onion Skin and setting the Onion Skin range to cover that range of frames.
Animate Off	When this option is selected, if you use the  Transform or  Advanced Animation tools to make transformation to an element in your scene, the transformations will affect the element throughout the whole scene. This can be useful if you want to reposition an element after you have already animated it.
Insert Keyframe	Adds a keyframe to the selected cell in the Timeline view.
Insert Control Point	
Set Stop-Motion Keyframe	Converts the selected keyframes to stop-motion keyframes. Between a stop-motion keyframe and the next keyframe, Harmony does not generate any animation and the element remains static until the next keyframe.
Set Motion Keyframe	Converts the selected keyframes to motion keyframes. With motion keyframes, Harmony generates the interpolation between the motion keyframe and the next keyframe. This means that a value for each frame between the keyframes is calculated by Harmony to progress from the value of the previous keyframe to the value of the next keyframe.
Flip	Flip Horizontal: Flips the current selection horizontally.
	Flip Vertical: Flips the current selection vertically.
	Flip Scale X: Once your drawing layer is rotated, the original horizontal and vertical axes change. The Flip Scale X and Flip Scale Y will perform a flip on your drawing layer following its original axis. Remembers the original X-axis of the layer and flips the element following it.
	Flip Scale Y: Remembers the original Y-axis of the layer and flips the element following it.
Set Ease for Multiple Parameters	Opens the Set Ease for Multiple Parameters dialog box where you can change the velocity of selection functions.

Linear Motion	
Lock in Time	Indicates whether the point is locked to a specific frame (keyframe) or only locked to a specific position and the curve can flow through it freely as other points are being added, moved, or adjusted (control point).
No Z Dragging	
Substitute Drawing Previous	Replaces the drawing or cell's symbol on the current frame by the next drawing.
Substitute Drawing Next	
Select Previous Keyframe /Point	Select the previous keyframe/point.
Select Next Keyframe /Point	Select Next Keyframe /Point
Lock	Lock: Locks one or a multiple selection of layers.
	Unlock: Unlocks one or a multiple selection of locked layers.
	Lock All: Locks all the layers in the Timeline view.
	Unlock All: Unlocks all the layers in the Timeline view.
	Lock All Others: Locks every layer except the selected ones.
Reset	Returns the value of the selected element to the initial value of the active tool. For example, if the Rotate tool is active, the transformation angle will be reset to 0 and if the Transform tool is active, all the transformation values will be reset.
Reset All	Resets all transformations on the current frame in a selected layer. Your keyframe will remain, but all the values will return to the starting value. All transformations are reset regardless of the tool you're using.
Reset All Except Z	Resets all transformations on the current frame except the Z position. This

	is useful when doing cut-out animation. Cut-out puppets often have a particular Z ordering for the different views of a character. You might want to reset the transformation, but not necessarily the Z position.
Animation Tools	
Transform	Allows you to select drawing layers and position, rotate, scale and skew them.
Translate	Lets you move the selected element along the X and Y axes.
Rotate	Turns a selected element around its pivot point.
Scale	Increases or decreases the size of a selected element. You can scale an object up to make it larger or down to make it smaller. Press Shift to scale the element while maintaining its proportions.
Maintain Size	Keeps elements the same size aspect ratio in the Camera view as you move them towards or away from the camera.
Spline Offset	Lets you Lets you reposition the visual trajectory without offsetting or modifying your animation. By default, the trajectory is located at 0,0,0 fields. If your elements were drawn in a different location than the centre of the drawing area, it will look like the trajectory is not aligned with your drawing. Also, if you have several elements attached to one trajectory, you might want your trajectory to be at a different location to represent the group's motion better.

Xsheet View Menu

The Xsheet View menu lets you modify columns, keyframe and timing.

How to access the Xsheet menu

- In the upper-left corner of the Xsheet view, click the menu  button.

Parameter	Description
File	
Import	Images: Imports bitmap images which you can choose to vectorize.
	From Scanner: Imports drawings from a TWAIN scanner.
	Sounds: Lets you import sound files into your project.
Print	Prints the exposure sheet so you can take it to your animation table, provide a copy to the animator, or create your Xsheet skeleton directly in Harmony.
Edit	
Cut cells from Xsheet	Removes selected objects. You can then paste the object or its properties to another object.
Copy cells from Xsheet	Copies selected objects and properties.
Paste	Places an object you cut or copied into the location you select in a view.
Paste Special	Lets you copy and paste selected drawings into a different layer or paste the selection in the same layer to duplicate the drawings.
Paste Special Again	Pastes new drawings with the previous Paste Special settings.
Paste Cycle	Cycles a portion of an animation. You can increase or decrease the number of cycles to paste and select a type of cycle: Normal, Reverse, Forward-Reverse and Reverse-Forward.

Paste Reverse	Reverses the timing of drawings or keyframes in range of selection after copying.
Delete	Removes selected objects.
Select All	Selects all drawing objects in the current drawing window in the Drawing, Timeline and Camera views. This helps you manage multiple objects as one when moving them.
Deselect All	Deselects all selected objects in the Drawing and Camera views.
Insert Mode	Adds a new value or a new value sequence over existing ones, the new values are inserted between the old ones. The existing timing sequence is pushed down the column. The Insert mode opposite of the Overwrite mode, which is the Xsheet default mode.
Gestural Drag Mode	Lets you drag a cell to any other frame in the same column or into another column. This feature does not apply to Annotation columns.
Send to Function View	Sends selected objects to the Function view where you can edit and adjust its function curve and parameters.
View	
Zoom In Xsheet	Zooms in the view.
Zoom Out Xsheet	Zooms out the view.
Reset Zoom	Resets the view's zoom to its default position.
Reset Pan	Resets the view's pan to its default position.
Reset View	Resets the view to its default position.
Set Tempo Marker	
Expand/Collapse	Collapse Selection:
	Expand Selection:



	Collapse All:
	Expand All:
Column Properties	Lets you rename a column, and enable or disable a column. To view additional properties, select Edit > Preferences from the top menu. In the Preferences dialog box, select the Advanced tab, then select the Advanced Element Mode option.
Show Column List	
Column Types Manager	Lets you add advanced column types to create particular animation paths. When you create these columns, they are not linked automatically to any particular drawing layer. You can create a motion path using these columns and then link or unlink several drawing or peg layers to it.
Show Thumbnails	Displays column thumbnails making it easier to identify a particular column. This option displays a small thumbnail picture of the current frame below the column header.
Show Selection	
Set Columns Width	Lets you change the column width (in pixels) and set it as the default.
All Columns to Default Width	Returns all columns to their default width of 100 pixels.
Change Columns Colour	Lets you customize the colour of the column by selecting one from the Select Colour dialog box. The colour you select is also reflected in the corresponding layer in the Timeline view.
Default Column Colour	Removes the colour you assigned to a column (if any).
Hide Selected Columns	Hides selected columns.
Unhide All Columns	Displays all columns.
Show Hidden Columns	Displays columns that were previously hidden.

Enable Playback	Plays back your animation in the Perspective view.
Columns	
Add Columns	Lets you add a column. You can specify the column name, type, and set drawing layer options in the Add Column dialog box that opens.
Delete Columns	Removes the selected column. You have the option to delete the associated drawing files and element folders.
Clone Selected Columns: Drawings Only	Creates a copy of the selected column that is linked to the original. If a drawing is modified in the original or cloned column, both will be updated. However, cloned columns can have different timings. You can clone the drawings only or both the drawings and timing.
Clone Selected Columns: Drawings and Timing	
Duplicate Selected Columns	Creates an independent copy of the selected column. This useful when you need to modify the element independently, including the timing (exposure). Changes to the original element do not propagate to the duplicate.
Merge Selected Columns	There are two methods of merging drawings. <ul style="list-style-type: none"> You can merge selected drawings in adjacent elements. The columns and layers will be left intact, and each new merged drawing will reside in the frames of the left-most column or lower layer. You can merge elements. All drawings will be merged. Unused columns and layers will be deleted, but the original drawing files are still accessible.
Frames	
Add Frames At Start	Adds the number of frames you specify to the end of the scene.
Add Frames At End	
Add Frames Before Selection	Adds the number of frames you specify before or after your selection.
Add Frames After Selection	

Remove Selected Frames	Deletes the selected frames from your scene.
Drawings	
Create Empty Drawing	Creates Creates a drawing in the selected cell, replacing any drawing that may already be exposed in that cell and the following ones until it meets another drawing, key exposure or a blank cell.
Duplicate Drawings	<p>Creates a duplicate of the selected drawing in the layer. The duplicate drawing will be exposed at the selected frame instead of the original drawing. Hence, this command allows you to instantly start working on a duplicate of the current drawing and retain the original.</p> <div style="border: 1px solid green; padding: 5px; margin-top: 10px;">  <p>NOTE When duplicating a drawing, the exposure at the selected cell is replaced with the new drawing, up until the next key exposure.</p> </div>
Rename Drawing	Lets you give a selected drawing a new name.
Mark Drawing As	<p>Marks selected drawings as one of the following: Key, Breakdown, In-between, RetakeKey, RetakeBD or RetakeIB.</p> <p>This helps to keep the Xsheet well organized while animating.</p> <p>When working with several animators, directors or even other studios, the necessity for retakes will often arise. Harmony gives you the possibility to mark new drawings as either Retake Key, Retake Breakdown, or Retake In-betweens.</p>
Substitute Drawing Previous	Replaces the drawing or cell's symbol on the current frame by the next drawing.
Substitute Drawing Next	
Exposure	
Increase	Adds Adds one more exposure to a selected cell; repeating this action adds an extra cell each time. This is an efficient way to extend a drawing's exposure and is always set in Insert mode. Increasing an exposure pushes the existing exposure forward.

Decrease	Decreases exposure of a selected cell by one; repeating this action decreases one exposure adds an extra cell each time. This is an efficient way to shorten a drawing's exposure. Decreasing an exposure pulls in the existing exposure.
Set Exposure to	Lets you set the exposure to 1, 2, 3 or a custom exposure.
Extend Exposure	Lets you extend the length of a selected cell.
Add Key Exposure	Adds a key exposure to the selected cell.
Remove Key Exposure	Removes key exposures from the selected cells.
Remove Duplicate Key Exposure	<p>When working with drawings to adjust the timing of a mouth in a lipsync, for example, and forcing the use of specific key exposures, unnecessary key exposures will be created. You can delete these duplicates without affecting the rest of the drawing. The first drawing of the selection will be used for the range.</p> <div style="border: 1px solid green; padding: 5px; margin-top: 10px;">  NOTE Duplicate key exposures may occur when pasting with the Enforce Key Exposure option selected. </div>
Fill Empty Cells	Lets you Fills the empty frames in the selection with the exposure just before. For example, if you select a range of frame that starts with an exposed drawing and then ends with empty cells, all of the empty cells in the selection will be filled with the exposed drawing just before the empty cells.
Insert Blank Cell	Adds Adds an empty cell between other cells.
Clear Exposure	Removes the exposure from the selected cell.
Clear Exposure and Pull	Replaces the exposure from the selected cell with exposures that follow it.
Fill Selection	Lets you Lets you fill the same value over an entire selection. The selection can be over one cell, a cell range in one column, a cell range over many columns, an entire column, or many columns. You can use numbers, words, letters, or any alphanumeric value.
Sequence Fill	Lets you Lets you create a numbered sequence over a selection. The sequence can

	be forward, backward, single, double or higher increment, as a cycle, and so on. The selection can be over one cell or a cell range in one column or more or an entire column or many entire columns.
Fill Cells Randomly	Lets you Lets you fill in random values over a selection. You can give a maximum and a minimum value and create a range for Harmony to choose the random values from. The selection can be over one cell or a cell range in one column or more or an entire column or many entire columns.
Hold Exposure	Lets you expose a drawing for three, four, or five cells and so on.
Motion	
Insert Keyframe	
Insert Keyframe and Duplicate Drawing	
Delete Keyframes	Deletes the selected keyframes.
Go to Previous Keyframe	
Go to Next Keyframe	
Set Stop-Motion Keyframe	Converts the selected keyframes to stop-motion keyframes. Between a stop-motion keyframe and the next keyframe, Harmony does not generate any animation and the element remains static until the next keyframe.
Set Motion Keyframe	Converts the selected keyframes to motion keyframes. With motion keyframes, Harmony generates the interpolation between the motion keyframe and the next keyframe. This means that a value for each frame between the keyframes is calculated by Harmony to progress from the value of the previous keyframe to the value of the next keyframe.
Morphing	
Create Morphing	Allows you to create and configure a morphing sequence, which will automatically generate the in-betweens between two drawings in the current layer.

Delete Morphing	Once a cell is selected in a morphing sequence, deletes the entire sequence between the two keyframes.
Insert Morphing Key Drawing	Creates a morphing keyframe from a selected morphing frame.
Convert Morphing to Drawing	Lets Lets you convert your morphing inbetweens to real drawings you can edit. This is useful when manually editing a morphing sequence or if you prefer to have animation timing in double frame (on twos) instead of single frame (on ones).
Lip-Sync	
Change Mouth Shape to	Lets you change the mouth shape to one of the following: A, B, C, D, E, F, G, X.
Auto Lip-Sync Detection	Generates a sound detection for lip-sync.
Map Lip-Sync	Automatically maps Automatically maps drawings in an element to the mouth chart you have generated for a sound. This can save time when you are lip-synching a voice track.
Sound Display	
Sound Name	Shows the name of the sound file, as well as the file format. The line running vertically through the column frames between the same file name indicates a continuity of the same sound file in these frames.
Mouth Shapes	Shows the letter (or name depending on the way you named your character's different mouth positions) in the column's frames. There is only one mouth position allotted per frame and this position should correspond to the sound file after performing a lip-sync.
Waveform	Shows a vertical display of the sound file's actual waveform. In the column header, in the field under the column name, you can type in a percentage to zoom in or zoom out on the waveform, or pass the scroll cursor  over the Zoom Waveform  icon.
Sound Edit	

Insert Blank Cell	Places an empty cell between other cells.
Clear Exposure and Pull	Replaces the exposure from the selected cell with exposures that follow it.
Annotation	
Import File	Lets you import an image file in an Annotation column.
Change Pen Colour	Lets you change the pen colour by selecting one from the Select Colour dialog box.
Pen Width	Lets you select a pen preset or change the pen width (in pixels).
Eraser Width	Lets you modify the width of the Eraser tool.
Erase All	Removes all text and drawn annotations. Annotations that you type in cannot be erased using this method.
Erase Selected Images	Removes images you select in the Annotation column.
Erase Selected Texts	Removes text you select in the Annotation column.
Enable Drawing	Lets you draw in the Annotation column using your mouse or pen tablet.

Chapter 3: Nodes / Layers

The Node view is a visual representation of how every element in your scene, be it drawing layers, pegs, effects and others are combined together to form the final composited image. It allows you to rig the elements in your scene together and add a wide range of effects to your scene. Getting to know how to use the Node view is important especially for rigging cut-out models, adding effects to scene or managing the way your scene is composited, rendered and displayed in Harmony.

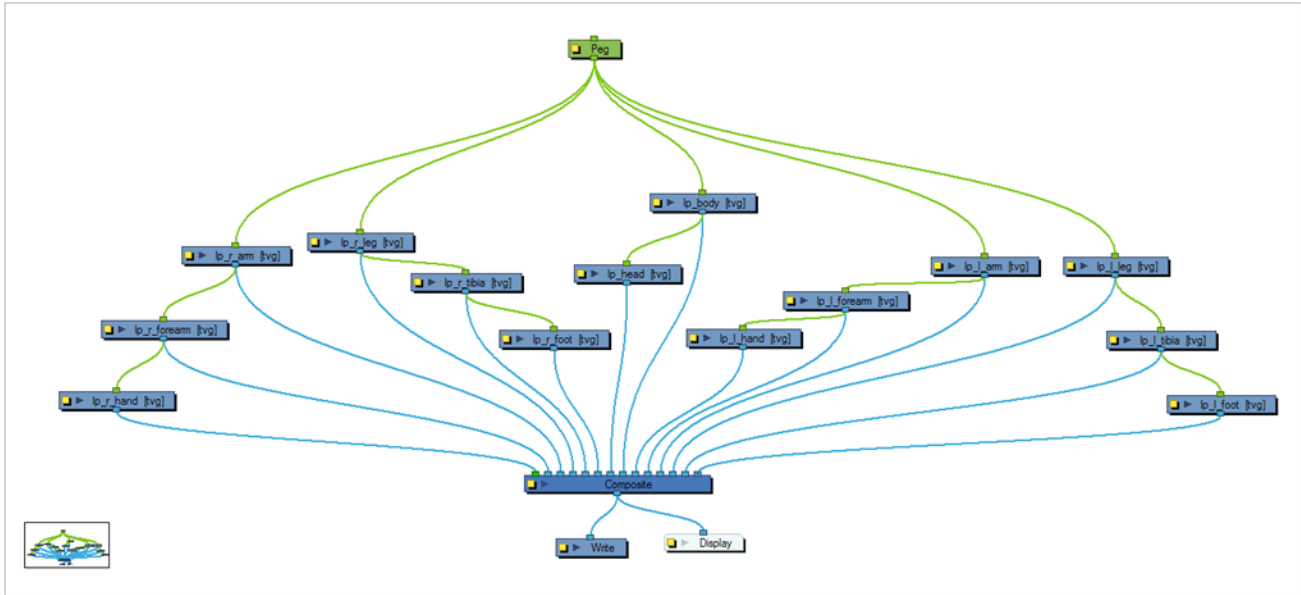

3D Nodes	411
3D Kinematic Output Node	412
Flatten Node	415
Render Maya Batch Node	417
Subnode Animation Node	422
Z Buffer Smoothing Node	426
Combine Nodes	428
Blending Node	429
Composite Node	435
Composite-Generic Node	440
Cutter Node	446
Highlight Node	448
Image Switch Node	452
Matte-Composite Node	454

Tone Node	457
Transformation Switch Node	461
Constraint Nodes	463
Constraint Switch Node	465
Dynamic Spring Node	468
Multi-Points Constraint Node	473
Static Transformation Node	476
Three-Points Constraint Node	479
Transformation Gate Node	482
Transformation Limit Node	484
Two-Points Constraint Node	490
Deformation Nodes	496
Articulation Node	497
Auto Fold Node	500
Auto Muscle Node	502
Bone Nodes	506
Curve Node	510
Deformation Composite Node	514
Deformation Root Node	517
Deformation Scale Node	518
Deformation Switch Node	523
Deformation Uniform Scale Node	525
Deformation Wave Node	527
Fold Node	530
Game Bone Node	534
Glue Node	536
Kinematic Output Node	538
Mesh Warp Node	539
Offset Node	543
Point Kinematic Output Node	545

Connections	546
Refract	552
Stick Node	554
Turbulence Node	556
Weighted Deform Node	560
Filter Nodes	564
Anti-Flicker Node	566
Auto-Patch Node	568
Bloom Node	570
Blur-Box Node	574
Blur-Directional Node	577
Connection	578
Layer Properties	579
Blur-Gaussian Node	581
Blur-Radial Node	584
Blur-Radial-Zoom Node	586
Blur-Variable Node	590
Brightness Contrast Node	592
Channel Selector Node	594
Channel Swap Node	596
Chroma-Keying Node	598
Colour Banding Node	604
Colour Art Node	607
Colour Curves Node Properties	609
Colour Fade Node	614
Palette Overrides	615
Individual Colour Overrides	617
Colour Levels Node	621
Colour-Override Node	624
Colour-Scale Node	629

Colour Selector Node	631
Contrast Node	634
Dither Node	636
Focus Node	638
Focus Multiplier Node	641
Gamma Node	643
Glow Node	646
Grain Node	650
Greyscale Node	652
Hue-Saturation Node	654
Increase Opacity Node	661
Layer Selector Node	664
Line Art Node	667
Luminance Threshold Node	669
Matte-Blur Node	672
Matte-Resize Node	675
Median Node	677
Motion Blur Node	680
Motion-Blur-Legacy Node	684
Negate Node	687
Overlay Layer Node	689
Pixelate Node	691
Remove Transparency Node	693
RGB Difference Keyer Node	695
Shadow Node	700
Transparency Node	703
Underlay Layer Node	705
Generator Nodes	708
Animated Matte Generator Node	709
Burn-In Node	720

Colour-Card Node	724
Element / Drawing Node	727
Connection	728
Field Chart Node	745
Gradient Node	750
Grid Node	756
Lens Flare Node	759
Turbulent Noise Node	762
Group Nodes	766
Group Node	767
Multi-Port-In Node	768
Multi-Port-Out Node	769
Miscellaneous Nodes	770
External Node	771
Master Controller Node	774
Note Node	780
OpenGL Bypass Node	781
OpenGL-Cache-Lock Node	783
Pre-Render Cache Node	786
Connection	787
Render Preview Node	790
Script Node	791
Visibility Node	794
Move Nodes	795
Apply Image Transformation Node	796
Apply Peg Transformation Node	799
Camera Node	803
OrthoLock Node	805
Peg Node	807
Shake Node	809

Transform-Loop Node	813
Quadmap Node	816
Quake Node	819
Output Nodes	822
Crop Node	823
Display Node	826
Multi-Layer Write Node	827
Scale Output Node	831
Write Node	833
Particle Nodes	847
3D Region	849
Baker	851
Baker Composite	854
Bounce	855
Explosion	857
Gravity	859
Image Fracture	861
Kill	867
Move Particles	869
Orbit	871
Planar Region	874
Random	878
Region Composite	879
Repulse	880
Rotation Velocity	881
Sink	884
Size	885
Sprite Emitter	887
System Composite	897
Velocity	898

Visualizer	901
Vortex	903
Wind-Friction	905
Shading Nodes	906
Ambient Occlusion Node	907
Cast Shadow Node	911
Light Position Node	918
Light Shader Node	920
Light Shader Properties - Surface Light Tab	924
Normal Map Node	925
Normal Map Converter Node	929
Shape Curve Node	931
Shape Line Node	934
Shape Render Node	936
Surface Map Node	939
Layer Properties	940
Surface Normal Node	943
Tone Shader Node	945
Tone Share Properties - Surface Light tab	948
Volume Object Node	949
Plugin Nodes	951
Sparkle	952
Selection Preset Note Node	955
Sound Layer	956

3D Nodes

The nodes found in the 3D category are used to handle and render 3D objects such as animating the sub-nodes or rendering using Maya.

3D Kinematic Output Node	412
Flatten Node	415
Render Maya Batch Node	417
Subnode Animation Node	422
Z Buffer Smoothing Node	426

3D Kinematic Output Node

A 3D Kinematic Output node can be used to connect the animation for a subnode to another node. This allows to use a subnode's animation on other elements in the scene, as if it was part of a hierarchy of peg and the subnode was the parent peg.

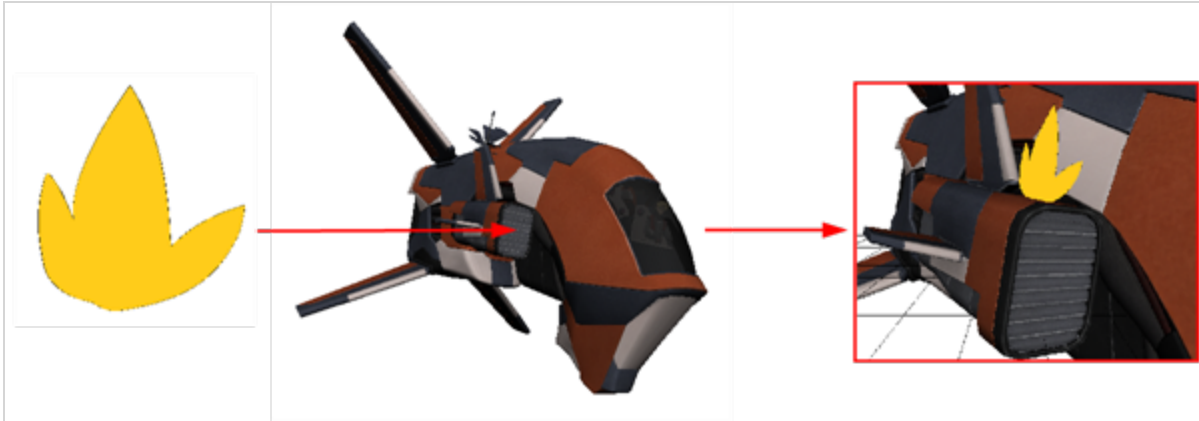

Connection

The 3D Kinematic Output node must be connected under a Subnode Animation node, from which it will take one of the subnode's animation, and then connected as a parent of the node on which it must apply that animation.

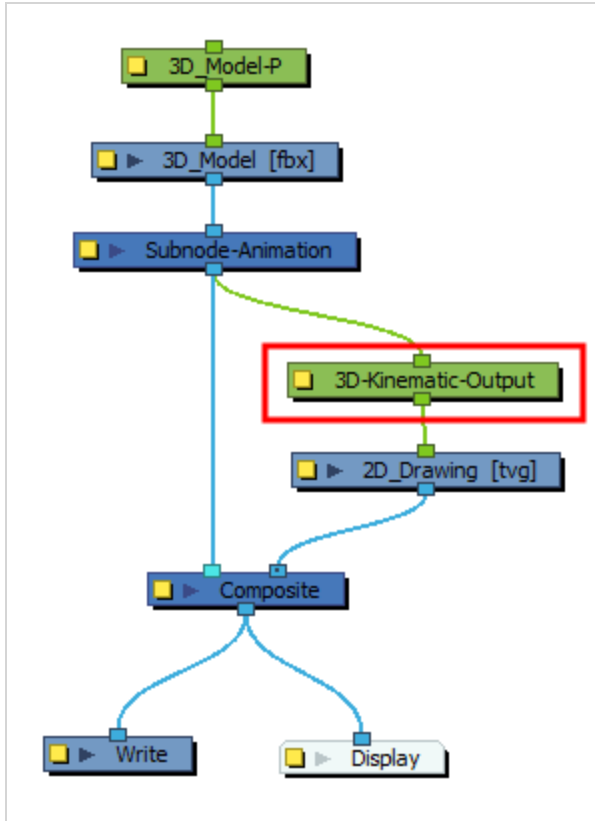

**TIP**

You can quickly create a 3D Kinematic Output node by selecting a subnode in the 3D Graph view, then clicking on the Add 3D Kinematic Output  button. The 3D Kinematic node will be connected under the model's Subnode Animation node, and configured to apply the selected subnode's animation to its child. It must then be connected to a child element in the Node view.

**NOTE**

It is not possible to animate the subnodes of a 3D model without a Subnode Animation node. Hence, the 3D Kinematic Output node must be connected under a Subnode Animation node, and not directly under a 3D model—see [Subnode Animation Node](#) on page 422.

Properties

The Subnode Name attribute of a 3D Kinematic Output node determines which of the 3D model's subnode will be used to animate the node's child.

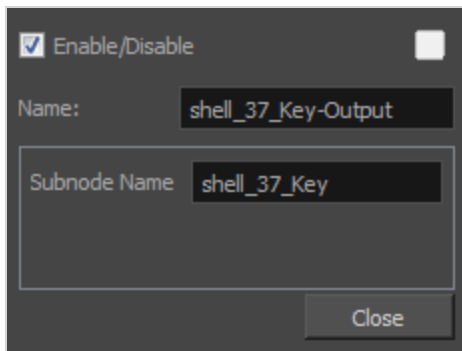

Parameter	Description
Enable/Disable	Allows you to enable or disable the node. When disabled, a node has no visible effect on the rendered image, nor on the preview in the Camera, Perspective, Side and Top views.
Colour Swatch	Sets the colour of the layer in the Timeline view and of the node in the Node view.
Name	Allows you to enter a name for the node. It is recommended to use the name of the subnode followed by -Output .
Subnode Name	Use this field to enter in the part of the 3D model whose movements you

	<p>would like to track. Entering the name of the 3D model subnode into this field is what lets the 3D Kinematic Output node know which part of the model to read.</p>
--	---

Flatten Node

The Flatten node is used to transform 3D objects into flat planes when ordered in the Composite node. That plane can then be moved around like any other drawing. Instead of intersecting with 2D layers, the 3D object will either be behind or in front.

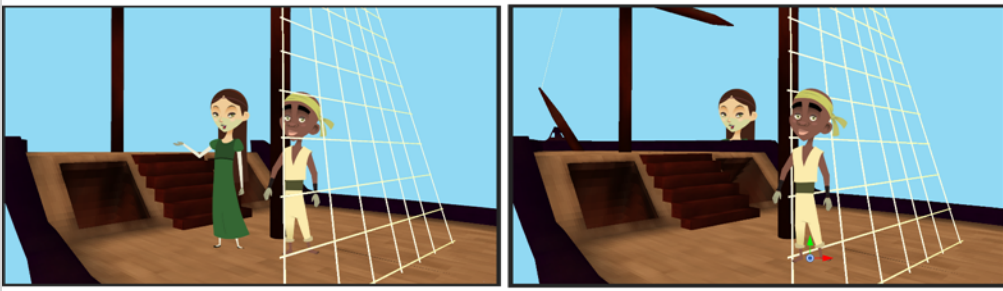

When all objects are at the same distance (z value) from the camera, the order is based on the Composite ports. When elements are placed at different distances from the camera, the z axis value overrides the composite port ordering.

Connection

The Flatten Node takes a 3D image in its input port and outputs a 2D image.

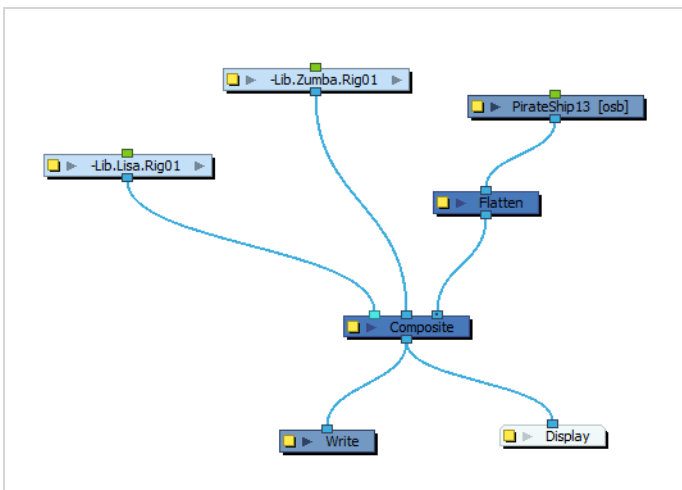

Layer Properties

Parameter	Description
Enable/Disable	Allows you to enable or disable the node. When disabled, a node has no visible effect on the rendered image, nor on the preview in the Camera, Perspective, Side and Top views.
Colour Swatch	Sets the colour of the layer in the Timeline view and of the node in the Node view.

Parameter	Description
Name	Allows you to enter a name for the node.

Render Maya Batch Node

By default, 3D models imported in Harmony are rendered using OpenGL. The Maya Batch Render can be used to render a 3D model connected to it through Autodesk Maya, then output the rendered image to the scene so that it can be composed. It can be configured to use one of several of the rendering engines supported by Maya, such as RenderMan, Mental Ray and Maya Software.



NOTE

The Maya Batch Render node is basically a Script Node pre-configured to take the input image and process it through the `renderMayaBatch()` built-in function of the Harmony scripting interface—see [Script Node](#).

Connection

The MayaBatchRender node takes a 3D model in its input port, and outputs a 2D rendered image when the scene is rendered.

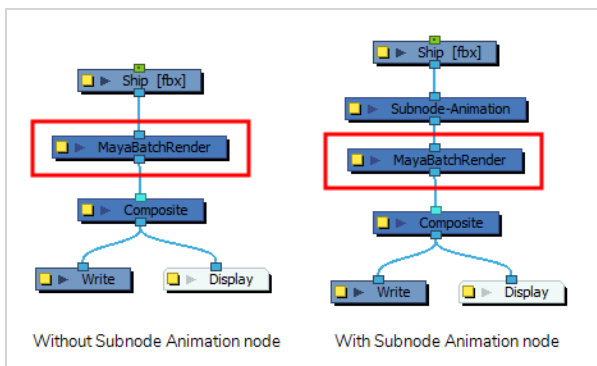

NOTE

The Maya Batch Render node does not affect the OpenGL preview of the scene in the Camera view. To see the effect of the Maya Batch Render node in Harmony, you must set the preview mode of the Camera view to Render View  mode.

Configuration

For the Maya Batch Render node to work, the following conditions must be met:

- The path to Autodesk Maya and, if needed, to RenderMan, must have been set on your machine using the `TB_Set_3dRendererer_Paths.js` script which is bundled with Harmony.
- The original Maya project in which the 3D model was created must be in the element folder of the 3D model you imported into your Harmony scene, and must have the same file name as the 3D model you imported, but with the appropriate extension. Additionally, the model's textures should also be in the element folder.

In the following example, the 3D model is a Filmbox (. **fbx**) model that was imported in a Harmony scene into an element named **Ship**. The . **fbx** file was named **Ship-1.fbx**. Hence, for the Maya Batch Render node to render it, the original Maya project must be in the folder of the **Ship** element. Since the Maya project has the extension . **ma** and the 3D model is named **Ship-1.fbx**, the Maya project must be named **Ship-1.ma**:

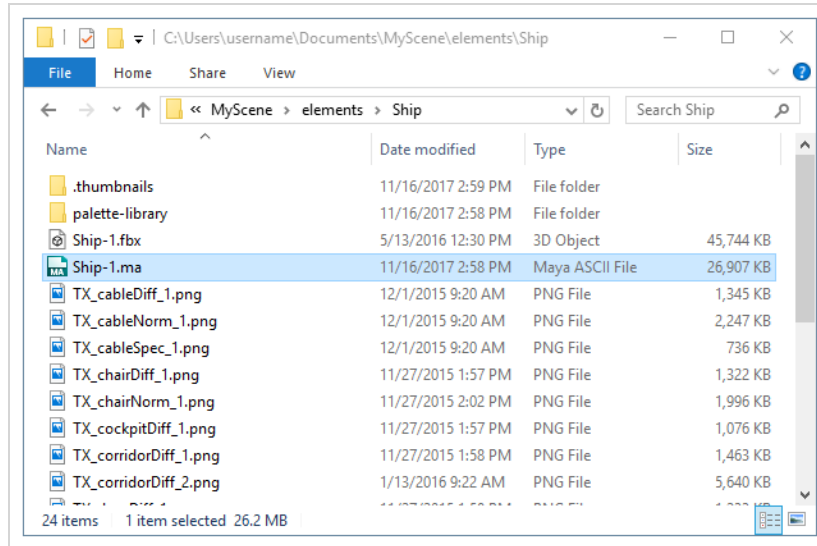

NOTES

- You can also make the Maya Batch Render node source the Maya project from its original location—see [Specifications Tab on page 419](#).
- For detailed steps on how to use the Maya Batch Render node, refer to the *3D Integration* chapter of the User Guide.

Layer Properties

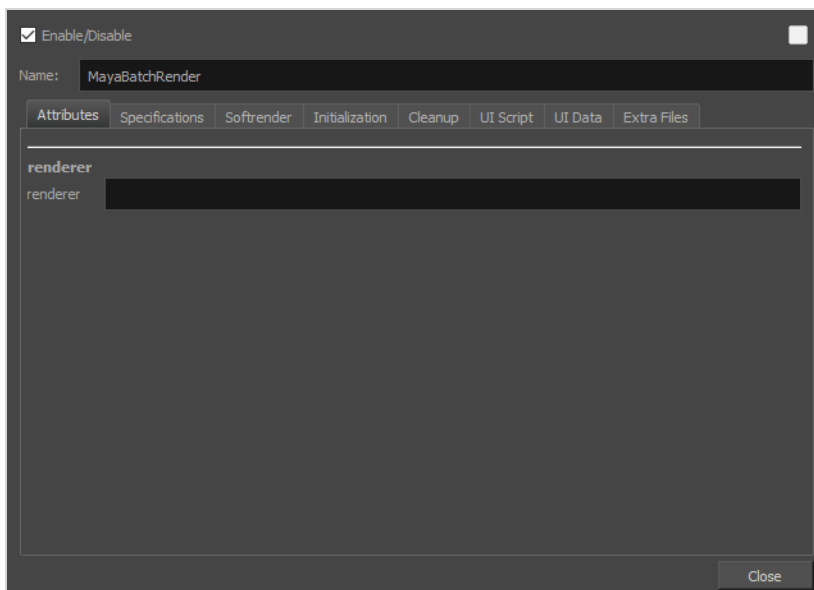

Parameter	Description
Enable/Disable	Allows you to enable or disable the node. When disabled, a node has no visible effect on the rendered image, nor on the preview in the Camera, Perspective, Side and Top views.
Colour Swatch	Sets the colour of the layer in the Timeline view and of the node in the Node view.
Name	Allows you to enter a name for the node.

Attributes Tab

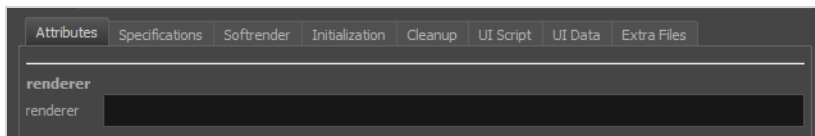

Parameter	Description
Renderer	Specify the rendering engine to use. The following engines are supported: <ul style="list-style-type: none"> 'renderMan' (or 'reyes') 'renderManRIS' (or 'RIS') 'arnold' 'mentalRay' 'mayaSoftware' (or 'maya')

Specifications Tab

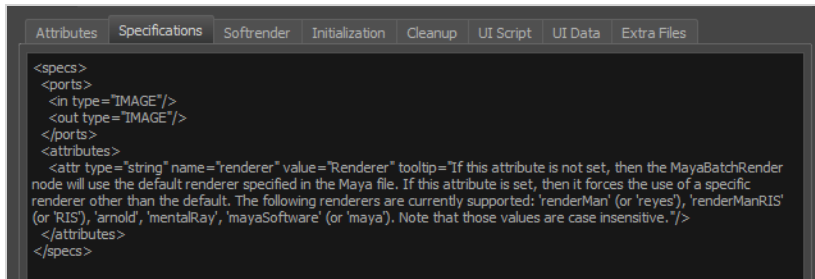

The specification tab is used to define the attributes in the Attributes tab as well as the input and output ports of the node. By default, it is configured to have one input image port, one output image port, and a Renderer parameter in the Attributes tab, which allows you decide which rendering engine to use to render the 3D model. The following is the default Specifications script for the Maya Batch Render node:

```

<specs>
  <ports>
    <in type="IMAGE"/>
    <out type="IMAGE"/>
  </ports>
  <attributes>
    <attr type="string" name="renderer" value="" tooltip="If this attribute is not set, then the MayaBatchRender node will use the default MayaBatchRender renderer."/>
  </attributes>
</specs>

```

By default, the Maya Batch Render node expects the Maya project for the 3D model to be in the same directory as the 3D model itself, with the same file name, but a different extension. However, you can add another attribute to the node which allows you to specify the path to the Maya project to use for rendering the 3D model. To do this, add the bolded line to the Specifications tab:

```

<specs>
  <ports>
    <in type="IMAGE"/>
    <out type="IMAGE"/>
  </ports>
  <attributes>
    <attr type="string" name="renderer" value="" tooltip="If this attribute is not set, then the MayaBatchRender node will use the default MayaBatchRender renderer."/>
    <attr type="string" name="OriginalMayaFileName" value="" tooltip="Write your project path here" />
  </attributes>
</specs>

```

After changing the content of the Specifications tab, you must save, close and re-open the scene before you can see the new OriginalMayaFileName field in the Attributes tab. You can then type in the path to the Maya project that the Maya Batch Render node should render.

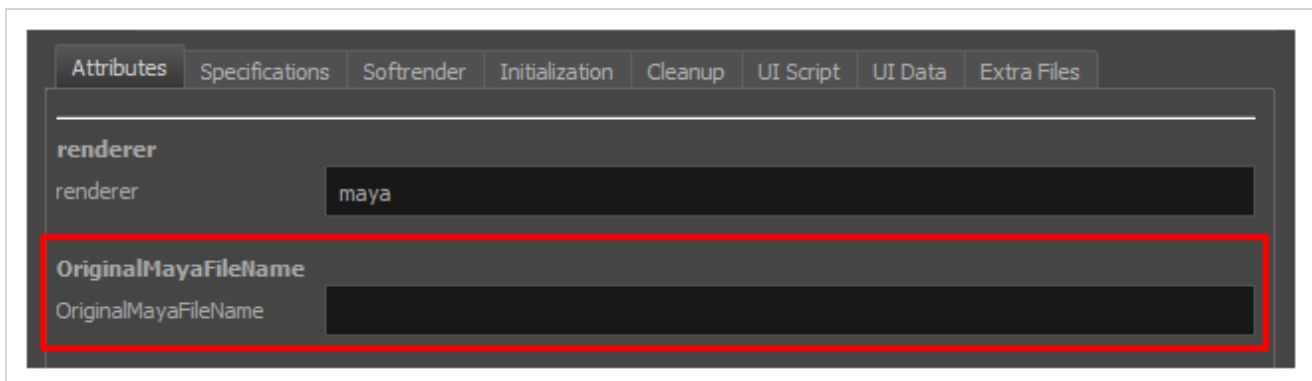

**NOTES**

- The path should include the name of the project file as well as its extension.
- You must use forward slashes (/) to separate the directories in the path, even on Windows, like in this example:

C : /Users/username/Documents/MyProject.ma

- You can use a relative path. The path is relative to the element folder containing the 3D model used in the Harmony scene. For example, `../.. /` points to the scene directory.

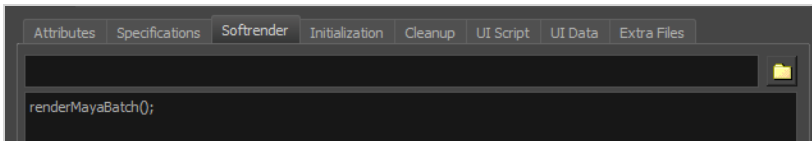
Softrender Tab

This tab contains the script to execute when the scene is rendered. By default, it contains this single function:

```
renderMayaBatch ( ) ;
```

This function takes the 3D model in the input image and renders it using Autodesk Maya, using the rendering engine specified in the Attributes tab. To do this, it uses the original Maya project for the 3D model and instructs Autodesk Maya to render it, but with the transformations in position, angle and scale applied to it in the current frame of the Harmony scene. Autodesk Maya then produces an OpenEXR (**.exr**) image with deep pixels, which Harmony integrates into the scene and composites it with other elements and effects.

**NOTE**

The other tabs in the Maya Batch Render node properties are the standard tabs for a Script node. This is because the Maya Batch Render node is just a Script node set up to execute **renderMayaBatch () ;**. For more information, see [Script Node on page 791](#).

Subnode Animation Node

When manipulating 3D models, by default, it is only possible to animate the transformation on the whole model. Transformations on their individual parts (subnodes) are static. In order to be able to animate the subnodes in a 3D model, it must be connected to a Subnode Animation node, which will store the animation information for individual subnodes and apply it to the model.

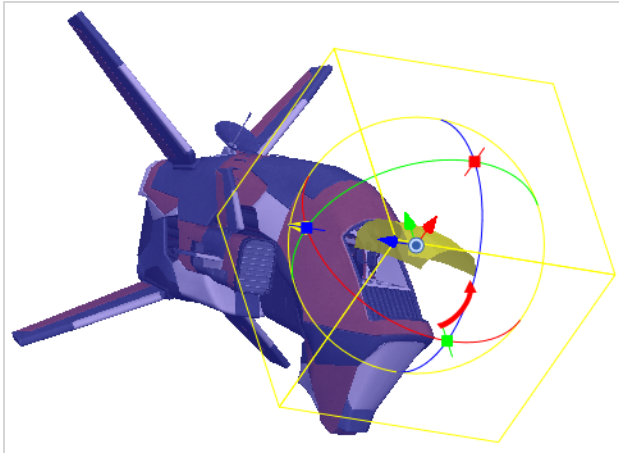

Connection

The Subnode Animation node takes a 3D model in its input port. As soon as a 3D model is connected to a Subnode-Animation node, its subnodes become animatable individually. Once you start animating the model's subnodes, the node outputs the 3D model with its subnodes animated.

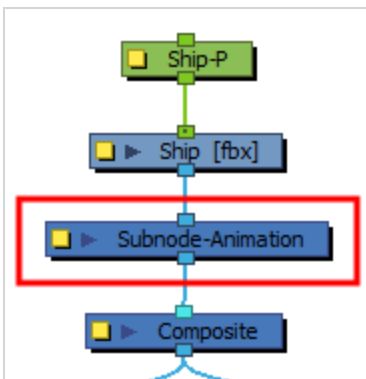

The parameters for each subnode that is animated will appear in the node's parameters in the timeline.

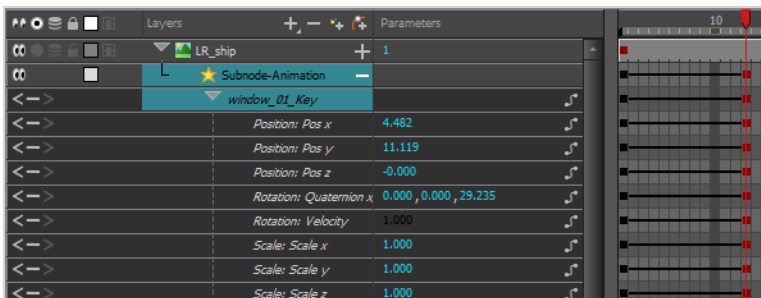



**TIP**

You can add the parameters for a subnode to the Subnode Animation node without animating it first. To do this, select the subnode, then click on the Make Properties Available  button in the 3D Graph view. This can be useful if you want to make a keyframe with the subnode's resting position before animating it.

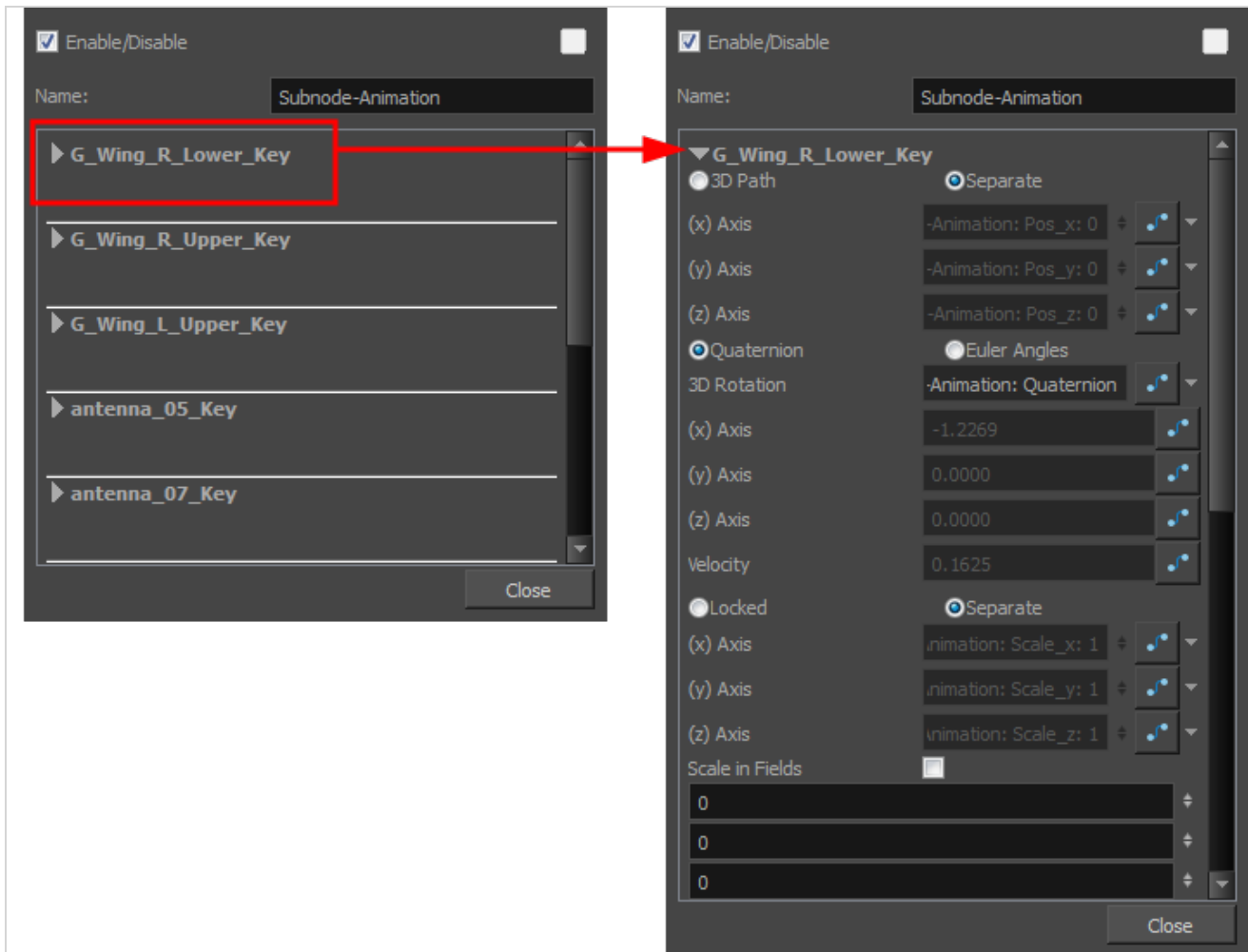

Layer Properties

All animatable 3D model subnodes appear in a list in the Subnode Animation Layer Properties. Expand any of the subnodes in the list to view its individual properties.



Click on any of the Function buttons  to open the Function Editor for that parameter.

If movements have already been created in the Camera view, you may not be able to edit some of the fields. They just display the value of that parameter at the given position in the Timeline. If you would like to edit these fields, change the field type to Local.

Parameter	Description
Enable/Disable	Allows you to enable or disable the node. When disabled, a node has no visible effect on the rendered image, nor on the preview in the Camera, Perspective, Side and Top views.
Colour Swatch	Sets the colour of the layer in the Timeline view and of the node in the Node view.
Name	The name of the node as it appears in the Node View and the Timeline view. Each node must have a name that is unique to its containing group.
Position	<p>3D Path: Lets you use a 3D path function to animate an element.</p> <p>Separate: Lets you independently edit the different coordinate fields.</p> <p>Path: When the 3D Path option is selected, lets you choose the path type. You can do this from the field menu, located after the Function button .</p> <p>Path (x) Axis: Lets you type in a new East/West coordinate corresponding to the desired position.</p> <p>Path (y) Axis: Lets you type in a new North/South coordinate corresponding to the desired position.</p> <p>Path (z) Axis: Lets you type in a new Forward/Backward coordinate corresponding to the desired position.</p> <p>Velocity: When the 3D Path option is selected, lets you set the speed at which movement occurs across the X, Y and Z axes.</p>
Rotation	<p>Quaternion: Rotations made on the X, Y and Z axes are linked, as is the velocity which acts on the three rotation functions simultaneously.</p> <p>Euler Angles: Rotations can be made on the X, Y and Z axes independent of each other; each has its own velocity.</p> <p>3D Rotation: When the Quaternion option is selected, lets you choose the path type. You can do this from the field menu, located after the Function button .</p> <p>(x) Axis: Lets you enter the horizontal rotation value in degrees.</p> <p>(y) Axis: Lets you enter the vertical rotation value in degrees.</p> <p>(z) Axis: Lets you enter the depth scale value in degrees.</p> <p>Velocity: When the Quaternion option is selected, lets you set the speed at which rotation occurs across the X, Y and Z axes.</p>
Scale	Locked: Resizes the element while keeping its ratio. The X and Y axes scale proportionally

	<p>Separate: Resizes the element allowing to modify the ratio (squash and stretch).</p> <p>(x) Axis: Lets you enter the horizontal scale value.</p> <p>(y) Axis: Lets you enter the vertical scale value.</p> <p>(z) Axis: Lets you enter the depth scale value.</p> <p>Scale in Fields: Instead of using the standard scaling units, when this option is enabled, images are scaled using field units, based on the traditional animation field chart. Enter in the x, y, z values respectively in the fields below.</p>
--	--

Z Buffer Smoothing Node

Rendering engines such as Maya and Mental Ray output images in a format that uses a simple Z-buffer that does not allow for proper antialiasing around the edges of the geometry. Hence, it is ultimately better for image quality to render using RenderMan or Arnold if possible. Otherwise, if a different rendering engine must be used and there appears to be pixelated hard seams around 3D models, the Z Buffer Smoothing node can be used to smooth out the edges of the rendered model.

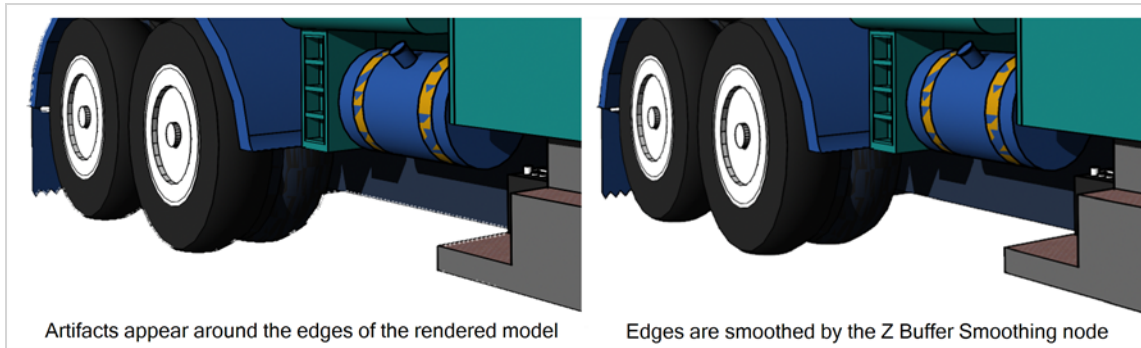

Connection

The Z-Buffer-Smoothing node takes the rendered 3D model output by a MayaBatchRender node as its input image, and outputs the rendered 3D model with its edges smoothed.

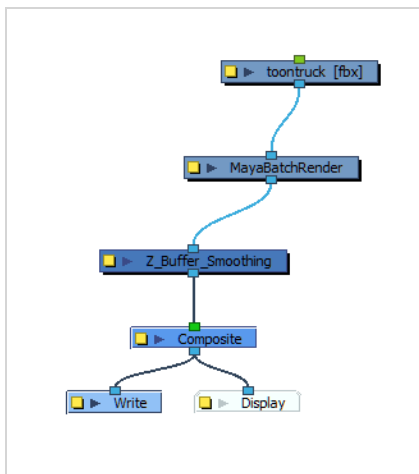

Layer Properties

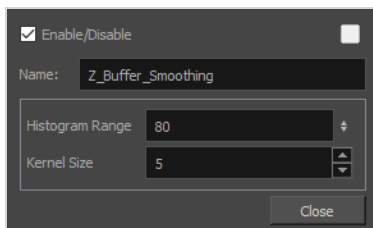

Parameter	Description
Enable/Disable	Allows you to enable or disable the node. When disabled, a node has no visible effect on the rendered image, nor on the preview in the Camera, Perspective, Side and Top views.
Colour Swatch	Sets the colour of the layer in the Timeline view and of the node in the Node view.
Name	Allows you to enter a name for the node.
Histogram Range	<p>Lets you define the range of clean pixels in the depth histogram when rendering 3D models. Only opaque or semi-transparent values are considered.</p> <p>A low value means fewer pixels are used in the depth calculations and may flatten your object, while a higher value uses more pixels in the depth calculations, but may not eliminate all the image artifacts.</p>
Kernel Size	Lets you determine the size of the matrix used for calculating the depth of a single pixel. For example, for an operation with a kernel size of 3 pixels, Harmony uses the pixels within a 1-pixel radius to calculate the effect. A larger kernel size means longer calculations.

Combine Nodes

The nodes found in the Combine category are used to take two or more elements and combine them into a new image.

Blending Node	429
Composite Node	435
Composite-Generic Node	440
Cutter Node	446
Highlight Node	448
Image Switch Node	452
Matte-Composite Node	454
Tone Node	457
Transformation Switch Node	461

Blending Node

T-COMP2-005-001

By default, layers are composited onto each other directly. This means that opaque pixels in front-most layers hide pixels in layers further back, and semi-transparent pixels on front-most layers are blended with pixels further back proportionally to their alpha ratio. This does the job for solid objects. However, some types of layers and effects may look better when composited into the scene using more advanced approaches. The Blending node can be used to composite an element, effect or composite using one of many different algorithms that may make it look much better in the final render.

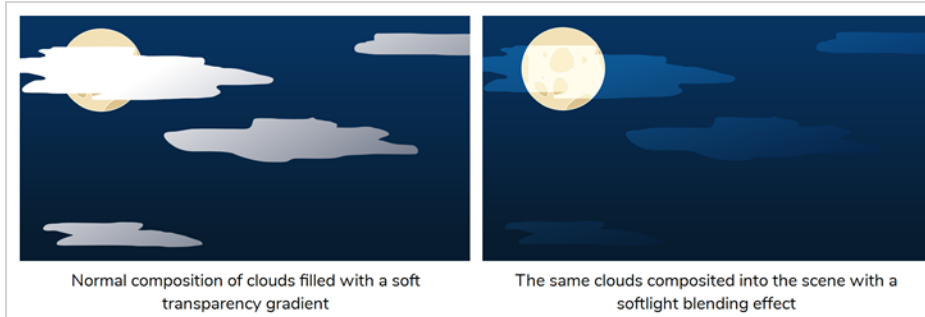

NOTE

The effect of the Blending node is only visible when the Camera view is in Render Preview  mode.

Connection

A Blending node can be connected under a layer, an effect or a composite to affect the way it will be composited into the scene.

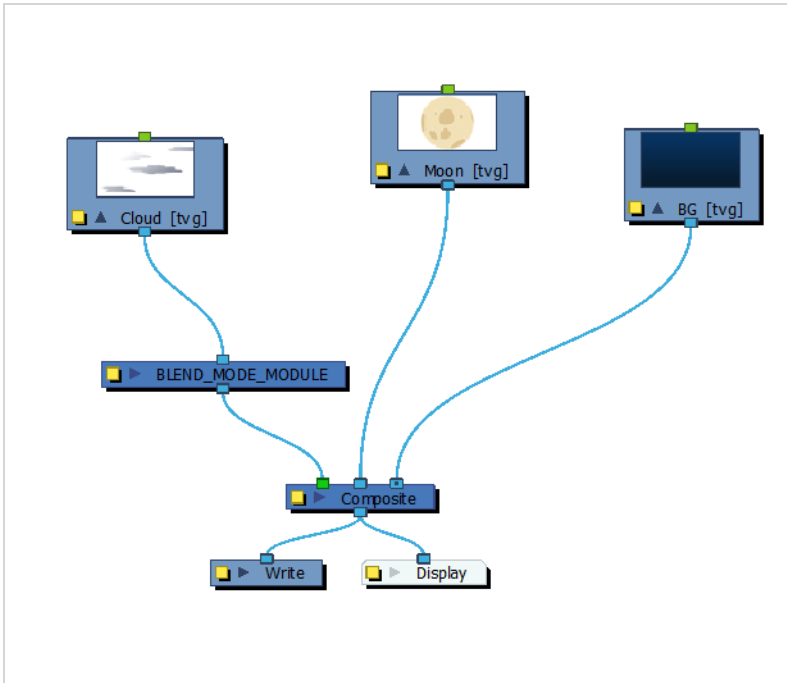

Properties

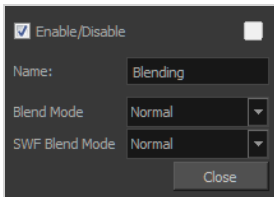

Parameter	Description
Enable/Disable	Allows you to enable or disable the node. When disabled, a node has no visible effect on the rendered image, nor on the preview in the Camera, Perspective, Side and Top views.
Colour Swatch	Sets the colour of the layer in the Timeline view and of the node in the Node view.
Name	Allows you to change the name given to the node.
Blend Mode	Choose the blending effect mode you wish to apply to your layer.





**NOTE**

Some of the available blending modes have a BETA or Legacy variant to them.

- A BETA blending mode is one that has been recently added in Harmony and which was made to more closely resemble results obtained in professional photo editing software such as Adobe Photoshop.
 - A Legacy blending mode is a blending mode that was present in older versions of Harmony. Starting from Harmony 10, these blending modes were enhanced by de-multiplying colours before compositing the image then re-multiplying them. Their legacy version remain available to ensure scenes created in older versions of Harmony do not render differently.
- **Normal:** Composites the image without any specific blending effect.
 - **Add / Add Legacy:** Adds the colour values of each channel in the overlay pixel and the underlay pixel. For example, adding two dark grey pixels with a value of 100 in each channel will result in a light grey pixel with a value of 200 in each channel. Likewise, if one of the pixels is red and the other is green, the resulting pixel will be yellow.
 - **Burn / BETA Colour Burn:** Darkens each channel in the underlay pixel with the darkness value of the corresponding channel in the overlay pixel, by increasing the contrast of the underlay pixel.
 - **Darken / BETA Darken:** For each channel, uses the value that is the darkest between the underlay pixel and the overlay pixel.
 - **BETA Linear Burn:** Darkens each channel in the underlay pixel with the darkness value of the corresponding channel in the overlay pixel, by reducing the brightness of the underlay pixel.
 - **Multiply / BETA Multiply:** Multiplies the value of each channel in the underlay pixel with the value of each channel in the overlay pixel, treating those values as ratios. Multiplying anything with black will result in black, and multiplying anything with white will leave the colour unchanged.
 - **Dodge / BETA Colour Dodge:** Lightens each channel in the underlay pixel with the brightness value of the corresponding channel in the overlay pixel, by decreasing the contrast of the underlay pixel.
 - **Erase:** Subtracts the overlay pixel's alpha from the underlay pixel, "cutting out" the overlay from the underlay. The overlay pixel's colour information is ignored.
 - **Lighten / Lighten Legacy / BETA Lighten:** For each channel, uses the value that is the brightest between the underlay pixel and the overlay pixel.
 - **BETA Linear Dodge:** Lightens each channel in the underlay pixel with the

brightness value of the corresponding channel in the overlay pixel, by increasing the brightness of the underlay pixel.

- **Screen / BETA Screen:** The reverse of multiply. Multiplies the reverse value of each channel in the underlay and overlay pixel, treating those values as ratios. Multiplying anything with white will result in white, and multiplying anything with black will leave the colour unchanged.
- **Vividlight:** This colour dodges overlay pixels with a value above 50% onto underlay pixels, and colour burns overlay pixels with a value below 50% onto underlay pixels. The brighter the overlay pixel is, the more intense the colour dodging effect will be. The darker the overlay pixel is, the more intense the colour burning effect will be.
- **Hardlight / Hardlight Legacy / BETA Hardlight:** This screens overlay pixels with a value above 50% onto underlay pixels, and multiplies overlay pixels with a value below 50% onto underlay pixels. The brighter the overlay pixel is, the more intense the screen effect will be. The darker the overlay pixel is, the more intense the multiplying effect will be. Blending any colour with white or black will result in white or black, and blending a colour with plain grey will leave the colour unchanged.
- **Linearlight:** This linear dodges overlay pixels with a value above 50% onto underlay pixels, and linear burns overlay pixels with a value below 50% onto underlay pixels. The brighter the overlay pixel is, the more intense the linear dodging effect will be. The darker the overlay pixel is, the more intense the linear burning effect will be.
- **Overlay / Overlay Legacy / BETA Overlay:** Like hardlight, except it screens or multiplies the underlay pixel over the overlay pixel, based on the value of the underlay pixel.
- **Pin Light:** For each channel, if the overlay pixel's value is above 50%, use the lightest pixel between the underlay and overlay pixels. If the overlay pixel's value is below 50%, use the darkest pixel between the underlay and overlay pixels.
- **Softlight / BETA Softlight:** Each channel of the overlay pixel lightens or darkens the corresponding channel of the underlay pixel on a softer scale. The effect is proportional to how dark or bright the overlay pixel is, but inversely proportional to how dark or bright the underlay pixel is.
- **Difference / Difference Legacy:** For each channel, this takes the darkest pixel among the overlay and underlay pixels, subtract it from the lightest pixel, and outputs the result.
- **Divide / Divide Legacy / BETA Divide:** For each channel, this divides the value of the underlay pixel by the value overlay pixel. Both values are treated as ratios, so the resulting colour is brighter. A white overlay pixel will leave the underlay colour unaffected, and a black overlay pixel will always result in white.
- **Exclusion / BETA Exclusion:** Adds the overlay and underlay pixel, then

	<p>subtracts the multiplied value of both pixels twice. This results in an effect similar to Difference, except that while the Difference mode produces consistently high contrast pixels, the contrast of the resulting pixels with the Exclusion mode is proportional to how dark or bright the overlay pixels are.</p> <ul style="list-style-type: none"> • Subtract / Subtract Legacy / BETA Subtract: For each channel, subtracts the value of the overlay pixel from the value of the underlay pixel. For example, if the underlay pixel is white, and the overlay pixel is dark gray, the resulting pixel will be light gray. Likewise, if the underlay pixel is yellow, and the overlay pixel is red, the resulting pixel will be green, as yellow is a mix of green and red. • Alpha: Adds the opacity of the overlay pixel to the opacity of the underlay pixel, ignoring the colour of the overlay pixel. <div data-bbox="599 678 1430 921" style="border: 1px solid #90EE90; padding: 10px;"> <p> NOTE</p> <p>The effect of this blending mode can only be observed if you render images with an alpha channel or if you set the Camera view to Matte View  mode. To do this, click on the Render View  mode button while it is selected to open its menu, then select  Matte View.</p> </div> <ul style="list-style-type: none"> • Colour: Outputs a colour with the hue and saturation of the overlay pixel, and the luminosity of the underlay pixel. The overlay layer can hence be used to "colourize" the underlay layer. • Hue: Outputs a colour with the luminosity and saturation of the underlay pixel and the hue of the overlay pixel. • Invert: Inverts the underlay pixel proportionally to the alpha value of the overlay pixel. The overlay image hence acts as a "matte" for an invert effect. • Luminosity / BETA Luminosity: Outputs a colour with the hue and saturation of the underlay pixel and the luminosity of the overlay pixel. This is the reverse of the Colour blending mode. • Replace: Ignores the underlay pixel completely, outputting the overlay pixel as if nothing existed behind it. This applies to all overlay pixels that have an alpha value of at least 1, so the negative space of the overlay image will not hide the underlay image. If the overlay pixel is not fully opaque, it will be mixed with black. • Saturation: Outputs a colour with the luminosity and hue of the underlying colour, and the saturation of the source colour.
<p>SWF Blend Mode</p>	<p>If you intend to export your scene in SWF format, you can use this option to choose which blend mode to use for this effect in the exported Flash movie. Since Flash does not support all the blending modes supported by Harmony, this is left as a separate option. You can ignore this option if you don't intend to export your scene in SWF format.</p>

- **Normal:** Composites the image without any specific blending effect.
- **Multiply:** Multiplies the value of each channel in the underlay pixel with the value of each channel in the overlay pixel, treating those values as ratios. Multiplying anything with black will result in black, and multiplying anything with white will leave the colour unchanged.
- **Screen:** The reverse of multiply. Multiplies the reverse value of each channel in the underlay and overlay pixel, treating those values as ratios. Multiplying anything with white will result in white, and multiplying anything with black will leave the colour unchanged.
- **Lighten:** For each channel, uses the value that is the brightest between the underlay pixel and the overlay pixel.
- **Darken:** For each channel, uses the value that is the darkest between the underlay pixel and the overlay pixel.
- **Difference:** For each channel, this takes the darkest pixel among the overlay and underlay pixels, subtract it from the lightest pixel, and outputs the result.
- **Add:** Adds the colour values of each channel in the overlay pixel and the underlay pixel. For example, adding two dark grey pixels with a value of 100 in each channel will result in a light grey pixel with a value of 200 in each channel. Likewise, if one of the pixels is red and the other is green, the resulting pixel will be yellow.
- **Subtract:** For each channel, subtracts the value of the overlay pixel from the value of the underlay pixel. For example, if the underlay pixel is white, and the overlay pixel is dark gray, the resulting pixel will be light gray. Likewise, if the underlay pixel is yellow, and the overlay pixel is red, the resulting pixel will be green, as yellow is a mix of green and red.
- **Invert:** Inverts the underlay pixel proportionally to the alpha value of the overlay pixel. The overlay image hence acts as a "matte" for an invert effect.
- **Overlay:** Like hardlight, except it screens or multiplies the underlay pixel over the overlay pixel, based on the value of the underlay pixel.
- **Hardlight:** This screens overlay pixels with a value above 50% onto underlay pixels, and multiplies overlay pixels with a value below 50% onto underlay pixels. The brighter the overlay pixel is, the more intense the screen effect will be. The darker the overlay pixel is, the more intense the multiplying effect will be. Blending any colour with white or black will result in white or black, and blending a colour with plain grey will leave the colour unchanged.

Composite Node

The Composite node allows you to use several images and output a single image. You can compare that to doing pre-compositions in editing software. You can connect several drawing, image generators and effect nodes in your Composite node and one bitmap (or vector in some cases) comes out of it.

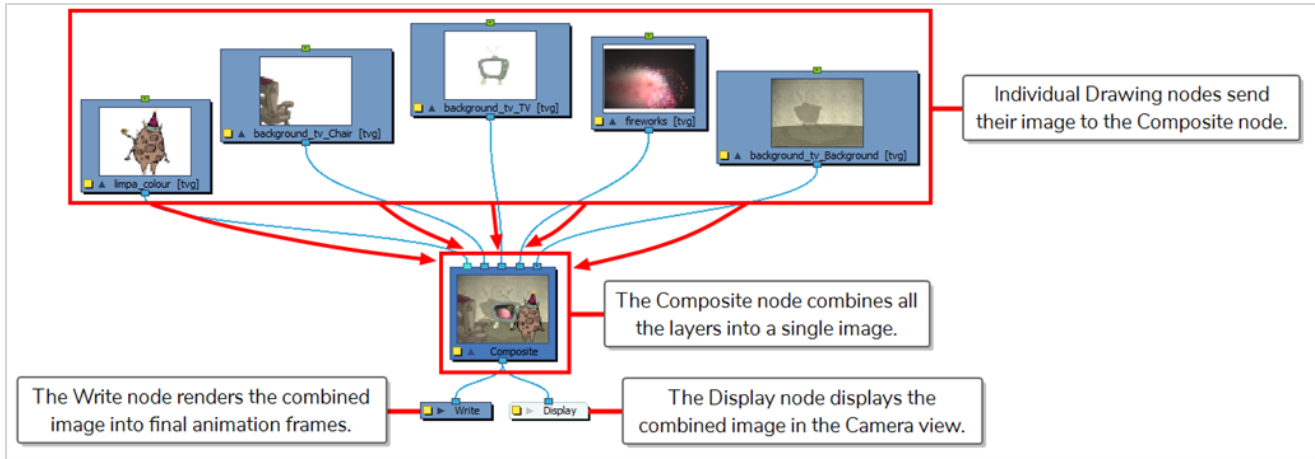

Using Composites is necessary if you wish to apply effects to several layers combined. For example, if you want a character rig that is composed of several layers to appear transparent, you must connect all the layers of your character's rig to the same composite, and connect a Transparency effect to that composite.

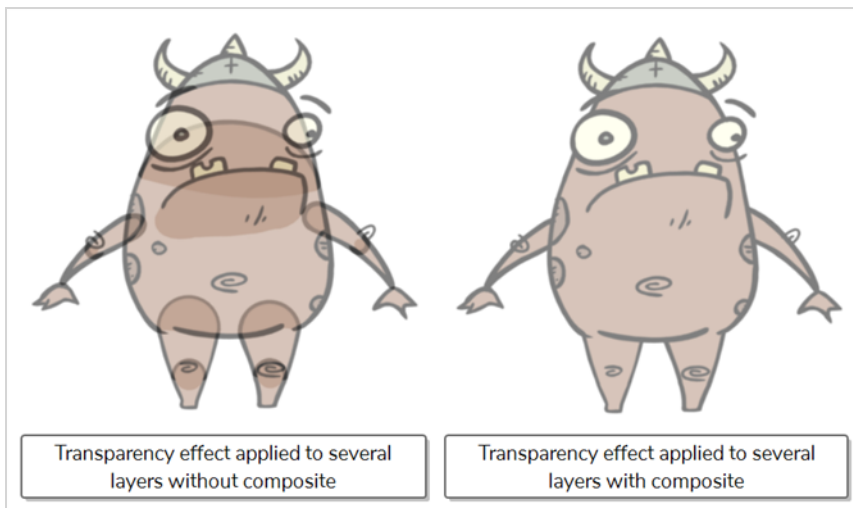
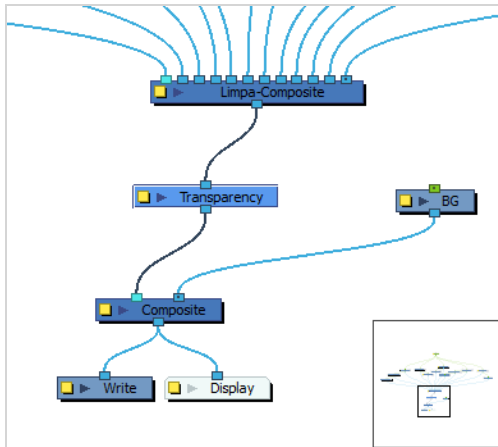

Properties

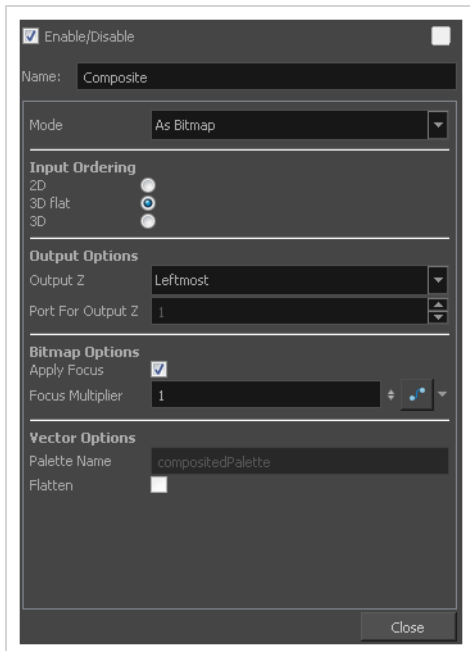

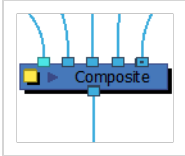
Parameter	Description
Enable/Disable	Allows you to enable or disable the node. When disabled, a node has no visible effect on the rendered image, nor on the preview in the Camera, Perspective, Side and Top views.
Colour Swatch	Sets the colour of the layer in the Timeline view and of the node in the Node view.
Name	The name of the node as it appears in the Node View and the Timeline view. Each node must have a name that is unique to its containing group.
Mode	<ul style="list-style-type: none"> • As Bitmap: This is the default mode for composites. A bitmap composite outputs a single composited image.  <ul style="list-style-type: none"> • As Seamless Bitmap: mode works very similarly to bitmap mode, except it prevents seams from appearing between vector shapes that have matching outlines or when vector drawings are 3D-rotated and made to mesh together.

	<div data-bbox="641 191 824 346" data-label="Image"> </div> <div data-bbox="641 384 1430 552" data-label="Text"> <p>NOTE Shadow, Glow, Blending and Focus effects do not work when connected to a Seamless Bitmap composite.</p> </div> <div data-bbox="609 579 1435 716" data-label="List-Group"> <ul style="list-style-type: none"> • As Vector: This mode outputs a flat vector drawing made of all the connected drawings. Vector composites should be used only when necessary, as they ignore any effect and bitmap information that is sent to them. </div> <div data-bbox="641 739 833 894" data-label="Image"> </div> <div data-bbox="609 926 1429 1171" data-label="List-Group"> <ul style="list-style-type: none"> • Pass Through: This mode simply passes all the information sent to the Composite, including artwork, effects and transformations, onto the next composite as is, as a multi-layered image. This means that if an effect is applied to the output of that composite, the effect will be applied individually to each layer connected to that composite. Hence, a pass through composite does not really perform any composition. It is essentially an organization tool. </div> <div data-bbox="641 1192 841 1348" data-label="Image"> </div> <div data-bbox="641 1386 1430 1753" data-label="Text"> <p>NOTES</p> <ul style="list-style-type: none"> • The cable coming from a Pass Through composite will be thicker and have a darker centreline. This can be useful to identify areas of your node system that carry a lot of information. • If a Composite set to Pass Through is at the bottom of the composite chain, it will act the same as a Bitmap composite. </div>
<p>Input Ordering</p>	<p>2D: Elements connected in the node are composited based on their port ordering.</p>

The Z-axis (forward-backward) values are ignored. The scaling value will be correct, but the actual position on the Z-axis is ignored.

You can use the 2D composite type to create effects such as a camera recording overlay on your scene. Since you always want this element to be in front regardless of the other elements' Z-axis position, you can set the option to 2D.

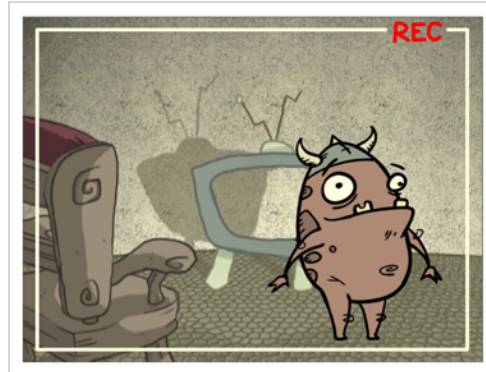

3D Flat: The Z-axis value of the elements connected in the Composite node are considered, so the visual representation is correct in the Camera view. The output is a flat image.

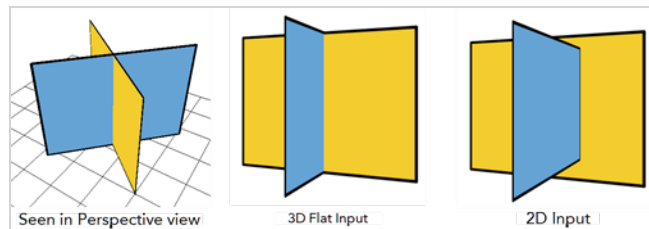

3D: The Z-axis value of the elements connected in the composite node are considered, so the visual representation is correct in the Camera view. The image is not flattened. The 3D aspect of the elements are kept. For example, if you rotated elements on the three axes, the information is retained and elements composited in lower levels are able to intersect with the elements coming from a 3D Composite node.

The 3D Composite node should only be used in advanced cases. It is better to use a Pass Through composite type than a 3D composite type. This way, all the elements are composited in the final Composite node.

Output Options

Output Z: Identifies which element's front-back value from the current composition is applied to the entire composited image in the next operation. If you select Portnumber, identify the appropriate port by its position using the Port For Output Z menu.

Port for Output Z: When using the Portnumber option in the Output Z menu, you can select which port you want to use as the Z value for the Composite node. The port used appears in a bright green colour on the Composite node. By default, the leftmost port is displayed in front and the rightmost port is displayed behind.

<p>Bitmap Options</p>	<p>These options are active when you select the As Bitmap mode.</p> <p>Apply Focus: Activates the Focus effect for this node in the composite operation.</p> <p>Focus Multiplier: The value entered in this field is used as a multiplier for the radius value specified in the Focus or Focus-Multiplier nodes.</p>
<p>Vector Options</p>	<p>These options are active when you select the As Vector mode.</p> <p>Palette Name: When you render files using As Vector Composite nodes, use this field to set the name of the palette files that Toon Boom Harmony Premium will create for them.</p> <p>Flatten: Flattens vector drawings into one vector drawing file. Any transparency will be lost in the process. This creates smaller vector files, but might increase the time required to composite the drawings. This can be useful when reusing drawings. Because they will be vector files, you can still apply vector-based transformations and effects.</p>

Composite-Generic Node

T-COMP2-005-002

The Composite-Generic node is a customizable effect that can be used to fit scenarios where the colours and alpha values of elements must be processed and combined in very specific ways. It can be configured to reproduce the effects of a Tone or Highlight node, or many of the blending effects available in the Blending node, but it offers significantly more control the way the effect is applied.

Among other things, the Composite Generic can be configured to apply a simple blending effect. However, contrary to the Blending node, the Composite Generic node does not composite its input image onto every element that is behind it in the scene. Rather, it composites one image, connected to its left input port, onto another, connected to its right input port. The resulting composited image is then composited onto the scene as normal.

Another interesting capability of the Composite Generic node is that it can use the colours and the alpha of either or both the overlay and the underlay image to make the output image. With the Colour Operation and Alpha Operation parameters, the colours and alpha values can be composited in different ways.



NOTE

In Harmony, colours with an alpha value are premultiplied with black. This means that their actual values in the back-end are different than what they appear to be in the rendered image, as they are multiplied by their alpha values. . Hence, mixing a colour operation and alpha operation that are not meant to work together may not only have undesired results on the way the overlay image is blended into the underlay image, it may even have undesired results on the colour composition of elements behind the Composite Generic node.

Connection

The Composite Generic node has two input ports and one output port. It will composite the image connected to its left input port (the overlay) onto the image connected to its right input port (the underlay) based on its properties, and will output the resulting composited image.

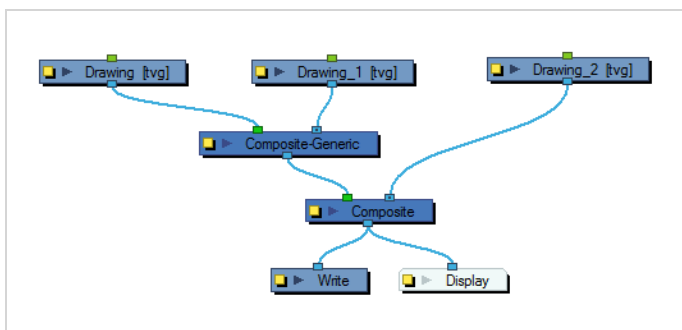

Properties

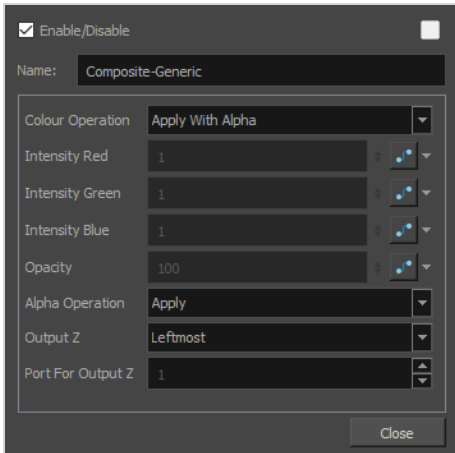

Parameter	Description
Enable/Disable	Allows you to enable or disable the node. When disabled, a node has no visible effect on the rendered image, nor on the preview in the Camera, Perspective, Side and Top views.
Colour Swatch	Sets the colour of the layer in the Timeline view and of the node in the Node view.
Name	The name of the node as it appears in the Node View and the Timeline view. Each node must have a name that is unique to its containing group.
Colour Operation	<p>The algorithm used to composite the colours of the underlay and overlay images together. Note that the way the alpha of the under and overlay images are composited depends entirely on the Alpha Operation parameter.</p> <div style="border: 1px solid green; padding: 10px; margin-top: 10px;"> <p> NOTE</p> <p>Some of the available blending modes have a BETA or Legacy variant to them.</p> <ul style="list-style-type: none"> • A BETA blending mode is one that has been recently added in Harmony and which was made to more closely resemble results obtained in professional photo editing software such as Adobe Photoshop. • A Legacy blending mode is a blending mode that was present in older versions of Harmony. Starting from Harmony 10, these blending modes were enhanced by de-multiplying colours before compositing the image then re-multiplying them. Their legacy version remain available to ensure scenes created in older versions of Harmony do not render differently. </div>

In the following descriptions, the *underlay* image is the image connected to the right input port of the node, and the *overlay* image is the image connected to the left input port of the node.

Right: Only outputs colour values from the underlay image and ignores colour values from the overlay image.

Left: Only outputs colour values from the overlay image and ignores colour values from the underlay images.

Apply With Alpha: Composites the overlay pixel onto the underlay pixel proportionally to its alpha value. This is the standard composition technique when layers are connected to a composite.

Apply Tone Highlight: Applies the colour of overlay pixel the same way a Tone or Highlight effect would apply its colour to the underlay pixel.

Apply Add / Apply Add Legacy: Adds the colour values of each channel in the overlay pixel and the underlay pixel. For example, adding two dark grey pixels with a value of 100 in each channel will result in a light grey pixel with a value of 200 in each channel. Likewise, if one of the pixels is red and the other is green, the resulting pixel will be yellow.

Apply Matte For Overlay: Multiplies the colour values of the underlay image with the transparency ratio of the overlay image. This uses the overlay image as a "matte" to remove colours from the underlay image. You can then combine the resulting image with the colour values of the other image element by connecting this Composite Generic node to another Composite Generic node with its Colour Operation parameter set to Apply Overlay Into Matte. This is useful if the matte of the overlay and the colours of the overlay are to be stored in separate images.



Apply Overlay Into Matte: Multiplies the colour values of the overlay by the alpha values of the underlay image, then adds the resulting colour to the colour values of the underlay image. This is useful if you have darkened an area of an underlay with a matte using a different Composite Generic with its Colour Operation parameter set to Apply Matte for Overlay. This parameter will take the colours from the overlay and apply them on the area darkened by the matte.

Apply Transparency: Multiplies the colour values of the underlay image with the transparency ratio of the overlay image. This setting is designed to be combined with the Apply Transparency Matte alpha operation. However, it is technically the same as Apply Matte For Overlay.

Apply Multiplicative Tone: Multiplies the value of each channel in the underlay pixel with the value of each channel in the overlay pixel, treating those values as ratios. Multiplying anything with black will result in black, and multiplying anything with white will leave the colour unchanged.

Multiply Colours: Multiplies the value of each channel in the underlay pixel with the value of each channel in the overlay pixel, treating those values as ratios. Multiplying anything with black will result in black, and multiplying anything with white will leave the colour unchanged.

	<p>Divide Colours / Divide Colours Legacy: For each channel, this divides the value of the underlay pixel by the value overlay pixel. Both values are treated as ratios, so the resulting colour is brighter. A white overlay pixel will leave the underlay colour unaffected, and a black overlay pixel will always result in white.</p> <p>Lighten / Lighten Legacy / BETA Lighten: For each channel, uses the value that is the brightest between the underlay pixel and the overlay pixel.</p> <p>Softlight / Softlight Legacy / BETA Softlight: Each channel of the overlay pixel lightens or darkens the corresponding channel of the underlay pixel on a softer scale. The effect is proportional to how dark or bright the overlay pixel is, but inversely proportional to how dark or bright the underlay pixel is.</p> <p>Hardlight / Hardlight Legacy / BETA Hardlight: This screens overlay pixels with a value above 50% onto underlay pixels, and multiplies overlay pixels with a value below 50% onto underlay pixels. The brighter the overlay pixel is, the more intense the screen effect will be. The darker the overlay pixel is, the more intense the multiplying effect will be. Blending any colour with white or black will result in white or black, and blending a colour with plain grey will leave the colour unchanged.</p> <p>Overlay / Overlay Legacy / BETA Overlay: Like hardlight, except it screens or multiplies the underlay pixel over the overlay pixel, based on the value of the underlay pixel.</p> <p>Linear Light: This linear dodges overlay pixels with a value above 50% onto underlay pixels, and linear burns overlay pixels with a value below 50% onto underlay pixels. The brighter the overlay pixel is, the more intense the linear dodging effect will be. The darker the overlay pixel is, the more intense the linear burning effect will be.</p> <p>Pinlight: For each channel, if the overlay pixel's value is above 50%, use the lightest pixel between the underlay and overlay pixels. If the overlay pixel's value is below 50%, use the darkest pixel between the underlay and overlay pixels.</p> <p>Vividlight: This colour dodges overlay pixels with a value above 50% onto underlay pixels, and colour burns overlay pixels with a value below 50% onto underlay pixels. The brighter the overlay pixel is, the more intense the colour dodging effect will be. The darker the overlay pixel is, the more intense the colour burning effect will be.</p> <p>Exclusion: Adds the overlay and underlay pixel, then subtracts the multiplied value of both pixels twice. This results in an effect similar to Difference, except that while the Difference mode produces consistently high contrast pixels, the contrast of the resulting pixels with the Exclusion mode is proportional to how dark or bright the overlay pixels are.</p> <p>Dodge: Lightens each channel in the underlay pixel with the brightness value of the corresponding channel in the overlay pixel, by decreasing the contrast of the underlay pixel.</p> <p>Burn: Darkens each channel in the underlay pixel with the darkness value of the corresponding channel in the overlay pixel, by increasing the contrast of the</p>
--	--

	<p>underlay pixel.</p> <p>Hue: Outputs a colour with the luminosity and saturation of the underlay pixel and the hue of the overlay pixel.</p> <p>Saturation: Outputs a colour with the luminosity and hue of the underlying colour, and the saturation of the source colour.</p> <p>Colour: Outputs a colour with the hue and saturation of the overlay pixel, and the luminosity of the underlay pixel. The overlay layer can hence be used to "colourize" the underlay layer.</p> <p>Luminosity: Outputs a colour with the hue and saturation of the underlay pixel and the luminosity of the overlay pixel. This is the reverse of the Colour blending mode.</p>
Intensity Red / Green / Blue	<p>The factor by which to multiply each channel in the overlay image. You can set this to a value between 0 and 1 to reduce the impact of the corresponding channel in the overlay image, or to a value above 1 to increase it.</p> <div data-bbox="565 842 1427 1010" style="border: 1px solid #c8e6c9; padding: 10px; margin-top: 10px;">  NOTE These parameters are only available when a BETA Colour Operation is selected. </div>
Opacity	<p>A value between 0 and 100 determining the opacity level of the overlay image when composited onto the underlay image.</p> <div data-bbox="565 1167 1427 1304" style="border: 1px solid #c8e6c9; padding: 10px; margin-top: 10px;">  NOTE This parameter is only available for certain Colour Operation settings. </div>
Alpha Operation	<p>Right: The transparency of the output image is based on the alpha values of the underlay image only.</p> <p>Left: The transparency of the output image is based on the alpha values of the overlay image only.</p> <p>Apply: Combines the alpha values of the overlay and underlay image. When combined with the Apply with Alpha colour operation, this results in standard alpha-based compositing.</p> <p>Add: The alpha value of each pixel is the sum of the alpha value of the underlay pixel and of the alpha value of the overlay pixel.</p> <p>Subtract: The alpha value of each pixel is based on the alpha value of the underlay pixel subtracted by the alpha value of the overlay pixel.</p> <p>Apply Transparent Matte: The alpha value of each pixel is based on the alpha value of the underlay pixel, multiplied by the transparency of the overlay pixel,</p>

	<p>effectively multiplying their transparency.</p> <p>Black: Outputs every pixel as fully transparent of both the output as fully transparent, leaving behind only the effect of premultiplication of their colour values onto the rendered image.</p> <p>White: Sets the matte of the entire output image to white, so that it is fully opaque. The bounding box of the output image will be filled with black and semi-transparent pixels will be mixed with black.</p>
<p>Output Z</p>	<p>Leftmost: Indicates that the Z value for the output image will be taken from the node in the left port.</p> <p>Rightmost: Indicates that the Z value for the output image will be taken from the node in the right port.</p> <p>Backmost: Indicates that the Z value for the output image will be taken from the image that is the farthest back in the scene.</p> <p>Frontmost: Indicates that the Z value for the output image will be taken from the image that is closest to the front of the scene.</p> <p>Portnumber: Indicates that the Z value for the output image will be taken from the node in the selected port. Enter the appropriate port in the Port for Output Z field.</p>

Cutter Node

T-HFND-010-009

The Cutter effect cuts out a portion of an image. To do this, it needs to be connected to the drawing it is intended to cut as well as to a matte layer. The cutter will take the shape of the drawing in the matte layer and cut this shape out of the drawing layer. This is especially useful if you want to make a character disappear between a background element, or if you want to cut out a hole in the middle of a character.

Like all effects that use a matte, the Cutter's effect has an Inverted parameter, which is disabled by default. When enabled, the Cutter will have the reverse effect: Instead of cutting the matte's shape out of the drawing, it will cut everything outside of the matte's shape out of the drawing, leaving only the parts of the drawing that are covered by the matte.

The Cutter effect can be used with 2D-3D integration. Rendered 2D drawings, integrated with 3D models, display soft, anti-aliased edges, even where the Cutter effect is applied.



Refer to the following example to connect this effect:

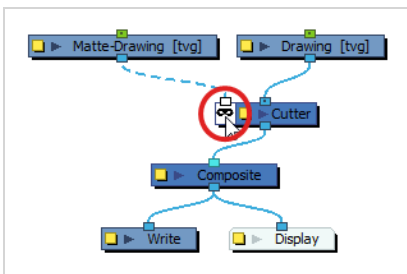

Properties

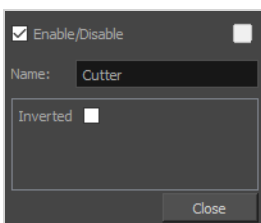

Parameter	Description
Enable/Disable	Allows you to enable or disable the node. When disabled, a node has no visible effect on the rendered image, nor on the preview in the Camera, Perspective, Side and Top views.
Colour Swatch	Sets the colour of the layer in the Timeline view and of the node in the Node view.
Name	Allows you to enter a name for the node.
Inverted	When this option is enabled, the Cutter node will invert the matte shape to cut the drawing. Instead of cutting the image intersecting with the matte, it will cut any artwork outside of the matte shape.

Highlight Node

T-HFND-010-009C

The Highlight node allows you to brighten an image's area to simulate a light source. For this effect, you will need to create a matte to determine the shape and position of the highlight on a separate element, so that you can blur the edges to create a softer effect. By adjusting the Highlight properties, you can control the type and amount of blur, as well as the colour of the Highlight effect.

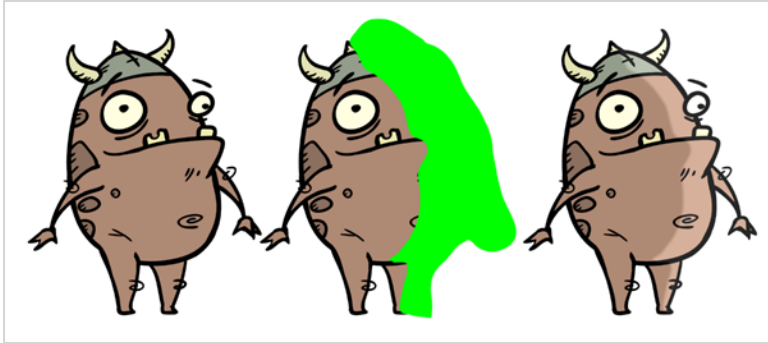

Connection

The Highlight node takes an image of any type in the right (Image) input port, and a matte drawing in the left (Matte) input port. It outputs a version of the input image with a highlight applied over it everywhere where the input image and the matte drawing intersect.

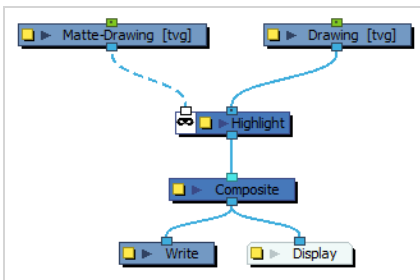

Layer Properties

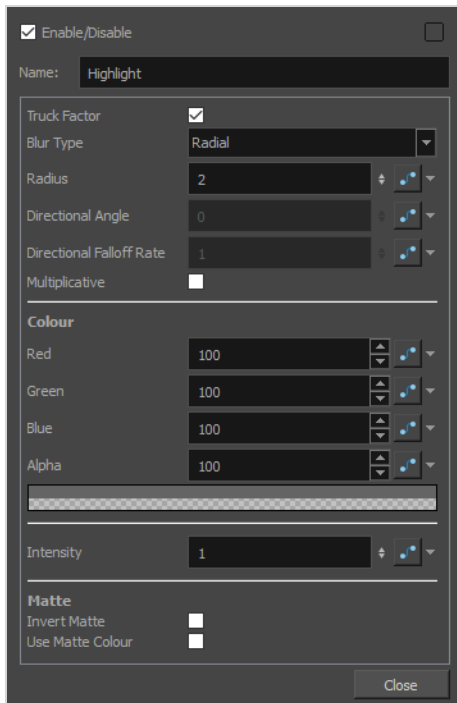

Parameter	Description
Enable/Disable	Allows you to enable or disable the node. When disabled, a node has no visible effect on the rendered image, nor on the preview in the Camera, Perspective, Side and Top views.
Colour Swatch	Sets the colour of the layer in the Timeline view and of the node in the Node view.
Name	The name of the node as it appears in the Node View and the Timeline view. Each node must have a name that is unique to its containing group.
Truck Factor	Activated by default, this option readjusts the blur when the elements undergo a change of depth or scale. When disabled, the effect's values will remain unchanged regardless of depth or scale changes. It is recommended that this option be disabled when multiple drawings are composited and attached this effect.
Blur Type	Allows you to choose between the following blur types for the effect: <ul style="list-style-type: none"> • Radial: The edges of the matte are blurred evenly around points that make up the edge of the matte. • Directional: The matte is blurred in the direction configured with the Directional Angle and Directional Falloff Rate parameters.

Parameter	Description
Radius	Enter a value for the size of the blur. The larger the value, the greater the blur effect. The blur radius is affected by the drawing scale and camera position.
Directional Angle	If you set the Blur Type to Directional, this sets the angle of the blur. The value goes from 0 to 360, with 0 meaning west, and angles going counterclockwise. For example: <ul style="list-style-type: none"> • 0: Blurs the image to the west. • 90: Blurs the image to the south. • 180: Blurs the image to the east. • 270: Blurs the image to the north.
Directional Falloff Rate	The distance where the blur fades from the edge of the image. Select a decimal value between 0 and 1. For example: <ul style="list-style-type: none"> • 0: Makes the blur fade out slowly, distributing the blur evenly from the edge of the character to the farthest edge of the blur. • 1: Makes the blur fade out quickly. The blur is heaviest closer to the edge of the image.
Multiplicative	Multiplies the colours of the effect with the colours of the source image. This intensifies the effect.
Colour	
Red	The amount of red to add to the colour of the source image.
Green	The amount of green to add to the colour of the source image.
Blue	The amount of blue to add to the colour of the source image.
Alpha	The alpha value of the effect.
Colour Swatch	Opens the Colour Picker dialog, in which you can visually select a colour for the effect.
Intensity	Allows you to set the factor by which to multiply the intensity of the effect. This parameter can take a decimal value between 0 and 1. At 1, the effect is fully applied. At 0, the effect is not visible.
Matte	



Parameter	Description
Invert Matte	Inverts the matte used to generate the effect. By default, the affect is applied to opaque areas of the matte and transparent areas of the matte are ignored. When this option is enabled, the effect is applied to transparent areas of the matte and opaque areas of the matte are ignored.
Use Matte Colour	<p>Instead of using the colour in the Colour parameters, this uses the colours in the matte drawing to generate the effect.</p> <div data-bbox="407 541 1430 684" style="border: 1px solid #c8e6c9; padding: 10px;"><p> NOTE The effect of this parameter is only visible in Render View  mode.</p></div>

Image Switch Node

T-COMP2-005-004

The Image Switch effect lets you use multiple effects, such as Colour Override, and choose which port will be sent to rendering if you want to apply different variations of an effect that cannot be changed over time. You then create multiple separate versions of the effect, connect them all to the Image Switch, and then if you want to change to a different version of the effect at different points in your scene, you would add a curve and animate the port number. Image Switch simply lets you change over time which port is being rendered.

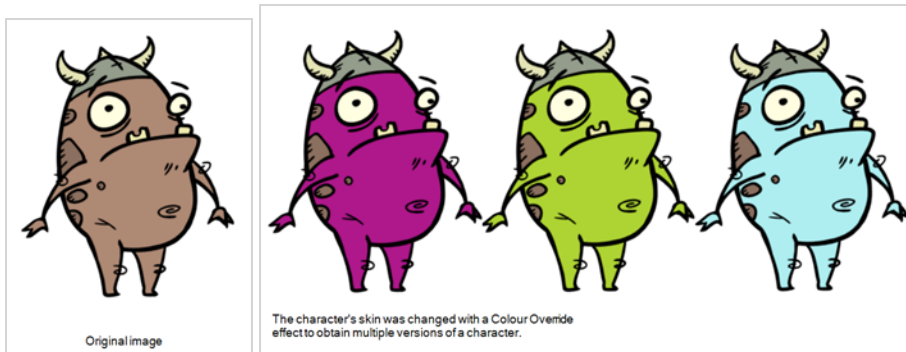

Refer to the following example to connect this effect:

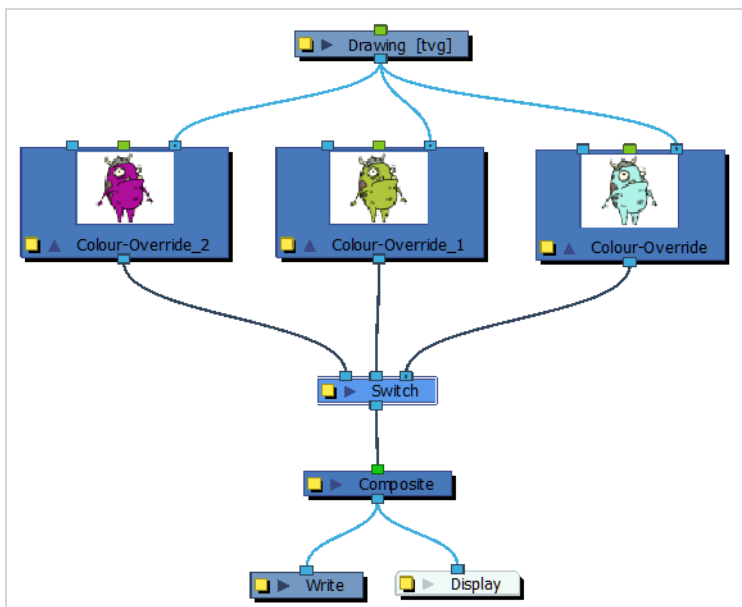

Properties

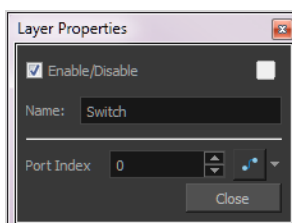

Parameter	Description
Enable/Disable	Allows you to enable or disable the node. When disabled, a node has no visible effect on the rendered image, nor on the preview in the Camera, Perspective, Side and Top views.
Colour Swatch	Sets the colour of the layer in the Timeline view and of the node in the Node view.
Name	The name of the node as it appears in the Node View and the Timeline view. Each node must have a name that is unique to its containing group.
Port Index	<p>Switches from one image to another. There is no gradual animation from one colour to another as you are only changing (over time) which port will be rendered. Use whole values.</p> <p>Click the Function  button to open the Function editor to animate a parameter over time—see .</p>

Matte-Composite Node

T-COMP2-005-003

The Matte-Composite node is a type of composite that is specifically designed to combine different matte drawings into a single matte, which can then be connected to the matte port of an effect or drawing node.

Contrary to a regular composite, the Matte-Composite node allows deciding whether each drawing connected to it is added, subtracted or intersected with the resulting composited matte, and each drawing connected to it can be composited as is, or inverted.



NOTE

Since the Matte-Composite node is meant to output mattes, it ignores colours and only composites alpha levels. The output image will be in plain white, with varying degrees of transparency.



Connection

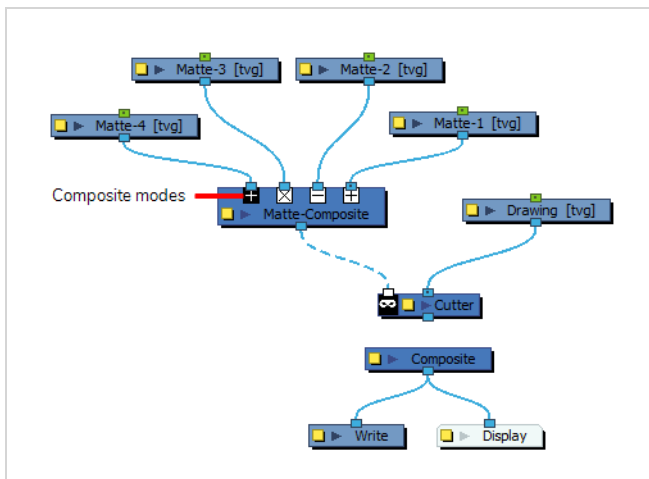

Like a regular composite, the Matte-Composite node can be connected to as many input images as needed, and combines them together. Its output port should be connected to the matte port of an effect.



The matte is generated by creating a matte from the first drawing connected to it, then compositing each subsequent drawing on top of it. Like with a Composite node, the order in which connected drawings are composited goes from right to left.





Each node connected to the Matte-Composite's input ports has its own composite mode as well as its own invert setting. In the Node view, you can immediately tell the mode in which the node is applied by looking at the symbol just below each input port:

- A  sign means the drawing is added to the composite matte.
- A  sign means the drawing is subtracted from the composite matte.
- A  sign means the drawing is intersected with the composite matte.

You can also tell whether the node is composited as is if the sign is black on white , or inverted if the sign is white on black .



TIP

In the Node view, you can quickly toggle between composite modes by double-clicking on the symbol. This will cycle between Add , Add Inverted , Subtract  and Intersect . If you want to set a connection to another combination of composite mode and invert setting, you must do it in the layer properties of the Matte-Composite node.

Properties

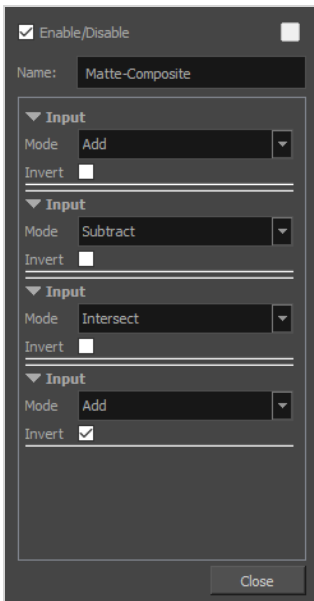

Parameter	Description
Name	The name of the node as it appears in the Node View and the Timeline view. Each node must have a name that is unique to its containing group.
Input Parameters	Each input connection has its own set of Input parameters, which determines how each node connected to the Matte-Composite node is composited into the resulting matte.
Mode	Each node connected to the Matte Composite node can be composited into the resulting matte in one of the following ways: <ul style="list-style-type: none"> • Add: The alpha of each pixel is added to the matte, resulting in combined shapes.

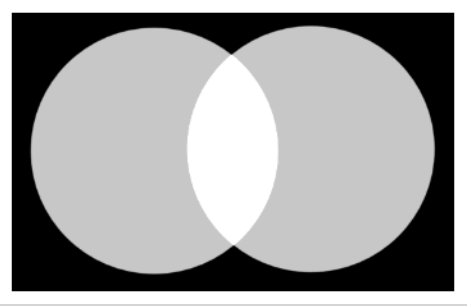
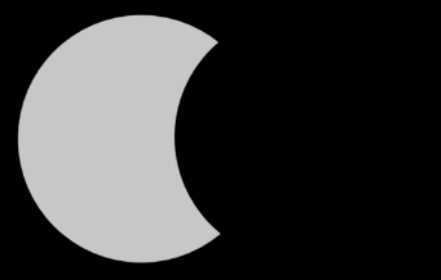
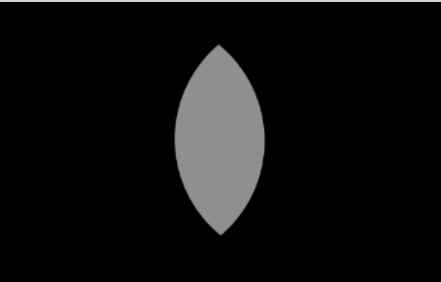
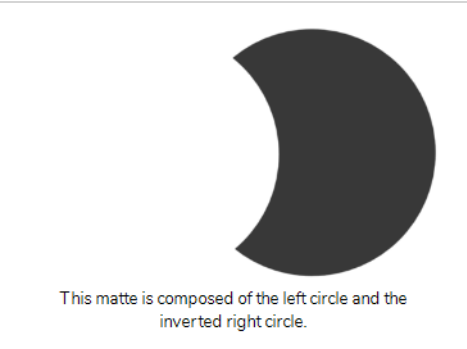
	 <ul style="list-style-type: none"> • Subtract: The alpha of each pixel is subtracted from the matte. This cuts the drawing's shape out of the matte.  <ul style="list-style-type: none"> • Intersect: The alpha ratio of each pixel is multiplied by the alpha ratio of the corresponding pixel on the matte. The resulting matte is made of the areas where the drawings intersect. 
Invert	<p>When enabled, the drawing is composited onto the matte with its alpha values reversed, as if its transparent pixels were opaque and its opaque pixels were transparent. This means that the shape of the negative space of the drawing will be composited to the matte instead of its actual shape.</p>  <p>This matte is composed of the left circle and the inverted right circle.</p>

Tone Node

T-COMP2-004-004

The Tone effect allows you to add a dark-coloured region to your drawing and simulate the shaded area away from a light source. To produce the tone effect, create a drawing to control where the tone will appear. The Tone effect uses a matte to determine the shape and position of the tone on your drawing and can be blurred at the edges to create a softer effect.

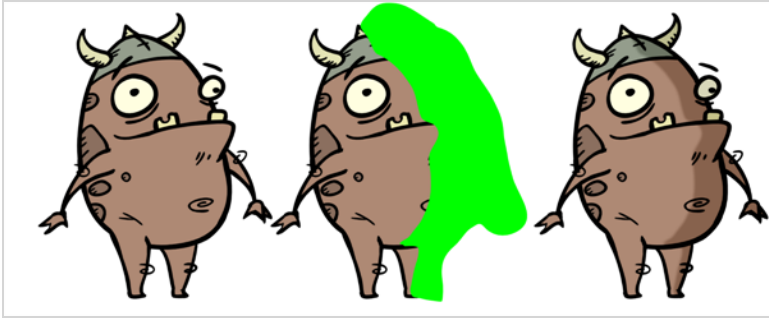

Connection

The Tone node takes an image of any type in the right (Image) input port, and a matte drawing in the left (Matte) input port. It outputs a version of the input image with a tone applied over it everywhere where the input image and the matte drawing intersect.

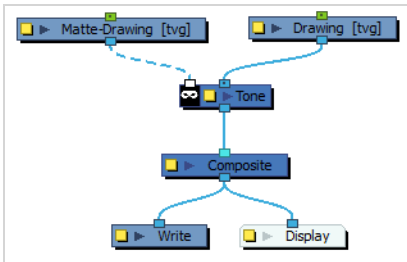

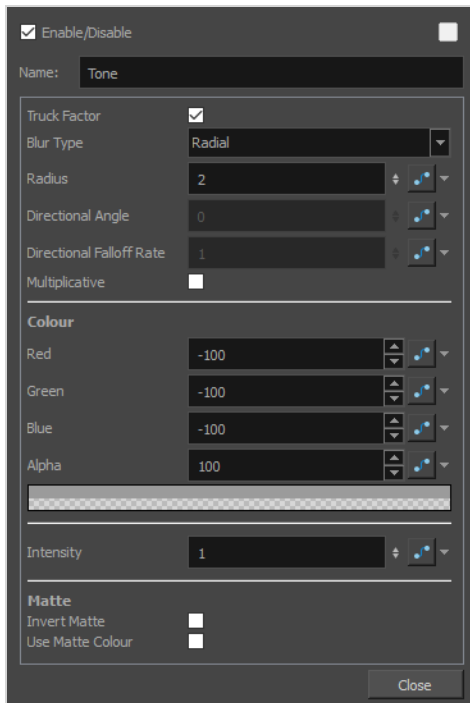

Layer Properties



Parameter	Description
Enable/Disable	Allows you to enable or disable the node. When disabled, a node has no visible effect on the rendered image, nor on the preview in the Camera, Perspective, Side and Top views.
Colour Swatch	Sets the colour of the layer in the Timeline view and of the node in the Node view.
Name	The name of the node as it appears in the Node View and the Timeline view. Each node must have a name that is unique to its containing group.
Truck Factor	Activated by default, this option readjusts the blur when the elements undergo a change of depth or scale. When disabled, the effect's values will remain unchanged regardless of depth or scale changes. It is recommended that this option be disabled when multiple drawings are composited and attached this effect.
Blur Type	Allows you to choose between the following blur types for the effect: <ul style="list-style-type: none"> • Radial: The edges of the matte are blurred evenly around points that make up the edge of the matte. • Directional: The matte is blurred in the direction configured with the Directional Angle and Directional Falloff Rate parameters.

Parameter	Description
Radius	Enter a value for the size of the blur. The larger the value, the greater the blur effect. The blur radius is affected by the drawing scale and camera position.
Directional Angle	If you set the Blur Type to Directional, this sets the angle of the blur. The value goes from 0 to 360, with 0 meaning west, and angles going counterclockwise. For example: <ul style="list-style-type: none"> • 0: Blurs the image to the west. • 90: Blurs the image to the south. • 180: Blurs the image to the east. • 270: Blurs the image to the north.
Directional Falloff Rate	The distance where the blur fades from the edge of the image. Select a decimal value between 0 and 1. For example: <ul style="list-style-type: none"> • 0: Makes the blur fade out slowly, distributing the blur evenly from the edge of the character to the farthest edge of the blur. • 1: Makes the blur fade out quickly. The blur is heaviest closer to the edge of the image.
Multiplicative	Multiplies the colours of the effect with the colours of the source image. This intensifies the effect.
Colour	
Red	The amount of red to subtract from the colour of the source image. To obtain a shadow effect, the value must be negative.
Green	The amount of green to subtract from the colour of the source image. To obtain a shadow effect, the value must be negative.
Blue	The amount of blue to subtract from the colour of the source image. To obtain a shadow effect, the value must be negative.
Alpha	The alpha value of the effect.
Colour Swatch	Opens the Colour Picker dialog, in which you can visually select a colour for the effect.
Intensity	Allows you to set the factor by which to multiply the intensity of the effect. This parameter can take a decimal value between 0 and 1. At 1, the effect is fully applied. At 0, the effect is not visible.

Parameter	Description
Matte	
Invert Matte	Inverts the matte used to generate the effect. By default, the affect is applied to opaque areas of the matte and transparent areas of the matte are ignored. When this option is enabled, the effect is applied to transparent areas of the matte and opaque areas of the matte are ignored.
Use Matte Colour	Instead of using the colour in the Colour parameters, this uses the colours in the matte drawing to generate the effect. <div data-bbox="407 632 1430 779" style="border: 1px solid #c8e6c9; padding: 10px;"> NOTE The effect of this parameter is only visible in Render View  mode.</div>

Transformation Switch Node

The Transformation-Switch node acts as a on and off switch for the deformation chains. It is used when building multi-pose (multiple deformation chains) rigs. the Transformation-Switch can also be used with other node types than Deformation nodes. It can be used with any transformation nodes such as Peg and Quadmap nodes.

Refer to the following example to connect this effect:

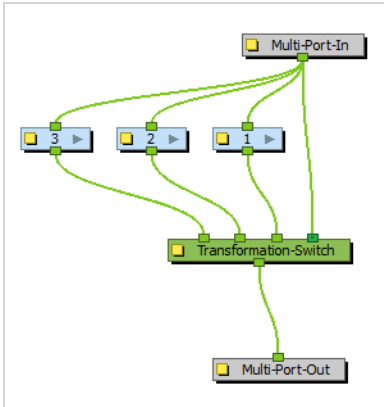

The Transformation-Switch replaces the Deformation-Switch node.

Properties

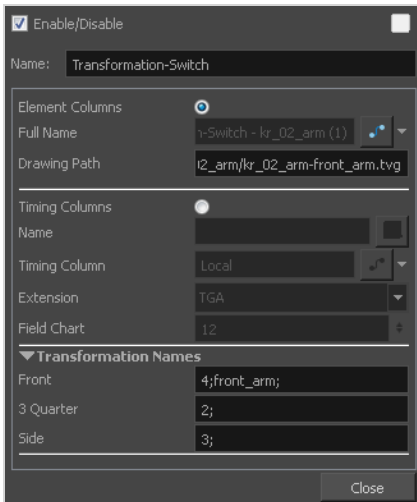

Parameter	Description
Enable/Disable	Allows you to enable or disable the node. When disabled, a node has no visible effect on the rendered image, nor on the preview in the Camera, Perspective, Side and Top views.
Colour Swatch	Sets the colour of the layer in the Timeline view and of the node in the Node view.

Name	Use this field to rename the node.
Element Columns	<p>Full Name: Select which element to connect to the node from the list of elements that already exist in your scene.</p> <p>Drawing Path: Displays the full path to the current drawing.</p>
Timing Columns	<p>Name: Path to the file you want to link to.</p> <p>Timing Column: Link to the column that contains the desired timing.</p> <p>Extension: When linking to a background file, enter its file name extension.</p> <p>Field Chart: If you are importing traditional animation, select the size of the paper on which the animation was drawn.</p>
Transformation Names	List the drawing names associated to each transformation chain. You can enter additional drawings and separate the names with semi-colons (;).

Constraint Nodes

Constraint nodes are a series of nodes that can be used to subject parts of a cut-out character rig to certain physical constraints. Specifically, they are designed to add the following capabilities for rigging and animation:

- Create points on drawings which, when moved, will translate, rotate and scale the drawing so that the parts of the drawings those points are attached remain locked to those points.
- Lock the different parts of a rig by their articulations. This makes it so moving a part of a rig that is constrained to its adjacent parts will move those other body parts along it, and rotate the part being moved as needed.
- Automate a "spring" like movement based on a simple translation. Specifically, the Dynamic Spring node is able to apply a delayed movement on a part of a character rig based on the movement of its parents. This can also be wielded to automate follow-through action for parts like hair, ears, whiskers, and such.
- Limit, switch between, turn on and off or interpolate different transformations applied by pegs onto elements.
- Bake transformations into the resting position of elements.

Constraint nodes use the pivot point of pegs connected to them to define their constraint points. Rigging with constraint nodes is more complicated than rigging with a mere hierarchy of pegs and elements, as it requires using the different nodes together, like building blocks, to define precisely the relationship between adjacent parts of a rig. They however allow the animator to pose and animate a character rig by moving the pivot points of its articulations rather than by transforming its individual layers, while the constraint nodes take care of making the appropriate transformations to the adjacent body parts. The resulting procedure is potentially much more natural and streamlined.

Harmony features the following Constraint nodes:

- **Two-Point Constraint:** Constrains a drawing between the pivot-point of two pegs. This node can be configured to stretch and squash the drawing it transforms automatically, as well as to stop stretching or squashing the drawing past specified limits. This can be especially useful for rigging limbs together and allow the animator to manipulate them by their articulations.
- **Three-Point Constraint:** Constrains a drawing between the pivot-point of three pegs.
- **Multi-Point Constraint:** Constrains a drawing between the pivot-point of multiple pegs.
- **Dynamic Spring:** Applies the movement of the parent peg with inertia and tension factors onto the child element. This can be used to automatically generate life-like ease and overshoot, as well as follow-through animation.
- **Transform Limit:** Filters the transformations from the parent node by multiplying each type of transformation (ie: translations, rotation, scale, etc.) by a factor going from 0% to 100%, before applying it to the child node.
- **Transformation-Gate:** This node can be used to dynamically select which one of several transformations from several connected parent nodes is applied to its child. It is also able to make an interpolation

between two transformations from two of its parents, and apply the interpolated transformation to its child. It can be used with constraint nodes or any other node that outputs a transformation, such as pegs and quadmaps.

- **Constraint Switch:** This node can be connected to the leftmost input port of any other constraint node to temper its effect. It does so by applying a ratio ranging from 0% to 100% to the transformations applied by the constraint node it is connected to. If connected to a Transformation-Gate, it can remotely control which input port the Transformation-Gate uses to apply transformations to its child.
- **Static Constraint:** Can be used to permanently store (or "bake") the transformation applied by its parent or parents. Once transformations are baked into the node, it can be disconnected from the parent, then connected to a child to apply the baked transformation onto it, acting like a transformation template or a resting position.



NOTE

Constraint nodes do not deform drawings like deformation nodes do, they apply standard transformations such as translations, rotations and scaling on them. The Multi-Point Constraint can optionally apply a perspective (quadmap) transformation on elements.

Constraint Switch Node	465
Dynamic Spring Node	468
Multi-Points Constraint Node	473
Static Transformation Node	476
Three-Points Constraint Node	479
Transformation Gate Node	482
Transformation Limit Node	484
Two-Points Constraint Node	490

Constraint Switch Node

The Constraint Switch node is used to remotely affect the Value and/or Target Gate parameter of other Constraint nodes.

Each node in the Constraint category has an Active parameter that can be set to a value ranging from 0 to 100. This value is used to determine how much of the transformation calculated by a constraint node should actually be applied to its child element. When set to 100, the transformation is fully applied. Then set to 0, the transformation is not applied at all. When set to a value between 0 and 100, the effect the constraint node has on its child is proportionally tempered.

The Constraint Switch has its own Active parameter. When connected to a constraint node, the Active value of that constraint node is multiplied by the Active value of the Constraint Switch. For example, if a Constraint Switch with an Active parameter set to 50 is connected to a Two-Points Constraint node with an Active parameter of 50, the effective Active value of the Two-Points Constraint node will be 25, and only 25% of its transformation will be applied. Likewise, if the Active value of the Constraint Switch is set to 0, it will effectively "switch off" the constraint node, and if it is set to any value below 0, it will reverse the effect of the constraint node.

A Constraint Switch can also be used to remotely control the Target Gate parameter of a Transformation Gate. A Transformation Gate takes several transformations as inputs and outputs one of the transformations. The Target Gate is the numerical index of the port the Transformation Gate takes the transformation from when its Value parameter is set to 100. The Target Gate for a Transformation Gate can be set within its own properties, but if a Constraint Switch is connected to it, the Constraint Switch's Target Gate parameter will override the Transformation Gate's Target Gate parameter.

Connection

The Constraint Switch node can be connected to the leftmost input port of any constraint node, except for the Static-Transformation node. The input port for a Constraint Switch will be the same shade of aquamarine as the Constraint-Switch node itself.

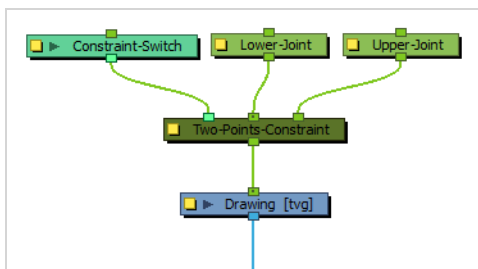

A Constraint-Switch node can be connected to several constraint nodes to control them simultaneously.

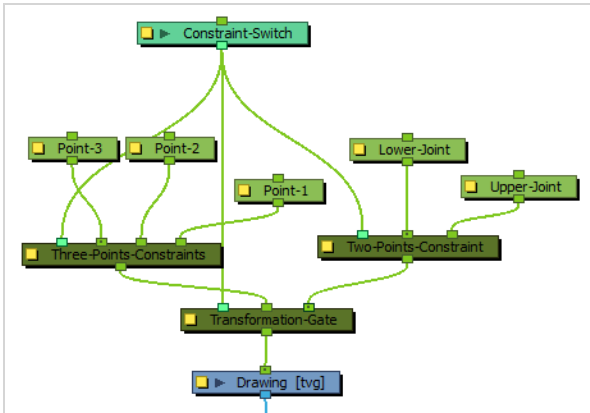

Controls

When the control of a Transformation Switch is displayed, a slider displays in the Camera view which can be used to manually set the value of the Active parameter.

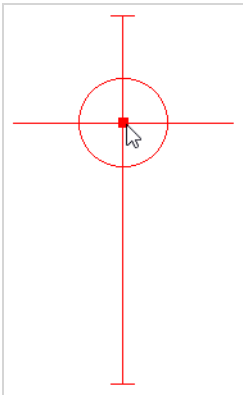

Properties

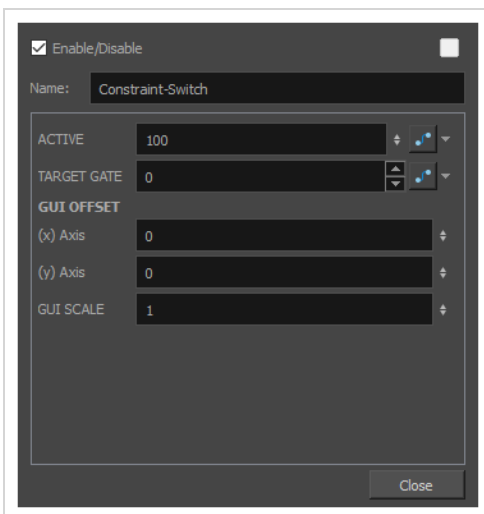

Parameter	Description
Active	<p>Defines the influence applied to the constraint node the Constraint Switch node is connected to. This value is multiplied with the value of the Active parameter of the constraint node to calculate its effective Active parameter.</p> <p>For example, if a Constraint Switch with an Active parameter set to 50 is connected to a Two-Points Constraint node with an Active parameter of 50, the effective Active value of the Two-Points Constraint node will be 25, and only 25% of its transformation will be applied. Likewise, if the Active value of the Constraint Switch is set to 0, it will effectively "switch off" the constraint node, and if it is set to any value below 0, it will reverse the effect of the constraint node.</p>
Target Gate	<p>If the Constraint Switch is connected to a Transformation Gate node, this parameter overrides the Target Gate parameter. of the Transformation Gate.</p>
GUI Offset	<p>When displaying this node's control, a slider displays in the Camera view to control the node's Active parameter. The following parameters affect the way the slider is displayed.</p>
(x) Axis	<p>Offsets the horizontal position of the slider in the Camera view..</p>
(y) Axis	<p>Offsets the vertical position of the slider in the Camera view.</p>
GUI Scale	<p>Multiplies the size of the slider in the Camera view. This parameter is set to 1 by default.</p>

Dynamic Spring Node

The Dynamic Spring node takes the animated transformation from the parent node then applies tension and inertia to make it into a "spring" motion.

When filtered with a Dynamic-Spring node, a peg that performs a simple translation from point A to point B with no ease-in or ease-out will result in an ease-in from point A, an ease-out to point B followed by a realistic overshoot.

Connection

A Dynamic Spring node must be connected to a peg or other transformation node through its rightmost input port. The spring effect will be applied to the transformation sent through this port.

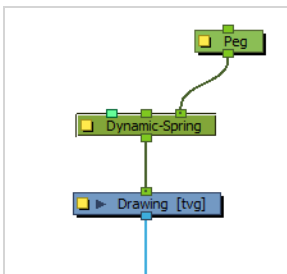

Rigged together with a Two-Points Constraint node and another peg to offset the pivot point of the original, you can automate the follow through action. In this example, the Movement-Peg node animates the Hair element from its top part. The same animation is also sent through a Dynamic-Spring node, then a peg that offsets the pivot point towards the bottom of the hair (via its own Pivot parameters) which results in the top of the hair being pulled by a regular motion while the bottom follows through with realistic ease and overshoot.

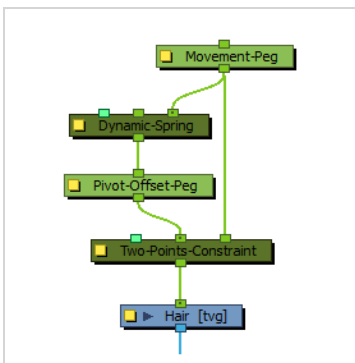

The spring effect the Dynamic Spring applies is based on the motion of the entire hierarchy of its parents, not just on the motion of its immediate parent. This may cause undesired effects. For example, if a Dynamic-Spring is connected to a hand drawing, and the forearm the hand is rigged to rotate, the hand will track behind the motion of the arm and appear detached from its wrist. This can be cancelled out by using the middle port of the Dynamic-Spring node. This port is used to cancel out the spring effect of another motion before applying the spring to its element. Hence, in this example, you would circumvent this issue by connecting the forearm peg to the middle port of the dynamic spring.

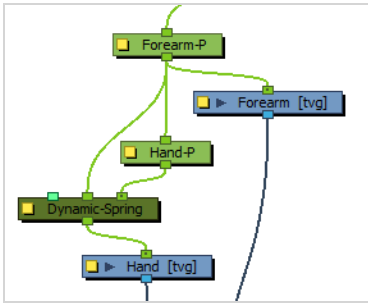

NOTE

The same effect can be achieved using the Ignore Parents and Parent Name properties of the Dynamic Spring node.

At last, the leftmost port of the Dynamic-Spring node can be connected to a Constraint Switch, the Active parameter of which is multiplied against the Active parameter of the Dynamic Spring node to reduce or disable its effect.

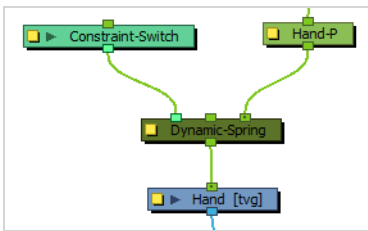



Properties



Enable/Disable

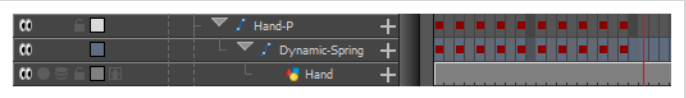

Name: Dynamic-Spring

Active	100	↕ ⚙
Match Animation on Active Attribute	<input type="checkbox"/>	
Tension X	7	↕ ⚙
Inertia X	80	↕ ⚙
Tension Y	7	↕ ⚙
Inertia Y	80	↕ ⚙
Tension Z	7	↕ ⚙
Inertia Z	80	↕ ⚙
Tension Scale	7	↕ ⚙
Inertia Scale	80	↕ ⚙
Tension Skew	7	↕ ⚙
Inertia Skew	80	↕ ⚙
Tension Rotate	7	↕ ⚙
Inertia Rotate	80	↕ ⚙
Ignore Parents	0	↕ ⚙
Parent's Name	<input style="width: 100%;" type="text"/>	

Close

Parameter	Description
Active	<p>The percentage of influence the Dynamic Spring node has on the transformation.</p> <p>If a Transformation Switch node is connected to the Dynamic Spring node, the Active parameters of the Transformation Switch and the Dynamic Spring nodes will be multiplied together.</p>
Match Animation on Active Attribute	<p>When enabled, the Dynamic Spring node will only perform a movement when its own attributes have a keyframe or an interpolation. This option can be useful if, for example, the animation must be done on twos or threes. You can enable this option, then add stop-motion keyframes on the Dynamic Spring node in the Timeline view on every frame where you want it to update the child element's position. The latter will remain static between keyframes.</p> <p>In the example below, the Match Animation on Active Attribute option has been enabled, and stop-motion keyframes have been added to the Dynamic Spring node to match the timing of the hand's animation. The frames are a light shade of blue where the Dynamic Spring node applies a movement to the child element, and are grey where it does not.</p>  <div data-bbox="565 1066 1432 1360" style="border: 1px solid green; padding: 10px;"> <p> NOTE</p> <p>The Dynamic Spring node will animate on ones after its last keyframe. Hence, to animate on twos, you must add keyframes on the Dynamic Spring node until it completely stops moving the element. The animation of the Dynamic Spring node often stops several frames later than the animation of the parent peg, because it adds an extra overshoot a movement.</p> </div>
Tension (X/Y/Z/Scale/Skew/Rotate)	<p>The tension applied to each parameter of the animation. The higher it is, the more the child element will appear to "snap" to the position of the original movement.</p>

	<div data-bbox="565 191 1430 894" style="border: 1px solid #add8e6; padding: 10px;">  <p>TIP</p> <p>You can set the Tension for all parameters to the same value by creating a function for the Tension X parameter, then linking every other Tension parameter to that function. If you create a single keyframe in this function, the parameter will remain constant throughout the scene.</p> <table border="1" data-bbox="672 407 1240 852"> <tr><td>Tension X</td><td>+ Dynamic-Spring: Tension_X: 100</td><td>0</td><td>100</td><td>▼</td></tr> <tr><td>Inertia X</td><td>+ Dynamic-Spring: Inertia_X: 20</td><td>0</td><td>20</td><td>▼</td></tr> <tr><td>Tension Y</td><td>+ Dynamic-Spring: Tension_X: 100</td><td>0</td><td>100</td><td>▼</td></tr> <tr><td>Inertia Y</td><td>+ Dynamic-Spring: Inertia_X: 20</td><td>0</td><td>20</td><td>▼</td></tr> <tr><td>Tension Z</td><td>+ Dynamic-Spring: Tension_X: 100</td><td>0</td><td>100</td><td>▼</td></tr> <tr><td>Inertia Z</td><td>+ Dynamic-Spring: Inertia_X: 20</td><td>0</td><td>20</td><td>▼</td></tr> <tr><td>Tension Scale</td><td>+ Dynamic-Spring: Tension_X: 100</td><td>0</td><td>100</td><td>▼</td></tr> <tr><td>Inertia Scale</td><td>+ Dynamic-Spring: Inertia_X: 20</td><td>0</td><td>20</td><td>▼</td></tr> <tr><td>Tension Skew</td><td>+ Dynamic-Spring: Tension_X: 100</td><td>0</td><td>100</td><td>▼</td></tr> <tr><td>Inertia Skew</td><td>+ Dynamic-Spring: Inertia_X: 20</td><td>0</td><td>20</td><td>▼</td></tr> <tr><td>Tension Rotate</td><td>+ Dynamic-Spring: Tension_X: 100</td><td>0</td><td>100</td><td>▼</td></tr> <tr><td>Inertia Rotate</td><td>+ Dynamic-Spring: Inertia_X: 20</td><td>0</td><td>20</td><td>▼</td></tr> </table> </div>	Tension X	+ Dynamic-Spring: Tension_X: 100	0	100	▼	Inertia X	+ Dynamic-Spring: Inertia_X: 20	0	20	▼	Tension Y	+ Dynamic-Spring: Tension_X: 100	0	100	▼	Inertia Y	+ Dynamic-Spring: Inertia_X: 20	0	20	▼	Tension Z	+ Dynamic-Spring: Tension_X: 100	0	100	▼	Inertia Z	+ Dynamic-Spring: Inertia_X: 20	0	20	▼	Tension Scale	+ Dynamic-Spring: Tension_X: 100	0	100	▼	Inertia Scale	+ Dynamic-Spring: Inertia_X: 20	0	20	▼	Tension Skew	+ Dynamic-Spring: Tension_X: 100	0	100	▼	Inertia Skew	+ Dynamic-Spring: Inertia_X: 20	0	20	▼	Tension Rotate	+ Dynamic-Spring: Tension_X: 100	0	100	▼	Inertia Rotate	+ Dynamic-Spring: Inertia_X: 20	0	20	▼
Tension X	+ Dynamic-Spring: Tension_X: 100	0	100	▼																																																									
Inertia X	+ Dynamic-Spring: Inertia_X: 20	0	20	▼																																																									
Tension Y	+ Dynamic-Spring: Tension_X: 100	0	100	▼																																																									
Inertia Y	+ Dynamic-Spring: Inertia_X: 20	0	20	▼																																																									
Tension Z	+ Dynamic-Spring: Tension_X: 100	0	100	▼																																																									
Inertia Z	+ Dynamic-Spring: Inertia_X: 20	0	20	▼																																																									
Tension Scale	+ Dynamic-Spring: Tension_X: 100	0	100	▼																																																									
Inertia Scale	+ Dynamic-Spring: Inertia_X: 20	0	20	▼																																																									
Tension Skew	+ Dynamic-Spring: Tension_X: 100	0	100	▼																																																									
Inertia Skew	+ Dynamic-Spring: Inertia_X: 20	0	20	▼																																																									
Tension Rotate	+ Dynamic-Spring: Tension_X: 100	0	100	▼																																																									
Inertia Rotate	+ Dynamic-Spring: Inertia_X: 20	0	20	▼																																																									
<p>Inertia (X/Y/Z/Scale/Skew/Rotate)</p>	<p>The inertia applied to each parameter of the animation. The higher it is, the more the child element will appear to be weighted against the spring effect.</p> <div data-bbox="565 1052 1430 1755" style="border: 1px solid #add8e6; padding: 10px;">  <p>TIP</p> <p>You can set the Inertia for all parameters to the same value by creating a function for the Inertia X parameter, then linking every other Inertia parameter to that function. If you create a single keyframe in this function, the parameter will remain constant throughout the scene.</p> <table border="1" data-bbox="672 1268 1240 1713"> <tr><td>Tension X</td><td>+ Dynamic-Spring: Tension_X: 100</td><td>0</td><td>100</td><td>▼</td></tr> <tr><td>Inertia X</td><td>+ Dynamic-Spring: Inertia_X: 20</td><td>0</td><td>20</td><td>▼</td></tr> <tr><td>Tension Y</td><td>+ Dynamic-Spring: Tension_X: 100</td><td>0</td><td>100</td><td>▼</td></tr> <tr><td>Inertia Y</td><td>+ Dynamic-Spring: Inertia_X: 20</td><td>0</td><td>20</td><td>▼</td></tr> <tr><td>Tension Z</td><td>+ Dynamic-Spring: Tension_X: 100</td><td>0</td><td>100</td><td>▼</td></tr> <tr><td>Inertia Z</td><td>+ Dynamic-Spring: Inertia_X: 20</td><td>0</td><td>20</td><td>▼</td></tr> <tr><td>Tension Scale</td><td>+ Dynamic-Spring: Tension_X: 100</td><td>0</td><td>100</td><td>▼</td></tr> <tr><td>Inertia Scale</td><td>+ Dynamic-Spring: Inertia_X: 20</td><td>0</td><td>20</td><td>▼</td></tr> <tr><td>Tension Skew</td><td>+ Dynamic-Spring: Tension_X: 100</td><td>0</td><td>100</td><td>▼</td></tr> <tr><td>Inertia Skew</td><td>+ Dynamic-Spring: Inertia_X: 20</td><td>0</td><td>20</td><td>▼</td></tr> <tr><td>Tension Rotate</td><td>+ Dynamic-Spring: Tension_X: 100</td><td>0</td><td>100</td><td>▼</td></tr> <tr><td>Inertia Rotate</td><td>+ Dynamic-Spring: Inertia_X: 20</td><td>0</td><td>20</td><td>▼</td></tr> </table> </div>	Tension X	+ Dynamic-Spring: Tension_X: 100	0	100	▼	Inertia X	+ Dynamic-Spring: Inertia_X: 20	0	20	▼	Tension Y	+ Dynamic-Spring: Tension_X: 100	0	100	▼	Inertia Y	+ Dynamic-Spring: Inertia_X: 20	0	20	▼	Tension Z	+ Dynamic-Spring: Tension_X: 100	0	100	▼	Inertia Z	+ Dynamic-Spring: Inertia_X: 20	0	20	▼	Tension Scale	+ Dynamic-Spring: Tension_X: 100	0	100	▼	Inertia Scale	+ Dynamic-Spring: Inertia_X: 20	0	20	▼	Tension Skew	+ Dynamic-Spring: Tension_X: 100	0	100	▼	Inertia Skew	+ Dynamic-Spring: Inertia_X: 20	0	20	▼	Tension Rotate	+ Dynamic-Spring: Tension_X: 100	0	100	▼	Inertia Rotate	+ Dynamic-Spring: Inertia_X: 20	0	20	▼
Tension X	+ Dynamic-Spring: Tension_X: 100	0	100	▼																																																									
Inertia X	+ Dynamic-Spring: Inertia_X: 20	0	20	▼																																																									
Tension Y	+ Dynamic-Spring: Tension_X: 100	0	100	▼																																																									
Inertia Y	+ Dynamic-Spring: Inertia_X: 20	0	20	▼																																																									
Tension Z	+ Dynamic-Spring: Tension_X: 100	0	100	▼																																																									
Inertia Z	+ Dynamic-Spring: Inertia_X: 20	0	20	▼																																																									
Tension Scale	+ Dynamic-Spring: Tension_X: 100	0	100	▼																																																									
Inertia Scale	+ Dynamic-Spring: Inertia_X: 20	0	20	▼																																																									
Tension Skew	+ Dynamic-Spring: Tension_X: 100	0	100	▼																																																									
Inertia Skew	+ Dynamic-Spring: Inertia_X: 20	0	20	▼																																																									
Tension Rotate	+ Dynamic-Spring: Tension_X: 100	0	100	▼																																																									
Inertia Rotate	+ Dynamic-Spring: Inertia_X: 20	0	20	▼																																																									
<p>Ignore Parents</p>	<p>If this property is set to any value but 0, the Dynamic Spring will go up its own hierarchy up to the value of this property, and consider the node at this level to be</p>																																																												

	<p>the "Ignored parent". The transformations applied by this parent and all its parents will not be taken in account for the spring effect.</p> <div data-bbox="565 285 1429 453" style="border: 1px solid #90EE90; padding: 5px;">  <p>NOTE This has the same effect as connecting one of the node's parents to its middle port.</p> </div>
Parent's Name	<p>If the Ignore Parents property is set to any value but 0, this property will also be used in determining which parent to consider as the "Ignored parent". When looking up the parent hierarchy of the Dynamic Spring node, if it finds any node with a matching name, it will consider it the "Ignored parent", and the transformations applied by this parent and all its parents will not be taken in account for the spring effect.</p> <div data-bbox="565 751 1429 982" style="border: 1px solid #90EE90; padding: 5px;">  <p>NOTE When both the Ignore Parents and the Parent's Name parameters are set, the "Ignored parent" will be the first node in the Dynamic Spring node's parent hierarchy that either matches the name of the Parent's Name parameter or the parent level in the Ignore Parents parameter.</p> </div> <div data-bbox="565 1014 1429 1276" style="border: 1px solid #ADD8E6; padding: 5px;">  <p>TIP This parameter only works if the Ignore Parents parameter is set to any value but 0. If you want the ignored parent to only be matched by its name and not its level in the hierarchy, you can set the Ignore Parents parameter to an improbably high number (ie: 100 or 1000), and set the Parent's Name to the name of the parent to ignore.</p> </div>

Multi-Points Constraint Node

The Multi-Points Constraint translates, rotates and scales a drawing to make it follow the pivots of the pegs that are connected to it. Optionally, it can also apply a perspective transformation on the element.

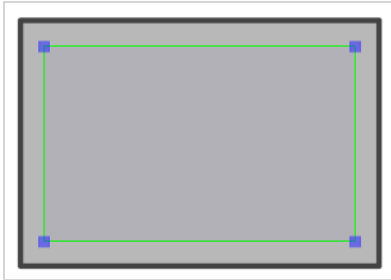



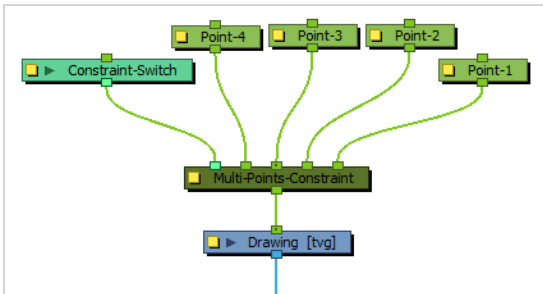

Connection

The Multi-Points Constraint node must be connected to at least two Peg nodes, and can be connected to as many Peg nodes as needed. The pivot point of each peg will define the resting position of one of the points used to transform the drawing connected under it. When one of the pegs is moved, the Multi-Points Constraint will transform the drawing so that it follows the pivot point of that peg.



NOTE

The resting position of the points is based on the pivot point of the peg. The pivot point of a peg can be set by selecting the peg with the Translate , Rotate , Scale  or Skew  tool, then clicking and dragging the pivot in the Camera view, or by entering its coordinates in the layer properties of the peg.

Only the position of the pegs is considered by the Multi-Point Constraint. The position of the peg connected to the rightmost input port on the Z-axis will be applied to the element.

Optionally, the Three-Points Constraint node can be connected to a Constraint-Switch, which can be used to reduce the effect of the Three-Points Constraint node on the element it is connected by setting its Active parameter between 0 and 100.

Controls

When the controls of the Multi-Points Constraint are displayed, the position of the points are displayed with blue squares linked by a green line.

These points are only a visual representation and cannot be manipulated.

How to animate an element connected to a Multi-Points Constraint

1. In the Tools toolbar, select the Transform tool or press Shift + T.
2. Do one of the following:
 - Select one of the pegs the Three-Points Constraint is connected to, then move the peg by clicking and dragging the centre point in the Camera view.
 - In the layer properties of the element, disable the **Animate Using Animation Tools** option. Then, select the element, and click and drag the element near one of the points. The point that is the closest to the mouse cursor will be automatically selected and moved.

Optionally, the leftmost input port of a Multi-Points Constraint node can be connected to a Constraint-Switch, which can be used to reduce the effect of the Multi-Points Constraint node on the element it is connected by setting its Active parameter between 0 and 100.

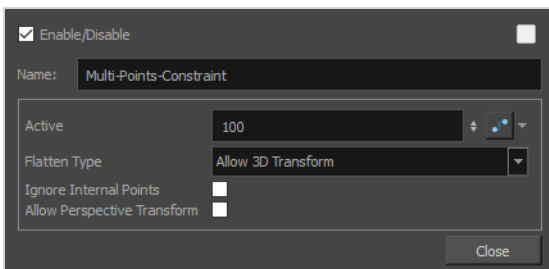

Parameter	Description
Active	<p>The percentage of influence the constraint has on its child element. If set to 100, the element will follow the points closely. If set to 0, the element will not be affected by the constraint.</p> <p>If a Transformation Switch node is connected to the Multi-Points Constraint node, the Active parameters of the Transformation Switch and the Multi-Points Constraint nodes will be multiplied together.</p>
Flatten Type	<p>This parameter defines what happens if one of the pegs defining the constraint points is moved on the Z-axis:</p> <ul style="list-style-type: none"> • Ignore 3D Transform: The element will be constrained to the vertical and horizontal position of the pegs, and will ignore their position on the Z axis. • Allow 3D Transform: The element will be 3D-rotated to follow the position of the pegs in the 3D space.

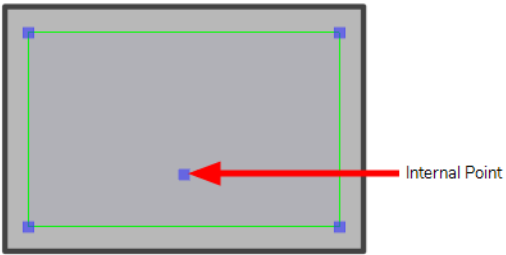
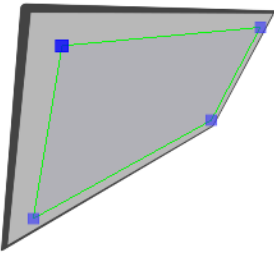
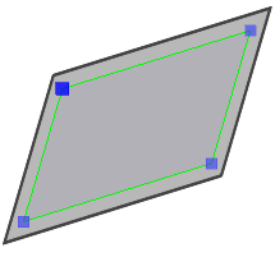
	<ul style="list-style-type: none"> • Project to Plane: The element will be constrained in 2D, but will be made to follow the perceived position of the points from the camera's point of view. This means the 3D position of the points will be projected on a 2D plane that is parallel to the camera. <div data-bbox="643 359 1430 590" style="border: 1px solid green; padding: 10px; margin-top: 10px;"> <p> NOTE This projection is based on the position of the primary point peg on the Z-axis. Hence, if the three pegs are on a different position on the Z-axis, there may be a perceived offset between the position of the non-primary points and their effect on the element.</p> </div>
<p>Ignore Internal Points</p>	<p>If enabled, internal points will be ignored by the Multi-Point Constraint.</p> <p>The envelope used to transform the element is always a convex shape. If any point connected to the Multi-Points Constraint is not an extreme point in its resting position, it is considered an internal point.</p> <div data-bbox="563 827 1131 1136" style="border: 1px solid gray; padding: 10px; margin-top: 10px;">  </div>
<p>Allow Perspective Transform</p>	<p>If this option is enabled, the Multi-Point Constraint node will apply a perspective deformation to the drawing instead of scaling, rotating and skewing the drawing to try to make it track the points.</p> <div data-bbox="563 1331 1190 1677" style="border: 1px solid gray; padding: 10px; margin-top: 10px;"> <div style="display: flex; justify-content: space-around;"> <div style="text-align: center;">  <p>Perspective Transformation</p> </div> <div style="text-align: center;">  <p>Regular Transformation</p> </div> </div> </div>

Static Transformation Node

The Static Transformation node can be used to store, or "bake" the transformation from its immediate parent or from its entire hierarchy of parents, then be connected to a node to apply this transformation to it. The transformation the node stores cannot be animated nor reset. It can hence be used to act as a sort of "resting" position for an element, without having to apply the required transformations to the element or to its parent peg.

Connection

To store transformations into a Static Transformation node, you must first connect a node containing these transformations to its input port.

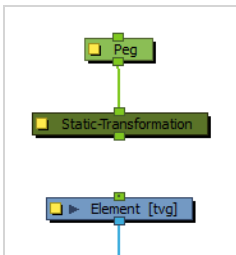

Once the transformations from the parent node have been baked into the Static Transformation node via its layer properties, you must disconnect the Static Transformation node from its parent, then connect it to a child so that this transformation is applied to it.

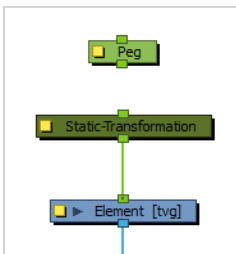

The Static-Transformation node will also dynamically apply its parent's transformations onto the child on top of its own static transformations, so it can be used as an intermediary in a rig.

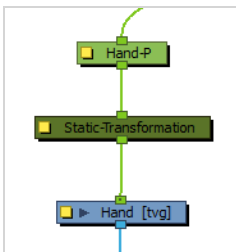

Properties

The layer properties of the Static Transformation allow you to bake the transformations of its parent or parent hierarchy into its own attributes. Optionally, you can also fine-tune the stored transformation.

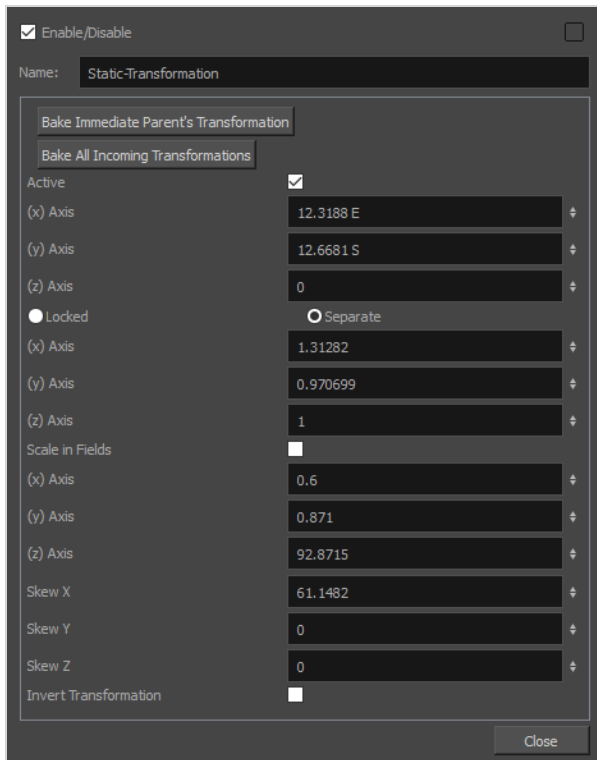

Parameter	Description
Bake Immediate Parent's Transformations	Copies the transformations applied by its parents at the current frame into its own attributes, making the node into a static template of the immediate parent peg's transformations.
Bake All Incoming Transformations	Bakes the transformations of the node's entire hierarchy of parents added up into its own attributes, making the node into a static template of all the transformations applied by its parents combined into a single set of coordinates.
Active	If unchecked, the node will not apply transformations to its child.
Static Transformations	<p>The static transformations baked into the node:</p> <ul style="list-style-type: none"> • (x) Axis: The horizontal translation baked into the node. • (y) Axis: The vertical translation baked into the node. • (z) Axis: The translation on the Z-axis baked into the node.
	<ul style="list-style-type: none"> • Locked: Use a single value for the scale factor baked into the node, preserving the child's proportions. • Separate: Use a separate value for the horizontal, vertical and depth scale factors.

	<ul style="list-style-type: none"> • (x) Axis: The horizontal scale factor baked into the node. • (y) Axis: The vertical scale factor baked into the node. • (z) Axis: The depth scale factor baked into the node. • Scale in Field: When checked, the scale factor will be expressed in a proportion based on the amount of fields for the scene's camera.
	<ul style="list-style-type: none"> • (x) Axis: The rotation around the X-axis baked into the node. • (y) Axis: The rotation around the Y-axis baked into the node. • (z) Axis: The rotation around the Z-axis baked into the node.
	<ul style="list-style-type: none"> • Skew X: The skew angle on the X-axis baked into the node. • Skew Y: The skew angle on the Y-axis baked into the node. • Skew Z: The skew angle on the Z-axis baked into the node.
Invert Transformations	If checked, all transformations baked into the node will be applied negatively.

Three-Points Constraint Node

The Three-Points Constraint translates, rotates and scales a drawing to make it follow the pivots of the three pegs connected to it.

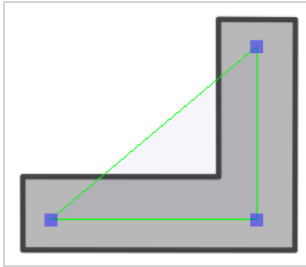



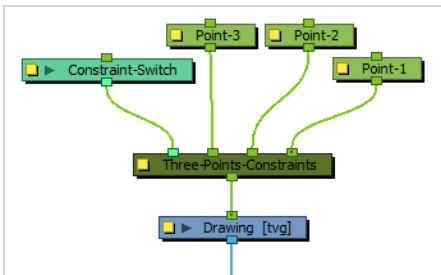

Connection

The Three-Points Constraint node must be connected to three Peg nodes. The pivot point of each peg will define the resting position of one of the points used to transform the drawing connected under it. When one of the pegs is moved, the Three-Points Constraint will transform the drawing so that it follows the pivot point of that peg.



NOTE

The resting position of the points is based on the pivot point of the peg. The pivot point of a peg can be set by selecting the peg with the Translate , Rotate , Scale  or Skew  tool, then clicking and dragging the pivot in the Camera view, or by entering its coordinates in the layer properties of the peg.

Optionally, the leftmost input port of a Three-Points Constraint node can be connected to a Constraint-Switch, which can be used to reduce the effect of the Three-Points Constraint node on the element it is connected by setting its Active parameter between 0 and 100.

Controls

When the controls of the Three-Points Constraint are displayed, the position of the three points are displayed with blue squares linked by a green line.

These points are only a visual representation and cannot be manipulated.

How to animate an element connected to a Three-Points Constraint

1. In the Tools toolbar, select the Transform tool or press Shift + T.
2. Do one of the following:
 - Select one of the pegs the Three-Points Constraint is connected to, then move the peg by clicking and dragging the centre point in the Camera view.
 - In the layer properties of the element, disable the **Animate Using Animation Tools** option. Then, select the element, and click and drag the element near one of the points. The point that is the closest to the mouse cursor will be automatically selected and moved.

Properties

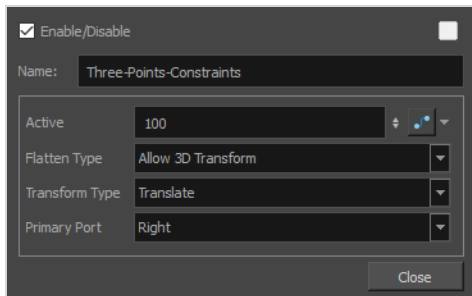

Parameter	Description
Active	<p>The percentage of influence the constraint has on its child element. If set to 100, the element will follow the three points closely. If set to 0, the element will not be affected by the constraint.</p> <p>If a Transformation Switch node is connected to the Three-Points Constraint node, the Active parameters of the Transformation Switch and the Three-Points Constraint nodes will be multiplied together.</p>
Flatten Type	<p>This parameter defines what happens if one of the pegs defining the constraint points is moved on the Z-axis:</p> <ul style="list-style-type: none"> • Ignore 3D Transform: The element will be constrained to the vertical and horizontal position of the pegs, and will ignore their position on the Z axis. • Allow 3D Transform: The element will be 3D-rotated to follow the position of the pegs in the 3D space. • Project to Plane: The element will be constrained in 2D, but will be made to follow the perceived position of the points from the camera's point of view. This means the 3D position of the points will be projected on a 2D

	<p>plane that is parallel to the camera.</p> <div style="border: 1px solid green; padding: 10px; margin: 10px 0;">  <p>NOTE</p> <p>This projection is based on the position of the primary point peg on the Z-axis. Hence, if the three pegs are on a different position on the Z-axis, there may be a perceived offset between the position of the non-primary points and their effect on the element.</p> </div>
<p>Transform Type</p>	<p>By default, only the position of the points is used to transform the element. Since those points are defined by pegs, these pegs can also be subjected to scale, angle and skew transformations that would be normally ignored by the Three-Points Constraint node. This parameter can be used to apply the other transformations done on the peg of the primary point on the element, rather than ignoring them.</p> <ul style="list-style-type: none"> • Translate: Ignores the transformations done on the primary peg, only applies the transformations required for the element to track the three points. • Transform: Applies the transformations calculated by the Three-Points Constraint node to make the element to track the three points, then applies the scale, angle and skew values of the primary peg on top of them. • Local Transform: Applies the scale, angle and skew values of the primary peg on the element, then applies the transformations calculated by the Three-Points Constraint node for the element to track the three points.
<p>Primary Port</p>	<p>Defines which one of the ports, and hence, which one of the pegs the node is connected to, is used to define the primary point.</p> <p>The primary point affects the other parameters in the following ways:</p> <ul style="list-style-type: none"> • When the Flatten Type is set to Ignore 3D Transform or Project to Plane, the position of the element on the Z-axis will be the one of the primary point. • When the Flatten Type is set to Project to Plane, the position of the primary point on the Z-axis is used as the plane on which to project the 3D positions of the points. • If the Transform Type is set to Transform or Local Transform, the scale, angle and skew transformations of the primary peg will be applied to the element.

Transformation Gate Node

The Transformation Gate can be connected to several pegs, or any node that outputs a geometric transformation, and dynamically select which one of these nodes controls its child element. For example, it is possible to connect two pegs to the Transformation Gate, and have the first peg transform the child element of the Transformation Gate for the first half of the scene, then the second peg transform the child element for the second half of the scene.

The Transformation Gate is also able to make an interpolation between two of the input transformations, and apply this combined transformation to its child.

Connection

The Transformation-Gate can be connected to as many nodes that output as transformation, such as Pegs, Quadmaps or other Constraint nodes, as needed.

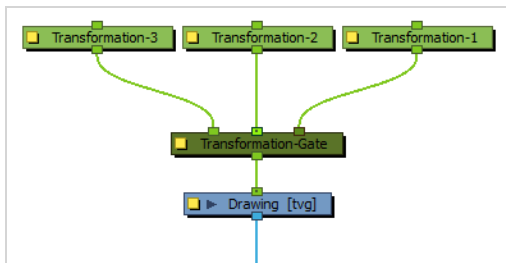

In the Node view, the colour of the input ports indicate which ports are active. The lightest input port is the target gate, which is the gate from which the transformation applied to the child element is sourced. The darkest input port is the default gate. The other ports are ignored.

If the Active parameter of the node is set to any value between 0 and 100, the shade difference between the target gate and default gate will fade. This indicates that the transformations going through the target gate and default gate are combined to create the transformation applied to the child element.

Optionally, a Transformation-Gate node can also be connected to a Constraint-Switch node, which can be used to multiply the Active parameter of the Transformation-Gate and override its Target Gate parameter.

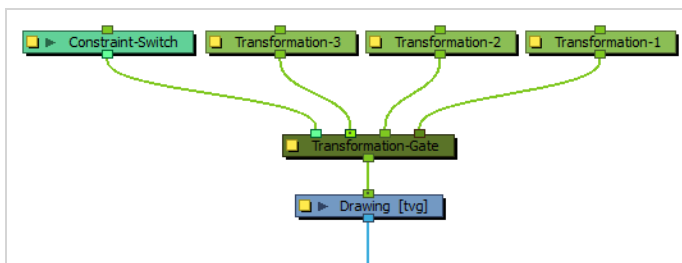

Properties

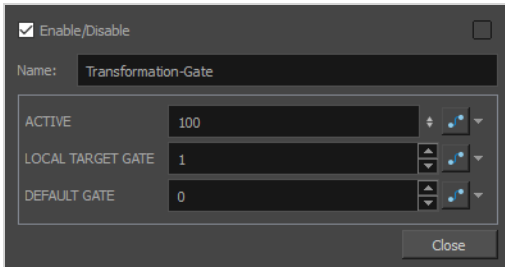

Parameter	Description
Active	<p>The percentage of the transformation sent to the target gate that is applied to the child element. If set to 100, only the transformation sent through the target gate will be applied. If set to 0, only the transformation sent through the default gate will be applied. If set to any value between 0 and 100, an interpolation of the transformations sent through the target gate and the default gate will be generated and applied to the child element.</p>
Local Target Gate	<p>The index of the input port referred to as the target gate.</p> <p>The input ports are numbered starting from 0. In the node view, they are ordered from right to left. Set this parameter to 0 to make the rightmost input port the target gate, to 1 to make the second rightmost port the target gate, etc.</p> <div style="border: 1px solid green; padding: 5px; margin-top: 10px;"> <p> NOTE If the Transformation Gate is connected to a Constraint Switch, the Target Gate parameter of the Constraint Switch will override this value.</p> </div>
Default Gate	<p>The index of the input port referred to as the default gate.</p> <p>The input ports are numbered starting from 0. In the node view, they are ordered from right to left. Set this parameter to 0 to make the rightmost input port the target gate, to 1 to make the second rightmost port the target gate, etc.</p>

Transformation Limit Node

The Transformation Limit node can be used as an intermediary between two nodes to limit the effect of the parent peg's transformations onto the child, by applying a ratio to the transformations applied to the parent before applying them to the child. This ratio can be set for each coordinate in the node's properties and can be animated.



NOTE

This node is designed to limit 2D and 3D translations, but not 3D rotations or scaling.

Connection

The Transformation Limit node must be connected to its parent peg by its right input port, and must be connected to the peg or element it will apply the transformation to via its output port. Transformations applied by the parent peg will be recalculated by the Transformation Limit node, then applied on its child.

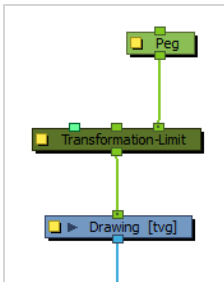

The transformations that are processed by the Transform Limit node are not the ones of its immediate parent, but rather, the ones of the entire hierarchy of parents it is connected to combined. If you need the Transformation-Limit node to only process the transformations of one or some of its parents and ignore the parents past a certain point in the hierarchy, simply connect the first parent the Transformation-Limit node should ignore to its middle input port.

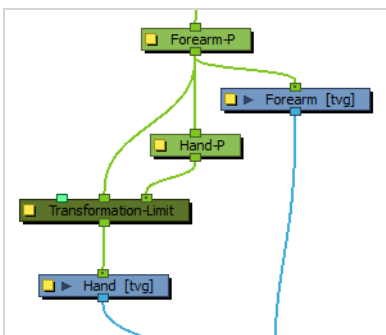

The effect of the Transformation Limit node on the transformation can be tempered by lowering its Active parameter. The Transformation Limit node can also be connected to a Constraint Switch node, the Active parameter of which will be multiplied with the Active parameter of the Transformation limit node, and hence can also be used to temper its effect on its child.

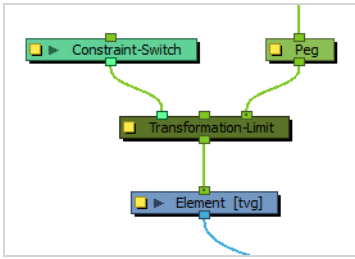

Controls

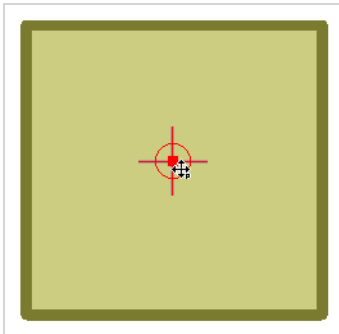

Because the Transformation Limit node can significantly influence the position of its child element relative to its peg pivot, the Transformation Limit has its own pivot point. The position of this pivot can be set in its layer properties, but can also be set visually by displaying its control in the Camera view and dragging it to the desired position using the Transform tool.

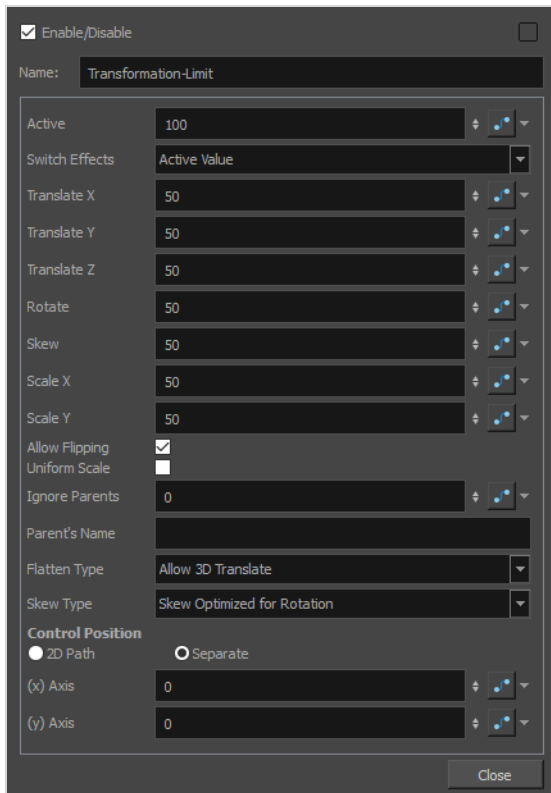

Properties



Parameter	Description
Active	The percentage of influence the Transformation Limit node has on the transformation before it applies it to the child. For example, if its Translate X parameter is set to 50, and its Active parameter is set to 50, the effective Translate X limit will be 75.
Switch Effects	Defines which coordinate limits the Active parameter affects. If set to Active value , it will affect the limits for all coordinates. If set to XYZ Translation, Scale, Rotation, Scale/Skew or Skew , it will affect the limit on the corresponding coordinates. If the Transformation-Limit node is connected to a Constraint Switch, this parameter will also dictate the effect of the switch.
Translate X	The percentage of the parent's horizontal translation to apply to the child.
Translate Y	The percentage of the parent's vertical translation to apply to the child.
Translate Z	The percentage of the parent's translation on the Z axis to apply to the child.

Rotate	The percentage of the parent's rotation to apply to the child.
Skew	The percentage of the parent's skew to apply to the child.
Scale X	The percentage of the parent's horizontal scale to apply to the child.
Scale Y	The percentage of the parent's vertical scale to apply to the child.
Allow Flipping	If disabled, the child element will not be flipped when one of the parent's scale transformations is negative.
Uniform Scale	Averages the horizontal and vertical scale factors to preserve the proportions of the child.
Ignore Parents	<p>If this property is set to any value but 0, the Transformation Limit node will go up its own hierarchy up to the value of this property, and consider the node at this level to be the "Ignored parent". The transformations applied by this parent and all its parents will not be affected by the Transform Limit.</p> <div data-bbox="565 978 1430 1146" style="border: 1px solid #c8e6c9; padding: 10px;">  <p>NOTE This has the same effect as connecting one of the node's parents to its middle port.</p> </div>
Parent's Name	<p>If the Ignore Parents property is set to any value but 0, this property will also be used in determining which parent to consider as the "Ignored parent". When looking up the parent hierarchy of the Transformation Limit node, if it finds any node with a matching name, it will consider it the "Ignored parent", and the transformations applied by this parent and all its parents will not be taken in account for the spring effect.</p> <div data-bbox="565 1444 1430 1675" style="border: 1px solid #c8e6c9; padding: 10px;">  <p>NOTE When both the Ignore Parents and the Parent's Name parameters are set, the "Ignored parent" will be the first node in the node's parent hierarchy that either matches the name of the Parent's Name parameter or the parent level in the Ignore Parents parameter.</p> </div>

	<div style="border: 1px solid #add8e6; padding: 10px;">  <p>TIP</p> <p>This parameter only works if the Ignore Parents parameter is set to any value but 0. If you want the ignored parent to only be matched by its name and not its level in the hierarchy, you can set the Ignore Parents parameter to an improbably high number (ie: 100 or 1000), and set the Parent's Name to the name of the parent to ignore.</p> </div>
Flatten Type	<p>Affects how the translations are applied in the 3D space.</p> <ul style="list-style-type: none"> • Allow 3D Translate: The parent's translation on the Z-axis will be affected by the Translate Z parameter, then applied to the Z axis position of the child, as with other parameters. This is the default behavior. • Project 3D Translate to Plane: The parent's translation on the Z-axis will be projected on the X and Y translations based on the position of the camera. This gives the illusion that the apparent position of the element from the point of view of the camera changes realistically depending on its position on the Z-axis, but without actually moving it on the Z-axis and hence without changing its order relative to other elements. • Project and Scale 3D Translate to Plane: The parent's translation on the Z-axis will be projected on the X and Y translations and on the X and Y scales, based on the position of the camera. This gives the illusion that the apparent position and size of the element from the point of view of the camera changes realistically depending on its position on the Z-axis, but without actually moving it on the Z-axis and hence without changing its order relative to other elements.
Skew Type	<p>Affects how Skew of the parent is applied to the child.</p> <ul style="list-style-type: none"> • Skew Applied as Rotation: Adds the value of the skew calculated by the Transformation Limit node to the rotation applied to the child. • Skew Ignored by Rotation: Processes the skew and rotation coordinates separately. Because the effect of these parameters is intertwined, this may yield unexpected results, but which may be preferable when transformations are fine tuned and manually calculated. • Skew Optimized for Rotation: Processes the skew and rotation coordinates together before applying them to the child element. The result will look more like what the human eye would guess the element would look like with a limit applied to its rotation and skew.
Control Position	<p>The following parameters affect the pivot point used to apply the transformations calculated by the Transformation Limit node.</p> <p>2D Path: The horizontal and vertical position of the pivot point are stored in a single function of control points. This makes the trajectory curvilinear and the</p>

	<p>pace of the movement set to a velocity function.</p> <p>Separate: The horizontal and vertical position of the pivot point are stored in separate functions of coordinates. This makes a trajectory where each point is joined by a straight line and each coordinate can have its own curve.</p>
	<p>Path: If the 2D Path option is selected, this allows you to create or link to a 2D Path function.</p> <p>(x) Axis: The position of the pivot point on the horizontal axis.</p> <p>(y) Axis: The position of the pivot point on the vertical axis.</p>

Two-Points Constraint Node

The Two-Points Constraint translates, rotates and scales a drawing to make it follow the pivots of the two pegs connected to it. Hence, it allows an animator to position an element (for example, a limb) by moving the two points at its extremities (the articulations).

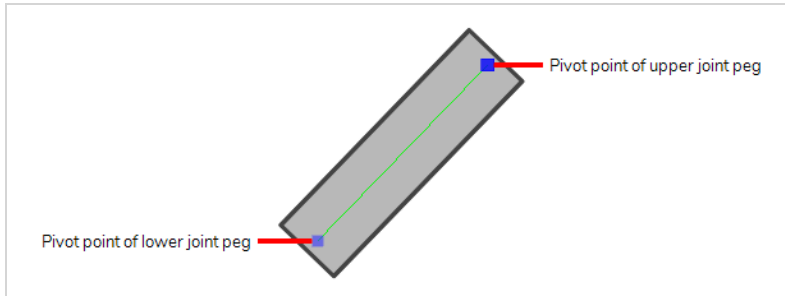



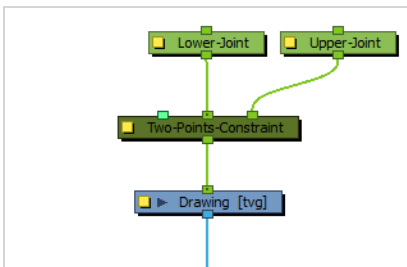

Contrary to Three-Points Constraint and Multi-Points Constraint nodes, Two-Points Constraint can automatically stretch and squash the element they are connected to depending on the distance between the two points. This effect can be fine-tuned in the layer properties of the Two-Point Constraint node.

Connection

The Two-Points Constraint node must be connected to two Peg nodes. The pivot point of each peg will define the resting position of one of the points used to transform the drawing connected under it. When one of the pegs is moved, the Two-Points Constraint will transform the drawing so that it follows the pivot point of that peg.



NOTE

The resting position of the points is based on the pivot point of the peg. The pivot point of a peg can be set by selecting the peg with the Translate , Rotate , Scale  or Skew  tool, then clicking and dragging the pivot in the Camera view, or by entering its coordinates in the layer properties of the peg.

It is possible to rig multiple Two-Points Constraint nodes together in order to connect adjacent parts of a character rig by their articulation. For example, the upper and lower part of an arm or a leg could be rigged together in the following fashion, to allow the animator to manipulate them by their articulations:

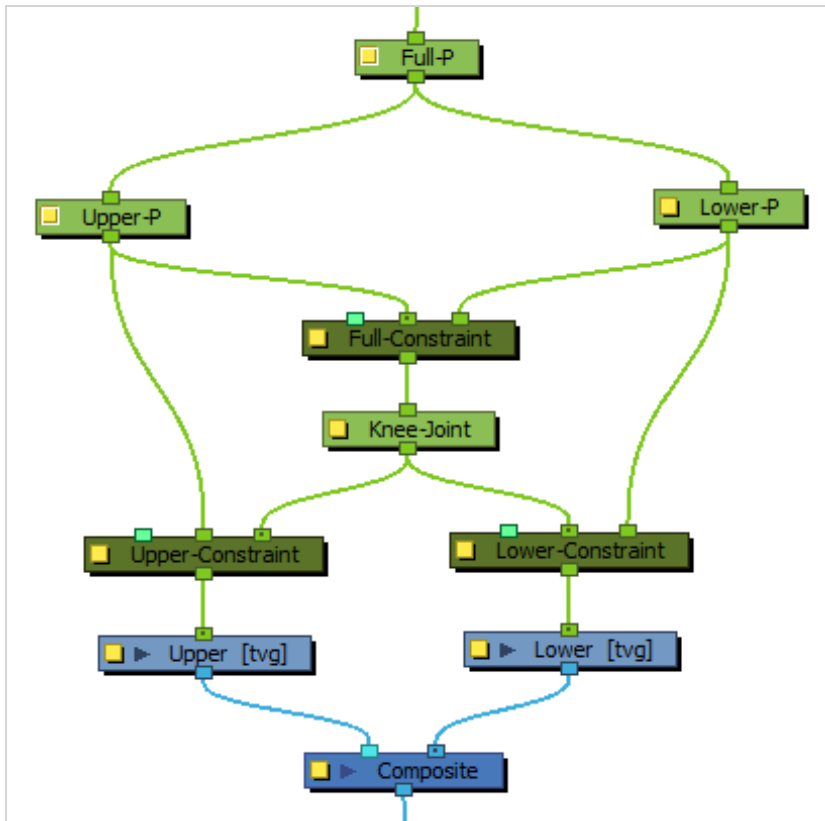

Optionally, the leftmost input port of a Two-Points Constraint node can be connected to a Constraint-Switch, which can be used to reduce the effect of the Two-Points Constraint node on the element it is connected by setting its Active parameter between 0 and 100.

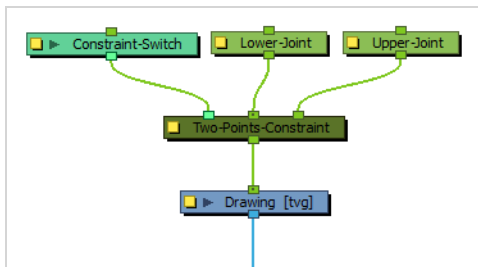

TIP

It is recommended to disable the **Animate Using Animation Tools** property of the element the Two-Points Constraint node is connected to. This will allow the animator to animate the Two-Points Constraint by selecting the element, then clicking and dragging near one of the two points using the Transform tool. The Two-Points Constraint will automatically select the closest point to the mouse cursor and move it.

Controls

When the controls of the Two-Points Constraint are displayed, the position of the two points are displayed with blue squares linked by a green line.

These points are only a visual representation and cannot be manipulated.

How to animate an element connected to a Two-Points Constraint

1. In the Tools toolbar, select the Transform tool or press Shift + T.
2. Do one of the following:
 - Select one of the pegs the Two-Points Constraint is connected to, then move the peg by clicking and dragging the centre point in the Camera view.
 - In the layer properties of the element, disable the **Animate Using Animation Tools** option. Then, select the element, and click and drag the element near one of the two points. The point that is the closest to the mouse cursor will be automatically selected and moved.

Properties

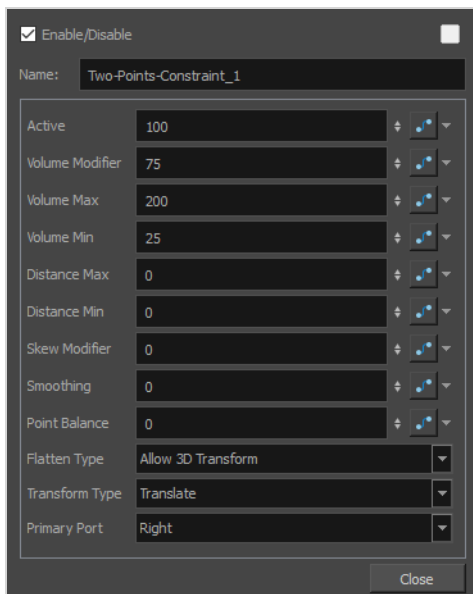

Parameter	Description
Active	<p>The percentage of influence the constraint has on its child element. If set to 100, the element will follow the two points closely. If set to 0, the element will not be affected by the constraint.</p> <p>If a Transformation Switch node is connected to the Two-Points Constraint node,</p>

	<p>the Active parameters of the Transformation Switch and the Two-Points Constraint nodes will be multiplied together.</p>
Volume Modifier	<p>Defines how much the Two-Points Constraint node should preserve the width of the child element when the distance between the points causes it to stretch or squash.</p> <p>If set to 100, the width of the element will increase when squashed and decreased when stretched based on the Volume Max and Volume Min parameters. If set to 0, the element will always have the same width regardless of how much it is stretched or squashed. The value can be set to a number between 0 and 100 to reduce the effect of the volume modifications, to a number above 100 to increase it, or to a negative number to reverse the volume modification logic.</p>
Volume Max	<p>The maximum width of the element when squashed.</p> <p>This value represents a percentage of the element's original width. If set to 0, no minimum width will be applied.</p>
Volume Min	<p>The minimum width of the element when stretched.</p> <p>The value represents a percentage of the element's original width. If set to 0, no maximum width will be applied.</p>
Distance Min	<p>The minimum distance between the two points. If the points are brought closer together than their minimum distance, the element will stop transforming.</p> <p>This value represents a percentage of the distance between the two points when in their respective resting positions.</p>
Distance Max	<p>The maximum distance between the two points. If the points are brought farther from each other than their maximum distance, the element will stop transforming.</p> <p>This value represents a percentage of the distance between the two points when in their respective resting positions.</p>
Skew Modifier	<p>When set to 0, the element is rotated to follow the two points. If set to 100, the element will skew to follow the two points. If set between 0 and 100, the element will be transform with a combination of rotation and skewing to follow the two points.</p>
Smoothing	<p>When the two points are moved away from each other and reach their maximum distance, this value will adds an extra buffer of distance that the two points can reach before the element stops stretching. In this buffer, the way the element stretches is tapered, making it stop stretching smoothly instead of abruptly.</p> <p>This value represents a percentage of the distance between the two points when</p>

	in their respective resting positions.
Point Balance	<p>This parameter comes in effect when the two points are being moved at a distance exceeding their maximum distance. If set to 0, the element will stop stretching and remain locked against the primary point. If set to 100, the element will stop stretching and remain locked against the second point. If set to a value between 0 and 100, the element will be moved between both points, at a distance from the primary point that is proportional to this setting.</p>
Flatten Type	<p>This parameter defines what happens if one of the pegs defining the constraint points is moved on the Z-axis:</p> <ul style="list-style-type: none"> • Ignore 3D Transform: The element will be constrained to the vertical and horizontal position of the pegs, and will ignore their position on the Z axis. • Allow 3D Transform: The element will be 3D-rotated to follow the position of the pegs in the 3D space. • Project to Plane: The element will be constrained in 2D, but will be made to follow the perceived position of the points from the camera's point of view. This means the 3D position of the points will be projected on a 2D plane that is parallel to the camera. <div style="border: 1px solid green; padding: 10px; margin-top: 10px;"> <p> NOTE This projection is based on the position of the primary point peg on the Z-axis. Hence, if the two pegs are on a different position on the Z-axis, there may be a perceived offset between the secondary point and its effect on the element.</p> </div>
Transform Type	<p>By default, only the position of the points is used to transform the element. Since those points are defined by pegs, these pegs can also be subjected to scale, angle and skew transformations that would be normally ignored by the Two-Points Constraint node. This parameter can be used to apply the other transformations done on the peg of the primary point on the element, rather than ignoring them.</p> <ul style="list-style-type: none"> • Translate: Ignores the transformations done on the primary peg, only applies the transformations required for the element to track the two points. • Transform: Applies the transformations calculated by the Two-Points Constraint node to make the element to track the two points, then applies the scale, angle and skew values of the primary peg on top of them. • Local Transform: Applies the scale, angle and skew values of the primary peg on the element, then applies the transformations calculated by the Two-Points Constraint node for the element to track the two points.

Primary Port	<p>Defines which one of the ports, and hence, which one of the pegs the node is connected to, is used to define the primary point, leaving the other port for the secondary point.</p> <p>The primary point affects the other parameters in several ways:</p> <ul style="list-style-type: none">• The Point Balance parameter ranges from 0 to 100, with 0 making the element balance towards the primary point and 100 making it balance towards the secondary point.• When the Flatten Type is set to Ignore 3D Transform or Project to Plane, the position of the element on the Z-axis will be the one of the primary point.• When the Flatten Type is set to Project to Plane, the position of the primary point on the Z-axis is used as the plane on which to project the 3D positions of the points.• If the Transform Type is set to Transform or Local Transform, the scale, angle and skew transformations of the primary peg will be applied to the element.
--------------	--

Deformation Nodes

The Deformation nodes category includes all the nodes which are used to make deformer. In Harmony, deformers are made of chains of deformation nodes connected in a hierarchy. By default, deformation chains made with the Rigging tool are created in groups by default to avoid cluttering the Node and Timeline views. Each deformation node represents a point in a deformation chain.

This category also includes nodes that are made to deform drawings without being part of a deformation chain, such as the Mesh Warp node.

Articulation Node	497
Auto Fold Node	500
Auto Muscle Node	502
Bone Nodes	506
Curve Node	510
Deformation Composite Node	514
Deformation Root Node	517
Deformation Scale Node	518
Deformation Switch Node	523
Deformation Uniform Scale Node	525
Deformation Wave Node	527
Fold Node	530
Game Bone Node	534
Glue Node	536
Kinematic Output Node	538
Mesh Warp Node	539
Offset Node	543
Point Kinematic Output Node	545
Connections	546
Refract	552
Stick Node	554
Turbulence Node	556
Weighted Deform Node	560

Articulation Node

The Articulation node is no longer used in the current release of Harmony. This node is still available for compatibility purposes with previous deformation rigs.

The Articulation node is used between two bones (legacy) to create a joint where the limb or element will rotate. The current Bone and Game Bone nodes include the articulation parameters.

Properties

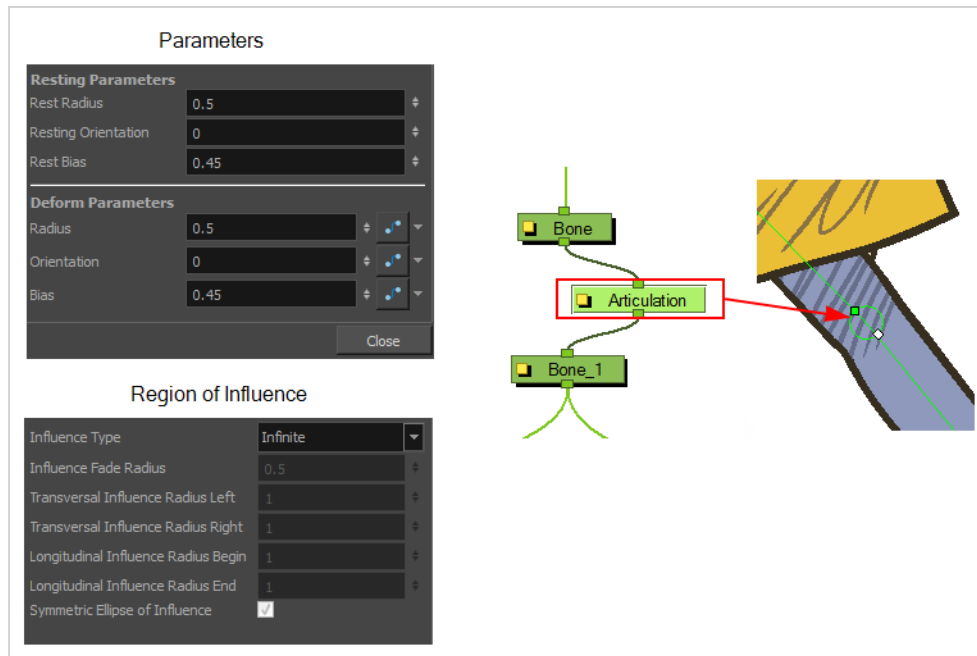

Parameter	Description
Enable/Disable	Allows you to enable or disable the node. When disabled, a node has no visible effect on the rendered image, nor on the preview in the Camera, Perspective, Side and Top views.
Colour Swatch	Sets the colour of the layer in the Timeline view and of the node in the Node view.
Name	Use this field to rename the node.
Resting Parameters	
Rest Radius	Lets you set the resting radius of the articulation (size of the circle).

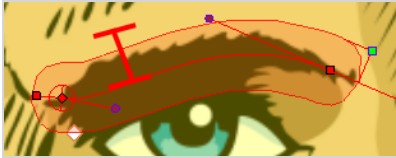
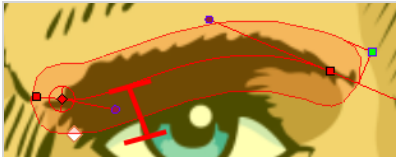
Resting Orientation	Lets you set the resting rotation angle value of the articulation.
Rest Bias	Lets you set the resting bias value of the articulation, which can also be seen as the steepness of the articulation. The smaller the bias value, the smoother the articulation angle, and the larger the bias value, the more angular the articulation is.
Deformation Parameters	
Radius	Lets you set the radius of the articulation (size of the circle). When animated, this value will be connected to a function.
Orientation	Lets you set the rotation angle value of the articulation. When animated, this value will be connected to a function.
Bias	Lets you set the bias value, which can also be seen as the steepness of the articulation. When animated, this value will be connected to a function.
Region of Influence	
Influence Fade Radius	This defines the size of the fade area around the actual region of influence's boundaries.
Transversal Influence Radius Left	<p>When the Symmetric Ellipse of Influence option is enabled, this field controls the Left and Right transversal radius values. When disabled, it controls the size of the left transversal radius. By default, this value is set to 2.</p> 
Transversal Influence Radius Right	<p>When the Symmetric Ellipse of Influence option is enabled, this field becomes inactive. The Left Transversal radius value is automatically applied to the Right Transversal. When the Symmetric Ellipse of Influence option is disabled, it controls the size of the Right Transversal radius. By default, this value is set to 2.</p> 

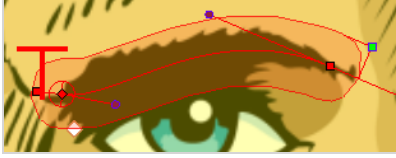
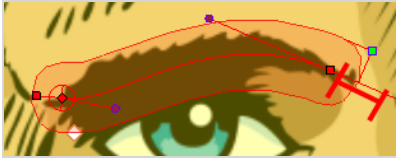
<p>Longitudinal Influence Radius Begin</p>	<p>When the Symmetric Ellipse of Influence option is enabled, this field becomes inactive. The End Longitudinal value is automatically applied to the Begin Longitudinal value. When the Symmetric Ellipse of Influence option is disabled, it controls the size of the Begin Longitudinal radius. By default, this value is set to 0.25.</p> 
<p>Longitudinal Influence Radius End</p>	<p>When the Symmetric Ellipse of Influence option is enabled, this field controls both the Begin and End Longitudinal radius values. When this option is disabled, it controls the size of the End Longitudinal radius. By default, this value is set to 0.25.</p> 
<p>Symmetric Ellipse Influence</p>	<p>Enabled by default. The shape of the ellipse will be symmetrical on both the transversal and longitudinal radii. In this case, use the Transversal Influence Radius Left field to set the transversal radius value and use the Longitudinal Influence Radius End field to set the longitudinal radius value. The two other fields will remain unused unless you disable the Symmetric Ellipse Influence option. In that case, you can set up different radius sizes for the four radii directions.</p>

Auto Fold Node

The AutoFold node lets you automatically fix the folding area of a deformer, so no line overlap occurs. If your drawing pieces are separated on different layers, you will not need the AutoFold node. The AutoFold node is similar to the Fold node, but since it's automated, it is optimized to fit the most standard folding point with fewer controls to set up. You can also avoid this issue by separating your drawing onto two layers or separating your drawing in two pieces using the Cutter tool and repasting it in place in the same drawing.

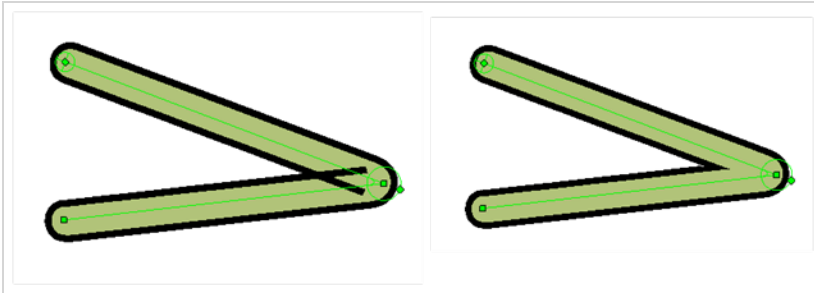

Connect the AutoFold node directly under the Deformation node which is causing the unwanted line effect, for example the forearm.

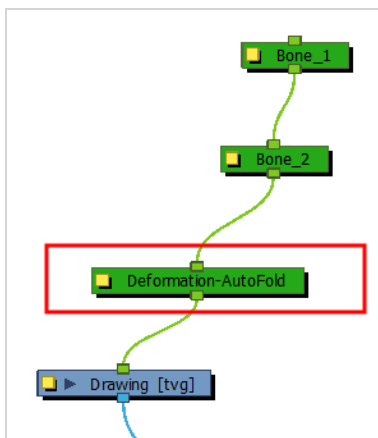

Properties

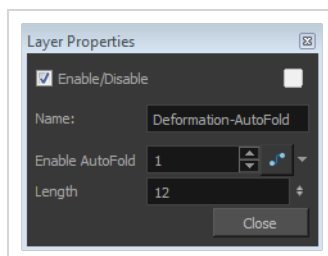

Parameter	Description
Enable/Disable	Allows you to enable or disable the node. When disabled, a node has no visible effect on the rendered image, nor on the preview in the Camera, Perspective, Side

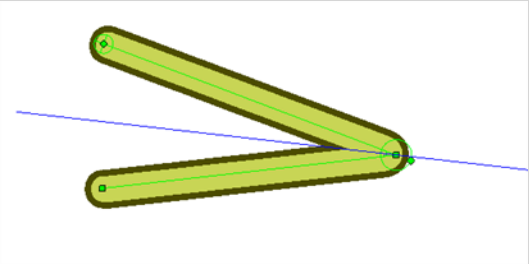
	and Top views.
Colour Swatch	Sets the colour of the layer in the Timeline view and of the node in the Node view.
Name	Name this field to rename the node.
Enable AutoFold	Type 1 to enable it or 0 to disable the effect. If you connect this option to a function, then you can enable or disable the effect at a specific point in your animation.
Length	Sets the length of the fold axis line. 

Auto Muscle Node

The Auto-Muscle node is used to simulate muscle movement. This will allow your characters to flex their muscles when they lift something or to create muscle tone when they move. When the Auto-Muscle node is connected to a Bone Deformer that is rotated, the drawing is automatically inflated to simulate muscle movement in the limb.



NOTE

Connect the Auto-Muscle node above the drawing you want to add a muscle to and after the Bone chain.

Properties

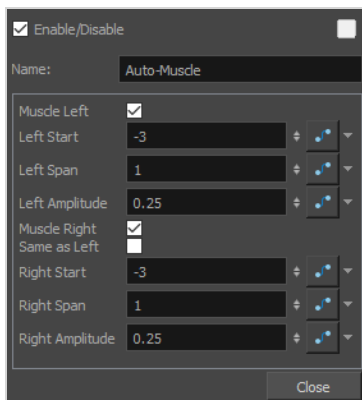

Parameter	Description
Enable/Disable	Allows you to enable or disable the node. When disabled, a node has no visible effect on the rendered image, nor on the preview in the Camera, Perspective, Side and Top views.
Colour Swatch	Sets the colour of the layer in the Timeline view and of the node in the Node view.
Name	Use this field to rename the node.
Muscle Left	This option is enabled by default. When enabled, the left side of the Bone Deformer will inflate as the articulation is rotated toward the direction of the Bone Deformer. Disable this option if you do not want the left side of the bone to inflate.

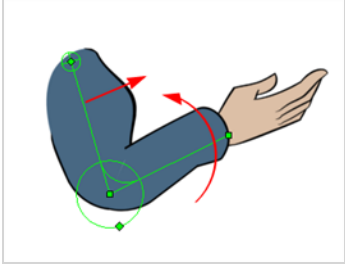
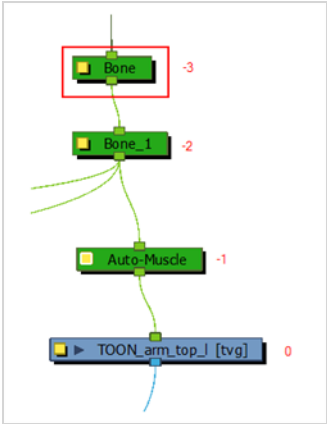
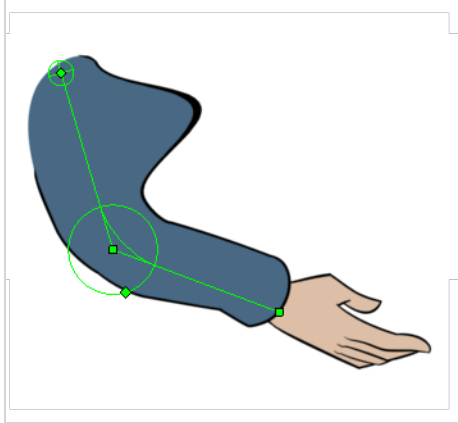
	
<p>Left Start</p>	<p>The default value of the starting position of the left muscle is set to -2. This means it will start at the deformer situated two steps before the position where the Auto-Muscle is connected. You can change the starting point by typing the number corresponding to the deformer node.</p> 
<p>Left Span</p>	<p>This parameter controls the length (muscle length) over which the effect node will be applied to the left side of the deformer. By default the setting is 1, representing the length of the deformer to which it is applied.</p>
<p>Left Amplitude</p>	<p>This parameter controls the physical size of the left muscle. Increase the value to make the muscle bigger, decrease the value to make it smaller.</p> 

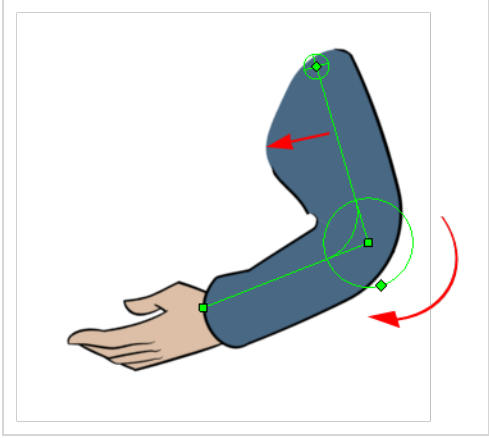
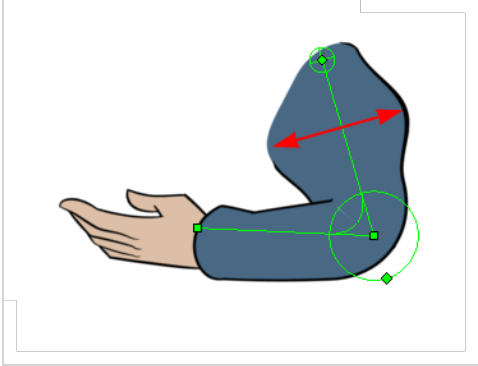
Muscle Right	<p>This option is enabled by default. When enabled, the right side of the Bone Deformer will inflate as the articulation is rotated toward the direction of the Bone Deformer. Disable this option if you don't want the right side of the bone to inflate.</p> 
Same as Left	<p>This option is enabled by default, allowing each side of the Bone Deformer to inflate to follow the rotation of the articulation. Enable this option to synchronize the right muscle with the left so both muscles inflate when the articulation is rotated to the left.</p> 
Right Start	<p>The default value of the starting position of the right muscle is set to -2. This means it will start at the deformer situated two steps before where the Auto-Muscle is connected, in this case, Bone. You can change the starting point by typing the number corresponding to the deformer node.</p>

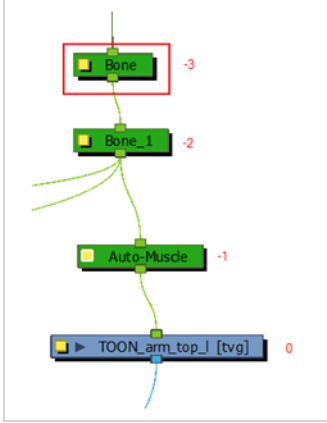
	
<p>Right Span</p>	<p>This parameter controls the length (muscle length) over which the effect node will be applied to the right side of the deformer. By default the setting is 1, representing the length of the deformer to which it is applied.</p>
<p>Right Amplitude</p>	<p>This parameter controls the physical size of the right muscle. Increase the value to make the muscle bigger, decrease the value to make it smaller.</p>

Bone Nodes

The Bone node is one of the main nodes used to build a deformation rig. Each Bone node consists of a bone and an articulation. You can chain Bone nodes to create a skeleton chain for your character. The Rigging tool can be used to create and connect those nodes automatically.

Properties

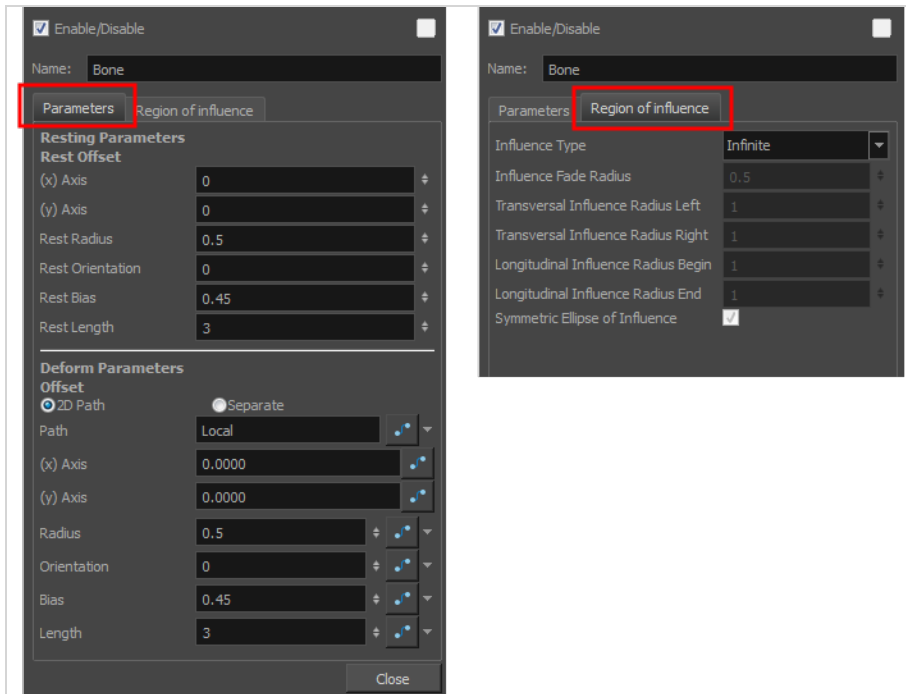

Parameter	Descriptions
Enable/Disable	Allows you to enable or disable the node. When disabled, a node has no visible effect on the rendered image, nor on the preview in the Camera, Perspective, Side and Top views.
Colour Swatch	Sets the colour of the layer in the Timeline view and of the node in the Node view.
Name	The name of the node as it appears in the Node View and the Timeline view. Each node must have a name that is unique to its containing group.
Resting Parameters Rest Offset	
(x) Axis	This is the bone x-axis (horizontal) coordinates for the resting position.
(y) Axis	This is the bone y-axis (vertical) coordinates for the resting position.

Rest Radius	This is the articulation's radius value (articulation size) for the resting position.
Rest Orientation	This is the bone's orientation angle for the resting position.
Rest Bias	This is the articulation's bias (roundness and smoothness) for the resting position.
Rest Length	This is the bone's length for the resting position.
Deform Parameters Offset	
2D Path	When this option is enabled, the X and Y-axis parameters are controlled by the same 2D path function.
Separate	When this option is enabled, the X and Y-axis parameters are individual one from another.
Path	When using a 2D Path, this field displays the name of the function.
(x) Axis	This is the bone X-axis (horizontal) coordinates for the animation position. This parameter can be linked to a function to be animated over time.
(y) Axis	This is the bone y-axis (vertical) coordinates for the animation position. This parameter can be linked to a function to be animated over time.
Radius	This is the articulation's radius value (articulation size) for the animation position. This parameter can be linked to a function to be animated over time.
Orientation	This is the bone's orientation angle for the animation position. This parameter can be linked to a function to be animated over time.
Bias	This is the articulation's bias (roundness and smoothness) for the animation position. This parameter can be linked to a function to be animated over time.
Length	This is the bone's length for the animation position. This parameter can be linked to a function to be animated over time.
Region of Influence	

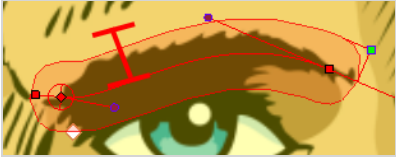
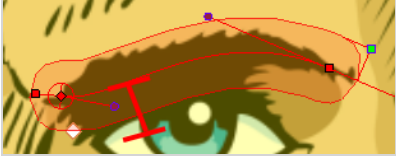
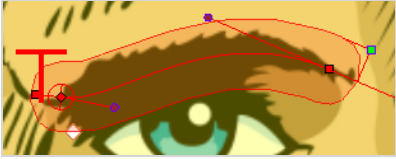
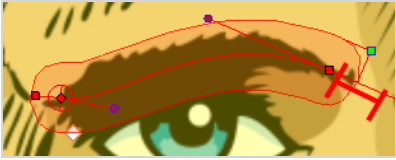
Influence Fade Radius	This defines the size of the fade area around the actual region of influence's boundaries.
Transversal Influence Radius Left	<p>When the Symmetric Ellipse of Influence option is enabled, this field controls the Left and Right transversal radius values. When disabled, it controls the size of the left transversal radius. By default, this value is set to 2.</p> 
Transversal Influence Radius Right	<p>When the Symmetric Ellipse of Influence option is enabled, this field becomes inactive. The Left Transversal radius value is automatically applied to the Right Transversal. When the Symmetric Ellipse of Influence option is disabled, it controls the size of the Right Transversal radius. By default, this value is set to 2.</p> 
Longitudinal Influence Radius Begin	<p>When the Symmetric Ellipse of Influence option is enabled, this field becomes inactive. The End Longitudinal value is automatically applied to the Begin Longitudinal value. When the Symmetric Ellipse of Influence option is disabled, it controls the size of the Begin Longitudinal radius. By default, this value is set to 0.25.</p> 
Longitudinal Influence Radius End	<p>When the Symmetric Ellipse of Influence option is enabled, this field controls both the Begin and End Longitudinal radius values. When this option is disabled, it controls the size of the End Longitudinal radius. By default, this value is set to 0.25.</p> 
Symmetric Ellipse Influence	Enabled by default. The shape of the ellipse will be symmetrical on both the transversal and longitudinal radii. In this case, use the Transversal Influence

	<p>Radius Left field to set the transversal radius value and use the Longitudinal Influence Radius End field to set the longitudinal radius value. The two other fields will remain unused unless you disable the Symmetric Ellipse Influence option. In that case, you can set up different radius sizes for the four radii directions.</p>
--	--

Curve Node

The Curve node is one of the main nodes for building a deformation rig. You can chaining Curve nodes to create a Bezier handles skeleton. The Rigging tool can be used to create and connect the nodes automatically.

Properties

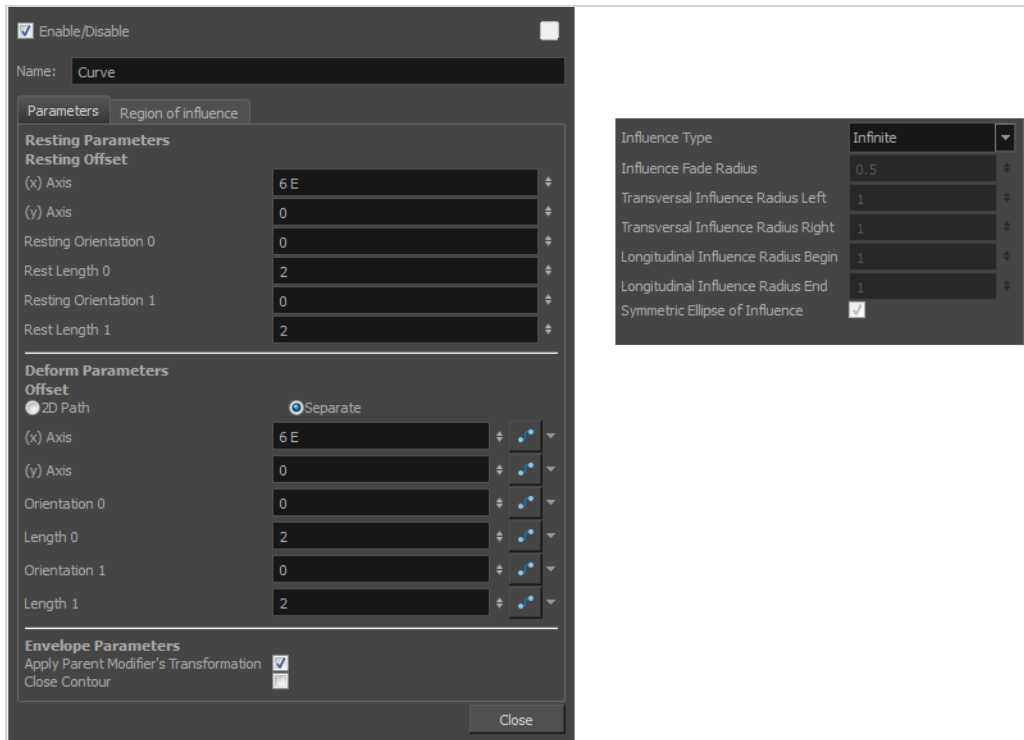

Parameter	Description
Enable/Disable	Allows you to enable or disable the node. When disabled, a node has no visible effect on the rendered image, nor on the preview in the Camera, Perspective, Side and Top views.
Colour Swatch	Sets the colour of the layer in the Timeline view and of the node in the Node view.
Name	The name of the node as it appears in the Node View and the Timeline view. Each node must have a name that is unique to its containing group.
Resting Parameters Resting Offset	
(x) Axis	This is the curve x-axis (horizontal) coordinates for the resting position.

(y) Axis	This is the curve y-axis (vertical) coordinates for the resting position.
Resting Orientation 0	This is the orientation for the first Bezier handle for the resting position.
Rest Length 0	This is the length for the first Bezier handle for the resting position.
Resting Orientation 1	This is the orientation for the second Bezier handle for the resting position.
Rest Length 1	This is the length for the second Bezier handle for the resting position.
Deform Parameters Offset	
2D Path	When this option is enabled, the X and Y-axis parameters are controlled by the same 2D path function.
Separate	When this option is enabled, the X and Y-axis parameters are individual one from another.
(x) Axis	This is the curve X-axis (horizontal) coordinates for the animation position.
(y) Axis	This is the curve Y-axis (vertical) coordinates for the animation position.
Orientation 0	This is the orientation for the first Bezier handle for the animation position.
Length 0	This is the length for the first Bezier handle for the animation position.
Orientation 1	This is the orientation for the second Bezier handle for the animation position.
Length 1	This is the length for the second Bezier handle for the animation position.
Envelope Parameters	
Apply Parent Modifier's Transformation	When this option is disabled, the deformation from the parent curves are no longer affecting the current curve. Interesting effects can be achieved when disabling this effect on the last child curve and rotating the Offset point. The curve tail end will remain pinned on the spot while the rest of the curves deforms.
Close Contour	When this option is enabled, the extrimity of the curve is snapped to the initial chain's Offset point. This creates an Envelope deformation. More than one curve

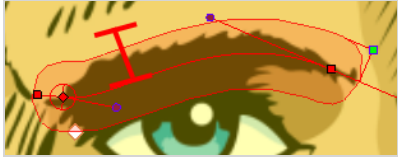
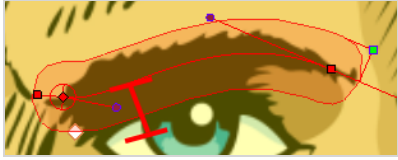
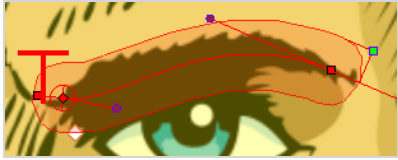
	can be linked to the Offset point.
Region of Influence	
Influence Fade Radius	This defines the size of the fade area around the actual region of influence's boundaries.
Transversal Influence Radius Left	<p>When the Symmetric Ellipse of Influence option is enabled, this field controls the Left and Right transversal radius values. When disabled, it controls the size of the left transversal radius. By default, this value is set to 2.</p> 
Transversal Influence Radius Right	<p>When the Symmetric Ellipse of Influence option is enabled, this field becomes inactive. The Left Transversal radius value is automatically applied to the Right Transversal. When the Symmetric Ellipse of Influence option is disabled, it controls the size of the Right Transversal radius. By default, this value is set to 2.</p> 
Longitudinal Influence Radius Begin	<p>When the Symmetric Ellipse of Influence option is enabled, this field becomes inactive. The End Longitudinal value is automatically applied to the Begin Longitudinal value. When the Symmetric Ellipse of Influence option is disabled, it controls the size of the Begin Longitudinal radius. By default, this value is set to 0.25.</p> 
Longitudinal Influence Radius End	<p>When the Symmetric Ellipse of Influence option is enabled, this field controls both the Begin and End Longitudinal radius values. When this option is disabled, it controls the size of the End Longitudinal radius. By default, this value is set to 0.25.</p>

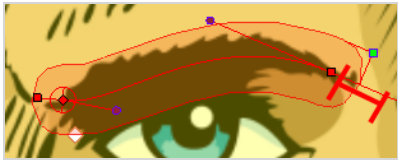
	
<p>Symmetric Ellipse Influence</p>	<p>Enabled by default. The shape of the ellipse will be symmetrical on both the transversal and longitudinal radii. In this case, use the Transversal Influence Radius Left field to set the transversal radius value and use the Longitudinal Influence Radius End field to set the longitudinal radius value. The two other fields will remain unused unless you disable the Symmetric Ellipse Influence option. In that case, you can set up different radius sizes for the four radii directions.</p>

Deformation Composite Node

The Deformation-Composite node is automatically added to a rig when creating a split deformation chain. It is used to link the different nodes of a split deformation chain together before deforming the drawing it is linked to. You can customize its parameters to influence the result of the combination.



Properties

Parameter	Description
Enable/Disable	Allows you to enable or disable the node. When disabled, a node has no visible effect on the rendered image, nor on the preview in the Camera, Perspective, Side and Top views.
Colour Swatch	Sets the colour of the layer in the Timeline view and of the node in the Node view.
Name	Use this field to rename the node.
Output Kinematic Only	This option is disabled by default, allowing the deformation chain to output deformation and position information. This option should be enabled in order to output the chain information position only. This will allow you to connect a part to the hierarchy without it undergoing the deformation applied to the rest of the chain.
Output Selected Port Only	This option is important if you have several deformation chains for one element, as in the case of a character with multiple poses. <ul style="list-style-type: none"> When this option is enabled, it will only use the selected chain, which you will be able to define in the Output Kinematic Chain options of the Deformation-Composite. In some situations, this

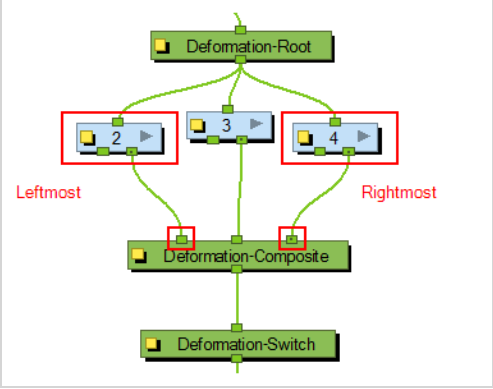
	<p>option is enabled and setup automatically (For example, when you are working with the Create Posed Deformer in Create Deformation Above/Under enabled).</p> <ul style="list-style-type: none"> When this option is disabled, all the different chains for this element will be used at once.
<p>Output Kinematic Chain</p>	<p>Lets you select a deformation chain option to use. This parameter is used when the Output Selected Port Only option is enabled.</p> 
	<p>Rightmost: Only the first chain connected to the right of the composite node will be used.</p>
	<p>Leftmost: Only the first chain connected to the left of the composite node will be used.</p>
	<p>Select: If you select this option, you can define which chain to output according to the order they are connected from left to right.</p>
	<p>Use First Connected Element's Exposure as Key: Allows the deformation effect to automatically detect which deformation chain to use (subgroup) by detecting the exposure of the first element connected to the deformation. This option is used in the case of a multiple pose rig.</p>
	<p>Use Parent Composite's Connected Element Exposure: When the Output Kinematic Only option enabled, the information from the parent element's exposure is used to attach the child to the correct chain, following which pose is exposed—see</p>
<p>Output Kinematic Chain Selection</p>	<p>When the Output Selected Port Only option is selected AND the Select option is used as the Output Kinematic Chain setting, this field defines which deformation chain you want to use on your element. Select the</p>

number which corresponds to the left to right order that the chains are connected to the Deformation-Composite node.

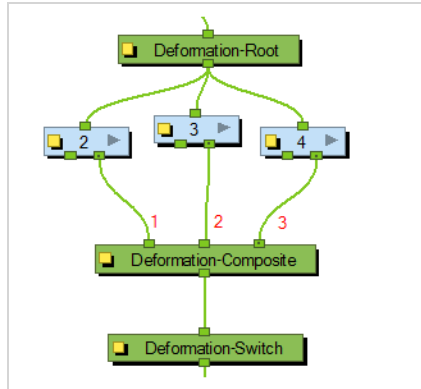

You can attach this value to a function and enable different chains over a period of time on specific frames. This value can be modified in the Timeline view by using the Deformation-Switch layer. Since the Deformation-Composite node is only visible in the Node view, the layer has a reference to this parameter enabling you to easily edit the value when working in the Timeline view.

Deformation Root Node

The Deformation-Root is used when creating manual legacy multi-pose rigs. It can be placed at the start of the deformation chains. This node is no longer used for the current multi-pose rig structure.

You can modify the quality level of the Deformation effect in the Deformation-Root Layer Properties window:

Properties

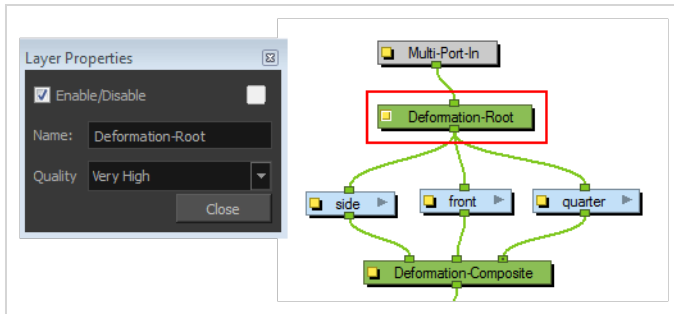

Parameter	Description
Enable/Disable	Allows you to enable or disable the node. When disabled, a node has no visible effect on the rendered image, nor on the preview in the Camera, Perspective, Side and Top views.
Colour Swatch	Sets the colour of the layer in the Timeline view and of the node in the Node view.
Name	Use this field to rename the node.
Quality	<p>Defines the number of slices the graphic is split into and used when undergoing a deformation. The higher the quality level, the more slices are created and the smoother the deformation applied to the graphic. There are five levels of quality:</p> <ul style="list-style-type: none"> • Low • Medium • High • Very High (default value) • Extreme

Deformation Scale Node

The deformers can only be scaled along the centre axis to adjust the length of the limb. The Deformation-Scale can be used in combination with a Bone or Curve deformer to scale a drawing so it follows the opposite direction of the deformer axis (the width). For example, when combined with function curves this can be used to create advanced muscle effects. All these settings can be animated over time.

How to set up the Deformation-Scale effect node

1. In the Node view, navigate to the node to which you want to add a Deformation-Scale effect.
2. In the Node Library view, select a Deformation-Scale node and drag it to the Node view.
3. Connect the Deformation-Scale node directly under the lower deformer node of your chain.

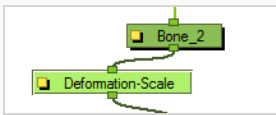

4. In the Node view, select the Deformation-Scale node and select **View > Show > Control** to display its controls in the Camera view.

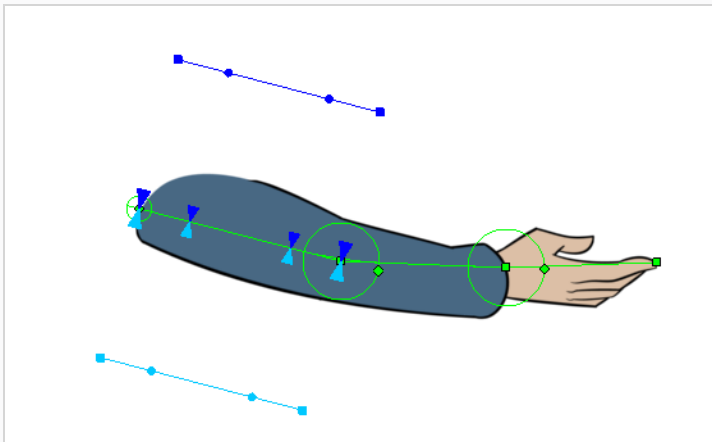

TIP

You can animate the different parameters of the Deformation-Scale node. To do this, make sure the Animate mode is set to  Animate Current Frame in the Tools toolbar before you manipulate it.



NOTE

If the controls are too far away from the deformer, you can change the default display of the Deformation-Scale and Deformation-Uniform-Scale controls in the Preferences dialog box to bring them closer.

5. Click on the square yellow button of the Deformation-Scale node to open the Layer Properties window.

Properties

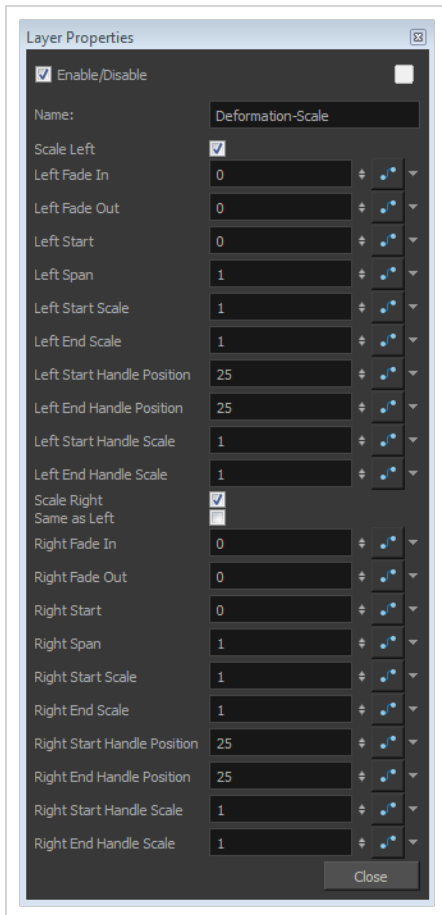

Parameter	Description
Enable/Disable	Allows you to enable or disable the node. When disabled, a node has no visible effect on the rendered image, nor on the preview in the Camera, Perspective, Side and Top views.
Colour Swatch	Sets the colour of the layer in the Timeline view and of the node in the Node view.

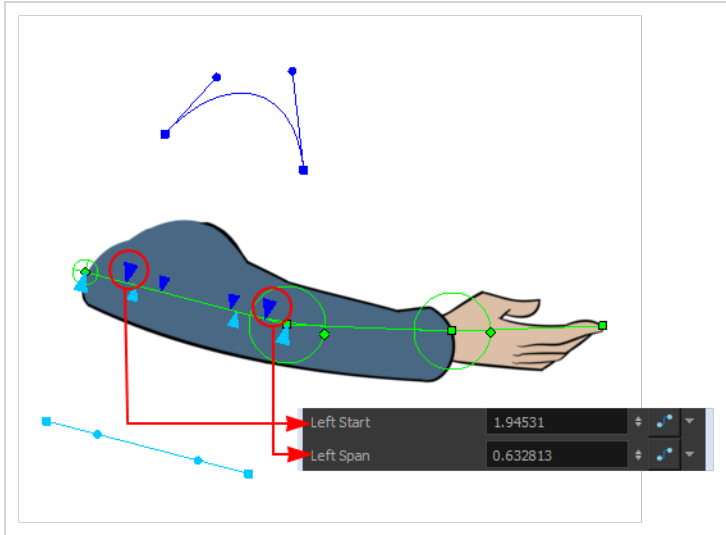
Name	Use this field to rename the node.
This series of options controls the left scaling deformation.	
Scale Left	This option is enabled by default. It allows the left side of the deformer to be scaled. In the Camera view, the dark blue controls are used for the left side. If you disable this option, the controls will be hidden and no scaling deformation will occur for this side.
Left Fade In	The value is set to 0 (no fade) by default. Increase the value to add a fade effect to smooth the transition between the starting point of the scale and the area before it.
Left Fade Out	The value is set to 0 (no fade) by default. Increase the value to add a fade effect to smooth the transition between the Left Span point of the scale and the area after it.
Left Start	<p>Defines the starting point of the left scale deformation. The default value is 0 and represents the Deformation-Root. Each main control point count for +1.</p> <p>Move the first blue arrow along the deformer's central axis to set the starting point of the Deformation-Scale and the last arrow to set the length (span) of the transformation.</p>  <p>The diagram shows a 3D model of a left arm with a deformer. A central axis is highlighted in green. Blue arrows point to control points along this axis. A red line indicates the 'Left Start' and 'Left Span' parameters. A UI panel at the bottom right shows the values: Left Start: 1.94531 and Left Span: 0.632813.</p>
Left Span	Defines the length of the left scale effect.
Left Start Scale	<p>Defines the start of the left scale effect.</p> <p>Drag the square scaling curve control points away and forward from the deformer axis to set the scaling value at the starting and ending point.</p>

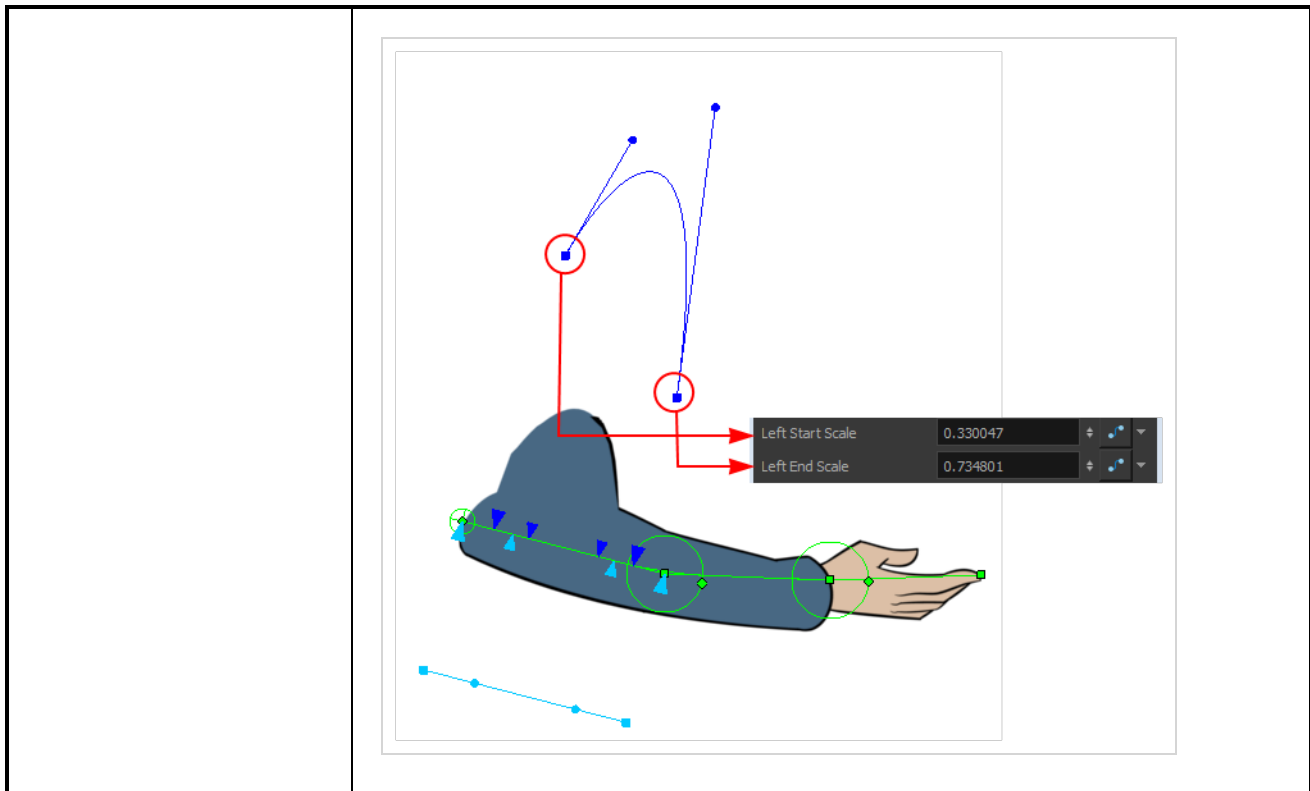

Left End Scale

Defines the end of the left scale effect.

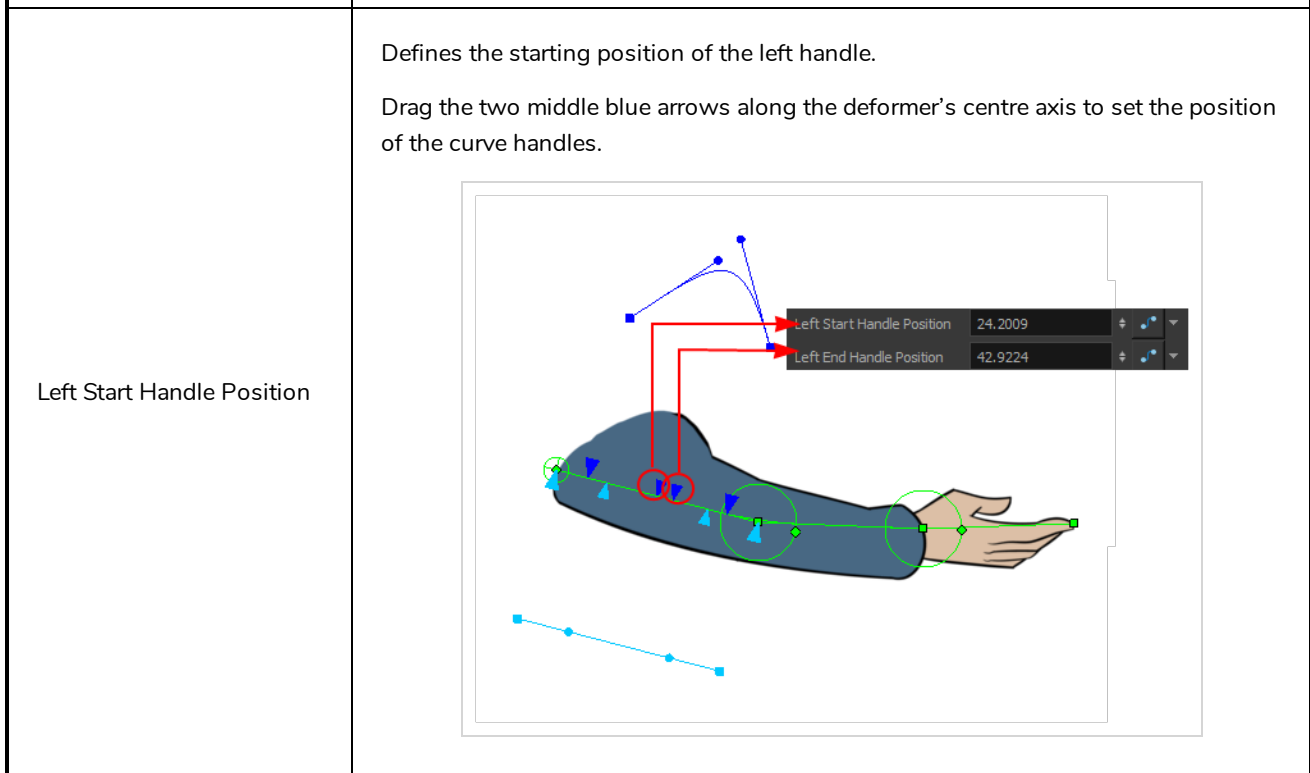

Left Start Handle Position

Left End Handle Position

Defines the ending position of the left handle.

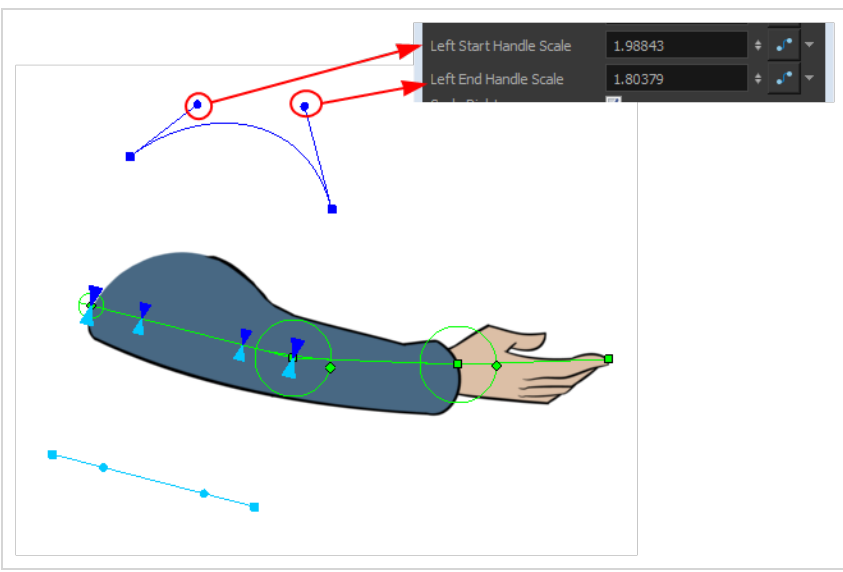
Left Start Handle Scale	<p>Defines the starting position of the left scale handle.</p> <p>To modify the scaling value of the curve, drag the two control handles away and forward from the deformation axis.</p> 
Left End Handle Scale	Defines the ending position of the left scale handle.
Scale Right	This option is enabled by default. It allows the right side of the deformer to be scaled. In the Camera view, the light blue controls are used for the right side. If you disable this option, the controls will be hidden and no scaling deformation will occur for this side.
Same as Left	This option is disabled by default. It means that the left and right sides will use different scaling parameters. If you enable this option, the right side controls will be hidden in the Camera view and the left parameters will be used for both side for a symmetrical scaling effect.
The right side parameters are a mirror of the left side parameters	

Deformation Switch Node

The Deformation-Switch (Legacy) node acts as a on and off switch for the deformation chain. It is used when building legacy multi-pose rigs. It is also the node which controls the Region of Influence Fade area. The Deformation-Switch also displays a Kinematic Chain Selection Reference option, which allows you to modify the chain selection directly in the Timeline view.

The Deformation-Switch has been replaced with the Transformation-Switch node.

Properties

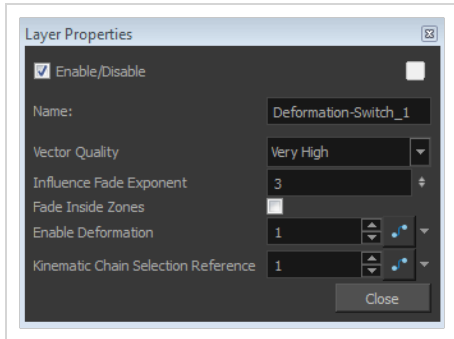

Parameter	Description
Enable/Disable	Allows you to enable or disable the node. When disabled, a node has no visible effect on the rendered image, nor on the preview in the Camera, Perspective, Side and Top views.
Colour Swatch	Sets the colour of the layer in the Timeline view and of the node in the Node view.
Name	Use this field to rename the node.
Vector Quality	Defines the quality of the deformation effect when your drawings are stretched and deformed. There are five levels of quality: <ul style="list-style-type: none"> • Low • Medium • High • Very High (default value) • Extreme
Influence Fade Exponent	A value of 1 is similar to a linear curve. A higher value will result in an ease-in type of curve. A lower value will result in an ease-out type of curve.

Fade Inside Region	This option is disabled by default. The fade effect will occur outside the zone of influence. Enable this option to have the fade effect inside the Zone of Influence.
Enable Deformation	Acts as an on/off switch for the deformation. The value of this field is set to 1 by default, which means the deformation is enabled. Enter a value of 0 to disable it.
Kinematic Chain Selection Reference	Determines which chain is selected and used at a specific frame. It is a reference to the option in the Deformation-Composite node. Having this reference in the Deformation-Switch node allows you to use and modify the chain selection value directly in the Timeline view since the Deformation-Composite node is only visible in the Node view.

Deformation Uniform Scale Node

The Deformation-Uniform-Scale effect node let you create the squash and stretch effect on your animated deformation rig. You can scale the rigged element on the opposite axis of the deformer (width).

How to use the Deformation-Uniform-Scale node

1. In the Node view, navigate to the deformation node to which you want to add a Deformation-Uniform-Scale node.
2. In the Node Library view, select the Deformation-Uniform-Scale node and drag it to the Node view.
3. Connect the Deformation-Uniform-Scale node directly below the lowest deformation node in your chain.

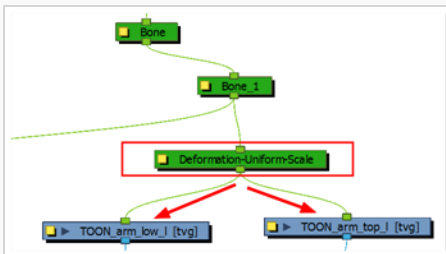

4. Connect the Deform-Uniform-Scale node to all the drawing nodes it should scale.
5. In the Node view, select the Deformation-Uniform-Scale node.
6. Display the Uniform Scale controls in the Camera view by pressing Shift + F11.
7. In the Camera view, drag the handle to resize the width of the limb. You can also use the Scale field to enter a specific value. These parameters can be animated over time.

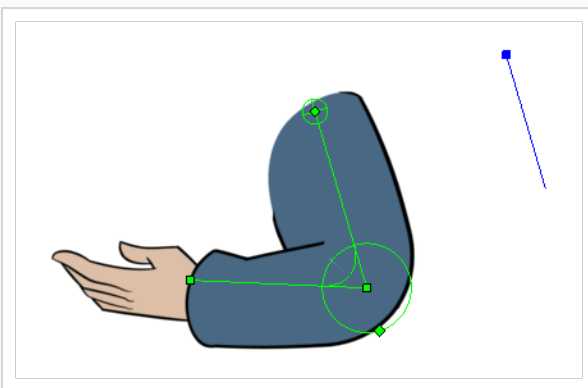

**NOTE**

If the controls are too far away from the deformer, you can change the default display of the Deformation-Scale and Deformation-Uniform-Scale controls in the Preferences dialog box to bring them closer.

Properties

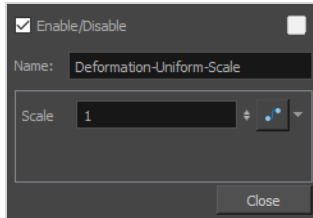

Parameter	Description
Enable/Disable	Allows you to enable or disable the node. When disabled, a node has no visible effect on the rendered image, nor on the preview in the Camera, Perspective, Side and Top views.
Colour Swatch	Sets the colour of the layer in the Timeline view and of the node in the Node view.
Name	The name of the node as it appears in the Node View and the Timeline view. Each node must have a name that is unique to its containing group.
Scale	Use this field to type in the value to resize the width of the limb.

Deformation Wave Node

The Deformation-Wave effect deforms the chain by adjusting the scaling in a waveform style. It can be used to animate a wave deformation effect on your deformation chain over a period of time.

How to use the Deformation-Wave effect

1. In the Node view, navigate inside the Deformation node to which you want to add a Deformation-Wave effect.
2. In the Node Library view, select an Deformation-Wave node and drag it to the Node view.
3. Connect the Deformation-Wave node to your deformation chain.

A wave deformation is applied to the limb or art connected to the deformation chain.

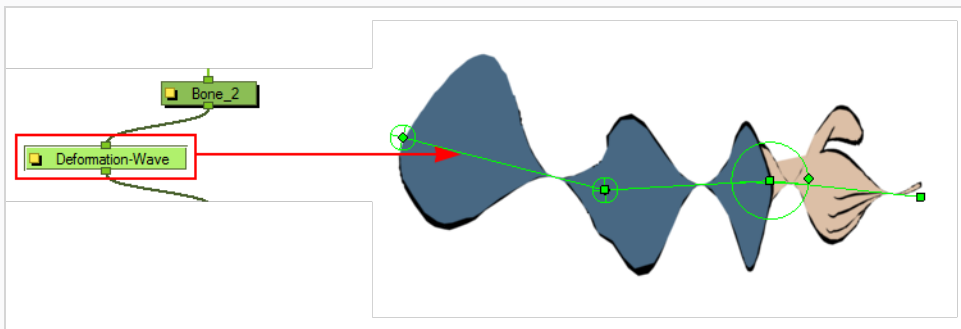

4. In the Node view, open the Layer Properties window of the Deformation-Wave node.

Properties

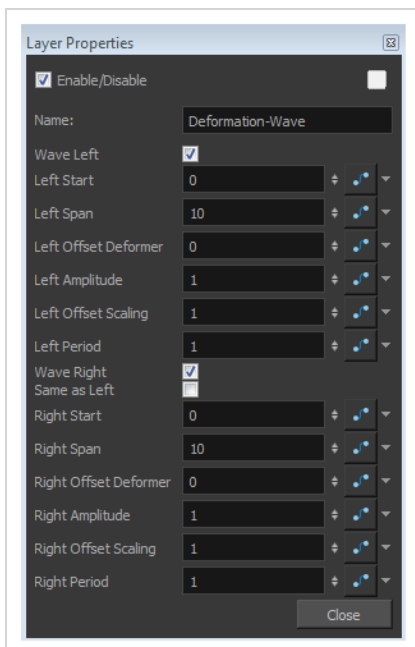

Parameter	Description
Enable/Disable	Allows you to enable or disable the node. When disabled, a node has no visible effect on the rendered image, nor on the preview in the Camera, Perspective, Side and Top views.
Colour Swatch	Sets the colour of the layer in the Timeline view and of the node in the Node view.
Name	Use this field to rename the node.
Wave Left	This option is enabled by default, allowing the Deformation-Wave effect to be applied on the left side of the deformer chain. Disable this option to prevent the effect from being applied.
Left Start	Defines the length of the left wave effect.
Left Span	Defines the starting point of the left wave deformation. The default value is 0 and represents the root point. Each main control point count for +1.
Left Offset Deformer	This is the parameter you may want to connect to a function. It controls the offset of the deformation on the left side and allows you to create a fluid wave animation along the deformer axis.
Left Amplitude	Controls the height of the left wave effect.
Left Offset Scaling	Used to apply an offset value to the amplitude of the left wave. The wave will be lifted and become higher, or dropped and become lower, depending whether the value is increased or decreased.
Left Period	Controls the interval of occurrence of the left waves. By default the value is 1, meaning that a wave will occur for every deformer. If you decrease the value to 0.5, it will result in a wave occurring every half deformer.
Wave Right	By default this option is enabled, allowing the Deformation-Wave effect to be applied on the right side of the deformer chain. Disable this option to prevent the effect from being applied.
Same as Left	This option is disabled by default. It allows the left and right size of the Deformation-Wave to be controlled separately. Select this option if you want the effect to be symmetrical and controlled by the left side parameters.

Right Start	Defines the starting point of the right wave deformation. The default value is 0 and represents the Deformation-Root. Each main control point count for +1.
Right Span	Defines the length of the right wave effect.
Right Offset Deformer	This is the parameter you might want to connect to a function. It controls the offset of the deformation on the right side, allowing you to create a fluid wave animation along the deformer axis.
Right Amplitude	Controls the height of the right wave effect.
Right Offset Scaling	Used to apply an offset value to the amplitude of the right wave. The wave will be lifted and become higher, or dropped and become lower, depending whether the value is increased or decreased.
Right Period	Controls the interval of occurrence of the right side waves. By default the value is 1, meaning that a wave will occur for every deformer. If you decrease the value at 0.5 it will result in a wave occurring every half deformer.

Fold Node

The Fold effect is used when bending a deformation further than the drawing is able to take it. This may result in an unwanted overlap of the line art at the junction of the articulation or deformation. The Fold effect lets you control certain parameters that will help eliminate the unwanted line effect. You can also avoid this issue by separating your drawing onto two layers or separating your drawing in two pieces using the Cutter tool and repasting it in place in the same drawing.

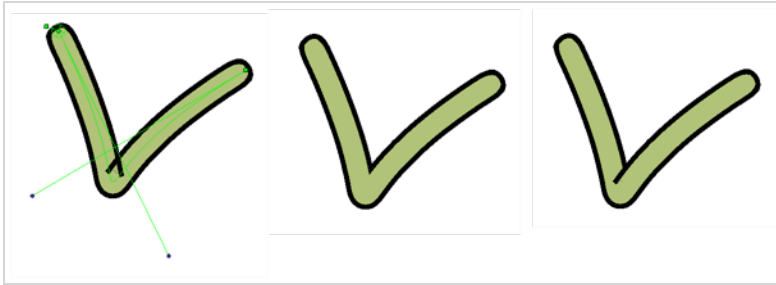

The Fold effect works best with the Curve deformers.

How to set up the Fold node

1. In the Node view, navigate to the Deformation node causing the unwanted overlap (in this case, an articulation).
2. In the Node Library view, select the **Fold** node and drag it to the Node view.
3. Connect the Deformation-Fold node directly under the deformation effect node which is causing the unwanted line effect.

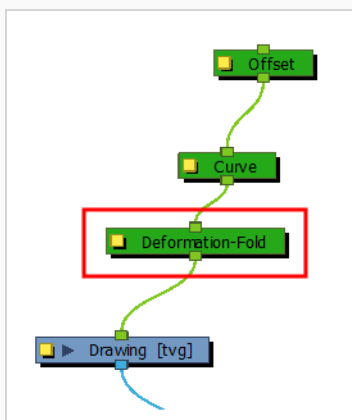

4. In the Node view, select the **Deformation-Fold** node.
5. From the top menu, select **View > Show > Control** or press Shift + F11 (Windows/Linux) or ⌘ + F11 (macOS) to display its controls in the Camera view.
6. In the Tools toolbar, select the Transform  tool.

7. In the Camera view, set up the Deformation-Fold. You can also set these parameters directly in the Deformation-Fold properties:

- ▶ Click on the fold axis and rotate it to match the angle of the bend articulation.

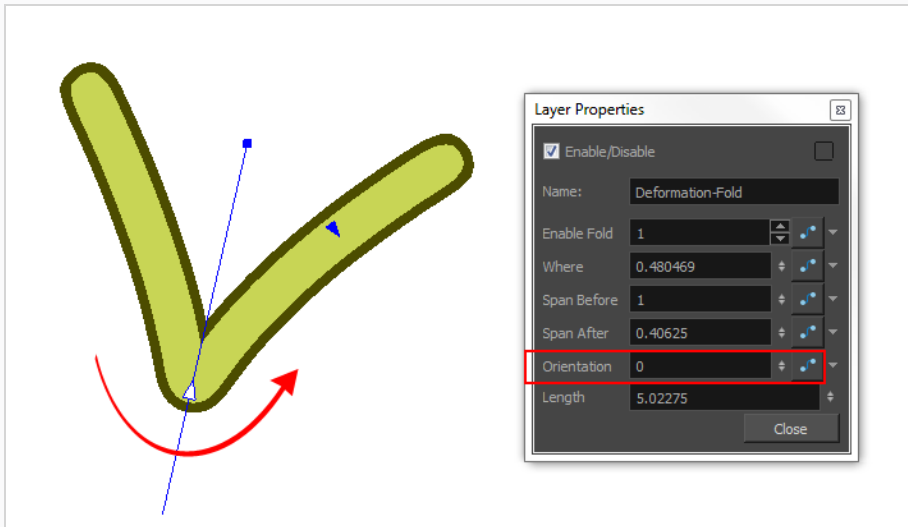

- ▶ Use the middle arrow to position the axis along the deformer's central line. It should be in the corner of the bending area.

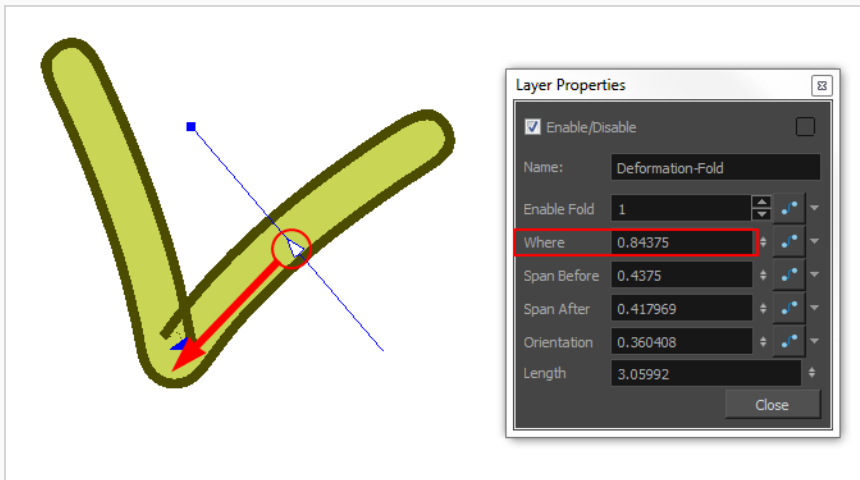

- ▶ Use the right and left arrows to control the appearance of the two overlapping lines.

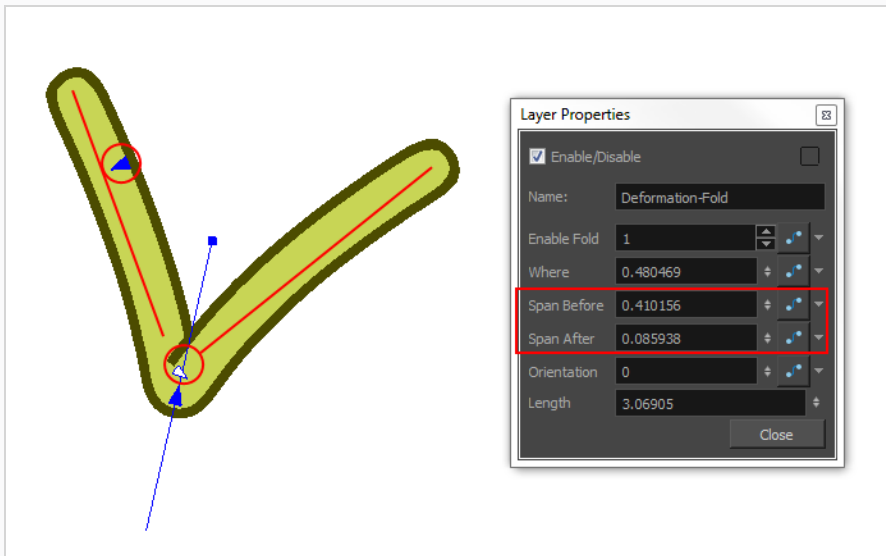

- ▶ Use the axis's square handle to lengthen or shorten the axis.

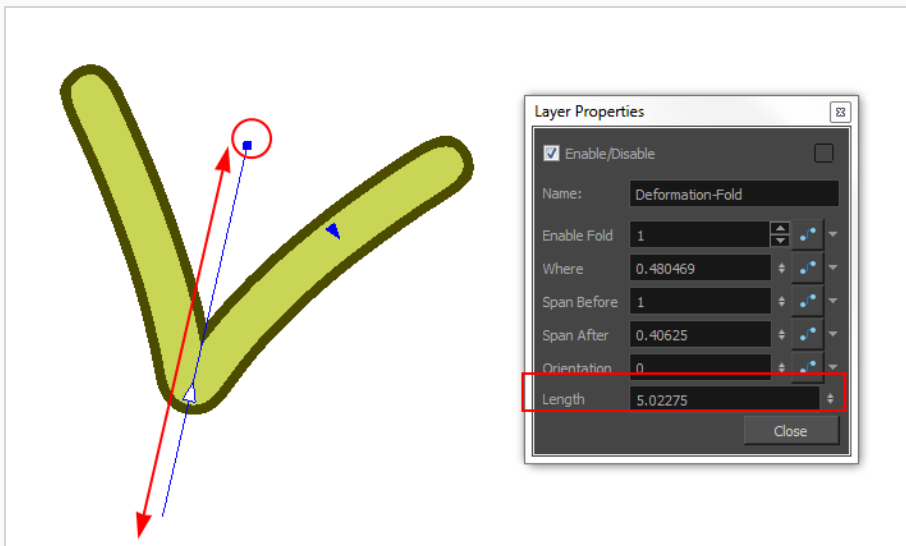

- If your character moves a lot and you need to adjust the fold at different positions to follow the limb animation, you can set up the Deformation-Fold node in a different position over time. To be able to do this, make sure that the Animate mode is set to  **Animate Current Frame** in the Tools toolbar.
- You can also enable/disable the Deformation-Fold node over time by connecting a function to the Enable Fold parameter in the Layer Properties. A value of 1 enables the effect, a value of 0 disables the effect.

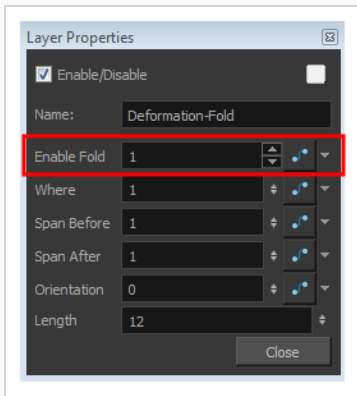

Game Bone Node

The Bone node is one of the main node used to build a deformation rig. Each Bone node consists of a bone and an articulation. Chaining Bone nodes will create a skeleton chain for your character. The Rigging tool can be used to create and connect those nodes automatically.

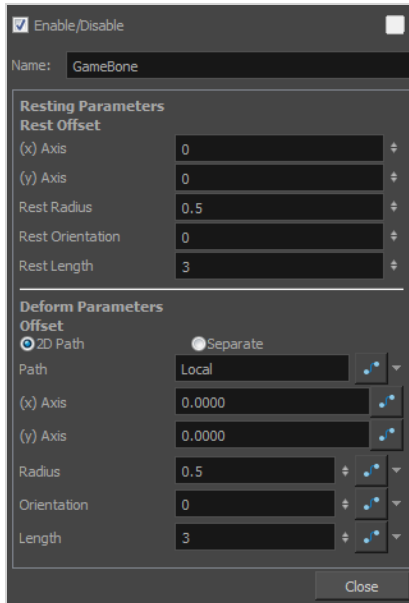

Parameter	Descriptions
Resting Parameters Rest Offset	
(x) Axis	This is the bone X-axis (horizontal) coordinates for the resting position.
(y) Axis	This is the bone Y-axis (vertical) coordinates for the resting position.
Rest Radius	This is the articulation's radius value (articulation size) for the resting position.
Rest Orientation	This is the bone's orientation angle for the resting position.
Rest Length	This is the bone's length for the resting position.
Deform Parameters Offset	
2D Path	When this option is enabled, the X and Y axis parameters are controlled by the same 2D path function.

Separate	When this option is enabled, the X and Y axis parameters are individual from each other.
Path	When using a 2D Path, this field displays the name of the function curve.
(x) Axis	This is the bone X-axis (horizontal) coordinates for the animation position. This parameter can be linked to a function curve to be animated over time.
(y) Axis	This is the bone Y-axis (vertical) coordinates for the animation position. This parameter can be linked to a function curve to be animated over time.
Radius	This is the articulation's radius value (articulation size) for the animation position. This parameter can be linked to a function curve to be animated over time.
Orientation	This is the bone's orientation angle for the animation position. This parameter can be linked to a function curve to be animated over time.
Length	This is the bone's length for the animation position. This parameter can be linked to a function curve to be animated over time.

Glue Node



The Glue effect lets you repair the cracks that appear between joints during animation.

The Glue node has three ports:

- **Left Port (Matte):** Receives the matte.
- **Middle Port (Port A):** Receives the element that will not be used to fill the joint.
- **Right Port (Port B):** Receives the element that will be used to fill the joint.

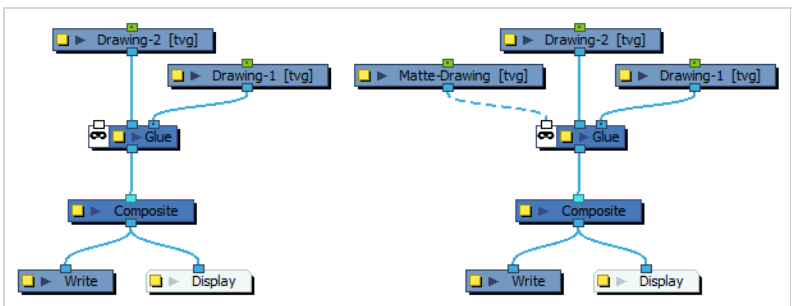

For most effects with the Glue node, the default options are sufficient. However, you can modify these options using the Glue editor.

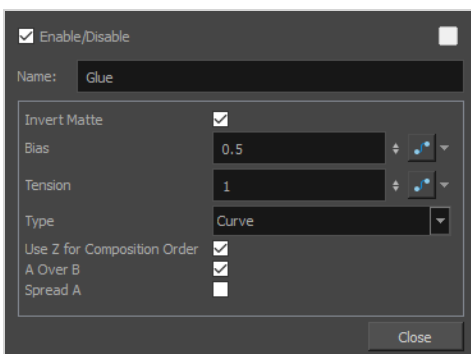

Glue Properties

Parameter	Description
Invert Matte	Activate this option to invert the matte used to fill the joint. If you want to use the

Parameter	Description
	"B" element as the matte, you must select this element.
Bias	Indicates the tendency to favour the static or moving element. Set to 0, it favours element A; set to 1 it favours element B; set to 0.5 it is in between A and B.
Tension	Indicates how tight the joint will be. Set to 1, the tension has no effect; set less than 1, the tension decreases; set greater than 1, the tension increases.
Type	From this menu, select the type of joint to create. You can choose from among Curve (default), Line and Corner.
Use Z for Composition Order	You can use this option to choose the drawing with the higher front-back value to create the joint.
A Over B	Indicates which image is rendered on top in the final image. By default, A is rendered on top of B, which indicates that the image in the middle port (A) is rendered on top of the image in the right port (B).
Spread A	By default, the image in port B is spread to fill the joint. You can use this option to choose the image in the A port to create the joint. If you select this option, the drawing node must receive position information from the "B" element. Thus, you must connect the Drawing node of the "B" element to the Drawing node of the matte.

Kinematic Output Node

The Kinematic Output node lets you hook a separate element that you want to be linked to the deformation chain but not be part of the deformation, such as a hand to an arm or an arm to the body. These elements will follow the movement of the chain just like a regular cut-out character hierarchy piece without being influenced by the deformation of the arm. If you don't use the Kinematic Output, the piece's pivot will not follow the deformation.

Connect a Kinematic Output node below the deformation node you want your drawing to follow.

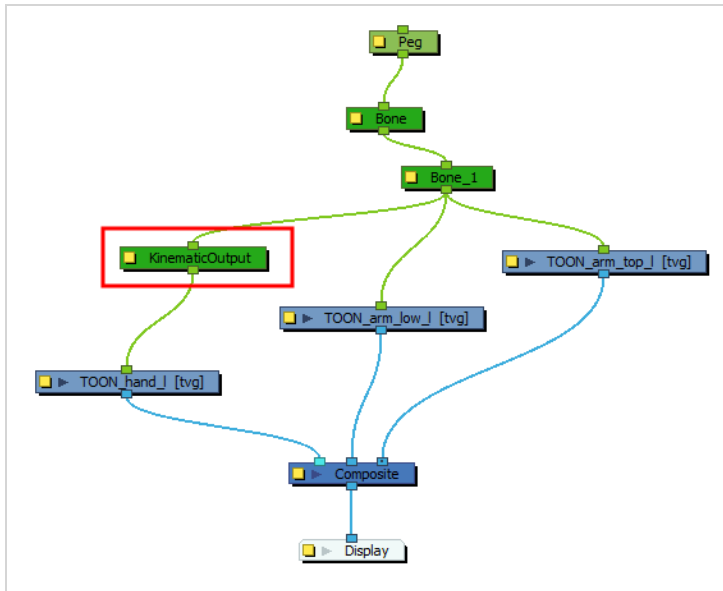

NOTE

The Kinematic Output node can only rig a drawing to a deformation point. To rig a drawing to a specific position in a deformation chain, see [Point Kinematic Output Node on page 545](#).

Mesh Warp Node

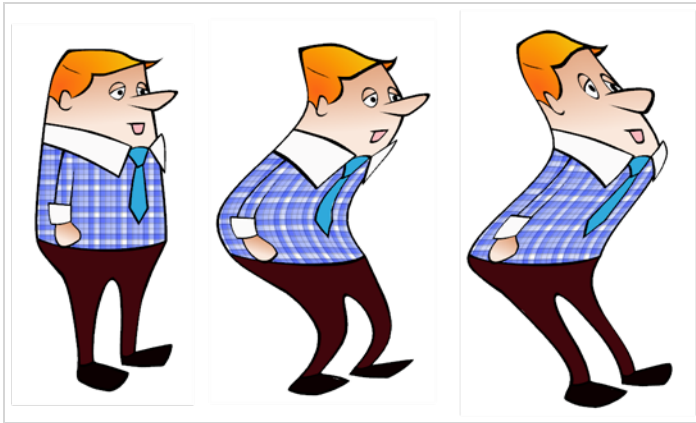

Use the Mesh Warp effect to distort your drawings. With this node you can create effects such as a character in a warped mirror and looking through a glass jar. You can also animate the position of the grid to perform the distortion over time.

The Mesh Warp node is a position node, same as a Peg node.

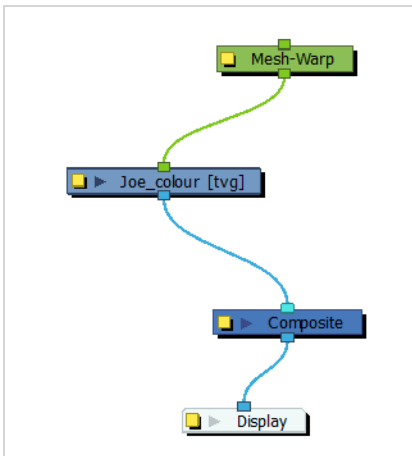

How to use the Mesh Warp Effect

1. In the Node Library, under the Filter tab, select the Mesh Warp node and drag it to the Node view.
2. In the Node view, connect the Mesh-Warp node to your drawing or group nodes to deform.

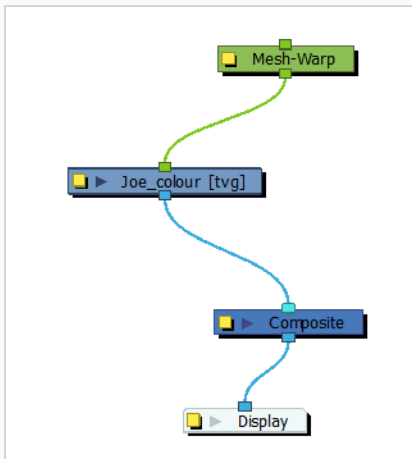

3. In the Node view, select the Mesh Warp node.
4. Select **View > Show > Control** or press Shift + F11 (Windows/Linux) or ⌘ + F11 (macOS) to display the deformation grid.

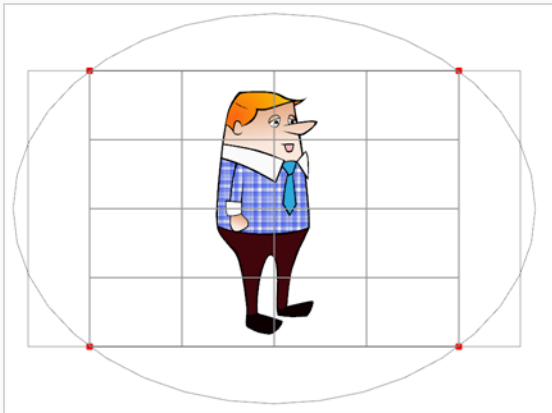

5. Move the intersection points and move the Bezier handles to deform the grid.

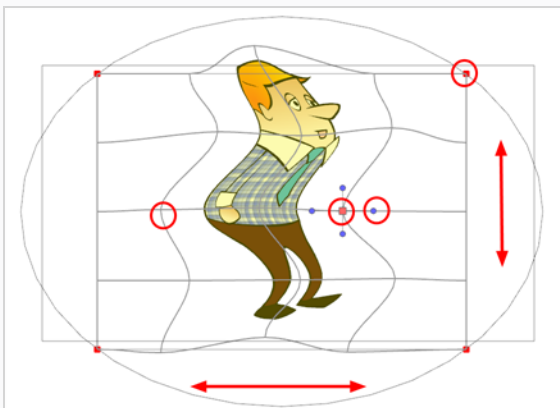

6. Grab the grid in the void spaces to pan it around. Using keyframes, you can animate its position over time.

Mesh Warp Properties

Use the Mesh Warp editor to adjust the grid size, deformation quality and the region of interest.

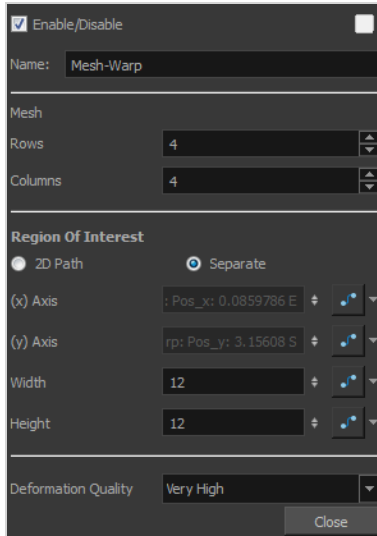

Parameter	Description
Rows	Increase or decrease the Rows value to change the amount of rows to use in the deformation grid.
Columns	Increase or decrease the Columns value to change the amount of columns to use in the deformation grid.
Region of Interest	Select the 2D Path option if you want both your X and Y curves to be controlled by the same velocity function. Select the Separate option if you want your X and Y curves to be independent and have independent velocity.
(x) Axis	This is the X position of the grid. This value can be animated overtime to move the grid horizontally.
(y) Axis	This is the Y position of the grid. This value can be animated overtime to move the grid vertically.
Width	This is the width value of the grid. This value can be animated overtime to squash or stretch the grid horizontally.
Height	This is the height value of the grid. This value can be animated overtime to squash or stretch the grid vertically.

Deformation Quality	This is the quality of the warm deformation. It ranges from Low to Extreme. The higher the quality, the better the formation will look, but the longer it will take to render.
---------------------	--

Offset Node

The Offset node lets you position the root of your deformation chain. It is automatically added to your deformation rig when you create a Curve or Envelope deformation rig using the Rigging  tool.

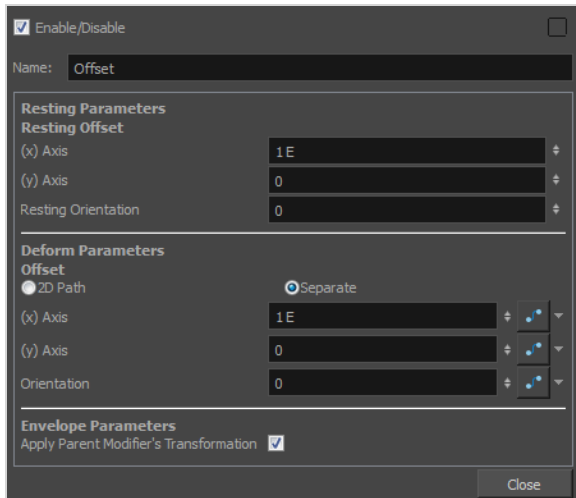

Parameter	Description
Name	Use this field to rename the node.
(x) Axis	Sets the resting position on the X (east/west) axis.
(y) Axis	Sets the resting position on the Y (north/south) axis.
Resting Orientation	Sets the rotation angle of the resting position.
Offset Type	Lets you choose the type of coordinates to use: Separate: The two coordinates are set separately. If they are connected to a function, each one will have its own function curve. This is the default setting. 2DPath: The two coordinates are set together within a single 2D path function.
(x) Axis (y) Axis	This option is only available when the Type is set to Separate. It is used to set the active position value of the Deformation-Root on the X (east/west) and Y (north/south) axis. You can enter the value, use the up and down arrow buttons to choose a value, or use the Transform tool, when Setup mode is NOT enabled, to move the deformation chain. Remember, that if you want to add a keyframe, you need to enable Animation mode from the Tools toolbar.

Path	<p>This option is only available when the Type is set to 2D Path. It is used to set the active position value of both the Y and X axis. Use the Transform tool when Setup mode is NOT enabled to move the deformation chain along the 2D path. Remember, if you want to add a keyframe, you need to enable the Animation mode on the Tools toolbar.</p>
Orientation	<p>Sets the rotation angle of the active position of the Deformation-Root. You can enter the angle, use the up and down arrow buttons to choose the desired value, or use the Transform tool when Setup mode is NOT enabled to rotate the deformation chain. Remember, if you want to add a keyframe, you need to enable Animation mode on the Tools toolbar.</p>
Apply Parent Modifier's Transformation	<p>When this option is disabled, the parent's deformations no longer affect the current deformer.</p>

Point Kinematic Output Node

The Point Kinematic Output node is a more advanced version of the Kinematic Output node. It tracks a point that can be placed anywhere on a deformation curve, and moves the drawing that is attached to it so that it remains stuck on that deformation curve, without deforming the drawing itself.

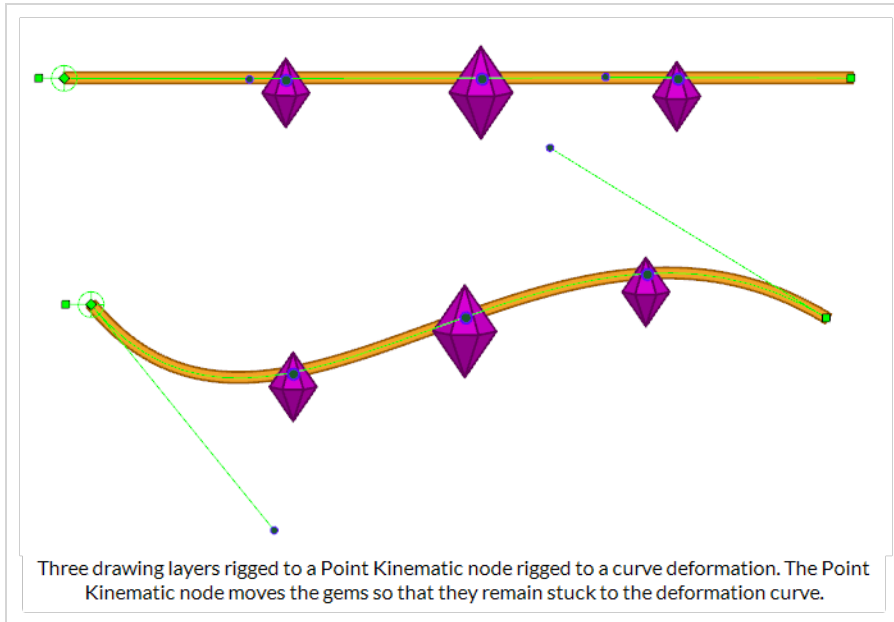

Additionally, it can:

- Make the angle of the drawing match the angle of the curve at the point where it's rigged.
- Scale the drawing to make it match the size of the area of the curve the drawing is rigged to.
- Rig the drawing to three points in the deformed drawing, which can be useful for rigging a drawing somewhere inside the deformed drawing without necessarily making it stick to the curve.



NOTE

A similar, simpler node, the Kinematic Output node, can be used to rig the position and angle of a drawing to a deformation point without any configuration. For more information, see [Kinematic Output Node](#)

Connections

The Point Kinematic Output has a deformation input port (rightmost) and an offset transformation port (leftmost). It takes the deformation sent to its rightmost port and outputs a transformation, without any deformation, through its only output port. If no deformation is attached to the node, the node will have no effect in the rig.

When no node is connected to the offset transformation port, the positions that the node tracks within the deformation will be based on the tracking positions in the node's properties. This is the most simple usage scenario.

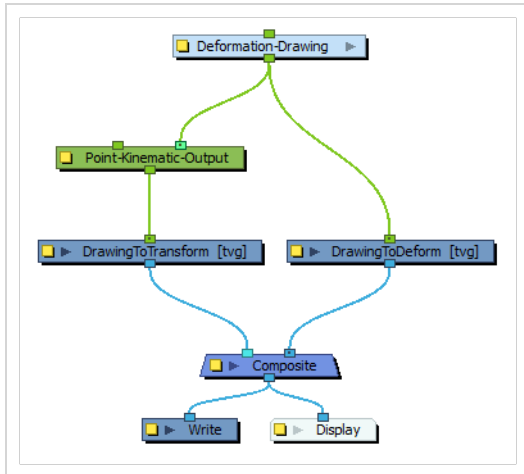

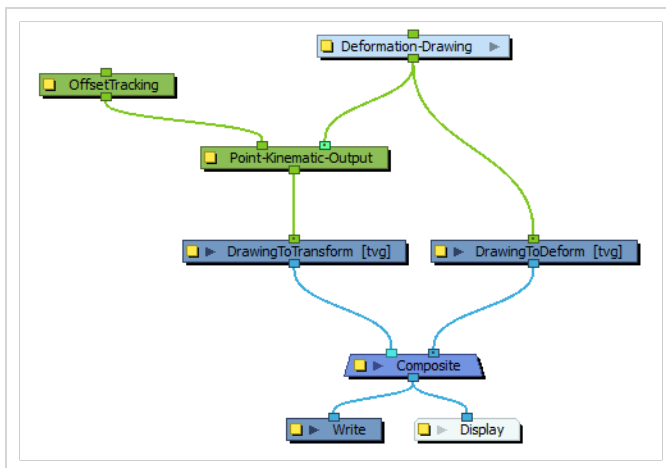

When a transformation module, such as a peg, is attached to the leftmost port, the tracking points will be offset based on the attached transformation to the port.



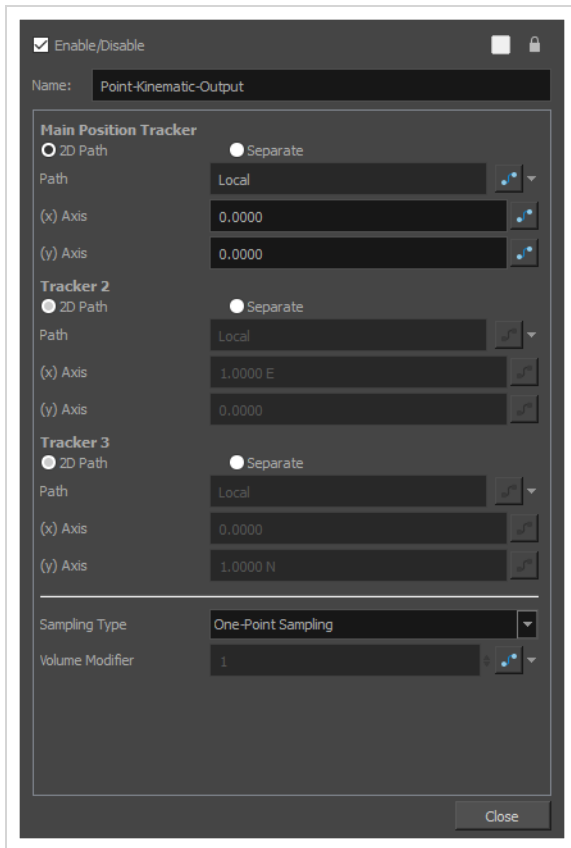

The leftmost port can then be used to offset the tracking points in a rig based on the transformation of other attached nodes in that rig.

Layer Properties

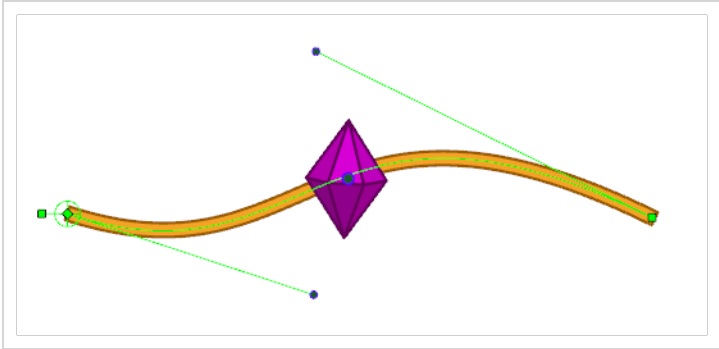
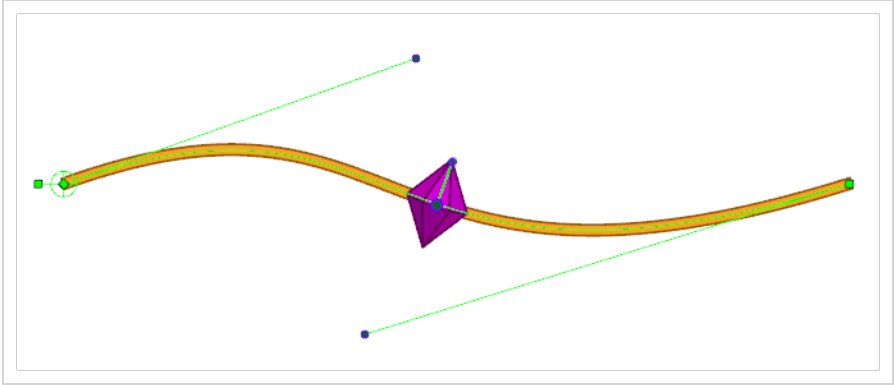

Parameter	Description
Main Position Tracker	<p>The position of the central point used in all sampling types.</p> <p>In One-Point Sampling, this point is used to track the translation in the deformation. In the other sampling-types, it is used to help define the transformation with the other relative points.</p> <div data-bbox="362 1381 1429 1801" style="border: 1px solid #add8e6; padding: 10px;"> <p> TIP</p> <p>You can display this point in the Camera view and manipulate it with the Transform tool by displaying the node's controls. To do this, select the node in the Node View and do one of the following:</p> <ul style="list-style-type: none"> • In the Camera view toolbar, click on  Show Control . • From the top menu, select View > Show > Control. • Press Shift + F11. <p>If you set the Sampling Type to use two or three points, you can also see and manipulate the other points in the Camera view.</p> </div>
Tracker 2	<p>The second sampling point is used in Two-Point Sampling, Two-Point Sampling with Scaling and</p>

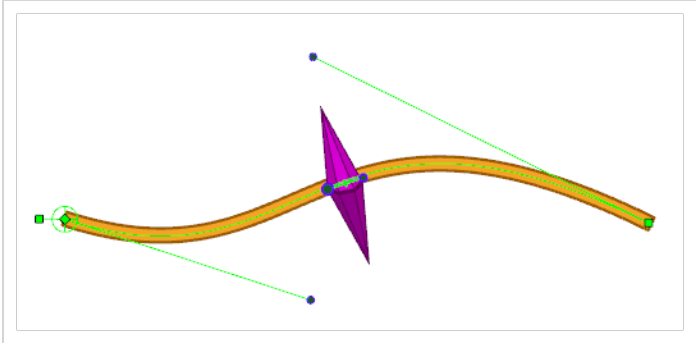
Parameter	Description
	<p>Three-Point Sampling.</p> <p>This point is used to help define the orientation in Two-Point Sampling, It helps to define the orientation and scale in Two-Point with Scale sampling, and helps to define the orientation, scale and skew in Three-Point Sampling.</p>
Tracker 3	<p>The third sampling point is used in Three-Point Sampling. It helps to define the orientation, scale and skew of the resulting transformation.</p>
Sampling Type	<p>The Sampling Type defines the number of points that track the deformation and which are then used to transform the attached drawing, as well as how those points are used to transform the drawing.</p> <ul style="list-style-type: none"> <p>One-Point Sampling: A single point, the Main Position Tracker, follows the deformation curve. It is used to translate drawing so that it remains on the deformation curve, but the drawing is not rotated or scaled.</p>  <p>Two-Point Sampling: Uses two points, the Main Position Tracker and Tracker 2, to track the deformation curve. The two points follow the position and angle of the curve. As a result, the attached drawing is translated to follow the deformation curve and rotated to match its angle.</p>  <p>Two-Point Sampling with Scale: Uses two points, the Main Position Tracker and Tracker 2, to track the deformation curve. The two points follow the position and angle of the curve, but also, their distance relative to each other changes with the length of the curve.</p>

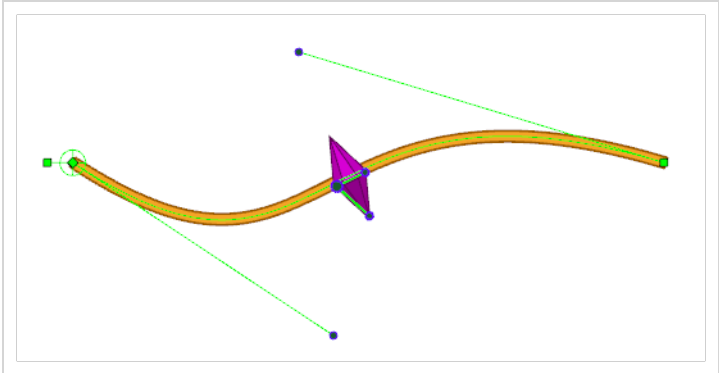
Parameter	Description
	<p>As a result, the attached drawing is translated to follow the deformation curve and rotated to match its angle, but also, the drawing's scale on the axis between the Main Position Tracker and Tracker 2 points will match the distance between those two points. This distance changes as the curve becomes longer or shorter.</p> <p>Additionally, scaling is applied to the drawing on the perpendicular axis so as to preserve the drawing's volume. If the drawing becomes smaller on the axis between the Main Position Tracker and the Tracker 2 points, it will become larger on the perpendicular axis, and if it becomes larger on the axis between the Main Position Tracker and the Tracker 2 points, it will become smaller on the perpendicular axis.</p>  <div data-bbox="440 1020 1430 1297" style="border: 1px solid #0070C0; padding: 10px; margin: 10px 0;"> <p> TIP</p> <p>How much scaling is applied to the perpendicular axis is relative to the Volume Modifier parameter. Setting it to a value between 0 and 1 can prevent the perpendicular scaling from deforming the drawing too much, but it won't preserve the entire volume of the drawing. Setting its value to 0 will make it so no scaling is applied to the perpendicular axis.</p> </div> <ul style="list-style-type: none"> • Three-Point Sampling: Uses all three tracking points, the Main Position Tracker, Tracker 2 and Tracker 3. It will translate, rotate, scale and skew the attached drawing as necessary to make it track all three points. The initial position of all three points will define the regions of the drawing that will be constrained to the deformation. 

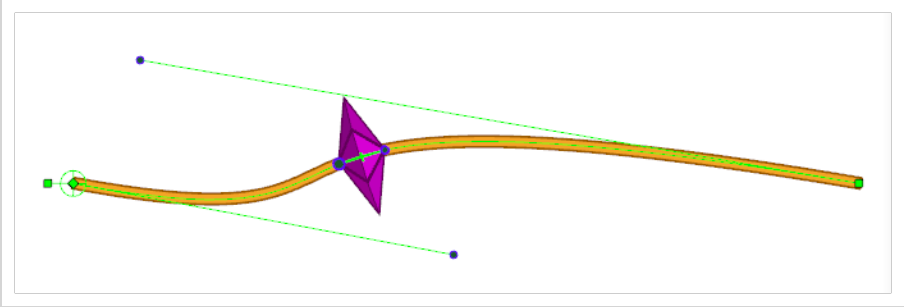
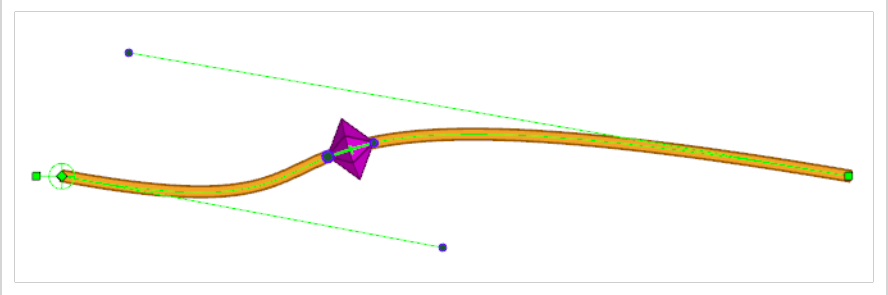
Parameter	Description
	<p>"This mode can be useful when rigging a drawing inside the surface of a deformed drawing. Instead of simply tracking along the deformation curve, it will transform a drawing to best match the tracking points within the deformed surface, such as the inside of an Envelope deformation or a Free Form Deformation.</p>
Volume Modifier	<p>The Volume Modifier is applied only when using the 2-Point with Scale sampling type.</p> <p>With this sampling type, the drawing is scaled on the axis between the Main Position Tracker point and the Tracker 2 point based on the distance between those two points. The distance between those points varies relative to the length of the deformation curve as it is modified. In other words, the drawing is stretched when the curve is made longer, and it is squashed when the curve is made shorter.</p> <p>To preserve the drawing's volume, a scale is also applied on the perpendicular axis. This scale is automatically calculated so that the drawing always keeps the same volume. So as to give you control on this, the scaling applied on the perpendicular axis is proportional to the Volume Modifier parameter.</p> <p>A Volume Modifier set to 1.0 will result in a squash-and-stretch that preserves the volume of the transformation. As the axis defined by the two tracking points is squashed, the perpendicular axis is stretched to preserve the volume. If the axis is stretched, then the perpendicular axis is squashed instead.</p>  <p>A Volume Modifier set to 0.0 will result in a transformation that does not attempt to preserve the volume of the transformation. As the axis defined by the two tracking points is squashed, no scale is applied to the perpendicular axis.</p>  <p>You can set the Volume Modifier parameter to any value between 0 and 1 so as to mitigate the effect of the perpendicular scaling and prevent it from deforming the drawing too much, but any value</p>

Parameter	Description
	lower than 1 means the volume of the drawing will not be fully preserved.

Refract

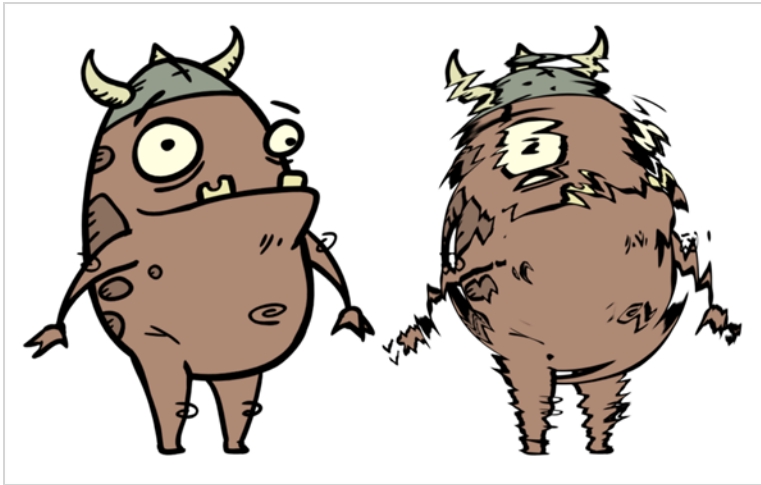

Use the Refract effect to create effects such as ripples and heat haze. This effect is based on the refraction of light, which occurs when a beam of light passes through media of different density, causing the light to refract or change angles. This effect makes objects appear distorted or offset from their actual positions. If you imagine an object in a pool of water the part beneath the surface of the water appears offset from its true position.

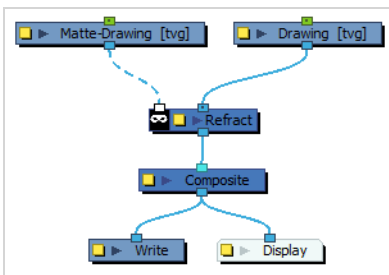

This creates the effect of a volume passing over an image, refracting the light that bounces off the contents below.

The refraction effect uses the matte's alpha values to taper the refractions. Hence, you can create a nice refraction effect with a drawing containing solid strokes if you run it through a Blur-Radial effect to blur its alpha values.

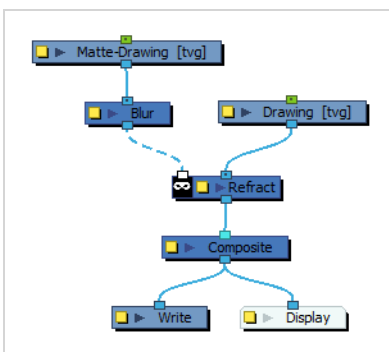

You can make the ripple effect move across the image by hooking the matte drawing to a peg and animating the peg.

Refract Properties

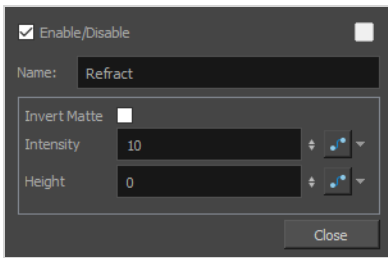

Parameter	Description
Name	Allows you to change the name given to the node.
Invert Matte	Inverts the matte used to generate the effect. By default, the effect is applied to the opaque areas of the matte drawing. When this option is enabled, the effect is applied to the transparent areas of the matte instead.
Intensity	The amount of refraction to apply to the image. You can attach the value to a function curve to change its value over time.
Height	The amount of depth to add to the refraction effect. When coupled with the Intensity effect, this value can create the effect of bending the objects below the refraction matte. You can attach the value to a function curve to change its value over time.

Stick Node

The Stick node is available for compatibility with previous versions of deformation rigs. This node is the legacy Bone node. When the Stick node is imported in the Node view, it is renamed Bone.

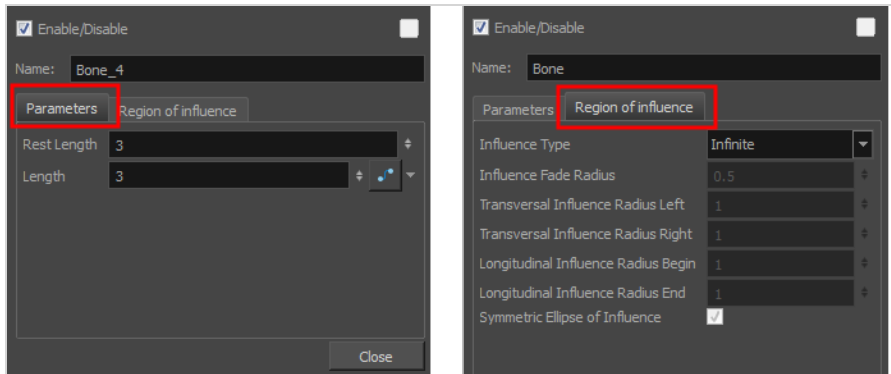

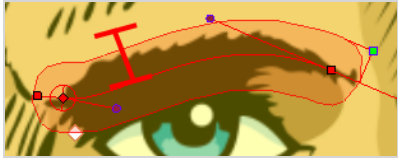
Parameter	Descriptions
Rest Length	This is the bone's length for the resting position.
Length	This is the bone's length for the animation position. This parameter can be linked to a function to be animated over time.
Region of Influence	
Influence Fade Radius	This defines the size of the fade area around the actual region of influence's boundaries.
Transversal Influence Radius Left	When the Symmetric Ellipse of Influence option is enabled, this field controls the Left and Right transversal radius values. When disabled, it controls the size of the left transversal radius. By default, this value is set to 2. 
Transversal Influence Radius Right	When the Symmetric Ellipse of Influence option is enabled, this field becomes inactive. The Left Transversal radius value is automatically applied to the Right Transversal. When the Symmetric Ellipse of Influence option is disabled, it controls the size of the Right Transversal radius. By default, this value is set to 2.

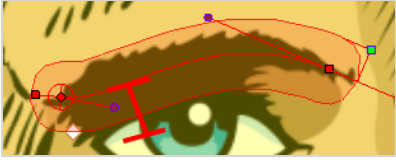
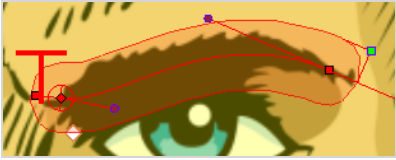
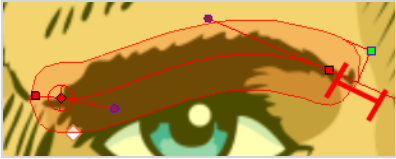
	
<p>Longitudinal Influence Radius Begin</p>	<p>When the Symmetric Ellipse of Influence option is enabled, this field becomes inactive. The End Longitudinal value is automatically applied to the Begin Longitudinal value. When the Symmetric Ellipse of Influence option is disabled, it controls the size of the Begin Longitudinal radius. By default, this value is set to 0.25.</p> 
<p>Longitudinal Influence Radius End</p>	<p>When the Symmetric Ellipse of Influence option is enabled, this field controls both the Begin and End Longitudinal radius values. When this option is disabled, it controls the size of the End Longitudinal radius. By default, this value is set to 0.25.</p> 
<p>Symmetric Ellipse Influence</p>	<p>Enabled by default. The shape of the ellipse will be symmetrical on both the transversal and longitudinal radii. In this case, use the Transversal Influence Radius Left field to set the transversal radius value and use the Longitudinal Influence Radius End field to set the longitudinal radius value. The two other fields will remain unused unless you disable the Symmetric Ellipse Influence option. In that case, you can set up different radius sizes for the four radii directions.</p>

Turbulence Node

The Turbulence effect is a mathematically generated effect that uses fractal noise to create turbulent distortions in an image. You can see the effect when used with an image as the background. You can create flowing water, funhouse mirrors, and waving flags.

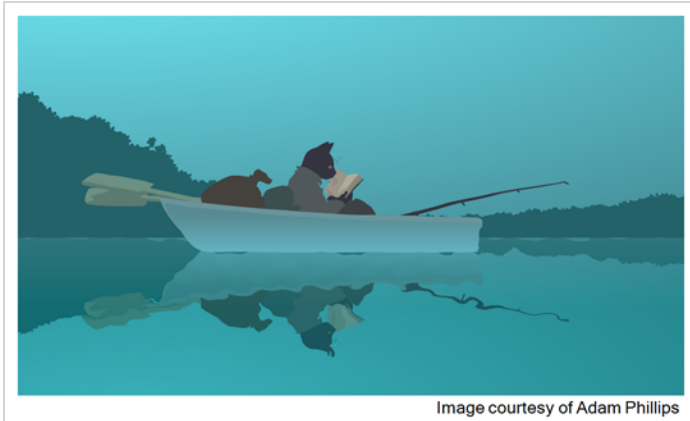

For detailed video tutorials and sample scenes by Adam Phillips, see:

<https://www.toonboom.com/resources/video-tutorials/chapter/adam-phillips-harmony-effects>

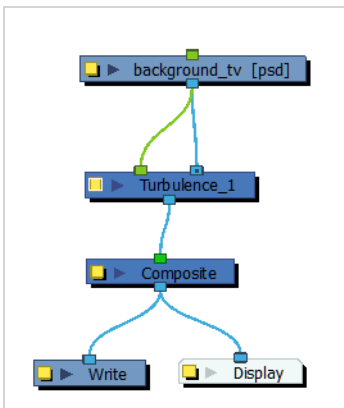

Turbulence Properties

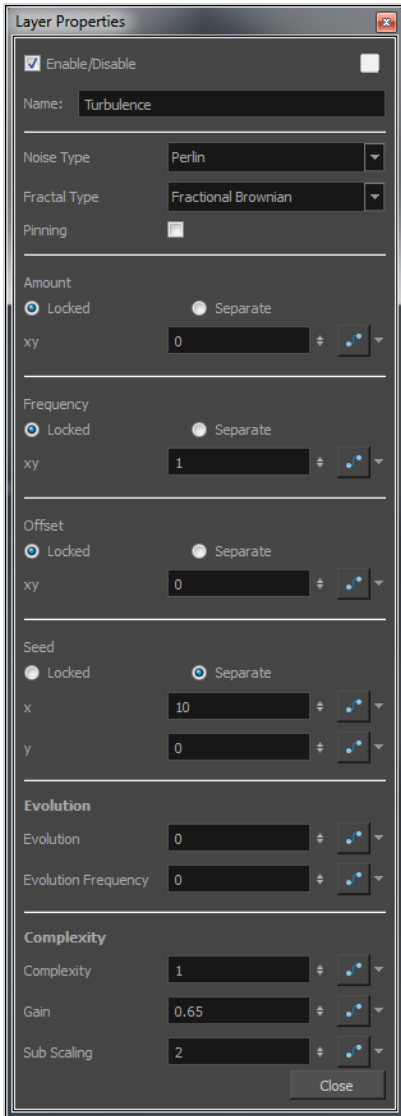

Parameter	Description
Noise Type	<p>The algorithm used to generate the noise:</p> <ul style="list-style-type: none"> • Perlin: Creates pseudo random patterns. The greyscale contains a continuity between different tones of grey. • Simplex: Creates a more contrasted noise pattern with more variation than Perlin. There is a smooth variation of intensity. • Sinusoidal: Creates a repeated wavelike pattern. • Sub Scaling: Applies Perlin noise twice. The second noise is added where dark areas appear in the original. The frequency of the second iteration is higher so the noise is smaller.

	<ul style="list-style-type: none"> • Rocky: Uses the Perlin pattern but converts the very high and low values to more moderate values. For example, the whites become light greys and the blacks become dark greys. • Small Bumps: Uses the Perlin pattern. The transitional grey areas between blacks and whites become inverted so they look like dark lines. The extremes, black and white areas, become whitish.
Fractal Type	<p>Transforms the noise pattern generated by the Noise type and controls the way layers are composited. These are variations of the basic noise.</p> <ul style="list-style-type: none"> • Turbulent Twist: Applies a turbulent effect on the pattern so it changes the transition between black and white by adding more modulation. • Fractional Brownian: Applies a basic application of noise and composites by adding subsequent layer with the Complexity parameter. • Threshold: Changes the dark greys into black values so there is more black in the noise for higher contrast. • Invert Threshold: Inverts all the values of the Threshold type so a negative image of it is created. • Terrain: Adds contrast and converts the dark greys into white or light greys.
Pinning	Constrains the effect within the image boundaries.
Amount	Specifies the amplitude of displacement.
Frequency	The density of displacement appearing in the noise. A higher value produces a greater amount of displacement in a given area; a lower value produces a smaller amount.
Offset	Moves the entire image.
Seed	This value determines the starting noise pattern on the first evolution of the effect.
Locked	Applies parameter value while retaining the X and Y ratio.
Separate	Allows you to apply different parameter values to X and Y.
xy	When locked, applies parameter values to both X and Y. When separated, allows you to apply different value to X and Y.

Evolution	Determines the displacement pattern over time.
Evolution Frequency	This factor makes the complexity iterations animate or transform at a higher speed. In other words, the second, third, etc. passes, controlled by the Complexity parameter, will mutate faster than the main one.
Complexity	<p>The number of noise layers that make up the noise. Each successive layer has a higher frequency, resulting in a smaller noise effect. You can have up to seven passes. Increasing this number increases the depth and amount of detail in the noise. Use Complexity with Sub Scaling when the value is 1 or greater.</p> <div data-bbox="561 611 1430 747" style="border: 1px solid #90EE90; padding: 5px;"><p> NOTE Increasing the Complexity results in longer rendering times.</p></div>
Gain	Controls the amount of opacity present in the iteration of noise. This also affects the layer when using Sub Scaling. With a value of 0, you will not see the sub noise. A value of 1 will show the sub noise just as strong as the main one. For example, with water ripples, a higher amount of Gain will reveal more ripple or subripples.
Sub Scaling:	The factor by which the main noise is modified at each iteration of complexity. A value of 1 make the two noises identical. A value of 2 makes the sub noise twice as small. The next iteration would be 4 times smaller. Values must be greater than 1.

Weighted Deform Node



The Weighted Deform node is a deformation node that creates a blended deformation from the regions defined by multiple sources. The deformation blends the points in a drawing or image based on the distance to a deformation source and is used to provide a clean deformed surface.

Connection

The Weighted Deform node acts as a composite for several kinds of transformations, and outputs the composited transformations onto a Drawing node.

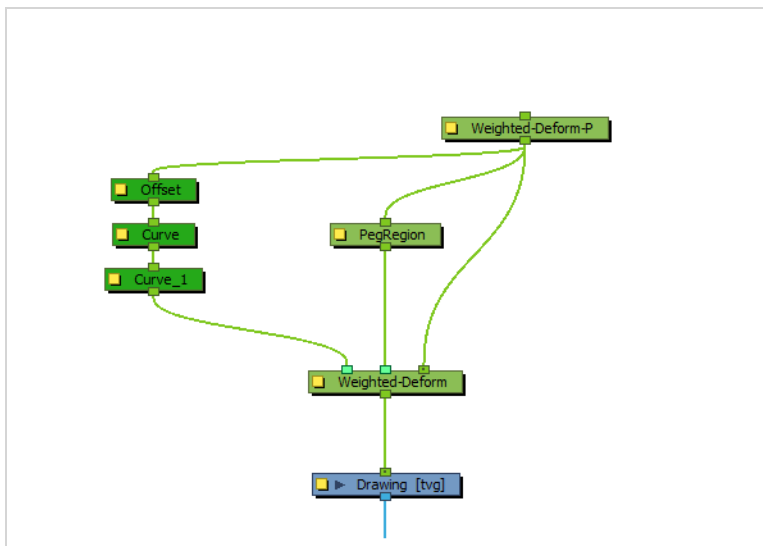

The rightmost input port of the Weighted Deform node is for the base transformation for the drawing. This port should be connected to what would have otherwise been the parent peg of the child Drawing node. For example, if the node connected under the Weighted Deform node is Arm_R, then the peg Arm_R-P should be connected to this port. It will pass this transformation onto the Drawing node, but it will also composite the other transformations onto it.

If you connect any other transformation or deformation (**green**) cable to the Weighted Deform node, an extra input port (**light green**) will appear. Those transformations are composited together to make a weighted deformation that is applied to the child element. The following transformations are supported:

- **Deformation nodes:** Bone, Curve and Envelope deformations are converted by the Weighted Deform node to deform the entire texture of the drawing, instead of only deforming its outlines. This is especially useful to create Envelope deformations around textured or detail-heavy drawings.
- **Peg nodes:** Pegs are used as deformation points to create a “cloth” like deformation. They work very similarly to the Free Form Transformation node. The position of the peg’s pivot point acts as the resting position of the point, and the actual position of the peg is the point’s offset.

Like all transformation and deformation nodes, the output port of the Weighted Deform node outputs a transformation and should be connected to the input port of an Drawing node.

Layer Properties

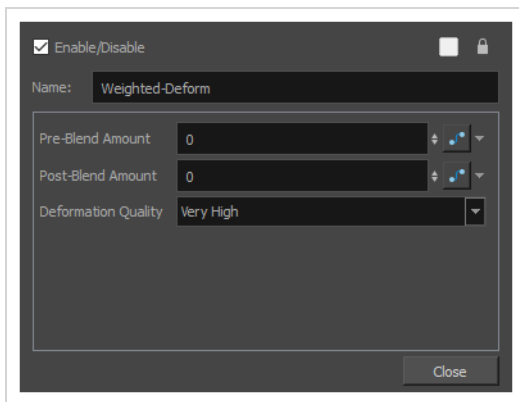

Parameter	Description
Name	
Pre-Blend Amount	<p>The blend amounts are used to define the rigidity of the deformation map. The values are added at different points in the computation and result in a different result when used.</p> <p>The Pre-Blend Amount is added when calculating the distance from the deformation regions. It blends the regions by making the regions less influential when close to the contours.</p>

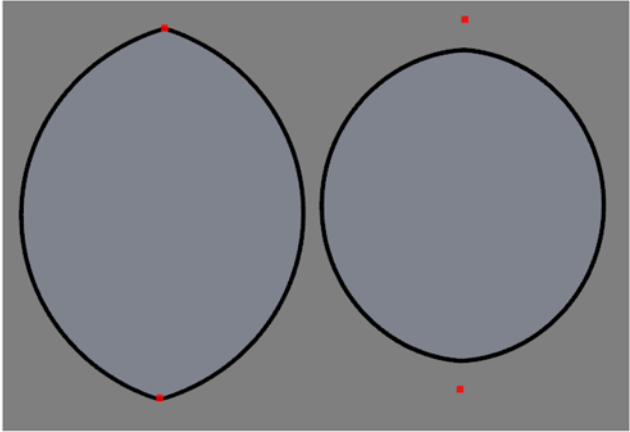
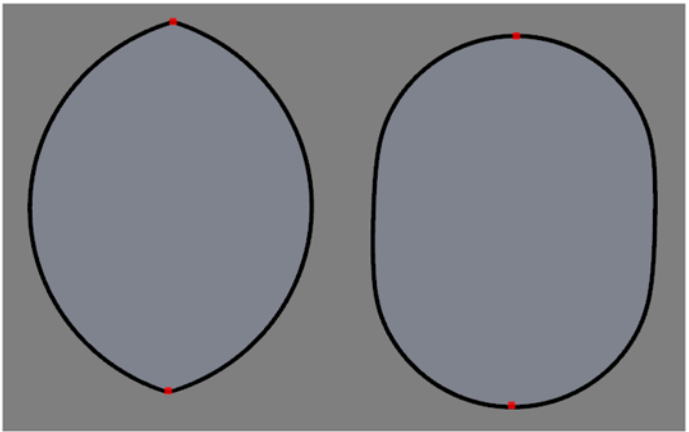
Parameter	Description
	<div data-bbox="386 285 1026 890" style="border: 1px solid black; padding: 10px;">  <div style="display: flex; justify-content: space-around; margin-top: 10px;"> <div style="text-align: center;"> <p>Pre-Blend Amount: 0 No bias is applied to the points. Each regional influence affects the nearby points based on their distance.</p> </div> <div style="text-align: center;"> <p>Pre-Blend Amount: 1 This applies a bias of 1 to the distance of all points, treating the points as if they're further from the regional controls and deforming the shape less overall.</p> </div> </div> </div>
Post-Blend Amount	<p>The Post-Blend Amount is added after calculating the deformation mapping of the weighting of the Weighted Deform's regional influences. It is used to round out the influence of the deformation region by applying the value as an exponent to the calculated deformation weights.</p> <p>A value of 0 will create a linearly interpolated deformation. A higher value will cause regions further from the source to have increasingly less influence as it recedes from the control.</p> <div data-bbox="386 1176 1084 1759" style="border: 1px solid black; padding: 10px;">  <div style="display: flex; justify-content: space-around; margin-top: 10px;"> <div style="text-align: center;"> <p>Post-Blend Amount: 0 The controls affect the regions linearly. This results in a deformed drawing with harder corners and edges.</p> </div> <div style="text-align: center;"> <p>Post-Blend Amount: 10 The controls affect the regions exponentially. This results in a deformed drawing with rounded corners and edges.</p> </div> </div> </div> <p>A negative value can be used to apply the blending inversely.</p>

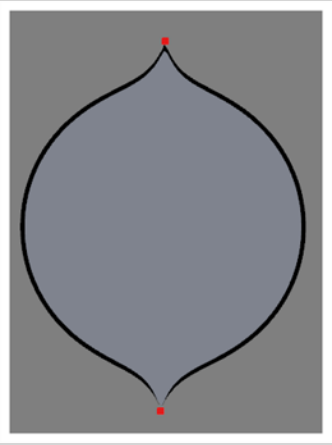
Parameter	Description
	
<p>Deformation Quality</p>	<p>This is the quality of the deformation. It ranges from Low to Extreme. The higher the quality, the better the deformation will look, but the longer it will take to render.</p>

Filter Nodes

Here is the list of the main filter effects available in Harmony.

Anti-Flicker Node	566
Auto-Patch Node	568
Bloom Node	570
Blur-Box Node	574
Blur-Directional Node	577
Connection	578
Layer Properties	579
Blur-Gaussian Node	581
Blur-Radial Node	584
Blur-Radial-Zoom Node	586
Blur-Variable Node	590
Brightness Contrast Node	592
Channel Selector Node	594
Channel Swap Node	596
Chroma-Keying Node	598
Colour Banding Node	604
Colour Art Node	607
Colour Curves Node Properties	609
Colour Fade Node	614
Palette Overrides	615
Individual Colour Overrides	617
Colour Levels Node	621
Colour-Override Node	624
Colour-Scale Node	629
Colour Selector Node	631
Contrast Node	634
Dither Node	636
Focus Node	638

Focus Multiplier Node	641
Gamma Node	643
Glow Node	646
Grain Node	650
Greyscale Node	652
Hue-Saturation Node	654
Increase Opacity Node	661
Layer Selector Node	664
Line Art Node	667
Luminance Threshold Node	669
Matte-Blur Node	672
Matte-Resize Node	675
Median Node	677
Motion Blur Node	680
Motion-Blur-Legacy Node	684
Negate Node	687
Overlay Layer Node	689
Pixelate Node	691
Remove Transparency Node	693
RGB Difference Keyer Node	695
Shadow Node	700
Transparency Node	703
Underlay Layer Node	705

Anti-Flicker Node

Use the Anti-Flicker to compensate for flickering in your output to TV formats. The Anti-Flicker effect applies a vertical blur to the rendered output. You should place the Anti-Flicker before a Write node in the Node view.

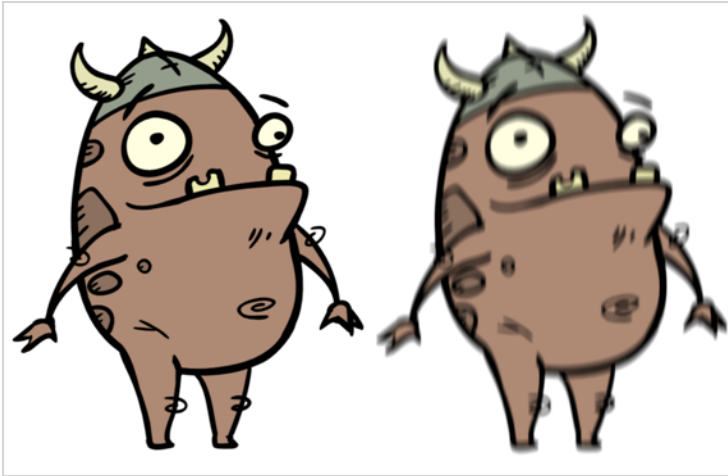

Refer to the following example to connect this effect:

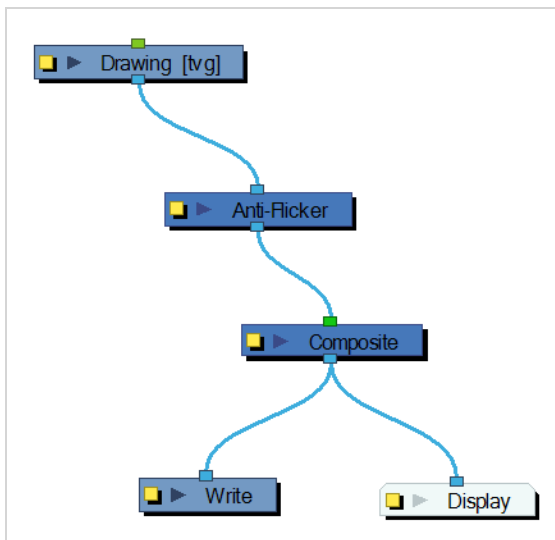

Use the Anti-Flicker editor to control the amount of blur that is applied to rendered output. In the Radius field, enter a value for the number of pixels to be considered in the blur.

Properties

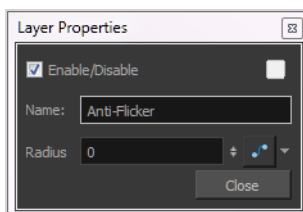

Parameter	Description
Name	The name of the node as it appears in the Node View and the Timeline view. Each node must have a name that is unique to its containing group.
Radius	Size of the blur. The larger the value, the greater the strength or reach of the blur. The blur radius is affected by the drawing scale and camera position. Click the Edit Curve button to change these values over time by adjusting the function curve.

Auto-Patch Node

T-RIG-005-001

The Auto Patch node is used mainly when creating joint patches for cut-out puppets drawn with pencil lines and painted in the Colour Art layer. Instead of removing a portion of the outline to attempt to create a seamless joint, you can draw complete pieces, and with the Auto Patch node, automatically create a perfect articulation.

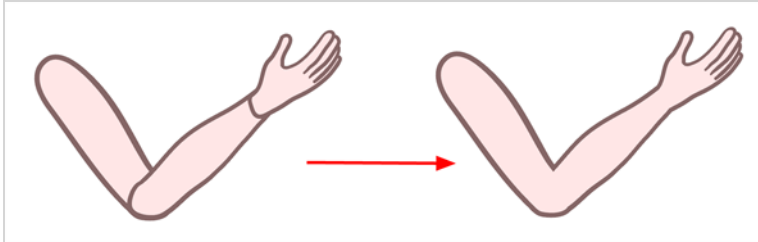

The requirements for this effect to work are:

- Drawing outlines must be drawn in pencil lines
- Drawing outlines must be drawn in the Line Art layer
- Drawing fill colours must be painted in the Colour Art layer

Pencil lines are central vector lines. The vector is located along the centre of the line. This means that when you paint a zone delimited by a pencil line, the colour fill will expand to the centre of the pencil line.

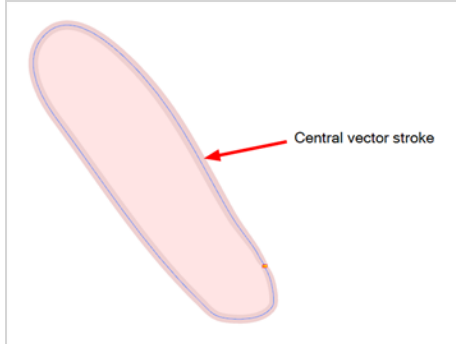

When using the regular patch technique, recommended for the brush line, the result with pencil lines is very odd looking because the colour fill zone is bigger than the pencil line inner contour.

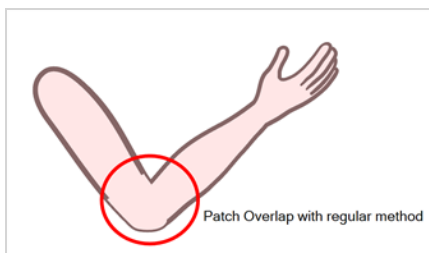

Instead of using the regular patch method, you can use the Auto Patch node. It will automatically extract the Colour Art and clip it to the right size. Then, you can connect it in front of the piece to be covered.

The node connection for the Auto Patch is quite simple. Once your basic character rigging is done, add the Auto Patch node to the joints you want to cover. There is no need to set any parameters.

Refer to the following example to connect this effect:

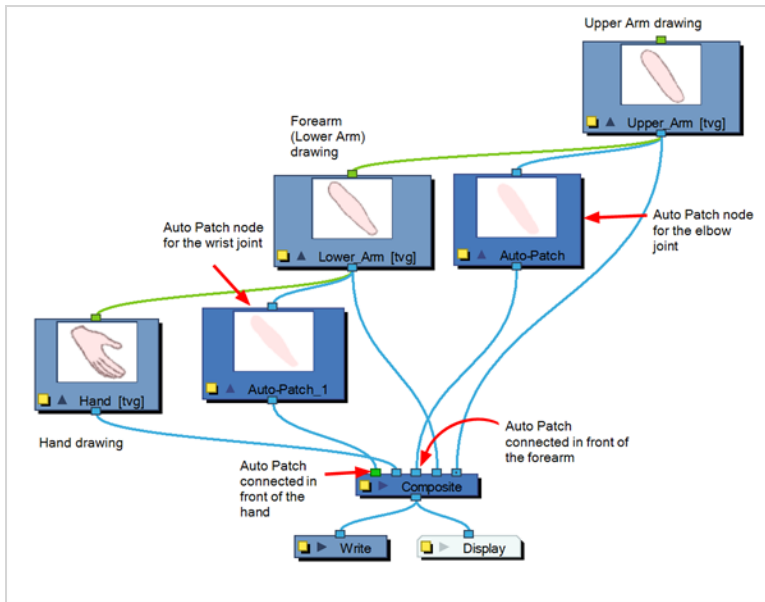

Properties

Parameter	Description
Name	The name of the node as it appears in the Node View and the Timeline view. Each node must have a name that is unique to its containing group.

Bloom Node

The Bloom effect is used to make a specular area blurrier on a bitmap image, such as street lamps at night.



Connection

The Bloom node takes an image of any type as its input and outputs an image in which pixels that pass the threshold are softened, blurred and their gamma is adjusted.

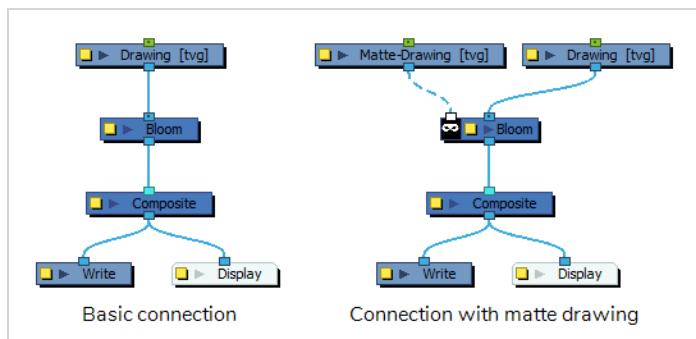

Optionally, it can also be connected to a matte image. In this case, only the parts of the input image that intersect with the matte will be affected by the effect.

The Bloom node is a combination of the Luminance Threshold, Cutter, Blur-Gaussian and Composite Generic nodes—see [Luminance Threshold Node](#) on page 669, [Cutter Node](#) on page 446 [Blur-Gaussian Node](#) on page 581, and [Composite-Generic Node](#) on page 440.

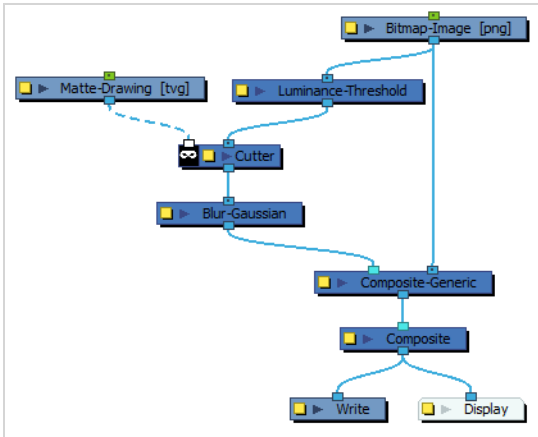

Layer Properties

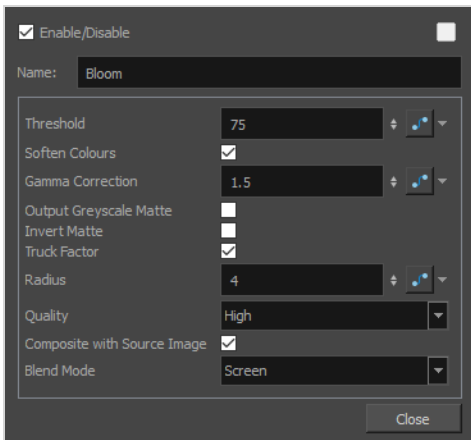

Parameter	Description
Name	Allows you to enter a name for the node.
Threshold	Controls how much of the dark value to clamp off. A high value will keep only the bright areas of your image.

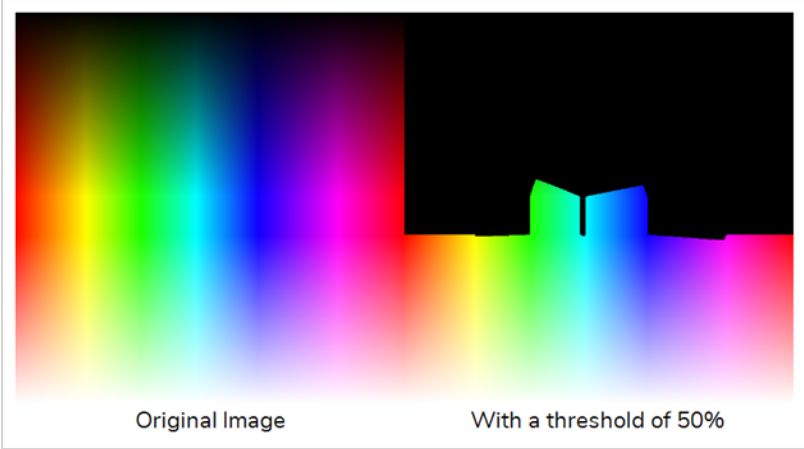
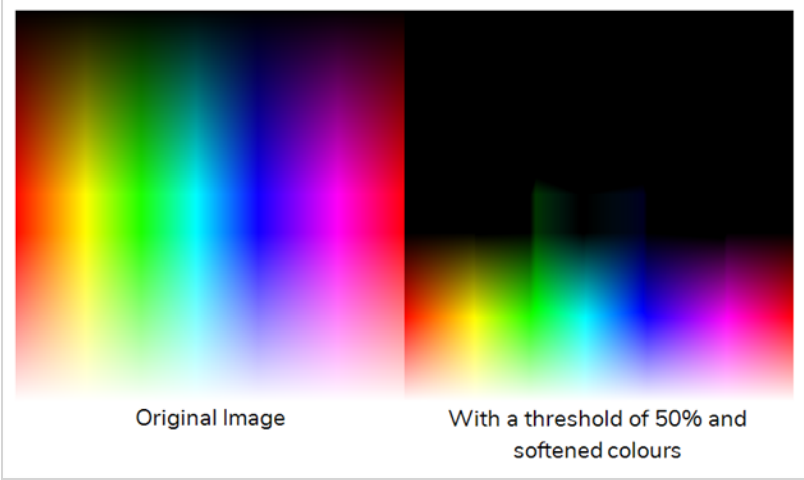
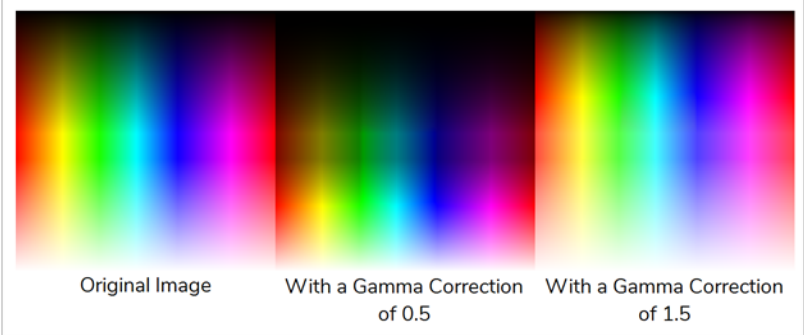
Parameter	Description
	 <p>The image shows two side-by-side panels. The left panel, labeled 'Original Image', displays a smooth horizontal gradient of colors from red on the left to purple on the right. The right panel, labeled 'With a threshold of 50%', shows the same gradient but with a black rectangular area covering the top portion of the image, and the colors below it appearing as sharp, blocky shapes.</p>
Soften Colours	<p>Brings back the entire spectrum of luminance in areas defined by the threshold to avoid having only bright values.</p>  <p>The image shows two side-by-side panels. The left panel, labeled 'Original Image', is the same color gradient as in the first row. The right panel, labeled 'With a threshold of 50% and softened colours', shows the same thresholded image as the first row, but the black area is now filled with a blurred, soft version of the original color gradient, making the transition between colors smoother.</p>
Gamma Correction	<p>Multiplies the gamma value to make the area brighter or darker. A value of 1 keeps the gamma the same as the original image. You can use the gamma modification on the whole image if you use a threshold of 0 for example.</p>  <p>The image shows three side-by-side panels. The left panel, labeled 'Original Image', is the color gradient. The middle panel, labeled 'With a Gamma Correction of 0.5', shows the gradient appearing darker and more compressed. The right panel, labeled 'With a Gamma Correction of 1.5', shows the gradient appearing brighter and more expanded.</p>

Parameter	Description
Output Greyscale Matte	Allows you output an image in levels of grey. This can be used in combination with a Blending or Cutter node, or other effects that use greyscale mattes.
Invert Matte	Inverts the matte used to generate the effect. By default, the effect is applied to the opaque areas of the matte drawing. When this option is enabled, the effect is applied to the transparent areas of the matte instead.
Truck Factor	Activated by default, this option readjusts the blur when the elements undergo a change of depth or scale. When this option is deselected, the effect's values remain unchanged regardless of any depth or scale changes. This option should be deselected when multiple drawings are composited and attached to this effect.
Radius	Adjusts the amount of blur applied to the image.
Quality	Controls the quality of the blur. A higher quality yields better results, but will be slower to render.
Composite with Source Image	Blends the area defined by the threshold with the original image.
Blend Mode	Defines the blending mode between the original image and the area defined by the threshold to avoid having to add a Composite Generic node after the Bloom node.

Blur-Box Node

T-COMP2-003-003

The Blur - Box effect is a quick and easy way to create a blurring effect. The Box blur changes the colour value of each pixel based on the pixels next to it in the vertical and horizontal directions. The look of the blur is similar to the look achieved using Gaussian blur, but renders much faster. This effect is useful when a fast rendering time is important, and the quality of the blur is less important. Also, you can use a matte with this effect to isolate areas of the image.

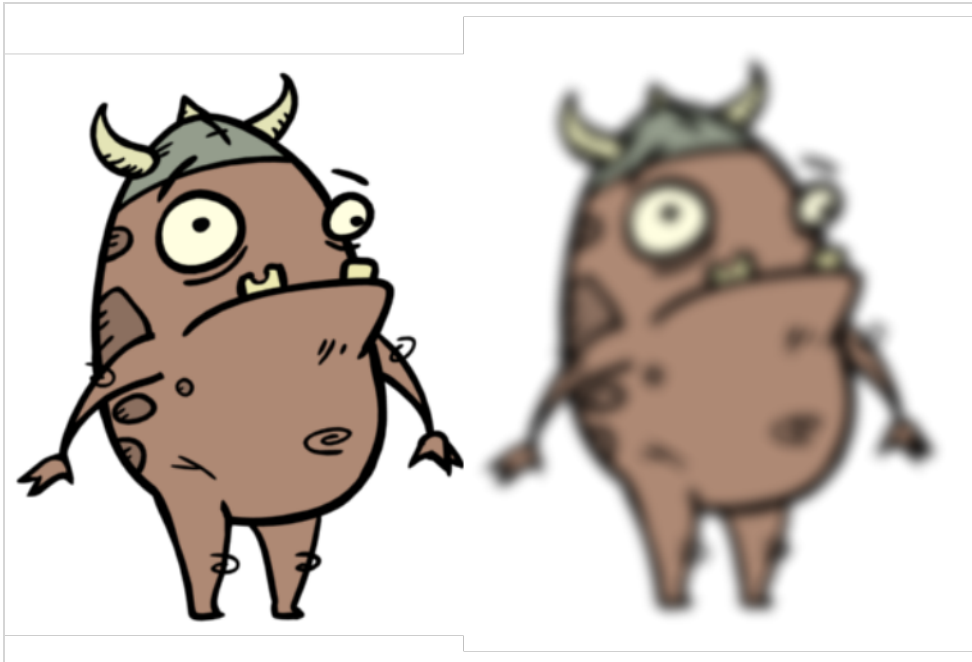

Refer to the following example to connect this effect:

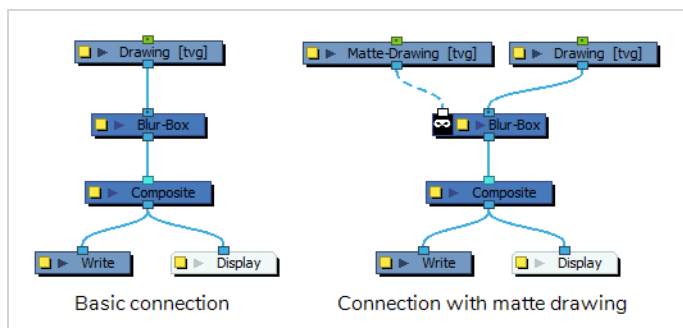

For detailed video tutorials and sample scenes by Adam Phillips, see:

<https://www.toonboom.com/resources/video-tutorials/chapter/adam-phillips-harmony-effects>

Properties

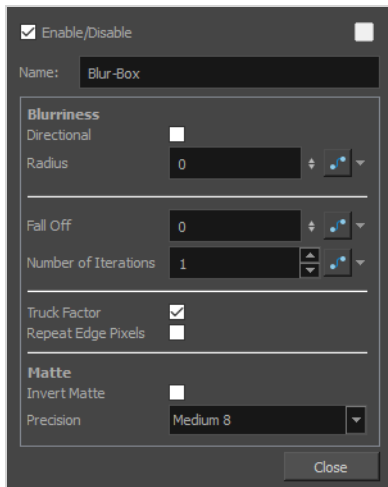

Parameter	Description
Name	The name of the node as it appears in the Node View and the Timeline view. Each node must have a name that is unique to its containing group.
Truck Factor	Activated by default, this option readjusts the blur when the elements undergo a change of depth or scale. When this option is deselected, the effect's values remain unchanged regardless of any depth or scale changes. This option should be deselected when multiple drawings are composited and attached to this effect.
Repeat Edge Pixels	Makes the blur algorithm operate as if the pixel values beyond the edge of the layer are the same as the values of the edge pixels. This keeps edges sharp, preventing them from darkening and becoming more transparent.
Blurriness	
Directional	Blurs according to the length, width, and angle you specify. For example, if a character is walking east, the blur may fall to the west.
Radius	Size of the blur. The larger the value, the greater the strength or reach of the blur. The blur radius is affected by the drawing scale and camera position. Click the Edit Curve button to change these values over time by adjusting the function curve.
Length	Length of the blur.
Width	Thickness of the blur.

Parameter	Description
Angle	The direction in which the blur is applied: sideways, up, down, 90 degrees, 45 degrees, and so on.
Bidirectional	Applies the blur on both sides of the pixel.
Fall Off	The distance where the blur fades from the edge of the image. Select a value between 0 and 1. A fall-off rate of 0 causes the blur to fade out slowly, distributing the blur evenly from the edge of the character to the farthest edge of the blur. A fall-off rate of 1 causes the blur to fade out quickly, so the blur is heaviest closer to the edge of the image.
Number of Iterations	The number of times the blur is applied to the image. A higher number of iterations creates smoother transitions between colours and increases the blur, but also increases render time.
Matte	
Invert Matte	Inverts the matte used to generate the effect. By default, the effect is applied to the opaque areas of the matte drawing. When this option is enabled, the effect is applied to the transparent areas of the matte instead.
Precision	Blurs the image the number of times the precision indicates at different radius (between 0 and the specified radius).

Blur-Directional Node

T-COMP2-003-005

The Blur-Directional effect creates the effect of a motion blur that pulls and smears the image from one contour edge to a different direction or angle. This effect is useful in creating the impression of speed, such as the streaks of colour that follow a car travelling at high speed.



Connection

The Blur-Directional node takes an image of any type as its input and outputs a blurred bitmap image.

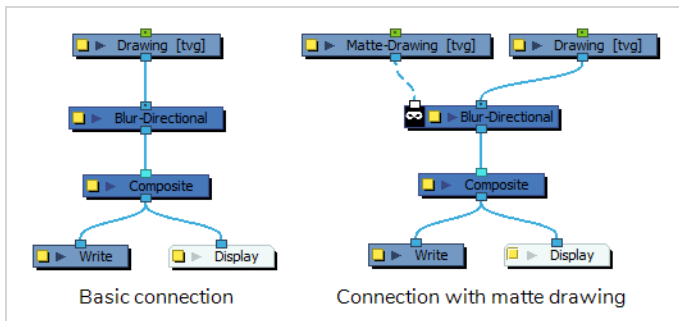

Optionally, it can also be connected to a matte image. In this case, only the parts of the input image that intersect with the matte will be affected by the effect.

Layer Properties

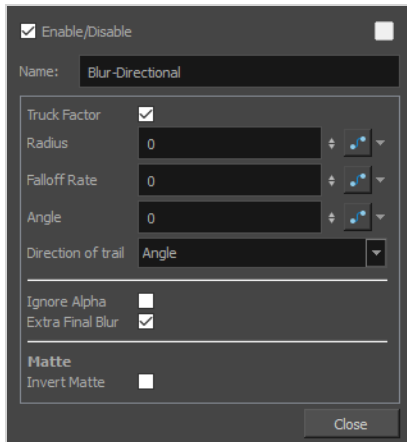

Parameter	Description
Name	The name of the node as it appears in the Node View and the Timeline view. Each node must have a name that is unique to its containing group.
Truck Factor	Activated by default, this option readjusts the blur when the elements undergo a change of depth or scale. When this option is deselected, the effect's values remain unchanged regardless of any depth or scale changes. This option should be deselected when multiple drawings are composited and attached to this effect.
Radius	Size of the blur. The larger the value, the greater the strength or reach of the blur. The blur radius is affected by the drawing scale and camera position. Click the Edit Curve button to change these values over time by adjusting the function curve.
Falloff Rate	The distance where the blur fades from the edge of the image. Select a value between 0 and 1. A fall-off rate of 0 causes the blur to fade out slowly, distributing the blur evenly from the edge of the character to the farthest edge of the blur. A fall-off rate of 1 causes the blur to fade out quickly, so the blur is heaviest closer to the edge of the image.
Angle	The angle of the blur. The value goes from 0 to 360, with 0 meaning west, and angles going counterclockwise. For example: <ul style="list-style-type: none"> • 0: Blurs the image to the west. • 90: Blurs the image to the south. • 180: Blurs the image to the east. • 270: Blurs the image to the north.

Parameter	Description
Direction of trail	If you do not set an Angle for the direction of the blur, you can select a direction (north, south, east, or west) from this menu. The calculations for this feature are faster than the calculations for the Angle setting.
Ignore Alpha	Controls the leading edge of the blur. Deselect this option for a solid or hard leading edge on the blur.
Extra Final Blur	Adds a second blur after the Blur-Directional is created. If you have a Blur-Directional that begins at 0 and gradually gets stronger, deselect this option to ensure a smooth progression.
Number of Iterations	The number of times the blur is applied to the image. A higher number of iterations creates smoother transitions between colours and increases the blur, but also increases render time.
Matte	
Invert Matte	Inverts the matte used to generate the effect. By default, the effect is applied to the opaque areas of the matte drawing. When this option is enabled, the effect is applied to the transparent areas of the matte instead.

Blur-Gaussian Node

T-COMP2-003-002

The Blur-Gaussian effect softens the image, reducing the amount of noise and detail. The look of the Gaussian blur is smooth, but does take some rendering time. This effect is useful when rendering time is less important, and quality is more important. Also, you can use a matte with this effect to isolate areas of the image.

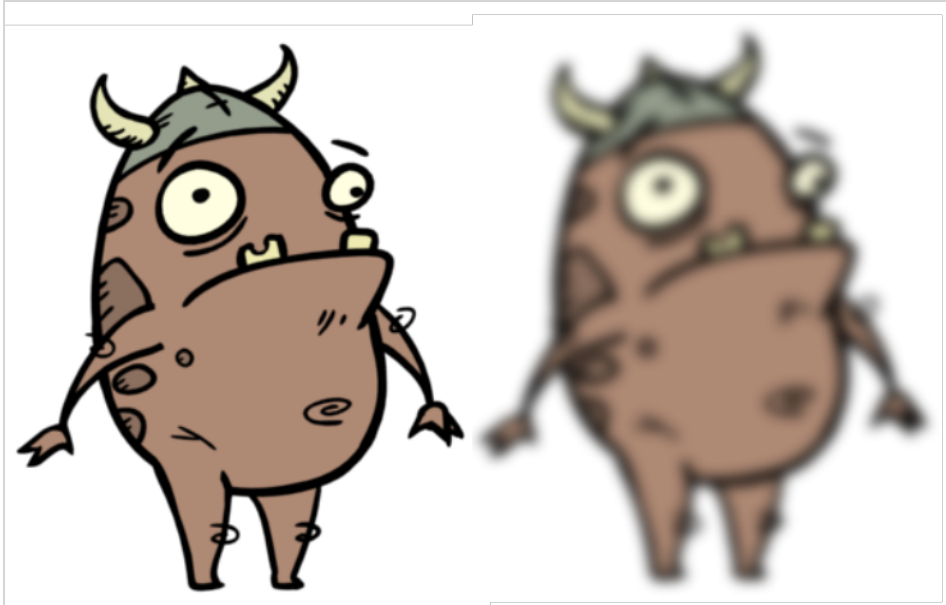

For detailed video tutorials and sample scenes by Adam Phillips, see:

<https://www.toonboom.com/resources/video-tutorials/chapter/adam-phillips-harmony-effects>

Refer to the following example to connect this effect:

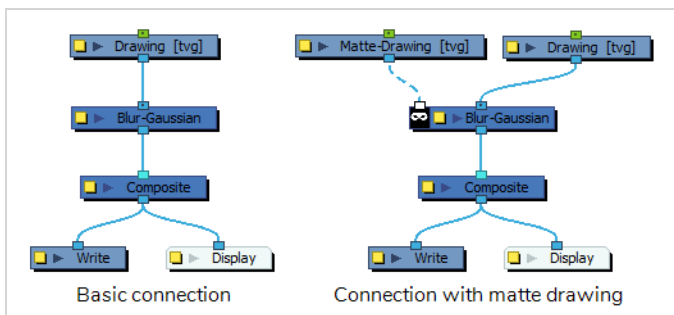

Properties

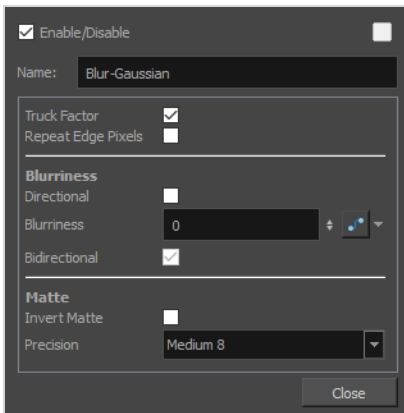

Parameter	Description
Name	The name of the node as it appears in the Node View and the Timeline view. Each node must have a name that is unique to its containing group.
Truck Factor	Activated by default, this option readjusts the blur when the elements undergo a change of depth or scale. When this option is deselected, the effect's values remain unchanged regardless of any depth or scale changes. This option should be deselected when multiple drawings are composited and attached to this effect.
Repeat Edge Pixels	Makes the blur algorithm operate as if the pixel values beyond the edge of the layer are the same as the values of the edge pixels. This keeps edges sharp, preventing them from darkening and becoming more transparent.
Blurriness	
Directional	Blurs according to the length, width, and angle you specify. For example, if a character is walking east, the blur may fall to the west.
Blurriness	Amount of blur applied to the layer.
Horizontal Blurriness	Length of the blur.
Vertical Blurriness	Thickness of the blur.
Angle	The direction in which the blur is applied: sideways, up, down, 90 degrees, 45 degrees, and so on.

Parameter	Description
Bidirectional	Blurs in both horizontal and vertical directions.
Matte	
Invert Matte	Inverts the matte used to generate the effect. By default, the effect is applied to the opaque areas of the matte drawing. When this option is enabled, the effect is applied to the transparent areas of the matte instead.
Precision	Blurs the image the number of times the precision indicates at different radius (between 0 and the specified radius).

Blur-Radial Node

T-HFND-010-007

The Blur-Radial effect creates an effect that softens, fogs or obscures the image evenly in all directions. This effect is useful when you want to make cloudy images not realistically seen in detail, such as a drawing object that is farther back or in the background of your scene, usually blurry due to the laws of atmospheric perspective. Other uses include the general softening of objects such as snow, stars and shadows that do not naturally have a hard outline.

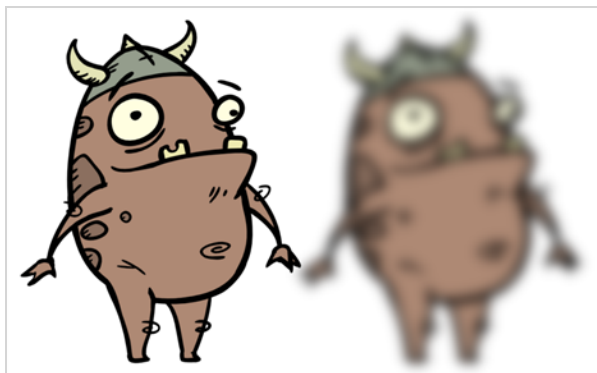

Refer to the following example to connect this effect:

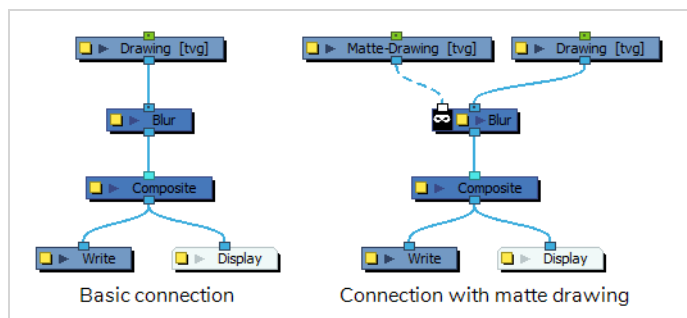

Properties

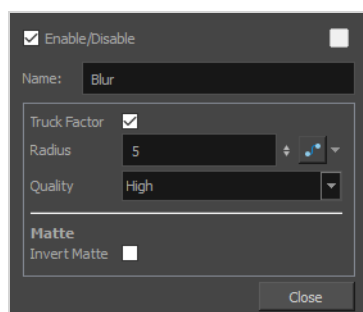

Parameter	Description
Name	The name of the node as it appears in the Node View and the Timeline view. Each

Parameter	Description
	node must have a name that is unique to its containing group.
Truck Factor	Activated by default, this option readjusts the blur when the elements undergo a change of depth or scale. When this option is deselected, the effect's values remain unchanged regardless of any depth or scale changes. This option should be deselected when multiple drawings are composited and attached to this effect.
Radius	Size of the blur. The larger the value, the greater the strength or reach of the blur. The blur radius is affected by the drawing scale and camera position. Click the Edit Curve button to change these values over time by adjusting the function curve.
Quality	Select High for a slow and accurate operation or Low for a faster operation with a more raw look.
Matte	
Invert Matte	Inverts the matte used to generate the effect. By default, the effect is applied to the opaque areas of the matte drawing. When this option is enabled, the effect is applied to the transparent areas of the matte instead.

Blur-Radial-Zoom Node

T-COMP2-003-007

The Blur - Radial Zoom effect creates blurs around a centre point, simulating the look of a zooming or rotating camera. You can use a matte to isolate the area of the image from which you want the effect to radiate from. For example, in the illustration below, a circular matte was created to mask the eyeball and a Negate effect was applied so the blur is outside the matte. Then the centre point was positioned on the character's iris, which is the centre of the matte.



For detailed video tutorials and sample scenes by Adam Phillips, see:

<https://www.toonboom.com/resources/video-tutorials/chapter/adam-phillips-harmony-effects>

Refer to the following example to connect this effect:

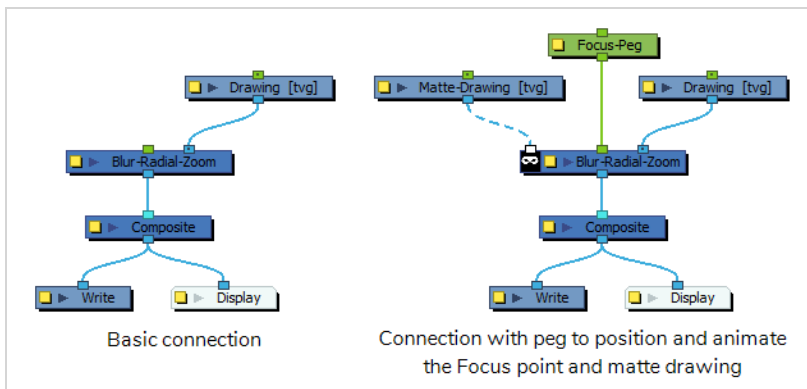

Properties

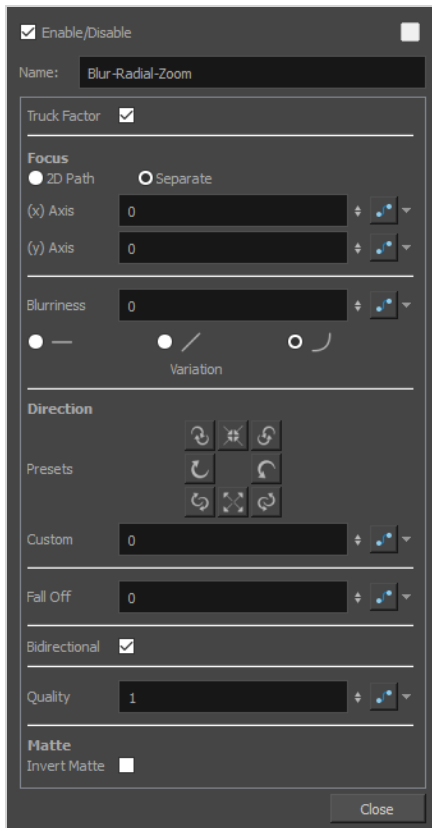

Parameter	Description
Enable/Disable	Allows you to enable or disable the node. When disabled, a node has no visible effect on the rendered image, nor on the preview in the Camera, Perspective, Side and Top views.
Colour Swatch	Sets the colour of the layer in the Timeline view and of the node in the Node view.
Name	The name of the node as it appears in the Node View and the Timeline view. Each node must have a name that is unique to its containing group.
Truck Factor	Activated by default, this option readjusts the blur when the elements undergo a change of depth or scale. When this option is deselected, the effect's values remain unchanged regardless of any depth or scale changes. This option should be deselected when multiple drawings are composited and attached to this effect.
Focus	The focus point is the point from which the radial-zoom blur radiates. By default, it is in the centre of the stage, but it can be positioned anywhere and it can also be animated.

Parameter	Description
	<p>If you want to animate the focus point, you can choose which type of function to use to store the animation.</p> <ul style="list-style-type: none"> • 2D Path: The horizontal and vertical position are on the same function. This makes the point move in a curvilinear trajectory between each keyframe. • Separate: The horizontal and vertical position are on separate functions. This makes the point move in a straight line between each keyframe and it allows you to modulate the trajectory differently on each axis. <div data-bbox="565 630 1429 861" style="border: 1px solid green; padding: 10px; margin-top: 10px;">  <p>NOTE The position of the Focus point is also influenced by the transformation information sent to the node's middle input (Focus Point) port. You can attach a peg to the middle input-port and position or animate the focus point by positioning or animating the peg.</p> </div>
(x) Axis	The horizontal position of the focus point.
(y) Axis	The vertical position of the focus point.
Blurriness	Amount of blur applied to the layer.
Variation	<p>Constant: An equal, constant blur is applied on all pixels.</p> <p>Linear: A gradual blur is applied on all pixels.</p> <p>Quadratic: An exponential blur is applied on all pixels.</p>
Direction	Lets you select preset blur types or create a custom blur.
Presets	A set of preset radial, zoom, and spiral blurs to get you started. You can then adjust the type to customize the blur.
Custom	Create your own blur by entering a value for the direction of the blur lines.
Fall Off	The distance where the blur fades from the edge of the image. Select a value between 0 and 1. A fall-off rate of 0 causes the blur to fade out slowly, distributing the blur evenly from the edge of the character to the farthest edge of the blur. A fall-off rate of 1 causes the blur to fade out quickly, so the blur is heaviest closer to the edge of the image.

Parameter	Description
Bidirectional	Applies the blur on both sides of the pixel.
Quality	Affects the quality of the blur by defining how fine the reference radial grid is on the image. This determines the width of all the wedges. A higher quality yields achieve better results, but will be slower to render.
Matte	
Precision	Blurs the image the number of times the precision indicates at different radius (between 0 and the specified radius).

Blur-Variable Node

T-COMP2-003-004

Use the Blur-Variable effect to create a radial blur that varies within a single image based on the white and black values in the matte you supply. You can set one blur value for the black regions in the matte, and another blur value for the white regions. The blur value for each grey region is interpolated between your black and white blur settings.

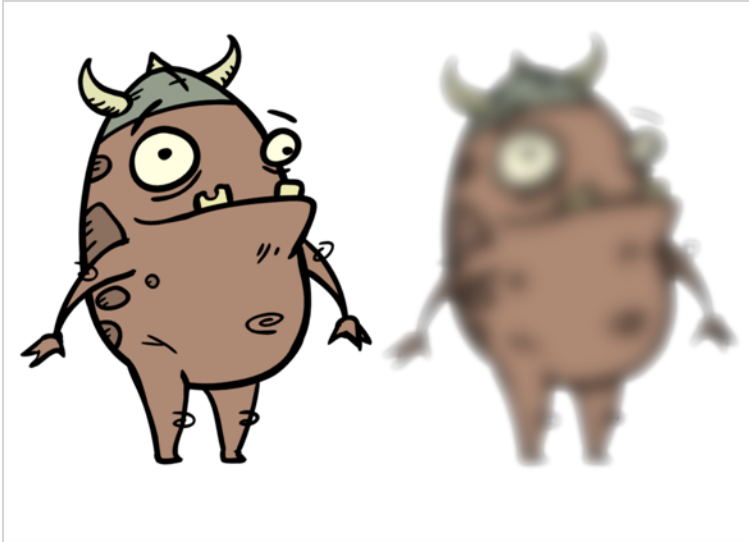

The following example is a network for a Variable Blur effect. A black and white copy of the character was used to create the effect. Use the Blur-Variable editor to control the blur value for the white and black radius.

Refer to the following example to connect this effect:

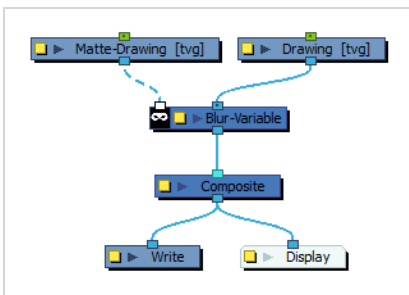

Properties

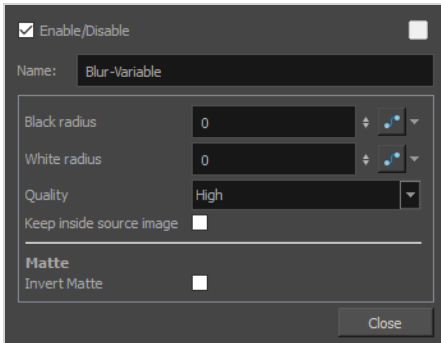

Parameter	Description
Name	The name of the node as it appears in the Node View and the Timeline view. Each node must have a name that is unique to its containing group.
Black radius	The amount of blur to apply to the black (transparent) values in the matte. Higher values create more blur in the colour image's regions that correspond to the black matte region.
White radius	The amount of blur to apply to the white (opaque) values in the matte. Higher values create more blur in the colour image's regions that correspond to the white matte region.
Quality	Select High for a slow and accurate operation or Low for a faster operation with a more raw look.
Keep inside source image	This option confines the blur to the source image.
Matte	
Invert Matte	Inverts the matte used to generate the effect. By default, the effect is applied to the opaque areas of the matte drawing. When this option is enabled, the effect is applied to the transparent areas of the matte instead.

Brightness Contrast Node

The Brightness and Contrast effect allows you to modify the brilliance or dullness of an image or to create a greater difference between the lights and darks of an image by increasing their respective intensities. This effect can be used when an image appears too flat. Increasing the brightness or contrast can give a drawing a more attractive and 3D quality. This can be useful if you want to push your background to the rear by making it look dull and flat and pulling your foreground elements to the front by giving them a higher contrast.

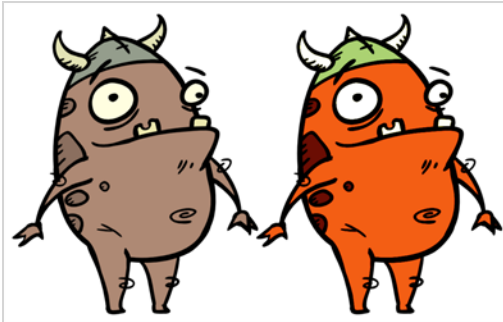

Connection

The Brightness Contrast node takes an image of any type as its input and outputs an image with different brightness and contrast parameters.

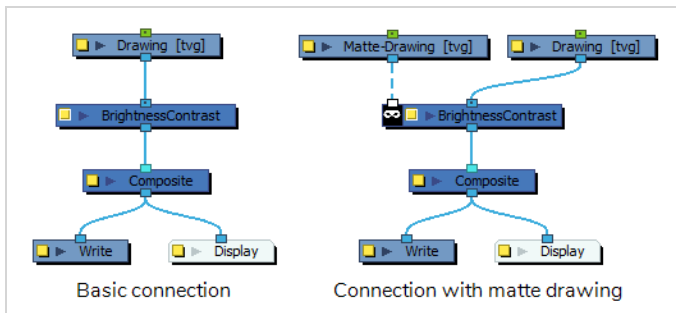

Optionally, it can also be connected to a matte image. In this case, only the parts of the input image that intersect with the matte will be affected by the effect.

Layer Properties

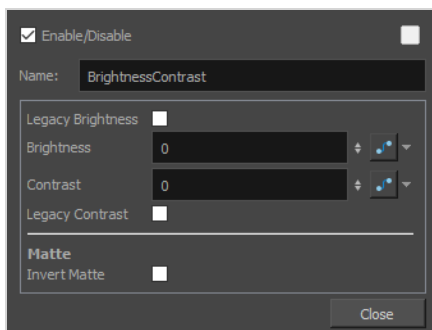

Parameter	Description
Name	The name of the node as it appears in the Node View and the Timeline view. Each node must have a name that is unique to its containing group.
Legacy Brightness	If you created this effect in an older version of Harmony, this option is enabled by default to prevent enhancements done to the effect in more recent versions of Harmony from affecting the rendered image.
Brightness	A value less than 0 will darken the image; a value greater than 0 will brighten it. Attach a Bezier or Ease function to change the brightness over time.
Contrast	A value less than 0 will reduce contrast; a value greater than 0 will increase contrast. Attach a Bezier or Ease function to change the contrast over time.
Legacy Contrast	If you created this effect in an older version of Harmony, this option is enabled by default to prevent enhancements done to the effect in more recent versions of Harmony from affecting the rendered image.
Matte	
Invert Matte	Inverts the matte used to generate the effect. By default, the effect is applied to the opaque areas of the matte drawing. When this option is enabled, the effect is applied to the transparent areas of the matte instead.

Channel Selector Node

The Channel Selector effect allows you to filter out some of the colour channels in an image.

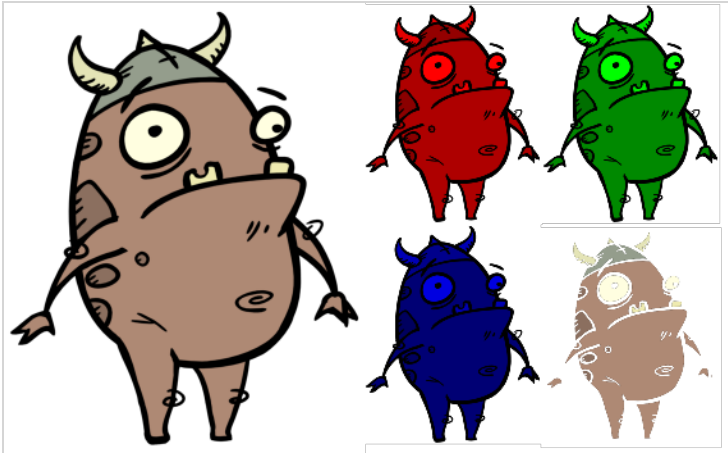

Refer to the following example to connect this effect:

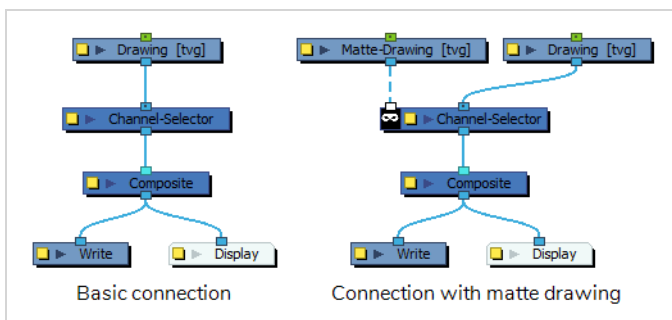

Properties

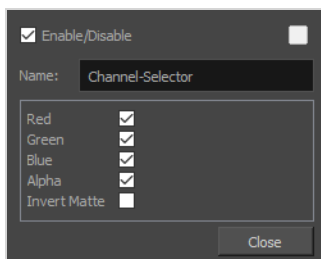

Parameter	Description
Name	Allows you to enter a name for the node.
Red	Allows the red values to go through.
Green	Allows the green values to go through.

Parameter	Description
Blue	Allows the blue values to go through.
Alpha	<p>Allows the alpha values to go through.</p> <div data-bbox="565 436 1429 638" style="border: 1px solid #c8e6c9; padding: 10px;"> NOTE When this parameter is disabled, the input image is composited with the scene as if the alpha value of each pixel was the sum of the red, green and blue values.</div>
Invert Matte	Inverts the matte used to generate the effect. By default, the effect is applied to the opaque areas of the matte drawing. When this option is enabled, the effect is applied to the transparent areas of the matte instead.

Channel Swap Node

The Channel Swap effect lets you take the image information from one channel and use it in another channel to achieve interesting effects. You can extract the following: red, green, blue, alpha values, hue, saturation, lightness, and luminance, as well as turn the information on or off.

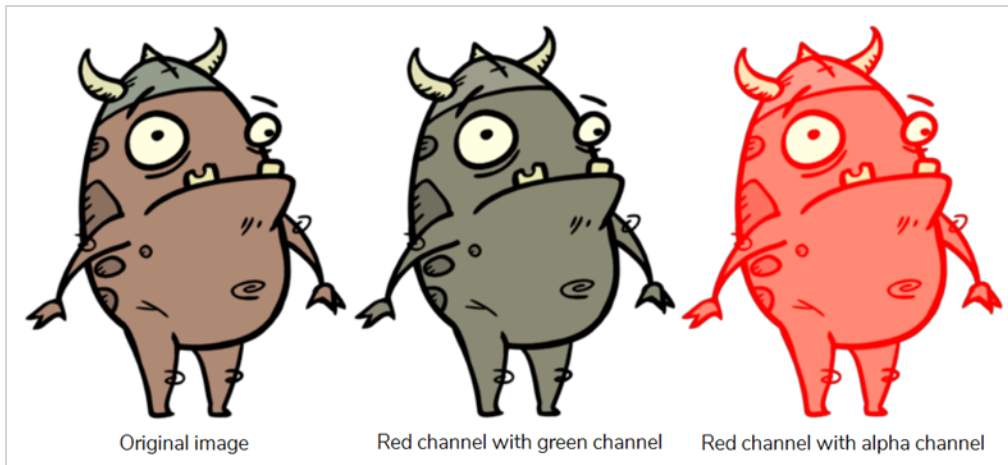

For detailed video tutorials and sample scenes by Adam Phillips, see:

<https://www.toonboom.com/resources/video-tutorials/chapter/adam-phillips-harmony-effects>

Refer to the following example to connect this effect:

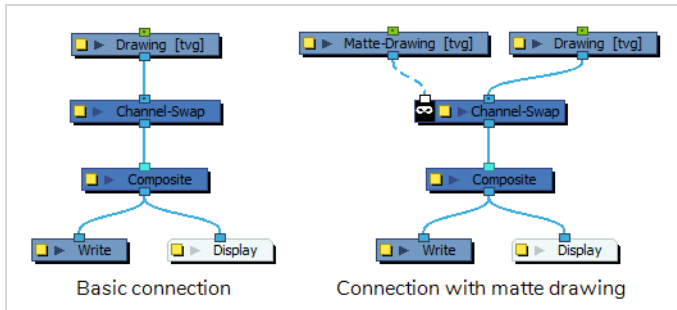

Properties

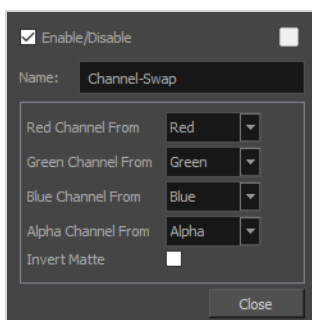

Parameter	Description
-----------	-------------

Name	The name of the node as it appears in the Node View and the Timeline view. Each node must have a name that is unique to its containing group.
Red Channel From	Allows you to select from which channel to get the red values.
Green Channel From	Allows you to select from which channel to get the green values.
Blue Channel From	Allows you to select from which channel to get the blue values.
Alpha Channel From	Allows you to select from which channel to get the alpha values.
Invert Matte	Inverts the matte used to generate the effect. By default, the effect is applied to the opaque areas of the matte drawing. When this option is enabled, the effect is applied to the transparent areas of the matte instead.

Chroma-Keying Node

The Chroma-Keying effect lets you create an alpha channel (transparency zone) for a bitmap image or image sequence. For example, if you have a series of bitmap images with a character filmed on a green or blue screen, you can use this node to create an alpha channel based on the screen colour and cut it out from your image sequence.



Refer to the following example to connect this effect:

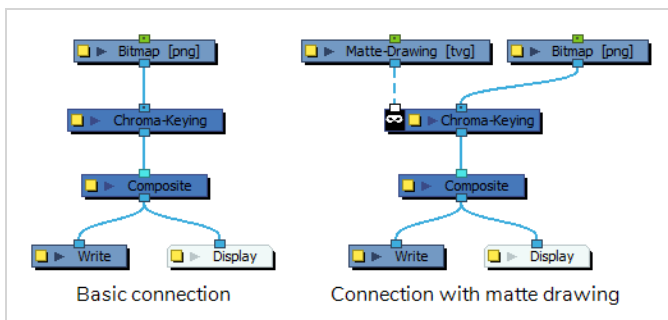



NOTES

- The input image must be a bitmap image.
- If a matte drawing is connected to the Chroma-Keying node, only the parts of the input image that intersect with the matte will be keyed out.

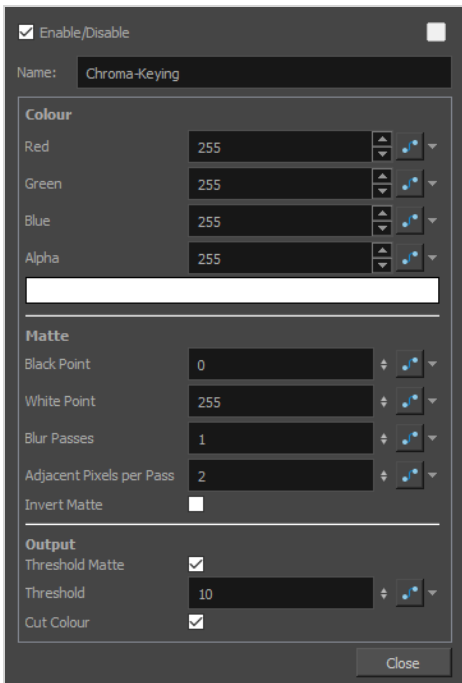
Properties

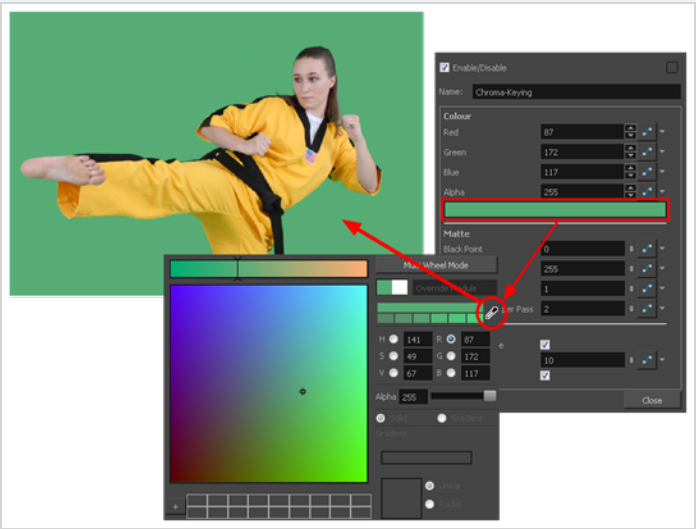

Parameter	Description
Name	Allows you to enter a name for the node.
Colour	
Colour	<p>The colour to filter out of the image. This should be set to the colour of the background in the image.</p> <ul style="list-style-type: none"> • Red: The red value of the background colour. • Green: The green value of the background colour. • Blue: The blue value of the background colour. • Alpha: The alpha value of the background colour.
Colour Swatch	Opens the Colour Picker dialog, in which you can visually select a colour for the effect.

Parameter	Description
	<p> TIP</p> <p>Since the Chroma Key node works better if its colour is set to the exact colour of the background of your image, it is recommended to open the Colour Picker dialog, then click and drag on the Dropper  and drop it over the background of your image to instantly select its background colour.</p> 
Matte	
Black Point	Increases the transparent (black) portion of the Chroma Key matte. This will reduce the edge of the visible image.

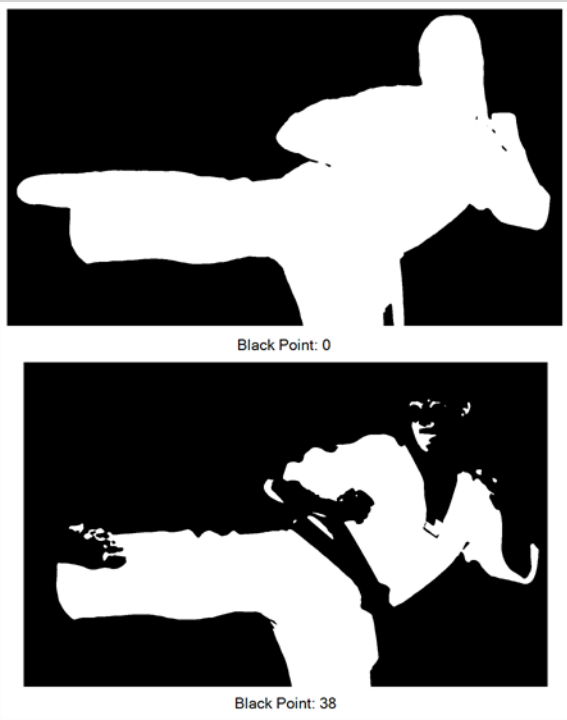
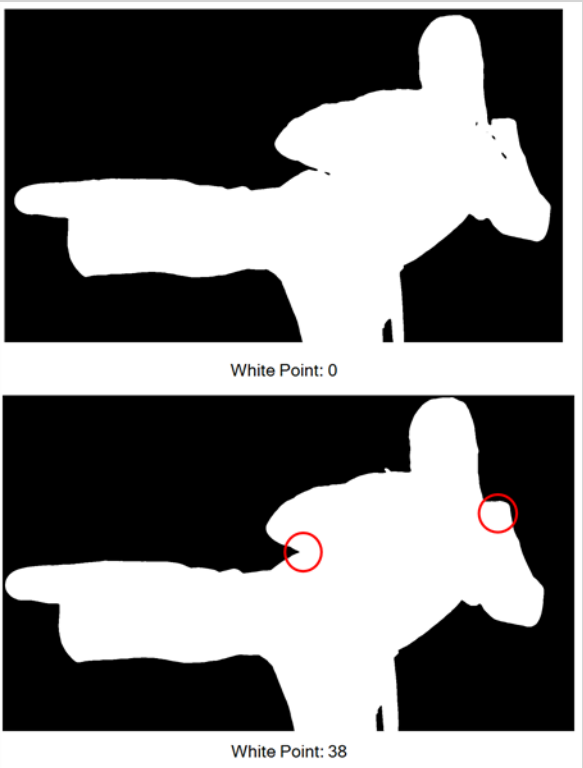
Parameter	Description
	
<p>White Point</p>	<p>Reduces the transparent (black) portion of the Chroma Key matte. This will increase the edge of the visible image.</p> 

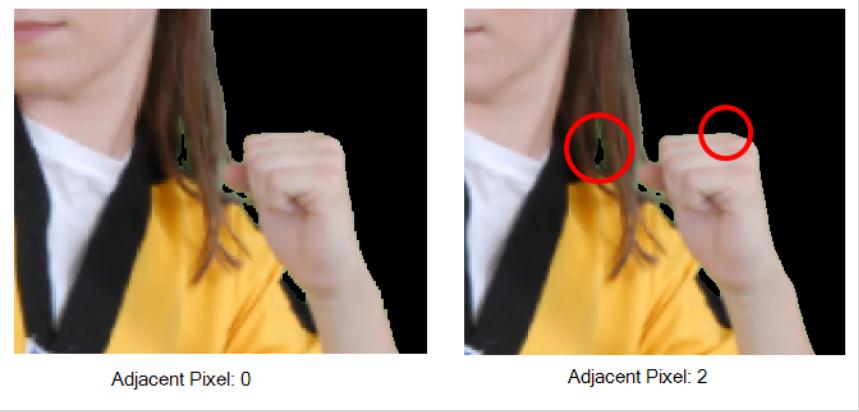
Parameter	Description
Blur Passes	<p>Allows you to set the number of times the input image is blurred before it is processed, which smooths out the small areas.</p> 
Adjacent Pixels per Pass	<p>When blurring the matte edge's with the Blur Passes parameter, the Adjacent Pixel parameter will blur the matte border with the next few pixels (amount indicated in the field) to create a nicer edge.</p> 
Invert Matte	<p>If a matte drawing is connected to the node, by default, only parts of the input image that intersect with opaque areas of the matte drawing are keyed out. If this option is enabled, only parts of the input image that intersect with transparent areas of the matte drawing are keyed out.</p>
Output	
Threshold Matte	<p>Applies a threshold (tolerance) to the selected colour to be removed. The Threshold amount is set in the Threshold field.</p>
Threshold	<p>Increases or decreases the tolerance for the selected colour to be removed from the image. The higher the value, the more coloured pixels will be considered in the Chroma-Keying matte. The pixel colour value will not have to be as close to the RGB value as the one selected in the colour swatch. A lower Threshold value means the RGB values must be closer to the selected colour in order to be part of</p>

Parameter	Description
	<div data-bbox="672 285 1414 604" style="text-align: center;"> </div> <p>the matte.</p>
Cut Colour	<p>Removes the selected colour from the image and leaves a transparent zone so you can see the background and other layers behind the image. If the option is disabled, the colour will remain, but an alpha channel is created that you can use with any other nodes with a a Matte input.</p>

Colour Banding Node

Use the Colour Banding effect to add a colour banding visual effect to your elements. The node will associate a flat colour to the different regions of your element. These regions are delimited according to the alpha values that are set up in the effect node and which will be recognized on the original element. You can use this effect to change the visual style of a particle node, for example, by giving it a more cartoonish look.

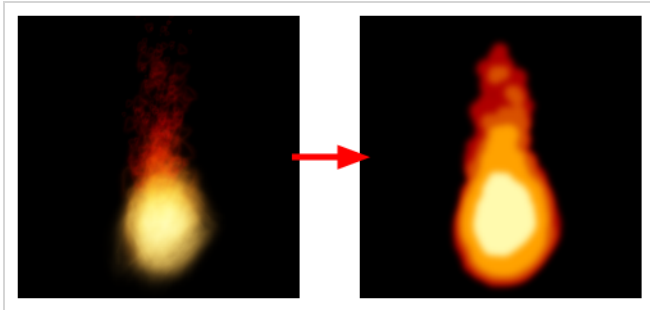

In this example, a Colour Banding node has been connected to a fire created with particle effects.

Refer to the following example to connect this effect:

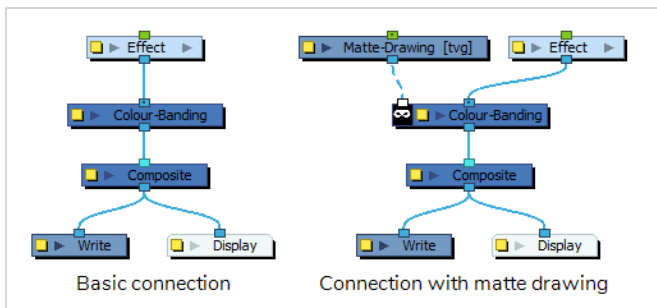

Properties

The Colour Banding node requires you to configure it with four colours, and to assign each of these colours with a threshold. Colours with a high threshold will replace brighter areas of the input image, and colours with a low threshold will replace its darker areas. Hence, the order in which you configure these colours does not matter.



TIP

If you only want to use 1, 2 or 3 colours, you can exclude a colour by setting its threshold to 100.

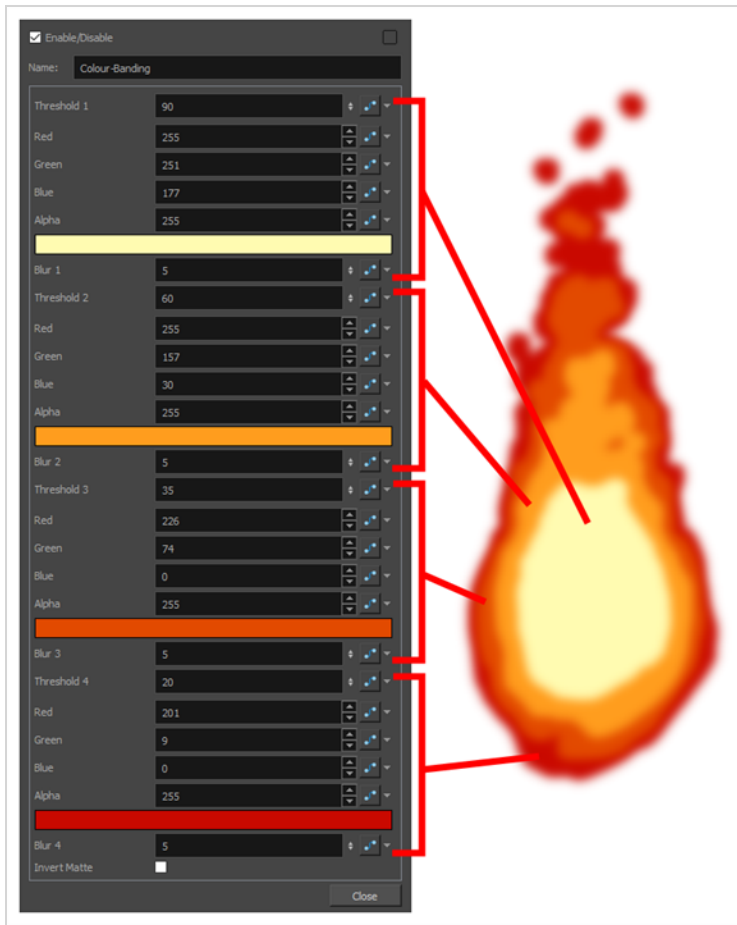

Parameter	Description
Name	The name of the node as it appears in the Node View and the Timeline view. Each node must have a name that is unique to its containing group.
Threshold	<p>The minimum value required in the source pixel for this colour to replace the source image colour. The threshold can be set to a value between 0 and 100. A high setting will make the colour replace brighter areas of the input image, whereas a low setting will make it replace darker areas.</p> <p>Colours are applied on the output image in order of their threshold. The colour with the lowest threshold is applied first, then the one with the second lowest threshold is applied over it, followed by the one with the second highest threshold and finally the one with the highest threshold.</p> <p>Setting this parameter to 100 will remove the colour from the effect, allowing you to use less than four colours if preferred.</p>
Colour	<p>The colour with which to fill the zone that exceeds the threshold:</p> <ul style="list-style-type: none"> Red: The amount of red in the colour.

Parameter	Description
	<ul style="list-style-type: none">• Green: The amount of green in the colour.• Blue: The amount of blue in the colour.• Alpha: The amount of alpha in the colour.
Colour Swatch	Opens the Colour Picker dialog, in which you can visually select a colour for the zone.
Blur	The amount of blurriness to apply to the zone.
Invert Matte	Inverts the matte used to generate the effect. By default, the effect is applied to the opaque areas of the matte drawing. When this option is enabled, the effect is applied to the transparent areas of the matte instead.

Colour Art Node

The Colour-Art effect lets you isolate the colour art in a layer. Placing a Colour Art node after a drawing node in the Node view only displays the Colour Art output. You can connect the Colour-Art node after nodes of any type. Any bitmap information will pass through the node and be processed.



This effect will only work if there is something on the Colour Art layer of the drawing.

Refer to the following example to connect this effect:

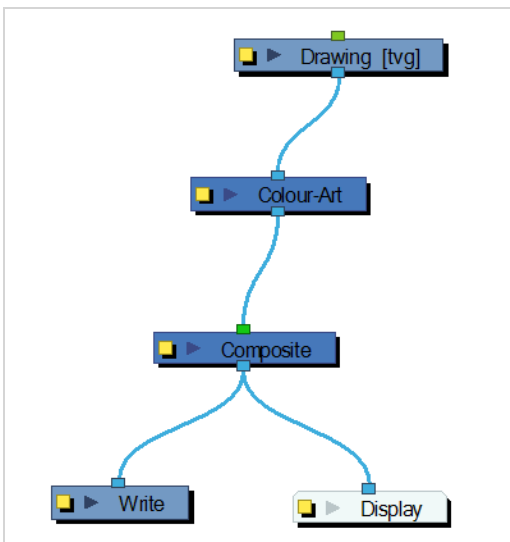

Properties

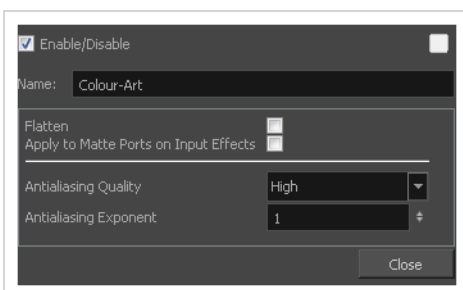

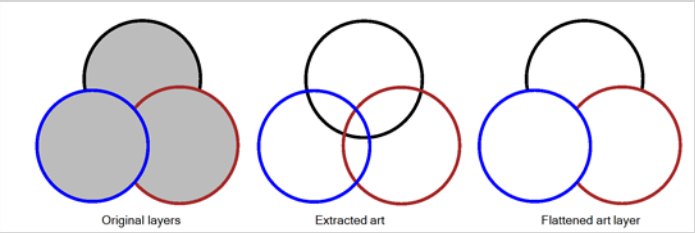
Parameter	Description
Name	Allows you to enter a name for the node.
Flatten	<p>When placing the node below a Composite node containing several drawing nodes, such as a cut-out character, you can use this option to flatten the extracted result. For example, when extracting a series of outlines, parts that may have been hidden by colour fills might now be visible. Enable the Flatten option to cut the extra artwork. Harmony will use the colour fills to cut unnecessary artwork. If your zones are not painted, nothing will be cut. This option works with both pencil lines and brush strokes.</p> 
Apply to Matte Ports on Input Effects	At times, you may have situations where your node is placed below a Cutter node using a mask input and a drawing input. By default, the effect only processes the colours in the drawing input. The mask drawing remains untouched. If you want to also filter the mask drawing, select the Apply to Matte Ports on Input Effects option.
Antialiasing Quality	Smoothness setting applied to Colour-Art. Choose from Low (no antialiasing), Medium Low, Medium and High (extensive antialiasing). The higher the setting, the greater the amount of antialiasing applied. Higher quality images require more time to render and more memory from your system. Use a lower quality when rendering a pencil test.
Antialiasing Exponent	Controls the extent of the area around the Colour-Art edges used in the antialiasing process. A higher value uses less area, resulting in sharper edges, while a lower value uses more area, resulting in softer edges. If the Antialiasing Quality value is set to Low (no antialiasing), this value is ignored.

Colour Curves Node Properties

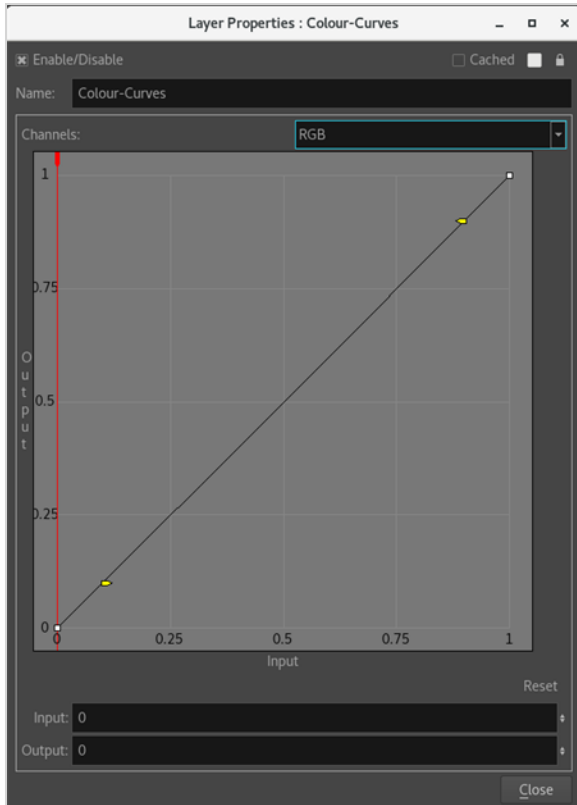

The Colour Curves properties presents a 4x4 grid. Since the Input and Output values are separated within a range of 0 and 1, which 0 represents 0% and 1 represents 100%, each line of the grid represents a graduation of 25%.

By moving the control points and handles of the diagonal line that goes through the 4x4 grid, you can modify the curve and create a more progressive setup. But the main distinction between the Colour Curves node and the Colour Levels node is the possibility to add more control point to the curve, which lets you create a more complex setup that gives you more control over the image.

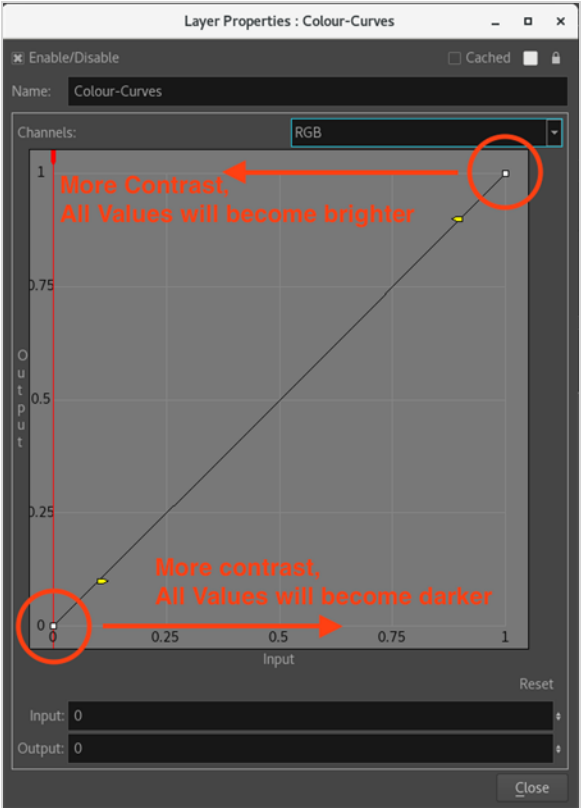

Parameter	Description
Enable/Disable	Allows you to enable or disable the node. When disabled, a node has no visible effect on the rendered image, nor on the preview in the Camera, Perspective, Side, and Top views.
Colour Swatch	Sets the colour of the layer in the Timeline view and of the node in the Node view.
Name	Allows you to change the name given to the node.
Channels	Lets you select which channel you want to modify: <ul style="list-style-type: none"> • RGB: Lets you modify every colour channel (red, green and blue) at the same time with a

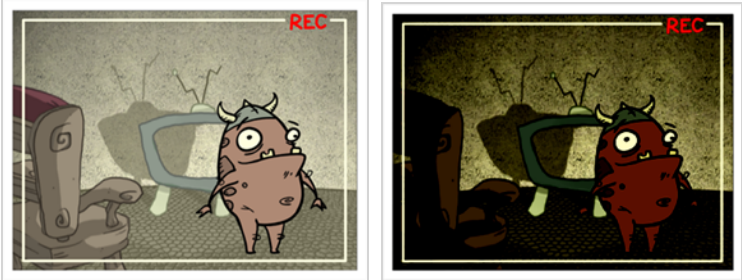
Parameter	Description
	<p>single curve.</p> <ul style="list-style-type: none"> • Red: Lets you modify only the red channel. • Green: Lets you modify only the green channel. • Blue: Lets you modify only the blue channel. • Alpha: Lets you modify only the alpha channel.
Input	<p>Lets you reduce the range of the input colours (by dragging left and right).</p>  <p>Modifying the first control point to a higher input value will create a more contrasted version of the picture. If the value is set near 1, every medium colour will become darker, extremely light colours will stay visible and white will remain white. Once the input is set to 1, only the white colour will remain.</p> <p>For example, the first control point has an output of 0 and an input of 0.5 instead of 0.</p>

Parameter	Description
	<div style="display: flex; justify-content: space-around; align-items: center;">  </div> <p>Modifying the last control point to a smaller input value will create a more contrast version of the picture. If the value is set near 0, medium colours will become brighter, extremely dark colours will stay visible and black will remain black. Once the input is set to 0, only the white colour will remain.</p> <p>For example, the first control point has an output of 1 and an input of 0.5 instead of 1.</p> <div style="display: flex; justify-content: space-around; align-items: center;">  </div>
Output	<p>Reducing the range of the output colours (dragging up and down) will reduce the levels in the output image but will not clamp the upper and lower pixels (by interpolating the values to a lower overall range). The perceived contrast might drop, but that's only because the overall levels in the image have been reduced.</p>

Parameter	Description
	<div data-bbox="402 281 980 1087" data-label="Image"> </div> <p data-bbox="402 1119 1365 1184">Modifying the first control point to a higher output value lets you transform the image to a brighter version of it. The contrast in the picture will mostly remain the same.</p> <p data-bbox="402 1207 1321 1236">For example, the first control point has an output of 0.5 instead of 0 and an input of 0.</p> <div data-bbox="406 1262 1133 1541" data-label="Image"> </div> <p data-bbox="402 1575 1370 1640">Modifying the last control point to a smaller output value lets you transform the image to a darker version of it. The contrast in the picture will mostly remain the same.</p> <p data-bbox="402 1663 1321 1692">For example, the last control point has an output of 0.5 instead of 1 and an input of 1.</p>

Parameter	Description
	
Reset	<p>Lets you reset all values of the first and last control point. It will also remove every added control point.</p>

Colour Fade Node

The Colour-Fade effect allows you to animate a change in colours for an element in your scene.

The Colour-Fade node works a lot like the Colour-Override node, in that it allows you to replace the palettes used by elements in your scene with different palettes, and to replace individual colours with different colours. But it also has a “Fade” function, that has a value between 0 and 100, which interpolates between the original colours and the replacement colours. Hence, by animating this function to go from 0 to 100 over a couple frames, you can animate the transition between the original colours and the replacement colours.

Connection

To use the Colour-Fade node, simply connect it under the element, effect or composite on which you want to perform a colour fade. The Colour-Fade node will take the image sent to its input (top) port, and output the image with the colour fade applied to it through its output (bottom) port.

Just like the Colour-Override node, the Colour-Fade node works by travelling up the node system to replace the colours in the vector artwork. Hence, it does not work with bitmap images, but it does work with vector images connected to bitmap composites and bitmap effects.

Properties

The Layer Properties for the Colour-Fade node are similar to the Colour-Override node, except that it has a Fade function and does not support overriding textures.

General Properties

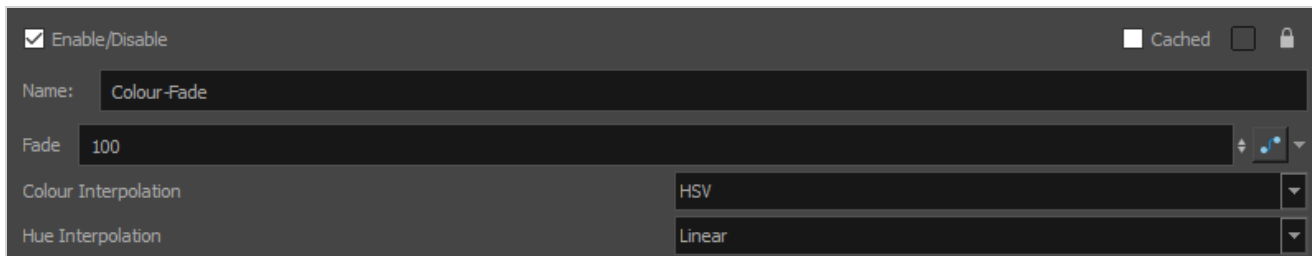

Parameter	Description
Name	The name of the node as it appears in the Node View and the Timeline view. Each node must have a name that is unique to its containing group.
Fade	An animatable function for the percentage of interpolation between the input image's original colours and the override colours. This parameter can be set to any value between 0 and 100. At 0, the input image preserves its original colours. At 100, the input image's colours are fully replaced by the override colours. At 50, the input image's colour are interpolated halfway towards the override colours.

Parameter	Description
Colour Interpolation	<p>This allows you to customize how the interpolation between the original colours and the override colours is calculated.</p> <p>By default, colours are interpolated in RGB mode, which means that the red, green and blue values are interpolated from their original values to their override values directly. This may not produce the best results. You can choose between the following colour spaces:</p> <ul style="list-style-type: none"> • RGB (Red, Green & Blue): Interpolates from the original colour's red, green and blue values to the override colour's red, green and blue values. • HSV (Hue, Saturation, Value): Interpolates from the original colour's hue, saturation and value to the override colour's hue, saturation and value. • HSL (Hue, Saturation, Lightness): Interpolates from the original colour's hue, saturation and lightness to the override colour's hue, saturation and lightness. <div data-bbox="386 772 1430 940" style="border: 1px solid green; padding: 5px;">  NOTE This parameter is not related to the colour space management functionalities of Harmony, such as your scene's colour space or the rendering colour space. </div>
Hue Interpolation	<p>This option allows selecting the type of interpolation used for the hue value and is available when the Colour Interpolation is set to HSL or HSV. The following options are available:</p> <ul style="list-style-type: none"> • Linear: Interpolates the hue value linearly between 0 and 360. Provided for legacy reasons. • Circular Shortest: Linear hue value interpolation from the source colour to the destination colour using the shortest distance, passing through 360 to 0, and vice versa if shortest. • Circular Clockwise: Clockwise value interpolation, wrapping around 360 to 0 if necessary. • Circular Counterclockwise: Counterclockwise value interpolation, wrapping around 0 to 360 if necessary.

Palette Overrides

This section of the Colour-Fade node allows you to fade from the input image's original palettes to alternate palettes.

For this to work, the colour swatches in the original palette and in the alternate palette must have the same colour IDs. This can be achieved in one of the following ways:

- By "cloning" the palette, a new palette is created with swatches that have the same colour IDs. You can modify the colours in a cloned palette without affecting the colours in the original palette. Hence, you can fade from a palette to its clone.

To clone a palette, right-click on that palette in the Palettes list of the Colour view, and select Clone in the context menu.

- By “cloning” the original colour swatches to a different palette. This can be useful in the case where you already cloned a palette, but added a new swatch to the original palette. You can clone the new swatch to the cloned palette and give it a different colour if needed.

To clone a colour swatch, right click on that swatch in the Colour view and select Copy in the context menu. Then, select the palette where you want to clone the swatch, right-click in the swatches list and select Paste As Clones in the context menu.

Icon	Parameter	Description
	Add database palette	<p>Allows you to add a palette that is located anywhere in your Harmony Server database to the list of palettes that can be used as overrides.</p> <p>If you're working on an Harmony Stand Alone scene, this allows you to add a palette that is located in your scene's environment, job, scene or element palettes to the list of palettes that can be used as overrides.</p> <div style="border: 1px solid green; padding: 5px; margin-top: 10px;">  <p>NOTE Typically, a Harmony Stand Alone scene only has environment and job palettes if it was exported from a Harmony Server database with those palettes.</p> </div>
	Add filesystem palette	Allows you to add a palette that is located anywhere in your workstation's file system to the list of palettes that can be used as overrides.
	Palettes	The list of palettes that can be added to the Whole Palette Overrides list. By default, this list contains all of the scene palettes as well as palettes linked to the elements affected by the Colour-Fade effect. Palettes can also be added using the Add database palette and Add filesystem palette buttons above.
	Delete current palette entry	Removes the currently selected palette from the Whole Palette Overrides list.
	Whole Palette Overrides	<p>The list of palettes that will override the palettes in the input image. When a palette is added to this list, any colour in the input image that has the same colour ID as any colour in one of the palettes in the list will be replaced with the colour in that palette.</p> <p>For example, if your character uses the palette MyCharacter_Day, and you've cloned that palette to create an alternate palette for this character named MyCharacter_Night, adding MyCharacter_Night to this list will make the Colour-Fade effect fade all of the colours from</p>

Icon	Parameter	Description
		<p>MyCharacter_Day to the colours in MyCharacter_Night.</p> <p>You do not need to add the original palette to any list in the Colour-Fade's layer properties. As long as the colours in the override palette have the same colour IDs as the ones used in the input image, the Colour-Fade node will find the original colours and replace them—see Palette Overrides on page 615.</p> <p>To add a palette to this list, select it in the Palettes list, then click on the Add button between the two lists.</p>

Individual Colour Overrides

This section allows you to fade specific colours in the input image to new custom colours.

Icon	Parameter	Description
	Colours Eyedropper	<p>Allows you to pick a colour from the Camera or Drawing views. To do this, click on the icon once, then click on the colour you want to select in the Camera or Drawing view. The colour's palette will become selected in the Palettes list, and the colour swatch itself will become selected in the Colours list.</p> <div style="border: 1px solid #c8e6c9; padding: 10px; margin-top: 10px;"> <p> NOTE</p> <p>If the colour you clicked on is not in one of the palettes listed in the Palettes list, it will not be selected. By default, the Palettes list only list palettes that are used by the input image of the Colour-Fade node, so make sure the node is properly connected to its input image in the Node View.</p> </div>
	Colours	The list of colours in the palette selected in the Palettes list in the section above. Allows you to select which colour to add to the Individual Colour Overrides list.
	Add	Adds the selected colour from the Colours list to the Individual Colour Overrides list.
	Delete current entry	Removes the currently selected colour from the Individual Colour Overrides list.
	Individual Colour Overrides	<p>The list of colours in the input image that the Colour-Fade effect must override. To add a colour to the list:</p> <ol style="list-style-type: none"> 1. Select the palette containing the colour in the Palettes list in the top left corner. 2. Select the colour to override in the Colours list in the bottom left corner.

Icon	Parameter	Description
		<p>3. Click on the Add button between the Colours list and the Individual Colour Overrides list.</p> <p>The selected colour will be added to the list. To select what to do with this colour:</p> <ol style="list-style-type: none"> Click on the drop-down arrow in the Mode column and select one of the following: <ul style="list-style-type: none"> Override Colour: If this colour is overridden by one of the palettes in the Whole Palette Overrides list, this option will prevent this specific colour from being overridden. Colour Not Visible: Fades out the selected colour. New RGB Only: Fades the selected colour to a new colour with custom red, green and blue values, without affecting the colour's alpha value. New Alpha Only: Changes the colour's alpha value without affecting its red, green and blue values. New RGBA: Fades the selected colour to a new colour with custom red, green, blue and alpha values. If you've selected New RGB ONLY, New Alpha Only or New RGBA, click on the colour swatch in the New column to open a Colour Picker dialog in which you can select the new colour to replace the selected colour with.

Render Selected Colours Only

This section allows you to make the Colour-Fade node make all but a sub-set of colours in the input image fade out.

Icon	Parameter	Description
	Colours Eyedropper	<p>Allows you to pick a colour from the Camera or Drawing views. To do this, click on the icon once, then click on the colour you want to select in the Camera or Drawing view. The colour's palette will become selected in the Palettes list, and the colour swatch itself will become selected in the Colours list.</p> <div style="border: 1px solid green; padding: 10px; margin-top: 10px;"> <p> NOTE</p> <p>If the colour you clicked on is not in one of the palettes listed in the Palettes list, it will not be selected. By default, the Palettes list only list palettes that are used by the input image of the Colour-Fade node, so make sure the node is properly connected to its input image in the Node View.</p> </div>

Icon	Parameter	Description
	Colours	The list of colours in the palette selected in the Palettes list in the section above. Allows you to select which colour to add to the Render Selected Colours Only list.
	Add	Adds the selected colour from the Colours list to the Render Selected Colours Only list.
	Delete current entry	Removes the currently selected colour from the Individual Colour Overrides list.
	Render All / Render Selected Colours Only drop-down	<p>This drop-down allows you to select whether Render Selected Colours Only mode of the Colour-Fade node is enabled:</p> <ul style="list-style-type: none"> • Render All: All colours in the input image are rendered. • Render Selected Colours Only: Only the colours in the Render Selected Colours Only list are rendered, regardless of whether or not they are overridden with a different colour. Other colours are filtered out and appear invisible.
	Apply to Matte Ports on Input Effects	If the output image of the Colour-Fade effect is connected to the Matte port of any effect, by default, even if the Colour-Fade effect is configured to only render selected colours,
	Individual Colour Overrides	<p>The list of colours in the input image that the Colour-Fade effect must override. To add a colour to the list:</p> <ol style="list-style-type: none"> 1. Select the palette containing the colour in the Palettes list in the top left corner. 2. Select the colour to override in the Colours list in the bottom left corner. 3. Click on the Add button between the Colours list and the Individual Colour Overrides list. <p>The selected colour will be added to the list. To select what to do with this colour:</p> <ol style="list-style-type: none"> 1. Click on the drop-down arrow in the Mode column and select one of the following: <ul style="list-style-type: none"> • Override Colour: If this colour is overridden by one of the palettes in the Whole Palette Overrides list, this option will prevent this specific colour from being overridden. • Colour Not Visible: Areas filled with the selected colour become invisible. • New RGB Only: Areas filled with the selected colour fade to a new colour with custom red, green and blue values, but the colour's alpha value remain unchanged. • New Alpha Only: Areas filled with the selected colour value fade to the

Icon	Parameter	Description
		<p>same colour with a different alpha value.</p> <ul style="list-style-type: none">• New RGBA: Areas filled with the selected colour fade to a new colour with custom red, green, blue and alpha values. <p>2. If you've selected New RGB ONLY, New Alpha Only or New RGBA, click on the colour swatch in the New column to open a Colour Picker dialog in which you can select the new colour to replace the selected colour with.</p>

Colour Levels Node

The Colour Levels node allows you to adjust the levels in an element in your scene or for your entire scene. The levels can be adjusted for all the colour channels, for a specific colour channel or even for the alpha channel.

Colour Levels are a way to fine tune the balance of black and white in an image. A good way to illustrate how levels work is by taking a scanned pencil drawing. When you look at a clean pencil drawing in real life, your eyes will mostly see clean outlines unless you focus on the erroneous details on purpose. A scanner will however pick up on the details indiscriminately, resulting in smudges and feathered pale outlines. By tweaking the input levels of an image, you can process a pencil drawing like so:

- Increasing the Input Black level will make the darkest parts of the drawing black, or closer to black. This results in darker, crisper outlines.
- Decreasing the Input White level will make the lightest parts of the drawing white, or closer to white. This results in removing smudges. Also, if the background is grey, it will turn white.

By tweaking the output levels of an image, you can perform the reverse effect:

- Increasing the Output Black level will make the black pixels in the drawing appear lighter. All other pixels in the drawing will also appear lighter, but the closer to white they are, the less lightness is added to them. This can result in grey outlines.
- Decreasing the Output Black level will make

Connection

To use the Colour Levels node, simply connect it under the element, effect or composite to which you want to apply the levels effect. The node will take the input image from its top port, apply the level settings to it and output the modified image out of its bottom port.

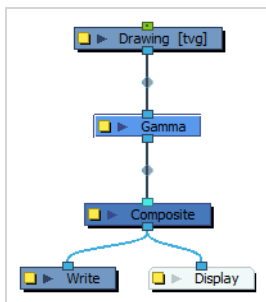

Properties

The Colour-Levels node has five tabs, each with the same parameters. What is different between tabs is the colour channels that they affect:

- The **RGB** is for adjusting the levels of all colours.
- The **Red**, **Green** and **Blue** tabs is for adjusting the levels of a single one of these three colour channels.
- The **Alpha** tab is used for adjusting the level of the Alpha channel.

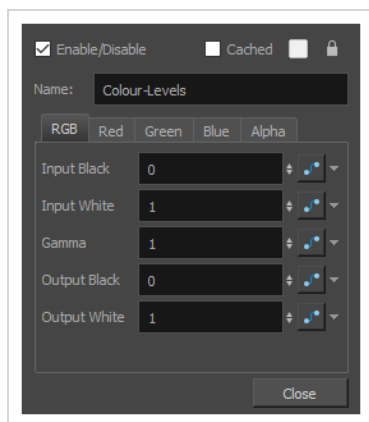

Parameter	Description
Name	The name of the node as it appears in the Node View and the Timeline view. Each node must have a name that is unique to its containing group.
Input Black	The level under which a colour value is rendered as black. This varies between 0 and 1 and is set to 0 by default. At 0, only a colour with a level of 0 is rendered as black. At 1, all colours are rendered as black. At 0.5, all colours with a level between 0 and 0.5 are output as black, and colours with a level between 0.5 and 1 are rendered darker, proportionally to how close they are to 0.5.
Input White	The level past which a colour value is rendered as white. This varies between 0 and 1 and is set to 1 by default. At 1, only a colour with a level of 1 is rendered as white. At 0, all colours are rendered as white. At 0.5, all colours with a level between 0.5 and 1 are rendered as white, and colours with a level between 0 and 0.5 are rendered lighter, proportionally to how close they are to 0.5.
Gamma	<p>The gamma correction to apply to the colours after the input levels are applied and before the output levels are applied.</p> <p>Gamma correction is a curvilinear function applied to the colour values. It is used to modulate the difference in intensity between colour values. In other words, it affects how much differences between low, medium and high colour values translate to actual variations of intensity between colours. For example:</p> <ul style="list-style-type: none"> • A gamma correction between 0 and 1 will make low values lower progressively lower, causing a bigger spectrum of dark colours to appear closer to black. The contrast between high values is increased to compensate. • A gamma correction above 1 will increase the value of dark colours proportionally to their actual values, increasing the contrast between them and making them lighter. The contrast between high values is decreased to compensate.
Output Black	The level at which black is output in the image. This varies between 0 and 1 and is set to 0 by default. For example, if you set this to 0.5, then black pixels in the image will actually appear gray, and all pixels will be made lighter proportionally to how close to black they are.

Parameter	Description
Output White	The level at which white is output in the image. This varies between 0 and 1 and is set to 1 by default. If you set this to 0.5, white pixels in the image will appear grey, and all other pixels will be made darker proportionally to how close to white they are.

Colour-Override Node

The Colour-Override effect processes the colours in a drawing layer. Using this effect, you can change colours from the palette without affecting the actual palette, swap clone palettes, or even replace a specific colour zone. You can also substitute colour areas with bitmap textures. The drawings in this layer must be .svg files as the Colour-Override uses the colour palettes linked to them.

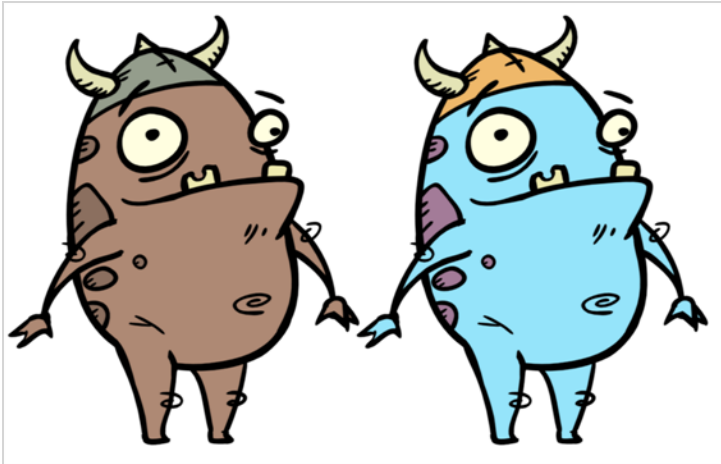

The Colour-Override effect lets you:

- Change colour values in drawings during the compositing process.
- Use colour values from a specific colour palette in the palette list.
- Establish the priority of override palettes in the palette list. For example, you may have different clones of the same palette, such as a daytime and nighttime version.
- Isolate specific areas of a drawing by selecting certain colours. For example, using specific colours to generate a matte for a glow effect.
- Hide certain colours.

Refer to the following example to connect this effect:

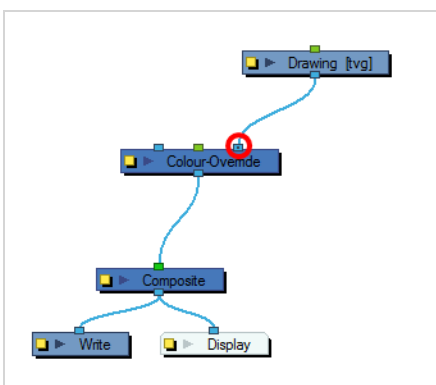

Interface

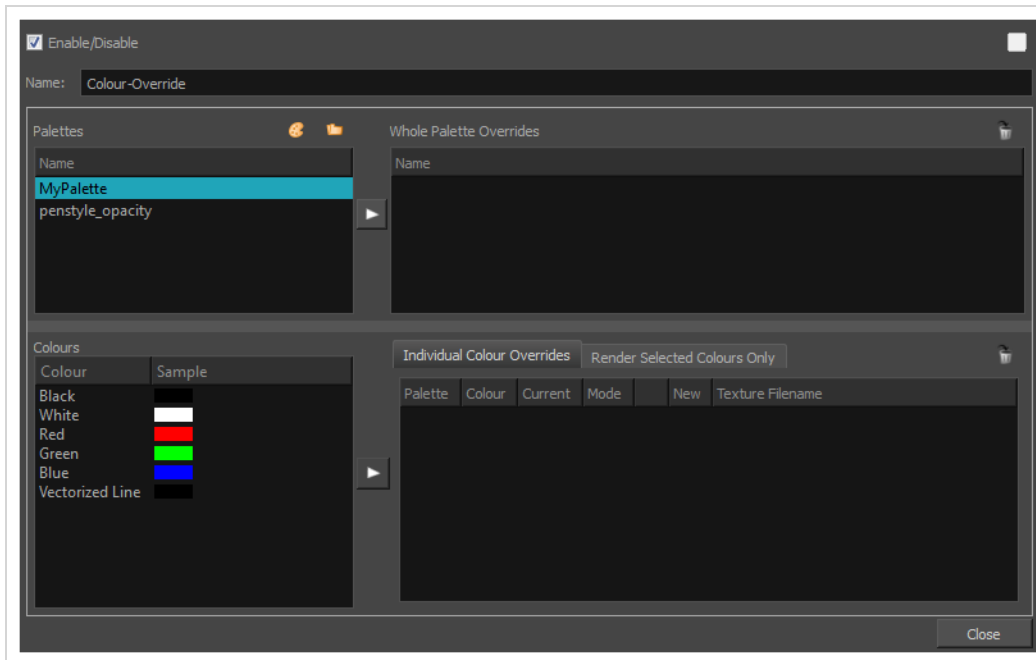

Palettes

The Palettes section displays the palettes in the palette list of the selected layer. You can move these palettes into the Whole Palette Overrides section to reorder them. If you have cloned palettes, the higher one in the list will override the others. This is useful for overriding the clone palette ordering set in the scene through the Colour view.

You can load additional palettes in the palette list from either your project, by clicking on The Palette 🎨 button, or your computer by clicking on the Browse 📁 button.

- The Palette 🎨 button allows you to load a palette contained within the project hierarchy (Environment, Job, Scene and Elements).
- The Browse 📁 button allows you to load a palette located outside the project hierarchy, anywhere on your system or server. If you link to a palette outside of your project, you will be prompted with the following warning message:

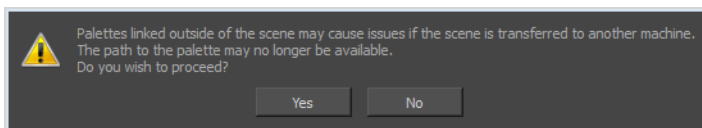

You can hover your mouse over the palette name in any of the override sections to display the path to the palette.

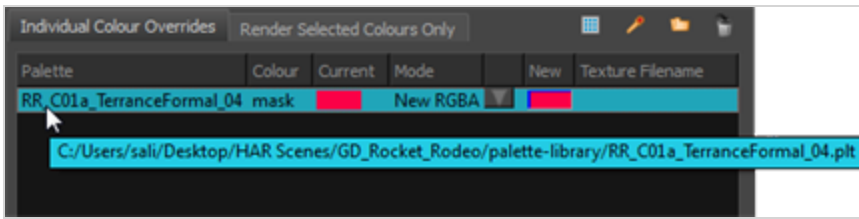

Colours

The Colours section displays the colour swatches of the selected palette. Move a swatch into the Colour-Overrides section to change its value.

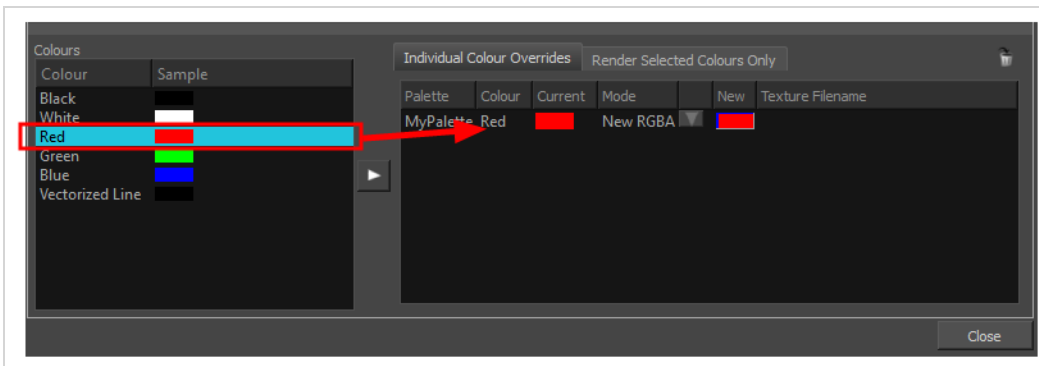

Whole Palette Overrides

The Whole Palette Overrides section forces the use of a particular palette (clone palette) or palette list ordering during the compositing process. You must drag palettes from the Palettes section to change their order. Harmony uses the palettes in the order they appear in the palette list to find the colour values associated with the colour IDs of each colour zone. To apply a different version of a colour palette to, for example, switch from a day to a night palette, use the Override section to change the order of the colour palettes (you must be working with cloned palettes).

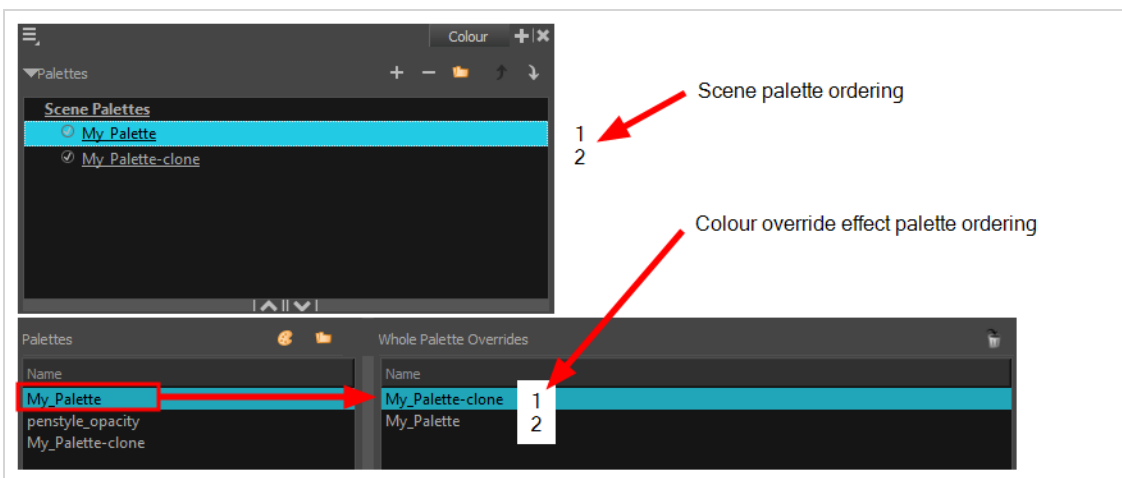

Individual Colour Overrides

When you drag a swatch from the Colours section to this section, you can override its value. You can also override a colour with a texture. The default override mode is set to New RGBA so you can override the RGB value as well as the transparency value.

The Current column always displays the colours from the currently active palette. Selecting a clone palette in the Palettes area will not change the colours if you haven't changed the active palette in the Whole Palette Overrides section. The update will be done once you close and reopen the Colour Override Layer Properties window.

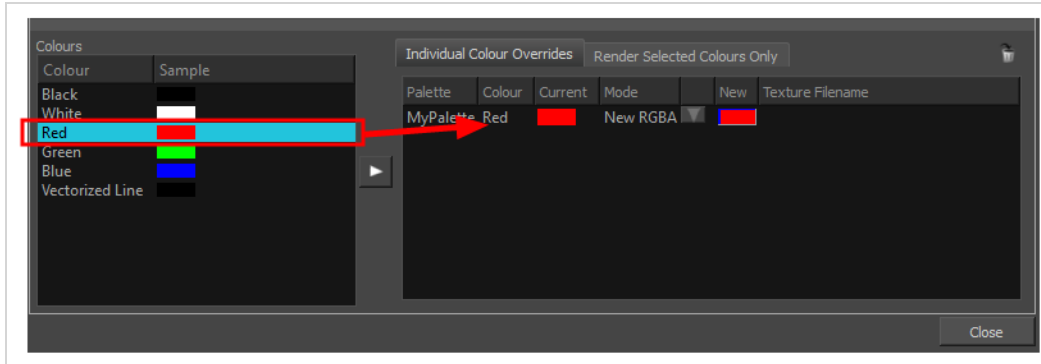

Render Selected Colours Only

The Render Selected Colours Only section is used to display some colours and ignore all others. You may, for example, want to display only the colour used for the character outline and ignore all the filling colours.

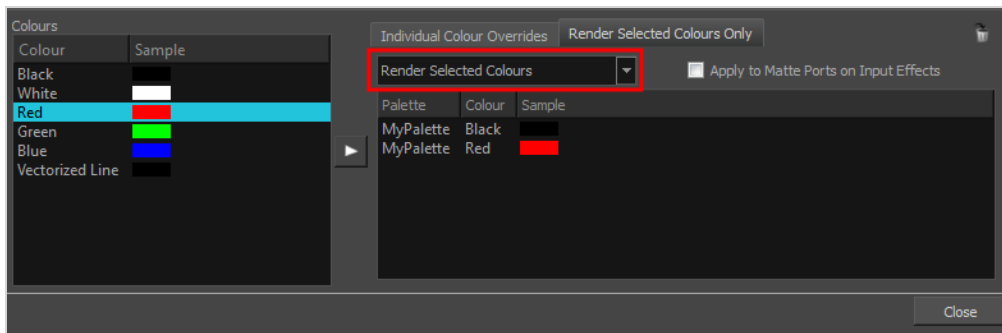

Only the colour swatches listed in the Rendered Selected Colours Only section will be rendered. The option is not activated by default. If you want to display only the selected colours, you must select the correct option from the Rendering menu:

- **Render All:** This is the default option. All colours in the palettes are rendered regardless of the listed selection. This allows you to quickly switch back and forth between your selection of colours and all the colours without having to delete and add your swatches from and to the list.
- **Render Selected Colours:** When this option is selected, the Colour Override module displays only the colours listed in your selection.

- **Rendered Selected Colours and Bitmaps:** This option displays all colours listed as well as any bitmap images passing through the Colour Override node. For example, if you have a Composite node grouping a series of drawing and bitmap nodes, the vector colours will be filtered through the Colour Override nodes but the bitmap images will pass through without being affected. Note that you must be in Render View mode to see the colours and bitmaps.

You might have situations where your Colour Override node is placed below a Cutter node using a mask input and a drawing input. By default, the Colour Override only processes the colours in the drawing input. The mask drawing remains untouched. If you want the Colour Override to also filter the mask drawing, select the **Apply to Matte Ports on Input Effects** option.

Colour-Scale Node

The Colour-Scale effect offsets an image's colours. This effect is useful in creating ambient transitions, such as from daytime to nighttime.

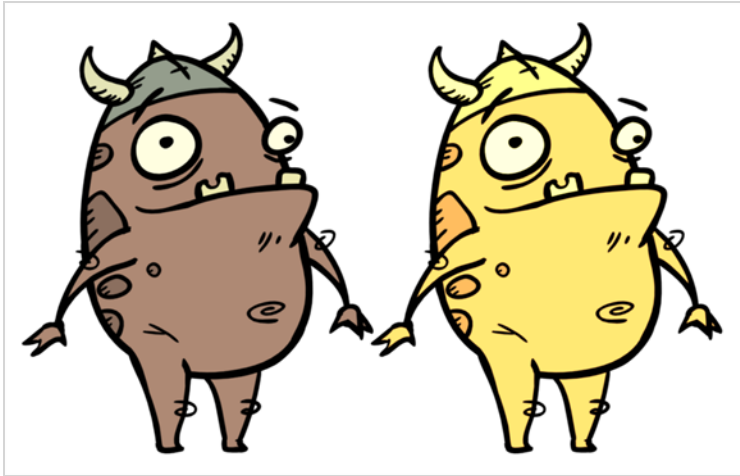

Refer to the following example to connect this effect:

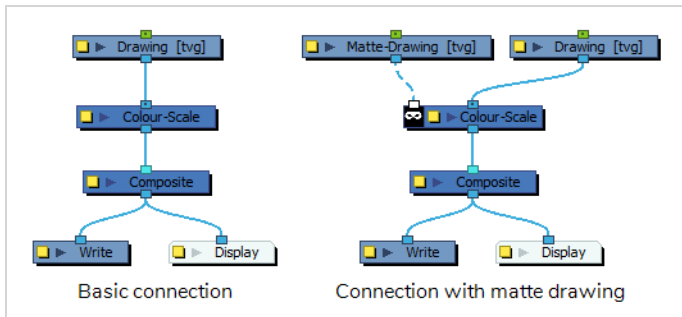

Properties

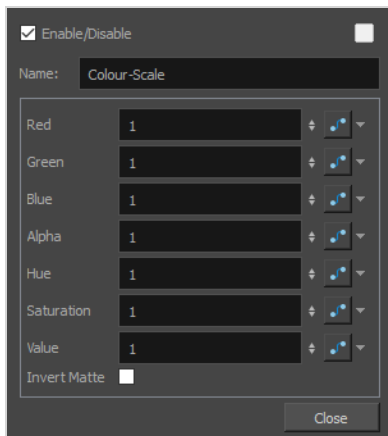

Parameter	Description
Name	The name of the node as it appears in the Node View and the Timeline view. Each node must have a name that is unique to its containing group.
Red	The factor by which to multiply red values in the image.
Green	The factor by which to multiply green values in the image.
Blue	The factor by which to multiply blue values in the image.
Alpha	The factor by which to multiply alpha values in the image.
Hue	The colour or hue to offset the image.
Saturation	The amount of colour to offset the image.
Value	<p>Enter the value for the colour to offset the image. The actual colour values of the image are not changed; instead, the channels are multiplied by a selected amount. For example:</p> <ul style="list-style-type: none"> • A value of 1 does not change the colour values. • A value greater than 1 brings the colour channel value closer to 255 (or white). • A value less than 1 brings the colour channel value closer to zero (0 or black).
Invert Matte	Inverts the matte used to generate the effect. By default, the effect is applied to the opaque areas of the matte drawing. When this option is enabled, the effect is applied to the transparent areas of the matte instead.

Colour Selector Node

The Colour-Selector node filters colours in the input image and outputs an image containing only the selected colours. The colours to display can be selected in the Layer Properties of the Colour-Selector.

The Colour-Selector does not just cut out the colours that are not selected from the input image, it outputs the image it is connected to as if these colours were invisible. Hence, if two brush strokes with different colours overlay each other, and the colour of the overlaying brush stroke is filtered out, the underlay brush stroke will not be cropped, it will display as if the overlay stroke did not exist.

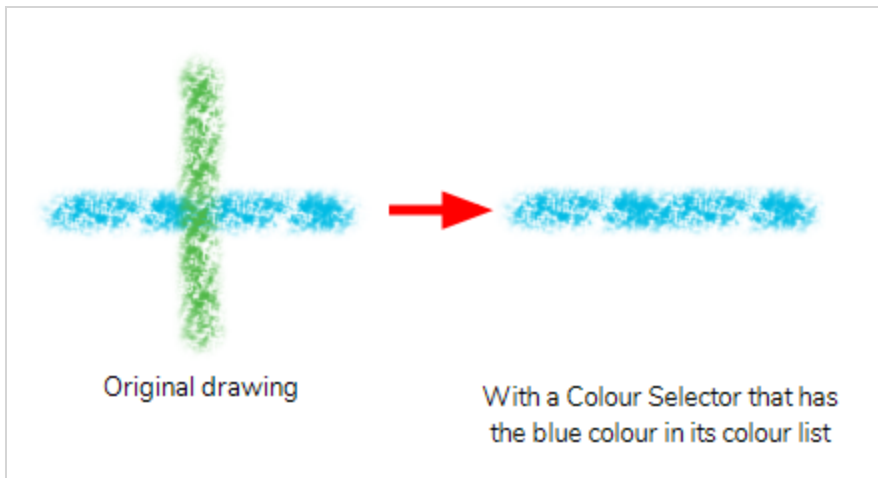

NOTE

The Colour-Selector node works exactly as when using the Render Selected Colours Only tab of the Colour Override node, except that it is made for that specific purpose, allowing the use of this feature to be more simple and streamlined.

Connection

To use the Colour-Selector, simply connect it as the intermediary between an image output (such as a drawing or composite's output port) and an image input (such as a composite's input port):

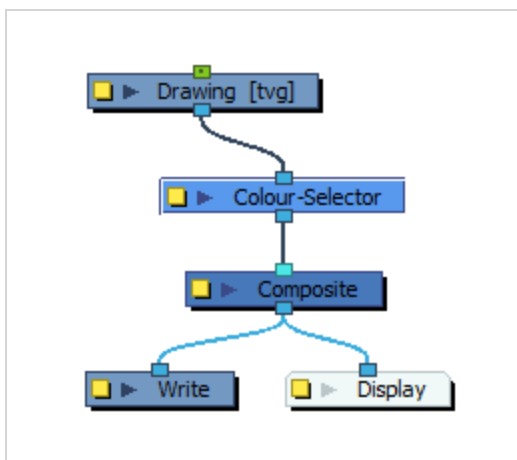

The Colour-Selector node will take the input image and output the image without the colours that are not in its colours list in its layer properties. By default, no colours are in the Colour-Selector's list, so the output image will be completely invisible until colours are added.

Properties

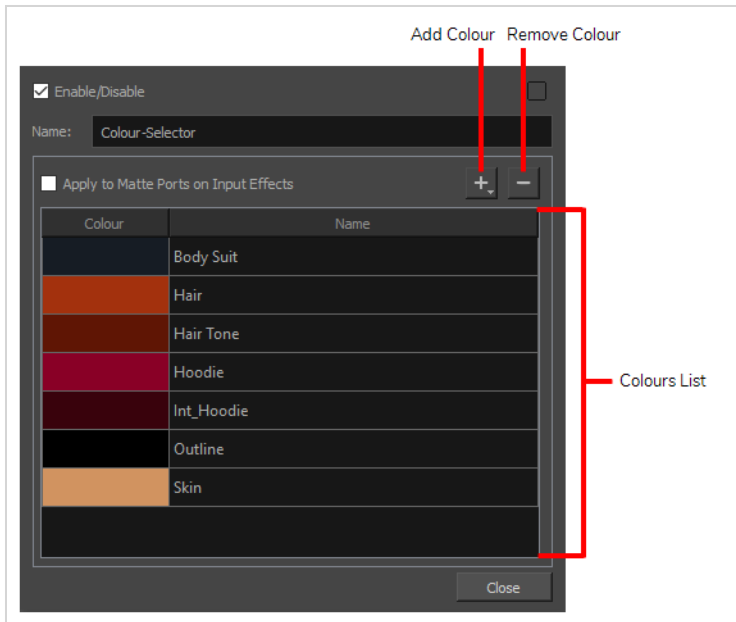

Parameter	Description
Name	The name of the node as it appears in the Node View and the Timeline view. Each node must have a name that is unique to its containing group.
Apply to Matte Ports on Input Effects	By default, the Colour-Selector does not filter out colours in drawings that are connected to the matte port of a node. This is because drawings connected to a matte port are used for their shape and transparency levels, and not their colours. If this option is checked, the Colour-Selector will filter out the colours that are not in the list, even in drawings that are connected to a matte port.
Add Colour Menu	The Add Colour menu allows you to add colours to the list of selected colours. You must add colours to the list for the Colour-Selector to know which colours to let through. <div data-bbox="560 1640 950 1902" data-label="Image"> </div>

	<p>The Add Colour menu has three sections:</p> <ul style="list-style-type: none"> • The palette list: The first section lists all palettes in the scene. When you select one of the palettes, it will list all the colours in that palette. This allows you to add any colour available in your scene to the list of selected colours. • The drawing list: The second section lists all drawings connected to the Colour-Selector node. When you select a drawing, it will only list the colours used by that drawing. This allows you to quickly select a colour that is used by one of the drawings being filtered, without having to go through every colour in the scene. • Add All Colours: This option will instantly add all colours used by all drawings connected to the Colour-Selector node. You can then remove the colours you want to hide using the Remove Colour button. This can be useful if you only want to filter out a few of many colours.
Remove Colour	Removes the selected colour from the list.
Selected colour list	The list of colour that the Colour-Selector will let through. Every other colour in the input image will be filtered out.

Contrast Node

Use the Contrast effect to increase or decrease the level of contrast in an image. This is done by changing the contrast in the dark and bright pixels and setting the transition point between dark and bright.

You can enter static values in the dialog box fields or you can attach these values to function curves to change over time.

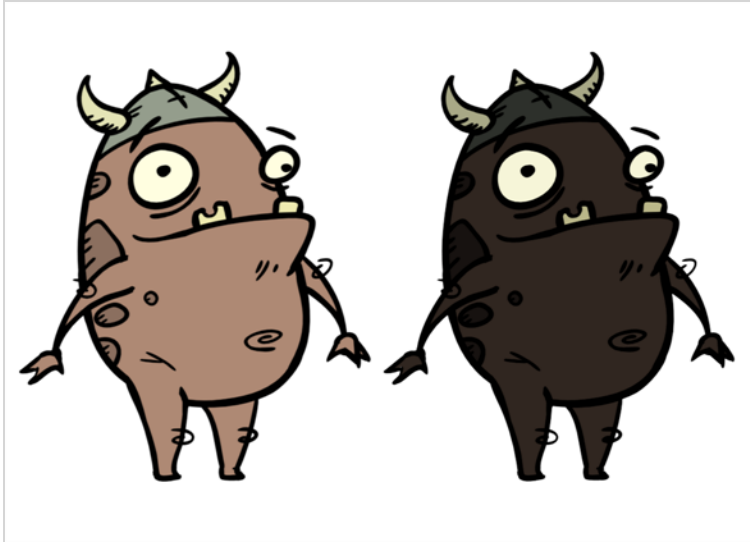

Refer to the following example to connect this effect:

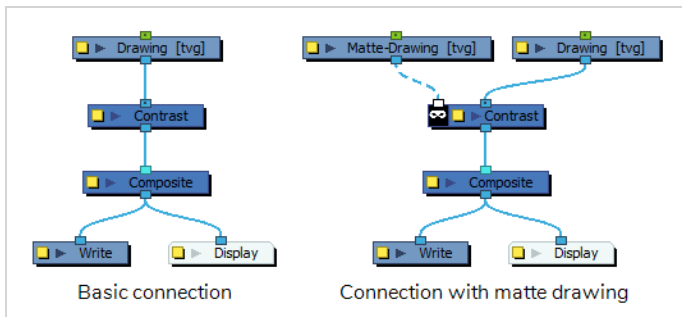

Properties

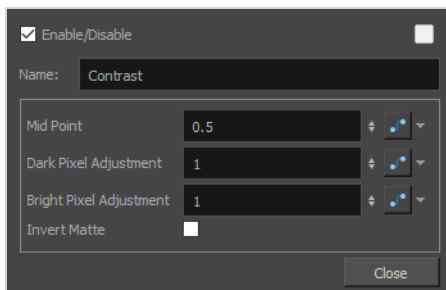

Parameter	Description
Name	The name of the node as it appears in the Node View and the Timeline view. Each node must have a name that is unique to its containing group.
Mid Point	The value that separates dark from bright colours. The midpoint is a value between 0 and 1 that represents the percentage of the 0 to 255 RGB channel range. <ul style="list-style-type: none">• Pixels with colour values lower than the midpoint: These are considered dark pixels.• Pixels with colour values higher than the midpoint: These are considered bright pixels.
Dark Pixel Adjustment Bright Pixel Adjustment	The amount of contrast to be applied to pixels that fall on either side of the Mid Point value. <ul style="list-style-type: none">• A value equal to 1: No change.• A value less than 1: Makes the pixel brighter.• A value greater than 1: Makes the pixel darker.
Invert Matte	Inverts the matte used to generate the effect. By default, the effect is applied to the opaque areas of the matte drawing. When this option is enabled, the effect is applied to the transparent areas of the matte instead.

Dither Node

Dithering is the process of approximating a higher number of colours in a low bit-depth colour system. Use the Dither effect to give the appearance of greater colour variability in 8-bit per channel colour images.

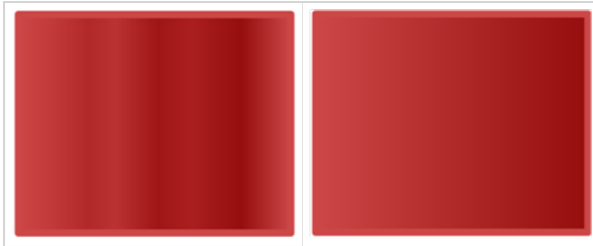

Refer to the following example to connect this effect:

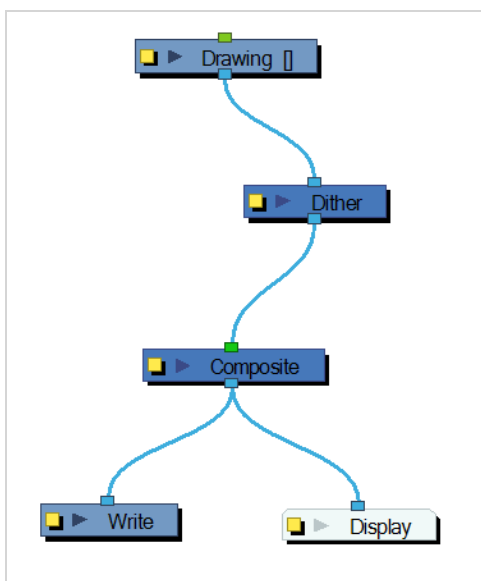

The Dither effect is useful in the case of a gradient that varies between 100 and 105 in the blue channel, for example. Since the difference in the colour values is not great, banding might appear in the image. In this case, use the Dither node to give the impression of greater values of blue, decreasing the unwanted banding effect.

The results of the dither operation may be imperceptible.

Properties

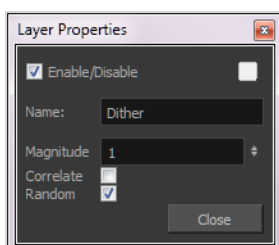

Parameter	Description
Name	The name of the node as it appears in the Node View and the Timeline view. Each node must have a name that is unique to its containing group.
Magnitude	A magnitude of 1 performs a normal dithering operation, using all bands of colour. A magnitude greater than 1 introduces a bias towards brighter colours. A magnitude of less than 1 creates a faster transition between bands of colour, lessening the bias towards brighter colours.
Correlate	When selected, the three colour channels (RGB) are changed simultaneously, for better colour accuracy. When this option is not selected, the three channels are dithered separately, resulting in smoother transitions.
Random	The standard algorithm for the dithering operation.

Focus Node

T-COMP2-011-006

Use the Focus effect to set up depth-of-field effects for your scene. The Focus node is used to determine how much blur will be applied to images, based on their distance from the focal point.



The focal point can be the zero value of your scene or you can link the Focus node to another node, such as a drawing or peg layer, to retrieve the focal point from the node's Z-axis position.

Refer to the following example to connect this effect:

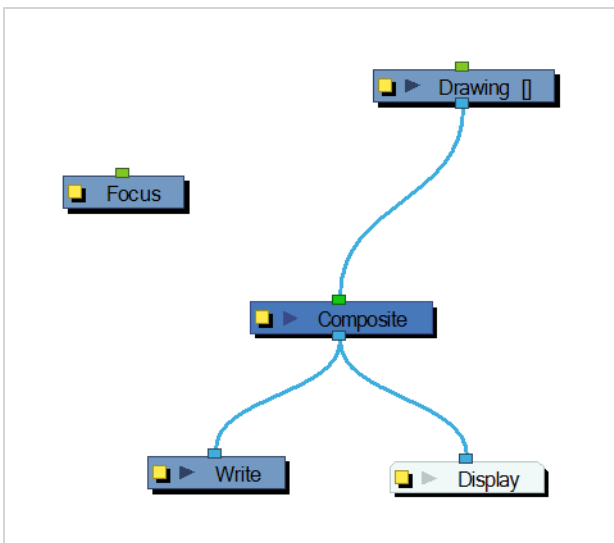

Use the Focus editor to determine how the focus will change as objects move farther from the focal point.

In the Side view window, you can see how the blur values change based on their distance from the focal point. Select the Focus node in the Node view, make sure you are using the Transform tool, then right-click on the Side view window and select Control from the pop-up menu.

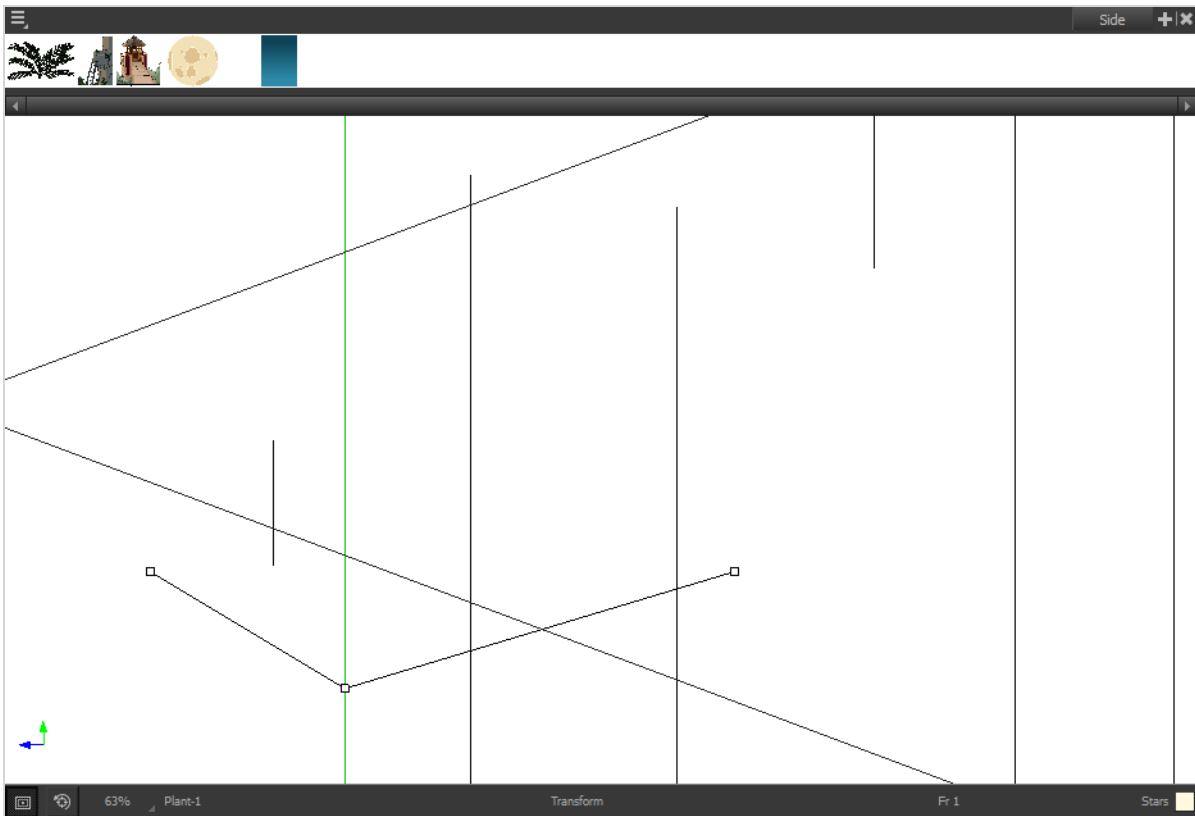

If you edited the function curve and adjusted the velocity, you can also adjust the Bezier handles in the Side view.

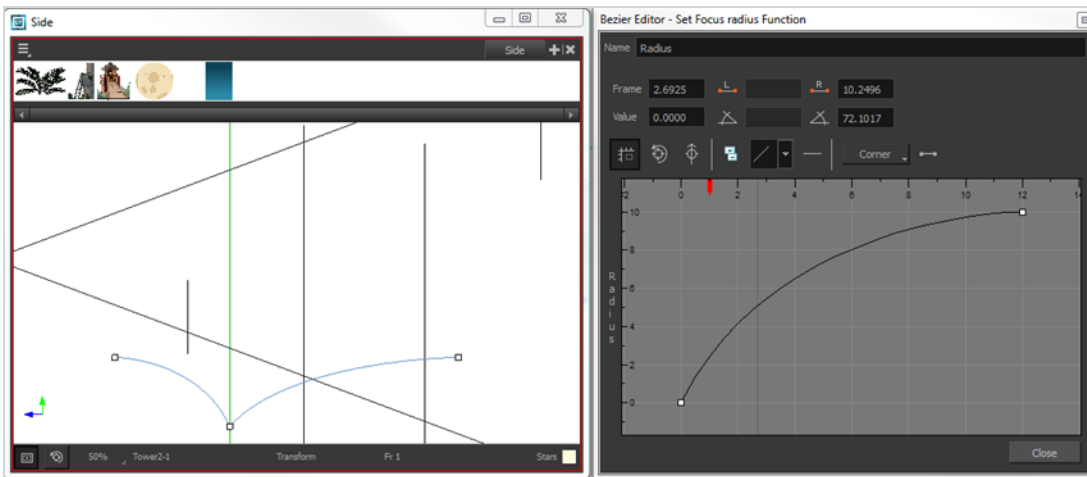

Properties

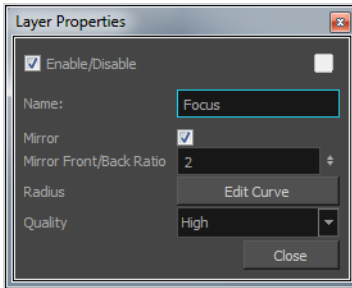

Parameter	Description
Name	The name of the node as it appears in the Node View and the Timeline view. Each node must have a name that is unique to its containing group.
Mirror	Select this option to also blur images in front of the focal point.
Mirror Front/Back Ratio	When the Mirror option is selected, this ratio is applied to the calculation of the blur on images in front of the focal point. The default ratio of 1:2 produces realistic results. Experiment with different values to create customized effects.
Radius	Controls the amount of blur applied to an element based on its distance from the focal point. Click on the Edit Curve button to change these values by adjusting the function curve.
Quality	Controls the quality of the blur. A higher quality will achieve better results but will be slower to render.

Focus Multiplier Node

T-COMP2-011-006A

The Focus Multiplier effect works with the Focus node. This node applies a blur to the selected layer, based on the blur radius in the Focus node.

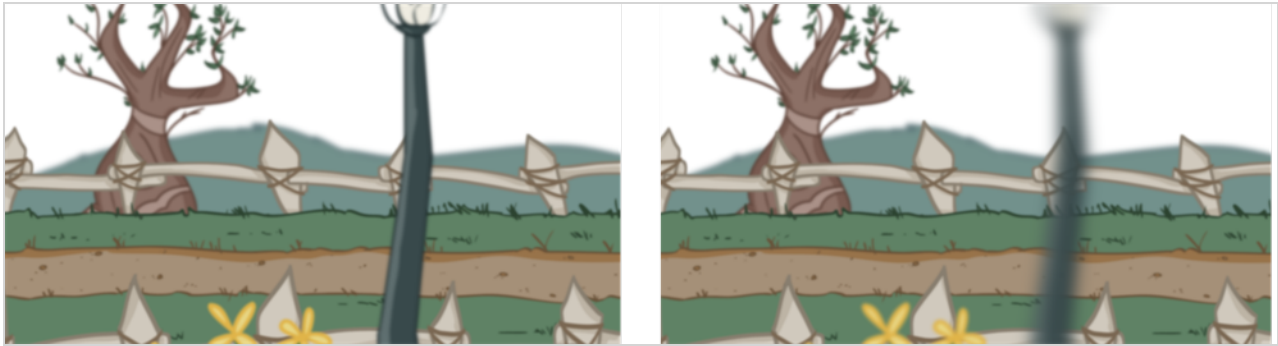

Use the Focus Multiplier node when you want to apply the focus to selected elements or when you need to apply the focus before doing more effects in a composite operation.

Refer to the following example to connect this effect:

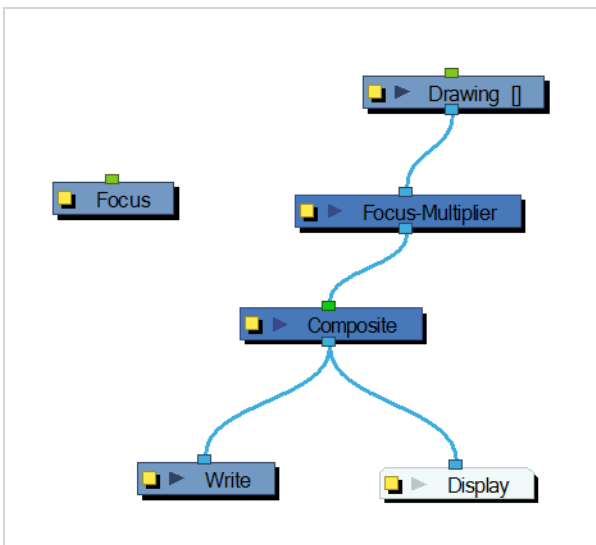

You must disable the Apply Focus option in the Composite node in order to apply the focus effect to the selected node only. If you do not disable that option, the focus effect will be calculated twice on the selected node.

Use the Focus Multiplier editor to multiply the Focus Radius by a selected value. You can enter a static value in the Multiplier field or attach it to a function curve.

Properties

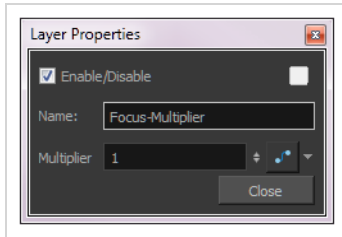

Parameter	Description
Name	The name of the node as it appears in the Node View and the Timeline view. Each node must have a name that is unique to its containing group.
Multiplier	This is the value by which the normal focus radius value is multiplied.

Gamma Node

The Gamma node allows you to apply gamma correction to an element in your scene or to your entire scene. The gamma correction can be applied to all colour channels, to a specific colour channel or even to the image's alpha channel.

Gamma correction is a curvilinear function applied to the colour values. It is used to modulate the difference in intensity between colour values. In other words, it affects how much differences between low, medium and high colour values translate to actual variations of intensity between colours. For example:

- A gamma correction between 0 and 1 will make low values lower progressively lower, causing a bigger spectrum of dark colours to appear closer to black. The contrast between high values is increased to compensate.
- A gamma correction above 1 will increase the value of dark colours proportionally to their actual values, increasing the contrast between them and making them lighter. The contrast between high values is decreased to compensate.

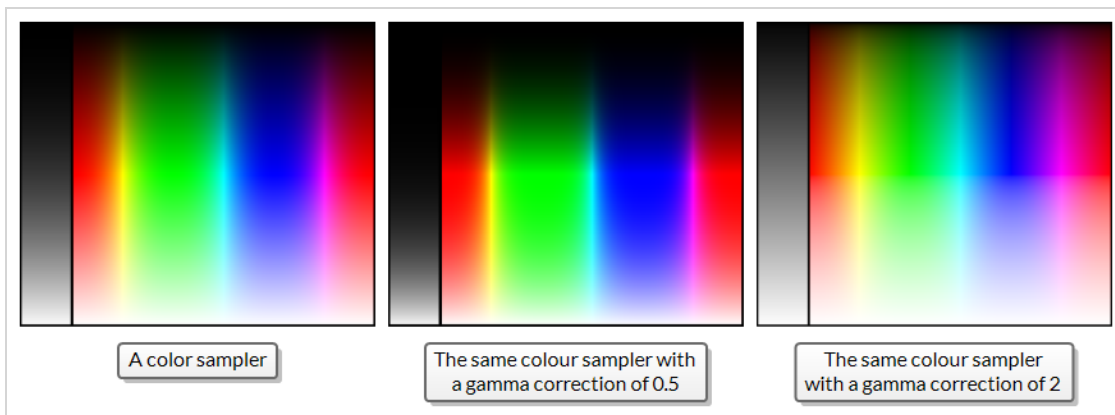

Connection

To use the Gamma node, simply connect it under the element, effect or composite to which you want to apply the gamma correction. The node will take the input image from its top port, apply the gamma correction to it and output the corrected image out of its bottom port.

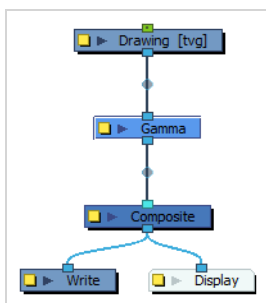

If you only need to apply gamma correction to the rendered frames without affecting the preview image in the Camera view, simply connect it between your scene's main Composite node and its Write node. Likewise, if you only need to apply a gamma correction to the preview image in the Camera view, but you don't want it to be

applied to the rendered frames, simply connect it between your scene's main Composite node and its Display node.

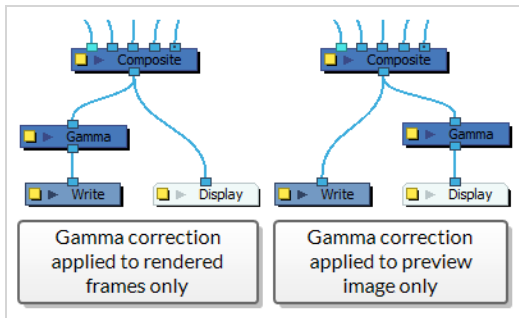

NOTE

Like with most effects, the effect of the Gamma correction node are only visible in the Camera view when it is in  Render View mode.

Properties

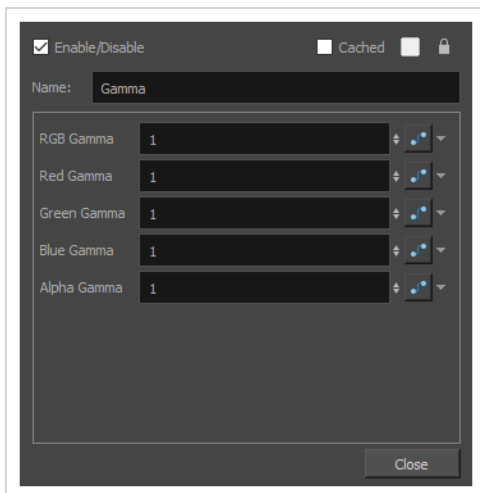

Parameter	Description
Name	The name of the node as it appears in the Node View and the Timeline view. Each node must have a name that is unique to its containing group.
RGB Gamma	The gamma correction value or function to apply to red, green and blue channels simultaneously.
Red Gamma	The gamma correction value or function to apply to red colour values only.

Parameter	Description
Green Gamma	The gamma correction value or function to apply to green colour values only.
Blue Gamma	The gamma correction value or function to apply to blue colour values only.
Alpha Gamma	The gamma correction value or function to apply to alpha values only.

Glow Node

T-HFND-010-009B

The Glow effect turns your image into a glow area with a bright soft-edged light or diffuse light region around an image. The Glow effect is useful for creating a shining rim around objects, such as the sun or stars. Clone your layer or connect it a second time to the Composite node to display the original image on top of the glow.



Refer to the following example to connect this effect:

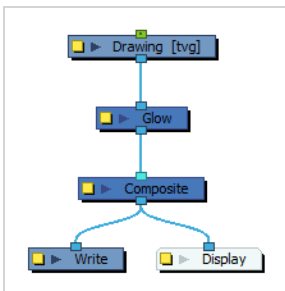



NOTE

If this effect is connected below a Composite node set to Pass-Through, the effect will be applied to each element connected in the Composite node individually. If some of these elements are overlapping, the effect will also overlap.

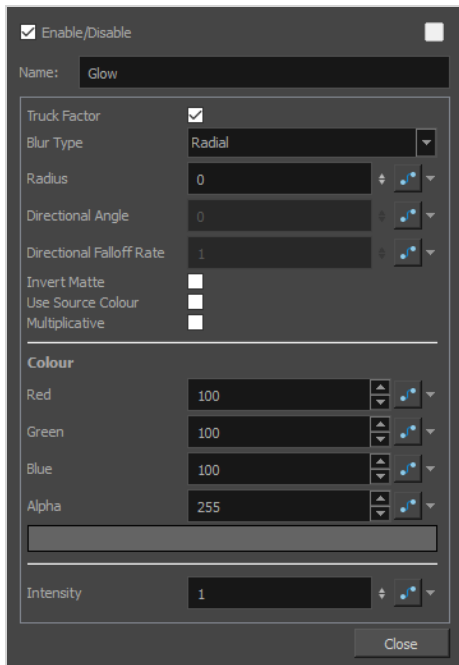
Properties



Parameter	Description
Enable/Disable	Allows you to enable or disable the node. When disabled, a node has no visible effect on the rendered image, nor on the preview in the Camera, Perspective, Side and Top views.
Colour Swatch	Sets the colour of the layer in the Timeline view and of the node in the Node view.
Name	The name of the node as it appears in the Node View and the Timeline view. Each node must have a name that is unique to its containing group.
Truck Factor	Activated by default, this option readjusts the blur when the elements undergo a change of depth or scale. When disabled, the effect's values will remain unchanged regardless of depth or scale changes. It is recommended that this option be disabled when multiple drawings are composited and attached this effect.
Blur Type	Allows you to choose between the following blur types for the effect: <ul style="list-style-type: none"> • Radial: The edges of the matte are blurred evenly around points that make up the edge of the matte. • Directional: The matte is blurred in the direction configured with the Directional Angle and Directional Falloff Rate parameters.

Parameter	Description
Radius	Enter a value for the size of the blur. The larger the value, the greater the blur effect. The blur radius is affected by the drawing scale and camera position.
Directional Angle	If you set the Blur Type to Directional, this sets the angle of the blur. The value goes from 0 to 360, with 0 meaning west, and angles going counterclockwise. For example: <ul style="list-style-type: none"> • 0: Blurs the image to the west. • 90: Blurs the image to the south. • 180: Blurs the image to the east. • 270: Blurs the image to the north.
Directional Falloff Rate	The distance where the blur fades from the edge of the image. Select a decimal value between 0 and 1. For example: <ul style="list-style-type: none"> • 0: Makes the blur fade out slowly, distributing the blur evenly from the edge of the character to the farthest edge of the blur. • 1: Makes the blur fade out quickly. The blur is heaviest closer to the edge of the image.
Invert Matte	Inverts the matte used to generate the effect. By default, the effect is applied to opaque areas of the drawing. When this option is enabled, the effect is applied to transparent or empty areas of the drawing.
Use Source Colour	Instead of using the colour in the Colour parameters, this uses the colours in the source drawing to generate the effect. <div data-bbox="561 1352 1429 1495" style="border: 1px solid #c8e6c9; padding: 10px; margin-top: 10px;">  NOTE The effect of this parameter is only visible in Render View  mode. </div>
Multiplicative	Multiplies the colours of the effect with the colours of the background. This intensifies the effect.
Colour	
Red	The amount of red to add to the colour in the background image.
Green	The amount of green to add to the colour in the background image.

Parameter	Description
Blue	The amount of blue to add to the colour in the background image.
Alpha	The alpha value of the effect.
Colour Swatch	Opens the Colour Picker dialog, in which you can visually select a colour for the effect.
Intensity	Allows you to set the factor by which to multiply the intensity of the effect. This parameter can take a decimal value between 0 and 1. At 1, the effect is fully applied. At 0, the effect is not visible.

Grain Node

Use the Grain effect to add a film grain to an image; the film grain looks like video noise.

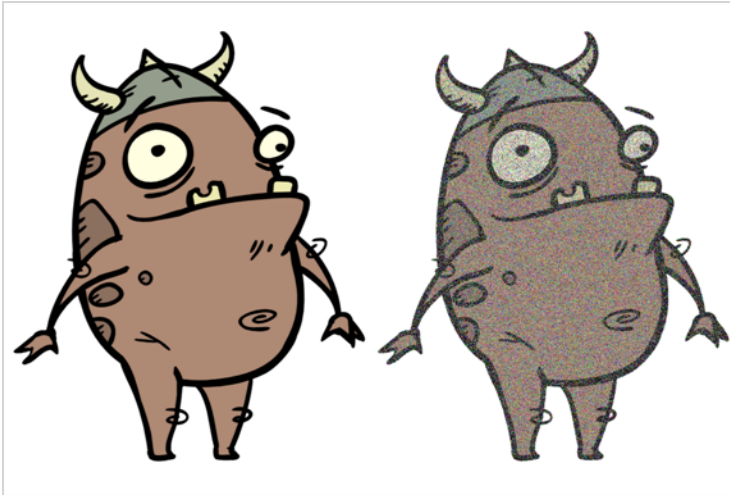

Refer to the following example to connect this effect:

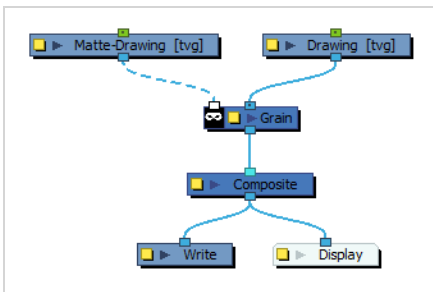

The Grain node has two input ports.

- On the left port, attach the element that will act as the matte defining the grain area.
- On the right port, attach the element on which you want to apply the grain effect.

The Grain node requires a matte drawing. If you simply want to apply a grain over the source drawing, simply connect it to both the image input port and the matte input port of the node:

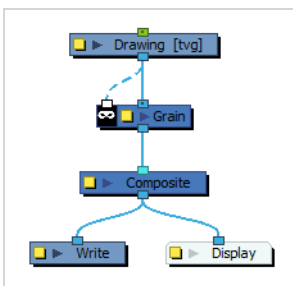

Properties

In the Layer Properties of the Grain node, you can adjust the amount of grain to add to an image as well as the sharpness and softness of the grain.

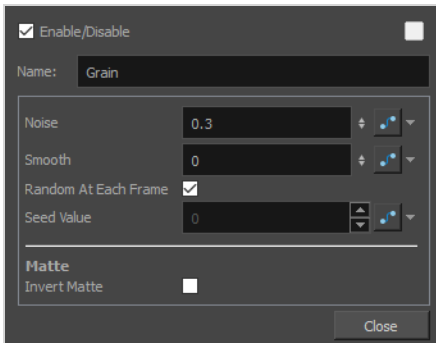

Parameter	Description
Name	The name of the node as it appears in the Node View and the Timeline view. Each node must have a name that is unique to its containing group.
Noise	The amount of grain to add to the image based on the percentage of pixels to alter. The larger the value, the coarser the grain. The smaller the value is to 0 (zero), the finer the grain.
Smooth	The amount of blending to apply to the grain effect, based on the blur radius, to make the effect appear less pixelated. The larger the value, the greater the smoothing.
Random at Each Frame	Computes the colour shift in the grain using a different value at each composite. This means that your images will look different each time you render them. Deselect this option and select a Seed Value to ensure the same result every time you composite the grain effect.
Seed Value	This value corresponds to a unique pattern in the grain. If you want to retain this pattern in other frames, you can reuse this value.
Matte	
Invert Matte	Inverts the matte used to generate the effect. By default, the effect is applied to the opaque areas of the matte drawing. When this option is enabled, the effect is applied to the transparent areas of the matte instead.

Greyscale Node

The Greyscale effect lets you convert a colour image to greyscale. This example demonstrates what happens when you set the greyscale to 100% using the Greyscale node.

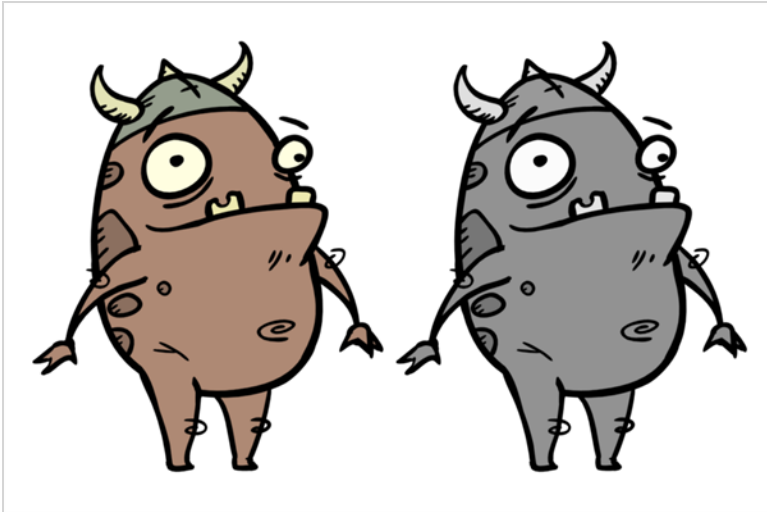

TIP

You can use this effect in combination with the Brightness Contrast effect to adjust the different levels of grey in the output image.

Refer to the following example to connect this effect:

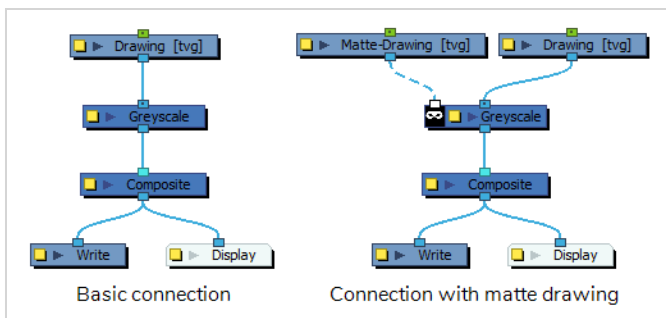

Properties

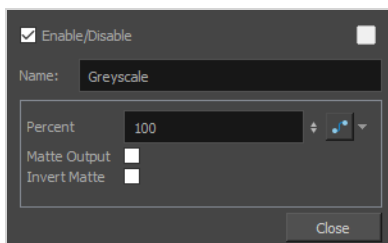

Parameter	Description
Name	Allows you to change the name given to the node.
Percent	The percentage of greyscale to apply to the input image. Lowering this parameter will only partially desaturate the image's colours.
Matte Output	Preserves the colours of the input image, but applies the greyscale version of the input image to the alpha channel of the output image. As a result, the darker a pixel in the image is, the more transparent it is. White pixels will remain opaque, and black pixels will become invisible.
Invert Matte	Inverts the matte used to generate the effect. By default, the effect is applied to the opaque areas of the matte drawing. When this option is enabled, the effect is applied to the transparent areas of the matte instead.

Hue-Saturation Node

The Hue-Saturation effect lets you adjust the hue, saturation and lightness values individually or by using the HLS picker or Hue Range picker. You can achieve effects over the entire image, such as a sepia tone. Changes you make to the values are additive to the final image.



For detailed video tutorials and sample scenes by Adam Phillips, see:

<https://www.toonboom.com/resources/video-tutorials/chapter/adam-phillips-harmony-effects>

Connection

The Hue-Saturation node takes an image of any type as its input and outputs an image with different hue, saturation and lightness parameters.

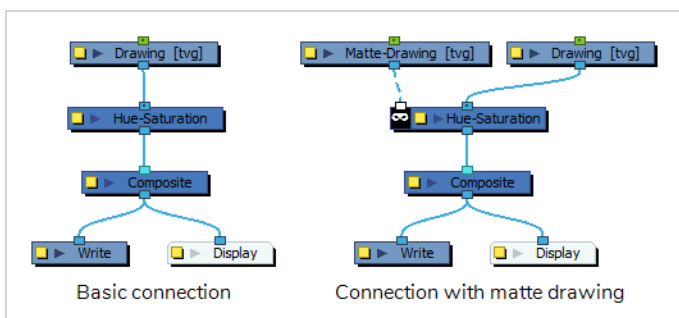

Optionally, it can also be connected to a matte image. In this case, only the parts of the input image that intersect with the matte will be affected by the effect.

Layer Properties

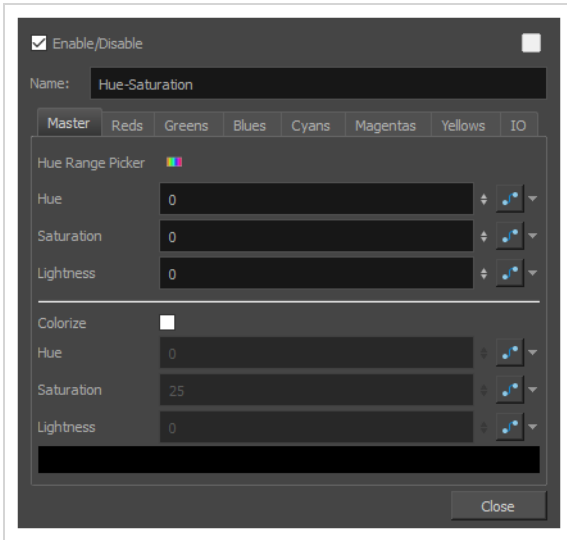

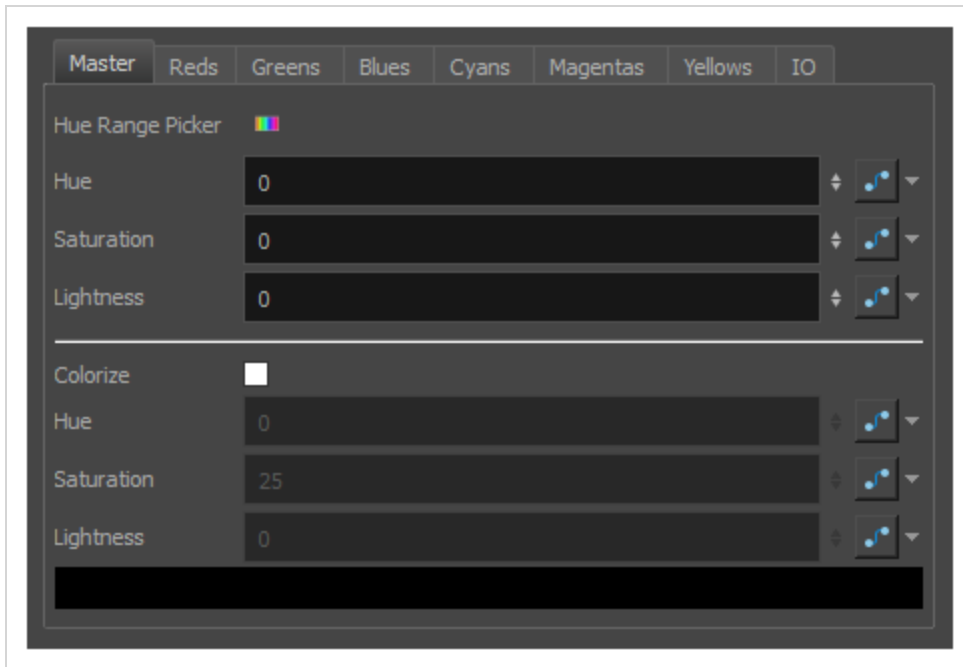

Parameter	Description
Enable/Disable	Allows you to enable or disable the node. When disabled, a node has no visible effect on the rendered image, nor on the preview in the Camera, Perspective, Side and Top views.
Colour Swatch	Sets the colour of the layer in the Timeline view and of the node in the Node view.
Name	The name of the node as it appears in the Node View and the Timeline view. Each node must have a name that is unique to its containing group.

Master Tab

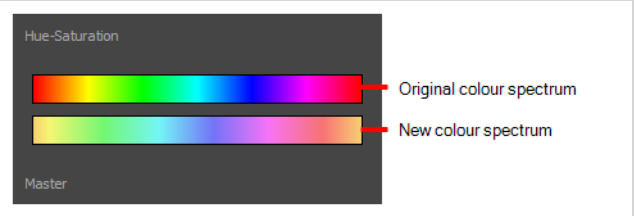

The master tab allows you to adjust the hue, saturation and lightness settings for all the hues in the source drawing simultaneously. It should be used unless you want to apply specific parameters on specific ranges of hues.

Parameter	Description
Hue Range Picker 	<p>Opens the Hue Range Picker. In the Master tab, the Hue Range Picker can only be used to see the original colour spectrum of the image and compare it to the colour spectrum as processed by the Hue-Saturation effect.</p> 
Hue	Offsets the hues in the source image. The hue of every pixel in the source image is offset on the spectrum of hues. This parameter can be set to a value between -360 and 360.
Saturation	Changes the saturation of the source image. This parameter can be set to a value between -100 and 100. Negative values make the image closer to a greyscale image. Positive values make the colours appear more saturated by exacerbating the difference between each channel.

Parameter	Description
Lightness	<p>Changes the lightness of the source image. The lightness can vary between -100 and 100, where -100 makes the image solid black and 100 makes the image solid white. Hence, negative values darkens the colours by making every pixel proportionally closer to black, and positive values lighten the colours by making every pixel proportionally closer to white.</p>
Colourize	<p>Enables colourization. Instead of affecting the existing colours of the input image, the Hue-Saturation effect will convert the image to greyscale, then add a single colour over the levels of grey based on the Hue, Saturation and Lightness settings you input below.</p> <div data-bbox="565 684 1430 856" style="border: 1px solid #c8e6c9; padding: 10px; margin: 10px 0;">  <p>NOTE When the Colourize parameter is enabled, fields below the check box are accessible and fields above the check box are greyed out.</p> </div>
Hue	<p>The colour with which to colourize the image.</p>
Saturation	<p>The saturation with which to colourize the image. A lower setting will make the colorized image closer to a greyscale image. A higher setting will make the colour more saturated.</p>
Lightness	<p>Changes the lightness of the source image. The lightness can vary between -100 and 100, where -100 makes the image solid black and 100 makes the image solid white. Hence, negative values darkens the colours by making every pixel proportionally closer to black, and positive values lightens the colours by making every pixel proportionally closer to white.</p>
Colour Swatch	<p>When Colourize mode is enabled, you can click on the colour swatch to open a Hue, Saturation and Lightness picker.</p> <p>The lightness can be selected by moving the slider at the top. The hue and saturation can be selected by moving the cursor in the box underneath the slider.</p>

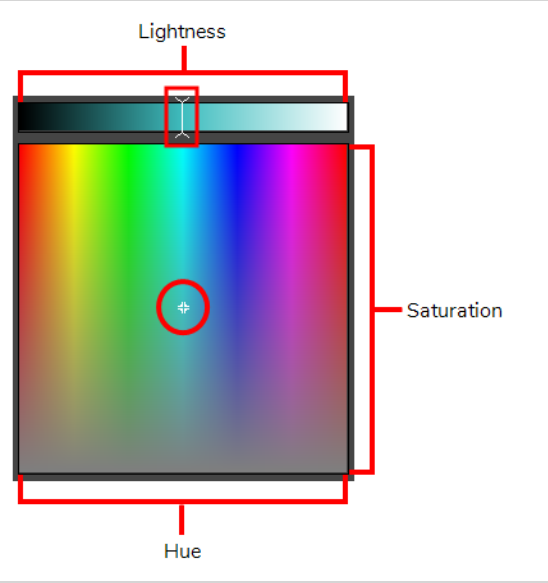
Parameter	Description
	

Hue Tabs

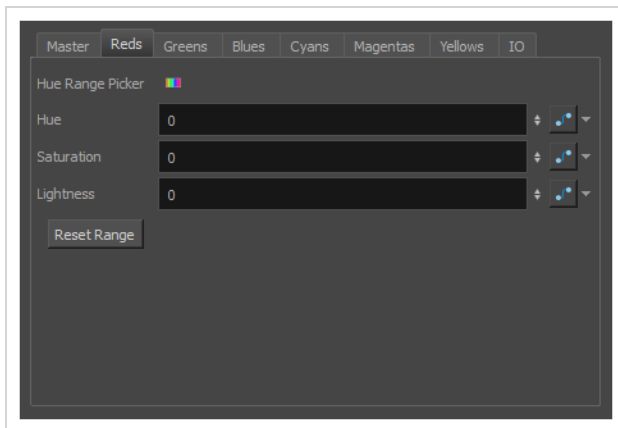

The other tabs in the Hue-Saturation Layer Properties are meant to allow you to specify the hue, saturation and lightness parameters for specific colour ranges. By default, each tab is configured to affect a specific colour range corresponding to their tab name, namely:

- Reds
- Greens
- Blues
- Cyans

- Magentas
- Yellows

At their default settings, all tabs combined cover the entire spectrum of hues. The colour spectrum that each tab affects can however be customized.

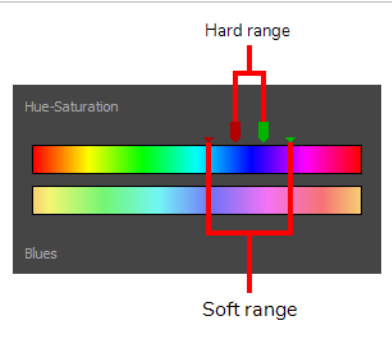
Parameter	Description
<p>Hue Range Picker </p>	<p>Open the Hue Range Picker dialog. This allows you to tweak the range of hues that the settings in the current tab affects. For example, this is the default range for the Blue tab:</p>  <p>Every pixel in the source drawing that has a hue within the hard range will be affected by the settings in the tab.</p> <p>As for pixels with a hue within the soft range, how much they are affected by the settings in the tab depends on how much their hue is closer to the hard range or to the limit of the soft range. The further away from the hard range the hue of a pixel is, the lesser the effect of the hue, saturation and lightness settings on this pixels is. This allows you to taper the effect of the ranges so as to not create hard seams between areas of different colours.</p>
<p>Hue</p>	<p>Offsets the hues in the area covered by the selected hue range. The hue of every pixel in this area is offset on the spectrum of hues. This parameter can be set to a value between -360 and 360.</p>
<p>Saturation</p>	<p>Changes the saturation of the area covered by the selected hue range. This parameter can be set to a value between -100 and 100. Negative values make the area closer to greyscale. Positive values make the colours in the area appear more saturated by exacerbating the difference between each channel.</p>
<p>Lightness</p>	<p>Changes the lightness of the area covered by the selected hue range. The lightness can vary between -100 and 100, where -100 makes the area solid black and 100 makes the area solid white. Hence, negative values darkens the colours by making every pixel proportionally closer to black, and positive values lighten the colours by making every pixel proportionally closer to white.</p>

Parameter	Description
Reset Range	Resets the range selected in the Hue Range Picker to the default range for the current colour tab.

IO Tab

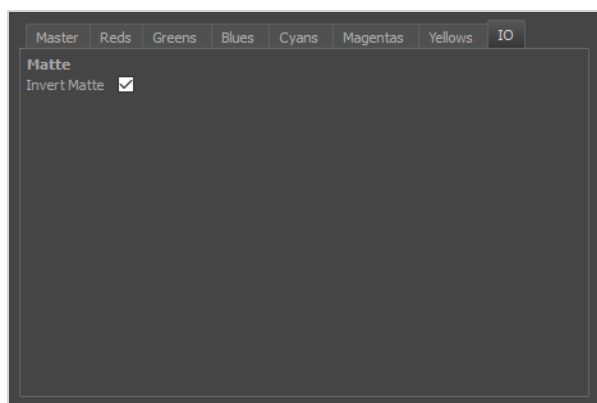

The IO tab contains parameters relating to the input and out ports of the effect.

Parameter	Description
Invert Matte	Inverts the matte used to generate the effect. By default, the effect is applied to the opaque areas of the matte drawing. When this option is enabled, the effect is applied to the transparent areas of the matte instead.

Increase Opacity Node

The Increase-Opacity node allows you to increase the opacity of a visual element. It works by multiplying the opacity level of each pixel in the input image by a customizable factor, and outputs the result in the output image.

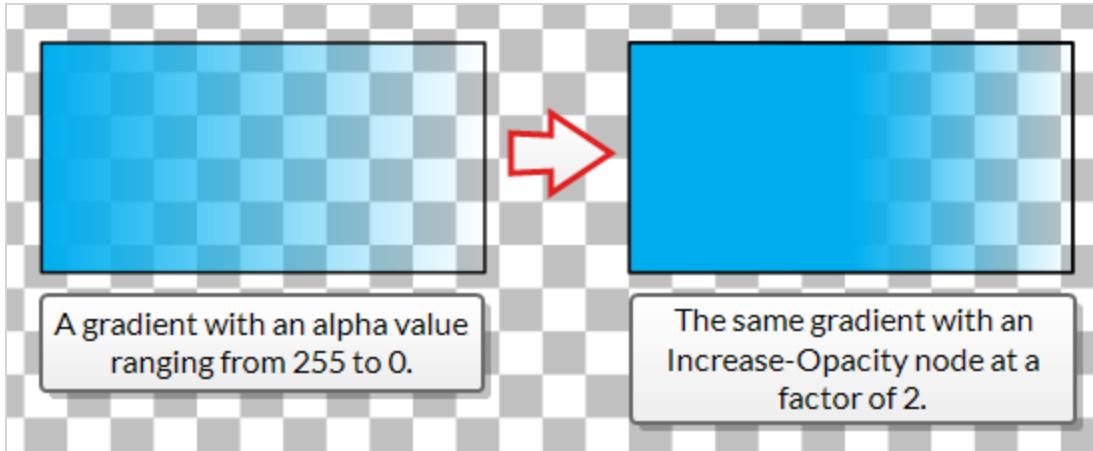

This can be used to fix a commonly encountered issue in digital animation, where a seam is visible between two elements in a rig because one element is used as the matte for a cutter for the other element. A known work-around to this is to connect the problematic parts of the rig several times to the same composite so as to increase the opacity on their edges, but this can negatively impact performance. This node will increase the opacity around the edges of scene elements without causing unnecessary overhead.

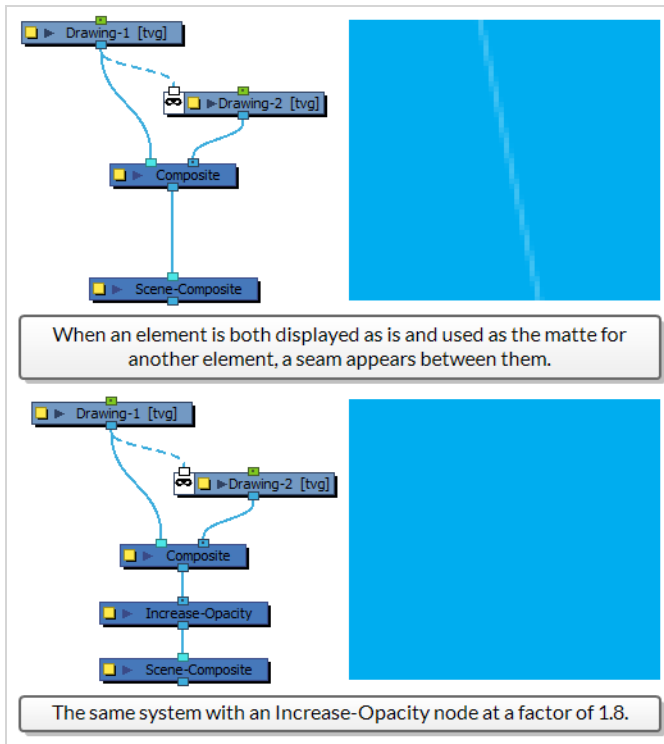

Connection

To use the Increase-Opacity node, simply connect the visual element for which you want to increase opacity into its input port, then connect its output port to a composite, or to the next effect you want to apply to the output image.

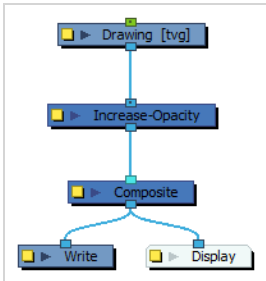

Optionally, you can use another visual element as the matte for the Increase Opacity effect by connecting this visual element to the left edge of the node. When you do this, only parts of the input image that intersect with the matte image will have their opacity increased.

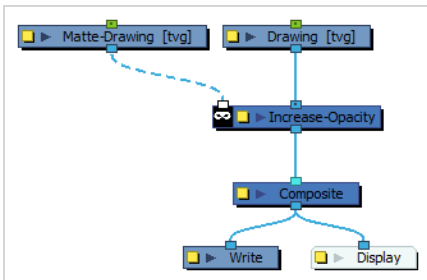

Properties

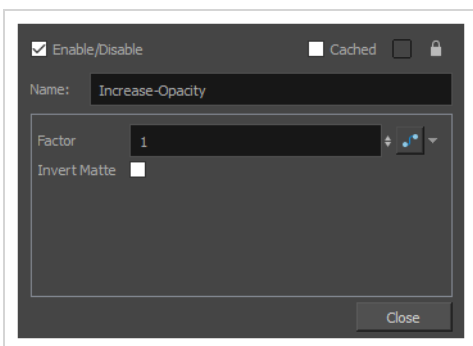

Parameter	Description
Name	The name of the node as it appears in the Node View and the Timeline view. Each node must have a name that is unique to its containing group.
Factor	The number by which to multiply the opacity of each pixel in the input image. For example, if this parameter is set to 2, a pixel that has an alpha value of 85 out of 255 will be output with an alpha

Parameter	Description
	<p>value of 170 out of 255.</p> <p>The default value for this parameter is 1.8. It can be set to any value between 1 and 100.</p>
Invert Matte	<p>Inverts the matte used to generate the effect. By default, the affect is applied to opaque areas of the matte and transparent areas of the matte are ignored. When this option is enabled, the effect is applied to transparent areas of the matte and opaque areas of the matte are ignored.</p>

Layer Selector Node

The Layer Selector effect lets you isolate and display one or more art layers:

- Overlay
- Line Art
- Colour Art
- Underlay



Refer to the following example to connect this effect:

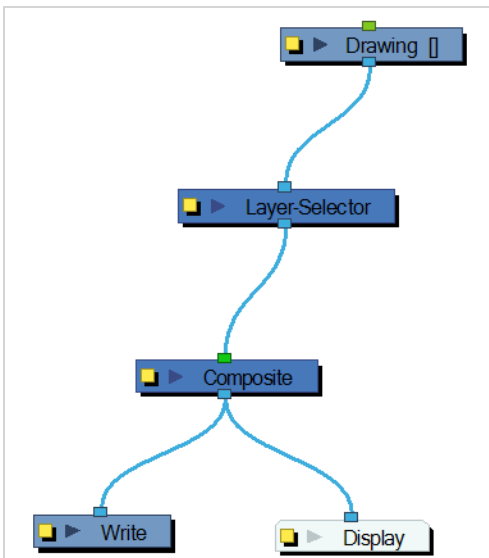

Properties

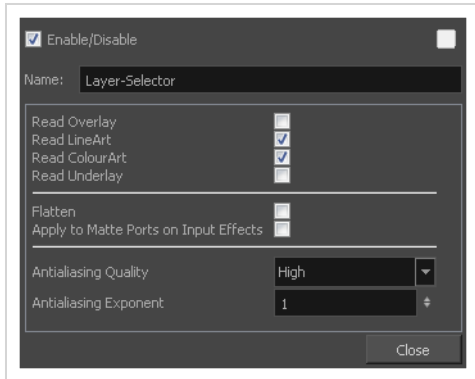

Parameter	Description
Name	Allows you to change the name given to the node.
Read Overlay, Line Art, Colour Art, Underlay	Turns the display of the Overlay, Line Art, Colour Art and Underlay layers on or off.
Flatten	<p>When placing the node below a Composite node containing several drawing nodes, such as a cut-out character, you can use this option to flatten the extracted result. For example, when extracting a series of outlines, parts that may have been hidden by colour fills might now be visible. Enable the Flatten option to cut the extra artwork. Harmony will use the colour fills to cut unnecessary artwork. If your zones are not painted, nothing will be cut. This option works with both pencil lines and brush strokes.</p>
Apply to Matte Ports on Input Effects	At times, you may have situations where your node is placed below a Cutter node using a mask input and a drawing input. By default, the effect only processes the colours in the drawing input. The mask drawing remains untouched. If you want to also filter the mask drawing, select the Apply to Matte Ports on Input Effects option.
Antialiasing Quality	Smoothness setting applied to the art layer. Choose from Low (no antialiasing), Medium Low, Medium and High (extensive antialiasing). The higher the quality of the chosen setting, the greater the amount of antialiasing that is applied. Higher

	quality images require more time to render and more memory from your system.
Antialiasing Exponent	Controls the amount of area around the art layer edges that is used in the antialiasing process. A higher value uses less area, resulting in sharper edges, while a lower value uses more area, resulting in softer edges. If the Antialiasing Quality value is set to Low (no antialiasing), this value is ignored.

Line Art Node

The Line Art effect lets you read only the Line Art in an element. Place a Line Art node after a drawing node in the Node view to display only the node's Line Art output. The Line Art node can be connected after nodes of any type. Any bitmap information will pass through and be processed.

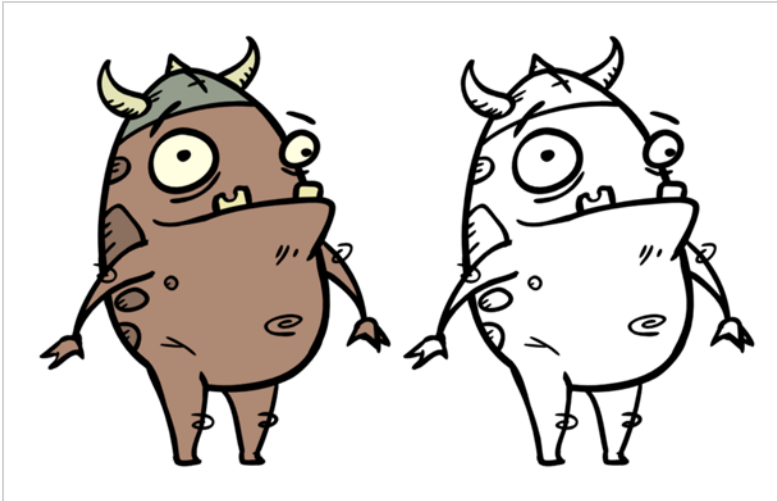

This effect will only work if you drew something on the Line Art layer of the drawing.

Refer to the following example to connect this effect:

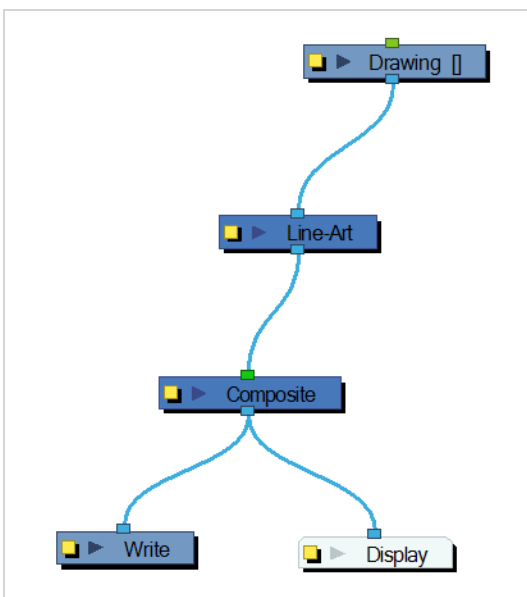

Properties

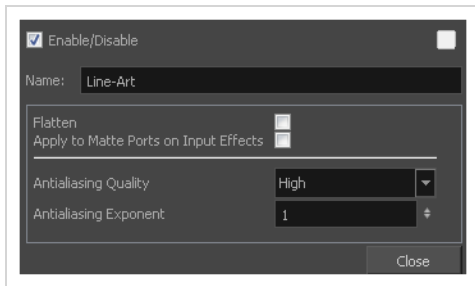

Parameter	Description
Name	Allows you to change the name given to the node.
Flatten	<p>When placing the node below a Composite node containing several drawing nodes, such as a cut-out character, you can use this option to flatten the extracted result. For example, when extracting a series of outlines, parts that may have been hidden by colour fills might now be visible. Enable the Flatten option to cut the extra artwork. Harmony will use the colour fills to cut unnecessary artwork. If your zones are not painted, nothing will be cut. This option works with both pencil lines and brush strokes.</p>
Apply to Matte Ports on Input Effects	At times, you may have situations where your node is placed below a Cutter node using a mask input and a drawing input. By default, the effect only processes the colours in the drawing input. The mask drawing remains untouched. If you want to also filter the mask drawing, select the Apply to Matte Ports on Input Effects option.
Antialiasing Quality	Smoothness setting applied to the art layer. Choose from Low (no antialiasing), Medium Low, Medium and High (extensive antialiasing). The higher the quality of the chosen setting, the greater the amount of antialiasing that is applied. Higher quality images require more time to render and more memory from your system.
Antialiasing Exponent	Controls the amount of area around the art layer edges that is used in the antialiasing process. A higher value uses less area, resulting in sharper edges, while a lower value uses more area, resulting in softer edges. If the Antialiasing Quality value is set to Low (no antialiasing), this value is ignored.

Luminance Threshold Node

The Luminance Threshold effect generates a matte by thresholding the luminance of an image. This works well with bitmap images that have many shades of colours. A pure vector image with flat colours could use a color override to isolate areas.



Thresholding is a method to segment or isolate certain zones in an image. This effect will isolate areas based on the image's luminance. Thresholding is used within the Bloom effect—see [Bloom Node on page 570](#).

Connection

The Luminance-Threshold node takes an image of any type as its input and outputs an image in which pixels that do not pass the threshold are filtered out and the remaining pixels are softened and have their gamma adjusted.

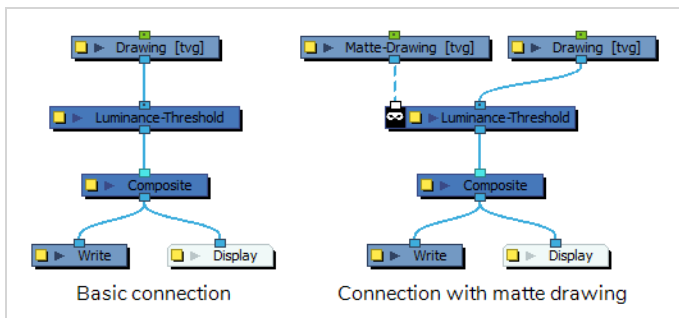

Optionally, it can also be connected to a matte image. In this case, only the parts of the input image that intersect with the matte will be affected by the effect.

Layer Properties

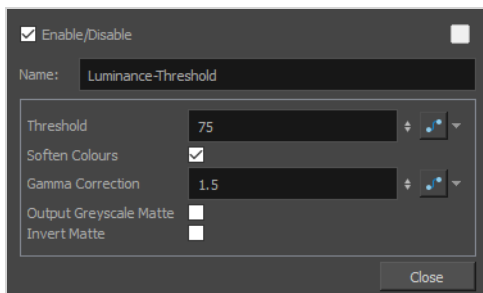

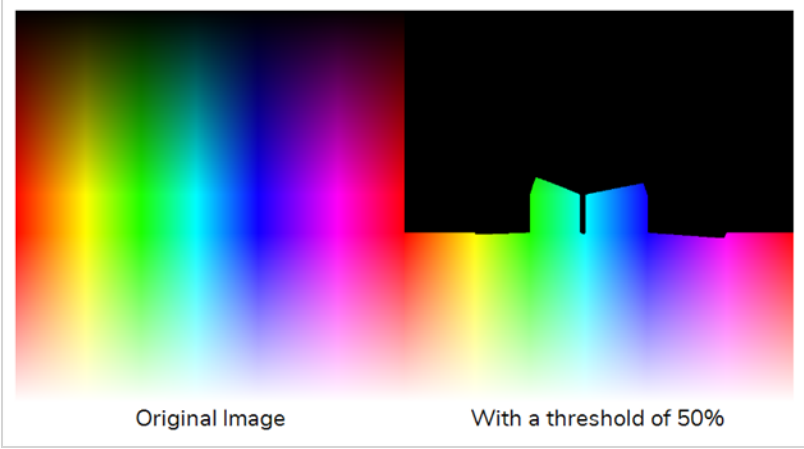
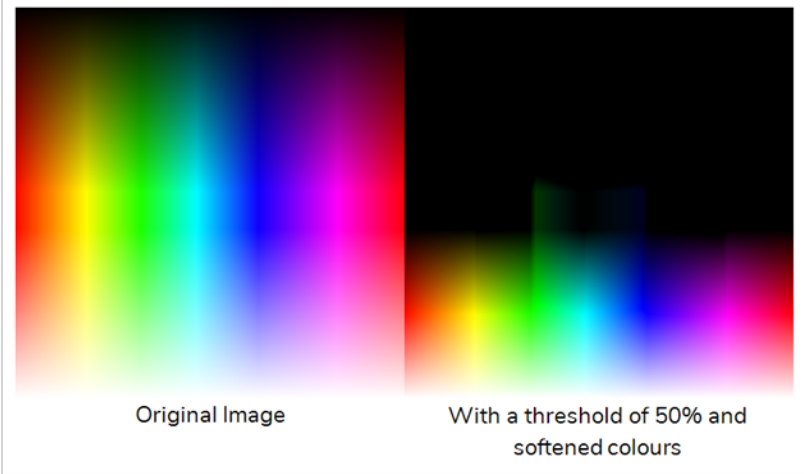
Parameter	Description
Enable/Disable	Allows you to enable or disable the node. When disabled, a node has no visible effect on the rendered image, nor on the preview in the Camera, Perspective, Side and Top views.
Colour Swatch	Sets the colour of the layer in the Timeline view and of the node in the Node view.
Name	The name of the node as it appears in the Node View and the Timeline view. Each node must have a name that is unique to its containing group.
Threshold	<p>Controls how much of the dark value to clamp off. A high value will keep only the bright areas of your image.</p> 
Soften Colours	<p>Brings back the entire spectrum of luminance in areas defined by the threshold to avoid having only bright values.</p> 
Gamma	Multiplies the gamma value to make the area brighter or darker. A value of 1 keeps the gamma

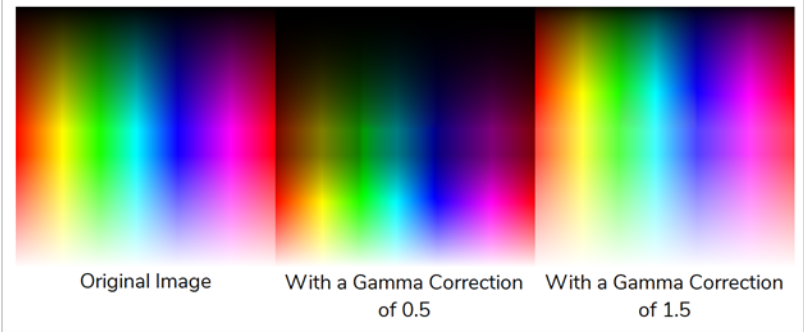
Parameter	Description
Correction	<p>the same as the original image. You can use the gamma modification on the whole image if you use a threshold of 0 for example.</p>  <p style="text-align: center;">Original Image With a Gamma Correction of 0.5 With a Gamma Correction of 1.5</p>
Output Greyscale Matte	<p>Allows you output an image in levels of grey. This can be used in combination with a Blending or Cutter node, or other effects that use greyscale mattes.</p>
Invert Matte	<p>Inverts the matte used to generate the effect. By default, the effect is applied to the opaque areas of the matte drawing. When this option is enabled, the effect is applied to the transparent areas of the matte instead.</p>

Matte-Blur Node

Use the Matte-Blur effect to blur a matte or change its colour. Here is an example of a network with the result of a Matte-Blur effect.

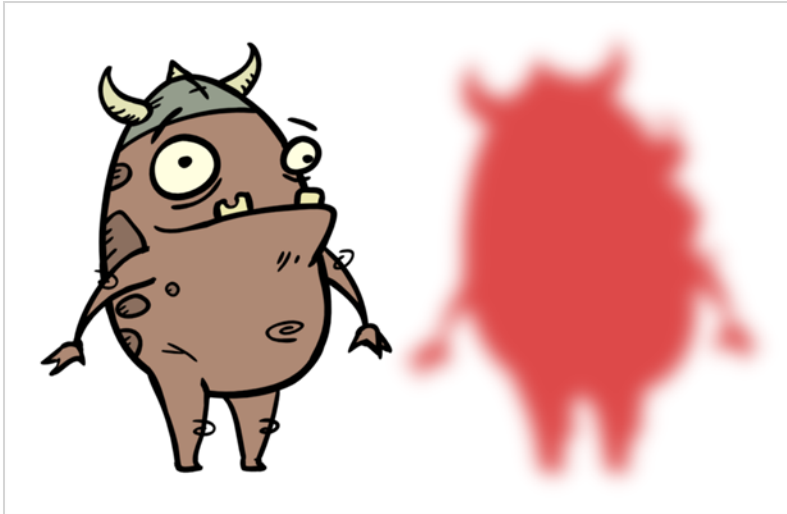

Refer to the following example to connect this effect:

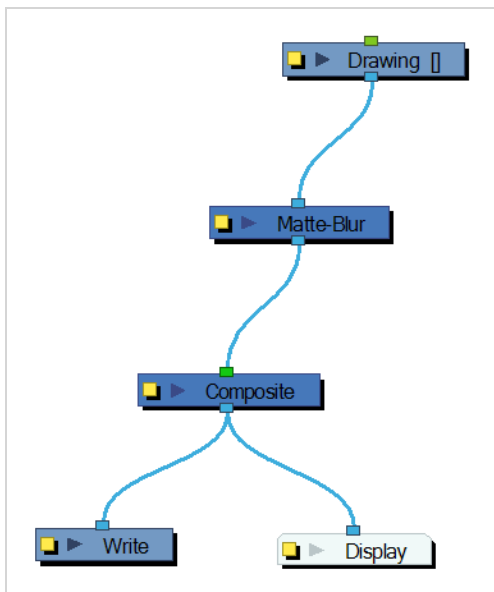

NOTE

If this effect is connected below a Composite node set to Pass-Through, the effect will be applied to each element connected in the Composite node individually. If some of these elements are overlapping, the effect will also overlap.

Properties

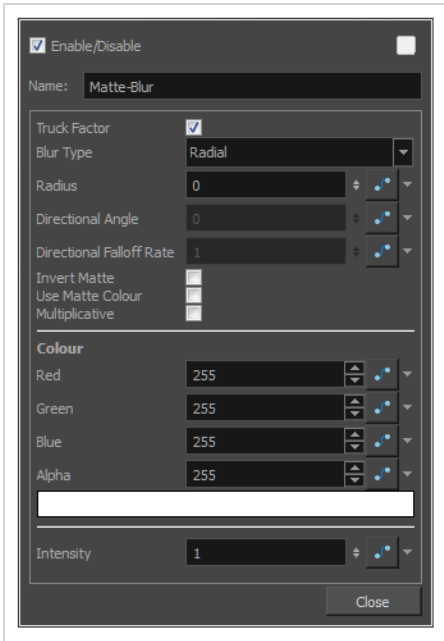

Parameter	Description
Name	The name of the node as it appears in the Node View and the Timeline view. Each node must have a name that is unique to its containing group.
Truck Factor	Activated by default, this option readjusts the blur when the elements undergo a change of depth or scale. When this option is deselected, the effect's values remain unchanged regardless of any depth or scale changes. This option should be deselected when multiple drawings are composited and attached to this effect.
Blur Type	<p>Directional: Blurs the matte in the direction you select. For example, if a character is walking east, the blur may fall to the west.</p> <p>Radial: Blurs the edges of the matte evenly around points that make up its edge.</p>
Radius	Enter a value for the size of the blur. The larger the value, the greater the blur effect. The blur radius is affected by the drawing scale and camera position.
Directional Angle	<p>If you select a Blur Directional type, you can select the direction of the blur by entering a value from 0 to 360 in this field.</p> <ul style="list-style-type: none"> ▶ 0: Blurs the image to the west. ▶ 90: Blurs the image to the south. ▶ 180: Blurs the image to the east.

	<p>► 270: Blurs the image to the north.</p>
Directional Fall-off Rate	<p>The distance where the blur fades from the edge of the image. Select a value between 0 and 1.</p> <ul style="list-style-type: none"> • A fall-off rate of zero causes the blur to fade out slowly, distributing the blur evenly from the edge of the character to the farthest edge of the blur. • A fall-off rate of 1 causes the blur to fade out quickly so that the blur is heaviest closer to the edge of the image.
Invert Matte	<p>Inverts the matte used to create the glow. The matte will become a black silhouette while the glow fills the background space.</p>
Use Source Colour	<p>Uses the colours painted in the matte for the glow effect. If you deselect this option, select a colour and alpha values in the Colour section.</p>
Multiplicative	<p>Creates a more diffused glow.</p>
Colour	<p>Lets you choose the colour and alpha values for the glow effect.</p>
Intensity	<p>Allows you to set the factor by which to multiply the intensity of the effect. This parameter can take a decimal value between 0 and 1. At 1, the effect is fully applied. At 0, the effect is not visible.</p>

Matte-Resize Node

The Matte-Resize effect lets you evenly expand a matte outward in all directions. The matte increases size from its centre.

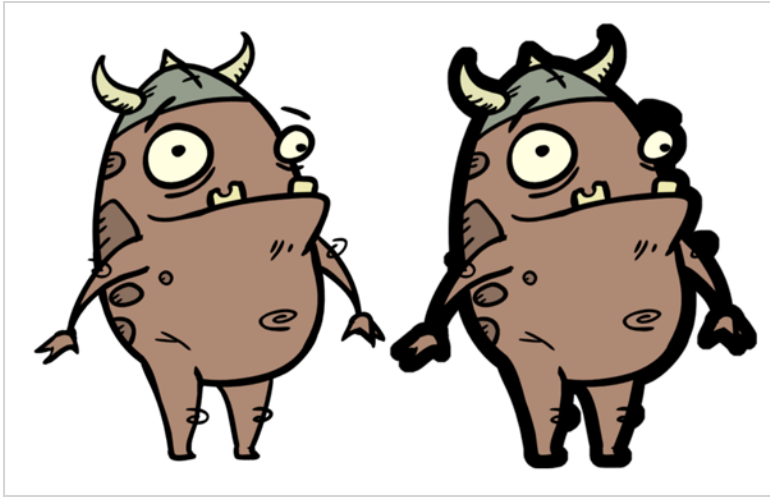

Refer to the following example to connect this effect:

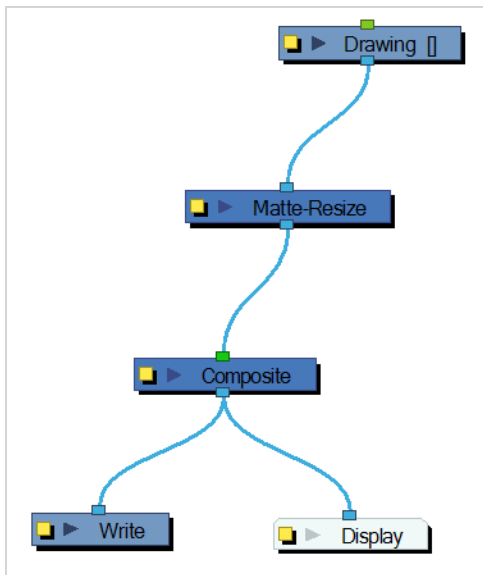

If you use the Matte-Resize node to create a pulsating glow, you can enlarge the region without softening the edges. Using the Blur-Radial effect, the effect may be softer than you intend. This node produces a limited antialiased matte, which can have slightly jagged edges. You could use this node in combination with other nodes, such as:

- Tone
- Highlight
- Glow

- Shadow
- Matte-Blur

Properties

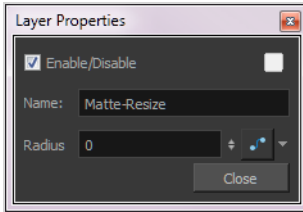

Parameter	Description
Name	Allows you to change the name given to the node.
Radius	Lets you enter a static value for the radius (size increase or decrease) of the matte. You can also attach the Radius value to a function column to change the value over time.

Median Node

The Median effect lets you reduce the noise in a drawing while preserving its edges. Harmony sorts the values of pixels within a specified radius and uses the median value. You can also use this effect to create an Impressionist type of style.

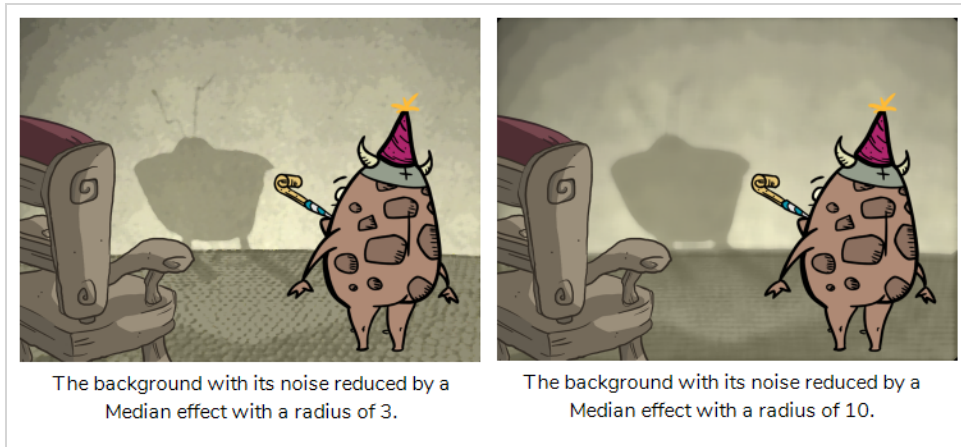
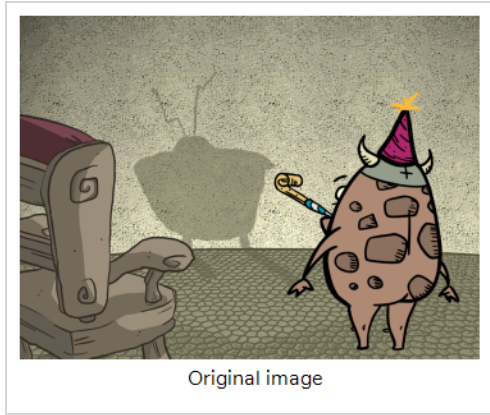

Connection

The Luminance-Threshold node takes a bitmap image as its input and outputs a bitmap image in which pixels that do not pass the threshold are filtered out.

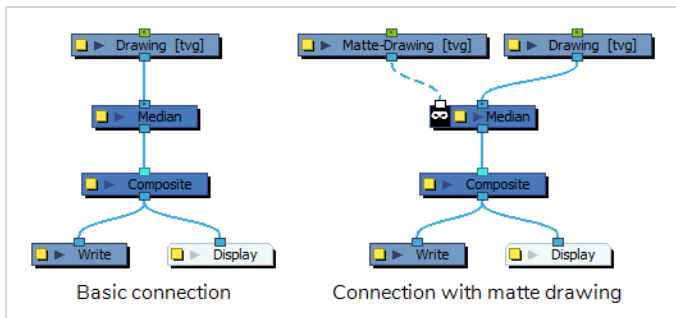

Optionally, it can also be connected to a matte image. In this case, only the parts of the input image that intersect with the matte will be affected by the effect.

Layer Properties

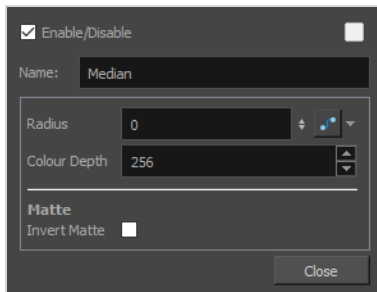

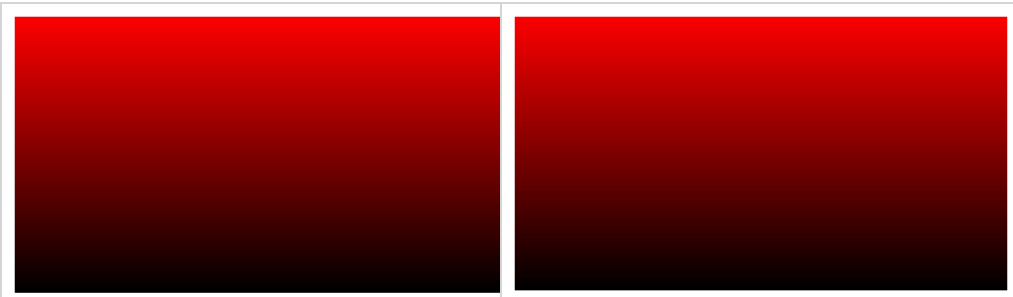
Parameter	Description
Enable/Disable	Allows you to enable or disable the node. When disabled, a node has no visible effect on the rendered image, nor on the preview in the Camera, Perspective, Side and Top views.
Colour Swatch	Sets the colour of the layer in the Timeline view and of the node in the Node view.
Name	The name of the node as it appears in the Node View and the Timeline view. Each node must have a name that is unique to its containing group.
Radius	Lets you specify the size of the area of values to consider determining the median value. A median is calculated by sorting all the pixel values from the surrounding area into numerical order. Then the middle pixel value is used to replace the pixel being considered. The median tends to make an image look a bit blurrier because it reduces the contrast of adjacent pixels. However, it does a good job of smoothing the image and removing artifacts.
Colour Depth	Determines the number of levels per colour channel. The larger the number, the more levels of colour are used in the image and the more time it takes to render. Conversely, the lower the colour depth, the fewer colours are used, the faster it is to render. 

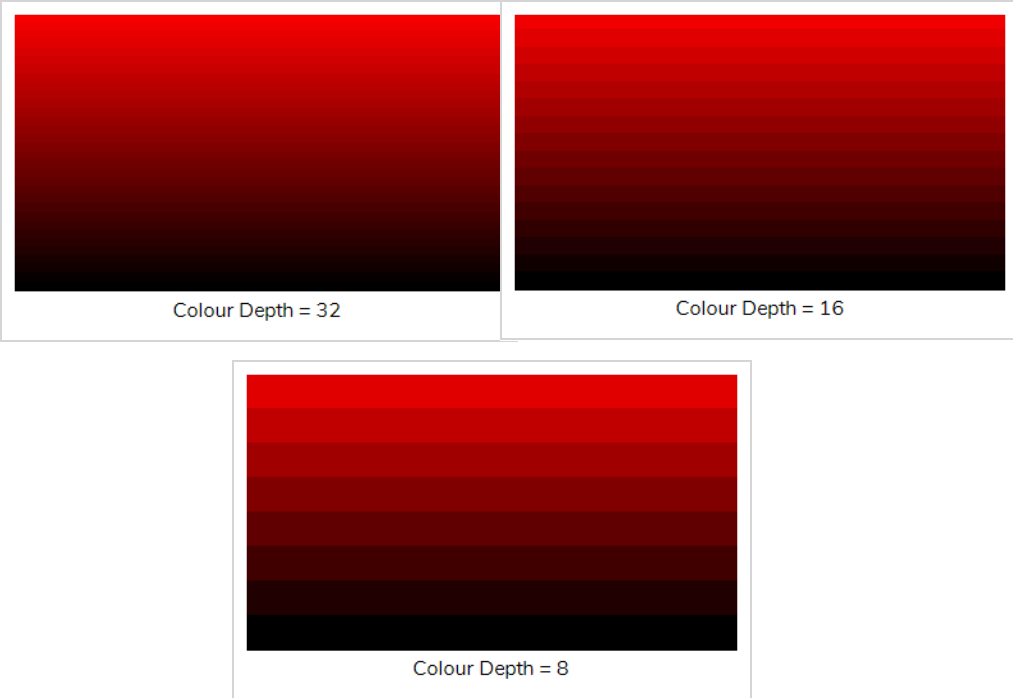
Parameter	Description
	
<p>Invert Matte</p>	<p>Inverts the matte used to generate the effect. By default, the effect is applied to the opaque areas of the matte drawing. When this option is enabled, the effect is applied to the transparent areas of the matte instead.</p>

Motion Blur Node

The Motion-Blur node allows you to generate a motion blur effect for animated elements in your scene.

The Motion-Blur node works by taking the position of the input element at the current frame as well as in previous frames. It then generates intermediary poses between each frame and combines the actual poses and the intermediary poses into a stack of “samples”. It then proceeds to lower the opacity of each sample, composite them together and add a directional blur between each sample.

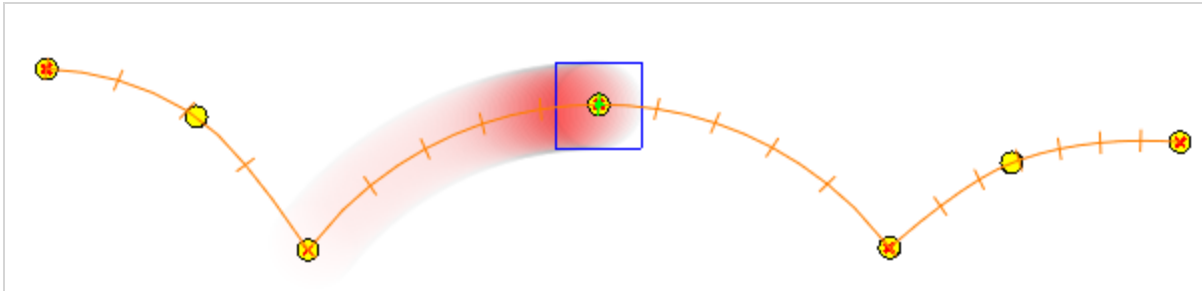

The Motion-Blur node can work with standard transformations such as translations, rotations, scaling and skewing. It can be used on single elements, or on several elements simultaneously, whether composited together or separately.



NOTE

The Motion-Blur effect does not work with deformations.

Connection

The Motion-Blur node has an image (rightmost) input port and a motion (leftmost) input port. It takes the image sent to its image input port and outputs the motion-blurred image through its only output port.

When nothing is connected to the motion input port, the direction of the motion blur is based on the transformations done on the element connected to the image input port. This is the most simple usage scenario.

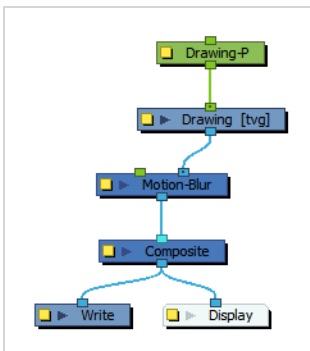

However, if the Motion-Blur node is connected to a composite node, the motion blur will be generated differently based on the composite’s mode:

- If the input image comes from a passthrough composite (wide cable), each input connected to the passthrough composite will have its own motion blur effect generated for it, using each input image's own motion.

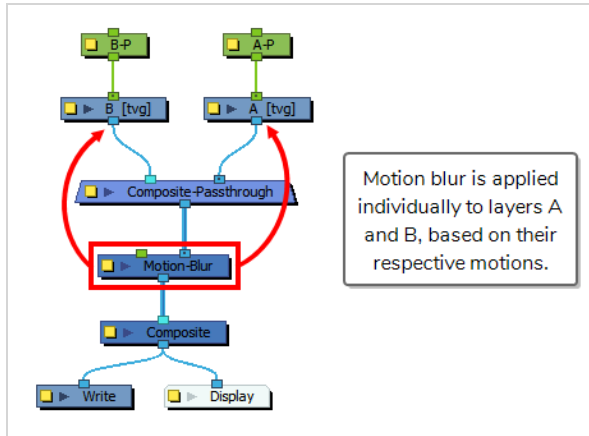

- If the input image comes from a non-passthrough composite, the motion-blur will be applied to the composited output image as a whole. It will however only use the motion of the element connected to the composite's Output Z port to generate the motion-blur effect. By default, a composite's Output Z port is its leftmost input port.

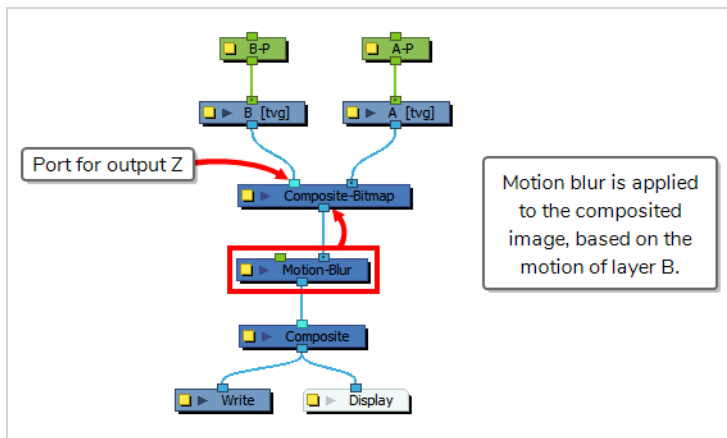

It is also possible to use the motion of any other node in your scene to determine the direction of the motion-blur effect. To do this, connect this node to the Motion-Blur's motion (leftmost) input port, like so:

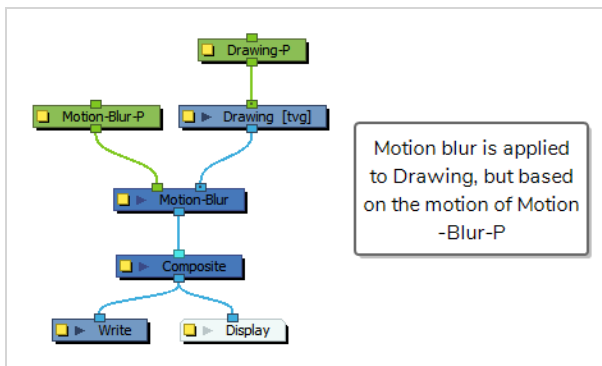



When a node is connected to the Motion-Blur node's left input port, it uses the motion of this node, rather than the motion of the input image, but it still applies the blur to the input image.

**TIP**

The Motion-Blur node can also use the motion of the scene's active camera to generate the motion blur. This can be done by enabling the Use Camera Motion option in the node's Layer Properties. When enabled, the Motion-Blur node ignores the motion of the input image and the left input port, and only uses the camera motion.

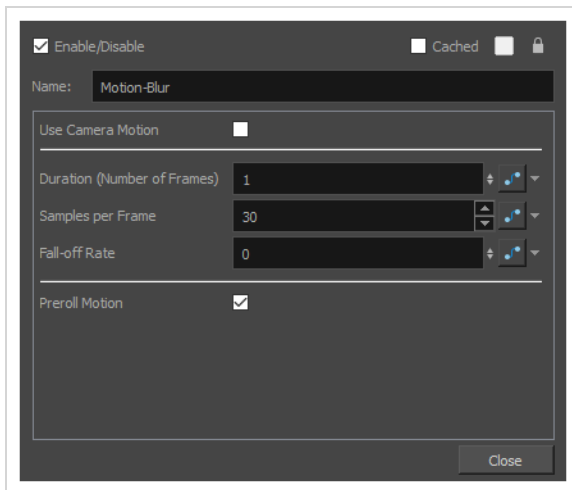
Layer Properties



Parameter	Description
Name	The name of the node as it appears in the Node View and the Timeline view. Each node must have a name that is unique to its containing group.
Use Camera Motion	When enabled, motion-blur is generated based on the motion of currently active camera. This option will override the transformation of the input image and the peg-port.
Duration (Number of Frames)	The span of animation before and up to the current frame to use to generate the motion blur effect, in frames. For example, if this parameter is set to 3, the motion blur effect will be generated using the trajectory of the element starting from 2 frames before the current frame up to the current frame. <div data-bbox="360 1698 1429 1837" style="border: 1px solid green; padding: 5px; margin-top: 10px;">  NOTE This number can be a decimal value. </div>

Parameter	Description
Samples per Frame	<p>This parameter sets the amount of in-betweens to add to the blur effect between each frame of animation used.</p> <p>For example, if the Duration parameter is set to 3, setting this parameter to 1 will only use the position of the element in the current frame and the two previous frames to generate the motion blur. However, if this parameter is set to 2, the Motion-Blur node will generate one extra inbetween sample between each frame used to generate the motion blur, to simulate a smoother motion.</p>
Fall-of Rate	<p>Defines the rate at which each trailing sample drops in weight and opacity as they get further and further from the position of the element in the current frame. This can be set to a decimal value between 0 and 1, where:</p> <ul style="list-style-type: none">• At 0, each sample used to generate the motion blur has the same opacity.• At 1, the sample at the current frame is almost opaque, and the opacity of each preceding sample is determined by a cubic function. <p>A value between 0 and 1 will result in a compromise between those two functions.</p>
Preroll Motion	<p>When enabled, samples are generated before the first frame of the scene, so that the motion blur effect is already in full effect when the scene begins. This can be useful in cases where the scene begins while the object is already in motion.</p>

Motion-Blur-Legacy Node

The Motion-Blur-Legacy effect is used to create a faded trail behind objects animated on a motion path. You cannot create a Motion-Blur-Legacy on a hand-drawn animation. The layer must be moving along a trajectory (motion path) in order to work properly.

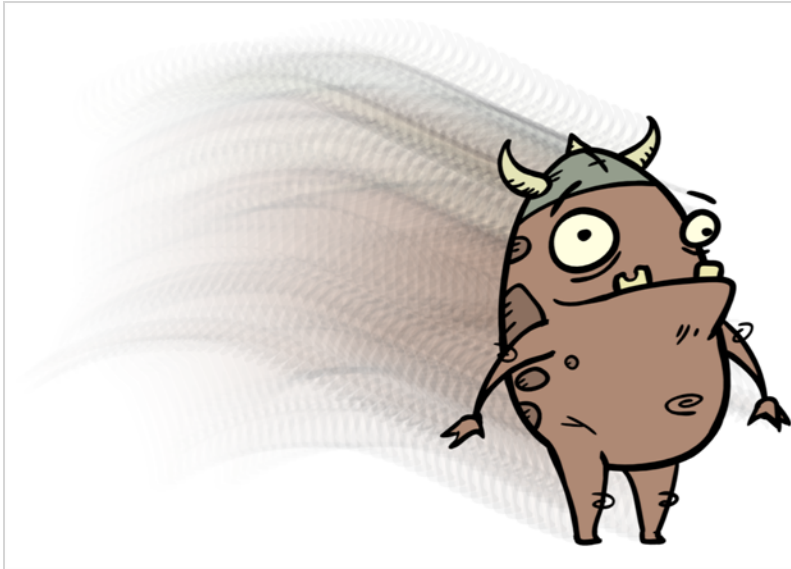

NOTE

For information on the new, non-legacy Motion-Blur node, see [Motion Blur Node on page 680](#)

Connection

As a filter-type effect, the Motion-Blur-Legacy node takes an input image in its right-most input port, and outputs the blurred image from its only output port.

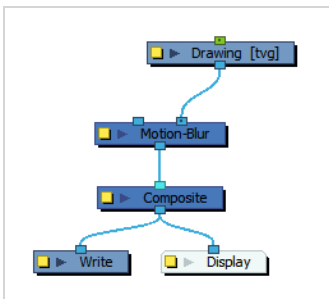

You can also connect another drawing to its left-most input port to act as the matte. The shape of the matte input drawing will determine the area of the actual input drawing to blur.

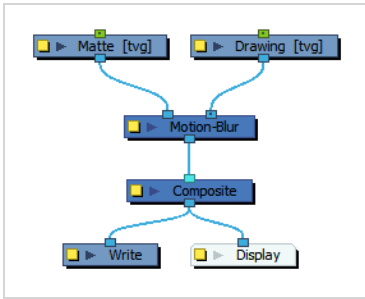

Properties

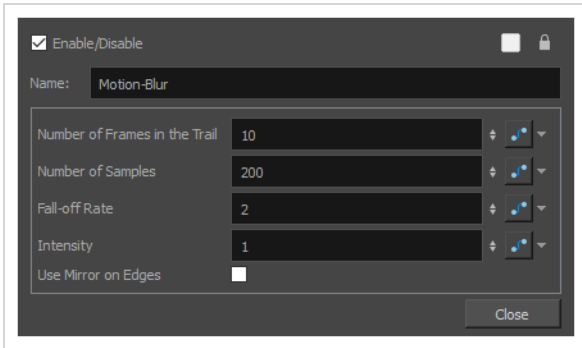

Parameter	Description
Name	The name of the node as it appears in the Node View and the Timeline view. Each node must have a name that is unique to its containing group.
Number of Frames in Trail	The number of frames before the current frame that will be used in the trail.
Number of Samples	The number of copies of each drawing used in the trail. The higher the number, the more continuous the trail appears.
Fall-off Rate	<p>The distance where the blur fades from the edge of the image. Select a value between 0 and 1.</p> <ul style="list-style-type: none"> A fall-off rate of 0 causes the trail to fade out slowly, distributing the colour evenly from the edge of the character to the farthest edge of the trail. A fall-off rate of 1 causes the trail to fade out quickly so that the trail is more opaque closer to the edge of the image and transparent at the end of the trail.
Intensity	Select a value to define the opacity of the trail between 0 and 10. A value of 10 will make the trail very dark and almost opaque, where as a value of 0 will make the trail quite pale and ghostly transparent.

Use Mirror on Edges	<p>When enabled this option appear when the image is close to the edge of the camera frame. It forces the software to use a mirror of the image to calculate the blur so that it appears on both sides of the drawing object. Without this option once your drawing reaches the edge of the Camera frame, it gets cropped so does the trail.</p>
---------------------	--

Negate Node

The Negate effect lets you invert the colour and/or alpha values in the Colour Art and Line Art of an image. The original value of each channel (RGB or A) is subtracted from the maximum value of that channel (255 for 8-bit channels) to produce the negative image.

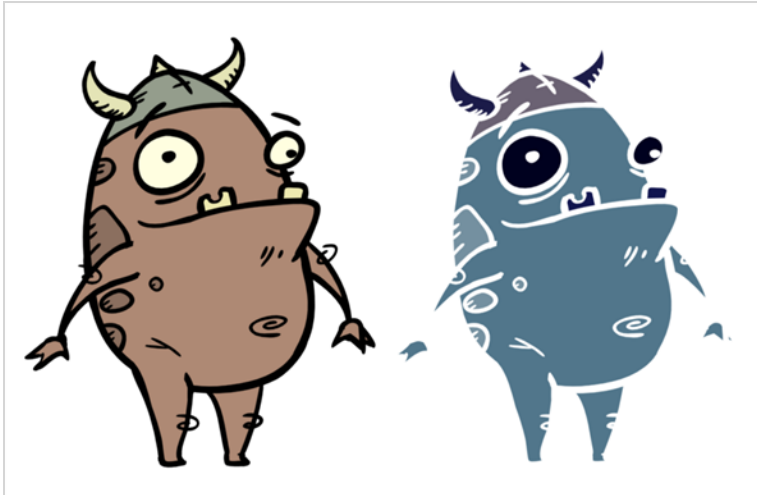

Connection

The Negate node takes an image of any type as its input and outputs an image in which colour values are inverted relative to their maximum.

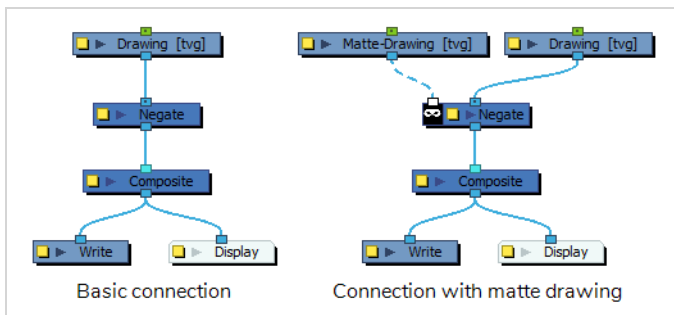

Optionally, it can also be connected to a matte image. In this case, only the parts of the input image that intersect with the matte will be affected by the effect.

Layer Properties

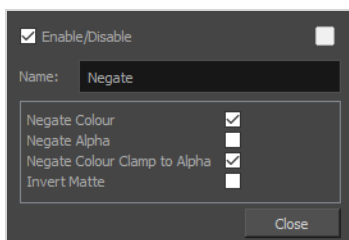

Parameter	Description
Enable/Disable	Allows you to enable or disable the node. When disabled, a node has no visible effect on the rendered image, nor on the preview in the Camera, Perspective, Side and Top views.
Colour Swatch	Sets the colour of the layer in the Timeline view and of the node in the Node view.
Name	The name of the node as it appears in the Node View and the Timeline view. Each node must have a name that is unique to its containing group.
Negate Colour	Inverts the values of the colour channels.
Negate Alpha	Inverts the transparency value (alpha channel).
Negate Colour Clamp to Alpha	Limits the negated area to the alpha channel.
Invert Matte	Inverts the matte used to generate the effect. By default, the effect is applied to the opaque areas of the matte drawing. When this option is enabled, the effect is applied to the transparent areas of the matte instead.

Overlay Layer Node

The Overlay Layer effect lets you read an element's Overlay Art layer. By placing an Overlay Layer node after a drawing node in the Node view, you can display only the node's Overlay layer output. The Overlay Layer node can be connected after nodes of any type. Any bitmap information will pass through and be processed.

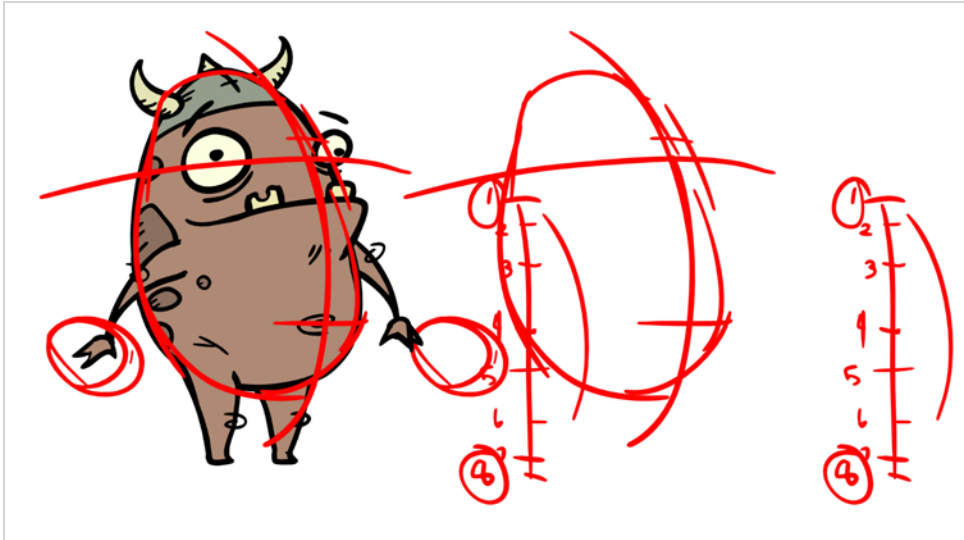

This effect will only work if something has been drawn or painted on a drawing's Overlay Art layer.

Refer to the following example to connect this effect:

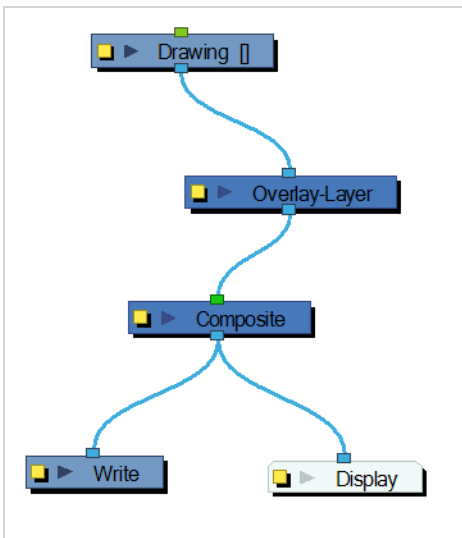

Properties

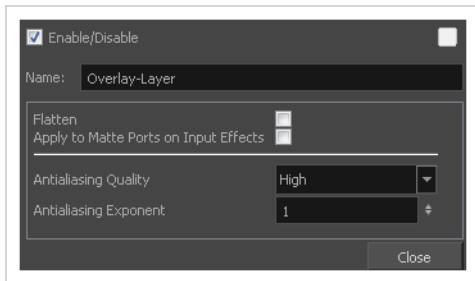

Parameter	Description
Name	Allows you to change the name given to the node.
Flatten	<p>When placing the node below a Composite node containing several drawing nodes, such as a cut-out character, you can use this option to flatten the extracted result. For example, when extracting a series of outlines, parts that may have been hidden by colour fills might now be visible. Enable the Flatten option to cut the extra artwork. Harmony will use the colour fills to cut unnecessary artwork. If your zones are not painted, nothing will be cut. This option works with both pencil lines and brush strokes.</p>
Apply to Matte Ports on Input Effects	At times, you may have situations where your node is placed below a Cutter node using a mask input and a drawing input. By default, the effect only processes the colours in the drawing input. The mask drawing remains untouched. If you want to also filter the mask drawing, select the Apply to Matte Ports on Input Effects option.
Antialiasing Quality	Smoothness setting applied to the art layer. Choose from Low (no antialiasing), Medium Low, Medium and High (extensive antialiasing). The higher the quality of the chosen setting, the greater the amount of antialiasing that is applied. Higher quality images require more time to render and more memory from your system.
Antialiasing Exponent	Controls the amount of area around the art layer edges that is used in the antialiasing process. A higher value uses less area, resulting in sharper edges, while a lower value uses more area, resulting in softer edges. If the Antialiasing Quality value is set to Low (no antialiasing), this value is ignored.

Pixelate Node

The Pixelate effect lets you apply a mosaic effect to an image (and its matte) based on the matte you supply. Pixelation makes the image look like it is made up of square tiles.

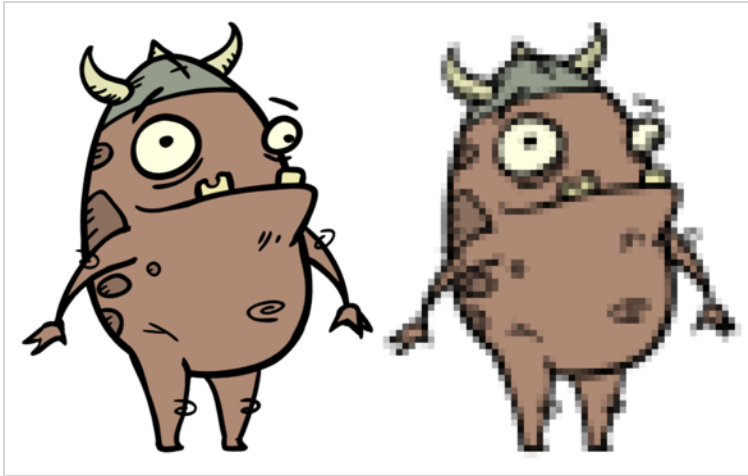

Connection

The Pixelate node takes an image of any type in the right (Image) input port, and a matte drawing in the left (Matte) input port. It outputs a version of the input image where the parts of the image that intersect with the matte are pixelated.

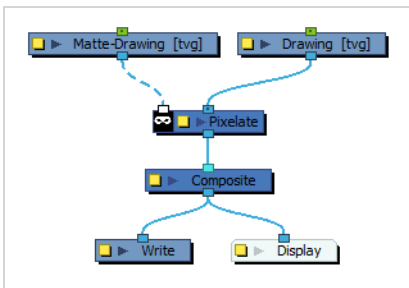

The Pixelate node requires a matte drawing. If you want to pixelate the entire input image, simply connect it to both the Image input port and the Matte input port.

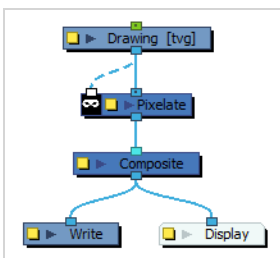

Layer Properties

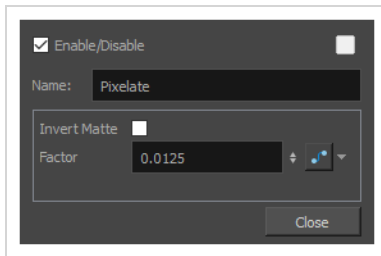

Parameter	Description
Enable/Disable	Allows you to enable or disable the node. When disabled, a node has no visible effect on the rendered image, nor on the preview in the Camera, Perspective, Side and Top views.
Colour Swatch	Sets the colour of the layer in the Timeline view and of the node in the Node view.
Name	The name of the node as it appears in the Node View and the Timeline view. Each node must have a name that is unique to its containing group.
Invert Matte	Inverts the matte used to generate the effect. By default, the effect is applied to the opaque areas of the matte drawing. When this option is enabled, the effect is applied to the transparent areas of the matte instead.
Factor	The pixelation factor. This parameter takes a decimal value between 0 and 1. The higher the value, the bigger the pixels. The default value is 0.0125 and creates sizeable pixels, so this parameter must be set to low values unless you want the pixels to take up the whole stage.

Remove Transparency Node

The Remove Transparency effect negates transparent values in an image. You can use the Remove Transparency node to remove the result of antialiasing around an image.

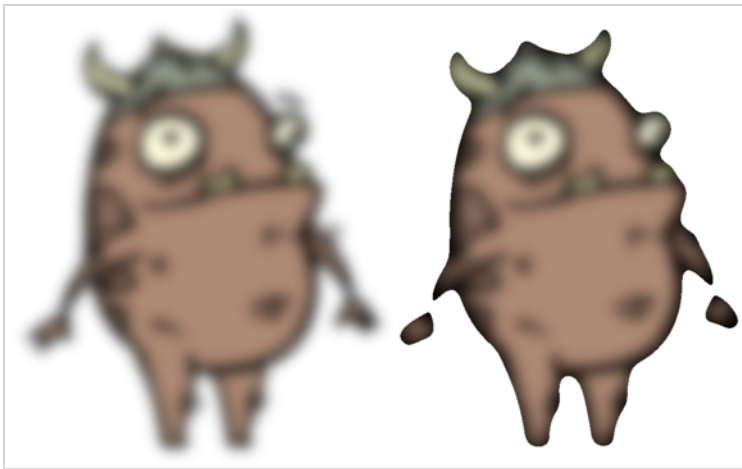

Refer to the following example to connect this effect:

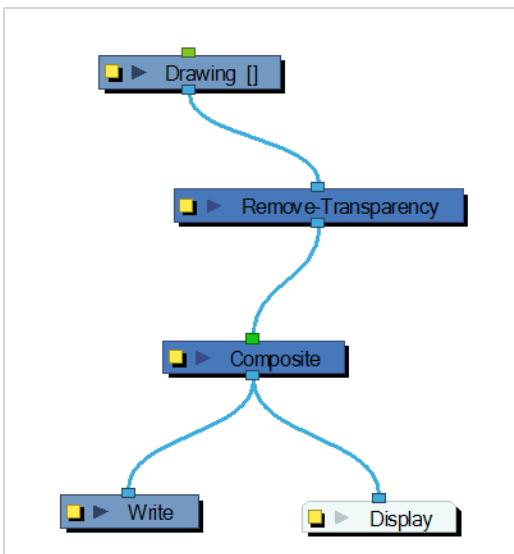

Properties

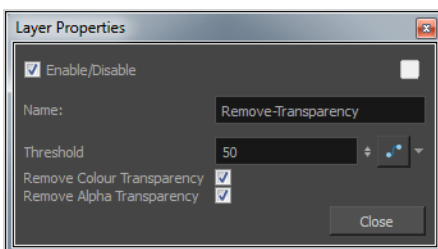

Parameter	Description
-----------	-------------

Name	Allows you to change the name given to the node.
Threshold	All values above the Threshold represent a transparent value. In this field, you must identify the value above which all alpha values are considered transparent. Alpha is measured from 0 to 255.
Remove Colour Transparency	Determines which pixels in the Colour-Art (RGB channels) to make fully opaque or fully transparent.
Remove Alpha Transparency	When selected, the Threshold value is used to determine which pixels in the alpha channel to make fully opaque or fully transparent.

RGB Difference Keyer Node

The RGB-Difference-Keyer node allows you to take an input image, and output it with an area of the image filtered out. The area of the image that is filtered out is determined by its colour, referred to as the key colour. This effect is typically used to take photos or live video footage shot against a green or blue screen and filter out the green or blue screen, so that it can be composited against the background.



Connection

The RGB-Difference-Keyer node has two image input ports.

If you only use the rightmost image input port, the RGB-Difference-Keyer will take the input image, generate a matte based on how much of the image matches the key colour, and remove the part of the image covered by this matte.

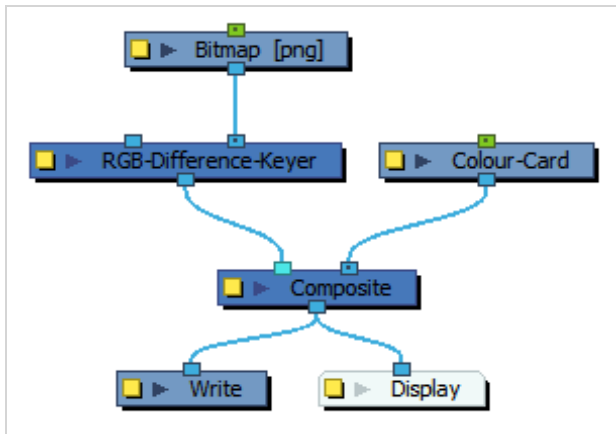



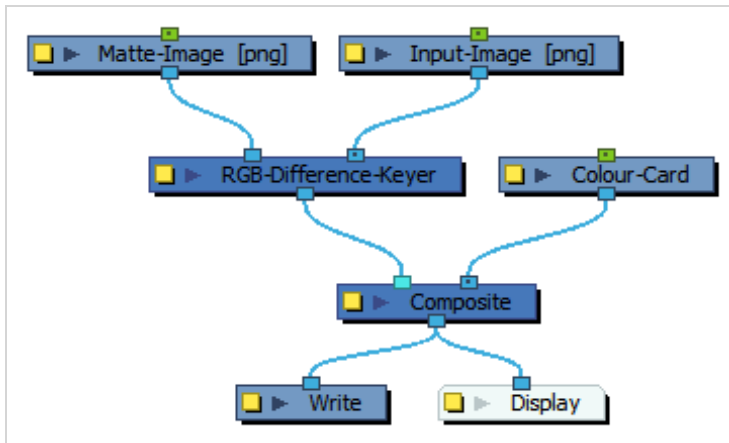

If you use both the left and right image input ports, the RGB-Difference-Keyer will generate a matte based on how much of the left input image matches the key colour, and cut that matte out of the right input image.

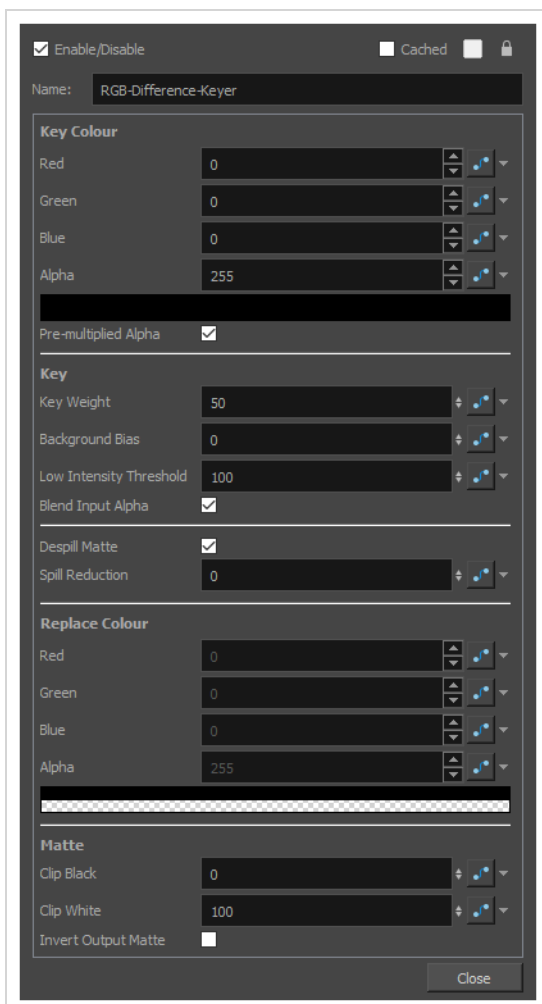

Properties



Parameter	Description
Name	The name of the node as it appears in the Node View and the Timeline view. Each node must have

Parameter	Description
	<p>a name that is unique to its containing group.</p>
<p>Key Colour</p>	<p>The colour used to generate the matte. This is used to set the colour of the image background. The matte is extracted by comparing the similarity of colour channel differences between key colour and the pixel colour.</p> <ul style="list-style-type: none"> • Red: The red value of the background colour. • Green: The green value of the background colour. • Blue: The blue value of the background colour. • Alpha: The alpha value of the background colour. <div data-bbox="380 720 1430 1255" style="border: 1px solid #add8e6; padding: 10px;"> <p> TIP</p> <p>If you click on the colour swatch below the Alpha field, a Colour Picker window will appear. In this video, you can click and drag on the  dropper and drop it over a pixel in the background of your photo or video to pick its colour.</p>  </div> <div data-bbox="380 1283 1430 1453" style="border: 1px solid #90ee90; padding: 10px;"> <p> NOTE</p> <p>This keyer requires chromatic differences between the red, green or blue colour channels, so greyscale images cannot be keyed using this effect.</p> </div>
<p>Pre-Multiplied Alpha</p>	<p>When checked, the RGB values of the input image are un-premultiplied before they are keyed. The output image is then re-pre-multiplied against the alpha channel.</p> <p>If the input image has alpha values and is pre-multiplied, this option will prevent the pre-multiplication from evening out the differences between the RGB channels.</p>
<p>Key</p>	
<p>Key Weight</p>	<p>Increasing values result in fewer pixels colours being selected in the background.</p>

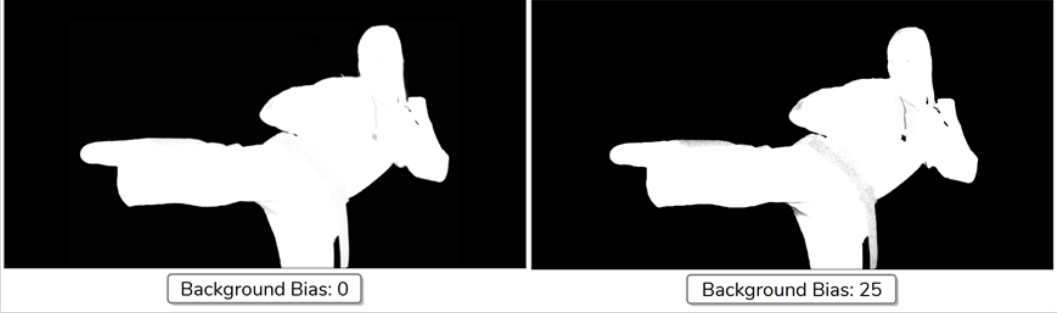
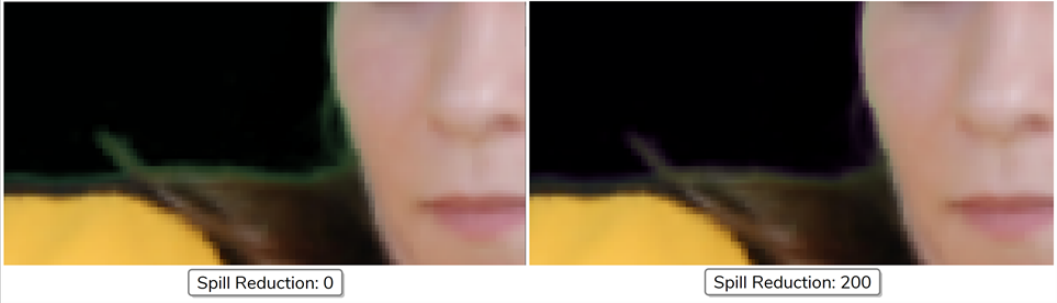
Parameter	Description
Background Bias	<p>Increasing this parameter will increase the tendency of the effect to find pixels that match the key colour and to key them out.</p> 
Low Intensity Threshold	<p>Increasing this parameter will make the node tend to key out darker pixels.</p>
Blend Input Alpha	<p>When enabled, the alpha values of the input image are carried over to the alpha values of the output image. This option is only useful if the input image contains transparency, and that transparency needs to be preserved.</p>
Despill Matte	<p>When enabled, the effect removes the primary channel of the key colour from the edges of the output image, resulting in smoother contours.</p>
Spill Reduction	<p>The amount of the colour key that should be removed from the edges of the output image. A higher setting will make the contours blend in better with the background of the scene.</p> 
Replace Colour	<p>If the Despill Matte parameter is unchecked, this colour is used to fill the areas of the keyed matte that are semi-transparent.</p>
Matte	

Parameter	Description
Clip Black	Determines how much the effect should key out dark pixels.
Clip White	Determines how much the effect should key out light pixels.
Invert Output Matte	Inverts the matte applied to the output image. When enabled, pixels that are keyed will be opaque, and pixels that are not keyed will be transparent.

Shadow Node

With the Shadow effect, you can turn a drawing into a shadow. It doesn't matter if the drawing layer is a fully coloured character. The Shadow effect will render it into a grey, semitransparent, slightly blurry silhouette. You must connect your layer a second time to the your Composite node to see the original image displayed on top of the shadow.



Refer to the following example to connect this effect:

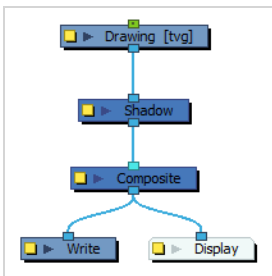



NOTE

If this effect is connected below a Composite node set to Pass-Through, the effect will be applied to each element connected in the Composite node individually. If some of these elements are overlapping, the effect will also overlap.

Properties

Parameter	Description
Enable/Disable	Allows you to enable or disable the node. When disabled, a node has no visible effect on the rendered image, nor on the preview in the Camera, Perspective, Side and Top views.
Colour Swatch	Sets the colour of the layer in the Timeline view and of the node in the Node view.

Parameter	Description
Name	The name of the node as it appears in the Node View and the Timeline view. Each node must have a name that is unique to its containing group.
Truck Factor	Activated by default, this option readjusts the blur when the elements undergo a change of depth or scale. When disabled, the effect's values will remain unchanged regardless of depth or scale changes. It is recommended that this option be disabled when multiple drawings are composited and attached this effect.
Blur Type	<p>Allows you to choose between the following blur types for the effect:</p> <ul style="list-style-type: none"> • Radial: The edges of the matte are blurred evenly around points that make up the edge of the matte. • Directional: The matte is blurred in the direction configured with the Directional Angle and Directional Falloff Rate parameters.
Radius	Enter a value for the size of the blur. The larger the value, the greater the blur effect. The blur radius is affected by the drawing scale and camera position.
Directional Angle	<p>If you set the Blur Type to Directional, this sets the angle of the blur. The value goes from 0 to 360, with 0 meaning west, and angles going counterclockwise. For example:</p> <ul style="list-style-type: none"> • 0: Blurs the image to the west. • 90: Blurs the image to the south. • 180: Blurs the image to the east. • 270: Blurs the image to the north.
Directional Falloff Rate	<p>The distance where the blur fades from the edge of the image. Select a decimal value between 0 and 1. For example:</p> <ul style="list-style-type: none"> • 0: Makes the blur fade out slowly, distributing the blur evenly from the edge of the character to the farthest edge of the blur. • 1: Makes the blur fade out quickly. The blur is heaviest closer to the edge of the image.
Invert Matte	Inverts the matte used to generate the effect. By default, the effect is applied to opaque areas of the drawing. When this option is enabled, the effect is applied to transparent or empty areas of the drawing.

Parameter	Description
Use Source Colour	<p>Instead of using the colour in the Colour parameters, this uses the colours in the source drawing to generate the effect.</p> <div style="border: 1px solid green; padding: 5px; margin-top: 10px;">  NOTE The effect of this parameter is only visible in Render View  mode. </div>
Multiplicative	Multiplies the colours of the effect with the colours of the background. This intensifies the effect.
Colour	
Red	The amount of red to subtract from the colour in the background image. To obtain a shadow effect, this value must be negative.
Green	The amount of green to subtract from the colour in the background image. To obtain a shadow effect, this value must be negative.
Blue	The amount of blue to subtract from the colour in the background image. To obtain a shadow effect, this value must be negative.
Alpha	The alpha value of the effect.
Colour Swatch	Opens the Colour Picker dialog, in which you can visually select a colour for the effect.
Intensity	Allows you to set the factor by which to multiply the intensity of the effect. This parameter can take a decimal value between 0 and 1. At 1, the effect is fully applied. At 0, the effect is not visible.

Transparency Node

T-HFND-010-008

The Transparency effect is used to make an image partially transparent. The Transparency effect is useful when fading images in and out, such as a phantom or to make something partially see-through, such as a window.

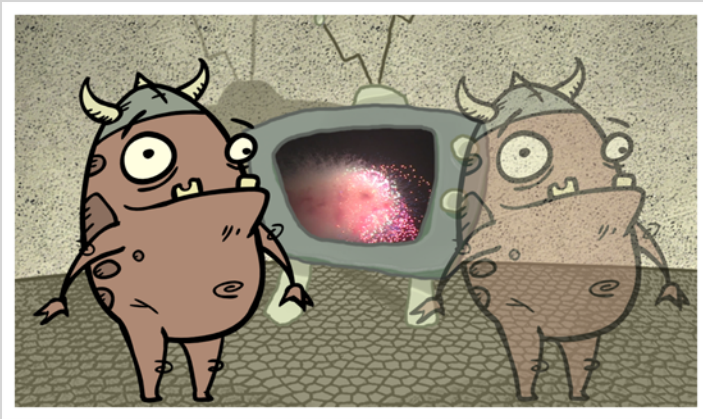

Refer to the following example to connect this effect:

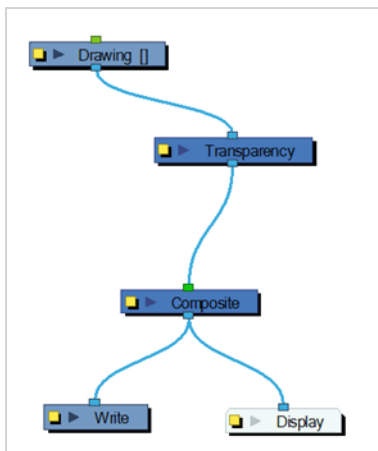

You can enter a value in the Transparency field or change the transparency value over time by linking it to a function curve. Entering a value of 100 in the Transparency field will make the element 100% transparent, in other words, invisible. Entering a value of 0 will render the element completely opaque.

It is also possible to adjust a drawing layer's transparency directly in the Layer Properties window without using the Transparency node. In the layer's properties, go to the Drawing tab and adjust the Opacity parameter. This parameter is visible in OpenGL mode.

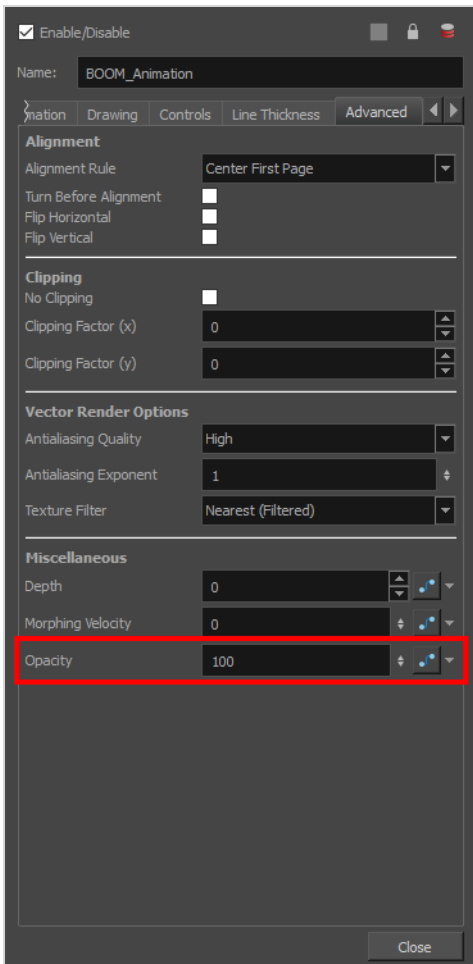

Properties

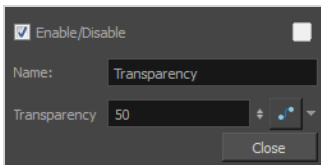

Parameter	Description
Name	Allows you to enter a name for the node.
Transparency	Lets you set the opacity of an element. Values range from 0 to 100. A value of 100 will make the element 100% transparent and a value of 0 will render the element completely opaque.

Underlay Layer Node

The Underlay Layer effect lets you read an element's Underlay Art layer. By placing an Underlay Layer node after a drawing node in the Node view, you can display only the node's Underlay layer output. The Underlay Layer node can be connected after nodes of any type. Any bitmap information will pass through and be processed.

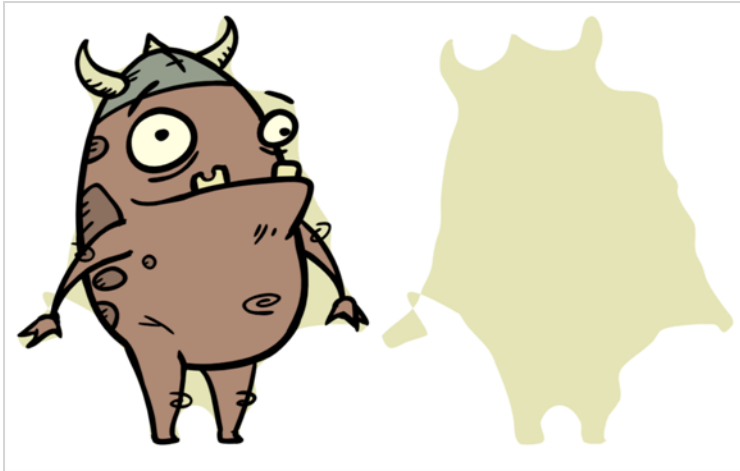

This effect will only work if something has been drawn or painted on a drawing's Underlay layer.

Refer to the following example to connect this effect:

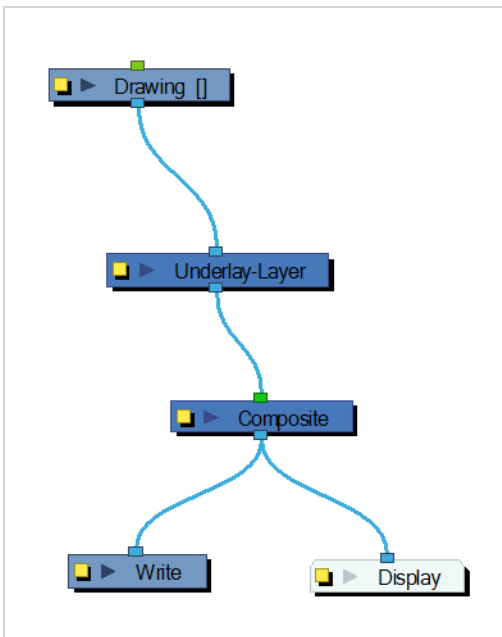

Properties

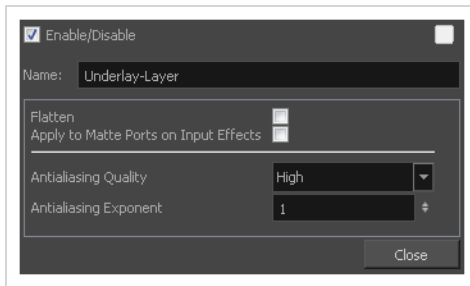

Parameter	Description
Name	Allows you to change the name given to the node.
Flatten	<p>When placing the node below a Composite node containing several drawing nodes, such as a cut-out character, you can use this option to flatten the extracted result. For example, when extracting a series of outlines, parts that may have been hidden by colour fills might now be visible. Enable the Flatten option to cut the extra artwork. Harmony will use the colour fills to cut unnecessary artwork. If your zones are not painted, nothing will be cut. This option works with both pencil lines and brush strokes.</p>
Apply to Matte Ports on Input Effects	At times, you may have situations where your node is placed below a Cutter node using a mask input and a drawing input. By default, the effect only processes the colours in the drawing input. The mask drawing remains untouched. If you want to also filter the mask drawing, select the Apply to Matte Ports on Input Effects option.
Antialiasing Quality	Smoothness setting applied to the art layer. Choose from Low (no antialiasing), Medium Low, Medium and High (extensive antialiasing). The higher the quality of the chosen setting, the greater the amount of antialiasing that is applied. Higher quality images require more time to render and more memory from your system.
Antialiasing Exponent	Controls the amount of area around the art layer edges that is used in the antialiasing process. A higher value uses less area, resulting in sharper edges, while a lower value uses more area, resulting in softer edges. If the Antialiasing

	Quality value is set to Low (no antialiasing), this value is ignored.
--	---

Generator Nodes

The nodes found in the Generator category are nodes that output an image without requiring an input image. Hence, they generate an image rather than transforming an existing image. Among those nodes is the Element node, also known as drawing layers, which generate an image based on the drawing exposed at the current frame. Other nodes in this category generate an image based on their parameters.

Animated Matte Generator Node	709
Burn-In Node	720
Colour-Card Node	724
Element / Drawing Node	727
Connection	728
Field Chart Node	745
Gradient Node	750
Grid Node	756
Lens Flare Node	759
Turbulent Noise Node	762

Animated Matte Generator Node

The animated matte generator is a very advanced tool in Harmony's suite of effects which, once connect to a drawing or character model, gives you three important capabilities.

- Digitally animate the lines and contours of vector drawings
- Create animated feathered (gradient) visual effects in specific shapes.
- Snap to the contours of a drawing to make the shape of its effect match the shape of the drawing.

The resulting image can be used as a deformed drawing or an effect, and can also be used as a transparency mask for other drawings or effects.

At the very least, the Animated Matte Generator node requires a vector drawing to be connected to its **Image Source** (right) input port. The node will generate animatable control points for each of the vector shapes in each of the drawings in its matte drawing layer, which can be manipulated and animated, allowing you to animate your drawing's vector points directly.

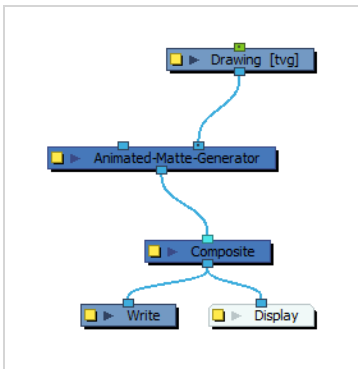

TIP

If the image source layer is moved, rotated or scaled, either directly or because of a parent peg, the control points of the Animated Matte Generator will follow these transformations. If you want the matte generated by the Animated Matte Generator node to follow the animation of another drawing, you can simply connect that drawing's output port to the image source drawing's input port.



IMPORTANT

If the Overlay and Underlay Arts preference is enabled, the Overlay art layer of the source drawing is reserved for annotations. Any artwork in the Overlay art layer of the source drawing will be ignored by the Animated Matte Generator node.

Based on its parameters, the Animated Matte Generator node will either output the source drawing after deforming it to match the position of the control points, or a feathered special effects matte gradating from its

inner contour to its outer contour. In either case, this allows to animate the image source, either as a simple vector drawing, as a special effect or as part of a more complex rig, without making new drawings for it.

Optionally, another vector drawing may be connected to the node's **Snapping Source** (left) input port. Using the Set to Snap editing mode in the Animated Matte Generator view, you can set some of the points and contours of the input drawing to automatically snap to the snapping source drawing's contours, making it easier to animate a matte to follow the contours of a drawing in your scene. A contour that is set to snap to one of the snapping source's contours will even match the precise shape of this contour.

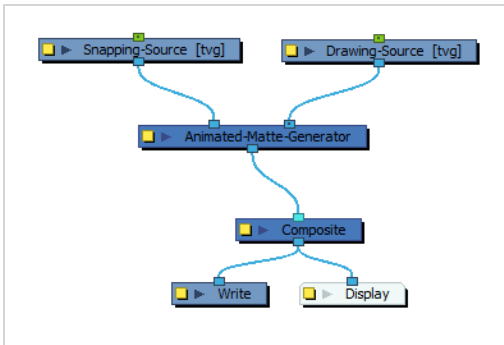

IMPORTANT

Only single vector drawing layers can be used for the image source and the snapping source of an Animated Matte Generator. The input ports of an Animated Matte Generator node should not be connected to a composite, an effect, or anything but a vector drawing node.

Often, an Animated-Matte-Generator will be used to add a fine-tuned effect, such as a glow or shadow, on part of a drawing. A typical set-up to accomplish this will make use of the Colour Selector node and Cutter nodes to trim the effect generated by the Animated Matte Generator so that it only affects zones of the drawing that are painted with the specific colour. Since the effect generated for this drawing should follow that drawing's movements, if any, pegging the Animated Matte Generator's drawing source to the drawing the effect is applied over will lock their position together. Likewise, it may be useful to connect the drawing the effect will be applied over as the Animated Matte Generator's snapping source, since the matte might need to be snapped to that drawing's contours.

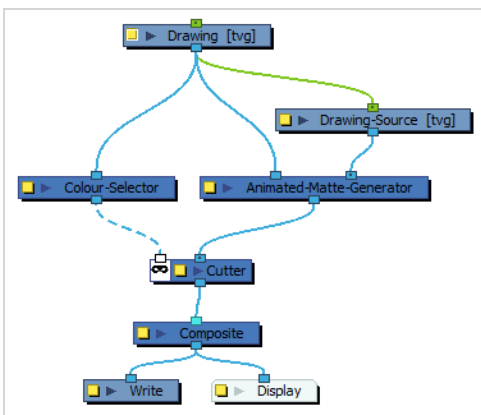

You can instantly add this template to your scene by clicking on the Add Matte Generator button in the Animated Matte Generator view. As an alternative, the Add Matte Generator as Mask button will add a similar template, except that the Animated-Matte Generator will be connected to the Cutter's matte port, and the drawing's Colour-Selector will be connected to the Cutter's input port. This can be used for example to use the Animated Matte Generator as a sophisticated transparency filter for an effect or element in your scene.

The contours of an Animated Matte Generator can be configured and animated by using the Animated Matte Generator view along with its control points in the Camera view.

How to access the Animated Matte Generator view

1. Do one of the following:
 - From the top-right corner of any currently visible view, click the Add View **+** button and select **Animated Matte Generator**.
 - From the top menu, select **Windows > Animated Matte Generator**.

How to display the Animated Matte Generator controls and enable the Animated Matte Generator view options

1. In the Tools toolbar, select the Transform tool or press Shift + T.
2. In the Timeline or Node view, select the Animated Matte Generator node you wish to configure or animate.
3. In the Camera view toolbar, click on Show Controls  or press Shift + F11.



NOTE

For more information on the Animated Matte Generator view, see [Animated Matte Generator View on page 1204](#).

Layer Properties

Using the Layer Properties dialog or view, you can configure the kind of matte the Animated Matte Generator should output, how the matte's points and contours should snap to its snapping source as well as the colours and other parameters for generating a feathered effect.



NOTE

The examples below demonstrate the effects of using the Animate Matte Generator with a simple drawing of a square. However, it is able to deform vector drawings of any shape and complexity.

Matte tab

The matte tab allows you to configure whether the Animated Matte Generator node will output a deformed version of its input source drawing or a feathered effect based on its outer and inner contour as well as how the contour's control points and lines should snap to the snapping source's contours, if any.

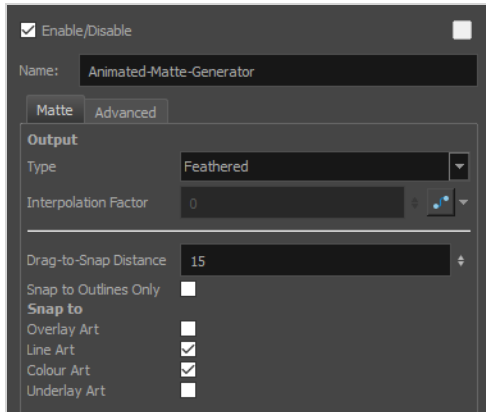

Property	Description
Output	
Type	<p>Determines which one of the following type of matte the node generates:</p> <ul style="list-style-type: none"> Feathered: Generates a matte that gradates from the inner contour's colour to the outer contour's colour, based on the parameters in the Advanced tab. <div data-bbox="578 1167 1024 1465" style="text-align: center;"> </div> Outer Contour: Displays the matte drawing as deformed by the outer contour's control points. <div data-bbox="578 1587 1024 1885" style="text-align: center;"> </div>

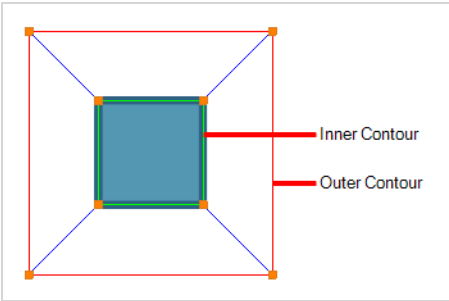
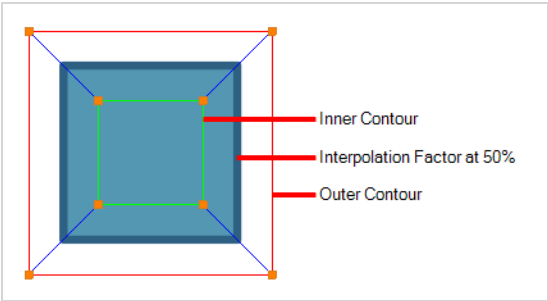
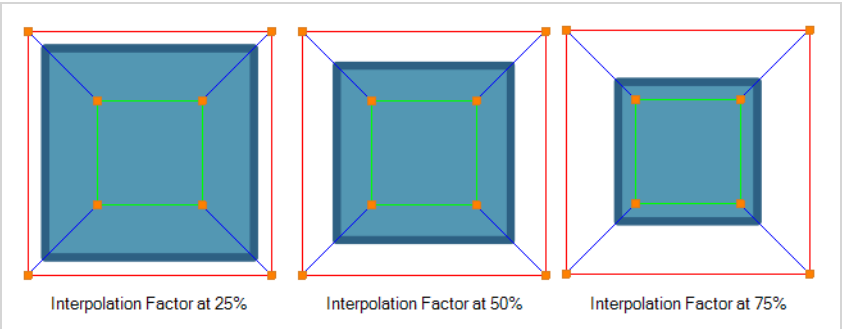
	<ul style="list-style-type: none"> Inner Contour: Displays the matte drawing as deformed by the inner contour's control points.  <ul style="list-style-type: none"> Interpolate between contours: Displays the matte drawing as deformed by a contour that is an intermediate between the outer contour and the inner contour. How close to the inner or outer contour this intermediate contour is is based on the Interpolation Factor parameter below. 
<p>Interpolation Factor</p>	<p>When the output type is set to Interpolate between contours, the matte drawing is deformed according to a contour that is an intermediate between the outer contour and the inner contour.</p> <p>The interpolation factor determines the percentage by which the intermediate contour is interpolated from the outer contour to the inner contour. For example, if the interpolation factor is set to 50, the intermediate contour will be halfway between the outer contour and the inner contour. By default, it is set to 0, which means the intermediate contour is the same shape as the outer contour. If it is set to 100, the intermediate contour will match the inner contour.</p> 

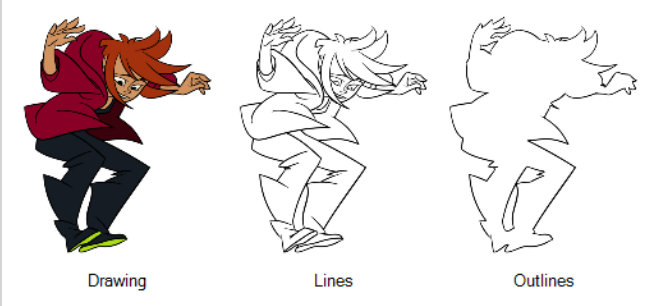
	<div style="border: 1px solid #add8e6; padding: 10px;">  <p>TIP</p> <p>The Interpolation Factor parameter can be animated. This can be useful if you want your drawing to morph back and forth between two different shapes, one of which would be defined by the outer contour and the other defined by the inner contour.</p> </div>
Snap	
Drag-to-Snap Distance	<p>If the Animated Matte Generator mode has a drawing connected to its Snapping Source port, and some of the matte's control points or contours are set to snap to that drawing, those points will always snap to the closest contour in the snapping source drawing, as long as it can find a contour within a certain distance.</p> <p>This distance is determined by the Drag-to-Snap distance parameter. By default, it is set to 15. You can increase it if you want the snapping points to snap to contours from a further distance to their actual position, or decrease it if you only want snapping points to snap to contours that are very close to their actual position.</p>
Snap to Outlines Only	<p>Make Snapping points and contours only snap to the outlines of the snapping source drawing. In this case, a contour is an outline that defines the silhouette of the drawing.</p> <div style="text-align: center;">  <p style="display: flex; justify-content: space-around; margin-top: 5px;"> Drawing Lines Outlines </p> </div>
Snap to	<p>Allows you to select which ones of the snapping source drawing's art layers the matte's points and contours will snap to, if they are set to snap. This can be useful if your snapping source drawing has its line art and colour art on different layers, as both art layers are likely to have a lot of meshing contours.</p>

Advanced Tab

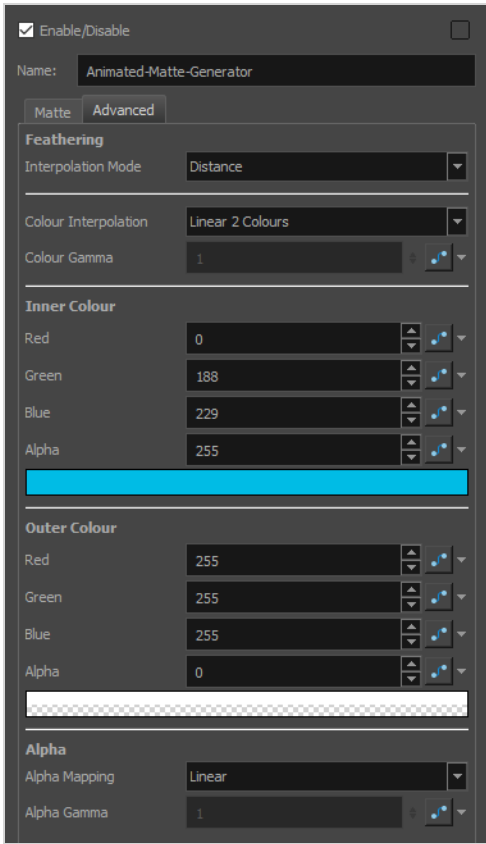

The settings in the Advanced tab are only available when the matte's output type is set to Feathered. A feathered matte ignores the colours and pencil lines in the drawing and, instead, uses the outer and inner matte's shape to generate a gradated colour effect, the colours and parameters of which can be set in the Advanced tab.

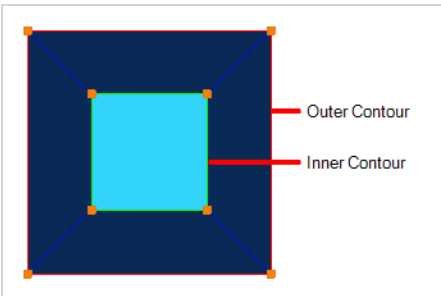

Property	Description
Feathering	
Interpolation Mode	<p>Determines the way the colour is gradated from the inner contour to the outer contour:</p> <ul style="list-style-type: none"> None: The outer and the inner contour are solid shapes, filled with their respective colours.  <ul style="list-style-type: none"> Parametric: Generates a linear gradient going from each side of the inner contour to the corresponding side of the outer contour. This mode is different from the Distance interpolation mode by how it makes the gradients track the matching sides of the inner and outer contours.

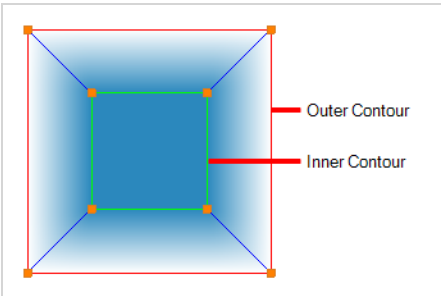
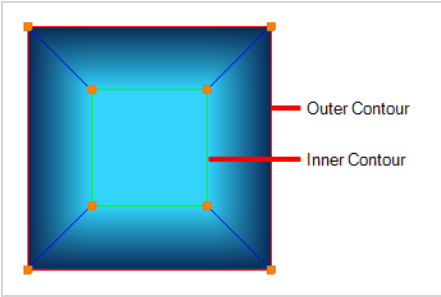
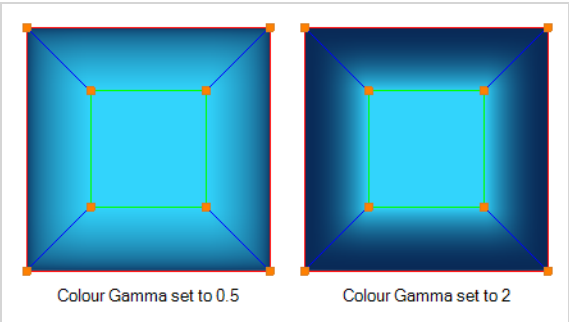
	<div data-bbox="576 184 1128 562" style="text-align: center;"> <p>Outer Contour Inner Contour Outer Contour Inner Contour</p> <p>Parametric Mode Distance Mode</p> </div> <ul style="list-style-type: none"> • Dot: Generates a gradient going from the inner contour to the outer contour, but based on a power function that creates the illusion of a thinner, harder outline. <div data-bbox="576 682 1015 976" style="text-align: center;"> <p>Outer Contour</p> <p>Inner Contour</p> </div> <ul style="list-style-type: none"> • Distance: Generates a linear gradient going from the inner contour to the outer contour. <div data-bbox="576 1092 1015 1386" style="text-align: center;"> <p>Outer Contour</p> <p>Inner Contour</p> </div>
Colour	
Colour Interpolation	<p>Determines the way the colours between the inner and outer contours are generated:</p> <ul style="list-style-type: none"> • Constant: Generates a gradient based on the inner colour, gradating in transparency only. The inner contour will have the opacity of the inner colour, and will gradate towards full transparency towards the outer contour.

	 <p>• Linear 2 Colours: Creates a gradient that steadily gradates from the inner colour to the outer colour.</p>  <p>• Gamma 2 Colours: Creates a gradient that gradates from the inner colour to the outer colour on a Gamma curve, the power of which can be set in the Colour Gamma field. For more information, see the Colour Gamma field section below.</p>
<p>Colour Gamma</p>	<p>When the Colour Interpolation parameter is set to Gamma 2 Colours, use this field to enter the gamma power used to generate the gradient. By default, it is set to 1, creating a linear gradient. When set to any value between 0 and 1, the gradient will ease in from the inner colour to the outer colour. When set to any value above 1, the gradient will ease out from the inner colour to the outer colour.</p>  <p>Colour Gamma set to 0.5 Colour Gamma set to 2</p>
<p>Inner Colour</p>	<p>The colour used to fill the matte's inner contour.</p>
<p>Outer Colour</p>	<p>The colour used for the matter's outer contour.</p>

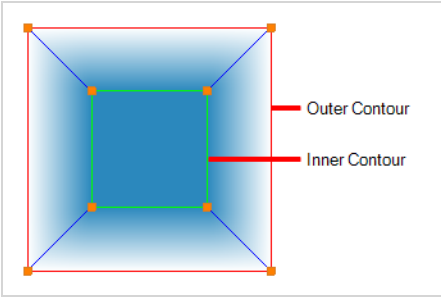
	<div data-bbox="500 191 1430 390" style="border: 1px solid #c8e6c9; padding: 10px; margin-bottom: 10px;"> <p> NOTE If the Interpolation mode is set to None, this colour will fill the outer contour. Otherwise, it is used to create a gradient going from the inner contour to the outer contour.</p> </div> <div data-bbox="500 422 1430 646" style="border: 1px solid #c8e6c9; padding: 10px;"> <p> NOTE If the Colour Interpolation parameter is set to Constant, this parameter is ignored and the outer colour will be set to the same colour as the inner colour, except with an alpha value of zero, making the matter a single solid colour with a transparency gradient.</p> </div>
Alpha	<p>Determines the way the alpha between the inner contour and the outer contour is gradated:</p> <ul style="list-style-type: none"> • Linear: Steadily gradates from the inner contour's alpha to the outer contour's alpha. <div data-bbox="578 978 1016 1272" style="text-align: center;">  </div> <ul style="list-style-type: none"> • Gamma: Calculates the alpha going from the inner contour to the outer contour based on a Gamma curve, the power of which can be set in the Alpha Gamma field. For more information, see the Alpha Gamma field section below.
Alpha Gamma	<p>When the Colour Mapping parameter is set to Gamma, use this field to enter the gamma power used to calculate the alpha values in the gradient. By default, it is set to 1, creating a linear alpha gradient. When set to any value between 0 and 1, the gradient's alpha values will ease in from the inner contour's alpha value to the outer contour's alpha value. When set to any value above 1, the alpha values of the gradient will ease out from the inner contour's alpha value to the outer contour's alpha value.</p>

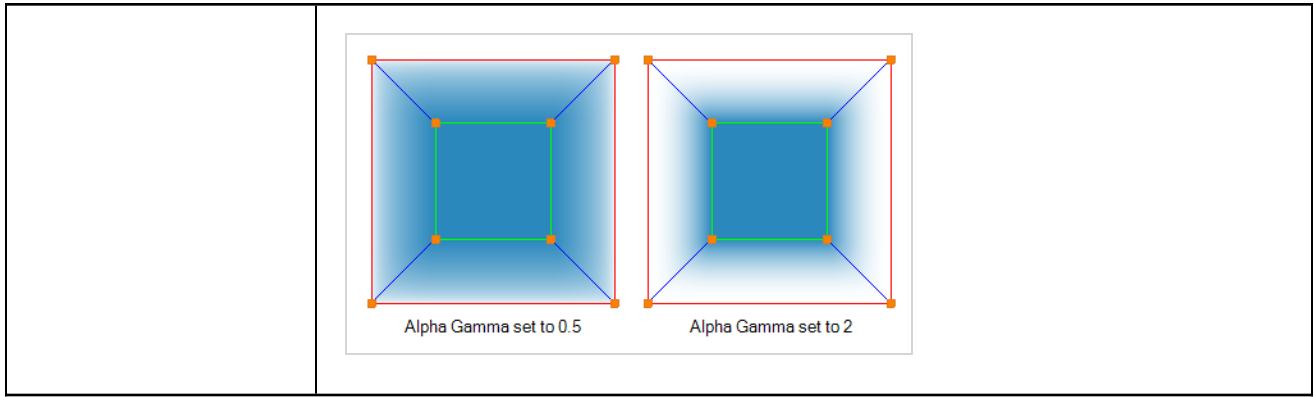

Burn-In Node



The Burn-In effect lets you add scene information which is visible in the Camera view. The information is displayed on top of any content in the scene. You can choose to display the scene name, timecode, frame count, environment and job, as well as add a frame offset if you need blank frames to precede the scene content. Also, to make the information more visible, you can also add a background and choose its colour, and customize the text font and alignment.

When you attach a Burn-In node to a Composite node, the burn-in information is rendered when you export the scene.



NOTE

When you're working with 3D objects with a high Z position value, you may find the objects obscuring the scene information. To work around this, use a peg to ensure the burned in scene information is always visible.

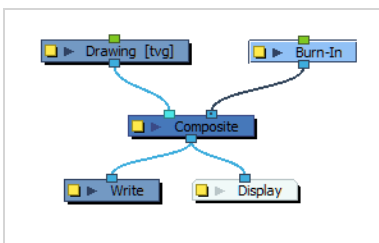

How to add burn in scene information

1. In the Node Library, drag a **Burn-In** node to the Node view.
2. Connect it to the Composite node.
3. On the Burn-In node, click the square yellow properties button.

The Burn-In property window displays.

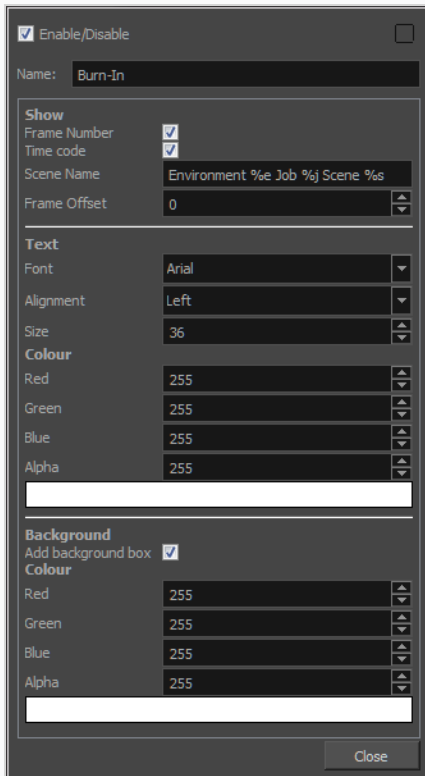

4. In the Show section, enter the following information:
 - **Frame Number:** The frame number to start the burn-in information.
 - **Time code:** The time code at which the burn-in information starts.
 - **Scene name:** By default the scene name, environment and job information is display. Type the following to display specific types of information.
 - Scene Name:** %s
 - Environment:** %e
 - Job:** %j
 - **Frame Offset:** Add lead-in frames before the scene begins or at a specific frame. Use positive values for frames that precede the scene content and negative values to start your scene information at a certain frame number.

5. In the Text section, customize the text that is displayed.
6. In the Background section, add a background box to make the text more visible and then customize the colour.

Burn-In Properties

Parameter	Description
Name	Allows you to enter a name for the node.
Show	
Frame Number	Displays the number of the current frame.
Time Code	Displays the time code of the current frame.
Scene Name	<p>Lets you display different types of information, including the scene name, environment and job. You can display one or all of these pieces of information. To do so, type the following in the Scene Name field:</p> <ul style="list-style-type: none"> • Scene Name: %s • Environment: %e • Job: %j <p>You can rearrange the order in which the information is displayed. For example, you may want to see the job before the environment.</p>
Frame Offset	<p>Lets you add blank lead-in frames before the scene or somewhere in the scene. Use positive values for frames that precede the scene content and negative values to start your scene information at a certain frame number.</p>
Text	
Font	Lets you select a font for the information displayed.
Alignment	Lets you set the alignment of the text: Left, Center, Right.
Size	Lets you set the size of the text.
Background	

Add Background Box	Adds a box behind the scene information which is useful when the scene contains colours or content that may make it difficult to read the scene information.
Colour	
Red/Green/Blue/Alpha	Lets you enter R, G, B and A values for the colour of the background box.
Colour Swatch	Opens the Colour Picker dialog, in which you can visually select a colour for the effect.

Colour-Card Node

T-ANIMPA-012-001

The Colour Card allows you to fill the scene's background with a solid colour when there is no background image. If no drawing or colour-card is present to cover the scene's background, the scene will be rendered on a pitch black canvas.



NOTE

By default, the Colour Card has a Z ordering value of **12 Backward**. This puts the Colour card behind all elements that have a value lower than **12 Backward**. Most of the time, the Colour card will appear automatically behind all the scene elements as they are all set to **0 Backward**, unless you have changed the Z ordering of the scene components. If so, the Colour Card will be in front of the elements that are pushed back to more than 12 fields backward.

Connection

The Colour Card only needs to be connected to a composite, and does not require an input image.

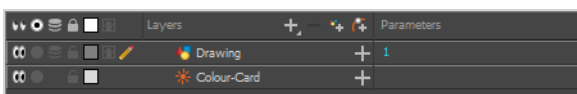
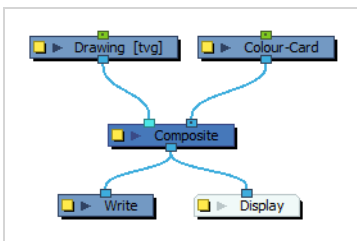

It is recommended to connect your Colour Card to the right-most port of the Composite for coherence, but because a Colour Card has a default position on the z-axis of 12 Backward, it will appear behind all the elements in your scene regardless of where you connect it on the scene's composite.

Optionally, a Colour Card can also be connected to a matte image. In this case, the Colour Card will only fill the shape of the matte with its colour, rather than the whole scene.

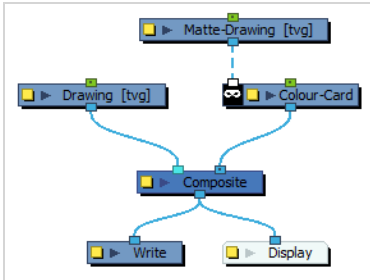

Layer Properties

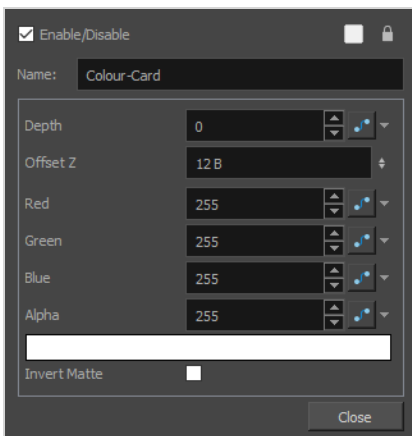

Parameter	Description
Enable/Disable	Allows you to enable or disable the node. When disabled, a node has no visible effect on the rendered image, nor on the preview in the Camera, Perspective, Side and Top views.
Colour Swatch	Sets the colour of the layer in the Timeline view and of the node in the Node view.
Name	The name of the node as it appears in the Node View and the Timeline view. Each node must have a name that is unique to its containing group.
Depth	This parameter can be used to determine whether the colour card displays behind or in front of elements with the same position on the z-axis. Elements and Gradient nodes also have a depth parameter.

Parameter	Description
Offset Z	The position of the Colour Card on the Z-axis. By default, this is set to 12 B to ensure the Colour Card appears behind other elements in the scene. You can set this to 0 F to make the Colour Card respect the order in which nodes are connected to the composite.
Colour	The colour and transparency of the Colour Card. You can also attach these parameters to function columns to change their values over time. Click the colour swatch to open the Colour Picker window and select a colour.
Colour Swatch	Opens the Colour Picker window in which you can specify the colour.
Invert Matte	If an image is connected to the Colour Card's matte port, by default, the colour is only applied on the opaque areas of the matte. If this parameter is enabled, the colour is applied to the transparent areas of the matte instead.

Element / Drawing Node

The Element node is at the very core of a scene's structure. An element is a directory in which drawings are stored, which is associate to an Xsheet column indicating when and for how long each drawing is exposed, and which is in turn linked to a layer which indicates the position of the drawings in the scene. The Element node allows you to connect the element to effects, pegs and composites, determining how its drawings are processed and rendered.

Connection

The Element node does not need an input image. It generates its output image from the drawings in its element and their exposure. Hence, it can be simply connected to a composite.

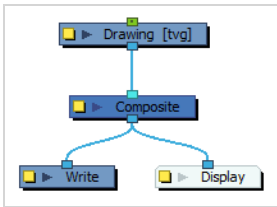

Although Element nodes can be transformed and animated on their own, it is typical to connect their input port to a Peg. This allows you to keep the position and animation information of the element in a separate node, making it easier to manipulate the exposure and the transformations separately. This is especially useful in digital cut-out animation where manipulating and transforming layers is often the main method of simulating movement, and changing drawings is the secondary method.

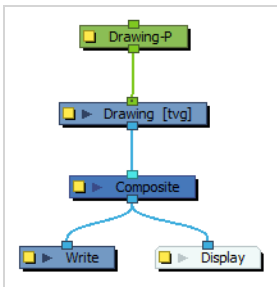

You can also connect an Element node to another Element node. Just like with pegs, any transformation done on the parent Element node, whether on itself or through one of its parents, will also be applied to the child Element node.

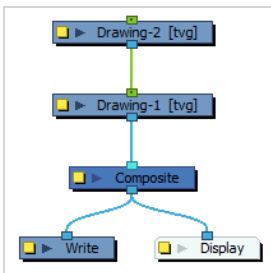

Optionally, you can connect a matte drawing to the left edge of an Element node. When an Element node is connected to a matte drawing, only the parts of the drawings that intersect with the opaque areas of the matte drawing will be rendered. This allows you to accomplish the same effect as connecting the Element node to a cutter node, without using an extra node.

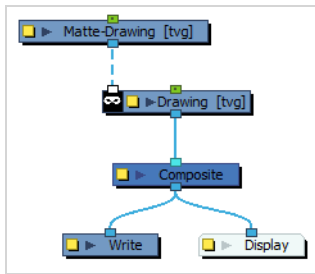

Layer Properties

The drawing node's properties are organized in the following tabs:

- [Transformation Tab](#)
- [Drawing Tab](#)
- [Controls Tab](#)
- [Line Thickness](#)
- [Advanced Tab](#)

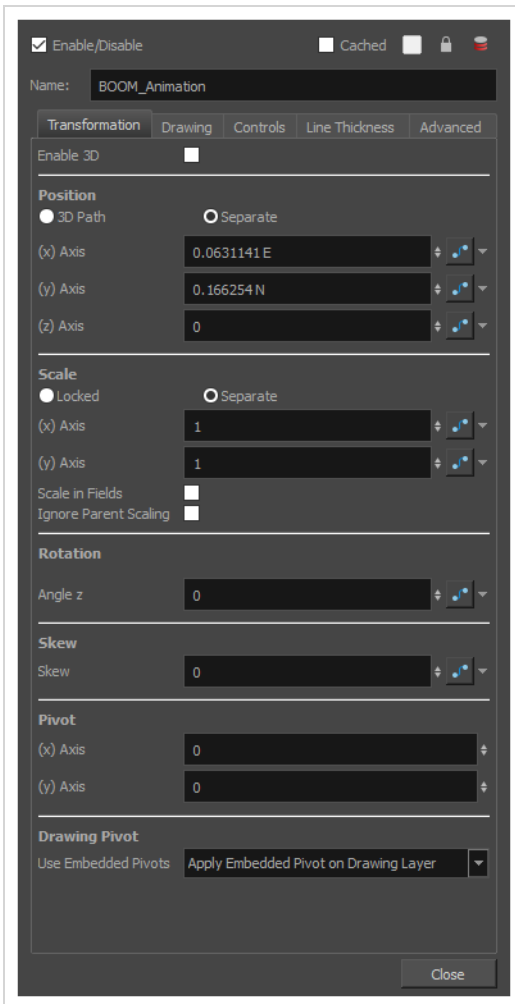

Transformation Tab

The Transformation tab contains parameters for adjusting the position, scale, rotation, skew and pivots of an element.



Parameter	Description
Enable 3D	Allows the layer to be rotated and scaled in 3D. This means it can be rotated on the X and Y axes and scaled on the Z axis.
Position	<p>3D Path: Use a 3D path to position the element. A 3D path uses a single function to define the position on the X, Y and Z axes. This function is made of control points linked by a curvilinear path, making the movement follow a natural curve. The pace and ease of the movement is determined by a single velocity function.</p> <p>Separate: Positions the element using separate functions for the X, Y and Z axes. This allows to control the direction and pace of the movement across all three axes separately. Unless ease is applied to the axes, the trajectory of the element will follow straight lines going between each keyframe.</p>
	<p>Path: If the 3D Path option is selected, this field allows you to create or select the 3D Path function used to position the element.</p>

	<p>Path (x) Axis: The position of the element on the East-West axis, in fields.</p> <p>Path (y) Axis: The position of the element on the South-North axis, in fields.</p> <p>Path (z) Axis: The position of the element in the Back-Front axis, in fields.</p> <p>Velocity: If the 3D Path option is selected, this function is used to control the pace at which the element moves towards each control point in the 3D Path function, on all three axes simultaneously.</p>
Scale	<p>Locked: Uses a single scale parameter to scale the element, preserving its proportions.</p> <p>Separate: Uses a separate parameter to scale the element on the X and Y axis, as well as on the Y axis if the element is 3D-enabled, allowing to stretch or squash the element.</p>
	<p>(x) Axis: The horizontal scale factor. The default value is 1.</p> <p>(y) Axis: The vertical scale factor. The default value is 1.</p> <p>(z) Axis: The depth scale factor for 3D-enabled elements. The default value is 1.</p> <p>Scale in Fields: With this option enabled, the scale factor is based on the amount of fields in the scene. For example, to shrink one of the dimensions of an element to half its original size, the scale factor would normally be set to 0.5. If this option is enabled and the amount of fields in the scene is 12, then the scale factor to shrink the element by half would be 6.</p> <p>Ignore Parent Scaling: When this option is enabled, scaling factors applied to a parent layer will not be applied to the current layer. This can be handy in cut-out rigs when you need to scale an arm without affecting the forearm.</p>
Rotation	<p>Angle z: The angle at which the element is rotated, based on the 360 degrees scale. Values below 0 or above 360 degrees will cause the rotation to cycle.</p>
Rotation (3D enabled)	<p>Quaternion: Similar to a 3D Path, the Quaternion determines the angle of a 3D object using a single function.</p> <p>Euler Angles: Determines the angle of a 3D object by rotating it on the X, Y and Z axes using separate angles.</p> <hr/> <p>3D Rotation: If the Quaternion option is selected, this field allows you to create or select the Quaternion function used to rotate the element.</p> <p>(x) Axis: The angle at which the element is rotated on the horizontal axis.</p> <p>(y) Axis: The angle at which the element is rotated at the vertical axis.</p> <p>(z) Axis: The angle at which the element is rotated on the depth axis.</p> <p>Velocity: If the Quaternion option is selected, this function is used to control the</p>

	speed at which the element is rotated on all 3 axes.
Skew	Skew: The angle at which the element is skewed. This value can range from -90 to 90 degrees.
Pivot	<p>(x) Axis: The horizontal position of the pivot point of the element relative to the pivot point of the drawing, in fields.</p> <p>(y) Axis: The vertical position of the pivot point of the element relative to the pivot point of the drawing, in fields.</p> <div style="border: 1px solid green; padding: 10px; margin-top: 10px;">  <p>NOTE These parameters can be changed visually by clicking and dragging the pivot point when using on of the tools in the Advanced Animation toolbar.</p> </div>
Drawing Pivot	<p>An element layer has two pivots:</p> <ul style="list-style-type: none"> • The pivot of the element, which is set by the Pivot parameters above. • The pivot of the currently exposed drawing, which is set using the Drawing Pivot  tool. <p>This preference is used to determine what to do with the pivot point of the currently exposed drawing:</p> <ul style="list-style-type: none"> • Don't Use Embedded Pivot: Ignores the pivot point of the exposed drawing. The pivot point of the element is positioned using the Pivot parameters above, relative to the centre of the drawing. • Apply Embedded Pivot on Parent Peg: Use the pivot point of the exposed drawing to determine the position of the pivot point of the parent peg of the drawing layer. This is useful when making a character rig where each element has a parent peg, and those parent pegs are intended to be used for animation. The pivot point of these parent pegs will be based on the pivot point set for the exposed drawing. • Apply Embedded Pivot on Drawing Layer: Use the pivot point of the drawing to determine the pivot point of the element. This means the pivot point is positioned using the Pivot parameters above, but relative to the pivot point of the drawing.

**TIP**

The two latter options are useful when making a character rig where a layer can represent a body part from different angles. Since each angle is represented by a drawing, and each angle is liable to have a different pivot point, you can set the pivot point of each angle by using the Drawing Pivot  tool on each drawing. Then, if you want to animate the drawing layers directly, you can set this parameter to the **Apply Embedded Pivot on Drawing Layer** option, and if you want to animate using the parent pegs of the drawing layers, you can set this parameter to the **Apply Embedded Pivot on Parent Peg** option, so that these pivots are used when animating the different parts of the rigs.

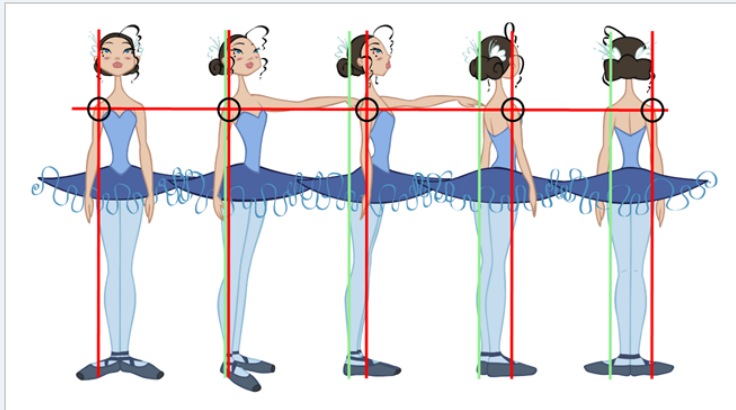

Drawing Tab

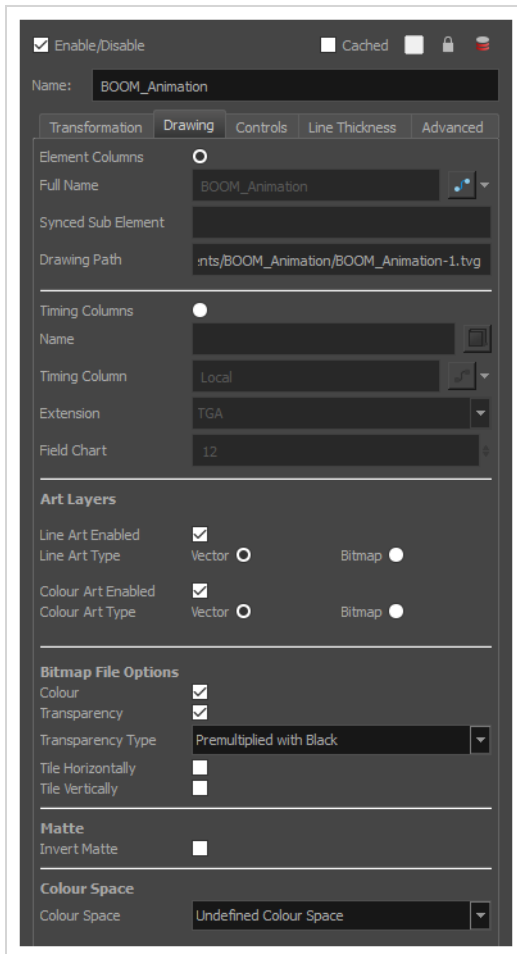

The Drawing tab contains parameters for element and timing columns, the art layers, bitmap images and the element's matte drawing.



Parameter	Description
Element Columns	<p>Full Name: Select which element to connect to the node from the list of elements that already exist in your scene.</p> <p>Synced Sub Element: If the layer is synced to another layer, this field displays the name of the layer's sub-element. A sub-element is an element stored inside another element for syncing layers.</p> <p>Drawing Path: Displays the full path to the current drawing.</p>
Timing Columns	<p>Name: The path to the drawing file the element links to.</p> <p>Timing Column: The name of the Xsheet timing column used for the layer's timing.</p> <p>Extension: The extension of the drawing file the element links to.</p> <p>Field Chart: The size of the field chart used for the drawings the element links to. This setting is useful when linking to traditional animation drawings.</p>

<p>Art Layers</p>	<p>These parameters allow you to set whether each art layer in the drawing layer is enabled, and whether they should contain vector or bitmap artwork. By default, options for the Line Art and Colour Art layers will be available. If the Enable Overlay and Underlay Arts preference is enabled, options for the Overlay Art and Underlay Art layers will also be available.</p> <p>Enabled: Determines whether the art layer is displayed.</p> <p>Vector: Makes the art layer enabled for vector artwork, Vector drawing tools will be used to draw in this art layer, and vector artwork information will be preserved.</p> <p>Bitmap: Makes the art layer enabled for bitmap artwork. Only bitmap-compatible drawing tools will be enabled when drawing on this layer, and all artwork will be rasterized into a bitmap image.</p>
<p>Bitmap File Options</p>	<p>Colour: Determines whether or not the colours in the image is processed. If unchecked, the image will be solid black.</p> <p>Transparency: Determines whether or not the transparency in the image is processed. If unchecked, the image will be fully opaque.</p> <p>Transparency Type: If the layer contains bitmap images with a transparency channel, there are several approaches to rendering the image's transparency. You may need to select the proper transparency type to make sure Harmony renders the image as intended.</p> <ul style="list-style-type: none"> • Premultiplied with Black: Semi-transparent pixels in the original image are blended with black. • Premultiplied with White: Semi-transparent pixels in the original image are blended with white. • Straight: Semi-transparent pixels in the original image are left as is (unmatted). • Clamp Colour to Alpha: Semi-transparent pixels in the original image are blended with black. On import, each of the RGB channels is clamped so that a color value never exceed the alpha value for a given pixel. When the RGB values are multiplied with the alpha value, that is to say, if you have a pixel of value R=247, G=188, B=29 and the alpha is 50% or the image has a 50% transparency, then the actual RGB values output would be half of the amounts listed above. <p>Tile Horizontally: Repeats the bitmap image infinitely to the left and to the right of the layer. This can be useful for making looping backgrounds.</p> <p>Tile Vertically: Repeats the bitmap image infinitely to over and underneath the layer. This can be useful for making looping backgrounds.</p>

	<div style="border: 1px solid green; padding: 10px;">  NOTE When both the Tile Horizontally and Tile Vertically options are used together, the bitmap image is tiled all over the scene. </div>
Matte	<p>Invert Matte: If a drawing, composite or effect is connected to the drawing's matte input port, the part of the drawing that intersect with the matte's opaque areas will be cut out by default. If this parameter is enabled, the part of the drawing that intersect with the matte's transparent areas will be cut out instead.</p>
Colour Space	<p>Colour Space: The colour space in which the element's colours should be interpreted. If the element's colour space is different from the project colour space, then the element's colours will be converted from the element's colour space to the project's colour space as they are processed, before being composited together with the scene's special effects.</p> <ul style="list-style-type: none"> • Undefined Colour Space: No colour space is defined for the drawing. The drawing's colours will be interpreted as if they were the same colour space the one selected in the Colour Space tab of the Scene Settings dialog. • Linear: The same primaries and white point as sRGB and Rec. 709, but with no gamma transfer curve applied to the colour values. This colour space is useful for compositing intermediary images that are meant to be rendered in sRGB or Rec. 709. • Display P3: A colour space commonly used for digital projection. It has the same primaries as DCI-P3, the same white point as sRGB and the same gamma transfer curve as sRGB. • Display P3 Linear: The same as Display P3, except with no gamma transfer curve. This colour space is useful for compositing intermediary images that are meant to be rendered in Display P3. • Rec. 709: The colour space used for HDTV. It has the same primaries and white point as sRGB, but has a different gamma transfer curve. • Rec. 709 2.4: The same colour space as Rec. 709 or sRGB, except with a gamma transfer curve of 2.4. This colour space exists because some editing systems use a gamma transfer curve of 2.4 instead of the standard gammae curve for Rec. 709. • Rec. 2020: A colour space used for Ultra High Definition TV (UHDTV). It has a complex gamma transfer curve and primaries that cover more of the human-perceivable colour space than other colour spaces, especially in the area of human-perceivable greens. • Rec. 2020 2.4: The same colour space as Rec. 2020, except with a simple gamma transfer curve of 2.4. This colour space exists because some editing systems use a gamma transfer curve of 2.4 instead of the standard



	<p>gamma curve for Rec. 2020.</p> <ul style="list-style-type: none"> • Rec. 2020 Linear: The same colour space as Rec. 2020, except with no gamma transfer curve. This colour space is useful for compositing intermediary images that are meant to be rendered in Rec. 2020. • sRGB: A colour space typically used for standard computer monitors. It has the same primaries and white point as Rec. 709, but has a different gamma transfer curve. <div style="border: 1px solid green; padding: 10px; margin-top: 10px;"> <p> NOTE</p> <p>In the  OpenGL View mode of the Camera view, the colour space of drawing layers is ignored and only the colour space of original bitmap files is taken in account. To test the colours of your drawing in their selected colour space, you must activate  Render View mode.</p> </div>
--	--

Controls Tab

The Controls tab contains animation control options.





Parameter	Description
Animation	<p>Animate Using Animation Tools: By default, a drawing layer can be animated directly, as if it was its own peg. If you disable this option, it will only be possible to animate the layer using its parent peg. If the layer has no parent peg, it will be immutable.</p> <p>This can be useful if you want to create cut-out character rigs that should only be animated using pegs, which can help separate the drawing exposure from the transformations on the drawings. If every drawing layer in a character rig has this option disabled, only layers that have a parent peg will be animatable, and the</p>

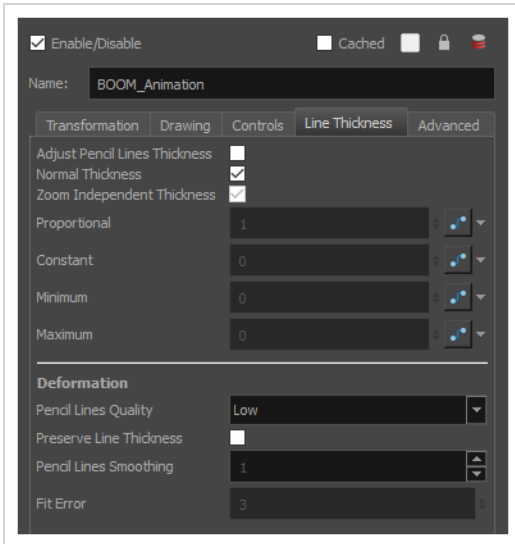

	<p>animator will only be able to animate on the pegs. This also rules out the possibility of accidentally animating an element directly and using its parent peg concurrently.</p> <p>When this option is disabled, clicking on the drawing layer in the Camera view with the Transform tool will automatically select the layer's parent peg.</p>
Angle Limit Values	<p>Lets you set a maximum and minimum rotation angle for a drawing. This option is used mainly for a cut-out character when you do not want an elbow to bend too far in or out.</p> <p>Enable Min/Max Angle: Activates the minimum and maximum angle constraints.</p> <p>Min Angle: The minimum rotation angle for the element.</p> <p>Max Angle: The maximum rotation angle for the element.</p>
Spline Offset	<p>If the layer's controls are displayed, you can see its animation trajectory in the Camera view. This is referred to as the <i>spline</i>. By default, the position of each point in the spline is based on the element's pivot point. However, you can use the spline offset to give it a more fitting position if desired. You can do this by using the Spline Offset tool of the Advanced Animation toolbar, or by manually entering the offset values in the Spline Offset fields.</p> <p>(x) Axis: The horizontal offset of the spline, in fields.</p> <p>(y) Axis: The vertical offset of the spline, in fields.</p> <p>(z) Axis: The depth offset of the spline, in fields.</p> <div data-bbox="565 1165 1429 1474" style="border: 1px solid #add8e6; padding: 10px; margin-top: 10px;"> <p> TIP</p> <p>To display the animation trajectory of the layer in the Camera view, select the layer, then do one of the following:</p> <ul style="list-style-type: none"> • In the Camera toolbar, click on Show Control . • From the top menu, select View > Show > Control. • Press Shift + F11 (Windows/Linux) or ⌘ + F11 (macOS). </div>

Line Thickness

The Line Thickness tab contains options regarding the way pencil lines in the element are rendered. These options can be very useful to enhance the quality of line art without having to work on it.



Parameter	Description
Line Thickness	<p>Adjust Pencil Lines Thickness: Enables the options below to adjust the line thickness in the rendered image.</p> <p>Normal Thickness: This setting makes the line thickness adjustments take one of two very different behaviors:</p> <ul style="list-style-type: none"> • Enabled: The line thickness settings are applied to pencil lines in all art layers in the element. This setting should be used if you want to adjust the line thickness of pencil lines. • Disabled: The line thickness settings are applied to all art, whether brush strokes or pencil lines, in the line art layer, so that it fits the desired thickness pattern around art in the colour art layer. This setting should be used for drawings that have their line art on the line art layer and their colour art on the colour art layer, which is typical of traditional and paperless animation productions. <div data-bbox="641 1402 1429 1602" style="border: 1px solid #c8e6c9; padding: 10px; margin: 10px 0;"> <p> NOTE When this option is disabled, all artwork in the line art layer that does not surround artwork in the colour art layer will be cropped out.</p> </div> <p>Zoom Independent Thickness: Makes the thickness of pencil lines remain unchanged when the camera zooms in or zooms out.</p>
	<p>Proportional: The factor by which to adjust line thickness. The original line thickness in the drawing will be multiplied by this value. A value between 0 and 1 can be used to make pencil lines thinner.</p> <p>Constant: The offset by which to adjust line thickness. This value will be added</p>

	<p>to the original line thickness in the drawing. A negative number can be entered to make pencil lines thinner.</p> <p>Minimum: The minimum pencil line thickness allowed. Line thickness will not go below this value.</p> <p>Maximum: The maximum pencil line thickness allowed. Line thickness will not go above this value. Set it to 0 to disable maximum line thickness.</p>
Deformation	<p>Pencil Lines Quality: The quality of the rendered pencil lines when deformed by deformation chains. Increasing this parameter is unlikely to yield noticeable result unless rendering in very high resolutions.</p> <p>Preserve Line Thickness: If this option is checked, the thickness of pencil lines will not be affected by deformations. Only their directions will be affected. Also, if a pencil line is textured, it will not be stretched or squashed by deformations.</p> <div data-bbox="565 751 1429 919" style="border: 1px solid #c8e6c9; padding: 10px; margin: 10px 0;"> <p> NOTE This setting must be enabled for the Pencil Lines Smoothing and Fit Error parameters to be available.</p> </div> <p>Pencil Lines Smoothing: The smoothing factor applied to pencil lines when rendering. This value can range from 0 to 10. The higher it is, the more corners and points will appear smoothed out.</p> <p>Fit Error: When this parameter is increased, pencil lines in the rendered image will have less vector points and the curves between the remaining vector points will be adjusted to fit the original shape. This setting can be increased if the amount of details and points in the pencil lines creates problems around deformation articulations and corners. Its value can range from 1 to 100.</p> <div data-bbox="565 1276 1429 1444" style="border: 1px solid #c8e6c9; padding: 10px; margin: 10px 0;"> <p> NOTE The Fit Error parameter will have no effect if the Pencil Lines Smoothing parameter is set to 0.</p> </div>

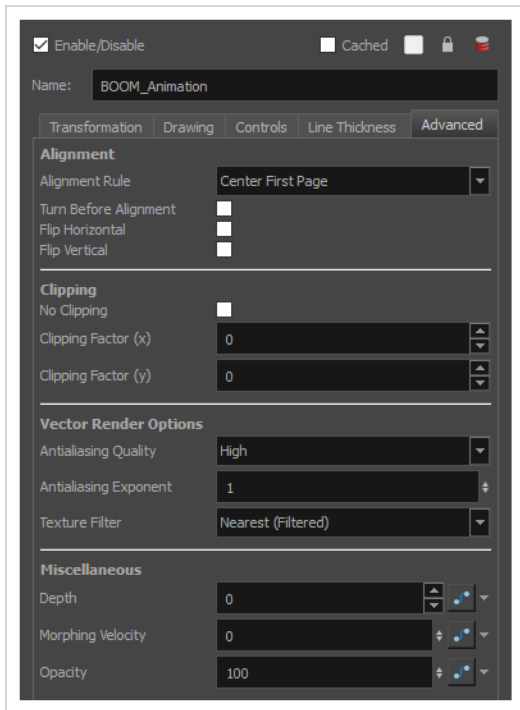

Advanced Tab

The Advanced tab contains options for setting the alignment of drawings, clipping, line thickness, vector render options, and more.



Parameter	Description
Alignment	<p>Alignment Rule: The alignment rule selections are intended to deal with drawings that were created on paper of a different size or orientation from the default alignment rule (set up in the Scene Settings dialog box) or imported bitmap images. The drawings are then scaled to match the Harmony alignment rectangle. Note that alignment rules are not based on the camera frame, but on the scene frame. Refer to the Fundamentals Guide to learn more about scene alignment and scene settings.</p> <ul style="list-style-type: none"> • Left: The default alignment for drawings; aligns the drawings to the left side of the scene’s alignment rectangle. Harmony scales the drawings to match their height to the alignment rectangle of the scene. • Right: Aligns the drawings to the right side of the alignment rectangle. Harmony scales the drawings to match their height to the height of the alignment rectangle of the scene. • Top: Aligns the drawings to the top of the alignment rectangle. Harmony scales the drawings to match their widths to the width of the alignment rectangle of the scene. • Bottom: Aligns the drawings to the bottom of the alignment rectangle. Harmony scales the drawings to match their widths to the width of the alignment rectangle of the scene. • Centre Fit: Centers the drawings. • Centre Fill: Centers the drawings and then scales them so the width or height fills the available space.

	<ul style="list-style-type: none"> • Centre LR: Aligns the drawings in the left-right centre of the alignment rectangle. Harmony scales the drawings to match their height to the height of the alignment rectangle of the scene. • Centre TB: Aligns the drawings in the top-bottom centre of the alignment rectangle. Harmony scales the drawings to match their widths to the width of the alignment rectangle of the scene. • Stretch: Scales the drawings so they fit within the alignment rectangle of the scene. This is particularly useful for images that you will manipulate with a Quadmap node. If the drawings in the Quadmap node do not have the same aspect ratio as the alignment rectangle of the scene (from the Scene Settings dialog box), the handles on the quadmap will not appear on the corners of the image, making it difficult to manipulate the quadmap. In this case, you would set the drawing layer of the quadmap images to Stretch to make the handles appear on the corner of the image. This can have the effect of distorting the images, but it is not an issue with images that will be distorted through the Quadmap node anyways. • As Is: Leaves the drawings aligned as they are. • Centre First Page: Aligns the centre of the first part of a standard pan cel with the centre of the field chart. <p>Turn Before Alignment: Rotates the drawings in the selected element 90 degrees to the left before scaling and aligning them according to the alignment rule, and before performing any offset, rotation or scaling for the element or peg. This and the Alignment Rule are intended for drawings that were created on paper of a different size or orientation than the other paper in the scene, and requires alignment so they are treated accurately.</p> <p>Flip Horizontal: Flips the drawing on the horizontal axis.</p> <p>Flip Vertical: Flips the drawing on the vertical axis.</p>
Clipping	<p>No Clipping: By default, when using the Apply-Image-Transformation node on a bitmap layer, the image is clipped by the camera frame before the transformation. This can cause the resulting image to appear cropped if the peg connected to the Apply-Image-Transformation node brings the element from outside of the camera frame, or shrinks it. Enable this option to avoid clipping the image—see Apply Image Transformation Node on page 796.</p> <div style="border: 1px solid green; padding: 10px; margin-top: 10px;"> <p> NOTE</p> <p>In the great majority of cases, it is recommended to use an Apply-Peg-Transformation node instead to avoid clipping—see Apply Peg Transformation Node on page 799.</p> </div>

	<p>Clipping Factor (X): This parameter would extend the horizontal clipping area of vector drawings before effects are applied to it. Using this parameter is no longer required as Harmony manages the clipping areas of vector drawings automatically, and is only made available for legacy support.</p> <p>Clipping Factor (Y): This parameter would extend the vertical clipping area of vector drawings before effects are applied to it. Using this parameter is no longer required as Harmony manages the clipping areas of vector drawings automatically, and is only made available for legacy support.</p>
Vector Render Options	<p>Antialiasing Quality: The smoothness (antialiasing) setting used to make the crisp vector contours appear smooth.</p> <ul style="list-style-type: none"> • None - No Transparency: Disables antialiasing, renders semi-transparent pixels either fully opaque or fully transparent, and fills single-pixel gaps with an opaque pixel to avoid generating out-of-place gaps when lines intersect each other. • Low: Disables antialiasing, but renders transparency. • Medium Low: Renders vector artwork with basic antialiasing. • Medium: Renders vector shapes with improved antialiasing. Bitmap texture fills will appear blurred. • High: Renders vector shapes with improved antialiasing, without blurring bitmap texture fills. <div data-bbox="565 1094 1430 1297" style="border: 1px solid #add8e6; padding: 10px; margin-bottom: 10px;"> <p> TIP It is recommended to leave this setting to High unless you are working on a pencil test, or another type of scene where rendering speed is more important than rendering quality.</p> </div> <div data-bbox="565 1325 1430 1598" style="border: 1px solid #add8e6; padding: 10px; margin-bottom: 10px;"> <p> TIP If the production requires exporting line art without antialiasing to colour them in a third-party software, it is recommended to use the None - No Transparency setting. This setting automatically fills one-pixel gaps created by crisp lines intersecting each other, which would otherwise need to be filled manually in the third-party software.</p> </div> <p>Antialiasing Exponent: Determines how much the artwork is scaled up to apply antialiasing onto it. A higher value will result in sharper edges, and a lower value will result in softer edges. Typical values range between 0 and 3. Higher values may be attempted but may result in overly crisp outlines. Negative values will cause the outlines to appear blurry.</p> <p>Texture Filter: This setting determines how textures in the element are resampled when rendering:</p>

	<ul style="list-style-type: none">• Bilinear: This option takes the four pixels around each point and makes a bilinear interpolation between them, which may make them look blurry.• Nearest: When sampling the texture up, this option generates extra pixels by using the colour of the nearest defined pixel. When sampling the texture down, this option simply removes pixels from the texture.• Nearest (Filtered): This option is similar to Nearest, but it adds an extra layer of resampling to make all pixels look like they are the same size.
Miscellaneous	<p>Depth: Overrides the order of cables in the node system to determine the forward/backward order in which this element is rendered. The Z position value overrides the depth value.</p> <p>Morphing Velocity: When morphing drawings in the element using the Morphing tool, this parameter can be used to create or select the velocity function used to determine the pace of the morphing animation.</p> <p>Opacity: Lets you quickly change the transparency of the selected element. Opacity settings here will be reflected in both OpenGL preview, and full render.</p>

Field Chart Node

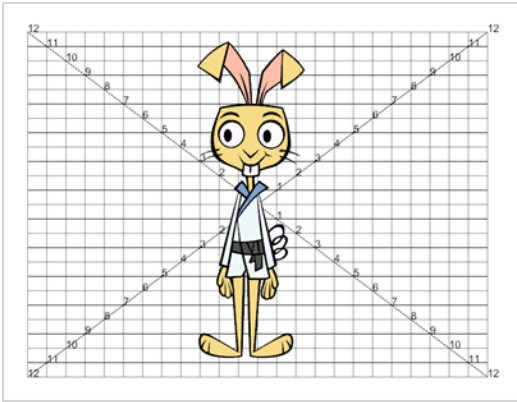

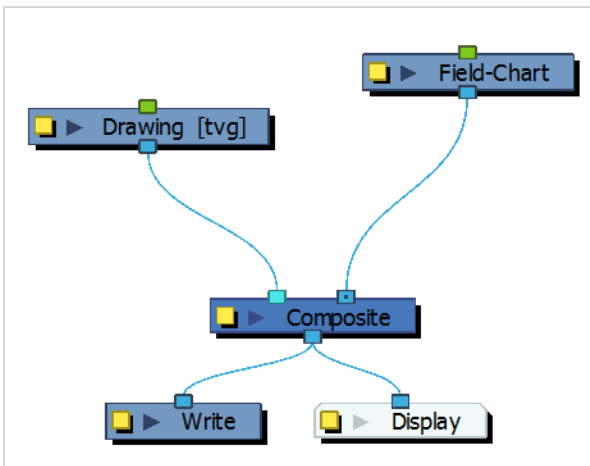

The Field Chart node displays a traditional animation field chart, which allows you to position elements in the Camera view. The Field Chart node doesn't export. If you want to export a field chart, use the Grid node—see [Grid Node on page 756](#).

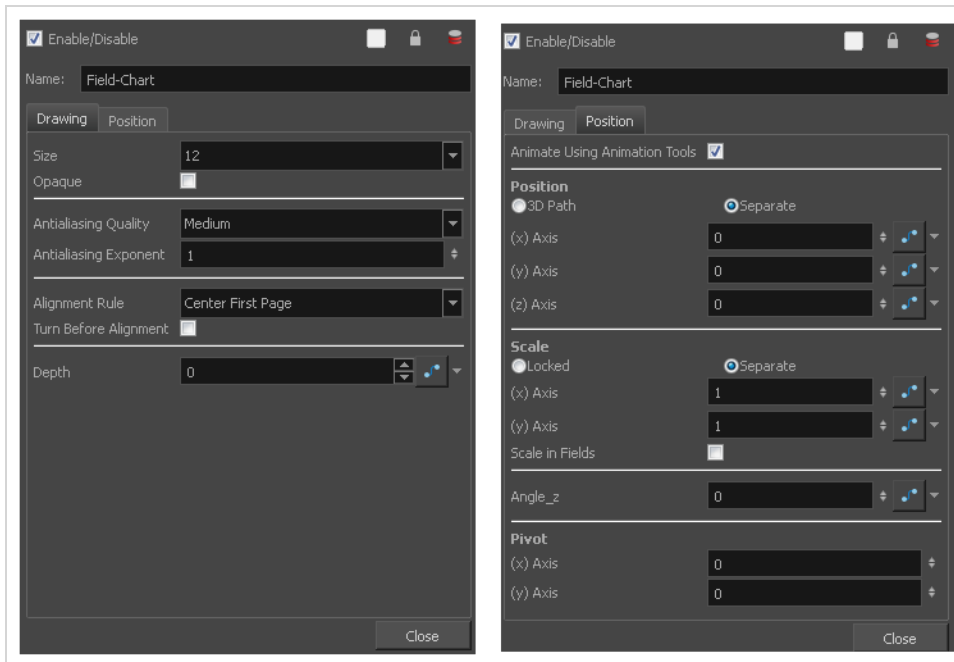

Field Chart Properties



Parameter	Description
Name	Allows you to change the name given to the node.
Drawing	
Size	Adjusts the number of units in the grid (field chart). The grid size will always be a 4:3 ratio, as per traditional animation standards. The grid is available in 12 or 16 fields.
Opaque	Inserts a white background behind the grid and covers everything else behind it. By default, you can see through the grid.
Antialiasing	<p>Antialiasing Quality: The smoothness (antialiasing) setting used to make the crisp vector contours appear smooth.</p> <ul style="list-style-type: none"> • None - No Transparency: Disables antialiasing, renders semi-transparent pixels either fully opaque or fully transparent, and fills single-pixel gaps with an opaque pixel to avoid generating out-of-place gaps when lines intersect each other. • Low: Disables antialiasing, but renders transparency. • Medium Low: Renders vector artwork with basic antialiasing. • Medium: Renders vector shapes with improved antialiasing. Bitmap

	<p>texture fills will appear blurred.</p> <ul style="list-style-type: none"> • High: Renders vector shapes with improved antialiasing, without blurring bitmap texture fills. <div data-bbox="565 338 1430 543" style="border: 1px solid #add8e6; padding: 10px; margin-bottom: 10px;">  <p>TIP</p> <p>It is recommended to leave this setting to High unless you are working on a pencil test, or another type of scene where rendering speed is more important than rendering quality.</p> </div> <div data-bbox="565 573 1430 844" style="border: 1px solid #add8e6; padding: 10px;">  <p>TIP</p> <p>If the production requires exporting line art without antialiasing to colour them in a third-party software, it is recommended to use the None - No Transparency setting. This setting automatically fills one-pixel gaps created by crisp lines intersecting each other, which would otherwise need to be filled manually in the third-party software.</p> </div> <p>Antialiasing Exponent: Determines how much the artwork is scaled up to apply antialiasing onto it. A higher value will result in sharper edges, and a lower value will result in softer edges. Typical values range between 0 and 3. Higher values may be attempted but may result in overly crisp outlines. Negative values will cause the outlines to appear blurry.</p>
<p>Alignment Rule</p>	<p>The alignment rule selections are intended to deal with drawings that were created on paper of a different size or orientation from the default alignment rule (set up in the Scene Settings dialog box) or imported bitmap images. The drawings are then scaled to match the Harmony alignment rectangle. Note that alignment rules are not based on the camera frame, but on the scene frame. Refer to the Fundamentals Guide to learn more about scene alignment and scene settings.</p> <ul style="list-style-type: none"> • Left: The default alignment for drawings; aligns the drawings to the left side of the scene's alignment rectangle. Harmony scales the drawings to match their height to the alignment rectangle of the scene. • Right: Aligns the drawings to the right side of the alignment rectangle. Harmony scales the drawings to match their height to the height of the alignment rectangle of the scene. • Top: Aligns the drawings to the top of the alignment rectangle. Harmony scales the drawings to match their widths to the width of the alignment rectangle of the scene. • Bottom: Aligns the drawings to the bottom of the alignment rectangle. Harmony scales the drawings to match their widths to the width of the alignment rectangle of the scene. • Centre Fit: Centers the drawings.

	<ul style="list-style-type: none"> • Centre Fill: Centers the drawings and then scales them so the width or height fills the available space. • Centre LR: Aligns the drawings in the left-right centre of the alignment rectangle. Harmony scales the drawings to match their height to the height of the alignment rectangle of the scene. • Centre TB: Aligns the drawings in the top-bottom centre of the alignment rectangle. Harmony scales the drawings to match their widths to the width of the alignment rectangle of the scene. • Stretch: Scales the drawings so they fit within the alignment rectangle of the scene. This is particularly useful for images that you will manipulate with a Quadmap node. If the drawings in the Quadmap node do not have the same aspect ratio as the alignment rectangle of the scene (from the Scene Settings dialog box), the handles on the quadmap will not appear on the corners of the image, making it difficult to manipulate the quadmap. In this case, you would set the drawing layer of the quadmap images to Stretch to make the handles appear on the corner of the image. This can have the effect of distorting the images, but it is not an issue with images that will be distorted through the Quadmap node anyways. • As Is: Leaves the drawings aligned as they are. • Centre First Page: Aligns the centre of the first part of a standard pan cel with the centre of the field chart.
Turn Before Alignment	<p>Turn Before Alignment: Rotates the drawings in the selected element 90 degrees to the left before scaling and aligning them according to the alignment rule, and before performing any offset, rotation or scaling for the element or peg. This and the Alignment Rule are intended for drawings that were created on paper of a different size or orientation than the other paper in the scene, and requires alignment so they are treated accurately.</p>
Depth	<p>Overrides the order of cables in the node system to determine the forward/backward order in which this element is rendered. The Z position value overrides the depth value.</p>
Position	
Animate Using Animation Tools	<p>By default, the grid can be animated using the same parameters as a peg, but you can disable this feature so the field chart remains in place. You can connect it to a peg to animate it or move it.</p> <p>When this option is deselected, you cannot move the layer in the Camera view using the Transform and Advanced tools. This prevents you from accidentally displacing or modifying a layer.</p>

Position	<p>3D Path: Use a 3D path to position the element. A 3D path uses a single function to define the position on the X, Y and Z axes. This function is made of control points linked by a curvilinear path, making the movement follow a natural curve. The pace and ease of the movement is determined by a single velocity function.</p> <p>Separate: Positions the element using separate functions for the X, Y and Z axes. This allows to control the direction and pace of the movement across all three axes separately. Unless ease is applied to the axes, the trajectory of the element will follow straight lines going between each keyframe.</p> <p>Path: If the 3D Path option is selected, this field allows you to create or select the 3D Path function used to position the element.</p> <p>Path (x) Axis: The position of the element on the East-West axis, in fields.</p> <p>Path (y) Axis: The position of the element on the South-North axis, in fields.</p> <p>Path (z) Axis: The position of the element in the Back-Front axis, in fields.</p> <p>Velocity: If the 3D Path option is selected, this function is used to control the pace at which the element moves towards each control point in the 3D Path function, on all three axes simultaneously.</p>
Scale	<p>Locked: Uses a single scale parameter to scale the element, preserving its proportions.</p> <p>Separate: Uses a separate parameter to scale the element on the X and Y axis, as well as on the Y axis if the element is 3D-enabled, allowing to stretch or squash the element.</p> <p>(x) Axis: The horizontal scale factor. The default value is 1.</p> <p>(y) Axis: The vertical scale factor. The default value is 1.</p> <p>(z) Axis: The depth scale factor for 3D-enabled elements. The default value is 1.</p> <p>Scale in Fields: With this option enabled, the scale factor is based on the amount of fields in the scene. For example, to shrink one of the dimensions of an element to half its original size, the scale factor would normally be set to 0.5. If this option is enabled and the amount of fields in the scene is 12, then the scale factor to shrink the element by half would be 6.</p>
Angle Z	<p>Lets you type in a degree value for the rotation angle. Note that you can enter values greater than 360 and -360 degrees. If you enter 720, the object will rotate twice.</p>
Pivot	<p>(x) Axis: The horizontal position of the pivot point of the element relative to the pivot point of the drawing, in fields.</p> <p>(y) Axis: The vertical position of the pivot point of the element relative to the pivot point of the drawing, in fields.</p>

Gradient Node

The Gradient node is similar to a Colour Card in which it fills all of the space in the stage, except that instead of filling it with a solid colour, it fills it with a configurable gradient. A gradient is a colour that tapers into another colour. The Gradient node can generate linear or radial gradient, between colours with or without transparency. The colours as well as the start and end points of the gradient in the stage can be configured and animated.



The Gradient node covers the entire camera frame and beyond. You do not need to scale it up or down. It will automatically cover an infinite zone. You simply need to connect it behind your scene's elements. You can connect it in front of some elements you want to cover. By default, the Gradient has a Z ordering value of 0. When you select the Gradient node, the Camera view displays yellow triangles to indicate that it's selected.

Connection

Being a generator, the Gradient node does not need an input image. It generates a gradient on its own, based on its parameters alone.

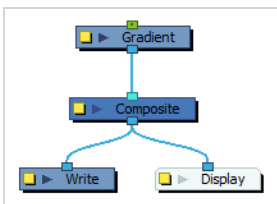

Just like Element nodes, Gradient nodes can be hooked to a peg, allowing you to easily move, rotate, scale and animate the gradient.

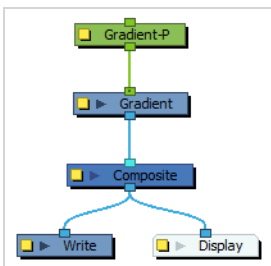

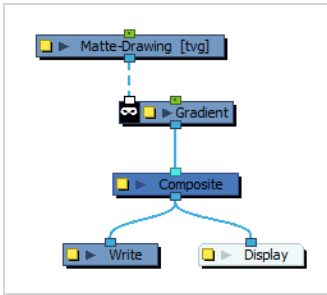

Optionally, the Gradient node can be connected to a matte image. In this case, the gradient will only be applied over the opaque areas of the matte.



Controls

If you want to control the gradient's orientation and points position in the Camera view, you can use the Control command to display the points and move them.

How to control the gradient in the Camera view

1. In the Tools toolbar, select the Transform  tool.
2. In the Timeline or Node view, select the Gradient node.
3. Do one of the following:
 - In the Camera toolbar, click on the Show Control  button.
 - From the top menu, select **View > Show > Control**.

The starting and ending points of the gradient will appear in the Camera view, like so:

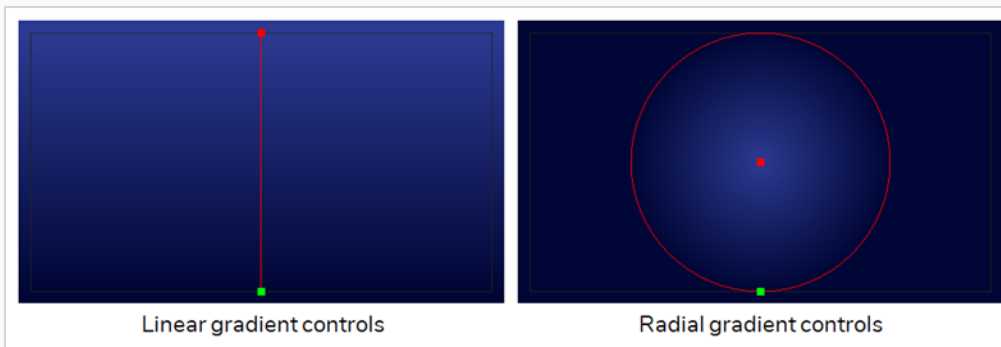

4. Click and drag on one of the points to change its position.

Layer Properties

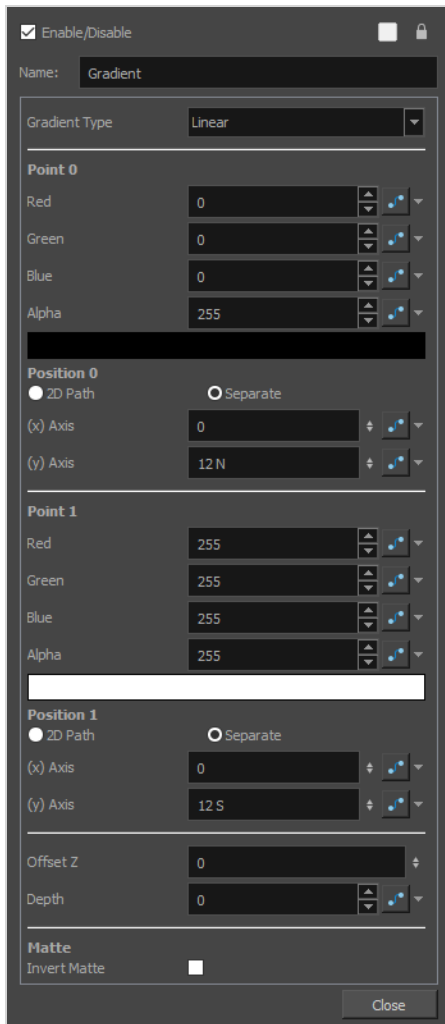

Use the Gradient property editor to modify the values of the gradient and the position of its output.

Parameter	Description
Gradient Type	<p>Allows you to select between the following types of gradient:</p> <ul style="list-style-type: none"> • Linear: Lines of colour are drawn perpendicular to the axis between point 0 and point 1.

	<div data-bbox="643 191 1305 720" data-label="Image"> <p>A dark blue rectangular area with a vertical red line passing through its center. A red dot at the top is labeled 'Point 0' and a green dot at the bottom is labeled 'Point 1'.</p> </div> <ul style="list-style-type: none"> • Radial: Circles of colour are drawn with point 0 as their center, with a ray progressing between point 0 and point 1. <div data-bbox="643 842 1433 1226" data-label="Image"> <p>A dark blue rectangular area with a large red circle centered on a red dot labeled 'Point 0'. A red line extends from 'Point 0' to a green dot labeled 'Point 1' at the bottom edge of the rectangle.</p> </div>
<p>Point 0</p>	
<p>Colour</p>	<p>The colour of point 0. The gradient will start with this colour and taper to the colour of point 1.</p> <ul style="list-style-type: none"> • Red: The value of red in the colour. • Green: The value of green in the colour. • Blue: The value of blue in the colour. • Alpha: The opacity of the colour.
<p>Position 0</p>	<p>The position of point 0 in the stage. The gradient will start from this position and end at the position of point 1.</p> <p>If you want to animate the point, you can choose which type of function to use to store the animation.</p>

	<ul style="list-style-type: none"> • 2D Path: The horizontal and vertical position are on the same function. This makes the point move in a curvilinear trajectory between each keyframe. • Separate: The horizontal and vertical position are on separate functions. This makes the point move in a straight line between each keyframe and it allows you to modulate the trajectory differently on each axis.
(x) Axis	The position of point 0 on the x-axis.
(z) Axis	The position of point 0 on the y-axis.
Point 1	
Colour	<p>The colour of point 1. The gradient will start with the colour in point 0 and taper to this colour.</p> <ul style="list-style-type: none"> • Red: The value of red in the colour. • Green: The value of green in the colour. • Blue: The value of blue in the colour. • Alpha: The opacity of the colour.
Position 1	<p>The position of point 1 in the stage. The gradient will start from the position of point 0 and end in this position.</p> <p>If you want to animate the point, you can choose which type of function to use to store the animation.</p> <ul style="list-style-type: none"> • 2D Path: The horizontal and vertical position are on the same function. This makes the point move in a curvilinear trajectory between each keyframe. • Separate: The horizontal and vertical position are on separate functions. This makes the point move in a straight line between each keyframe and it allows you to modulate the trajectory differently on each axis.
(x) Axis	The position of point 1 on the x-axis.
(z) Axis	The position of point 1 on the y-axis.
Position	
Offset Z	The position of the Gradient layer on the z-axis.

Depth	This parameter can be used to determine whether the gradient displays behind or in front of elements with the same position on the z-axis. Elements and Colour Cards also have a depth parameter.
Matte	
Invert Matte	If an image is connected to the Gradient node's matte port, by default, the gradient is only applied on the opaque areas of the matte. If this parameter is enabled, the gradient is applied to the transparent areas of the matte instead.

Grid Node

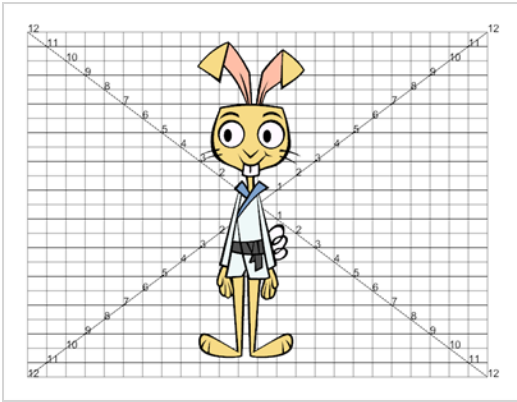

The Grid node displays a grid, in field chart unit, which allows you to position elements in the Camera view.

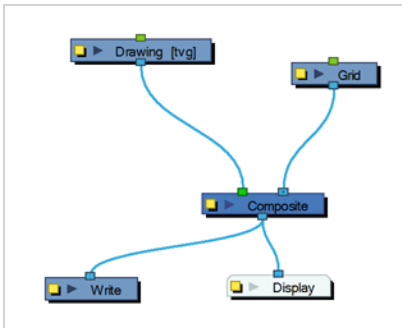

Grid Properties

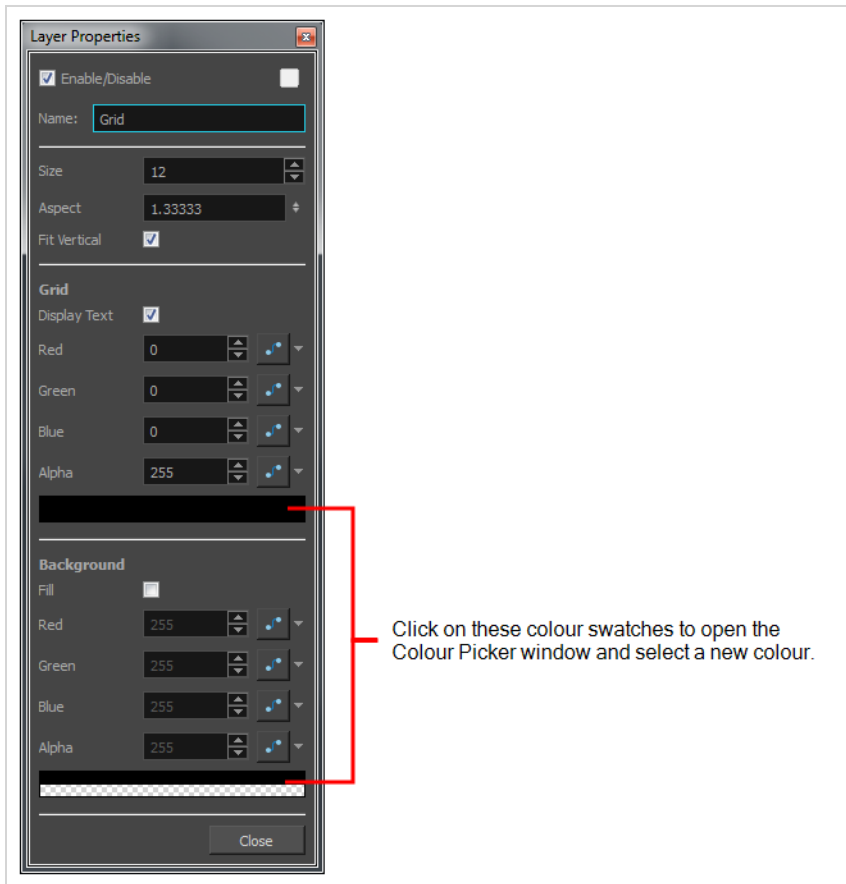

Parameter	Description
Name	Allows you to change the name given to the node.
Size	Adjusts the amount of units in the grid (field chart). The grid size will always be a 4:3 ratio, as per traditional animation standards, but will adjust the camera frame width. You can change the grid to adjust to the camera frame by deselecting the Fit Vertical option.

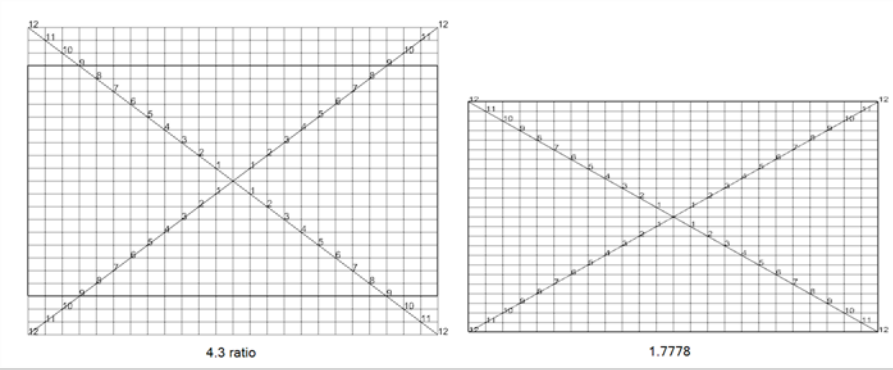
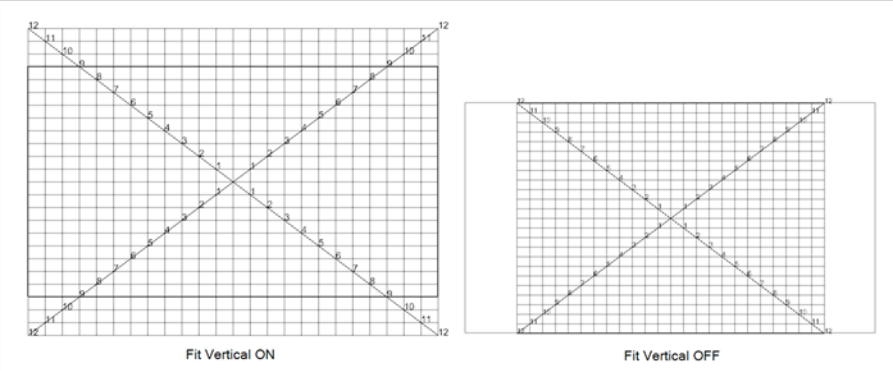
Aspect	 <p>The grid size default format is 4:3 ratio, as per traditional animation standards, but will adjust the camera frame width. You can change the grid ratio by entering a new ratio. To find your scene ratio, select Scene > Scene Settings.</p>
Fit Vertical	 <p>Makes the grid size adjust the camera width or height.</p>
Display Text	Turns the display of numbers on or off.
Fill	Makes the grid's background opaque. Nothing behind will be shown. You can also click on the colour swatch to open the Colour Picker window and select a background colour.
RGBA	The colour and alpha values of the corresponding point. You can also click on the colour swatch to open the Colour Picker window and select a grid or background colour. Default values: 0,0,0 and 255, 255, 255.
Colour Swatch	Opens the Colour Picker window in which you can specify the colour.

Lens Flare Node

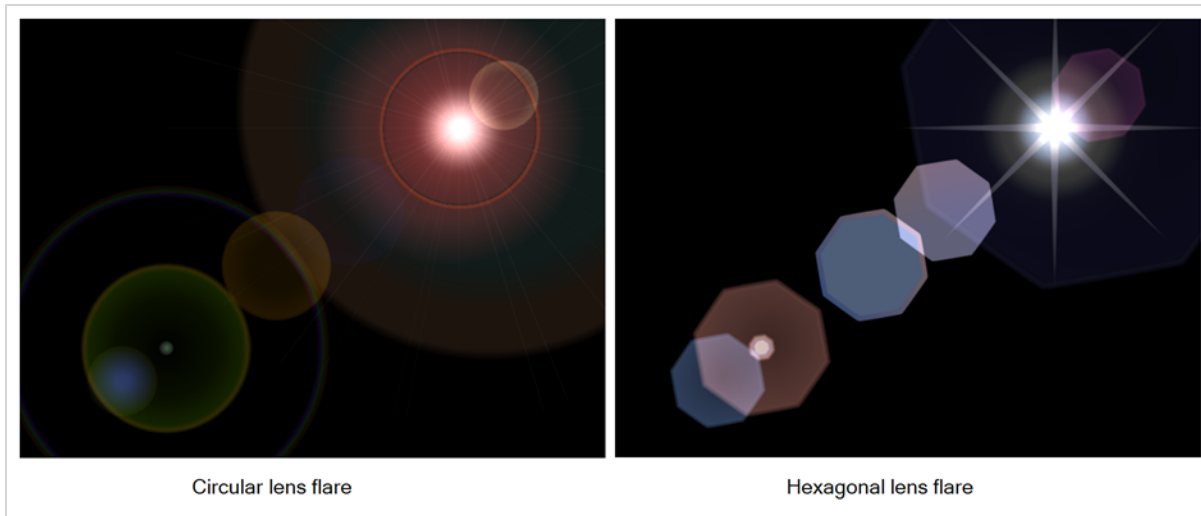

The Lens Flare effect simulates the refraction caused by shining a bright light into a camera lens. The shape of the lens flare can be circular or hexagonal.

For detailed video tutorials and sample scenes by Adam Phillips, see:

<https://www.toonboom.com/resources/video-tutorials/chapter/adam-phillips-harmony-effects>

Here is how a typical lens flare can be set up:

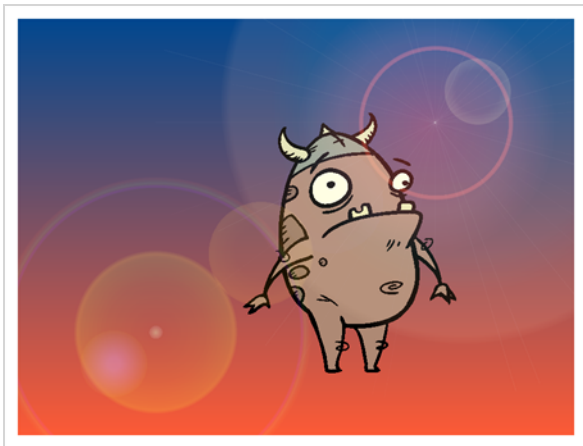

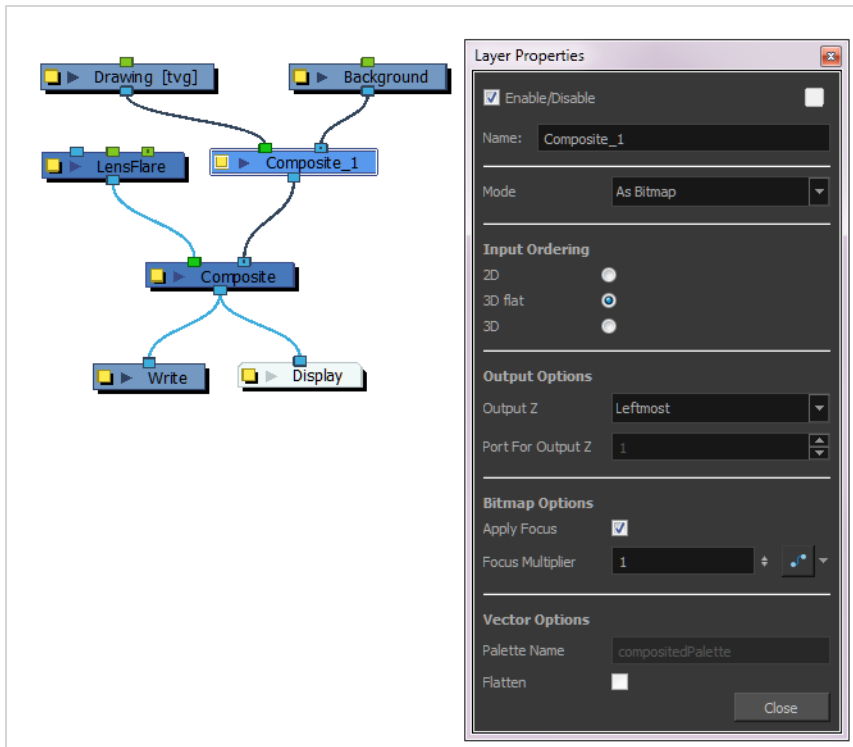

Lens Flare Properties

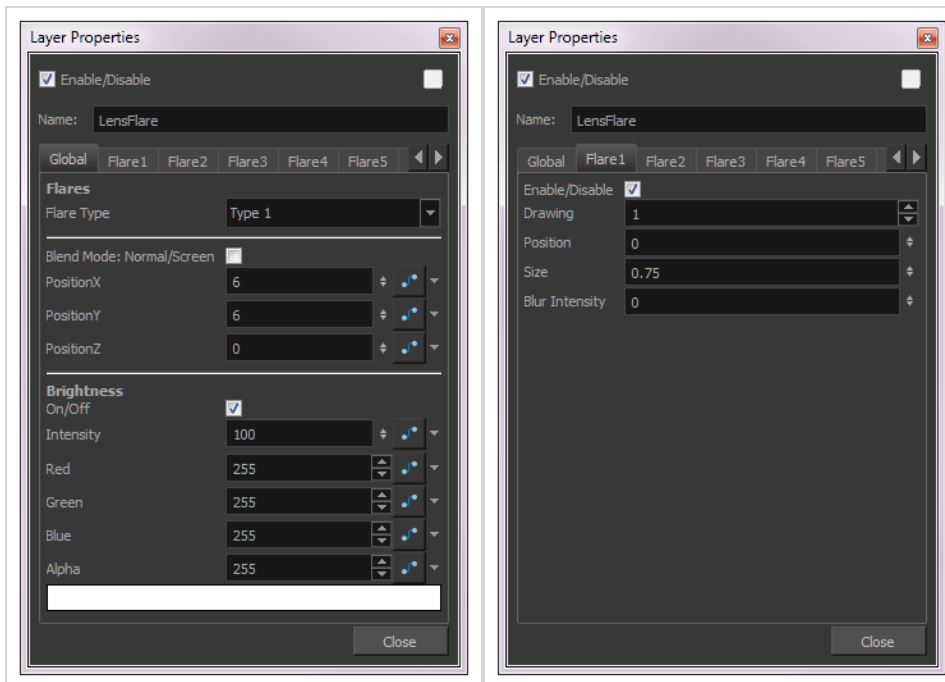

Parameter	Description
Flares	

Flare Type	<p>Custom: Lets you use your own custom art or drawing.</p> <p>Type 1: Circular lens flare.</p> <p>Type 2: Hexagonal lens flare.</p>
Blend Mode: Normal/Screen	<p>Lets you apply a normal or screen blending mode to the image.</p> <p>Normal: When selected, this operation will not create any blending mode effect.</p> <p>Screen: When deselected, this operation multiplies the inverted colour of the blending element with the image. This lightens the colour of the overlapping area. Screen is the default blending mode.</p>
Position X, Y, Z	Lets you precisely orient the flare in the x, y, and z axes.
Brightness	
Intensity	The strength of the lens flare.
Red	Red values of the image.
Green	Green values of the image.
Blue	Blue values of the image.
Alpha	Alpha values of the image.
Colour Swatch	Opens the Colour Picker where you can specify the colour of the main flare.
Flare 1–10	Lets you create custom lens flares by associating them with specific drawings. You can create up to 10 different flares.
	<p>Drawing: Lets you specify a drawing to use for the flare.</p> <p>Position: The position of the flare.</p> <p>Size: The size of the flare.</p> <p>Blur Intensity: The strength of the flare.</p>

Turbulent Noise Node

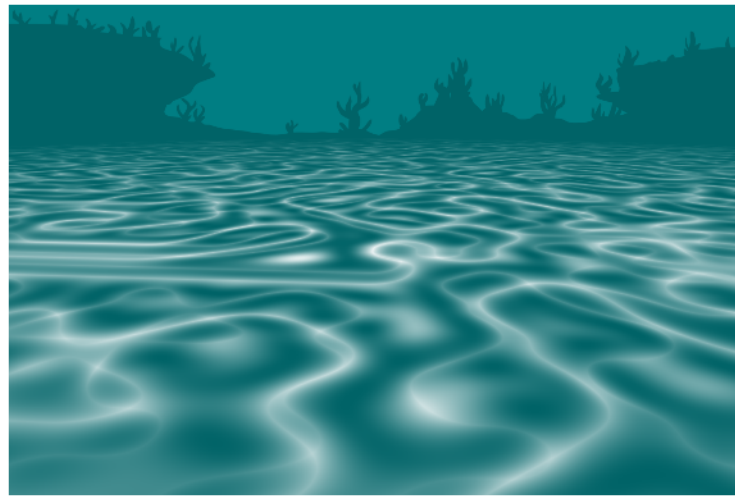

Image courtesy of Adam Phillips

The Turbulent Noise effect uses Perlin noise to create greyscale noise for organic-looking backgrounds, displacement maps and textures. Among other things, it can be used to simulate fluid effects like clouds, fire, lava, steam, flowing water, or vapour. The Turbulent Noise effect models turbulent systems with smaller noise features moving more quickly than larger noise features. The Turbulent Noise effect creates smooth animations and takes less time to render than other noise or grain effects.

For detailed video tutorials and sample scenes by Adam Phillips, see:

<https://www.toonboom.com/resources/video-tutorials/chapter/adam-phillips-harmony-effects>

Connection

Being a generator, the Turbulent Noise node does not require an input image. It generates noise using its Layer Properties. However, its default settings will only output solid black.

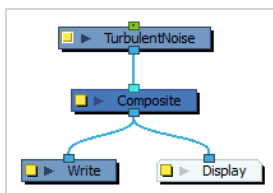

The Turbulent Noise node can be hooked to a peg, allowing you to transform and animate the effect.

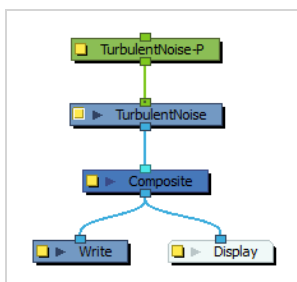



NOTE

In the example above, it is hooked to a Quadmap to simulate a perspective effect.

Optionally, a Turbulent Noise node can also be connected to a matte image. In this case, the noise will only fill the shape of the matte.

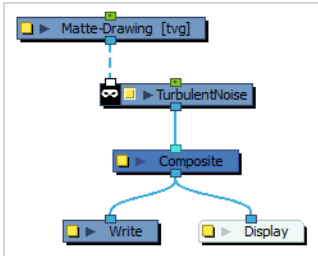

Layer Properties

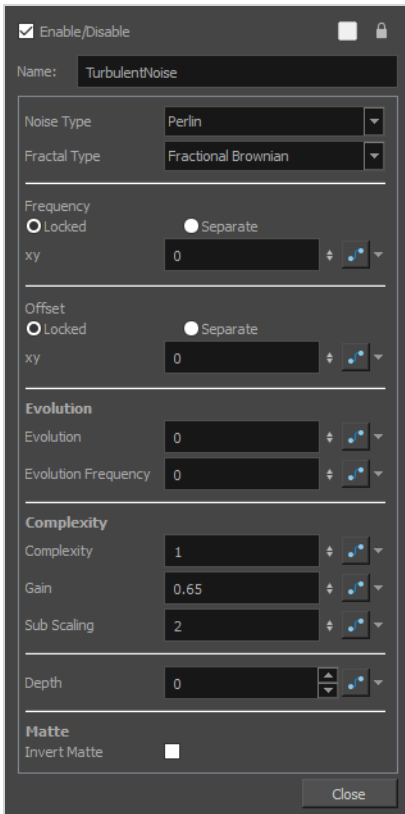

Parameter	Description
Enable/Disable	Allows you to enable or disable the node. When disabled, a node has no visible effect on the rendered image, nor on the preview in the Camera, Perspective, Side and Top views.

Parameter	Description
Colour Swatch	Sets the colour of the layer in the Timeline view and of the node in the Node view.
Name	The name of the node as it appears in the Node View and the Timeline view. Each node must have a name that is unique to its containing group.
Noise Type	<p>The algorithm used to generate the noise:</p> <ul style="list-style-type: none"> • Perlin: Creates pseudo random patterns. The greyscale contains a continuity between different tones of grey. • Simplex: Creates a more contrasted noise pattern with more variation than Perlin. There is a smooth variation of intensity. • Sinusoidal: Creates a repeated wavelike pattern. • Sub Scaling: Applies Perlin noise twice. The second noise is added where dark areas appear in the original. The frequency of the second iteration is higher so the noise is smaller. • Rocky: Uses the Perlin pattern but converts the very high and low values to more moderate values. For example, the whites become light greys and the blacks become dark greys. • Small Bumps: Uses the Perlin pattern. The transitional grey areas between blacks and whites become inverted so they look like dark lines. The extremes, black and white areas, become whitish.
Frequency	The density of displacement appearing in the noise. A higher value produces a greater amount of displacement in a given area; a lower value produces a smaller amount.
Offset	Moves the entire image.
Locked	Applies parameter value while retaining the X and Y ratio.
Separate	Allows you to apply different parameter values to X and Y.
xy	When locked, applies parameter values to both X and Y. When separated, allows you to apply different value to X and Y.
Evolution	Determines the displacement pattern over time.
Evolution Frequency	This factor makes the complexity iterations animate or transform at a higher

Parameter	Description
	speed. In other words, the second, third, etc. passes, controlled by the Complexity parameter, will mutate faster than the main one.
Complexity	<p>The number of noise layers that make up the noise. Each successive layer has a higher frequency, resulting in a smaller noise effect. You can have up to seven passes. Increasing this number increases the depth and amount of detail in the noise. Use Complexity with Sub Scaling when the value is 1 or greater.</p> <div data-bbox="565 579 1430 716" style="border: 1px solid green; padding: 5px;">  NOTE Increasing the Complexity results in longer rendering times. </div>
Gain	Controls the amount of opacity present in the iteration of noise. This also affects the layer when using Sub Scaling. With a value of 0, you will not see the sub noise. A value of 1 will show the sub noise just as strong as the main one. For example, with water ripples, a higher amount of Gain will reveal more ripple or subripples.
Sub Scaling:	The factor by which the main noise is modified at each iteration of complexity. A value of 1 make the two noises identical. A value of 2 makes the sub noise twice as small. The next iteration would be 4 times smaller. Values must be greater than 1.
Depth	This value determines the composition order when the Z value of two elements is the same.
Matte	
Invert Matte	If the Turbulent Noise node is connected to a matte image, by default, the noise will only fill the opaque areas of the matte. If this parameter is enabled, the noise will fill the transparent areas of the matte instead.

Group Nodes

The nodes found in the group category are used to organize the Node view by grouping nodes and providing input and output ports for these groups.

Group Node	767
Multi-Port-In Node	768
Multi-Port-Out Node	769

Group Node

The Group node is the node containing all the layers in a group. In the Timeline view, a Group node appears as a layer that you can expand or collapse to display or hide the layers it contains in the layer list. In the Node view, a Group appears as a node that can be entered by clicking on the arrow in the right end of the node.

Multi-Port-In Node

A Multi-Port-In node is added by default in a new Group node. Use it to add one or more input ports to the Group node so that you can process an image through the nodes in the Group node.

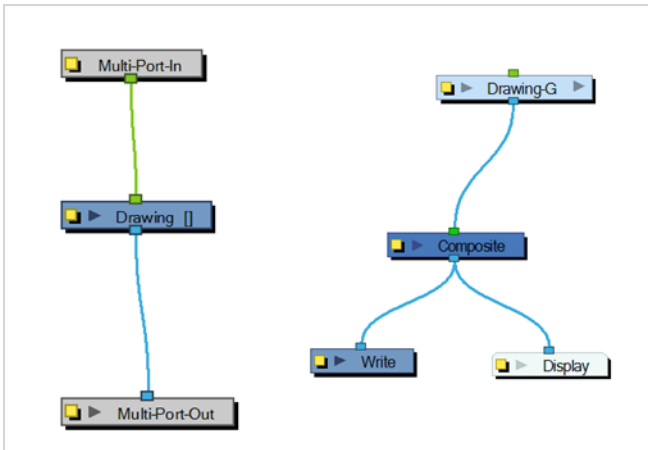

When you plug an element to a Multi-Port-In node, an input port appears at the top of the Group node. You can add additional ports to the nodes as needed.

Pass your cursor over the Group node input port to see the name of the Port Image In node that it connects to. You will notice that the Group node in these examples has no output port. It requires a Multi-Port-Out node to output data from its network.

A Multi-Port-In is automatically added when you create a group.

Use the Multi-Port-In editor to rename the node.

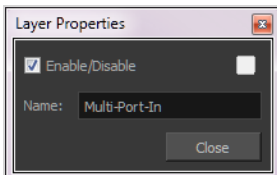

Multi-Port-Out Node

A Multi-Port-Out node is added in a new Group node by default. Use it to add output ports to the Group node so that you can output the result of the group operation to the rest of the network. After you plug an element to a Multi-Port-Out node, an output port appears on the bottom of your Group node. You can add additional output ports as needed.

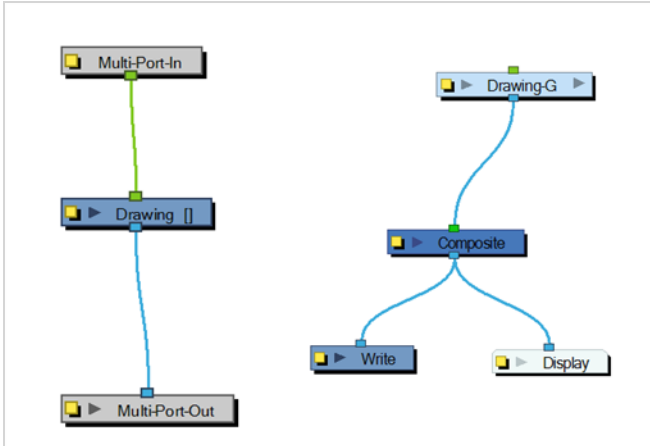

A Multi-Port-Out is automatically added when you create a group.

Use the Multi-Port-Out editor to rename the node in the network.

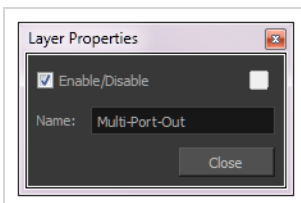

Miscellaneous Nodes

The nodes found in the Miscellaneous category are various nodes used to either add notes to the Node view, use external scripts or previous and hide elements in OpenGL and Render view.

External Node	771
Master Controller Node	774
Note Node	780
OpenGL Bypass Node	781
OpenGL-Cache-Lock Node	783
Pre-Render Cache Node	786
Connection	787
Render Preview Node	790
Script Node	791
Visibility Node	794

External Node

Use the External node to process images through external programs and input the resulting images back into the network. Note that not all programs work with the External node.

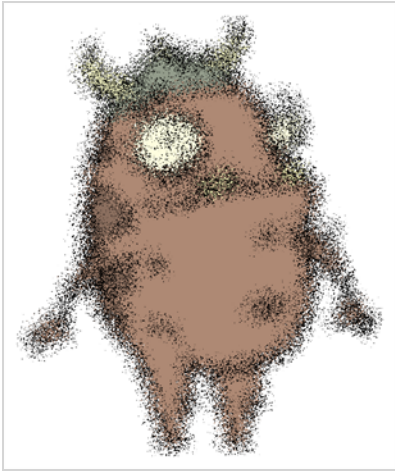

Using the External node lets you avoid having to export your animation to another software to do some processing over it and then bringing it back to Harmony. This way, you can modify your scene and animation as much as you want and still use the effects or render process from a third-party software.



NOTE

Harmony also supports OpenFX plugins.

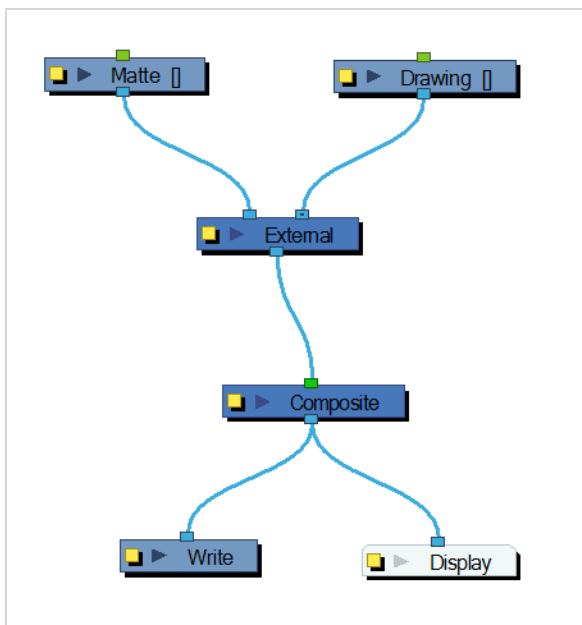

The External node writes input files to temporary files on the system. It then calls the external program, which will process the input images. If two images are input into the node, the program must composite them

together to produce one output image. Finally, the file produced by the external program is read back into the network.

The command is sent to the external program in the following format:

```
program_name file_1 file_2 output_file numerical_param extension
```

Use the External editor to control the program that is launched by the node, the files that it reads, and the file that it outputs into the network.

```
Version: ImageMagick 6.3.0 11/06/06 Q16 http://www.imagemagick.org
Copyright: Copyright (C) 1999-2006 ImageMagick Studio LLC
Usage: mogrify [options ...] file [ [options ...] file ...]
Where options include:
-adaptive-blur geometry      adaptively blur pixels; decrease effect near edges
-adaptive-resize geometry    adaptively resize image with data dependent triangulation
-adaptive-sharpen geometry   adaptively sharpen pixels; increase effect near edges
-affine matrix               affine transform matrix
-annotate geometry text     annotate the image with text
-antialias                   remove pixel-aliasing
-authenticate value          decrypt image with this password
-auto-orient                 automatically orient image
-background color            background color
-bias value                  add bias when convolving an image
```

In this example, the ImageMagick 6.3 software was used without a matte connection.

Use the External editor to write down the parameters matching the chosen external program.

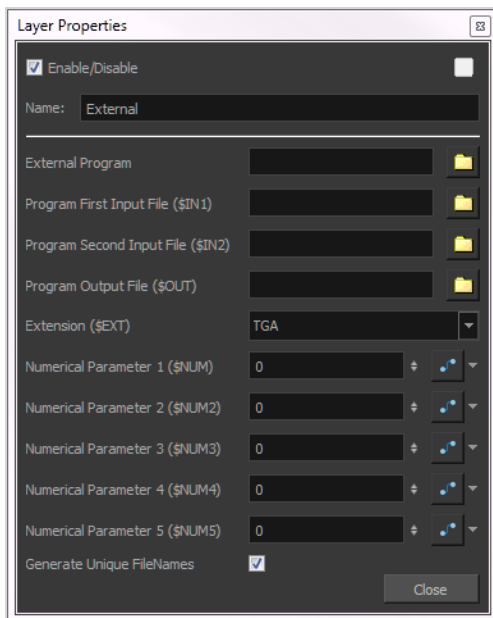

External Properties

Parameter	Description
External Program	The name of the program launched by the External node. This field can include a full or relative path to the executable file. If no path is entered, the user's path is searched to locate the program.

	<p>Enter the command directly into this field.</p> <p>For example:</p> <pre>mogrify -spread \$NUM \$IN1</pre> <p>Where:</p> <p>mogrify: Is the name of the program</p> <p>spread: Is the option to be applied,</p> <p>\$NUM and \$IN1: Are the numerical parameter and first input file variable declared in the External node.</p>
Program First Input File (\$IN1)	The name and location of the temporary file that Harmony will write to the file system for the external program to read. It must not include the dot or the extension; the External node will add these based on the Extension field.
Program Second Input File (\$IN2)	When processing two files through this node (such as an image and a matte), this is the name and location of the second temporary file that Harmony writes to the file system for the external program to read. It must not include the dot or the extension; the External node will add these based on the Extension field.
Program Output File (\$OUT)	The name and location of the temporary file that the external program will write to the file system so that Harmony can read it back into the network.
Extension (\$EXT)	The file type that will be processed by the external program.
Numerical Parameter(\$NUM)	A value passed to the external program as a file processing option. It can be attached to a function curve to change over time.
The program files are temporary files that are overwritten at each frame as the node is executed. They are only meant to temporarily store the image that is being processed at each frame.	
Generate Unique FileNames	If this option is enabled, the temporary output file will have a unique identification number added to its name to avoid any file override if another scene or External script is rendered at the same time. It could be possible to have an override when two scenes using the External nodes are rendered in batch processing.

Master Controller Node

The master controller node is a special kind of script node that allows you to create visual widgets that you can display in the Camera view, and script to programmatically affect a character rig when manipulated by the user.

For information and examples on how to use the Master Controller node, refer to the *Master Controller* subsection of the *Rigging* chapter of the *User Guide*.

Connection

The Master Controller does not need to be connected to a node in order to work, unless it is scripted to affect nodes that are connected to it.

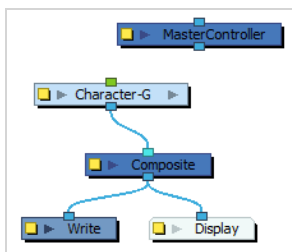

If a Master Controller is connected to a node, the node system it is connected to should ultimately end up connected to a Display node in order for the Master Controller to work.

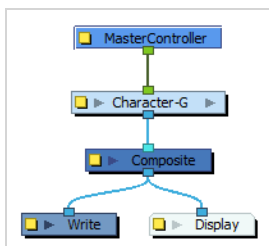

If you configure the Master Controller's first (rightmost) input port to be a transformation (peg) input port, you can connect a peg to the Master Controller, and use this peg to move its widget around in the Camera view, allowing you to easily set the widget's default position in the scene.

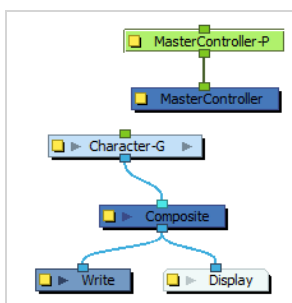





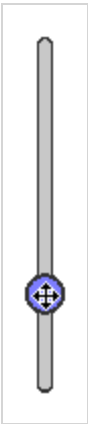
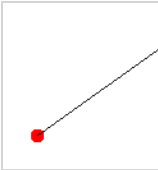

**IMPORTANT**

A Master Controller node must have at least one output port to function, even if this port is not connected to anything.

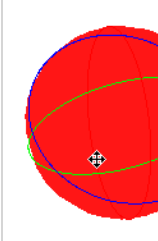
Controls

The Master Controller can be scripted to display any one of the following kinds of controls in the Camera view:

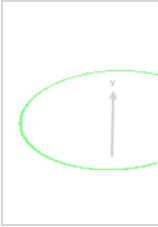
Control	Appearance	Description
Slider		A slider that allows the user to slide a handle up or down. When manipulated, it provides a value between its minimum and maximum values.
2D Line Display		Displays a line going between two 2D Point widgets, make a "bone" type manipulator that can be moved by either end.
2D Point		A point that the user can freely drag around the stage. When manipulated, it provides its position.
3D Rotation		A 3D sphere that the user can rotate in all directions. When manipulated, it provides an object with a rotation angle for each axis.

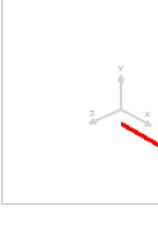
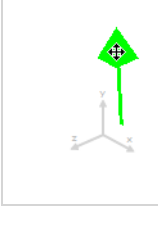
Control	Appearance	Description
X Rotation		A circle that can be rotated around the x-axis. When manipulated, it provides a rotation angle.
Y Rotation		A circle that can be rotated around the y-axis. When manipulated, it provides a rotation angle.
Z Rotation		A circle that can be rotated around the z-axis. When manipulated, it provides a rotation angle.
X Translation		An arrow that can be dragged along the x-axis. When manipulated, it provides an offset.
Y Translation		An arrow that can be dragged along the y-axis. When manipulated, it provides an offset.

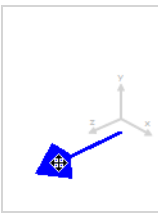
Control	Appearance	Description
Z Translation		An arrow that can be dragged along the z-axis. When manipulated, it provides an offset.

Scripting Interface

To access the scripting interface reference, open the Script Editor view. Then, open the  View Menu and select **Help > Scripting Interface Documentation**.

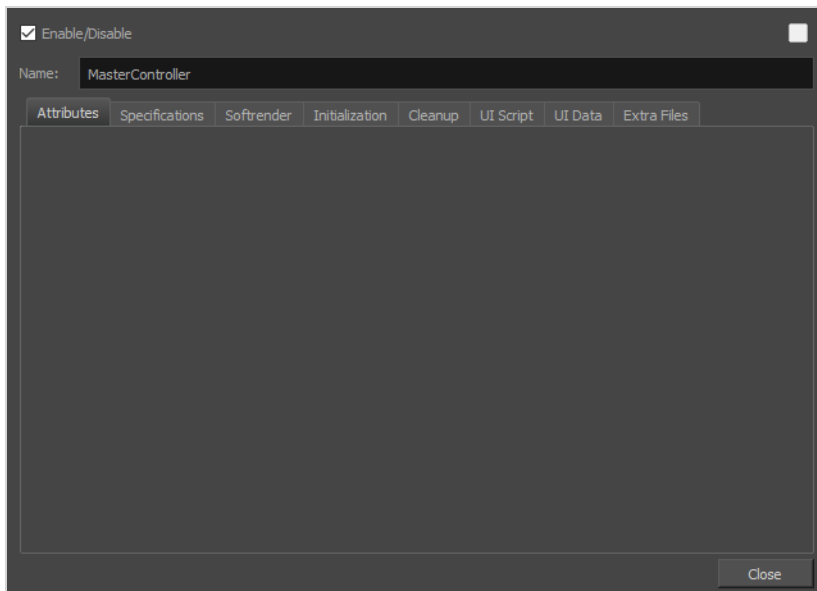

Layer Properties

The Master Controller node is essentially a Script node with an extra layer of functionality in its scripting interface. Hence, its layer properties are very similar to that of the Script node. However, its most important tab is the **UI Script** tab. The script in this tab is executed when the layer is selected and the user clicks on the  Show Control button in the Camera toolbar. This is where you can define which widget the node displays, and what happens when the user manipulates the widget.



Parameter	Description
Name	The name of the node as it appears in the Node View and the Timeline view. Each node must have a name that is unique to its containing group.

Parameter	Description
Tabs	
Attributes	This tab allows you to set values for the attributes defined in the Specifications tab.
Specifications	<p>This tab allows you to define the attributes as well as the input and output ports for the Master Controller.</p> <p>The Master Controller supports the following types of attributes:</p> <ul style="list-style-type: none"> • bool • int • double • String • Text • Colour • Position2d • Position3d <p>The Master Controller supports the following types of ports:</p> <ul style="list-style-type: none"> • Image • Peg
Softrender	<p>This tab allows you to write or link to a script that will be executed when rendering the node.</p> <div data-bbox="565 1371 1430 1539" style="border: 1px solid #c8e6c9; padding: 10px; margin-top: 10px;"> <p> NOTE Scripts in this tab are ignored by the Master Controller node. The Softrender tab is only executed by Script nodes.</p> </div>
Initialization	This tab allows you to write or link to a script that will be executed when loading the scene.
Cleanup	This tab allows you to write or link to a script that will be executed when closing the scene.
UI Script	This tab allows you to write or link to a script that will be executed when using

Parameter	Description
	the Show Control command while the node is selected. This is where widgets and their functionalities should be defined.
Extra Files	<p>This tab allows you to define folders or files from root directory of the scene that should be preserved when creating templates or saving the scene in a different location. Any asset, such as external scripts, user interface files, data files or images that the Master Controller requires should be listed in this tab.</p> <div data-bbox="565 579 1430 1087" style="border: 1px solid #c8e6c9; padding: 10px;"><p> NOTES</p><ul style="list-style-type: none">• To add Extra Files to the Extra Files attribute, click on the  Function button right of the Extra Files field to create the Extra Files attribute, then click on it again to open a dialog box in which you can type the file path of each file or folder that you want to copy with the Master Controller, with one file path per line.• File paths must use forward slashes (/) and must be relative to the scene directory. They can point to files or folders. For example, if you want to copy everything in the scripts sub-directory of your scene with your Master Controller, you can simply add scripts to the list.</div>

Note Node

The Note node allows you to record any textual information that is relevant to your project. You can add comments, suggestions or reminders. You can add Note nodes anywhere in the network, including groups.

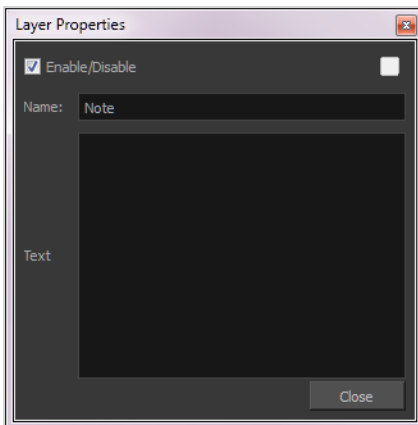
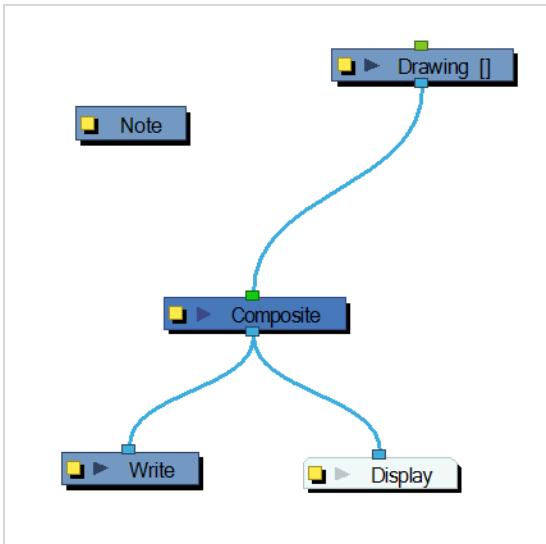

OpenGL Bypass Node

The OpenGL Bypass node can be used to define what is displayed in the OpenGL preview of the Camera view separately from what appears in the final rendered image. This can be used to help with performance when working on a scene or during playback. The OpenGL preview can be made to only display elements that are important to the animator as they are working on the scene, making the generation of the OpenGL preview a lot less demanding for Harmony, without affecting the rendered image.

Connection

The OpenGL Bypass node has two input ports and one output port. What is connected to the left input port displays in the OpenGL preview, and what is connected to the right input port appears in the rendered image.

How to connect an OpenGL Bypass node

1. Identify a part of the scene's node system that adds a lot of unnecessary load to the OpenGL preview.
2. If that part of the node system is not connected to a composite, add a Composite node and connect all the elements of that area to this composite. This will be the *render composite*.
3. Connect the OpenGL Bypass node under the render composite through its right input port.
4. Create another composite. This will be the *preview composite*.
5. Connect only the parts of the node system that are useful to the animator to the preview composite.
6. Connect the preview composite to the left input port of the OpenGL Bypass node.

In the following example the scene includes a background, a character (which is rigged to be cut by part of the background), a drop shadow, light and shadow effects, a node system deformed by a Quadmap to make a computer or television screen effect, a snowstorm particle system and an overlay. All of these elements are connected to a composite that is connected to the right port of the OpenGL Bypass. Connected to the left port of the OpenGL Bypass is a composite that is only connected to the character without the cutter, the background, and the content of the screen without the Quadmap deformation, which would typically be all the animator needs to work on the scene.

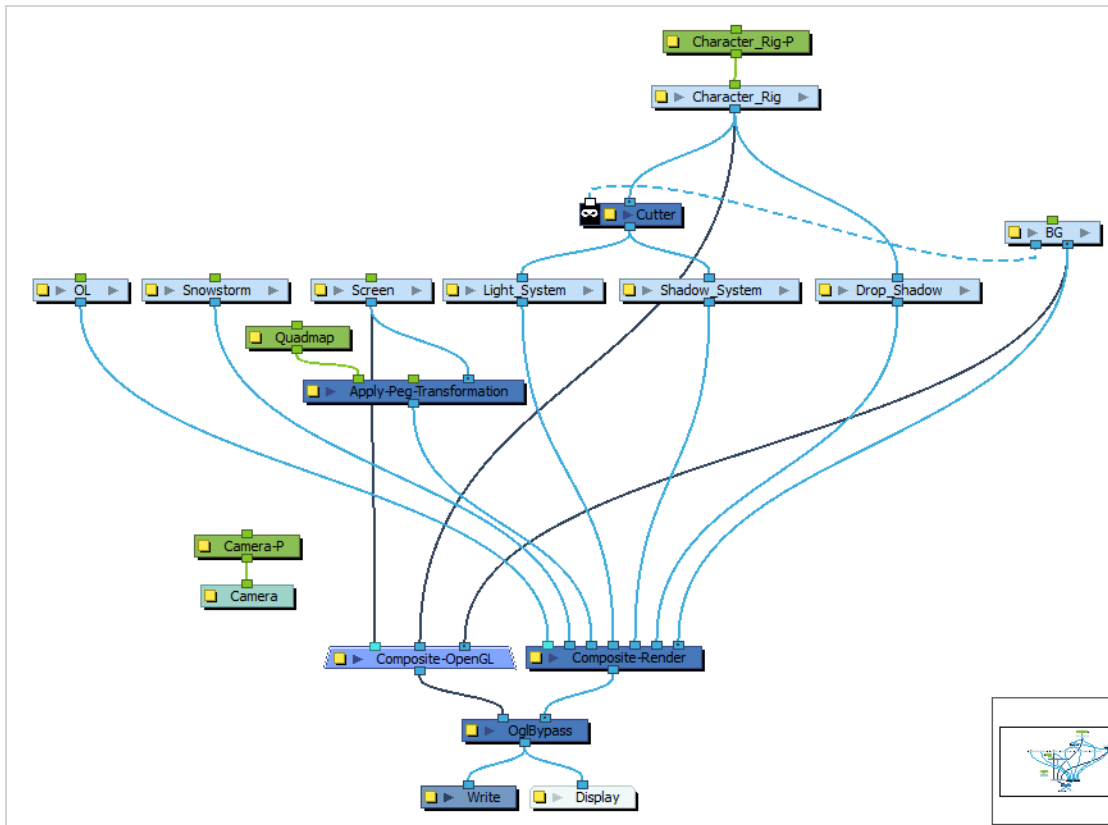
**NOTE**

This example showcases the OpenGL Bypass node being used for the scene's main composite. It is also possible to use it for very precise areas of a node system, such as individual body parts of a character, as long as they are linked together by a composite.

Properties

Parameter	Description
Name	The name of the node as it appears in the Node View and the Timeline view. Each node must have a name that is unique to its containing group.

OpenGL-Cache-Lock Node

The OpenGL Cache Lock node can significantly increase the performance of Harmony when working in heavy scenes with many characters, very complex rigs or an otherwise heavy node system.

Without the OpenGL-Cache-Lock node, Harmony must regenerate the OpenGL preview displayed in the Camera view every time an element is changed or manipulated from scratch. This means it has to process every node in the scene's node system all over again. Although the OpenGL preview is optimized for quick real-time rendering, a complex enough node system can make this process slow enough that each action done on the scene causes a delay, ultimately making working on heavy scenes excessively time-consuming.

A typical way to circumvent this is to temporarily disable elements in the scene that are not being worked on. For example, an animator working on a scene with several characters can disable the characters they are not working on at the time, and can also temporarily disable the scene's background and props, so that only the elements they need to manipulate are visible which reduces the load on OpenGL previewing.

The purpose of the OpenGL-Cache-Lock is to obtain virtually the same benefit in performance without having to hide any element in the scene. When connected under a node system, this node creates a cache of the OpenGL preview of the elements it is connected to. Every time a change is made to any element in the scene and the OpenGL preview must be refreshed, the OpenGL-Cache-Lock node checks if the change affects one of the elements it is connected to. If it does not, it will simply output the cached image for the preview, saving Harmony the burden of regenerating the preview for these elements.

Hence, in the previous example, an OpenGL-Cache-Lock node could be connected under the main composite of each character. Harmony would then cache the preview of each character separately, and would only regenerate the preview of a character when one of its parts is manipulated or modified. The animator would not need to disable any characters as Harmony will keep re-using the cached previews of the characters they are not currently working on.



NOTE

The OpenGL Cache Lock node only affects the way the OpenGL preview is generated and has no effect on the actual rendered image.

Connection

The OpenGL-Cache-Lock node must be connected under elements or composites that should be cached separately for the OpenGL preview. Typically, this means adding an OpenGL-Cache-Lock node under elements that will be animated individually. In the example below, an OpenGL-Cache-Lock node can be connected under the main composite of each character. But for a scene with very complex character rigs, an OpenGL-Cache-Lock node could also be connected under composites for each limb of the character, for their torso, for their head, etc.

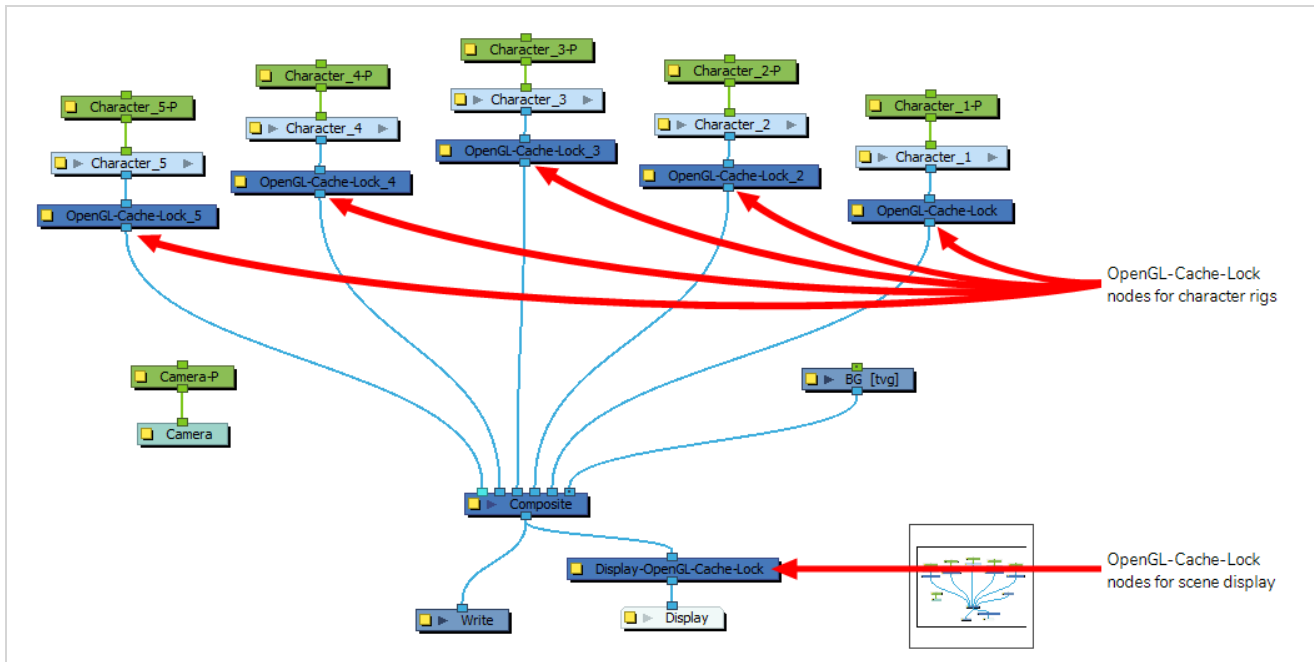

An OpenGL-Cache-Lock node can also be connected between the scene's main composite and its main display. This can help with performance when zooming in, panning and rotating the scene. Harmony will use the cached preview while zooming in, panning or rotating, and will only regenerate the preview half a second after the operation is done.





IMPORTANT

The OpenGL-Cache-Lock node must be used with some caution:

- If the user begins zooming in, rotating or panning the Camera view, the preview will not regenerate immediately. Rather, it will regenerate half a second after the user releases is done. During that short delay, because the preview cached by the OpenGL-Cache-Lock is a bitmap image and that it does not extend the borders of the Camera view, zoomed-in areas will appear pixelated, and areas that are brought from outside of the Camera view's borders by zooming out or panning will appear blank until the preview is regenerated.
- It is important not to add too many OpenGL-Cache-Lock nodes, and to only use them for complex node systems. If a scene has too many OpenGL-Cache-Lock nodes and that they are used on node systems that are too simple, the caching overhead as well as the need to composite all the different caches is liable to cause more load on Harmony than it would save.
- Likewise, whether adding an OpenGL-Cache-Lock node under layout elements such as backgrounds, underlays and overlays will enhance performance depends on how complex they are. For example, a single vector drawing layer might benefit from an OpenGL-Cache-Lock if it has an exceptionally high amount of detail. Otherwise, the performance gain for a few drawing layers is unlikely to surpass the incurred caching overhead. You should use them with discretion with such elements, and test whether they cause a noticeable improvement or decrease in performance.

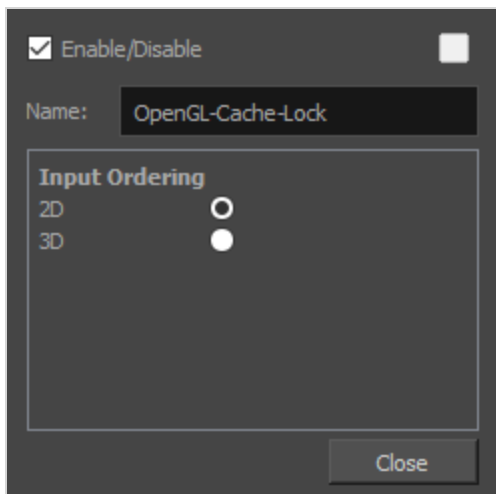
Properties



Parameter	Description
Name	The name of the node as it appears in the Node View and the Timeline view. Each node must have a name that is unique to its containing group.
Input Ordering	<p>Determines the way the elements connected to the OpenGL-Cache-Lock node are ordered in the preview:</p> <ul style="list-style-type: none"> • 2D: Elements connected to the node will appear flattened together. Their apparent position on the Z axis relative to other elements in the scene will be the one of the foremost element. • 3D: Elements will appear in their appropriate order based on their position on the Z axis relative to other elements in the scene. <div data-bbox="565 1314 1430 1516" style="border: 1px solid green; padding: 5px; margin-top: 10px;"> <p> NOTE This only affects the way elements are displayed in the OpenGL preview. The OpenGL-Cache-Lock node does not affect the way elements are rendered in the final render.</p> </div>

Pre-Render Cache Node

The Pre-render Cache node is a special type of Composite node that can create and store a cache of its rendered image on demand, and only output that cached image in the Camera view when it is in Render View mode.

This node can be very useful when working on a scene that contains an element that is extremely long to render, such as a 3D model, a complex special effect or even a scene rendered in 4K.

Typically, when you view a frame of your scene in Render View mode, Harmony renders every element of your scene one by one to composite them into the preview image. Then, if you change anything in your scene, Harmony has to render every element in your scene from scratch again to ensure that the preview is accurate. For example, in a scene with one character and a very resource-intensive special effect, making a change to the character requires Harmony to re-render every element in the scene including the resource-intensive special effect, which is very time consuming.

The Pre-render Cache node allows you to control when certain elements in your scene are rendered again. In the previous example, you can connect the resource-intensive special effect to a Pre-render Cache node, then make it generate a cache of the rendered special effect. From that point on, when the Camera view is in Render View mode, it will pull the rendered special effect from the Pre-render Cache node's cache instead of regenerating it every time. If you make a change to the special effect that requires its preview image to be regenerated, you can manually render the Pre-Render Cache node again, which will update its preview image in the Camera view.

The Pre-render Cache node now shows green frames in the Timeline once a frame is rendered and available in the cache.



NOTE

- The Pre-render Cache node is not intended to be used in the design department (Backgrounds, Props and Rigs) nor in the animation department since they do need to modify too often the contents of the scene. The Pre-render Cache node is in fact more efficient in the Compositing department.
- The Pre-render Cache node can only output a flat bitmap image.
- The cached rendered images are only used when generating a preview image for the Camera view. When rendering your scene's frames as images or as a movie, the nodes connected to the Pre-render Cache nodes are rendered again, and the cached images are ignored.
- Effects that require vector images, such as the Colour Override or the Apply Peg Transformation effects, will not work when connected under a Pre-render Cache node, since the Pre-render cache node acts like a bitmap Composite.

Connection

The Pre-render Cache node should be connected as the intermediary node between the element, effect or composite for which you want to cache the rendered image, and the composite for the remainder of the scene. For example, if a character is made of various effects, the most efficient place to put the Pre-render Cache node will be under the character's group on the scene level.

Example: One Pre-render Cache node by character's rig

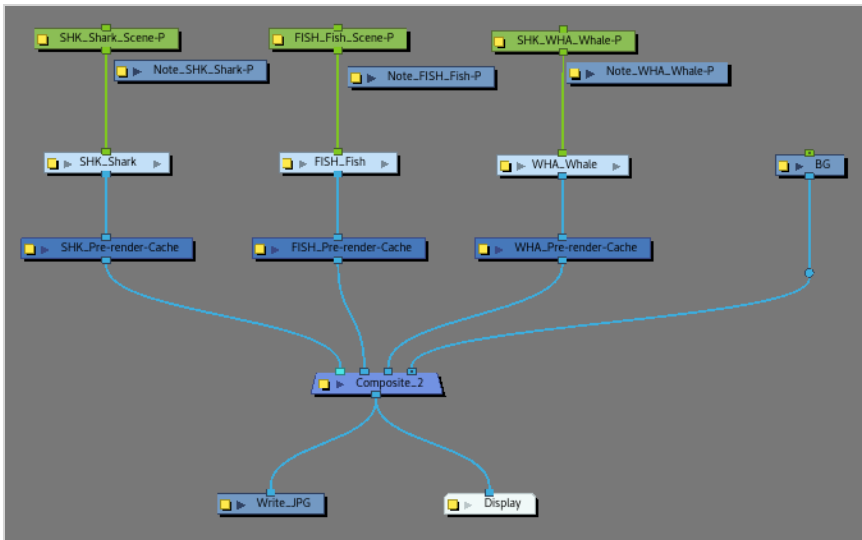

Being a “composite” type node, you can connect as many input images as you want to the Pre-render Cache node.

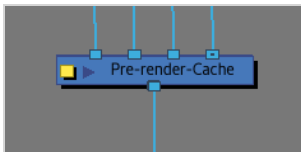

The Pre-render Cache outputs a bitmap image and, contrary to regular Composite nodes, it does not allow vector effects to travel up its node system. Hence, effects such as the Colour Override or the Apply Peg Transformation effects will not work when connected under a Pre-render Cache node.

The Pre-Render Cache node shares some of its properties with the Composite node.

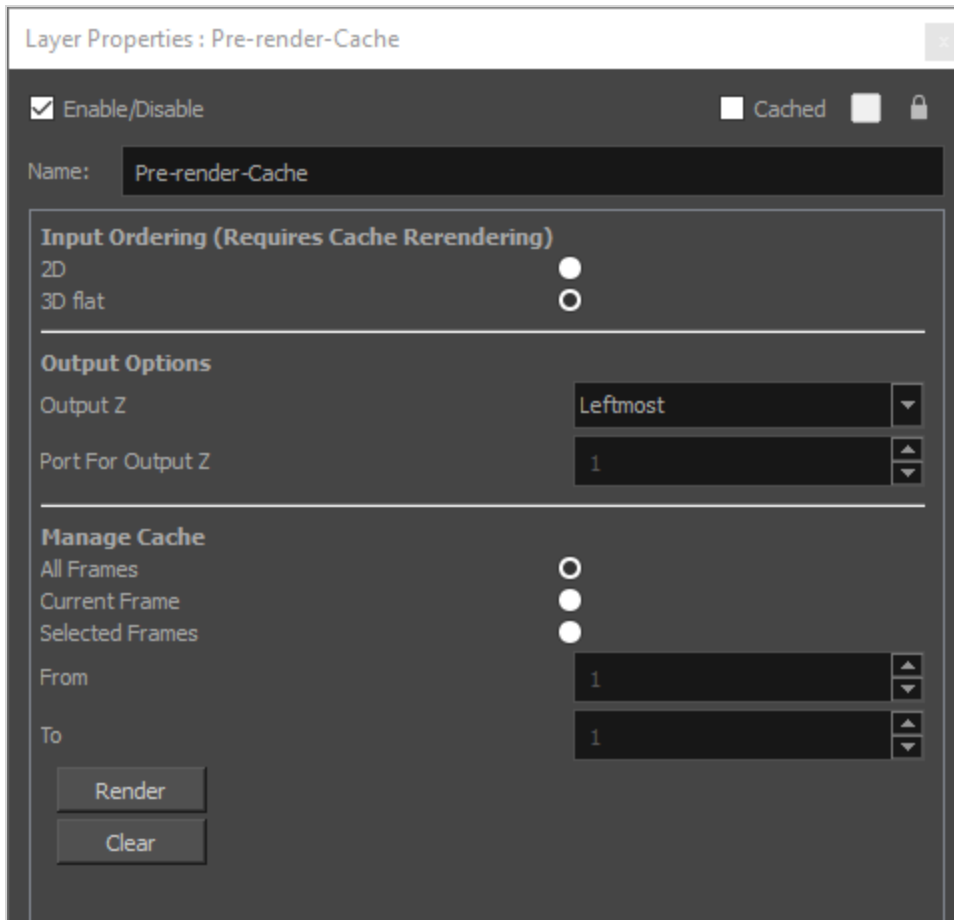

Parameter	Description
Enable/Disable	Allows you to enable or disable the node. When disabled, a node has no visible effect on the rendered image, nor on the preview in the Camera, Perspective, Side and Top views.
Colour Swatch	Sets the colour of the layer in the Timeline view and of the node in the Node view.
Name	Allows you to enter a name for the node.
Input ordering (Requires Cache Rendering)	<ul style="list-style-type: none"> • 2D: Elements connected in the node are composited based on their port ordering. The Z-axis (forward-backward) values are ignored. The scaling value will be correct, but the actual position on the Z-axis is ignored. <p>You can use the 2D composite type to create effects such as a camera recording overlay on your scene. Since you always want this element to be in front regardless of the other elements' Z-axis position, you can set the option to 2D.</p>

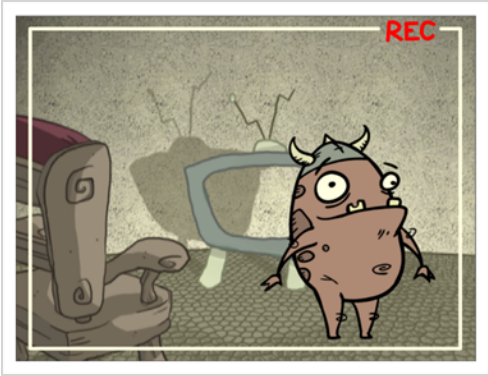
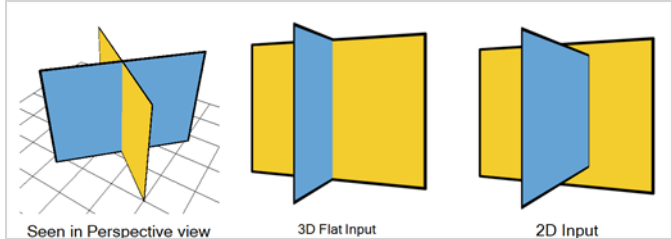
	 <ul style="list-style-type: none"> • 3D Flat: The Z-axis value of the elements connected in the Composite node are considered, so the visual representation is correct in the Camera view. The output is a flat image. 
<p>Output Options</p>	<ul style="list-style-type: none"> • Output Z: Identifies which element's front-back value from the current composition is applied to the entire composited image in the next operation. If you select Portnumber, identify the appropriate port by its position using the Port For Output Z menu. • Port for Output Z: When using the Portnumber option in the Output Z menu, you can select which port you want to use as the Z value for the Composite node. The port used appears in a bright green colour on the Composite node. By default, the leftmost port is displayed in front and the rightmost port is displayed behind.
<p>Manage Cache</p>	<ul style="list-style-type: none"> • All Frames: Select All Frames if you want to pre-render the entire scene. • Current Frames: Select Current Frames if you want to pre-render the current scene. • Selected Frames: Select Selected Frames if you want to render a part of your scene. Then, in the field From, type in the first frame of the sequence you want to export, and in the other field, the last frame of the sequence you want to render. • Render: Renders the frames into cache images within the prerender.db folder of the current Pre-render Cache node. Those images will be rendered as .rpng files. • Clear: Removes every cache image rendered within the prerender.db folder of the current Pre-render Cache node.

Render Preview Node

To adjust the effect's visual controls in OpenGL mode, from the Node Library view, drag a Render Preview node to the Node view. Connect it between the effect and the Composite nodes.

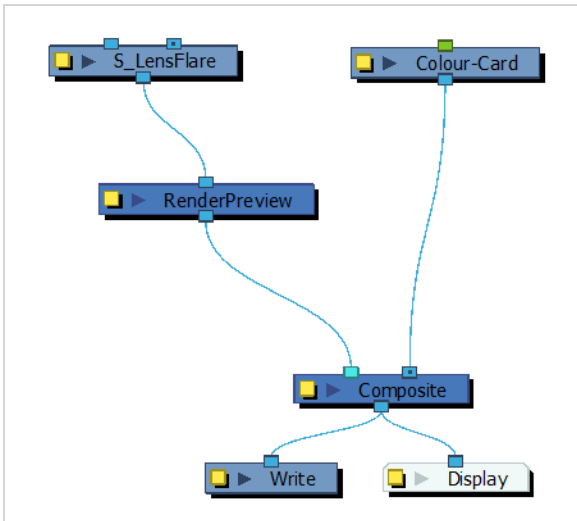

Script Node

You can use the script node to create a custom node that processes peg and image information from other nodes using the Harmony scripting interface.

Connection

By default, the Script node has one image input port and one image output port, which do not have any purpose until you add scripts to it.

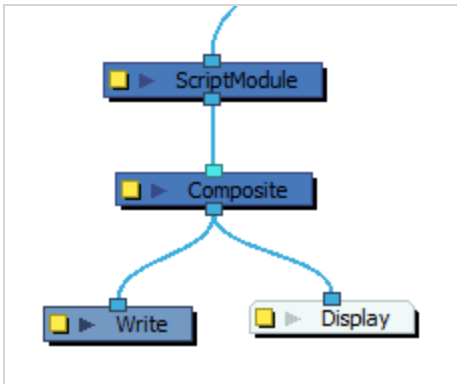

The Script node can be configured to have as many input and output ports as needed. Each port can be configured to carry image information or transformation (peg) information.

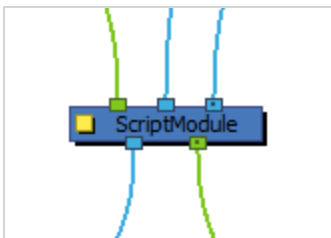

Scripting Interface

For a reference on the modules and methods available in the scripting interface used by the Script node, refer to the Script Node reference guide, which is packaged with Harmony and can be found on the following location on your system:



- Windows: `C:\Program Files (x86)\Toon Boom Animation\Toon Boom Harmony 20 Premium\help\scriptmodule\index.html`
- macOS: `/Applications/Toon Boom Harmony 20 Premium/Harmony Premium.app/Contents/Documentation/scriptmodule/index.html`
- GNU/Linux: `/usr/local/ToonBoomAnimation/harmonyPremium_20/help/scriptmodule/index.html`

Layer Properties

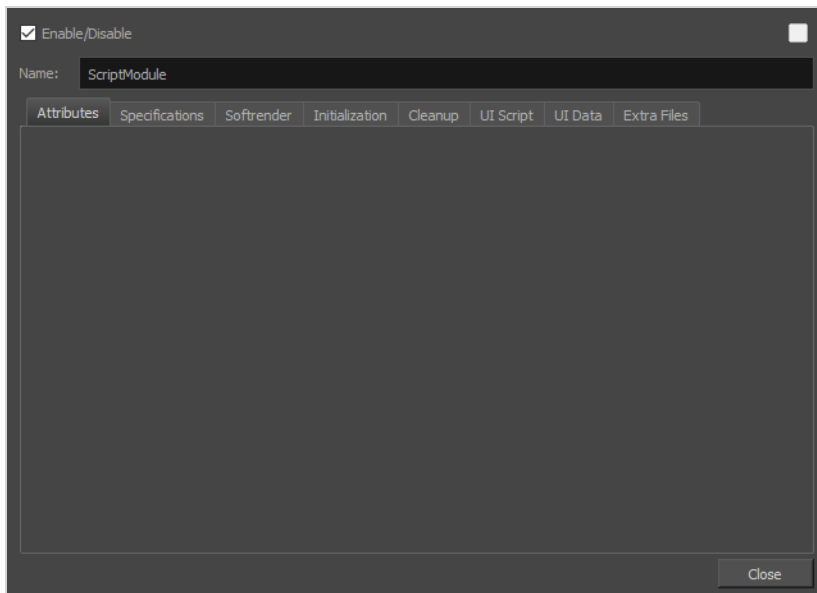
The layer properties of a Script Node allow you to configure which properties and ports it has, to set values for the properties you added to it, to link it to files and to script its behaviour in various events.



Parameter	Description
Name	The name of the node as it appears in the Node View and the Timeline view. Each node must have a name that is unique to its containing group.
Tabs	
Attributes	This tab allows you to set values for the attributes defined in the Specifications tab.
Specifications	<p>This tab allows you to define the attributes as well as the input and output ports for the Script node.</p> <p>The Script node supports the following types of attributes:</p> <ul style="list-style-type: none"> • bool • int • double • String • Text • Colour

Parameter	Description
	<ul style="list-style-type: none"> • Position2d • Position3d <p>The Script node supports the following types of ports:</p> <ul style="list-style-type: none"> • Image • Peg
Softrender	This tab allows you to write or link to a script that will be executed when rendering the node.
Initialization	This tab allows you to write or link to a script that will be executed when loading the scene.
Cleanup	This tab allows you to write or link to a script that will be executed when closing the scene.
UI Script	This tab allows you to write or link to a script that will be executed when using the Show Control command while the node is selected.
Extra Files	<p>This tab allows you to define folders or files from root directory of the scene that should be preserved when creating templates or saving the scene in a different location. Any asset, such as external scripts, user interface files, data files or images that the Script node requires should be listed in this tab.</p> <div data-bbox="565 1266 1430 1776" style="border: 1px solid #c8e6c9; padding: 10px;"> <p> NOTES</p> <ul style="list-style-type: none"> • To add Extra Files to the Extra Files attribute, click on the  Function button right of the Extra Files field to create the Extra Files attribute, then click on it again to open a dialog box in which you can type the file path of each file or folder that you want to copy with the Master Controller, with one file path per line. • File paths must use forward slashes (/) and must be relative to the scene directory. They can point to files or folders. For example, if you want to copy everything in the scripts sub-directory of your scene with your Master Controller, you can simply add scripts to the list. </div>

Visibility Node

The Visibility node lets you control whether an item is visible in OpenGL mode versus the Soft Render mode in the Camera view. If the Soft Render option is not enabled, the layer will not be exported.

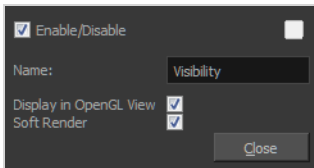

Visibility Properties

Parameter	Description
Display in OpenGL View	Displays your render in OpenGL mode.
Soft Render	

Move Nodes

The nodes found in the Move category are used to animate layers as well as camera motions.

Apply Image Transformation Node	796
Apply Peg Transformation Node	799
Camera Node	803
OrthoLock Node	805
Peg Node	807
Shake Node	809
Transform-Loop Node	813
Quadmap Node	816
Quake Node	819

Apply Image Transformation Node

The Apply Image Transformation effect is mainly used when you want to pan an object out of the camera frame and that object has an effect such as a Glow or a Blur on it. When you use a peg or the Apply Peg Transformation node to translate an object such as the sun out of the camera frame, as soon as the sun starts to go outside of the camera frame, the sun's circle is cropped and the blur is applied on the shape left over. This also means that when the sun is completely out of the frame, the Blur is not calculated anymore and the Blur pops out.

To prevent this from happening, you must use the Apply Image Transformation node to pan the sun out.

The Apply Image Transformation node applies the panning transformation once the full drawing of the sun is blurred, once the image is composited. Here is an example of this network:

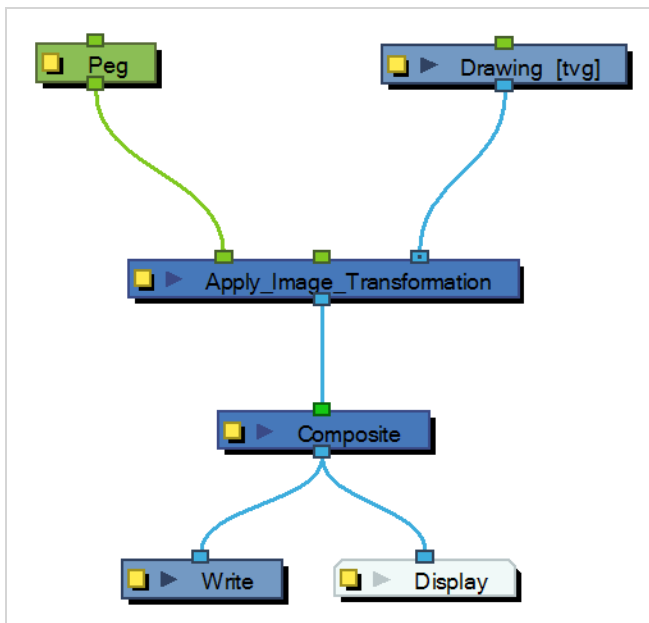

Here is how to connect the Blur effect for a sun panning out:

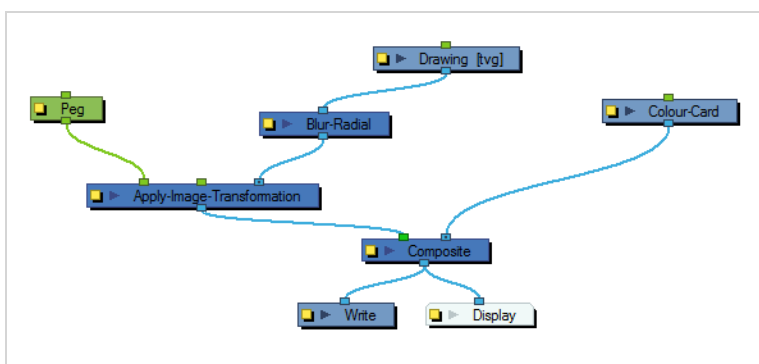

Here is the visual result of the blurred sun:

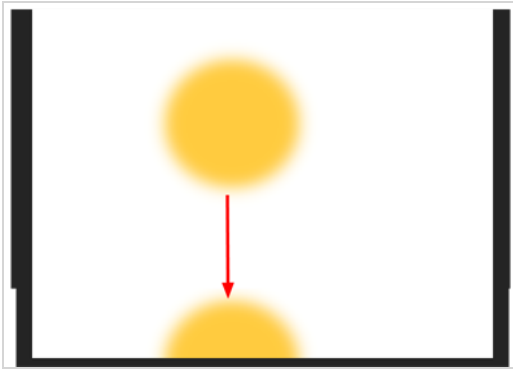

Look at the following example to understand better why using the Apply Image Transformation instead of a regular peg or the Apply Peg Transformation node.

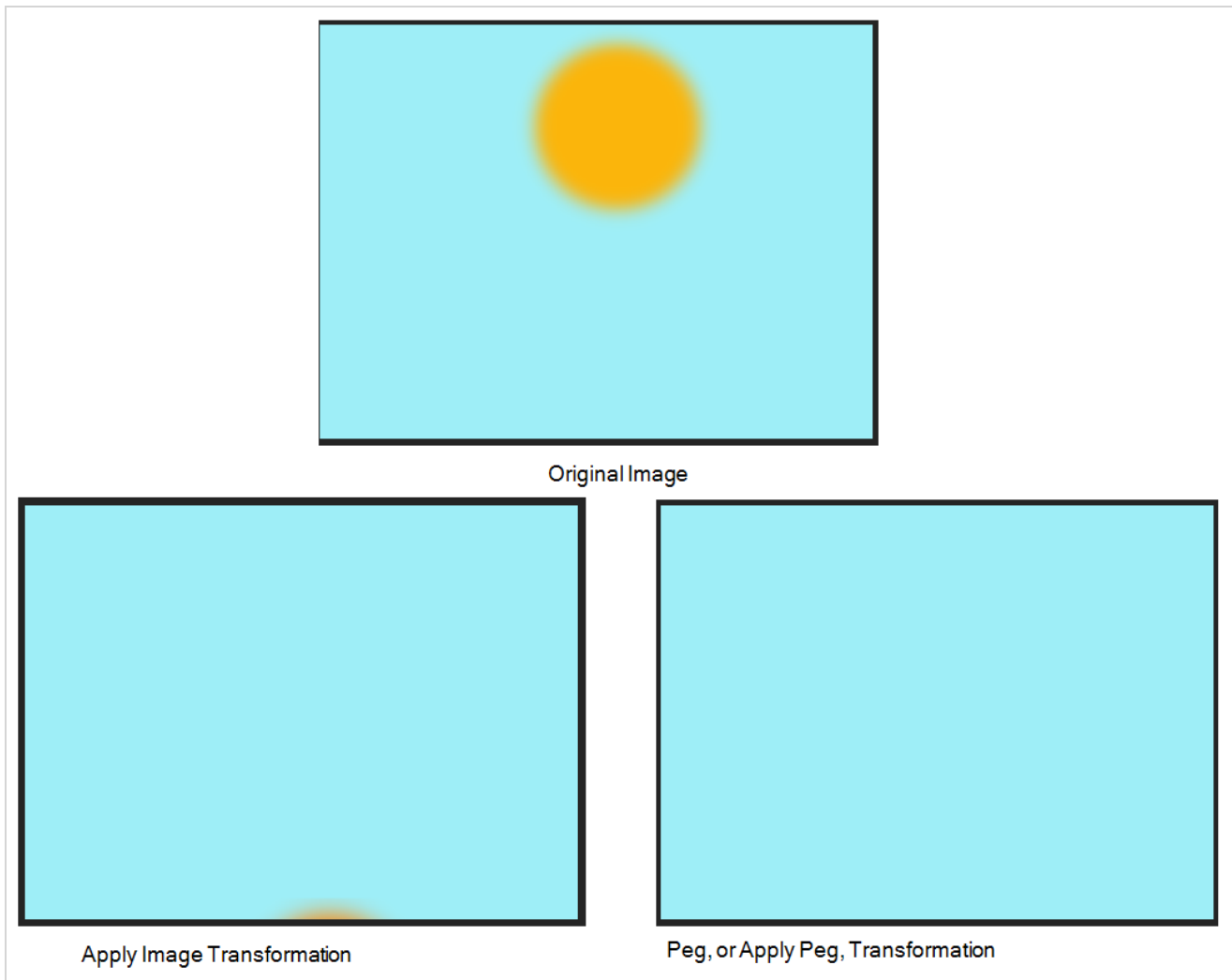

The normal rendering behaviour is to crop the image before applying the effects. When planning a sunset using either a Peg or the Apply Peg Transformation node, as soon as the drawing of the sun is out of the camera frame, the drawing is cropped and there is no image left to blur. This means that the glowing edge pops out of the camera instead of panning out gradually. Using the Apply Image Transformation node, the image is blurred before being panned out, so this means that even once the drawing is out of the camera frame,

its glowing edge will still show until the drawing is far enough from the camera border. This way, there is no pop when panning out blurred objects.

Use the Apply Image Transformation editor to change the name of the node.

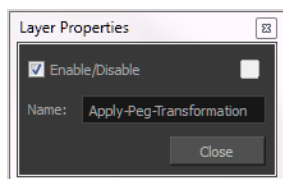

Apply Peg Transformation Node

Use the Apply Peg Transformation node to apply a transformation coming from a Peg, Ortholock, or Quadmap node on a single node or a group of nodes. When using the drawing layer's No Clipping option, you can use this node to apply all Camera and Peg transformations once all of the effects and nodes connected above the drawing node are calculated.



You can use this effect node to create a simple highlight on a cut-out puppet or use the No Clipping option available in the drawing layer.

The No Clipping option, found under the drawing Layer Properties' Advanced tab is used when you do not want to crop your images before all effects are applied to your drawing. No camera motion or peg transformation will be applied to your drawing until you connect an Apply Peg Transformation.

The advantage of this node is that you can create a second output of your image or puppet and offset it, scale it or apply any kind of transformation on it.

The transformations set in the Peg, Ortholock, or Quadmap node connected to the Apply Peg Transformation node are applied **BEFORE** the image is composited.

Here is an example of how to connect the Apply Peg Transformation node:

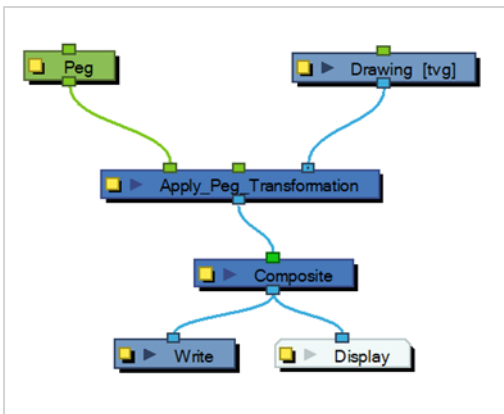

The transformation set in the Peg node from the example above is applied before the image is composited, which is the equivalent of the following network:

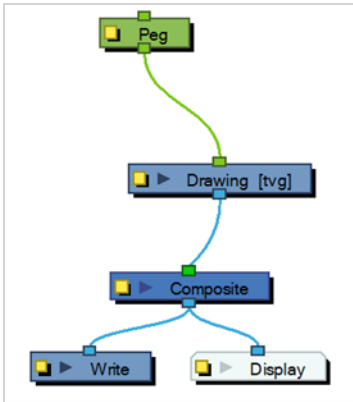

In the following images you can see the result of the transformation without the Apply Peg Transformation node and with it:

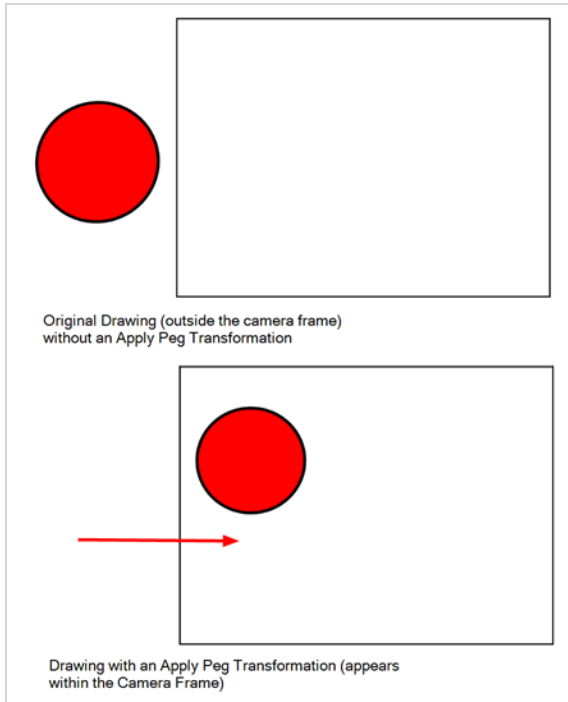

Using the Apply Peg Transformation you can apply transformation on drawings that are outside the camera frame and make them appear inside the frame.

If you are using the Apply Image Transformation node to create a drop-down shadow for a character, it will work correctly so long as the character is not going outside of the camera frame or that the drawing connected in it is a **VECTOR** drawing. The reason is the Apply Image Transformation node applies the transformation once the drawing is rendered, moved by its own set of Pegs, motion paths and quadmap and cropped to the camera frame size. This crop operation does not occur if the drawing is a vector drawing (*.TVG). Although, as soon as the drawing is passed through an effect node or a bitmap type Composite node, the drawing is turned into a bitmap image and gets cropped.

So, if you offset a bitmap half inside and half outside the camera frame, the outside part is cropped out and then moved by the Apply Image Transformation node. A part of the original drawing is cut. You need to use the Apply Peg Transformation node for the transformation to be applied before the image is processed and cropped.

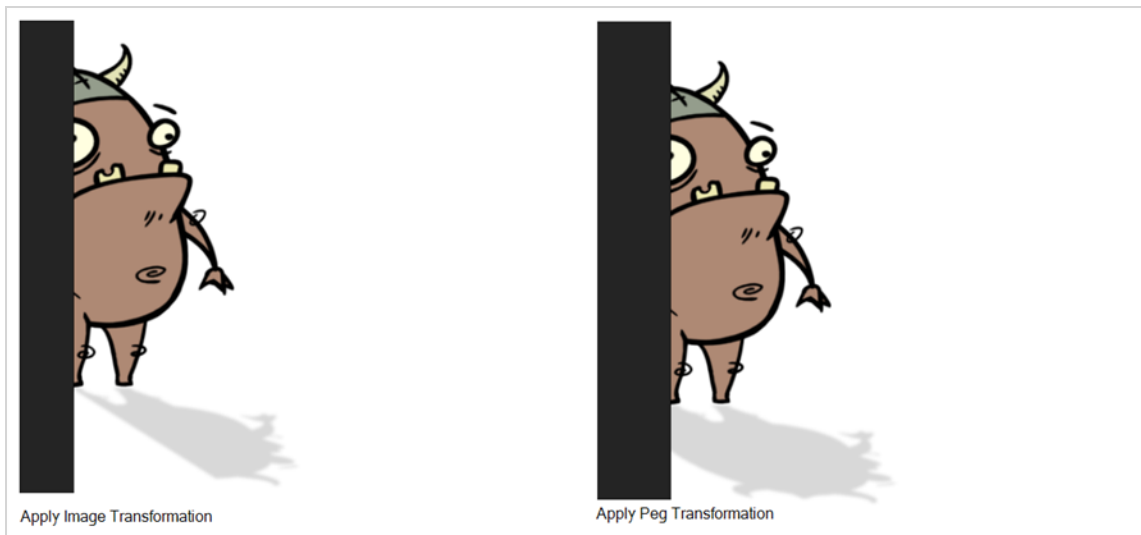
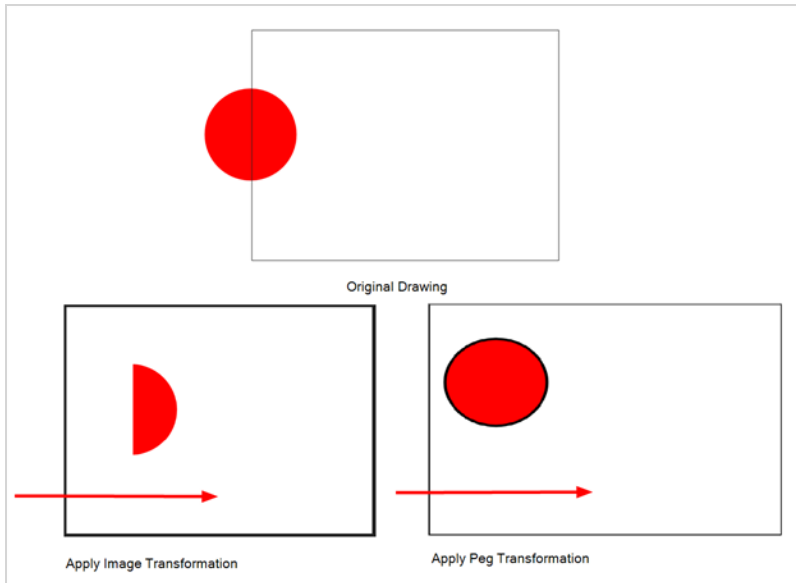

Advanced Apply Peg Transformation

You can use the Apply Peg Transformation's middle port to apply the transformation you connected to the node after one of the Peg or Quadmap connected above the drawing node.

In the following example, two pegs were added to control the different motions on independent trajectories:

- Peg-Translation
- Peg-Scale

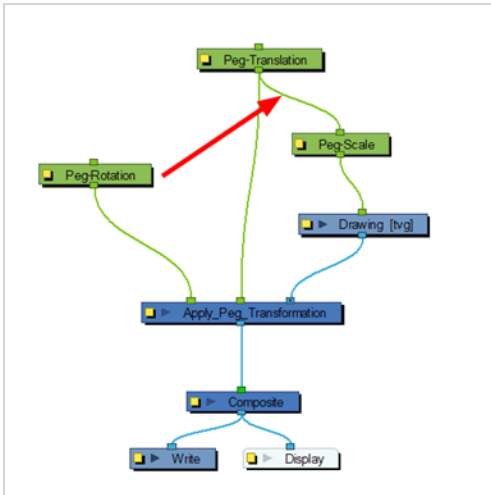

When there is no Apply Peg Transformation node, the Peg-Translation is the first trajectory to affect the drawing node. Then, once the translation is applied, the Scale trajectory affects the drawing node.

When using an Apply Peg Transformation node without using the middle port, the Peg-Rotation connected in the APT node is applied at the top of everything. The order in which the trajectories are applied to the drawing node is:

1. Peg-Rotation
2. Peg-Translation
3. Peg-Scale

When the Peg-Translation is connected in the Apply Peg Transformation's middle port, the Peg-Rotation is applied after the Peg-Translation and before the Peg-Scale. This means that the translation is done before the rotation instead of the rotation before the translation.

The order in which the trajectories are applied to the drawing node is:

1. Peg-Translation
2. Peg-Rotation
3. Peg-Scale

Use the Apply Peg Transformation editor to rename the node.

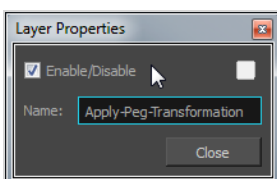

Camera Node

You can setup the camera position by entering coordinates and values in the Layer Properties view.

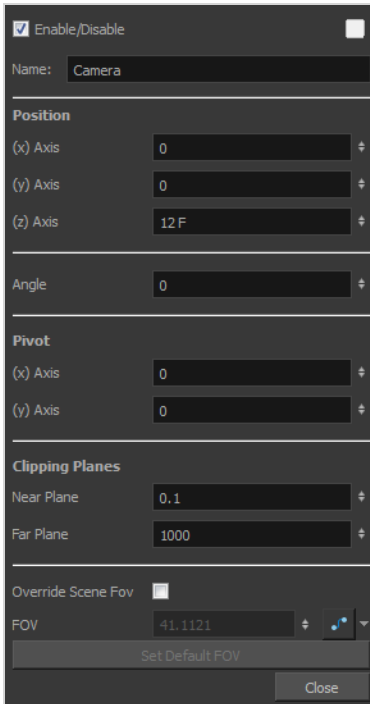

Parameter	Description
Enable/Disable	Turns the camera layer on or off.
Change Track Colour	The Change Track Colour button lets you change the colour of the exposed frames; this helps you to quickly locate a layer in the Timeline view. Click the Change Track Colour button to open the Select Colour window and choose a new colour. You can modify the colour for any type of layer, such as group, peg, drawing, and effects.
Name	Displays the current layer name. You can rename the layer by typing in a new layer name.
Position	Displays the current position of the camera layer using X-axis (East/West), Y-axis (North/South) and Z-axis (Forward/Backward) coordinates. To reposition your camera frame, type in the new values corresponding to the desired position coordinates. You can also use the up and down arrows to set the value of each field.
Angle	Displays the current rotation value. To set a new rotation position, type in a new angle value. You can also use the up and down arrows to set the new angle value.

Pivot	Displays the current position of the rotation pivot of the camera layer. The camera will perform a rotation taking the position of the pivot as its angle centre. By default, the pivot is set at the centre of the camera frame. To reposition the pivot point, enter new X and Y coordinates values in the appropriate field. To see the pivot's position, the Rotate tool must be selected.
Clipping Planes	You can change the near and far clipping planes of the camera. The near plane is the point on the camera cone where the camera is located. The far clipping plane is the far end of the camera cone. Nothing outside that range is visible. This is useful when dealing with 3D elements and 3D sets. For example, the camera can be looking inside a 3D box or room and you might want the foreground wall to not obstruct the view of the interior. By default, the near clipping plane is set to 1 field and the far clipping plane is set to 1000 fields.
Override Scene FOV	Enable the FOV field in which you can type in a new field-of-view value.
FOV	Displays the current field-of-view default value. When enabled, you can type in a new zoom value for your camera frame. You can also use the up and down arrows to set the new zoom value. Click on the Create Function button to animate the camera zoom value.
Set Default FOV	Resets the custom zoom value to its default value.

OrthoLock Node

When you create a 3D camera move in your scene, notice that layers are treated as flat objects. That is, animation layers that are supposed to face the camera at all times will look like a flat sheet of rotating paper.



Use the Ortholock layer when mixing flat animation layers with a set built in 3D. Ortholock forces your drawing layer to always follow the Camera angle. It does not follow its position or zooming level, only the rotation. This prevents drawings from being distorted by the camera motion.

Connection

The OrthoLock node can be connected as a parent of the drawing or drawings which you want to face the camera.

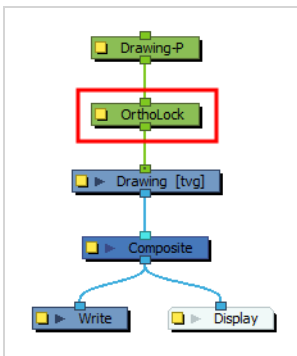

Layer Properties

Parameter	Description
Enable/Disable	Allows you to enable or disable the node. When disabled, a node has no visible effect on the rendered image, nor on the preview in the Camera, Perspective, Side and Top views.
Colour Swatch	Sets the colour of the layer in the Timeline view and of the node in the Node view.
Name	The name of the node as it appears in the Node View and the Timeline view. Each

Parameter	Description
	node must have a name that is unique to its containing group.
Rotation Axis	<p>The axes on which to rotate the input image to keep facing the camera.</p> <ul style="list-style-type: none"> • X and Y Axes: The drawing will be rotated on the x and y axes to keep facing the camera regardless of its position in the 3D space. • X Axis Only: The drawing will be rotated on the x-axis when the camera is rotated in the x-axis. The drawing will keep facing the camera if it moves to a low or high angle view, but not if it moves around it while staying on the ground. • Y Axis Only: The drawing will be rotated on the y-axis when the camera is rotated on the y-axis. The drawing will keep facing the camera if it moves around it while staying on the ground, but not if it moves to a low or high angle view.
Max Angle	<p>The maximum angle at which the drawings can appear to be relative to the camera angle, on both the x and y axes, in either direction.</p> <p>For example, at the default setting, 0, the input image will always be facing the camera. If however you set this parameter to 30°, you can rotate the camera around the drawing up to 30° in either direction and the drawing will appear in perspective, but past 30°, the drawing will appear to rotate to keep its angle relative to the camera.</p>

Peg Node

Find below a description of all the Peg node parameters.

Transformation Tab

Parameter	Description
Enable 3D	Displays additional parameters for working with 3D objects.
Position	<p>3D Path: Use a 3D path to position the element. A 3D path uses a single function to define the position on the X, Y and Z axes. This function is made of control points linked by a curvilinear path, making the movement follow a natural curve. The pace and ease of the movement is determined by a single velocity function.</p> <p>Separate: Positions the element using separate functions for the X, Y and Z axes. This allows to control the direction and pace of the movement across all three axes separately. Unless ease is applied to the axes, the trajectory of the element will follow straight lines going between each keyframe.</p> <p>Path: If the 3D Path option is selected, this field allows you to create or select the 3D Path function used to position the element.</p> <p>Path (x) Axis: The position of the element on the East-West axis, in fields.</p> <p>Path (y) Axis: The position of the element on the South-North axis, in fields.</p> <p>Path (z) Axis: The position of the element in the Back-Front axis, in fields.</p> <p>Velocity: If the 3D Path option is selected, this function is used to control the pace at which the element moves towards each control point in the 3D Path function, on all three axes simultaneously.</p>
Scale	<p>Locked: Uses a single scale parameter to scale the element, preserving its proportions.</p> <p>Separate: Uses a separate parameter to scale the element on the X and Y axis, as well as on the Z axis if the element is 3D-enabled, allowing to stretch or squash the element.</p> <p>(x) Axis: The horizontal scale factor. The default value is 1.</p> <p>(y) Axis: The vertical scale factor. The default value is 1.</p> <p>(z) Axis: The depth scale factor for 3D-enabled elements. The default value is 1.</p> <p>Scale in Fields: With this option enabled, the scale factor is based on the amount of fields in the scene. For example, to shrink one of the dimensions of an element to half its original size, the scale factor would normally be set to 0.5. If this option is enabled and the amount of fields in the scene is 12, then the scale factor to shrink the element by half would be 6.</p>

	<p>Ignore Parent Scaling: When this option is enabled, any scaling value applied to a parent layer is ignored in the current layer. This can be handy in cut-out rigs when you need to scale an arm without affecting the forearm.</p>
Rotation	<p>Angle z: Lets you type in a degree value for the rotation angle. Note that you can enter values greater than 360 and -360 degrees. If you enter 720, the object will rotate twice.</p>
Skew	<p>Skew: Lets you type in a degree value between -90 to 90 for the skew angle.</p>
Pivot	<p>(x) Axis: The horizontal position of the pivot point of the element relative to the pivot point of the drawing, in fields.</p> <p>(y) Axis: The vertical position of the pivot point of the element relative to the pivot point of the drawing, in fields.</p>

Shake Node

T-H16NEW-004-001

The Shake node allows you to generate a fully animated, fully customizable shake animation, which can be used to create camera shakes or to make an element in your scene shake.

The Shake node is a more advanced version of the Quake node. Among many enhancements, you can make each shaking motion interpolate over several frames by reducing its Frequency parameter, and you can make each movement hold for 2 or more frames, if needed, by increasing its Step parameter. Additionally, you can configure each big shaking motion to have several smaller shaking motion across it, to make a more erratic looking shaking movement.

Connection

Just like a peg, you can connect the Shake node as a parent of the element you want it to move. Hence, if you want to shake an element in your scene, connect the Shake node as a parent of that element.

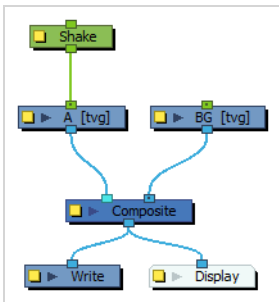

To create a Camera shake, connect the Shake node as a parent of the scene's Camera node.

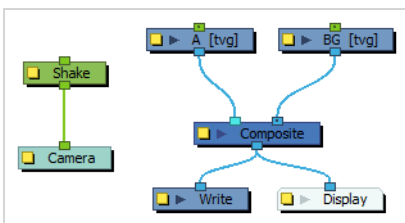

Like pegs, Shake nodes can be connected in chain, either with other Shake nodes or with other Move-type nodes, such as Peg nodes.

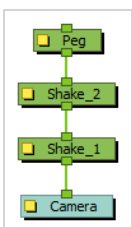

Layer Properties

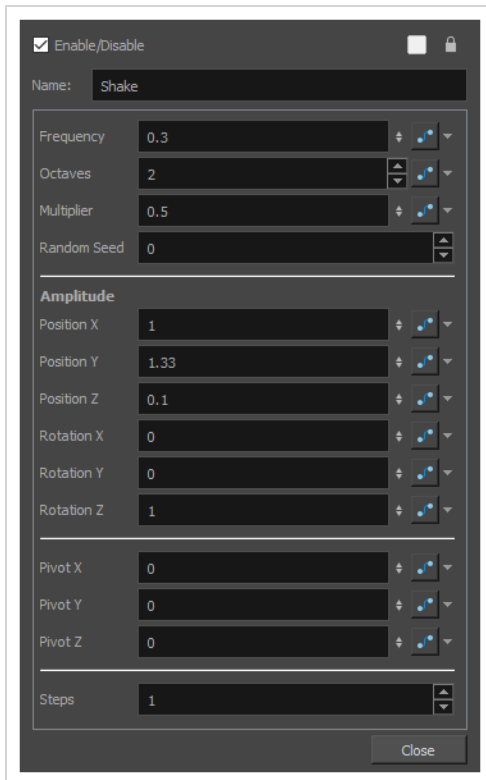

Parameter	Description
Name	Allows you to change the name given to the node.
Frequency	<p>The speed of the big vibrations. This field takes a decimal value between 0 and 1. At 1, each vibration only takes a single frame. At 0.5, each vibration takes 2 frames, etc.</p> <p>When set to 0, the Shake node produces no vibration. You can animate this parameter to control when the Shake node has an effect and when it doesn't, as well as to increase or decrease the speed of the shake.</p>
Octaves	With the Octave parameter, you can add smaller vibrations to the big vibrations, making for a more erratic, forceful shake. This parameters takes an integer, which determines the amount of smaller vibrations to add to each big vibration.

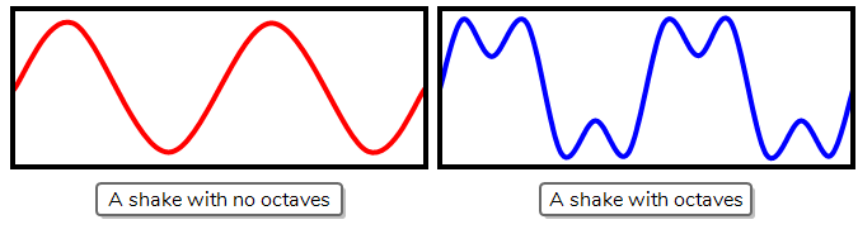
Parameter	Description
	
Multiplier	<p>The strength of the smaller vibrations, relative to the big vibrations. This is set to 0.5 by default, which means smaller vibrations will have, at most, half the amplitude of big vibrations.</p>
Random Seed	<p>This parameter determines the pattern of random motions it uses to simulate shaking. There is no wrong value for this parameter. Entering any value will simply make it uses a different random pattern.</p> <p>If you have two or more Shake nodes in your scene and they have the same Random Seed value, their shaking will be similar, if not exactly the same, as it will be based on the same pattern of random motions. Hence, you might need to assign different Random Seed values to all of your Shake nodes to make sure their motion pattern feel different.</p> <p>You should also assign a different Random Seed value to each Shake node if they make a shaking motion that goes on throughout several scenes so that it doesn't look like the motion pattern is repeating itself.</p> <p>You can also change the value of this parameter just to make the Shake node use a different shake pattern, and see if you can find a pattern that fits your expectations better.</p>
Amplitude	
Position X	The maximum distance, in fields, to shake left or right.
Position Y	The maximum distance, in fields, to shake up or down.
Position Z	The maximum distance, in fields, to shake closer to or further from the camera.
Rotation X	The maximum angle, in degrees, to shake around the horizontal axis.
Rotation Y	The maximum angle, in degrees, to shake around the vertical axis.

Parameter	Description
Rotation Z	The maximum angle, in degrees, to shake clockwise or counterclockwise.
Pivot	
Pivot X	The horizontal offset of the pivot point, in fields, relative to its default horizontal position.
Pivot Y	The vertical offset of the pivot point, in fields, relative to its default vertical position.
Pivot Z	<p>The offset of the pivot point on the z-axis, in fields, relative to its default position on the z-axis.</p> <div style="border: 1px solid green; padding: 10px; margin-top: 10px;"> <p> NOTES</p> <ul style="list-style-type: none"> • The position of the pivot is used for rotations in the shaking motions. • The pivot of the Shake node is positioned in the centre by default. However, if an element connected under it has the Use Embedded Pivots property set to Apply Embedded Pivot on Parent Peg, the default pivot position of the Shake node will be the same as the pivot of that element. </div>
Steps	
Steps	The amount of frames to hold each movement. By default, this is set to 1, which means the Shake node will move each frame. You can set this to 2 or 3 if you animate on twos or threes, so that the motions of the Shake node match the pace of your animation.

Transform-Loop Node

The Transform-Loop node allows you to automatically loop a transformation applied by a peg onto its element, so that you do not have to copy and paste this animation over and over again throughout your scene. This is especially useful if you need to repeat the pan animation of a looping background.

The Transform-Loop node will take the animation that is fed to it by its parent node, for a given frame range, and repeat this animation onto its child node throughout the entire scene. It can automatically detect the range of frames to repeat, or you can manually set this range. It can loop the animation in three ways:

- **Repeat** will simply repeat the animation as is, going from the start all the way to the end, and instantly playing it again from the start.

When the Transform-Loop node repeats the animation, it skips the first frame of the animation. This is useful when using looping backgrounds. Typically, with a looping background, the first frame of the looping animation looks exactly like the last frame of the looping animation. Hence, skipping the first frame avoids having two frames that look exactly the same when the animation loops, making a smooth infinite loop.

- **Ping-Pong** plays the animation, then plays it again backward, then forward again, etc.
- **Repeat and Offset** repeats the transformation, but also accumulates the effect of the transformation. Hence, if the animation is, for example, of a ball bouncing once towards the right, then the Transform-Loop node will make it bounce further and further towards the right until it exits the camera field.

Connection

The Transform-Loop node repeats the transformations that are sent to it from its top (input) port, and outputs the looped transformation through its bottom (output) port.

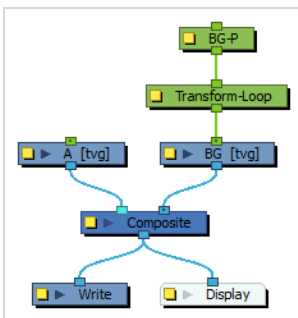

The Transform-Loop node repeats the transformations from all the nodes connected directly or indirectly to its top (input) port, not just the one connected right above it.

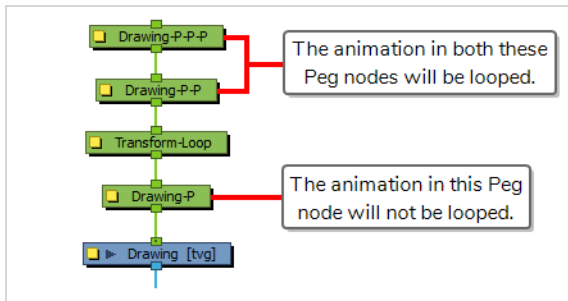

Layer Properties

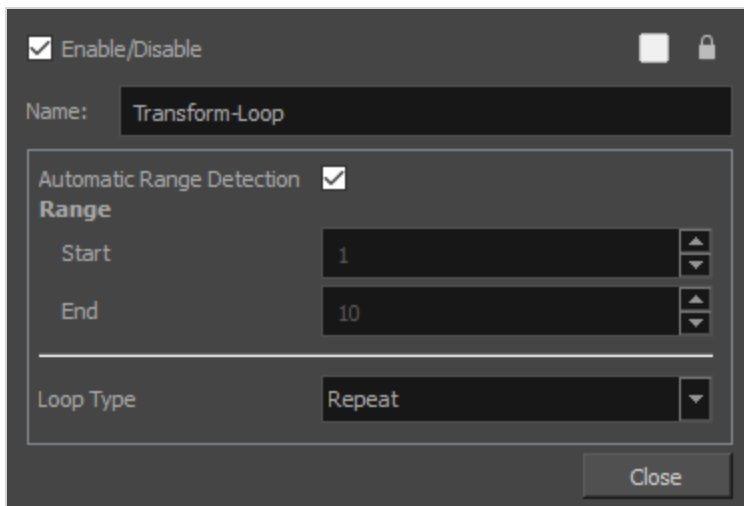

Parameter	Description
Name	Allows you to change the name given to the node.
Automatic Range Detection	<p>Automatically sets the range of the animation to loop based on the animation in its parent peg. It will start the range at the first keyframe in the parent peg, and end it at the last keyframe in the parent peg.</p> <div style="border: 1px solid green; padding: 10px; margin-top: 10px;"> <p> NOTE</p> <p>If there are several peg nodes connected in a chain to the top port of the Transform-Loop node, it will loop the animation of all these Peg nodes combined. However, it will only use the keyframes in the node right above it to determine the range of animation to loop. In this case, you have to disable Automatic Range Detection and set the range manually to make sure the Transform-Loop node repeats all of the animation you want it to repeat.</p> </div>
Range	The range of animation frames to loop.

Parameter	Description
	<ul style="list-style-type: none">• Start: The number of the first frame of the animation that the Transform-Loop node should loop.• End: The number of the last frame of the animation that the Transform-Loop node should loop.
Loop Type	<p>The way the Transform-Loop node should loop the animation:</p> <ul style="list-style-type: none">• Repeat will simply repeat the animation as is, going from the start all the way to the end, and instantly playing it again from the start. <p>When the Transform-Loop node repeats the animation, it skips the first frame of the animation. This is useful when using looping backgrounds. Typically, with a looping background, the first frame of the looping animation looks exactly like the last frame of the looping animation. Hence, skipping the first frame avoids having two frames that look exactly the same when the animation loops, making a smooth infinite loop.</p> <ul style="list-style-type: none">• Ping-Pong plays the animation, then plays it again backward, then forward again, etc.• Repeat and Offset repeats the transformation, but also accumulates the effect of the transformation. Hence, if the animation is, for example, of a ball bouncing once towards the right, then the Transform-Loop node will make it bounce further and further towards the right until it exits the camera field.

Quadmap Node

T-COMP2-010-001

The Quadmap transformation layer lets you deform the shape of an element. For example, you can use it to create a drop-shadow effect on an element.



You can edit the Quadmap visually in the Camera view.

How to edit the Quadmap in the Camera view

1. In the Timeline view, click the Add Layer **+** button and select **Quadmap**.
2. Connect the drawing you want to deform to the Quadmap.
 - In the Node view, add a Quadmap node and connect to the drawing element node that you want the effect to act on.

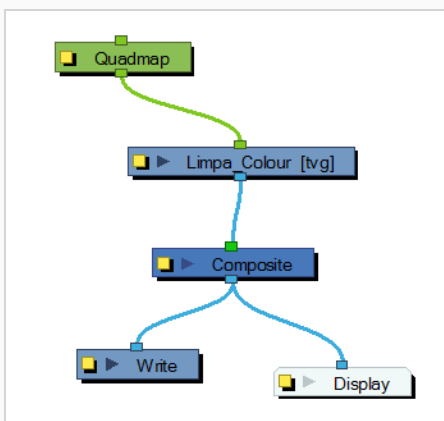
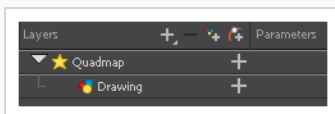

3. In the Tools toolbar, disable the Animate mode to change the value for the Quadmap over the entire duration of the element.
4. In the Timeline view, click on the Quadmap layer to select it.

- From the top menu, select **View > Show > Control** or press Shift + F11.

The quadmap handles appear around the element in the window. There is also a pivot point at the centre of the quadmap frame that you can reposition.

- In the Camera view window, use the Transform tool to move the points on the quadmap. Shift + click to select multiple points.

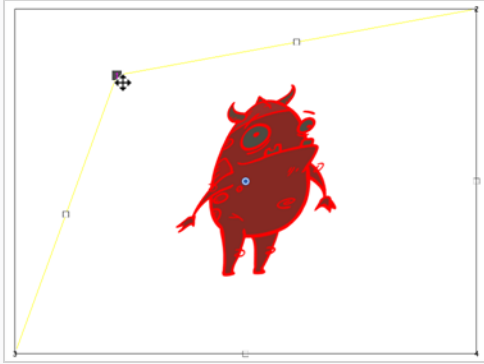

TIP

The position of the points can be animated. To do this, open the Quadmap node layer properties and create functions for each of the coordinates.

Properties

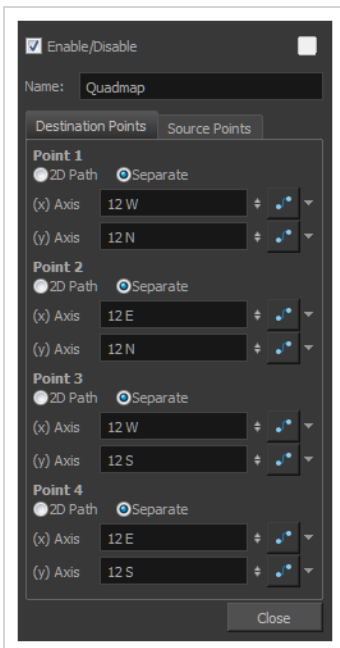

Parameter	Description
-----------	-------------

Name	Allows you to change the name given to the node.
2D Path	Changes the X and Y values simultaneously and control the velocity of the change.
Separate	Changes the X and Y values separately. Each one can be attached to separate function curves.

Quake Node

The Quake node allows you to create a very common camera move, the camera shake. Using the Quake node, you can generate an automated quake instead of manually entering random keyframes. This way, you can simulate the shock of something heavy falling on the ground, like an earthquake or a strong vibration.

How to use the Quake node to create a camera shake

1. From the Node Library view, drag a **Quake** node to the Node view.
2. If you do not have a Camera node already, drag one from the Node Library view to the Node view.
3. Connect the Quake node to the Camera node.

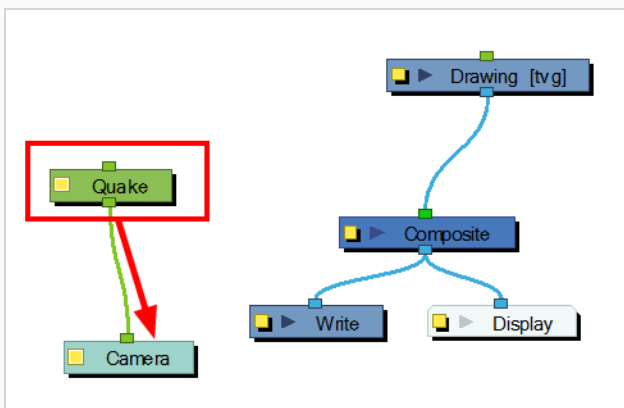

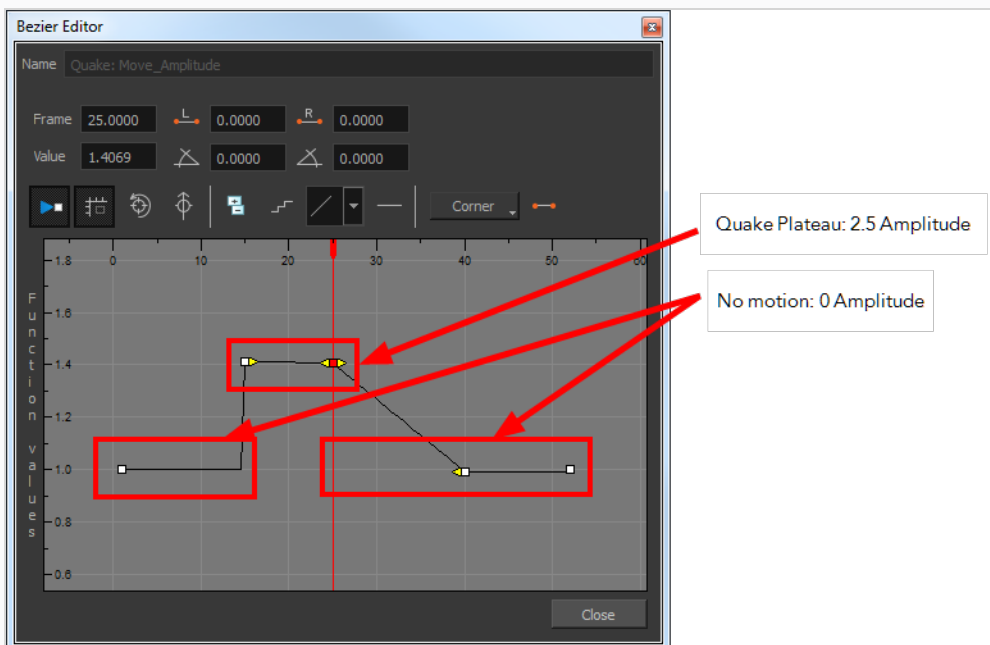

4. Click on the Quake node's yellow square properties button to open the Quake properties.
5. In the Quake properties window, adjust the properties.

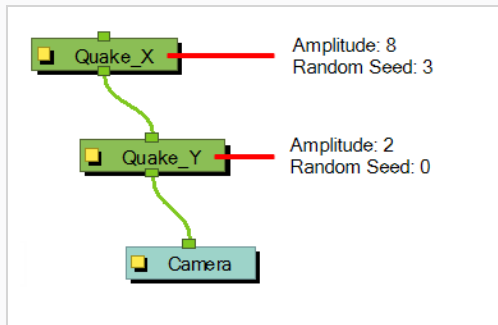

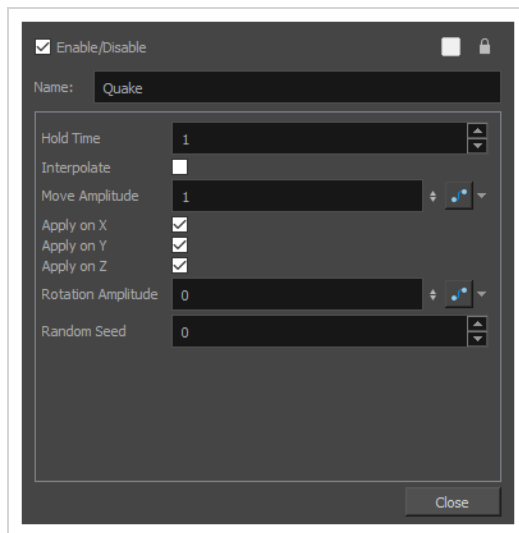

Layer Properties



Parameter	Description
Name	Allows you to change the name given to the node.
Hold Time	Allows you to enter the number of frames you want one of the quake vibrations (position) to hold for. Most camera shakes are done in a single frame (1) or double frame (2).
Interpolate	An interpolation is generated between the random values. Instead of jumping to the next position, it will slowly progress forwards to the next position. It is the same principle as stop-motion keyframes and motion keyframes.
Move Amplitude	This is the strength of the quake. The higher the value, the stronger the quake. If the value is set to 0, there will be no motion. To have the motion start and stop at a specific frame during the scene, you can create a function curve and animate the amplitude over time. Simply click the Function  button to generate the

	function, then click on it again to open the Function editor.
Apply on X, Y, Z	Applies the quake to the X, Y and Z-axis.
Rotation Amplitude	When the value is higher than 0, a rotating quake is applied. The higher the value, the stronger the quake.
Random Seed	<p>This parameter determines the pattern of random motions it uses to simulate shaking. There is no wrong value for this parameter. Entering any value will simply make it uses a different random pattern.</p> <p>If you have two or more Quake nodes in your scene and they have the same Random Seed value, their shaking will be similar, if not exactly the same, as it will be based on the same pattern of random motions. Hence, you might need to assign different Random Seed values to all of your Quake nodes to make sure their motion pattern feel different.</p> <p>You should also assign a different Random Seed value to each Quake node if they make a shaking motion that goes on throughout several scenes so that it doesn't look like the motion pattern is repeating itself.</p> <p>You can also change the value of this parameter just to make the Quake node use a different shake pattern, and see if you can find a pattern that fits your expectations better.</p>

Output Nodes

The nodes found in the Output category are used to control the image outputted in the various views as well as during the rendering process.

Crop Node	823
Display Node	826
Multi-Layer Write Node	827
Scale Output Node	831
Write Node	833

Crop Node

To output two files with different aspect ratios, such as 16:9 and 4:3, you can use the Crop node. This node is used to crop the final image in order to discard excess information without distorting the render.

If you want to export your scene in a resolution that is smaller than your scene's resolution and which does not have the same aspect ratio, you should use a Scale-Output node to shrink the output, but preserve the scene's proportions, then a Crop node to adjust the output to fit the desired aspect ratio.

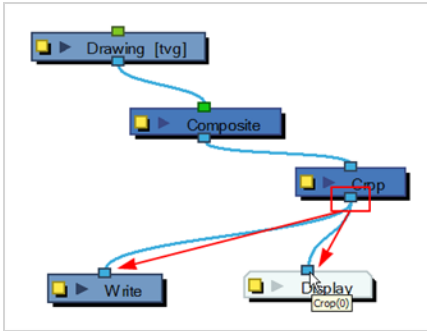

Find below the Crop node properties.

Cropping Tab

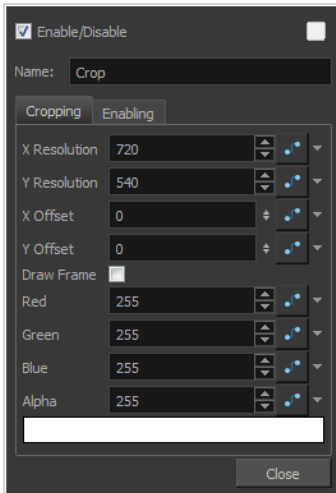

Parameter	Description
X Resolution	This is the X (width) value in pixel of the resolution to crop the final image to.
Y Resolution	This is the Y (height) value in pixel of the resolution to crop the final image to.
X Offset	This is the X (horizontal) offset value in pixel to move the crop box to in the final image.

Y Offset	This is the Y (vertical) offset value in pixel to move the crop box to in the final image.
Draw Frame	Enable the Draw Frame option if, instead of cropping the images, you prefer to have Harmony draw a frame over the rendered scene.
Red, Green, Blue, Alpha	These are the RGBA values used for the frame colour if you enabled the Draw Frame option.
Colour Swatch	Displays the selected colour for the frame to draw. You can click on the Colour Swatch to open the Colour Picker dialog and select a colour for the frame.

Enabling Tab

Using the options in the Enabling tab, you can set up some Crop nodes to only be enabled if the scene is rendered at a specific resolution. This is mostly useful on Harmony Server, as Harmony Server allows you select the resolution at which to render a scene when sending a scene for rendering by the Harmony database's render farm.

This can be useful if you want your scene to render differently depending on the resolution in which you render it. For example, you could have a storyboard thumbnail in a small corner of your scene, and a crop node that connects between your scene's main Composite node and your Write node. Then, by setting up this Crop node to only be enabled when the scene is rendered at the storyboard thumbnail's resolution, you can decide whether your scene will render its animation or its storyboard by deciding whether to render at the scene's resolution or the storyboard thumbnail's resolution.

This option allows you to filter with either resolution presets, or by specifying the width and height of the chosen resolution in pixels. You can hence create custom resolution presets named after the Crop node's purpose, to make it easier to choose the resolution when rendering a scene.

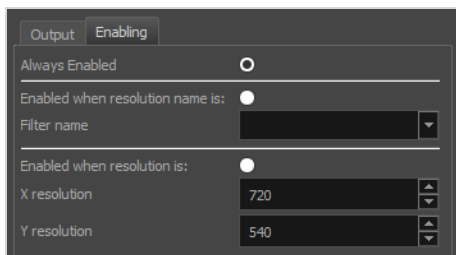

Parameter	Description
Always Enabled	Makes this Crop node render every time the scene is rendered. This is the default option.

Enabled when Resolution Name is	Makes this Crop node render only when the scene is rendered at the specified resolution preset.
Filter Name	Select the resolution preset at which to render the scene to activate this Crop node.
Enabled when Resolution is	Make this Crop node render only when the scene is rendered at the resolution with the specified width and height, in pixels.
X Resolution	The width (in pixels) of the resolution at which to render the scene to activate this Crop node.
Y Resolution	The height (in pixels) of the resolution at which to render the scene to activate this Crop node.

Display Node

The Display node is an important node; it is used by the export and views to display your scene, primarily the Camera and Timeline views. By default, a scene's node system always has a Display node which can be used to show your entire scene, a single node or a group of nodes through a Composite or Group node. You might use it to see one single character as you animate it, debug your node system as you create complex effects or export your complete scene or a portion of it.

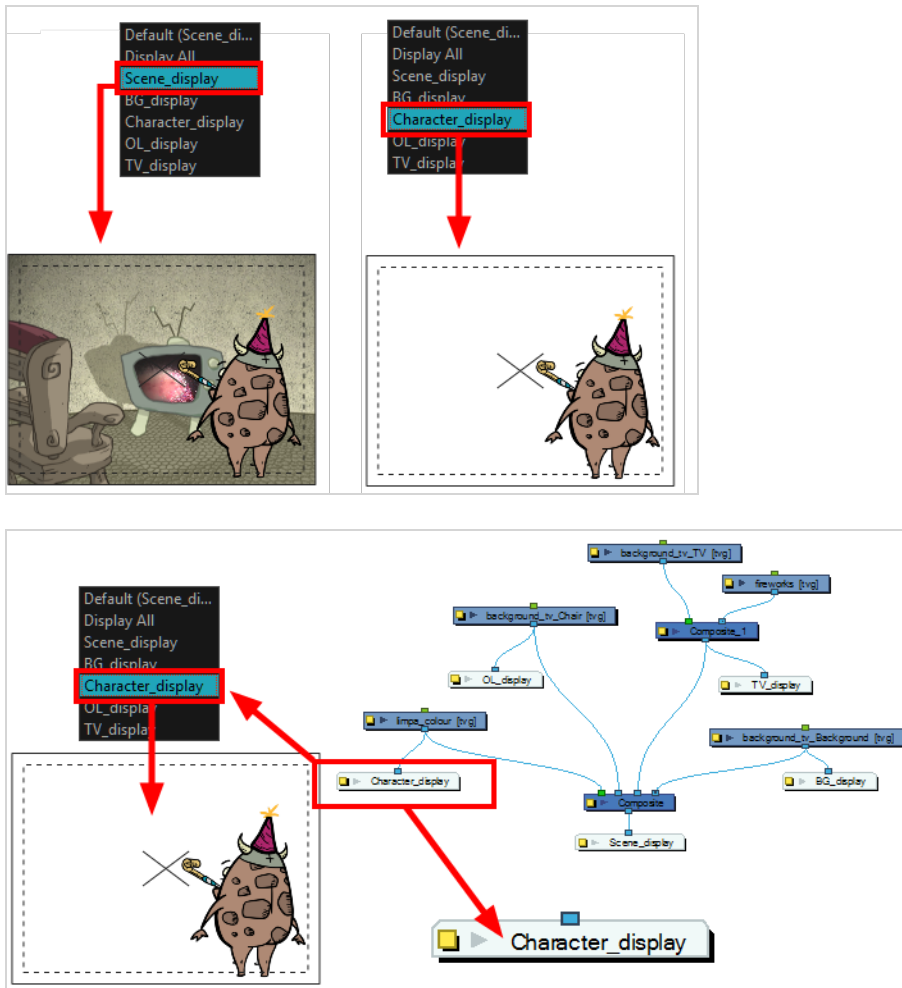

Multi-Layer Write Node

The Multi-Layer Write node allows you to export Photoshop Document (.psd) or OpenEXR (.exr) files with multiple layers inside them. It works just like a Write node, except that it takes several input images instead of just one, and each input image is used to generate one of the layers of the image files it outputs when rendering.



NOTE

To learn more about the Write node, see [Write Node on page 833](#).

Connection

Like the Write node, the Multi-Layer Write node only takes input images. Its output is stored in image files when your scene is rendered. However, contrary to the Write node, the Multi-Layer Write node takes several input images.

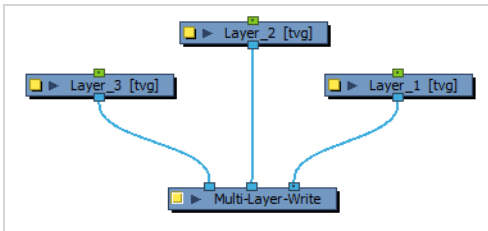

Each image connected to the Multi-Layer Write node will be used to make one of the layers of the image files the node creates. The image connected to the rightmost port will be the bottom layer, and the image connected to the leftmost port will be the top layer.

Layer Properties

Inputs Tab

The Inputs tab displays a list of the elements connected to the node's input ports. The input ports are listed from right to left. The layers listed in this list are ordered from the bottommost layer to the topmost layer. Hence, the layer appearing at the top of the list will be the bottom layer.

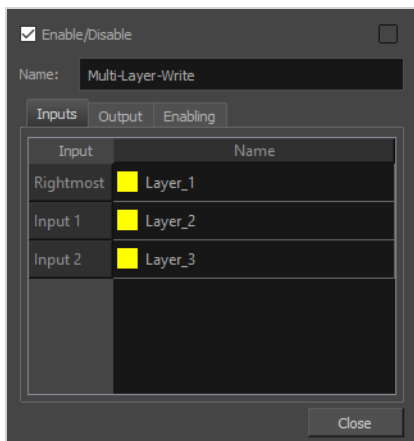

The layers will be named in the output file as they appear in the Name column. By default, each layer is named after their respective input node. If you prefer, you can customize the name of each layer. Simply double-click on a layer's name to be prompted to type a new name.

A coloured square appears to the left of each name to indicate whether the name is based on the node or is a custom name. If the square is **yellow**, the name is based on the node. If it is **green**, it is a custom name. Once a layer name has been customized, it will no longer automatically update based on the connected node's name.

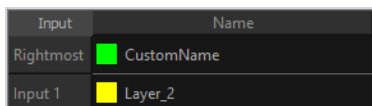

Output Tab

The output tab can be used to configure the path, file naming pattern and file type of images exported by the Multi-Layer Write node.

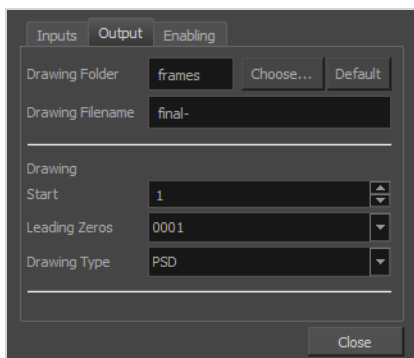

Parameter	Description
Drawing Folder	The path to the folder in which to save the rendered frames. This path can be absolute or relative to the scene's folder. For example, the default path for rendered frames is frames , which means the images are saved in the frames subfolder of the scene folder. If you want to select an absolute path, you can click

Parameter	Description
	on the Choose button at the right of the text field and select the folder in which your scenes should export their frames. You can also click on the Default button to set the export path to the default value.
Drawing Filename	The prefix for the file name of each exported frame. Frames will be named with this value, followed by the frame number and their image type extension. It is recommended to leave the hyphen (-) at the end of the prefix to separate the prefix from the frame number.
Drawing	
Start	Select the starting number for the image sequence.
Leading Zeros	Allows you to select the number of digits in the number used to identify each frame.
Drawing Type	Allows you to select the image type in which to export the frames. You can choose between the following file types: <ul style="list-style-type: none"> • PSD: A multi-layer Photoshop Document (.psd) file. • EXR: A multi-layer OpenEXR (.exr) file, compressed in ZIPS format, which compresses the image in blocks of 16 scanlines. • EXR_ZIP_1LINE: A multi-layer OpenEXR (.exr) file, compressed in ZIP1 format, which compresses the image in blocks of 1 scanline.

Enabling Tab

You can create several Write nodes for a single scene and, by default, when a scene is rendered, all of its Write nodes will perform their render. However, using the options in the Enabling tab, you can set up some Write nodes to only perform their render if the scene is rendered at a specific resolution. This is mostly useful on Harmony Server, as Harmony Server allows you select the resolution at which to render a scene when sending a scene for rendering by the Harmony database's render farm.

A good example of how this can be useful is if your scene has storyboard thumbnails in the corner, and a Write node connected to a composite that crops the picture to only include the storyboard thumbnail, so that your scene can export both the final animation and the animated storyboard when rendered. You can set up your scene's main Write node to only work when exporting the scene at the scene's original resolution, and the storyboard thumbnails Write node to only work when exporting at the desired resolution for an animated storyboard.

This option allows you to filter with either resolution presets, or by specifying the width and height of the chosen resolution in pixels. You can hence create custom resolution presets named after their Write node's purpose, to make it easier to choose the resolution when rendering a scene.

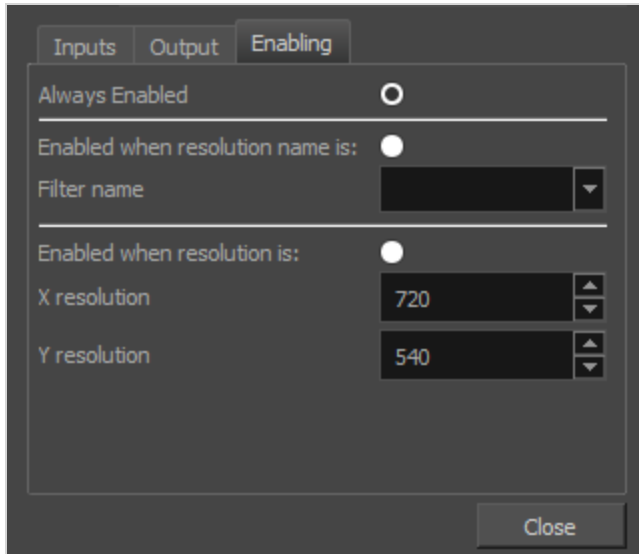

Parameter	Description
Always Enabled	Makes this Write node render every time the scene is rendered. This is the default option.
Enabled when Resolution Name is	Makes this Write node render only when the scene is rendered at the specified resolution preset.
Filter Name	Select the resolution preset at which to render the scene to activate this Write node.
Enabled when Resolution is	Make this Write node render only when the scene is rendered at the resolution with the specified width and height, in pixels.
X Resolution	The width (in pixels) of the resolution at which to render the scene to activate this Write node.
Y Resolution	The height (in pixels) of the resolution at which to render the scene to activate this Write node.

Scale Output Node

Once your Write nodes are connected, you need some Scale-Output nodes to change the resolution output of the Write node without changing the scene settings. For example, if you export in a high resolution and a low resolution, you need one Scale-Output node.



NOTE

If you use a Scale-Output node to scale up the image, it will look pixelated. If you want to export a scene in multiple resolutions, you should set your scene's resolution to be the highest resolution in which you want to render, and use Scale-Output nodes to scale down the output.

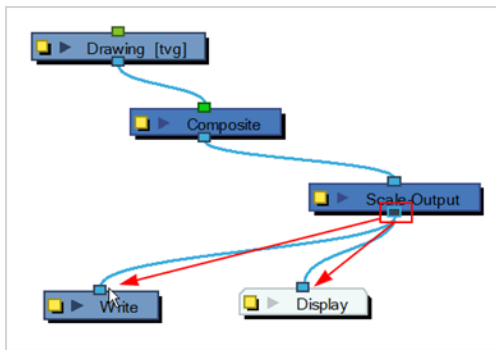

Find below the Scale-Output node properties.

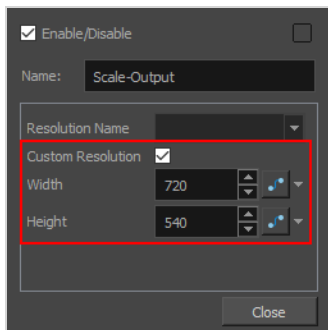

Parameter	Description
Resolution Name	Select one of the existing resolution preset from the list to indicate the resolution you want the final images to be scaled at. Always make sure the selected resolution is smaller than the scene setting one.
Custom Resolution	Enable this option to set a resolution that is not available in the Resolution preset list.
Width	X (horizontal) value in pixels of the resolution to scale the images down to.

Height	Y (vertical) value in pixels of the resolution to scale the images down to.
--------	---

Write Node

The Write node is the node that is used by Harmony to render a scene. When rendering a scene, Harmony renders the image information sent to the Write node, and outputs it using the parameters in the Write node's layer properties.

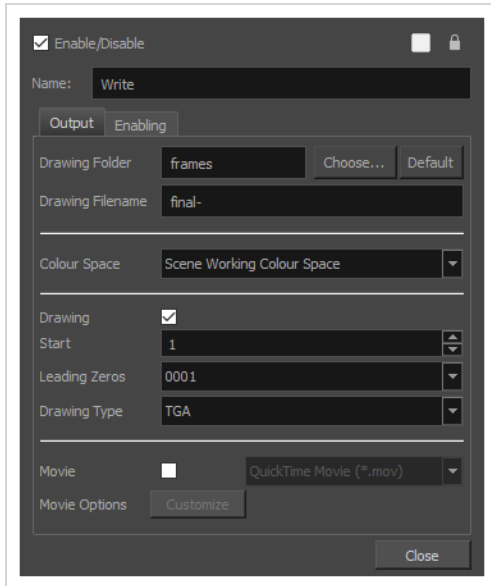

The Node view allows you to branch out and merge elements of your scene in specific ways. By default, a scene has a Write node connected to its main composite, meaning all of the scene's elements are rendered. However, a Write node can be connected to any node in your scene that outputs image information, even a drawing or an effect. A scene's renders are based on the image information that is sent to its Write node, and nothing else. Hence, you can control exactly what gets rendered, which is especially useful if you want to have elements in your scene that are only visible in the Camera view, such as a storyboard overlay or a camera guide, without having them appear in the renders.

You can also set up a scene to create multiple renders by connecting several Write nodes to it. Your Write nodes can be connected to different elements of your scene, which allows you to create separate renders for different parts of your Node view every time your scene is rendered. For example, a scene can have a Write node for rendering the scene without any annotations, so that render can be used in post production, and another one for rendering the scene with its storyboard and annotations for reviewing. A scene can also have multiple Write Nodes connected to the same composite, which can allow you to render the same image in multiple file formats or locations at the same time.

Each Write node can be configured to export individual frames as image files, a video file, or both simultaneously.

Layer Properties



Output Tab

The output tab can be used to configure whether the Write node creates individual frame images, a movie file, or both. Further more, you can configure the path, file naming pattern and file type of frames exported by the

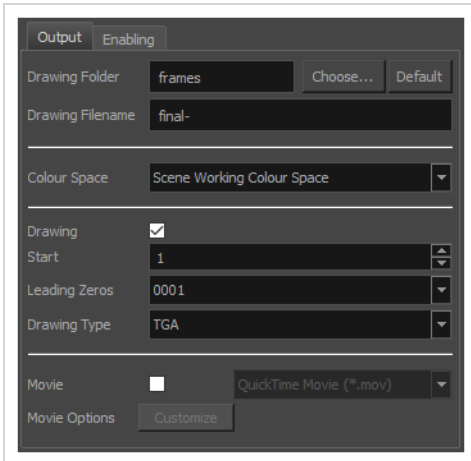

Write node, as well as the path, file name and encoding options of the movie file created by the Write node.



Parameter	Description
Drawing Folder	The path to the folder in which to save the rendered frames. This path can be absolute or relative to the scene's folder. For example, the default path for rendered frames is frames , which means the images are saved in the frames subfolder of the scene folder. If you want to select an absolute path, you can click on the Choose button at the right of the text field and select the folder in which your scenes should export their frames. You can also click on the Default button to set the export path to the default value.
Movie Folder	Only available when the Movie option is enabled. The folder in which to export the movie file. You can click Choose to the right of the text field to browse for the directory where you want the movie to be exported, or click Default to set the export path to the default value. You can also type a path relative to the scene's directory. For example, the default value is frames , which exports the movie to the scene's frames subdirectory.
Drawing Filename	The prefix for the file name of each exported frame. Frames will be named with this value, followed by the frame number and their image type extension. It is recommended to leave the hyphen (-) at the end of the prefix to separate the prefix from the frame number.
Movie Filename	Only available when the Movie option is enabled. The name of the movie file to export. Do not enter the file's extension.
Drawing	Select this option to create an image sequence.
Start	Select the starting number for the image sequence.

<p>Leading Zeros</p>	<p>Allows you to select the number of digits in the number used to identify each frame.</p>																						
<p>Drawing Type</p>	<p>The image format in which the exported frames will be saved. The following formats are supported:</p> <table border="1" data-bbox="561 407 1427 1898"> <thead> <tr> <th data-bbox="561 407 737 495">Format</th> <th data-bbox="737 407 922 495">Specification</th> <th data-bbox="922 407 1427 495">Description</th> </tr> </thead> <tbody> <tr> <td data-bbox="561 495 737 1089">TVG</td> <td data-bbox="737 495 922 1089"></td> <td data-bbox="922 495 1427 1089"> <p>Toon Boom Vector Graphic (*.tvg)</p> <p>Toon Boom's proprietary format for storing vector drawings. TVG images contain vector shape, colour and texture information.</p> <div data-bbox="951 701 1398 1062" style="border: 1px solid green; padding: 5px;"> <p> NOTE</p> <p>To export TVG files, your Write node must be connected to a vector drawing layer or to a vector composite node. The exported TVG files will contain the vector and bitmap drawing information, but will ignore effects and deformations.</p> </div> </td> </tr> <tr> <td data-bbox="561 1089 737 1178">TGA</td> <td data-bbox="737 1089 922 1178">Full colour</td> <td data-bbox="922 1089 1427 1503" rowspan="4"> <p>Truevision TGA/TARGA (*.tga)</p> <p>A standard image format with lossless compression and support for transparency. TGA files use more disk space than PNG files, but rendering in TGA is faster.</p> </td> </tr> <tr> <td data-bbox="561 1178 737 1266">TGA1</td> <td data-bbox="737 1178 922 1266">Greyscale</td> </tr> <tr> <td data-bbox="561 1266 737 1354">TGA3</td> <td data-bbox="737 1266 922 1354">Full colour</td> </tr> <tr> <td data-bbox="561 1354 737 1503">TGA4</td> <td data-bbox="737 1354 922 1503">Full colour with transparency</td> </tr> <tr> <td data-bbox="561 1503 737 1654">SGI</td> <td data-bbox="737 1503 922 1654">Full colour / 8 bits per channel</td> <td data-bbox="922 1503 1427 1898" rowspan="3"> <p>Silicon Graphics Image (*.sgi)</p> <p>A highly capable format with lossless compression as well as support for double precision and transparency.</p> </td> </tr> <tr> <td data-bbox="561 1654 737 1806">SGI1</td> <td data-bbox="737 1654 922 1806">Greyscale / 8 bits per channel</td> </tr> <tr> <td data-bbox="561 1806 737 1898">SGI3</td> <td data-bbox="737 1806 922 1898">Full colour /</td> </tr> </tbody> </table>	Format	Specification	Description	TVG		<p>Toon Boom Vector Graphic (*.tvg)</p> <p>Toon Boom's proprietary format for storing vector drawings. TVG images contain vector shape, colour and texture information.</p> <div data-bbox="951 701 1398 1062" style="border: 1px solid green; padding: 5px;"> <p> NOTE</p> <p>To export TVG files, your Write node must be connected to a vector drawing layer or to a vector composite node. The exported TVG files will contain the vector and bitmap drawing information, but will ignore effects and deformations.</p> </div>	TGA	Full colour	<p>Truevision TGA/TARGA (*.tga)</p> <p>A standard image format with lossless compression and support for transparency. TGA files use more disk space than PNG files, but rendering in TGA is faster.</p>	TGA1	Greyscale	TGA3	Full colour	TGA4	Full colour with transparency	SGI	Full colour / 8 bits per channel	<p>Silicon Graphics Image (*.sgi)</p> <p>A highly capable format with lossless compression as well as support for double precision and transparency.</p>	SGI1	Greyscale / 8 bits per channel	SGI3	Full colour /
Format	Specification	Description																					
TVG		<p>Toon Boom Vector Graphic (*.tvg)</p> <p>Toon Boom's proprietary format for storing vector drawings. TVG images contain vector shape, colour and texture information.</p> <div data-bbox="951 701 1398 1062" style="border: 1px solid green; padding: 5px;"> <p> NOTE</p> <p>To export TVG files, your Write node must be connected to a vector drawing layer or to a vector composite node. The exported TVG files will contain the vector and bitmap drawing information, but will ignore effects and deformations.</p> </div>																					
TGA	Full colour	<p>Truevision TGA/TARGA (*.tga)</p> <p>A standard image format with lossless compression and support for transparency. TGA files use more disk space than PNG files, but rendering in TGA is faster.</p>																					
TGA1	Greyscale																						
TGA3	Full colour																						
TGA4	Full colour with transparency																						
SGI	Full colour / 8 bits per channel	<p>Silicon Graphics Image (*.sgi)</p> <p>A highly capable format with lossless compression as well as support for double precision and transparency.</p>																					
SGI1	Greyscale / 8 bits per channel																						
SGI3	Full colour /																						

Format	Specification	Description
	8 bits per channel	
SGI4	Full colour with transparency / 8 bits per channel	
SGIDP	Full colour / 16 bits per channel	
SGIDP3	Full colour / 16 bits per channel	
SGIDP4	Full colour with transparency / 16 bits per channel	
PSD	Full colour / 8 bits per channel	<p>Photoshop Document (*.psd)</p> <p>An Adobe Photoshop proprietary format used for image editing.</p> <p>PSD files exported by Harmony contain a single background layer with the rasterized image.</p> <div style="border: 1px solid green; padding: 5px; margin-top: 10px;"> <p> NOTE</p> <p>PSD files exported from Harmony are tagged with their colour space information in their metadata, except for PSD files exported in greyscale.</p> </div>
PSD1	Greyscale / 8 bits per channel	
PSD3	Full colour / 8 bits per channel	
PSD4	Full colour with transparency / 8 bits per channel	
PSDDP	Full colour / 16 bits per	



Format	Specification	Description
	channel	
PSDDP1	Greyscale / 16 bits per channel	
PSDDP3	Full colour / 16 bits per channel	
PSDDP4	Full colour with transparency / 16 bits per channel	
YUV	<p>YUV frame (*.yuv)</p> <p>A legacy format optimized for NTSC television. The image information is encoded in the YUV color space, which means Luma (Y) and Chrominance (UV).</p> <div data-bbox="954 1119 1398 1320" style="border: 1px solid green; padding: 5px;">  <p>NOTE YUV images must be exported in NTSC resolution (720 x 540), or they will not be legible.</p> </div>	
PAL	<p>PAL frame (*.pal)</p> <p>A legacy format optimized for PAL television.</p> <div data-bbox="954 1488 1398 1690" style="border: 1px solid green; padding: 5px;">  <p>NOTE PAL images must be exported in PAL resolution (768 x 576), or they will not be legible.</p> </div>	
SCAN	<p>Toon Boom Scan Files (*.scan)</p> <p>A Toon Boom proprietary format used by Scan to store scanned image information</p>	

Format	Specification	Description
		along with its registration (peg), resolution and field chart metadata. SCAN files are in gresyscale.
PNG	Full colour / 8 bits per channel	<p>Portable Network Graphics (*.png)</p> <p>A highly portable image format with high lossless compression as well as support for transparency and double-precision. PNG is typically used for Web applications, graphical user interfaces and image sharing.</p> <p>Rendering in PNG takes more time than rendering in TGA or in uncompressed image formats, but saves a lot of disk space.</p> <div style="border: 1px solid green; padding: 5px; margin-top: 10px;">  <p>NOTE PNG files exported from Harmony are tagged with their colour space information in their metadata.</p> </div>
PNG4	Full colour with transparency / 8 bits per channel	
PNGDP	Full colour / 16 bits per channel	
PNGDP3	Full colour / 16 bits per channel	
PNGDP4	Full colour with transparency / 16 bits per channel	
JPG		
BMP	Full colour	<p>Bitmap (*.bmp)</p> <p>A standard uncompressed image format commonly used on Microsoft operating systems.</p>
BMP4	Full colour with transparency	

Format	Specification	Description
OPT	Full colour	<p>Toon Boom Optimized image (*.opt)</p> <p>A legacy Toon Boom proprietary format that stores bitmap image data with lossless compression. It supports transparency.</p>
OPT1	Greyscale	
OPT3	Full colour	
OPT4	Full colour with transparency	
VAR		<p>Toon Boom Variable Header image (*.var)</p> <p>A legacy Toon Boom proprietary format that stores greyscale bitmap image data with lossless compression.</p>
TIF		<p>Tagged Image File Format (*.tiff)</p> <p>An image format with many compression and encoding settings. It is often used for image exchange in visual arts and publishing.</p> <p>TIFF images exported by Harmony are uncompressed, encoded on a per-pixel (interleaved) basis in PC byte order.</p>
DPX	8 bits per channel / Full color / RGB channel order	<p>Digital Picture Exchange (*.dpx)</p> <p>A professional photo format that supports various different approaches to storing colour information, which can be used for storing, exchanging and editing raw information recorded by cameras. It is commonly used in film production.</p>
DPX3_8	8 bits per channel / Full color / RGB channel order	
DPX3_10	10 bits per channel / Full color / RGB channel order	

Format	Specification	Description
DPX3_12	12 bits per channel / Full color / RGB channel order	
DPX3_16	16 bits per channel / Full color / RGB channel order	
DPX3_10_INVERTED_CHANNELS	10 bits per channel / Full color / BGR channel order	
DPX3_12_INVERTED_CHANNELS	12 bits per channel / Full color / BGR channel order	
DPX3_16_INVERTED_CHANNELS	16 bits per channel / Full color / BGR channel order	
EXR	16 lines Zip compression	<p>OpenEXR (*.exr)</p> <p>A highly capable deep image format. Each pixel in an EXR file is exported with its Z-depth information. Additionally, if a pixel is semi-transparent, the color and depth information of pixels further back is stored along with it. If your scene has multiplane or 3D elements, this format can be used for compositing your animation with other graphical elements in 3D animation software.</p>

Format	Specification	Description
		<div style="border: 1px solid green; padding: 10px;">  <p>NOTES</p> <ul style="list-style-type: none"> • OpenEXR files exported from Harmony are tagged with the white point and primaries coordinates for their colour space. • OpenEXR files are always exported by Harmony always have 1 line Zip compression if they contain a 3D image. </div>
EXR_ZIP_1LINE	1 line Zip compression	
PDF		<p>Portable Document File (*.pdf)</p> <p>Typically, PDF files are used to store, archive, share and print documents. However, Harmony uses the PDF format for its capability to store bitmap images and vector graphics.</p> <p>If the write node is connected to a vector drawing layer or to a vector composite, the exported PDF files will contain the image as a vector graphic. It will ignore bitmap layers, effects and deformations. Otherwise, the PDF files will contain the rendered image as a bitmap.</p>
DTEX		<p>Deep Texture (*.dtex)</p> <p>A commonly used deep image format. Each pixel in an DTEX file is exported with its Z-depth information. Additionally, if a pixel is semi-transparent, the color and depth information of pixels further back is stored along with it. If your scene has multiplane or 3D elements, this format can be used for compositing your animation with other graphical elements in 3D animation software.</p>

	<table border="1"> <thead> <tr> <th data-bbox="565 191 737 279">Format</th> <th data-bbox="737 191 922 279">Specification</th> <th data-bbox="922 191 1425 279">Description</th> </tr> </thead> <tbody> <tr> <td data-bbox="565 279 737 741"></td> <td data-bbox="737 279 922 741"></td> <td data-bbox="922 279 1425 741"> <div data-bbox="954 310 1398 709" style="border: 1px solid green; padding: 10px;">  <p>NOTE Exporting in Deep Texture requires RenderMan to be installed on the machine and the path to RenderMan properly configured in Harmony. For more information, see the Setting 3D Renderer Paths topic of the User Guide.</p> </div> </td> </tr> </tbody> </table>	Format	Specification	Description			<div data-bbox="954 310 1398 709" style="border: 1px solid green; padding: 10px;">  <p>NOTE Exporting in Deep Texture requires RenderMan to be installed on the machine and the path to RenderMan properly configured in Harmony. For more information, see the Setting 3D Renderer Paths topic of the User Guide.</p> </div>
Format	Specification	Description					
		<div data-bbox="954 310 1398 709" style="border: 1px solid green; padding: 10px;">  <p>NOTE Exporting in Deep Texture requires RenderMan to be installed on the machine and the path to RenderMan properly configured in Harmony. For more information, see the Setting 3D Renderer Paths topic of the User Guide.</p> </div>					
Colour Space	<p>The colour space in which to render your scene's frames. When a specific colour space is selected for a Write node, frames rendered by this Write node will be converted from the project's working colour space to the Write node's colour space.</p> <p>The following colour spaces are supported in Harmony:</p> <ul style="list-style-type: none"> • Scene Working Colour Space: The same colour space as the one selected in the Colour Space tab of the Scene Settings dialog. • Linear: The same primaries and white point as sRGB and Rec. 709, but with no gamma transfer curve applied to the colour values. This colour space is useful for compositing intermediary images that are meant to be rendered in sRGB or Rec. 709. • Display P3: A colour space commonly used for digital projection. It has the same primaries as DCI-P3, the same white point as sRGB and the same gamma transfer curve as sRGB. • Display P3 Linear: The same as Display P3, except with no gamma transfer curve. This colour space is useful for compositing intermediary images that are meant to be rendered in Display P3. • Rec. 709: The colour space used for HDTV. It has the same primaries and white point as sRGB, but has a different gamma transfer curve. • Rec. 709 2.4: The same colour space as Rec. 709 or sRGB, except with a gamma transfer curve of 2.4. This colour space exists because some editing systems use a gamma transfer curve of 2.4 instead of the standard gammae curve for Rec. 709. • Rec. 2020: A colour space used for Ultra High Definition TV (UHDTV). It has a complex gamma transfer curve and primaries that cover more of the human-perceivable colour space than other colour spaces, especially in the area of human-perceivable greens. 						

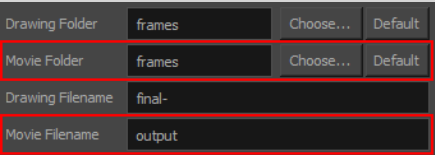
	<ul style="list-style-type: none"> • Rec. 2020 2.4: The same colour space as Rec. 2020, except with a simple gamma transfer curve of 2.4. This colour space exists because some editing systems use a gamma transfer curve of 2.4 instead of the standard gamma curve for Rec. 2020. • Rec. 2020 Linear: The same colour space as Rec. 2020, except with no gamma transfer curve. This colour space is useful for compositing intermediary images that are meant to be rendered in Rec. 2020. • sRGB: A colour space typically used for standard computer monitors. It has the same primaries and white point as Rec. 709, but has a different gamma transfer curve. <div style="border: 1px solid green; padding: 10px; margin-top: 10px;">  <p>NOTES</p> <ul style="list-style-type: none"> • When rendering a movie in a specific colour space, the movie will be tagged with its colour space only if it is rendered in QuickTime Movie (*.mov) format on macOS. • When rendering frames in a specific colour space, the following file formats will be tagged with their colour space information: <ul style="list-style-type: none"> • Portable Network Graphic (.png) • Photoshop Document (.psd) • OpenEXR (.exr) OpenEXR files are only tagged with the coordinates for their white point and primaries. </div>																
<p>Movie</p>	<p>Select this option to create a QuickTime movie. When enabled, the Movie Folder and the Movie Filename fields appear among the Drawing Folder and Drawing Filename fields.</p>  <table border="1" style="border-collapse: collapse; width: 100%; text-align: left;"> <tr> <td style="padding: 2px;">Drawing Folder</td> <td style="padding: 2px;">frames</td> <td style="padding: 2px;">Choose...</td> <td style="padding: 2px;">Default</td> </tr> <tr> <td style="padding: 2px;">Movie Folder</td> <td style="padding: 2px;">frames</td> <td style="padding: 2px;">Choose...</td> <td style="padding: 2px;">Default</td> </tr> <tr> <td style="padding: 2px;">Drawing Filename</td> <td colspan="3" style="padding: 2px;">final-</td> </tr> <tr> <td style="padding: 2px;">Movie Filename</td> <td colspan="3" style="padding: 2px;">output</td> </tr> </table>	Drawing Folder	frames	Choose...	Default	Movie Folder	frames	Choose...	Default	Drawing Filename	final-			Movie Filename	output		
Drawing Folder	frames	Choose...	Default														
Movie Folder	frames	Choose...	Default														
Drawing Filename	final-																
Movie Filename	output																
<p>Video Format</p>	<p>The drop down list to the right of the Movie option. Allows you to select one of the following formats:</p> <ul style="list-style-type: none"> • QuickTime Movie (*.mov): The Apple QuickTime format. This is the default export format and is recommended for its portability, and also because it allows you to choose among several video codecs. 																



NOTES

- On Windows, [Apple QuickTime](#) must be installed to allow Harmony to export QuickTime movies. You can configure the export of QuickTime movies to use any codec that is compatible with QuickTime, including H.264, MPEG-4 and Animation.
- On macOS, Harmony uses Apple AVFoundation to export QuickTime movies, which allows you to export using codecs such as H.264, Apple ProRes 422 and Apple ProRes 4444, among others.
- If you are looking to export a QuickTime movie with transparency, be sure to choose a codec that supports encoding with an alpha channel.
- On GNU/Linux, Harmony uses the OpenQuickTime library to export QuickTime movies. This only allows you to export videos in non-proprietary formats such as Motion-JPEG, Photo JPEG, PNG or Uncompressed (RGB).





- **H.264/MPEG-4 (*.mov)** : A simple movie format that uses the H.264 codec, which is supported by most web browsers.



NOTES

- Using this format does not require additional software. However, if this is the first time you export a movie in H.264/MPEG-4 format, you will be prompted to download the OpenH264 library from Cisco. Simply click **Yes** when prompted, and Harmony will automatically download the library, then export the movie.
- There are no encoding options for this format.
- This format supports resolutions of up to 4096×2304. Each dimension must be a multiple of 16 pixels.
- Audio exported in this format is encoded in PCM 16-bit stereo, 22.05 kHz.

- **Windows Media Video (*.wmv)**: The native format for Windows Media Player.

	<div data-bbox="643 191 1430 449" style="border: 1px solid #c8e6c9; padding: 10px;">  <p>NOTES</p> <ul style="list-style-type: none"> • Windows Media Video (.wmv) files can only be exported on Windows. • Video players and editors on non-Windows systems can generally not open Windows Media Video (.wmv) files. </div> <ul style="list-style-type: none"> • Flash (.swf) • Image sequence in Jpeg (.jpg), Targa (.tga) or Portable Network Graphics (.png) format.
<p>Movie Options</p>	<p>Opens the movie settings dialog box for your selected video format, in which you can set the video and audio compression settings for your video file:</p> <ul style="list-style-type: none"> • QuickTime Movie (*.mov) on Windows: Movie Options Dialog Box (macOS), • QuickTime Movie (*.mov) on macOS: QuickTime Movie Settings Dialog Box (Windows) • Windows Media Video (*.wmv): Windows Media Video Settings Dialog Box (Windows) <div data-bbox="563 1020 1430 1159" style="border: 1px solid #c8e6c9; padding: 10px;">  <p>NOTE</p> <p>This button is available on Windows and macOS only.</p> </div>
<p>Video Options</p>	<p>Opens the video settings dialog box, which allows you to set the video compression settings for your video file—see OpenQuickTime Video Options Dialog Box (GNU/Linux).</p> <div data-bbox="563 1350 1430 1488" style="border: 1px solid #c8e6c9; padding: 10px;">  <p>NOTE</p> <p>This button is available on GNU/Linux only.</p> </div>
<p>Sound Option</p>	<p>Opens the audio settings dialog box, which allows you to set the audio compression settings for your video file—see OpenQuickTime Sound Options Dialog Box (GNU/Linux).</p> <div data-bbox="563 1677 1430 1816" style="border: 1px solid #c8e6c9; padding: 10px;">  <p>NOTE</p> <p>This button is available on GNU/Linux only.</p> </div>

Enabling Tab

You can create several Write nodes for a single scene and, by default, when a scene is rendered, all of its Write nodes will perform their render. However, using the options in the Enabling tab, you can set up some Write nodes to only perform their render if the scene is rendered at a specific resolution. This is mostly useful on Harmony Server, as Harmony Server allows you select the resolution at which to render a scene when sending a scene for rendering by the Harmony database's render farm.

A good example of how this can be useful is if your scene has storyboard thumbnails in the corner, and a Write node connected to a composite that crops the picture to only include the storyboard thumbnail, so that your scene can export both the final animation and the animated storyboard when rendered. You can set up your scene's main Write node to only work when exporting the scene at the scene's original resolution, and the storyboard thumbnails Write node to only work when exporting at the desired resolution for an animated storyboard.

This option allows you to filter with either resolution presets, or by specifying the width and height of the chosen resolution in pixels. You can hence create custom resolution presets named after their Write node's purpose, to make it easier to choose the resolution when rendering a scene.

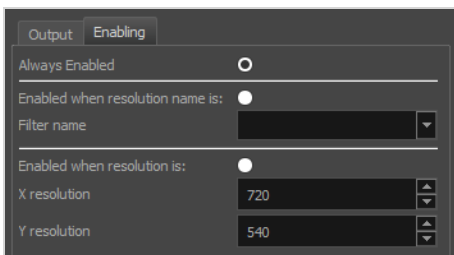

Parameter	Description
Always Enabled	Makes this Write node render every time the scene is rendered. This is the default option.
Enabled when Resolution Name is	Makes this Write node render only when the scene is rendered at the specified resolution preset.
Filter Name	Select the resolution preset at which to render the scene to activate this Write node.
Enabled when Resolution is	Make this Write node render only when the scene is rendered at the resolution with the specified width and height, in pixels.
X Resolution	The width (in pixels) of the resolution at which to render the scene to activate this Write node.
Y Resolution	The height (in pixels) of the resolution at which to render the scene to activate this Write node.

Particle Nodes

You can access the Particle effects through the Node Library view. The Particle category contains all the nodes needed to build various Particle effect systems.

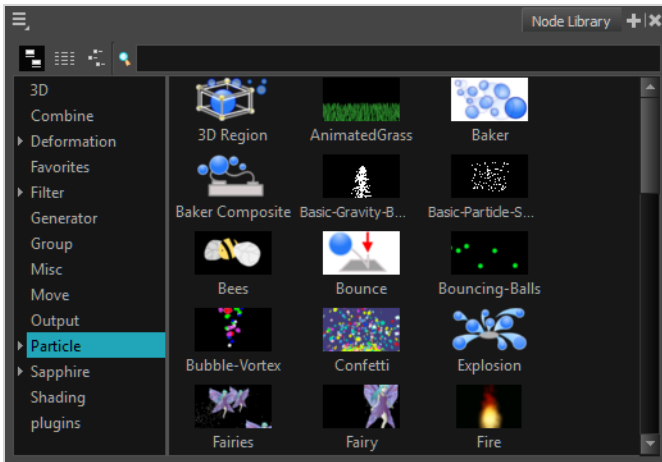

This section explains each node's purpose, its layer properties and how to adjust these properties.

3D Region	849
Baker	851
Baker Composite	854
Bounce	855
Explosion	857
Gravity	859
Image Fracture	861
Kill	867
Move Particles	869
Orbit	871
Planar Region	874
Random	878
Region Composite	879
Repulse	880
Rotation Velocity	881
Sink	884
Size	885

Sprite Emitter	887
System Composite	897
Velocity	898
Visualizer	901
Vortex	903
Wind-Friction	905

3D Region

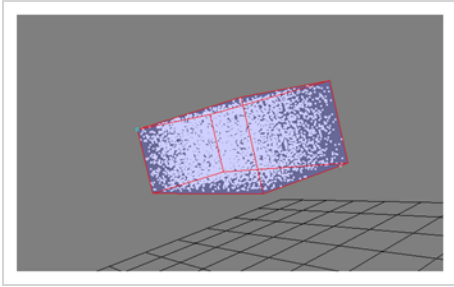

The 3D Region effect lets you define the 3D region, which can take many forms, such as a sphere, cone, cylinder or box. The 3D Region node acts in contrast to the Planer Region node, which generates and emits particles from a 2D plane.

You can connect a 3D Region to a Sprite-Emitter to define the region from which particles are generated. It could also be connected to a Bounce node to define a region against which particles bounce. If connected to a Sink node, it will define a region where the particles will disappear.

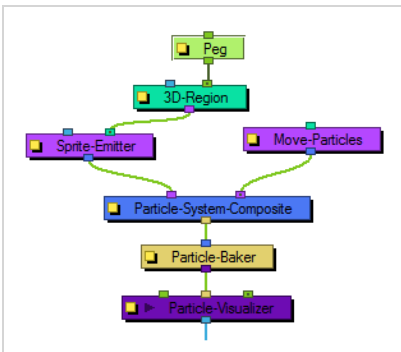

How to preview the 3D Region

1. From the top menu, select **View > Show > Control** or press Shift + F11 (Windows/Linux) or ⌘ + F11 (macOS).

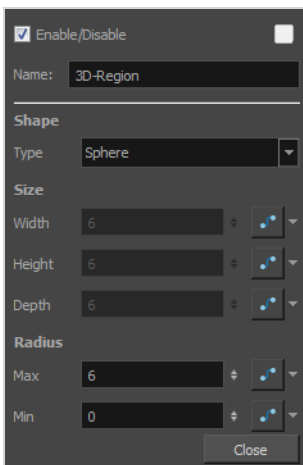

3D Region Properties

Parameter	Description
Name	Allows you to change the name given to the node.
Shape	<p>Choose a shape for the 3D Region by clicking on the Type drop-down menu and selecting either Box, Cylinder, Cones, Sphere or Image.</p> <p>If you select Image, you must connect the node of a vector drawing or a vectorized bitmap image to the left port (blue node) of the 3D Region node. The particles will then be emitted from that image' shape. Don't forget that you can rotate your vector drawing in 3D space by enabling the 3D option in its Layer Properties.</p>
Size	Enter different values into the Width, Height and Depth fields to change the dimensions of the 3D Region's selected shape. Depending on the shape selected, some fields may be greyed-out if they are not applicable. You can also modify the shape with the Transform Tool by grabbing the control handles (turquoise squares) in the Camera or Perspective views. You can also change the dimensions of the region over time by click on the function button at the end of each field.
Radius	Enter different values in the Max or Min fields to change the inner or outer radius of applicable shapes, such as a cylinder, cone or sphere. You can also change the radii by grabbing the control handles (turquoise squares) in the Camera or Perspective views. The radii of the region can be changed over time by clicking the function button at the end of each field.

Baker

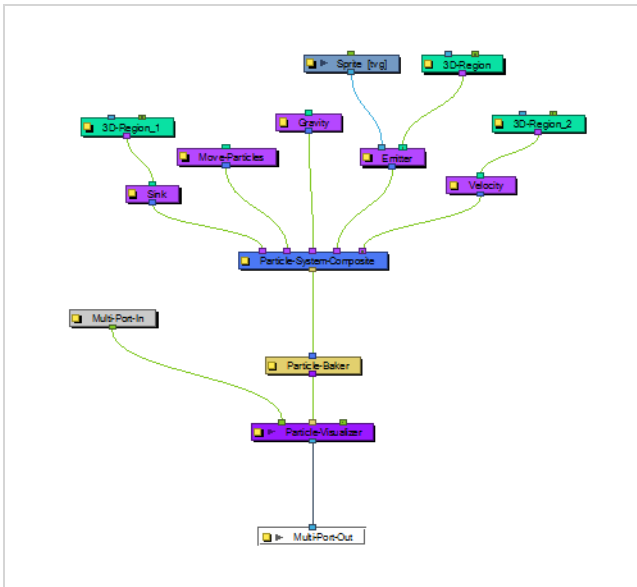

The Baker effect, also known as *Particle-Baker*, lets you make decisions about the particle system's position, angle, number, etc. in the same way that a baker would make decisions about the ingredients that go into baking a cake. The Baker performs the particle simulation, combining all the ingredients specified to get the final result. The Baker must always be connected to the Particle-Visualizer.

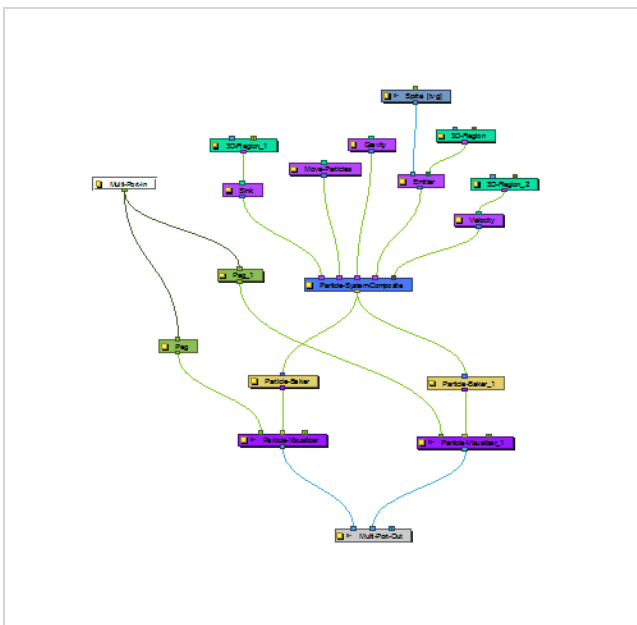

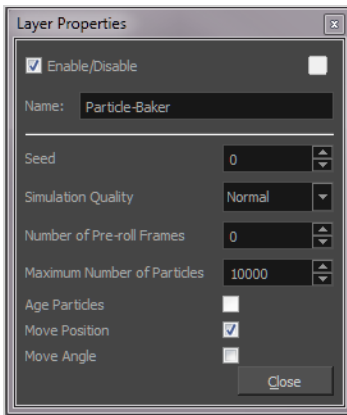

Particle Baker Properties

Parameter	Description
Name	Allows you to change the name given to the node.
Seed	Allows you to apply a random effect to the particle system. There may be times when you want to copy the particle system to two different locations on your screen. You can take the out-port of the Particle System Composite node, and plug this into two separate Bakers and Visualizers. Then you could move one system over by attaching a peg into the left side of one Visualizer. This makes the two systems look exactly the same. Add a random Seed to make them look different.
Simulation Quality	Defines how many simulation steps per frame are performed. The lowest quality creates one step per frame. Raising the quality will divide the simulation time and create two or more steps of simulation for each frame. This increases the computation time, but also increases the quality of the result.
Number of Pre-roll Frames	Allows you to select a start position in the particle effect sequence, other than the start (generation) of the sequence. This allows you to start the particle effect part-way through its cycle, even if it starts on frame 1 of your project. An example of when this parameter might come in handy is when you want it to be already raining at the start of your scene. If you don't change the number of Pre-roll Frames, it will always start to rain at the beginning of the scene.
Maximum Number of Particles	Lets you put a limit on the number of particles that will be created; particles will stop being generated once this number is reached.
Age Particles	Tracks how long a particle has existed in its cycle from the time of its inception. Knowing a particles "age" means you can tack other parameters onto its life span, such as having the particle start to disappear or change colour at a certain

	time.age.
Move Position	Allows the particles to move position, otherwise the particles cannot flow in a specified direction. This option also exists in the Move Particles node. You do not always need a Move Particles node; this is why this option exists in the Baker. This option is also useful when your Move Particles node is cut off by a sink—see Sink on page 884 .
Move Angle	Allow particles to flow from different angles. This option also exists in the Move Particles node. You do not always need a Move Particles node; this is why this option exists in the Baker. This option is also useful for when your Move Particles node is cut off by a sink—see Sink on page 884 .

Baker Composite

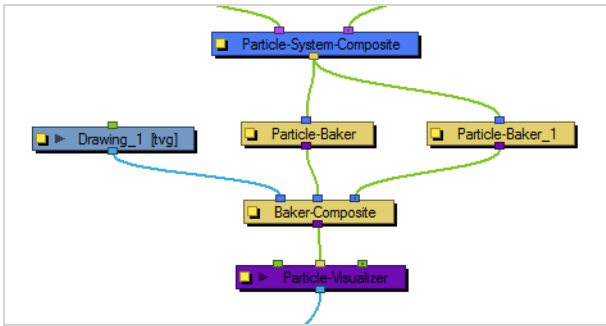

The Baker Composite effect is used to composite more than one Particle-Baker, as well as any other elements that need to be combined before they pass through the Particle Visualizer.

Bounce

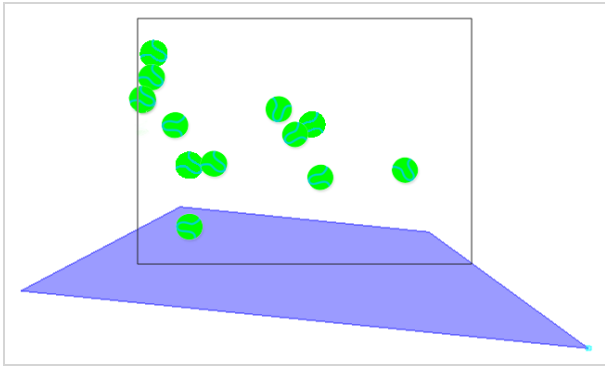

The Bounce effect lets you to make particles bounce off a surface with realistic physical modelling. This node should have a region connected to it, and that region will act as a bounce plane so when any particle hits it, it will bounce off at the correct angle.

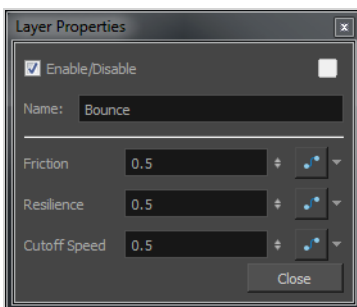
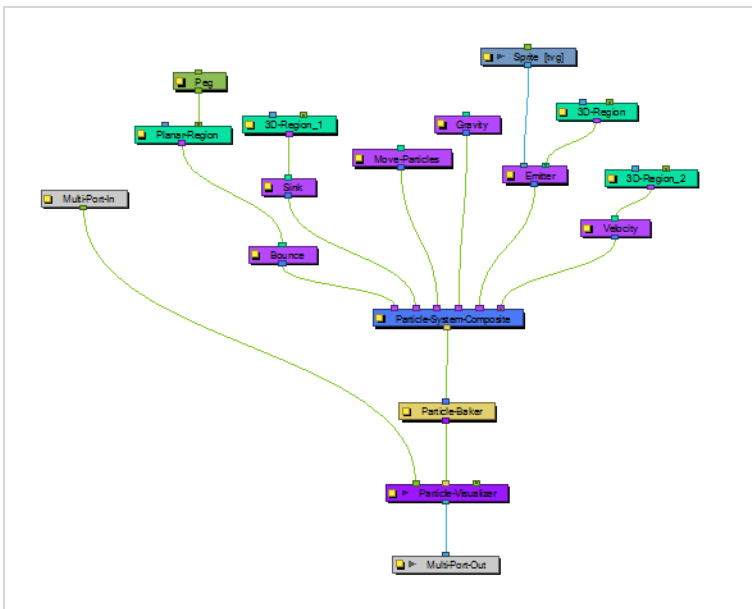

Bounce Properties

Parameter	Description
-----------	-------------

Name	Allows you to change the name given to the node.
Trigger	An on/off switch using binary code. 1 = on, 0 = off.
Friction	Enter a value in this field to increase the amount of friction each particle experiences as it makes contact with the planar surface. A positive value creates more friction and slows the particle down. A negative value lessens the friction and makes the surface appear more slippery.
Resilience	Increases or decreases the bounciness of the particle. A value of zero causes the particle to hit the planar surface once and slide off any downward facing angle. A positive value, even by decimal increments, causes the particle to become bouncy. A negative value deadens the effect, the same way a lack of Region would.
Cutoff Speed	Increasing this value widens the bounce arc. If the connected Planar Region is completely flat, a value of zero will cause the particle to bounce up and down in place. A tilted plane in the direction of the bounce will also widen the arc.

Explosion

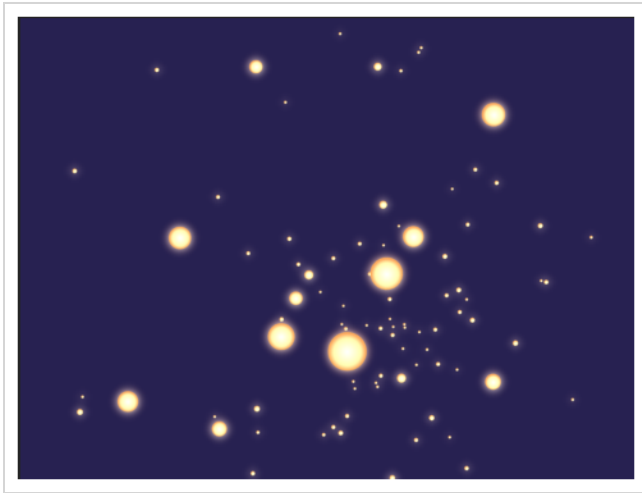

The Explosion effect lets you create an explosion. As it is an Action node, it should be connected to the Particle System Composite after the Sprite Emitter. As the explosion occurs, the particles will burst rapidly away from the centre of the explosion (the centre of the defined Region), then gradually slow down.

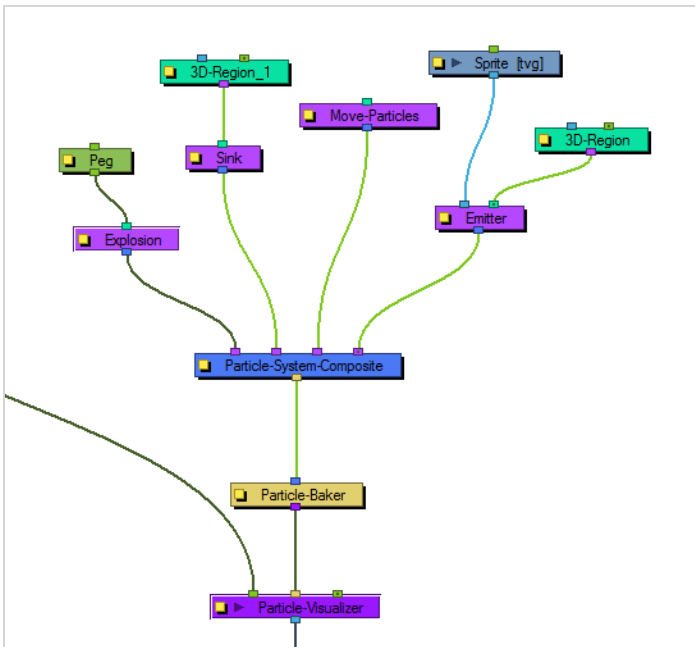

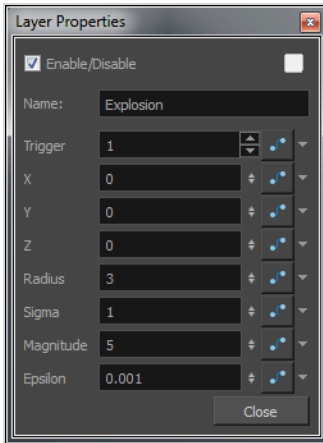

Explosion Properties

Parameter	Description
Name	Allows you to change the name given to the node.
Trigger	An on/off switch using binary code. 1 = on, 0 = off.
Coordinates	Use the X, Y and Z fields to enter different position values to move the particle system around in 3D space. You can also connect a Peg node to the Explosion to manipulate its position with the Transform or Move tool.
Radius	Defines the surface of an invisible sphere. As the explosion occurs, the exploded particles inside the boundaries of this sphere will be effected by the force of the explosion, while the particles that eventually pass through will remain unaffected.
Sigma	The higher the Sigma value, the longer it takes for the particles to completely disappear, even if the initial explosion seems to occur just as rapidly.
Magnitude	Defines the magnitude of the explosion. The greater the magnitude, the faster the particles break up.
Epsilon	This value works in opposition to the Sigma value. The higher the value, the slower the initial explosion occurs. If the value is high (an integer value) then larger particles remain suspended for a longer period of time from the initial explosion and takes a while to gradually break down. A smaller (decimal) value breaks the particles down to smaller forms more rapidly from the time of the initial explosion.

:

Gravity

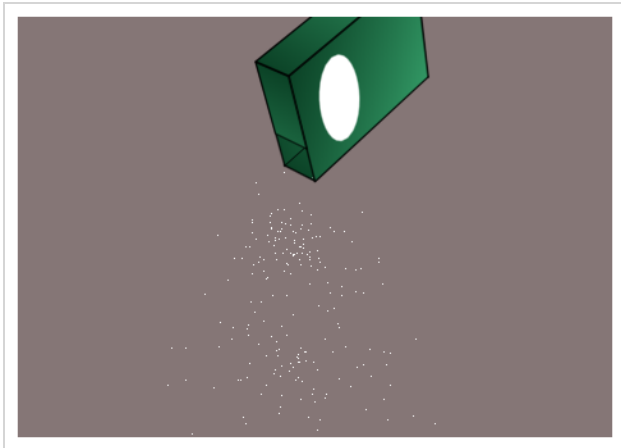

The Gravity effect lets you define the gravity of the particle system.

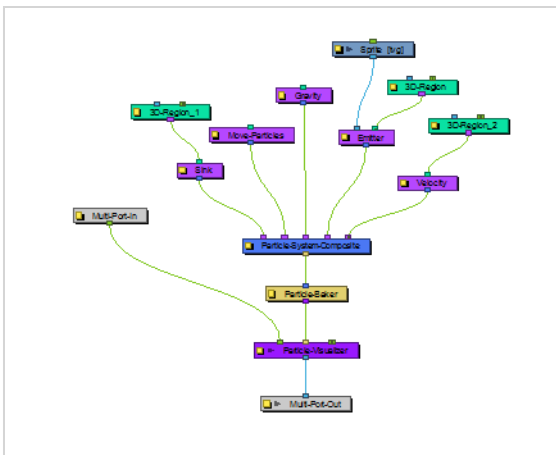

Layer Properties

Enable/Disable

Name: Gravity

Trigger: 1

Apply Gravity:

X Direction: 0

Y Direction: -1

Z Direction: 0

Apply Gravity between Partides (Relative Gravity):

Relative Gravity Magnitude: 1

Relative Gravity Epsilon: 0.001

Relative Gravity Maximum Distance: 2

Close

Gravity Properties

Parameter	Description
-----------	-------------

Name	Allows you to change the name given to the node.
Trigger	An on/off switch using binary code. 1 = on, 0 = off.
Apply Gravity	Forces the particle system to adhere to the force of gravity. Values must be entered into the Direction fields, along with enabling this option, in order for it to work. If this option is not selected, the particle system will explode outwards from its origin point.
X Direction	Directs the particle stream to the left or right (along the X-axis). A value of 1 forces the particle stream to the right, while a value of -1 forces the particle stream to the left.
Y Direction	Directs the particle stream up or down (along the Y-axis). A value of 1 forces the particle stream to flow upwards, while a value of -1 forces the particle stream to flow downwards.
Z Direction	Directs the particle stream forwards or backwards (along the Z-axis). A value of 1 forces the particle stream to flow forwards, while a value of -1 forces the particle stream to flow backwards.
Apply Gravity between Particles (Relative Gravity)	Applies gravity between each particle, taking their masses into account. The mass of the particle can be specified at emission time via the Sprite or Image Emitter.
Relative Gravity Magnitude	Adjust the amount of gravity applied between particles.
Relative Gravity Epsilon	The acceleration falls off the further the particles get from each other. When the particles are very close to each other, the acceleration becomes very high, so you should define a small region around the particles so they never actually touch.
Relative Gravity Maximum Distance	Adjusts the radius beyond which particles do not affect each other.

Image Fracture

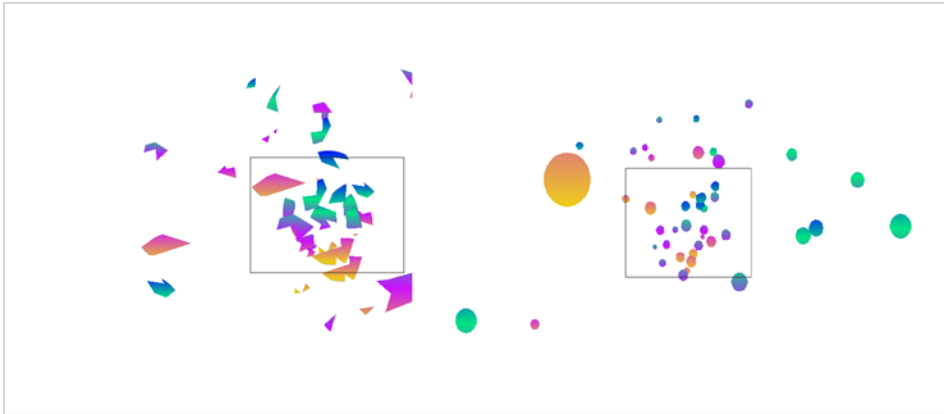

The Image Fracture effect breaks an image into pieces. This effect requires two image objects: the image to be cut and the shape of the cut pieces (matte). The image to be cut can be anything from a vector drawing to a bitmap image to an entire scene's composite—effects and all. The image to be cut should be hooked to the Image Fracture's right port.

The matte should be flattened if you want it to work like a cookie cutter (hollow shape with a frame) and can be composed of brush or pencil lines. It can also be a solid shape, many solid filled shapes, and even many solid filled overlapping shapes. When the matte is made of overlapping pieces, the cut image will be multiplied at those zones to break apart in multiple layers. The matte drawing should be hooked to the Image Fracture's left port.

The two image objects overlap perfectly when combined in the Image Fracture. This means that you must take the 12 by 12 field into account when judging the scale and proportion of these objects. If the matte does not overlap a part of the image, that part of the image will not be cut. The matte does not have to be a continuous shape. It could be three separate circles, which would then be cut and pulled away from the image.

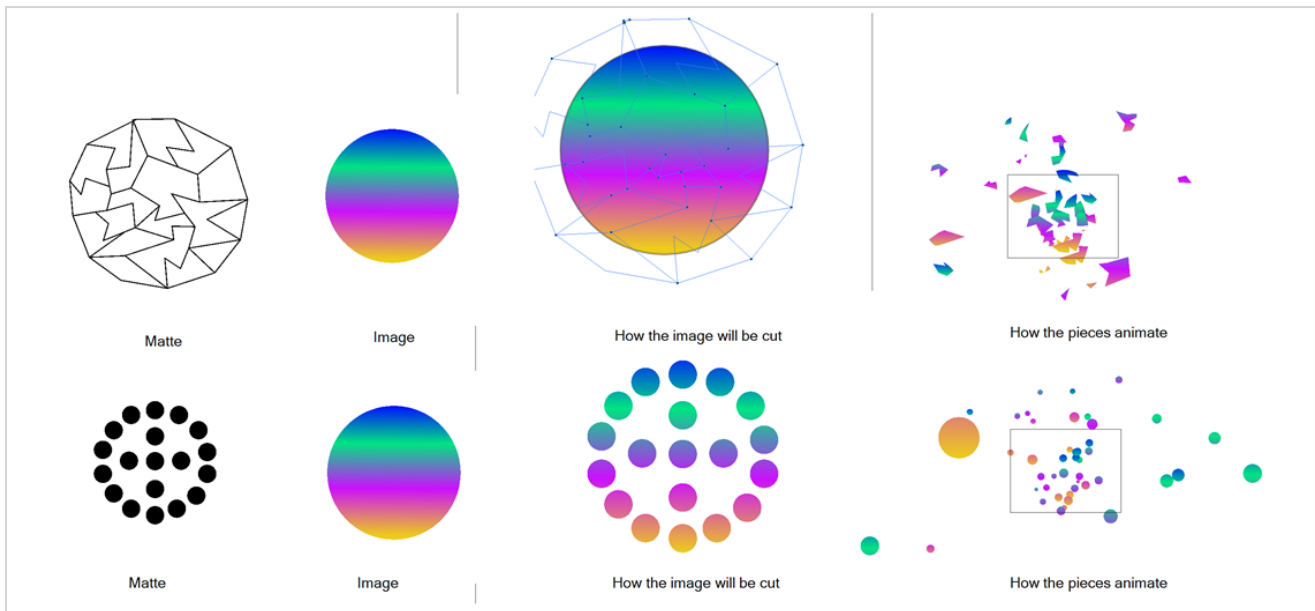

**NOTE**

You can display the grid and use the Light Table feature in the Drawing view while drawing or scaling the image and matte to ensure that they're the correct size relative to one another.

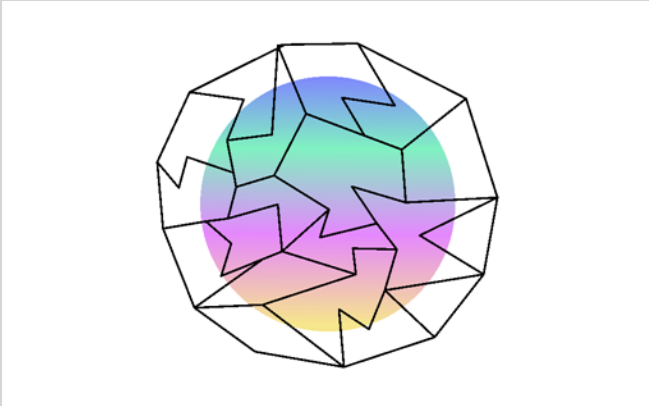

Here's an example of a node structure with the Image Fracture effect:

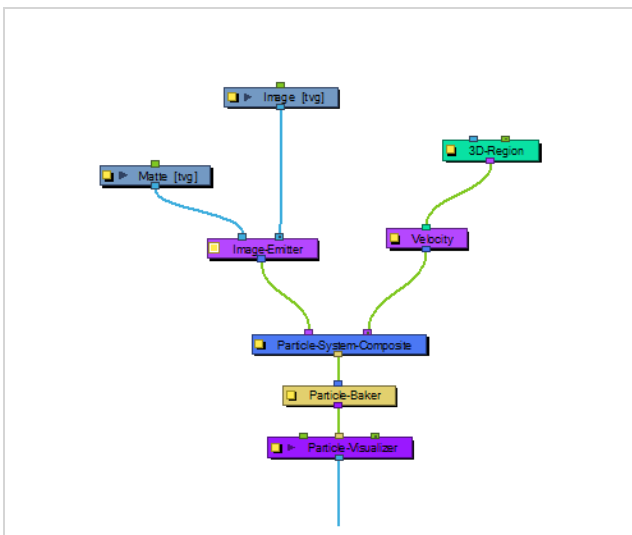
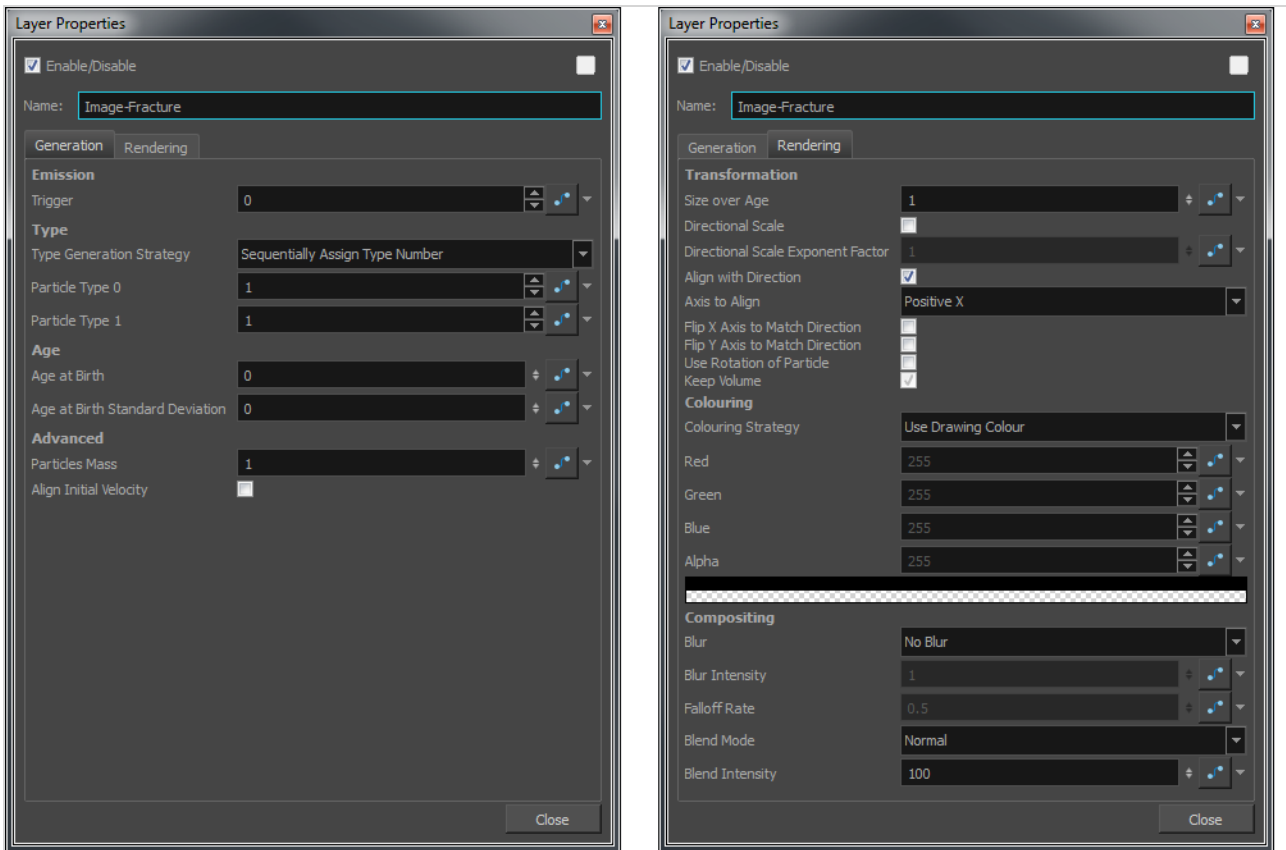

Image Fracture Properties



Generation Tab

Parameter	Description
Emission	
Trigger	An on/off switch using binary code. 1 = on, 0 = off.
Type	You may want to design a variety of different drawings that will vary the appearance of the particle system. In this case, you should put each drawing on its own cell in the drawing layer. Each drawing will then be a new type of particle.
Type Generation Strategy	Lets you sequentially or randomly assign a type (moving from one drawing to the next).
Particle Type 0	This is the frame number of the first drawing. If you have a 5-frame cycle that starts on frame 1, you would put a 1 here.

Particle Type 1	This is the frame number of the last drawing. If you have a 5-frame cycle that starts on frame 1, you would put 5 here.
Age	
Age at Birth	A different start frame number can be entered in this field. This means that a particle can start with a different drawing than the drawing on frame 1.
Age at Birth Standard Deviation	Allows a random deviation for the birth of the particles. If you have a five-frame cycle that starts on frame 1, but you want the particles to be a random type, then you may want to set the Age and Birth to 3 with a standard deviation of 2. That means the particles will randomly be born at any frame from 1 to 5.
Advanced	
Particles Mass	Defines a mass for the particles which will affect how the particles interact with gravity.
Align Initial Velocity	Aligns the initial velocity with the region from which the particles are being emitted. If you are emitting from a sphere, the particles will all start out moving away from the centre of the sphere.

Rendering Tab

Parameter	Description
Transformation	
Size over Age	Lets you determine the size of the particle as it ages. Attach a function to this attribute if you would like to, for example, have the particles get smaller as time goes on.
Directional Scale	Scales the particle in the direction of its movement.
Directional Scale Exponent Factor	Sets an exponent here for how much you would like that particle to scale.
Align with Direction	Aligns the particle in the direction of its movement.
Axis to Align	Select the axis that you want to align. This axis refers to the axis of the Drawing

	grid from the Drawing node plugged into the emitter.
Flip X Axis to Match Direction	You may want to have the particle align to the X direction of movement. You can see this property being used in the Lemmings example.
Flip Y Axis to Match Direction	Similar to flipping the X axis, you may want to flip the Y axis of a drawing to match the direction of the particle movement.
Use Rotation of Particle	Enables rotation on the particle.
Keep Volume	When you choose to do a Directional Scale, this will automatically maintain the volume of the particle by squashing it proportionally to how much it stretches as a result of the directional scale.
Colouring	
Colouring Strategy	Lets you choose how to define the colour of the particle.
Use Drawing Colour	The particle remains the same colour as it was drawn with.
Map RGB Based on Age	Attach a function to this to vary the Red, Green, and Blue values of the particle as it ages.
Map RGBA Based on Age	Attach a function to this to vary the Red, Green, Blue, and Alpha values of the particle as it ages.
Apply Opacity Based on Age	Keeps the original RGB values from the drawing, but vary the Alpha (Opacity) according to a function that you define here.
Map RGB Based on Frame	Changes the Red, Green, and Blue values of the particles based on the frame. Changing based on the frame means that ALL particles will change colour on that frame, regardless of their age.
Map RGBA Based on Frame	Changes the Red, Green, Blue, and Alpha values of all particles on a given frame by attaching a function.
Apply Opacity Based on Frame	Uses the original RGB values from your drawing, but varies the Alpha (Opacity) of the particles on a certain frame by attaching a function to this.
Red, Blue, Green, Alpha	This is where you can attach functions to the Red, Blue, Green and Alpha values.

	You can also click on the colour swatch to adjust the colour.
Compositing	
Blur	Lets you attach a function to define how you want the particles to blur based on the age, frame or camera distance of each particle. There are low and high quality blurs. Also, you can attach a function to define how all particles should be blurred.
Blur Intensity	Lets you set a value or attach a function to animate the blur according to the type of blur that was defined from the drop-down list.
Falloff Rate	<p>The distance where the blur fades from the edge of the image. Select a value between 0 and 1.</p> <p>A falloff rate of 0 causes the blur to fade out slowly, distributing the blur evenly from the edge of the drawing to the farthest edge of the blur.</p> <p>A falloff rate of 1 causes the blur to fade out quickly so that the blur is heaviest at the edge of the drawing.</p>
Blend Mode	Defines a blend mode for the particles to get cool effects.
Blend Intensity	This is a percentage of how opaque you want the particles to be blended. 50 = 50% transparent. 100 = opaque.

Kill

The Kill effect lets you determine when particles disappear.

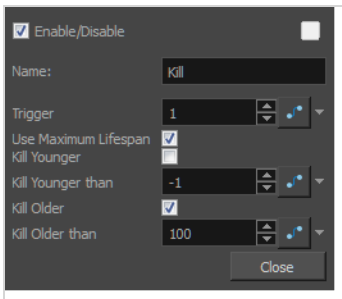
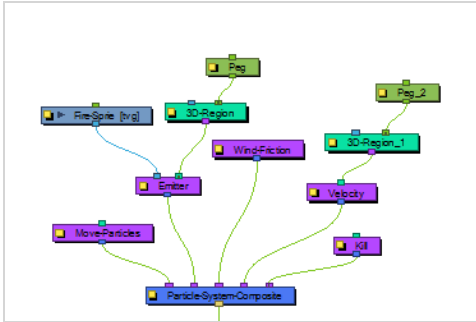

Kill Properties

Parameter	Description
Name	Allows you to change the name given to the node.
Trigger	An on/off switch using binary code. 1 = on, 0 = off.
Use Maximum Lifespan	Makes particles disappear when they reach their maximum lifespan.
Kill Younger	<p>To use this parameter, you must attach a function to this property because if you select this option at time 0, you will never see any particles. If you set Kill Younger to 10, at time 0, there will be no particles older than 10, so you will never see any particles.</p> <p>It may be useful to have the particles animating over time, and at some point in time, you may want to kill all the younger particles. An example would be an animation where the particles change from blue to yellow. At every frame, new particles are generated, and the particles that already exist age. Then you would add an explosion that kills all particles younger than 10 frames. It would kill all the blue particles, leaving only the yellow particles.</p>
Kill Younger Than	This is where you can animate the effect for Kill Younger.

Kill Older	Makes particles disappear when they reach a certain level of maturity.
Kill Older Than	Lets you set the age at which particles disappear.

Move Particles

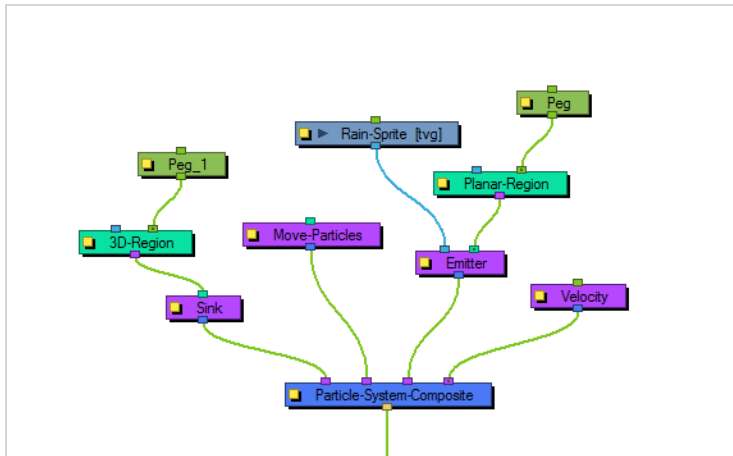

The Move Particles effect lets you determine whether the particles are stationary (like grass) or moving (like rain), and you can animate this function on and off.

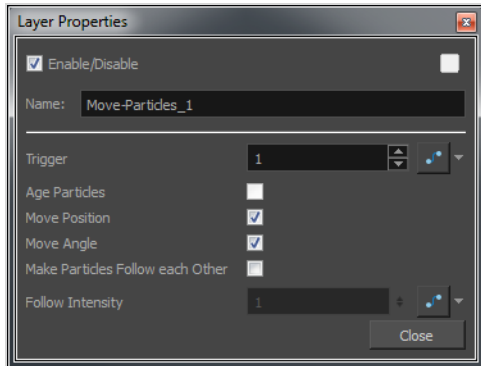

Move Particles Properties

Parameter	Description
Trigger	An on/off switch using binary code. 1 = on, 0 = off.
Age Particles	<p>Ages the particles. Note that if you select the Move Position and Move Angle, then the particles will age implicitly. If you do not want the particles to move, but still want them to age, deselect Move Position and Move Angle, and select Age Particles.</p> <p>The Age Particles parameter also exists in the Baker, however whatever happens in the Baker happens after everything else in the particle system. So, if for example you have a Kill node, it will kill the particles before they age. You probably want to age the particles before you determine whether to kill them. Therefore, if you have a Kill node, make sure to age the particles in your Move node before you kill them. If you age the particles both in the Move and Baker node, then the particles will age twice on that frame instead of once.</p>

Move Position	Lets you enable movement on the particles. There is also a Move Particles option in the Baker. If it's deselected in the Baker and in the Move node, the particles will not move; they will simply generate in place and stay there. If the option is selected on the Baker, the particles will move. But if you need the particles to interact with another Action, say a Sink, then you want the particles to move before they reach the sink. This is why you have a separate Move node, so you can place this Move before (to the right of) the Sink in your particle system composite.
Move Angle	Like the Move Position, this enables the rotation of particles in the particle system.
Move Particles Follow Each Other	Allows one particle to follow another particle, through an attraction between the particles. This is particularly useful when you want to create a snake-like effect, where the particles are animating across the screen and following each other.
Follow Intensity	Lets you adjust the strength of the attraction between particles following each other.

Orbit

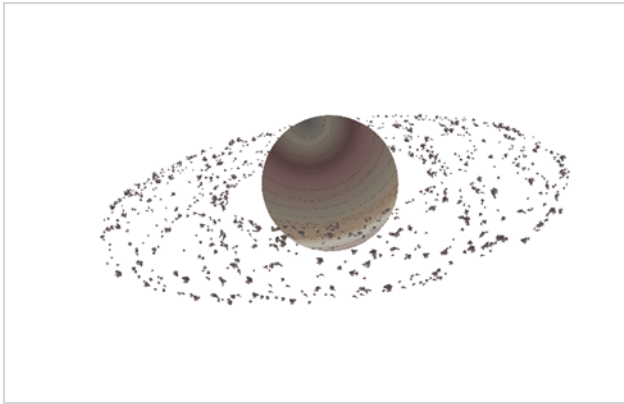

The Orbit effect lets you define an axis the particles will be attracted to and orbit around. You can place a Peg layer into the orbit to move the position of the orbit without adjusting the parameters in the Layer Properties.

Fine-tuning the Orbit effect can take a bit of finesse because the orbit takes into account the velocity of the particles, and uses this to determine whether:

- The particle will orbit around the axis
- The particle will be influenced but eventually escape
- The particle will hardly be influenced at all.

This is just like how gravity between astral bodies works in space. Here are some examples of how having the orbit in the wrong place can give some cool (but perhaps not useful) effects:

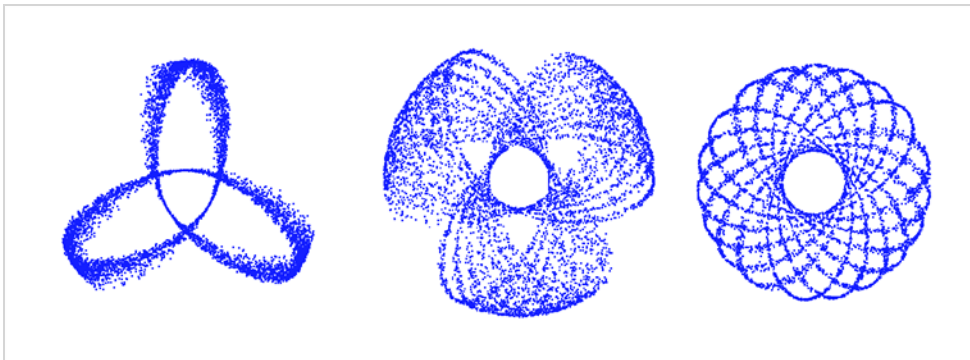

You will also want to make sure that your initial velocity is varied, so use an interpolated speed and set two different values. That way, there will be a spread between them. If not, then you will get the effects as shown above.

Also, you should use the Peg layer to move the position of the Orbit node around until you find the right spot to get the look you're trying to achieve. It also helps to set some pre-roll frames on your Baker to get things ramped-up before you start to manipulate the position of the Orbit node.

Here's an example of what a typical node structure with an Orbit node looks like:

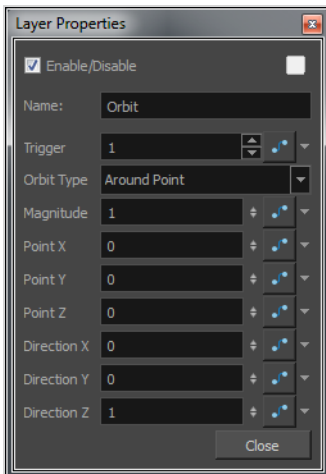
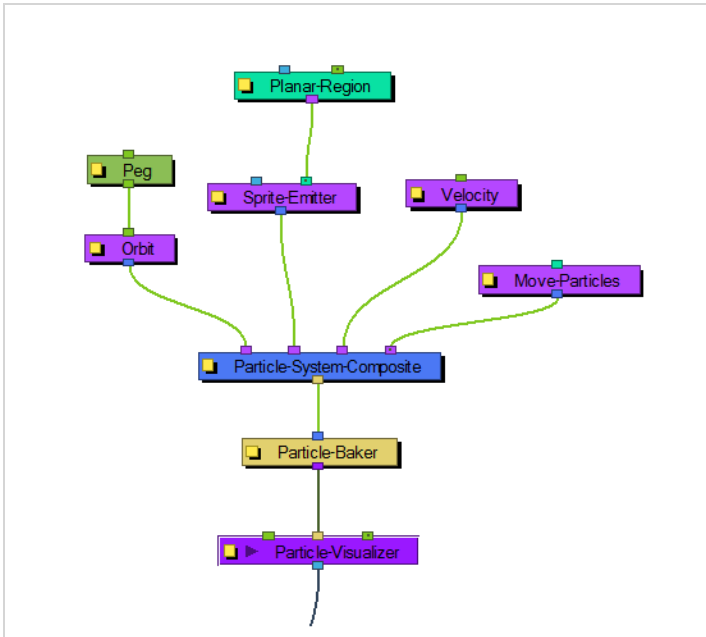

Orbit Properties

Parameter	Description
Name	Allows you to change the name given to the node.
Trigger	An on/off switch using binary code. 1 = on, 0 = off.
Orbit Type	Lets you select the type of Orbit you want to use. For most scenarios, like asteroids orbiting a planet, a point will suffice. If you want to rotate around an axis instead, choose between the X, Y, Z axes or set up your own custom axis.
Magnitude	Adjust the amount that the acceleration of each particle will be adjusted. The

	higher the value, the more the particle will accelerate towards the orbit. A magnitude of 0.001 is a good number to use for this. When the magnitude is set too high, the particles will simply fly out into space.
Point X	Defines the X position of the centre of the Orbit. You may also leave this at 0 and use a peg to move the position of the Orbit node.
Point Y and Z	Defines the Y and Z position of the centre of the Orbit.
Direction X	Defines the X component of the axis of rotation for the orbit. This is only taken into account if you choose to set up a custom axis. If this is set to 1, and Y and Z are set to 0, then the axis will be going in the same direction as the X axis. If the X component is set to 1, and the Y component is also set to 1, then the axis will be at a 45 degree angle between the two.
Direction Y and Z	Defines the Y and Z components of the axis of rotation for the orbit.

Planar Region

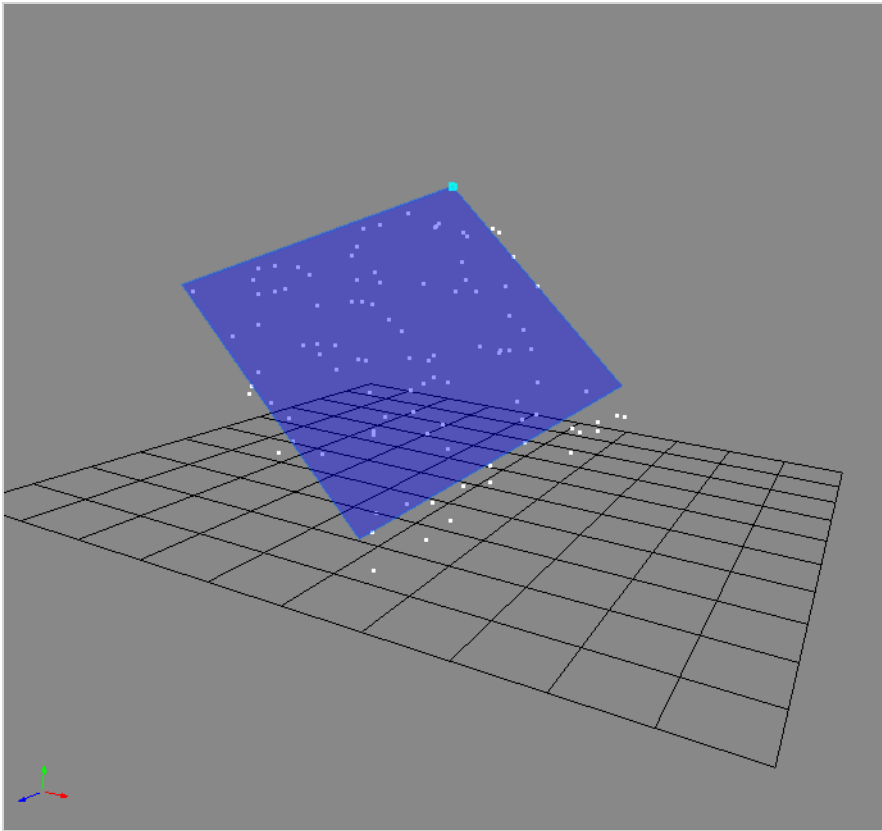

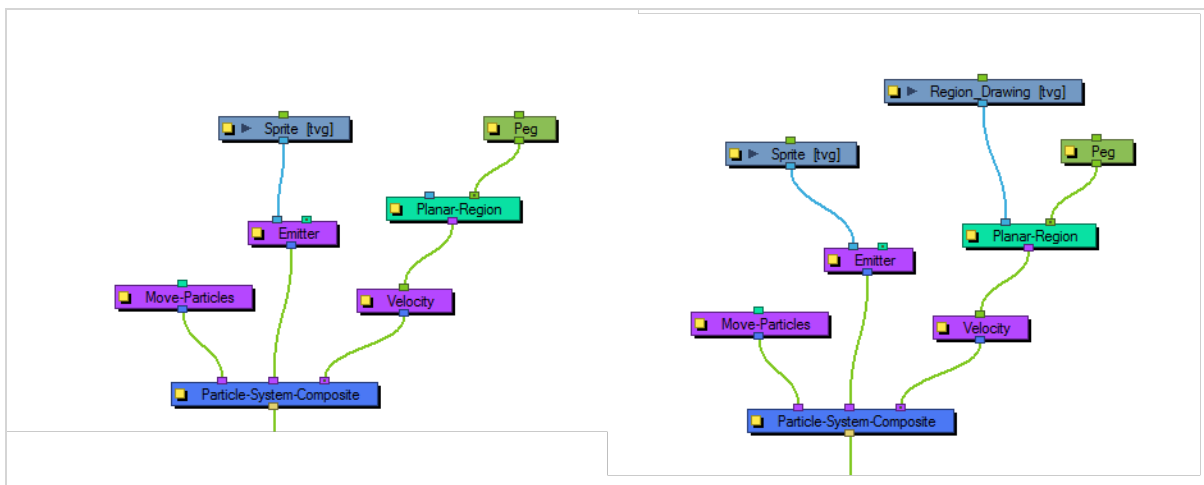

Like the 3D region, this determines a region that you can use as a source or as a bounce plane, but instead of a 3D region, it's a 2D plane. Connect a peg to the right in-port to adjust the position of the plane.

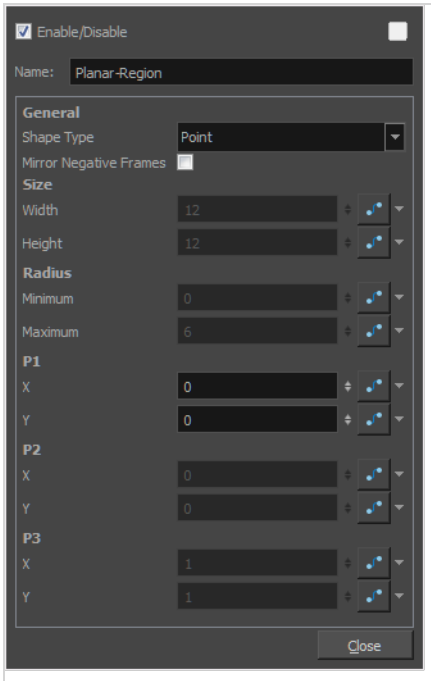



Planar Region Properties

Parameter	Description
Name	Allows you to change the name given to the node.
Shape Type	<p>Allows you to define the type of shape of the plane.</p> <p>The following shape types are available:</p> <ul style="list-style-type: none"> Basic shape types: <p>Those are simple shapes that are defined by a small set of coordinates.</p> <p>Depending on the type of shape you choose, the parameters below will be available or greyed out so that you can adjust the actual shape of the plane. However, you can also adjust the shape of the plane visually using the  Transform tool. To do that, you must display the Planar-Region's control by selecting the Planar-Region node in the Node view, then doing one of the following:</p> <ul style="list-style-type: none"> In the Camera view toolbar, click on  Show Control . From the top menu, select View > Show > Control. Press Shift + F11. <p>The following basic shape types are available:</p> <ul style="list-style-type: none"> Rectangle: A rectangle. You can set the size of the rectangle using the Width and Height parameters.

- **Disc:** A circle with a circular hole in the middle. You can adjust the disc's size by changing the **Radius** parameters, where **Minimum** is the radius of the hole and **Maximum** is the radius of the disc.
- **Triangle:** A triangle. The coordinates of all three points can be set in the **X** and **Y** fields under **P1**, **P2** and **P3**.
- **Line:** A line. The coordinates of the two points defining the lines can be set in the **X** and **Y** fields under **P1** and **P2**.
- **Point:** A single point. Its coordinates can be set in the **X** and **Y** fields under **P1**.
- Image shape types:

Those shape types use an input image to define the plane. To use them, connect a single drawing layer to the left input port of the Planar-Region node.

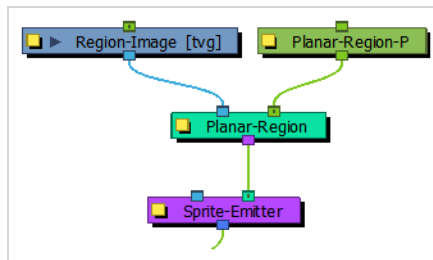

The two following image shape types are available, and produce slightly different results:

- **Image:** With this option, the input image shape is used to determine the planar region, but its alpha is also used to modulate the density of the particles. For example, semi-transparent areas will have less particles than fully opaque ones.

However, with this option, the region is cropped to the input drawing's 4:3 grid. By default, this grid is shrunk to fit the vertical resolution of the scene. Hence, with this option, the particles will be cropped by a frame that has a 4:3 aspect ratio and will not reach all the way to the left and right edges of the camera frame. To work around this, you can use the **Vector Drawing** option, or set your scene's field of view to **Horizontal Fit**—see [Scene Settings Dialog Box on page 199](#).

- **Vector Drawing:** This uses the entire shape of the input drawing to define the planar region, without accounting for the drawing's grid. As a side effect, an input drawing that is considerably bigger than the camera frame will result in more sparse particles. This option ignores the alpha of the input image, and only uses its shape.

Mirror Negative Frames

Mirrors the input peg transformation to generate positions for frames before the

	scene begins.
Size	<p>Width: The width of a rectangular shape.</p> <p>Height: Adjust the height of a rectangular shape.</p>
Radius	<p>Minimum: The radius of the hole for a disc shape.</p> <p>Maximum: The radius of the whole disc for a disc shape.</p>
P1	<p>X: The X position of Point 1. Point 1 could refer to the point on a triangle, line, or point.</p> <p>Y: The Y position of Point 1.</p>
P2	<p>X: The X position of Point 2. Point 2 could refer to the point on a triangle or line.</p> <p>Y: The Y position of Point 2.</p>
P3	<p>X: The X position of Point 3. Point 3 refers to a point on a triangle.</p> <p>Y: The Y position of Point 3.</p>

Random

The Random effects lets you put a random seed on some qualities like acceleration, speed, rotation speed, and position. There's also a Seed value in the Baker, but you may only want to make one particular aspect of the system random. This effect gives you control over the randomness of a particular property.

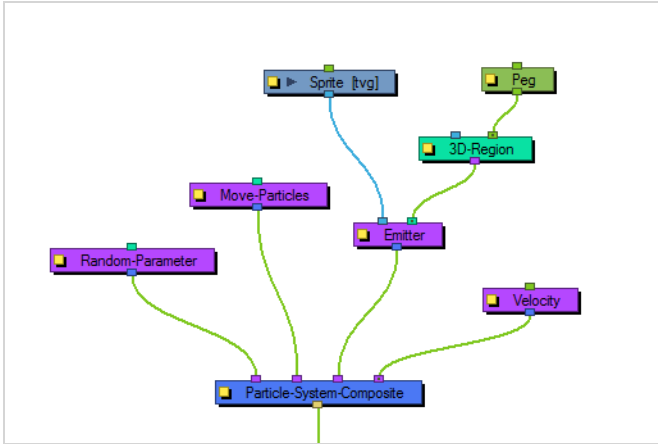

Random Properties

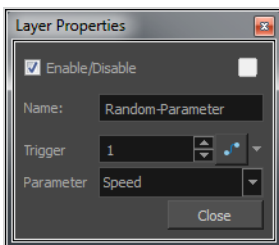

Parameter	Description
Name	Allows you to change the name given to the node.
Trigger	An on/off switch using binary code. 1 = on, 0 = off.
Parameter	Lets you choose a parameter to make random: None, Acceleration, Speed, Rotation Speed, and Position.

Region Composite

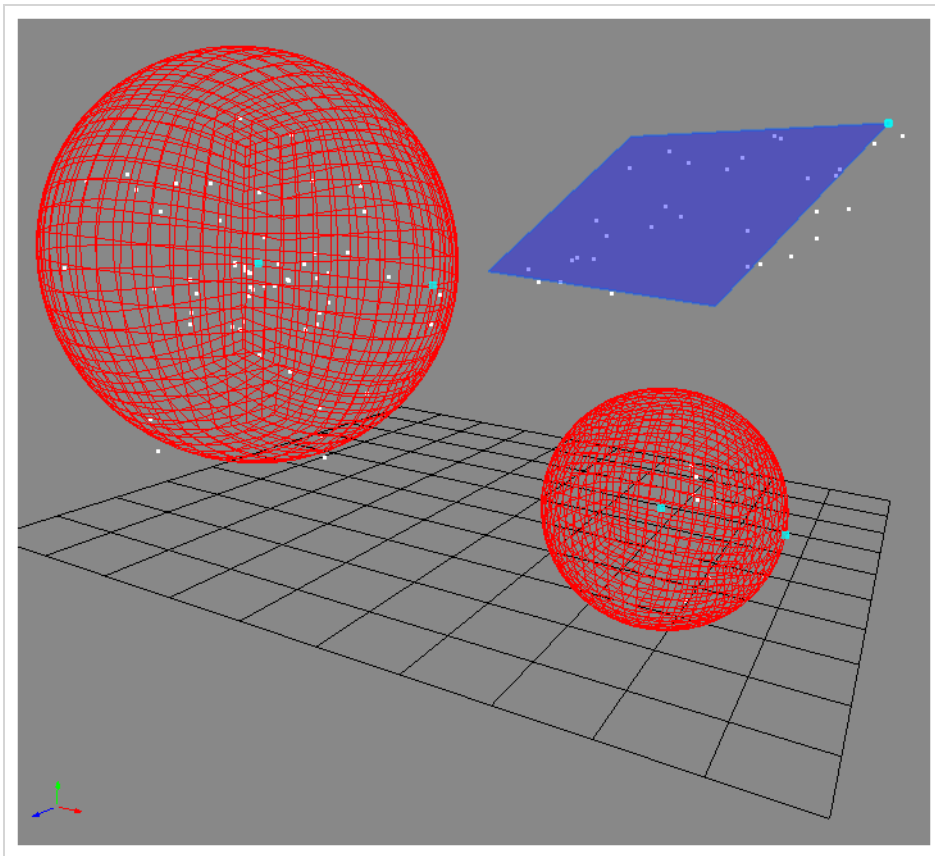

The Region Composite effect lets you composite multiple regions, 3D regions or planar regions. You may want to emit particles from multiple regions in the same particle system.

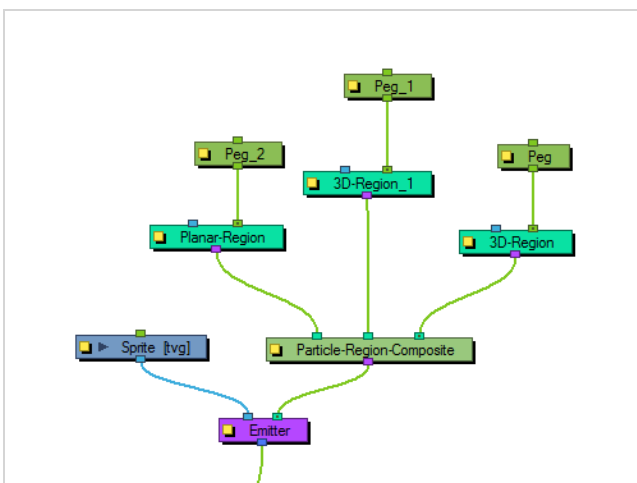

Repulse

The Repulse effect repulses a particle around a region, but is different than the Bounce node as it is repelled before it physically hits the region.

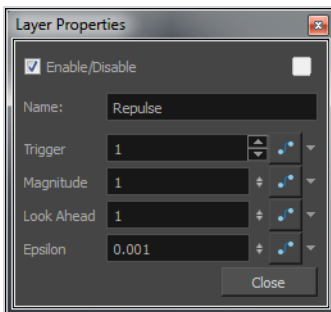
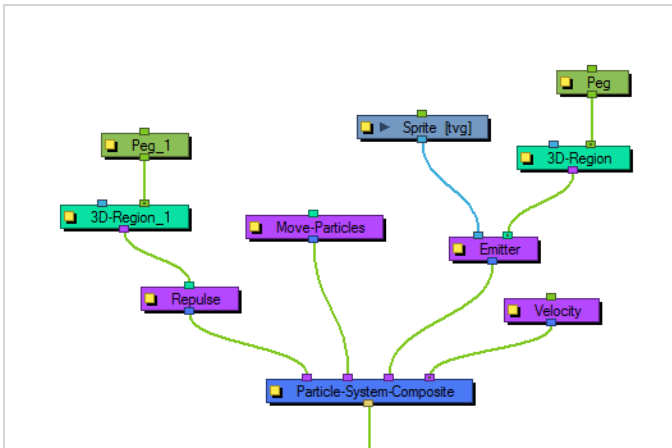

Repulse Properties

Parameter	Description
Name	Allows you to change the name given to the node.
Trigger	An on/off switch using binary code. 1 = on, 0 = off.
Magnitude	This value should be between 0 and 2. The higher the value, the more drastically the particles will be repulsed.
Look Ahead	Determines how far ahead of the particle's current position to see whether there's an obstacle coming. This value should be between 0 and 100.
Epsilon	Affects how quickly the effect of the repulse wears off. The smaller the number, the longer the effect lasts. This value should be between 0.1 and 0.0001.

Rotation Velocity

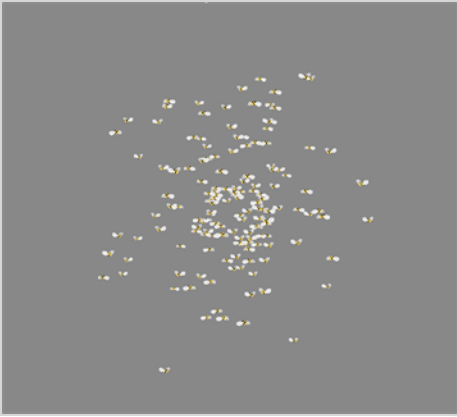

The Rotation Velocity effect lets you define the initial rotational velocity of the particles. The values that you set up for this node refer to each individual particle's drawing axes. This means that if you choose to rotate around the X-axis, it will rotate around each particle's local X-axis as defined by its drawing plane.

The rotational velocity should be set before you emit the particles, such as to the right, so the velocity is taken into account when the particles are created.

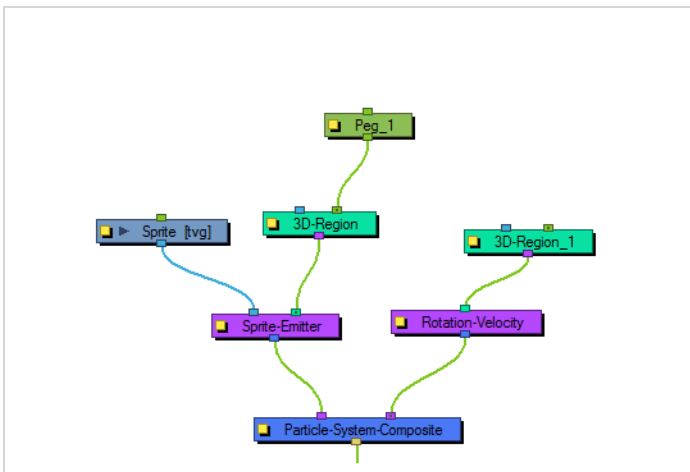

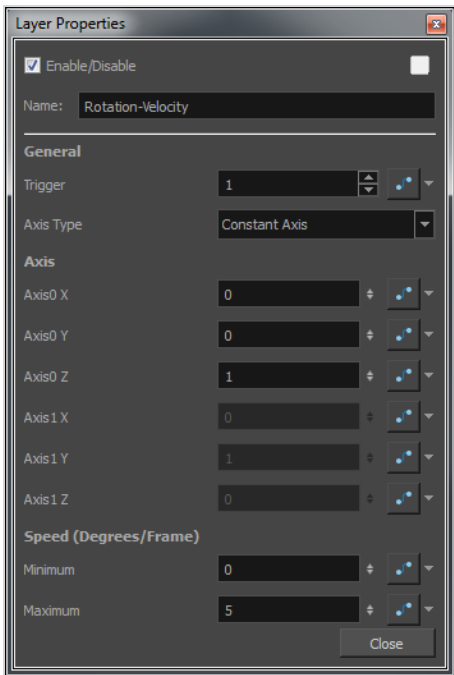

Rotation Velocity Properties

Parameter	Description
Name	Allows you to change the name given to the node.
General	<p>Trigger: An on/off switch using binary code. 1 = on, 0 = off.</p> <p>Axis Type: Lets you select the type of axis to use.</p> <ul style="list-style-type: none"> • Use Input Shape: Uses a region to define the rotational axis of the particles. The axis of each particle's rotation will be perpendicular to the plane that particle is created on. • Constant Axis: If you choose to rotate the particles around a constant axis, then each particle will rotate around the same axis. This axis will then be defined as Axis0. • Interpolated Axis: If you choose to rotate the particles around an interpolated axis, that means each particle will have its own rotational velocity which lies somewhere between Axis0 and Axis1.
Axis	<p>Axis0 X: Defines the X component of Axis0. If you set the X to 1, and the Y and Z to 0, then the particle will rotate around its X-axis as defined by its drawing plane. If you set X to 1 and also Y to 1, then it will rotate around an axis that is 45 degrees between X and Y.</p> <p>Axis0 Y: Defines the Y component of Axis0.</p> <p>Axis0 Z: Defines the Z component of Axis0.</p>

	<p>Axis1 X: Defines the X component of Axis1. This applies only when you have selected an Interpolated axis.</p> <p>Axis1 Y: Defines the Y component of Axis1.</p> <p>Axis1 Z: Defines the Z component of Axis1.</p>
<p>Speed (Degrees/Frame)</p>	<p>Minimum: The minimum initial rotation that a particle can have, in degrees per frame.</p> <p>Maximum: The maximum initial rotation that a particle can have, in degrees per frame.</p>

Sink

The Sink effect causes particles to disappear when outside the region that is plugged into the sink. It can also be inverted, so the particles disappear when they enter the region instead.

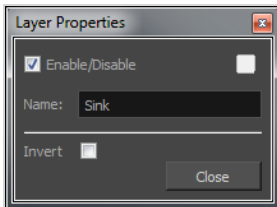
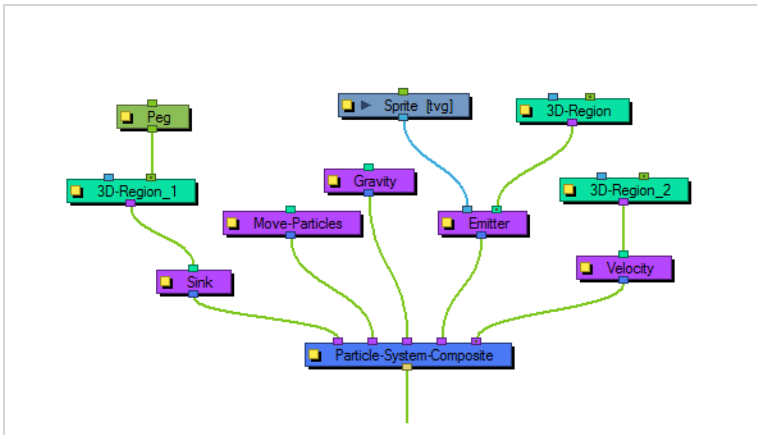

Sink Properties

Parameter	Description
Name	Allows you to change the name given to the node.
Invert	The default behaviour of the sink is for particles to disappear when they depart the region. When inverted, the particles disappear when they enter the region instead.

Size

The Size effect lets you animate the size of the particles.

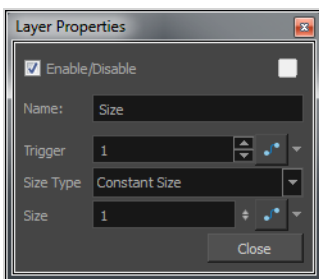
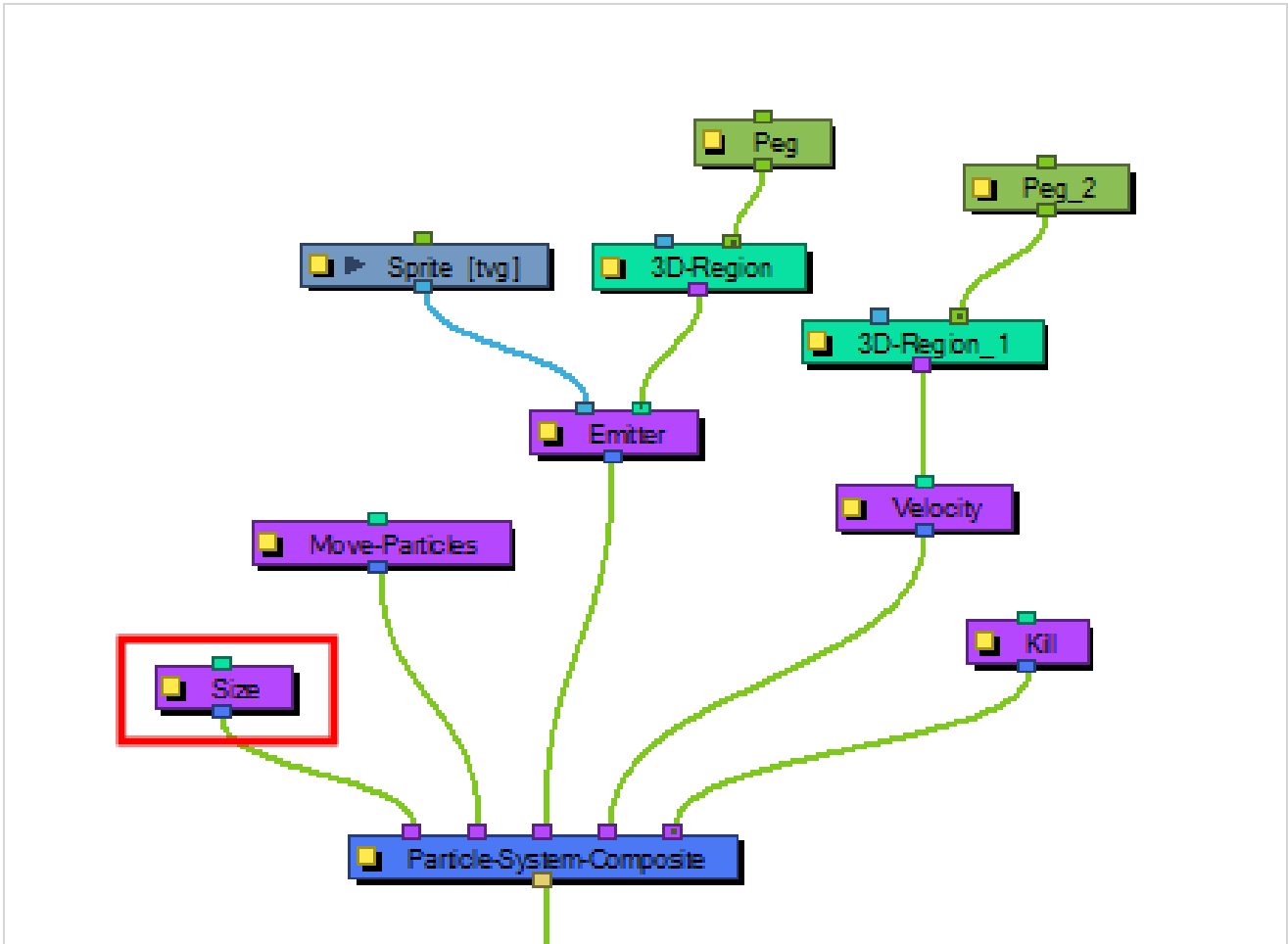

Size Properties

Parameter	Description
Name	Allows you to change the name given to the node.
Trigger	An on/off switch using binary code. 1 = on, 0 = off.

Size Type	Lets you select a type for the size. If you choose Constant Size, then all particles will be animated to have the same size. If you choose Input Shape instead, then you must input a Region into the in-port of the Size node. It will use this region to determine the size of the particles.
Size	Lets you adjust the size of the particles.

:

:

Sprite Emitter

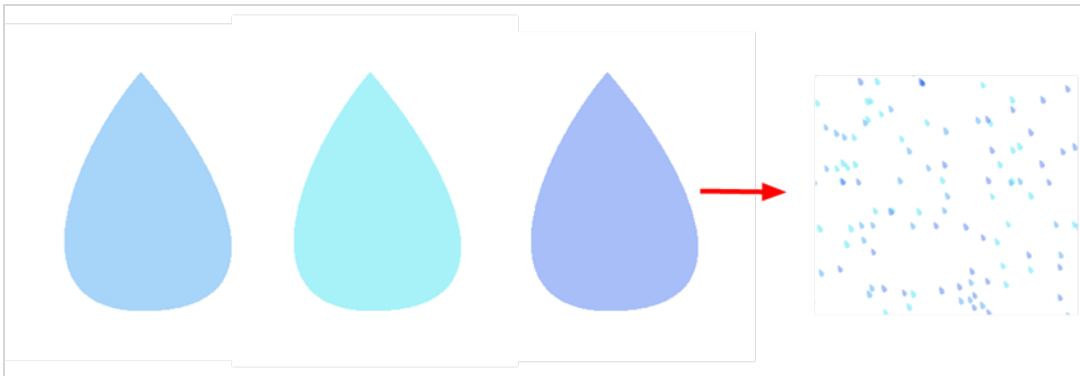

The Sprite Emitter effect is an all-purpose emitter. You can plug it into a drawing layer to generate particles that look like your drawing layer. You could also just output dot particles if you have no image layer connected. There are many parameters to control how particles are emitted.

Sprite Emitter Properties

Generation Tab

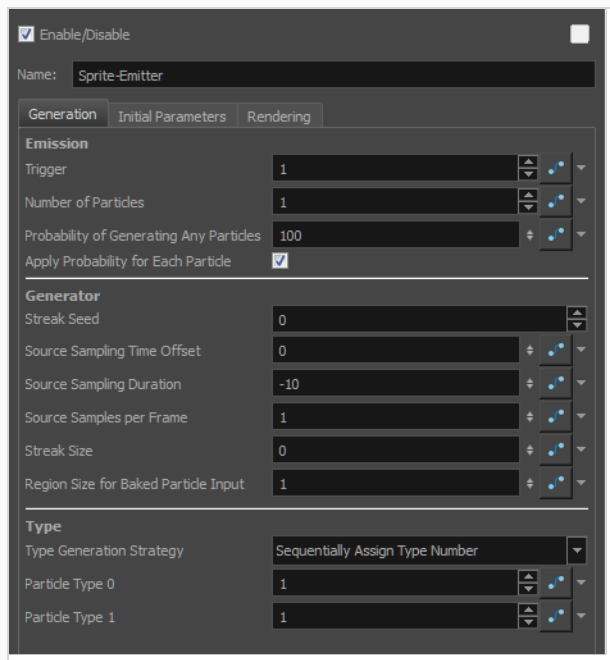

Parameter	Description
Emission	Trigger: An on/off switch using binary code. 1 = on, 0 = off.

	<p>Number of Particles: This is where you can define how many particles will be emitted on each frame.</p>
Generator	<p>Probability of Generating Any Particles: This is a probability percentage between 0 and 100. If the probability is set to 100%, it will generate the Number of Particles specified. If you set the percentage to 50%, then there's only a 50% chance that it will generate the number of particles set in the Number of Particles. You can play with this value to add random spacing to the generation of particles.</p> <p>Streak Seed: The number of streaks to generate.</p> <p>Source Sampling Time Offset: Sets the streak start at a different time to offset its position.</p> <p>Source Sampling Duration: This parameter is the key to generating streaks. If set to 0, the behaviour is the same as before. If set to -10 for example, it will sample the input region (in this example the Planar-Region) 10 frames in the past. If in this mode, the Number of Particles parameter is the number of streaks to generate. If you want to generate five streaks for example, you need to set the Streak Size to a value different than 0, otherwise all the streaks will be at the same spot.</p> <p>Source Samples Per Frame: The number of subdivisions for each frame. A value of 1 generates a particle for each frame. A value of 16 generates a particle on each 1/16th of a frame.</p> <p>Streak Size: The radius of the sphere used for sampling the offset of the streak.</p> <p>Region Size for Baked Particle Input: The Baked Particle Input property refers to when you use a Baker as an input to a Sprite Emitter. You can do this when you want to generate particles from other particles. When you do this, you have the option of setting a sphere around the source particle from which the new particle system will generate particles. That is the region which is referred to in this value. If you look at the following example, you'll see that the purple smiley faces are generating smaller green, blue, and yellow smiley faces. This is done by plugging the Baker from the purple smiley faces into the Sprite Emitter of the other smiley faces. See the following images:</p>

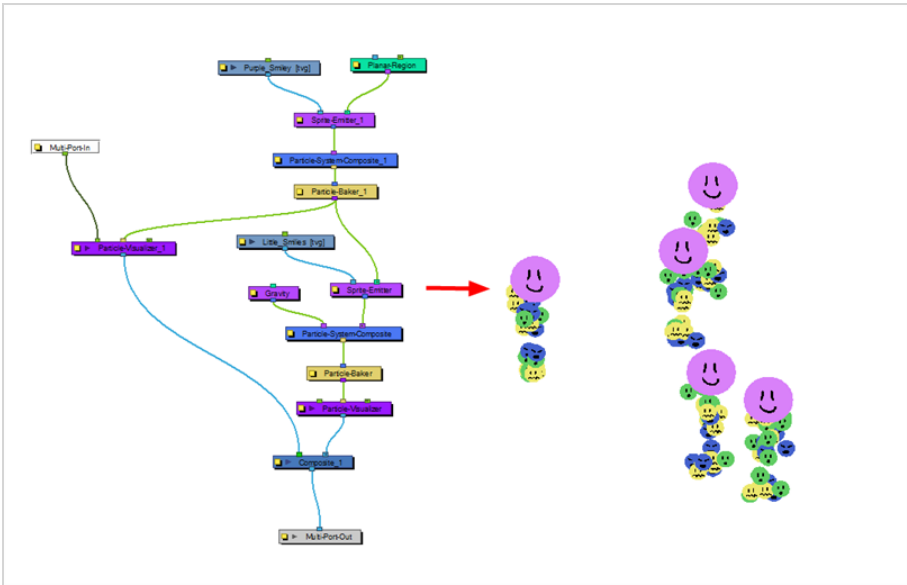
	
<p>Type</p>	<p>You may want to design a variety of different drawings that will vary the appearance of your particle system. To do this, you should put each drawing on its own cell in the drawing layer. Each drawing will then be a new Type of particle.</p> <p>Type Generation Strategy:</p> <p>Lets you sequentially or randomly assign a type (moving from one drawing to the next).</p> <p>Particle Type 0:</p> <p>This is the frame number of the first drawing. If you have a 5-frame cycle that starts on frame 1, you would put a 1 here.</p> <p>Particle Type 1:</p> <p>This is the frame number of the last drawing. If you have a 5-frame cycle that starts on frame 1, you would put 5 here.</p>

Initial Parameters Tab

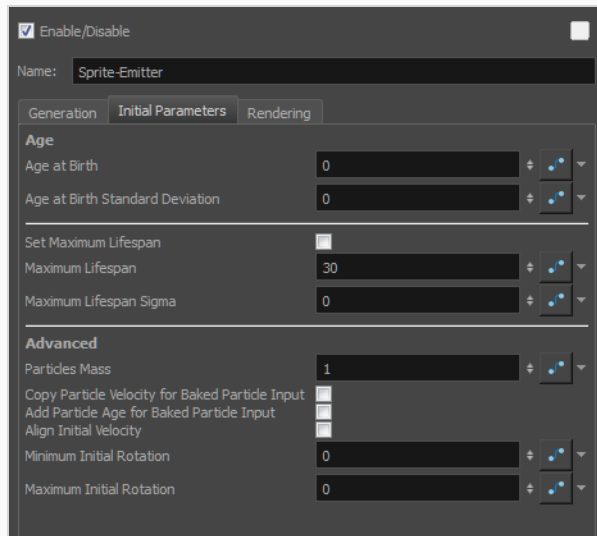

Parameter	Description
Age	<p>Age at Birth: A different start frame number can be entered in this field. This means that a particle can start with a different drawing than the drawing that you have on frame 1.</p> <p>Age at Birth Standard Deviation: Allows a random deviation for the birth of the particles. If you have a 5-frame cycle that starts on frame 1, but you want the particles to be of a random type, then you may want to set the Age and Birth to 3 with a standard deviation of 2. That means that particles will randomly be born at any frame from 1 to 5.</p>
	<p>Set Maximum Lifespan: Makes particles die automatically.</p> <p>Maximum Lifespan: This is how long the particle will exist before dying.</p> <p>Maximum Lifespan Sigma: The lifespan variation of particles. If set to 0, all particles will have the same lifespan. A larger value means that particle lifespans will be distributed over a larger range.</p>
Advanced	<p>Particles Mass: Define a mass for the particles. This mass will affect how the particles interact with gravity.</p> <p>Copy Particle Velocity for Baked Particle Input: If you select this option, the velocity of the parent system will be applied to the child system when a Baker is used as the region for a Sprite Emitter.</p> <p>Add Particle Age for Baked Particle Input: If you select this option, the age of the</p>

	<p>parent system will be inherited by the child system when a Baker is used as the region for a Sprite Emitter.</p> <p>Align Initial Velocity: This aligns the initial velocity with the region from which the particles are being emitted. If you are emitting from a sphere, then the particles will all start out moving away from the centre of the sphere.</p> <p>Minimum Initial Rotation: Define a minimum rotation in degrees that the particle can have when it is generated. There is also a separate Rotation-Velocity node in which you can define this parameter.</p> <p>Maximum Initial Rotation: Define a maximum rotation in degrees that the particle can have when it is generated.</p>
--	--

Rendering Tab

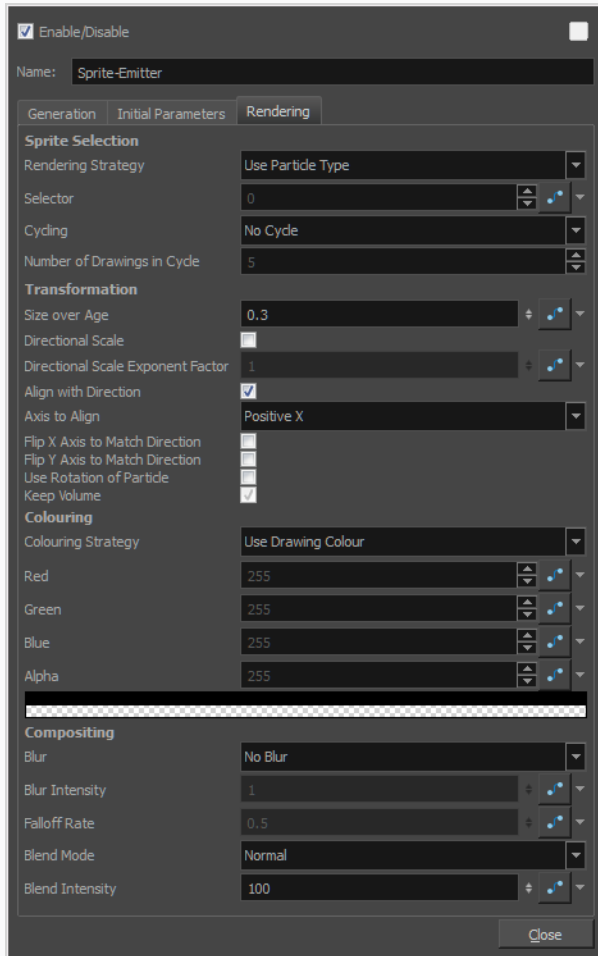

Parameter	Description
-----------	-------------

Sprite Selection

Rendering Strategy: Select a method to determine the particle type defined for each particle that is created.

- **Render as Dot:** Renders each particle as a dot. This is useful mainly for previewing the effects of your particle system without using the drawing layer (sprite).
- **Use Frame Number:** As the frame number increases, the type of particle will change to match the frame number. This means that ALL particles in the system will change together as the frame number changes. If you only have a few drawings, then you may want to enable Cycling to cycle those drawings.
- **Use Frame Number as Index in Selector:** When you select this option, you can use the Selector to animate the Frame Number it uses over time. So, instead of taking the current frame as the Frame Number, you can write your own function instead. For example, if you animate the selector so that at frame 1, it starts out at 2, then 8 frames later you add another keyframe to set the value to 4. Between frame 1 and frame 8, the particles will all change type together from what they look like on frame 2 to what they look like on frame 4.
- **Use Particle Type:** Each particle that is generated will look like the Particle Type that was assigned on the Generation tab. For example, if you use a value of 1 for Particle Type 0, and 6 for Particle Type 1, then each particle will be assigned a type from 1 to 6. This type corresponds to the drawing that appears on the sprite on that frame number. So if you have a drawing layer called Sprite that is plugged into the left in-port of the Emitter, it will look for the drawings in cells 1 to 6 of Sprite to assign those drawings to each particle.
- **Use Particle Type as Index in Selector:** This option allows you to use the Selector to manually create a function that assigns how many of which particle will be created.

For example, you can set the Particle Type to go from 1 to 100 in the Generation tab. Then use the Selector to remap the particle types to a certain drawing. So for example you could create five drawings, labelled 1 to 5, and use the selector to create mainly 1s, no 2s, a few 3s, 4s, and a very few 5s. What it's doing is looking at the X-axis to find what the particle "type" is, then looking at the Y-axis to find out which drawing to assign to that "type." When you use 1 to 100 as a type, then when you're setting the values, they act as a percentage.

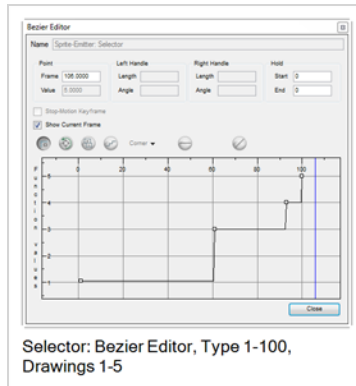
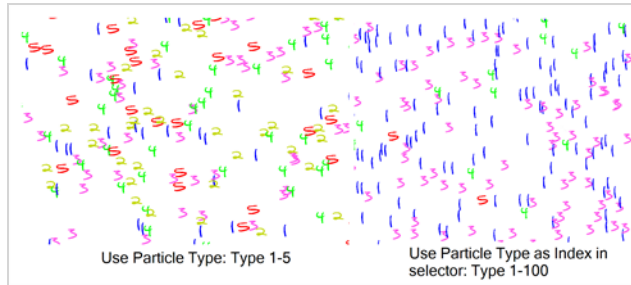

Selector: Bezier Editor, Type 1-100, Drawings 1-5

- **Use Age:** As the particle ages, it will change appearance from what appears on the Sprite's first drawing to the subsequent drawings. This means that each particle can have its appearance animated as it gets older.
- **Use Age as Index in Selector:** You can animate the Selector to change how a particle ages over time. For example, if you have a Sprite with six drawings on it, you might want to animate it so it changes from drawing 1, on frame 1, to drawing 2, on frame 10, then drawing 3 on frame 14, drawing 4 on frame 16, drawing 5 on frame 17, etc. so the particle rapidly ages. This allows you to change the timing of the aging dynamically through the selector, instead of having to modify the exposure of the cells on the Sprite.

Selector: Animates the Selector in conjunction with the Rendering Strategy to adjust the parameters that control the particle's appearance at birth and over time.

Cycling: If you're using rendering strategies like Frame Number or Age, you may want to cycle the drawings. For example, if you are using Frame Number, but you've only got 5 frames worth of drawings in your Sprite, then if you use "No Cycle," your Particles will disappear after frame 5. You can choose to cycle Normally (1-2-3-4-5-1-2-3-4-5) or Back and Forth (1-2-3-4-5-4-3-2-1).

Number of Drawings in Cycle: Lets you indicate how many frames from your Sprite you'd like to cycle.

Transformation	<p>Size over Age: Lets you determine the size of the particle as it ages. Attach a function to this attribute if you want to, for example, have the particles get smaller as time goes on.</p> <p>Directional Scale: Scales the particle in the direction of its movement.</p> <p>Directional Scale Exponent Factor: Sets an exponent here for how much you want that particle to scale.</p> <p>Align with Direction: Aligns the particle in the direction of its movement.</p> <p>Axis to Align: Select the axis that you want to align. This axis refers to the axis of the Drawing grid from the Drawing node plugged into the emitter.</p> <p>Flip X Axis to Match Direction: You may want to have the particle align to the X direction of movement. You can see this property being used in the Lemmings example.</p> <p>Flip Y Axis to Match Direction: Similar to flipping the X axis, you may want to flip the Y axis of a drawing to match the direction of the particle movement..</p> <p>Use Rotation of Particle: Enables rotation on the particle.</p> <p>Keep Volume: When you choose to do a Directional Scale, this will automatically maintain the volume of the particle by squashing it proportionally to how much it stretches as a result of the directional scale.</p>
Colouring	<p>Colouring Strategy: Lets you choose how to define the colour of the particle.</p> <ul style="list-style-type: none"> • Use Drawing Colour: The particle remains the same colour as it was drawn with. • Map RGB Based on Age: Attach a function to this to vary the Red, Green, and Blue values of the particle as it ages. • Map RGBA Based on Age: Attach a function to this to vary the Red, Green, Blue, and Alpha values of the particle as it ages. • Apply Opacity Based on Age: Keeps the original RGB values from the drawing, but vary the Alpha (Opacity) according to a function that you define here. • Map RGB Based on Frame: Changes the Red, Green, and Blue values of the particles based on the frame. Changing based on the frame means that ALL particles will change colour on that frame, regardless of their age. • Map RGBA Based on Frame: Changes the Red, Green, Blue, and Alpha values of all particles on a given frame by attaching a function. • Apply Opacity Based on Frame: Uses the original RGB values from your drawing, but varies the Alpha (Opacity) of the particles on a certain frame by attaching a function to this.

	<ul style="list-style-type: none"> • Use Particle Colour: Particles are created using the Red, Green, Blue and Alpha values at the current frame. The colour and alpha of each particle remain static. If those values are animated, the colour of new particles change, while existing particles remain the same colour. • Use Particle Alpha: Particles are created with the Red, Green, Blue and Alpha value of the current frame. While their colours remain synchronized with the Red, Green and Blue values, the alpha of each particle remains static. So if the Red, Green, Blue and Alpha values are animated, the colour of all the particles will be animated, but each particle will retain the alpha they had when they were created. <p>Red, Blue, Green, Alpha: This is where you can attach functions to the Red, Blue, Green and Alpha values. You can also click on the colour swatch to adjust the colour.</p>
<p>Compositing</p>	<p>Blur: Lets you determine the Blur to apply to the particles.</p> <ul style="list-style-type: none"> • No Blur: No blur will be applied to the particles. • Directional Blur Based on Age: Attaches a function to define how you want the particles to blur based on the age of each particle. The particle will blur in the direction of movement. • Directional Blur Based on Frame: Attaches a function to define how all particles should be blurred at a particular frame. The particle will blur in the direction of movement. • Low Quality Radial Blur Based on Age: Attaches a function to define how you want the particles to blur based on the age of each particle. This will be a low quality blur. • Low Quality Radial Blur Based on Frame: Attaches a function to define how all particles should be blurred at a particular frame. This will be a low quality blur. • Low Quality Radial Blur Based on Camera Distance: Defines how you want the particles to blur based on their distance from the camera. This is a low quality blur. • High Quality Radial Blur Based on Age: Attaches a function to define how you want the particles to blur based on the age of each particle. This is a high quality blur. • High Quality Radial Blur Based on Frame: Attaches a function to define how all particles should be blurred at a particular frame. This is a high quality blur. • High Quality Radial Blur Based on Camera Distance: Defines how you want the particles to blur based on their distance from the camera. This is a high quality blur.

Blur Intensity: Lets you set a value or attach a function to animate the blur according to the type of blur that was defined from the drop-down list.

Falloff Rate: The distance where the blur fades from the edge of the image. Select a value between 0 and 1. A falloff rate of 0 causes the blur to fade out slowly, distributing the blur evenly from the edge of the drawing to the farthest edge of the blur. A falloff rate of 1 causes the blur to fade out quickly so that the blur is heaviest at the edge of the drawing.

Blend Mode: Defines a blend mode for the particles to get cool effects.

Blend Intensity: This is a percentage of how opaque you want the particles to be blended. 50 = 50% transparent. 100 = opaque.

System Composite

The System Composite node is where you connect all the "Actions" of your particle system. An action includes any of the light-purple nodes, like Gravity, Emitters, and velocity parameters. All of the "Actions" help to define the behaviour of the particle system.

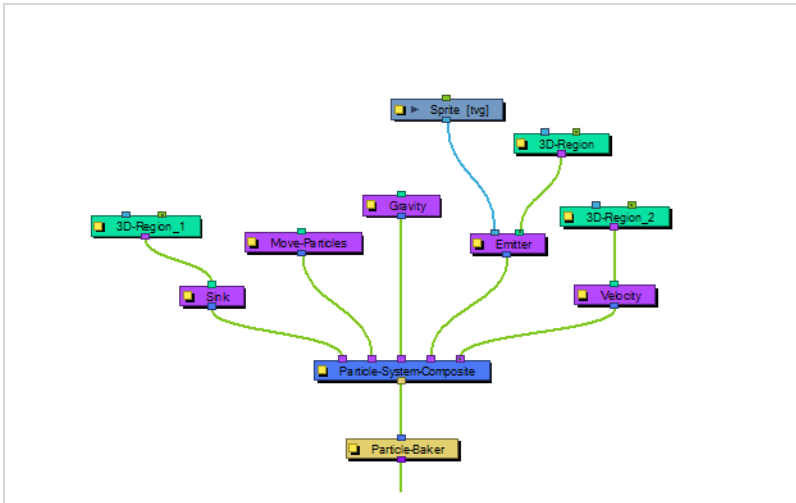

Velocity

The Velocity effect defines the initial velocity of the particles that are emitted in the particle system. You can select this node and select **View > Show > Control** to display the manipulation handles to help you set the parameters of this node. Use your Transform tool to modify the manipulation handles in the Camera or Perspective view.

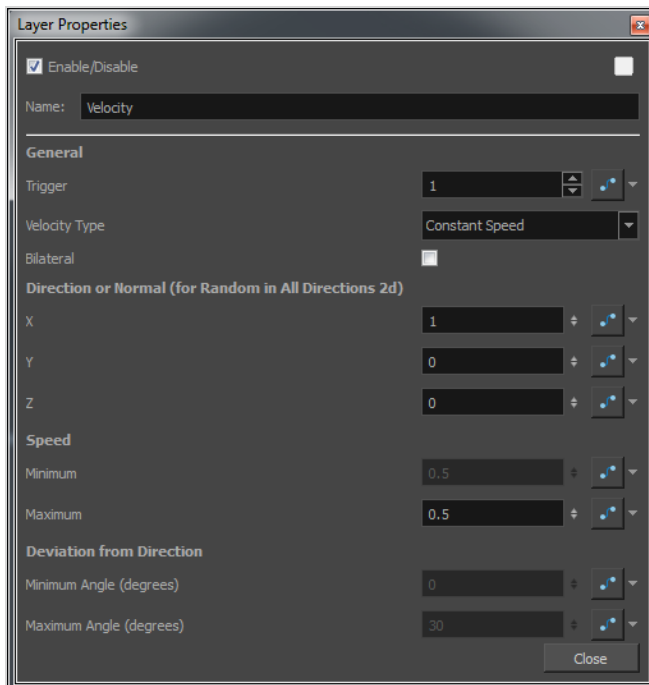
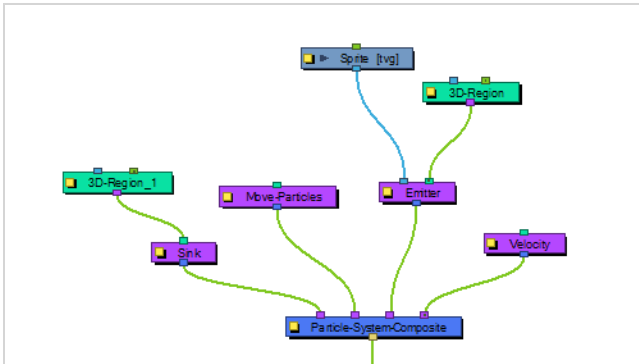

Velocity Properties

Parameter	Description
General	Trigger: Is an on/off switch using binary code, where 1 = on, while 0 = off.
	Velocity Type <ul style="list-style-type: none"> • Use Input Shape: If you plug a Region into the in-port of the Velocity

	<p>node, it will take the shape of this region to determine the initial velocity of the particles. They will take a velocity that is perpendicular to the surface of the shape.</p> <ul style="list-style-type: none"> • Constant Speed: Sets a constant speed for the initial velocity of the particles. • Interpolated Speed: Each particle is assigned an initial speed that is somewhere between the two values set for Interpolated Speed. • Random in All Directions 2D: All particles will be assigned a random velocity in any direction on a 2D plane. • Random in All Directions 3D: All particles will be assigned a random velocity in any direction. • Random in Cone: Particles will be assigned an initial velocity anywhere in the shape of a cone. • Random in 2D-Pie: Particles will be assigned an initial velocity anywhere in the shape of a pie slice on a 2D plane. <p>Bilateral: Generates positive and negative velocities in a given direction. For example, you can generate particles with cone-shaped velocity, (e.g. a bazooka firing) going only in the forward direction, but you can also generate velocities in the opposite direction.</p>
<p>Direction of Normal (for Random in all Directions 2D)</p>	<p>Lets you input values for the perpendicular direction for the Random property in All Directions 2D.</p> <p>X: Sets a value between 0 and 1 to determine how much influence the X-axis has over the direction of the normal. For example, if the X value is set to 1, and Y and Z are set to 0, then the perpendicular (normal) will be going in the X direction. If X is set to 1, and Y is also set to 1, then the axis will be 45 degrees, halfway between X and Y. Feel free to use the Manipulation Handles for the velocity node by selecting the Velocity node and then selecting View > Show > Control. This will allow you to use the Transform tool in the Camera View or the Perspective View to set the appropriate values.</p> <p>Y: Set a value between 0 and 1 to determine how much influence the Y-axis has over the direction of the normal.</p> <p>Z: Set a value between 0 and 1 to determine how much influence the Z-axis has over the direction of the normal.</p>
<p>Speed</p>	<p>Minimum: There are some speeds that are constant, and some that are a range of values between a minimum and maximum. Set the minimum speed here.</p> <p>Maximum: Set the maximum speed for interpolated speeds.</p>
<p>Deviation from Direction</p>	<p>Minimum Angle: This is used for Cone and Pie shapes. Put a non-zero value here</p>

	<p>if you want there to be a hole in the middle of your cone or pie.</p>
--	--

Maximum Angle: Set the maximum angle for your cone or pie here.

Visualizer

The Particle-Visualizer effect renders and flattens the particle system down to a single plane. You can plug a peg module into the left port to animate the position of the whole particle system. Plugging a peg into the right port will move the depth where the flat plane is generated, so you can move it behind or in front of various other drawing layers in your scene. You can even have two Visualizers with pegs in the right in-ports that are at different depths to display some particles in front of and some particles behind a character or drawing in the scene.

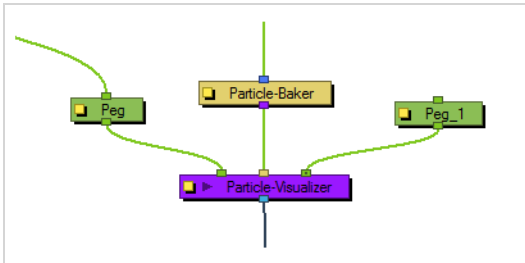

Visualizer Properties

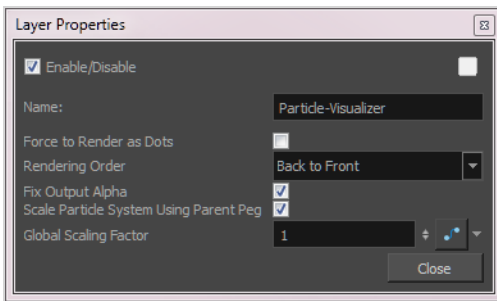

Parameter	Description
Force Render as Dots	Temporarily renders your system as Dots when previewing a simulation. All drawings are ignored and the system is forced to render as dots. Note: You can also use the option View > Particle > Show Particles as Dots in OpenGL. When enabled, the particles will always be displayed as dots in the OpenGL preview mode to make playback speed faster for heavy scenes.
Rendering Order	Lets you set the order in which you want the particles to appear in the render. Back to Front: Added particles will appear behind existing particles. Front to Back: Added particles will appear in front of existing particles. Oldest to Youngest: Older particles will appear behind younger particles. Youngest to Oldest: Older particles will appear in front of younger particles. Ascending Types: Lower types will appear behind higher types. Descending Types: Lower types will appear in front of higher types.

Fix Output Alpha	This is an important option when using some filters like Screen or Multiply in the Blend Mode that can be specified in the Rendering tab of the Emitter. When working with premultiplied images, if the alpha is not fixed in the visualizer, you may see some unusual artifacts.
Scale Particle System Using Parent Peg	Respects the scaling of a particle system so you can position and resize it as you like. Old scenes with particle system will still work as this option is disabled.
Global Scaling Factor	Lets you set the scaling factor for particle system.

Vortex

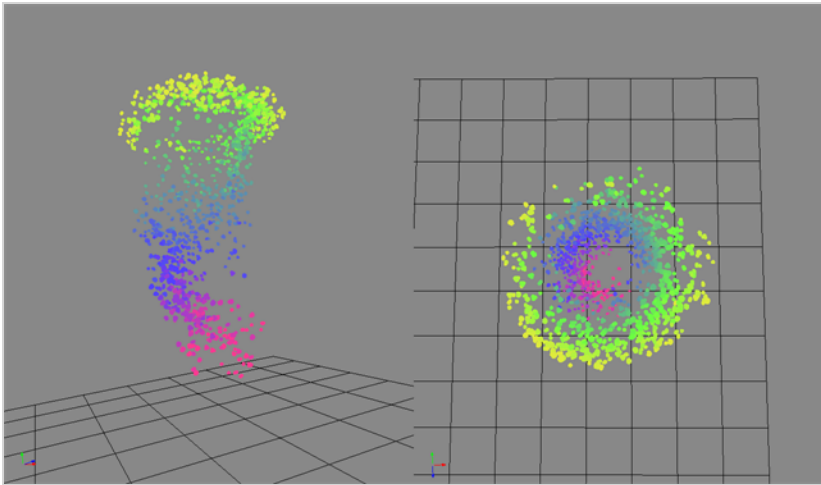

The Vortex effect allows you to define an axis as a vortex, so the particles will spin around this axis.

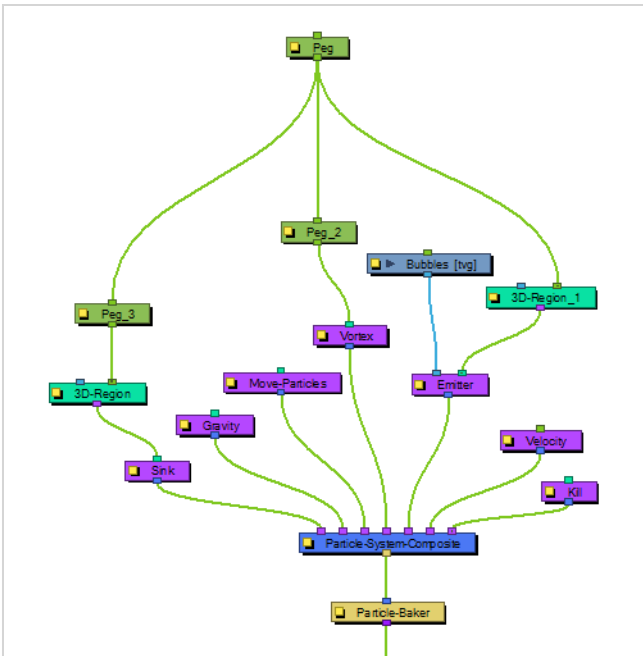

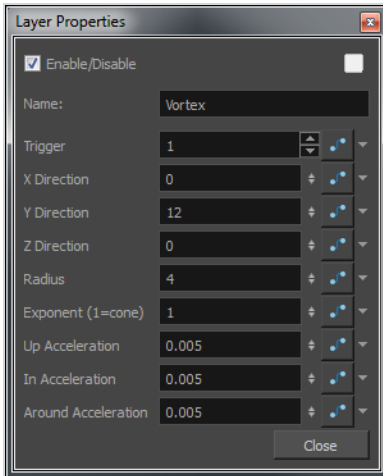

Vortex Properties

Parameter	Description
Trigger	An on/off switch using binary code, where 1 = on and 0 = off.
X Direction	Defines the X portion of the axis of rotation for the Vortex.
Y Direction	Defines the Y portion of the axis of rotation for the Vortex.
Z Direction	Defines the Z portion of the axis of rotation of the Vortex.
Radius	Defines the radius at the top of the vortex.
Exponent (1=cone)	Defines a curve that gives the Vortex a certain silhouette. 1 forms a cone, greater than 1 curves inward.
Up Acceleration	Defines the vertical acceleration of the particles that are inside the Vortex.
In Acceleration	Defines the inward acceleration of particles that are outside the Vortex.
Around Acceleration	Defines the acceleration around the vortex of particles that are inside the Vortex.

Wind-Friction

The Wind-Friction effect lets you define the amount of wind in the scene, and animate the wind over time.

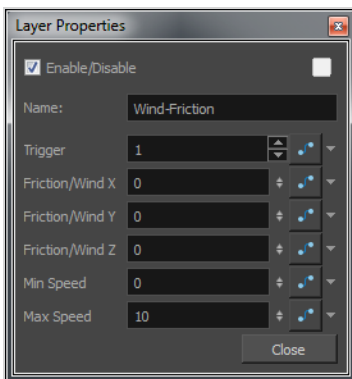
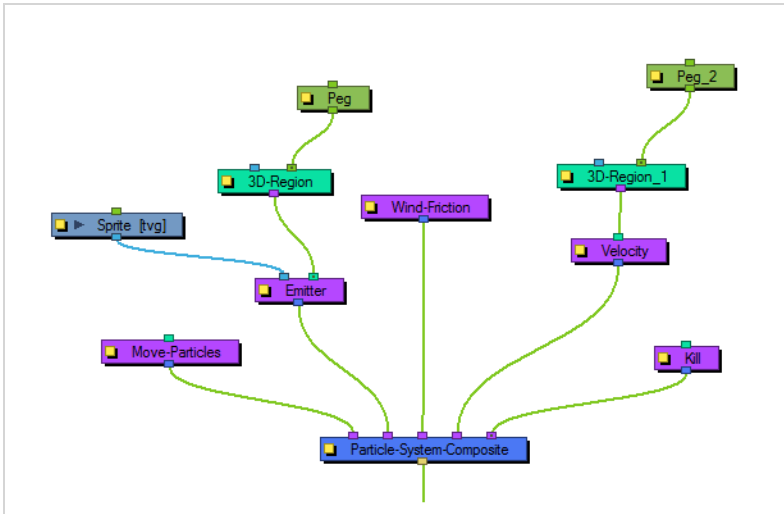

Wind-Friction Properties

Parameter	Description
Trigger	An on/off switch using binary code, where 1 = on and 0 = off.
Friction/Wind X, Y, Z	Defines the amount that the wind will dampen or increase the speed of the particles in the X, Y or Z direction.
Min Speed	The minimum speed of particles that will be affected by the wind. Particles moving slower than this will not be affected
Max Speed	The maximum speed of particles that will be affected by the wind. Particles moving faster than this will not be affected.

Shading Nodes

Harmony provides you with a wide series of parameters to customize your light shading effects.

Ambient Occlusion Node	907
Cast Shadow Node	911
Light Position Node	918
Light Shader Node	920
Light Shader Properties - Surface Light Tab	924
Normal Map Node	925
Normal Map Converter Node	929
Shape Curve Node	931
Shape Line Node	934
Shape Render Node	936
Surface Map Node	939
Layer Properties	940
Surface Normal Node	943
Tone Shader Node	945
Tone Share Properties - Surface Light tab	948
Volume Object Node	949

Ambient Occlusion Node

The Ambient Occlusion node is part of the Surface Shading set of nodes and uses the Surface Map node to calculate the shadows.

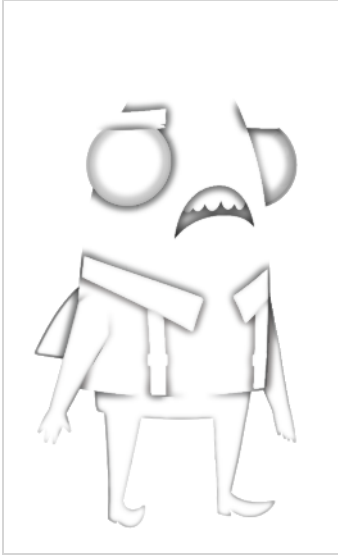

The ambient occlusion node creates a shadow that helps to emphasize the depth and roundness of a character. This node shades areas on a surface that would be difficult for any ambient lighting to reach. The value of the shadow is relative to the depth of the pixel compared to depth of the surrounding pixels in a range. This shadow does not refer to the position of the light, but instead behaves as an ambient shadow in the scene.



NOTE

For more information on how to use the Surface Shading set of nodes, refer to the User Guide.

Layer Properties

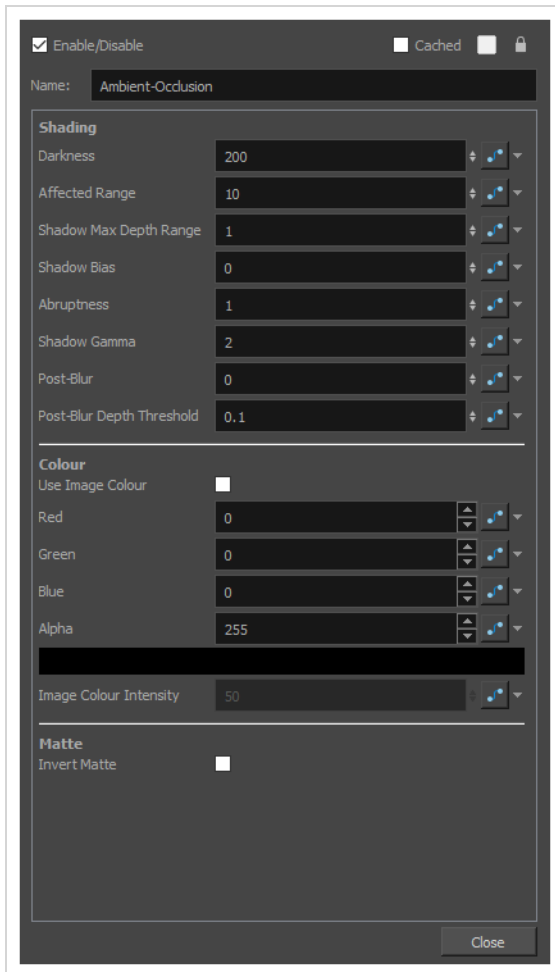

Parameter	Description
Shading	All properties relating to the shading method appear in the Shading category.
Darkness	The percentage multiplier defining the darkness of the shadow. A higher value will produce a darker shadow. Often, the ambient occlusion requires a larger multiplier in order to amplify its effect.
Affected Range	The range in pixels that is scanned when calculating the ambient occlusion. A lower value will produce a smaller, sharper shadow.
Shadow Max Depth Range	In order to prevent major differences in shadows from surface to surface, the Shadow Max Depth Range limits the maximum difference between surface depths to the value defined.

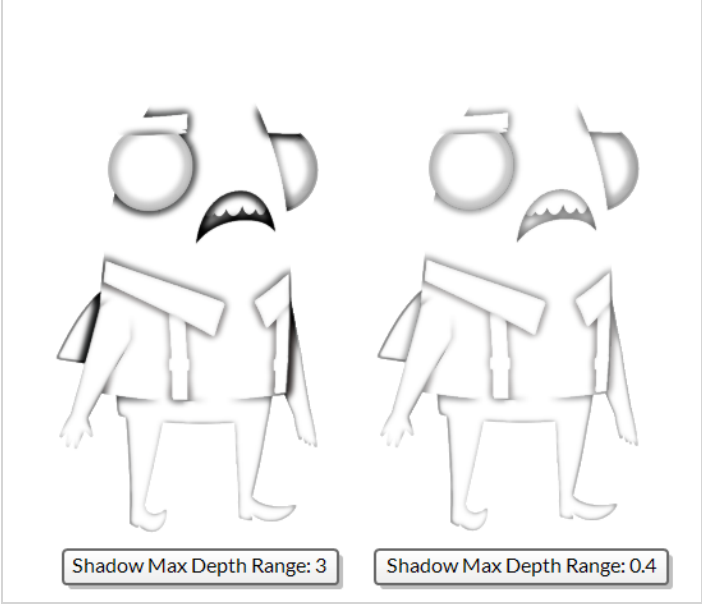
Parameter	Description
	
<p>Shadow Bias</p>	<p>The Shadow Bias can be used to lighten a shadow. This value is subtracted from the shadow's value when calculated.</p> <p>Darker shadows will be kept, but values below the shadow bias will be removed.</p>
<p>Abruptness</p>	<p>The Abruptness is a value that is used to change the sharpness of a shadow and affects its rate of change.</p> <p>A value of one produces a linear shadow that falls off smoothly, a higher value will cause darker areas to become darker, and lighter areas to become lighter.</p>
<p>Shadow Gamma</p>	<p>Defines the rate of change in a shadow.</p> <p>A lower value will produce a shadow that appears softer and changes from light to dark slowly. A higher value will appear sharper and darker, and changes from light to dark quickly.</p>
<p>Post-Blur</p>	<p>The range of the blur applied to the calculated Ambient-Occlusion effect.</p>
<p>Post-Blur Depth Threshold</p>	<p>In order to separate different surface elevations, this depth range defines a bucket-range in which the shadows are separated and blurred together. This can be used to keep certain edges of the cast shadow sharp, and other areas blended.</p>
<p>Colour</p>	<p>All properties relating to colour and value of the shadow.</p>
<p>Use Image</p>	<p>When checked, the colour of the cast shadow is tinted by the source image provided in the first</p>

Parameter	Description
Colour	image port of the Cast Shadow node.
Colour (Red, Green, Blue and Alpha)	<p>The colour used for the Cast Shadow.</p> <p>If the Use Image Colour option is checked, this colour is used as a tint and is applied to the image colour based on the Image Colour Intensity parameter.</p>
Matte	Properties relating to the optional Matte port of the Cast Shadow node. If you connect a node that outputs an image to the left edge of the Cast Shadow node, it will create a matte connection, and this image will be used as the matte for the Cast Shadow node effect.
Invert Matte	<p>The Matte Port of the Cast Shadow node masks out pixels based on the opacity of the attached image.</p> <p>When unchecked, the default behaviour is to render cast shadows only in areas with transparent or translucent pixels.</p> <p>When checked, this behaviour is inverted and cast shadows will render only in areas with opaque or translucent pixels.</p>

Cast Shadow Node

The Cast Shadow node is part of the Surface Shading set of nodes. It uses the Surface Map node generate cast shadows over the generated surface of a rig.

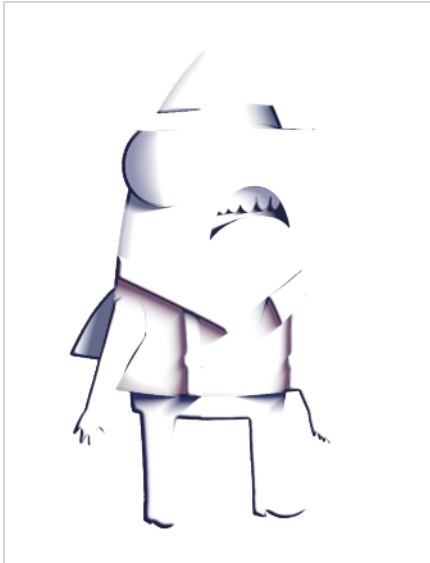

The Cast Shadow is connected to an image source, the Surface Map node and a Light Position node. Based on the relative heights in the Surface Map and the Light Position, shadows are created when the light on a surface is being occluded by another surface in the way of the light.

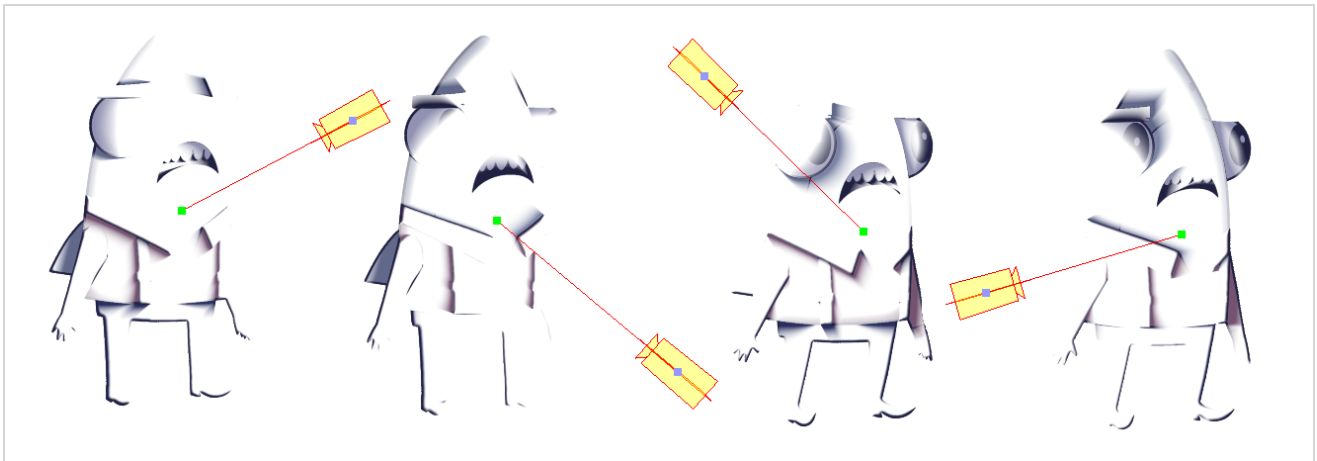

NOTE

For more information on how to use the Surface Shading set of nodes, refer to the User Guide.

Layer Properties

Shadow Tab

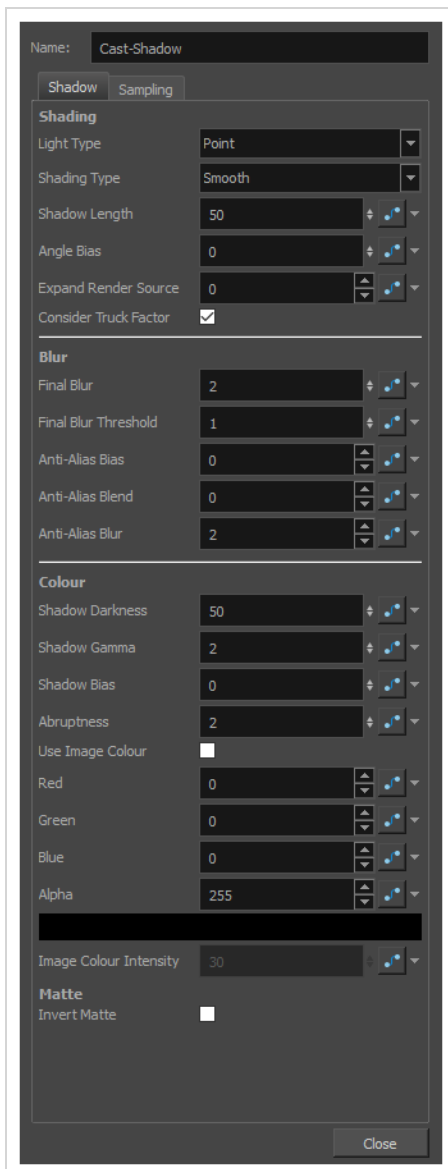

Parameter	Description
Shading	All properties relating to the shading method appear in the Shading category.
Light Type	<ul style="list-style-type: none"> • Directional: A light that is parallel in the scene. Each “beam” of light follows the direction defined by the light source and target, and point in the same direction. This type of light is used when the light source is far away or very big, like the sun. • Point: A light that illuminates everything around it. Its “beam” of light will go in all directions like a fire.

Parameter	Description
Shading Type	<ul style="list-style-type: none"> • Smooth: The shadow effect will have smooth edges. • Sharp: The shadow effect will have sharp edges.
Shadow Length	<p>The shadow length defines how far, in pixels, the shadow will be cast after first being occluded on the surface.</p> <p>A value of 0 will not limit the shadow length, and instead, it will be defined by the position of the light source.</p> <p>A lower value will create a smaller shadow and a higher value will create a longer shadow that falls off as it recedes from the occluded point.</p>
Angle Bias	<p>When calculating the cast shadows, this value is used as a bias comparing the light's angle and the occlusion angle. A positive value will increase the occlusion angle and the shaded areas will appear darker. A negative value will decrease the occlusion angle and the shaded areas will lighten.</p> <p>This bias is applied prior to all further calculations.</p>
Expand Render Source	<p>In order to avoid over-rendering content out of screen this value defaults to 0. Otherwise, this value defines the range that the cast shadow will scan outside of the frame when rendering the shadow.</p>
Consider Truck Factor	<p>Keeps the same ratio for the Light Shading system when the camera zooms in or out.</p>
Blur	<p>All properties relating to blurring the final cast image appear in the Blur category.</p>
Final Blur	<p>The range of the blur applied to the calculated cast shadow effect.</p>
Final Blur Threshold	<p>In order to separate different surface elevations, the final blur threshold defines a bucket-range in which the shadows are separated and blurred together.</p> <p>This can be used to keep certain edges of the cast shadow sharp, and other areas blended.</p>

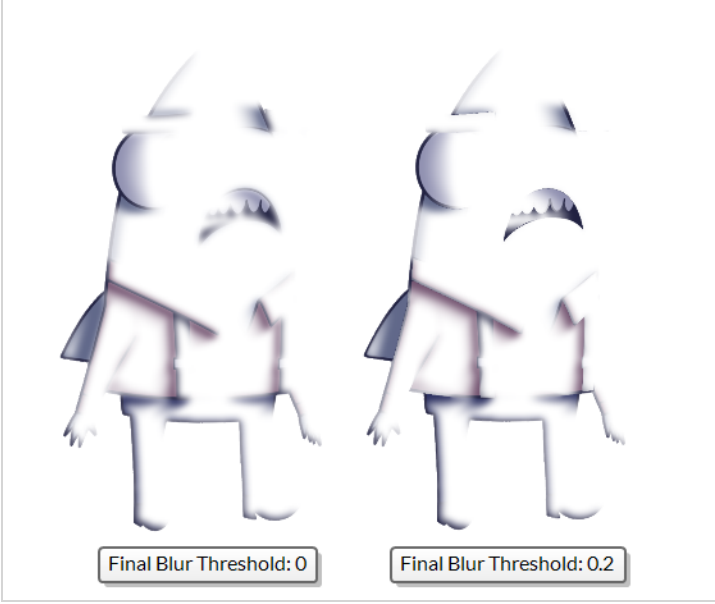
Parameter	Description
	
Anti-Alias Bias	<p>This value works in conjunction with the Anti-Alias Blend.</p> <p>When a shadow begins on an occluded surface, the bias is the amount of pixels ignored before rendering the shadow . This allows you to recede a shadow from its initial occlusion source.</p>
Anti-Alias Blend	<p>This value works in conjunction with the Anti-Alias Bias.</p> <p>When a shadow begins on a surface, the shadow is blended with the surface for the amount of pixels defined by the Anti-Alias Blend.</p>
Anti-Alias Blur	<p>This value defines a blur range that is applied specifically to the starting-edge of a shadow.</p>
Colour	<p>All properties relating to colour and value of the shadow.</p>
Shadow Darkness	<p>A percentage value defining the opacity of the cast shadow.</p>
Shadow Gamma	<p>Defines the rate of change in a shadow.</p> <p>A lower value will produce a shadow that appears softer and changes from light to dark slowly. A higher value will appear sharper and darker, and changes from light to dark quickly.</p>
Shadow Bias	<p>The Shadow Bias can be used to lighten a shadow. This value is subtracted from the shadow's value when calculated.</p>

Parameter	Description
Abruptness	<p>The Abruptness is a value that is used to change the sharpness of a shadow and affects its rate of change.</p> <p>A value of one produces a linear shadow that falls off smoothly, a higher value will cause darker areas to become darker, and lighter areas to become lighter.</p>
Use Image Colour	<p>When checked, the colour of the cast shadow is tinted by the source image provided in the first image port of the Cast Shadow node.</p>
Colour (Red, Green, Blue and Alpha)	<p>The colour used for the Cast Shadow.</p> <p>When the Cast Shadow uses the Image Colour, this colour is used as a tint and is applied to the image colour based on the <i>Image Colour Intensity</i>.</p>
Image Colour Intensity	<p>When Use Image Colour is checked, the incoming colour and value of the source image is used to tint the Cast Shadow colour.</p> <p>This percentage value defines how much of the Cast Shadow colour is provided by the source image.</p>
Matte	<p>Properties relating to the optional Matte port of the Cast Shadow node. If you connect a node that outputs an image to the left edge of the Cast Shadow node, it will create a matte connection, and this image will be used as the matte for the Cast Shadow node effect.</p>
Invert Matte	<p>The Matte Port of the Cast Shadow node masks out pixels based on the opacity of the attached image.</p> <p>When unchecked, the default behaviour is to render cast shadows only in areas with transparent or translucent pixels.</p> <p>When checked, this behaviour is inverted and cast shadows will render only in areas with opaque or translucent pixels.</p>

Sampling Tab

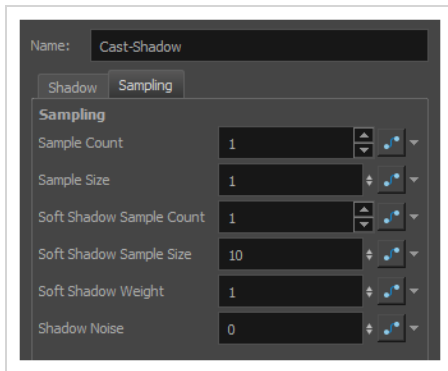

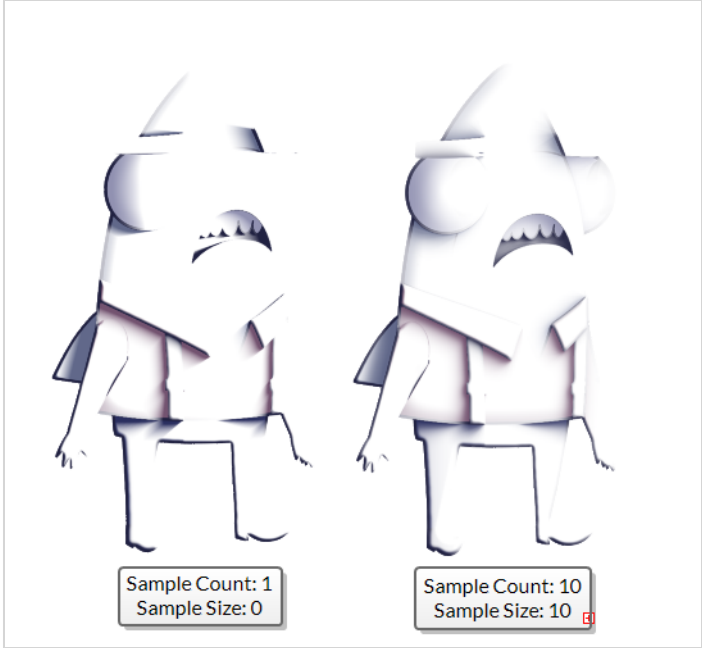
Parameter	Description
Sample Count	<p>For more advanced cast shadows, the sampling values define the number of times the cast shadow is calculated in order to produce a higher quality render.</p> <p>The Sample Count defines the number of points on the light source that are sampled in a radius parallel with the surface.</p> <p>A higher number will produce a more rounded shadow with more refined edges.</p>
Sample Size	<p>When using a higher Sampling Count, the sample size defines the range used when sampling points from the light source. The samples are taken in an even distribution around the point of the light source at a radius defined by the sample size.</p> 
Soft	<p>The Soft Shadow Sample Count defines the number of points on the light source that are sampled in</p>

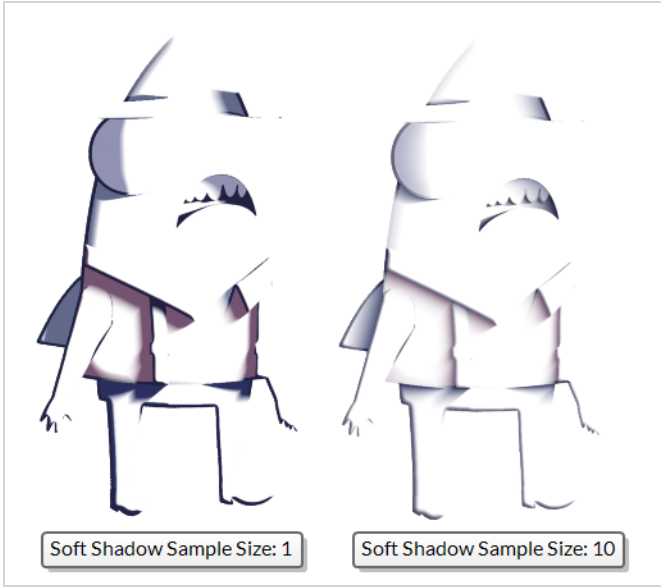
Parameter	Description
<p>Shadow Sample Count</p>	<p>a line perpendicular with the surface.</p> <p>This has less effect than the Sample Count, but is useful when calculating softer shadows with a larger Soft Shadow Sample Size.</p> <p>This value defines how many times the shadow is resampled when occluded.</p>
<p>Soft Shadow Sample Size</p>	<p>The Soft Shadow Sample Size is a useful attribute that helps to define the falloff of a shadow as it recedes from the light source. A higher value will cause the trailing edge of a shadow to appear softer.</p> 
<p>Soft Shadow Weight</p>	<p>The Soft Shadow Weight defines the exponential weighting of the Soft Sampling. A value of one will maintain a linear sampling rate. A higher value will cause each subsequent sample to be taken from a further source than the last.</p>
<p>Shadow Noise</p>	<p>When rendering Cast Shadows, adding noise to the sampling can often produce a result more organic in appearance.</p> <p>Increasing the Shadow Noise property will add an offset of random noise to each sample taken.</p>

Light Position Node

The Light Position node is the actual light source interacting with all the defined volume objects. You can set its position in relation to the objects and animate it over time. All volumes will react according to the light's motion.

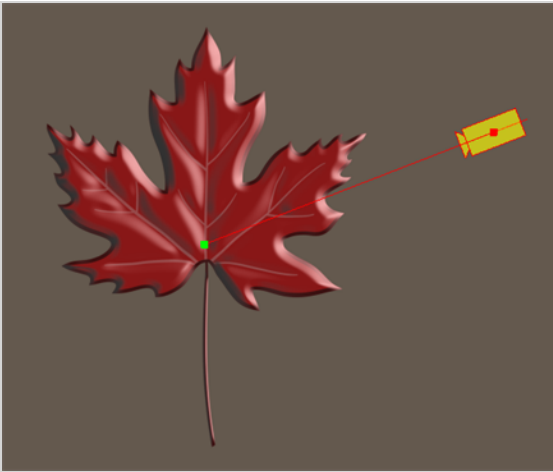

This is not where you set the light type or colour. You'll be adjusting these in the Light Shader and Tone Shader nodes.

Light Position Properties

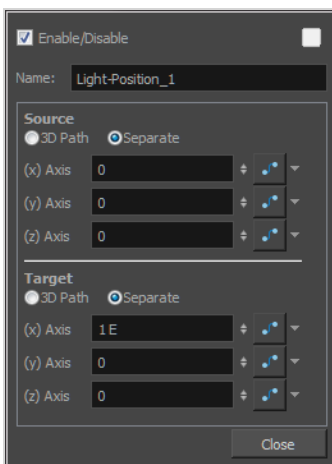

Parameter	Description
Source	Lets you control the value of the light source.
Target	The point or direction at which the light is pointing
	3D Path: Lets you use a 3D path when animating the light.

	Separate: Lets you enter separate values for the X, Y and Z axes.
	(x) Axis: Lets you type in a new East/West coordinate corresponding to the desired position.
	(y) Axis: Lets you type in a new North/South coordinate corresponding to the desired position.
	(z) Axis: Lets you type in a new Forward/Backward coordinate corresponding to the desired position.

Light Shader Node

The Light Shader node lets you adjust the highlight parameters, such as the colour, to create the desired ambiance. You can animate most parameters over time to create a mood change, sunset or any other type of light transition. The beveling height and smoothing is set in the Normal Map node.

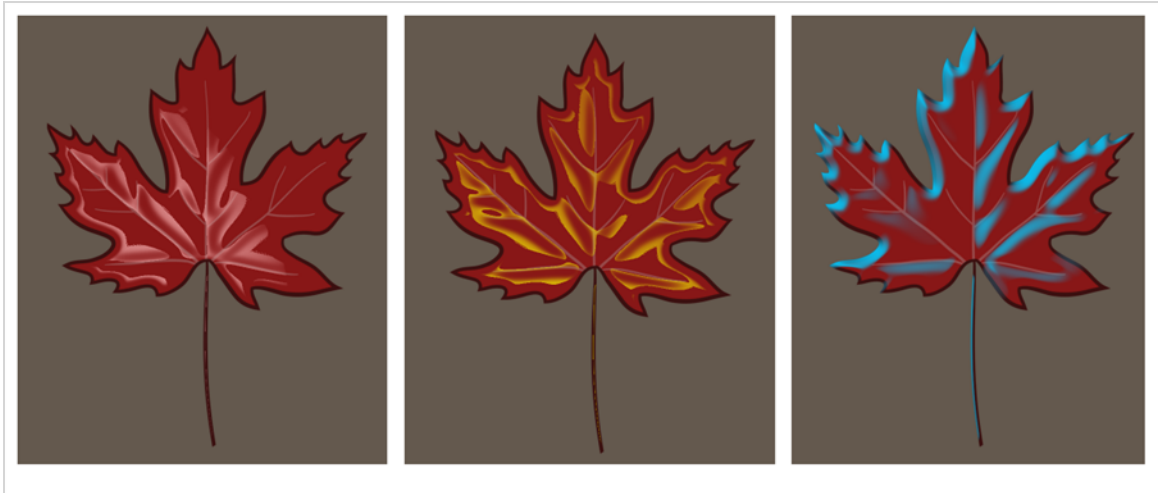

Light Shader Properties - Parameters tab

The Parameters tab can be used for both Light Shading and Surface Shading features.

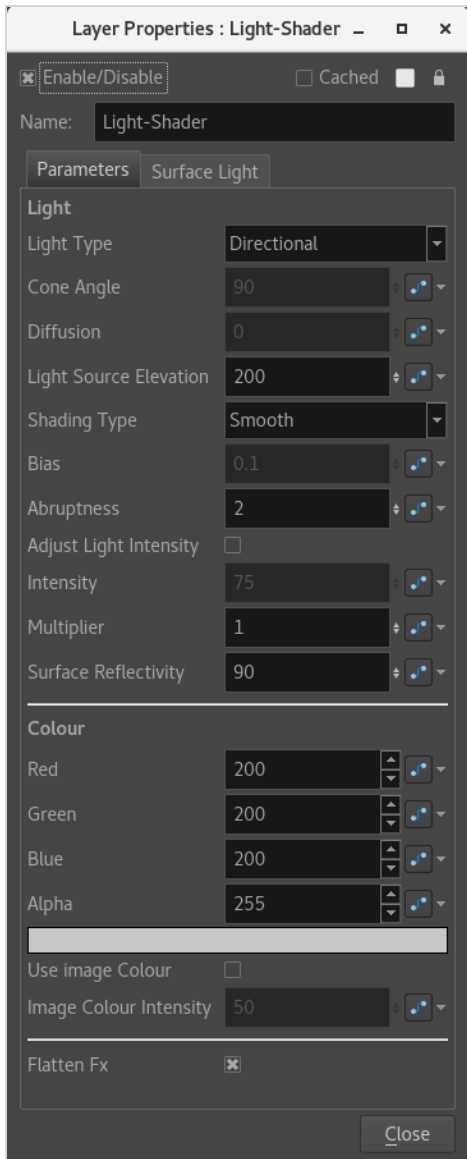

Parameter	Description
Enable/Disable	Allows you to enable or disable the node. When disabled, a node has no visible effect on the rendered image, nor on the preview in the Camera, Perspective, Side and Top views.
Colour Swatch	Sets the colour of the layer in the Timeline view and of the node in the Node view.
Name	Allows you to change the name given to the node.
Light	

Light Type	<p>Directional: A light that is parallel in the scene. Each “beam” of light follows the direction defined by the light source and target, and point in the same direction. This type of light is used when the light source is far away or very big, like the sun.</p> <p>Point: A light that illuminates everything around it. Its “beam” of light will go in all directions like a fire.</p> <p>Spot: A light that forms a conical shape like a flashlight.</p>
Cone Angle	The value that defines the light’s cone angle. This option is only accessible with the Light Type set to Spot.
Diffusion	Lets you play with the diffusion of the light on the surface of the drawing. In other words, it is the edge softness. This option is only accessible with the Light Type set to Spot.
Light Source Elevation	Defines the height of the spotlight. This option is only accessible when the Light Type set to Spot or Point.
Shading Type	<p>Smooth: The light and tone fx will have smooth edges.</p> <p>Sharp: The light and tone fx will have sharp edges.</p>
Bias	<p>Define the polarization of the light.</p> <p>When the Shade type is set to Smooth, it defines the width of the light’s smooth zone.</p> <p>When the Shade type is set to Sharp, the Bias defines the antialiasing on the edge of the highlight or tone zone. But,if the Shade type is set to Sharp, the Bias option need a small value such as 0.1 or 0.2. The exponent will be able to compensate the limitation of this small value.</p>
Abruptness	This is a multiplier value of the Bias option. It will define how quick the polarization of the light will change from a value to another.
Adjust Light Intensity	Lets you adjust the light intensity.
Intensity	Lets you set the strength of the light.
Multiplier	Multiplies the value of the Intensity option.
Surface Reflectivity	This option is useful for exaggerating the light on the edge of the 3D geometry. The closer an edge is to the light source, the more intense the light will be.

Colour	
Red/Green/Blue/Alpha	<p>The colour and transparency of the Colour Card. You can also attach these parameters to function columns to change their values over time.</p> <p>Click the colour swatch to open the Colour Picker window and select a colour.</p>
Colour Swatch	<p>Opens the Colour Picker window in which you can specify the colour.</p>
Use Image Colour	<p>Lets you use the colour of the drawing in a lighter or darker colour for the highlight and tone fx.</p>
Image Colour Intensity	<p>Lets you blend the colour of the light with the image colour.</p>
Flatten Fx	<p>This is useful when there are several highlight and tone fx, one over the other, but are supposed to be merged together. Sometimes, shadows and lights look better when they do not overlap.</p>

Light Shader Properties - Surface Light Tab

The Surface Light tab can be used only with the Surface Shading feature, therefore it should be ignored when using the Light Shading feature.

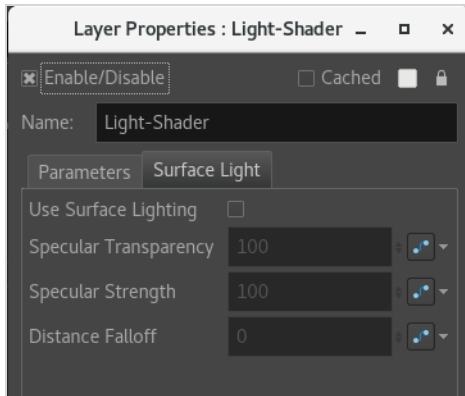

Parameter	Description
Use Surface Light	<p>Checking the Use Surface Lighting will have the Light Shader node/Tone Shader node consider the Surface depth when rendering the Light/Tone.</p> <p>The specular detail and falloff is only available when this property is enabled.</p>
Specular Transparency	<p>The Specular Transparency property defines the opacity of the specular highlight. A higher value will make the specular more visible and a lower value will have the specular blend into the diffuse.</p>
Specular Strength	<p>The Specular Strength defines the sharpness of the highlight. A higher value results in a more defined, sharper highlight, a lower value results in a more diffused render.</p>
Distance Falloff	<p>The Distance Falloff is a percentage value defining the amount of light that falls off between the Light Position's source and the Light Position's target.</p> <p>A value of 0 will result in a render in which the light has no falloff and remains consistent between the source and the target.</p>

Normal Map Node

The Normal Map node lets you centralize all Volume Object nodes and chisel out the shading 3D geometry (bevel height, smoothing, carving, etc.). It could be described as carving a bas relief. You only need one Normal Map node per light shading effect and, in general, only one per scene.

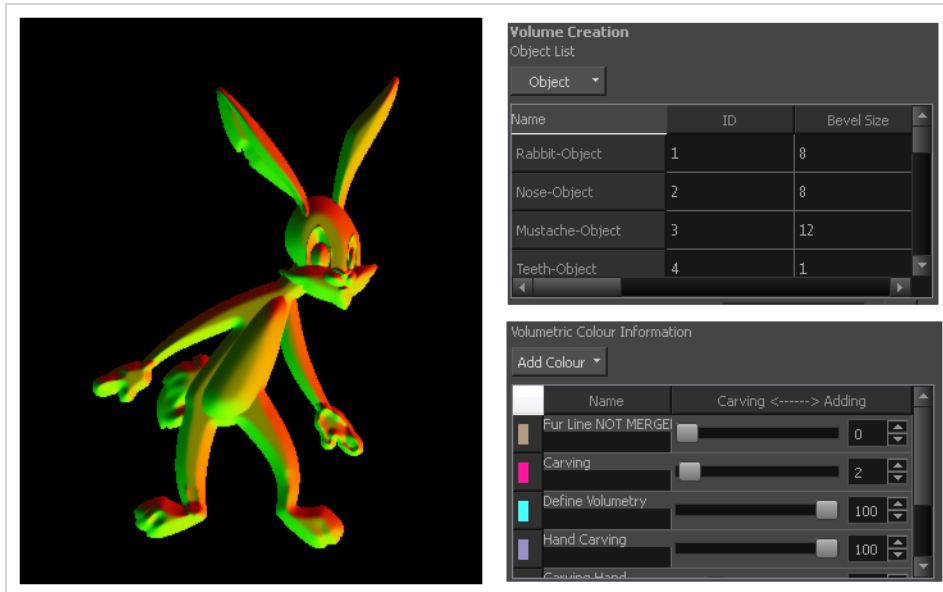

A normal map can be used to create other effects. If you're working with an OpenFX plugin or other plugin requiring a normal map, you can use the Normal Map Converter node to translate the Harmony normal map to a format supported by your plugin. The Normal Map Converter node has been optimized to work with GenArts® plugins, but you also have the ability to use it on custom plugins..

Normal Map Properties

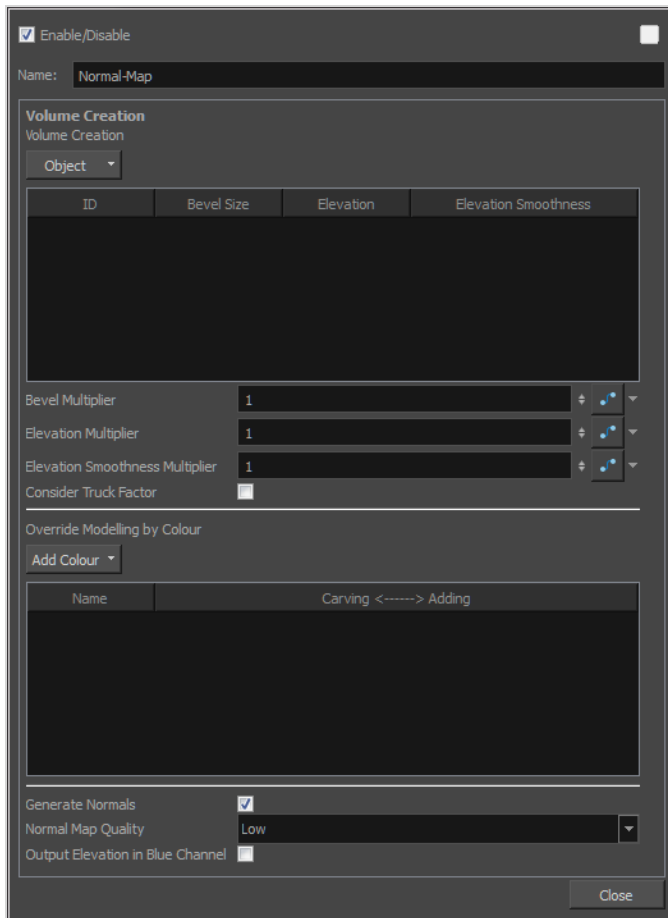

Parameter	Description
Volume Creation	Lists all the different volume object IDs are listed. This is where you can define the basic volumetric shape of each Volume Object node connect to the Normal Map.
Object	<p>Let you add or remove Volume Object nodes that are connected to the Normal Map node.</p> <p>Add All Defined Objects: Adds all Volume Object nodes connected to the Normal Map node.</p> <p>Remove Selected Objects: Removes all Volume Object nodes from the Volume Creation list.</p>
Name	The name that was previously set in each Volume Object node. This information can be really helpful when there are many volume objects listed. With a good name, it is easy to discover what the ID number is related to. When you hover over this column, a tooltip appears listing all volume objects with the same ID.

In the following image, the tooltip indicates that three copies were made from FootR-Object. By keeping the same name, you can easily see that each time you see a Volume Object named “FootR-Object”, the ID will be the same.

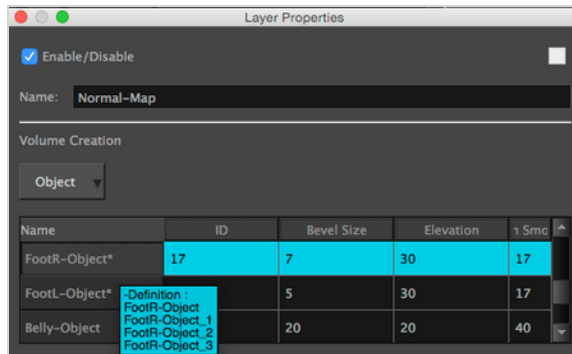

In the second example, a specific name was created for each volume object, even if they have the same ID. That way, it is easy to find a specific nodenode when searching for an element with the Search tool in the NetworkNode view.

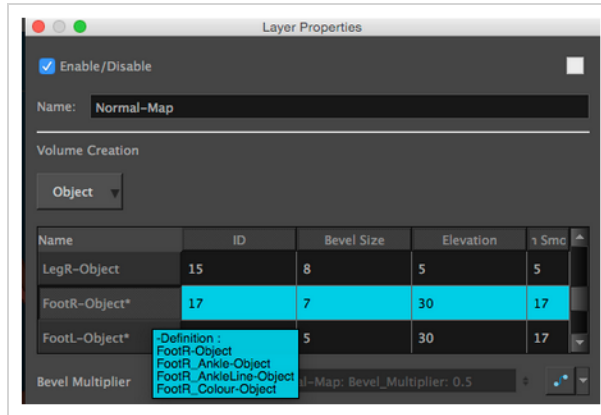

ID

The identity number that was previously set in the volume object nodenode appears here. The tooltip in the ID column lists all drawing elements that are connected to the volume object with this identity number.

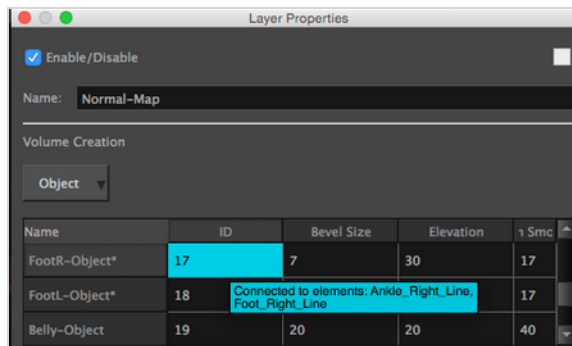

Bevel Size

Defines the size of the bevel on the contour of all the drawings related to a specific ID number

Elevation	Defines the elevation of a specific volume object. The higher the value, the more the volumetry of this Volume Object resembles a conical or pyramidal shape.
Elevation Smoothness	Complementary to the Elevation column. Instead of keeping a conical or pyramidal shape, the shape will be smoothed to create a sphere or a bump shape. The edge will be round instead of sharp.
Bevel Multiplier	A multiplier of the Bevel Size value in the board. This affects every object listed.
Elevation Multiplier	A multiplier of the Elevation value in the board. This affects every object listed.
Elevation Smoothness Multiplier	A multiplier of the Elevation Smoothness value in the list. This affects every object listed.
Consider Truck Factor	Keeps the same ratio for the Light Shading system when the camera zooms in or out. This parameter cannot work properly if the size of the drawing, with a volume object nodedata, is changed on the drawing itself. In other words, if the animation is directly created on the drawing layer.
Override Modelling by Colour	
Add Colour	Lets you add or remove any colour that will affect the Adding/ Carving options in the list beneath. When you select this button, each colour palette in the scene is listed and all their swatches are displayed.
Swatches	The first column of the Override Modelling by Colour board is the Swatches. This column does not have a name. When you select a colour swatch from the Add Colour list, the colour swatch appears at the beginning of the list.
Generate Normals	Activates or deactivates the generation of the Normal Map.
Normal Map Quality	Lets you change the Quality of the Normal Map from low to high.
Output Elevation in Blue Channel	When selected, the Elevation is calculated and appears in the soft render mode. When deselected, the object ID appears in the soft render mode. Because it is connected to the blue channel of a drawing, the result will only affect the blue channel.

Normal Map Converter Node

The normal map will carve and emboss a flat plane using vectors. The X, Y and Z coordinates of the normal map vectors are stored in RGB values to convert the 3D aspect into a visual result and use it to create various effects, such as light reflections (light shading). The X value is stored in the Red channel. The Y value is stored in the Green channel. The Z value is stored in the Blue channel.



NOTE

Note that not all normal map formats are supported.

The Normal Map Converter uses the following formula per channel:

- **value * (+/- length) + offset**
- *** +/- depending if inverse is set to true ("- " if true)**

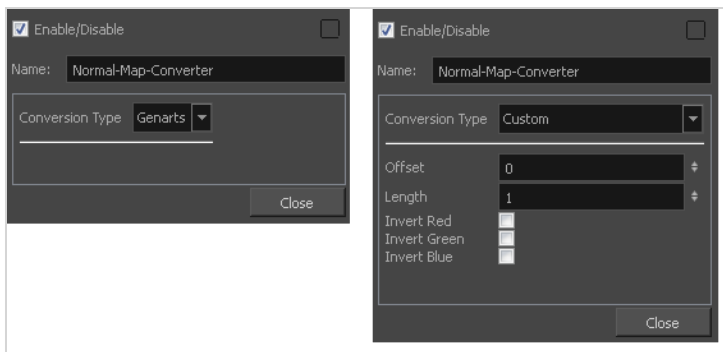

Parameter	Description
Conversion Type	By default, the conversion type is set to Genarts. If you work with a different manufacturer and want to adjust the parameters, set the conversion type to Custom.
Offset	Offsets the original position of the vector. You need to read the plugin documentation to know the offset you need to use. You must use the same offset value as the manufacturer is using. By default the offset is set to 0.
Length	The Normal Map Converter normalizes Harmony vectors to 1. By default the length value is set to 1. If your plugin requires shorter or longer vectors, enter a value smaller or greater than 1. It will multiply the vector length.
Invert Red	Inverts the red value (x). If your value is 125, the invert setting will transform it to -125.

Invert Green	Inverts the green value (y). If your value is 125, the invert setting will transform it to -125.
Invert Blue	Inverts the blue value (z). If your value is 125, the invert setting will transform it to -125.

Shape Curve Node

The Shape Curve node is part of the Height Shape suite of nodes. It is used to define a curved region of a height map and it is rendered with the Shape Render node.

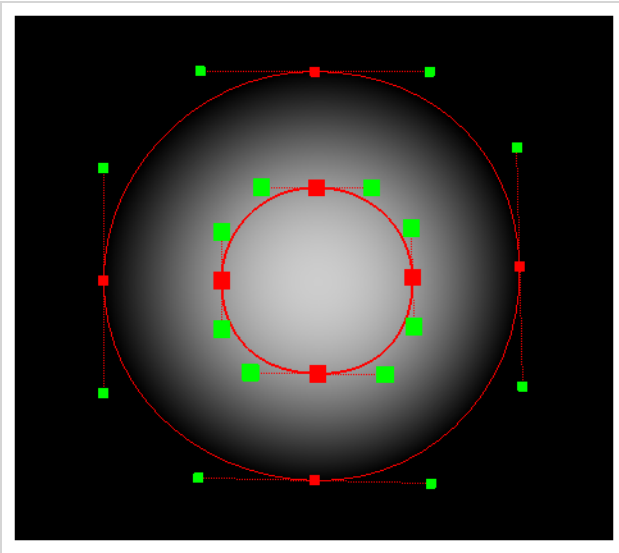

Shape Curve nodes help to define bezier segments on a height map that can be used for the Height Map port of a Volume Object node. Each Shape Curve node creates a control point to define the height shape. When Shape Curve and Shape Line nodes are chained together and connected to a Shape Render node, it generates a whole height shape.







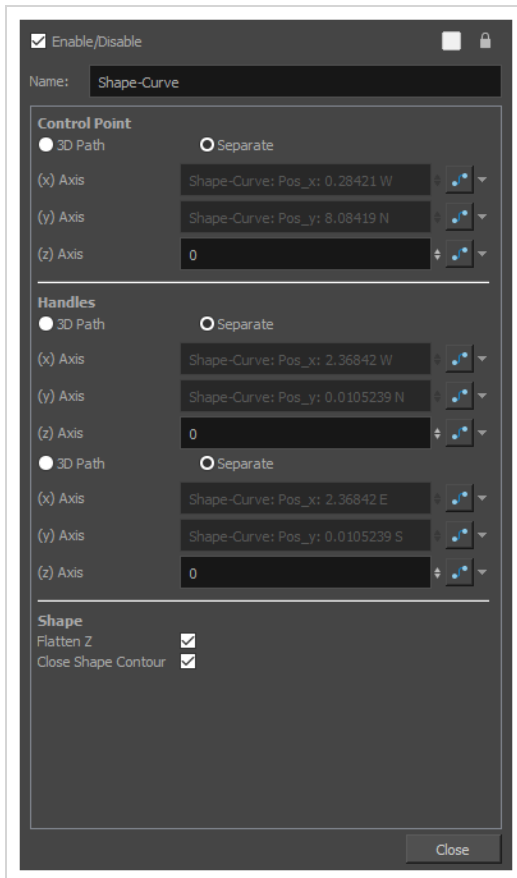

NOTE

For more information on how to use the Height Shape nodes for a surface shading system, refer to the User Guide.

Layer Properties



Parameter	Description
Name	The name of the node as it appears in the Node View and the Timeline view. Each node must have a name that is unique to its containing group.
Control Point	The position of the control point for this node in the stage. Just like the position of a drawing layer or a peg, the point can be positioned with a single 3D Path function or separate functions for the x, y and z axes. The position of the point can be animated so as to animate the whole height shape.

Parameter	Description
	<div data-bbox="363 285 1430 753" style="border: 1px solid #add8e6; padding: 10px;">  TIPS <ul style="list-style-type: none"> • Using the  Transform tool, you can manipulate the control point of a Shape Curve in the Camera view by displaying its control. To do this, select the node in the Node View, then do one of the following: <ul style="list-style-type: none"> • In the Camera view toolbar, click on  Show Control . • From the top menu, select View > Show > Control. • Press Shift + F11. • You can also display and manipulate all the control points for the entire height shape by selecting the Shape Render node that your Shape Curve nodes are connected to and displaying its controls. </div>
Handles	<p data-bbox="363 814 1414 915">The position of the Bezier handles on each side of the control point. These handles affect the curve of the contour on each side of the control point. The position of these handles can also be defined with either a 3D Path or with separate functions, and they can be animated as well.</p> <div data-bbox="363 947 1430 1415" style="border: 1px solid #add8e6; padding: 10px;">  TIPS <ul style="list-style-type: none"> • Using the  Transform tool, you can also manipulate the Bezier handles of the Shape Curve's control point in the Camera view. To do this, select the node in the Node View, then do one of the following: <ul style="list-style-type: none"> • In the Camera view toolbar, click on  Show Control . • From the top menu, select View > Show > Control. • Press Shift + F11. • You can also display and manipulate all the control points for the entire height shape by selecting the Shape Render node that your Shape Curve nodes are connected to and displaying its controls. </div>
Flatten Z	<p data-bbox="363 1476 1406 1612">This nullifies the camera's parallax effect when the point is moved back and forth on the z-axis. In other words, when enabled, moving the point on the z-axis will not change its apparent horizontal and vertical position. It will make the point higher on the height map without affecting how the shape is rendered.</p>
Close Shape Contour	<p data-bbox="363 1675 1430 1812">This option is useful for the last point in a chain of Shape Line or Shape Curve nodes. The nodes that are chained together are automatically linked by a contour, but the first and last nodes are not linked by a contour by default. Enable this option on the last point in the chain to create and contour between the first and last point in the chain and make a closed shape.</p>

Shape Line Node

The Shape Line node is part of the Height Shape suite of nodes. It is used to define a linear region of a height map and it is rendered with the Shape Render node.

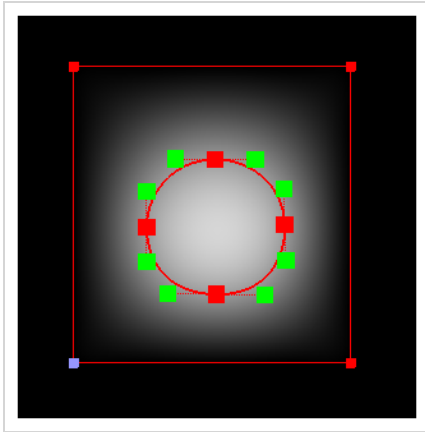

Shape Line nodes help to define rigid linear surfaces on a height map that can be used in the Volume Object's Height Map port. Each Shape Line node creates a control point to define the height shape. When Shape Curve and Shape Line nodes are chained together and connected to a Shape Render node, it generates a whole height shape.





NOTE

For more information on how to use the Height Shape nodes for a surface shading system, refer to the User Guide.

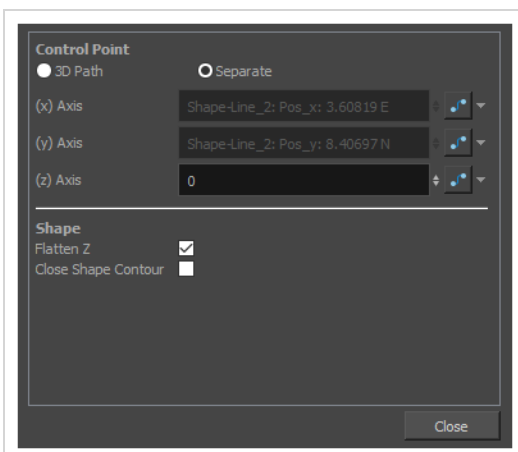
Layer Properties



Parameter	Description
Name	The name of the node as it appears in the Node View and the Timeline view. Each node must have a

Parameter	Description
	<p>name that is unique to its containing group.</p>
<p>Control Point</p>	<p>The position of the control point for this node in the stage.</p> <p>Just like the position of a drawing layer or a peg, the point can be positioned with a single 3D Path function or separate functions for the x, y and z axes. The position of the point can be animated so as to animate the whole height shape.</p> <div data-bbox="360 560 1430 1031" style="border: 1px solid #add8e6; padding: 10px;"> <p> TIPS</p> <ul style="list-style-type: none"> • Using the  Transform tool, you can manipulate the control point of a Line Curve in the Camera view by displaying its control. To do this, select the node in the Node View, then do one of the following: <ul style="list-style-type: none"> • In the Camera view toolbar, click on  Show Control . • From the top menu, select View > Show > Control. • Press Shift + F11. • You can also display and manipulate all the control points for the entire height shape by selecting the Shape Render node that your Shape Line nodes are connected to and displaying its controls. </div>
<p>Flatten Z</p>	<p>This nullifies the camera's parallax effect when the point is moved back and forth on the z-axis. In other words, when enabled, moving the point on the z-axis will not change its apparent horizontal and vertical position. It will make the point higher on the height map without affecting how the shape is rendered.</p>
<p>Close Shape Contour</p>	<p>This option is useful for the last point in a chain of Shape Line or Shape Curve nodes. The nodes that are chained together are automatically linked by a contour, but the first and last nodes are not linked by a contour by default. Enable this option on the last point in the chain to create and contour between the first and last point in the chain and make a closed shape.</p>

Shape Render Node

The Shape Render node is the base node that uses Shape Curve nodes and Shape Line nodes to define and interpolate a surface. The Shape renders a height-map representing the height with a pixel value that can be used in the Volume Object's Height Map port.

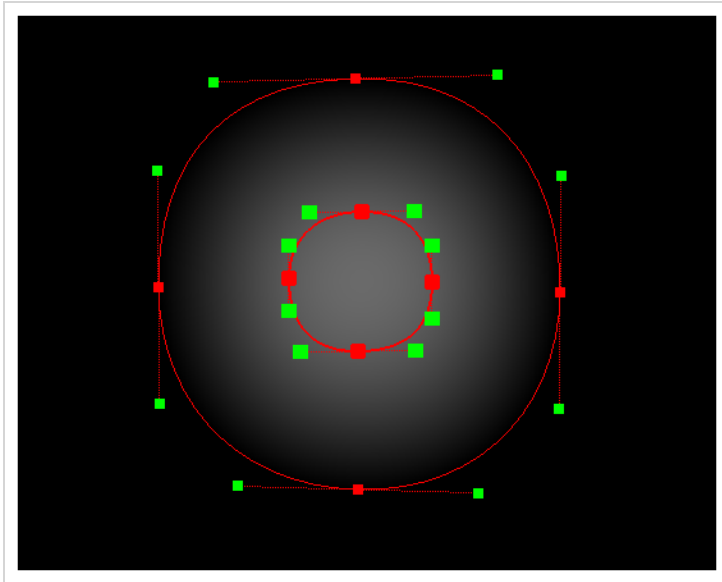

To generate shapes with the Shape Render node, you must connect several Shape Line or Shape Curve nodes in a chain, and connect the output port of the node at the bottom of the chain to the Shape Render node. Each Shape Line or Shape Curve in the chain will represent a point in the shape.

You can combine several shapes in the same Shape Render node by creating several chains and connecting them in parallel to the Shape Render node.

You can display and manipulate the control points for all of the Shape Line and Shape Curve nodes connected to your Shape Render node in the Camera view by selecting the Shape Render node in the Node View and doing one of the following:

- In the Camera view toolbar, click on  Show Control .
- From the top menu, select **View > Show > Control**.
- Press Shift + F11.



NOTE

For more information on how to use the Height Shape nodes for a surface shading system, refer to the User Guide.

Layer Properties

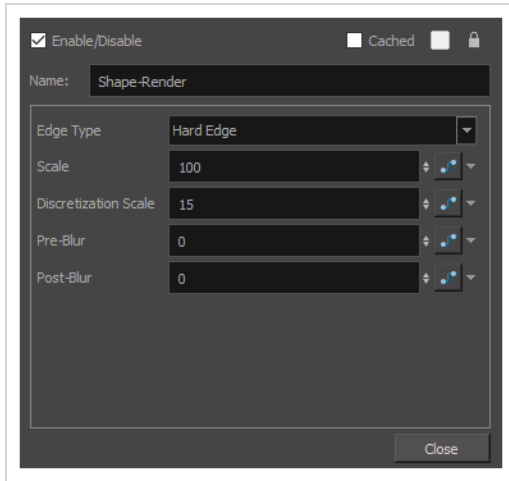

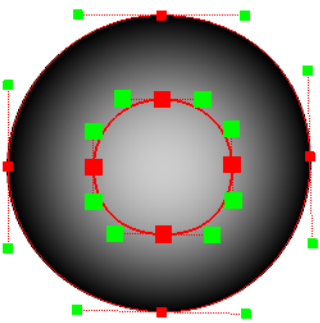
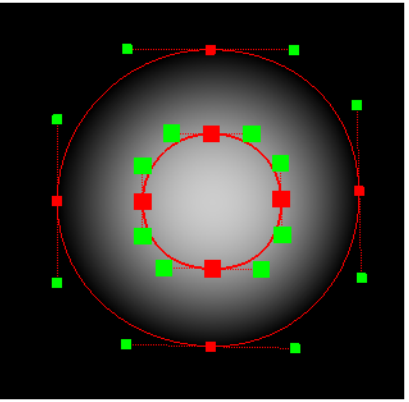
Parameter	Description
Name	The name of the node as it appears in the Node View and the Timeline view. Each node must have a name that is unique to its containing group.
Edge Type	<p>The Edge Type defines how the height is interpolated past the bounds of the defined shape.</p> <ul style="list-style-type: none"> • Hard Edge: The render will not render past the edges of the defined shape. Anything outside of the shape will be transparent. • Expand: The render will expand past the edges of the defined shape and interpolates by extrapolating the values within the shape. <div style="display: flex; justify-content: space-around; align-items: center;"> <div style="text-align: center;">  <p>Hard Edge: The render ends at the edge of the defined shape.</p> </div> <div style="text-align: center;">  <p>Expand: The render expands past the edge of the shape.</p> </div> </div>
Scale	On larger shapes, a smooth interpolated height map can be expensive to render. The scale property allows you to shrink the scale of the render, lowering the quality in favour of speed.

Parameter	Description
Discretization Scale	The discretization scale defines the map detail in the defined shape. A lower value will add more interpolation points to the mask, creating a higher quality height map but taking more time to render.
Pre-Blur	The Pre-Blur defines how rigidly the height map will adhere to the defined shape. A higher value will loosen the mapping, resulting in a less rigid map.
Post-Blur	The Post-Blur applies a blur to the final rendered height map.

Surface Map Node

The Surface Map is part of the Surface Shading set of nodes. It is a more advanced version of the Normal Map node and system. It provides a surface mapping that is used by the Surface Normal, Cast Shadow and Ambient Occlusion nodes, and it allows you to define height ranges in a rig or a scene that help define the surface being lit and shaded.

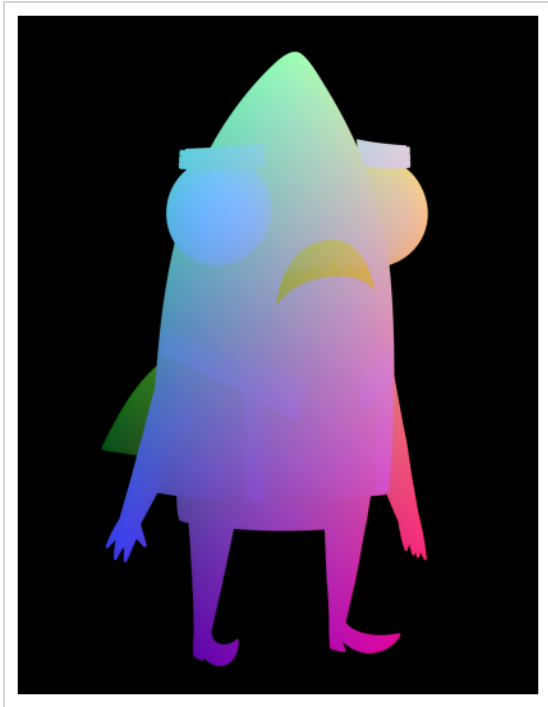

This mapping is different from the Normal Map, as it allows for the height ranges to interact relative to each other. A Surface Map is able to Cast Shadows from one elevation to another and interacts within the scene in field units.

The Surface Map requires that Volume Objects be set up to appropriately define the surfaces. Once these Volume Objects have been created above the Surface Map, the map can be initialized.

**NOTE**

For more information on how to use the Surface Shading set of nodes, refer to the User Guide.

Layer Properties

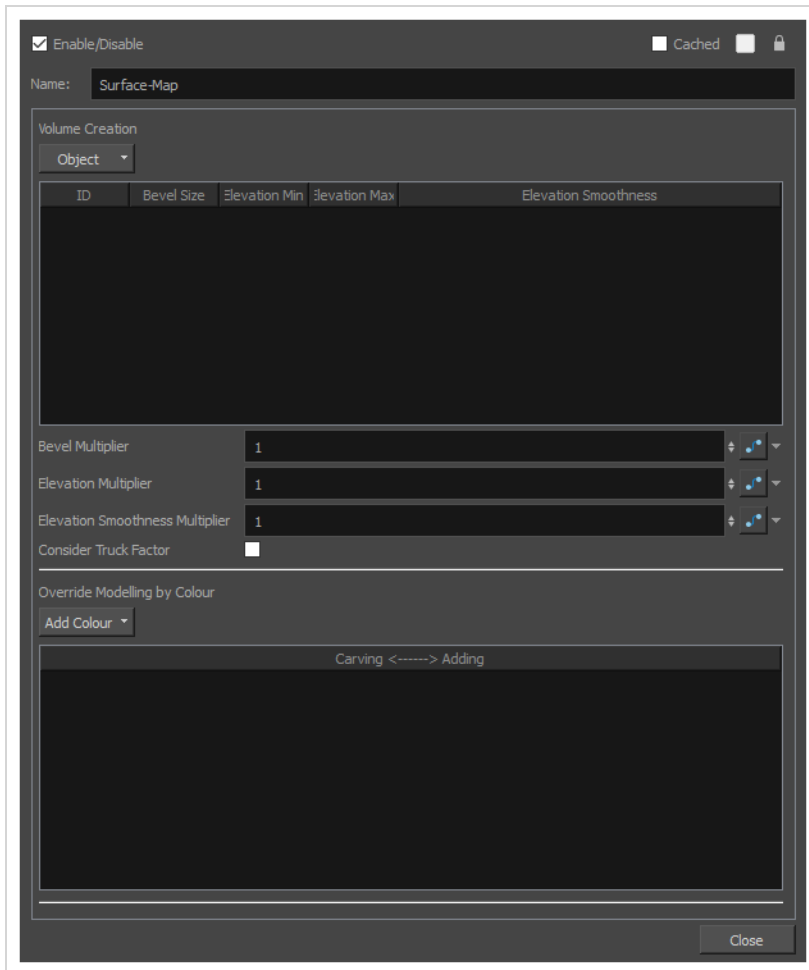

Parameter	Description
Name	The name of the node as it appears in the Node View and the Timeline view. Each node must have a name that is unique to its containing group.
Volume Creation	
Object	<p>Allows you to add or remove Volume Object nodes that are connected to the Surface Map node to the Volume Creation list, so that you can specify their properties.</p> <p>The drop-down menu will list every Volume Object node connected to the Surface Map node so that you can add them individually, as well as the following commands:</p> <ul style="list-style-type: none"> • Add All Defined Objects: Adds all Volume Object nodes connected to the Surface Map node. • Remove Selected Objects: Removes all Volume Object nodes from the Volume Creation list.

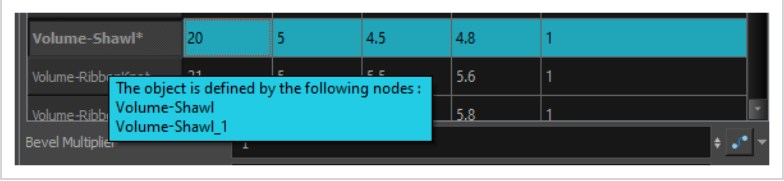
Parameter	Description
<p>Volume Creation list</p>	<p>Lists the different volume objects that are connected to the Surface Map node and which were added through the Object menu. In this list, you can define the basic volumetric shape and height range of each Volume Object node using the following fields:</p> <ul style="list-style-type: none"> • Name: The name that was previously set in each Volume Object node. This information can be really helpful when there are many volume objects listed. With a good name, it is easy to identify to which Volume Object node the ID number relates. <p>When you hover over this column, a tooltip appears listing all volume objects with the same ID. The star (*) denotes multiple Volume Objects share the same ID.</p>  <p>The screenshot shows a table with columns for Name, ID, Bevel Size, Elevation Min, Elevation Max, and Elevation Smoothness. A tooltip is displayed over the ID column, listing 'Volume-Shawl' and 'Volume-Shawl_1'.</p> <ul style="list-style-type: none"> • ID: The identity number that was previously set in the volume object node appears here. The tooltip in the ID column lists all drawing elements that are connected to the volume object with this identity number. • Bevel Size: Defines the size of the bevel on the contour of all the drawings related to a specific ID number. The bevel is applied by blurring the Volume Objects sharing the same ID. • Elevation Min: The Z position in Field Units at which the lowest point of the Volume is mapped. Any baseline height, or Carving values at 0% will be mapped to this minimum Z value. Otherwise, the surface height is mapped to an interpolated value between the Elevation Min and Elevation Max. • Elevation Max: The Z position in Field Units at which the highest point of the Volume is mapped. Any baseline height, or Carving values at 100% will be mapped to this maximum Z value. Otherwise, the surface height is mapped to an interpolated value between the Elevation Min and Elevation Max. • Elevation Smoothness: Complementary to the Elevation column. Instead of keeping a conical or pyramidal shape, the shape will be smoothed to create a sphere or a bump shape. The edge will be round instead of sharp.
<p>Elevation Smoothness Multiplier</p>	<p>A multiplier of the Elevation Smoothness value in the list. This affects every object listed.</p>
<p>Consider Truck Factor</p>	<p>Keeps the same ratio for the Light Shading system when the camera zooms in or out.</p>
<p>Override Modelling by Colour</p>	

Parameter	Description
Add Colour	<p>Allows you to add or remove a Override Modelling by Colour list below.</p> <p>Zones that are painted with the colours added to the list will have more or less elevation. This allows you to use specific colours to carve from or add to the surface of the volume object, and add complexity to its surface.</p> <p>You can draw with one of the colours in the list on the Colour Art or Underlay Art layer so that the colour itself is hidden behind the artwork in the Line Art layer. The shape of the zone painted with this colour will still affect the surface.</p>
Override Modelling by Colour list	<p>The list of colours that are used to override the surface of the volume object. Zones painted with the colours in this list will have a different elevation than the remainder of the volume object.</p> <p>Whether the elevation of the surface painted by the colour is lower or higher, and by how much, is determined by the value in the Carving <-----> Adding field for that colour. If that value is higher than the Volume Object's Elevation Baseline parameter, then the zones painted with that colour will be more elevated. If the value is lower than the Volume Object's Baseline parameter, then the zones painted with that colour will be less elevated.</p>

Surface Normal Node

The Surface Normal node is part of the Surface Shading set of nodes. It converts the output of a Surface Map node into a directional normal map, which is the same kind of output that is given by the Normal Map node in the legacy Light Shading system, and which is used by the Light Shader and Tone Shader nodes to create light shading effects.



Using the Surface Map and Surface Normal node instead of the Normal Map node allows you to use the more detailed height maps and height mattes from the Volume Objects with the Light and Tone shaders, as well as to animate the surface definition on a rig.



NOTE

For more information on how to use the Surface Shading set of nodes, refer to the User Guide.

Layer Properties

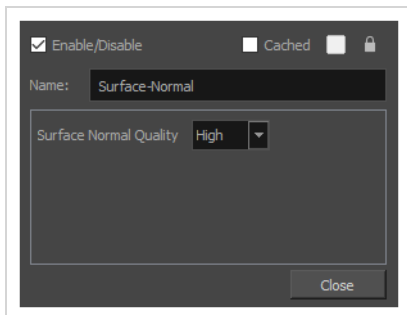

Parameter	Description
Name	The name of the node as it appears in the Node View and the Timeline view. Each node must

Parameter	Description
	have a name that is unique to its containing group.
Surface Normal Quality	<p>The surface normal quality provides three levels of quality when calculating and rendering the normal:</p> <ul style="list-style-type: none">• Low: Renders very fast and provides the first immediate normal direction.• Medium: Renders all four available surfaces orientations at a given pixel and averages the result.• High: Medium render speed. Calculates all available normals on a surface and blends the nearest normals at the given pixel.

Tone Shader Node

The Tone Shader node lets you adjust the tone parameters, such as the colour, to create the desired ambiance. You can animate most parameters over time to create shade transitions. The beveling height and smoothing is set in the Normal Map node.



Tone Shader Properties - Parameters tab

The Parameters tab can be used for both Light Shading and Surface Shading features.

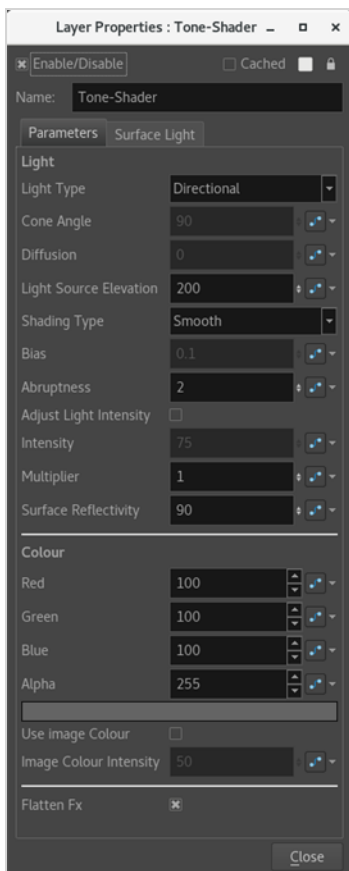

Parameter	Description
Enable/Disable	Allows you to enable or disable the node. When disabled, a node has no visible effect on the rendered image, nor on the preview in the Camera, Perspective, Side and Top views.
Colour Swatch	Sets the colour of the layer in the Timeline view and of the node in the Node view.
Name	Allows you to change the name given to the node.
Light	
Light Type	<p>Directional: A light that is parallel in the scene. Each “beam” of light follows the direction defined by the light source and target, and point in the same direction. This type of light is used when the light source is far away or very big, like the sun.</p> <p>Point: A light that illuminates everything around it. Its “beam” of light will go in all directions like a fire.</p> <p>Spot: A light that forms a conical shape like a flashlight.</p>
Cone Angle	The value that defines the light’s cone angle. This option is only accessible with the Light Type set to Spot.
Diffusion	Lets you play with the diffusion of the light on the surface of the drawing. In other words, it is the edge softness. This option is only accessible with the Light Type set to Spot.
Light Source Elevation	Defines the height of the spotlight. This option is only accessible when the Light Type set to Spot or Point.
Shading Type	<p>Smooth: The light and tone fx will have smooth edges.</p> <p>Sharp: The light and tone fx will have sharp edges.</p>
Bias	<p>Define the polarization of the light.</p> <p>When the Shade type is set to Smooth, it defines the width of the light’s smooth zone.</p> <p>When the Shade type is set to Sharp, the Bias defines the antialiasing on the edge of the highlight or tone zone. But,if the Shade type is set to Sharp, the Bias option need a small value such as 0.1 or 0.2. The exponent will be able to compensate the limitation of this small value.</p>

Abruptness	This is a multiplier value of the Bias option. It will define how quick the polarization of the light will change from a value to another.
Adjust Light Intensity	Lets you adjust the light intensity.
Intensity	Lets you set the strength of the light.
Multiplier	Multiplies the value of the Intensity option.
Surface Reflectivity	This option is useful for exaggerating the light on the edge of the 3D geometry. The closer an edge is to the light source, the more intense the light will be.
Colour	
Red/Green/Blue/Alpha	The colour and transparency of the Colour Card. You can also attach these parameters to function columns to change their values over time. Click the colour swatch to open the Colour Picker window and select a colour.
Colour Swatch	Opens the Colour Picker window in which you can specify the colour.
Use Image Colour	Lets you use the colour of the drawing in a lighter or darker colour for the highlight and tone fx.
Image Colour Intensity	Lets you blend the colour of the light with the image colour.
Flatten Fx	This is useful when there are several highlight and tone fx, one over the other, but are supposed to be merged together. Sometimes, shadows and lights look better when they do not overlap.

Tone Share Properties - Surface Light tab

The Surface Light tab can be used only with the Surface Shading feature, therefore it should be ignored when using the Light Shading feature.

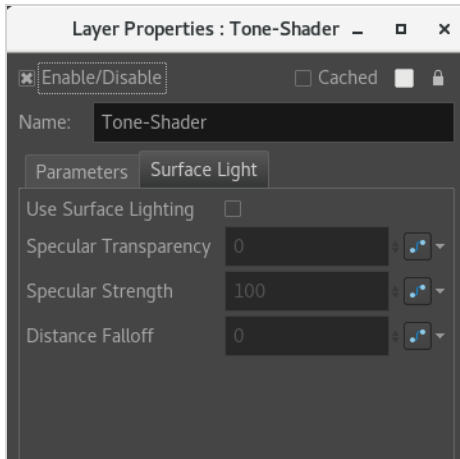

Parameter	Description
Use Surface Light	<p>Checking the Use Surface Lighting will have the Light Shader node/Tone Shader node consider the Surface depth when rendering the Light/Tone.</p> <p>The specular detail and falloff is only available when this property is enabled.</p>
Specular Transparency	<p>The Specular Transparency property defines the opacity of the specular highlight. A higher value will make the specular more visible and a lower value will have the specular blend into the diffuse.</p>
Specular Strength	<p>The Specular Strength defines the sharpness of the highlight. A higher value results in a more defined, sharper highlight, a lower value results in a more diffused render.</p>
Distance Falloff	<p>The Distance Falloff is a percentage value defining the amount of light that falls off between the Light Position's source and the Light Position's target.</p> <p>A value of 0 will result in a render in which the light has no falloff and remains consistent between the source and the target.</p>

Volume Object Node

The Volume Object node allows you to define which parts of your rig constitute a single volume to which shading should be applied. For example, if you need the arm, forearm and hand of your character to be shaded together, you can connect all the nodes that constitute these body parts to the same Volume Object node, and the shading will be applied to these parts of your rig as if they were a single object.

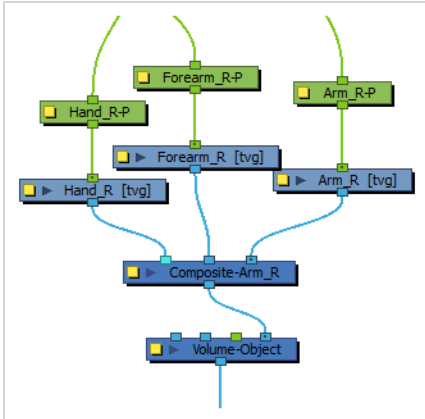

NOTES

- Even if you want to apply shading separately to a single drawing, you must connect a Volume Object node under that drawing.
- If you create separate Volume Object nodes for parts of your rig that are attached together, you may see bumps in the shading where the joints overlap.

Volume Object Properties

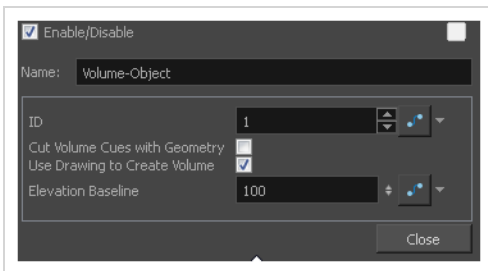

NOTE

Volume Object nodes are connected to a Normal Map or Surface Map node to be composited together. You can define the parameters of each volume in your rig in the properties of the Normal Map or Surface Map node to which they are connected.

Parameter	Description
-----------	-------------

Name	<p>With the light shading feature, the naming of the nodes becomes important. Since there isn't any limitation on the number of Volume Object nodes that can be added to a node structure, it's quite important to give a good name to each Volume Object node. These names will later appear in the Normal Map node, in the Volume Creation section.</p>
ID	<p>This is the identity number you assign to a drawing or a group of drawings that will be represented in the same volume once it is generated by the Normal Map node. This ID is also in the Normal Map node, where a list of all Volume Objects is applied.</p>
Cut Volume Cues with Geometry	<p>When this option is not selected, Harmony cuts the 3D geometry (shading bas relief) of the drawing after it has been generated by the Normal Map node.</p> <p>Some nodes, such as filters, can affect the shape or colour of the drawing. Those nodes will be processed and recognized by the Normal Map node. Therefore, it is possible to limit the 3D geometry only on a part of the drawing, but not all of it. The 3D geometry follows the edge of the entire drawing and will not be affected by the filters.</p>
Use Drawing to Create Volume	<p>During the generation created by the Normal Map node, the shape of the drawing or group of drawings identified with the same ID will be recognized to create the volume. When this option is selected, the Light Shader and Tone Shader effect appear inside the contour of those drawings.</p>
Elevation Baseline	<p>The baseline defines how much you can add or carve the Volume Object. The drawing or group of drawings connected to this Volume Object node share the same baseline value. Because this setting is closely tied to the adding/carving option called Intensity (0-100) (accessible in the Volumetric Colour Information of the Normal Map node), both places need to have some parameters set. Playing only with the Geometry Intensity won't change anything if there aren't any parameters set in the Normal Map node.</p>

Plugin Nodes

There are 2 plug-in node effects available in Harmony:

- Brightness-Contrast—see [Brightness Contrast Node](#) on page 592
- Sparkle

Sparkle

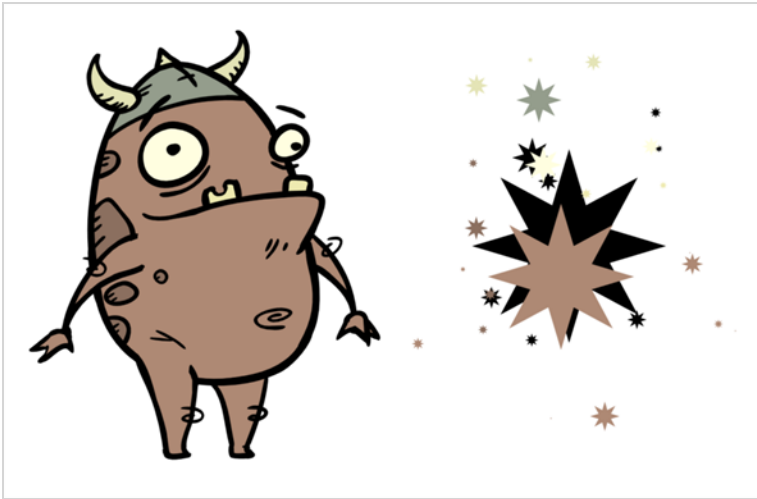

The Sparkle effect transforms a vector drawing into sparkles. You have a high degree of control over the appearance of the sparkles.

The sparkle effect can only be used with vector drawings. If the sparkle effect node is attached to a composite, verify that the Composite editor is set to Vector Flatten Output.

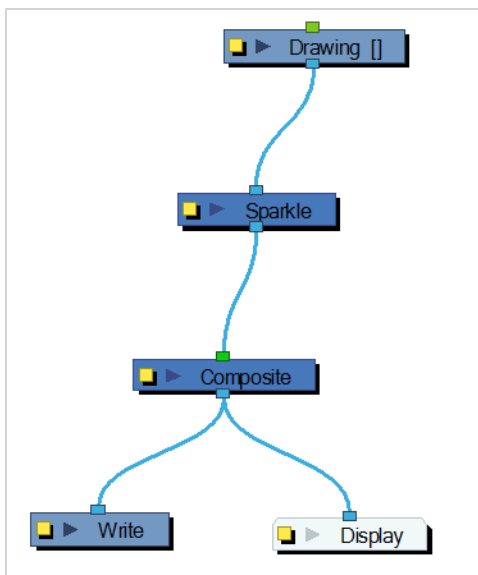

Use the Sparkle editor to modify how the Sparkle node creates the sparkle effect. You can also use Bezier and Ease function curves to change the values of factors over time.

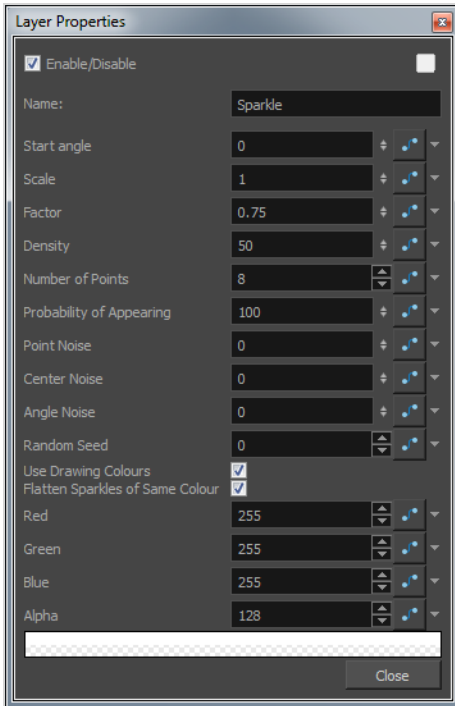

Sparkle Properties

Parameter	Description
Start Angle	Enter a value between -360 and 360 to indicate the angle of rotation of each sparkle.
Scale	Sparkles are determined by the size of the bounding box of the coloured areas in the drawing. Enter the multiple to use to scale the sparkle size.
Factor	Enter a value between 0.1 and 1 to determine how pointy the sparkle is. A value closer to 0 will result in a more pointed sparkle. A value closer to 1 will result in a more rounded sparkle.
Density	Adjusts the density level.
Number of Points	Enter the number of points you want each sparkle to have.
Probability of Appearing	Enter the percentage of possibility that sparkles will be displayed. Enter 100 to always show sparkles. Enter 0 to always hide sparkles.
Point Noise	Enter a value between 0.1 and 1 to indicate the amount by which points in a sparkle will distort.

Centre Noise	Enter a value between 0.1 and 1 to indicate the amount by which the angles between each point in a sparkle will distort.
Angle Noise	Enter a value between 0.1 and 1 to indicate the amount by which the Start Angle in a sparkle will distort.
Random Seed	Enter a positive integer value that will be used to determine the sparkle pattern.
Use Drawing Colours	Select this option to use the colour attributes of the drawing for the sparkle colour. When this selection is disabled (default setting), the colour values will be used as they are entered in the editor.
Flatten Sparkles of Same Colour	Flatten all drawings of the same colour into a single layer.
Red/Green/Blue/Alpha	In the RGBA fields, enter the values to use for the sparkle colour.

Selection Preset Note Node

The Selection Preset Note node appears in the Node view after an initial Selection Preset is created.

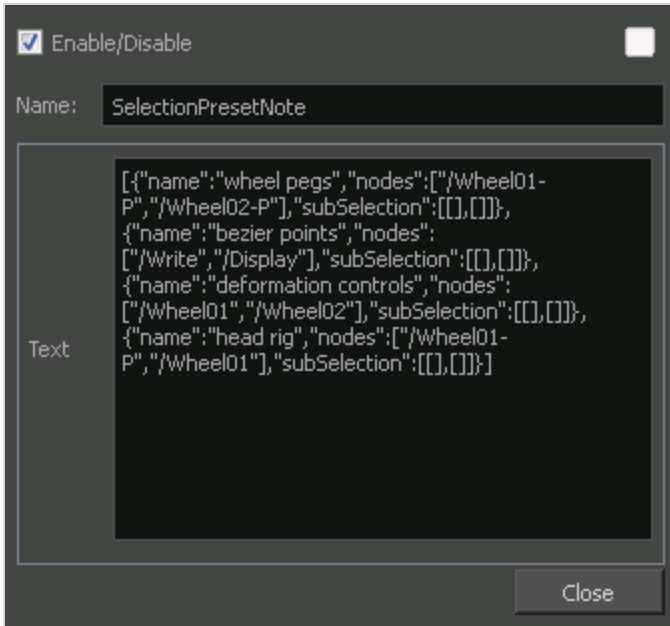

Selection Preset Note Properties

Parameter	Description
Enable/Disable	Checking this option enables the node. Unchecking this option disables the node.
Track Colour	Click on this swatch to open the Select Colour window. Select a colour and click OK to mark the node with the selected colour. 
Name	Allows you to change the name given to the node.
Text	Displays the code text for the Selection Presets list that can be found in the Selection Presets window.
Close	Closes the Properties window.

Sound Layer

When you select a sound layer in the Timeline view, the options related to that layer appear in the Layer Properties view.

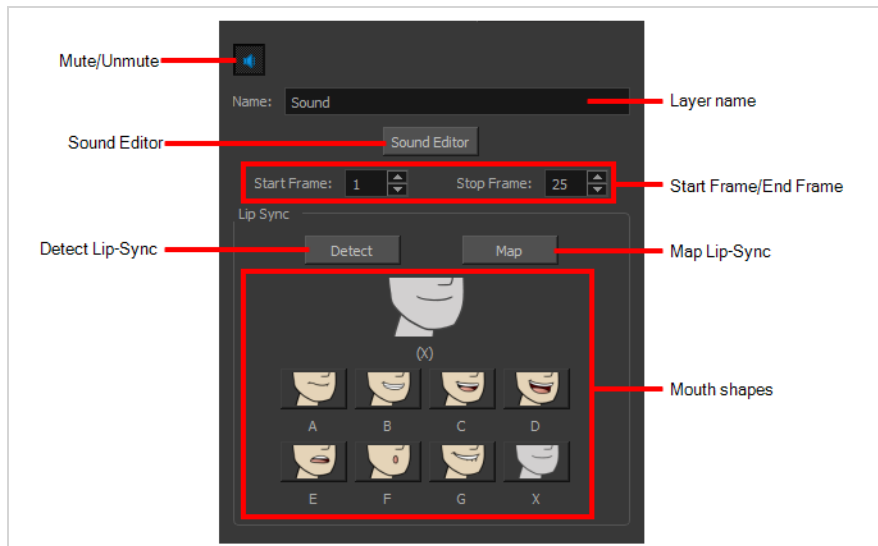

If you double-click on a sound layer in the Timeline view, or in a sound column in the Xsheet view, the Sound Element Editor dialog will open. This dialog allows you to fine-tune the sound track's lip sync, start time, stop time and volume.

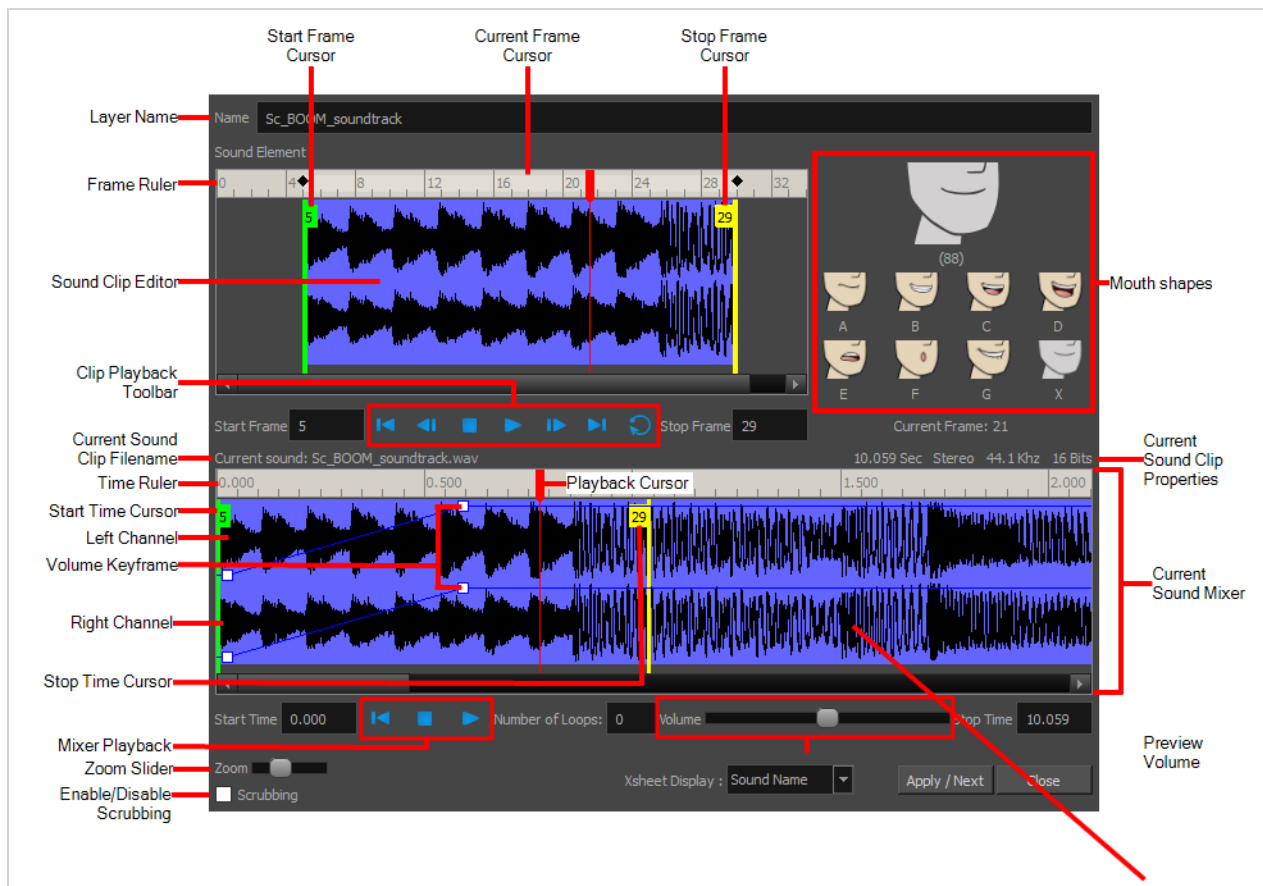



NOTE

Contrary to all other layers, sound layers are not represented by nodes in the Node view.

Chapter 4: Tools Properties

Harmony has a wide variety of drawing and manipulation tools and each one of them has a series of options and modes available in the Tool Properties view. This section covers these options.

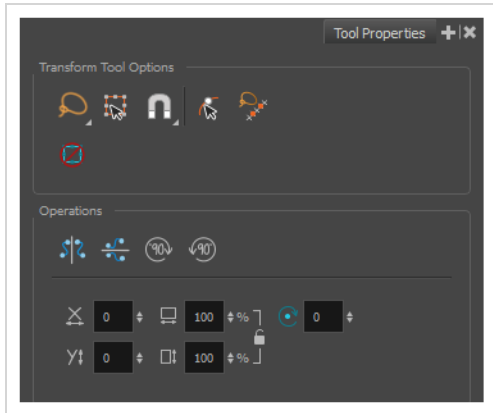

Brush Tool Properties	960
Centerline Editor Tool Properties	981
Close Gap Tool Properties	983
Colour Eyedropper Tool Properties	984
Contour Editor Tool Properties	985
Cutter Tool Properties	990
Drawing Pivot Tool Properties	995
Edit Gradient/Texture Tool Properties	997
Ellipse Tool Properties	998
Envelope Tool Properties	1008
Eraser Tool Properties	1011
Ink Tool Properties	1032
Inverse Kinematics Tool Properties	1034
Line Tool Properties	1037
Morphing Tool Properties	1049
Node Caching Toolbar	1053
Paint Tool Properties	1054
Pencil Tool Properties	1061
Pencil Editor Tool Properties	1072

Perspective Tool Properties	1077
Polyline Tool Properties	1080
Rectangle Tool Properties	1088
Reposition All Drawings Tool Properties	1098
Rigging Tool Properties	1100
Select Tool Properties	1103
Shift and Trace Tool Properties	1115
Smooth Editor Tool Properties	1118
Stamp Tool Properties	1120
Stroke Tool Properties	1128
Text Tool Properties	1130
Transform Tool Properties	1133
Zoom Tool Properties	1137

Brush Tool Properties

The Brush tool allows you to draw by creating shapes based on your drawing strokes and filling them with colour or textures. When used with a tablet, it is pressure sensitive, just like a real life brush.

How to access the Brush tool properties

1. In the Tools toolbar, select the Brush  tool.

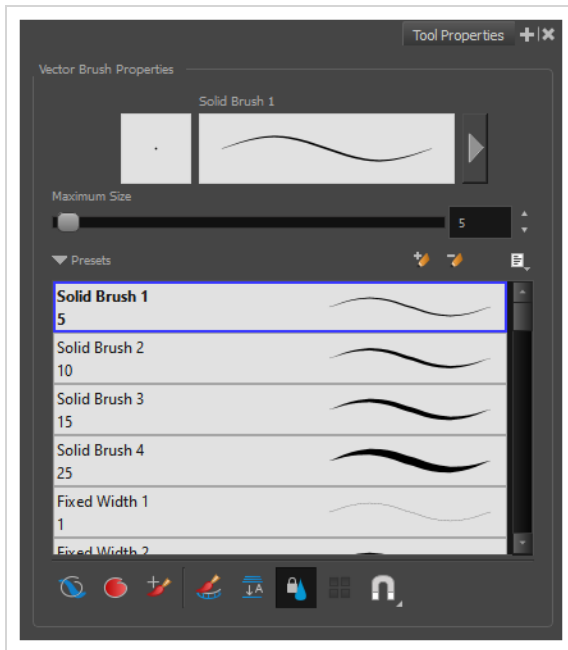

The tool's properties are displayed in the Tool Properties view.



Brush Properties





The following properties affect the brush's size, smoothing and other properties for the drawing style of your brush. Those properties can be saved into brush presets for later use.

Property	Description
Preview Area	The Preview area lets you see a preview of the stroke your drawing tool will make. 
Brush Properties Dialog	The arrow button right of the preview area opens the Brush Properties dialog.

Property	Description
	 <p>While the Tool Properties view only gives you access to a few of the brush properties, a list of brush presets and other drawing options, the Brush Properties dialog gives you access to all the available options for your brush's tip and texture. For more information on the Brush Properties dialog, see the Brush Properties Dialog section below.</p>
Maximum Size	<p>Defines the maximum width of brush strokes.</p> <p>If the tool is used with a pressure sensitive pen tablet, the width of the stroke will vary between its maximum size and minimum size depending on the amount of pressure used. If used with a mouse, the width of the stroke will always be its maximum size.</p>
Flow	<p>Allows you to set the opacity for each instance of the brush tip that gets printed into your canvas. Contrary to the Opacity parameter, the flow parameter has a cumulative effect. This means that a lower flow will make your brush strokes more transparent towards its extremities and more opaque in its center. Your stroke's flow will also accumulate if you draw over it. By default, your brush's flow varies with the amount of pressure you put on your tablet pen.</p> <div data-bbox="527 1150 1429 1318" style="border: 1px solid #c8e6c9; padding: 5px;"> <p> NOTE This option is only displayed in the Tool Properties view when drawing on a bitmap layer.</p> </div>
Opacity	<p>The Opacity parameter are where Lets you set the opacity of your brush strokes. Contrary to the Flow parameter, the Opacity parameter is non-cumulative. Your whole brush stroke's opacity will not exceed the Opacity parameter. By default, the Opacity parameter varies depending on the amount of pressure you put on your tablet pen.</p> <div data-bbox="527 1581 1429 1749" style="border: 1px solid #c8e6c9; padding: 5px;"> <p> NOTE This option is only displayed in the Tool Properties view when drawing on a bitmap layer.</p> </div>











Brush Presets



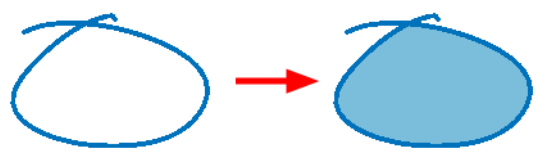



These options allow you to select, create and manage brush presets.



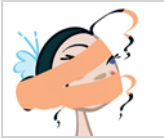

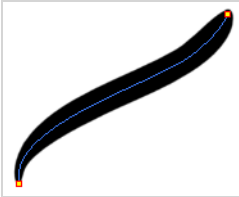
Icon	Property	Description
	Presets list	<p>By default, Harmony has preloaded brush presets. You can also create your own brush presets by configuring your brush, then saving its properties into a new preset. It is also possible to export and import brush presets.</p>  <p>The screenshot shows a window titled 'Presets' with a list of brush presets. The list includes 'Solid Brush 1' (value 5), 'Solid Brush 2' (value 10), 'Solid Brush 3' (value 15), 'Solid Brush 4' (value 25), 'Fixed Width 1' (value 1), and 'Fixed Width 2' (value 10). Each entry has a small preview of the brush stroke to its right.</p>
	New Brush Preset	Creates a new preset based on the current tool properties.
	Delete Brush	Deletes the currently selected preset.
	Brush Presets Menu	<p>Open a menu that contains the following options:</p> <ul style="list-style-type: none"> • New Brush Preset: Creates a new preset based on the current tool properties. • Delete Brush: Deletes the currently selected preset. • Rename Brush: Allows you to rename the currently selected preset. • Import Brushes: Allows you to import brush presets exported from Harmony. • Export Brushes: Allows you to export your brush presets into an <code>.xml</code> file. • Small Thumbnail: Displays presets in a grid of small thumbnails with a preview of their tip. • Large Thumbnail: Displays presets in a grid of big thumbnails, with their name and a preview of their tip. • Stroke View: Displays presets in a list, with their name and a preview of a stroke done with each preset.

Drawing Options

These options affect the way your drawing strokes are added to your artwork.

Icon	Property	Description
	Draw Behind	<p>When enabled, your brush strokes will appear behind the existing artwork.</p> <div data-bbox="646 506 1117 699">  <p>The orange stroke was drawn over the black stroke, then put underneath it.</p> </div> <div data-bbox="646 737 1430 905" style="border: 1px solid green; padding: 5px;"> <p> NOTE</p> <p>Your brush stroke will temporarily appear over your artwork as you draw it, until you release the mouse cursor or tablet pen.</p> </div>
	Auto Fill	<p>When enabled, drawing a closed shape will automatically fill it with the currently selected Paint colour.</p> <div data-bbox="646 1056 1224 1236">  </div> <div data-bbox="646 1274 1430 1766" style="border: 1px solid blue; padding: 5px;"> <p> TIP</p> <p>By default the pencil line and its fill will be the same colour. To select different colours for the line and its fill, do the following:</p> <ol style="list-style-type: none"> 1. In the Colour view, click the  Unlock Three Colours button. 2. Click on the  Set Current Brush Colour swatch. Then, in the colour list, select the desired colour swatch for your outline. 3. Click on the  Set Current Paint Colour swatch. Then, in the colour list, select the desired colour swatch for the fill. </div>
	Repaint Brush	<p>When enabled, your brush strokes will only repaint existing artwork and will not add colour to empty areas. If you repaint semi-transparent</p>

		<p>artwork, your artwork will not become more opaque than it already is.</p> 
	Automatically Create Colour Art	<p>As you draw in the Line Art layer, the Automatically Create Colour Art option instantly creates the corresponding strokes in the Colour Art layer.</p>  <div style="border: 1px solid green; padding: 5px; margin-top: 10px;">  <p>NOTE This option is only available when drawing on a vector layer.</p> </div>
	Auto-Flatten Mode	<p>By default, when drawing on a vector layer, each new stroke is created as a separate drawing object, which can be edited independently from other parts of the artwork. When enabled, the Auto-Flatten option automatically merges strokes into existing artwork.</p> <div style="border: 1px solid green; padding: 5px; margin-top: 10px;">  <p>NOTE This option is only available when drawing on a vector layer. When drawing on a bitmap layer, artwork is always flattened.</p> </div>
	Snapping	<p>Allows you to enable or disable snapping for this tool and all other animation and drawing tools that support snapping, as well as to select which types of snapping are enabled.</p> <p>If you double-click or long-click on this button, it will open a pop-up menu in which you can toggle different snapping modes. You can also click on this button to toggle it off, which will disable all snapping modes, and click on it again and toggle it on to re-enable the snapping modes which were previously enabled.</p> <p>This tool supports the following snapping mode:</p> <ul style="list-style-type: none"> • Snap to Alignment Guides: While drawing, the drawing tool will snap against nearby alignment guides.

	<p>Respect Protected Colour</p>	<p>In the Colour view, it is possible to make some of the colours in your palettes protected from change. When enabled, the Respect Protected Colour option will prevent the brush tool from drawing over areas filled with a protected colour.</p> <div data-bbox="646 359 1430 558" style="border: 1px solid #c8e6c9; padding: 10px;"> <p> NOTE This option is only available when drawing on a vector layer. When drawing on a bitmap layer, colour is not linked to your palettes and cannot be protected.</p> </div>
	<p>Use Stored Colour Gradient</p>	<p>The Use Stored Colour Gradient option can be used when painting with a gradient colour to always position the gradient in the same way it was stored, making it consistent across brush strokes. You can store a gradient by selecting a zone painted with a gradient with the Select tool, then clicking on Store Colour Gradient  in the Tool Properties view.</p> <div data-bbox="646 825 1430 961" style="border: 1px solid #c8e6c9; padding: 10px;"> <p> NOTE This option is only available when drawing on a vector layer.</p> </div>

Brush Properties Dialog

Brushes have an extensive set of options and properties that are not displayed in the Tool Properties view, but rather, in a dialog you can access from it. To open the Brush Properties dialog, click on the arrow button right of the stroke display area.





The Brush Properties dialog has five different tabs, minus the Smoothing tab if you are working on a bitmap layers. Below is detailed information about the options available in each tab:



- [Tip Tab](#) on page 965
- [Smoothing Tab](#) on page 971
- [Transparency Tab](#) on page 971
- [Dual Tip Tab](#) on page 975
- [Paper Texture Tab](#) on page 978

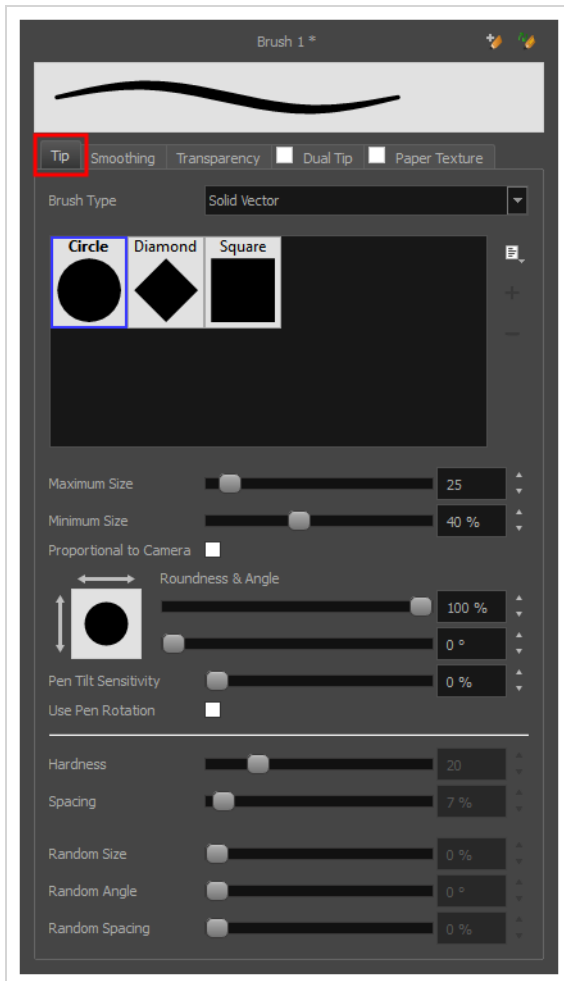





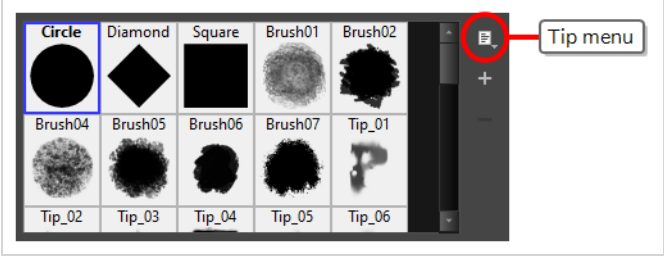









Tip Tab



The Tip tab allows you to configure the shape, size, hardness and spacing of your brush tip.

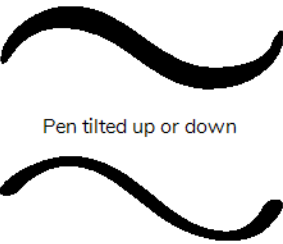





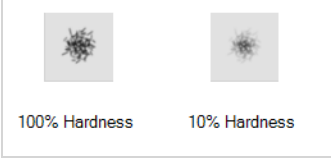
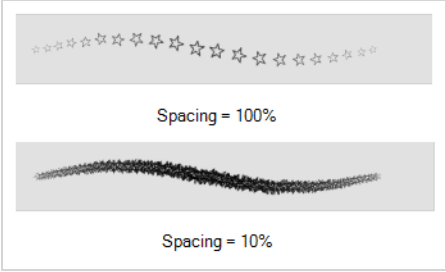

Property	Description
Brush Type	<p>Allows you to select between one of the following brush types:</p> <ul style="list-style-type: none"> • Solid Vector Brush: Creates vector shapes filled with a solid colour. Makes artwork lightweight, scalable and easy to tweak. Since this kind of brush can only create solid colour shapes, solid vector brushes have a limited set of options including size, roundness, angle, centerline smoothing and contour smoothing. • Textured Vector Brush: Creates vector shapes filled with a texture. This gives you access to bitmap brush tips, paper textures, transparency and several other options. <div data-bbox="570 1675 1429 1875" style="border: 1px solid green; padding: 10px; margin-top: 10px;"> <p> NOTE This option is not available when working on a bitmap layer. With bitmap layers, brushes are always textured, and textured brush options are always available.</p> </div>

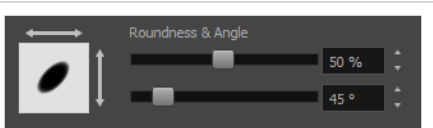
<p>Brush Tip Library</p>	 <p>This is where you select the shape of the brush tip. By default it is round. Note that some tips are designed to have semitransparent areas, even when the maximum brush opacity is set to 100%.</p> <p>To create a custom brush tip, you must prepare the file ahead of time, either in Harmony or in a third-party software, such as Adobe Photoshop. Colour is not supported and transparency is not supported in the traditional sense. Black appears as 100% opaque, white appears as 100% transparent and all the shades of grey in between appear as varying degrees of semitransparency. A range of file formats are supported—.jpeg, .png, .tif, .psd, .tga to name a few. Alpha channels are disregarded on import. It is recommended that your file be between 100 x 100 pixels and 400 x 400 pixels.</p> <p>You can also import brush tips that you exported from Harmony, so you can share them with colleagues.</p>
<p>Minimum and Maximum Size</p>	<p>The minimum and maximum sizes of your drawing tool produce the thick and thin effect on your stroke. This works with the pressure sensitivity of a pen tablet.</p> <ul style="list-style-type: none"> • Maximum Size: Defines the maximum width of the stroke. • Minimum Size: Defines the minimum width of the stroke in relation to and as a percentage of the maximum size. <div style="border: 1px solid green; padding: 10px; margin-top: 10px;"> <p> NOTE</p> <p>Setting the Minimum Size value to 100% eliminates the possibility of creating width variation on your stroke. In other words, you would be forcing a uniform line width using the Maximum Size value.</p> </div>
<p>Proportional to Camera</p>	<p>If you check this option, the size of the brush will be adjusted to the position of the camera on the z-axis. This means that if the camera is zoomed in on the scene, the brush will be proportionally smaller so that it appears the same size in the rendered image. Likewise, if the camera is zoomed out, the brush will be proportionally bigger.</p>
<p>Roundness and Angle</p>	<p>The Roundness and Angle parameters allow you to change the shape and orientation of the tip.</p>

	<ul style="list-style-type: none"> • Roundness: The vertical scaling to apply to the tip. Reducing this setting squashes the tip vertically, allowing you to turn round or square tips into flat tips. • Angle: The angle at which to rotate the brush tip, counterclockwise. <div data-bbox="570 373 1429 732" style="border: 1px solid #c8e6c9; padding: 10px;"> <p> NOTE The squashing is not relative to the angle—if the tip is rotated, the squashing will still be done relative to the tip's original orientation.</p> <table border="1" data-bbox="678 527 1395 695" style="width: 100%; text-align: center;"> <tr> <td></td> <td></td> <td></td> <td></td> </tr> <tr> <td>Roundness: 100%</td> <td>Roundness: 33%</td> <td>Roundness: 100%</td> <td>Roundness: 33%</td> </tr> <tr> <td>Angle: 0°</td> <td>Angle: 0°</td> <td>Angle: 45°</td> <td>Angle: 45°</td> </tr> </table> </div>					Roundness: 100%	Roundness: 33%	Roundness: 100%	Roundness: 33%	Angle: 0°	Angle: 0°	Angle: 45°	Angle: 45°
													
Roundness: 100%	Roundness: 33%	Roundness: 100%	Roundness: 33%										
Angle: 0°	Angle: 0°	Angle: 45°	Angle: 45°										
Pen Tilt Sensitivity	<p>If your pen and tablet support tilt sensitivity, this option allows you to set whether your brush takes your pen's tilt angle into account, and how much.</p> <p>When your pen is fully tilted, your brush tip will be stretched by the percentage you set in this parameter, in the angle in which you tilt it. For example, if you set the Pen Tilt Sensitivity to 50%, and you tilt your pen all the way up or down, your brush tip will be stretched vertically by 50%. With the same setting, if you tilt your pen all the way left or right, your brush tip will be stretched horizontally by 50%.</p> <div data-bbox="570 1115 902 1440" style="border: 1px solid #ccc; padding: 10px;">  <p style="text-align: center;">Pen tilted up or down</p>  <p style="text-align: center;">Pen tilted left or right</p> </div>												
Use Pen Rotation	<p>If enabled, and if your pen and tablet support tip rotation, your brush tip will rotate with the angle of your pen tip.</p> <div data-bbox="570 1598 1057 1824" style="border: 1px solid #ccc; padding: 10px;">  <p style="text-align: center;">A stroke with a square tip without pen rotation</p>  <p style="text-align: center;">A stroke with a square tip with pen rotation, with the pen rotated at 45°</p> </div>												

<p>Hardness</p>	<p>The hardness value corresponds to the softness of the brush tip's edges. The lower the value, the softer the tip edge. The higher the value, the sharper the tip edge. Be aware that some brush tips are not 100% opaque, so they will always appear somewhat soft, even at 100% hardness.</p> 
<p>Spacing</p>	<p>Defines the amount of space between each stamp of the brush. A value of 100% sets the stamp marks edge to edge, if there is no white space around the shape. The larger the value, the greater the space between marks. A really large value can make the brush stroke appear as a string of individual marks. Conversely, a small spacing value will give the appearance of a fluid brush stroke.</p> <p>Spacing is only evident when making a continuous stroke.</p> 
<p>Random Size</p>	<p>You can create variation between the thick and thin of your brush stroke just by setting the Maximum and Minimum Size values. If you add randomness to the mix, pressure sensitivity from your drawing tablet will still be applied. Light pressure will create random values around the minimum, while heavy pressure will create random values closer to the maximum. The larger the percentage, the larger the range of random variation.</p> 

	<div style="border: 1px solid green; padding: 10px;">  <p>NOTE</p> <p>Setting the Minimum Size to 100% eliminates the possibility of creating width variation on your stroke, whether you are applying randomness or not. Therefore, you would be forcing a uniform line width using the Maximum Size value.</p> </div>
<p>Random Angle</p>	<p>Sets the range for random rotation around the set Angle value. For example, if the Angle is set to 45° and the Random Angle set to 10°, the software will choose values between 40°–50° (plus or minus 5 degrees, equaling a total of 10 degrees).</p>   <p>Random Angle = 0%</p>  <p>Random Angle = 60%</p>
<p>Random Spacing</p>	<p>Sets the range for random spacing around the set Spacing value. For example, if the Spacing is set to 50% and the Random Spacing is set to 10%, then Harmony will choose values between 45%–55% (plus or minus 5 percent, equaling a total of 10 percent).</p>  <p>Spacing = 10% Random Spacing = 0%</p>  <p>Spacing = 10% Random Spacing = 80%</p>  <p>Spacing = 100% Random Spacing = 0%</p>  <p>Spacing = 100% Random Spacing = 80%</p>

Smoothing Tab

The Smoothing tab contains options to configure how Harmony should automatically smooth your brush strokes as you paint.

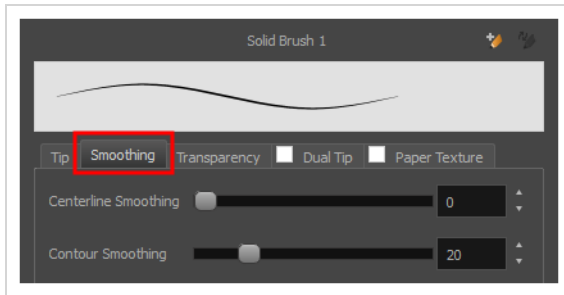

NOTE

The Smoothing tab is only available when working on a vector layer, as bitmap layers do not support smoothing.

Property	Description
Centerline Smoothing	Defines the amount of smoothing Harmony should perform on the central line of the brush stroke. A higher setting will prevent your line from being shaky, but is liable to reduce drawing precision and turn sharp angles into curves.
Contour Smoothing	Defines the amount of smoothing Harmony should perform on the outer contour of the brush stroke. A higher setting will round sharp corners and reduce the amount of control points for the resulting vector shape.

Transparency Tab

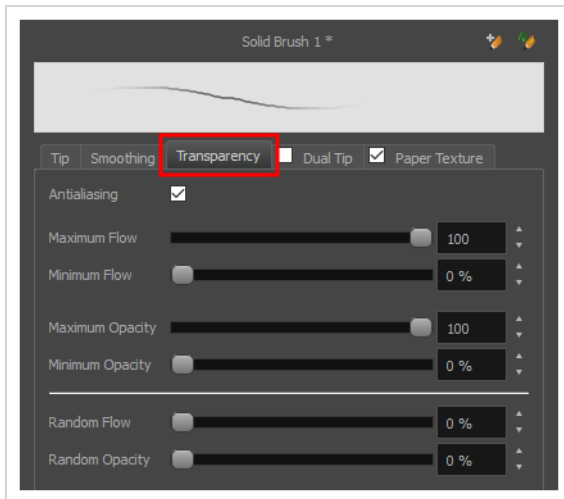

The Transparency tab allows you to decide if your brush has antialiasing as well as to set its flow and opacity settings.

**NOTE**

The Transparency tab's options are only available on vector layers if the **Brush Type** option of the **Tip** tab is set to **Textured Vector Brush**. On bitmap layers, those options are always available.

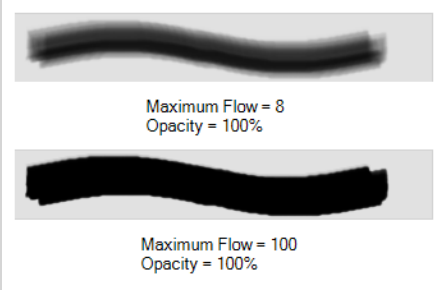
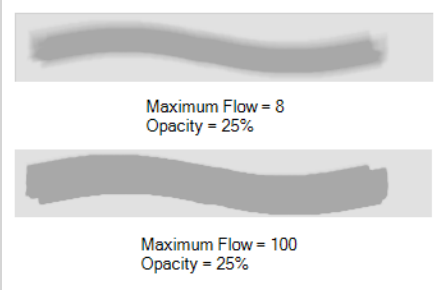
Property	Description
Antialiasing	<p>Enabled by default. This option causes the contours of the brush strokes to blend with the surrounding colours, to create an illusion of smoothness otherwise not possible due to the picture resolution.</p> <p>If antialiasing is disabled, the brush's texture will only render fully transparent or fully opaque pixels. Disabling this option can be useful if you need your outlines to be very crisp, if you want to make pixel art or if you need your brush strokes to render in solid colours with no variation, which makes them easier to repaint or process in third party software.</p> <div data-bbox="573 1356 1430 1493" style="border: 1px solid green; padding: 5px;">  <p>NOTE When disabled, all other options in the Transparency tab are disabled.</p> </div>
Maximum and Minimum Flow	<p>The Maximum and Minimum Flow parameters let you set the range for the rate at which paint flows from your brush. The analogy works better with a pen. The greater the flow, the more ink comes out, hence the more consistent the colour and texture of the line. If the flow is light, then the colour and texture of the line may look spotty. This feature works with the pressure sensitivity of a pen tablet.</p> <ul style="list-style-type: none"> • Maximum Flow: Sets the maximum rate at which colour and texture are applied as you create a fluid stroke. • Minimum Flow: Sets the minimum rate at which colour and texture are applied as you create a fluid stroke. It is defined as a percentage of the

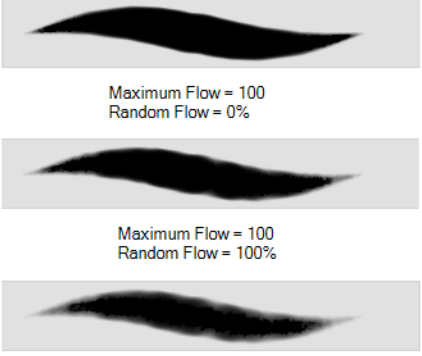
	<p>Maximum Flow value. If the Minimum Flow value is set to 100%, then tablet pressure sensitivity will no longer be applicable. The flow will be set to the constant rate of the Maximum Flow value.</p> 
<p>Maximum Opacity and Minimum Opacity</p>	<p>The Maximum and Minimum Opacity parameters are where you set the opacity range for a brush mark. This works with the pressure sensitivity of a pen tablet.</p> <ul style="list-style-type: none"> • Maximum Opacity: Sets the transparency limit of the brush mark when the pressure is heavy. • Minimum Opacity: Sets the transparency limit of the brush mark when the pressure is very light. It is defined as a percentage of the Maximum Opacity value. If the Minimum Opacity value is set to 100%, then tablet pressure sensitivity will no longer be applicable. The opacity will be set to the constant rate of the Maximum Opacity value. 
<p>Randomness</p>	<p>The Randomness parameter lets you set the range for the randomness of the flow and opacity. This works with the pressure sensitivity of a pen tablet.</p>
<p>Randomness Flow</p>	<p>You can create variation in the flow of your brush stroke just by setting the Maximum and Minimum Flow values. If you add randomness to the mix, pressure sensitivity from your drawing tablet will still be applied. Light pressure will create random values around the minimum, while heavy pressure will create random values closer to the maximum. The larger the percentage, the larger the range of random variation.</p>

	<div data-bbox="574 191 1016 632">  <p>Maximum Flow = 100 Random Flow = 0%</p> <p>Maximum Flow = 100 Random Flow = 100%</p> <p>Maximum Flow = 50 Random Flow = 100%</p> </div> <div data-bbox="574 667 1430 905" style="border: 1px solid green; padding: 10px;"> <p> NOTE</p> <p>Setting the Minimum Flow value to 100% eliminates the possibility of creating flow variation on your stroke, whether you are applying randomness or not. That is, you would be forcing a uniform flow using the Maximum Flow value.</p> </div>
Random Opacity	<p>You can create variation in the opacity of your brush stroke just by setting the Maximum and Minimum Opacity values. If you add randomness to the mix, pressure sensitivity from your drawing tablet will still be applied. Light pressure will create random values around the minimum, while heavy pressure will create random values closer to the maximum. The larger the percentage, the larger the range of random variation.</p> <div data-bbox="574 1192 1016 1707">  <p>Maximum Opacity = 100 Minimum Opacity = 10% Random Opacity = 0%</p> <p>Maximum Opacity = 100 Minimum Opacity = 10% Random Opacity = 10%</p> <p>Maximum Opacity = 100 Minimum Opacity = 10% Random Opacity = 50%</p> </div>

**NOTE**

Setting the Minimum Opacity value to 100% eliminates the possibility of creating opacity variation on your stroke, whether you are applying randomness or not. That is, you would be forcing a uniform opacity using the Maximum Opacity value.

Dual Tip Tab

The Dual Tip tab lets you set the parameters for creating a dual tip brush. The primary bitmap brush tip and the dual tip always work together. You can set the parameters for the primary tip in the Tip tab and those for the dual tip in the Dual Tip tab. The Blend mode you select determines how the tips are combined.

By default, the Blend Mode is set to Multiply and the Random Angle to 360°.

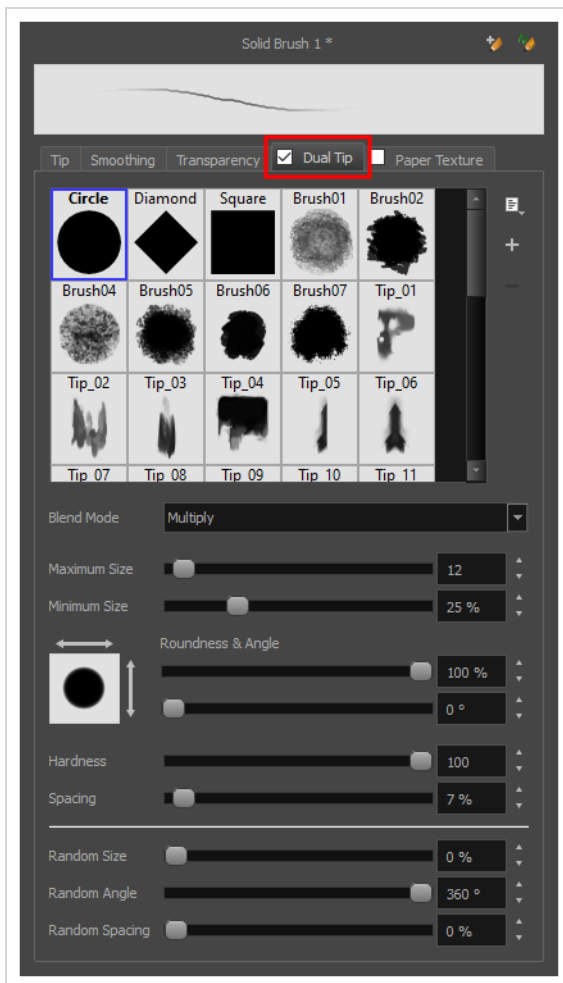

**NOTE**

To use a Dual Tip, you must enable option by checking the checkbox inside the **Dual Tip** tab. Additionally, if you are working on a vector layer, the **Brush Type** option of the Tip tab must be set to **Textured Vector Brush**.

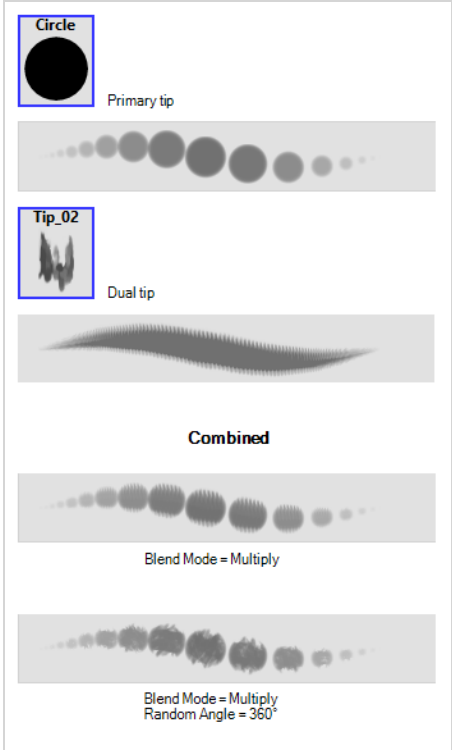
Property	Description
Enable/Disable	The checkbox inside the tab allows you to decide whether or not your brush uses a dual tip. If this checkbox is unchecked, the options in the Dual Tip tab will be disabled.
Blend Mode	The Blend modes let you decide how the primary tip and the dual tip are combined.
Multiply	<p>This is the default blend mode. When the two brush tips are combined in this mode, they essentially cut each other out in overlapping areas, where one or both tips have an area of 100% transparency. The less opaque the brush tips are, the lighter their combination.</p> 
Colour Dodge	In this mode, the primary tip cuts out the shape of the dual tip. Where the tip shapes overlap, within the boundaries of the primary shape, the colour and opacity appear darker.

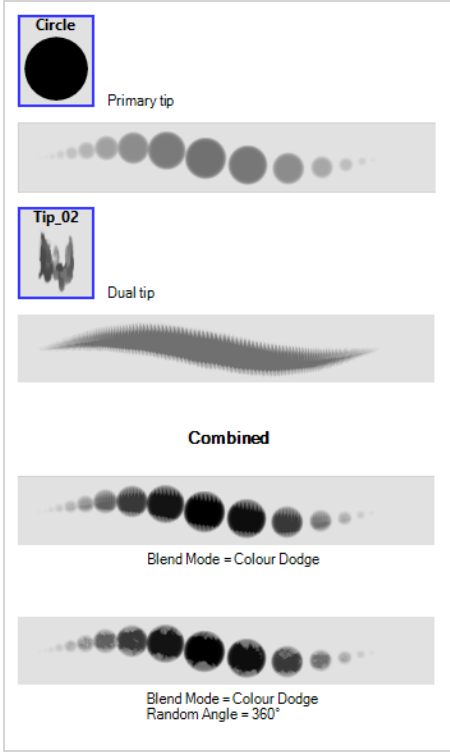
Property	Description
	 <p>Circle Primary tip</p> <p>Tip_02 Dual tip</p> <p>Combined</p> <p>Blend Mode = Colour Dodge</p> <p>Blend Mode = Colour Dodge Random Angle = 360°</p>
Combine	<p>This mode treats the two tips as two different and separate brushes that have the same colour and follow the same path.</p>

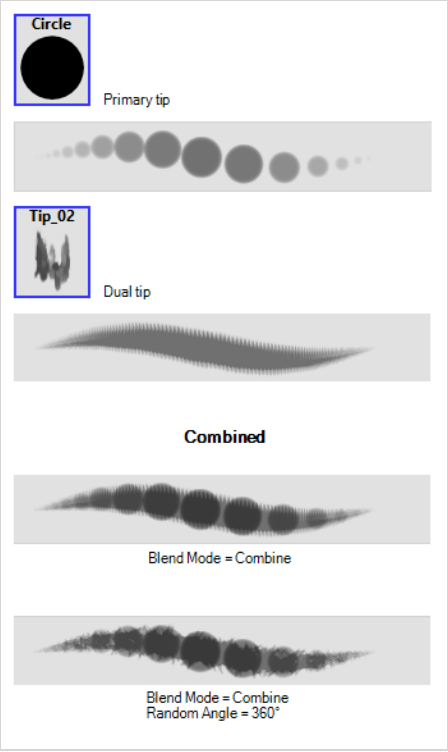
Property	Description
	 <p>The diagram illustrates various brush tip configurations and their resulting strokes. It is organized into four sections:</p> <ul style="list-style-type: none"> Circle: A solid black circle is shown as the 'Primary tip'. Below it, a horizontal brush stroke is composed of a series of overlapping circles of varying sizes, creating a soft, feathered edge. Tip_02: A dual-pointed tip is shown. Below it, a horizontal brush stroke is a smooth, wavy line with a soft, feathered edge. Combined: This section shows two examples of combined tips. The first example shows a brush stroke with a soft, feathered edge, labeled 'Blend Mode = Combine'. The second example shows a brush stroke with a soft, feathered edge and a random angle of 360 degrees, labeled 'Blend Mode = Combine' and 'Random Angle = 360°'.

Paper Texture Tab

The Paper Texture tab lets you configure a paper-like texture for your brush. You can also add textures by importing image files, or import paper textures that were previously exported from Harmony.

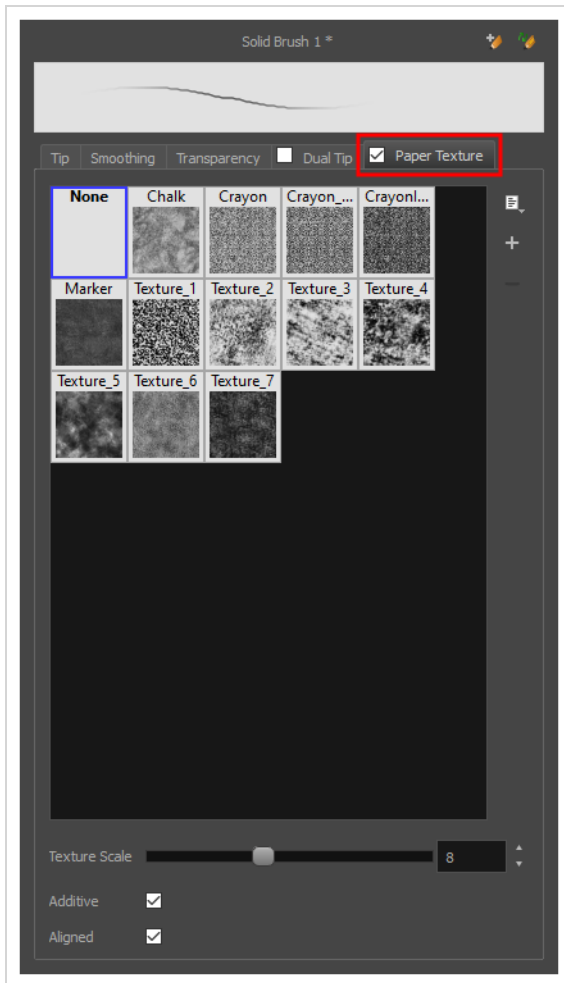

NOTE

To use a Paper Texture, you must enable option by checking the checkbox inside the **Paper Texture** tab. Additionally, if you are working on a vector layer, the **Brush Type** option of the Tip tab must be set to **Textured Vector Brush**.

Property	Description
Enable/Disable	The checkbox inside the tab allows you to decide whether or not your brush uses a paper texture. If this checkbox is unchecked, the options in the Paper Texture tab will be disabled.
Texture Scale	Increase or decreases the size of the paper texture.
Additive	This option layers the texture on top of itself as you scribble overlapping lines in one continuous stroke. If this option is turned off, areas of overlapping lines from a single, continuous stroke will appear the same, in terms of darkness and texture, as non-

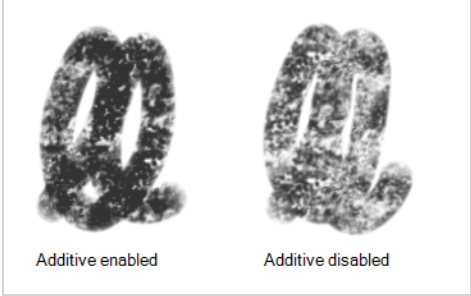
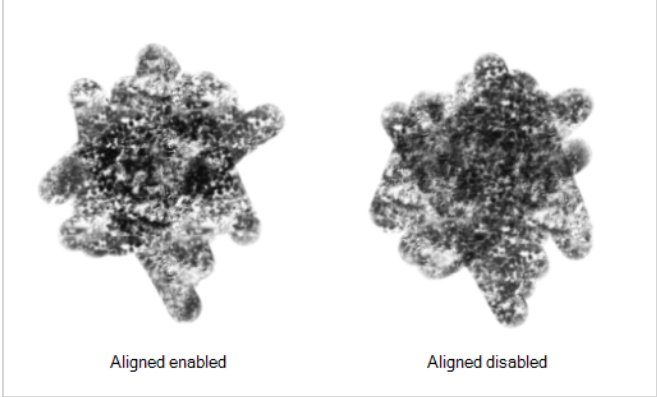
Property	Description
	<p>overlapping areas.</p>  <p>The image shows two examples of overlapping areas. The left example is labeled 'Additive enabled' and shows two overlapping, textured shapes where the overlapping area is a darker shade of the texture. The right example is labeled 'Additive disabled' and shows the same two overlapping shapes, but the overlapping area is a lighter shade, indicating that the textures are not being combined additively.</p>
Aligned	<p>This option defines the way separate, overlapping strokes behave. If this option is enabled, the paper texture's position does not change with each sweep of the brush. If this option is disabled, each sweep of the brush produces a different texture position. The texture orientation always stays the same.</p>  <p>The image shows two examples of overlapping strokes. The left example is labeled 'Aligned enabled' and shows two overlapping, textured strokes where the texture is consistently positioned across both strokes. The right example is labeled 'Aligned disabled' and shows the same two overlapping strokes, but the texture is shifted relative to each stroke, indicating that the texture position changes with each sweep of the brush.</p>

Centerline Editor Tool Properties





The Centerline Editor tool allows you to edit brush strokes by their centreline rather than by their contour. This makes it easier to tweak the tips, curves and corners of brush strokes. The purpose of this tool is to make it as easy to edit brush strokes as it is to edit pencil lines with the Contour Editor tool.

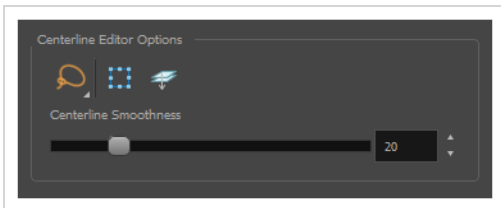

How to access the Centerline Editor tool properties

1. In the Tools toolbar, select the Centerline Editor  tool.
2. The tool's properties are displayed in the Tool Properties view.

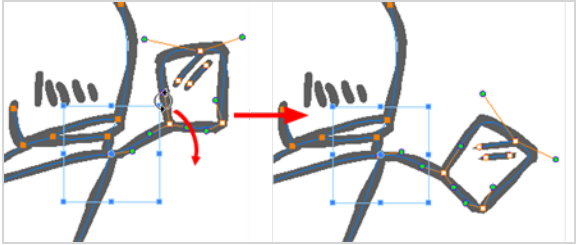

Tool Options

Icon	Property	Description
	Selection Mode	<p>Allows you to choose the method to visually select multiple elements:</p> <ul style="list-style-type: none"> •  Lasso: Allows you to select multiple elements by drawing an irregular closed shape around them with your mouse. •  Marquee: Allows you to select multiple elements by drawing a rectangle around them. This is faster, as you only need to drag your mouse from one corner of the rectangle to its opposite corner, but it may not be as precise as you want. <div style="border: 1px solid #0070C0; padding: 5px; margin-top: 10px;"> <p> TIP You can press and hold the Alt key to temporarily use the other selection mode.</p> </div>
	Show Centerline Editor Controls	When enabled, selecting several control points will make a manipulator bounding box appear. You can use this manipulator to scale and rotate the selection of points.

Icon	Property	Description
		
	Apply to Line and Colour Art	<p>Allows you to perform drawing operations on both the Line Art and Colour Art layers of your drawing simultaneously.</p> <div data-bbox="737 688 1429 858" style="border: 1px solid green; padding: 5px;"> <p> NOTE If you have Overlay and Underlay Art layers enabled, they will also be affected when this option is enabled.</p> </div>
	Centerline Smoothness	<p>Allows you to adjust the amount of control points on the centerline that is generated from the selected stroke. A lower value will create a centerline with less points, which makes it easier to manipulate large lengths of the stroke, and a higher value will generate a centerline with more points, allowing you to tweak details.</p>

Close Gap Tool Properties

The paint tool requires the area you attempt to fill to be closed in order to know exactly what area of your artwork must be filled. However, it is common for artists to accidentally leave small gaps in their artwork.

The Close Gap tool allows you to quickly close small gaps in a shape by creating an invisible stroke connecting two extremities of the gap. You can then fill the area using the Paint tool, as this invisible stroke will be taken in account to determine the outline of the shape to fill.



TIP

You do not need to use the Close Gap tool with precision. If you draw a crude stroke near the gap you want to close, the tool will automatically detect the two closest line extremities and will draw an invisible straight line connecting them, closing the gap between them.



How to access the Close Gap tool properties

1. In the Tools toolbar, select the Close Gap  tool.

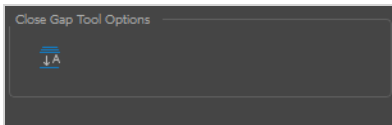
The tool's properties are displayed in the Tool Properties view.



Tool Options

Icon	Property	Description
	Auto Flatten	<p>The Close Gap tool creates an invisible drawing stroke to close the shape. Enabling this option will merge the stroke into the artwork instead of adding the stroke on top of it.</p> <div style="border: 1px solid green; padding: 10px; margin-top: 10px;"> <p> NOTE</p> <p>The area you close with the Close Gap tool will be fillable regardless of whether or not this option is enabled.</p> </div>

Colour Eyedropper Tool Properties

The Colour Eyedropper tool allows you to pick a colour from your drawing without going to the Colour view.



NOTE



The following options will only have an effect when picking colours from a bitmap layer, as they affect the colour that gets picked. When working on a vector layer, you can only pick colours that are available in one of the palettes in your scene. Therefore, the colour you pick will always be exactly the colour that was used to fill the shape or stroke you clicked on.

How to access the Colour Eyedropper tool properties

1. In the Tools toolbar, select the Colour Eyedropper  tool.

The tool's properties are displayed in the Tool Properties view.



Icon	Property	Description
	Sample All Layers	<p>By default, the Colour Eyedropper tool picks the colour from the active drawing layer only. This means that if the colour is semi-transparent, it will still only take the colour from the active layer, along with its transparency, and ignore the colours from layers behind it.</p> <p>With this option enabled, the Colour Eyedropper tool will pick the colour as it appears on the screen instead, allowing you to pick colours that are the result of several layers composited together.</p>
	Do Not Pick Transparency	<p>By default, the Colour Eyedropper tool picks the colour's alpha value as well as its colour values. When enabled, the colour picked will always have an alpha value of 255.</p>

Contour Editor Tool Properties

The Contour Editor lets you reshape vector shapes, brush strokes and lines in your drawings.

Artwork in Harmony is made of vector shapes. Vector shapes are defined by points, the lines joining the points together (contours) and the curve vectors, represented by Bezier handles, which make the curve of said lines.

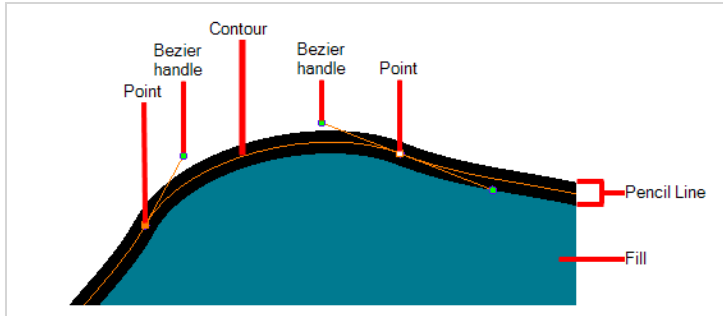

The Contour Editor tool allows you to select a contour or point, and change the position of points, add and remove points from the shape, rotate, lengthen and shorten curve handles to influence the curve of contours between those points, or drag contours between points to change their curve directly.



How to access the Contour Editor tool properties

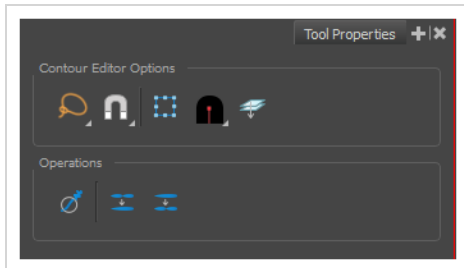

1. In the Tools toolbar, select the Contour Editor  tool.







The tool's properties are displayed in the Tool Properties view.

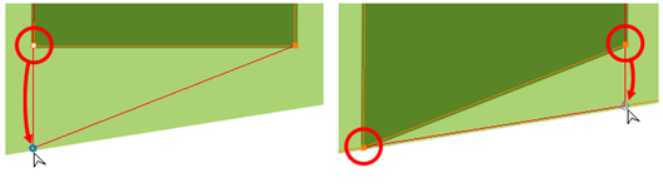
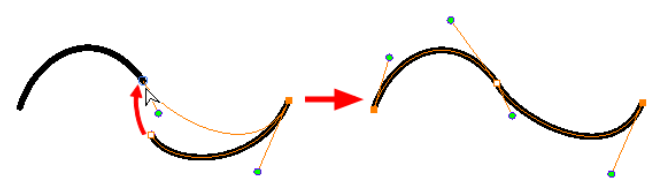





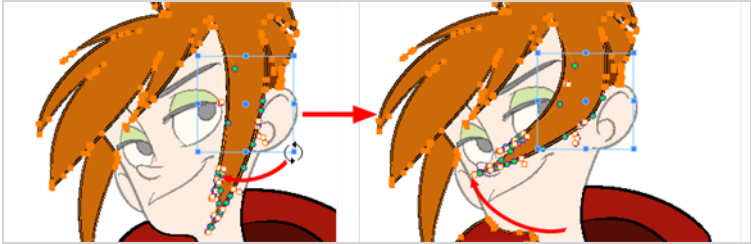

Tool Modes



Icon	Property	Description
	Selection Mode	<p>Allows you to choose the method to visually select multiple elements:</p> <ul style="list-style-type: none"> •  Lasso: Allows you to select multiple elements by drawing an irregular closed shape around them with your mouse. •  Marquee: Allows you to select multiple elements by drawing a rectangle around them. This is faster, as you only need to drag your mouse from one corner of the rectangle to



Icon	Property	Description
		<p>its opposite corner, but it may not be as precise as you want.</p> <div data-bbox="683 344 1430 512" style="border: 1px solid #add8e6; padding: 10px;">  <p>TIP You can press and hold the ALT key to temporarily use the other selection mode.</p> </div>
	Snapping	<p>Allows you to enable or disable snapping for this tool and all other animation and drawing tools that support snapping, as well as to select which types of snapping are enabled.</p> <p>If you double-click or long-click on this button, it will open a pop-up menu in which you can toggle different snapping modes. You can also click on this button to toggle it off, which will disable all snapping modes, and click on it again and toggle it on to re-enable the snapping modes which were previously enabled.</p> <p>This tool supports the following snapping modes:</p> <ul style="list-style-type: none"> • Snap to Contour: When enabled, moving the control point in a contour near another contour will snap that control point against that contour. This will lock the point and the contour together, and moving the control point will deform the contour. <p>This option can be especially useful if you need to make the edges of two shapes snap together, like so:</p> <div data-bbox="761 1234 1433 1430" style="border: 1px solid #ccc; padding: 5px;">  </div> <p>You can also use this option to make a control point snap against another control point, allowing you to join lines together.</p> <div data-bbox="761 1583 1433 1787" style="border: 1px solid #ccc; padding: 5px;">  </div>

Icon	Property	Description
		<div data-bbox="761 283 1430 648" style="border: 1px solid #90EE90; padding: 10px;"> <p> NOTE</p> <p>When a control point is snapped against a contour or another control point in your drawing, the Contour Editor will manipulate them together. However, even if you make a point in one drawing stroke snap against another drawing stroke, they will remain separate drawing strokes unless they are flattened together, and you will still be able to manipulate them individually with the Select  tool.</p> </div> <ul style="list-style-type: none"> • Snap to Alignment Guides: While moving the selection or one of its control points, it will snap against nearby alignment guides. • Snap and Align: Snaps the selected anchor point to any existing line while displaying temporary rulers as a guide that you can also snap your anchor point to. <div data-bbox="761 926 1198 1014" style="border: 1px solid #ccc; padding: 5px;">  </div> <ul style="list-style-type: none"> • Snap to Grid: While moving the selection, the mouse cursor will snap against the intersecting points of the grid. <div data-bbox="761 1142 1430 1316" style="border: 1px solid #ADD8E6; padding: 10px;"> <p> TIP</p> <p>To display the grid, select View > Grid > Show Grid from the top menu or press Ctrl + '.</p> </div>
	<p>Show Contour Editor Controls</p>	<p>When enabled, selecting several control points will make a manipulator bounding box appear. You can use this manipulator to scale and rotate the selection of points.</p> <div data-bbox="683 1503 1430 1745" style="border: 1px solid #ccc; padding: 5px;">  </div>
	<p>Tip Style</p>	<p>If you select and remove part of a pencil line, this option allows you to choose which kind of line tip the removed segment should leave behind:</p>

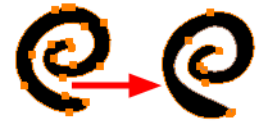
Icon	Property	Description
		<ul style="list-style-type: none">  Tip Style: Round: Leaves rounded tips at the extremities of the deleted line segment.   Tip Style: Flat: Leaves flat tips at the extremities of the deleted line segment. 
	Apply to Line and Colour Art	<p>Allows you to perform drawing operations on both the Line Art and Colour Art layers of your drawing simultaneously.</p> <div data-bbox="683 934 1430 1102" style="border: 1px solid #c8e6c9; padding: 10px;"> <p> NOTE If you have Overlay and Underlay Art layers enabled, they will also be affected when this option is enabled.</p> </div>

Operations

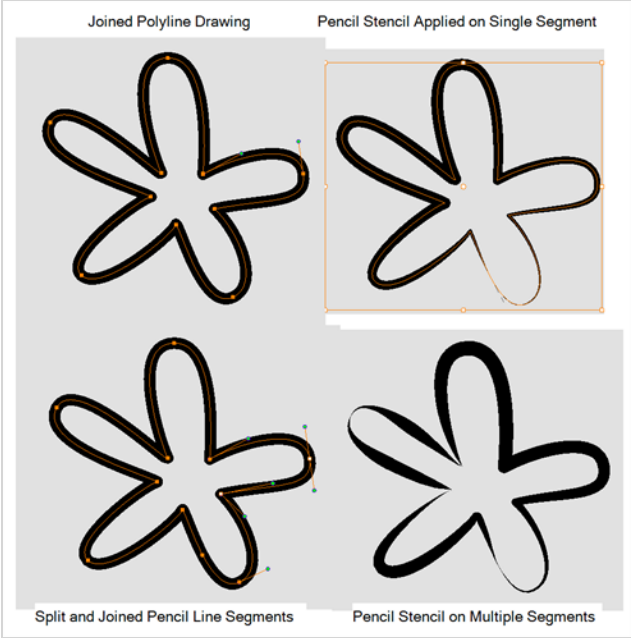

Icon	Property	Description
	Smooth Selection	<p>The Smooth operation lets you smooth out selected drawing strokes and remove extra points.</p> <div data-bbox="761 1451 1031 1585" style="border: 1px solid #ccc; padding: 5px; text-align: center;">  </div> <div data-bbox="683 1623 1430 1833" style="border: 1px solid #bbdefb; padding: 10px;"> <p> TIP You can also smooth the selection by selecting Drawing > Optimize > Smooth from the top menu or by pressing Alt + Shift + S.</p> </div>

Icon	Property	Description
 	<p>Split Pencil Line</p> <p>Join Pencil Lines</p>	<p>When drawing with the Polyline tool, your drawing has an even line thickness. You can use the Pencil Editor to adjust the thickness point by point, but if you want to adjust it quicker, you can use the Split Pencil Line and Point Pencil Lines options to create segments and apply a pencil stencil to your drawing. Note that if you did not join the pencil lines on your polyline stroke, the segments between the points will act as separated segments.</p> 

Cutter Tool Properties

The Cutter tool lets you cut out part of a drawing so that you can transform it, copy it or delete it. It also allows you to trim overshoot lines.





How to access the Cutter tool properties

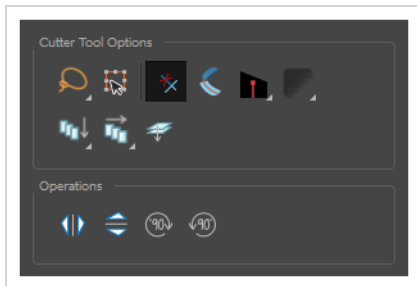



1. In the Tools toolbar, select the Cutter  tool. In the Tools toolbar, click and hold on the Select  tool to display the menu beneath and select the Cutter  tool.







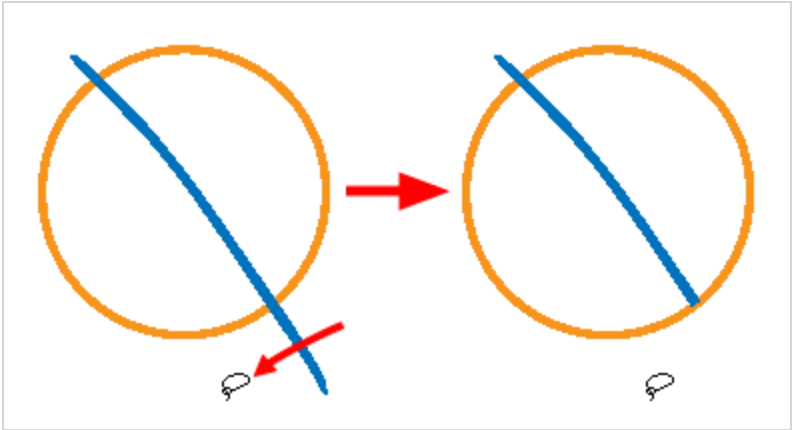

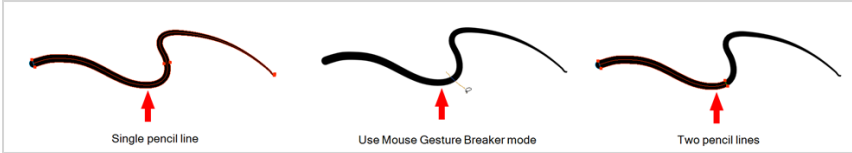



The tool's properties are displayed in the Tool Properties view.





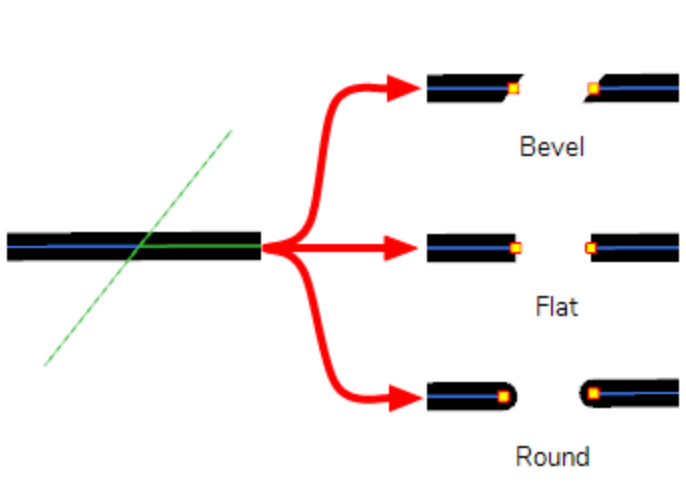





Tool Options

Icon	Property	Description
	Selection Mode	<p>Allows you to choose the method to visually select multiple elements:</p> <ul style="list-style-type: none"> •  Lasso: Allows you to select multiple elements by drawing an irregular closed shape around them with your mouse. •  Marquee: Allows you to select multiple elements by drawing a rectangle around them. This is faster, as you only need to drag your mouse from one corner of the rectangle to its opposite corner, but it may not be as precise as you want. <div style="border: 1px solid #00a0e3; padding: 10px; margin-top: 10px;"> <p> TIP You can press and hold the ALT key to temporarily use the other selection mode.</p> </div>
	Easy Drag	<p>When enabled, you can drag the selection by clicking anywhere inside its bounding box. By default, you must click on the artwork in the selection to be able to drag it.</p>



Icon	Property	Description
	<p>Use Mouse Gesture</p>	<p>When this option is enabled along with the Lasso  selection type, quickly drawing a line with the Cutter tool over a line segment in your artwork will instantly delete it. This can be useful if you want to use the Cutter tool to quickly clean up your artwork.</p>  <p>It allows you to cut in two modes as follows:</p> <ul style="list-style-type: none"> • Single Line Cutting Gesture: It deletes first line segment over which a straight gesture is drawn with the cutter. • Multiple Lines Cutting Gesture: It deletes all line segments over which a straight gesture is drawn with the cutter. <div data-bbox="583 1142 1430 1409" style="border: 1px solid green; padding: 10px;"> <p> NOTE</p> <p>This option will only work when using the Cutter tool on separate brush or pencil strokes. Hence, it is important not to flatten your artwork if you intend to use this option to clean up your drawings. This option has no effect on bitmap layers as the artwork in bitmap layers is always flattened.</p> </div>
	<p>Use Mouse Gesture Breaker Mode</p>	<p>When using the Lasso selection type, the Use Mouse Gesture Breaker Mode option lets you draw an invisible stroke on a pencil line to cut it in two individual objects. Once a pencil line is cut with this option, you will be able to select the two portions independently with either the Cutter tool, Pencil Editor tool or Select tool.</p> 

Icon	Property	Description
		<div data-bbox="584 283 1429 420" style="border: 1px solid green; padding: 5px;">  NOTE This option only works with pencil lines. </div>
	Tip Style	<p>When cutting through pencil lines, this option decides what kind of pencil line tips to put at the extremities of the remaining pencil line segments, where they were cut.</p> <div data-bbox="584 604 743 739" style="border: 1px solid gray; padding: 2px;">  Tip Style: Round  Tip Style: Flat  Tip Style: Bevel </div> <p>By default, this is set to Bevel , which will leave the tip of the pencil line cut at the same angle as your cutter stroke. If you prefer, you can make pencil lines that you split with the Cutter tool have Flat  or Round  tips instead.</p> <div data-bbox="584 898 1299 1411" style="border: 1px solid gray; padding: 10px;">  <p>The diagram illustrates the effect of the Tip Style property. A thick black pencil line is intersected by a thin green line. Three red arrows point from the intersection to three pairs of resulting pencil line segments. The top pair is labeled 'Bevel' and shows the segments with tips cut at an angle matching the green line. The middle pair is labeled 'Flat' and shows the segments with flat, perpendicular tips. The bottom pair is labeled 'Round' and shows the segments with rounded tips.</p> </div>
	Antialiasing	<p>When working on bitmap artwork, enabling this will smooth the edges of the artwork you cut out, so that they do not appear pixelated.</p> <div data-bbox="584 1570 1429 1707" style="border: 1px solid green; padding: 5px;">  NOTE This option is only available with bitmap layers. </div>
	Apply to Visible Drawing Layers	<p>This option allows you to select which layers the tool should affect. It can be toggled on or off. When toggled on, it has two different modes. You can select a mode by clicking and holding on the button.</p>

Icon	Property	Description
		<ul style="list-style-type: none"> • Off: When this button is toggled off, the tool only works on the currently selected layers. If several layers are selected, the tool will work on all these layers simultaneously. •  Apply to Visible Drawing Layers: The tool will work on all the visible layers in the Camera view. •  Apply to Synced Drawing Layers: If the currently selected layer is synced with another layer, the tool will work on both the current layer and its synced layer. <div style="border: 1px solid green; padding: 5px; margin-top: 10px;">  NOTE This option only works in the Camera view. </div>
	Apply to All Frames	<p>This option allows you to determine which drawings in the current layer the tool should affect. It can be toggled on or off. When toggled on, it has two different modes. You can select a mode by clicking and holding on the button.</p> <ul style="list-style-type: none"> • Off: When this button is toggled off, the tool only works on the drawing in the current frame. •  Apply to All Frames: The tool will work on every exposed drawing in the selected layer simultaneously. •  Apply to Onion Skin Range: The tool will work on every drawing displayed in the Onion Skin. Onion Skin must be enabled for this option to work.
	Apply to Line and Colour Art	<p>Allows you to perform drawing operations on both the Line Art and Colour Art layers of your drawing simultaneously.</p> <div style="border: 1px solid green; padding: 5px; margin-top: 10px;">  NOTE If you have Overlay and Underlay Art layers enabled, they will also be affected when this option is enabled. </div>

Operations

Icon	Property	Description
	Flip Horizontal	Flips the current selection horizontally.



	Flip Vertical	Flips the current selection vertically.
	Rotate 90 Degrees CW	Rotates the current selection 90 degrees clockwise.
	Rotate 90 Degrees CCW	Rotates the current selection 90 degrees counter-clockwise.



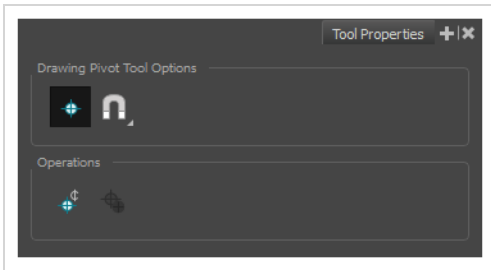

Drawing Pivot Tool Properties

The Drawing Pivot tool lets you set the pivots on your character. You can set the drawing pivots on drawings and symbols.



Tool Options

Icon	Property	Description
	Setting the Drawing Pivot for Symbols on All Frames	<p>The Set the Pivot for Symbol on All Frames option is enabled by default. When you set a drawing pivot on a symbol, all of its cells use the same drawing pivot. This means you do not have to set a drawing pivot on all frames. Once you set it, it is done.</p> <p>If you prefer to set a different drawing pivot for a series of cells, you can deselect the option and set your pivots on each cell or cell range.</p> <div data-bbox="854 1167 1430 1465" style="border: 1px solid #c8e6c9; padding: 10px; margin-top: 10px;"> <p> NOTE</p> <p>If you have already set several different pivots on your symbol's cells and selected the Set the Pivot for Symbol on All Frames option, once you set a new pivot on the same symbol, all of its pivots will be reset and will use your new pivot.</p> </div>
	Snapping	<p>Allows you to enable or disable snapping for this tool and all other animation and drawing tools that support snapping, as well as to select which types of snapping are enabled.</p> <p>If you double-click or long-click on this button, it will open a pop-up menu in which you can toggle different snapping modes. You can also click on this button to toggle it off, which will disable all snapping modes, and click on it again and toggle it on to re-enable the snapping modes which were previously</p>

Icon	Property	Description
		<p>enabled.</p> <p>This tool supports the following snapping modes :</p> <ul style="list-style-type: none"> • Snap to Contour: When moving the pivot, it will snap against the nearby points and contours of your artwork. • Snap to Alignment Guides: When moving the pivot, it will snap against nearby alignment guides. • Snap and Align: When moving the pivot, it will align with the edges of elements in the drawing. • Snap to Grid: When moving the pivot, it will snap against the intersecting points of the grid. <div data-bbox="933 898 1430 1108" style="border: 1px solid #add8e6; padding: 10px;">  <p>TIP To display the grid, select View > Grid > Show Grid from the top menu or press Ctrl + '.</p> </div>
	Reset Pivot	<p>When you click the Reset Pivot option, the drawing pivot of the selected drawing or symbol is reset to the centre of the Camera view.</p>
	Copying Pivot on Parent Symbol	<p>When you import new extra drawings, such as hands and mouths, you can use the drawing pivot that was set on your drawings and report them to the symbol's cells. Use the Copy Pivot to Parent Symbol command for this.</p> <div data-bbox="854 1535 1430 1892" style="border: 1px solid #90ee90; padding: 10px;">  <p>NOTE When you copy drawing pivots to the parent symbol, there is no link between the drawings' pivots and the symbol's pivots. If you modify the drawing pivot later, it will not link to the symbol. You would need to perform the operation again. If you need to modify the symbol's pivots, you can do it directly on the symbol's cells.</p> </div>

Edit Gradient/Texture Tool Properties

The Edit/Gradient Texture tool allows you to move, rotate and scale a gradient or texture fill within the shape it fills, without modifying the shape itself.

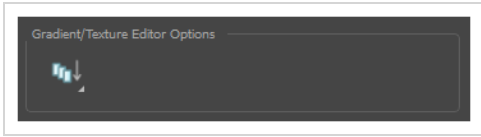





How to access the Edit Gradient/Texture tool properties

1. In the Tools toolbar, select the Edit Gradient/Texture  tool.

The tool's properties are displayed in the Tool Properties view.

Tool Options

Icon	Property	Description
	Apply to Visible Drawing Layers	<p>This option allows you to select which layers the tool should affect. It can be toggled on or off. When toggled on, it has two different modes. You can select a mode by clicking and holding on the button.</p> <ul style="list-style-type: none"> • Off: When this button is toggled off, the tool only works on the currently selected layers. If several layers are selected, the tool will work on all these layers simultaneously. •  Apply to Visible Drawing Layers: The tool will work on all the visible layers in the Camera view. •  Apply to Synced Drawing Layers: If the currently selected layer is synced with another layer, the tool will work on both the current layer and its synced layer. <div style="border: 1px solid green; padding: 5px; margin-top: 10px;"> <p> NOTE This option only works in the Camera view.</p> </div>

Ellipse Tool Properties

The Ellipse tool allows you to quickly draw an ellipse or a circle.

How to access the Ellipse tool properties

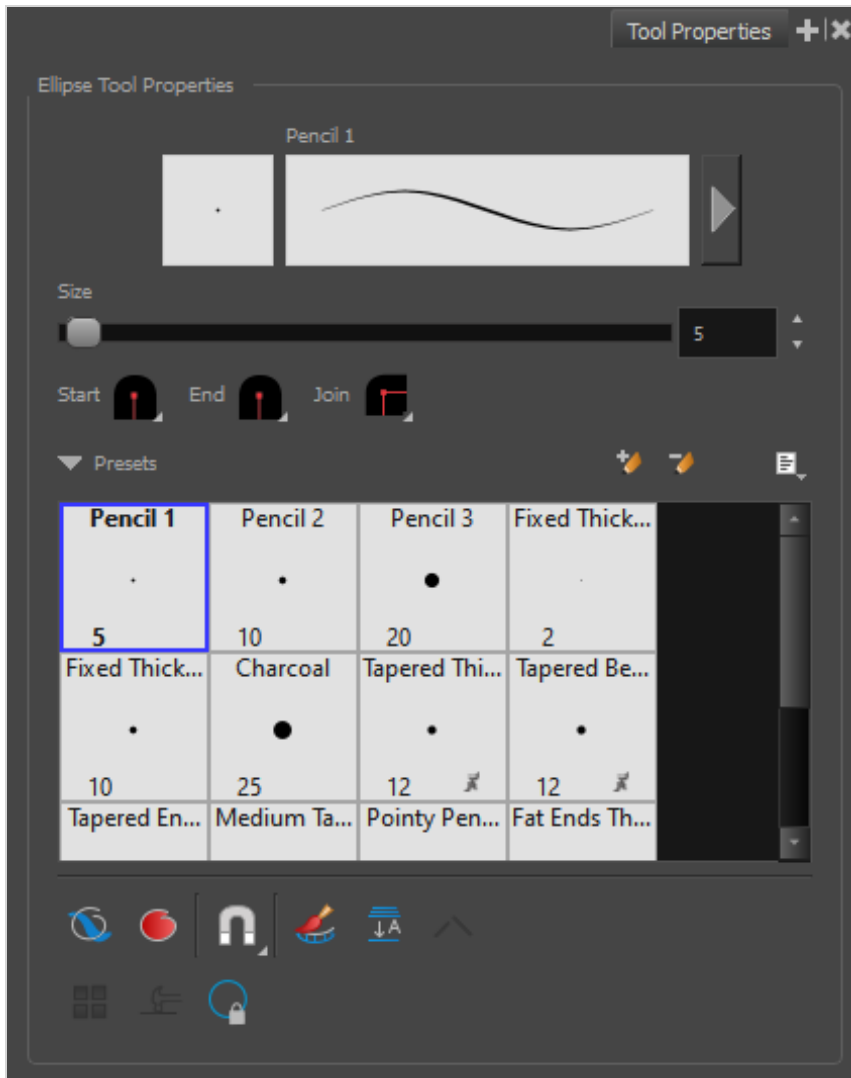

1. In the Tools toolbar, select the Ellipse  tool.

The tool's properties are displayed in the Tool Properties view.



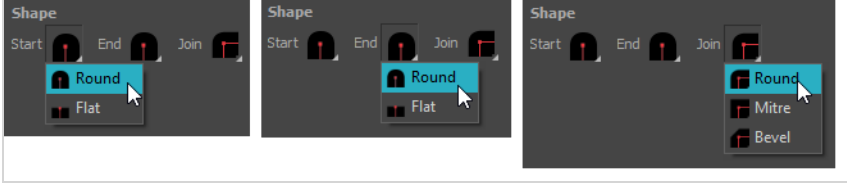

Pencil Properties

Just like other shape tools, this tool creates pencil lines. Hence, its tool properties are similar to the ones of the Pencil tool and it can be used with pencil presets.

Property	Description
Preview Area	<p>The Preview area lets you see a preview of the stroke your drawing tool will make.</p> 
Pencil Properties Dialog	<p>The arrow button right of the preview area opens the Pencil Properties dialog.</p>  <p>While the Tool Properties view only gives you access to a few of the pencil properties, a list of pencil presets and other drawing options, the Pencil Properties dialog gives you access to all the available options for your pencil's shape and texture. For more information on the Pencil Properties dialog, see the Pencil Properties Dialog on page 1003 section below.</p>
Size	<p>Defines the width of the pencil line used to draw the shape.</p>
Shape	<p>You can adjust the start, end, and join style of a pencil line.</p>  <ul style="list-style-type: none"> • Start: Lets you select the style of the start tip, which is the first tip you drew. You can choose between Round or Flat style. • End: Lets you select the style of the end tip, which is the last tip you drew. You can choose between Round or Flat style. • Join: Lets you select the joint style. The joints are where the line curves abruptly. You could also define the Join style as the corner style. You can choose between Round, Mitre and Bevel style.











Pencil Presets



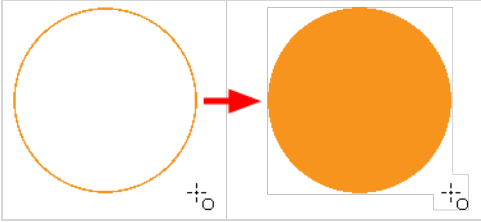

These options allow you to select, create and manage pencil presets.



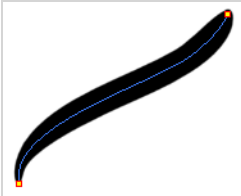

Icon	Property	Description
	Presets list	<p>Harmony provides a variety of pencil presets and thickness stencils and also lets you create and save your own. It is a good idea to create and save pencils with precise sizes and parameters when you draw for efficiency and consistency.</p> <p>A thickness stencil saves the thickness information across the length of the line. When drawing with a thickness stencil, the pressure sensitivity of the tablet is discarded. A thickness stencil can be used while drawing, or applied afterwards.</p> <p>You also have the possibility to apply different textures to your lines by either using the default presets or to import your own.</p> <p>You can export the pencil presets that you have created and import those that others have created. This is a good way for you and project collaborators to keep a consistent look for the project.</p>
	New Brush Preset	Creates a new preset based on the current tool properties.
	Delete Brush Preset	Deletes the currently selected preset.
	Brush Presets Menu	<p>Open a menu that contains the following options:</p> <ul style="list-style-type: none"> • New Brush Preset: Creates a new preset based on the current tool properties. • Delete Brush: Deletes the currently selected preset. • Rename Brush: Allows you to rename the currently selected preset. • Import Brushes: Allows you to import brush presets exported from Harmony. • Export Brushes: Allows you to export your brush presets into an <code>.xml</code> file. • Small Thumbnail: Displays presets in a grid of small thumbnails with a preview of their tip. • Large Thumbnail: Displays presets in a grid of big thumbnails, with their name and a preview of their tip. • Stroke View: Displays presets in a list, with their name and a preview of a stroke done with each preset.

Drawing Options

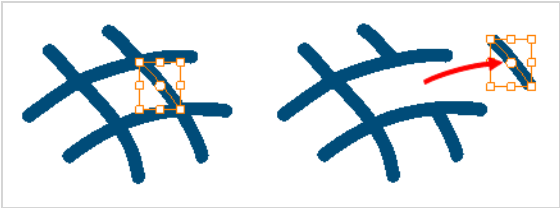
These options affect the way your shape is added to your artwork.

Icon	Property	Description
	<p>Draw Behind</p>	<p>When enabled, your brush strokes will appear behind the existing artwork.</p> <div data-bbox="634 338 1105 533">  <p>The orange stroke was drawn over the black stroke, then put underneath it.</p> </div> <div data-bbox="634 569 1430 741" style="border: 1px solid green; padding: 5px;"> <p> NOTE</p> <p>Your brush stroke will temporarily appear over your artwork as you draw it, until you release the mouse cursor or tablet pen.</p> </div>
	<p>Auto Fill</p>	<p>When enabled, the shape you draw is automatically filled with the selected colour. By default, drawing a shape only creates its outlines.</p> <div data-bbox="634 888 1112 1108">  </div> <div data-bbox="634 1144 1430 1602" style="border: 1px solid blue; padding: 5px;"> <p> TIP</p> <p>By default the pencil line and its fill will be the same colour. To select different colours for the line and its fill, do the following:</p> <ol style="list-style-type: none"> 1. In the Colour view, click the  Unlock Three Colours button. 2. Click on the  Set Current Pencil Colour swatch. Then, in the colour list, select the desired colour swatch for your outline. 3. Click on the  Set Current Paint Colour swatch. Then, in the colour list, select the desired colour swatch for the fill. </div>
	<p>Snapping</p>	<p>Allows you to enable or disable snapping for this tool and all other animation and drawing tools that support snapping, as well as to select which types of snapping are enabled.</p> <p>If you double-click or long-click on this button, it will open a pop-up menu in which you can toggle different snapping modes. You can also click on this button to toggle it off, which will disable all snapping modes, and click</p>

Icon	Property	Description
		<p>on it again and toggle it on to re-enable the snapping modes which were previously enabled.</p> <p>This tool supports the following snapping modes:</p> <ul style="list-style-type: none"> • Snap to Contour: When enabled, while you're drawing, the mouse cursor will snap to the nearby contours of the artwork in your drawing. • Snap to Alignment Guides: While drawing, the drawing tool will snap against nearby alignment guides. • Snap and Align: When enabled, while you're drawing, the mouse cursor will automatically align to the rectangular bounding boxes of other strokes and shapes in your drawing. • Snap to Grid: While moving the selection, the mouse cursor will snap against the intersecting points of the grid. <div data-bbox="712 863 1430 1037" style="border: 1px solid #add8e6; padding: 10px; margin-top: 10px;">  TIP To display the grid, select View > Grid > Show Grid from the top menu or press Ctrl + '. </div>
	<p>Automatically Create Colour Art</p>	<p>As you draw in the Line Art layer, the Automatically Create Colour Art option instantly creates the corresponding strokes in the Colour Art layer.</p> 
	<p>Auto Flatten Mode</p>	<p>By default, when drawing on a vector layer, each new stroke is created as a separate drawing object, which can be edited independently from other parts of the artwork. When enabled, the Auto-Flatten option automatically merges strokes into existing artwork.</p> 

Icon	Property	Description
		<div style="border: 1px solid #c8e6c9; padding: 10px;">  <p>NOTE</p> <p>Using the Select tool, you can use select and remove a segment of flattened pencil lines. Overlapping pencil lines drawn with the Auto-Flatten mode are essentially cut into segments by the overlap and can be treated as individual lines.</p> </div>
	<p>Use Stored Colour Gradient</p>	<p>The Use Stored Colour Gradient option can be used when painting with a gradient colour to always position the gradient in the same way it was stored, making it consistent across brush strokes. You can store a gradient by selecting a zone painted with a gradient with the Select tool, then clicking on Store Colour Gradient  in the Tool Properties view.</p>
	<p>Draw Circle</p>	<p>When enabled, the ellipsis tool will always draw an ellipsis of equal width and height, making it a perfect circle.</p> <div style="border: 1px solid #bbdefb; padding: 10px;">  <p>TIP</p> <p>You can also draw a perfect circle by holding the Shift key while drawing.</p> </div>

Pencil Properties Dialog

The Ellipse tool draws the same type of line as the Pencil tool. Hence, you can configure the Ellipse tool's lines using the Pencil Properties dialog, which you can open by clicking on the arrow button right of the stroke display area in the Tool Properties view.



Size and Smoothness Tab

The Size and Smoothness tab allows you to select your pencil's size, its smoothing parameters as well as the shape of its tips and corners.

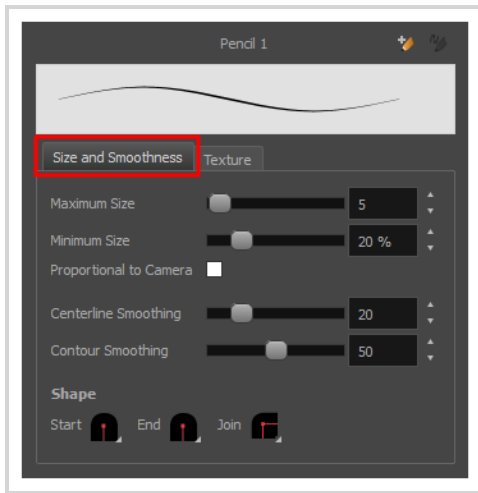

Property	Description
Maximum Size	Defines the maximum size of the pencil line. If the tool is used with a pressure sensitive pen tablet, the width of the stroke will vary between its maximum size and minimum size depending on the amount of pressure used. If used with a mouse, the width of the stroke will always be its maximum size.
Minimum Size	Defines the minimum size of your stroke as a percentage of the maximum size. If you do not have pressure sensitivity from a pen table, the minimum size value will be ignored.
Proportional to Camera	If you check this option, the size of the pencil will be adjusted to the position of the camera on the z-axis. This means that if the camera is zoomed in on the scene, the pencil will be proportionally smaller so that it appears the same size in the rendered image. Likewise, if the camera is zoomed out, the pencil will be proportionally bigger.
Centerline Smoothing	Defines the amount of smoothing Harmony should perform on the central line of the pencil stroke. A higher setting will prevent your line from being shaky and will reduce the amount of control points it has, making it easier to tweak, but is liable to reduce drawing precision and turn sharp angles into curves.
Contour Smoothing	<p>Defines the amount of smoothing Harmony should perform on the outer contour of the pencil stroke.</p> <p>A pencil line is defined by its centreline and its variations in thickness, rather than its apparent shape. When drawing a pencil line with a mouse, its thickness is uniform. Therefore, its outer contour does not have any control point, except at its extremities, and no smoothing is required for its contour.</p> <p>However, when drawing a pencil line with a pressure sensitive tablet, its contour will have control points and Bezier curves to define the line's variations in thickness, and</p>

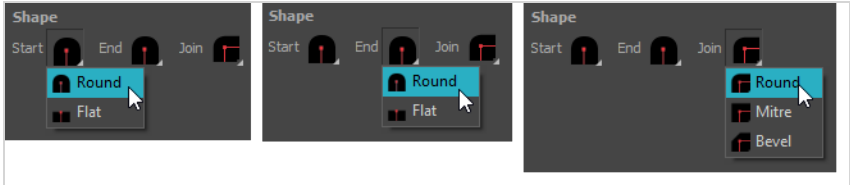
Property	Description
	<p>thus smoothing must be performed on its contour. An increased contour smoothing will reduce the amount of control points on the line's thickness and smoothen its curves, but may affect the precision of the variations in line thickness.</p>
Shape	<p>You can adjust the start, end, and join style of a pencil line.</p>  <ul style="list-style-type: none"> • Start: Lets you select the style of the start tip, which is the first tip you drew. You can choose between Round or Flat style. • End: Lets you select the style of the end tip, which is the last tip you drew. You can choose between Round or Flat style. • Join: Lets you select the joint style. The joints are where the line curves abruptly. You could also define the Join style as the corner style. You can choose between Round, Mitre and Bevel style.

Texture Tab

In the Pencil Properties view, the Texture tab allows you to select a pencil texture from the currently selected pencil texture palette to use with the Pencil tool. You can also add, remove or rename textures, save the current pencil texture palette as the default one, or import the pencil texture palette into your scene.

The pencil texture palette used in the Texture tab of the Pencil Properties dialog is the one selected in the Colour view. You can select a pencil texture palette by selecting it from the pencil texture palette list in the Colour view—see [Colour View on page 1220](#).

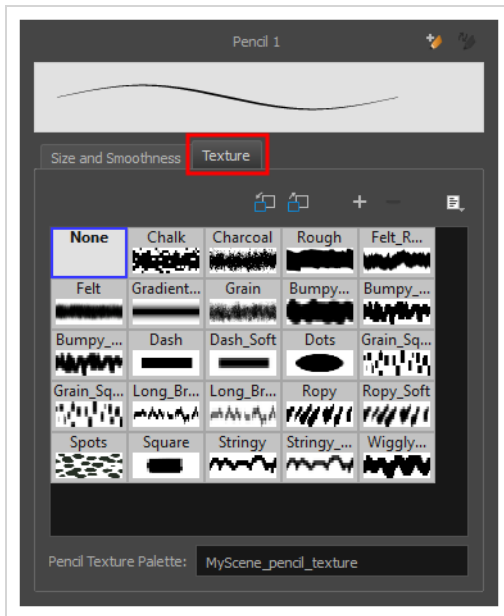





Icon	Property	Description
	Use as Default Pencil Texture Palette	This option is available from the menu button. Sets the currently selected pencil texture palette as the default pencil texture palette in your user preferences. The default pencil texture palette is added to every scene you create in Harmony. The palette is copied in your preferences, so it will be added to your new scenes in the exact state it is when you make it the default pencil texture palette.
	Reload Default Texture Palette	Imports the default pencil texture palette as a new pencil texture palette into your scene's palette list, and selects it as the current pencil texture palette.
	New Texture	Allows you to import an image file into a new pencil texture swatch in the current pencil texture palette. The pencil texture's effect on your pencil line will be based on the image's transparency channel, and will follow your pencil lines on its horizontal axis. This option is also available from the menu button.
	Delete Texture	Deletes a pencil texture swatch from the current pencil texture palette. This option is also available from the menu button.
	Rename Texture	Renames the selected pencil texture swatch in the current pencil texture palette. This option is also available from the menu button.
	Pencil Texture Display	Displays the pencil textures in the current pencil texture palette and allows



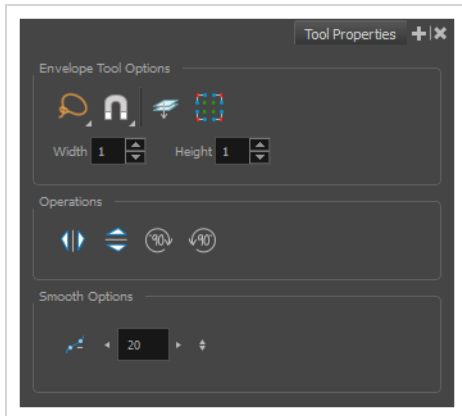

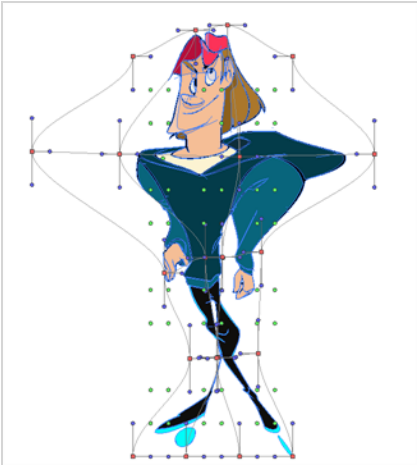
Icon	Property	Description
		you to select one to use with the Pencil tool.
	Pencil Texture Palette	Displays the name of the currently selected pencil texture palette, for reference. To select a different pencil texture palette, you must select it in the Colour view—see Colour View on page 1220 .







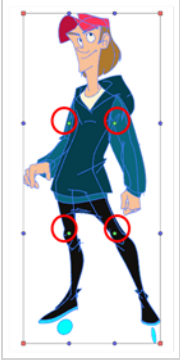

Envelope Tool Properties

Selecting the Envelope tool displays its properties and options in the Tool Properties view.



Icon	Tool Name	Description
	Width and Height	<p>Increase the width and height values to add more columns and rows to the deformation grids.</p> 
	Lasso	<p>Sets the selection mode to Lasso, which allows you to select multiple items by drawing a lasso around them.</p> <div style="border: 1px solid #0070C0; padding: 10px; margin-top: 10px;"> <p> TIP When this option is enabled, you can press and hold the Alt key to temporarily use Marquee mode.</p> </div>
	Marquee	<p>Sets the selection mode to Marquee, which allows you to select multiple items by drawing a rectangle around them.</p>

Icon	Tool Name	Description
		<div data-bbox="505 283 1430 453" style="border: 1px solid #add8e6; padding: 10px;">  <p>TIP When this option is enabled, you can press and hold the Alt key to temporarily use Lasso mode.</p> </div>
	<p>Snapping</p>	<p>Allows you to enable or disable snapping for this tool and all other animation and drawing tools that support snapping, as well as to select which types of snapping are enabled.</p> <p>If you double-click or long-click on this button, it will open a pop-up menu in which you can toggle different snapping modes. You can also click on this button to toggle it off, which will disable all snapping modes, and click on it again and toggle it on to re-enable the snapping modes which were previously enabled.</p> <p>This tool supports the following snapping modes:</p> <ul style="list-style-type: none"> • Snap to Contour: While moving the selection or one of its control points, it will snap against the nearby points and contours of your artwork, allowing you to snap parts of your artwork together. • Snap to Alignment Guides: While moving the selection or one of its control points, it will snap against nearby alignment guides. • Snap and Align: When enabled, while moving a selection, the rectangular bounding box of the selection will snap to the rectangular bounding box of any other drawing stroke in the drawing, allowing you to align drawing strokes laterally. • Snap to Grid: While moving the selection, the mouse cursor will snap against the intersecting points of the grid. <div data-bbox="583 1320 1430 1495" style="border: 1px solid #add8e6; padding: 10px;">  <p>TIP To display the grid, select View > Grid > Show Grid from the top menu or press Ctrl + !.</p> </div>
	<p>Show Advanced Controls</p>	<p>To display more controls, you can click on the Show Advanced Controls button.</p>

Icon	Tool Name	Description
		
	Apply to Line and Colour Art	<p>Allows you to perform drawing operations on both the Line Art and Colour Art layers of your drawing simultaneously.</p> <div style="border: 1px solid green; padding: 5px;"> <p> NOTE If you have Overlay and Underlay Art layers enabled, they will also be affected when this option is enabled.</p> </div>
	Flip Horizontal	Flips the current selection horizontally.
	Flip Vertical	Flips the current selection vertically.
	Rotate 90 Degrees CW	Rotates the current selection 90 degrees clockwise.
	Rotate 90 Degrees CCW	Rotates the current selection 90 degrees counter-clockwise.
	Smooth	<p>You can modify the central line smoothness of your line using this option. This parameter smooths the deformed lines. Increasing the value will result in a smoother line with fewer control points. The more you increase the value, the less details and curves you will get. Use the left and right arrows to increment the value by one full unit. Use the Up - Down slider to quickly increment the value.</p>

Eraser Tool Properties

The Eraser tool allows you to erase artwork by drawing eraser strokes over it. When using the Eraser tool with a tablet, it is pressure sensitive, like with the Brush and Pencil tool.

How to access the Eraser tool properties

1. In the Tools toolbar, select the Eraser  tool.

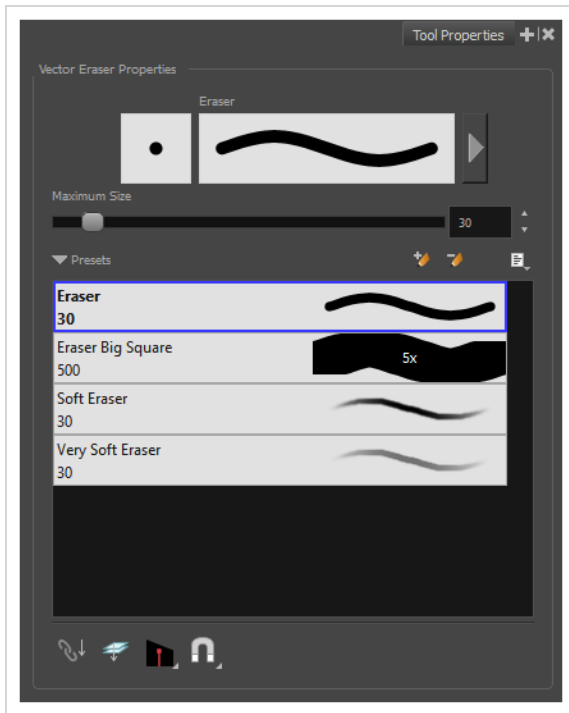

The tool's properties are displayed in the Tool Properties view.



Eraser Properties



The way the Eraser tool is configured is almost identical to the way the Brush tool is configured.

Property	Description
Stroke Preview Area	<p>The Preview area lets you see a preview of the stroke your drawing tool will make.</p> 
Eraser Properties Dialog	<p>The arrow button right of the display area opens the Eraser Properties dialog, which gives you access to all the parameters and options for your eraser. The Tool Properties</p>

Property	Description
	<p>view only gives you access to a few of the eraser properties, a list of eraser presets and options for the Eraser tool that are not related to the eraser properties. For more information on the Eraser Properties dialog, see the Eraser Properties Dialog section below.</p> 
Maximum Size	<p>Defines the maximum size of the eraser.</p> <p>If the tool is used with a pressure sensitive pen tablet, the width of the stroke will vary between its maximum size and minimum size depending on the amount of pressure used. If used with a mouse, the width of the stroke will always be its maximum size.</p>
Flow	<p>Lets you set the opacity for each instance of the eraser tip that gets erased from your artwork. Contrary to the Opacity parameter, the flow parameter has a cumulative effect. This means that a lower flow will make your eraser strokes less effective towards its extremities and more effective in its center. Your stroke's flow will also accumulate if you draw over it. By default, your eraser's flow varies with the amount of pressure you put on your tablet pen.</p> <div data-bbox="500 1079 1430 1251" style="border: 1px solid green; padding: 5px;"> <p> NOTE This option is only displayed in the Tool Properties view when drawing on a bitmap layer.</p> </div>
Opacity	<p>The Opacity parameter are where Lets you set the opacity of your brush strokes. Contrary to the Flow parameter, the Opacity parameter is non-cumulative. Your whole brush stroke's opacity will not exceed the Opacity parameter. By default, the Opacity parameter varies depending on the amount of pressure you put on your tablet pen.</p> <div data-bbox="500 1476 1430 1648" style="border: 1px solid green; padding: 5px;"> <p> NOTE This option is only displayed in the Tool Properties view when drawing on a bitmap layer.</p> </div>



Eraser Presets









These options allow you to select, create and manage eraser presets.

Icon	Property	Description
	Presets list	By default, Harmony has preloaded eraser presets. You can also create your own eraser presets by configuring your eraser, then saving its properties into a new preset. It is also possible to export and import eraser presets.
	New Brush Preset	Creates a new preset based on the current tool properties.
	Delete Brush	Deletes the currently selected preset.
	Rename Brush	Allows you to rename the currently selected preset.
	Import Brushes	Allows you to import brush presets exported from Harmony.
	Export Brushes	Allows you to export your brush presets into an .xml file.
	Small Thumbnail	Displays presets in a grid of small thumbnails with a preview of their tip.
	Large Thumbnail	Displays presets in a grid of big thumbnails, with their name and a preview of their tip.
	Stroke View	Displays presets in a list, with their name and a preview of a stroke done with each preset.

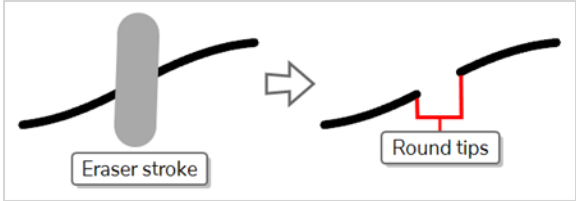
Erasing Options

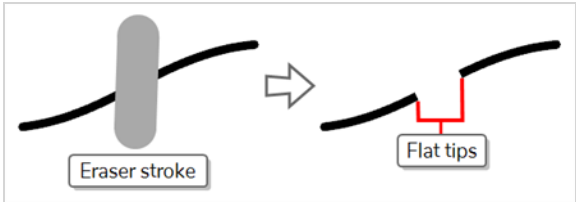
These options affect the way your eraser strokes are applied to your artwork.

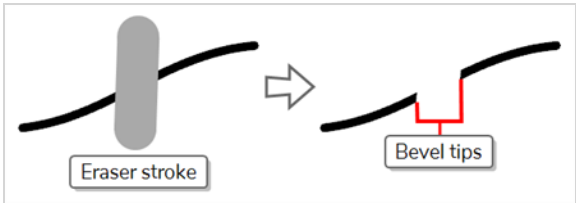
Icon	Property	Description
	Apply to Line and Colour Art	<p>Allows you to perform drawing operations on both the Line Art and Colour Art layers of your drawing simultaneously.</p> <div style="border: 1px solid green; padding: 5px;"> <p> NOTE If you have Overlay and Underlay Art layers enabled, they will also be affected when this option is enabled.</p> </div>

Icon	Property	Description
	Tip Style	<p>When you erase part of a pencil line, this option determines the shape of the extremity of the pencil line where you erased:</p> <ul style="list-style-type: none">  Round: Leaves a round tip at the extremities of the pencil line you erased.   Flat: Leaves a flat tip at the extremities of the pencil line you erased. A flat tip is always perpendicular to the angle of the centreline of the pencil line, so it may not match the angle of your eraser stroke.   Bevel: Leaves a bevel tip at the extremities of the pencil line you erased. A bevel tip is flat, but its angle matches the angle of your eraser stroke. 
	Snapping	<p>Allows you to enable or disable snapping for this tool and all other animation and drawing tools that support snapping, as well as to select which types of snapping are enabled.</p> <p>If you double-click or long-click on this button, it will open a pop-up menu in which you can toggle different snapping modes. You can also click on this button to toggle it off, which will disable all snapping modes, and click on it again and toggle it on to re-enable the snapping modes which were previously enabled.</p> <p>This tool supports the following snapping mode:</p> <ul style="list-style-type: none"> Snap to Alignment Guides: While erasing, the eraser will snap

Icon	Property	Description
		against nearby alignment guides.
	Apply to Synced Drawing Layers	If the currently selected layer is synced with another layer, the tool will work on both the current layer and its synced layer.

Eraser Properties Dialog

Erasers have an extensive set of options and properties that are not displayed in the Tool Properties view, but rather, in a dialog you can access from it. To open the Eraser Properties dialog, click on the arrow button right of the stroke display area.



The Eraser Properties dialog has five different tabs, minus the Smoothing tab if you are working on a bitmap layers. Below is detailed information about the options available in each tab:



- [Tip Tab](#) on page 1015
- [Smoothing Tab](#) on page 1021
- [Transparency Tab](#) on page 1022
- [Dual Tip Tab](#) on page 1025
- [Paper Texture Tab](#) on page 1029

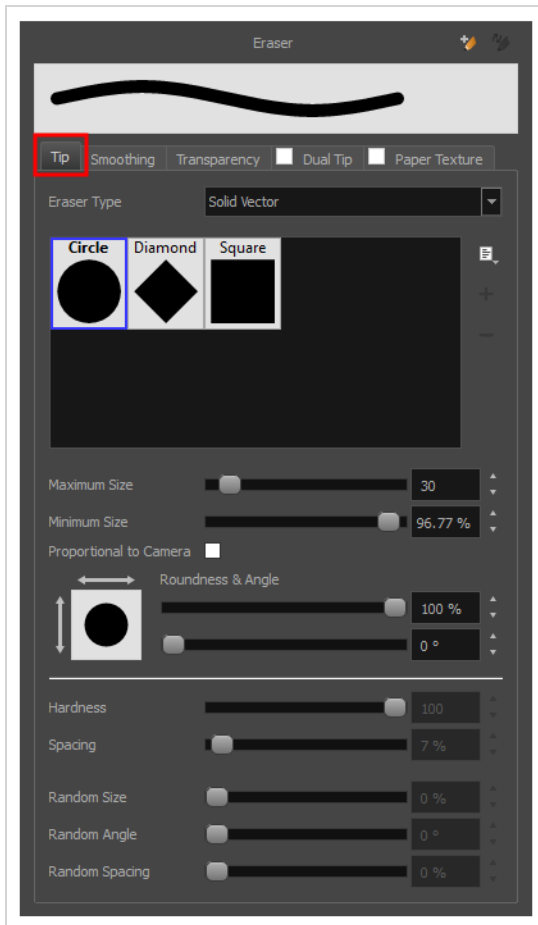

Tip Tab



The Tip tab allows you to configure the shape, size, hardness and spacing of your eraser tip.

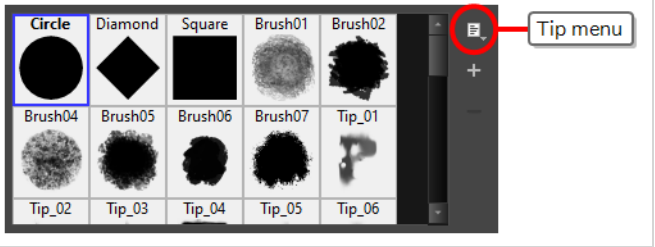

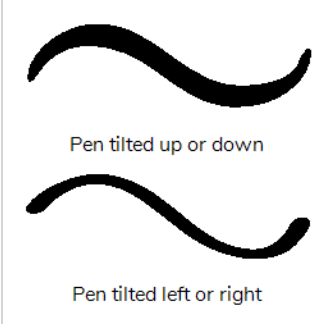
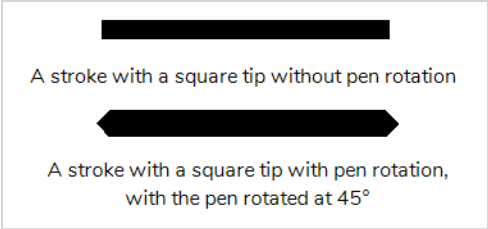

Property	Description
Eraser Type	<p>Allows you to select between one of the following eraser types:</p> <ul style="list-style-type: none"> • Solid Vector: Simply cuts out the eraser stroke's shape from the vector artwork. A solid vector eraser always completely erase the artworks leaving hard seams. • Textured Eraser: Allows to configure the eraser with the same options as with a textured brush. A textured eraser will decrease the opacity of bitmap textures in textured brush strokes if it doesn't completely erase it. If it completely erases a brush stroke, it will cut out the erased part from the vector artwork. • Textured, Preserve Vector: Like a Textured Eraser, except that it will not cut out from the vector shapes, even if it fully erases pixels in a textured brush stroke's texture.

Property	Description
	<div data-bbox="505 285 1430 548" style="border: 1px solid #c8e6c9; padding: 10px; margin-bottom: 10px;">  <p>NOTE Textured erasers only work as expected on textured brush strokes. Using a Textured eraser on a solid vector brush stroke or on a pencil line will only cut the eraser stroke's shape out of it. If you use a Textured, Preserve Vector type eraser on a solid vector shape or on a pencil line, the eraser will not erase anything.</p> </div> <div data-bbox="505 579 1430 747" style="border: 1px solid #c8e6c9; padding: 10px;">  <p>NOTE This option is not available when working on a bitmap layer. With bitmap layers, erasers are always textured, and textured eraser options are always available.</p> </div>
<p>Eraser Tip Library</p>	<div data-bbox="505 804 1166 1058" style="border: 1px solid #ccc; padding: 10px; margin-bottom: 10px;">  </div> <p>This is where you select the shape of the eraser tip. By default, it is round. Note that some tips are designed to have semitransparent areas, even when the maximum eraser opacity is set to 100%.</p> <p>To create a custom eraser tip, you must prepare the file ahead of time, either in Harmony or in a third-party software, such as Adobe Photoshop. Colour is not supported and transparency is not supported in the traditional sense. Black appears as 100% opaque, white appears as 100% transparent and all the shades of grey in between appear as varying degrees of semitransparency. A range of file formats are supported—jpeg, .png, .tif, .psd, .tga to name a few. Alpha channels are disregarded on import. It is recommended that your file be between 100 x 100 pixels and 400 x 400 pixels.</p> <p>You can also import eraser tips that you exported from Harmony, so you can share them with colleagues.</p>
<p>Minimum and Maximum Size</p>	<p>The minimum and maximum sizes of your drawing tool produce the thick and thin effect on your stroke. This works with the pressure sensitivity of a pen tablet.</p> <ul style="list-style-type: none"> • Maximum Size: Defines the maximum width of the stroke. • Minimum Size: Defines the minimum width of the stroke in relation to and as a percentage of the maximum size.

Property	Description
	<div data-bbox="505 285 1430 485" style="border: 1px solid #c8e6c9; padding: 10px;">  <p>NOTE</p> <p>Setting the Minimum Size value to 100% eliminates the possibility of creating width variation on your stroke. In other words, you would be forcing a uniform line width using the Maximum Size value.</p> </div>
Proportional to Camera	<p>If you check this option, the size of the eraser will be adjusted to the position of the camera on the z-axis. This means that if the camera is zoomed in on the scene, the eraser will be proportionally smaller so that it appears the same size in the rendered image. Likewise, if the camera is zoomed out, the eraser will be proportionally bigger.</p>
Roundness and Angle	<p>The Roundness and Angle parameters allow you to change the shape and orientation of the tip.</p> <ul style="list-style-type: none"> • Roundness: The vertical scaling to apply to the tip. Reducing this setting squashes the tip vertically, allowing you to turn round or square tips into flat tips. • Angle: The angle at which to rotate the brush tip, counterclockwise. <div data-bbox="505 1020 1430 1377" style="border: 1px solid #c8e6c9; padding: 10px;">  <p>NOTE</p> <p>The squashing is not relative to the angle—if the tip is rotated, the squashing will still be done relative to the tip's original orientation.</p> <div data-bbox="613 1171 1328 1339" style="border: 1px solid #ccc; padding: 10px; text-align: center;">  <p>Roundness: 100% Roundness: 33% Roundness: 100% Roundness: 33% Angle: 0° Angle: 0° Angle: 45° Angle: 45°</p> </div> </div>
Pen Tilt Sensitivity	<p>If your pen and tablet support tilt sensitivity, this option allows you to set whether your eraser takes your pen's tilt angle in account, and how much.</p> <p>When your pen is fully tilted, your eraser tip will be stretched by the percentage you set in this parameter, in the angle in which you tilt it. For example, if you set the Pen Tilt Sensitivity to 50%, and you tilt your pen all the way up or down, your eraser tip will be stretched vertically by 50%. With the same setting, if you tilt your pen all the way left or right, your eraser tip will be stretched horizontally by 50%.</p>

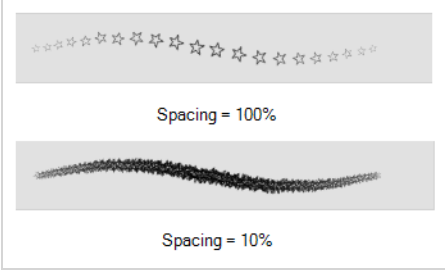
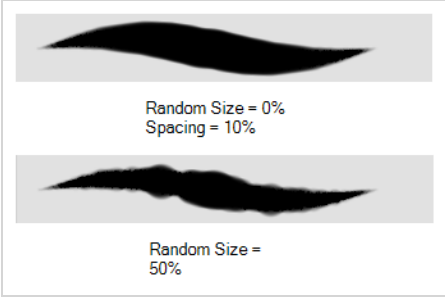
Property	Description
	
Use Pen Rotation	<p>If enabled, and if your pen and tablet support tip rotation, your eraser tip will rotate with the angle of your pen tip.</p> 
Hardness	<p>The Hardness and Spacing parameters allow you to change the softness and spacing of the marks made by the eraser tip. You can preview the hardness and spacing at the top of the Eraser Properties window, stroke preview area.</p> <p>The hardness value corresponds to the softness of the eraser tip's edges. The lower the value, the softer the tip edge. The higher the value, the sharper the tip edge. Be aware that some eraser tips are not 100% opaque, so they will always appear somewhat soft, even at 100% hardness.</p> 
Spacing	<p>Defines the amount of space between each stamp of the eraser. A value of 100% sets the stamp marks edge to edge, if there is no white space around the shape. The larger the value, the greater the space between marks. A really large value can make the eraser stroke appear as a string of individual marks. Conversely, a small spacing value will give the appearance of a fluid brush stroke.</p> <p>Spacing is only evident when making a continuous stroke.</p>

Property	Description
	
Randomness	<p>The Randomness parameters let you create a varied bitmap eraser stroke. Refining these options can give your stroke a lovely, non-mechanical look.</p>
Random Size	<p>You can create variation between the thick and thin of your eraser stroke just by setting the Maximum and Minimum Size values. If you add randomness to the mix, pressure sensitivity from your drawing tablet will still be applied. Light pressure will create random values around the minimum, while heavy pressure will create random values closer to the maximum. The larger the percentage, the larger the range of random variation.</p>  <div data-bbox="505 1314 1430 1545" style="border: 1px solid green; padding: 10px; margin-top: 10px;"> <p> NOTE</p> <p>Setting the Minimum Size to 100% eliminates the possibility of creating width variation on your stroke, whether you are applying randomness or not. Therefore, you would be forcing a uniform line width using the Maximum Size value.</p> </div>
Random Angle	<p>Sets the range for random rotation around the set Angle value. For example, if the Angle is set to 45° and the Random Angle set to 10°, the software will choose values between 40°–50° (plus or minus 5 degrees, equaling a total of 10 degrees).</p>

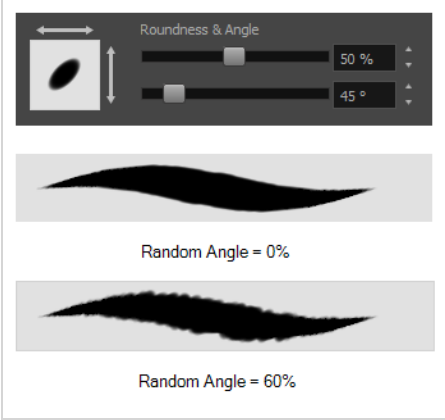
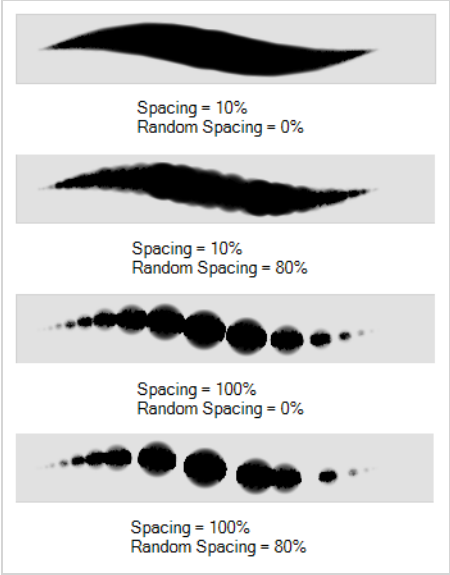
Property	Description
	
<p>Random Spacing</p>	<p>Sets the range for random spacing around the set Spacing value. For example, if the Spacing is set to 50% and the Random Spacing is set to 10%, then Harmony will choose values between 45%–55% (plus or minus 5 percent, equaling a total of 10 percent).</p> 

Smoothing Tab

The Smoothing tab contains options to configure how Harmony should automatically smooth your eraser strokes as you paint.

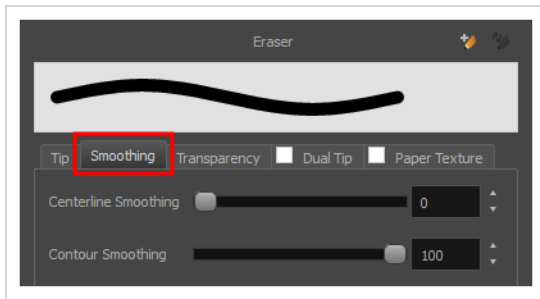
**NOTE**

The Smoothing tab is only available when working on a vector layer, as bitmap layers do not support smoothing.

Property	Description
Centerline Smoothing	Defines the amount of smoothing Harmony should perform on your eraser stroke's direction, curves and corners. A higher setting will prevent your line from being shaky, but is liable to reduce drawing precision and turn sharp angles into curves.
Contour Smoothing	Defines the amount of smoothing Harmony should perform on outer contour of the eraser stroke. A higher setting will round sharp corners and reduce the amount of control points for the resulting vector shape.

Transparency Tab

The Transparency tab allows you to decide if your eraser has antialiasing as well as to set its flow and opacity settings.

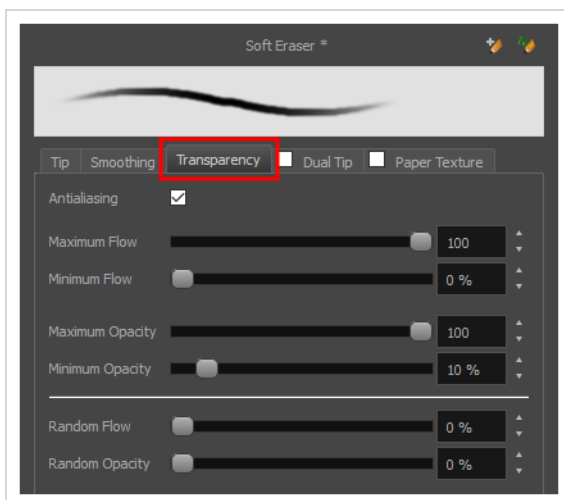





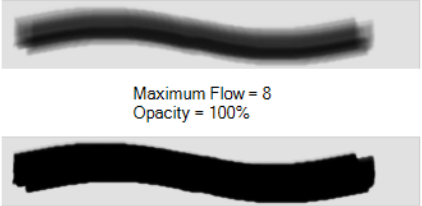

NOTE

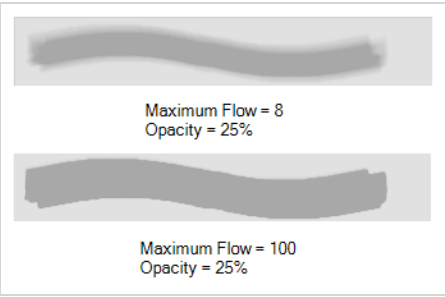
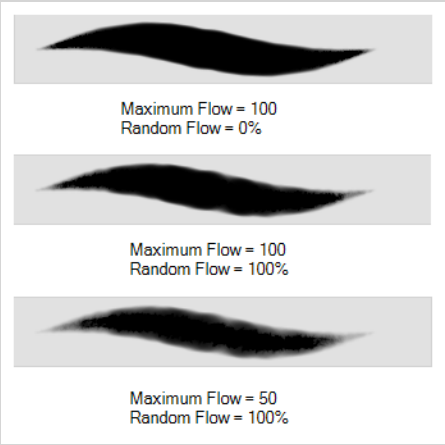
The Transparency tab's options are only available on vector layers if the **Eraser Type** option of the Tip tab is set to **Textured Vector** or **Textured, Preserve Vector**.. On bitmap layers, those options are always available.

Property	Description
<p>Antialiasing</p>	<p>Enabled by default. This option causes the contours of the eraser strokes to blend with the surrounding colours, to create an illusion of smoothness otherwise not possible due to the picture resolution.</p> <p>If antialiasing is disabled, the eraser will either fully erase pixels or leave them intact.</p> <div data-bbox="574 758 1430 894" style="border: 1px solid #c8e6c9; padding: 5px; margin-top: 10px;"> <p> NOTE When disabled, all other options in the Transparency tab are disabled.</p> </div>
<p>Maximum and Minimum Flow</p>	<p>The Maximum and Minimum Flow parameters let you set the range for the rate at which your eraser's effect flows. The greater the flow, the more consistent the effect is. If the flow is light, then the effect may look spotty. This feature works with the pressure sensitivity of a pen tablet.</p> <ul style="list-style-type: none"> • Maximum Flow: Sets the maximum rate at which colour and texture are applied as you create a fluid stroke. • Minimum Flow: Sets the minimum rate at which colour and texture are applied as you create a fluid stroke. It is defined as a percentage of the Maximum Flow value. If the Minimum Flow value is set to 100%, then tablet pressure sensitivity will no longer be applicable. The flow will be set to the constant rate of the Maximum Flow value. <div data-bbox="574 1402 1016 1692" style="border: 1px solid #ccc; padding: 10px; margin-top: 10px;">  </div>
<p>Maximum Opacity and Minimum Opacity</p>	<p>The Maximum and Minimum Opacity parameters are where you set the opacity range for an eraser mark. This works with the pressure sensitivity of a pen tablet.</p> <ul style="list-style-type: none"> • Maximum Opacity: Sets the transparency limit of the eraser mark when the pressure is heavy.

Property	Description
	<ul style="list-style-type: none"> Minimum Opacity: Sets the transparency limit of the eraser mark when the pressure is very light. It is defined as a percentage of the Maximum Opacity value. If the Minimum Opacity value is set to 100%, then tablet pressure sensitivity will no longer be applicable. The opacity will be set to the constant rate of the Maximum Opacity value. 
Randomness	<p>The Randomness parameter lets you set the range for the randomness of the flow and opacity. This works with the pressure sensitivity of a pen tablet.</p>
Randomness Flow	<p>You can create variation in the flow of your eraser stroke just by setting the Maximum and Minimum Flow values. If you add randomness to the mix, pressure sensitivity from your drawing tablet will still be applied. Light pressure will create random values around the minimum, while heavy pressure will create random values closer to the maximum. The larger the percentage, the larger the range of random variation.</p>  <div data-bbox="574 1682 1430 1913" style="border: 1px solid green; padding: 10px;"> <p> NOTE</p> <p>Setting the Minimum Flow value to 100% eliminates the possibility of creating flow variation on your stroke, whether you are applying randomness or not. That is, you would be forcing a uniform flow using the Maximum Flow value.</p> </div>

Property	Description
<p>Random Opacity</p>	<p>You can create variation in the opacity of your eraser stroke just by setting the Maximum and Minimum Opacity values. If you add randomness to the mix, pressure sensitivity from your drawing tablet will still be applied. Light pressure will create random values around the minimum, while heavy pressure will create random values closer to the maximum. The larger the percentage, the larger the range of random variation.</p> <div data-bbox="574 516 1013 1031" style="border: 1px solid gray; padding: 10px; margin: 10px 0;">  <p style="text-align: center; margin: 5px 0;">Maximum Opacity = 100 Minimum Opacity = 10% Random Opacity = 0%</p> <p style="text-align: center; margin: 5px 0;">Maximum Opacity = 100 Minimum Opacity = 10% Random Opacity = 10%</p> <p style="text-align: center; margin: 5px 0;">Maximum Opacity = 100 Minimum Opacity = 10% Random Opacity = 50%</p> </div> <div data-bbox="574 1066 1430 1297" style="border: 1px solid green; padding: 10px; margin: 10px 0; background-color: #e0f2f1;"> <p> NOTE</p> <p>Setting the Minimum Opacity value to 100% eliminates the possibility of creating opacity variation on your stroke, whether you are applying randomness or not. That is, you would be forcing a uniform opacity using the Maximum Opacity value.</p> </div>

Dual Tip Tab

The Dual Tip tab lets you set the parameters for creating a dual tip eraser. The primary bitmap eraser tip and the dual tip always work together. You can set the parameters for the primary tip in the Tip tab and those for the dual tip in the Dual Tip tab. The Blend mode you select determines how the tips are combined.

By default, the Blend Mode is set to Multiply and the Random Angle to 360°.

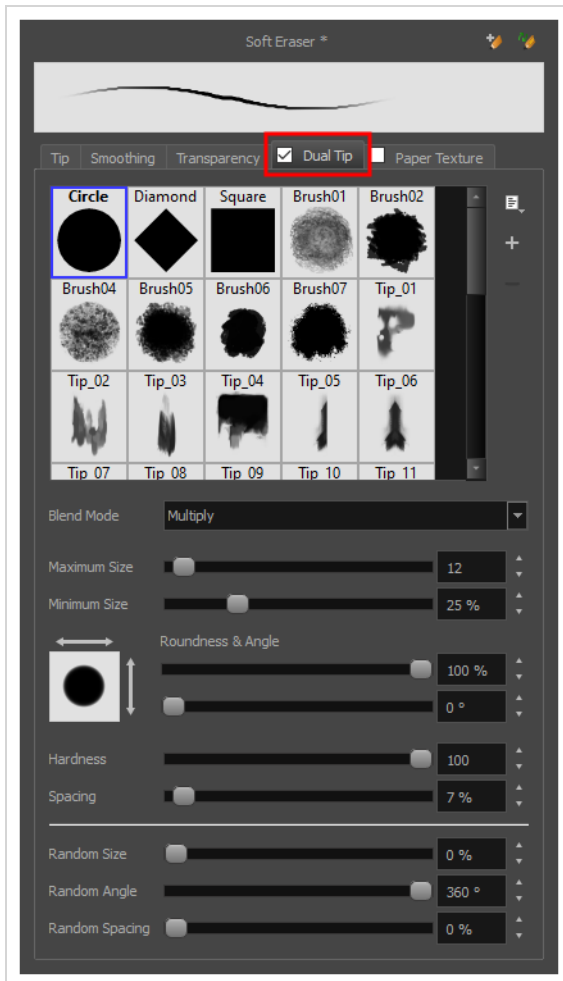
**NOTE**

To use a Dual Tip, you must enable option by checking the checkbox inside the **Dual Tip** tab. Additionally, if you are working on a vector layer, the **Eraser Type** option of the Tip tab must be set to **Textured Vector** or **Textured, Preserve Vector**.

Tool Name	Description
Enable/Disable	The checkbox inside the tab allows you to decide whether or not your eraser uses a dual tip. If this checkbox is unchecked, the options in the Dual Tip tab will be disabled.
Blend Mode	The Blend modes let you decide how the primary tip and the dual tip are combined.
Multiply	This is the default blend mode. When the two eraser tips are combined in this mode, they essentially cut each other out in overlapping areas, where one or both tips have an area of 100% transparency. The less opaque the eraser tips are, the lighter their

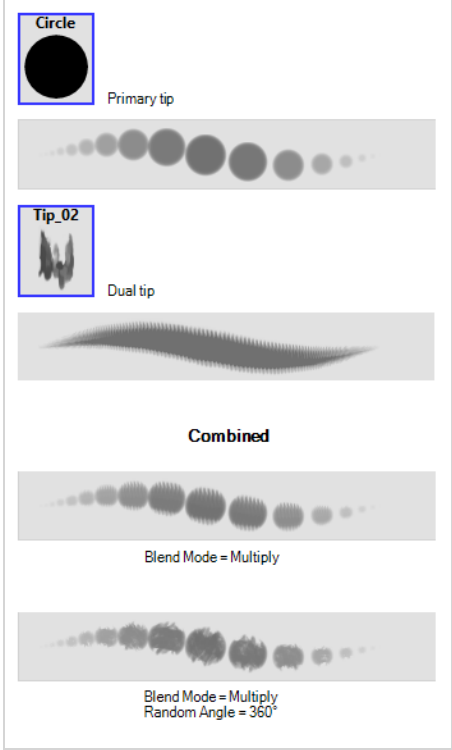
Tool Name	Description
	<p>combination.</p>  <p>Circle Primary tip</p> <p>Tip_02 Dual tip</p> <p>Combined</p> <p>Blend Mode = Multiply</p> <p>Blend Mode = Multiply Random Angle = 360°</p>
<p>Colour Dodge</p>	<p>In this mode, the primary tip cuts out the shape of the dual tip. Where the tip shapes overlap, within the boundaries of the primary shape, the colour and opacity appear darker.</p>

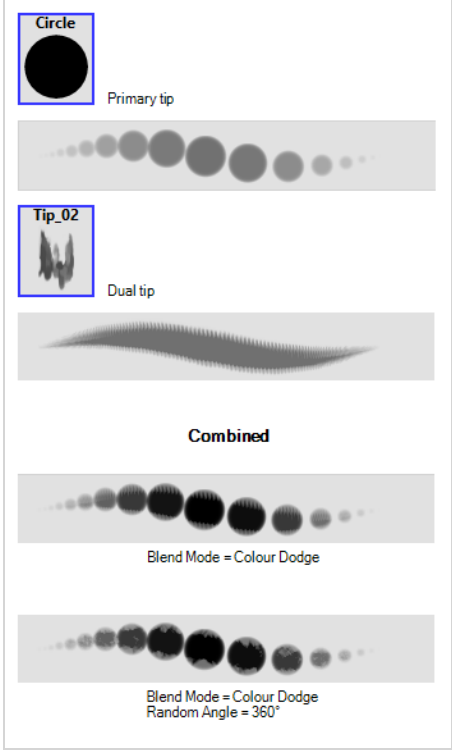
Tool Name	Description
	 <p>Circle Primary tip</p> <p>Tip_02 Dual tip</p> <p>Combined</p> <p>Blend Mode = Colour Dodge</p> <p>Blend Mode = Colour Dodge Random Angle = 360°</p>
Combine	This mode treats the two tips as two different and separate erasers that have the same colour and follow the same path.

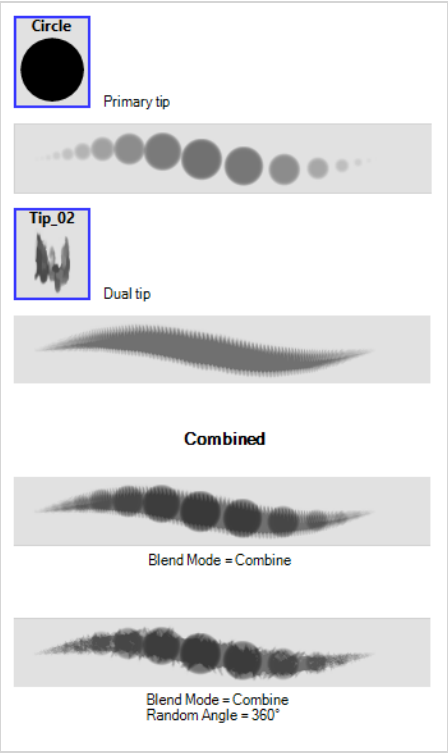
Tool Name	Description
	 <p>The image displays five horizontal panels illustrating different eraser tip configurations:</p> <ul style="list-style-type: none"> Circle: A solid black circle, labeled "Primary tip". Tip_02: A dual-pointed shape, labeled "Dual tip". Combined: The two tips overlapping. Blend Mode = Combine: The two tips merged into a single shape. Blend Mode = Combine, Random Angle = 360°: The two tips merged with a random rotation.

Paper Texture Tab

The Paper Texture tab lets you configure a paper-like texture for your eraser. You can also add textures by importing image files, or import paper textures that were previously exported from Harmony.

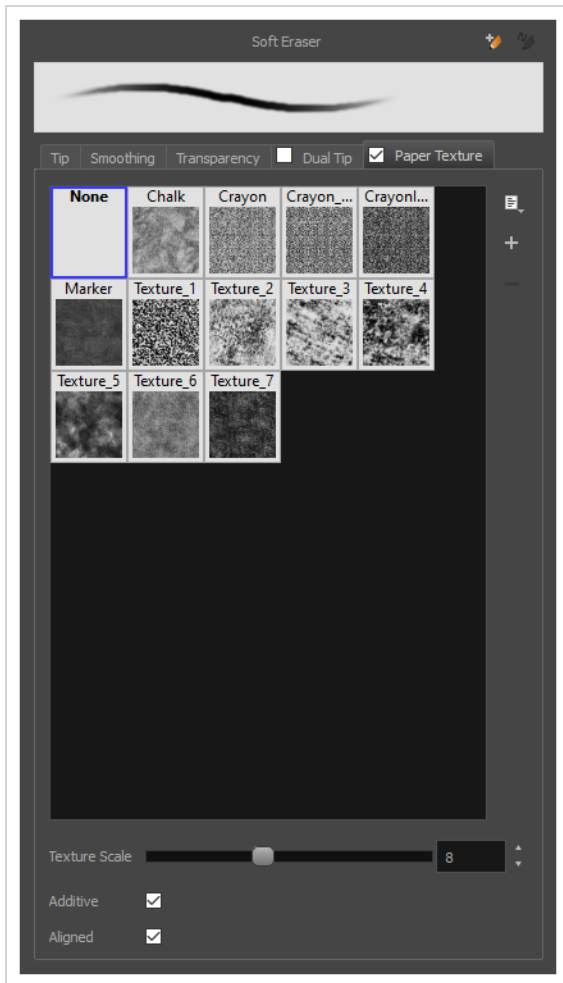
**NOTE**

To use a Paper Texture, you must enable option by checking the checkbox inside the **Paper Texture** tab. Additionally, if you are working on a vector layer, the **Eraser Type** option of the **Tip** tab must be set to **Textured Vector** or **Textured, Preserve Vector**.



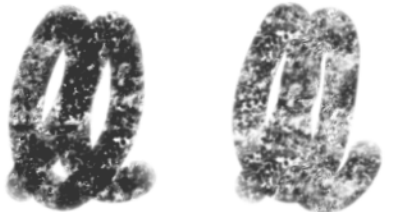
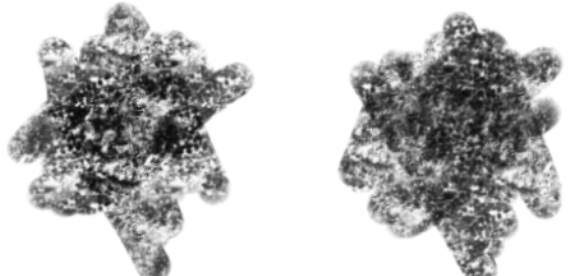



Property	Description
Enable/Disable	The checkbox inside the tab allows you to decide whether or not your eraser uses a paper texture. If this checkbox is unchecked, the options in the Paper Texture tab will be disabled.
Texture Scale	Increase or decreases the size of the paper texture.
Additive	This option layers the texture on top of itself as you scribble overlapping lines in one continuous stroke. If this option is turned off, areas of overlapping lines from a single, continuous stroke will appear the same, in terms of darkness and texture, as non-

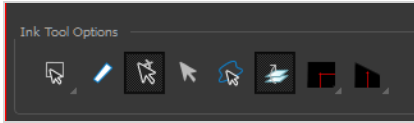





Property	Description
	<p>overlapping areas.</p> <div data-bbox="521 338 989 632" style="border: 1px solid black; padding: 10px; text-align: center;">  <p data-bbox="553 583 678 604">Additive enabled</p> <p data-bbox="781 583 911 604">Additive disabled</p> </div>
<p>Aligned</p>	<p>This option defines the way separate, overlapping strokes behave. If this option is enabled, the paper texture's position does not change with each sweep of the eraser. If this option is disabled, each sweep of the eraser produces a different texture position. The texture orientation always stays the same.</p> <div data-bbox="521 842 1174 1241" style="border: 1px solid black; padding: 10px; text-align: center;">  <p data-bbox="626 1192 748 1213">Aligned enabled</p> <p data-bbox="943 1192 1065 1213">Aligned disabled</p> </div>

Ink Tool Properties

When you select the Ink tool, its properties and options appear in the Tool Properties view.

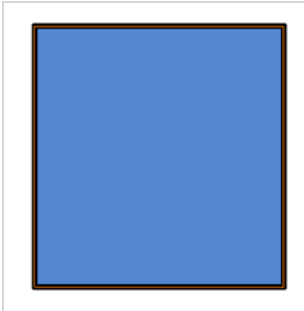

Icon	Tool Name	Tool
	Lasso	<p>Sets the selection mode to Lasso, which allows you to select multiple items by drawing a lasso around them.</p> <div style="border: 1px solid #add8e6; padding: 5px;"> <p> TIP When this option is enabled, you can press and hold the Alt key to temporarily use Marquee mode.</p> </div>
	Marquee	<p>Sets the selection mode to Marquee, which allows you to select multiple items by drawing a rectangle around them.</p> <div style="border: 1px solid #add8e6; padding: 5px;"> <p> TIP When this option is enabled, you can press and hold the Alt key to temporarily use Lasso mode.</p> </div>
	Show Inkable Lines	<p>Highlights all pencil lines (no brush strokes) on the selected layer. Pencil line segments that are already inked with the selected swatch colour from the colour palette are also not highlighted.</p>
	Be Smart on Connecting Lines	<p>As you hover and move the cursor across intersecting pencil lines, the path that you create will be highlighted. When you click on your mouse or stylus the highlighted segments are inked. With this option disabled, all the intersecting segments that your cursor comes near will be highlighted and become part of the selection, even if they were not situated in the direction of the chosen path.</p>

		<div style="border: 1px solid green; padding: 5px;">  <p>NOTE This option only works if the Ink tool is in Hover mode.</p> </div>
	Select Mode	Use this mode instead of the Hover Mode. In the Hover Mode, any potentially inkable pencil line will have its central vector line highlighted as the Ink tool's cursor hovers over it. Use Ctrl (Windows/Linux) or ⌘ (macOS) to toggle between the two modes.
	Select Newly Painted, Repainted, and Unpainted Contours/Lines	<p>In the Paint tool properties, this option keeps a selection highlighted around the latest painted zone after using the Paint, Repaint, Unpaint, or Paint Unpainted tool.</p> 
	Raise	As you ink the pencil line, the segment will be moved on top of the other intersecting strokes. Disable this option for the line to be sent behind. Hold down the Alt key to perform the opposite operation as you ink.
	Mitre	As you hover over two perpendicular or nearly perpendicular segments, a highlighted path with a corner is created. Clicking on these highlighted segments inks both segments and makes them appear as a single stroke with a corner or bend. Options include: As Is, Round, Miter, and Bevel.
	Tip Style	Lets you customize the edge of the Ink tool. Options include: Round, Flat, and Bevel.

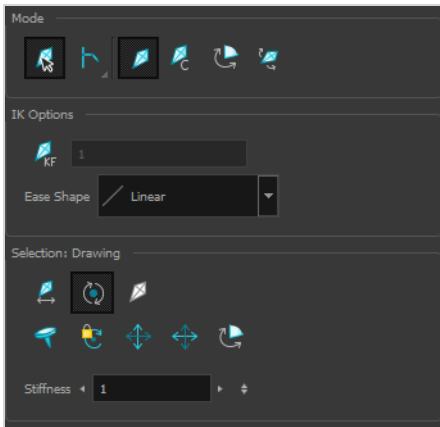

Inverse Kinematics Tool Properties

The IK tool has a series of different modes and options available in the Tool Properties view.



Mode

Mode	Button	Description
Bone Selection		<p>Enabled by default, this mode lets you click on any bone in a character and move it without having to select the actual layer.</p> <p>When you disable this mode, you cannot move any bone except the selected one. This allows you to grab and rotate the selected part from many angles and locations. You can click completely outside the character and move the pieces.</p>
Chain		<ul style="list-style-type: none"> Simple Chain Mode: This is the default mode and will only allow for the movement of parts attached to a single chain up to the point of intersection. A single chain is a straight line with no secondary chain attached. Direct Chain Mode: This mode allows you to move parts up a simple secondary chain to a principle chain, as long as translation movement is possible (the principle chain is attached to its own peg), but will ignore all secondary chains. A direct chain is a single chain which goes directly to the core. All Chain Mode: This mode allows you to move all parts attached to all chains in the IK skeleton. All chains are attached and move simultaneously when one part is moved.
IK Manipulation		<p>The main working mode for the IK tool. Enable this mode when you want to animate and position a puppet.</p> <p>Ctrl + click (Windows/Linux) or ⌘ + click (macOS) on a body part to</p>

		select it. You do not need to select a part to be able to move it.
Apply IK Constraints		Lets you correct a part's position on a series of frames. For example, if the character's foot is sinking into the floor, you can correct its position and angle over a series of frames.
Edit Min/Max Angle		Lets you set a rotation restriction on some of your parts, such as elbows, knees and ankles.
Bone Editing		Lets you fix the bone orientation on extremities, such as hands and feet.

IK Options

Parameter	Description
IK Keyframe	Used in combination with the IK Constraints mode, this option determines the starting frame of the constraint you will apply.
Ease Shape	<div data-bbox="561 1020 1032 1444" data-label="Image"> </div> <p>While animating with the IK tool and before doing a movement, set an easing preset so the motion is not so mechanical.</p> <p>Before moving the part, select a preset from the Ease Shape menu:</p> <div data-bbox="561 1619 748 1833" data-label="Image"> </div> <p>If you select a new preset in the list and move the part again on the same</p>

keyframe, the easing will automatically update.

Selection

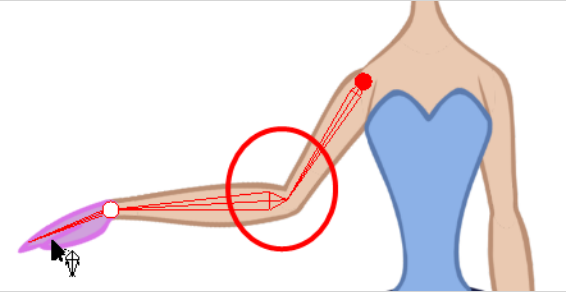
Parameter	Description
Enable Translation If Top of Hierarchy	 <p>Used only on master pegs. This option is useful when you have this particular situation: You want the character to do a perfect split (sitting down with the legs at right angles to the body or at the sides with the torso facing forwards), then the hip will need to translate and not just rotate on the spot. And since IK is all about rotation, you would select the hip layer and enable the translation option.</p>
Enable Rotation	 <p>This option is enabled by default. The pivot disappears but you can still see the bone. When this option is disabled, the selected part cannot be rotated and will remain in the same position. You can use this option to simulate an arm in a plaster cast.</p>
Exclude from IK	<p>This option lets you exclude certain parts of the puppet from the IK influence, such as the eyes and mouth.</p>
IK Nails	<p>These options let you temporarily fix a part of a character to a spot either in translation or rotation, or enable maximum and minimum angle usage.</p>
Stiffness	<p>When a certain part is selected, you can apply a stiffness value to it. A different stiffness value can be set to each body part individually. The greater the stiffness, the more difficult it is to make that part rotate, thereby rendering it stiff while the other parts continue to move freely on their joints.</p>

Line Tool Properties

The Line tool allows you to quickly draw a line segment by dragging the mouse from its starting point to its end point.

How to access the Line tool properties

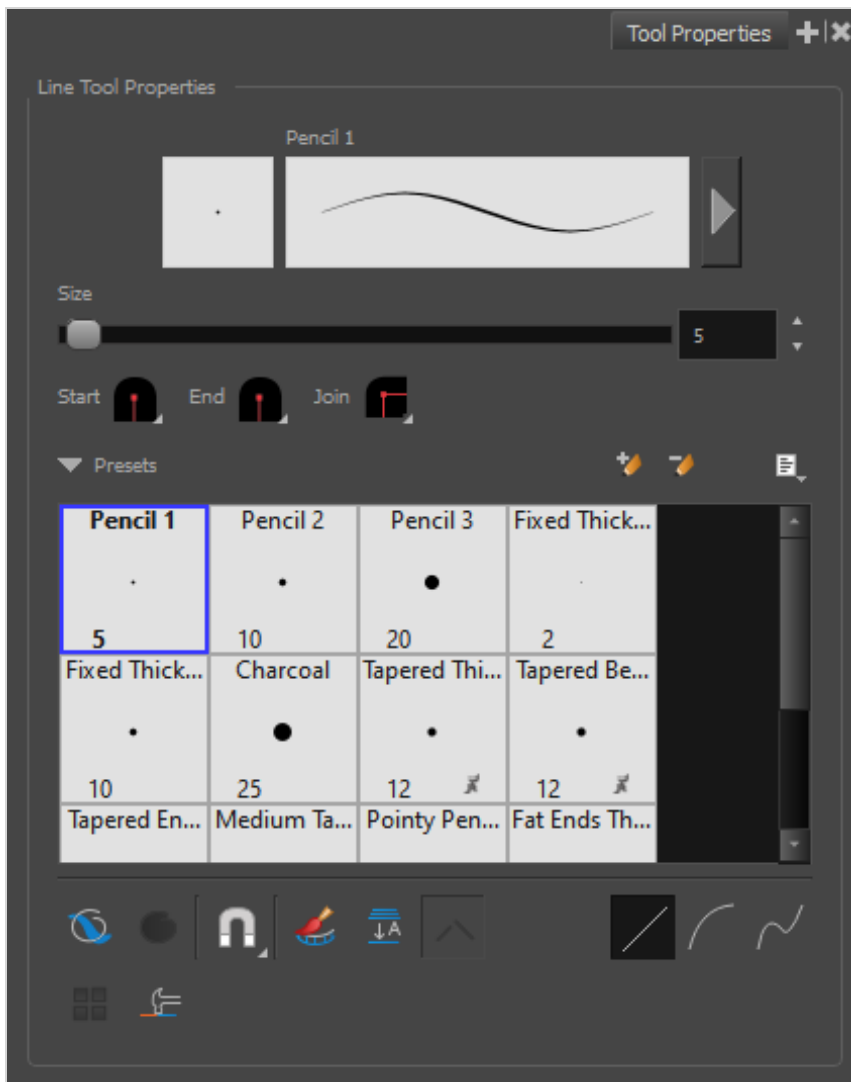

1. In the Tools toolbar, select the Line  tool.

The tool's properties are displayed in the Tool Properties view.



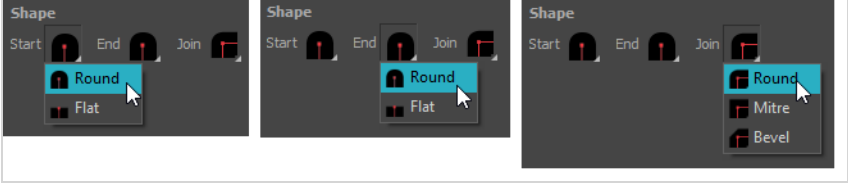

Pencil Properties

Just like other shape tools, this tool creates pencil lines. Hence, its tool properties are similar to the ones of the Pencil tool and it can be used with pencil presets.

Tool Name	Description
Preview Area	<p>The Preview area lets you see a preview of the stroke your drawing tool will make.</p> 
Pencil Properties Dialog	<p>The arrow button right of the preview area opens the Pencil Properties dialog.</p>  <p>While the Tool Properties view only gives you access to a few of the pencil properties, a list of pencil presets and other drawing options, the Pencil Properties dialog gives you access to all the available options for your pencil's shape and texture. For more information on the Pencil Properties dialog, see the Pencil Properties Dialog section below.</p>
Size	<p>Defines the width of the pencil line used to draw the line.</p>
Shape	<p>You can adjust the start, end, and join style of a pencil line.</p>  <ul style="list-style-type: none"> • Start: Lets you select the style of the start tip, which is the first tip you drew. You can choose between Round or Flat style. • End: Lets you select the style of the end tip, which is the last tip you drew. You can choose between Round or Flat style. • Join: Lets you select the joint style. The joints are where the line curves abruptly. You could also define the Join style as the corner style. You can choose between Round, Mitre and Bevel style.









Pencil Presets



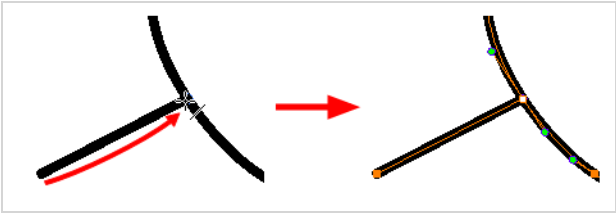

These options allow you to select, create and manage pencil presets.



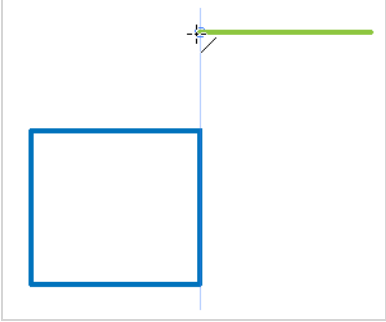

Icon	Property	Description
	Presets list	<p>Harmony provides a variety of pencil presets and thickness stencils and also lets you create and save your own. It is a good idea to create and save pencils with precise sizes and parameters when you draw for efficiency and consistency.</p> <p>A thickness stencil saves the thickness information across the length of the line. When drawing with a thickness stencil, the pressure sensitivity of the tablet is discarded. A thickness stencil can be used while drawing, or applied afterwards.</p> <p>You also have the possibility to apply different textures to your lines by either using the default presets or to import your own.</p> <p>You can export the pencil presets that you have created and import those that others have created. This is a good way for you and project collaborators to keep a consistent look for the project.</p>
	New Brush Preset	Creates a new preset based on the current tool properties.
	Delete Brush Preset	Deletes the currently selected preset.
	Brush Presets Menu	<p>Open a menu that contains the following options:</p> <ul style="list-style-type: none"> • New Brush Preset: Creates a new preset based on the current tool properties. • Delete Brush: Deletes the currently selected preset. • Rename Brush: Allows you to rename the currently selected preset. • Import Brushes: Allows you to import brush presets exported from Harmony. • Export Brushes: Allows you to export your brush presets into an <code>.xml</code> file. • Small Thumbnail: Displays presets in a grid of small thumbnails with a preview of their tip. • Large Thumbnail: Displays presets in a grid of big thumbnails, with their name and a preview of their tip. • Stroke View: Displays presets in a list, with their name and a preview of a stroke done with each preset.

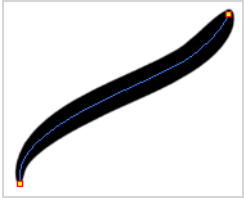

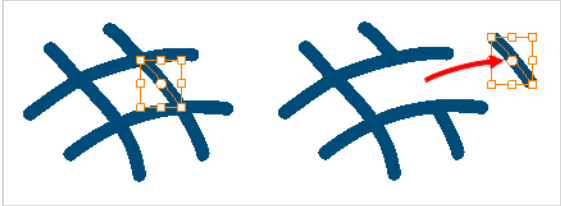

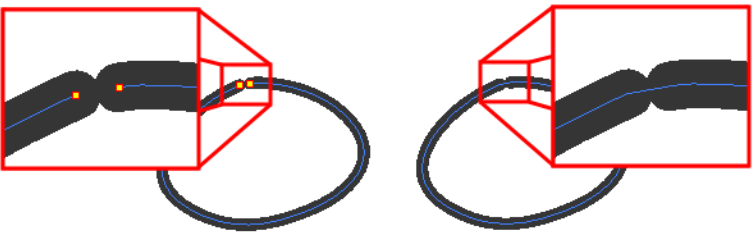

Drawing Options



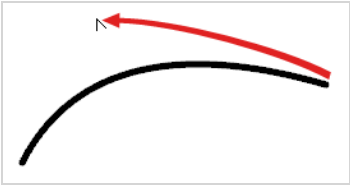

These options affect the way your drawing strokes are added to your artwork.

Icon	Tool Name	Description
	Draw Behind	<p>When enabled, your brush strokes will appear behind the existing artwork.</p> <div data-bbox="540 338 1013 533">  <p>The orange stroke was drawn over the black stroke, then put underneath it.</p> </div> <div data-bbox="540 569 1430 741" style="border: 1px solid green; padding: 5px;"> <p> NOTE</p> <p>Your brush stroke will temporarily appear over your artwork as you draw it, until you release the mouse cursor or tablet pen.</p> </div>
	Snapping	<p>Allows you to enable or disable snapping for this tool and all other animation and drawing tools that support snapping, as well as to select which types of snapping are enabled.</p> <p>If you double-click or long-click on this button, it will open a pop-up menu in which you can toggle different snapping modes. You can also click on this button to toggle it off, which will disable all snapping modes, and click on it again and toggle it on to re-enable the snapping modes which were previously enabled.</p> <p>This tool supports the following snapping modes:</p> <ul style="list-style-type: none"> • Snap to Contour: When enabled, while you're drawing, the mouse cursor will automatically snap to the nearby contours of existing artwork, allowing you to draw shapes that connect with other parts of your drawing. <div data-bbox="620 1262 1232 1472">  </div> <div data-bbox="620 1509 1430 1814" style="border: 1px solid green; padding: 5px;"> <p> NOTE</p> <p>If you draw a line with the Line tool and make its tip snap to a contour or another control point in your artwork, they will be locked together. You can then manipulate both simultaneously using the  Contour Editor tool. You can also separate two drawing strokes that have been snapped together by selecting one of them with the  Select tool and moving it away.</p> </div> <ul style="list-style-type: none"> • Snap to Alignment Guides: While drawing, the drawing tool will snap against nearby alignment guides.

Icon	Tool Name	Description
		<ul style="list-style-type: none"> Snap and Align: When enabled, while you're drawing, the mouse cursor will automatically align with the edges of strokes and shapes in your artwork, allowing you to draw shapes that align with parts of your drawing.  <ul style="list-style-type: none"> When enabled, while you're drawing, the mouse cursor will snap against the intersecting points of the grid. <div data-bbox="620 856 1430 1031" style="border: 1px solid #add8e6; padding: 10px;"> <p> TIP To display the grid, select View > Grid > Show Grid from the top menu or press Ctrl + '.</p> </div>
	<p>Automatically Create Colour Art</p>	<p>As you draw in the Line Art layer, the Automatically Create Colour Art option instantly creates the corresponding strokes in the Colour Art layer.</p> 
	<p>Auto-Flatten Mode</p>	<p>By default, when drawing on a vector layer, each new stroke is created as a separate drawing object, which can be edited independently from other parts of the artwork. When enabled, the Auto-Flatten option automatically merges strokes into existing artwork.</p> 

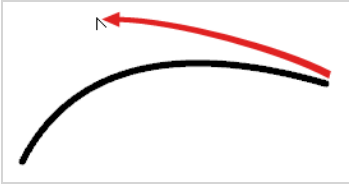
Icon	Tool Name	Description
		<div data-bbox="540 283 1429 514" style="border: 1px solid green; padding: 5px;">  <p>NOTE Using the Select tool, you can use select and remove a segment of flattened pencil lines. Overlapping pencil lines drawn with the Auto-Flatten mode are essentially cut into segments by the overlap and can be treated as individual lines.</p> </div>
	<p>Auto-Close Gap</p>	<p>When enabled, small gaps between the pencil lines you draw will be closed by an invisible stroke to make sure your shapes are closed and that they can be filled with the Paint tool.</p> <p>When drawing contours with pencil lines, the centreline is used to determine whether or not the contour is closed, but the visible tips of the pencil line will extend a bit beyond the tips of its centreline, making it possible to have shapes that appear closed, but are not really. This can prevent the shape from being filled with the Paint tool. Enabling this option when drawing with the Pencil or Line tool will prevent you from leaving invisible gaps in your contours.</p> <div data-bbox="540 930 1365 1241" style="border: 1px solid gray; padding: 5px;">  <p style="text-align: center;">Auto Close Gap off Auto Close Gap on</p> </div>
	<p>Line Building Mode</p>	<p>The Line Building mode is very useful when drawing long lines and curves in small increments with pencil lines or the Line tool. As the pencil lines are central vector lines, it may be difficult to align the line tips perfectly to create a uniform stroke and close all gaps.</p> <p>In this mode, you can draw lines in small increments and the tips are merge into one single stroke.</p> <div data-bbox="540 1556 1360 1793" style="border: 1px solid gray; padding: 5px;">  <p style="text-align: right;">Line Building mode</p> <p style="text-align: right;">Normal mode</p> </div>

Icon	Tool Name	Description
		<div style="border: 1px solid #c8e6c9; padding: 10px; background-color: #e8f5e9;">  <p>NOTE This mode only works with pencil lines or the line tool.</p> </div>
	<p>Use Stored Colour Gradient</p>	<p>The Use Stored Colour Gradient option can be used when painting with a gradient colour to always position the gradient in the same way it was stored, making it consistent across brush strokes. You can store a gradient by selecting a zone painted with a gradient with the Select tool, then clicking on Store Colour Gradient  in the Tool Properties view.</p>
	<p>Straight Line Mode</p>	<p>Draws a straight line.</p> <p>In this mode, you can draw curved lines with the following method:</p> <ol style="list-style-type: none"> 1. Draw the line by clicking and dragging from the start point to the end point of the line, but don't release the mouse button or pen yet.  <ol style="list-style-type: none"> 2. While holding the mouse button or pen down, press and hold the Ctrl (Windows/Linux) or ⌘ (macOS) and move the mouse or pen to define the line's curve.  <ol style="list-style-type: none"> 3. Once the line's curve looks right, release the mouse button or pen.
	<p>Curve Line Mode</p>	<p>This mode allows you to draw a simple curved (quadratic Bezier) line in two clicks:</p> <ol style="list-style-type: none"> 1. Draw the line by clicking and dragging from the start point to the end point of the line.  <ol style="list-style-type: none"> 2. Move the mouse or pen to define the curve of the line and click.

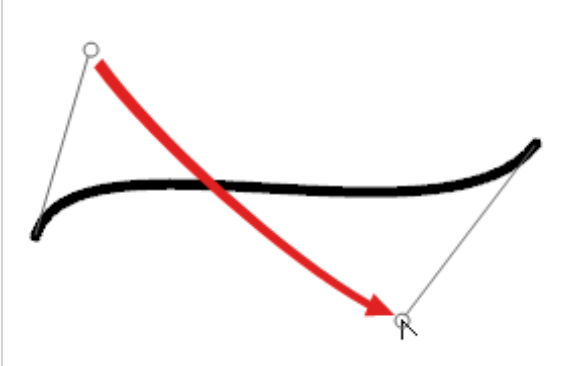
Icon	Tool Name	Description
		
	<p data-bbox="321 1045 457 1108">S Curve Line Mode</p>	<p data-bbox="539 535 1388 598">Draws an S-shaped (cubic Bezier) line. This mode allows you to draw lines with finely tuned or even S-shaped curves with three clicks:</p> <ol data-bbox="581 625 1421 688" style="list-style-type: none"> <li data-bbox="581 625 1421 688">1. Draw the line by clicking and dragging from the start point to the end point of the line.  <ol data-bbox="581 865 1421 928" style="list-style-type: none"> <li data-bbox="581 865 1421 928">2. Move the mouse or pen to define the Bezier position of the beginning of the line and click.  <ol data-bbox="581 1155 1421 1218" style="list-style-type: none"> <li data-bbox="581 1155 1421 1218">3. Move the mouse or pen to define the Bezier position of the end of the line and click. 

Pencil Properties Dialog

Since the Line tool draws pencil lines, you can use the Pencil Properties dialog to customize the type of lines it draws. To open the Pencil Properties dialog, click on the arrow button right of the stroke display area.

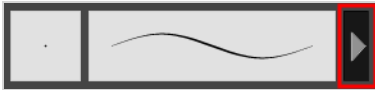

Size and Smoothness Tab

The Size and Smoothness tab allows you to select your pencil's size, its smoothing parameters as well as the shape of its tips and corners.

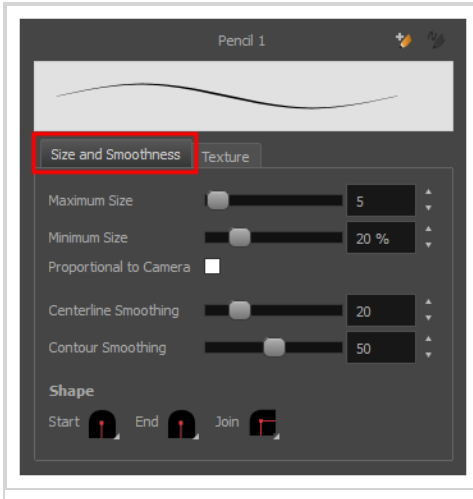

Property	Description
Maximum Size	Defines the maximum size of the pencil line. If the tool is used with a pressure sensitive pen tablet, the width of the stroke will vary between its maximum size and minimum size depending on the amount of pressure used. If used with a mouse, the width of the stroke will always be its maximum size.
Minimum Size	Defines the minimum size of your stroke as a percentage of the maximum size. If you do not have pressure sensitivity from a pen table, the minimum size value will be ignored.
Proportional to Camera	If you check this option, the size of the pencil will be adjusted to the position of the camera on the z-axis. This means that if the camera is zoomed in on the scene, the pencil will be proportionally smaller so that it appears the same size in the rendered image. Likewise, if the camera is zoomed out, the pencil will be proportionally bigger.
Centerline Smoothing	Defines the amount of smoothing Harmony should perform on the central line of the pencil stroke. A higher setting will prevent your line from being shaky and will reduce the amount of control points it has, making it easier to tweak, but is liable to reduce drawing precision and turn sharp angles into curves.
Contour Smoothing	Defines the amount of smoothing Harmony should perform on the outer contour of

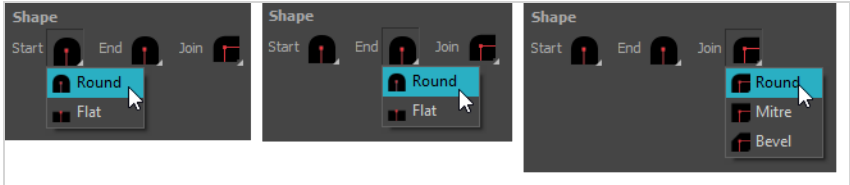
Property	Description
	<p>the pencil stroke.</p> <p>A pencil line is defined by its centreline and its variations in thickness, rather than its apparent shape. When drawing a pencil line with a mouse, its thickness is uniform. Therefore, its outer contour does not have any control point, except at its extremities, and no smoothing is required for its contour.</p> <p>However, when drawing a pencil line with a pressure sensitive tablet, its contour will have control points and Bezier curves to define the line's variations in thickness, and thus smoothing must be performed on its contour. An increased contour smoothing will reduce the amount of control points on the line's thickness and smoothen its curves, but may affect the precision of the variations in line thickness.</p>
Shape	<p>You can adjust the start, end, and join style of a pencil line.</p>  <ul style="list-style-type: none"> • Start: Lets you select the style of the start tip, which is the first tip you drew. You can choose between Round or Flat style. • End: Lets you select the style of the end tip, which is the last tip you drew. You can choose between Round or Flat style. • Join: Lets you select the joint style. The joints are where the line curves abruptly. You could also define the Join style as the corner style. You can choose between Round, Mitre and Bevel style.

Texture Tab

In the Pencil Properties view, the Texture tab allows you to select a pencil texture from the currently selected pencil texture palette to use with the Pencil tool. You can also add, remove or rename textures, save the current pencil texture palette as the default one, or import the pencil texture palette into your scene.

The pencil texture palette used in the Texture tab of the Pencil Properties dialog is the one selected in the Colour view. You can select a pencil texture palette by selecting it from the pencil texture palette list in the Colour view—see [Colour View on page 1220](#).

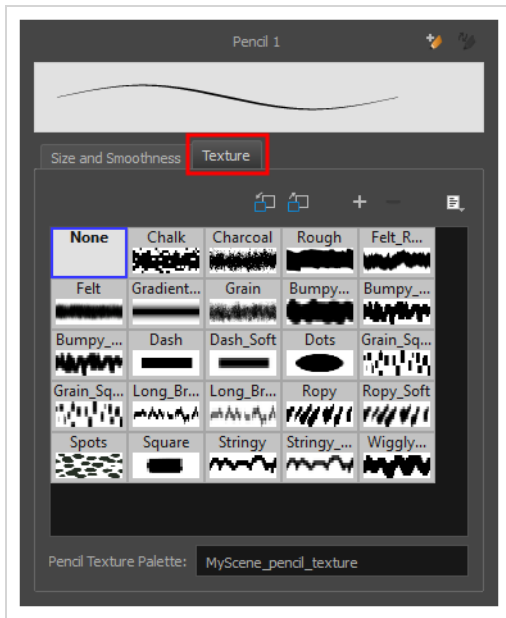





Icon	Property	Description
	Use as Default Pencil Texture Palette	This option is available from the menu button. Sets the currently selected pencil texture palette as the default pencil texture palette in your user preferences. The default pencil texture palette is added to every scene you create in Harmony. The palette is copied in your preferences, so it will be added to your new scenes in the exact state it is when you make it the default pencil texture palette.
	Reload Default Texture Palette	Imports the default pencil texture palette as a new pencil texture palette into your scene's palette list, and selects it as the current pencil texture palette.
	New Texture	Allows you to import an image file into a new pencil texture swatch in the current pencil texture palette. The pencil texture's effect on your pencil line will be based on the image's transparency channel, and will follow your pencil lines on its horizontal axis. This option is also available from the menu button.
	Delete Texture	Deletes a pencil texture swatch from the current pencil texture palette. This option is also available from the menu button.
	Rename Texture	Renames the selected pencil texture swatch in the current pencil texture palette. This option is also available from the menu button.
	Pencil Texture Display	Displays the pencil textures in the current pencil texture palette and allows



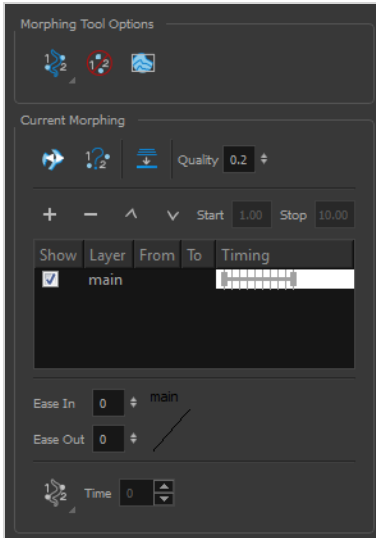

Icon	Property	Description
		you to select one to use with the Pencil tool.
	Pencil Texture Palette	Displays the name of the currently selected pencil texture palette, for reference. To select a different pencil texture palette, you must select it in the Colour view—see Colour View on page 1220 .

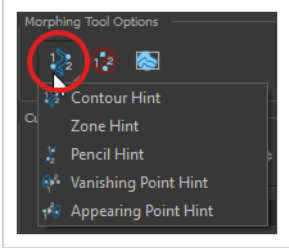
Morphing Tool Properties

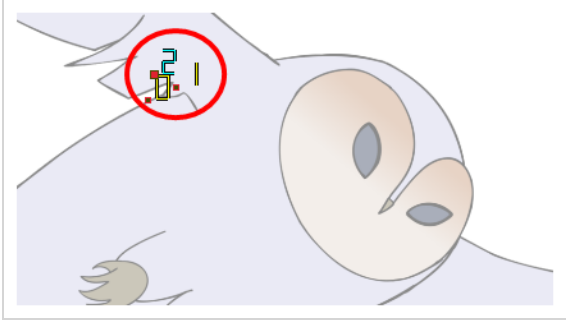

As you create and adjust your morphing sequences, you will often use the Tool Properties view. Using this view allows you to do things such as toggle between your key drawings, adjust the easing or select a hint type.

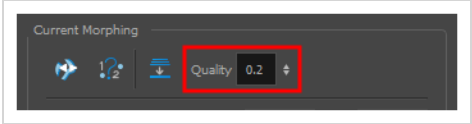

Icon	Tool Name	Description
	Hint Type	<p>The Hint Type drop-down menu allows you to select the correct hint to remedy any problem areas in your drawing.</p>  <p>You can have more than one hint type in your drawings. You can mix all of the hint types in your morphing sequence.</p>
	Do not Pick Transparency	<p>The Hide Hints button temporarily hides the hint points from the key drawings. Use this option when you have a series of hint points hiding some lines you would like to see.</p>

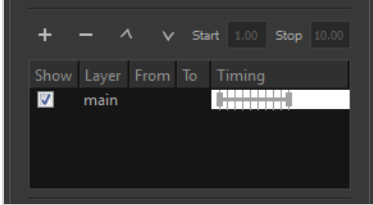
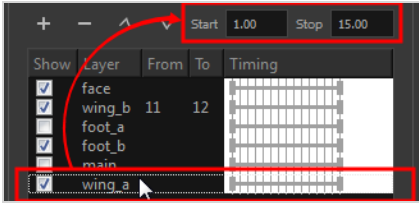
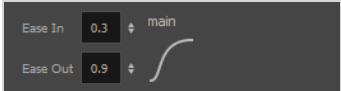
		
	Show Morphing in Place	The Show Morphing In Place option is used with morphing layers. Enabling this option prevents the currently selected morphing layer from being shown on top of the others and maintains the correct layer ordering.
	Suggest Hints	The Suggest Hints option is used to automatically set Automatically sets hint points on key drawings as a help tool. If you're not sure where to set hints, you can use this option. It will set the main hints which you can then fine tune.
	Switch Between Drawings	The Switch Between Drawings button is used to toggle Toggles between the two key drawings in your morphing sequence. This option is useful while setting hints. You can use the default keyboard shortcut F4 to toggle between your drawings.
	Flatten	The Flatten option is used when you have to morph a sequence with a semi-transparent or transparent colour in it.
	Quality	<p>The Quality setting is used to make the lines of the morphed drawings smoother. Adjust this parameter when you are doing an extreme close up of your animation.</p> 
	Morphing Layers	The Morphing Layers option is used when working with morphing layers. You can add, remove and manage your different morphing layers in this space.

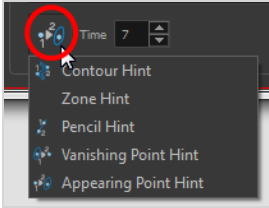



		 <p>To create new drawings, double-click on the blank area under the From section to create the source drawing and the To section for the destination drawing and type a different value than the ones used for the main layer.</p>
+	Add Layer	Adds a new Morphing layer.
-	Delete Layer	Deletes the selected Morphing layer.
^	Move Up	Moves the new layer up in the stack.
v	Move Down	Moves the new lower up in the stack.
	Start	<p>Indicates the start frame of the selected Morphing layer.</p> 
	Stop	Indicates the end frame of the selected Morphing layer.
	Ease in and Ease out	<p>The Easing option is used to adjust the starting and ending velocity of your morphing sequence so that the motion is smooth and not mechanical.</p> <p>You can adjust the Ease In and Ease Out value by dragging your cursor up and down or typing a new value. The values go from -1.0 to 1.0.</p> 

	Convert Hints	<p>The Convert Hints option is used to switch the type of the selected hint points. This option is useful when you position hints and then realize they are not the right type. You can select them and convert them to the correct type instead of deleting them and setting new ones.</p>  <p>Use the Morphing tool to select the hints and then convert them by going to the Tool Properties view and selecting the new hint type from the Convert Hints drop-down menu.</p>
	Time	<p>The Time field is used to set the timing on Appearing Point and Vanishing Point hints. These hints are used to set the trajectory of appearing and vanishing objects, With the Time field, select your Appearing Point or Vanishing Point hint and type the frame number on which the object will start its appearing or vanishing animation.</p> 

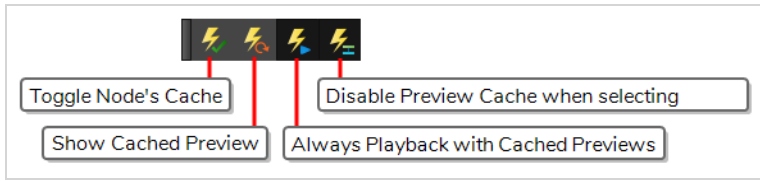
Node Caching Toolbar

The Node Caching toolbar allows you to control how nodes in your scene are cached.



Icon	Button	Description
	Toggle Node's Cache	Toggles the Cached property of every selected node on or off.
	Show cached preview	Re-enables cache for every element or rig in your scene for which it was temporarily disabled.
	Always Playback with Cached Previews	When toggled on, if you play your scene, the cache will be re-enabled for every element for which it was temporarily disabled.
	Disable Preview Cache when selecting nodes	When toggled on, selecting a node in the Timeline or Node view will disable caching for this node, or for any node connected underneath it. <div style="border: 1px solid green; padding: 10px; margin-top: 10px;"> <p>NOTE</p> <p>Selecting an element in the Camera view always disables the cache for this element and its children, regardless of whether this option is enabled or disabled. This option only affects what happens when selecting in the Timeline or Node view.</p> </div>

Paint Tool Properties

The Paint tool allows you to fill closed areas of your drawing with the selected colour.





How to access the Paint tool properties











1. In the Tools toolbar, select the Paint , Paint Unpainted , Repaint  or Unpaint  tool.





The tool's properties are displayed in the Tool Properties view.







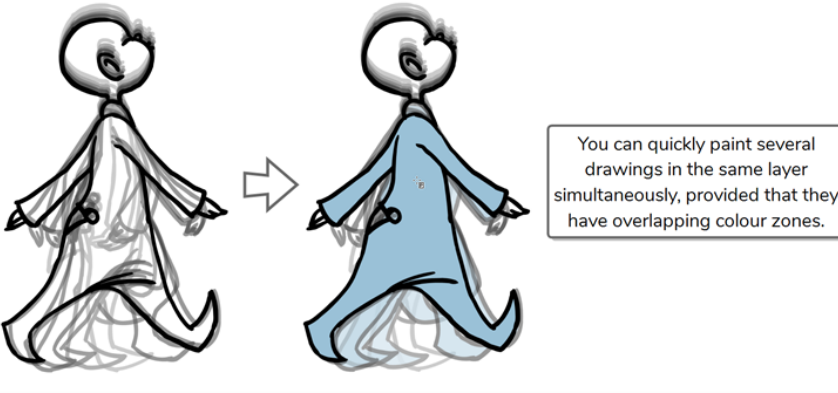

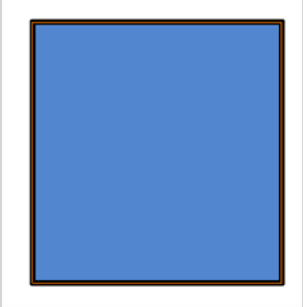

Paint Tool Options

Icon	Property	Description
	Selection Mode	<p>Allows you to choose the method to visually select multiple elements:</p> <ul style="list-style-type: none"> •  Lasso: Allows you to select multiple elements by drawing an irregular closed shape around them with your mouse. •  Marquee: Allows you to select multiple elements by drawing a rectangle around them. This is faster, as you only need to drag your mouse from one corner of the rectangle to its opposite corner, but it may not be as precise as you want. <div style="border: 1px solid #0070C0; padding: 5px; margin-top: 10px;"> <p> TIP You can press and hold the Alt key to temporarily use the other selection mode.</p> </div>

Icon	Property	Description
	<p>Paint Mode</p>	<p>The Paint tool has four different modes:</p> <ul style="list-style-type: none">  Paint: Paints or repaints selected zones, whether or not they are already filled.  Paint Unpainted: Only paints empty zones, and does not repaint zones that are already filled with colour.  Repaint: Only paints zones that are already filled with colour, and does not fill empty zones.  Unpaint: Removes colour from the selected zone, replacing it with transparency.
	<p>Paint and Remove Textures</p>	<p>The Paint and Remove Texture option is used when you vectorized images as greyscale texture style. An image vectorized as texture is a mix of bitmap filling encapsulated in a vector-based frame. Painting a textured zones with the Paint tool will change the tint of the textured lines. Painting the textured zones using the Paint and Remove Texture option transforms the bitmap filling into a 100% vector based zone and fills it with a solid colour.</p> 
	<p>Apply to Visible Drawing Layers</p>	<p>This option allows you to select which layers the tool should affect. It can be toggled on or off. When toggled on, it has two different modes. You can select a mode by clicking and holding on the button.</p> <ul style="list-style-type: none"> Off: When this button is toggled off, the tool only works on the currently selected layers. If several layers are selected, the tool will work on all these layers simultaneously.  Apply to Visible Drawing Layers: The tool will work on all the visible layers in the Camera view.  Apply to Synced Drawing Layers: If the currently selected layer is synced with another layer, the tool will work on both the current layer and its synced layer. <div style="border: 1px solid green; padding: 5px; margin-top: 10px;">  NOTE This option only works in the Camera view. </div>

Icon	Property	Description
	Apply to All Frames	<p>This option allows you to determine which drawings in the current layer the tool should affect. It can be toggled on or off. When toggled on, it has two different modes. You can select a mode by clicking and holding on the button.</p> <ul style="list-style-type: none"> • Off: When this button is toggled off, the tool only works on the drawing in the current frame. •  Apply to All Frames: The tool will work on every exposed drawing in the selected layer simultaneously. •  Apply to Onion Skin Range: The tool will work on every drawing displayed in the Onion Skin. Onion Skin must be enabled for this option to work. <div data-bbox="561 716 1433 1136" style="border: 1px solid gray; padding: 10px; margin-top: 10px;">  </div>
	Respect Protected Colour	<p>The Respect Protected Colour option is enabled by default. In your Colour view, you can protect some colour swatches to avoid repainting or unpainting the zones linked to that swatch.</p> <p>If you disable this option the Paint tool will not follow the protect colour rule and will repaint or unpaint the protected colours on your drawings until you enable the option again.</p>
	Use Stored Colour Gradient	<p>When you paint a zone with a gradient or textured colour swatch, the gradient or texture's position is set relative to the size of the zone you are painting. If you want the Paint tool to use a particular size and position, you must first store your desired position and size using the Select tool and then enable the Use Stored Colour Gradient option in the Paint tool properties.</p>



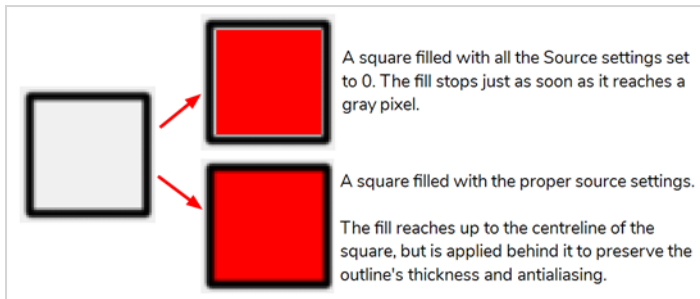

Icon	Property	Description
		
	<p>Select Newly Painted, Repainted, and Unpainted Contours/Lines</p>	<p>In the Paint tool properties, this option keeps a selection highlighted around the latest painted zone after using the Paint, Repaint, Unpaint, or Paint Unpainted tool.</p> 
	<p>Close Gap</p>	<p>By default, if you attempt to fill a shape that has a small gap in its contour, the Paint tool will not be able to fill the shape. This option allows you to make the Paint tool automatically add a stroke to close the shape when it detects a small gap between two strokes in the shape.</p> <p>The Close Gap setting can be set to a value between 0 and 10. This determines the maximum size of a gap to close, in pixels. You can also use one of the following presets:</p> <ul style="list-style-type: none"> •  No Close Gap: Sets the Close Gap setting to 0, disabling the feature. •  Close Small Gap: Sets the Close Gap setting to 2, making the Paint tool close gaps that are barely visible. •  Close Medium Gap: Sets the Close Gap setting to 4, making the Paint tool close gaps that are somewhat visible. •  Close Large Gap: Sets the Close Gap setting to 8, making the Paint tool close gaps that are easy to notice.

Bitmap Options



Since bitmap drawings are made of pixels instead of shapes, and that the outlines of shapes in bitmap drawings are often feathered, it can be complicated to figure out exactly the area the Paint tool must fill when trying to fill a zone in a bitmap drawing. For example, if the Paint tool only replaces pixels with the exact same colour as the one you click on with the selected colour, it will leave a small gap near the outlines of the shape.



The following settings determine how the Paint tool figures out the area it must fill. When any of these settings are increased, the Paint tool's tolerance for colour or alpha differences increases and it will a bigger area that it otherwise would.

Icon	Property	Description
	Source	<p>Allows you to select which art layer to use in order to determine the fillable zone. By default, this is set to Current Art , which means the layer you are filling will be used to determine the fillable zone. However, if you want to keep your colour art on the Colour Art layer and the line art on the Line Art layer, you can set the Source to Line Art , and then use the Paint tool on the Colour Art layer. The Paint tool will use the artwork in the Line Art layer to determine the area to fill with colour, but will still add this colour to the Colour Art layer.</p> <p>This property has the following options:</p> <ul style="list-style-type: none"> •  Current Art: Bases the zone to fill on the current art layer. •  Line Art: Bases the zone to fill on the Line Art layer, regardless of which layer you are painting on. •  Colour Art: Bases the zone to fill on the Colour Art layer, regardless of which layer you are painting on.
--	Alpha	<p>The alpha threshold that separates opaque and transparent zones. When filling a "transparent" zone, the paint tool will apply the colour under semi-transparent pixels, making them opaque. Then filling an "opaque" zone, the paint tool will replace the colour of semi-transparent pixels without affecting their transparency.</p> <p>If you want to repaint lineart or shapes that have no outlines, you can do so by decreasing this setting completely. This will make it fill any pixel</p>

Icon	Property	Description
		<p>that isn't 100% transparent, so it will paint your outlines completely. However, if you're using this method to repaint outlines, they must not be filled yet for this method to work.</p> <p>If you want to paint transparent zones that have dirt or semi-transparent spots, you can increase this setting to make the Paint tool paint behind them instead of around them.</p> <div data-bbox="657 541 1430 772" style="border: 1px solid #c8e6c9; padding: 10px; margin-top: 10px;">  <p>NOTE</p> <p>Raising this setting too high may cause the paint tool to ignore outlines that are not 100% opaque, which can cause it to think the shape is not closed. Hence, it might fail to find a zone to fill and not do anything.</p> </div>
--	Colour Tolerance	<p>The amount of tolerance the paint tool has for changes in colour when filling an area. Raising this setting will allow the paint tool to fill over areas that have some variations in colour, but may cause it to fill beyond the areas you meant to paint.</p>
--	Maximum Overlap	<p>The maximum amount of pixels beyond the fillable zone that the Paint tool can fill.</p> <p>When this setting is set to any value above zero, the paint tool will fill the zone until it finds a pixel that is a different colour, value or transparency as the one you clicked on. Then, it will start filling pixels beyond that point, up until it filled the amount of pixels in the Maximum Overlap setting.</p> <p>If it lands outside of a fillable zone before it reached the maximum overlap, it will stop filling at that point. However, if it lands into another fillable zone before reaching its maximum overlap, it will fill that zone as well. Therefore, if you're filling shapes inside other shapes, you have to set this setting to the approximate width of your outlines. Setting it higher will make the colour spill beyond the zone you clicked on and fill the zone outside of it, and setting it lower is liable to leave a small gap between the fill and the outlines.</p>

Icon	Property	Description
		<div data-bbox="656 285 1429 676" style="border: 1px solid #c8e6c9; padding: 10px;">  <p>NOTE</p> <p>When you fill a zone with overlap, Harmony tries to detect and preserve the outlines of your shape. This is easy to do when filling a transparent shape, or when repainting a shape made of solid outlines and a solid fill. However, if you are trying to repaint an already painted zone, it may fail to detect your outlines and may repaint over them if the colour of your outlines or inside the shape isn't consistent. Therefore, it is highly recommended to avoid repainting painted zones as much as possible when working with bitmap layers.</p> </div>
	Antialiasing	<p>When enabled, the outlines of the fill will be smoothed so that they do not look pixelated.</p> <div data-bbox="656 831 1429 1033" style="border: 1px solid #c8e6c9; padding: 10px;">  <p>NOTE</p> <p>The effect of this setting will not be visible if you fill all the way to the outlines, as the Paint tool will preserve the antialiasing of existing outlines when filling up to them.</p> </div>

Pencil Tool Properties

The Pencil tool allows you to draw simple contour lines that are defined by their centerline and their thickness. When you select the Pencil tool, the Tool Properties view displays the different Pencil modes that control how the pencil line is drawn.

How to access the Pencil tool properties

1. In the Tools toolbar, select the Pencil  tool.

The tool's properties are displayed in the Tool Properties view.

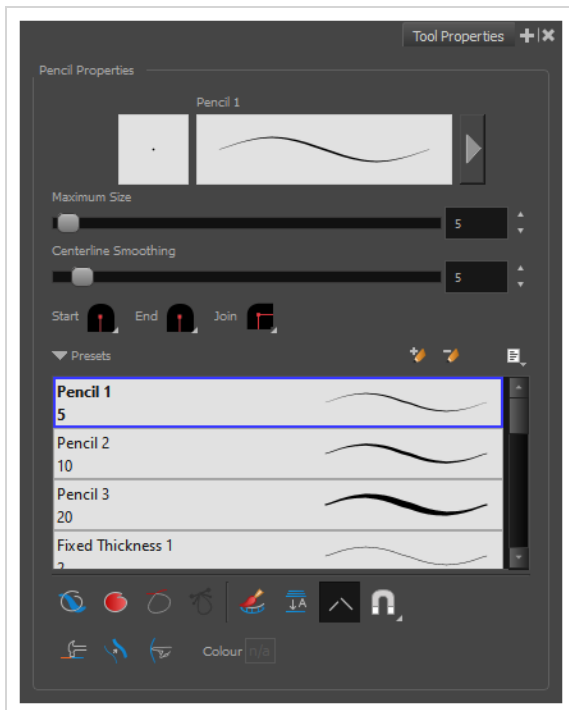

Pencil Properties

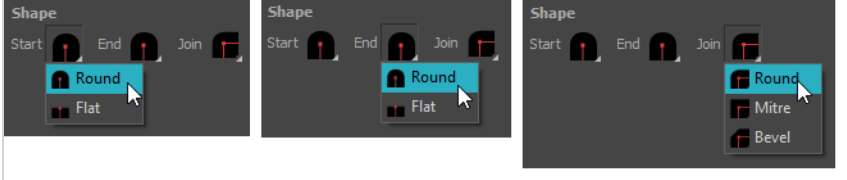

The following properties affect the pencil's size, smoothing, shape and other properties for the drawing style of your pencil. Those properties can be saved into pencil presets for later use.

Property	Description
Preview Area	<p>The Preview area lets you see a preview of the stroke your drawing tool will make.</p> 

Property	Description
Pencil Properties Dialog	<p>The arrow button right of the preview area opens the Pencil Properties dialog.</p>  <p>While the Tool Properties view only gives you access to a few of the pencil properties, a list of pencil presets and other drawing options, the Pencil Properties dialog gives you access to all the available options for your pencil's shape and texture. For more information on the Pencil Properties dialog, see the Pencil Properties Dialog section below.</p>
Maximum Size	<p>Defines the maximum width of the pencil line.</p> <p>If the tool is used with a pressure sensitive pen tablet, the width of the stroke will vary between its maximum size and minimum size depending on the amount of pressure used. If used with a mouse, the width of the stroke will always be its maximum size.</p>
Centerline Smoothing	<p>Defines the number of control points added to the centre line. The fewer the control points the smoother (but less faithful) the line.</p>
Shape	<p>You can adjust the start, end, and join style of a pencil line.</p>  <ul style="list-style-type: none"> • Start: Lets you select the style of the start tip, which is the first tip you drew. You can choose between Round or Flat style. • End: Lets you select the style of the end tip, which is the last tip you drew. You can choose between Round or Flat style. • Join: Lets you select the joint style. The joints are where the line curves abruptly. You could also define the Join style as the corner style. You can choose between Round, Mitre and Bevel style.











Pencil Presets



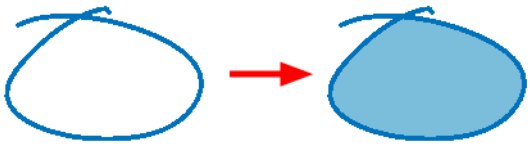



These options allow you to select, create and manage pencil presets.

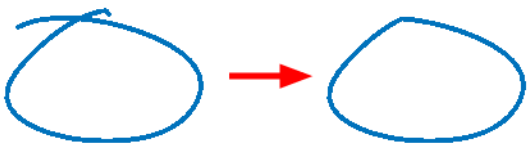

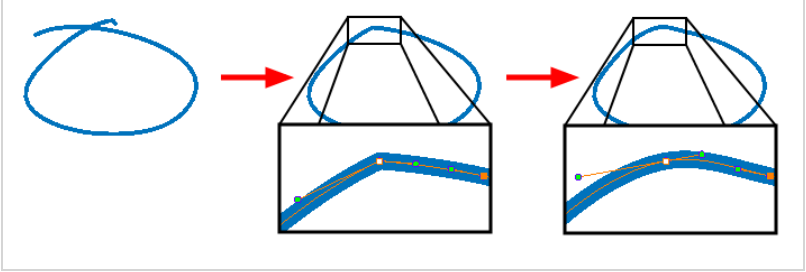
Icon	Property	Description
	Presets list	<p>Harmony provides a variety of pencil presets and thickness stencils and also lets you create and save your own. It is a good idea to create and save pencils with precise sizes and parameters when you draw for efficiency and consistency.</p> <p>A thickness stencil saves the thickness information across the length of the line. When drawing with a thickness stencil, the pressure sensitivity of the tablet is discarded. A thickness stencil can be used while drawing, or applied afterwards.</p> <p>You also have the possibility to apply different textures to your lines by either using the default presets or to import your own.</p> <p>You can export the pencil presets that you have created and import those that others have created. This is a good way for you and project collaborators to keep a consistent look for the project.</p>
	New Brush Preset	Creates a new preset based on the current tool properties.
	Delete Brush Preset	Deletes the currently selected preset.
	Brush Presets Menu	<p>Open a menu that contains the following options:</p> <ul style="list-style-type: none"> • New Brush Preset: Creates a new preset based on the current tool properties. • Delete Brush: Deletes the currently selected preset. • Rename Brush: Allows you to rename the currently selected preset. • Import Brushes: Allows you to import brush presets exported from Harmony. • Export Brushes: Allows you to export your brush presets into an <code>.xml</code> file. • Small Thumbnail: Displays presets in a grid of small thumbnails with a preview of their tip. • Large Thumbnail: Displays presets in a grid of big thumbnails, with their name and a preview of their tip. • Stroke View: Displays presets in a list, with their name and a preview of a stroke done with each preset.

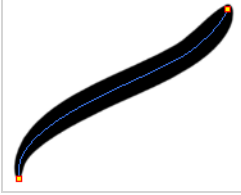

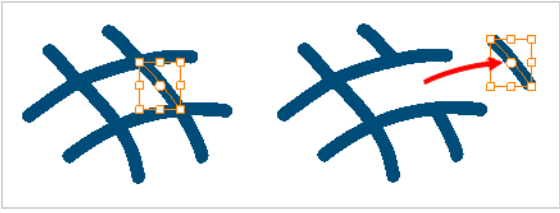

Drawing Options

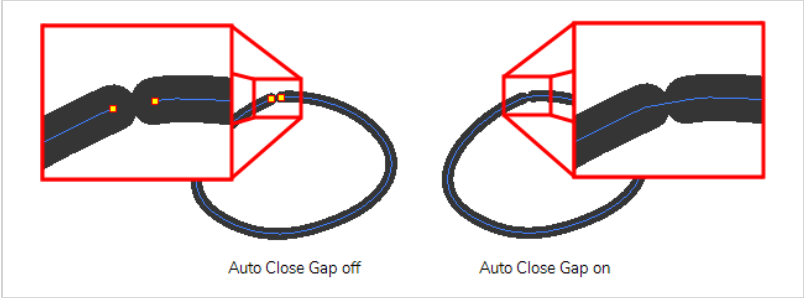
These options affect the way your drawing strokes are added to your artwork.

Icon	Property	Description
	Draw Behind	<p>When enabled, your brush strokes will appear behind the existing artwork.</p> <div data-bbox="634 338 1105 533">  <p>The orange stroke was drawn over the black stroke, then put underneath it.</p> </div> <div data-bbox="634 569 1430 741" style="border: 1px solid green; padding: 5px;"> <p> NOTE</p> <p>Your brush stroke will temporarily appear over your artwork as you draw it, until you release the mouse cursor or tablet pen.</p> </div>
	Auto Fill	<p>When enabled, drawing a closed shape will automatically fill it with the currently selected Paint colour.</p> <div data-bbox="634 888 1213 1071">  </div> <div data-bbox="634 1106 1430 1562" style="border: 1px solid blue; padding: 5px;"> <p> TIP</p> <p>By default the pencil line and its fill will be the same colour. To select different colours for the line and its fill, do the following:</p> <ol style="list-style-type: none"> 1. In the Colour view, click the  Unlock Three Colours button. 2. Click on the  Set Current Pencil Colour swatch. Then, in the colour list, select the desired colour swatch for your outline. 3. Click on the  Set Current Paint Colour swatch. Then, in the colour list, select the desired colour swatch for the fill. </div>
	Trim Extra Lines	<p>When enabled, drawing a closed shape will automatically remove the outstanding lines.</p> <div data-bbox="634 1709 1219 1892">  </div>

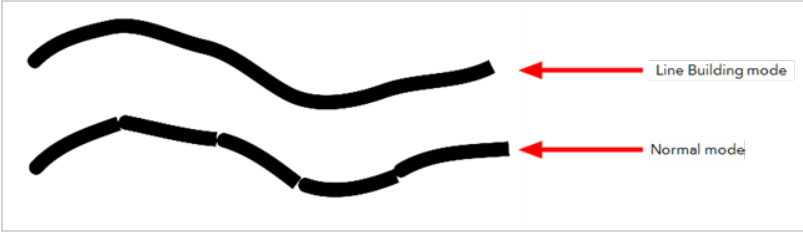
Icon	Property	Description
	<p>Align Handles After Trim</p>	<p>When the Trim Extra Lines option is enabled, enable this option to make the point where the beginning and end of the stroke meet into a smooth curve rather than a hard corner.</p> 
	<p>Automatically Create Colour Art</p>	<p>As you draw in the Line Art layer, the Automatically Create Colour Art option instantly creates the corresponding strokes in the Colour Art layer.</p> 
	<p>Auto Flatten</p>	<p>By default, when drawing on a vector layer, each new stroke is created as a separate drawing object, which can be edited independently from other parts of the artwork. When enabled, the Auto-Flatten option automatically merges strokes into existing artwork.</p>  <div data-bbox="634 1507 1430 1738" style="border: 1px solid green; padding: 5px;"> <p> NOTE</p> <p>Using the Select tool, you can select and remove a segment of flattened pencil lines. Overlapping pencil lines drawn with the Auto-Flatten mode are essentially cut into segments by the overlap and can be treated as individual lines.</p> </div>
	<p>Auto-Close Gap</p>	<p>When enabled, small gaps between the pencil lines you draw will be closed by an invisible stroke to make sure your shapes are closed and that they can be filled with the Paint tool.</p>

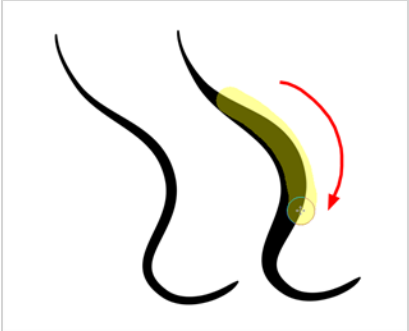
Icon	Property	Description
		<p>When drawing contours with pencil lines, the centreline is used to determine whether or not the contour is closed, but the visible tips of the pencil line will extend a bit beyond the tips of its centreline, making it possible to have shapes that appear closed, but are not really. This can prevent the shape from being filled with the Paint tool. Enabling this option when drawing with the Pencil or Line tool will prevent you from leaving invisible gaps in your contours.</p> 
	Snapping	<p>Allows you to enable or disable snapping for this tool and all other animation and drawing tools that support snapping, as well as to select which types of snapping are enabled.</p> <p>If you double-click or long-click on this button, it will open a pop-up menu in which you can toggle different snapping modes. You can also click on this button to toggle it off, which will disable all snapping modes, and click on it again and toggle it on to re-enable the snapping modes which were previously enabled.</p> <p>This tool supports the following snapping mode:</p> <ul style="list-style-type: none"> • Snap to Alignment Guides: While drawing, the drawing tool will snap against nearby alignment guides.
	Line Building Mode	<p>The Line Building mode is very useful when drawing long lines and curves in small increments with pencil lines or the Line tool. As the pencil lines are central vector lines, it may be difficult to align the line tips perfectly to create a uniform stroke and close all gaps.</p> <p>In this mode, you can draw lines in small increments and the tips are merge into one single stroke.</p>

Icon	Property	Description
		 <div data-bbox="634 548 1432 688" style="border: 1px solid green; padding: 5px; margin-top: 10px;">  <p>NOTE This mode only works with pencil lines or the line tool.</p> </div>
	<p>Auto Adjust Thickness</p>	<p>The Auto Adjust Thickness tool is useful when you want to render a portion of a line thicker. When tracing a drawing on paper, you will often go back to a section of a curve to make it thicker to add dynamism to the line. Using the Auto Adjust Thickness tool, you can draw highlight strokes over the section to make thicker. Once you release the pen or mouse, the line becomes thicker following the shape and curve of the original stroke. This way is much faster and smoother than using the Pencil Editor tool. You do not have to add extra points and adjust the position and Bezier handles.</p>  <p>The default overlay colour is light yellow. If this colour is difficult to see because of the background or drawing colour, you can adjust the colour.</p>
	<p>Line Pushing Mode</p>	<p>The Line Pushing Mode option lets you draw highlight strokes over existing pencil lines. You can reshape the curves. Depending how you draw the pushing stroke over your line, the highlighted section will be reshaped in one direction or the other.</p> <p>The default overlay colour is light yellow. If this colour is difficult to see because of the background or drawing colour, you can adjust the colour.</p>
	<p>Colour</p>	<p>You can change the colour of the temporary strokes that appear in the</p>

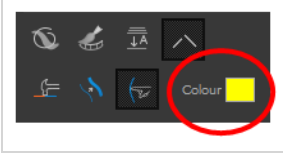
Icon	Property	Description
		<p>drawing space when using the Line Pushing Mode or the Auto Adjust Thickness option by clicking on the Colour swatch and selecting a new colour in the Colour Picker dialog.</p> 

Pencil Properties Dialog

Pencils have extra parameters which are not accessible from the Tool Properties view. To open the Pencil Properties dialog, click on the arrow button right of the stroke display area.



Size and Smoothness Tab

The Size and Smoothness tab allows you to select your pencil's size, its smoothing parameters as well as the shape of its tips and corners.

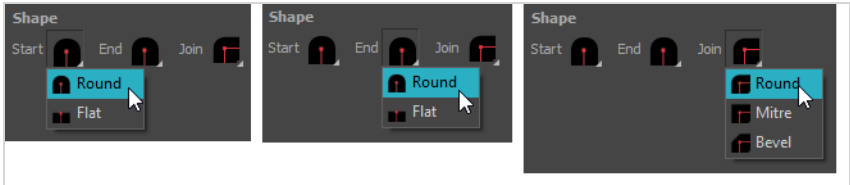

Property	Description
Maximum Size	Defines the maximum size of the pencil line. If the tool is used with a pressure sensitive pen tablet, the width of the stroke will vary between its maximum size and minimum size depending on the amount of pressure used. If used with a mouse, the width of the stroke will always be its maximum size.

Property	Description
Minimum Size	Defines the minimum size of your stroke as a percentage of the maximum size. If you do not have pressure sensitivity from a pen table, the minimum size value will be ignored.
Proportional to Camera	If you check this option, the size of the pencil will be adjusted to the position of the camera on the z-axis. This means that if the camera is zoomed in on the scene, the pencil will be proportionally smaller so that it appears the same size in the rendered image. Likewise, if the camera is zoomed out, the pencil will be proportionally bigger.
Centerline Smoothing	Defines the amount of smoothing Harmony should perform on the central line of the pencil stroke. A higher setting will prevent your line from being shaky and will reduce the amount of control points it has, making it easier to tweak, but is liable to reduce drawing precision and turn sharp angles into curves.
Contour Smoothing	<p>Defines the amount of smoothing Harmony should perform on the outer contour of the pencil stroke.</p> <p>A pencil line is defined by its centreline and its variations in thickness, rather than its apparent shape. When drawing a pencil line with a mouse, its thickness is uniform. Therefore, its outer contour does not have any control point, except at its extremities, and no smoothing is required for its contour.</p> <p>However, when drawing a pencil line with a pressure sensitive tablet, its contour will have control points and Bezier curves to define the line's variations in thickness, and thus smoothing must be performed on its contour. An increased contour smoothing will reduce the amount of control points on the line's thickness and smoothen its curves, but may affect the precision of the variations in line thickness.</p>
Shape	<p>You can adjust the start, end, and join style of a pencil line.</p>  <ul style="list-style-type: none"> • Start: Lets you select the style of the start tip, which is the first tip you drew. You can choose between Round or Flat style. • End: Lets you select the style of the end tip, which is the last tip you drew. You can choose between Round or Flat style. • Join: Lets you select the joint style. The joints are where the line curves abruptly. You could also define the Join style as the corner style. You can choose between Round, Mitre and Bevel style.



Texture Tab

In the Pencil Properties view, the Texture tab allows you to select a pencil texture from the currently selected pencil texture palette to use with the Pencil tool. You can also add, remove or rename textures, save the current pencil texture palette as the default one, or import the pencil texture palette into your scene.

The pencil texture palette used in the Texture tab of the Pencil Properties dialog is the one selected in the Colour view. You can select a pencil texture palette by selecting it from the pencil texture palette list in the Colour view—see [Colour View](#) on page 1220.







Icon	Property	Description
	Use as Default Pencil Texture Palette	This option is available from the menu button. Sets the currently selected pencil texture palette as the default pencil texture palette in your user preferences. The default pencil texture palette is added to every scene you create in Harmony. The palette is copied in your preferences, so it will be added to your new scenes in the exact state it is when you make it the default pencil texture palette.
	Reload Default Texture Palette	Imports the default pencil texture palette as a new pencil texture palette into your scene's palette list, and selects it as the current pencil texture palette.
	New Texture	Allows you to import an image file into a new pencil texture swatch in the current pencil texture palette. The pencil texture's effect on your pencil line will be based on the image's transparency channel, and will follow your pencil lines on its horizontal axis. This option is also available from the menu button.



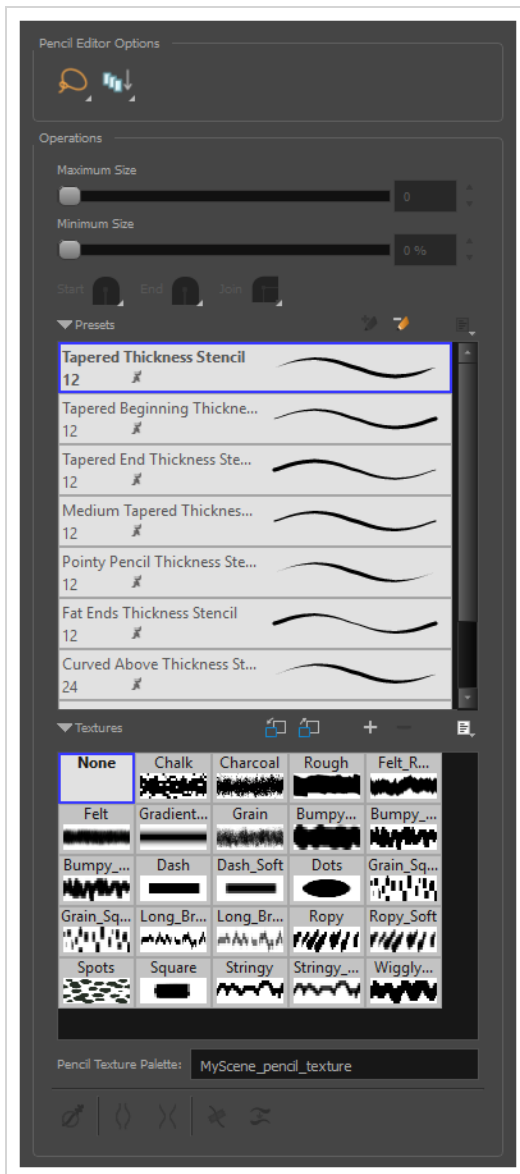

Icon	Property	Description
	Delete Texture	Deletes a pencil texture swatch from the current pencil texture palette. This option is also available from the menu  button.
	Rename Texture	Renames the selected pencil texture swatch in the current pencil texture palette. This option is also available from the menu  button.
	Pencil Texture Display	Displays the pencil textures in the current pencil texture palette and allows you to select one to use with the Pencil tool.
	Pencil Texture Palette	Displays the name of the currently selected pencil texture palette, for reference. To select a different pencil texture palette, you must select it in the Colour view—see Colour View on page 1220.





Pencil Editor Tool Properties



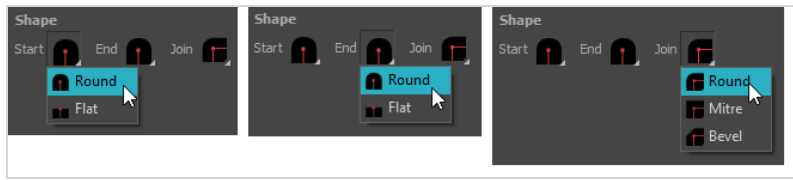

When you select the Pencil Editor tool, its properties and options appear in the Tool Properties view.





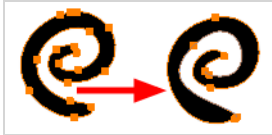

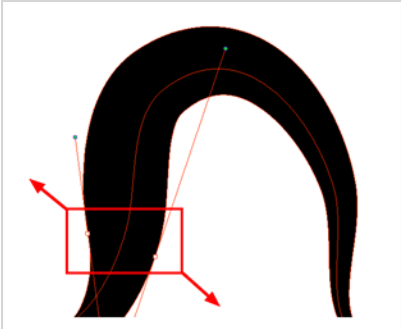
Icon	Tool Name	Description
	Selection Mode	<p>Allows you to choose the method to visually select multiple elements:</p> <ul style="list-style-type: none">  Lasso: Allows you to select multiple elements by drawing an irregular closed shape around them with your mouse.  Marquee: Allows you to select multiple elements by drawing a rectangle around them. This is faster, as you only need to drag your mouse from one corner of the rectangle to its opposite corner, but it may not be as precise as you want.

		<div style="border: 1px solid #add8e6; padding: 10px;">  <p>TIP</p> <p>You can press and hold the Alt key to temporarily use the other selection mode.</p> </div>
	<p>Apply to Visible Drawing Layers</p>	<p>This option allows you to select which layers the tool should affect. It can be toggled on or off. When toggled on, it has two different modes. You can select a mode by clicking and holding on the button.</p> <ul style="list-style-type: none"> • Off: When this button is toggled off, the tool only works on the currently selected layers. If several layers are selected, the tool will work on all these layers simultaneously. •  Apply to Visible Drawing Layers: The tool will work on all the visible layers in the Camera view. •  Apply to Synced Drawing Layers: If the currently selected layer is synced with another layer, the tool will work on both the current layer and its synced layer. <div style="border: 1px solid #90ee90; padding: 10px;">  <p>NOTE</p> <p>This option only works in the Camera view.</p> </div>
	<p>Maximum Size</p>	<p>Defines the maximum width of the pencil line.</p> <p>If the pencil line has a constant size, this will define the width of the pencil line all over. If the pencil line has a varying size, this will define the width of its larger areas. Areas that are in-between the maximum and minimum size will be resized proportionally.</p>
	<p>Minimum Size</p>	<p>Defines the minimum width of the pencil line. If the pencil line has a varying size, this will define the width of its smaller areas. Areas that are in-between the maximum and minimum size will be resized proportionally.</p>
	<p>Shape</p>	<p>You can adjust the start, end, and join style of a pencil line.</p> <div style="border: 1px solid #ccc; padding: 5px;">  </div> <ul style="list-style-type: none"> • Start: Lets you select the style of the start tip, which is the first tip you drew. You can choose between Round or Flat style. • End: Lets you select the style of the end tip, which is the last tip you drew. You can choose between Round or Flat style.

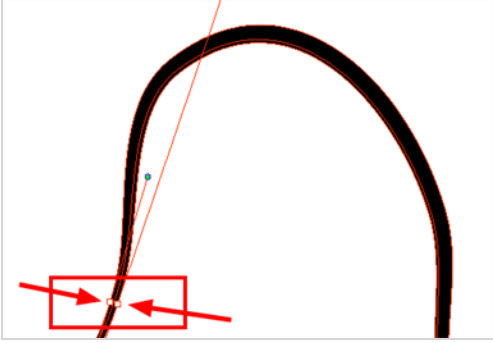
		<ul style="list-style-type: none"> • Join: Lets you select the joint style. The joints are where the line curves abruptly. You could also define the Join style as the corner style. You can choose between Round, Mitre and Bevel style.
	Presets	<p>Harmony provides a variety of pencil presets and thickness stencils and also lets you create and save your own. It is a good idea to create and save pencils with precise sizes and parameters when you draw for efficiency and consistency.</p> <p>A thickness stencil saves the thickness information across the length of the line. When drawing with a thickness stencil, the pressure sensitivity of the tablet is discarded. A thickness stencil can be used while drawing, or applied afterwards.</p> <p>You also have the possibility to apply different textures to your lines by either using the default presets or to import your own.</p> <p>You can export the pencil presets that you have created and import those that others have created. This is a good way for you and project collaborators to keep a consistent look for the project.</p>
	New Brush	Allows to create a new preset from the selected pencil line.
	Delete Brush	Deletes the currently selected preset.
	Rename Brush	Allows you to rename the currently selected preset.
	Small Thumbnail, Large Thumbnail, and Stroke View	Allows you to display the presets as small square thumbnails, large square thumbnails or a list of stroke preview.
	Use as Default Pencil Texture Palette	This option is available from the menu  button. Sets the currently selected pencil texture palette as the default pencil texture palette in your user preferences. The default pencil texture palette is added to every scene you create in Harmony. The palette is copied in your preferences, so it will be added to your new scenes in the exact state it is when you make it the default pencil texture palette.
	Reload Default Texture Palette	Imports the default pencil texture palette as a new pencil texture palette into your scene's palette list, and selects it as the current pencil texture palette.
	New Texture	Adds a new custom pencil texture to the list.

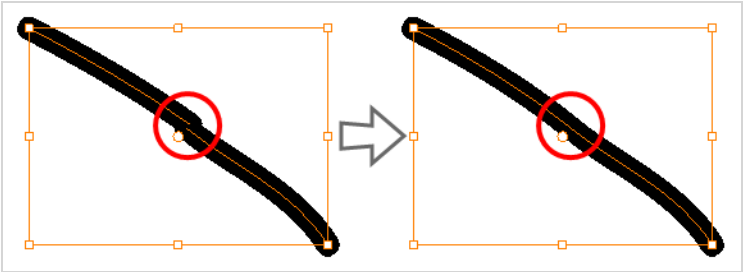
	Delete Texture	Deletes a texture preset from the list.
	Rename Texture	Renames the selected texture to keep the list organized.
	Presets	Harmony provides a variety of pencil texture presets and also lets you create and save your own.
	Pencil Texture Palette	Displays the colour palette assigned to hold the pencil textures. Use the Colour View menu to assign a new palette.
	Smooth Selection	<p>The Smooth operation lets you smooth out selected drawing strokes and remove extra points.</p>  <div style="border: 1px solid #add8e6; padding: 10px; margin-top: 10px;">  TIP You can also smooth the selection by selecting Drawing > Optimize > Smooth from the top menu or by pressing Alt + Shift + S. </div>
	Pump Pencil Pressure	<p>The Pump Pencil Pressure option is used to increase the line thickness of a selected area on a pencil line.</p> 
	Deflate Pencil Pressure	<p>The Deflate Pencil Pressure option is used to decrease the line thickness of a selected area on a pencil line.</p>

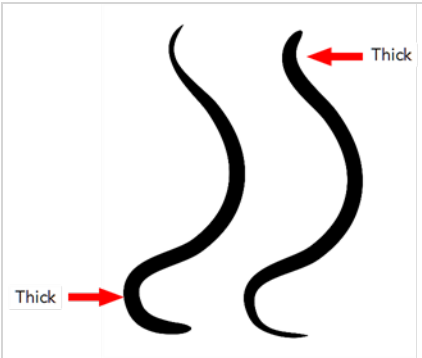
		
	<p>Merge Pencil Lines</p>	<p>Because pencil lines are defined by their centre lines, two pencil lines that brush against each other may not actually make a closed shape, even if they appear closed. If you select several pencil lines that are close together, you can use this button to close the small gaps between these pencil lines and make them into a single pencil line.</p> 
	<p>Reverse Pencil Thickness</p>	<p>The Reverse Pencil Thickness option inverts the thick and thin section on a selected pencil line. This option will take the thickest size on the line and apply it to the thinnest, and it will apply the thinnest to the thickest.</p> 

Perspective Tool Properties





The perspective tool allows you to deform artwork by creating a rectangular bounding box around it and allowing you to manipulate any of the four corners. The selected artwork will be deformed to fit the shape you make by simulating a perspective effect.



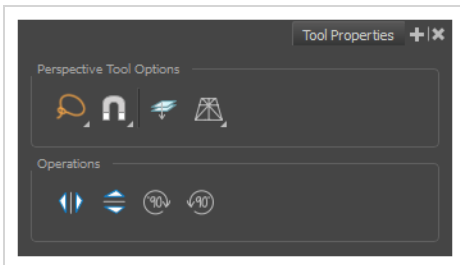



How to access the Perspective tool properties





1. In the Tools toolbar, select the Perspective  tool.

The tool's properties are displayed in the Tool Properties view.

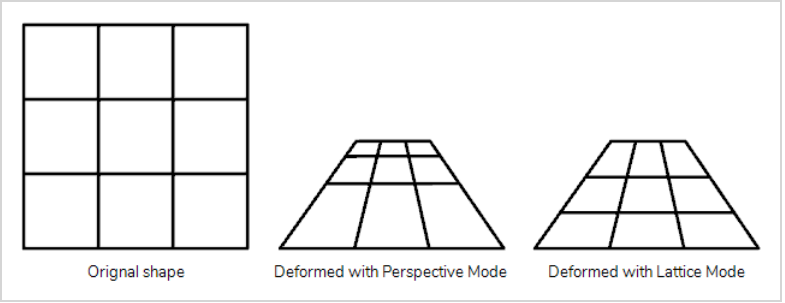

Icon	Tool Name	Description
Perspective Tool Options		
	Selection Mode	<p>Allows you to choose the method to visually select multiple elements:</p> <ul style="list-style-type: none"> •  Lasso: Allows you to select multiple elements by drawing an irregular closed shape around them with your mouse. •  Marquee: Allows you to select multiple elements by drawing a rectangle around them. This is faster, as you only need to drag your mouse from one corner of the rectangle to its opposite corner, but it may not be as precise as you want. <div style="border: 1px solid #0070C0; padding: 5px; margin-top: 10px;"> <p> TIP You can press and hold the Alt key to temporarily use the other selection mode.</p> </div>
	Snapping	<p>Allows you to enable or disable snapping for this tool and all other animation and drawing tools that support snapping, as well as to select which types of snapping are enabled.</p> <p>If you double-click or long-click on this button, it will open a pop-up menu in which you can toggle different snapping modes. You can also</p>

Icon	Tool Name	Description
		<p>click on this button to toggle it off, which will disable all snapping modes, and click on it again and toggle it on to re-enable the snapping modes which were previously enabled.</p> <p>This tool supports the following snapping modes:</p> <ul style="list-style-type: none"> • Snap to Contour: While moving the selection or one of its control points, it will snap against the nearby points and contours of your artwork, allowing you to snap parts of your artwork together. • Snap to Alignment Guides: While moving the selection or one of its control points, it will snap against nearby alignment guides. • Snap and Align: When enabled, while moving a selection, the rectangular bounding box of the selection will snap to the rectangular bounding box of any other drawing stroke in the drawing, allowing you to align drawing strokes laterally. • Snap to Grid: While moving the selection, the mouse cursor will snap against the intersecting points of the grid. <div data-bbox="735 968 1429 1142" style="border: 1px solid #add8e6; padding: 10px;">  <p>TIP To display the grid, select View > Grid > Show Grid from the top menu or press Ctrl + !.</p> </div>
	<p>Apply to Line and Colour Art</p>	<p>Allows you to perform drawing operations on both the Line Art and Colour Art layers of your drawing simultaneously.</p> <div data-bbox="656 1295 1429 1465" style="border: 1px solid #90ee90; padding: 10px;">  <p>NOTE If you have Overlay and Underlay Art layers enabled, they will also be affected when this option is enabled.</p> </div>
	<p>Deformation Mode</p>	<p>Allows you to select between one of the two following deformation modes:</p> <ul style="list-style-type: none"> •  Perspective: Deforms the selection by simulating a perspective effect. •  Lattice: Deforms the selection by simply making the artwork fit the bounding box, without applying a perspective effect. <p>The difference between both modes becomes easier to understand if you apply a transformation to a drawing of a grid to make it look like it's laid down on a surface:</p>

Icon	Tool Name	Description
		 <p>Original shape Deformed with Perspective Mode Deformed with Lattice Mode</p>
Operations		
	Flip Horizontal	Flips the selection horizontally.
	Flip Vertical	Flips the selection vertically.
	Rotate 90 CW	Rotates the selection 90° clockwise.
	Rotate 90 CCW	Rotates the selection 90° counterclockwise.

Polyline Tool Properties

The Polyline tool allows you to draw complex lines or shapes by defining each point and their Bezier handles one by one.

How to access the Polyline tool properties

1. In the Tools toolbar, select the Polyline  tool.

The tool's properties are displayed in the Tool Properties view.

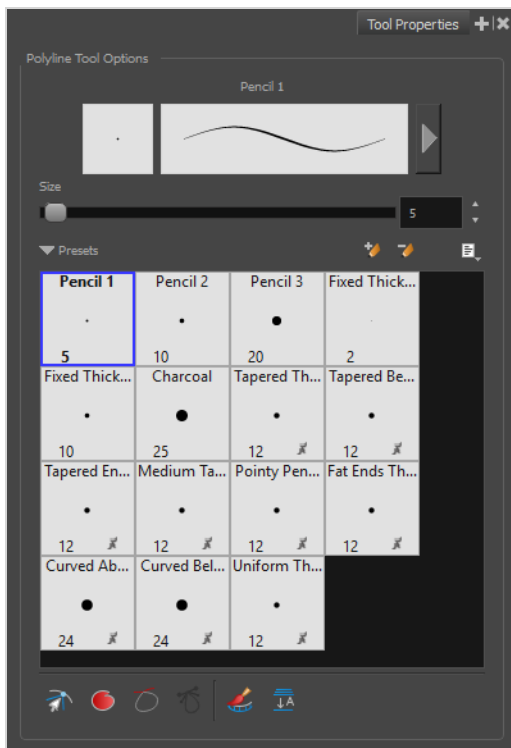



Pencil Properties

Just like other shape tools, this tool creates pencil lines. Hence, its tool properties are similar to the ones of the Pencil tool and it can be used with pencil presets.

Icon	Property	Description
	Preview Area	<p>The Preview area lets you see a preview of the stroke your drawing tool will make.</p> 





	<p>Pencil Properties Dialog</p>	<p>The arrow button right of the preview area opens the Pencil Properties dialog.</p>  <p>While the Tool Properties view only gives you access to the pencil size, a list of pencil presets and other drawing options, the Pencil Properties dialog gives you access to all the available options for your pencil's shape and texture. For more information on the Pencil Properties dialog, see the Polyline Tool Properties section below.</p>
	<p>Size</p>	<p>Defines the width of the pencil line used to draw the shape.</p>





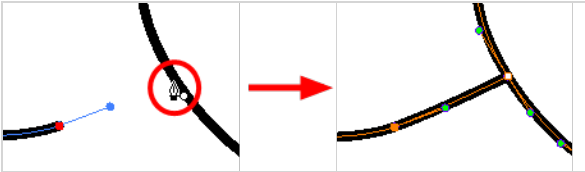



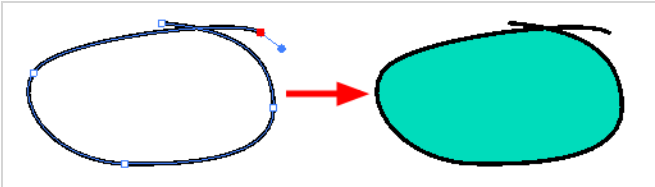

Pencil Presets

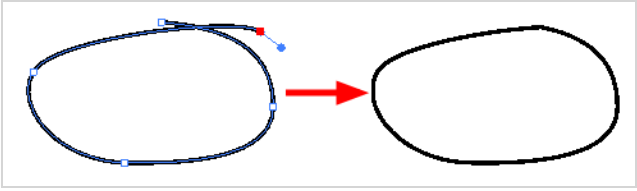

Icon	Property	Description
	<p>Presets list</p>	<p>Harmony provides a variety of presets and also lets you create and save your own. It is a good idea to create and save pencils with precise sizes and parameters when you draw and design for efficiency and consistency.</p> <p>All tools using pencil lines share the same preset list. Therefore, the Polyline, Line, Rectangle, Ellipse, and Pencil tools share the same preset list.</p>
	<p>New Preset</p>	<p>Creates a new preset based on the current tool properties.</p>
	<p>Delete Preset</p>	<p>Deletes the currently selected preset.</p>
	<p>Presets Menu</p>	<p>Gives access to more options for managing presets.</p>
	<p>Rename Brush</p>	<p>Allows you to rename the currently selected preset.</p>
	<p>Import Brushes</p>	<p>Allows you to import brush presets exported from Harmony.</p>
	<p>Export Brushes</p>	<p>Allows you to export your brush presets into an .xml file.</p>
	<p>Small Thumbnail</p>	<p>Displays presets in a grid of small thumbnails with a preview of their tip.</p>

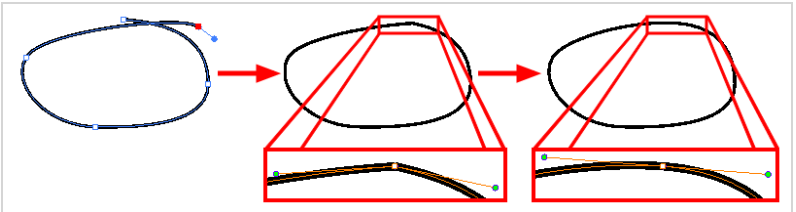
	Large Thumbnail	Displays presets in a grid of big thumbnails, with their name and a preview of their tip.
	Stroke View	Displays presets in a list, with their name and a preview of a stroke done with each preset.

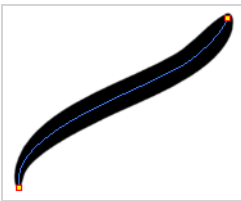
Drawing Options

Icon	Property	Description
	Snap to Contour	<p>When this option is enabled, clicking close to a contour in your drawing will add the point to that contour. The line you are building will be linked to that contour.</p>  <p>If this option is disabled, attempting to click on existing contours will always create a point very close to that contour, but not exactly on it. Therefore, it is necessary to enable this mode if you want to create lines that branch from into existing contours in your drawing.</p> <div style="border: 1px solid green; padding: 10px; margin-top: 10px;"> <p> NOTE</p> <p>If you draw a line with the Line tool and make its tip snap to a contour or another control point in your artwork, they will be locked together. You can then manipulate both simultaneously using the  Contour Editor tool. You can also separate two drawing strokes that have been snapped together by selecting one of them with the  Select tool and moving it away.</p> </div>
	Auto Fill	<p>When enabled, drawing a closed shape will automatically fill it with the currently selected Paint colour.</p> 

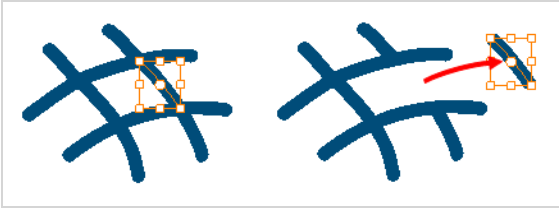
		<div style="border: 1px solid #add8e6; padding: 10px;">  <p>TIP</p> <p>By default the pencil line and its fill will be the same colour. To select different colours for the line and its fill, do the following:</p> <ol style="list-style-type: none"> 1. In the Colour view, click the  Unlock Three Colours button. 2. Click on the  Set Current Pencil Colour swatch. Then, in the colour list, select the desired colour swatch for your outline. 3. Click on the  Set Current Paint Colour swatch. Then, in the colour list, select the desired colour swatch for the fill. </div>
	<p>Trim Extra Lines</p>	<p>When enabled, drawing a closed shape will automatically remove the outstanding lines.</p> 
	<p>Align Handles After Trim</p>	<p>When the Trim Extra Lines option is enabled, enable this option to make the point where the beginning and end of the stroke meet into a smooth curve rather than a hard corner.</p> 
	<p>Automatically Create Colour Art</p>	<p>As you draw in the Line Art layer, the Automatically Create Colour Art option instantly creates the corresponding strokes in the Colour Art layer.</p> 
	<p>Auto-Flatten Mode</p>	<p>By default, when drawing on a vector layer, each new stroke is created as a separate drawing object, which can be edited independently from other</p>

		<p>parts of the artwork. When enabled, the Auto-Flatten option automatically merges strokes into existing artwork.</p>  <div data-bbox="649 520 1429 756" style="border: 1px solid green; padding: 5px;"> <p> NOTE</p> <p>Using the Select tool, you can use select and remove a segment of flattened pencil lines. Overlapping pencil lines drawn with the Auto-Flatten mode are essentially cut into segments by the overlap and can be treated as individual lines.</p> </div>
--	--	---

Pencil Properties Dialog

The Polyline tool draws the same type of line as the Pencil tool. Hence, you can configure the Polyline tool's lines using the Pencil Properties dialog, which you can open by clicking on the arrow button right of the stroke display area in the Tool Properties view.



Size and Smoothness Tab

The Size and Smoothness tab allows you to select your pencil's size, its smoothing parameters as well as the shape of its tips and corners.

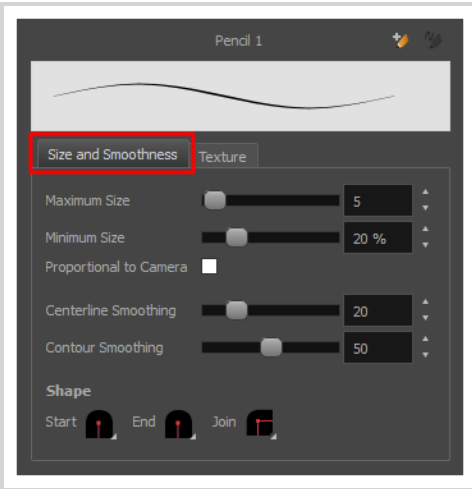
	
---	--

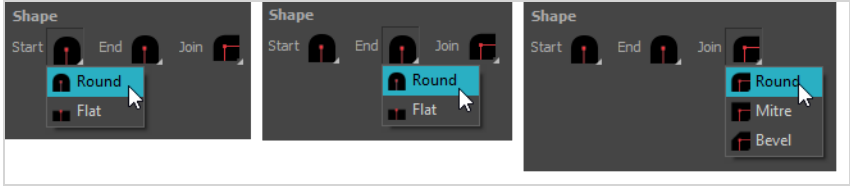
Property	Description
Maximum Size	Defines the maximum size of the pencil line. If the tool is used with a pressure sensitive pen tablet, the width of the stroke will vary between its maximum size and minimum size depending on the amount of pressure used. If used with a mouse, the width of the stroke will always be its maximum size.
Minimum Size	Defines the minimum size of your stroke as a percentage of the maximum size. If you do not have pressure sensitivity from a pen table, the minimum size value will be ignored.
Proportional to Camera	If you check this option, the size of the pencil will be adjusted to the position of the camera on the z-axis. This means that if the camera is zoomed in on the scene, the pencil will be proportionally smaller so that it appears the same size in the rendered image. Likewise, if the camera is zoomed out, the pencil will be proportionally bigger.
Centerline Smoothing	Defines the amount of smoothing Harmony should perform on the central line of the pencil stroke. A higher setting will prevent your line from being shaky and will reduce the amount of control points it has, making it easier to tweak, but is liable to reduce drawing precision and turn sharp angles into curves.
Contour Smoothing	<p>Defines the amount of smoothing Harmony should perform on the outer contour of the pencil stroke.</p> <p>A pencil line is defined by its centreline and its variations in thickness, rather than its apparent shape. When drawing a pencil line with a mouse, its thickness is uniform. Therefore, its outer contour does not have any control point, except at its extremities, and no smoothing is required for its contour.</p> <p>However, when drawing a pencil line with a pressure sensitive tablet, its contour will have control points and Bezier curves to define the line's variations in thickness, and thus smoothing must be performed on its contour. An increased contour smoothing will reduce the amount of control points on the line's thickness and smoothen its curves, but may affect the precision of the variations in line thickness.</p>
Shape	<p>You can adjust the start, end, and join style of a pencil line.</p>  <ul style="list-style-type: none"> • Start: Lets you select the style of the start tip, which is the first tip you drew. You can choose between Round or Flat style. • End: Lets you select the style of the end tip, which is the last tip you drew.

Property	Description
	<p>You can choose between Round or Flat style.</p> <ul style="list-style-type: none"> • Join: Lets you select the joint style. The joints are where the line curves abruptly. You could also define the Join style as the corner style. You can choose between Round, Mitre and Bevel style.





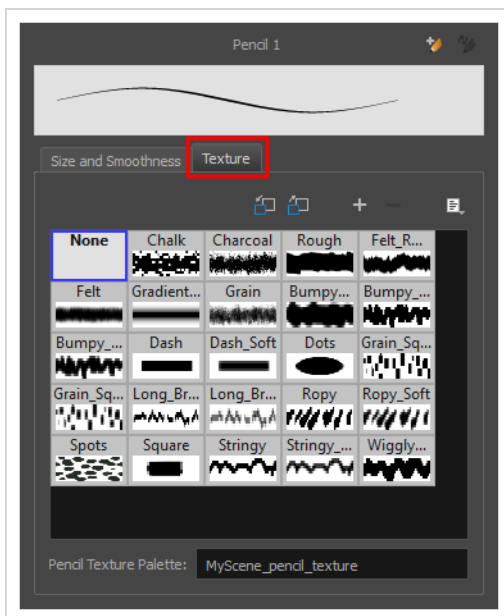

Texture Tab

In the Pencil Properties view, the Texture tab allows you to select a pencil texture from the currently selected pencil texture palette to use with the Pencil tool. You can also add, remove or rename textures, save the current pencil texture palette as the default one, or import the pencil texture palette into your scene.

The pencil texture palette used in the Texture tab of the Pencil Properties dialog is the one selected in the Colour view. You can select a pencil texture palette by selecting it from the pencil texture palette list in the Colour view—see [Colour View on page 1220](#).



Icon	Property	Description
	Use as Default Pencil Texture Palette	This option is available from the menu  button. Sets the currently selected pencil texture palette as the default pencil texture palette in your user preferences. The default pencil texture palette is added to every scene you create in Harmony. The palette is copied in your preferences, so it will be added to your new scenes in the exact state it is when you make it the default pencil texture palette.

Icon	Property	Description
	Reload Default Texture Palette	Imports the default pencil texture palette as a new pencil texture palette into your scene's palette list, and selects it as the current pencil texture palette.
	New Texture	Allows you to import an image file into a new pencil texture swatch in the current pencil texture palette. The pencil texture's effect on your pencil line will be based on the image's transparency channel, and will follow your pencil lines on its horizontal axis. This option is also available from the menu  button.
	Delete Texture	Deletes a pencil texture swatch from the current pencil texture palette. This option is also available from the menu  button.
	Rename Texture	Renames the selected pencil texture swatch in the current pencil texture palette. This option is also available from the menu  button.
	Pencil Texture Display	Displays the pencil textures in the current pencil texture palette and allows you to select one to use with the Pencil tool.
	Pencil Texture Palette	Displays the name of the currently selected pencil texture palette, for reference. To select a different pencil texture palette, you must select it in the Colour view—see Colour View on page 1220 .

**NOTE**

L

Rectangle Tool Properties

The Rectangle tool allows you to quickly draw a rectangle or a square.

How to access the Rectangle tool properties

1. In the Tools toolbar, select the Rectangle  tool.

The tool's properties are displayed in the Tool Properties view.

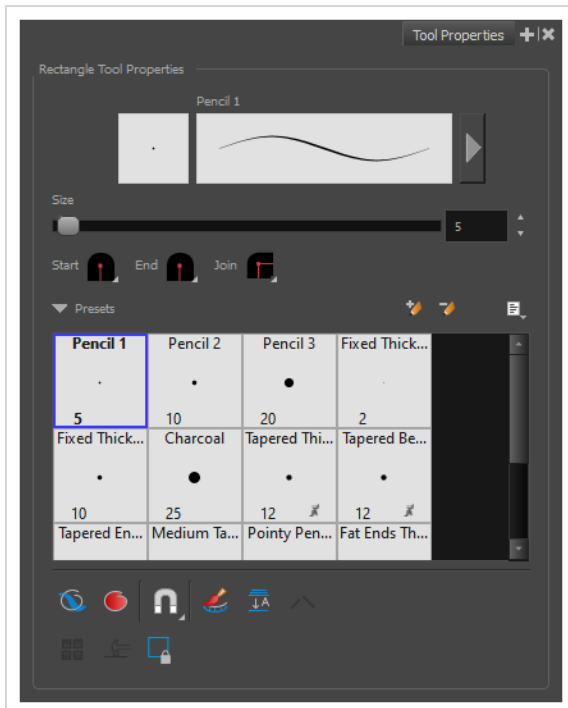

Pencil Properties

Just like other shape tools, this tool creates pencil lines. Hence, its tool properties are similar to the ones of the Pencil tool and it can be used with pencil presets.



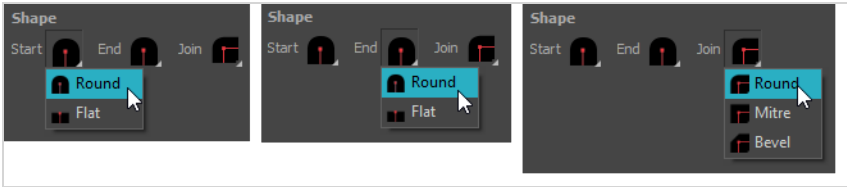



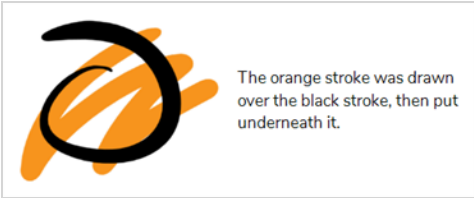

Property	Description
Preview Area	<p>The Preview area lets you see a preview of the stroke your drawing tool will make.</p> 
Pencil Properties Dialog	<p>The arrow button right of the preview area opens the Pencil Properties dialog.</p>



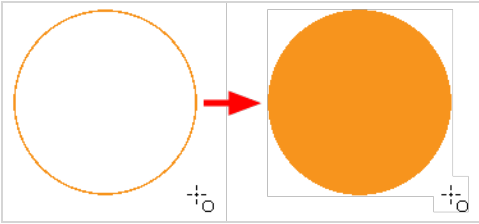



Property	Description
	 <p>While the Tool Properties view only gives you access to a few of the pencil properties, a list of pencil presets and other drawing options, the Pencil Properties dialog gives you access to all the available options for your pencil's shape and texture. For more information on the Pencil Properties dialog, see the Pencil Properties Dialog on page 1093 section below.</p>
Size	<p>Defines the width of the pencil line used to draw the shape.</p>
Shape	<p>You can adjust the start, end, and join style of a pencil line.</p>  <ul style="list-style-type: none"> • Start: Lets you select the style of the start tip, which is the first tip you drew. You can choose between Round or Flat style. • End: Lets you select the style of the end tip, which is the last tip you drew. You can choose between Round or Flat style. • Join: Lets you select the joint style. The joints are where the line curves abruptly. You could also define the Join style as the corner style. You can choose between Round, Mitre and Bevel style.

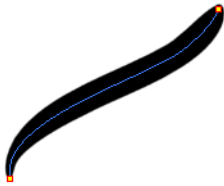

Drawing Options

These options affect the way your shape is added to your artwork.

Icon	Property	Description
	<p>Draw Behind</p>	<p>When enabled, your brush strokes will appear behind the existing artwork.</p>  <p>The orange stroke was drawn over the black stroke, then put underneath it.</p>



Icon	Property	Description
		<div data-bbox="634 283 1430 453" style="border: 1px solid #c8e6c9; padding: 10px;">  NOTE Your brush stroke will temporarily appear over your artwork as you draw it, until you release the mouse cursor or tablet pen. </div>
	Auto Fill	<p>When enabled, the shape you draw is automatically filled with the selected colour. By default, drawing a shape only creates its outlines.</p> <div data-bbox="634 600 1110 821" style="text-align: center;">  </div> <div data-bbox="634 856 1430 1312" style="border: 1px solid #bbdefb; padding: 10px;">  TIP By default the pencil line and its fill will be the same colour. To select different colours for the line and its fill, do the following: <ol style="list-style-type: none"> 1. In the Colour view, click the  Unlock Three Colours button. 2. Click on the  Set Current Pencil Colour swatch. Then, in the colour list, select the desired colour swatch for your outline. 3. Click on the  Set Current Paint Colour swatch. Then, in the colour list, select the desired colour swatch for the fill. </div>
	Snapping	<p>Allows you to enable or disable snapping for this tool and all other animation and drawing tools that support snapping, as well as to select which types of snapping are enabled.</p> <p>If you double-click or long-click on this button, it will open a pop-up menu in which you can toggle different snapping modes. You can also click on this button to toggle it off, which will disable all snapping modes, and click on it again and toggle it on to re-enable the snapping modes which were previously enabled.</p> <p>This tool supports the following snapping modes:</p> <ul style="list-style-type: none"> • Snap to Contour: When enabled, while you're drawing, the mouse cursor will snap to the nearby contours of the artwork in your drawing. • Snap to Alignment Guides: While drawing, the drawing tool will

Icon	Property	Description
		<p>snap against nearby alignment guides.</p> <ul style="list-style-type: none"> • Snap and Align: When enabled, while you're drawing, the mouse cursor will automatically align to the rectangular bounding boxes of other strokes and shapes in your drawing. • When enabled, while you're drawing, the mouse cursor will snap against the intersecting points of the grid. <div data-bbox="712 558 1430 730" style="border: 1px solid #add8e6; padding: 10px; margin-top: 10px;"> <p> TIP To display the grid, select View > Grid > Show Grid from the top menu or press Ctrl + '</p> </div>
	<p>Automatically Create Colour Art</p>	<p>As you draw in the Line Art layer, the Automatically Create Colour Art option instantly creates the corresponding strokes in the Colour Art layer.</p> <div data-bbox="634 879 873 1075" style="border: 1px solid #ccc; padding: 5px; margin-top: 10px;">  </div>
	<p>Auto Flatten Mode</p>	<p>By default, when drawing on a vector layer, each new stroke is created as a separate drawing object, which can be edited independently from other parts of the artwork. When enabled, the Auto-Flatten option automatically merges strokes into existing artwork.</p> <div data-bbox="634 1304 1190 1509" style="border: 1px solid #ccc; padding: 5px; margin-top: 10px;">  </div> <div data-bbox="634 1545 1430 1780" style="border: 1px solid #90ee90; padding: 10px; margin-top: 10px;"> <p> NOTE Using the Select tool, you can use select and remove a segment of flattened pencil lines. Overlapping pencil lines drawn with the Auto-Flatten mode are essentially cut into segments by the overlap and can be treated as individual lines.</p> </div>
	<p>Use Stored Colour Gradient</p>	<p>The Use Stored Colour Gradient option can be used when painting with a gradient colour to always position the gradient in the same way it was</p>

Icon	Property	Description
		stored, making it consistent across brush strokes. You can store a gradient by selecting a zone painted with a gradient with the Select tool, then clicking on Store Colour Gradient  in the Tool Properties view.
	Draw Square	<p>When enabled, the rectangle tool will always draw a rectangle of equal width and height, making it a perfect square.</p> <div style="border: 1px solid #add8e6; padding: 10px; margin-top: 10px;"> <p> TIP You can also draw a perfect square by holding the Shift key while drawing.</p> </div>

Pencil Presets

These options allow you to select, create and manage pencil presets.

Icon	Property	Description
	Presets list	<p>Harmony provides a variety of pencil presets and thickness stencils and also lets you create and save your own. It is a good idea to create and save pencils with precise sizes and parameters when you draw for efficiency and consistency.</p> <p>A thickness stencil saves the thickness information across the length of the line. When drawing with a thickness stencil, the pressure sensitivity of the tablet is discarded. A thickness stencil can be used while drawing, or applied afterwards.</p> <p>You also have the possibility to apply different textures to your lines by either using the default presets or to import your own.</p> <p>You can export the pencil presets that you have created and import those that others have created. This is a good way for you and project collaborators to keep a consistent look for the project.</p>
	New Brush Preset	Creates a new preset based on the current tool properties.
	Delete Brush Preset	Deletes the currently selected preset.
	Brush Presets Menu	<p>Open a menu that contains the following options:</p> <ul style="list-style-type: none"> • New Brush Preset: Creates a new preset based on the current tool

Icon	Property	Description
		<p>properties.</p> <ul style="list-style-type: none"> • Delete Brush: Deletes the currently selected preset. • Rename Brush: Allows you to rename the currently selected preset. • Import Brushes: Allows you to import brush presets exported from Harmony. • Export Brushes: Allows you to export your brush presets into an <code>.xml</code> file. • Small Thumbnail: Displays presets in a grid of small thumbnails with a preview of their tip. • Large Thumbnail: Displays presets in a grid of big thumbnails, with their name and a preview of their tip. • Stroke View: Displays presets in a list, with their name and a preview of a stroke done with each preset.

Pencil Properties Dialog

The Rectangle tool draws the same type of line as the Pencil tool. Hence, you can configure the Rectangle tool's lines using the Pencil Properties dialog, which you can open by clicking on the arrow button right of the stroke display area in the Tool Properties view.

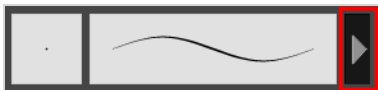

Size and Smoothness Tab

The Size and Smoothness tab allows you to select your pencil's size, its smoothing parameters as well as the shape of its tips and corners.

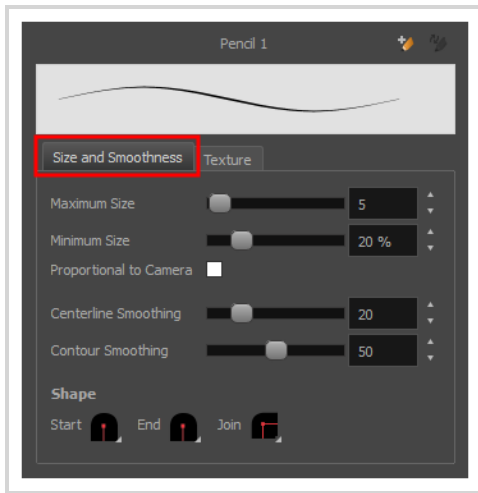

Property	Description
Maximum Size	Defines the maximum size of the pencil line. If the tool is used with a pressure sensitive pen tablet, the width of the stroke will vary between its maximum size and minimum size depending on the amount of pressure used. If used with a mouse, the width of the stroke will always be its maximum size.
Minimum Size	Defines the minimum size of your stroke as a percentage of the maximum size. If you do not have pressure sensitivity from a pen table, the minimum size value will be ignored.
Proportional to Camera	If you check this option, the size of the pencil will be adjusted to the position of the camera on the z-axis. This means that if the camera is zoomed in on the scene, the pencil will be proportionally smaller so that it appears the same size in the rendered image. Likewise, if the camera is zoomed out, the pencil will be proportionally bigger.
Centerline Smoothing	Defines the amount of smoothing Harmony should perform on the central line of the pencil stroke. A higher setting will prevent your line from being shaky and will reduce the amount of control points it has, making it easier to tweak, but is liable to reduce drawing precision and turn sharp angles into curves.
Contour Smoothing	<p>Defines the amount of smoothing Harmony should perform on the outer contour of the pencil stroke.</p> <p>A pencil line is defined by its centreline and its variations in thickness, rather than its apparent shape. When drawing a pencil line with a mouse, its thickness is uniform. Therefore, its outer contour does not have any control point, except at its extremities, and no smoothing is required for its contour.</p> <p>However, when drawing a pencil line with a pressure sensitive tablet, its contour will have control points and Bezier curves to define the line's variations in thickness, and</p>

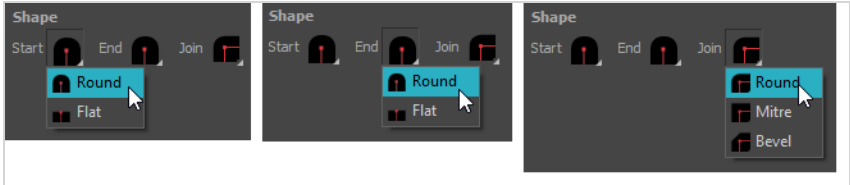
Property	Description
	<p>thus smoothing must be performed on its contour. An increased contour smoothing will reduce the amount of control points on the line's thickness and smoothen its curves, but may affect the precision of the variations in line thickness.</p>
Shape	<p>You can adjust the start, end, and join style of a pencil line.</p>  <ul style="list-style-type: none"> • Start: Lets you select the style of the start tip, which is the first tip you drew. You can choose between Round or Flat style. • End: Lets you select the style of the end tip, which is the last tip you drew. You can choose between Round or Flat style. • Join: Lets you select the joint style. The joints are where the line curves abruptly. You could also define the Join style as the corner style. You can choose between Round, Mitre and Bevel style.

Texture Tab

In the Pencil Properties view, the Texture tab allows you to select a pencil texture from the currently selected pencil texture palette to use with the Pencil tool. You can also add, remove or rename textures, save the current pencil texture palette as the default one, or import the pencil texture palette into your scene.

The pencil texture palette used in the Texture tab of the Pencil Properties dialog is the one selected in the Colour view. You can select a pencil texture palette by selecting it from the pencil texture palette list in the Colour view—see [Colour View on page 1220](#).

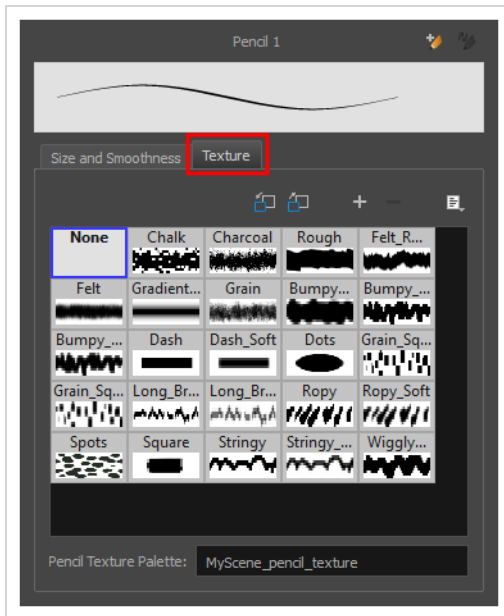

Icon	Property	Description
	Use as Default Pencil Texture Palette	This option is available from the menu button. Sets the currently selected pencil texture palette as the default pencil texture palette in your user preferences. The default pencil texture palette is added to every scene you create in Harmony. The palette is copied in your preferences, so it will be added to your new scenes in the exact state it is when you make it the default pencil texture palette.
	Reload Default Texture Palette	Imports the default pencil texture palette as a new pencil texture palette into your scene's palette list, and selects it as the current pencil texture palette.
	New Texture	Allows you to import an image file into a new pencil texture swatch in the current pencil texture palette. The pencil texture's effect on your pencil line will be based on the image's transparency channel, and will follow your pencil lines on its horizontal axis. This option is also available from the menu button.
	Delete Texture	Deletes a pencil texture swatch from the current pencil texture palette. This option is also available from the menu button.
	Rename Texture	Renames the selected pencil texture swatch in the current pencil texture palette. This option is also available from the menu button.
	Pencil Texture Display	Displays the pencil textures in the current pencil texture palette and allows

Icon	Property	Description
		you to select one to use with the Pencil tool.
	Pencil Texture Palette	Displays the name of the currently selected pencil texture palette, for reference. To select a different pencil texture palette, you must select it in the Colour view—see Colour View on page 1220 .

Reposition All Drawings Tool Properties

When you use the Reposition All Drawings tool, its properties and options appear in the Tool Properties view.

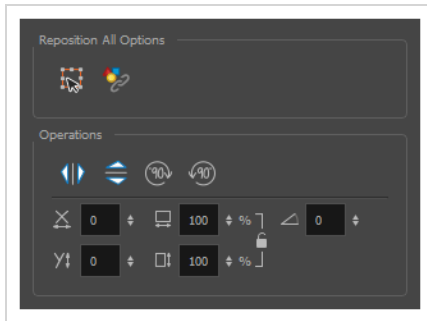

Tool Options

Icon	Option	Description
	Easy Drag	When enabled, you can drag the selection by clicking anywhere inside its bounding box. By default, you must click on the artwork in the selection to be able to drag it.
	Apply to Synced Drawing Layers	If the currently selected layer is synced with another layer, the tool will work on both the current layer and its synced layer.

Operations

Icon	Option	Description
	Flip Horizontal	Flips the current selection horizontally.
	Flip Vertical	Flips the current selection vertically.
	Rotate 90 Degrees CW	Rotates the current selection 90 degrees clockwise.
	Rotate 90 Degrees CCW	Rotates the current selection 90 degrees counter-clockwise.
	Offset X and Y	Use the Offset X and Offset Y operation fields to enter specific values and precisely reposition the selected shape.

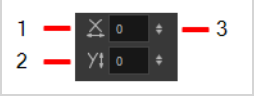
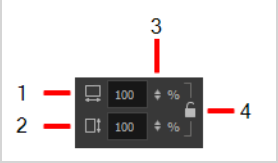
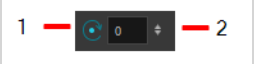
Icon	Option	Description
		 <ol style="list-style-type: none"> X: Type a value in this field to reposition your selection along the X-axis. Y: Type a value in this field to reposition your selection along the Y-axis. Up/Down arrows: Use the up and down arrows to modify the value in the X or Y value field.
	<p>Width and Height</p>	<p>Use the Width and Height operation fields to enter specific values to resize the selected shape with precision.</p>  <ol style="list-style-type: none"> Width: Type a value in this field to resize the width of your selection. Height: Type a value in this field to resize the height of your selection. Up/Down arrows: Use the up and down arrows to modify the value in the Width or Height fields. Lock icon: Click the lock icon to lock or unlock the ratio between the Width and Height values.
	<p>Angle</p>	<p>The Angle operation lets you to enter specific values and accurately rotate the selected shape.</p>  <ol style="list-style-type: none"> Angle: Type a degree value in this field to rotate your selection. Up/Down arrows: Use the up and down arrows to modify the value in the Angle value field.

Rigging Tool Properties



In the Tool Properties view, you can customize not only the behaviour of the tool but also the settings of the deformer that you will create.



Mode



Button	Name	Description
	Automatic Mode	Sets the Rigging tool to automatically create a Bone or Curve deformer, corresponding to the movement of the cursor in the Camera view.
	Bone Mode	Sets the Rigging tool to create Bone deformations.
	Curve Mode	Sets the Rigging tool to create Curve deformations.
	Envelope Mode	Sets the Rigging tool to create Envelope deformations.
	Game Bone Mode	Sets the Rigging tool to create Game Bone deformations.
	Free Form Mode	Sets the Rigging too to create Free Form deformations.

Options

Button	Parameter	Description
	Show All Manipulators	Lets you immediately see the resting position in red (Setup) and the animated position in green.
	Show All Regions of Influence	Lets you visualize the area within which the art will be influenced by the deformation effect—see Rigging Tool Properties on page 1100.
	Automatically Create Group when Creating a New Deformation Rig	This option automatically creates a deformation group connected to the input port of the selected element. This group includes all the necessary deformation nodes you created.
	Bone	<p>Sets the zone of influence for newly created Bone deformation points:</p> <ul style="list-style-type: none"> • Zero Influence: The Zone of Influence does not exist. No deformation will happen. • Infinite Influence: This is the default option and is the most commonly used. The Zone of Influence has no boundary and covers the whole element to which the deformer is linked and its children, excluding areas that are already part of another elliptic or shaped Zone of Influence. The Infinite Influence zone will extend from the centre of your skeleton to infinity, working perpendicularly to the skeleton. • Elliptic Influence: The Zone of Influence boundary is defined by an elliptical shape; its size can be customized using the Bone, Articulation or Curve node properties or by using the Transform tool. The Elliptic Influence will most likely be used on a bitmap picture you want to deform. • Shaped Influence: The Zone of Influence boundary is defined by a shape which you can customize using the Transform tool. The Shaped Influence will most likely be used on a bitmap picture you want to deform.
	Influence Radius	For Bone deformations with an Elliptic Influence, this sets the size of the influence zone.
	Curve	<p>Sets the zone of influence for newly created Curve deformation points:</p> <ul style="list-style-type: none"> • Zero Influence: The Zone of Influence does not exist. No deformation will happen. • Infinite Influence: This is the default option and is the most

Button	Parameter	Description
		<p>commonly used. The Zone of Influence has no boundary and covers the whole element to which the deformer is linked and its children, excluding areas that are already part of another elliptic or shaped Zone of Influence. The Infinite Influence zone will extend from the centre of your skeleton to infinity, working perpendicularly to the skeleton.</p> <ul style="list-style-type: none"> • Elliptic Influence: The Zone of Influence boundary is defined by an elliptical shape; its size can be customized using the Bone, Articulation or Curve node properties or by using the Transform tool. The Elliptic Influence will most likely be used on a bitmap picture you want to deform. • Shaped Influence: The Zone of Influence boundary is defined by a shape which you can customize using the Transform tool. The Shaped Influence will most likely be used on a bitmap picture you want to deform.
	Influence Radius	For Curve deformations with an Elliptic Influence, this sets the size of the influence zone.

Operations

Button	Name	Description
	Convert Elliptic Zone of Influence to Shape	After you have created a deformation chain using Elliptic as the Zone of Influence type, you can select your deformer and click on this button to convert it to a Shaped type. Control points will appear around the shape making it easy to customize. You can also convert the Elliptic zone of influence to a shape. Select Animation > Deformation > Convert Elliptic Deformation ROI to Shape . This will create a much smaller initial zone of influence than if you were to convert it directly to a shape.
	Reset Deform (Reset Current Keyframe)	Copies the resting position of the deformation skeleton to the current frame.

Select Tool Properties

The Select tool lets you select strokes and apply basic transformations such as repositioning, rotating, scaling or skewing, using the different handles of the bounding box.

If you have text or pencil lines selected with the Select tool, their properties will display in the Tool Properties view, allowing you to make changes to your selection.





How to access the Select tool properties

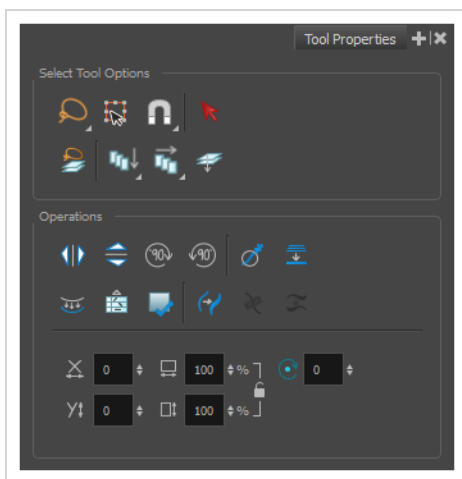

1. In the Tools toolbar, select either the Select  tool.







The tool's properties are displayed in the Tool Properties view.







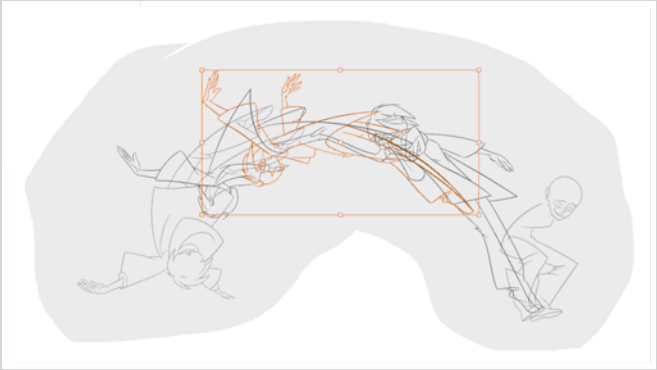

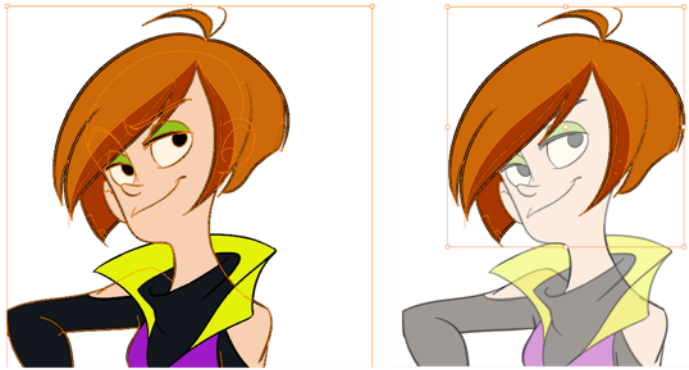

Tool Options

Icon	Property	Description
	Selection Mode	<p>Allows you to choose the method to visually select multiple elements:</p> <ul style="list-style-type: none"> •  Lasso: Allows you to select multiple elements by drawing an irregular closed shape around them with your mouse. •  Marquee: Allows you to select multiple elements by drawing a rectangle around them. This is faster, as you only need to drag your mouse from one corner of the rectangle to its opposite corner, but it may not be as precise as you want. <div style="border: 1px solid #add8e6; padding: 10px; margin-top: 10px;"> <p> TIP You can press and hold the Alt key to temporarily use the other selection mode.</p> </div>



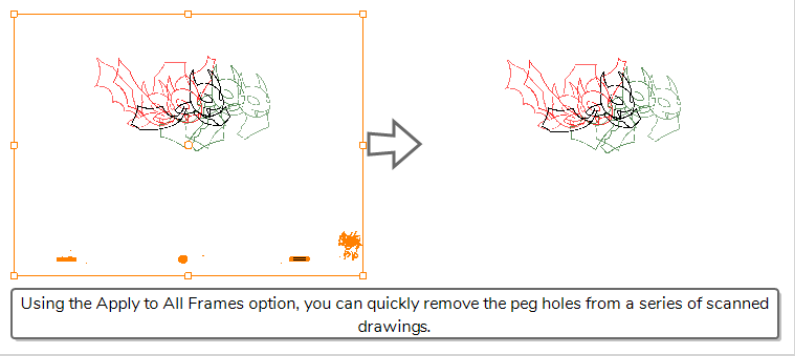

Icon	Property	Description
	Easy Drag	<p>When enabled, you can drag the selection by clicking anywhere inside its bounding box. By default, you must click on the artwork in the selection to be able to drag it.</p>
	Snapping	<p>Allows you to enable or disable snapping for this tool and all other animation and drawing tools that support snapping, as well as to select which types of snapping are enabled.</p> <p>If you double-click or long-click on this button, it will open a pop-up menu in which you can toggle different snapping modes. You can also click on this button to toggle it off, which will disable all snapping modes, and click on it again and toggle it on to re-enable the snapping modes which were previously enabled.</p> <p>This tool supports the following snapping modes:</p> <ul style="list-style-type: none"> • Snap to Contour: While moving the selection or one of its control points, it will snap against the nearby points and contours of your artwork, allowing you to snap parts of your artwork together. • Snap to Alignment Guides: While moving the selection or one of its control points, it will snap against nearby alignment guides. • Snap and Align: While moving the selection, the rectangular bounding box of the selection will align with the rectangular bounding boxes of other strokes and shapes in your artwork. If you move one of your selection's control points, it will also align with the bounding boxes of other strokes and shapes in your artwork. <div data-bbox="719 1268 1101 1619" data-label="Image"> </div> <ul style="list-style-type: none"> • Snap to Grid: While moving the selection, the mouse cursor will snap against the intersecting points of the grid. <div data-bbox="719 1745 1430 1919" data-label="Complex-Block"> <p> TIP To display the grid, select View > Grid > Show Grid from the top menu or press Ctrl + '</p> </div>







Icon	Property	Description
	<p>Select by Colour</p>	<p>When enabled, clicking on a coloured zone in your artwork will instantly select all the zones that are filled with the same colour.</p>  <div data-bbox="641 804 1430 1041" style="border: 1px solid green; padding: 5px;"> <p> NOTE</p> <p>Only the zones painted with the same colour swatch in your palette will be selected. If another zone is coloured with the exact same colour, but not the same colour swatch, it will not be selected.</p> </div>
	<p>Permanent Selection</p>	<p>Allows you maintain a selection while editing multiple drawings. Once this option is enabled, the selection zone made using the Select tool will remain as you navigate through drawings of the same layer and drawings from other drawing layers.</p> 
	<p>Apply to Visible Drawing Layers</p>	<p>This option allows you to select which layers the tool should affect. It can be toggled on or off. When toggled on, it has two different modes. You can select a mode by clicking and holding on the button.</p> <ul style="list-style-type: none"> • Off: When this button is toggled off, the tool only works on the currently selected layers. If several layers are selected, the tool will

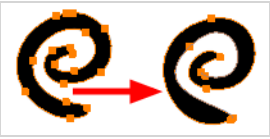

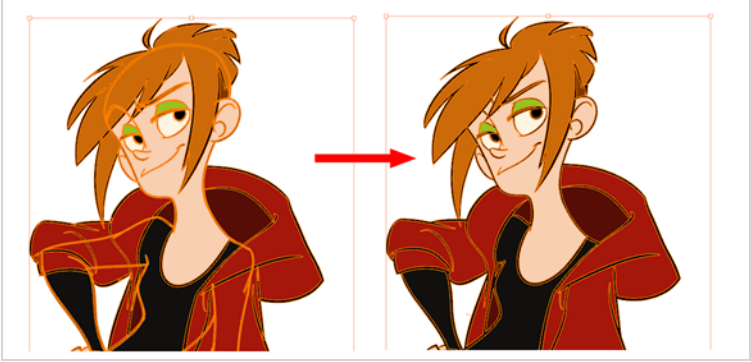



Icon	Property	Description
		<p>work on all these layers simultaneously.</p> <ul style="list-style-type: none">  Apply to Visible Drawing Layers: The tool will work on all the visible layers in the Camera view.  Apply to Synced Drawing Layers: If the currently selected layer is synced with another layer, the tool will work on both the current layer and its synced layer. <div data-bbox="643 558 1386 947" style="border: 1px solid #ccc; padding: 5px; margin: 10px 0;">  </div> <div data-bbox="643 984 1430 1121" style="border: 1px solid #ccc; padding: 5px; margin: 10px 0; background-color: #e0f2f1;"> <p> NOTE This option only works in the Camera view.</p> </div>
	Apply to All Frames	<p>This option allows you to determine which drawings in the current layer the tool should affect. It can be toggled on or off. When toggled on, it has two different modes. You can select a mode by clicking and holding on the button.</p> <ul style="list-style-type: none"> Off: When this button is toggled off, the tool only works on the drawing in the current frame.  Apply to All Frames: The tool will work on every exposed drawing in the selected layer simultaneously.  Apply to Onion Skin Range: The tool will work on every drawing displayed in the Onion Skin. Onion Skin must be enabled for this option to work.



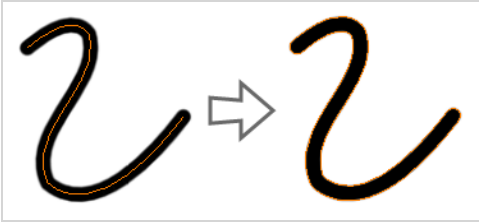

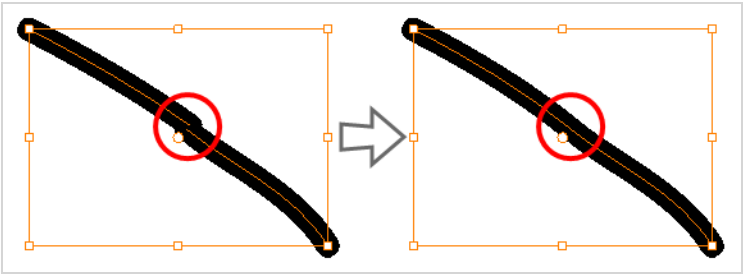
Icon	Property	Description
		
	<p>Apply to Line and Colour Art</p>	<p>Allows you to perform drawing operations on both the Line Art and Colour Art layers of your drawing simultaneously.</p> <div style="border: 1px solid green; padding: 5px; margin-top: 10px;"> <p> NOTE If you have Overlay and Underlay Art layers enabled, they will also be affected when this option is enabled.</p> </div>

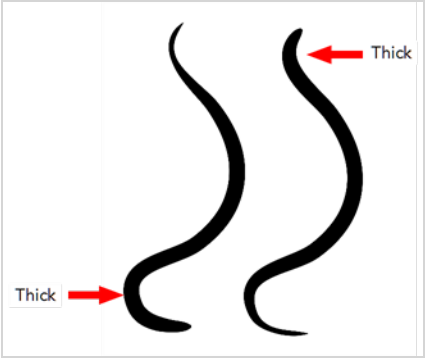
Operations

Icon	Property	Description
	<p>Flip Horizontal</p>	<p>Flips the current selection horizontally.</p>
	<p>Flip Vertical</p>	<p>Flips the current selection vertically.</p>
	<p>Rotate 90 Degrees CW</p>	<p>Rotates the current selection 90 degrees clockwise.</p>
	<p>Rotate 90 Degrees CCW</p>	<p>Rotates the current selection 90 degrees counter-clockwise.</p>
	<p>Smooth</p>	<p>Smooth out selected drawing strokes and remove extra points.</p> 

Icon	Property	Description
	Flatten	<p>Merges drawing objects and brush strokes into a single layer. If you draw new lines to fix a drawing or line with many brush strokes, it can be useful to flatten them all into a single shape. By default, lines are drawn one on top of each other. If you intend to repaint the lines or modify their shape, it will be easier if they are flattened.</p> 
	Create Colour Art from Line Art	<p>Lets you use the outline you traced on one of the four embedded layers (line art, colour art, overlay, underlay) and create invisible strokes to paint your drawings on separate layers. This provides more inking and painting flexibility.</p> <p>You can also configure this option to create the invisible strokes on any of the four embedded layers.</p>
	Distribute to Layers	<p>The Distribute to Layers option is used to separate the selected art strokes and send them to new drawing layers. In the Camera view, once you have drawn your artwork, you can select the strokes you want to distribute using the Select tool and click on the Distribute to Layers button; you can also select Drawing > Distribute to Layers. It will automatically take every stroke from the drawing selection made in the Camera view and separate them into a different layer for each. If an artwork is composed of several strokes, you must group them using Edit > Group > Group before using the Distribute to Layers option. This option cannot be done from the Drawing view.</p>
	Store Colour Gradient	<p>Use the Store Colour Gradient operation to record the selected gradient's position. This reuses the stored position of the gradient when drawing new brush lines or painting colour zones. Enable the Use Stored Colour Gradient  option in the Paint or Brush Tool Properties view to do this.</p>
	Pencil to Brush	<p>Converts the selected centre line pencil strokes into contour strokes brush lines.</p>



Icon	Property	Description
		
	<p>Merge Pencil Lines</p>	<p>Because pencil lines are defined by their centre lines, two pencil lines that brush against each other may not actually make a closed shape, even if they appear closed. If you select several pencil lines that are close together, you can use this button to close the small gaps between these pencil lines and make them into a single pencil line.</p>  <div data-bbox="636 1075 1430 1243" style="border: 1px solid green; padding: 5px;"> <p> NOTE Points must be close enough to be merged. If there is a large gap between the lines, they will not be merged.</p> </div>
	<p>Reverse Pencil Thickness</p>	<p>The Reverse Pencil Thickness option inverts the thick and thin section on a selected pencil line. This option will take the thickest size on the line and apply it to the thinnest, and it will apply the thinnest to the thickest.</p> 
	<p>Offset X</p>	<p>Lets you enter a value to reposition the selection along the X-axis.</p>

Icon	Property	Description
	Offset Y	Lets you enter a value to reposition the selection along the Y-axis.
	Width	Lets you enter a value to resize the width of the selection.
	Height	Lets you enter a value to resize the height of the selection.
	Lock	Locks or unlocks the ratio between the Width and Height values.
	Angle	Lets you enter specific values to rotate the selection. A positive value rotates the selection counter clockwise and a negative value rotates the selection clockwise.

Pencil Selection

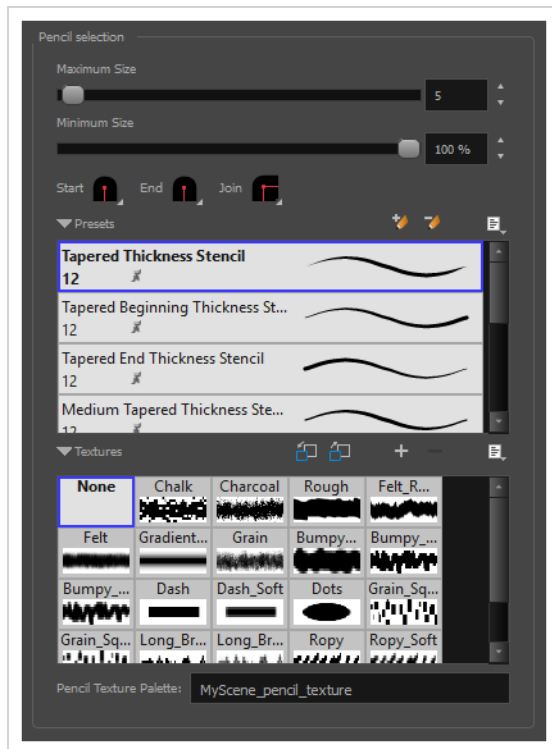
If the selection contains pencil lines, the Pencil Selection section appears at the bottom of the Tool Properties view, allowing you to adjust the properties of those pencil lines.

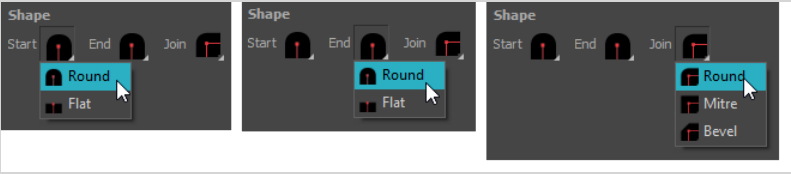

Icon	Property	Description
	Maximum Size	Adjusts the size of the parts of the pencil lines that are the thickest. Parts of the pencil lines that are between the minimum and maximum sizes will be adjusted proportionally.
	Minimum Size	Adjusts the size of the parts of the pencil lines that are the thinnest. Parts of the pencil lines that are between the minimum and maximum sizes will be adjusted proportionally.
	Pencil Line Shape	<p>You can adjust the start, end, and join style of a pencil line.</p>  <ul style="list-style-type: none"> • Start: Lets you select the style of the start tip, which is the first tip you drew. You can choose between Round or Flat style. • End: Lets you select the style of the end tip, which is the last tip you drew. You can choose between Round or Flat style. • Join: Lets you select the joint style. The joints are where the line curves abruptly. You could also define the Join style as the corner style. You can choose between Round, Mitre and Bevel style.
	Pencil Stencils	<p>Allows you to apply one of the available line thickness stencils to the selected pencil lines. Stencils set the width of a pencil lines all along its length. You can use one of the preloaded presets, or create your own pencil stencils.</p> 
	Adding Texture to a Pencil Line	Pencil lines support texture. Once a pencil line is drawn, you can apply a preset texture or load your own. Textures are independent from pencil stencils.

Text Selection







If your selection include text boxes created with the Text tool, a Text Selection section will appear at the bottom of the Tool Properties view, allowing you to adjust the formatting of the whole text box.

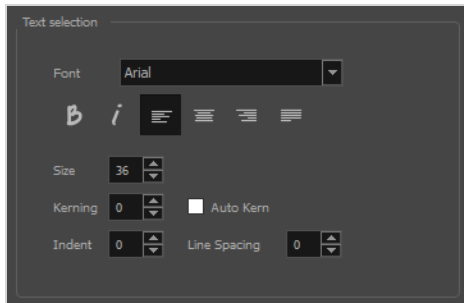

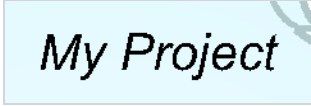

TIP

You can also adjust the formatting of parts of the text in the text box using the Text tool—see [Text Tool Properties](#) on page 1130.



Icon	Property	Description
	Font	Lets you select the font in which to display the text. 
	Bold	Makes the selected text bold. 
	Italic	Makes the selected text italic. 
	Align Left	Aligns the text in the selected text box to the left.

Icon	Property	Description
		<div data-bbox="659 285 954 527" style="border: 1px solid black; padding: 5px;"> <p>LOREM IPSUM DOLOR SIT AMET, CONSECTETUR ADIPISCING ELIT. AENEAN VESTIBULUM, METUS AC FERMENTUM PORTTITOR, ODIO TURPIS PORTTITOR NIBH, ID CONSEQUAT MAGNA LIGULA ET ELIT. CURABITUR SOLLICITUDIN ELIT AC LOREM MOLLIS ACC UMSAN.</p> </div>
	Align Center	<p>Aligns the text in the selected text box to the centre.</p> <div data-bbox="659 663 938 867" style="border: 1px solid black; padding: 5px;"> <p>LOREM IPSUM DOLOR SIT AMET, CONSECTETUR ADIPISCING ELIT. AENEAN VESTIBULUM, METUS AC FERMENTUM PORTTITOR, ODIO TURPIS PORTTITOR NIBH, ID CONSEQUAT MAGNA LIGULA ET ELIT. CURABITUR SOLLICITUDIN ELIT AC LOREM MOLLIS ACC UMSAN.</p> </div>
	Align Right	<p>Aligns the text in the selected text box to the right.</p> <div data-bbox="659 993 915 1192" style="border: 1px solid black; padding: 5px;"> <p>LOREM IPSUM DOLOR SIT AMET, CONSECTETUR ADIPISCING ELIT. AENEAN VESTIBULUM, METUS AC FERMENTUM PORTTITOR, ODIO TURPIS PORTTITOR NIBH, ID CONSEQUAT MAGNA LIGULA ET ELIT. CURABITUR SOLLICITUDIN ELIT AC LOREM MOLLIS ACC UMSAN.</p> </div>
	Justify	<p>Makes the text in the selected text box take all the horizontal space by adjusting the spacing between each word. Text that use a single line and text in the last line of a paragraph is aligned to the left.</p> <div data-bbox="659 1388 927 1591" style="border: 1px solid black; padding: 5px;"> <p>LOREM IPSUM DOLOR SIT AMET, CONSECTETUR ADIPISCING ELIT. AENEAN VESTIBULUM, METUS AC FERMENTUM PORTTITOR, ODIO TURPIS PORTTITOR NIBH, ID CONSEQUAT MAGNA LIGULA ET ELIT. CURABITUR SOLLICITUDIN ELIT AC LOREM MOLLIS ACC UMSAN.</p> </div>
	Size	<p>Allows you to set the size of the selected text.</p> <div data-bbox="659 1717 1089 1839" style="border: 1px solid black; padding: 5px;"> <p>small text big text</p> </div>

Icon	Property	Description
	Kerning	<p>Allows you to increase or decrease the spacing between each character.</p> <div style="display: flex; justify-content: space-around;"> <div style="border: 1px solid gray; padding: 5px; width: 45%;"> <p> Lorem ipsum dolor sit amet, consectetur adipiscing elit. Aenean vestibulum, metus ac fermentum porttitor, odio turpis porttitor nibh, id consequat magna ligula et elit. Curabitur sollicitudin elit ac lorem mollis acc umsan.</p> </div> <div style="border: 1px solid gray; padding: 5px; width: 45%;"> <p> Lorem ipsum dolor sit amet, consectetur adipiscing elit. Aenean vestibulum, metus ac fermentum porttitor, odio turpis porttitor nibh, id consequat magna ligula et elit. Curabitur sollicitudin elit ac lorem mollis acc umsan.</p> </div> </div>
	Auto Kern	<p>Sets the kerning automatically based on the font's predefined standard.</p>
	Indent	<p>Allows you to increase or decrease the indentation of the first line of text in each paragraph.</p> <div style="display: flex; justify-content: space-around;"> <div style="border: 1px solid gray; padding: 5px; width: 45%;"> <p> Lorem ipsum dolor sit amet, consectetur adipiscing elit. Aenean vestibulum, metus ac fermentum porttitor, odio turpis porttitor nibh, id consequat magna ligula et elit. Curabitur sollicitudin elit ac lorem mollis acc umsan.</p> </div> <div style="border: 1px solid gray; padding: 5px; width: 45%;"> <p> Lorem ipsum dolor sit amet, consectetur adipiscing elit. Aenean vestibulum, metus ac fermentum porttitor, odio turpis porttitor nibh, id consequat magna ligula et elit. Curabitur sollicitudin elit ac lorem mollis acc umsan.</p> </div> </div>
	Line Spacing	<p>Increases or decreases the space between each line of text.</p> <div style="display: flex; justify-content: space-around;"> <div style="border: 1px solid gray; padding: 5px; width: 45%;"> <p> Lorem ipsum dolor sit amet, consectetur adipiscing elit. Aenean vestibulum, metus ac fermentum porttitor, odio turpis porttitor nibh, id consequat magna ligula et elit. Curabitur sollicitudin elit ac lorem mollis acc umsan.</p> </div> <div style="border: 1px solid gray; padding: 5px; width: 45%;"> <p> Lorem ipsum dolor sit amet, consectetur adipiscing elit. Aenean vestibulum, metus ac fermentum porttitor, odio turpis porttitor nibh, id consequat magna ligula et elit. Curabitur sollicitudin elit ac lorem mollis acc umsan.</p> </div> </div>

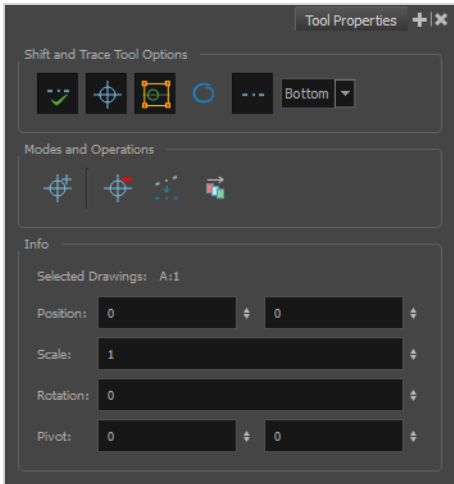

Shift and Trace Tool Properties

The Shift and Trace tool allows you to temporarily move, rotate and scale drawings, then trace over them in other drawings, using Onion Skin to keep the outlines of the shifted drawings in your drawing space. Contrary to Shift and Trace with the Drawing Desk, you can use the Shift and Trace tool in the Camera view.













How to access the Shift and Trace Tool Properties

1. Do one of the following:

- In the Tools toolbar, double-click on the Hand  tool and select Shift and Trace  in the pop-up menu.
- In the top menu, select **Drawing > Drawing Tools > Shift and Trace**.

The Shift and Trace tool properties appear in the Tool Properties view.

Icon	Tool Name	Description
Shift and Trace Tool Options		
	Enable/Disable Shift and Trace	Enabled by default. When disabled, drawings that were repositioned, rotated or scaled with the Shift and Trace tool appear in their original position.
	Display Cross Hair	Enabled by default. When disabled, cross hairs added with the Shift and Trace tool are invisible.
	Show manipulators for shift and	Enabled by default. This displays the manipulator allowing you to rotate and scale drawings for Shift and Trace, as well as to re-position their pivot point. When hidden, you can only shift drawings laterally.



Icon	Tool Name	Description
	trace	
	Show the outline of the selected shift and trace drawing	When enabled, the contours of each brush stroke for the current drawing will appear highlighted in cyan.
	Show/Hide Pegs	Enabled by default. When using the Shift and Trace tool, peg holes are displayed at the bottom of every drawing to help keep track of how offset drawings are from their original position and from each other. You can also click and drag on the left or right peg hole of a drawing to rotate it around the centre peg hole. When disabled, those peg holes are hidden.
	Peg Position	Allows you to select on which edge of the drawings to display peg holes. By default, they are displayed at the bottom of the drawings.
Modes and Operations		
	Set Add Cross Hair Mode	When selected, clicking on the drawing will add a cross hair where you click. Cross hairs are marks that appear on the same location on every drawing in the current layer and which move when you offset a drawing with the Shift and Trace tool, and they appear in the Onion Skin rendition of neighbouring drawings as well. This allows you to keep track of how offset each drawing is.
	Remove All Cross Hair	Removes all the cross hairs created for shift and trace.
	Reset Selected Drawings Shift Position	Undoes all transformations done with the Shift and Trace tool on the selected drawings, resetting them to their original position, angle and scale.
	Reset All Drawings Shift Position	Undoes all transformations done with the Shift and Trace tool on all drawings, resetting them to their original position, angle and scale.
Info		
Selected Drawings	The element name and drawing name of the currently selected drawing.	

Icon	Tool Name	Description
	Position	The offset of the current drawing from its original position on the x and y axes, in fields, when moved with the Shift and Trace tool.
	Scale	The Shift and Trace scale factor of the currently selected drawing, when scaled with the Shift and Trace tool.
	Rotation	The Shift and Trace rotation angle of the currently selected drawing, in degrees, counterclockwise, when rotated with the Shift and Trace tool.
	Pivot	The offset, in fields, of the current drawing's pivot point from its centre, on the x and y axes. The pivot point is the point from which drawings are rotated and scaled.

Smooth Editor Tool Properties

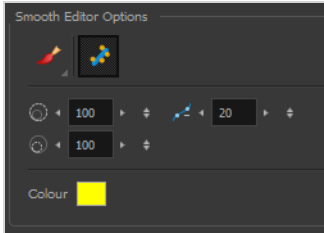
When you select the Smooth Editor tool, its properties and options appear in the Tool Properties view.

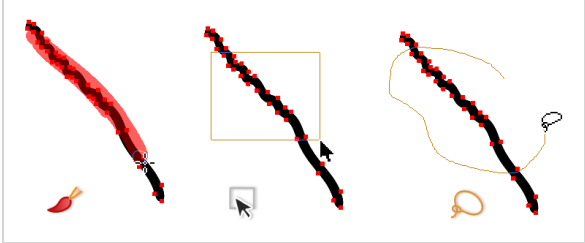

Icon	Tool Name	Description
	Smoothing Style	<p>The Smoothing Style options allow you to smooth a portion of your drawing by tracing a smoothing stroke over the zone to optimize or by selecting an area of the drawing with the Marquee or Lasso.</p> <p>Note that by default, the Smooth Editor tool colour is yellow, it was changed to orange for screen grab clarity.</p> 
	Show Control Points	<p>The Show Control Points option allows you to show or hide the Bezier points around lines. When the Bezier points are displayed, you can see the result of your smoothing and the number of points left on the curve. When it is turned off, only the original artwork is displayed.</p>
	Minimum Size and Maximum Size	<p>This is where you set the minimum and maximum sizes of your drawing tool which will produce the thick and thin effect on your stroke. This works with the pressure sensitivity of a pen tablet.</p> <p>This options is available while using the Brush Smoothing  style.</p> <ul style="list-style-type: none"> Maximum and Minimum Size: Defines the maximum and minimum width of the stroke.

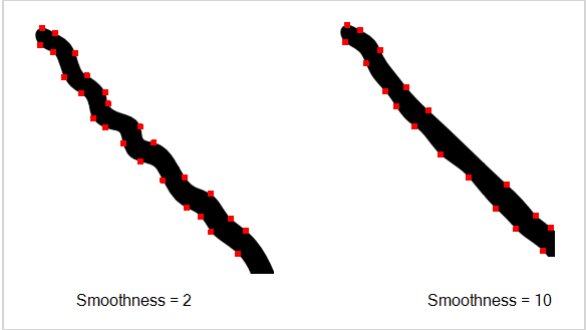
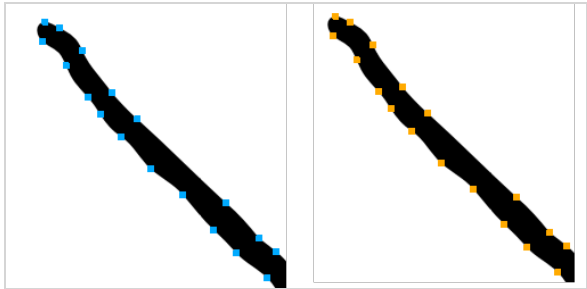
		<ul style="list-style-type: none"> • Up/Down arrows: Use the up and down arrows to set the minimum and maximum size value.
	<p>Smoothness</p>	<p>The Smoothness impacts the strength of the smoothing result. The higher the value, the more points are removed and the smoother the curve. The Smoothness range is from 0 to 100; the default value is 20.</p> <div data-bbox="852 550 1435 877">  </div>
	<p>Colour</p>	<p>You can modify the colour of the control points displayed on the artwork while working with the Smooth Editor tool by double-clicking on the colour swatch.</p> <div data-bbox="852 1108 1435 1394">  </div>

Stamp Tool Properties

The Stamp tool allows you to create and use stamps, which can contain one or several drawings that can be stamped individually or in sequence onto your artwork.

How to access the Stamp tool properties

1. In the Tools toolbar, select the Stamp  tool.

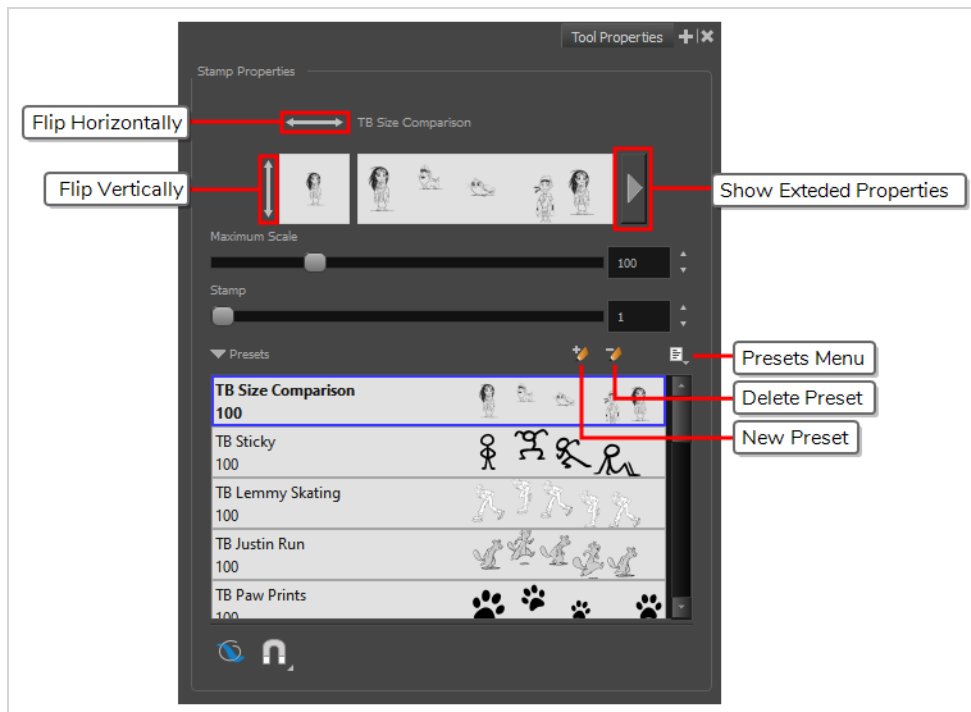

The tool's properties are displayed in the Tool Properties view.



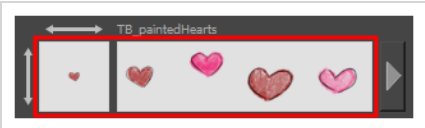

Stamp Properties

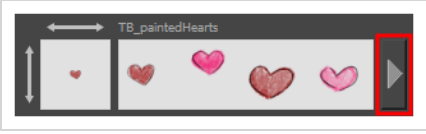
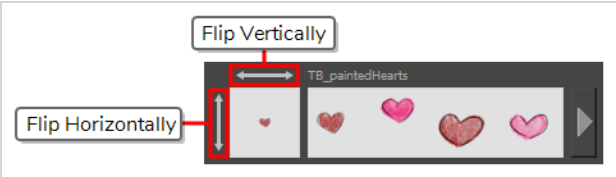
The following options allow you, among other things, to preview your stamp, to change the size of your stamp as well as to flip it horizontally and vertically.

Property	Description
Preview Area	<p>The Preview area lets you see a preview of what will appear if you draw a stroke with the Stamp tool.</p> 





Property	Description
<p>Stamp Properties Dialog</p>	<p>The arrow button right of the preview area opens the Stamp Properties dialog.</p>  <p>While the Tool Properties view only gives you access to a few of the stamp properties and a list of stamp presets, the Stamp Properties dialog gives you access to all the available options for the way your stamp will be applied. For more information on the Stamp Properties dialog, see the Stamp Properties Dialog on page 1124 section below.</p>
<p>Flip Horizontally / Flip Vertically</p>	<p>The two-ended arrows to the left and over the Stamp thumbnail allow you to flip the stamp horizontally or vertically.</p> 
<p>Maximum Scale</p>	<p>The maximum scaling factor to apply to the stamp before stamping it onto the drawing.</p> <p>This setting is a percentage, which is relative to the size of the original drawing that was used to create the stamp. This means that, at 100%, the drawing will be stamped into your artwork in its original size.</p> <div data-bbox="380 1213 1430 1451" style="border: 1px solid green; padding: 10px;"> <p> NOTE</p> <p>If the tool is used with a pressure sensitive tablet, the scale of the stamp can be made to be relative to the amount of pressure you put on your pen. To do this, you must reducing the Minimum Scale property of your stamp in the Stamp Properties dialog. If the Minimum Scale setting is left at its default value, which is 100%, the size of the stamp will not vary.</p> </div>
<p>Stamp</p>	<p>When using a multi-drawing stamp, this is the number of the drawing in the series that will be stamped on the next time you use the Stamp tool. For example, if your stamp has 3 drawings and this is set to 2, the next drawing that will be stamped on is the second drawing in the series.</p> <p>If your stamp's Cycle setting is set to Hold, then you have to use this slider to select which drawing to stamp with the Stamp tool.</p> <p>If your stamp's Reset Cycle for Each Stroke option is enabled, then you can use this slider to select which drawing to start each stroke with.</p> <p>Otherwise, when you draw a stroke with the Stamp tool, the Stamp slider will automatically update to the next drawing in the sequence.</p>

Property	Description
	<div style="border: 1px solid #add8e6; padding: 10px; margin-bottom: 10px;">  TIP You can also cycle through the drawings in your stamp by using the Left Arrow and Right Arrow keys. </div> <div style="border: 1px solid #90ee90; padding: 10px;">  NOTE The Cycle and Reset Cycle for Each Stroke options are available in the Stamp Properties dialog. </div>

Stamp Presets

These options allow you to select, create and manage stamp presets.





Contrary to the Brush and Pencil tools, creating a Stamp preset is required to use the Stamp tool, as this preset will contain the drawings to stamp onto your artwork. A Stamp preset is created by selecting one or several layers, then adding a preset to the Stamp Presets list. If several layers are selected, the Stamp will contain a series of drawings, which it will stamp onto your artwork in a sequence as you draw strokes with the Stamp tool.

Icon	Property	Description
	Presets list	The list of Stamp presets. Click on one of the presets to select it and use it in your drawing.
	New Brush Preset	<p>Creates a new Stamp preset based on the selected artwork. The artwork can either be a selection made with the Select  tool, or by selecting a layer.</p> <p>If several layers are selected, this will create a multi-drawing Stamp. As you draw a stroke with the Stamp tool using a multi-drawing stamp, each drawing in the stamp will be applied onto your artwork, one after the other.</p>
	Delete Brush	Deletes the currently selected preset.
	Brush Presets Menu	<p>Open a menu that contains all of the previous options, along with all of the following options:</p> <ul style="list-style-type: none"> • New Brush Preset: Creates a new stamp based on the selected artwork.

		<ul style="list-style-type: none"> • Rename Preset: Allows you to rename the currently selected preset. • Import Brushes: Allows you to import brush presets exported from Harmony. • Export Brushes: Allows you to export your brush presets into an <code>.xml</code> file. • Small Thumbnail: Displays presets in a grid of small thumbnails with a preview of their tip. • Large Thumbnail: Displays presets in a grid of big thumbnails, with their name and a preview of their tip. • Stroke View: Displays presets in a list, with their name and a preview of a stroke done with each preset.
--	--	---

Drawing Options

These options affect the way your drawing strokes are added to your artwork

Icon	Property	Description
	<p>Draw Behind</p>	<p>When enabled, your brush strokes will appear behind the existing artwork.</p> <div data-bbox="646 1115 1118 1310" style="border: 1px solid #ccc; padding: 5px; margin: 10px 0;">  <p>The orange stroke was drawn over the black stroke, then put underneath it.</p> </div> <div data-bbox="646 1350 1430 1520" style="border: 1px solid #90EE90; padding: 5px; margin: 10px 0;"> <p> NOTE Your brush stroke will temporarily appear over your artwork as you draw it, until you release the mouse cursor or tablet pen.</p> </div>
	<p>Snapping</p>	<p>Allows you to enable or disable snapping for this tool and all other animation and drawing tools that support snapping, as well as to select which types of snapping are enabled.</p> <p>If you double-click or long-click on this button, it will open a pop-up menu in which you can toggle different snapping modes. You can also click on this button to toggle it off, which will disable all snapping modes, and click on it again and toggle it on to re-enable the snapping modes which were previously enabled.</p>

This tool supports the following snapping mode:



- **Snap to Alignment Guides:** While drawing, the drawing tool will snap against nearby alignment guides.



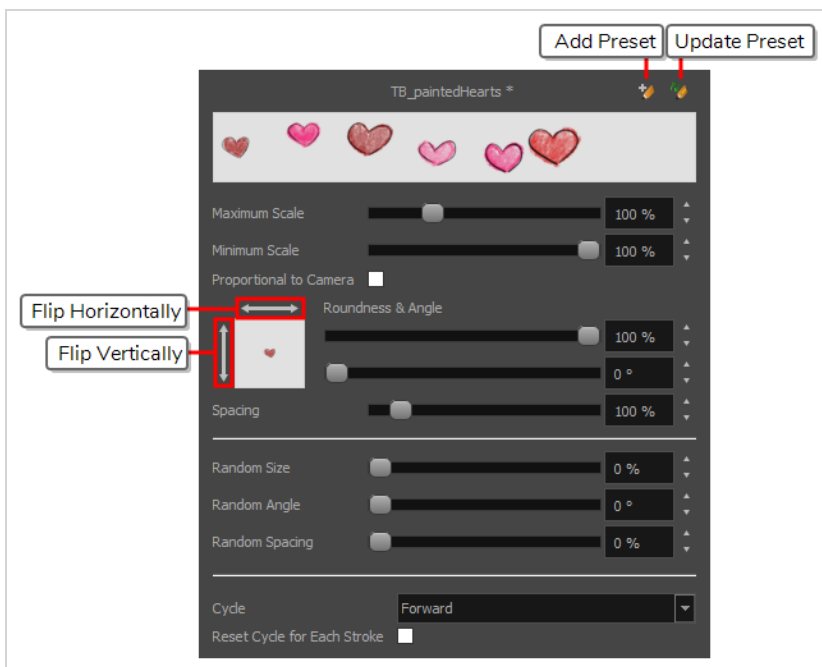
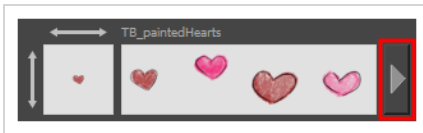

Stamp Properties Dialog

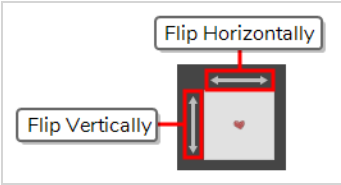
The Stamp Properties dialog allows you to set more specific settings for your stamp, such as pressure sensitivity, spacing, angle, randomness and, for multi-drawing stamps, how to cycle through each drawing in the stamp. To open the Stamp Properties dialog, click on the arrow button right of the stroke display area.

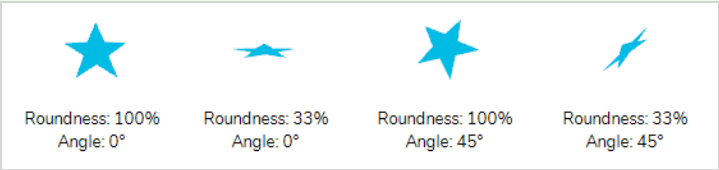

Property	Description
Maximum Scale	The maximum scaling factor to apply to the stamp before stamping it onto the drawing. This setting is a percentage, which is relative to the size of the original drawing that was used to create the stamp. This means that, at 100%, the drawing will be stamped into your artwork in its original size.
Minimum Scale	The minimum scaling factor to apply to the stamp before stamping it onto your drawing. When using the Stamp tool with a pressure-sensitive pen tablet, the size of the stamps applied onto your artwork will vary between its Minimum Scale and Maximum Scale

Property	Description				
	<p>properties, relative to the amount of pressure you apply to the pen.</p> <p>This setting is relative to the Maximum Scale property. This means that if the Maximum Scale is set to 50% and the Minimum Scale is set to 50%, the actual scaling factor applied to the stamp will vary between 25% and 50%.</p> <p>This setting is also used with the Random Size setting.</p>				
<p>Flip Horizontally / Flip Vertically</p>	<p>The two-ended arrows to the left and over the Stamp thumbnail allow you to flip the stamp horizontally or vertically.</p> 				
<p>Roundness & Angle</p>	<p>The Roundness and Angle parameters allow you to change the shape and orientation of the stamp.</p> <ul style="list-style-type: none"> • Roundness: The vertical scaling to apply to the stamp. Reducing this setting squashes the stamp vertically, allowing you to turn round or square stamps into flat stamps. • Angle: The angle at which to rotate the brush tip, counterclockwise. <div data-bbox="451 1167 1430 1528" style="border: 1px solid green; padding: 10px;"> <p> NOTE</p> <p>The squashing is not relative to the angle—if the stamp is rotated, the squashing will still be done relative to the stamp's original orientation.</p>  <table border="0" style="width: 100%; text-align: center;"> <tr> <td>Roundness: 100% Angle: 0°</td> <td>Roundness: 33% Angle: 0°</td> <td>Roundness: 100% Angle: 45°</td> <td>Roundness: 33% Angle: 45°</td> </tr> </table> </div>	Roundness: 100% Angle: 0°	Roundness: 33% Angle: 0°	Roundness: 100% Angle: 45°	Roundness: 33% Angle: 45°
Roundness: 100% Angle: 0°	Roundness: 33% Angle: 0°	Roundness: 100% Angle: 45°	Roundness: 33% Angle: 45°		
<p>Spacing</p>	<p>Defines the amount of space between each stamp that is applied onto the artwork. The larger the value, the greater the space between each stamp.</p>				

Property	Description
	
Random Size	<p>The percentage of randomness to apply to the size of the stamp. This makes the size of the stamp randomly vary between its Maximum Scale and Minimum Scale settings each time it is applied to your artwork.</p>  <p>The greater the value of the Random Size property, the closer to its Minimum Scale the size of each stamp can get. For example, if the Random Size setting is set to 50% and the Minimum Scale is set to 50%, the size of the stamp will randomly vary between 75% and 100% of its Maximum Scale.</p>
Random Angle	<p>The maximum value of randomness to apply to the angle of the stamp. This makes the angle of the stamp randomly vary within the range of degrees in this setting, in either direction, each time it is applied to your artwork. For example, if the stamp's Angle is set to 0°, and the Random Angle is set to 180°, each instance of the stamp will be at a random angle varying between -90° and 90°.</p> 
Random Spacing	<p>The maximum amount of randomness to apply to the spacing of the stamp. Increasing this setting makes the distance between each instance of the stamp vary randomly as you draw a stroke. At 100%, this makes the distance between each stroke vary between 0% and 200% of its Spacing property.</p> 
Cycle	<p>For multi-drawing stamps, this decides the logic with which to cycle through the sequence of drawings in the stamp as you draw a stroke.</p> <ul style="list-style-type: none"> • Forward: Starts by applying the first drawing in the sequence, then the next one, and so on until it reaches the last drawing in the sequence, then cycles back to the first one.



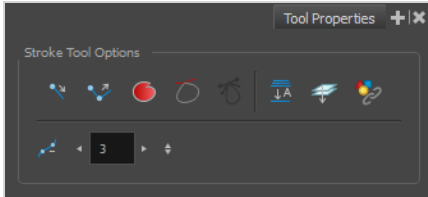

Property	Description
	<div data-bbox="532 283 766 352" style="border: 1px solid gray; padding: 2px; margin-bottom: 10px;"> <p>1231231</p> </div> <ul style="list-style-type: none"> • Reverse: Starts by applying the last drawing in the sequence, then the previous one, and so on until it reaches the first drawing in the sequence, then cycles back to the last one. <div data-bbox="532 510 766 579" style="border: 1px solid gray; padding: 2px; margin-bottom: 10px;"> <p>3213213</p> </div> <ul style="list-style-type: none"> • Forward->Reverse: Starts by cycling forward through the sequence until it reaches the last drawing, then cycles backward to the first drawing, and so on. <div data-bbox="532 699 766 768" style="border: 1px solid gray; padding: 2px; margin-bottom: 10px;"> <p>1232123</p> </div> <ul style="list-style-type: none"> • Reverse->Forward: Starts by cycling backward through the sequence until it reaches the first drawing, then cycles back to the last drawing, and so on. <div data-bbox="532 888 766 957" style="border: 1px solid gray; padding: 2px; margin-bottom: 10px;"> <p>3212321</p> </div> <ul style="list-style-type: none"> • Random: Applies a random drawing in the sequence each time the stamp is applied. <div data-bbox="532 1045 766 1115" style="border: 1px solid gray; padding: 2px; margin-bottom: 10px;"> <p>1321123</p> </div> <ul style="list-style-type: none"> • Hold: Applies a single one of the drawings in the sequence over and over again. <div data-bbox="532 1203 766 1272" style="border: 1px solid gray; padding: 2px; margin-bottom: 10px;"> <p>1111111</p> </div> <div data-bbox="451 1310 1429 1486" style="border: 1px solid gray; padding: 10px; margin-top: 20px;"> <div style="display: flex; align-items: center;">  <div> <p>TIP</p> <p>When this option is set to Hold, you can select which one of the drawings is stamped on by changing the Stamp setting in the Tool Properties view.</p> </div> </div> </div>
<p>Reset Cycle for Each Stroke</p>	<p>For multi-drawing stamps. This makes it so each stroke you draw with the stamp too always starts with the first drawing in the cycle, which is decided by the Stamp option in the Tool Properties view.</p> <p>When disabled, the Stamp tool keeps track of which drawing it was going to stamp next when you finish drawing a stroke by storing the number of that drawing in the Stamp setting. When this option is enabled, it simply stops updating the Stamp setting. Hence, your strokes always start at the drawing selected with that setting. Likewise, you can manually decide which drawing to start your strokes with by adjusting the Stamp setting.</p>

Stroke Tool Properties

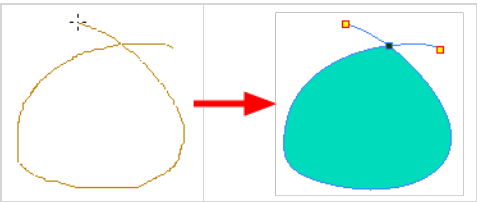
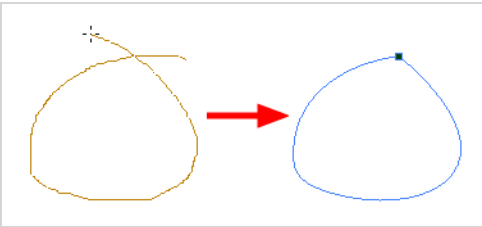
When you select the Stroke tool, its properties and options appears in the Tool Properties view.

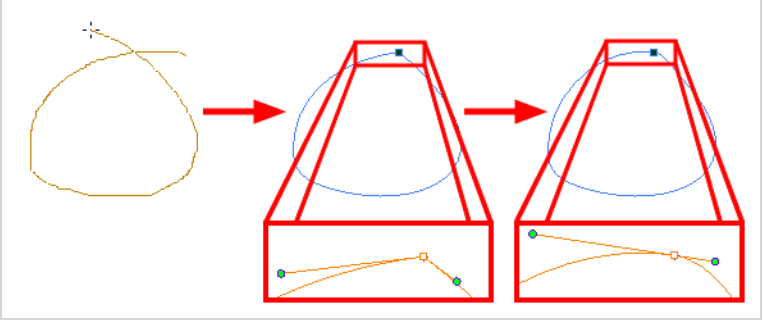

Icon	Tool Name	Description
	Draw Stroke as Straight Lines	Enable the Draw Stroke as Straight Lines option if you want the new strokes you draw to be a perfect straight line. Disable the option if you want the stroke to follow the mouse gesture.
	Connect Line Ends	Enable the Connect Line Ends option if you want the start or end point of your new stroke to connect to your existing strokes to make sure no gaps are left in your drawing.
	Auto Fill	When enabled, drawing a closed shape will automatically fill it with the currently selected Paint colour. 
	Trim Extra Lines	When enabled, drawing a closed shape will automatically remove the outstanding lines. 
	Align Handles After Trim	When the Trim Extra Lines option is enabled, enable this option to make the point where the beginning and end of the stroke meet into a smooth curve rather than a hard corner.

		
	<p>Auto-Flatten Mode</p>	<p>By default, when drawing on a vector layer, each new stroke is created as a separate drawing object, which can be edited independently from other parts of the artwork. When enabled, the Auto-Flatten option automatically merges strokes into existing artwork.</p>
	<p>Apply to Line and Colour Art</p>	<p>Allows you to perform drawing operations on both the Line Art and Colour Art layers of your drawing simultaneously.</p> <div data-bbox="607 871 1430 1041" style="border: 1px solid green; padding: 10px; margin-top: 10px;"> <p> NOTE If you have Overlay and Underlay Art layers enabled, they will also be affected when this option is enabled.</p> </div>
	<p>Apply to Synced Drawing Layers</p>	<p>If the currently selected layer is synced with another layer, the tool will work on both the current layer and its synced layer.</p>
	<p>Smoothness</p>	<p>You can modify the central line smoothness of your line using this option. This parameter smooths the initial movement of your line. Increasing the value will result in a smoother line with fewer control points. Use the left and right arrows to increment the value by one full unit. Use the Up - Down slider to quickly increment the value.</p>

Text Tool Properties

The Text tool lets you add text fields to your project, in which you can type text, then adjust its formatting using various fonts and text attributes.





With the Text tool selected, you can select text within text boxes you created and change the formatting of the selection. You can also select and manipulate text boxes using the Select tool, and change the formatting of the entire text box in the Select tool properties.



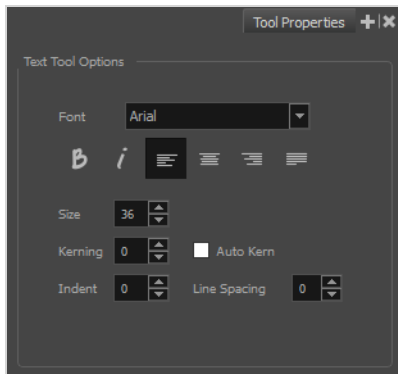



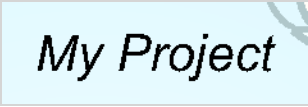

How to access the Text tool properties

- In the Tools toolbar, select the Text **T** tool.

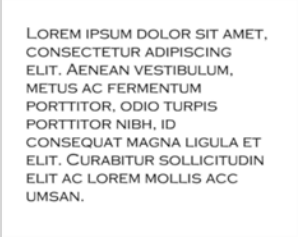
The tool's properties are displayed in the Tool Properties view.

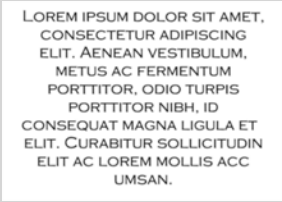

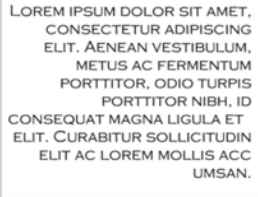
Icon	Property	Description
	Font	Lets you select the font in which to display the text. 
	Bold	Makes the selected text bold. 
	Italic	Makes the selected text italic.

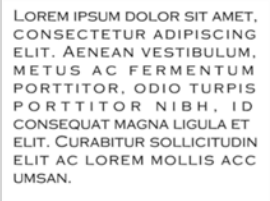

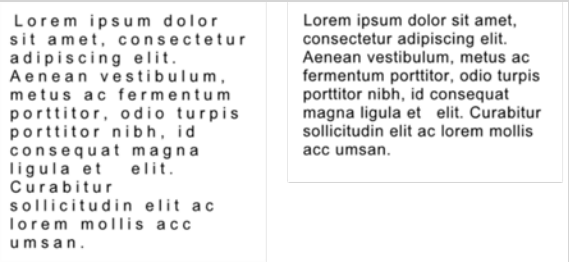
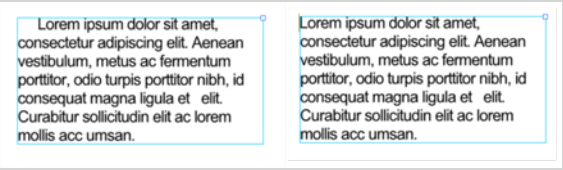
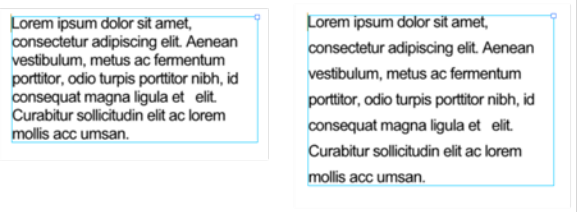



Icon	Property	Description
		
	Align Left	<p>Aligns the text in the selected text box to the left.</p> 
	Align Center	<p>Aligns the text in the selected text box to the centre.</p> 
	Align Right	<p>Aligns the text in the selected text box to the right.</p> 
	Justify	<p>Makes the text in the selected text box take all the horizontal space by adjusting the spacing between each word. Text that use a single line and text in the last line of a paragraph is aligned to the left.</p> 

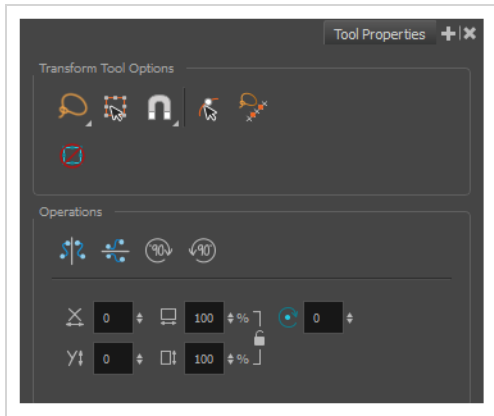



Icon	Property	Description
	Size	<p>Allows you to set the size of the selected text.</p> 
	Kerning	<p>Allows you to increase or decrease the spacing between each character.</p> 
	Auto Kern	<p>Sets the kerning automatically based on the font's predefined standard.</p>
	Indent	<p>Allows you to increase or decrease the indentation of the first line of text in each paragraph.</p> 
	Line Spacing	<p>Increases or decreases the space between each line of text.</p> 





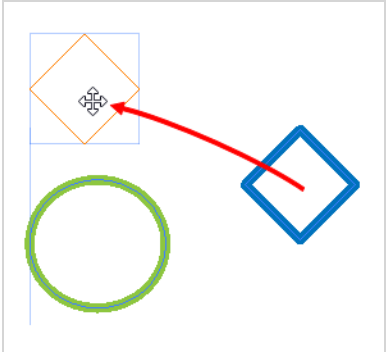

Transform Tool Properties

When selecting the Transform tool, several options are available in the Tool Properties view.



Icon	Tool Name	Description
	Lasso	<p>Sets the selection mode to Lasso, which allows you to select multiple items by drawing a lasso around them.</p> <div style="border: 1px solid #add8e6; padding: 10px; margin-top: 10px;"> <p> TIP When this option is enabled, you can press and hold the Alt key to temporarily use Marquee mode.</p> </div>
	Marquee	<p>Sets the selection mode to Marquee, which allows you to select multiple items by drawing a rectangle around them.</p> <div style="border: 1px solid #add8e6; padding: 10px; margin-top: 10px;"> <p> TIP When this option is enabled, you can press and hold the Alt key to temporarily use Lasso mode.</p> </div>
	Easy Drag	<p>When enabled, you can drag the selection by clicking anywhere inside its bounding box. By default, you must click on the artwork in the selection to be able to drag it.</p>
	Snapping	<p>Allows you to enable or disable snapping for this tool and all other animation and drawing tools that support snapping, as well as to select which types of snapping are enabled.</p> <p>If you double-click or long-click on this button, it will open a pop-up menu in which you can toggle different snapping modes. You can also click on this button to toggle it off, which will disable all</p>

		<p>snapping modes, and click on it again and toggle it on to re-enable the snapping modes which were previously enabled.</p> <p>This tool supports the following snapping modes:</p> <ul style="list-style-type: none"> • Snap to Alignment Guides: While moving the selection or one of its control points, it will snap against nearby alignment guides. • Snap and Align: While moving the selection, the rectangular bounding box of the selection will align with the rectangular bounding boxes of other elements in your scene. If you move one of your selection's control points, it will also align with the bounding boxes of other elements.  <ul style="list-style-type: none"> • Snap to Grid: While moving the selection, the mouse cursor will snap against the intersecting points of the grid. <div data-bbox="782 1129 1429 1310" style="border: 1px solid #add8e6; padding: 5px;"> <p> TIP To display the grid, select View > Grid > Show Grid from the top menu or press Ctrl + '.</p> </div>
	<p>Peg Selection Mode</p>	<p>In the Camera view, the Peg Selection Mode limits the selection to peg layers instead of drawing layers. This mode is useful when you have created a character rig using peg layers for each drawing. That way, you do not accidentally select the drawing layer when you want to animate on the peg.</p> <p>When disabled, the Transform tool selects the drawing layers.</p>
	<p>Control Selection Mode</p>	<p>When enabled, you can select several control points in the Camera view by drawing a lasso or marquee around them. By default, drawing a lasso or marquee in the Camera view will select layers in the area.</p>

		<div style="border: 1px solid green; padding: 5px;">  NOTE This option works with curve and envelope deformation points as well as Animated Matte Generator control points. </div>
	Hide Manipulator Controls	The Hide Manipulator Controls button lets you hide the bounding box and manipulator controls from the Camera view when an element is selected.
	Flip Horizontal	Flips the current selection horizontally. You can also select Animation > Flip > Flip Horizontal from the top menu or press 4 or 5.
	Flip Vertical	Flips the current selection vertically. You can also select Animation > Flip > Flip Vertical from the top menu or press 4 or 5.
	Rotate 90 Degrees CW	Rotates the current selection 90 degrees clockwise.
	Rotate 90 Degrees CCW	Rotates the current selection 90 degrees counter-clockwise.
	Offset X ad Y	Use the Offset X and Offset Y operation fields to enter specific values and precisely reposition the selected shape. <div style="border: 1px solid gray; padding: 5px; margin: 10px 0;">  </div> <ol style="list-style-type: none"> 1. X: Type a value in this field to reposition your selection along the X-axis. 2. Y: Type a value in this field to reposition your selection along the Y-axis. 3. Up/Down arrows: Use the up and down arrows to modify the value in the X or Y value field.
	Width and Height	Use the Width and Height operation fields to enter specific values to resize the selected shape with precision.

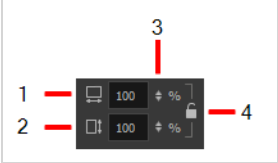
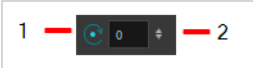
		 <ol style="list-style-type: none"> 1. Width: Type a value in this field to resize the width of your selection. 2. Height: Type a value in this field to resize the height of your selection. 3. Up/Down arrows: Use the up and down arrows to modify the value in the Width or Height fields. 4. Lock icon: Click the lock icon to lock or unlock the ratio between the Width and Height values.
	Angle	<p>The Angle operation lets you to enter specific values and accurately rotate the selected shape.</p>  <ol style="list-style-type: none"> 1. Angle: Type a degree value in this field to rotate your selection. 2. Up/Down arrows: Use the up and down arrows to modify the value in the Angle value field.

Zoom Tool Properties

The Zoom tool lets you zoom in and out of the Camera, Drawing, Side and Top views. You can also use it to reset the zoom level.



How to access the Zoom tool properties

1. In the Tools toolbar, select the Zoom  tool.

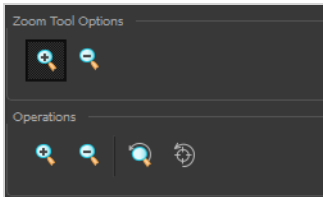



The tool's properties are displayed in the Tool Properties view.



Tool Options

Icon	Parameter	Description
	Zoom In Mode	Use the mouse cursor to zoom in to the Camera or Drawing view.
	Zoom Out Mode	Use the mouse cursor to zoom out of the Camera or Drawing view.

Operations

Icon	Parameter	Description
	Perform Zoom In	Zoom in the Camera or Drawing view. The keyboard shortcut is 2.
	Perform Zoom Out	Zoom out the Camera or Drawing view. The keyboard shortcut is 1.
	Reset Zoom	Restores the current zoom level to 100%.
	Reset View	Restores the original display by resetting any pan, rotation or zoom actions.

Chapter 5: Toolbars

Harmony contains toolbars which, by default, are located at the top of the interface. Some views also have a toolbar which you can reposition to suit your work style. You can show or hide toolbars, as well as customize it with the tools you use most often and hide the ones you don't.

Workspace Toolbars	1140
Advanced Animation Toolbar	1141
Art Layer Toolbar	1143
Control Point Toolbar	1145
Coordinate Toolbar	1147
Deformation Toolbar	1148
Display Toolbar	1153
Easy Flipping Toolbar	1154
Edit Toolbar	1155
File Toolbar	1156
Flip Toolbar	1158
Game Toolbar	1159
Mark Drawing Toolbar	1160
Master Controller Toolbar	1161
Mini Playback Toolbar	1163
Node Caching Toolbar	1164
Onion Skin Toolbar	1165
Pen Settings Toolbar	1167
Playback Toolbar	1170
Scripting Toolbar	1173
Shift and Trace Toolbar	1174
Tool Presets Toolbar	1176
Tools Toolbar	1177
Workspace Toolbar	1183
View Toolbars	1184
3D Graph View Toolbar	1185

Animated Matte Generator Toolbar	1186
Script Editor Toolbar	1189
Timeline View Toolbar	1194
Xsheet View Toolbar	1199

Workspace Toolbars

Harmony has a series of toolbars that are added by default at the top of the interface. These toolbars can be moved on the sides of the interface as well as within specific views.

All top toolbars can be added by selecting **Windows > Toolbars** in the top menu.

Advanced Animation Toolbar	1141
Art Layer Toolbar	1143
Control Point Toolbar	1145
Coordinate Toolbar	1147
Deformation Toolbar	1148
Display Toolbar	1153
Easy Flipping Toolbar	1154
Edit Toolbar	1155
File Toolbar	1156
Flip Toolbar	1158
Game Toolbar	1159
Mark Drawing Toolbar	1160
Master Controller Toolbar	1161
Mini Playback Toolbar	1163
Node Caching Toolbar	1164
Onion Skin Toolbar	1165
Pen Settings Toolbar	1167
Playback Toolbar	1170
Scripting Toolbar	1173
Shift and Trace Toolbar	1174
Tool Presets Toolbar	1176
Tools Toolbar	1177
Workspace Toolbar	1183

Advanced Animation Toolbar

The Advanced Animation toolbar contains tools to position and animate layers. The Scale, Translate and Rotate tools can be used to reposition the permanent pivot position of a layer. Unlike the Transform tool, each tool in the Advanced Animation toolbar performs a single operation, either rotate, scale, translate or scale in relation to the camera distance.



How to access the Advance Animation toolbar

1. Select **Windows > Toolbars > Advanced Animation**.

Icon	Tool Name	Description
	Translate	Lets you move the selected element along the X and Y axes.
	Rotate	Turns a selected element around its pivot point.
	Scale	Increases or decreases the size of a selected element. You can scale an object up to make it larger or down to make it smaller. Press Shift to scale the element while maintaining its proportions.
	Skew	Slants the selected element.
	Maintain Size	Keeps elements the same size aspect ratio in the Camera view as you move them towards or away from the camera.
	Spline Offset	Lets you reposition the visual trajectory without offsetting or modifying your animation. By default, the trajectory is located at 0,0,0 fields. If your elements were drawn in a different location than the centre of the drawing area, it will look like the trajectory is not aligned with your drawing. Also, if you have several elements attached to one trajectory, you might want your trajectory to be at a different location to represent the group's motion better.
	Reposition Drawing	Lets you reposition, scale, rotate or skew all drawing

		strokes on every drawing included in a layer.
--	--	---

Art Layer Toolbar

The Art Layer toolbar lets you access the art layers. By default, only the Line Art and Colour Art are displayed. A drawing is composed of two layers, a line layer and a colour layer. The colour layer is always placed under the line layer. These layers are accessible in the Drawing or Camera view (using drawing tools). When you view the final drawing, you will see the final composition of the lines and colours, not two separate layers.



You can draw and paint in all layers. If you prefer to work in a single layer, everything can be done in the Line Art layer.

You can change your preferences to enable the advanced use of layers and have access to four layers instead of two:



- Overlay
- Line Art
- Colour Art
- Underlay



How to access the Art Layer toolbar

1. Select **Windows > Toolbars > Art Layer**.

How to enable the Support Overlay and Underlay Arts option

1. Select **Edit > Preferences** (Windows/Linux) or **Harmony Premium > Preferences** (macOS).
2. In the Preferences dialog box, select the **Advanced** tab.
3. In the Advanced Options section, select the **Support Overlay and Underlay Arts** option.
4. Click **OK**.

Icon	Tool Name	Description
	Preview Line Art and Colour Art	Displays all Art layers.
	Overlay Art	Makes the Overlay Art layer current.

	Line Art	Makes the Line Art layer current.
	Colour Art	Makes the Colour Art layer current.
	Underlay Art	Makes the Underlay Art layer current.

Control Point Toolbar

The Control Point toolbar displays parameters when you select a keyframe or control point in the Camera, Timeline or Xsheet view. You can edit keyframes and control point parameters, such as the continuity, bias, tension and lock-in-time.

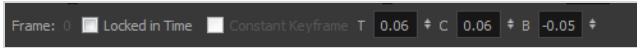

How to access the Control Point toolbar

1. Select **Windows > Toolbars > Control Point**.

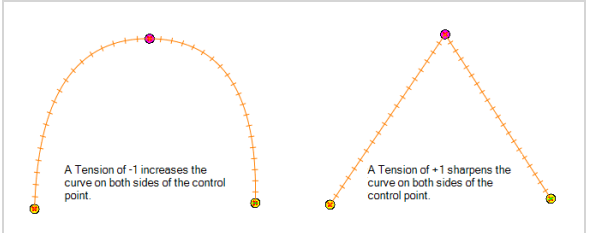
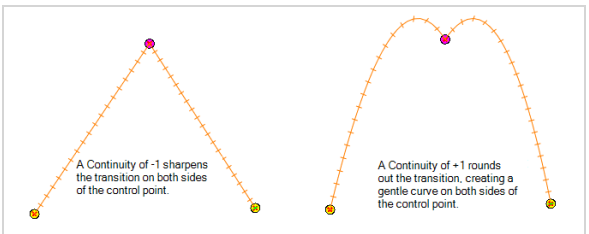
Icon	Tool Name	Description
	Frame	Indicates the current frame.
	Locked in Time	Locks a control point in time, making it a keyframe.
	Constant Keyframe	Removes any interpolation and keeps the keyframe value constant up to the next keyframe.
T	Tension	Controls how sharply the path bends as it passes through a control point or keyframe. 
C	Continuity	Controls the smoothness of a transition between the segments joined by a point. 
B	Bias	Controls the slope of the path so it flows towards one

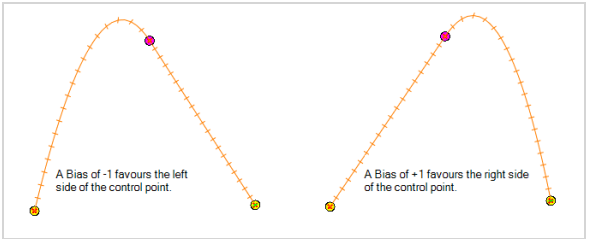
		<p>side of the motion point or the other.</p>  <p>A Bias of -1 favours the left side of the control point.</p> <p>A Bias of +1 favours the right side of the control point.</p>
--	--	---

Coordinate Toolbar

T-ANIMCO2-001-001

The Coordinate toolbar displays parameters of keyframes or control points in the Camera, Timeline or Xsheet view. You can edit keyframes and control point parameters, such as the position, scale and rotation coordinates.



For tasks related to this toolbar, see [Coordinates and Control Points View on page 1228](#).

How to access the Coordinate toolbar

1. Select **Windows > Toolbars > Coordinate**.

Parameter	Description
Translation	The translation fields display the X, Y and Z translation values of the selected layer. You can enter precise values to set the first frame and last frame position of a layer. By default the Z value field is disabled. It will automatically become active when the 3D option is enabled.
Scale	The scale fields display the X, Y and Z scaling values of the selected layer. You can enter precise values to set the first frame and last frame size of a layer. By default the Z value field is disabled. It will automatically become active when the 3D option is enabled.
Rotation	The rotation fields display the X, Y and Z rotation values of the selected layer. You can enter precise values to set the first frame and last frame rotation of a layer. By default the Z value field is disabled. It will automatically become active when the 3D option is enabled.
Skew	The skew field displays skew value of the selected object. You can enter a precise value to set the skew of the object.

Deformation Toolbar



T-RIG-007-009



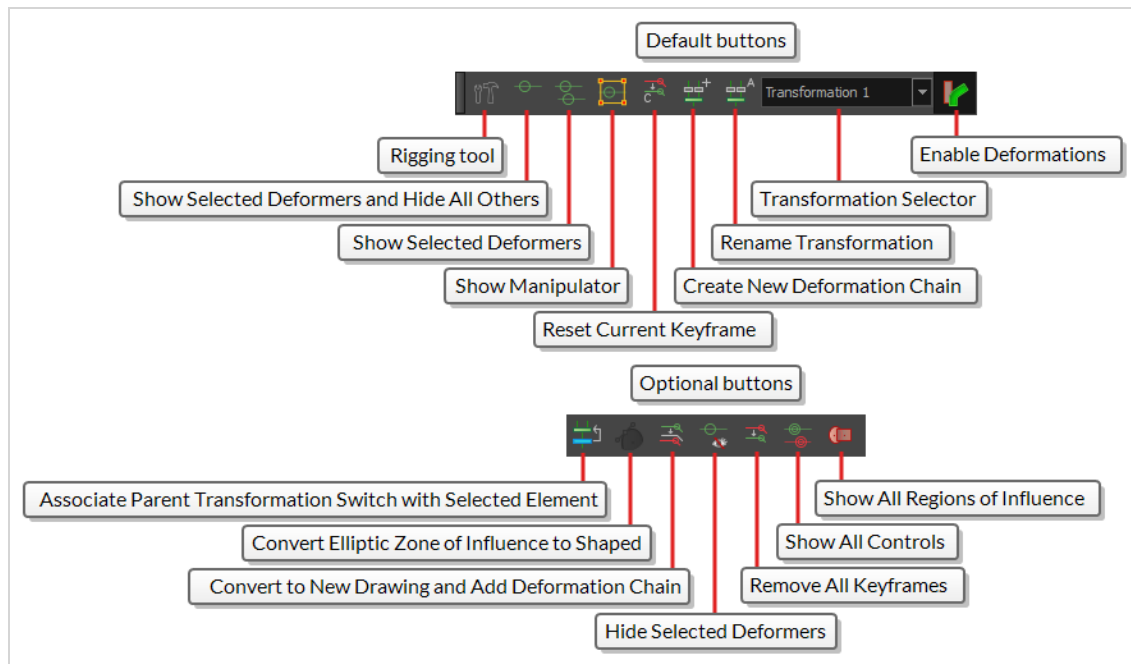

The Deformation toolbar contains the various tools and options used to create a deformation rig. This toolbar is displayed in the default interface.



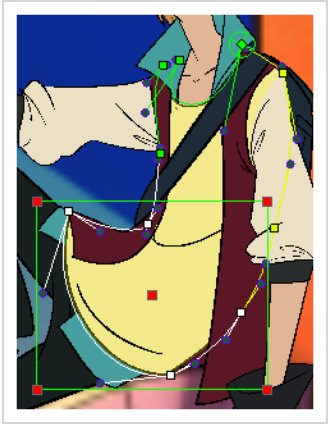

By default, the Deformation toolbar only contains the essential options. If you right-click on the toolbar and select **Customize**, you can add additional buttons.



Default Buttons

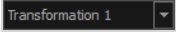





Icon	Tool Name	Description
	Rigging Tool	The Rigging tool is used to create either a Bone or Curve deformation chain. You also use it to set up the resting position. To learn more about the Rigging tool's properties, see Rigging Tool Properties on page 1100.
	Show Selected Deformation Chain and Hide All Others	Displays the deformation controls for the selected element and all of its children in the Camera view, and hides the deformation controls for any other element in your scene.
	Show Selected Deformers	Displays the deformation controls for the selected element and all of its children in the Camera view. If

		deformation controls for other elements are currently visible, they will remain visible as well.
	Show Manipulator	<p>When several points from a curve or envelope deformation chain are selected, this displays a manipulator bounding box around them. Using this manipulator, you can move, rotate and scale the selected points together.</p> 
	Reset Current Keyframe	<p>The Reset Current Keyframe copies the resting position, the original setup of your skeleton before undergoing any deformation, to your current frame. Once you have created a deformation chain, you can use the Rigging tool to adjust the position and appearance of the rig to fit the element. When the skeleton is in place, you can use the Reset Current Keyframe button to reset the current frame position to the resting position.</p>
	Create New Deformation Chain	<p>The Create New Deformation Chain option allows you to create a new deformation chain on a same character. For example, if you have drawings for the different views of your puppet (front, profile, back, etc.), you can use this feature to setup a new set of chains for each angle without having to create completely different puppets.</p>
	Rename Transformation	<p>The Rename Transformation option allows you to give specific names to your different transformation chains. By default, chains are named Transformation plus the number of the chain, such as Transformation 2. You can rename these to identify them easier, such as front, side, back, and so on.</p>

	Transformation Selector	<p>The Transformation Selector drop-down menu allows you to assign an existing chain to a set of drawings. For example you might want to reuse the front deformation chains for another series of drawing.</p> <p>When creating a new drawing, the Default Transformation is assigned. While on the new drawing frames, from the drop-down menu, select a different chain to automatically assign it.</p>
	Enable Deformations	<p>The Enable Deformations button allows you to display your drawings in their original state or with deformations while creating additional drawings. Depending on the artwork you need to create, you might need to refer to the other images either deformed or in their original position.</p> <div data-bbox="852 787 1429 1050" style="border: 1px solid green; padding: 5px;"> <p> NOTE</p> <p>Disabling deformations is only a display mode. Although drawings will not appear deformed in the Camera view, even in Render View mode, they will still be deformed in the rendered images.</p> </div>
	Associate Parent Transformation Switch with Selected Element	<p>Matches the drawing name and drawing location path in the Transformation Switch node's Properties with the drawing name and drawing location path found in the Drawing Layer's Properties. For this button to work, a drawing node connect to a deformation group, with a Transformation Switch inside, must be selected.</p>

Optional Buttons

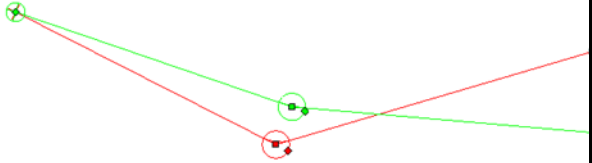
Icon	Tool Name	Description
	Convert Elliptic Zone of Influence to Shape	<p>After you have created a deformation chain using Elliptic as the Zone of Influence type, you can select your deformer and click on this button to convert it to a Shaped type. Control points will appear around the shape making it easy to customize. You can also convert the Elliptic zone of influence to a shape. Select Animation > Deformation > Convert Elliptic Deformation ROI to Shape. This will create a much</p>

		<p>smaller initial zone of influence than if you were to convert it directly to a shape.</p> <div data-bbox="852 283 1429 625" style="border: 1px solid green; padding: 10px;"> <p> NOTE</p> <p>You can also convert the Elliptic zone of influence to a shape. Select Animation > Deformation > Convert Elliptic Deformation ROI to Shape. This will create a much smaller initial zone of influence than if you were to convert it directly to a shape.</p> </div>
	<p>Convert to New Drawing and Add Deformation Chain</p>	<p>Takes the pose/drawing and the deformer of the selected frame and converts it to a new pose/drawing with the corresponding deformer.</p>
	<p>Remove All Keyframes</p>	<p>The Remove All Keyframes option removes all keyframes on the selected deformation chain.</p>
	<p>Show All Controls</p>	<p>The Show All Controls button lets you visualize the resting position in red (Setup mode) and the active position (Animation) in green at the same time</p> <div data-bbox="852 1079 1534 1320" style="border: 1px solid gray; padding: 10px;">  </div>
	<p>Show All Regions of Influence</p>	<p>The Show All Regions of Influence button displays all regions of influence in the deformer in your project. Note that the deformer's controls must be visible in order for its zones of Influence to show. The regions will not be displayed when a deformer's zone of Influence is set to Infinite or Zero.</p>

**NOTE**

Region of influences are not available for Game Bone deformer.

Display Toolbar

The Display toolbar lets you select the different Display nodes available in the node system.



When your scene does not have a Display node, it is automatically set to Display All which uses the Timeline view ordering and shows floating nodes from the Node view. You can also set your scene to use Display All using the Display toolbar.



NOTE

If you try to add a peg or other transformation layer in the Timeline view without having a layer selected, an error message will display. Make sure to change to Display All. The peg layer will be floating in the Node view and will not be visible in the Timeline view. The Timeline view shows only layers that are connected to the Composite node.

If you switch to Display All, you run the risk of not realizing when you have floating nodes that are not connected to your composite. For this reason, it is not recommended to work in Display All mode.

How to access the Display toolbar

1. Select **Windows > Toolbars > Display**.

Easy Flipping Toolbar

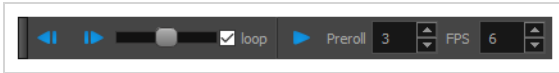

T-LAY-003-007

The Easy Flipping toolbar lets you rapidly flip through drawings in the Drawing view as is done with paper drawings. In order for the features in this toolbar to work, you must be in the Drawing view.



How to access the Easy Flipping toolbar

1. Select **Windows > Toolbars > Easy Flipping**.

Icon	Tool Name	Description
	Previous Drawing	Displays the previous drawing of your animation.
	Next Drawing	Displays the next drawing of your animation.
	Slider	Lets you flip forwards or backwards through your drawings by moving the slider.
	Loop	Displays drawings in the first frame after you reach the last frame of your animation.
	Easy Flip	Automatically flips through the drawings based on the FPS.
	Preroll	Sets the number of drawings to be flipped through before the starting drawing. The starting drawing is determined by the position of the red playhead in the Timeline view.
	FPS	Sets the speed of playback in the units of frames per second.

Edit Toolbar

The Edit toolbar contains common operations such as Undo, Redo, Cut, Copy and Paste. These commands can also be found in the Edit top menu.

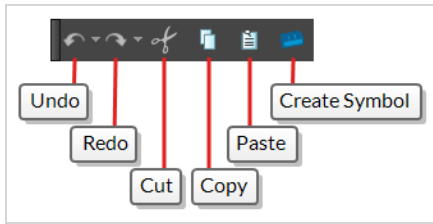

How to access the Edit toolbar

1. Select **Windows > Toolbars > Edit**.



Icon	Tool Name	Description
	Undo	Removes the last change made to your project. Harmony supports multiple undo, so you can undo changes you made in the order you made them.
	Redo	Redoes an operation you have undone. This command is active only after you use the Undo command.
	Cut	Removes selected objects. You can then paste the object or its properties to another object.
	Copy	Copies selected objects and properties.
	Paste	Places an object you cut or copied into the location you select in a view.
	Create Symbol	Creates a symbol from selected drawing elements in the Drawing or Camera view, nodes in the Node view, or a layer or cells in the Timeline view.

File Toolbar

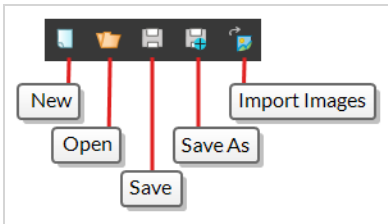
The File toolbar contains buttons for common file operations such as New, Save and Open. These commands can also be found in the File top menu.









NOTE

The  New, and  Save As buttons are only available in Harmony Stand Alone. With Harmony Server,  Control Center must be used to create scenes.

How to access the File toolbar

1. Select **Windows > Toolbars > File**.

Icon	Tool Name	Description
	New (Harmony Stand Alone)	Creates a new scene while closing any scene already open. The New Scene dialog box opens, asking for directory, name, and resolution information.
	Open	Displays the Open Scene dialog box where you can browse for a scene file. You can open a new scene from the current one and the previous scene will close.
	Save	Saves all changes made to the opened scene, drawings, palettes, and palette lists.
	Save As	Saves the current file with a different name and at a different location. Saves the current state of a scene as another scene. The Save As window prompts you for a new name and a different location for this scene before saving it. This will create a complete scene directory for the new scene.

Icon	Tool Name	Description
		<div style="border: 1px solid #c8e6c9; padding: 10px;">  <p>NOTE The scene name cannot exceed 23 characters.</p> </div>
	<p>Import Images</p>	<p>Imports bitmap images which you can choose to vectorize.</p>







Flip Toolbar

The Flip toolbar lets you determine the type of drawing to include in your flipping selection. You can flip through the key, breakdown or in-between drawings individually, or view a combination.



How to access the Easy Flipping toolbar

1. Select **Windows > Toolbars > Easy Flipping**.

Icon	Tool Name	Description
	Show Key Drawings	Displays key drawings when flipping through drawings.
	Show Breakdown Drawings	Displays breakdown drawings when flipping through drawings.
	Show In-between Drawings	Displays in-between drawings when flipping through drawings.
	Show Retake Key Drawings	Displays retake key drawings when flipping through drawings.
	Show Retake Breakdown Drawings	Displays breakdown retake drawings when flipping through drawings.
	Show Retake In-between Drawings	Displays retake in-between drawings when flipping through drawings.



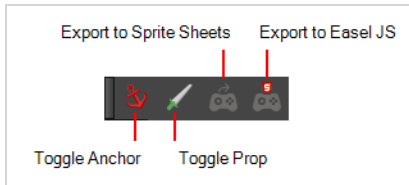

Game Toolbar

The Game toolbar contains tools for setting anchors and props, as well as exporting to sprite sheets and Easel JS.



How to access the Game toolbar

1. Select **Windows > Toolbars > Game**.

Icon	Tool Name	Description
	Toggle Anchor	Adds the Anchor parameter to the selected layer.
	Toggle Prop	Adds the Prop parameter to the selected layer.
	Export to Sprite Sheets	Opens the Export to Sprite Sheets window where you can export your animation as sprite sheets .
	Export to Easel JS	Opens the Export to Easel JS window where you can export your animation as Easel JS.







Mark Drawing Toolbar

The Mark Drawing toolbar lets you identify drawings such as key, breakdown and in-between. The drawing Identification feature can help the animator stay well organized and save time when identifying key, breakdown or in-between drawings in the Xsheet and Timeline views.



How to access the Mark Drawing toolbar

1. Select **Windows > Toolbars > Mark Drawings**.

Icon	Tool Name	Description
	Mark as Key Drawing	Identifies the selected drawing as a key drawing.
	Mark as Breakdown Drawing	Identifies the selected drawing as a breakdown drawing.
	Mark as In-between Drawing	Identifies the selected drawing as an in-between drawing.
	Mark as Retake Key Drawing	Identifies the selected drawing as a key retake drawing.
	Mark as Retake Breakdown Drawing	Identifies the selected drawing as a breakdown retake drawing.
	Mark as Retake In-between Drawing	Identifies the selected drawing as a in-between retake drawing.

Master Controller Toolbar



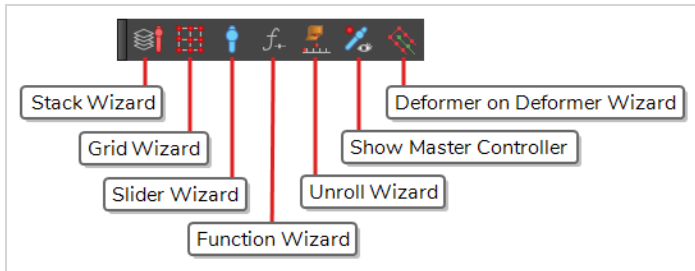

T-RIG3-008-002



The Master Controller toolbar allows you to launch one of the wizards that are packaged with Harmony which can be used to generate Master Controller widgets.



How to access the Master Controller toolbar

1. Do one of the following:
 - In the top menu, select **Windows > Toolbars > Master Controller**.
 - Right-click on any existing toolbar and select **Master Controller**.

Icon	Tool Name	Description
	Stack Wizard	Opens the Master Controller Stack Wizard, which allows you to create a Master Controller that combines a 2D point widget and a slider. The 2D point widget can be used to rotate part of your rig in any direction, used a grid of preset poses, and the slider can be used to switch between different grids of poses.
	Grid Wizard	Opens the Master Controller Grid Wizard, which allows you to create a Master Controller with a 2D point widget that can be used to rotate part of your rig in any direction, using a grid of preset poses—see Master Controller Grid Wizard Dialog Box on page 121 .
	Slider Wizard	Opens the Master Controller Slider Wizard, which allows you to create a Master Controller with a slider widget which can be used to change the pose of part or all of your rig, based on a line-up of 2 or more poses—see Master Controller Slider Wizard Dialog Box on page 225 .
	Unroll Poses Wizard	Opens the Unroll Poses Wizard, which allows you to take an existing Master Controller and break it into the set of poses that were used to generate it. You can then make changes to the poses and generate an updated Master Controller.

Icon	Tool Name	Description
	Function Wizard	Opens the Function Wizard, which allows you to create a custom Master Controller that controls a specific parameter in a selection of one or several drawings or nodes.
	Show Master Controllers	If you selected a group containing Master Controllers, or multiple nodes in which there are Master Controllers, this will open a dialog allowing you to select some or all of these Master Controllers and to display their controls in the Camera view.
	Deformer on Deformer Wizard	Opens the Deformer on Deformer Wizard, which allows you to create a Curve deformer over an Envelope deformer. The Curve deformer will be converted to a set of Master Controller widgets which can be used to deform the points of the Envelope deformer, which will in turn deform the drawing it is rigged to. This makes it possible to combine the versatility of an Envelope deformer with the ease of use of a Curve deformer—see See Deformer On Deformer Wizard Dialog Box on page 58.

Mini Playback Toolbar

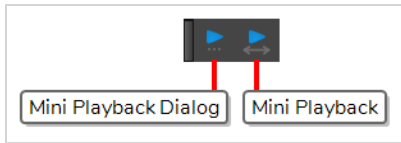

The Mini Playback toolbar allows you to quickly preview a short span of animation starting a few frames before the current frame and ending a few frames after the current frame, at a customizable frame rate.



How to add the Mini Playback toolbar to your workspace

1. Do one of the following:





- In the top menu, select **Windows > Toolbars > Mini Playback**.
- Right-click on any existing toolbar and select **Mini Playback**.

Icon	Tool Name	Description
	Mini Playback Dialog	Open the Mini Playback dialog. This dialog allows you to set the amount of frames before and after the current frame to playback when using Mini Playback, to set the speed of Mini Playback and to start Mini Playback.
	Mini Playback	Begins Mini Playback using the last settings entered in the Mini Playback dialog. By default, Mini Playback will play 5 frames before and after the current frame, at the scene's frame rate.

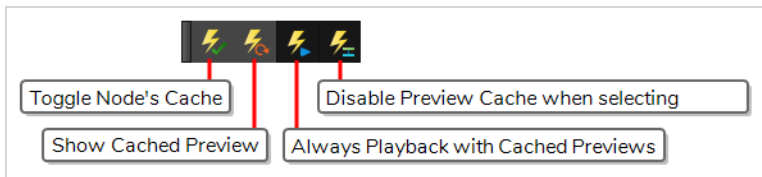
Node Caching Toolbar

The Node Caching toolbar allows you to control how nodes in your scene are cached.



Icon	Button	Description
	Toggle Node's Cache	Toggles the Cached property of every selected node on or off.
	Show cached preview	Re-enables cache for every element or rig in your scene for which it was temporarily disabled.
	Always Playback with Cached Previews	When toggled on, if you play your scene, the cache will be re-enabled for every element for which it was temporarily disabled.
	Disable Preview Cache when selecting nodes	When toggled on, selecting a node in the Timeline or Node view will disable caching for this node, or for any node connected underneath it. <div data-bbox="537 1178 1430 1409" style="border: 1px solid green; padding: 10px; margin-top: 10px;"> <p> NOTE</p> <p>Selecting an element in the Camera view always disables the cache for this element and its children, regardless of whether this option is enabled or disabled. This option only affects what happens when selecting in the Timeline or Node view.</p> </div>

Onion Skin Toolbar

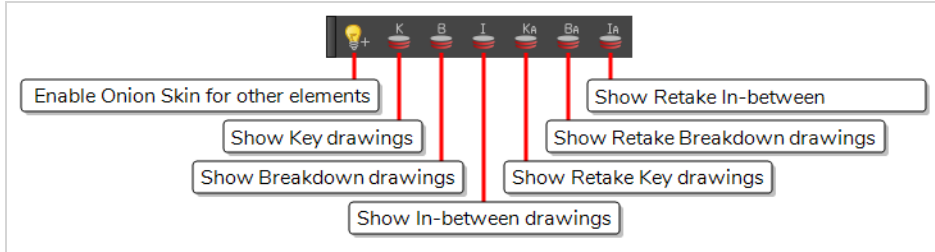

The Onion Skin toolbar contains a few options that can be used with Onion Skin. Specifically, you can use it to quickly toggle the Enable Onion Skin for other elements option, as well as to only display drawings with specific markers in the Onion Skin.



How to access the Onion Skin toolbar

1. Select **Windows > Toolbars > Onion Skin**.

Icon	Tool Name	Description
	Enable Onion Skin in Other Elements	In the Drawing View, when the Light Table is enabled, making other layers visible alongside the current layer, this will make the Onion Skin for other visible layers appear alongside the Onion Skin for the current layer. Drawings for elements above the current layer will appear in blue, and drawings for elements below will appear in yellow. NOTE The drawings from other elements that get displayed in the Onion Skin are the drawings that are exposed at the same time as the drawings displayed in the current layer's Onion Skin.
	Show Key Drawings	Only displays drawings marked as key drawings in the Onion Skin.
	Show Breakdown Drawings	Only displays drawings marked as breakdowns in the Onion Skin.
	Show In-between Drawings	Only displays drawings with no marker in the Onion Skin. Drawings with no marker are considered in-betweens.
	Show Retake Key Drawings	Only displays drawings marked as retake key drawings in the Onion Skin.

Icon	Tool Name	Description
	Show Retake Breakdown Drawings	Only displays drawings marked as retake breakdowns in the Onion Skin.
	Show Retake In-between Drawings	Only displays drawings marked as retake in-betweens in the Onion Skin.



Pen Settings Toolbar

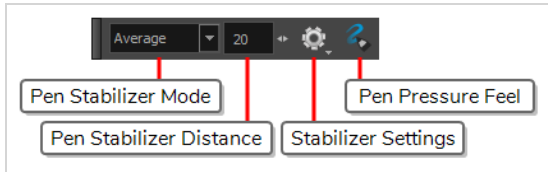





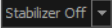

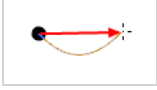

The Pen Settings toolbar provides options for enabling and configuring the Pen Stabilizer, which can help you draw smooth lines with precision and minutia. It also allows you to access the Pen Pressure Feel dialog, which allows you to configure how the pressure you apply to your tablet pen is processed by Harmony to affect the size of your drawing strokes.



NOTE

For information on how to use the Pen Settings toolbar, refer to the User Guide.

Icon	Parameter	Description
	Pen Stabilizer Mode	<p>Allows you to select a method for Harmony to stabilize your drawing strokes.</p> <p>Stabilization is a process by which Harmony uses the general direction of your drawing strokes to create smooth, stable curves and avoid jittering and sharp corners.</p> <p>Harmony accomplishes this by letting you draw a stroke of a certain length without generating artwork right away. After your stroke has reached that length, Harmony starts generating an drawing stroke that keeps trailing behind your mouse cursor or tablet pen as you draw. Harmony uses the buffer between your mouse cursor or pen tablet and the actual drawing stroke to generate smooth curves and ignore jittering and small mistakes.</p> <p>The way Harmony does this depends on the stabilization method you choose:</p> <ul style="list-style-type: none"> Stabilizer Off: No stabilization is performed. When you draw a stroke, artwork for it is generated immediately. Average: Harmony calculates the average direction of all of your mouse or pen gestures between the end of the actual drawing stroke and the current position of your mouse cursor or pen tip, and extends the stroke in this average direction, effectively evening out jitter and rounding sharp turns.  <ul style="list-style-type: none"> Pulled String: When you start drawing a stroke, Harmony positions the drawing tool where your stroke starts. As you move the mouse or tablet pen, the drawing tool remains in that position, but a "string" appears, linking your drawing tool to your mouse cursor or pen tip.



Icon	Parameter	Description
		 <p>This string has a certain maximum length. Once that length is reached, the string pulls the drawing tool in the direction of your mouse cursor or tablet pen.</p>  <div data-bbox="581 615 1430 814" style="border: 1px solid green; padding: 5px;"> <p> NOTE</p> <p>The distance between your mouse cursor or tablet pen and the stroke can be adjusted. For the purpose of demonstration, these images were done using the largest supported distance.</p> </div>
	Pen Stabilizer Distance	<p>This parameter determines how far your drawing strokes trail behind your mouse cursor or tablet pen as you draw.</p> <p>In the case of the Average technique Harmony lets you draw an invisible stroke of a certain length before it starts generating the artwork based on the average direction of that invisible stroke. This parameter determines the invisible stroke's length.</p> <p>In the case of the Pulling String, Harmony binds your drawing tool to your mouse cursor or tablet pen with a virtual string of a given length. This parameter sets the length of that string.</p>
	Pen Stabilizer Settings	<p>Allows you to enable or disable the following options:</p> <ul style="list-style-type: none"> • Catch Up: When using stabilization, your drawing strokes trail behind your mouse cursor or tablet pen. With this option enabled, when you stop moving your pen and just leave it pressed against your tablet, the brush stroke will progressively catch up to the position of your pen. <div data-bbox="581 1472 1430 1661" style="border: 1px solid green; padding: 5px;"> <p> NOTES</p> <ul style="list-style-type: none"> • This option only works if you are drawing with a pen tablet. • This option only works with the Average stabilization method. </div> <ul style="list-style-type: none"> • Show String: When using the Pulled String method, the virtual string binding your drawing tool to your mouse cursor or tablet pen will be displayed as you draw, allowing you to visualize how the brush stroke trails behind your mouse cursor or tablet pen. • Eraser: If enabled, strokes with the  Eraser tool will also be stabilized. By default, the stabilizer works with the  Brush,  Pencil and  Stroke tools.



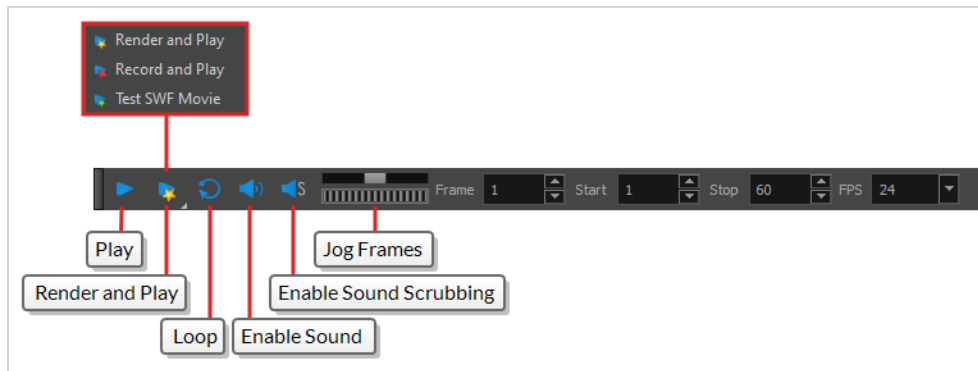

Icon	Parameter	Description
	Pen Pressure Feel	Opens the Pen Pressure Feel dialog, which allows you to configure how Harmony processes the pressure you put on your tablet pen before applying it to the thickness of your drawing strokes—see Pen Pressure Feel Dialog Box .



Playback Toolbar

The Playback toolbar allows you to play your animation as well as to set some playback options such as looping, audio playback, playback range and playback speed.



Name	Button	Description
Play		Plays the scene in the Camera or Drawing view. You can also select Play > Play or Stop from the top menu.
Render and Play		Renders your scene's frames, then opens the rendered frames in Play for playback. This allows you to preview your scene's animation in real time, with the effects rendered and with no risk of slowdown. You can click and hold this button to switch its mode to Record and Play or Test SWF Movie .
Record and Play		Exports your scene as it appears in the Camera view into a movie file, then opens it in your workstation's default video player. This allows you to preview your animation without any risk of slowdown, but it does not preview the effects in your scene. However, it is much faster than Render and Play.
Test SWF Movie		Quickly exports your scene as a Flash Movie (.swf), then opens it in your workstation's default web browser.

<p>Enable Loop</p>		<p>If pressed, your scene will repeat indefinitely when playing. Otherwise, it will stop when the end is reached.</p> <p>You can also select Play > Loop from the top menu.</p>
<p>Enable Sound</p>		<p>When pressed, your scene's soundtrack will play during playback.</p> <p>You can also select Play > Enable Sound from the top menu.</p>
<p>Enable Sound Scrubbing</p>		<p>When pressed, you will hear a sample of your scene's soundtrack at the current frame when moving your scene's playhead in the Timeline view.</p> <p>This allows you to easily situate where the action is relative to the sound track.</p> <p>You can also select Play > Enable Sound Scrubbing.</p>
<p>Jog Frames</p>		<p>Allows you to quickly play your scene forward or backward to preview your animation.</p> <p>Moving the handle towards the right will play your scene forward, while moving it towards the left will play your scene backward.</p> <p>The closer to the edge you move the handle, the faster the playback will be, allowing you to dose the speed at which your scene is played. When the handle is at the edge, your scene will play at its actual framerate.</p> <p>Once the head is released, it returns to the middle and playback stops.</p>
<p>Frame</p>		<p>Lets you manually enter the current frame number, setting the playhead's position.</p>
<p>Start</p>		<p>Let's you manually enter the number of the first frame to play during playback.</p>

		 TIP You can also click on Start (just left of the input field) to quickly set the Start frame to the current frame.
Stop		<p>Let's you manually enter the number of the first frame to play during playback.</p>  TIP You can also click on Stop (just left of the input field) to quickly set the Stop frame to the current frame.
FPS (Frames per second)		<p>Lets you set the amount of frames that should be played during every second of playback, which is how the playback speed is determined.</p>  NOTE This does not change the frames per second setting in your scene's resolution settings.

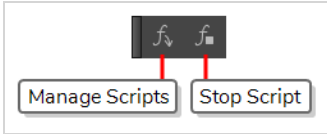

Scripting Toolbar

The scripting toolbar allows you to create buttons that run functions in your scripts. You can add one button for each function you want to be able to run, and clicking on the button will instantly run the script function you linked it to.



How to add the Scripting toolbar to your workspace

1. Do one of the following:
 - In the top menu, select **Windows > Toolbars > Scripting**.
 - Right-click on any existing toolbar and select **Scripting**.

Icon	Tool Name	Description
	Manage Scripts	Opens the Scripts Manager dialog box where you can add scripts and functions to your Scripting toolbar.
	Stop Script	Stops the execution of a script launched from the Scripting toolbar.

Shift and Trace Toolbar

The Shift and Trace toolbar allows you to temporarily move, rotate and scale drawings, then trace over them in other drawings using Onion Skin. Contrary to Shift and Trace with the Drawing Desk, you can use the Shift and Trace toolbar in the Camera view.

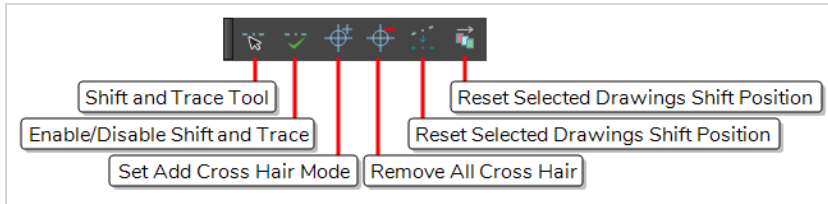





How to access the Shift and Trace toolbar



1. Do one of the following:
 - In the top menu, select **Windows > Toolbar > Shift and Trace**.
 - Right-click on any existing toolbar and select **Shift and Trace**.



NOTE

You can also select the Shift and Trace  tool from the Tools toolbar, under the pop-up menu of the Hand  tool. When the Shift and Trace tool is active, all the commands in the Shift and Trace toolbar are available in the Tool Properties view.

Icon	Tool Name	Description
	Shift and Trace Tool	<p>Enables the Shift and Trace tool, with which you can temporarily offset, rotate and scale drawings.</p> <p>The transformations done on drawings with the Shift and Trace tool are only meant to allow you to trace these drawings, and can be undone at any time to reset the drawings back to their intended position.</p> <p>Selecting the Shift and Trace tool also enables Shift and Trace and Onion Skin.</p>
	Enable/Disable Shift and Trace	<p>Enabled by default. When disabled, drawings that were repositioned, rotated or scaled with the Shift and Trace tool appear in their original position.</p>
	Set Add Cross Hair Mode	<p>When selected, clicking on the drawing will add a cross hair where you click. Cross hairs are marks that appear on the same location on every drawing in the current layer and which move when you offset a drawing with the Shift and Trace tool, and they appear in the Onion Skin rendition of neighbouring drawings as</p>

Icon	Tool Name	Description
		well. This allows you to keep track of how offset each drawing is.
	Remove All Cross Hair	Removes all the cross hairs created for shift and trace.
	Reset Selected Drawings Shift Position	Undoes all transformations done with the Shift and Trace tool on the selected drawings, resetting them to their original position, angle and scale.
	Reset All Drawings Shift Position	Undoes all transformations done with the Shift and Trace tool on all drawings, resetting them to their original position, angle and scale.



Tool Presets Toolbar

The Tool Presets toolbar lets you create new tool presets and manage them.



How to access the Tool Presets toolbar

1. Select **Windows > Toolbars > Tool Presets**.

Icon	Tool Name	Description
	New Tool Preset	Creates a new tool preset from the current tool settings.
	Manage Presets	Opens the Manage Tool Preset dialog box where you can update, organize, and delete existing presets.

Tools Toolbar

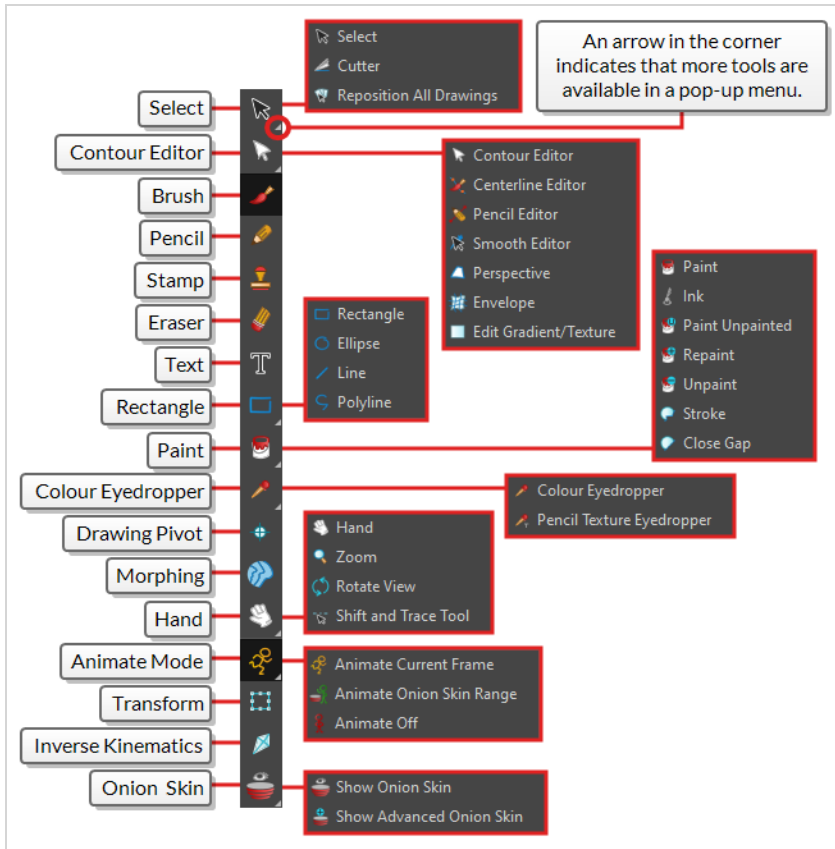

The Tools toolbar contains the main tools you need to work in Harmony. In the default workspace, this toolbar is located on the left edge of the application window.

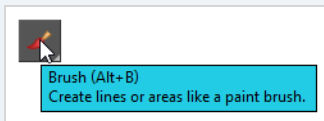

TIP

Many toolbar buttons have a keyboard shortcut associated to them. You can check which keyboard shortcut is associated to a button by leaving your mouse cursor over the button for a second. If the button has a keyboard shortcut, it will be indicated in the tooltip that appears.



By default, the Tools toolbar hides some of its tools inside pop-up menus. For example, to select the  Cutter tool, you must double-click or long-click the  Select tool button, and select  **Cutter** in the pop-up menu.

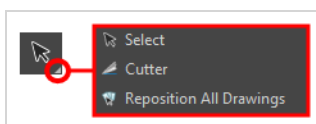

However, it is possible to make the Tools toolbar display each tool as a separate button by enabling the **Flat Tools Toolbar** preference. This makes the selection of tools quicker.

How to make every tool in the Tools toolbar display in buttons rather than pop-up menus

1. Do one of the following to open the Preferences dialog:
 - **Windows or GNU/Linux:**
 - In the top menu, select **Edit > Preferences**.
 - Press **Ctrl + U**.
 - **macOS:**
 - In the top menu, select **Harmony Premium > Preferences**.
 - Press **⌘ + U**.
2. Select the **General** tab.
3. In the **Options** section, check the **Flat Tool Toolbar** option.
4. Click **OK**.
5. Close and relaunch Harmony.



NOTE



In Flat Tools Toolbar mode, some tools are hidden from the Tools toolbar by default. To customize which tools are displayed in the Tools toolbar, and the order in which they are displayed, right-click on the Tools toolbar and select **Customize**.





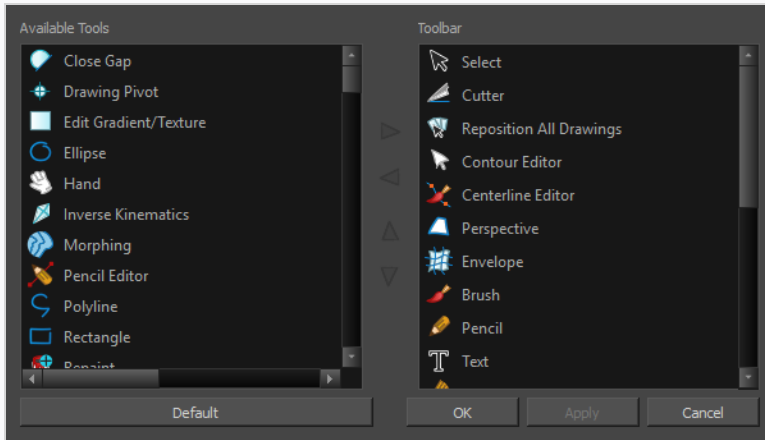

How to customize which tools are displayed in the Tools toolbar when it is in Flat mode

1. Right-click on the Tools toolbar and select **Customize**.

















The Toolbar Manager dialog appears.













2. In the Available Tools list, select each tool that you want to add to the Tools toolbar, then click on the Add the selected tool to the toolbar  button.
3. In the Toolbar list, select each tool that you want to remove from the Tools toolbar, then click on the Remove the selected tool from the toolbar  button.

Tool Name	Icon	Description
Select		Allows you to select and reposition, scale, rotate and skew brush strokes, pencil lines, shapes and other parts of your artwork.
Cutter		Allows you to cut a part of your artwork, then reposition, scale, rotate and skew it.
Reposition All Drawings		Allows you to reposition, scale, rotate and skew all drawings in the current layer.
Contour Editor		Allows you to edit the vector contours of brush strokes, pencil lines and shapes in your artwork. You can add, remove, tweak and move vector points, move the Bezier handles of the vector points as well as deform vector outlines.
Centerline Editor		Allows you to tweak and deform a brush stroke by manipulating the points at the centre of its line rather than its contour.
Pencil Editor		Allows you to adjust the thickness of a pencil line at its different points and corners, tweak the shape of its extremities and scale its texture.
Smooth Editor		Allows you to optimize contours and lines by removing its extra points, making them easier to edit.

Perspective		Allows you to deform artwork by applying a perspective effect on it.
Envelope		Allows you to deform and warp artwork by moving points and tweaking lines in a grid.
Edit Gradient/Texture		Allows you to adjust the position, angle and size of gradients and textures in a colour zone.
Brush		A pressure-sensitive tool for creating a contour shape with a thick and thin line effect, as if created with a paint brush.
Pencil		A pressure-sensitive tool for drawing outlines. Pencil lines are made of central vector lines, making them easier to tweak and edit than brush strokes.
Text		Allows you to add text and to format it.
Eraser		A pressure-sensitive tool for erasing parts of a drawing.
Paint		Allows you to fill colour zones with a colour or texture.
Ink		Allows you to recolour pencil lines with precision by changing the colour of one segment at a time.
Paint Unpainted		Allows you to quickly fill empty zones in your artwork with a colour or texture, leaving filled zones unchanged.
Repaint		Allows you to quickly repaint painted zones in your artwork. Empty zones will remain empty.
Unpaint		Allows you to empty filled colour zones of their colour and texture.
Stroke		Allows you to create invisible lines that can serve as colour zones that can be filled, or close the gaps in existing colour zones.
Close Gap		Allows you to close open shapes so that they can be filled with the Paint tool. By drawing a stroke near a small gap in a shape, this tool will create

		a small invisible stroke connecting the two closest points around the gap.
Line		Draws a straight line segment going from one point to the other.
Rectangle		Draws a rectangle.
Ellipse		Draws an ellipse.
Polyline		Allows you to draw shapes, segmented lines or complex curved lines by clicking to create each point in the sequence of line segments.
Colour Eyedropper		Allows you to select a colour by clicking on a colour in your artwork.
Pencil Texture Eyedropper		Allows you to select a pencil texture by clicking on a textured pencil line.
Drawing Pivot		Allows you to position the pivot on a drawing layer by clicking where you want its location to be.
Morphing		Allows you to create and configure a morphing sequence, which will automatically generate the in-betweens between two drawings in the current layer.
Hand		Allows you to pan the Camera and Drawing views.
Zoom		Allows you zoom in and out of the Camera and Drawing views.
Rotate View		Lets you rotate the Camera and Drawing views just like with a real animation disc.
Shift and Trace		Allows you to temporarily move drawings so you can trace over them in other drawings using Onion Skin.
Animate Current Frame		When this option is selected, every time you use the  Transform,  Advanced Animation or  Inverse Kinematic tools to

		manipulate an element in your scene, the position of the element will be stored in a keyframe at the current frame. This allows you to animate elements in your scene without creating keyframes manually.
Animate Onion Skin Range		When this option is selected, if you use the  Transform or  Advanced Animation tools to make transformations to an element in your scene, the transformations will be stored as keyframes at the beginning and at the end of the current Onion Skin range, as well as on every existing keyframe in-between. This can be useful if you want to reposition an element that you have already animated, but only during a specific range of frames, which you can define by enabling Onion Skin and setting the Onion Skin range to cover that range of frames.
Animate Off		When this option is selected, if you use the  Transform or  Advanced Animation tools to make transformation to an element in your scene, the transformations will affect the element throughout the whole scene. This can be useful if you want to reposition an element after you have already animated it.
Transform		Allows you to select drawing layers and position, rotate, scale and skew them.
Inverse Kinematics		Allows you to pose a character model by pulling on its extremities, such as hands and feet, and have the other connected limbs follow. Can be used on any piece connected in a hierarchy.
Onion Skin		Displays the previous and next frames of an animation. Useful when animating cut-out characters.
Advanced Onion Skin		Enables Advanced Onion Skin, a more flexible kind of Onion Skin that can be easily configured using the Onion Skin view.

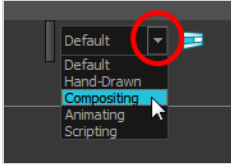

Workspace Toolbar

The Workspace toolbar lets you load other workspaces. The first time you start Harmony, the default workspace is loaded. Other workspaces are available such as the Hand-Drawn Animation and Compositing workspaces; these display different views and toolbars. You can access these workspaces and any you create, from the Windows menu and the Workspace toolbar.



How to access the Workspace toolbar

1. Select **Windows > Toolbars > Workspace**.

Icon	Tool Name	Description
	Workspace List	Allows you to select an existing workspace.
	Workspace Manager	Opens the Workspace Manager where you can organize, display, and remove workspace from your list.
	Save Workspace	When the Automatically Save Workspace preference is disabled, the Save Workspace button becomes available. This allows you to manually save your new workspace configuration.

View Toolbars

Harmony has a series of view specific toolbars that are only available in a given view. These toolbars can be moved only within their view.

All view toolbars can be added, as long as the view is visible, through the top menu **Windows > Toolbars > desired toolbar**.

3D Graph View Toolbar	1185
Animated Matte Generator Toolbar	1186
Script Editor Toolbar	1189
Timeline View Toolbar	1194
Xsheet View Toolbar	1199

3D Graph View Toolbar

The 3D Graph toolbar works in conjunction with the elements in the 3D Graph view.



How to access the 3D Graph toolbar

1. With the 3D Graph view open in your workspace, do one of the following:
 - From the top menu, select **Windows > Toolbars > 3D Graph**.
 - Right-click on the top area of the 3D Graph view and select **3D Graph**.



NOTE

This toolbar is for use with the 3D Graph view. For more information on this view, see [3D Graph View on page 1202](#).

Icon	Functionality	Description
	Enable Subnode	Enables the selected subnode, making it and all its enabled children visible. You can also enable a selection of multiple subnodes.
	Disable Subnode	Disables the selected subnode, making it and all its children invisible. You can also disable a selection of multiple subnodes.
	Make Properties Available	When the 3D model is connected to a Subnode Animation node, this will add the properties (ie: position, angle, scale) of the selected subnode to the Subnode Animation node's list of properties in the Timeline view. This is useful if you want to add keyframes to a subnode before animating it or if you want to outline which subnodes should be animated and which ones should not.
	Add 3D Kinematic Output	Creates a 3D Kinematic Output node and connects it under the 3D Model's Subnode Animation node. This 3D Kinematic Output node will be configured to use the currently selected subnode's animation. You can then connect this 3D Kinematic Output node to an element in your scene to apply the selected subnode's animation to that element.

Animated Matte Generator Toolbar

The Animated Matte Generator toolbar displays by default at the top of the Animated Matte Generator view, adding some extra functionalities for editing and animating Animated Matte Generator nodes.

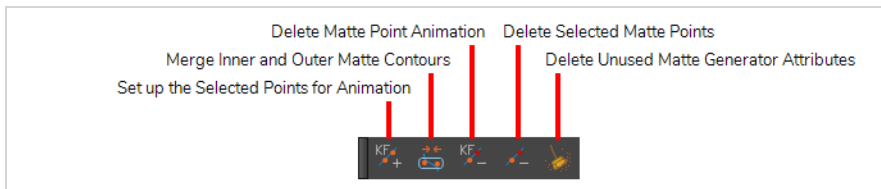

How to access the Animated Matte Generator toolbar

1. Add the Animated Matte Generator view to your workspace by doing one of the following:
 - From the top-right corner of any currently visible view, click the Add View **+** button and select **Animated Matte Generator**.
 - From the top menu, select **Windows > Animated Matte Generator**.
2. Click on the Animated Matte Generator to set the focus on it.
3. In the top menu, select **Windows > Toolbars > Animated Matte Generator**.









NOTE

This toolbar is for the Animated Matte Generator view. For information about the options and functionalities of the Animated Matte Generator view, see [Animated Matte Generator View on page 1204](#).

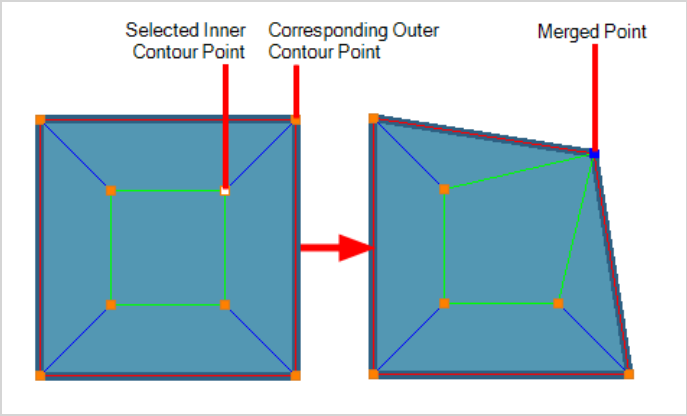
Icon	Functionality	Description
	Set up the Selected Points for Animation	<p>Adds the attribute for the position and handles of the selected matte point(s) to the list of visible attributes for the Animated Matte Generator node in the Timeline view.</p> <p>If you expand the parameters of an Animated Matte Generator toolbar in the Timeline view, by default, you will see its interpolation factor and its colour properties, which are animatable, but you will not see the attributes of each of the control points of the matte contours.</p>

Icon	Functionality	Description
		<div data-bbox="748 283 1433 674" data-label="Image"> </div> <p data-bbox="748 705 1433 842">Attributes for a point are automatically added to the node's list of attributes if you animate the point in the Camera view. A keyframe is created at the same time for these attributes, to record the point's position.</p> <div data-bbox="748 867 1433 1052" data-label="Image"> </div> <p data-bbox="748 1056 1433 1108">By moving one of the matte's points in the Camera view, attributes for that point and its handles are added to the list and a keyframe is created for these attributes.</p> <p data-bbox="748 1146 1433 1276">You can use this button to add the attributes of the currently selected control points in the matte contour to the list of attributes of the Animated Matte Generator node in the Timeline view, without requiring you to animate them first.</p> <div data-bbox="748 1304 1433 1551" data-label="Image"> </div> <p data-bbox="748 1566 1433 1633">By selecting another point and clicking on the Set up the Selected Points for Animation button, attributes for the point and its handles are added to the list without creating keyframes for them.</p> <p data-bbox="748 1675 1433 1776">This can serve as an indication to animators as to which control points they are supposed to animate and which ones should be left in their default position.</p>
	<p data-bbox="321 1837 630 1894">Merge Inner and Outer Matte Contours</p>	<p data-bbox="748 1843 1401 1873">By default, the points in the animated matte generator's outer</p>

Icon	Functionality	Description
		<p>contour and their corresponding points from the inner contour are locked together, allowing you to animate a single matte instead of two mattes. If you disable one of the contours by toggling off the Outer Contour  or Inner Contour  visibility buttons in the Animated Matte Generator view, you can animate the other contour's points separately from the hidden contour, which causes the points to be separated. This command puts separated contour points from the inner and outer contours in the same position, and locks them back together, as they were initially.</p> 
	Delete Matte Point Animation	Deletes every keyframe in the scene for the selected matte points, as well as their attributes in the Timeline view. This resets the selected points to their original position and makes them static throughout the scene.
	Delete Selected Matte Point	<p>Deletes the selected matte control points from the contour.</p> <div data-bbox="750 1402 1433 1633" style="border: 1px solid green; padding: 5px;"> <p> NOTE</p> <p>If a point from one of the two contours is deleted, the corresponding point from the other contour will also be deleted. It is not possible to have a different amount of points on a matte's inner and outer contours.</p> </div>
	Delete Unused Matte Generator Attributes	This cleans up the list of attributes for the Animated Matte Generator layer in the Timeline view by removing attributes that have been created for points that no longer exist. For example, points that were created for a drawing that was deleted, or for a part of a drawing that was erased or modified.



Script Editor Toolbar

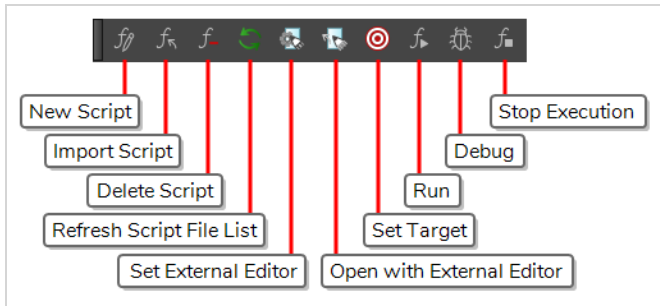

The Script Editor toolbar gives you quick access to some commonly used commands for editing and testing scripts in the Script Editor view—see [Script Editor View on page 1270](#).



















How to access the Script Editor toolbar

1. Add the Script Editor view to your workspace by doing one of the following:
 - In the top-right corner of an existing view, click on the **+** Add View button and select Script Editor.
 - In the top menu, select **Windows > Script Editor**.
2. Click on the Script Editor view to set the focus on it.
3. In the top menu, select **Windows > Toolbars > Script Editor**.

Icon	Button	Description
	New Script	<p>Creates a new script. When you click on this button, you are first prompted to type in a name for the script. Then, you will be prompted to select which location to save the script in:</p> <ul style="list-style-type: none"> • User: Saves the script to a directory in your user preferences directory. You will be able to run and edit the script from any scene as long as you are logged in as the same user. <div style="border: 1px solid green; padding: 10px; margin: 10px 0;"> <p> NOTE</p> <p>If you are using Harmony Stand Alone, the script will be saved to the preferences for your account on your computer. If you are using Harmony Server, the script will be saved to the preferences for your Harmony database user.</p> </div> <ul style="list-style-type: none"> • Global: If you are using Harmony Server, select this option to save the script to the Harmony database's global script directory. Anyone who is logged in to the database will be able to edit and run this script.

Icon	Button	Description
		<ul style="list-style-type: none"> • Environment: If you are using Harmony Server, select this option to save the script to the current scene's environment. Anyone will be able to edit and run the script as long as they are working on a scene inside this environment. • Job: If you are using Harmony Server, select this option to save the script to the current scene's job. Anyone will be able to edit and run the script as long as they are working on a scene inside this job. • Scene: Save the script to the scene's scripts sub-folder. Anyone will be able to edit and run the script when working on this specific scene. • System Variable: Save the script to the directory in the TOONBOOM_GLOBAL_SCRIPT_LOCATION environment variable. This option is only available if this environment variable is set. <div data-bbox="503 751 1429 898" style="border: 1px solid green; padding: 5px; margin-top: 10px;">  NOTE For more information on script locations, see Script list on page 1270. </div>
	Import Script	<p>Allows you to import a script from your machine into Harmony. When you click on this button, you are prompted to browse for and select a script on your file system. Then, you are prompted to select which location to import the script in:</p> <ul style="list-style-type: none"> • User: Saves the script to a directory in your user preferences directory. You will be able to run and edit the script from any scene as long as you are logged in as the same user. <div data-bbox="581 1213 1429 1444" style="border: 1px solid green; padding: 5px; margin-top: 10px;">  NOTE If you are using Harmony Stand Alone, the script will be saved to the preferences for your account on your computer. If you are using Harmony Server, the script will be saved to the preferences for your Harmony database user. </div> <ul style="list-style-type: none"> • Global: If you are using Harmony Server, select this option to save the script to the Harmony database's global script directory. Anyone who is logged in to the database will be able to edit and run this script. • Environment: If you are using Harmony Server, select this option to save the script to the current scene's environment. Anyone will be able to edit and run the script as long as they are working on a scene inside this environment. • Job: If you are using Harmony Server, select this option to save the script to the current scene's job. Anyone will be able to edit and run the script as long as they are working on a scene inside this job. • Scene: Save the script to the scene's scripts sub-folder. Anyone will be able to edit and run the script when working on this specific scene.

Icon	Button	Description
		<ul style="list-style-type: none"> • System Variable: Save the script to the directory in the TOONBOOM_GLOBAL_SCRIPT_LOCATION environment variable. This option is only available if this environment variable is set. <div data-bbox="505 415 1430 709" style="border: 1px solid #c8e6c9; padding: 10px;"> <p> NOTES</p> <ul style="list-style-type: none"> • When you import a script, any user interface (.ui) or icon (.png) file that is in the same directory and has the same filename as the script will also be imported. • For more information on script locations, see Script Editor View on page 1270. </div>
	Delete Script	<p>Deletes the selected script.</p> <div data-bbox="505 831 1430 1157" style="border: 1px solid #c8e6c9; padding: 10px;"> <p> NOTES</p> <ul style="list-style-type: none"> • You cannot delete a script if it is in the Application Resources location, as those are scripts that are installed with Harmony. • If you delete a script that was originally in Application Resources but which you copied to another location so you could make changes to it, the original version of the script in the Application Resources folder will be restored to the list. </div>
	Refresh Script File List	<p>Refresh the list of scripts in the Script Editor. If there are new scripts in your user preferences or your scene's scripts sub-folder, click on this button to be able to open them in the Script Editor.</p>
	Set External Editor	<p>Allows you to type in the path and name for your preferred text editing software.</p> <div data-bbox="505 1444 1430 1770" style="border: 1px solid #c8e6c9; padding: 10px;"> <p> NOTES</p> <ul style="list-style-type: none"> • On macOS, only typing the name of your preferred text editing software is enough if that application supports the AppleScript Open Document protocol. • On Windows and GNU/Linux, unless your text editor is in your system's PATH environment variable, you will have to type in the full path to the editor. </div>
	Open with External	<p>Opens the selected script in the chosen external text editing software.</p>

Icon	Button	Description
	Editor	
	Set Target	<p>Prompts you to select which script and which function to use with the  Run and  Debug buttons.</p> <div data-bbox="505 472 1430 802" style="border: 1px solid green; padding: 10px;"> <p> NOTES</p> <ul style="list-style-type: none"> You can set the entire script as the target by selecting the <Nothing> function from the functions list. You cannot link an entire script to a toolbar button. Only functions within scripts can be added as toolbar buttons. Therefore, running or debugging an entire script rather than one of its functions should be done for testing purposes only. </div>
	Run	<p>Runs the target script and function.</p> <div data-bbox="505 919 1430 1297" style="border: 1px solid green; padding: 10px;"> <p> NOTES</p> <ul style="list-style-type: none"> If you have not set a target script and function, you will be prompted to set one when you click on this button. You can set or change the target script and function by clicking on the  Set Target button. If you are editing <<<Sandbox>>>, this button will simply run what you typed into the sandbox, regardless of whether another target is set. </div>
	Debug	<p>Open the target script and function in the Qt Script Debugger, in which you can test and debug the function.</p> <div data-bbox="505 1451 1430 1829" style="border: 1px solid green; padding: 10px;"> <p> NOTES</p> <ul style="list-style-type: none"> If you have not set a target script and function, you will be prompted to set one when click on this button. You can set or change the target script and function by clicking on the  Set Target button. If you are editing <<<Sandbox>>>, this button will simply debug what you typed into the sandbox, regardless of whether another target is set. </div>

Icon	Button	Description
	Stop Execution	If a script is currently running, this interrupts its execution.

Timeline View Toolbar

The 3D Graph toolbar works in conjunction with the elements in the 3D Graph view.

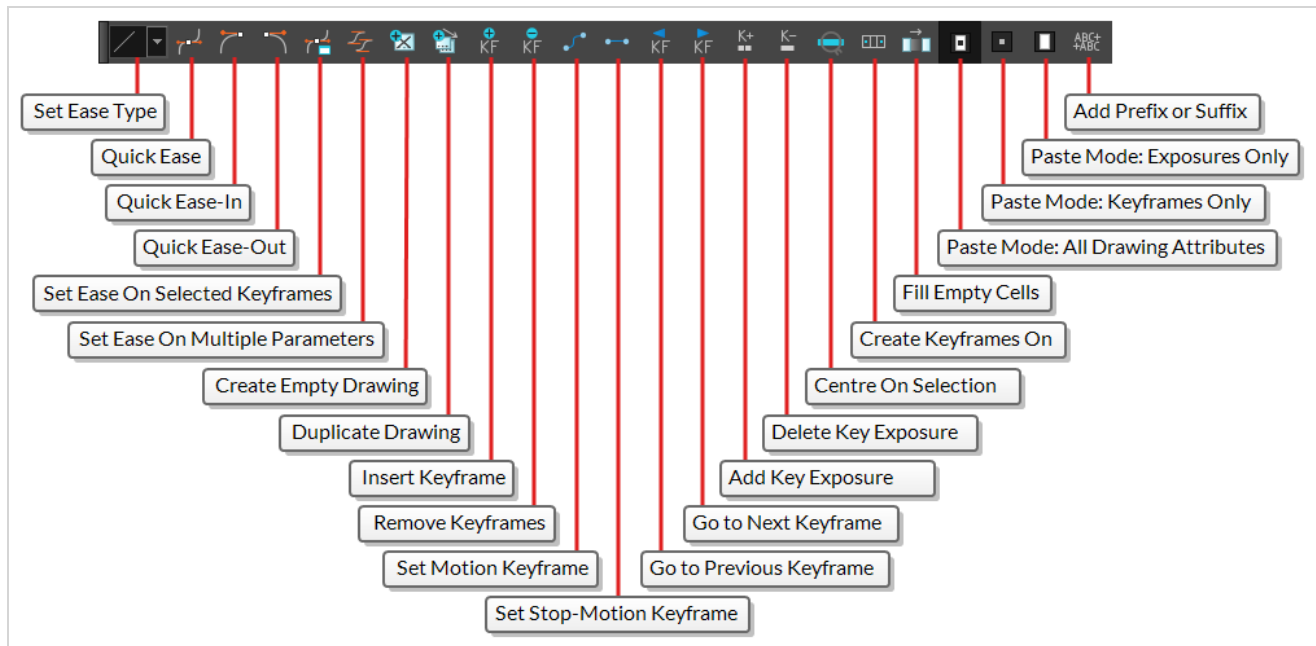



















How to access the Timeline view toolbar

- Do one of the following:
 - In the top menu, select **Windows > Toolbars > Timeline View**.
 - Right-click on the space at the top of the Timeline view and, in the context menu, select **Timeline View**.

Icon	Name	Description
	Set Ease Type	<p>Allows you to quickly apply an ease to the selected animation keyframes in the camera view.</p> <p>To set the ease of an animation, simply select the first keyframe in the animation, then select the ease type in this drop-down. The ease-in will be applied to the selected keyframe, and the ease-out will be applied to the next keyframe in the timeline.</p> <p>The following presets are available:</p>

Icon	Name	Description																																												
		<table border="1"> <thead> <tr> <th>Icon</th> <th>Preset</th> <th>Ease-In (Selected Keyframe)</th> <th>Ease-Out (Next keyframe)</th> </tr> </thead> <tbody> <tr> <td></td> <td>Linear</td> <td>0%</td> <td>0%</td> </tr> <tr> <td></td> <td>Slow ease-in</td> <td>25%</td> <td>0%</td> </tr> <tr> <td></td> <td>Medium ease-in</td> <td>50%</td> <td>0%</td> </tr> <tr> <td></td> <td>Fast ease-in</td> <td>75%</td> <td>0</td> </tr> <tr> <td></td> <td>Fast ease-in / ease-out</td> <td>75%</td> <td>75%</td> </tr> <tr> <td></td> <td>Medium ease-in / ease-out</td> <td>50%</td> <td>50%</td> </tr> <tr> <td></td> <td>Slow ease-in / ease-out</td> <td>25%</td> <td>25%</td> </tr> <tr> <td></td> <td>Slow ease-out</td> <td>0%</td> <td>25%</td> </tr> <tr> <td></td> <td>Medium ease-out</td> <td>0%</td> <td>50%</td> </tr> <tr> <td></td> <td>Fast ease-out</td> <td>0%</td> <td>75%</td> </tr> </tbody> </table>	Icon	Preset	Ease-In (Selected Keyframe)	Ease-Out (Next keyframe)		Linear	0%	0%		Slow ease-in	25%	0%		Medium ease-in	50%	0%		Fast ease-in	75%	0		Fast ease-in / ease-out	75%	75%		Medium ease-in / ease-out	50%	50%		Slow ease-in / ease-out	25%	25%		Slow ease-out	0%	25%		Medium ease-out	0%	50%		Fast ease-out	0%	75%
Icon	Preset	Ease-In (Selected Keyframe)	Ease-Out (Next keyframe)																																											
	Linear	0%	0%																																											
	Slow ease-in	25%	0%																																											
	Medium ease-in	50%	0%																																											
	Fast ease-in	75%	0																																											
	Fast ease-in / ease-out	75%	75%																																											
	Medium ease-in / ease-out	50%	50%																																											
	Slow ease-in / ease-out	25%	25%																																											
	Slow ease-out	0%	25%																																											
	Medium ease-out	0%	50%																																											
	Fast ease-out	0%	75%																																											
	Quick Ease	Sets the ease before and after the selected keyframe to 33%.																																												
	Quick Ease In	Sets the ease before the selected keyframe to 33%.																																												
	Quick Ease Out	Sets the ease after the selected keyframe to 33%.																																												
	Set Ease on	Opens the Set Ease on Keyframes dialog. In this dialog, you can set the ease-in																																												

Icon	Name	Description
	Selected Keyframes	(before) and the ease-out (after) on the selected keyframes to a custom percentage.
	Set Ease for Multiple Parameters	Opens the Set Ease for Multiple Parameters dialog. This dialog allows you to adjust the Bezier handles on all the selected animation keyframes in the Timeline.
	Create Empty Drawing	Creates a drawing in the selected cell, replacing any drawing that may already be exposed in that cell and the following ones until it meets another drawing, key exposure or a blank cell.
	Duplicate Drawing	Creates a duplicate of the selected drawing in the layer. The duplicate drawing will be exposed at the selected frame instead of the original drawing. Hence, this command allows you to instantly start working on a duplicate of the current drawing and retain the original. <div data-bbox="516 905 1430 1073" style="border: 1px solid green; padding: 10px; margin-top: 10px;">  NOTE When duplicating a drawing, the exposure at the selected cell is replaced with the new drawing, up until the next key exposure. </div>
	Insert Keyframe	Adds a keyframe on the selected cell in the Timeline view.
	Delete Keyframes	Deletes the selected keyframes.
	Set Motion Keyframe	Converts the selected keyframes to motion keyframes. With motion keyframes, Harmony generates the interpolation between the motion keyframe and the next keyframe. This means that a value for each frame between the keyframes is calculated by Harmony to progress from the value of the previous keyframe to the value of the next keyframe.
	Set Stop-Motion Keyframe	Converts the selected keyframes to stop-motion keyframes. Between a stop-motion keyframe and the next keyframe, Harmony does not generate any animation and the element remains static until the next keyframe.
	Go to Previous Keyframe	Goes to the previous keyframe.

Icon	Name	Description
	Go to Next Keyframe	Goes to the next keyframe.
	Add Key Exposure	Adds a key exposure to the selected cell.
	Delete Key Exposure	Removes key exposures from the selected cells.
	Centre On Selection	Scrolls the layers list to the currently selected layer. This is useful if you want to select a layer in the Camera view, then manipulate its timing Timeline view.
	Create Keyframes On	Opens the Create Keyframes On dialog box, in which you can create keyframes at every set number of frames within a given range of frames.
	Fill Empty Cells	Fills the empty frames in the selection with the exposure just before. For example, if you select a range of frame that starts with an exposed drawing and then ends with empty cells, all of the empty cells in the selection will be filled with the exposed drawing just before the empty cells.
	Paste Mode: All Drawing Attributes	<p>Sets the Paste Mode to All Drawing Attributes. In this mode, when you cut or copy and paste frames in the Timeline view, both the animation keyframes and the exposed drawings will be pasted.</p> <p>Likewise, if you drag and drop frames in the Timeline view, both the animation keyframes and the exposed drawings will be moved.</p>
	Paste Mode: Keyframes Only	<p>Sets the Paste Mode to Keyframes Only. In this mode, when you cut or copy and paste frames in the Timeline view, only the animation keyframes will be pasted. The exposed drawings will not be pasted.</p> <p>Likewise, if you drag and drop frames in the Timeline view, only the animation keyframes will be moved. The exposed drawings will not be affected.</p>
	Paste Mode: Exposures Only	<p>Sets the Paste Mode to Exposures Only. In this mode, when you cut or copy and paste frames in the Timeline view, only the exposed drawings will be pasted. The animation keyframes will not be pasted.</p> <p>Likewise, if you drag and drop frames in the Timeline view, only the exposed drawings will be moved. The animation keyframes will not be affected.</p>

Icon	Name	Description
	Add Prefix or Suffix	Opens the Add Prefix or Suffix dialog. This dialog allows you to instantly rename all the selected layers by adding a prefix or a suffix to their name.

Chapter 6: Views

The Harmony interface is composed of different views, each one designed for a specific purpose. You can modify the location of the views by adding a new view as a tab or as a window. You can also swap the location of a view.

When a view is active, a red rectangle appears around the view. Keyboard shortcuts and top menu options are associated with the active view. If a menu option is greyed out, it means it does not apply to the layer, drawing or other type of selection or the option does not apply to the active view.

3D Graph View	1202
Animated Matte Generator View	1204
Camera View	1211
Colour View	1220
Coordinates and Control Points View	1228
Drawing View	1231
Drawing Substitutions View	1234
Function View	1236
Guides View	1239
Integrated Help View	1243
Layer Properties View	1244
Library View	1246
Master Controller View	1249
Message Log View	1251
Metadata Editor View	1252
Model View	1254
Node View	1256
Node Library View	1258
Onion Skin View	1261
Perspective View	1267
Script Editor View	1270
Side View	1275
Timeline View	1277
Tool Properties View	1287

Top View	1288
Xsheet View	1290

3D Graph View

When a 3D model is selected, the 3D Graph view allows you to view a list of the subnodes composing the 3D model, arranged in their hierarchy. You can select a subnode from the list. When a subnode is selected, you can manipulate it with the Transform tool, disable or enable it.

If your 3D model is connected to a Subnode Animation node, you can select this Subnode Animation node and use the 3D Graph view to select and animate a subnode, to add its properties to the Subnode Animation's properties in the Timeline view, or connect a subnode to a 3D Kinematic Output node to it so that its animation can be applied to another element.

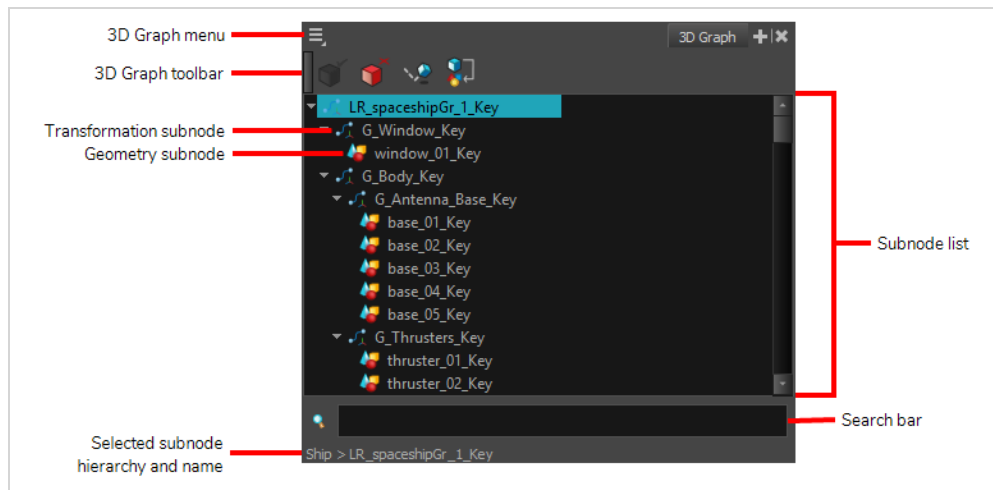



How to access the 3D Graph view

Do one of the following:

- From the top menu, select **Windows > 3D Graph**.
- From any of the other views, click the Add View **+** button and select **3D Graph**.

Section	Description
3D Graph menu	Access commands through this menu—see 3D Graph View Menu .
3D Graph toolbar	See 3D Graph View Toolbar .
Subnode list	Lists the selected 3D model's subnodes in a tree hierarchy and allows you to select a subnode.

	<div style="border: 1px solid #c8e6c9; padding: 10px;">  <p>NOTE</p> <p>Subnodes preceded with a  icon are transformation subnodes which are only used to affect the position, size and angle of its child subnodes. Subnodes preceded with a  are geometry subnode, which actually contain a visible part of the 3D model.</p> </div>
<p>Selected subnode hierarchy and name</p>	<p>Displays the subnode's parent hierarchy followed by the subnode's name.</p>
<p>Search bar</p>	<p>Allows you to filter and search for subnodes. Typing anything in the field will make the subnode list only display subnodes that contain the typed text string in their name, along with their parents.</p>

Animated Matte Generator View

The Animated Matte Generator view allows you to configure and animate the matte created by a Animated-Matte-Generator node. It also allows you to quickly add Animated-Matte-Generator templates to your Node view.

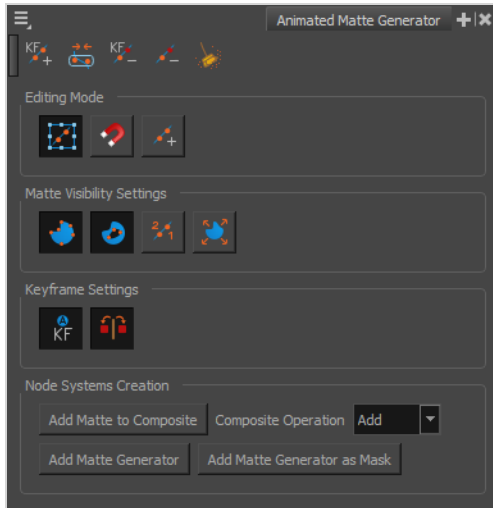

How to access the Animated Matte Generator view

1. Do one of the following:
 - From the top-right corner of any currently visible view, click the Add View **+** button and select **Animated Matte Generator**.
 - From the top menu, select **Windows > Animated Matte Generator**.



How to display the Animated Matte Generator controls and enable the Animated Matte Generator view options





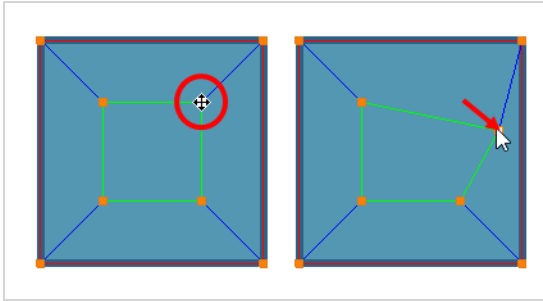

1. In the Tools toolbar, select the Transform tool or press Shift + T.
2. In the Timeline or Node view, select the Animated Matte Generator node you wish to configure or animate.
3. In the Camera view toolbar, click on Show Controls  or press Shift + F11.

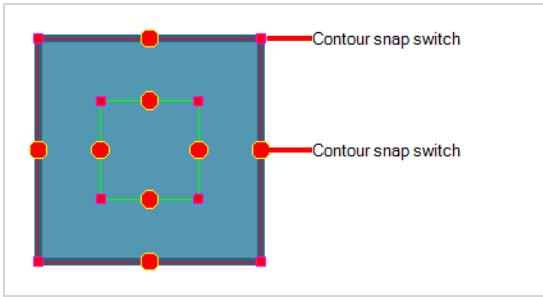
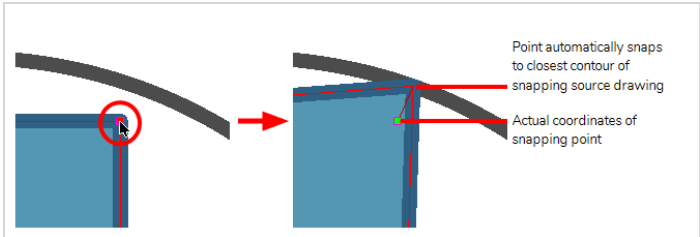

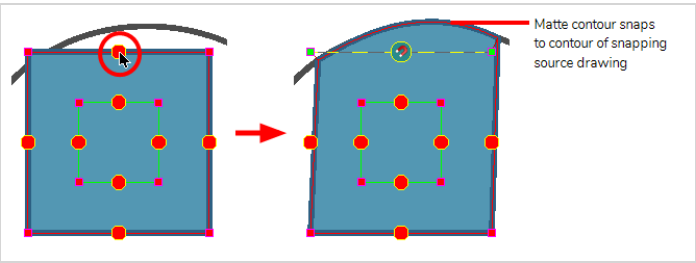

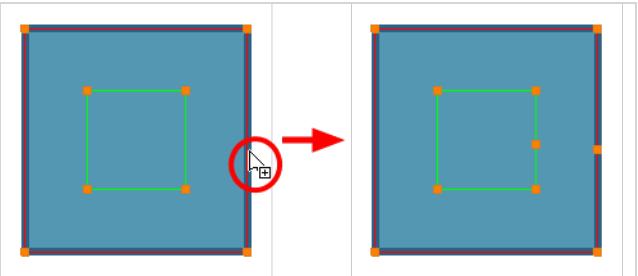







NOTE

The Animated Matte Generator view also has its own toolbar. For information on the buttons in this toolbar, see [Animated Matte Generator Toolbar](#).

Icon	Functionality	Description
Editing Mode		
	<p>Define Matte Point</p>	<p>Allows you to manipulate the matte's contour points by dragging them in the Camera view. Use this mode to edit and animate your matte.</p> 
	<p>Set to Snap</p>	<p>If the Animated Matte Generator node is connected to a snapping source drawing, this allows you to define which points and contours of the matte should snap to the contours of the snapping source drawing, by clicking on them.</p>  <p>If you click on a point in this mode, it will be set to snap to the nearest contour of the snapping source drawing.</p>  <p>If you click on a contour in this mode, the contour will be set to snap to the nearest contour of the snapping source drawing, and will be made to match its curve. Both points on either end of that contour will also be set to snap to the snapping source drawing.</p>

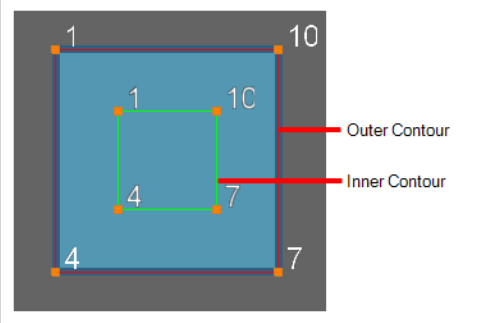
		 <p>Points and contours that are configured to snap will snap to the closest point or contour they can find in the snapping source, provided that they are at a reasonable distance from their actual coordinates. This distance can be adjusted by changing the Drag-to-Snap Distance parameter in the Animated Matte Generator's layer properties.</p>
	<p>Add Matte Point</p>	<p>Allows you create a point on the contour of the map by clicking on one of the matte's contour where you want the point to be created.</p>  <div data-bbox="743 1184 1435 1415" style="border: 1px solid green; padding: 5px;"> <p> NOTE Adding a matte point to one of the matter's contours will also add a point to the matte's other contour. It is not possible to have a different amount of points on a matte's inner and outer contours.</p> </div> <div data-bbox="743 1444 1435 1646" style="border: 1px solid green; padding: 5px;"> <p> NOTE Contrary to tools like the Contour Editor, you cannot use a keyboard shortcut to click and add a point to a matte contour.</p> </div>
<p>Matte Visibility Settings</p>		
	<p>Outer Contour</p>	<p>When enabled, the matte's Outer Contour and its controls display in the Camera view, and the Outer Contour can be modified.</p>

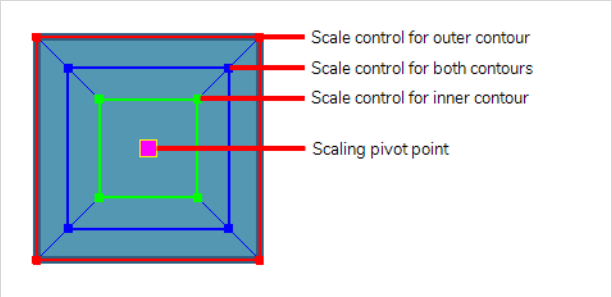
		<div data-bbox="743 191 1430 453" style="border: 1px solid #add8e6; padding: 10px;">  <p>TIP</p> <p>You can hold Alt while pressing this button to quickly enable the outer contour and disable the inner contour simultaneously. You can also hold Shift while pressing any of the Matte Visibility Settings buttons to quickly enable all matte visibility settings.</p> </div>
	<p>Inner Contour</p>	<p>When enabled, the matte's Inner Contour and its controls display in the Camera view, and the Inner Contour can be modified.</p> <div data-bbox="743 611 1430 942" style="border: 1px solid #90ee90; padding: 10px;">  <p>NOTE</p> <p>A matte always has an <i>outer contour</i> and an <i>inner contour</i>. By default, both contours are merged together, having the same shape and points, allowing you to animate them simultaneously as if the matte had a single contour. You can separate the points of the inner and outer contours by hiding one of the contours and making modifications on the other contour.</p> </div> <div data-bbox="743 974 1430 1272" style="border: 1px solid #90ee90; padding: 10px;">  <p>NOTE</p> <p>When two contour points are separated, you can lock them back together by selecting them and clicking on the Merge Inner and Outer Matte Contour  button of the Animated Matte Generator toolbar or by moving one of the points close to its corresponding point until they snap together.</p> </div> <div data-bbox="743 1304 1430 1566" style="border: 1px solid #add8e6; padding: 10px;">  <p>TIP</p> <p>You can hold Alt while pressing this button to quickly enable the inner contour and disable the contour simultaneously. You can also hold Shift while pressing any of the Matte Visibility Settings buttons to quickly enable all matte visibility settings.</p> </div>
	<p>Point Id</p>	<p>When enabled, the identification number of each of the matte's points display in the Camera view. These numbers are used to track which point of the outer contour are matched with which points of the inner contour.</p>

		 <p>TIP You can hold Shift while pressing any of the Matte Visibility Settings buttons to quickly enable all matte visibility settings.</p>
	<p>Scaling Controls</p>	<p>When enabled, moving one of the control points of the matte contours will scale the entire matte. A purple square will appear in the middle of the matte's contour. Moving this square will change the position of the pivot point used for scaling the contour.</p>  <p>TIP You can hold Shift while pressing any of the Matte Visibility Settings buttons to quickly enable all matte visibility settings.</p>
<p>Keyframe Settings</p>		
	<p>Auto Key on All Points</p>	<p>By default, when a matte control point is moved in the Camera view, a keyframe is created for that point and its handles. With this option enabled, a keyframe will be created for all the points in the matte and all of their handles.</p>

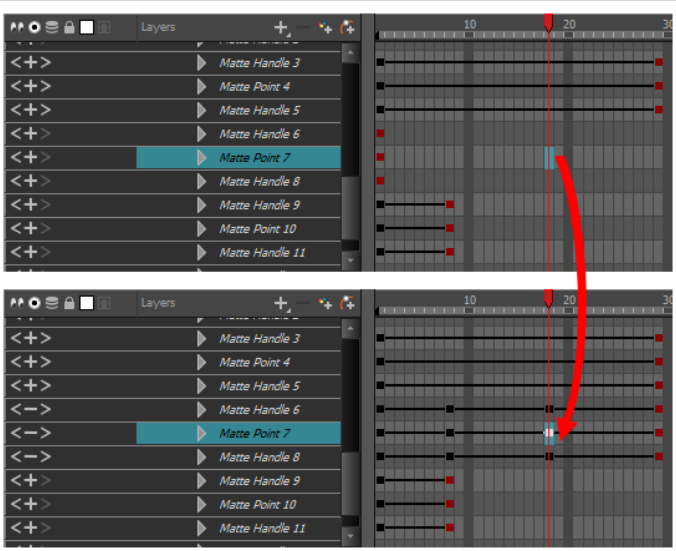
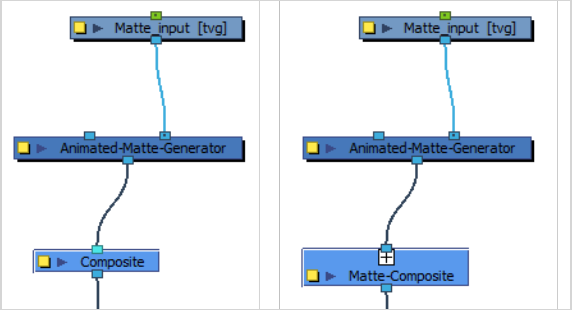
	<p>Fix Adjacent Keyframes</p>	<p>When moving a control point, this will look for keyframes on other control points right before and after the current frame and, if it finds any, it will create keyframes for the control point being moved at these frames. This ensures that animating without the Auto Key on All Points option does not create overlapping animation for control points, but does not create unnecessary keyframes.</p>  <p>When matte point 7 is moved, a keyframe is created at the current frame, but also at frame 8, because matte point 10 has a keyframe at frame 8, and also at frame 29, because matte point 4 has a keyframe at frame 29. This prevents overlapping animation.</p>
<p>Node Systems Creation</p>		
	<p>Add Matte to Composite</p>	<p>If a Composite or Matte-Composite node is selected in the Node view, this creates an Animated Matte Generator template with an empty matte drawing layer in the Node view, then connects the newly created Animated-Matte-Generator node to the selected composite.</p> 
	<p>Composite Operation</p>	<p>When using the Add Matte to Composite option on a Matte Composite node, this determines whether the Animated Matte</p>

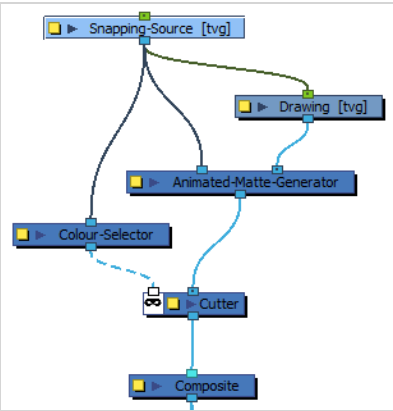
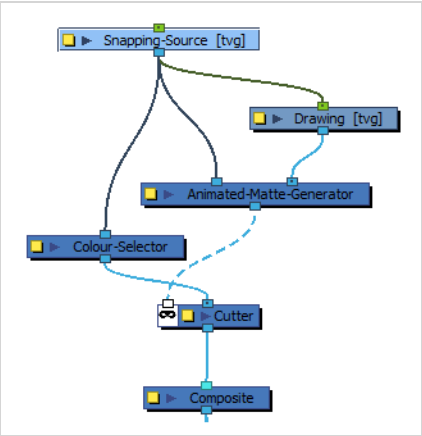
		<p>Generator node being created will be connected to the selected Matte Composite node in Add, Subtract or Intersect mode.</p>
	<p>Add Matte Generator</p>	<p>This creates an Animated Matte Generator template in the Node view which includes a Matte drawing layer, an Animated Matte Generator node, a Colour Selector and a Cutter.</p>  <p>If a drawing layer is selected when clicking this button, it will be connected as the peg of the Matte drawing layer, and as the input of the Colour Selector node.</p>
	<p>Add Matte Generator as Mask</p>	<p>This creates a similar template to the one created by the Add Matte Generator button, except that the Animated-Matte-Generator node created by this option is connected to the matte port of the Cutter node, and the Colour-Selector node connected to the selected layer is connected to the input port of the Cutter node.</p> 

Camera View

The Camera view is the centre of operations in Harmony. In this view, you can draw, paint, animate, set up your scene, manipulate objects, open symbols and preview your animation.

The Camera view also has a top and bottom toolbar that you can use to navigate in the view, change the display mode or go up your symbol hierarchy.

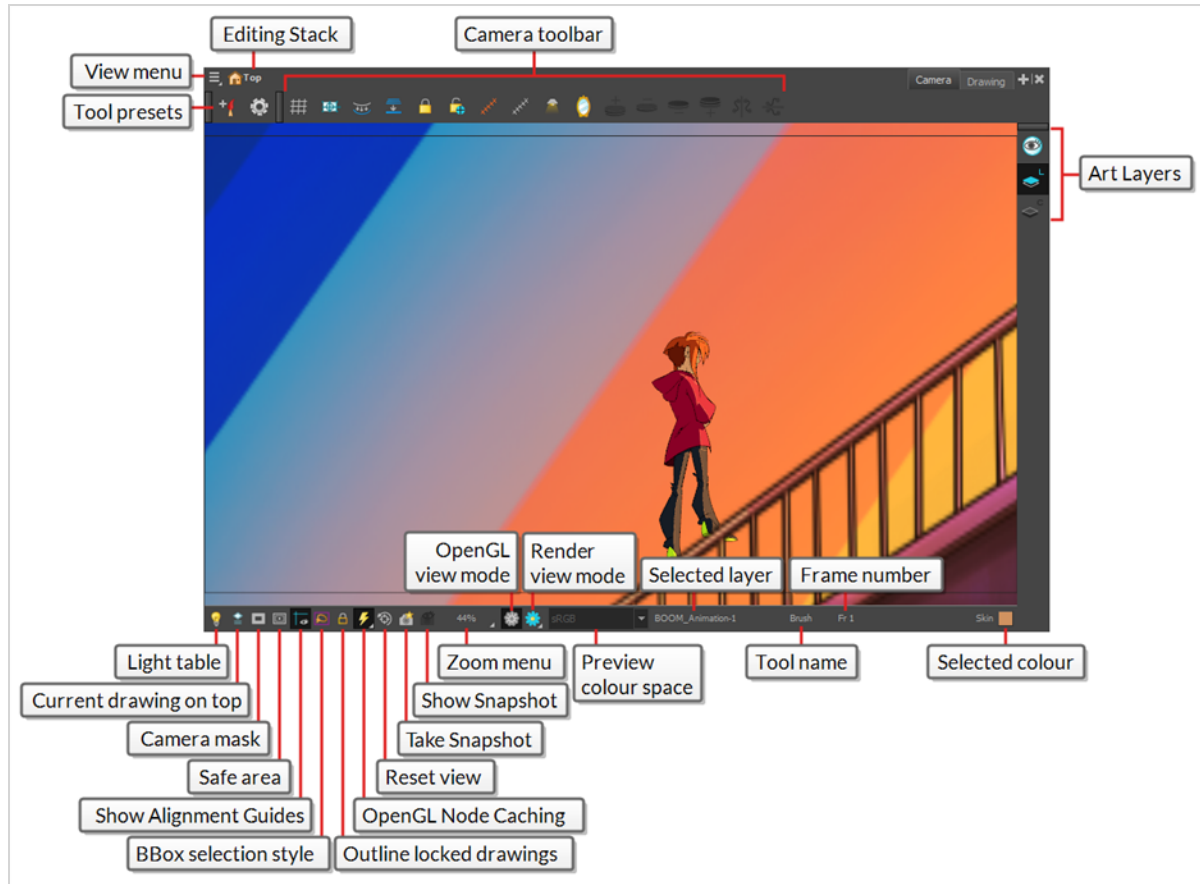













How to access the Camera view



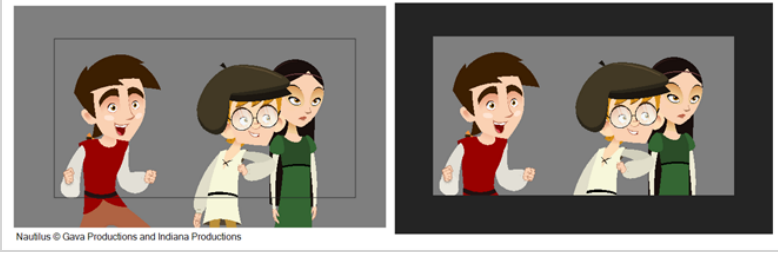

Do one of the following:



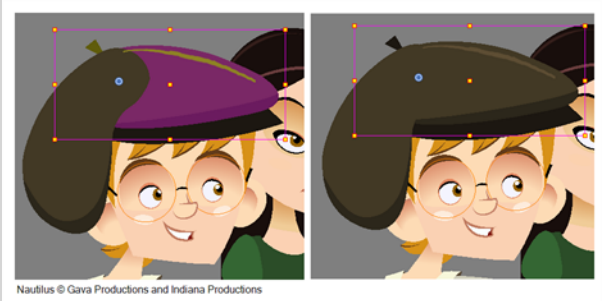

- From the top menu, select **Windows > Camera**.
- From any of the other views, click the Add View **+** button and select **Camera**.





Icon	Section	Description
	View Menu	The View menu contains all the tools and options that you can use in the Camera view to draw, animate or set up the scene.



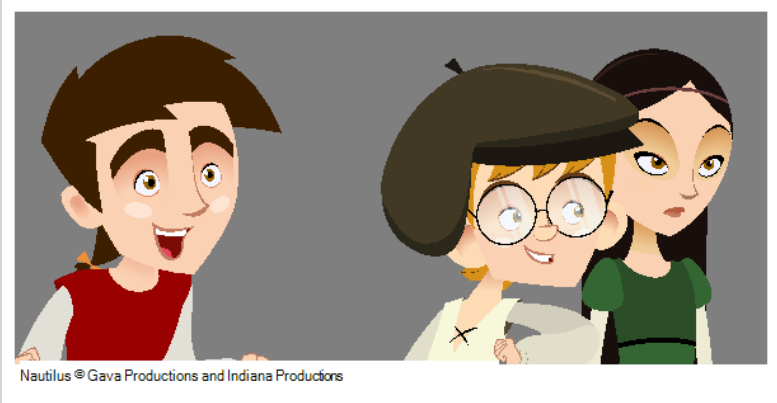

Icon	Section	Description
	Editing Stack	The Editing Stack menu displays the names of the symbols and their hierarchy when you are editing a symbol. You can click on the different names to go back up to the different parent symbols or the top/current project.
	Camera View Toolbar	The Camera View toolbar contains all the tools and options you can use in the Camera view to draw, animate or set up the scene. The toolbar can be displayed or hidden by right-clicking on it and selecting or deselecting the Camera View toolbar.
	Light Table	<p>When you have a drawing layer or drawing selected, the Light Table button allows you to fade the colours of the other layers so you can see the current artwork better as you edit with a drawing tool. Note that the light table does not work when using a layer editing tool, such as the Transform tool.</p>  <p><small>Nautilus © Gava Productions and Indiana Productions</small></p>
	Current Drawing on Top	<p>When this button is enabled, the drawing that you are currently editing with a drawing tool is temporarily displayed in front of all the other elements. The actual scene is not modified.</p>  <p><small>Nautilus © Gava Productions and Indiana Productions</small></p>
	Camera Mask	The Camera Mask button shows or hides Displays a black mask around the scene's frame to avoid seeing the unnecessary artwork. This option is handy when you're animating and setting up the scene. It allows you to see your scene's composition better.

Icon	Section	Description
		<p>You can also access this from the top menu by selecting View > Show > Camera Mask.</p> 
	<p>Safe Area</p>	<p>The Safe Area button shows or hides Displays the TV safety zone and the centre of the camera frame. The safe area adapts to the scene resolution, as well as the safety zone and frame's centre.</p> <p>You can also access this feature from the top menu by selecting View > Show > Safe Area.</p> 
	<p>Show Alignment Guides</p>	<p>When enabled, alignment guides will be visible in the Camera and Drawing views.</p> <p>This is enabled by default. Disabling this option will hide and disable alignment guides, meaning that animation and drawing tools will not snap to them, even if the  Snap to Alignment Guides option is enabled in the Tool Properties view.</p>
	<p>BBox Selection Style</p>	<p>When you select an object in the Camera view with the Transform tool, a bounding box always appears around the object and the artwork is tinted in fuchsia, red or yellow. Enabling this option will only keep the bounding box and remove the colour tint.</p>



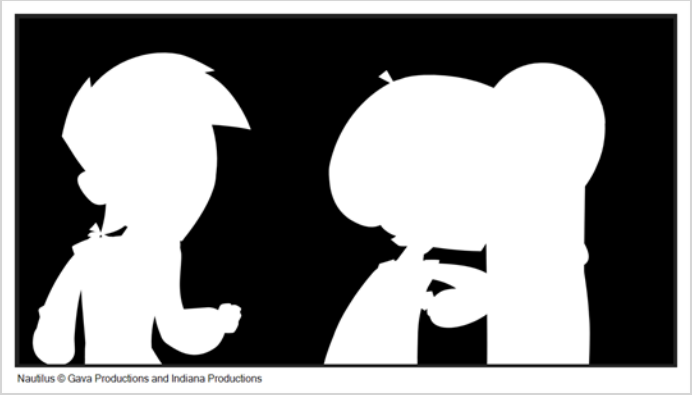

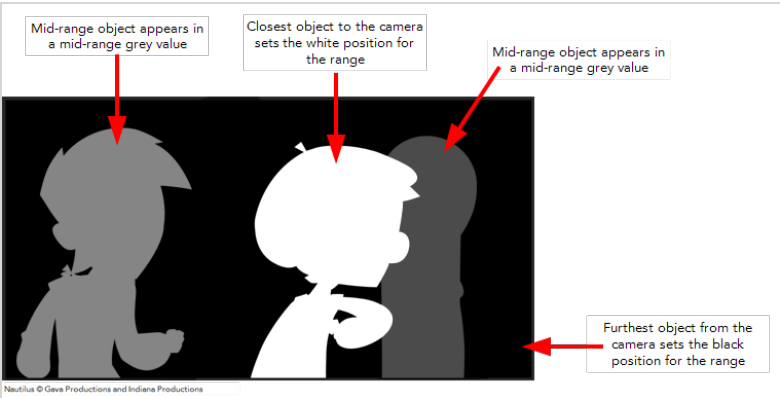
Icon	Section	Description
		 <p>Nautilus © Gava Productions and Indiana Productions</p>
	Outline Locked Drawings	<p>Drawings that are locked in the Timeline view (cannot be selected in the Camera view) are displayed as wireframes.</p>  <p>Nautilus © Gava Productions and Indiana Productions</p>
	OpenGL Node Caching	<p>Toggles OpenGL Node Caching. When enabled, the preview image of nodes that have the Cached layer property enabled will be cached so as to help with performance when refreshing the OpenGL preview image in the Camera view.</p> <p>You can also double-click or long-click this button to open a pop-up menu in which you can select the size of cached preview images:</p> <ul style="list-style-type: none"> • 64x64 • 128x128 • 256x256 • 512x512 • 1024x1024 <p>Smaller cached images will look less detailed, but will increase the performance of node caching as well as decrease the amount of memory the cache requires. Larger cached images will look closer to the actual OpenGL preview, but will impact performance and require more memory to store.</p>
	Reset View	<p>The Reset View button resets any panning, zooming or rotation done in the Camera view and returns the display to the initial settings. You can</p>

Icon	Section	Description
		also press Shift + M.
	Take Snapshot	<p>Saves the preview image of the Camera view in memory as a snapshot.</p> <div data-bbox="657 436 1430 730" style="border: 1px solid #c8e6c9; padding: 10px;"> <p> NOTES</p> <ul style="list-style-type: none"> • Harmony stores only one snapshot at a time. So if any snapshot was in memory when taking a snapshot, it will be overwritten by the new snapshot. • Snapshots are not saved to the scene and are discarded when the scene is closed. </div>
	Show Snapshot	<p>Displays the snapshot currently in memory. To display the snapshot, you must click and hold the button. Releasing it will restore the Camera view preview.</p> <div data-bbox="657 919 1430 1184" style="border: 1px solid #c8e6c9; padding: 10px;"> <p> NOTE</p> <p>The snapshot is displayed as it was taken, regardless of the preview mode of the Camera view. For example, if you took a screenshot in Render View mode, and display it while in OpenGL View mode, the snapshot will display as it was taken in Render View mode.</p> </div>
	Zoom Menu	<p>The Zoom menu lets you enlarge or reduce the Camera or Drawing view display.</p> <p>To make the camera frame size always match the size of your view, select the Fit to View option. Click the drop-down arrow and select a zoom level or press 1 and 2.</p> <div data-bbox="657 1457 810 1881" style="border: 1px solid #ccc; padding: 5px;"> <ul style="list-style-type: none"> 10% 16% 25% 40% 63% ✓ 100% 160% 200% 250% 400% 630% 1000% 100% Fit To View </div>

Icon	Section	Description
	OpenGL View Mode	<p>The OpenGL View Mode button switches the Camera view to fast display, letting you see your animation play in real time. The OpenGL display requires less memory. The final look of your effects is not shown in the OpenGL View Mode. You must switch to the Render View Mode to see your effects.</p>  <p>Nautilus © Gava Productions and Indiana Productions</p>
	Render View Mode	<p>The Render View Mode button switches the Camera view to a fully rendered display showing the final image of the current frame. If a modification is done to your current frame or if you move to a different frame, click the Update Preview button to update the display if your preview does not update automatically. The Render View Mode display lets you see the final look of your frames including effects and antialiasing. You cannot play back your scene in Render View Mode. To see your scene fully rendered and to play it back, you must press the Render and Play button in the Playback toolbar.</p>  <p>Nautilus © Gava Productions and Indiana Productions</p>
	Matte View Mode	<p>The Matte View Mode button switches the Camera view to a matte display showing the alpha channel of the elements in your scene. The transparency level ranges from 0 to 100 percent. Zero percent is completely transparent and represented by black and 100 percent is</p>

Icon	Section	Description
		<p>completely opaque and represented by white. Everything in between these extremes has a transparency level somewhere between 1 and 99 percent and is represented in various shades of grey.</p> <ul style="list-style-type: none"> To access the Matte View mode, click on the Render View button and select Matte View from the drop-down menu.  <p><small>Nautilus © Gava Productions and Indiana Productions</small></p>
	<p>Depth View Mode</p>	<p>The Depth View mode displays images in a relative white to black gradient scale. The object(s) closest to the camera are displayed in white and the object(s) furthest from the camera are displayed in black. If the position of the last object changes along the z-axis, that object will still remain black, so long as it retains its position as the object the farthest back. It does not matter where that object is in 3D space, it just matters what its position is relative to the other object in the same space. The objects closest and furthest from the camera set the range of the white to black scale. All the other objects fall somewhere in between.</p>  <p><small>Nautilus © Gava Productions and Indiana Productions</small></p> <ul style="list-style-type: none"> To access the Depth View mode, click on the Render View button and select Depth View from the drop-down menu.
	<p>Preview Colour Space</p>	<p>The colour space in which to display the preview image when in </p>

Icon	Section	Description
		<p>Render Preview mode.</p> <p>You can set this to any colour space supported by Harmony. It is recommended to set this to the colour space intended for rendering your frames, unless that colour space is not supported by your monitor. In the latter case, it's recommended to set this to the closest colour space available that your monitor can display.</p> <p>The following colour spaces are available:</p> <ul style="list-style-type: none"> • Linear: The same primaries and white point as sRGB and Rec. 709, but with no gamma transfer curve applied to the colour values. This colour space is useful for compositing intermediary images that are meant to be rendered in sRGB or Rec. 709. • Display P3: A colour space commonly used for digital projection. It has the same primaries as DCI-P3, the same white point as sRGB and the same gamma transfer curve as sRGB. • Display P3 Linear: The same as Display P3, except with no gamma transfer curve. This colour space is useful for compositing intermediary images that are meant to be rendered in Display P3. • Rec. 709: The colour space used for HDTV. It has the same primaries and white point as sRGB, but has a different gamma transfer curve. • Rec. 709 2.4: The same colour space as Rec. 709 or sRGB, except with a gamma transfer curve of 2.4. This colour space exists because some editing systems use a gamma transfer curve of 2.4 instead of the standard gamma curve for Rec. 709. • Rec. 2020: A colour space used for Ultra High Definition TV (UHDTV). It has a complex gamma transfer curve and primaries that cover more of the human-perceivable colour space than other colour spaces, especially in the area of human-perceivable greens. • Rec. 2020 2.4: The same colour space as Rec. 2020, except with a simple gamma transfer curve of 2.4. This colour space exists because some editing systems use a gamma transfer curve of 2.4 instead of the standard gamma curve for Rec. 2020. • Rec. 2020 Linear: The same colour space as Rec. 2020, except with no gamma transfer curve. This colour space is useful for compositing intermediary images that are meant to be rendered in Rec. 2020. • sRGB: A colour space typically used for standard computer monitors. It has the same primaries and white point as Rec. 709,

Icon	Section	Description
		<p>but has a different gamma transfer curve.</p> <div data-bbox="656 342 1429 596" style="border: 1px solid #c8e6c9; padding: 10px; margin-bottom: 10px;">  <p>NOTE</p> <p>You can only select the display colour space in  Render View mode. In  OpenGL View mode, the preview image is generated in the colour space selected in the Display Colour Space drop-down in the Camera tab of the Preferences dialog.</p> </div> <div data-bbox="656 623 1429 856" style="border: 1px solid #bbdefb; padding: 10px;">  <p>TIP</p> <p>You can have multiple Camera views in your workspace, each set to their own colour space. Hence, you can preview your scene on multiple monitors with different colour spaces by having a Camera view on each monitor.</p> </div>
	Drawing Name	The Drawing Name field displays the name of the selected drawing, as well as the layer containing it. If the cell does not contain any drawing, an Empty Cell text is shown in the field.
	Tool Name	The Tool Name field displays the name of the selected tool. If you temporarily override a drawing tool using a keyboard shortcut, the tool's name will be highlighted in red. You can temporarily override a tool by holding its keyboard shortcut without the Alt key. For example, the Select tool shortcut is Alt + S. If you hold down the S key, you will switch to the Select tool. When you release the key, you will return to the tool you were using.
	Frame Number	The Frame Number field displays the number of the current frame.
	Selected Colour	The colour swatch displays the currently selected colour in the Colour view.

Colour View

The Colour view is where you create colours and palettes and import existing palettes into your project. The Colour view is also necessary for drawing, painting and creating colour styling.

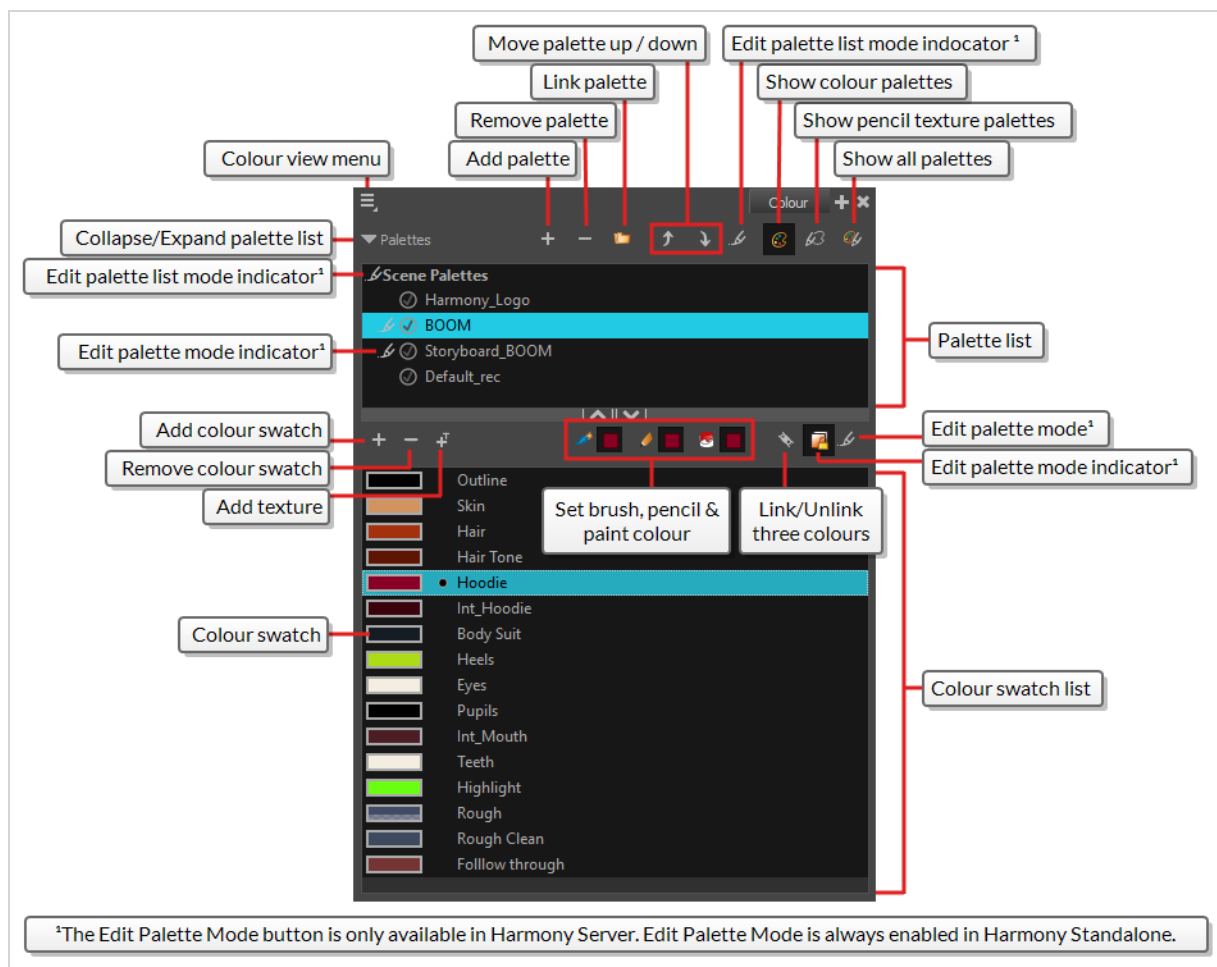







How to access the Colour view





Do one of the following:

- From the top menu, select **Windows > Colour**.
- From any of the other views, click the Add View **+** button and select **Colour**.





Palette List Panel

Icon	Option	Description
	View Menu	The View menu contains all the commands and options that you can use in the Colour view to manage colours and palettes.



	Collapse/Expand Palette List	Allows you to show or hide your palette list and its options. By default, the palette list is displayed, but you may want to hide it if you are working with a single palette and want to allow more vertical space for the colour swatch list.
	Add Palette	Allows you to create a new palette.
	Remove Palette	Deletes the currently selected palette. If the colour swatch is used in your project, zones painted with colour swatches which have been deleted will turn red, easily identifying them so you can repaint them with another colour swatch. 
	Link Palette	Allows you to add a palette from a different location, be it in a scene, job, environment or even an element to your palette list. The palette will be linked to its original location rather than copied to your scene's folder. Hence, if you make changes to the original palette, it will affect the colour of elements in your scene. If you want to import a palette as a copy into your scene's palette library, right-click on your palette list and select Import . You can also link to a palette in any location on your machine or network by selecting Link to External .
	Order Palette List	Moves palettes further up or down the palette list. If a palette has been cloned, the highest palette among the original palette and its clone(s) will be used by Harmony. This can be overridden by using a Colour-Override effect—see Colour-Override Node on page 624 .
	Edit Palette List Mode Indicator	In Harmony Server, this icon appears when you have the modifying rights on your scene's palette list. While several users can work on a scene at the same time, only one user may have the right to modify a palette list at any given time.









		 NOTE In Harmony Stand Alone, you can always modify your scene's palette list. On Harmony Server, you must unlock your palette list before making modifications to it.
	Show Colour Palettes	Shows only colour palettes in the palette list. This is the default option.
	Show Pencil Texture Palettes	Shows only pencil texture palettes in the palette list.
	Show All Palettes	Shows both colour and pencil texture palettes in the palette list.

Palette List

Icon	Description
	In Harmony Server, this indicates that you have the rights to modify the palette.
	Indicates that the palette is stored at the same level as its palette list. For example, a palette that is stored in the scene's palette library and which is listed in the scene's palette list, or a palette that is stored in an element's palette library and which is listed in that same element's palette list.
	Indicates that the palette file is stored in an external location, such as a different scene, an element in a different scene, a job other than the scene's job, an environment other than the scene's environment, or a custom location on your file system or network. This means the palette is liable to be missing if it is moved from its original location, or if the scene is exported from the database into an offline scene or to a different database.
	This indicates that the palette is stored at a higher level than its palette list, making it a shared palette. For example, a palette in your scene's palette list that is stored in the palette library of the scene's job or environment, or a palette in an element's palette list that is stored in the palette library of the scene.
	Indicates a potentially dangerous situation. For example, a palette file that is stored in one of the scene's element folders, but which is added to your scene's palette list. The whole scene can use the palette, but since it's stored inside an element, deleting that element will make your whole scene lose access to that palette.

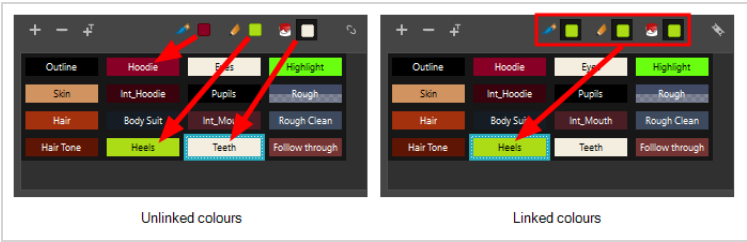
Colour Swatch List Panel

Icon	Option	Description
+	Add Colour	Adds a new colour swatch to the bottom of your colour list.
-	Remove Colour	<p>The Remove Colour button lets you delete the currently selected colour swatches. If the colour swatch is used in your project, and confirmation dialog will appear prompting you to confirm that you want to delete the colour. Zones painted with colour swatches which have been deleted will turn red, easily identifying them so you can repaint them with another colour swatch.</p> 
+	Add Texture	<p>Allows you to import a bitmap image as a texture, which can be painted with just like a colour. When used with the Brush or Paint tools, bitmap textures are tiled inside the shape they fill. The scaling and position of the texture inside their shape can be tweaked with the Edit Gradient/Texture tool. When used with the Pencil tool or one of the Shape tools, a bitmap texture will follow the pencil line's direction.</p> 

	Set Current Brush Colour	When enabled, the colour you select in the colour view will be selected for the Brush tool.
	Set Current Pencil Colour	When enabled, the colour you select in the colour view will be selected for the Pencil tool, as well as other tools that create pencil lines, such as the Line, Rectangle, Ellipse and Polyline tools.
	Set Current Paint Colour	When enabled, the colour you select in the colour view will be selected for the Paint tool.
	Link/Unlink Three Colours	<p>When enabled, the colour you select will be selected for all drawing tools. When disabled, you can select individual colours for the Brush, Pencil and Paint tools.</p> 
	Edit Palette Mode	<p>In Harmony Server, this allows you to get the modifying rights to the selected palettes.</p> <p>Since several people can work on any given scene at the same time, and a palette can be shared between scenes, palettes may be loaded in read-only mode when opening a scene on a Harmony database. Then, an user would only be able to edit a palette by first activating Edit Palette Mode. This prevents several users from making changes on the palette at the same time, since a user cannot activate Edit Palette Mode on a palette that is already being edited by someone else. This also prevents users from accidentally making modifications on important palettes.</p>
	Edit Palette Mode Indicator	<p>In Harmony Server, this icon appears when you have the modifying rights on the currently selected palette.</p> <div data-bbox="690 1600 1432 1768" style="border: 1px solid green; padding: 10px;"> <p> NOTE</p> <p>In Harmony Stand Alone, you can always modify your palettes.</p> </div>
	Colour Swatch Name	Each colour swatch available in the Colour view can have its own name, making it easy to identify which colour is used to paint what

		<p>part of your character or background.</p> <div data-bbox="690 241 868 352"> <ul style="list-style-type: none"> Skin Teeth Horns Helmet </div> <div data-bbox="690 388 1429 562" style="border: 1px solid green; padding: 5px; margin-top: 10px;"> <p>NOTE</p> <p>Two colours can have the same name. Harmony identifies colours by an identification number.</p> </div>
	<p>Colour Swatch</p>	<p>Also referred to as <i>colour pots</i>, the colour swatch is the actual colour information for a colour in your palette. It is represented by a rectangle displaying the colour in the list.</p> <div data-bbox="690 745 885 903"> <ul style="list-style-type: none"> Colour 2 Colour 3 Colour 4 colour 5 colour 6 colour 7 </div>

Colour Editor Panel

The Colour Editor panel is an optional panel in the Colour view which can be enabled to edit your colour swatches on the go.

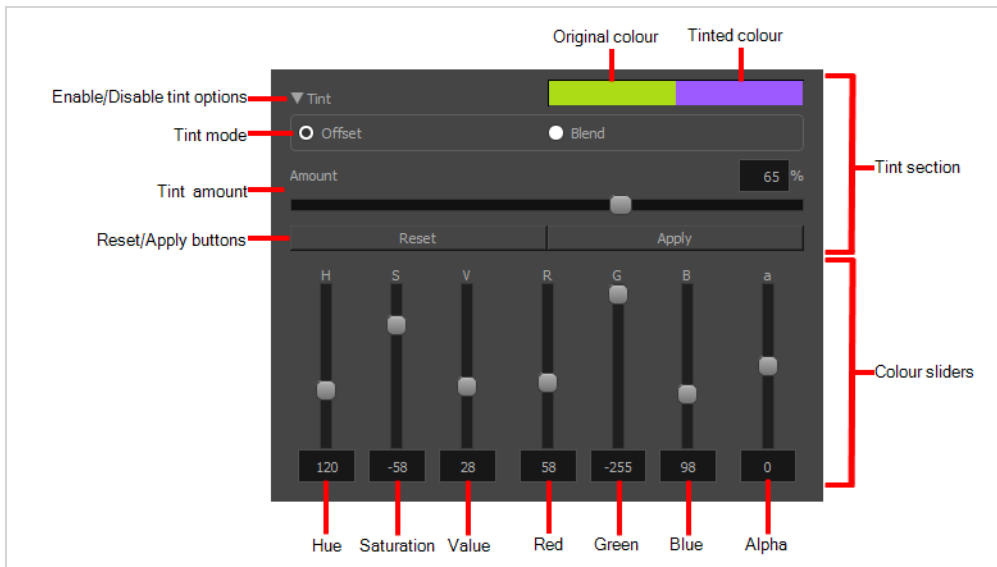

How to enable the Colour Editor panel

1. Do one of the following:

- Right-click on the palettes list, then select **Colour Editor**.
- Click on the View Menu  button and select **Palettes > Colour Editor**.

Option	Description
Enable/Disable Tint Options	<p>This collapses or expands the Tint section of the Colour Editor panel.</p> <p>When tint options are enabled, the Colour Editor panel can be used to add a tint to the colour. This means that all sliders start with a value of 0 and that the new colour will be calculated relative to the old colour, using the algorithm chosen in the Tint Mode option. As you change the values of the colour sliders, the colour in your palette is not updated immediately. Rather, it is only updated when you click on the Apply button.</p> <p>When Tint options are disabled, the Colour Editor panel only has colour sliders, and those sliders start out with the values of the selected colour. Changing the value of any of the colour sliders immediately updates the colour in your palette with the new value.</p>
Tint Mode	<p>Allows you to select how the colour will be modified by the tint:</p> <ul style="list-style-type: none"> • Offset: The chosen tint's colour values will be added to the selected colour's values to make the new colour. You can choose negative values if you wish to subtract from the selected colour's values. • Blend: The selected colour will be blended with the selected tint, resulting in the average between the selected colour and the tint.
Reset	<p>In tint mode, this sets all the colour sliders to their neutral value, leaving the selected colour unchanged.</p>
Apply	<p>In tint mode, this applies the tint to the selected colour. Note that when tint mode is not enabled, changes to the selected colour are automatically applied.</p>
H (Hue)	<p>Sets the hue of the colour or tint.</p>
S (Saturation)	<p>Sets the saturation level of the colour or tint.</p>
V (Value)	<p>Sets the value of the colour or tint.</p>
R (Red)	<p>Sets the red value of the colour or tint.</p>
G (Green)	<p>Sets the green value of the colour or tint.</p>

B (Blue)	Sets the blue value of the colour or tint.
a (Alpha)	Sets the alpha (transparency) value of the colour or tint.

Coordinates and Control Points View

The Coordinates and Control Points view displays the parameters of keyframes or control points selected in the Camera, Timeline or Xsheet view. You can also see the same information in the Coordinate and Control Point toolbars.

In this view, you can edit keyframes and control point parameters, such as the position, continuity, bias, tension and lock-in-time.

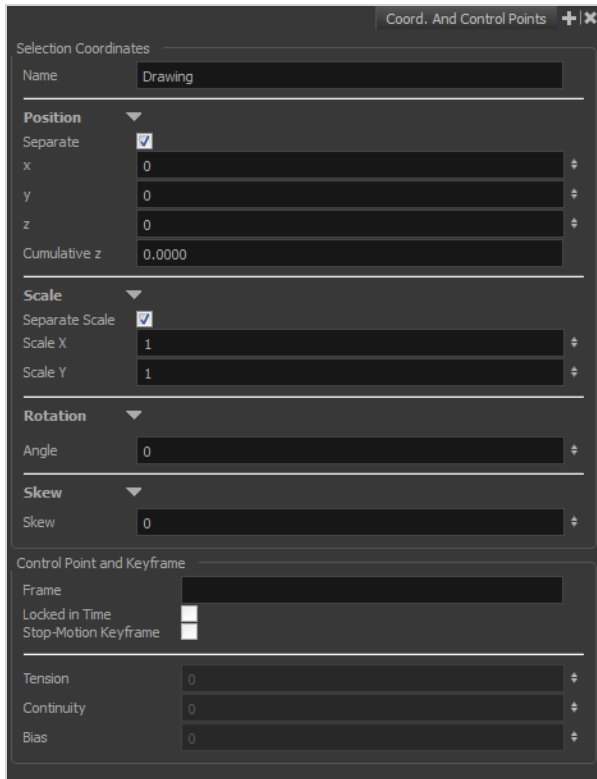

How to access the Coordinates and Control Points view

Do one of the following:

- From the top menu, select **Windows > Coordinates and Control Points**.
- From any of the other views, click the Add View **+** button and select **Coordinates and Control Points**.

Parameter	Description
Name	The name of the function curve to which the select point is linked.
Position	

Separate	Modifies modify the X, Y and Z coordinates independently. When this option is deselected, all three parameters are linked. If one is deleted, all others will also be deleted.
Cumulative Z	When a layer is parented to other layers that are moved forward or backward on the Z-axis, the currently selected layer's Z position value may not be accurate since its parent will also have an offset on the Z-axis. The Cumulative Z value is a compilation of all the Z-axis offsets to give the real Z-axis offset value related to the (0,0) centre.
Scale	
Separate Scale	Modifies the width and height values independently. When this option is selected, the width and height are locked to the same value, forcing the scale to be on a 1:1 ratio. If the option is deselected, you have the ability to squash and stretch your layer at will.
Rotation	
Angle	The rotation angle value from the permanent pivot of the element.
Skew	
Skew	This is the skewing value.
Control Point and Keyframe	
Frame	The frame at which the select point is set.
Locked in Time	Indicates whether the point is locked to a specific frame (keyframe) or only locked to a specific position and the curve can flow through it freely as other points are being added, moved, or adjusted (control point).
Stop-Motion Keyframe	When this option is selected, the keyframe is set as a stop-motion point. This means that there is no automatic interpolation created between the selected point and the next one. The layer will maintain its position until the animation reaches the frame of the next point and will then jump to the new position. Deselect this option to generate interpolation and get the layer to progressively move to the next position.
Tension	Controls how sharply the path bends as it passes through a control point or

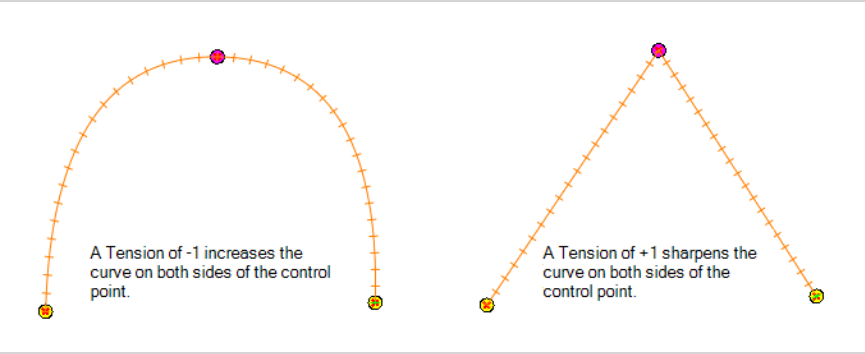
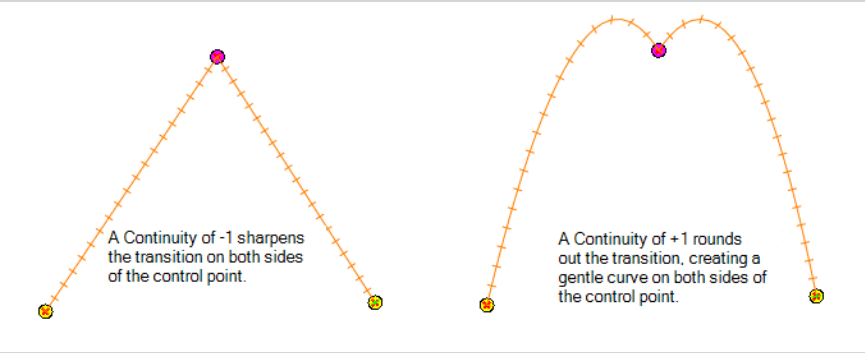
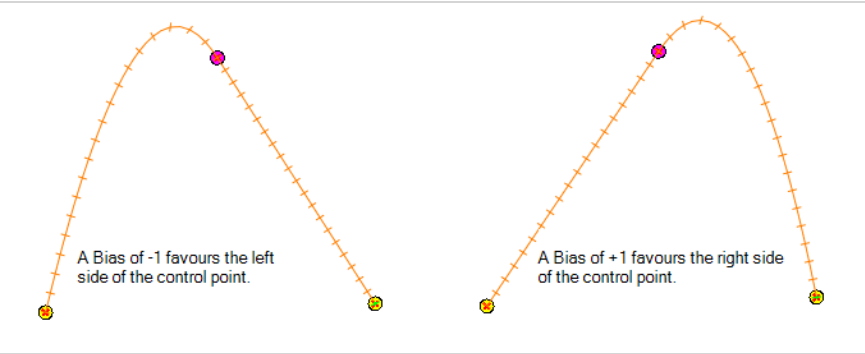
	<p>keyframe.</p> 
Continuity	<p>Controls the smoothness of a transition between the segments joined by a point.</p> 
Bias	<p>Controls the slope of the path so it flows towards one side of the motion point or the other.</p> 

Drawing View

In Harmony, you can draw in both the Drawing or Camera views. Although the two views are similar, there are some differences when it comes to drawing.

Only the selected drawing is displayed by default in the Drawing view. You can use features, such as the light table to display the current drawing of all the enabled layers of your scene in washed-out colours, or the Onion Skin to display the previous and next drawings of the currently selected drawing layer.

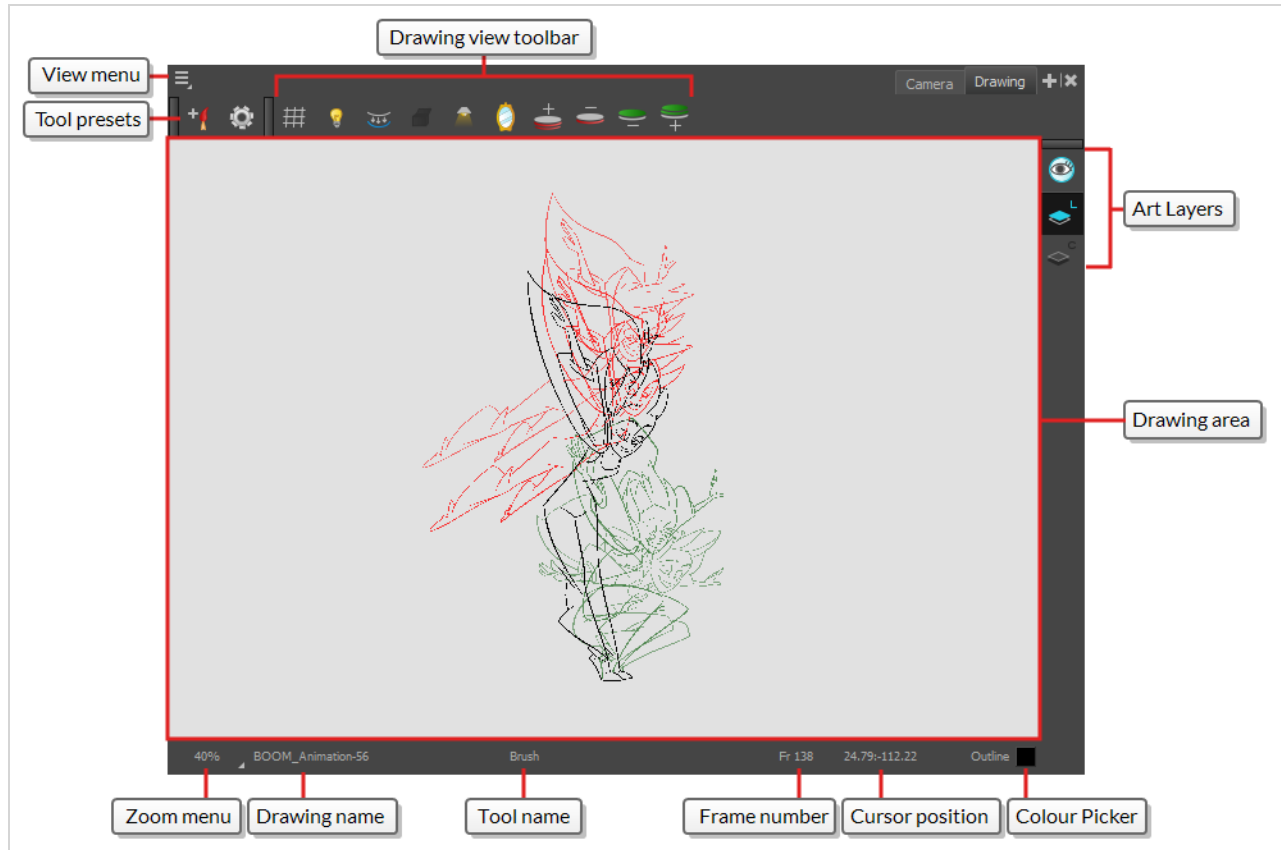

How to access the Drawing view

Do one of the following:

- From the top menu, select **Windows > Drawing** .
- From any of the other views, click the Add View **+** button and select **Drawing**.

Icon	Section	Description
	View Menu	The View menu contains all the tools and options that you can use in the Drawing view to draw, animate and paint.

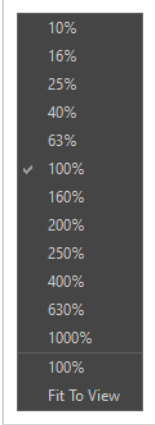
	Drawing Area	This is the main space in the Drawing view. It is where you draw and where the drawings are displayed.
	Zoom Menu	<p>The Zoom menu lets you enlarge or reduce the Camera or Drawing view display.</p> <p>To make the camera frame size always match the size of your view, select the Fit to View option. Click the drop-down arrow and select a zoom level or press 1 and 2.</p> 
	Drawing Name	The Drawing Name field displays the name of the selected drawing, as well as the layer containing it. If the cell does not contain any drawing, an Empty Cell text is shown in the field.
	Tool Name	The Tool Name field displays the name of the selected tool. If you temporarily override a drawing tool using a keyboard shortcut, the tool's name will be highlighted in red. You can temporarily override a tool by holding its keyboard shortcut without the Alt key. For example, the Select tool shortcut is Alt + S. If you hold down the S key, you will switch to the Select tool. When you release the key, you will return to the tool you were using.
	Frame Number	This field displays the current frame of the animation you are working on.
	Cursor Coordinates	This indicates the position of the your pointer in the drawing area.

	Colour Picker	The Colour Picker allows you to select a colour for drawing.
--	---------------	--

Drawing Substitutions View

T-H16NEW-002-001

The Drawing Substitutions view allows you to view all the drawings in the selected layer in a list of thumbnails, as well as to quickly select which drawing should be exposed at the current frame.

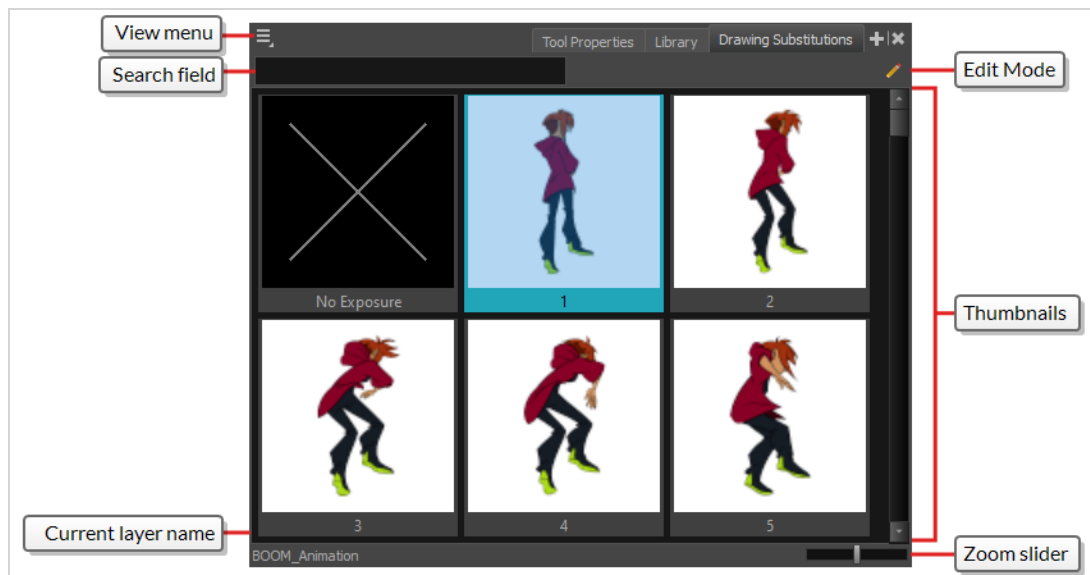

How to access the Drawing Substitutions view

1. Do one of the following
 - From the top menu, select **Windows > Drawing Substitutions**.
 - In the top-right corner of any view, click on the **+** Add View button and select **Drawing Substitutions**.

Section	Description
View Menu	<p>Opens a menu with the Create Key Exposure option. This option can be enabled or disabled. It determines what happens when you set the drawing in the current frame to the same drawing as the drawing in the previous frame.</p> <ul style="list-style-type: none"> • When enabled, the exposure of the drawing at the current frame will be separated from the drawing in the previous frame with a key exposure. • When disabled, the exposure of the current frame will be merged with the exposure of the previous frame.

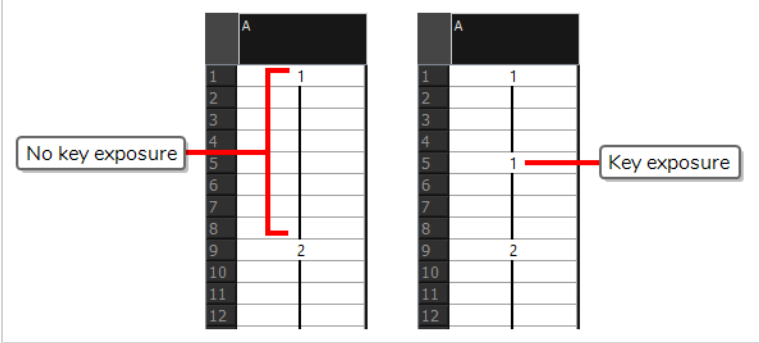
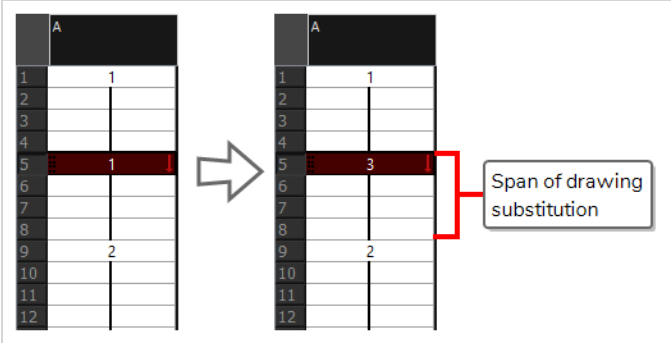
Section	Description
	 <p>The diagram illustrates two vertical grids representing drawing exposure. Each grid has 12 rows and a column labeled 'A'. In the left grid, a red bracket spans from row 1 to row 8, with a label 'No key exposure' pointing to it. In the right grid, a red horizontal line is at row 5, with a label 'Key exposure' pointing to it.</p>
<p>Thumbnails</p>	<p>Allows you to select the drawing to be exposed at the current frame. This will also replace the drawing for all subsequent frames during which the current drawing is exposed.</p>  <p>The diagram shows two vertical grids representing drawing thumbnails. The left grid has drawing 1 highlighted in row 5. An arrow points to the right grid, where drawing 3 is highlighted in row 5. A red bracket spans from row 5 to row 6 in the right grid, with a label 'Span of drawing substitution' pointing to it.</p>
<p>Current layer name</p>	<p>The name of the currently selected layer. The drawings in the thumbnails list are the drawings currently stored in this layer.</p>
<p>Zoom slider</p>	<p>Allows you to change the size of the thumbnails.</p>

Function View

The Function view lets you edit function curves and parameters. It contains a visual graph for adding, removing, and editing keyframes, as well as adjusting the velocity. The Function view allows you to display multiple functions in the background as a reference.

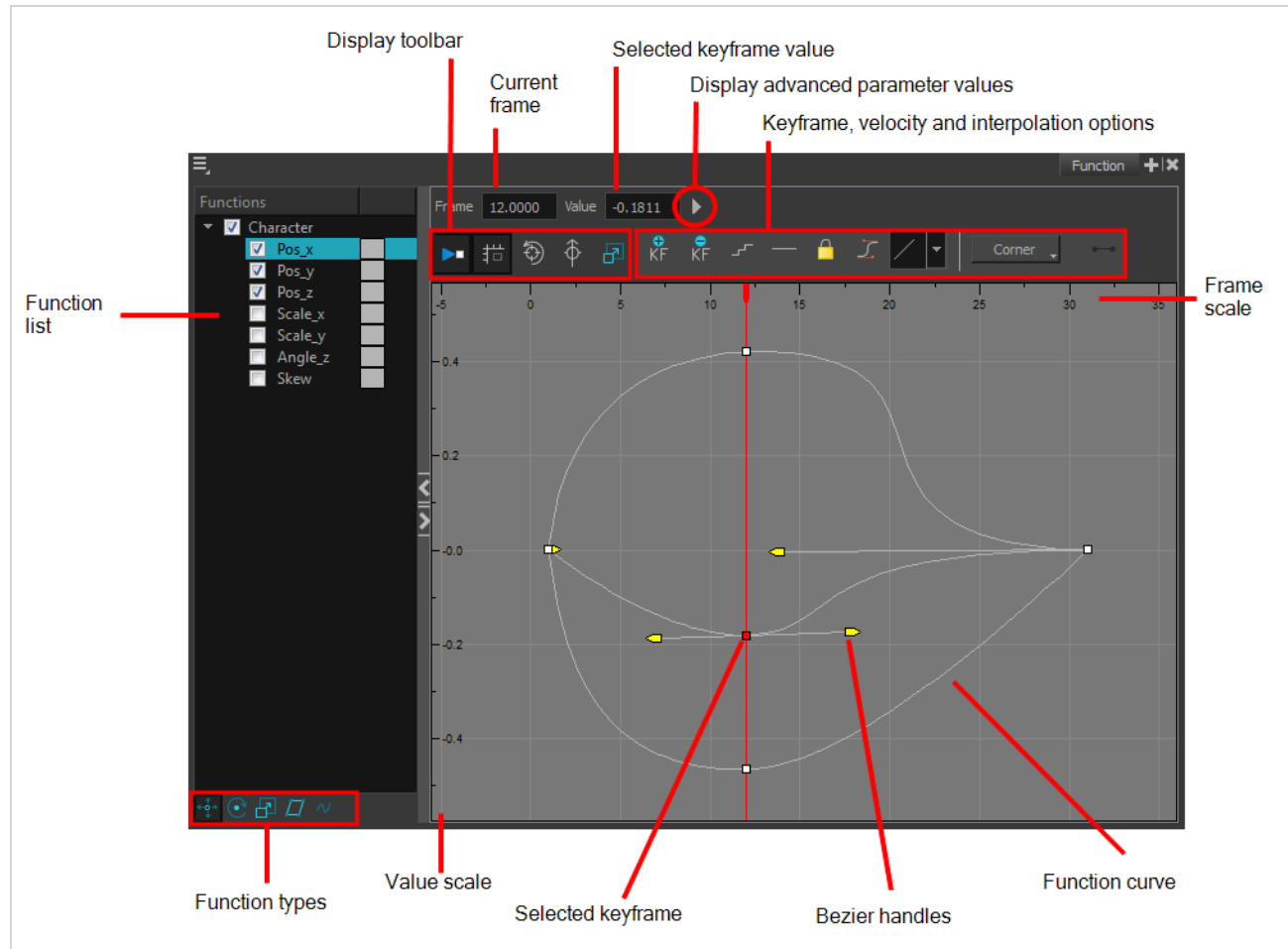

How to access the Function view

Do one of the following:

- From the top menu, select **Windows > Function**.
- From any of the other views, click the Add View **+** button and select **Function**.

How to display functions in the Function view

1. Open the Function view.

The Function view is blank until you select the layer containing the functions you want to display.

2. To display a function in the Function view, click on the layer containing the functions to adjust in the Timeline view.
3. To select the functions you want to edit, select them in the Function list.

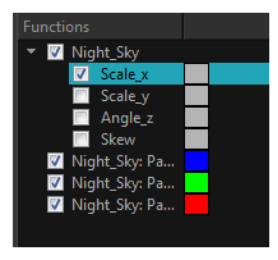
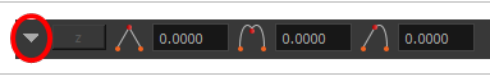
Parameter	Description
Function List	 <p>When selecting a layer in the Timeline view, all the corresponding functions are displayed (if any). Select the functions you want to see and edit, and hide the ones you don't.</p>
Display Toolbar	<p>Allows you to modify how the editing area is displayed. You can hide the grid, disable the synchronization with the current frame, reset the zoom level and normalize the function display by stacking them one over the other to compare them regardless of their value range.</p>
Current Frame	<p>Displays the current scene frame.</p>
Selected Keyframe Value	<p>Displays the value of the selected keyframe.</p>
Display Advanced Parameter Values	 <p>Displays the Projection, Bias, Tension and Continuity parameters to adjust the curve around the selected keyframe.</p>
Keyframe, Velocity and Interpolation Options	<p>This toolbar lets you add and delete keyframes, adjust the velocity curve, adjust the segments to motion or stop-motion keyframes and set the velocity to create steps instead of a constant progression.</p>
Function Types	<p>This toolbar lets you click on the different function types to enable or disable all the listed functions of that type.</p>
Value Scale	<p>Displays the value range for the displayed editing area. It can be referenced to know the value of a keyframe.</p>

Selected Keyframe	The selected keyframe is displayed in red. When selected, the keyframe values are displayed in the corresponding fields.
Bezier Handles	The Bezier handles let you adjust the ease in and ease out of each keyframe. The more the handle is pulled out horizontally, the slower the animation will be. The more the handle is pulled out vertically, the faster the animation will be.
Function Curve	The thin line going from keyframe to keyframe is the actual curve. The section of a curve located between two keyframes is called a segment.
Frame Scale	The Frame Scale displays the frame range for the displayed editing area. It can be referenced to know the current frame of a keyframe.





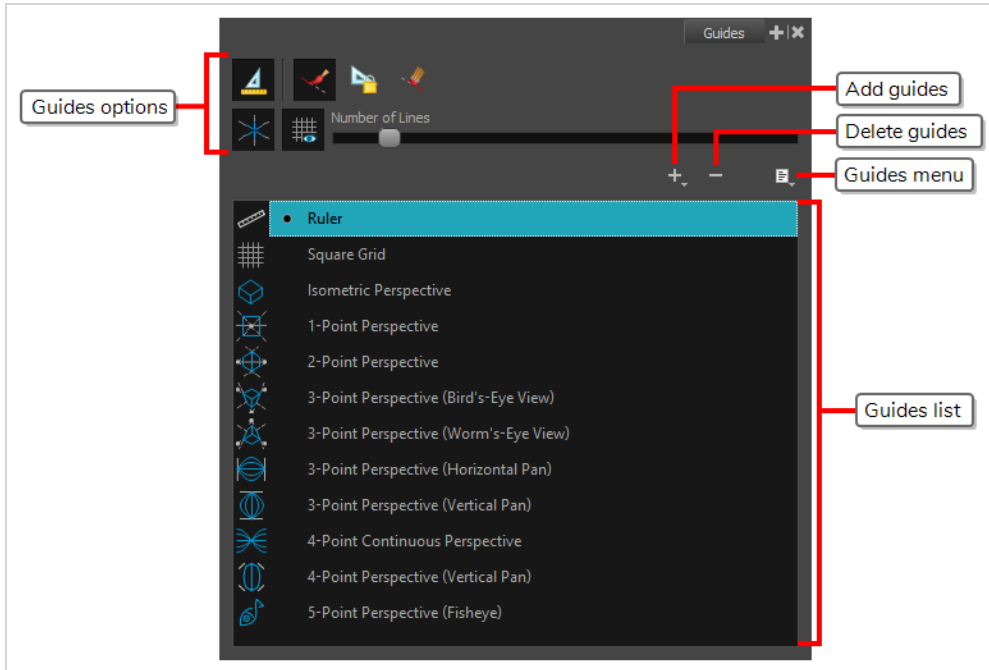

Guides View















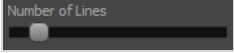

The Guides view allows you to add drawing guides to the current scene, to select which guide to use, to manage existing guides, to export and import guides and to enable or disable drawing guides as well as their various options.







NOTE

For more information on each type of guide and how to use them, refer to the User Guide.

Icon	Name	Description
Options		
	Enable Guide	Enables or disables drawing guides. When guides are disabled, they are not visible and you cannot edit them or use them with drawing tools.
	Align with Guide	<p>When enabled, when drawing with the  Brush,  Pencil,  Stroke and  Line tools tool, the cursor is automatically locked against the axis of the currently selected guide that most closely matches the angle of your stroke, as if you were drawing against a rule.</p> <p>When disabled, the drawing tools are not constrained by the axes of the guide, allowing you to draw freely. The guide's axes act as a visual aids only.</p>

Icon	Name	Description
	Lock Guide	When enabled, you cannot do modifications on the currently selected guide. This prevents making unwanted modifications to the guide when drawing.
	Enable Guide with Eraser	Allows you to use the Eraser tool with drawing guides.
	Full Cursor Display	<p>When enabled, the guide's axes that go through the mouse cursor in the drawing space go throughout the entire drawing space and display even when you're drawing.</p> <p>When disabled, the guide's axes that go through the mouse cursor only display over a short distance from the mouse cursor. Also, the guide's axes disappear when drawing a stroke.</p>
	Show Reference Lines	When enabled, semi-transparent reference lines for each of the currently selected guide's axes appear all over your drawing space.
	Number of Lines	<p>Adjusts the amount of reference lines to display in your drawing space.</p> 
Guides List		
	New Guide	<p>Allows you to add a guide to the scene's guides list. You can add a guide of one of the following types:</p> <ul style="list-style-type: none">  Ruler  Square Grid  Isometric Perspective  1-Point Perspective  2-Point Perspective  3-Point Perspective (Bird's-Eye View)  3-Point Perspective (Worm's-Eye View)  3-Point Perspective (Horizontal Pan)  3-Point Perspective (Vertical Pan)  4-Point Continuous Perspective  4-Point Perspective (Vertical Pan)

Icon	Name	Description
		<ul style="list-style-type: none"> •  5-Point Perspective (Fisheye) <div data-bbox="537 344 1430 516" style="border: 1px solid #c8e6c9; padding: 10px; margin-top: 10px;"> <p> NOTE For more information on each type of guide and how to use them, refer to the User Guide.</p> </div>
	Delete Guide	Deletes the selected drawing guides from the scene's guides list.
	Guides View Menu	Opens a menu with the following commands:
	Rename Guide	Renames the selected drawing guide.
	Cut	Cuts the selected drawing guides from the list and adds them to the clipboard.
	Copy	Copies the selected drawing guides to the clipboard.
	Paste	Pastes drawing guides from the clipboard to the current scene's guides list. Pasted guides are inserted under the selected guide.
	Import Guides	Imports drawing guides that were previously exported to a file and inserts them at the bottom of the scene's guides list. Duplicate guides are filtered out to avoid cluttering the list.
	Export Selected Guides	Exports the selected drawing guides into a file.
	Drawing Guides List	Displays the scene's list of guides and allows you to select which guide to display, edit and use.

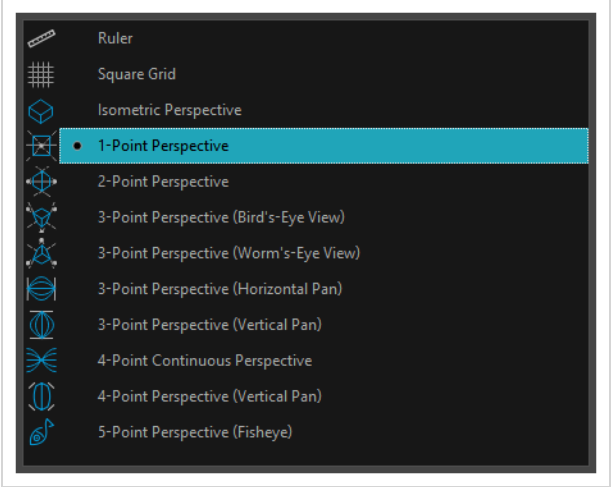
Icon	Name	Description
		 <p>Ruler Square Grid Isometric Perspective • 1-Point Perspective 2-Point Perspective 3-Point Perspective (Bird's-Eye View) 3-Point Perspective (Worm's-Eye View) 3-Point Perspective (Horizontal Pan) 3-Point Perspective (Vertical Pan) 4-Point Continuous Perspective 4-Point Perspective (Vertical Pan) 5-Point Perspective (Fisheye)</p>

Integrated Help View

Use the Integrated Help when you are unsure about what a certain menu item is or the function of a specific preference in the Preferences panel.

If you keep the Integrated Help window open for the entire duration of your work session, then you can use the forward and backward arrows to scroll through a history of the help information that you called up during your session.

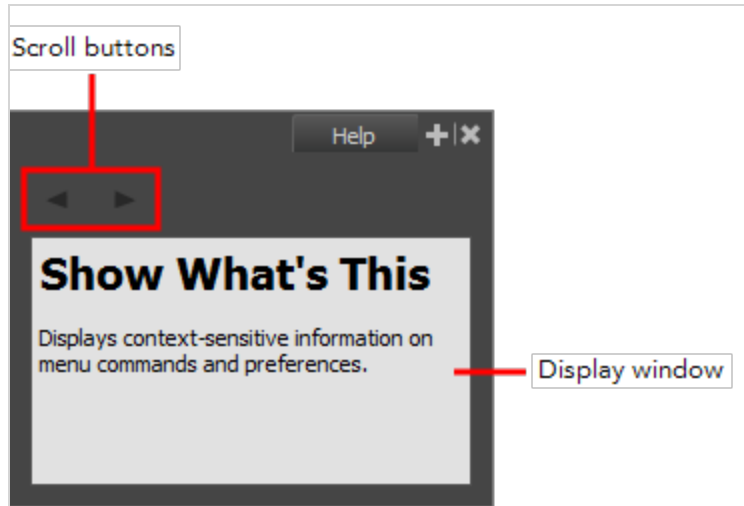

How to access the Integrated Help view

1. Do one of the following:
 - From the top menu, select **Windows > Integrated Help**.
 - From any of the other views, click the Add View **+** button and select **Integrated Help**.

Layer Properties View

The Layer Properties editor or view lets you adjust the properties of a layer in the Timeline view or a node in the Node view. The Layer Properties can be viewed as a floating window or as a view (docked).

Each layer has its own set of properties that can be modified, including effect and peg layers. Display the Layer Properties editor or view if you want to modify some of the layer's properties, such as the name or the antialiasing quality.



NOTE

To know more about the parameters displayed in the Layer Properties view, see [Nodes / Layers](#).

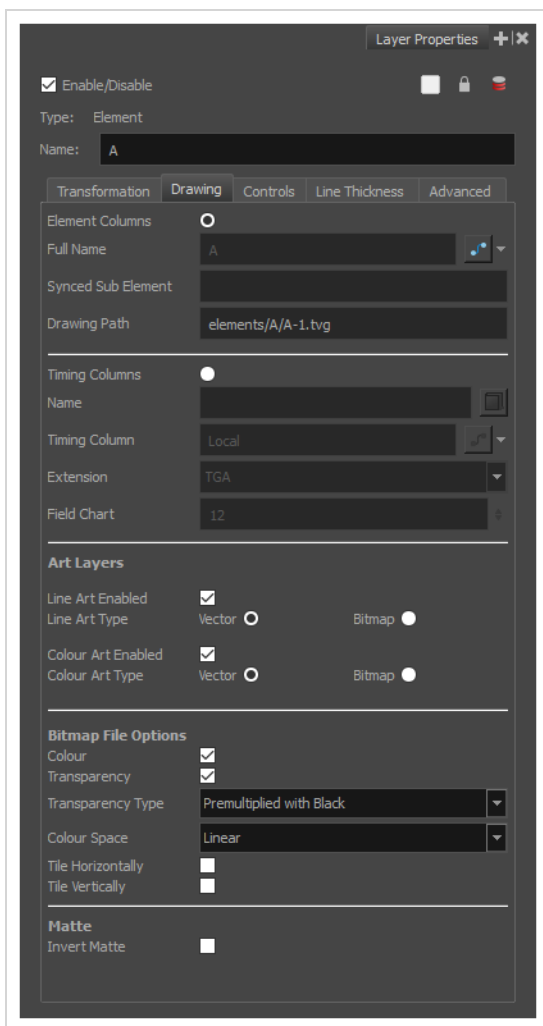

How to access the Layer Properties view

Do one of the following:

- From the top menu, select **Windows > Layer Properties**.
- From any of the other views, click the Add View **+** button and select **Layer Properties**.

How to access the Layer Properties editor

- Double-click on a layer in the Timeline view or a node in the Node view.
- Right-click on a layer in the Timeline view or a node in the Node view and select **Layer Properties**.
- Select a layer in the Timeline view or a node in the Node view and press Shift + E.

Library View

The Library view is used to store elements such as animation, drawings, backgrounds and character models so as to reuse in different scenes and projects. You can also use the Library view to create and store symbols, as well as to store and import images, sound files and 3D models.

To reuse elements from a scene in other scenes, you must create a template so that you can import it into different scenes. Templates can contain anything from a single drawing to a whole scene structure. You can create a template by creating it in a scene, then copying the elements you want in your template into a library. The resulting template is structured like a mini-scene that contains only the elements you copied into it. A template does not have any dependencies on the scene it was originally created in. Hence, it can safely be imported in any other scene.

Additionally, the Library view's Drawing Substitutions panel allows you to quickly change the current frame's exposure to one of the existing drawings in a layer. This is especially useful for animating a cut-out character's mouths, hands, eyelids and other such body parts which typically contain several drawings to choose from.

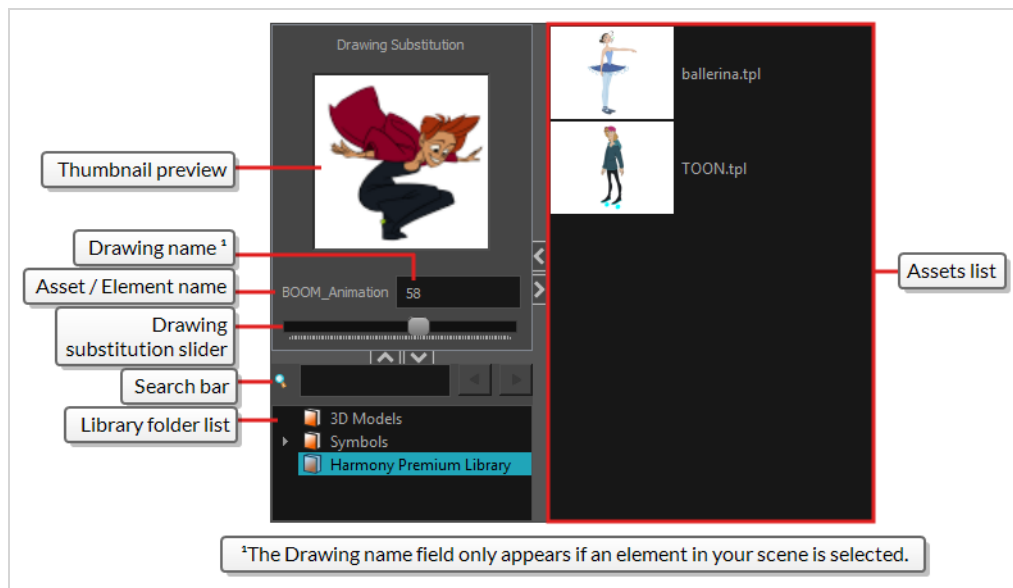

How to access the Library view

Do one of the following:

- From the top menu, select **Windows > Library**.
- From any of the other views, click the Add View **+** button and select **Library**.

Icon	Section	Description
	View Menu	The Library menu lets you access commands related to the Library view, importing .swf movies and Illustrator files, add a new folder, and refresh

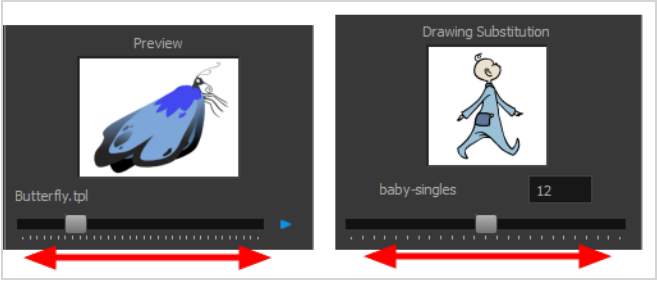
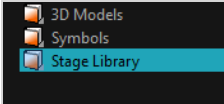
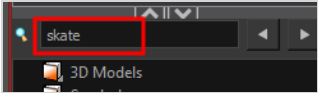
Icon	Section	Description
		the library's content.
	Preview Window	<p>The Preview window lets you see the content of the currently selected template or symbol in the Template/Symbol list.</p> 
	Preview Playback	<p>The Preview Playback button lets you play back the content of the selected template or symbol if it contains more than one frame. Press the Play button to play back the preview.</p>
	Library Folder List	<p>The Library Folder List displays all the folders linked to the Library view.</p>  <p>There are two default folders:</p> <ul style="list-style-type: none"> • Symbols: This folder is the only folder containing symbols. You can organize it by adding subfolders inside. • Harmony Premium Library: This is a default folder found on the hard drive in your user documents. This folder can contain templates, but no symbols. <p>You can link new library folders to the Library view and organize them with subfolders.</p>
	Library Search tool	<p>When working on a movie or series, you will probably end up with many templates and symbols in your library. Using the Search tool, you can quickly find the templates and symbols in your folders.</p> 
	Template/Symbol List	<p>The Template/Symbol list displays the templates or symbols contained in the selected library folder. You can display the templates by right-clicking</p>

Icon	Section	Description
		the symbols' thumbnails and selecting View > Thumbnails .

Master Controller View

T-RIG3-008-008

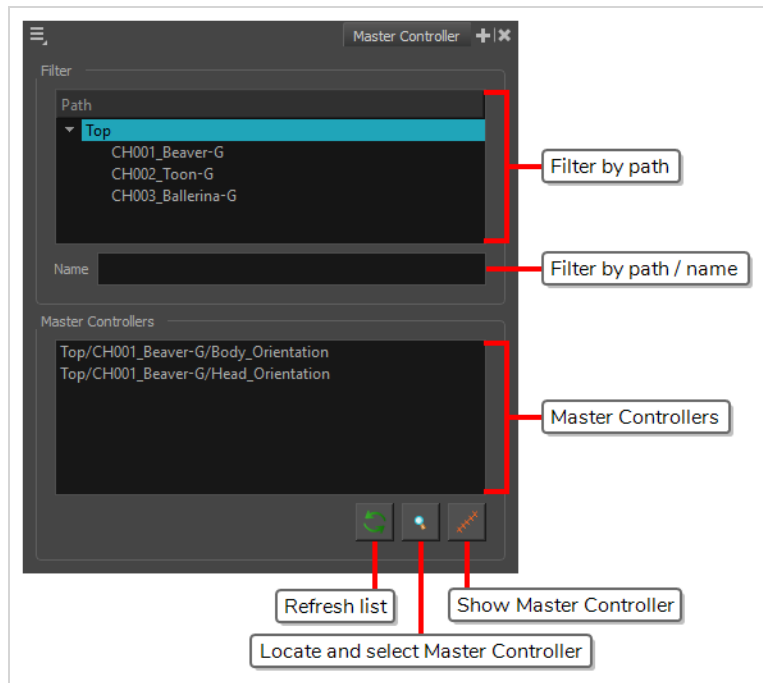

The Master Controller view allows you to quickly find, select and display Master Controllers in the current scene.



How to add the Master Controller view to your workspace

- Do one of the following:
 - In the top-right corner of an existing view, click on **+** Add View and select **Master Controller**.
 - In the top menu, select **Windows > Master Controller**.

Icon	Section	Description
Filter		
	Path	Allows you to select a group in the current scene. When a group is selected, only the Master Controllers within that group will be listed in the Master Controllers list. This can be useful if you have several characters and only want the list of Master Controllers for a specific character.

Icon	Section	Description
	Name	Allows you to filter the Master Controllers in the Master Controllers list by their path or name. When you type something in this field, only the Master Controllers that contain the text you typed in their full path including their name will be listed in the Master Controllers list.
Master Controllers		
	Master Controllers	<p>Allows you to select one of the Master Controllers in your scene. This list displays the Master Controllers in your scene with their full path in the group hierarchy. Groups in the hierarchy are separated by forward slashes (/).</p> <p>If a group is selected in the Path list, only the Master Controllers within this group will appear in the list. If anything is typed in the Name field, only Master Controllers with this text in their full path including their name will appear in the list. Otherwise, all the Master Controllers in your scene are listed.</p>
	Refresh List	Refreshes the Path list if there are any changes in the name or hierarchy of groups in your scene, as well as the Master Controllers list if there are any changes in the Master Controllers in your scene.
	Locate and Select Master Controller	If a Master Controller is selected in the Master Controllers list, clicking on this button will select the actual Master Controller node. It will also make the Node View navigate instantly to and focus on that Master Controller node.
	Show Master Controller	If a Master Controller is selected in the Master Controllers list, clicking on this button will display its widget in the Camera view.

Message Log View

The Message log view displays information gathered during a render task, such as which frames and at what time they were each rendered. The view also contains a list of the colour recovery operations.

```

T: 17:04:39.202 Color recovery disabled - 1 colors not found in palette list [C:/Toon Boom
Projects/Harmony/HAR11/TB_magazine/Guru_Nautilus/Ale/_LINEUP_/elements/fundilhos]
T: 17:04:39.206 Color recovery disabled - 1 colors not found in palette list [C:/Toon Boom
Projects/Harmony/HAR11/TB_magazine/Guru_Nautilus/Ale/_LINEUP_/elements/piru]
T: 17:04:39.212 Missing palette [C:/Toon Boom Projects/Harmony/HAR11/TB_magazine/Guru_Nautilus/Ale/_LINEUP_/jobs/Digital/palette-
library/STILPEN_JOV_01.plt]
T: 17:04:39.214 Color recovery disabled - 2 colors not found in palette list [C:/Toon Boom
Projects/Harmony/HAR11/TB_magazine/Guru_Nautilus/Ale/_LINEUP_/elements/fivela.632]
T: 17:04:48.323 Color recovery for palette list [C:/Toon Boom Projects/Harmony/HAR11/TB_magazine/Guru_Nautilus/Ale/_LINEUP_]
T: 17:04:48.323 14 colors recovered and 0 palettes loaded
T: 17:04:48.323 Colors: [Pele.01] [New 12] [New 15] [Arma.02] [New 14] [Pele.01b] [New 0] [Bracelete] [Cinto.02] ...

T: 17:16:52.626 Missing palette [C:/Toon Boom Projects/Harmony/HAR11/TB_magazine/Guru_Nautilus/Ale/_LINEUP_/jobs/Digital/palette-
library/STILPEN_JOV_01.plt]
T: 17:16:52.789 Missing palette [C:/Toon Boom Projects/Harmony/HAR11/TB_magazine/Guru_Nautilus/Ale/_LINEUP_/jobs/Digital/palette-
library/PUCK_01.plt]
T: 17:16:53.153 Missing palette [C:/Toon Boom Projects/Harmony/HAR11/TB_magazine/Guru_Nautilus/Ale/_LINEUP_/jobs/Digital/palette-
library/CRIS_01.plt]
T: 17:16:53.299 Missing palette [C:/Toon Boom Projects/Harmony/HAR11/TB_magazine/Guru_Nautilus/Ale/_LINEUP_/jobs/Digital/palette-
library/CRIS_01.plt]
T: 17:16:53.378 Missing palette [C:/Toon Boom Projects/Harmony/HAR11/TB_magazine/Guru_Nautilus/Ale/_LINEUP_/jobs/Digital/palette-
library/CRIS_01.plt]
T: 17:16:53.383 Missing palette [C:/Toon Boom Projects/Harmony/HAR11/TB_magazine/Guru_Nautilus/Ale/_LINEUP_/jobs/Digital/palette-
library/CRIS_01.plt]
T: 17:16:53.602 Missing palette [C:/Toon Boom Projects/Harmony/HAR11/TB_magazine/Guru_Nautilus/Ale/_LINEUP_/jobs/Digital/palette-
library/STILPEN_JOV_01.plt]
T: 17:17:25.094 Color recovery disabled - 1 colors not found in palette list [C:/Toon Boom
Projects/Harmony/HAR11/TB_magazine/Guru_Nautilus/Ale/_LINEUP_/elements/Lingua.409]
T: 17:17:25.095 Color recovery disabled - 1 colors not found in palette list [C:/Toon Boom
Projects/Harmony/HAR11/TB_magazine/Guru_Nautilus/Ale/_LINEUP_/elements/Coxa.475]
T: 17:17:25.095 Color recovery disabled - 1 colors not found in palette list [C:/Toon Boom
Projects/Harmony/HAR11/TB_magazine/Guru_Nautilus/Ale/_LINEUP_/elements/Nariz.01]
T: 17:17:25.119 Color recovery for palette list [C:/Toon Boom Projects/Harmony/HAR11/TB_magazine/Guru_Nautilus/Ale/_LINEUP_]
T: 17:17:25.119 3 colors recovered and 0 palettes loaded
T: 17:17:25.120 Colors: [Boca.01] [Calca.01a] [Pele.01b]

T: 17:17:25.120 Rendering frame 1
T: 17:17:27.194 Rendering frame 2
T: 17:17:27.207 Rendering frame 3
T: 17:17:27.350 Rendering frame 4
T: 17:17:28.518 Color recovery for palette list [C:/Toon Boom
Projects/Harmony/HAR11/TB_magazine/Guru_Nautilus/Ale/_LINEUP_/elements/Orelha.357]
T: 17:17:28.519 1 colors recovered and 0 palettes loaded
T: 17:17:28.519 Colors: [Pele.03]

```

How to access the Message Log view

Do one of the following:

- From the top menu, select **Windows > Message Log**.
- From any of the other views, click the Add View **+** button and select **Message Log**.

Metadata Editor View

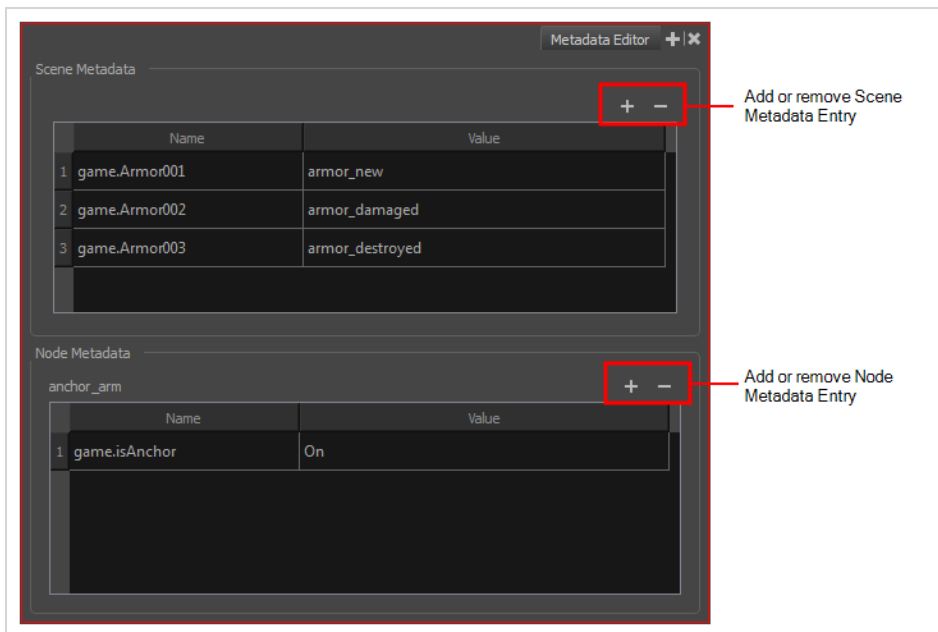

The Metadata Editor view lets you access the information of the props and anchors to be exported to Unity.



NOTE

Because the Unity game engine does not support Unicode characters, it is recommended to avoid using it in scenes intended for games.

How to access the Metadata Editor view

- In the top-right corner of a view, click the Add View **+** button and select **Metadata Editor**.
- In the top menu, select **Windows > Metadata Editor**.

Parameter	Description
Scene Metadata	This is a list of optional parameters you can create in a scene project to be exported to Unity. It will not have any incentive towards your scene assets, but can help developers know what to do with the assets contained in your Harmony scene.
	Once in Unity, scene Metadata will appear in Inspector view > Metadata when the Asset is selected in the Hierarchy view.
	Name: Name of the Scene entry. (e.g. game.Armor001)

	<p>Value: This can be anything that describes the state of an object. You could, for example, have three different stages of armour: new, damaged and destroyed.</p>
<p>Node Metadata</p>	<p>Displays only the props and anchors held inside your selection. If nothing is selected, no information will display. Name and value appear in this box as well. Name will show you the associated .tvg name and value will be set as either On or Off, depending on whether you want the connection to be set as active or not. Once in Unity, scene Metadata will appear in the Hierarchy view.</p>
	<p>Name: Name of the selected anchor or prop. (e.g. game.isAnchor). Notice that it differs from the drawing layer name on the top-left corner of the Node Metadata section.</p>
	<p>Value: Can be set to be active (On) or inactive (Off).</p>



NOTE

For any anchor or prop information created within the Metadata Editor, the naming convention must always use the prefix "game.". The term "game." is recognized automatically by Unity as a metadata information. For example: `game.Armor001`.

Model View

T-ANIMPA-004-004

Once you have a fully painted drawing, you can use it as a colour model and load it in the Model view. This drawing can be used and loaded in any of your Harmony scenes.

Once a drawing is loaded in the Model view, you can use the Colour Eyedropper  tool to select a colour from the model and use it to paint in the Camera or Drawing view without having to pick the colour from the colour palette.

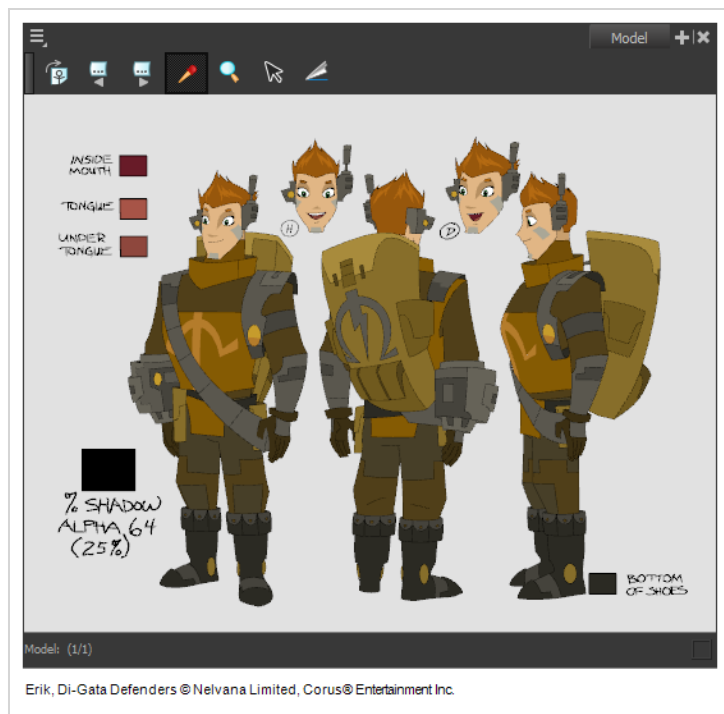

How to access the Model view

Do one of the following:

- From the top menu, select **Windows > Model**.
- From any of the other views, click the Add View  button and select **Model**.

Tool/Menu Item	Icon	Description
	View Menu	The View menu contains all the tools and options that you can use to manage models.
	Model View Toolbar	The Model View toolbar contains all the tools and

		options you can use in the Model view to navigate through and manage models.
Colour Eyedropper		Allows you to select a colour by clicking on a colour in your artwork.

Node View

T-HFND-010-002

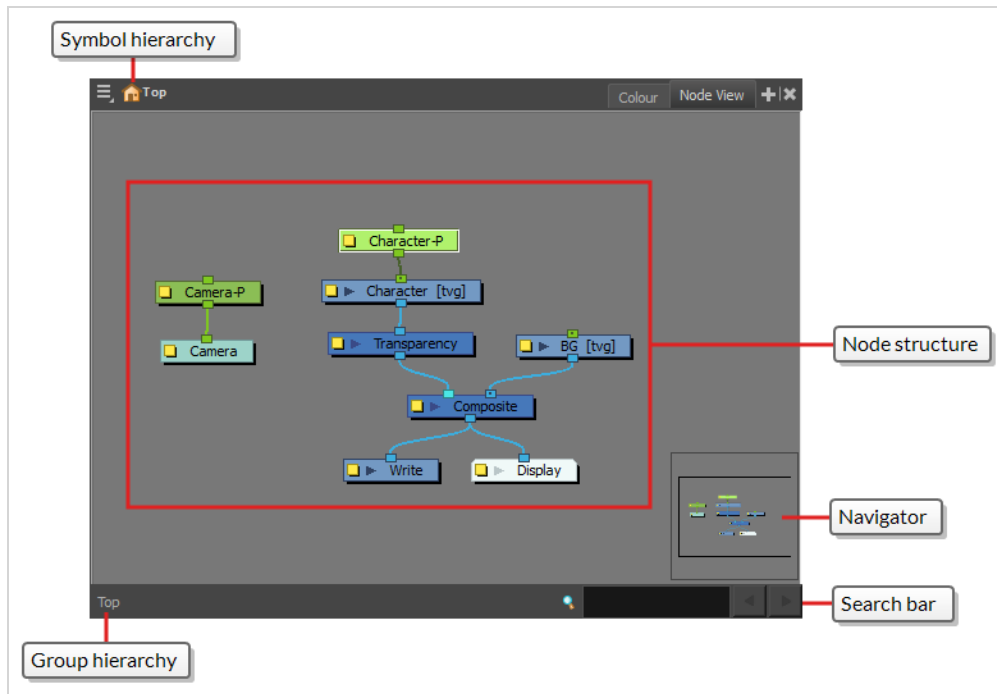

In the Node view, you can connect effects and compositing nodes to form a network, also known as a *node system*. This view is very useful for rigging puppets, creating advanced effects and having a clear view of complex scenes. The organization and order of the nodes determines the flow of data during the compositing process and how your animation elements will be composited.



How to access the Node view

Do one of the following:

- From the top menu, select **Windows > Node View**.
- From any of the other views, click the Add View **+** button and select **Node**.

Icon	Section	Description
	View Menu	The View menu contains all the tools and options that you can use to manage the node system.
	Editing Stack	The Editing Stack menu displays the names of the symbols and their hierarchy when you are editing a symbol. You can click on the different names to go back up to the different parent symbols or the

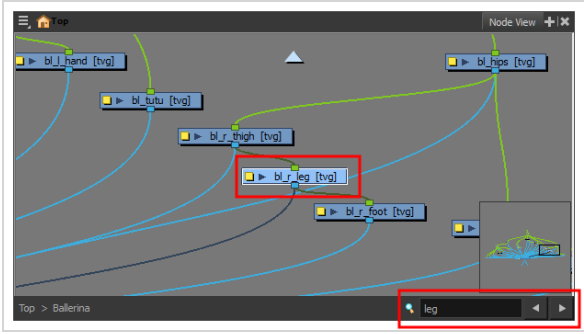
		<p>top/current project.</p>
	<p>Node System</p>	<p>The main area of the Node view is where you can add and organize different nodes to represent a scene.</p>
	<p>Navigator</p>	<p>The Navigator view lets you pan the visible area to move quickly through extensive node sets.</p>
	<p>Search Toolbar</p>	<p>The Search toolbar lets you find and match a node in the project. The search is not case-sensitive. Once you have entered characters in the search field, press Enter/Return to validate and find the pattern in the node names. If successful, the node is selected and centred in the view. If many instances are found, use the Previous and Next buttons to cycle through each node.</p> 
	<p>Group Navigation</p>	<p>When entering a group, the Group Navigation allows you to navigate back to the top and see the hierarchy of the group in which you are.</p>

Node Library View

T-HFND-010-003

To add effects or other types of nodes to the Node view, you must first find them in the Node Library view.

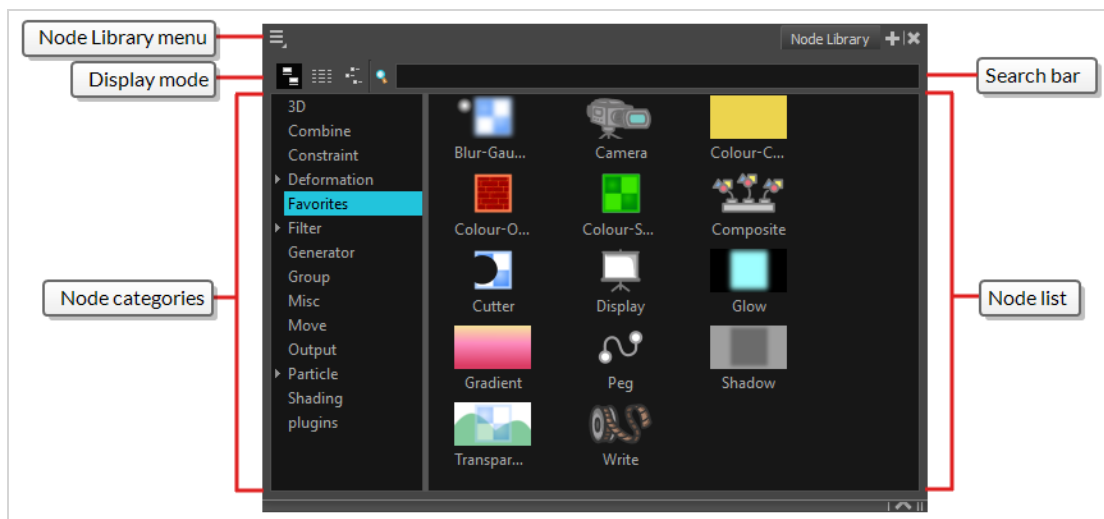

When you create a new project in Harmony, the default node system that appears in the Node view looks similar to the one below.

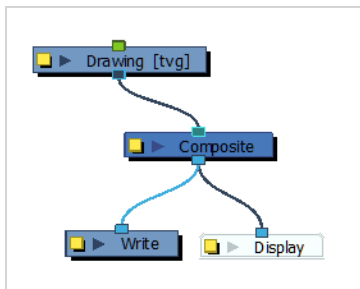

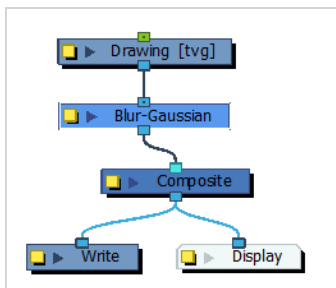

Notice how layers are connected to your scene's composite. For an effect to work, it must be connected as an intermediary between a layer and its composite, as if it was made to filter the layer's drawing information before it reaches the composite.



How to access the Node Library view

Do one of the following:

- From the top menu, select **Windows > Node Library View**.
- From any of the other views, click the Add View **+** button and select **Node Library View**.

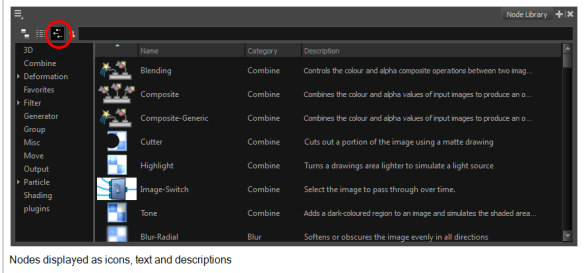
Icon	Section	Description
	View Menu	The View menu contains all the tools and options that you can use to manage the Node Library.
	Node Library View Toolbar	<p>In the Node Library View toolbar, you can change how the nodes are displayed. You can display nodes as icons, as a textual list or as icons with their names and a description.</p>   <p>Nodes displayed as icons, text and descriptions</p>
	Node Categories	The Node Library view is conveniently divided into several categories retaining the related nodes.
	Category	Description
	3D	Nodes related to working with 3D models within Harmony.
	Combine	Nodes for combining images.
	Deformation	Nodes needed for building a deformation chain, as well as advanced effects such as Fold and Auto Muscle. The Deformation category is divided into the Bone and Distort categories.
	Favorites	Nodes most commonly used. To add nodes to the Favorites category, select any node from any other section and drag it onto the Favorites category.

	Filter	Effect nodes, such as blurs. This category is subdivided into the following categories: Adjust, Blur, Colour Correct, Isolate and Stylize.
	Generator	Nodes that create an image, such as a gradient or colour.
	Group	Nodes for grouping, like Group nodes and Multi-Port-In nodes.
	Misc	Various nodes including External, Note, Script and Visibility.
	Move	Nodes for changing elements over time, like Peg nodes, as well as certain transformations.
	Output	Output (Export) nodes such as Crop, Display, Scale-Output and Write nodes.
	Particle	Nodes needed to construct complex particle systems. This category includes a series of examples of particle effects and is subdivided into the following categories: Basic, Examples and Modifier.
	Plugins	Plugin nodes.
	Shading	Nodes for light shading.

Onion Skin View

The Onion Skin view allows you to quickly configure onion skin. Using this view, you can choose the colour of previous and next drawings, which kind of marked drawings to display and whether to measure the span of onion skin per frame or per drawing. When using Advanced Onion Skin, you can also use this view to pick which drawings are included in the Onion Skin, as well as the opacity of the drawings relative to how far they are from the current frame.

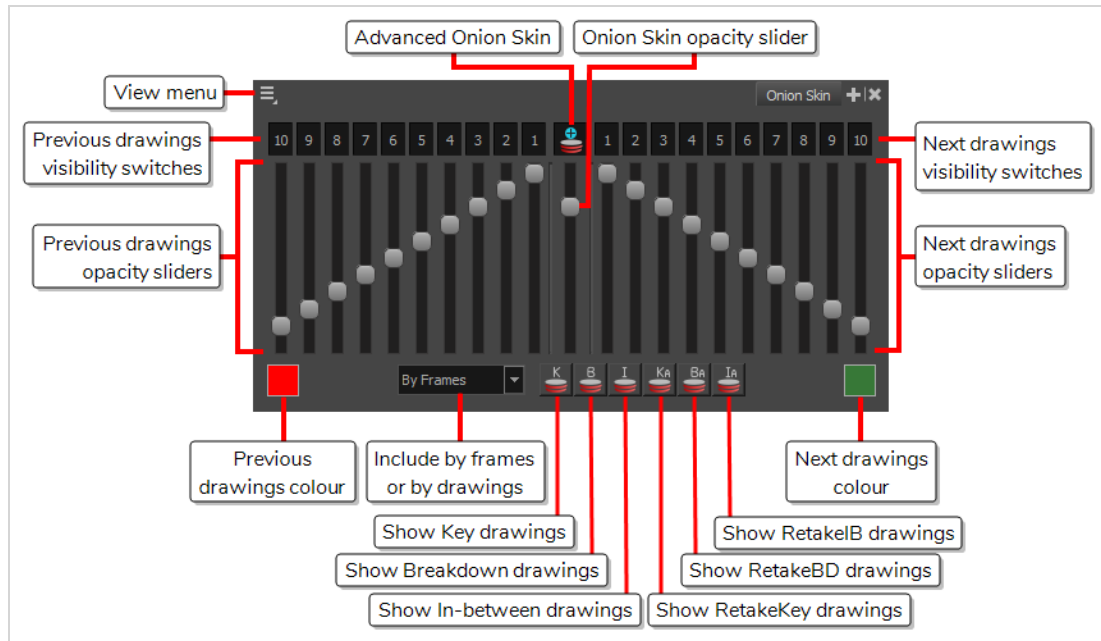

How to access the Onion Skin view

- Do one of the following:
 - In the top-right corner of a view, click on the **+** Add View button and select **Onion Skin**.
 - In the top menu, select **Windows > Onion Skin**.



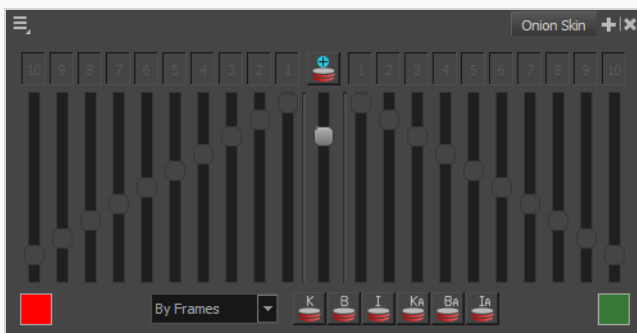

The Onion Skin view is added to your workspace.



A lot of the controls in the Onion Skin view are only accessible when using Advanced Onion Skin.





How to enable Advanced Onion Skin



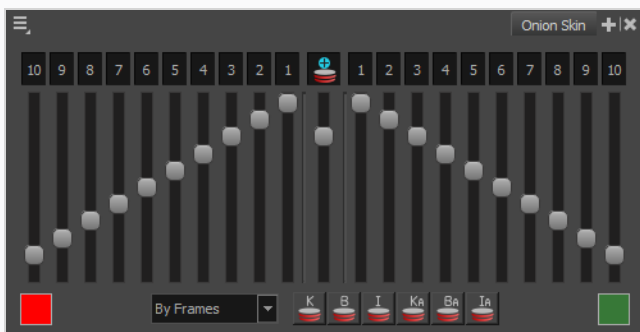

1. Do one of the following:



- In the Tools toolbar, double-click on  Onion Skin and select  **Advanced Onion Skin**.
- In the Onion Skin view, click on the  Advanced Onion Skin button.
- In the top-left corner of the Onion Skin view, open the  View Menu and select **Advanced Onion Skin**.

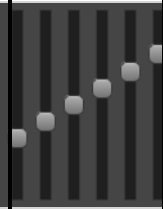
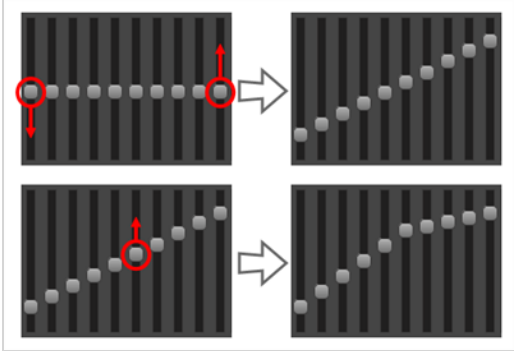

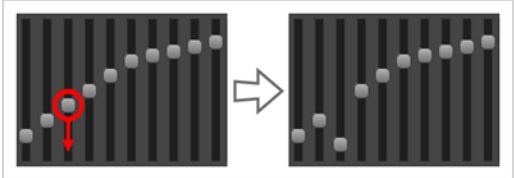

The controls for the Advanced Onion Skin are now accessible in the Onion Skin view.

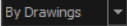



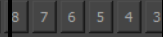

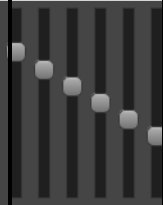
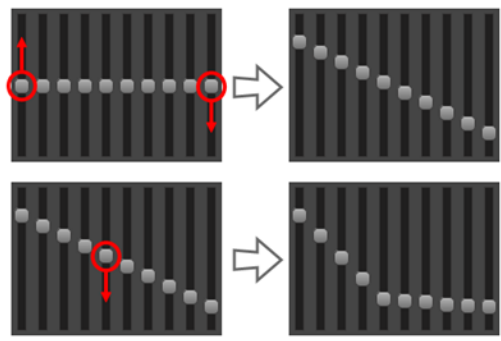

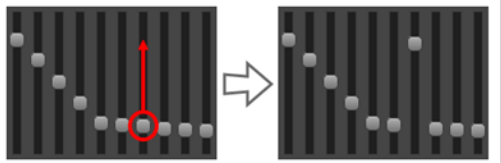
User Interface	Section	Description
	View Menu	Open the Onion Skin view menu, which contains extra options for Advanced Onion Skin—see Onion Skin View Menu on page 366.
Previous Drawings Settings		
	Previous drawings visibility switches	<p>Allows you to select which drawings before the current frame to include in the Onion Skin. A drawing that is toggled on will be visible in the Onion Skin, and a drawing that is toggled up will be excluded from it. You can select a range of drawings, or include and exclude specific drawings individually.</p> <div style="border: 1px solid #add8e6; padding: 10px; margin-top: 10px;"> <p> TIP</p> <p>You can quickly select or deselect a range of drawings by clicking and holding on one drawing, then dragging the mouse cursor over the other drawings you want to toggle.</p>  </div>

User Interface	Section	Description
	<p>Previous drawings opacity sliders</p>	<p>Allows you to adjust the opacity scale of drawings before the current frame. Each slider represents the opacity of one drawing.</p> <p>By default, moving one of these sliders will move the other sliders so that the opacity remain on a gradated scale. In this case, you can start by adjusting the opacity on one end, the opacity on another end and then, if you want, adjust one of the sliders in-between to make a segmented progression.</p>  <p>You can disable this behaviour by unchecking the Link Sliders option in the  View Menu in the top-left corner of the Onion Skin view. This option is enabled by default. When disabled, you can adjust the opacity of each drawing independently.</p> 
	<p>Previous drawings colour</p>	<p>Allows you to select the colour in which to display the drawings before the current frame.</p>
<p>Onion Skin Settings</p>		
	<p>Advanced Onion Skin</p>	<p>Enables Advanced Onion Skin. Advanced Onion Skin allows you to select, on the fly, which drawings to include in your Onion Skin, even if those drawings are not consecutive drawings, as well as the opacity scales for the drawings before and after the current frame.</p> <p>The controls for selecting which drawings to display in the Onion Skin as well as their opacity sliders are only accessible when Advanced Onion Skin is enabled. Otherwise, when using regular Onion Skin, the opacity of drawings in the Onion Skin is determined by the Onion Skin settings in the Preferences dialog. The amount of</p>

User Interface	Section	Description
		<p>drawings to include in the Onion Skin is set using the Onion Skin Add / Reduce One Previous Drawing and Onion Skin Add / Reduce One Next Drawing commands, available in the Camera and Drawing toolbars as well as in View > Onion Skin in the top menu.</p>
	<p>Onion skin opacity slider</p>	<p>Allows you to set the overall opacity of all the drawings in the Onion Skin.</p>
	<p>Include by frames or by drawings</p>	<p>Allows you to select whether the drawings to include in the Onion Skin are selected by frame or by drawing.</p> <ul style="list-style-type: none"> By Frames: Selects the drawings to display in the Onion Skin by their frame number relative to the current frame. For example, if the Onion Skin is set to include 2 drawings before and after the current frame, it will include the drawings up to two frames before and up to two frames after the current frame, even if those drawings are the same as the one in the current frame. This is more useful for cut-out animation as it allows you to position a drawing relative to its position in adjacent frames. <div data-bbox="602 1157 1429 1293" style="border: 1px solid #c8e6c9; padding: 5px;"> <p> NOTE This option only works in the Camera view.</p> </div> <ul style="list-style-type: none"> By Drawings: Selects the drawings to display in the Onion Skin by the amount of different drawings before and after the current frame. For example, if the Onion Skin is set to include 2 drawings before and after the current frame, this will display the nearest two different drawings before and after the drawing in the current frame in the Onion Skin, even if those drawings are further than 2 frames away from the current frame. This is more useful for frame-by-frame animation. <div data-bbox="602 1598 1429 1766" style="border: 1px solid #c8e6c9; padding: 5px;"> <p> NOTE When this option is enabled, the handles allowing you to adjust the extent of the Onion Skin in the Timeline view are not available.</p> </div>
<p>Next Drawings Settings</p>		

User Interface	Section	Description
	<p>Next drawings visibility switches</p>	<p>Allows you to select which drawings after the current frame to include in the Onion Skin. A drawing that is toggled on will be visible in the Onion Skin, and a drawing that is toggled up will be excluded from it. You can select a range of drawings, or include and exclude specific drawings individually.</p> <div data-bbox="521 485 1430 835" style="border: 1px solid #add8e6; padding: 10px;">  <p>TIP</p> <p>You can quickly select or deselect a range of drawings by clicking and holding on one drawing, then dragging the mouse cursor over the other drawings you want to toggle.</p>  </div>
	<p>Next drawings opacity sliders</p>	<p>Allows you to adjust the opacity scale of drawings after the current frame. Each slider represents the opacity of one drawing.</p> <p>By default, moving one of these sliders will move the other sliders so that the opacity remain on a gradated scale. In this case, you can start by adjusting the opacity on one end, the opacity on another end and then, if you want, adjust one of the sliders in-between to make a segmented progression.</p> <div data-bbox="521 1142 1040 1497" style="border: 1px solid #ccc; padding: 10px;">  </div> <p>You can disable this behaviour by unchecking the Link Sliders option in the  View Menu in the top-left corner of the Onion Skin view. This option is enabled by default. When disabled, you can adjust the opacity of each drawing independently.</p> <div data-bbox="521 1654 1029 1833" style="border: 1px solid #ccc; padding: 10px;">  </div>

User Interface	Section	Description
	Next drawings colour	Allows you to select the colour in which to display the drawings after the current frame.
Marked Drawings Settings		
	Show Key drawings in Onion Skin	Only displays drawings marked as key drawings in the Onion Skin.
	Show Breakdown drawings in Onion Skin	Only displays drawings marked as breakdowns in the Onion Skin.
	Show In-between drawings in Onion Skin	Only displays drawings with no marker in the Onion Skin. Drawings with no marker are considered in-betweens.
	Show RetakeKey drawings in Onion Skin	Only displays drawings marked as retake key drawings in the Onion Skin.
	Show RetakeBD drawings in Onion Skin	Only displays drawings marked as retake breakdowns in the Onion Skin.
	Show RetakeIB drawings in Onion Skin	Only displays drawings marked as retake in-betweens in the Onion Skin.

Perspective View

The Perspective view is used during scene setup. It allows you to see a multiplane scene's orientation. The Perspective view is similar to a 3D display, as it lets you rotate the scene through all possible angles to understand the spacing between the elements. You can also position and rotate your layers and the camera inside the 3D display to achieve some 3D setup and camera moves.

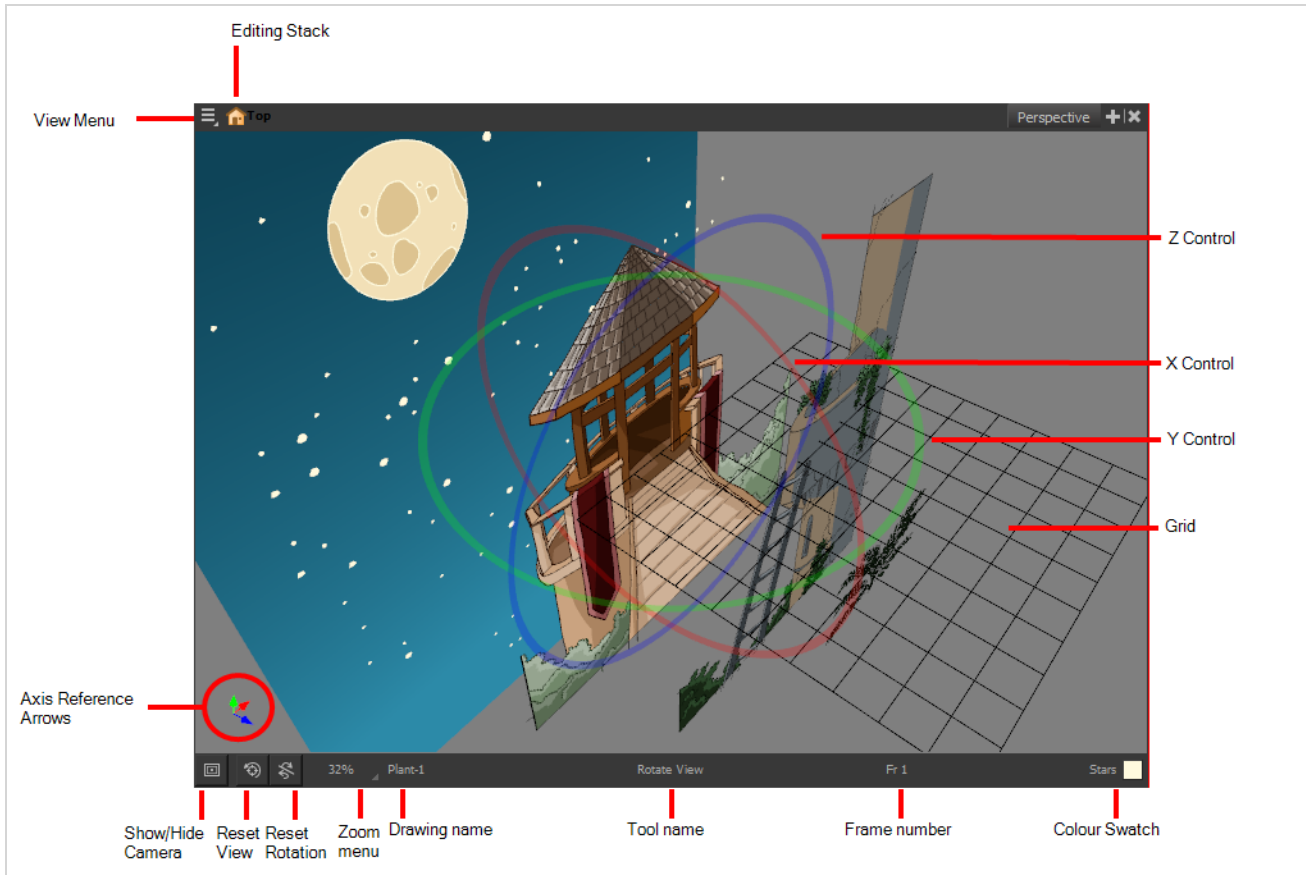





How to access the Perspective view

Do one of the following:

- From the top menu, select **Windows > Perspective**.
- From any of the other views, click the Add View **+** button and select **Perspective**.

Icon	Section	Description
	View Menu	The View menu contains all the tools and options that you can use to work in the Perspective view.

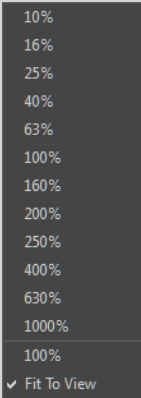
	Editing Stack	The Editing Stack menu displays the names of the symbols and their hierarchy when you are editing a symbol. You can click on the different names to go back up to the different parent symbols or the top/current project.
	X Control	The red circle rotates the view on its X axis.
	Y Control	The green circle rotates the view on its Y axis.
	Z Control	The blue circle rotates the view on its Z axis.
	Grid	This is a perspective (3D) grid reference.
	Axis Reference Arrows	The axis reference arrows let you maintain your orientation when navigating in the Perspective view.
	Show/Hide Camera	Shows or hides camera frame in the Perspective view.
	Reset View	Resets the pan, rotation, and zoom of the Perspective view.
	Reset Rotation	Resets the rotation of the Perspective view.
	Zoom Menu	<p>This field displays the current zoom level in the Perspective view. You can use the Zoom level drop-down menu to select a specific zoom level from the list. Zoom levels from 2.5% to 6400% are available; you can also select Fit To View to automatically use a zoom level that lets you see all your scene layers and information in the Perspective view at once.</p> 

	Layer Name	This field displays the currently selected layer and drawing name.
	Tool Name	This field displays the currently selected tool.
	Frame Number	This field displays the currently selected frame of your animation.
	Colour Swatch	This field displays the currently selected colour in the palette.

Script Editor View

The Scripting view allows you to edit scripts to run in Harmony directly from the application. It displays a list of available scripts, from which you can select an existing script, edit it, test it and save it. The Script Editor will highlight the syntax of your script for easy reading.

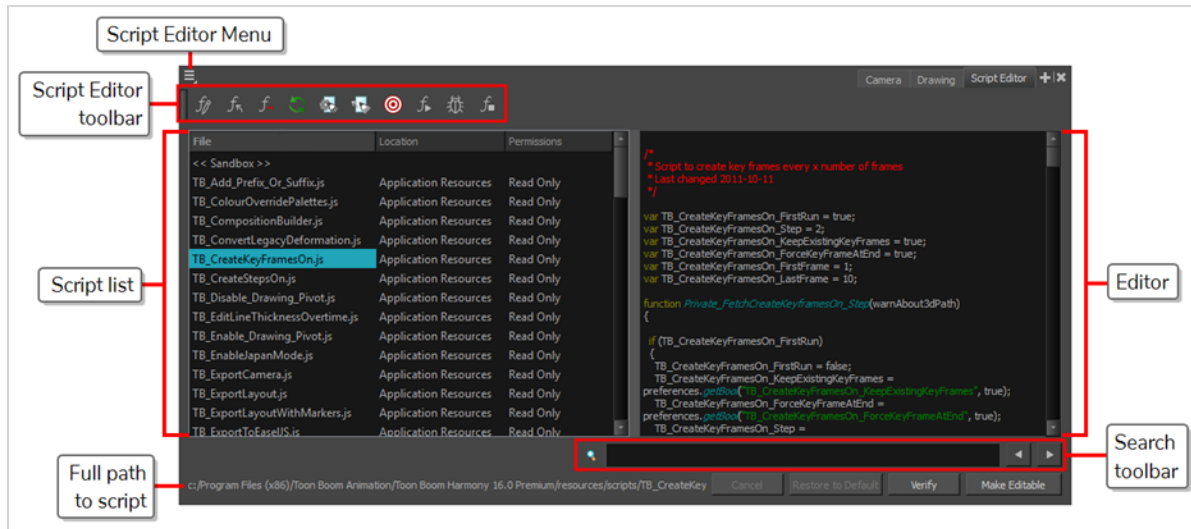

How to access the Script Editor view

Do one of the following:

- From the top menu, select **Windows > Script Editor**.
- From any of the other views, click the Add View **+** button and select **Script Editor**.

Parameter	Description
Script Editor menu	The menu for this view—see Script Editor View Menu on page 374.
Script Editor toolbar	The toolbar for this view—see Script Editor Toolbar on page 1189.
Script list	The list of script files available as well as their location and their read and write permissions. Selecting a script in this list will open it in the editor.

**NOTE**

The << **Sandbox** >> item at the top of the list does not correspond to an actual script file. It is a temporary container to type and test code, and its content cannot be saved.

The file list has three columns: **File**, **Location** and **Permissions**.

- The **File** column indicates the filename of each script.

**NOTE**

The << **Sandbox** >> item at the top of the list does not correspond to an actual script file. It is a temporary container to type and test code, and its content cannot be saved.

- The **Location** of the script can be one of the following:
 - **Application Folder:** Scripts that are packaged and installed with Harmony. By default, you cannot edit these scripts until you select them and click on Make Editable, at which point you are prompted to copy the script to a location from which you can edit them.

Scripts in the Application Resources folder are in the following location:

- **Windows:** `C:\Program Files (x86)\Toon Boom Animation\Toon Boom Harmony 20 Premium\resources\scripts`
- **macOS:** `/Applications/Toon Boom Harmony 20 Premium/Harmony Premium.app/Contents/tba/resources/scripts`
- **GNU/Linux:** `/usr/local/ToonBoomAnimation/harmonyPremium_20/resources/scripts`
- **User:** Scripts that are saved in your user preferences. Those scripts can be edited and executed from any scene, provided that you are logged in as the same user.

In Harmony Stand Alone, scripts in the User folder are in the following location:

- **Windows:** `C:\Users\[username]\AppData\Roaming\Toon Boom Animation\Toon Boom Harmony Premium\2000-scripts`
- **macOS:** `/Users/[username]/Library/Preferences/Toon Boom Animation/Toon Boom Harmony Premium/2000-scripts`
- **GNU/Linux:** `/home/[username]/Toon Boom Animation/Toon Boom Harmony Premium/2000-scripts`

In Harmony Server, scripts in the User folder are in the following location:

`/USA_DB/users/[username]/HarmonyPremium/2000-scripts`

- **Scene:** Scripts in the **scripts** sub-folder of the currently open scene. These scripts can only be edited and executed when the current scene is open.
- **Job (Harmony Server only):** When using Harmony Server, these are the scripts saved in the directory of the current scene's job. These scripts can be edited and executed by any user when any scene that is part of this job is open.

Scripts in the Job folder can be found in the following location:

`/USA_DB/jobs/[job name]`

- **Environment (Harmony Server only):** When using Harmony Server, these are scripts saved in the directory of the current scene's environment. These scripts can be edited and executed by any user when any scene that is part of this environment is open.

Scripts in the Environment folder can be found in the following location:

`/USA_DB/environments/[environment name]`

- **Global (Harmony Server only):** Scripts in the Harmony database's scripts directory. These scripts can be edited by any user when any scene in the database is open.

Scripts in the Global folder can be found in the following location:

`/USA_DB/scripts`

- **System Variable:** Scripts inside the directory set in the `TOONBOOM_GLOBAL_SCRIPT_LOCATION` environment variable, if this variable is set. These scripts can be edited and executed by anyone on your workstation.



NOTE



When two or more scripts with the same file name exist in different locations, Harmony will give priority to a single one of these scripts. The script given priority will be the one listed in the Script Editor and the one executed if it is associated to a toolbar button.



Which script is prioritized is determined by the order of priority of script locations. From highest priority to lowest priority, the order goes as follows:

User > Scene > System Variable > Job > Environment > Global > Application Resources

An exception to this rule is if you have a script with the same name in both the scene folder and your user preferences. In this case, both versions of the script will be listed and you will be able to edit both.

- The **Permissions** of the script can be one of the following:
 - **Read Only:** You cannot edit the script in the Script Editor and save your changes.

	<div data-bbox="521 191 1430 663" style="border: 1px solid #c8e6c9; padding: 10px;">  <p>NOTES</p> <ul style="list-style-type: none"> • If the script's location is the Application Resources folder, it will always be Read Only to prevent you from making changes to scripts packaged with Harmony. However, you can click on the Make Editable button below the script editor to make a copy of the script in your user preferences folder, after which you can make changes to this copy. • If the script is in any other location and is Read Only, then it is likely that a network administrator made the script or the folder containing the script read-only to prevent other users from making unwanted changes to it. </div> <ul style="list-style-type: none"> • Read/Write: You can edit the script in the Script Editor and save your changes.
<p>Editor</p>	<p>A text field in which you can edit the selected script.</p> <div data-bbox="362 842 1430 1016" style="border: 1px solid #c8e6c9; padding: 10px;">  <p>NOTE</p> <p>If the selected script is in the Application Resources folder, you will not be able to edit it until you click on the Make Editable button.</p> </div>
<p>Search toolbar</p>	<p>Allows you to type in a keyword and search for this keyword within the script. You can use the ► Next button to go to the next instance of the keyword and the ◀ Previous button to go to the previous instance.</p>
<p>Cancel</p>	<p>If you have made any changes to your script that you have not yet saved, this discards those changes and reloads the saved version.</p>
<p>Restore to Default</p>	<p>If the selected script is a script that was packaged with Harmony, and which you copied to your User folder, to the Scene folder or to the Job, Environment or Global folder to make changes to it, you can click on this button to delete this copy of this script and resume using the original version of the script that is packaged with Harmony instead.</p> <div data-bbox="362 1535 1430 1675" style="border: 1px solid #ffcdd2; padding: 10px;">  <p>IMPORTANT</p> <p>This will permanently delete your version of the script and any changes you have made to it.</p> </div>
<p>Verify</p>	<p>Verifies that the script has no syntax error.</p>
<p>Make Editable</p>	<p>If the currently selected script is in the Application Resources folder, you cannot edit it. By clicking on this button, the script can be copied to a location where you can edit it.</p>

	<p>When you click on this button, you are prompted to choose whether to copy in either of these locations:</p> <ul style="list-style-type: none"> • User: Saves the script to a directory in your user preferences directory. You will be able to run and edit the script from any scene as long as you are logged in as the same user. <div data-bbox="441 373 1429 575" style="border: 1px solid #c8e6c9; padding: 10px; margin: 10px 0;">  <p>NOTE If you are using Harmony Stand Alone, the script will be saved to the preferences for your account on your computer. If you are using Harmony Server, the script will be saved to the preferences for your Harmony database user.</p> </div> <ul style="list-style-type: none"> • Global: If you are using Harmony Server, select this option to save the script to the Harmony database's global script directory. Anyone who is logged in to the database will be able to edit and run this script. • Environment: If you are using Harmony Server, select this option to save the script to the current scene's environment. Anyone will be able to edit and run the script as long as they are working on a scene inside this environment. • Job: If you are using Harmony Server, select this option to save the script to the current scene's job. Anyone will be able to edit and run the script as long as they are working on a scene inside this job. • Scene: Save the script to the scene's scripts sub-folder. Anyone will be able to edit and run the script when working on this specific scene. • System Variable: Save the script to the directory in the TOONBOOM_GLOBAL_SCRIPT_LOCATION environment variable. This option is only available if this environment variable is set. <div data-bbox="362 1199 1429 1367" style="border: 1px solid #c8e6c9; padding: 10px; margin: 10px 0;">  <p>NOTE This button will be greyed out if the script is in any location other than Application Resources and is read only.</p> </div>
Save	<p>Saves the modifications you made to the script.</p> <p>This button replaces the Make Editable button after you have used the Make Editable button to copy the script to a location from which you can edit it.</p>

Side View

T-HFND-008-015

The Side view is used mainly for multiplane scenes and to position elements in 3D space. It allows you to see a scene's stage from the side. This lets the camera cone and spacing between the elements to be seen.

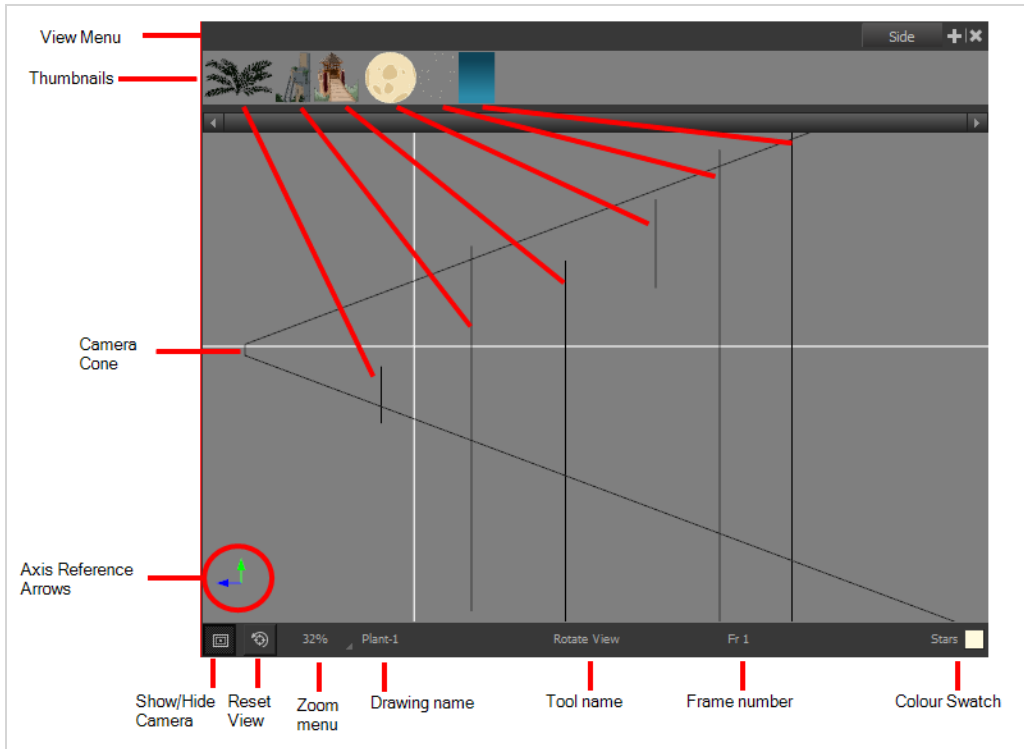



How to access the Side view

Do one of the following:

- From the top menu, select **Windows > Side**.
- From any of the other views, click the Add View **+** button and select **Side**.

Icon	Section	Description
	View Menu	The View menu contains all the tools and options that you can use to work in the Side view.
	Thumbnails	A thumbnail of each drawing layer in the scene. The order of the thumbnail images is based on each element's FB position in the scene space. You can see a representation of the FB position of each layer in the

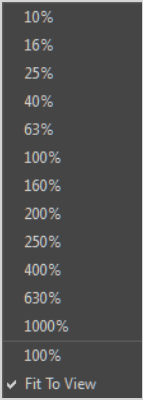
		camera cone.
	Camera Cone	The camera cone represents the camera's position and field-of-view (FOV).
	Axis Reference Arrows	The axis reference arrows let you maintain your orientation when navigating in the view.
	Show/Hide Camera	Shows or hides camera frame in the Perspective view.
	Reset View	Resets the pan, rotation, and zoom of the Perspective view.
	Zoom Menu	<p>This field displays the current zoom level in the Perspective view. You can use the Zoom level drop-down menu to select a specific zoom level from the list. Zoom levels from 2.5% to 6400% are available; you can also select Fit To View to automatically use a zoom level that lets you see all your scene layers and information in the Perspective view at once.</p> 
	Layer Name	This field displays the currently selected layer and drawing name.
	Tool Name	This field displays the currently selected tool.
	Frame Number	This field displays the currently selected frame of your animation.
	Colour Swatch	This field displays the currently selected colour in the palette.

Timeline View

T-HFND-006-002

To set your animation timing, you will mostly work with the Timeline and Xsheet views. It's extremely useful to become familiar with the Timeline view, how it works, and its interface.

The Timeline view is the main view used when adjusting the timing of drawings, adding keyframes and ordering layers. The Timeline view displays layers, effects, sounds, keyframe values, scene length, layer names, drawings, keyframes, timing, and frames.

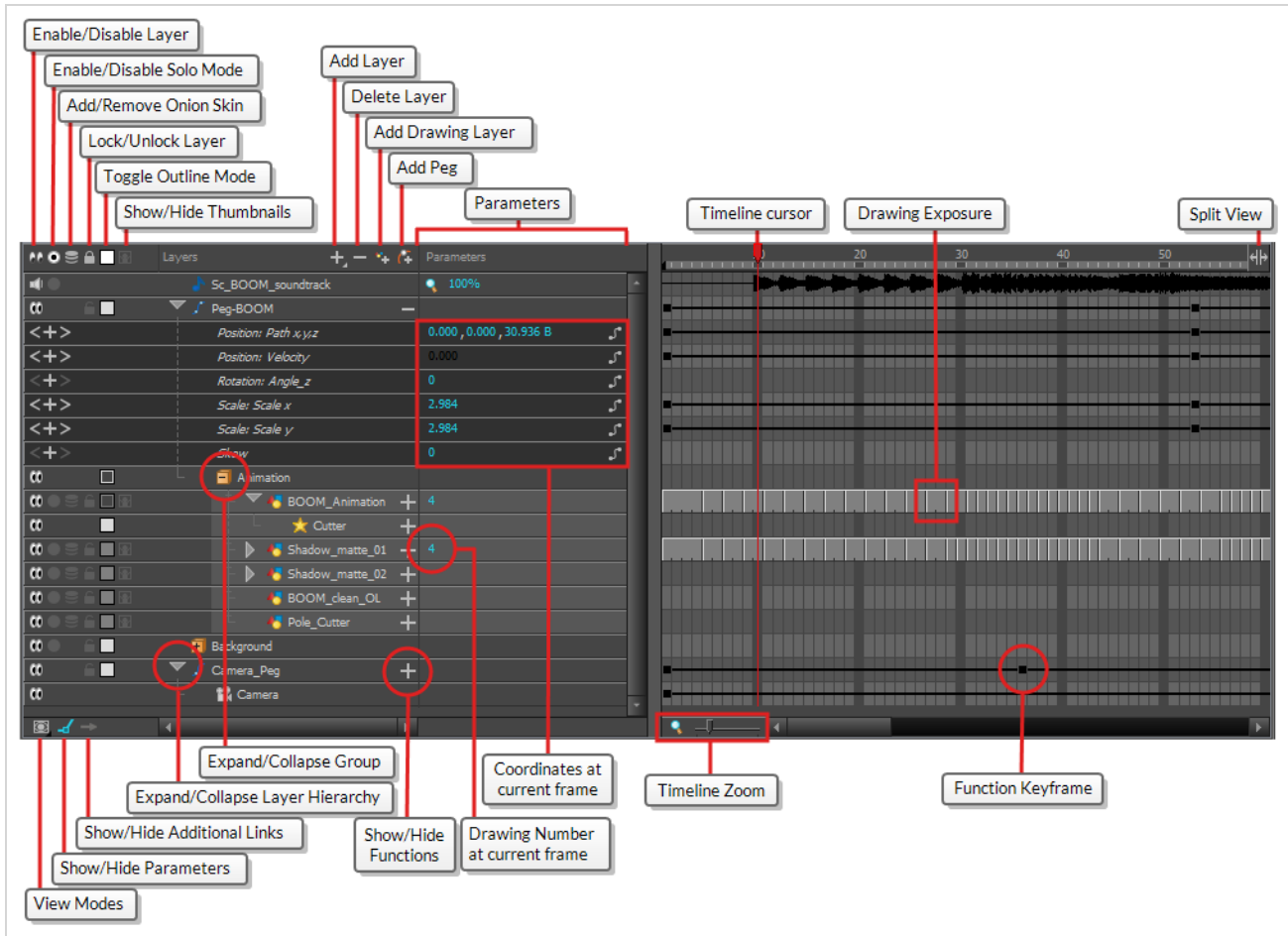



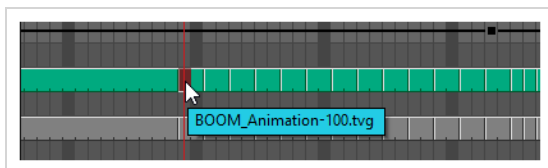





The Timeline view allows you to read your timing from left to right. It represents the scene's elements in their simplest form. You can also see the layers and their names, as well as the drawing's exposure. The drawing name is displayed when you place your pointer over the drawing's exposure.



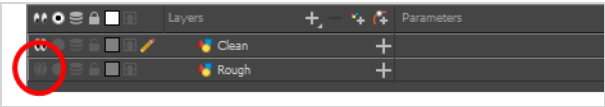
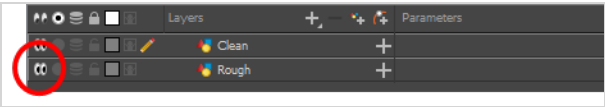







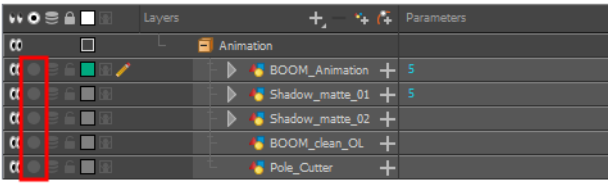
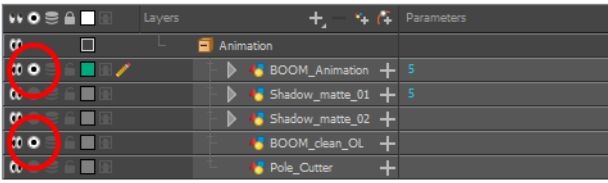

How to access the Timeline view

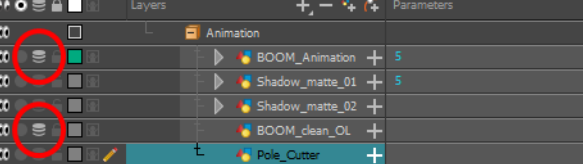

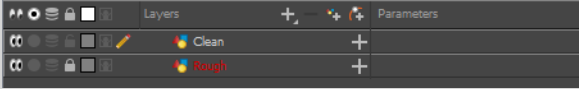

Do one of the following:

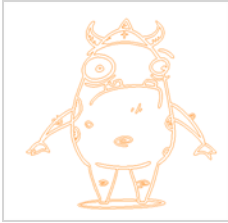
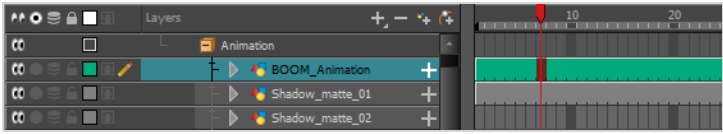



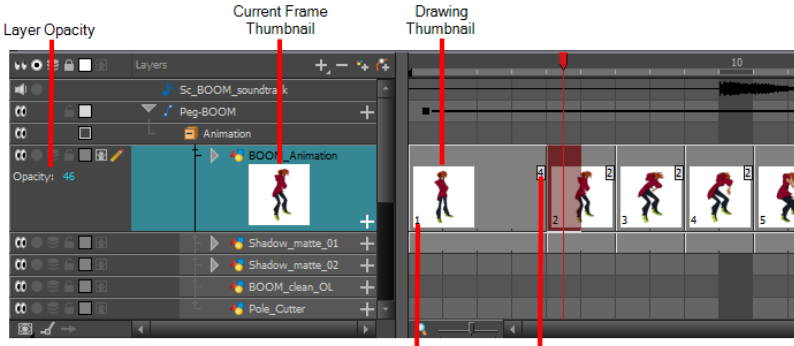



- From the top menu, select **Windows > Timeline**.
- From any of the other views, click the Add View **+** button and select **Timeline**.





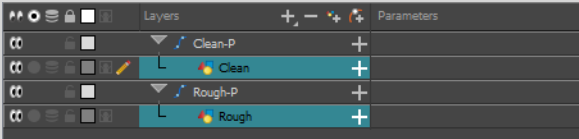

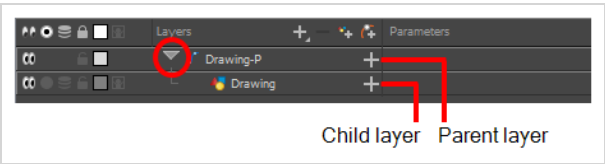

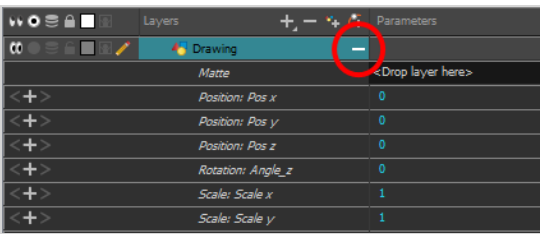

Icon	Section	Description
	View Menu	The View menu contains all the tools and options that you can use to manage models.
	Enable/Disable Layer	<p>The Enable/Disable All button lets you enable or disable layers. Disabling a layer makes the scene behave as if it didn't exist, including when rendering the scene. For example:</p> <ul style="list-style-type: none"> • A disabled drawing layer will be invisible. • A disabled sound layer will be mute. • A disabled peg layer will not affect the position of its child layers. <p>To disable a layer, click the layer's Enable/Disable button or press D.</p>  <p>To enable a layer, click the layer's Enable/Disable button or press A.</p>  <div data-bbox="613 1398 1430 1575" style="border: 1px solid green; padding: 5px;"> <p> NOTE</p> <p>Next to sound layers, the Enable/Disable layer button will look like this: .</p> </div> <div data-bbox="613 1602 1430 1778" style="border: 1px solid blue; padding: 5px;"> <p> TIP</p> <p>You can enable or disable all layers by clicking on the Enable or disable all layers  button in the top row.</p> </div>
	Enable/Disable Solo Mode	Solo mode allows you to only view specific layers in the Camera view and hide all others. When solo mode is enabled on one layer, only this layer will











		<p>be visible. If solo mode is enabled on several layers, and only these layers will be visible. If solo mode is not enabled on any layer, all enabled layers will be visible.</p> <p>You can also use solo mode on sound tracks. If solo mode is enabled on any sound tracks, only those sound tracks will play during playback.</p> <div data-bbox="613 405 1243 642">  <p>All layers are visible in the Camera view</p> </div> <div data-bbox="613 674 1243 911">  <p>Only layers with the Solo icon activated are currently visible in the Camera view.</p> </div> <div data-bbox="613 947 1430 1150" style="border: 1px solid #0070C0; padding: 10px;"> <p> TIP</p> <p>When some layers are in solo mode, you can disable or re-enable solo mode on all layers that have it enabled by clicking on the Toggle solo mode on or off  button in the top row.</p> </div>
	<p>Add to/Remove from Onion Skin</p>	<p>For when the Onion Skin option is enabled, this allows you to enable or disable Onion Skin on specific layers.</p> <div data-bbox="613 1297 1218 1478">  </div> <div data-bbox="613 1514 1430 1682" style="border: 1px solid #0070C0; padding: 10px;"> <p> TIP</p> <p>To activate the general Onion Skin preview, in the Tools toolbar, click the Onion Skin button</p> </div>
	<p>Lock/Unlock Layer</p>	<p>The Lock/Unlock Layer button lets you prevent the selection or editing of a layer in the Camera view. To select some of the layers without selecting others, in the Timeline view, lock the layers you do not want to select. When a layer is locked, its name is displayed in red.</p>



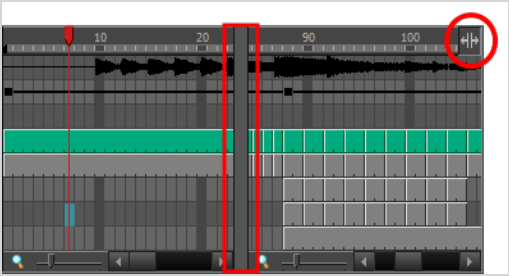



		 <p>In the top menu, there is a series of locking options. Select Animation > Lock > select one of the following:</p> <ul style="list-style-type: none"> • Lock: Locks the currently selected element. • Unlock: Unlocks the currently selected element. • Lock All: Locks all the elements in the Camera view. • Unlock All: Unlocks all the elements in the Camera view. • Lock All Others: Locks all the elements in the Camera view except the currently selected one.
	<p>Toggle Outline Mode / Change Track Colour</p>	<p>Each drawing layer has a little colour swatch that has two functionalities:</p> <ul style="list-style-type: none"> • Single-clicking a layer's colour swatch toggles Outline mode on or off. Outline mode makes the layer display as nothing but the outlines of its vector shapes in the Camera view, allowing you to see the drawing's shape without it blocking the view of layers behind it.  <ul style="list-style-type: none"> • Double-clicking the layer's colour swatch opens a colour picker dialog that allows you to change the layer's track colour. The track colour displays in the layer's track in the Timeline view, allowing you to give special visibility to specific layers. It also determines the colour of the layer's outlines if it's in outline mode. 
	<p>Show/Hide Thumbnails</p>	<p>Expands the layer to display a thumbnail of the drawing in the current frame, as well as for each drawing in the timeline.</p>

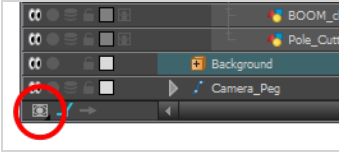

		<div data-bbox="613 191 1430 457" style="border: 1px solid green; padding: 10px; margin-bottom: 10px;">  <p>NOTE</p> <p>By default, the timeline's zoom level does not allow enough horizontal space to fully display the thumbnails of drawings exposed for one or two frames only. To see the thumbnails for drawings with short exposure, you must increase the timeline's zoom level—see Timeline Zoom on page 1286.</p> </div> <div data-bbox="613 485 1430 877" style="border: 1px solid gray; padding: 10px; margin-bottom: 10px;">  </div> <p>When a drawing layer is in Show Thumbnails mode:</p> <ul style="list-style-type: none"> • An exposure indicator appears at the right of each exposed drawing in the timeline, indicating the amount of frames the drawing spans over. • An Opacity parameter appears to the left of the layer, allowing you to set the layer's opacity level. <div data-bbox="613 1186 1430 1360" style="border: 1px solid blue; padding: 10px;">  <p>TIP</p> <p>You can show or hide thumbnails for all drawing layers by clicking on the Show/Hide All Thumbnails  button in the top row.</p> </div>
	<p>Opacity</p>	<p>Allows you to set the opacity level of the layer. Click and drag the value left or right to decrease or increase the layer's opacity.</p> <div data-bbox="613 1516 1430 1690" style="border: 1px solid green; padding: 10px; margin-top: 10px;">  <p>NOTE</p> <p>This parameter only displays for drawing layers that are in Show Thumbnails mode.</p> </div>
	<p>Active Drawing Layer Indicator</p>	<p>This icon appears next to the active drawing layer, which is the layer you draw on when using drawing tools.</p>

		<div style="border: 1px solid #c8e6c9; padding: 10px;">  <p>NOTE</p> <p>The active drawing layer is not always the selected layer. For example, if you select a drawing layer, then a peg layer, the peg layer will be the selected layer, but the active drawing layer will remain the last drawing layer you selected, until you select another drawing layer.</p> </div>
	<p>Add Layer</p>	<p>The Add Layers button lets you add new layers to the Timeline view. When you click the Add Layers button, a menu appears displaying the most commonly used layer types so that you can quickly add them to your scene. If you need to add other types of layers, you must use the Node view and the Node library.</p>
	<p>Delete</p>	<p>The Delete Layers button lets you delete the currently selected layers in the Timeline view.</p>
	<p>Add Drawing Layer</p>	<p>The Add Drawing Layer button lets you automatically add a new drawing layer to the Timeline view. By default, the layer is named Drawing.</p>
	<p>Add Peg</p>	<p>The Add Peg button lets you add a peg layer to the timeline. If several layers are selected, a peg is added and parented to each layer.</p> 
	<p>Expand/Collapse</p>	<p>The Expand/Collapse button is used to display the children layers of a parent layer. Once a layer is parented to another layer, it is indented to the right and the Collapse/Expand Children button appears on the parent layer allowing you to show or hide the child layer.</p> 
	<p>Show/Hide Functions</p>	<p>The Show/Hide Functions button lets you display the functions embedded in each layer. The functions are the different coordinates and values used to record a layer's parameters at each frame. This information is stored on the function curves using keyframes.</p> <p>If the layer can be connected to another layer, for example to use a drawing</p>

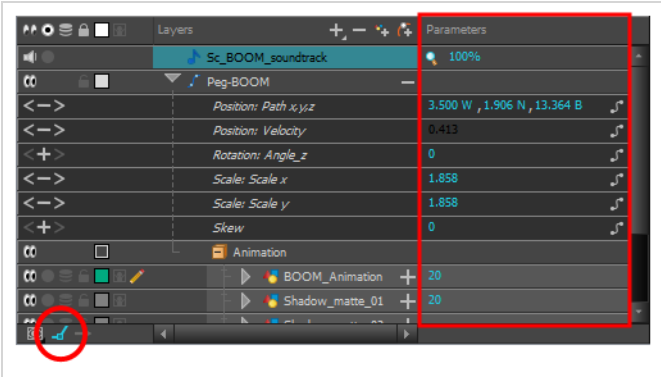
		<p>layer as a matte, expanding a layer's functions will also list its possible connections. You can connect layers by dragging and dropping a layer onto another layer's connection.</p> 
	<p>Add/Remove Keyframe</p>	<p>Adds a keyframe at the current frame of the selected function or removes the keyframe at the current frame of the selected function, if there is one already.</p> <div data-bbox="613 705 1430 846" style="border: 1px solid #c8e6c9; padding: 10px;"> <p> NOTE This button only displays for function layers.</p> </div>
	<p>Previous Keyframe</p>	<p>Moves the timeline cursor to the previous keyframe on the selected function.</p> <div data-bbox="613 961 1430 1102" style="border: 1px solid #c8e6c9; padding: 10px;"> <p> NOTE This button only displays for function layers.</p> </div>
	<p>Next Keyframe</p>	<p>Moves the timeline cursor to the next keyframe on the selected function.</p> <div data-bbox="613 1213 1430 1354" style="border: 1px solid #c8e6c9; padding: 10px;"> <p> NOTE This button only displays for function layers.</p> </div>
	<p>Function Menu</p>	<p>Displays the Function menu, which allows you to create a new function for the function layer, or to link it to an existing shared function.</p> <div data-bbox="613 1507 1430 1686" style="border: 1px solid #c8e6c9; padding: 10px;"> <p> NOTE This button only displays for functions layers, in the Parameters column—see Show/Hide Parameters on page 1285.</p> </div>
	<p>Function Keyframe</p>	<p>A frame where the value for one or more of the layer's functions is preset. The position of each layers in key poses for digital animation is recorded in function keyframes. You can grab and move function keyframes as well as copy, cut, paste and delete them.</p>

		<div data-bbox="613 191 1430 564" style="border: 1px solid #add8e6; padding: 10px;">  <p>TIP</p> <p>If you have a keyframe and a drawing selected simultaneously, and you wish to delete the keyframe without deleting the drawing's exposure by doing one of the following:</p> <ul style="list-style-type: none"> • In the Timeline toolbar, click on the Delete Keyframe  button. • Press F7. • From the top menu, select Animation > Delete Keyframe </div> <div data-bbox="613 594 1430 768" style="border: 1px solid #90ee90; padding: 10px; margin-top: 10px;">  <p>NOTE</p> <p>If a collapsed layer has children that have function keyframes, you will see a white square  instead.</p> </div>
	<p>Split</p>	<p>The Split button lets you split the Timeline view in two sections, allowing you to see two different portions of the Timeline view. This can be useful if you need to often switch between two specific points of a lengthy scene.</p> 
	<p>Drawing Exposure</p>	<p>In the Timeline view, when a drawing is exposed, it is represented by a grey block that extends from the first frame it is exposed to the last frame it is exposed.</p> 
	<p>View Modes</p>	<p>Lets you choose between different view modes allowing you to decide which layers are listed in the Timeline view. This can be useful if you're working on a scene with a lot of layers, and you only want layers you will be working on to appear in the Timeline view so as to declutter it. The following view modes are available:</p> <ul style="list-style-type: none"> • Normal View Mode  will show all the layers that are connected to your scene's display node. • Selection Only Mode  will hide all the layers that are not currently selected, leaving only the currently selected layers in the Timeline view.

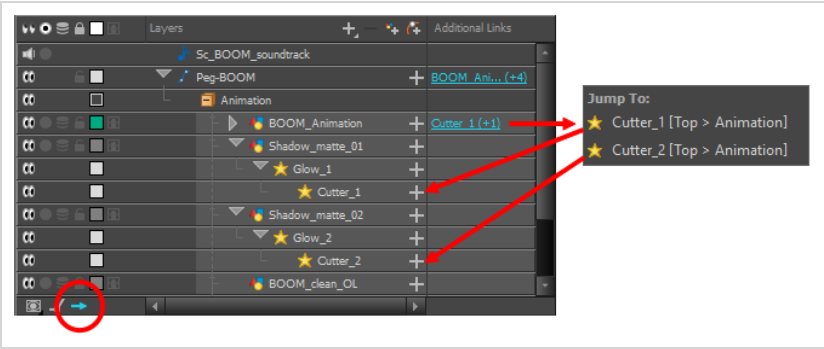
		<ul style="list-style-type: none"> View Tagged Layers  will only show layers which you have tagged.  <div style="border: 1px solid #add8e6; padding: 10px; margin-top: 10px;"> <p> TIP</p> <p>You can tag a layer by doing one of the following:</p> <ul style="list-style-type: none"> Right click on the layer and select Tag > Timeline Tag. Open the Timeline view menu  and select Edit > Tag > Timeline Tag. </div>
	<p>Show/Hide Parameters</p>	<p>Shows or hides the Parameters column, right of the Layers column. The Parameters column displays information on the layer at the current frame, depending on the type of layer it is:</p> <ul style="list-style-type: none"> If the layer is a drawing, it displays the name of the drawing at the current frame. If the layer is a function, it displays the value of the function at the current frame. If the layer is a sound track, it displays the sound track's volume.  <p>Using the mouse, you can drag the parameter left and right to change its value. This is especially useful for quickly changing a drawing's exposure at the current frame.</p>
	<p>Show/Hide Additional Links</p>	<p>Shows or hides the Additional Links column. The Additional Links column displays layers that are connected under the layer, but for other purposes than being the parent of those layers. For example, if a layer is used as the matte of an effect, the effect will be displayed in that layer's Additional Links.</p> <p>If more than one layers are in a layer's Additional Links, only the first of these</p>

		<p>layers will be displayed, followed by the amount of extra linked layers there are.</p> <p>By clicking on the Additional Links, you can open a menu listing the linked layers, and click on one of these layers to navigate to it.</p> <p>In the following example, the BOOM_Animation layer is used as the matte of Cutter_1 and Cutter_2:</p> 
	<p>Timeline Zoom</p>	<p>Reduces or increases the width of frames in the Timeline view. Move the slider right to increase the width or left to reduce it. You can also press 2 to zoom in and 1 to zoom out when the Timeline view is focused on.</p> <p>If you want to reset the Timeline view's zoom, click on the Timeline Zoom  icon left of the slider.</p>

Tool Properties View

T-HFND-004-002

The Tool Properties view contains the most common options and operations related to the currently selected tool. When you select a tool from the Tools toolbar, the Tool Properties view updates.

For example, if you choose the Select tool, the Tool Properties view will display the options and operations related to it, such as Snap to Contour, Apply to All Drawings, Flip Horizontal, and Flatten.

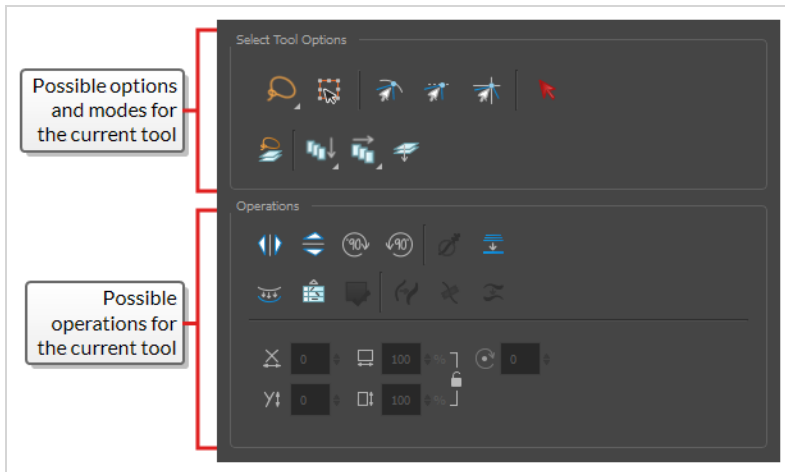

NOTE

To learn more about the options appearing in the Tool Properties view, see [Tools Properties on page 958](#).

How to access the Tool Properties view

Do one of the following:

- From the top menu, select **Windows > Tool Properties**.
- From any of the other views, click the Add View **+** button and select **Tool Properties**.

Top View

T-HFND-008-014

The Top view is used mainly for multiplane scenes and to position elements in 3D space. It allows you to see the scene's stage from above. This lets the camera cone and the spacing between the elements be seen.

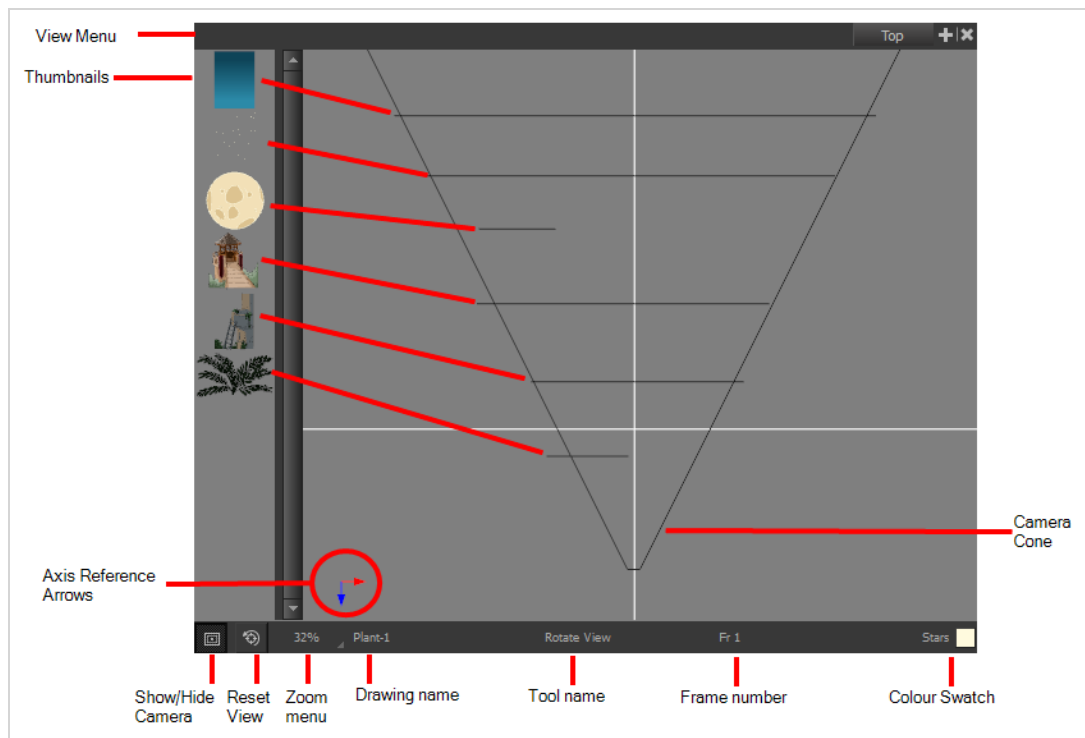



How to access the Top view

Do one of the following:

- From the top menu, select **Windows > Top**.
- From any of the other views, click the Add View **+** button and select **Top**.

Icon	Section	Description
	View Menu	The View menu contains all the tools and options that you can use to work in the Side view.
	Thumbnails	A thumbnail of each drawing layer in the scene. The order of the thumbnail images is based on each element's FB position in the scene space. You can see a representation of the FB position of each layer in the camera cone.

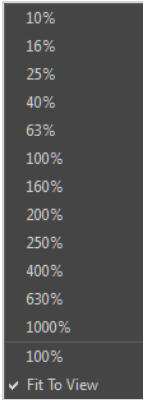
	Camera Cone	The camera cone represents the camera's position and field-of-view (FOV).
	Axis Reference Arrows	The axis reference arrows let you maintain your orientation when navigating in the view.
	Show/Hide Camera	Shows or hides camera frame in the Perspective view.
	Reset View	Resets the pan, rotation, and zoom of the Perspective view.
	Zoom Menu	<p>This field displays the current zoom level in the Perspective view. You can use the Zoom level drop-down menu to select a specific zoom level from the list. Zoom levels from 2.5% to 6400% are available; you can also select Fit To View to automatically use a zoom level that lets you see all your scene layers and information in the Perspective view at once.</p> 
	Layer Name	This field displays the currently selected layer and drawing name.
	Tool Name	This field displays the currently selected tool.
	Frame Number	This field displays the currently selected frame of your animation.
	Colour Swatch	This field displays the currently selected colour in the palette.

Xsheet View

T-HFND-006-003

The Xsheet view lets you read the timing vertically by displaying it in a grid, with each drawing layer represented by a column, each frame of your scene represented by a row, and each exposed drawing displayed by its name in the cells. It is meant to work like a traditional animation exposure sheet.

Using the functions panel, you can also view the functions and keyframes of the motion paths for the selected column, with the value of those functions for each frame listed in the cells.

Contrary to the Timeline view, the Xsheet view does not display pegs, effects or layer hierarchy. Hence, it is optimized for traditional and paperless animation, whereas the Timeline view is optimized for digital or cut-out animation.

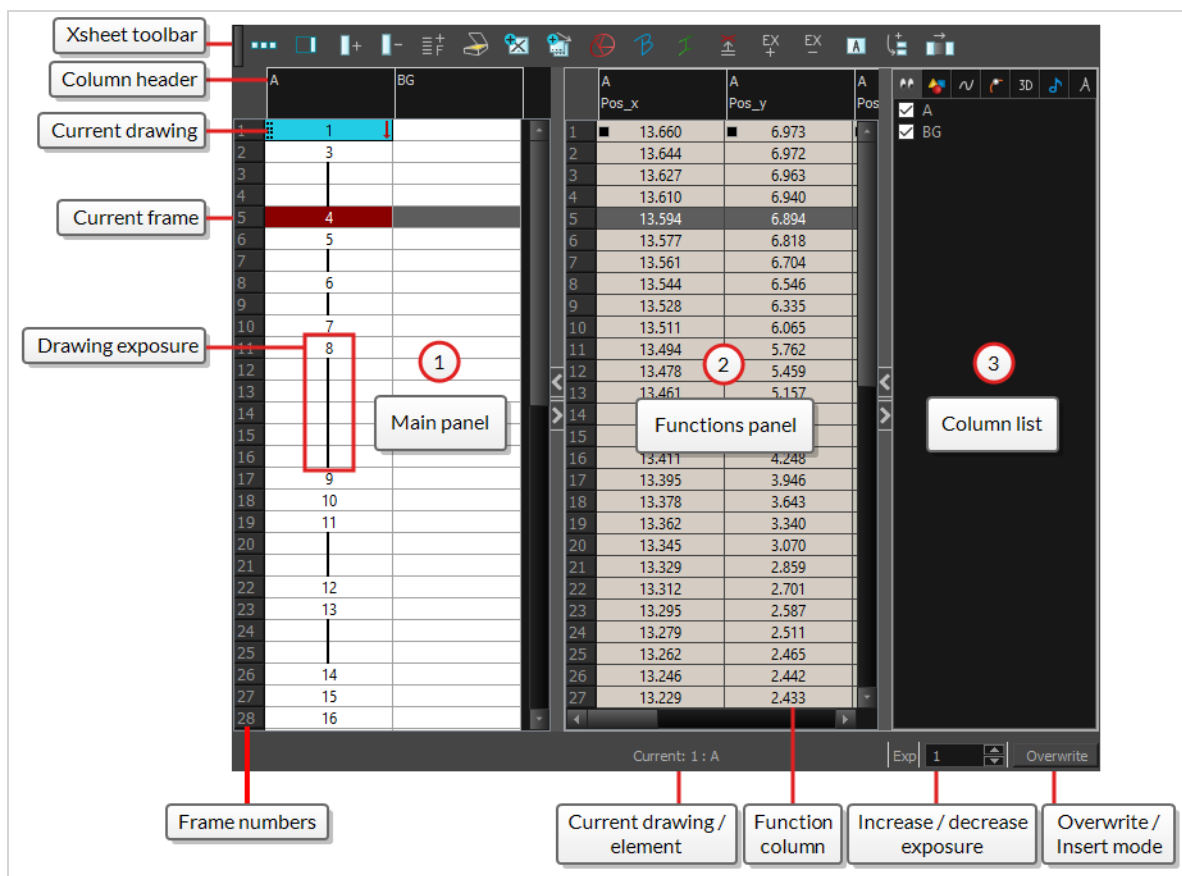

How to access the Xsheet view

Do one of the following:

- From the top menu, select **Windows > Xsheet**.
- From any of the other views, click the Add View **+** button and select **Xsheet**.

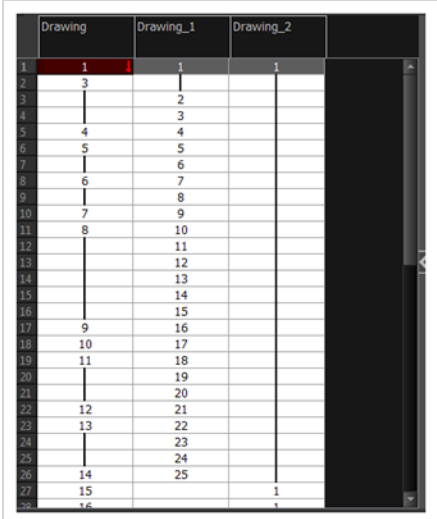
Icon	Section	Description
	View Menu	The View menu contains all the tools and options that you can use to manage columns and timing.
	View Toolbar	The view toolbar contains all the tools and options you can use in the Xsheet view to manage columns and timing.
	Xsheet Main Section	<p>The Xsheet view has three sections. By default, only the main section is visible. It displays the drawing layers, also known as <i>drawing columns</i>.</p>  <p>When using advanced compositing and animation techniques, unconnected functions (motion paths) also appear in the main section. Unconnected functions mean that some motion paths are not attached to any particular layer.</p> <p>When you reconnect functions to a layer, they are still visible in the main section.</p>

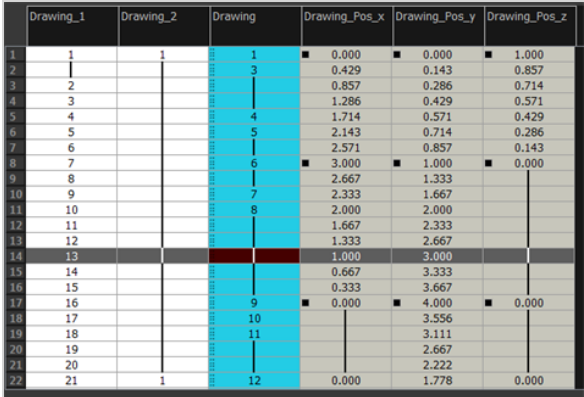
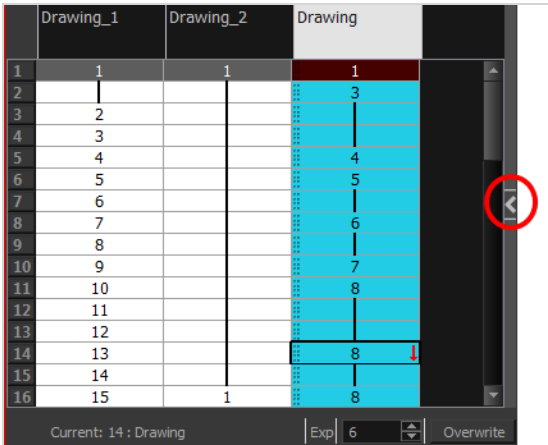
		
	<p>Functions Section</p>	<p>The Functions section is used for more advanced techniques. This section displays the functions (paths) related to the selected layer in the Timeline view. By default, the Functions section is hidden.</p> <p>In the Xsheet view, click the Expand button located on the right side of the main section. Click on the same button to collapse it. You can also use the Show Column List button in the Xsheet View toolbar. If you select a drawing column in the main section of the Xsheet view, the function columns will not be displayed. You must select the layer from the Timeline view.</p> 
	<p>Column List Section</p>	<p>The Column List section allows you to show and hide columns in the Xsheet view. When you hide a layer in the Xsheet view, it is also disabled in the Timeline view.</p>

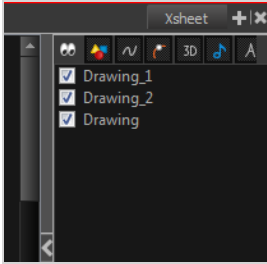
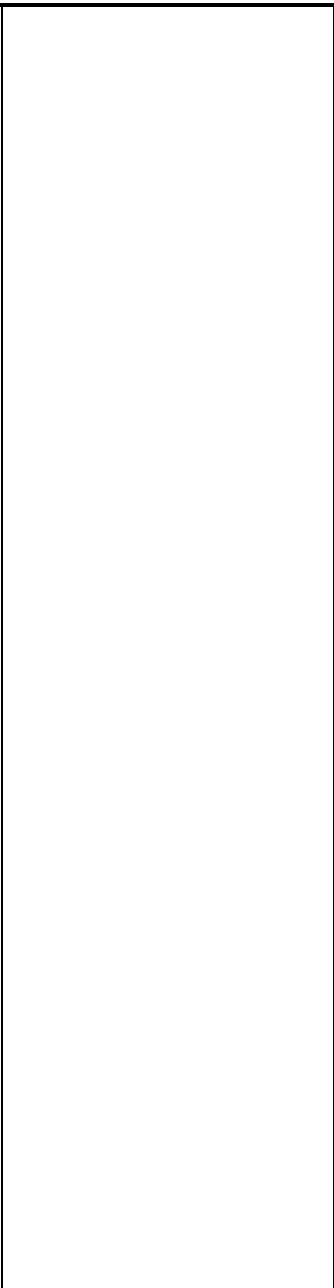
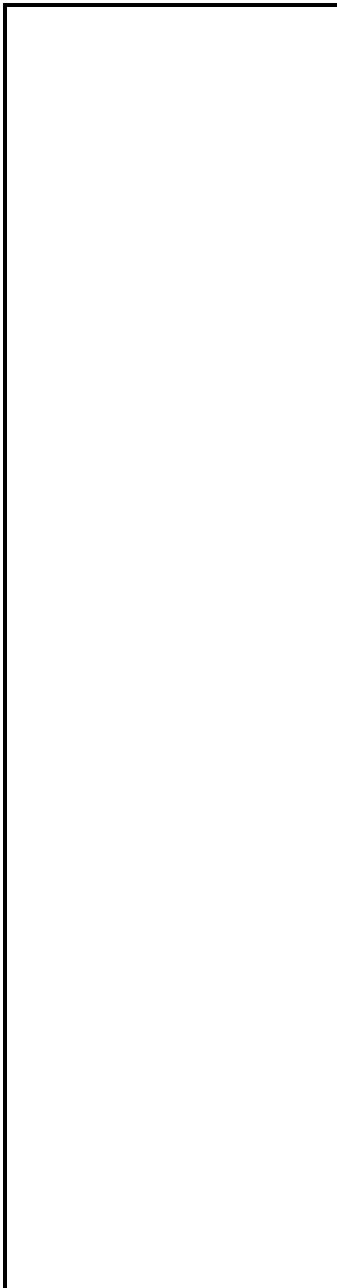

You can use the Column List to hide individual columns or hide an entire column type (drawing or function) from the Xsheet view. By default, the Functions section is hidden.

In the Xsheet view, click the Expand button on the right side of the main section to show the Functions section. Click on the same button to collapse it. You can also use the Show Column List button in the Xsheet toolbar.

Go to the Xsheet view menu and select **View > Show Column List**. Click the Expand button on the right side of the Functions section to display the Column List section.

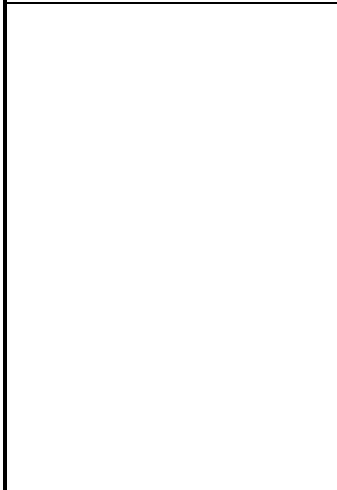
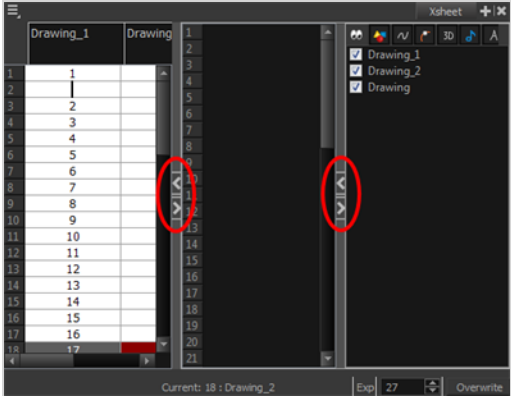



Column Header

Each column available in the Xsheet view has a header displaying the column's name. The column's name is the same as the corresponding timeline layer. If you rename one or the other, they will both be renamed.

A quick access menu is available when you right-click. This menu contains the command affecting an entire column such as renaming, changing the default colour, or deleting a column.

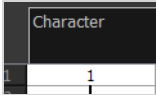
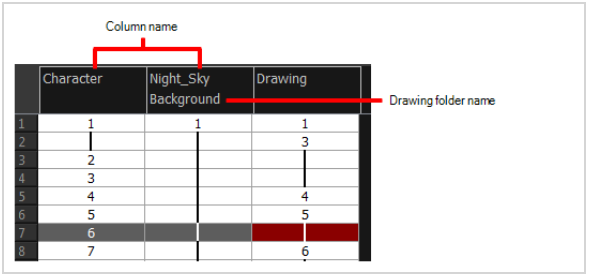
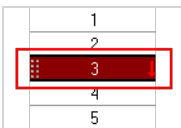
The tooltip that appears when you hover at the top of each Xsheet column shows the folder path to the source drawings for that column.

		 <p>In Harmony, the column header shows the layer's name and the name of the drawing folder to which it is linked. If the name of the layer is the same as the drawing folder, the drawing folder's name will not be displayed. For example; when you link a Timing column to a certain element (and thereby the Element's folder). To modify the name of the element folder independently from the column and layer name, you must select the Advanced Element Mode option preference in the Advanced tab of the Preferences dialog box.</p> 
	<p>Current Drawing</p>	<p>A drawing selected in dark red indicates that the drawing is currently displayed in the Drawing and Camera views. The current drawing selection is not linked to the drawing displayed in the Camera view since drawings from each visible layer are displayed at once.</p> 
	<p>Current Frame</p>	<p>The darker frame appearing in the Xsheet view represents the current frame.</p> 
	<p>Drawing Exposure</p>	<p>In the drawing columns, you can see the drawing names and their exposure. You can use any alphanumeric symbol to name your drawing. When a drawing is exposed over more than one cell, a vertical black line is displayed to indicate the continuity of the exposure. When there is no drawing in a cell, the cell</p>

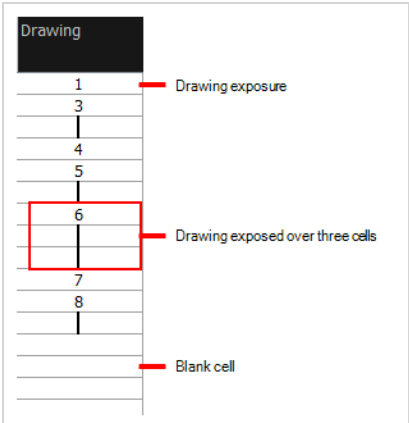
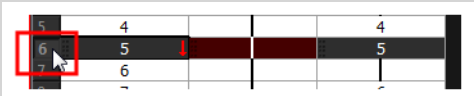
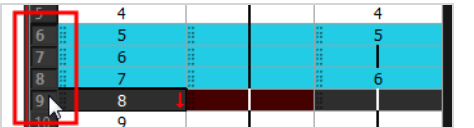
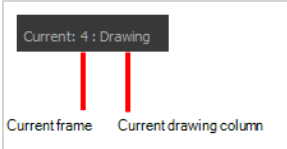
		<p>will be blank.</p> 
	<p>Frame Numbers</p>	<p>On the left side of the Xsheet view, the frame numbers are shown indicating where you are. These read vertically instead of being displayed horizontally as they are in the Timeline view.</p> <ul style="list-style-type: none"> To go to a particular frame, click the frame number.  <ul style="list-style-type: none"> To select an entire range of frames, click and drag a selection downwards. 
	<p>Current Frame Display</p>	<p>At the bottom-right of the Xsheet view, you can see the current frame number, as well as the column containing the drawing currently displayed in the Drawing view.</p> 
	<p>Functions Column</p>	<p>The functions columns are displayed in the Functions section of the Xsheet view. They represent the motion and rotation you applied to a drawing layer. Only the</p>

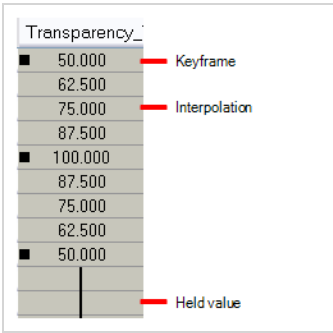
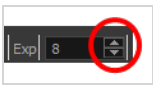
		<p>function columns related to the selected layer are displayed.</p> <p>A function column can also be related to an effect. Selecting the effect layer shows you the corresponding function column in the Xsheet view.</p> <p>The function columns display the position value or effect value on each cell. If there is a keyframe on a cell, a black square is displayed. Holding the same value for several frames displays a vertical black line.</p> 
	<p>Increase/Decrease Exposure</p>	<p>You can quickly increase or decrease the exposure of the selected cell by clicking on the up and down arrows in the Increase/Decrease Exposure field.</p> 
	<p>Overwrite/Insert Modes</p>	<p>The Overwrite/Insert button allows you to decide the way the values are inserted into the Xsheet.</p>