

Harmony22

Toon Boom Harmony22

Scan Application User Guide

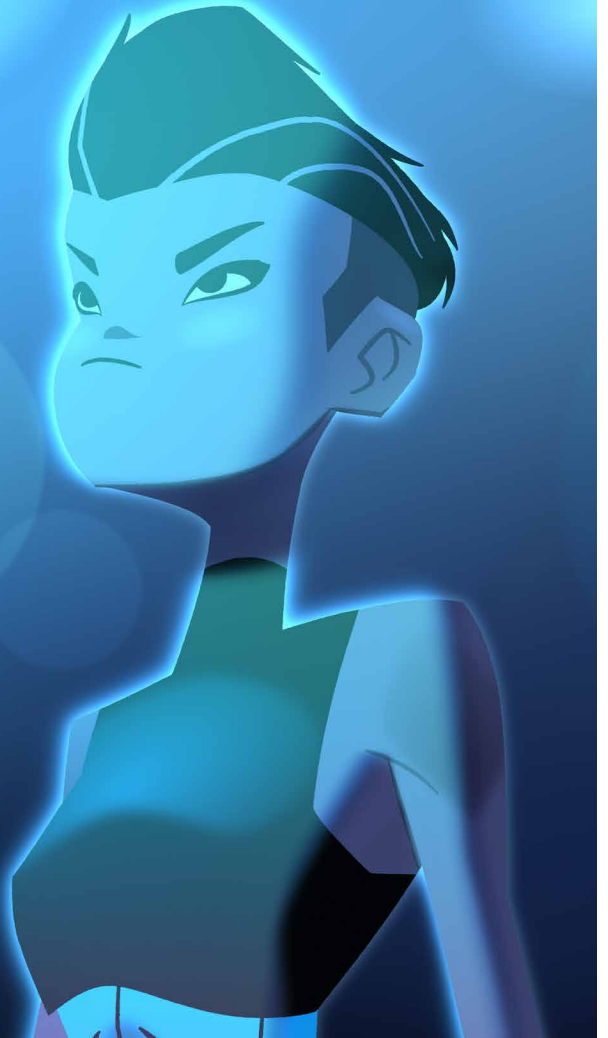

TOON BOOM ANIMATION INC.

4200 St.Laurent Blvd, Suite 1020
Montreal, Quebec, Canada
H2W 2R2

+1 514 278 8666

contact@toonboom.com
toonboom.com

Legal Notices

Toon Boom Animation Inc.
4200 Saint-Laurent, Suite 1020
Montreal, Quebec, Canada
H2W 2R2

Tel: +1 514 278 8666

Fax: +1 514 278 2666

toonboom.com

Disclaimer

The content of this document is the property of Toon Boom Animation Inc. and is copyrighted. Any reproduction in whole or in part is strictly prohibited.

The content of this document is covered by a specific limited warranty and exclusions and limit of liability under the applicable License Agreement as supplemented by the special terms and conditions for Adobe® Flash® File Format (SWF). For details, refer to the License Agreement and to those special terms and conditions.

Trademarks

Toon Boom® is a registered trademark. Harmony™ and the Toon Boom logo are trademarks of Toon Boom Animation Inc. All other trademarks of the property of their respective owners.

Publication Date

09-23-2022

Copyright © 2022 Toon Boom Animation Inc., a Corus Entertainment Inc. company. All rights reserved.

Table of Contents

Table of Contents	2
About the Scan Application	4
Chapter 1: Scanner Set Up	6
About Scanner Configuration	7
About Scanner Configuration for Windows	8
Using the Scan Configuration Editor	9
Running the Findscanner Utility	13
Configuring the Scanner Using the Configuration Wizard	14
About Scanner Configuration for GNU/Linux	17
Identifying the Name of the Scanner Device Driver	18
Setting the Permissions for the Scanner	20
About Configuring Scanners for Mac OS X	21
Modifying the Scan.conf File	22
Establishing Communication	24
About Adapting the Scanner Hardware	27
Removing Paper Chute Cog Wheels	28
Adding Paper Guides to Scanners	29
Installing Tape on ADF Paper Paths	30
Creating Off-set Scanning	34
Calibrating Scanners with Peg Bars	35
Chapter 2: User Interface	38
Scan Module Top Menu	41
Chapter 3: Pre-scanning Process	44
Launching the Scan Application	45
Creating Scenes in the Scan application	47
Creating Elements from the Scan Module	50
Loading Drawings	52
Editing Drawing Lists	55
Setting Up Scanning Sessions	57

Displaying Scanner Information	59
Performing Trial Scans	60
Chapter 4: Scanning	64
Scanning with the Automatic Document Feeder	65
Scanning Manually	68
Scanning Pan Cels	70
Stopping the Scanning Process	72
Chapter 5: Advanced Scanning Techniques	74
Scanning Drawings without Matching Frames	75
Loading Previously Scanned Drawings	78
Setting the Vectorization Style	79

About the Scan Application

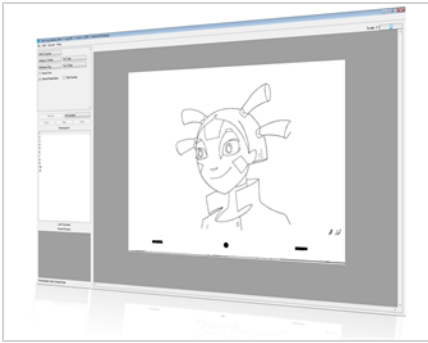

Toon Boom Harmony is a complete animation solution that offers a variety of tools to suit your needs, from pre-production steps to the end of production. Some of these tools are provided in specialized modules, such as the Paint, Scan and Play modules, which are designed to help you focus on a specific task to ensure the efficiency of the entire production.

In this guide, you will learn how to use the Scan module and integrate it in your production workflow .

Chapter 1: Scanner Set Up

Before you can start scanning drawings, you will need to connect, configure, and calibrate your scanner to work with Harmony. It is important that you install the scanner hardware according to the manufacturer's instructions.

- About Scanner Configuration 7
 - About Scanner Configuration for Windows 8
 - Using the Scan Configuration Editor 9
 - Running the Findscanner Utility 13
 - Configuring the Scanner Using the Configuration Wizard 14
- About Scanner Configuration for GNU/Linux 17
 - Identifying the Name of the Scanner Device Driver 18
 - Setting the Permissions for the Scanner 20
- About Configuring Scanners for Mac OS X 21
 - Modifying the Scan.conf File 22
- Establishing Communication 24
- About Adapting the Scanner Hardware 27
 - Removing Paper Chute Cog Wheels 28
 - Adding Paper Guides to Scanners 29
 - Installing Tape on ADF Paper Paths 30
 - Creating Off-set Scanning 34
- Calibrating Scanners with Peg Bars 35

About Scanner Configuration

Before you can start scanning drawings, you will need to configure your scanner to work with Harmony. The instructions for this procedure are different depending on which platform you are using: Windows, macOS or GNU/Linux.

About Scanner Configuration for Windows	8
Using the Scan Configuration Editor	9
Running the Findscanner Utility	13
Configuring the Scanner Using the Configuration Wizard	14
About Scanner Configuration for GNU/Linux	17
Identifying the Name of the Scanner Device Driver	18
Setting the Permissions for the Scanner	20
About Configuring Scanners for Mac OS X	21
Modifying the Scan.conf File	22

About Scanner Configuration for Windows

After you have installed the hardware, you will need to configure your scanner. The findscanner utility will help you obtain information about your scanner for the Configuration Wizard.

Using the Scan Configuration Editor	9
Running the Findscanner Utility	13
Configuring the Scanner Using the Configuration Wizard	14

Using the Scan Configuration Editor

Once you have recorded information about the scanner attached to your computer, you are ready to configure your scanner to communicate with Harmony. Use the Harmony Configuration Editor to configure your scanner.

How to configure the scanner with the Configuration Editor

1. From the Start menu, select **All Programs >Harmony 22 [edition] >Tools > Configuration Editor**.

The Configuration Editor dialog box opens.

3. In the Configuration Editor dialog box, select the Scan.conf tab.

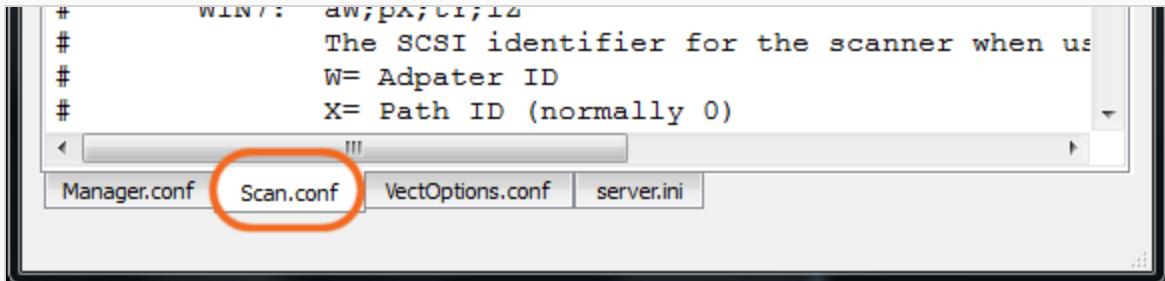

4. Scroll down the text until you reach the Examples for Windows 7 section.

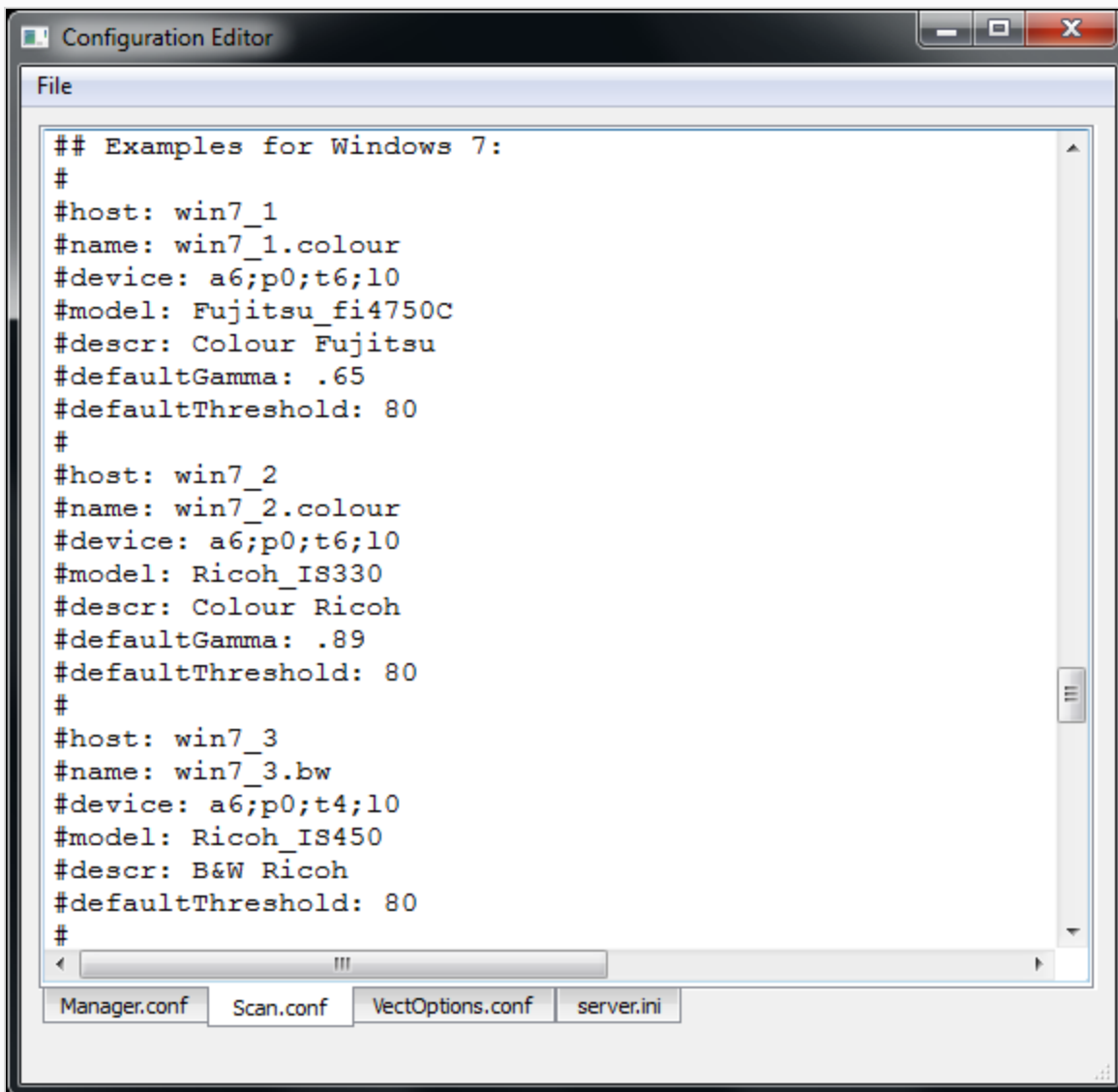

5. Using the list, locate the model of scanner connected to your computer.
 - When you find the models that matches, edit the file to remove the pound signs (#) in front of each lines of that example.

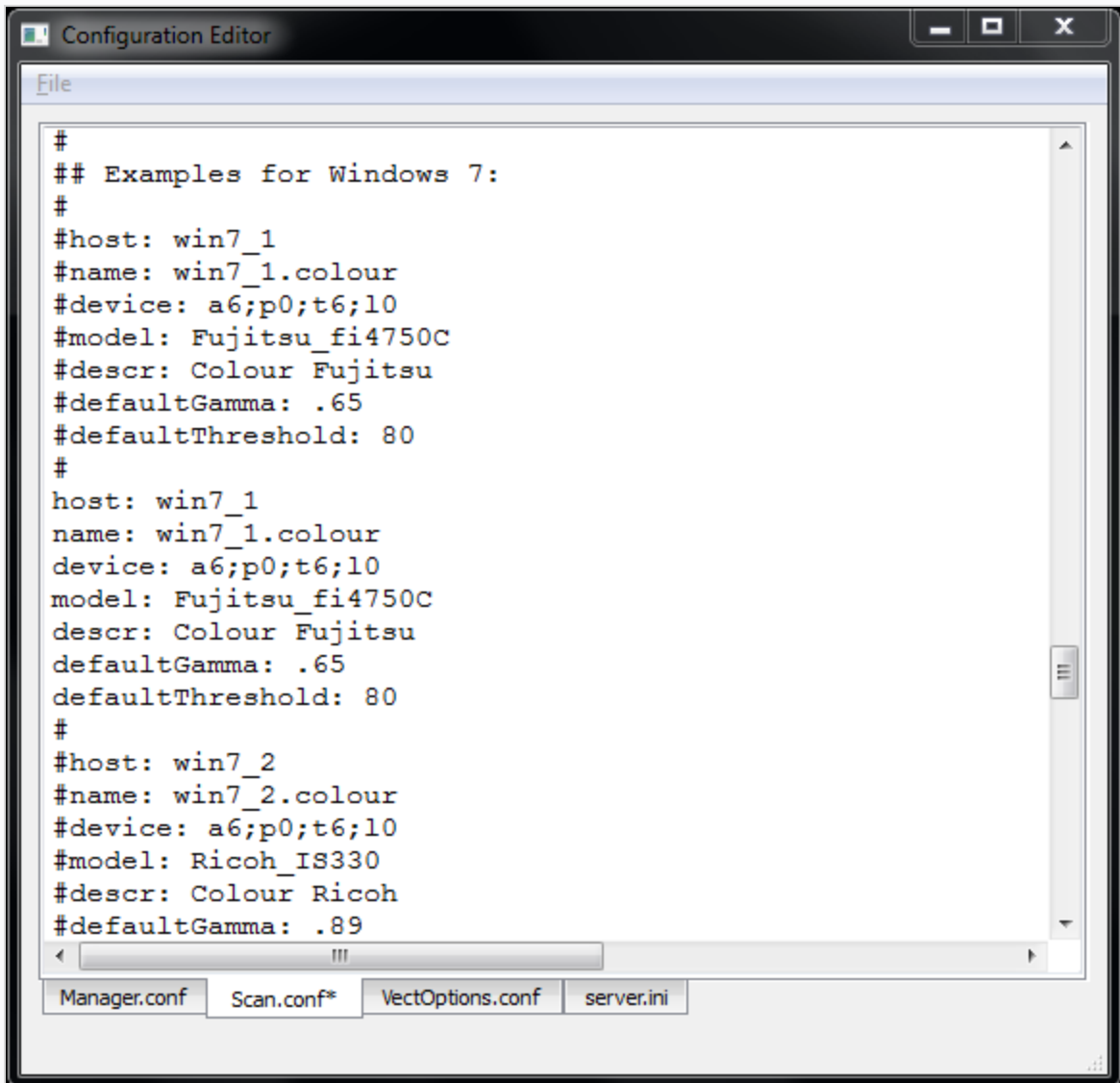

```
Configuration Editor
File
#
## Examples for Windows 7:
#
#host: win7_1
#name: win7_1.colour
#device: a6;p0;t6;l0
#model: Fujitsu_fi4750C
#descr: Colour Fujitsu
#defaultGamma: .65
#defaultThreshold: 80
#
host: win7_1
name: win7_1.colour
device: a6;p0;t6;l0
model: Fujitsu_fi4750C
descr: Colour Fujitsu
defaultGamma: .65
defaultThreshold: 80
#
#host: win7_2
#name: win7_2.colour
#device: a6;p0;t6;l0
#model: Ricoh_IS330
#descr: Colour Ricoh
#defaultGamma: .89
Manager.conf Scan.conf* VectOptions.conf server.ini
```

- If none of the models match the scanner connected to your computer, highlight all the lines of the example that is the closest to your scanner model and paste them below that example. Once the lines are pasted, edit the file by removing the pound signs (#) in front of each line of that new example.

**NOTE**

Make sure that a pound sign (#) separates the pasted example from the one above and below it.

6. Edit the following lines of the example:

host: Enter the hostname of the computer the scanner is connected to.

**NOTE**

If you do not know the hostname of the computer, open a Command Prompt window, type the "hostname" command and press Enter to obtain the name of the computer.

```

C:\Windows\system32\cmd.exe
Microsoft Windows [Version 6.1.7601]
Copyright (c) 2009 Microsoft Corporation. All rights reserved.

C:\Users\mabouvier>hostname
chewy
C:\Users\mabouvier>

```

name: Enter a name for the scanner configuration that will appear in the Scan application.

device: Enter the information returned by the findscanner utility. Ex.: a6;p0;t5;l0

- If the example you just edited matches the scanner model connected to your computer, read the information entered for the host, name and device, and decide if you want to continue.
- If the configuration is accurate, then go to the File menu, save the changes made and close the Configuration Editor.
- If the example you just edited **did not** match the scanner model connected to your computer, you will need to edit the following lines as well:

model: Enter the model of the scanner connected to the computer.

**NOTE**

Make sure the scanner model is included in the supported scanner list found at the beginning of the Scan.conf document and that the syntax is identical as well.

descr: Enter a short, but meaningful description of the scanner. Ex: B&W Ricoh or Colour Fujitsu.

7. If the information entered for the host, name, device, model and descr entry are accurate, then go to the File menu, save the changes made to the file and close the Configuration Editor.

**NOTE**

Other configurations, like the default Threshold, Gamma, Black&White point and Resolution can also be edited later if needed.

Running the Findscanner Utility

To configure your scanners using the **Harmony Configuration Wizard**, you need the following scanner information:

- Adapter ID number
- Path ID
- Target ID
- Logical unit number (LUN)

To obtain this information, run the **findscanner** utility provided with Harmony. **findscanner** issues a report including all this information.

How to run the Findscanner utility

1. Locate **findscanner.exe**. It is stored in **\Program Files (x86)\Toon Boom Animation\Harmony 22 [edition]\win64\bin**.
2. Double-click on the file to start it.

A terminal or command prompt opens and displays a report. In this example, the scanner is on the last line. The information you need is contained in this segment:

a6;p0;t6;l0.

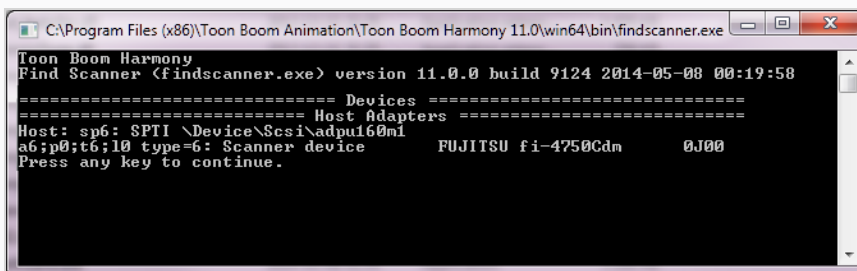

```
C:\Program Files (x86)\Toon Boom Animation\Toon Boom Harmony 11.0\win64\bin\findscanner.exe
Toon Boom Harmony
Find Scanner (findscanner.exe) version 11.0.0 build 9124 2014-05-08 00:19:50
===== Devices =====
===== Host Adapters =====
Host: sp6: SPII \Device\Scsi\adpu160m1
a6;p0;t6;l0 type=6: Scanner device FUJITSU fi-4750Cdn 0J00
Press any key to continue.
```

- ▶ **a6**: The Adapter ID number. Its value is 6.
 - ▶ **p0**: The Path ID. The value is 0.
 - ▶ **t6**: The Target ID. The value is 6.
 - ▶ **l0**: The logical unit number (LUN). The value is 0.
3. Record this information so you can enter it into the **Harmony Configuration Wizard**.

Configuring the Scanner Using the Configuration Wizard

After upgrading your SCSI adapter and recording information about the scanner attached to your computer, you are ready to configure the scanner to communicate with Harmony. Use the Harmony Configuration Wizard to configure your scanner.

How to start the Harmony Configuration Wizard

1. From the Start menu, select **All Programs > Harmony 22 [edition] > Tools > Configuration Wizard**.

The Harmony Configuration dialog box opens.

How to configure the scanner

1. In the Harmony Configuration dialog box, click **Scanners Configuration**.

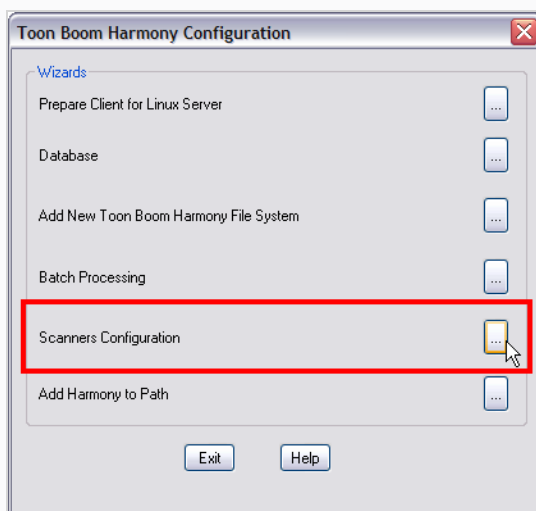

The Scanner dialog box opens.

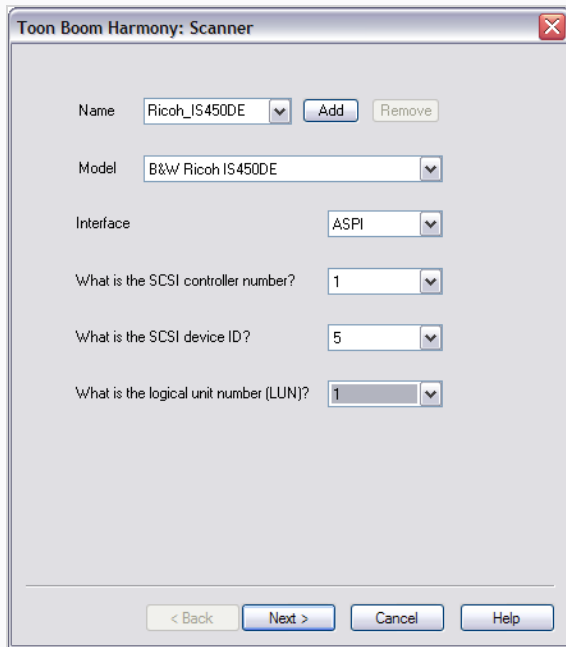

2. In the Name menu, type or select the scanner's name.
3. In the Model menu, select the scanner model.
4. In the Interface menu, select the scanner interface type.
5. From the SCSI controller number menu, select the SCSI number that identifies your SCSI Adapter.
6. From the SCSI ID menu, select the SCSI number of the scanner.
7. From the logical unit number (LUN) menu, select logical unit number. Due to a scanner's default configuration and the nature of the device, the LUN should always be zero (0).
8. After you have completed all the fields in this dialog box, click **Add**.
9. Repeat the previous steps in this procedure for each scanner you want to add.

To remove a scanner from the list, select the scanner from the Name field and click **Remove**.

10. After you have added all your scanners, click **Next**.

The Review dialog box opens.

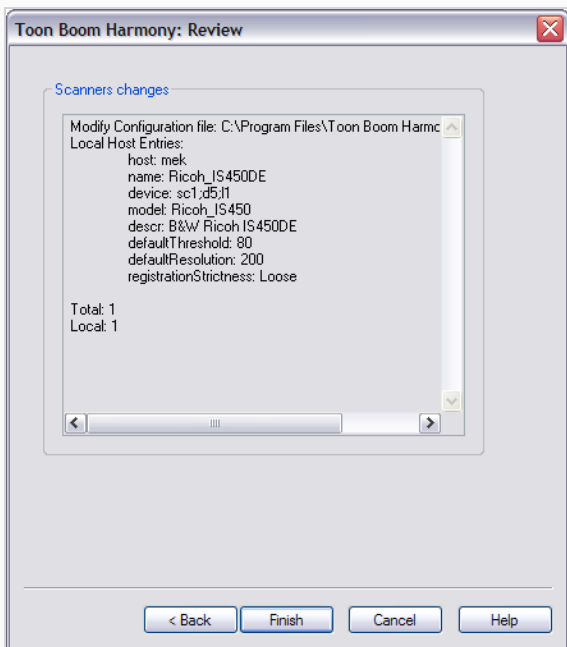

11. Read the summary of how you have configured your scanner and decide if you want to continue.
 - If the summary is accurate, click **Finish** to complete the configuration.
 - If you want to change the configuration, click **Back** until you reach the dialog box where you can change the option.
 - After you make your changes, click **Next** until you reach the Review dialog box again.

A confirmation message appears when your Scanner configuration file (`scan.conf`) is updated.

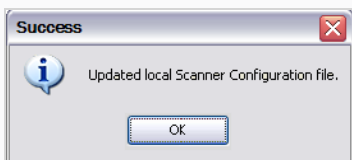

About Scanner Configuration for GNU/Linux

After you have installed the hardware, you will need to identify the name of the scanner device driver and set permissions for the scanner.

Identifying the Name of the Scanner Device Driver	18
Setting the Permissions for the Scanner	20

Identifying the Name of the Scanner Device Driver

You must identify the name of the SCSI device that is working with your scanner so that you can configure Harmony to communicate with it.

Device drivers all have names starting with `/dev/sg`. If your scanner is the only generic SCSI device connected to your system, it is likely that the name of its driver is `/dev/sga`.

If you are uncertain about the device name, you can use the `findscanner` utility provided with Harmony. Use the `findscanner` utility to probe your SCSI bus for devices. It will tell you the name of the device being used by scanners attached to your system.



NOTE

The device name of your scanner will change if you add, remove or swap other generic SCSI devices.

How to use the findscanner utility to identify the scanner

- ▶ Start the `findscanner` utility. While in the bin folder of your Harmony installation, type the following in a terminal or command prompt:

```
./findscanner
```

The `findscanner` utility is installed in `//usr/local/ToonBoomAnimation/harmony [Edition]_22grep/ln86_64/bin/`

If there are scanners connected to your computer and they are properly installed, the `findscanner` utility will return information like the following:

```
/dev/sga type=6: Scanner device RICOH IS450 Vers:1R04
/dev/sgb type=6: Scanner device FUJITSU fi-4750Cdm Vers:0G00
```

If `findscanner` cannot find SCSI scanners attached to your computer, it will return a statement like this:

```
No scsi devices attached
```

If you get this message, it may indicate that your system could not initialize your SCSI adapter at boot time.

How to make sure the SCSI devices are initialized correctly when booting GNU/Linux

1. Go to the `/boot` directory and rename the `initrd-[version].img` file, where [version] represents the version of your kernel. You can run the `uname -r` command to find out the version

of your kernel.

```
cd /boot
```

```
mv initrd-2.4.18-3.img noscsi-initrd-2.4.18-3.img
```

2. Type the following command:

```
/sbin/mkinitrd initrd-2.4.18-3.img 2.4.18-3
```

This command recreates a new "init ramdisk" image that will load your SCSI driver when your system starts.

3. Reboot your system.

Setting the Permissions for the Scanner

If you want multiple user accounts to be able to access your scanner, you must modify the permissions on the device driver.

How to change the permissions on the scanner

1. On a command line, type the following:

```
chmod 666 /dev/sga
```

`/dev/sga` must represent the device driver of your scanner.

How to set the permissions on the scanner each time you boot

1. Open `/etc/rc.d/rc.local` in a text editor.
2. Add the following line:

```
chmod 666 /dev/sga
```
3. Save and close the file.

t and replace it with your own content.

About Configuring Scanners for Mac OS X

This chapter explains how to configure your scanner to work with Harmony on macOS.

Before you can configure your scanner, your scanner should already be configured, switched on, and connected to your system.

After your scanner is configured, you must modify the hardware so Harmony can align images scanned using autofeed.

Modifying the Scan.conf File	22
---	-----------

Modifying the Scan.conf File

After you have installed your scanner hardware, you must configure your scanner to communicate with Harmony. To do this, you must find the name of your scanner using the Find Scanner Utility. Then, you must add this name to the `Scan.conf` file.

How to modify the Scan.conf file

1. Open a terminal and type the following:

```
findscanner.
```



IMPORTANT

The path to the Harmony's terminal applications must be registered for this process to work. Refer to the macOS Installation chapter to learn how to register the path to the Terminal application.

The findscanner utility reports the following information:

```
Device found:
```

```
<FUJITSU/M4097Ddim>
```

The device found must be copied into the `Scan.conf` file, including the angle brackets.

2. Modify the `Scan.conf` file with the Harmony Configuration Editor. Open a Finder and select **Applications > Harmony 22 [edition] > Tools > Configuration Editor**.
3. In the Harmony Configuration Editor, select the **Scan.conf** tab.

The following is an example of entries in a `Scan.conf` file for a Fujitsu scanner on macOS.

```
host: scan1
name: Fujitsu BW
model: Fujitsu_M4097D
device: <FUJITSU/M4097Ddim>
descr: The scanner to use for black & white and greyscale scans.
defaultGamma: .89
defaultResolution: 200
```

The following options must be included in the `Scan.conf` file:

- `host: [hostName]`

where `[hostName]` is the name of the machine that the scanner is attached to.

- `name: [scannerName]`

where `[scannerName]` is the name you want the scanner to be listed as in the scanner drop-list in the Harmony.

- `device: <device name>`

where `<device name>` is the name the findscanner utility reports. You must include the angle brackets.

- `model: [modelName]`

where `[modelName]` is the model name of your scanner (the name is case sensitive and there can be no spaces separating the name and the number). Following is a list of supported scanners.

`Epson_836XL`

`Epson_1640XL`

`Epson_GT-15000`

`Fujitsu_M3096G`

`Fujitsu_M4097D`

`Fujitsu_fi4750C`

`Fujitsu_fi5750C`

`Fujitsu_fi6770`

`Ricoh_IS330`

`Ricoh_IS420`

`Ricoh_IS430`

`Ricoh_IS450`

`Ricoh_IS760`

`TWAIN`

Establishing Communication

Once your scanner is set up and you know the device driver name, brand and model, you are ready to configure the `Scan.conf` file so that the Harmony can communicate with it. The `Scan.conf` file contains a number of configuration parameters you can use to control the communication between your scanner and the Harmony.

The Harmony Configuration Wizard updates the `Scan.conf` file with the required information. If there are other variables you want to modify in this file, use the Harmony Configuration Editor.

Location of the Scan.conf File

Windows: `C:\Program Files (x86)\Toon Boom Animation\Toon Boom Harmony 22 [Edition]\etc`

macOS: `/Applications/Toon Boom Harmony 22 [Edition]/Harmony [Edition].app/Contents/tba/etc`

GNU/Linux: `/usr/local/ToonBoomAnimation/harmony[Edition]_22/etc`

Location of Original Default Scan.conf File

Windows 7: `C:\Program Files (x86)\Toon Boom Animation\Toon Boom Harmony 22 [Edition]\resources\samples`

macOS: `/Applications/Toon Boom Harmony 22 [Edition]/Harmony [Edition].app/Contents/tba/resources/samples`

GNU/Linux: `/usr/local/ToonBoomAnimation/harmony[Edition]_22/resources/samples`

Here is an example of entries in a `Scan.conf` file for a Ricoh scanner on Linux.

```
host: scan-1
name: My_Ricoh_IS450DE_Scanner
descr: The scanner to use for black & white and greyscale scans.
device: /dev/sga
model: Ricoh_IS450DE
defaultThreshold: 80
defaultResolution: 200
registrationStrictness: Loose
```

The following options must be included in the `Scan.conf` file:

- `host: [hostName]`

where `[hostName]` is the name of the machine the scanner is attached to.

- `name: [scannerName]`

where `[scannerName]` is the name you want the scanner to be listed as in the Scanner menu in the Scan application.

- `device:`

- **GNU/Linux:** `/dev/[filename]`

where [filename] is the filename of the device driver for your scanner.

- Windows: **scX;dY;lZ**

The SCSI identifier for the scanner.

X=controller number (normally 0)

Y= device number (as set on the scanner)

Z= The logical unit (normally 0)

ex: device: sc0;d5;l0 (if the scanner is set to scsi id 5)

- macOS: **<device name>**

where **<device name>** is the name findscanner reports. You must include the angle brackets.

- **model: [modelName]**

where [modelName] is model name of your scanner (the name is case sensitive and there can be no spaces separating the name and the number). Following is a list of supported scanners.

Epson_1640XL

Epson_GT-15000

Fujitsu_M3096G

Fujitsu_M4097D

Fujitsu_fi4750C

Fujitsu_fi5750C

Fujitsu_fi6770

Ricoh_IS330

Ricoh_IS420

Ricoh_IS430

Ricoh_IS450

Ricoh_IS760

TWAIN

The following are optional additions to the scanner description.

- **descr: [scannerDescription]**

Where [scannerDescription] is a description of the scanner, which appears in the Scanner Information dialog box in the Scan window. This text must be all on one line.

- **defaultThreshold: [value]**

Where [value] is the default value for threshold for black and white scanning. The value should be an integer ($0 \leq [value] \leq 255$). The default threshold value at installation is 100 if no value is specified.

- **defaultBlackPoint: [value]**

Where [value] is the colour value ($0 < [\text{value}] < 255$) that the Scan application considers to be black. The Scan application forces any colour darker than this value to black. If no value is specified, it defaults to 20.

- **defaultWhitePoint:** [value]

Where [value] defines the colour value ($0 < [\text{value}] < 255$) that the Scan application considers white. The Scan application forces any colour lighter than this value to white. If no value is specified, it defaults to 235.

- **defaultGamma:** [value]

Where [value] is the default value for colour and grayscale gamma correction ($0.0 < [\text{value}] \leq 2.55$) on the scanner. The default gamma value at installation is 1.0 if no value is specified.

- **defaultResolution:** [value]

Where [value] is the default resolution in dpi (dots per inch) for the scanner. The value should be an integer that is one of the scanner's legal resolutions. The default resolution value at installation is 300. For Fujitsu and Ricoh scanners, 300 DPI is appropriate. For colour scanners, like the Epson, 150 DPI is suggested.

- **defaultPegSide:** [value]

Where [value] defines the default value in the Peg-Side menu when you select the scanner. You can choose between Top, Right, Left or Bottom.

- **registrationStrictness:** [level]

Where [level] defines how exact the location of the peg holes must be for the software to recognize them. You have two values to choose from:

- **Strict:** The peg holes must be in a tightly defined area to be recognized. This is the default setting.
- **Loose:** The peg holes can be anywhere in a larger area to be recognized. This setting is recommended.

- **pegPitch:** [value]

Where [value] is the number of decimal places permitted when defining the distance in inches between side pegs. The peg pitch can be defined to fix splicing problems when aligning panels. The default value is 8 (e.g., a distance of 0.12345678 could be defined).

side0CleanSize: [value]

side1CleanSize: [value]

side2CleanSize: [value]

side3CleanSize: [value]

Where [value] is the distance in inches from the edge of the drawing that will not be included in the scan. Including these values can save vectorization time and remove dirtiness at the edges of a drawing. Side "0" is the side with peg holes. Remaining sides are numbered in clockwise fashion.

About Adapting the Scanner Hardware

Before using your scanner, you must make a few minor adjustments to make sure it can handle the special types of animation paper you will be using.

On the ADF paper chutes of supported Fujitsu scanners, the paper guides are connected to each other by a cog wheel that keeps the paper guides and the drawings centred on the chute. Adjustments must be made to this type of Fujitsu scanner to avoid problems during the scanning process.

To compensate for the centred scanning on the ADF chute of Fujitsu scanners, there are several things you can do.

Removing Paper Chute Cog Wheels	28
Adding Paper Guides to Scanners	29
Installing Tape on ADF Paper Paths	30
Creating Off-set Scanning	34

Removing Paper Chute Cog Wheels

If you don't want to modify the `Scan.conf` file, you can remove the cog wheel so the paper guides can slide independently. This allows you to position the paper guide closest to the back of the scanner as far as it can go towards the back of the scanner. You can then slide the other paper guide up to meet the bottom edge of the stack of drawings to keep them aligned.

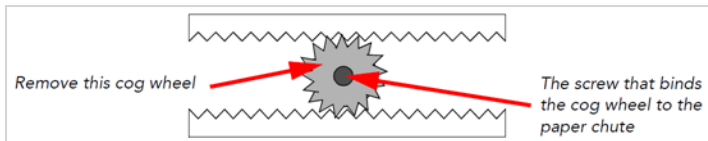

How to remove the cog wheel

1. Remove the paper chute from the scanner.
2. Remove the screw that attaches the cog wheel to the paper chute.

After you remove the cog, the paper guides should be able to slide independently of each other.

Adding Paper Guides to Scanners

Instead of removing the cog wheel on the ADF paper chute, you can make a paper guide to place between the existing paper guides to keep the stack of drawings in the proper alignment in the paper chute.

To perform this procedure, you will need the following materials:

- A paper guide made of cardboard, a block of wood, or similar material.
- Adhesive tape to secure the paper guide to the paper chute.

How to place a paper guide on the scanner

1. Open the ADF paper guides to their widest position.

Place the paper guide closest to the back of the scanner as far out as it can go (toward the back of the scanner).

If you did not remove the cog wheel, this will make for a very wide paper chute, wider than most of your animation paper.

Now you must create an intermediate paper guide to hold your drawings in place.

2. Place a stack of drawings in the paper chute so that they are touching the back paper guide. Make sure the back paper guide is as far back as it can go.
3. Position the paper guide you created to secure the other edge of the paper stack.
4. Secure the paper guide with tape.

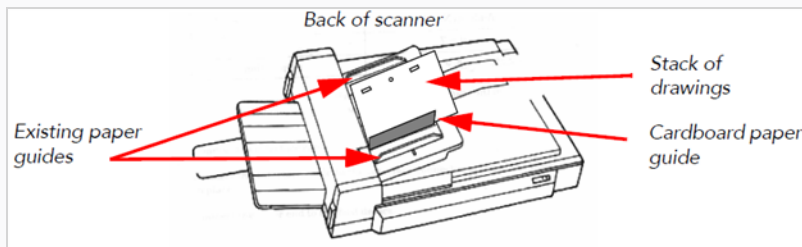

Installing Tape on ADF Paper Paths

When you scan drawings with the Scan application, drawings on paper become digital images in the Harmony system. These digital images must be properly aligned during the scan process to ensure that the animation flows smoothly from frame to frame in the final output.

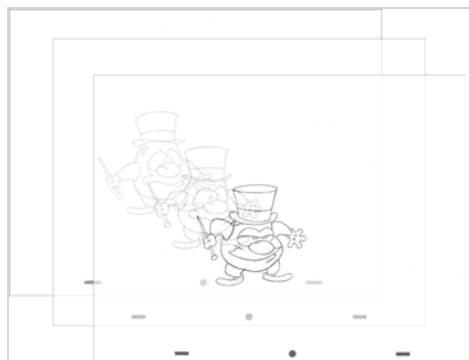

- If you want to scan many drawings using the ADF chute on your scanner, you must use the Optical Registration option in the Scan application to automatically align your drawings.

When you select the Optical Registration option, the Scan application identifies the peg holes to align the drawings.

You can also use the Optical Registration option if you want to manually scan a drawing on the flatbed part of the scanner.

- If you have a peg bar attached to your scanner, you don't have to use optical registration because the drawings will be aligned by the peg bar. However, you will have to scan your drawings one at a time.

Peg holes in your drawings must be filled with black in the final scanned image for the optical registration to be able to locate them. Your scanner must be modified prior to scanning to ensure black peg holes appear in the scanned image.

For ADF Scanning

Tape a piece of dark paper to the ADF feeder in the position where the peg holes will pass as they are scanned.

If you don't place the black tape on the ADF paper path, the peg holes in the drawing pass in front of a white background. This does not provide enough contrast for the Scan application to distinguish where the peg holes are and it will not be able to register and align the autofeed drawings.

For Manual Scanning

Tape a piece of dark paper to the scanner cover above the position of the peg holes.

RICOH Scanner

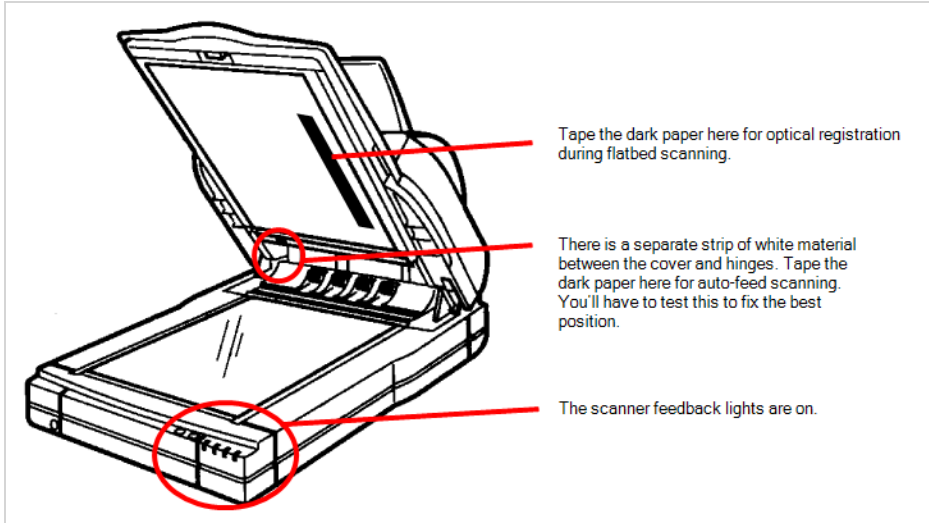

Fujitsu Scanner - ADF

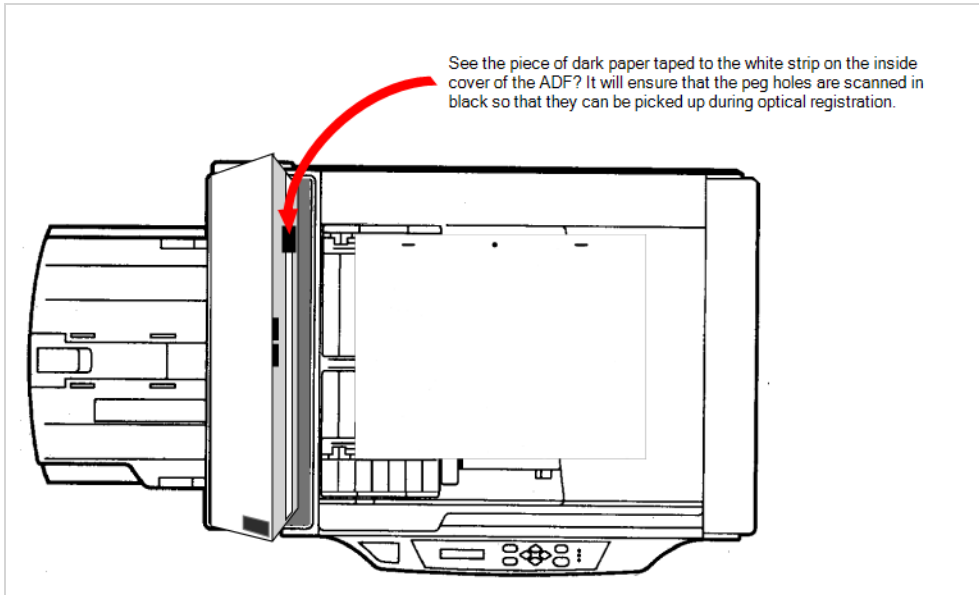

Fujitsu Scanner - Cover

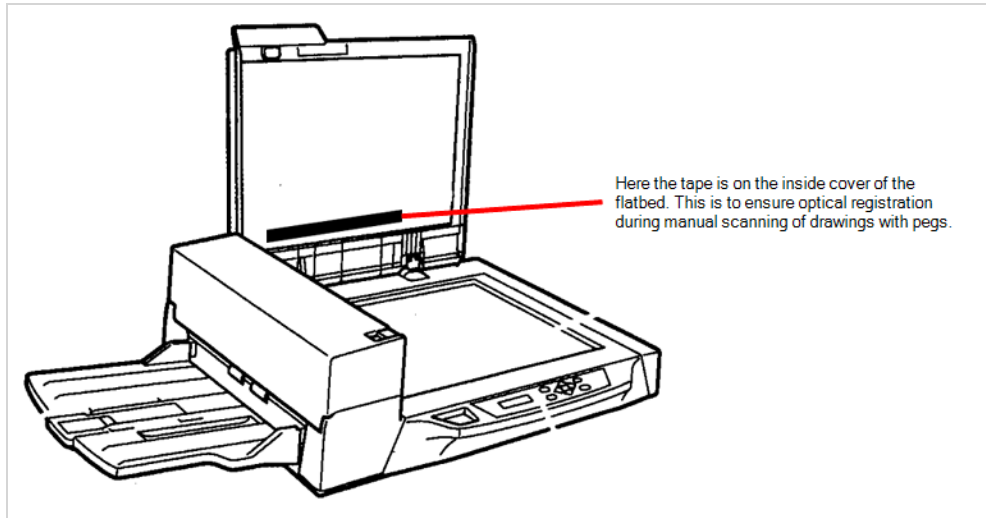

Before you perform this procedure, you need the following materials:

- A strip of black adhesive tape approximately 1.25 inches (3.5 cm) by 0.75 inches (2 cm). Black plastic electrician's tape is fine.
- A sheet of drawing paper with field size and peg hole locations identical to the type that you intend to scan with the autfeeder.

How to install the tape on the ADF paper path

1. Turn off the scanner's power and open the ADF cover.

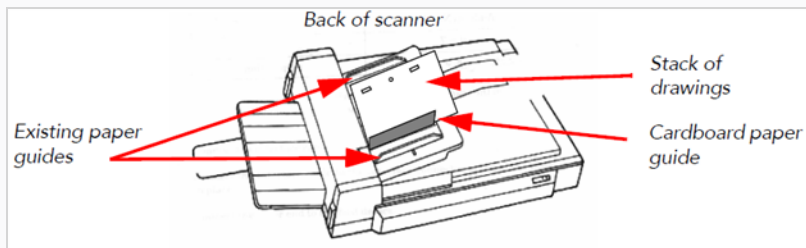

2. Place the paper guides in their scanning position. This will depend on your scanner and any modifications you made to it.
3. Place the drawing paper in the paper chute with the peg holes toward the back of the scanner. The top edge of the paper should touch the paper guide closest to the back of the scanner.
4. Slide the paper into ADF chute.
5. Place the strip of black tape across the width of the white strip on the inside of the ADF cover. Use the peg holes in the drawing paper as a visual guide.

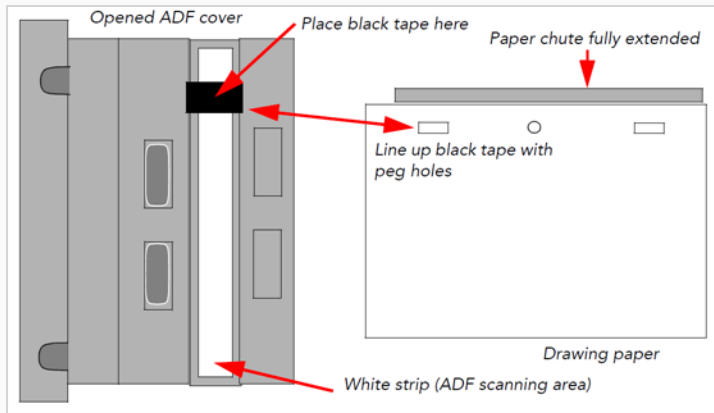

6. Close the ADF cover and scan a few test drawings to see that the Scan application can identify the peg holes.

Creating Off-set Scanning

Modifying the Scan.conf File for Centred ADF Scanning

If you do not want to modify the ADF chute so that it is aligned towards the back of the scanner, you can use the `leftOffset` option in the `Scan.conf` file. To calculate the `leftOffset` option, consider that the paper chute on all supported Fujitsu scanners are 12 inches (2.54 cm) wide. If your paper is 10.5 inches (26.67 cm) wide, the difference between the chute and the paper is 1.5 inches (3.81 cm). Since this difference is distributed on both sides of the paper chute, the offset from either edge is 0.75 inches (1.90 cm). Therefore, the `leftOffset` option is 0.75 inches (1.90 cm).

The `leftOffset` option was added to this sample of the `Scan.conf` file:

```
host: scan-1
name: Fujitsu10.5
descr: The scanner to use for black & white and greyscale scans.
device: sc1;d5;10

model: Fujitsu_fi4750C
defaultThreshold: 80
defaultResolution: 200
registrationStrictness: Loose
leftOffset: 0.75
```

You can add additional entries in the `Scan.conf` file to support paper of different sizes. For example:

```
host: scan-1
name: Fujitsu8
descr: The scanner to use for black & white and greyscale scans.
device: sc1;d5;10
model: Fujitsu_fi4750C
defaultThreshold: 80
defaultResolution: 200
registrationStrictness: Loose
leftOffset: 2
```

Calibrating Scanners with Peg Bars

Autofed and manually pegged drawings must register against each other if you intend to use both scanning methods. Therefore, you must calibrate the scanner so that it can register the peg holes accurately using the peg bar.

Before you perform this procedure, you will need the following materials:

- An ultra-thin peg bar. Suggestion: Audio-Visual Stainless Steel Pegbar (catalog number AP105)
 - Accurate ACME standard registration
 - 3-peg, single-field length (0.05" x 1.5" x 12.0") (1.27mm x 38 mm x 304.7mm)
 - Low brass pegs (1/16" in height) (1.58 mm in height)
 - Lightweight sprung stainless steel base
 - Ideal for work requiring exposure on a process camera, print down frame or scanning bed

This is obtainable from Chromacolour International www.chromacolour.com

- A drawing with field size and peg hole locations identical to the type you intend to scan.

Instead of using a drawing of a character or object, you may find it helpful to create a test "drawing" by placing a sheet of drawing paper over a field chart and tracing several heavy line segments from the field chart.

For more accurate calibration, draw lines from the centre to the edges of the paper. This will give more reference points at various locations on the paper. For example, trace over the centre X and several corners of the fields from the centre out towards the edges of the field chart. Then peg and autofeed the test drawing as described in the following procedure.

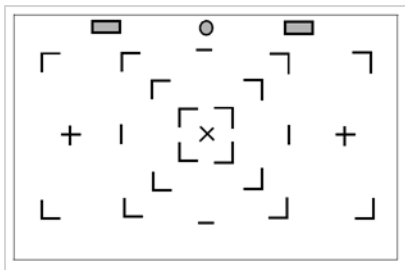

Before calibrating the scanner:

- Create a small scene in Harmony using the test drawing.
- Using Control Center, create a job that has one scene.
- Using Harmony, create an exposure sheet for the job that has two drawing columns (one for the drawing you will autofeed and one for the drawing you will manually peg before scanning).

How to calibrate a scanner with a peg bar

1. Create a test scene.
2. Open the Scan application and open the elements you created.
3. Perform an Autofeed scan of the test drawing in the autofeed element, with **Optical Registration** enabled.
4. After the drawing has vectorized, load it in Stage by reopening the scene.
5. Loosely tape the peg bar to the scanner bed (centre the bar horizontally on the scanner bed; move the bar vertically on the top of the scanner bed).
6. Scan the pegged drawing with the **Autofeed** feature off.
7. After the drawings has vectorized, load it in Harmony by reopening the scene, and comparing its alignment with the drawing scanned in step 4.
8. If the two images do not align, move the peg bar and rescan the pegged drawing again.
9. Repeat these steps until you have aligned the drawings. When the peg bar is in the desired position, securely attach the peg bar to the scanner bed. Keep the test drawing for future use.

Chapter 2: User Interface

It is important to become familiar with the following elements of the user interface as it will help you get started using the Scan application. You can learn more about the highlights described here, and how to use them in a production context throughout this guide.



When you start the Scan application for the first time, the default workspace is displayed. It contains all of the main elements you need to use.

The Scan application has five major components.

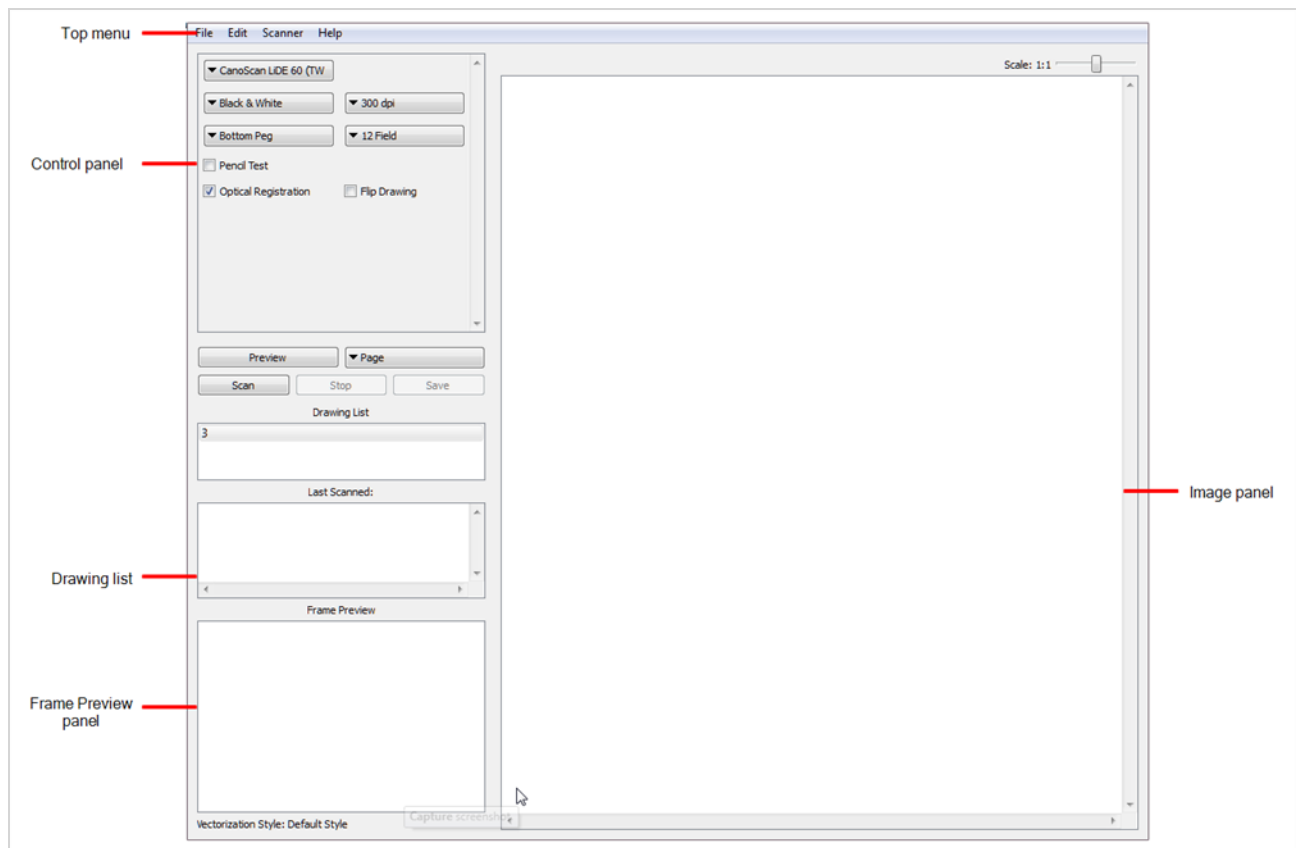

Top Menu

The top menu contains most of the commands available in the Scan application.

The menu categories are:

Menu	Description
File	Lets you load drawings and manage exposure sheet elements.
Edit	Lets you modify the Drawing List, apply vectorization options and create a text file of scan details for each scanned drawing.
Scanner	Lets you eject a page from the scanner and display scanner information.
Help	Lets you access the integrated help system and Scan application version information.



NOTE

In macOS, there is a Scan menu with the following commands: About Scan and Quit.

Control Panel

The Control panel allows you to set up the scan.

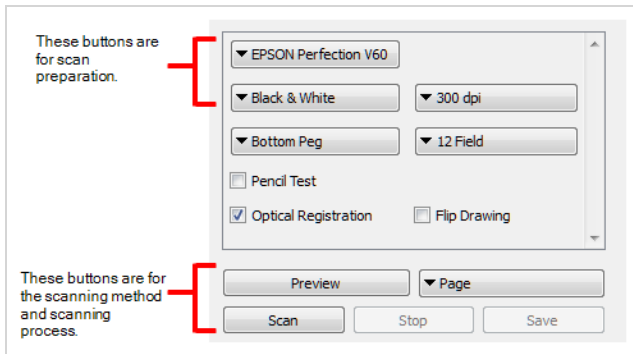

When you select a scan type, you can control the following:

- Exposure
- Contrast
- Time required to scan a line, measured in lines per millisecond.

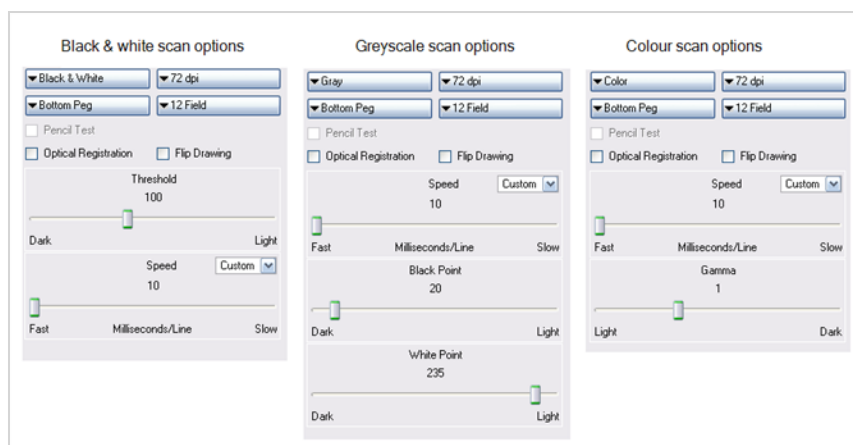

Drawing List

The Drawing list displays the names of the drawings loaded for scanning. As each drawing is scanned, this is indicated.

Frame Preview Panel

The Frame Preview panel shows the upcoming frame to be scanned.

Image Panel

The Image panel displays the current drawing being scanned.

Scan Module Top Menu

The menu commands in the Scan application let you access commands for executing many different tasks.

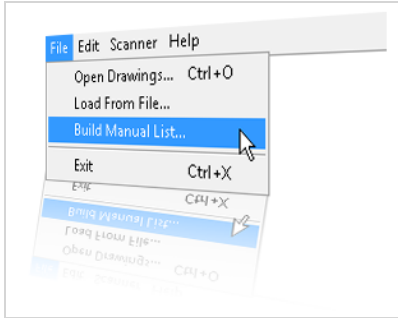

Scan Menu

If you are using macOS, the Scan menu commands let you display product and version information, and close the Harmony.

Command	Description
About Scan	Displays product and version information.
Exit	In macOS, closes the Harmony and ends the current session.

File Menu

The File menu commands let you open drawings, select scanned drawings to load, create a list of labelled cells and close your session.

Command	Description
Open Drawings	Opens the Database Selector dialog box in which you select the drawings to be scanned or add new scenes and elements to a job.
Load From File	Lets you select a previously scanned drawing to load into the Scan module.
Build Manual List	Opens the Manual List dialog box for you to create a list of labeled cells.
Exit	In Windows or Linux, closes the Scan module and ends your current session.

Edit Menu

The Edit menu commands let you open the drawing list, reverse the drawing list, select the vectorization style, and create a plain text file for each scan.

Command	Description
Drawing List	Opens the Drawings Selector dialog box for labelling cells to accept drawings.
Reverse Drawing List	Reverses the sequence of drawings in the Drawing List.
Vectorize Style	Opens the Vectorization Styles dialog box for selecting the vectorization style to apply when scanning drawings.
Create ScanInfo File	Creates a plain text file for each subsequent scan. This file contains information such as the paper size and DPI used during scanning. Each plain text file is located in the same directory and has the same file name as the scanned image with the file extension SI.

Scanner Menu

The Scanner menu commands let you eject paper from a scanner and access scanner information.

Command	Description
Info	Opens the Scanner Information dialog box to view scanner name, device, model, and description information.
Eject Page	Ejects a page from a scanner's automatic document feeder (ADF). This command is only activated when a paper jam occurs. This option is not available on all the scanners.

Help Menu

The Help menu commands let you access scanner information, identify problems when scanning and access the documentation.

Command	Description
About	In Windows or Linux, displays product and version information.

Debug Mode	Identifies a problem encountered in Harmony.
Help	Opens the online help product documentation.

Chapter 3: Pre-scanning Process

Toon Boom Harmony's dedicated Scan application lets you scan drawings fast. It creates a drawing list from the previously created exposure sheet. To use this module, you must create your exposure sheet in Harmony before the scan process.



Usually, when you're ready for scanning, a scene has been created containing the elements to be scanned and the exposure sheet has been filled.



If you have not previously prepared your scene's exposure sheet or created your elements or scenes, you can always create drawing lists, elements or scenes directly from the Scan application without having to go through the Control Center.

- Launching the Scan Application 45
- Creating Scenes in the Scan application 47
- Creating Elements from the Scan Module 50
- Loading Drawings 52
- Editing Drawing Lists 55
- Setting Up Scanning Sessions 57
 - Displaying Scanner Information 59
- Performing Trial Scans 60

Launching the Scan Application

You can launch the Scan application using the desktop icon or the application menu.

How to launch the Scan application

1. Depending on your operating system, do one of the following:
 - **Windows:** Open the Start menu and, in the list of programs, select **Harmony 22 [Edition] >  Scan**.
 - **macOS:** Do the following:
 - a. In Finder, proceed to **Applications >  Toon Boom Harmony 22 [Edition]** and double-click **Harmony [Edition]**.

The main Harmony application launches.
 - b. In the top menu, select **Harmony [Edition] > Tools > Scan**.
 - **GNU/Linux:** In the GNOME top menu, select **Applications > Harmony 22 [Edition] >  Scan**.

If no scanner is connected to your computer, or if a scanner is connected but its driver is not installed, the following message will appear:

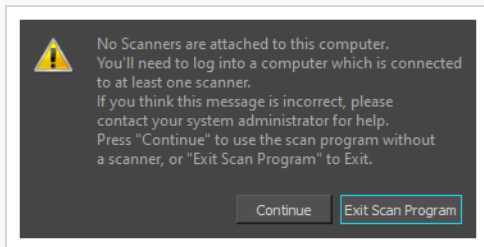

- Click **Continue** to open the Scan application. Note that you will not be able to scan.
- Click **Exit Scan Program** to quit the Scan application.

The database login dialog appears.

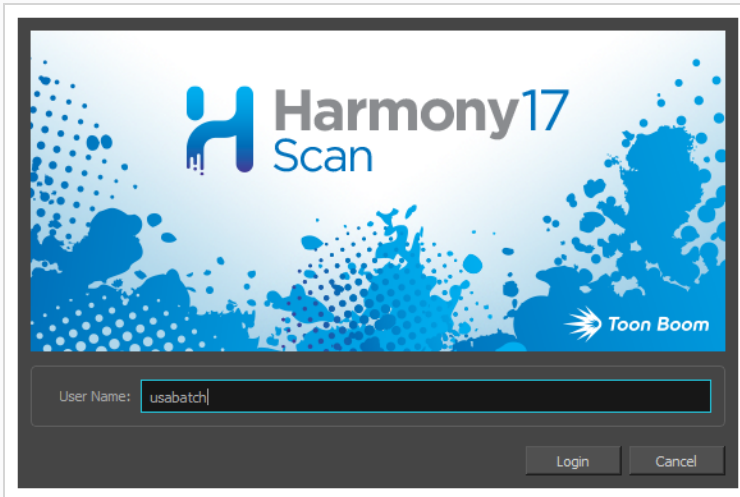

2. In the **User Name** field, enter your Harmony Server username.
3. Click **Login**.

Creating Scenes in the Scan application

Before you can scan drawings, you must have a scene, element and drawing list ready. You can create these directly from the Scan application without having to go through the Control Center.

How to create a scene from the Scan application

1. Start the Scan application and log on to the database using your Harmony user name.

The Database Selector dialog box opens, displaying the Environments available from the Harmony database.

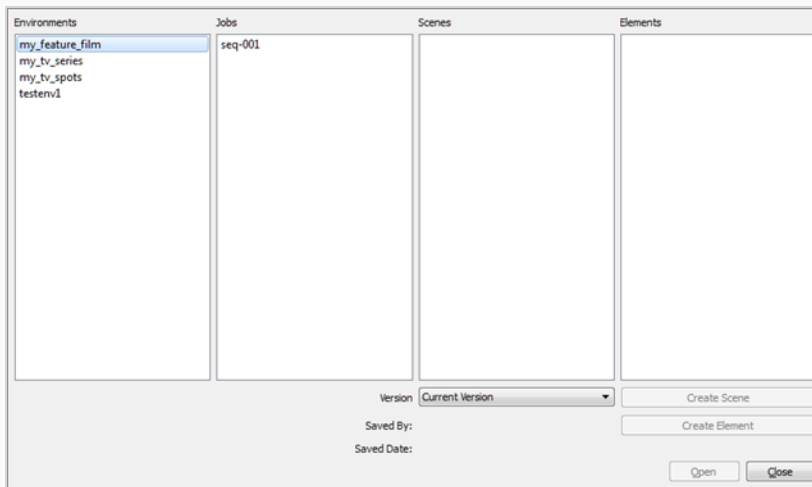

2. Select the Environment and Job in which you want to add a scene.

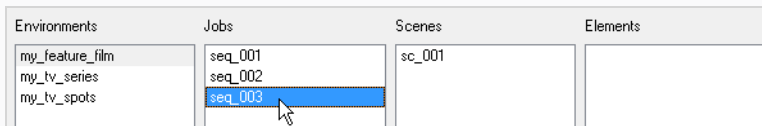

3. Click **Create Scene**.

The Create Scene dialog box opens.

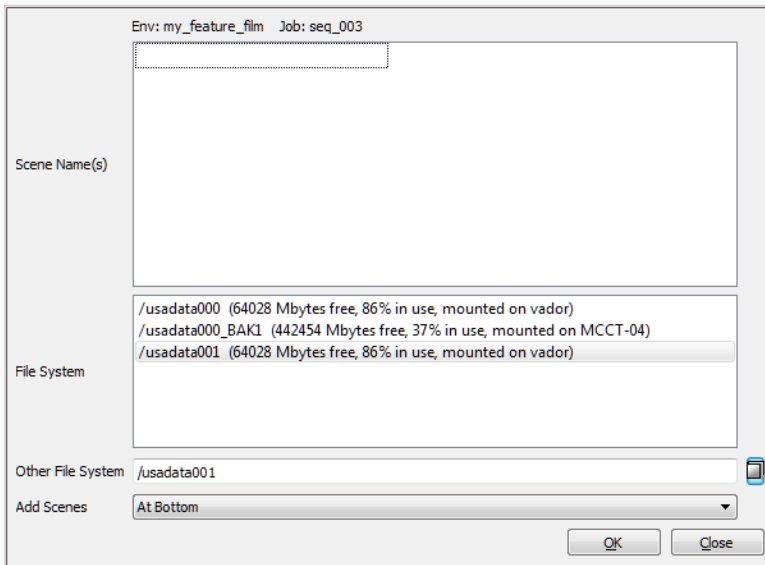

4. In the **Scene Name(s)** field, type the new scene's name. Press Enter/Return after each scene's name to create additional scenes.

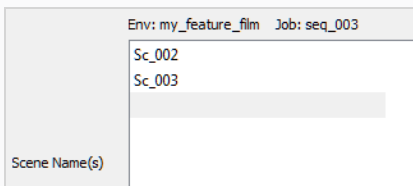

5. From the File System list, select the file system. Click the **Other File System** button to select another file system to use.

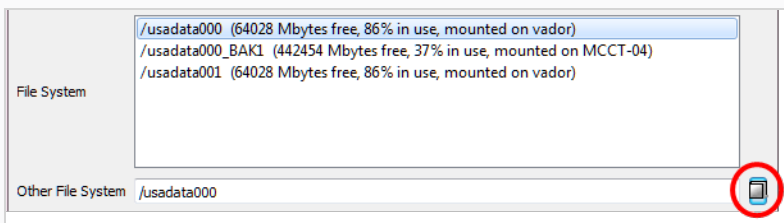

To learn more about creating a project in the database, refer to the Control Center Guide.

6. Select where you want to place the new scenes in the database scene list using the Add Scenes menu.

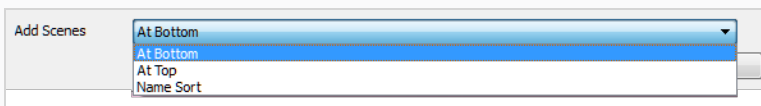

- **At Bottom:** Places new scenes at the bottom of the scenes list.
- **At Top:** Places new scenes at the top of the scenes list.

- **Name Sort:** Sorts new scenes alphabetically.

7. Click **OK**.

The new scenes appear in the Database Selector.

Environments	Jobs	Scenes	Elements
my_feature_film	seq_001	sc_001	
my_tv_series	seq_002	Sc_002	
my_tv_spots	seq_003	Sc_003	

Creating Elements from the Scan Module

Elements don't need to be created in the Control Center, they can also be created in the Scan application.

How to create elements from the Scan application

1. Start the Scan application and log in to the database with your username.

The Database Selector dialog box opens, displaying the Environments available from the Harmony database.

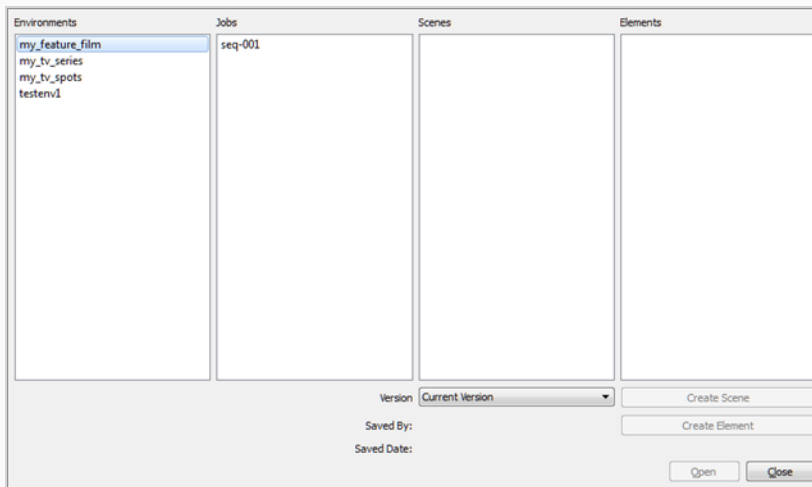

2. Select the Environment, Job and Scene in which you want to add elements.

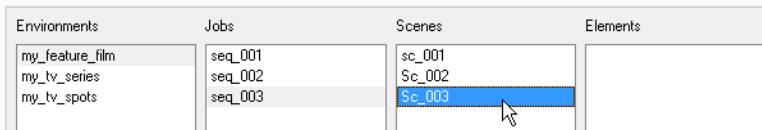

3. Click **Create Element**.



NOTE

If your system administrator did not complete the resolution configuration tasks, a warning message displays. This message notifies you that the `resolution.conf` file was not properly inserted in the configuration folder.

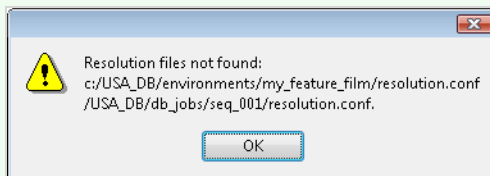

4. Click **OK**.

The Scan application opens and the Create Element dialog box opens.

The screenshot shows a dialog box with the following fields and values:

- Name: [Empty text box]
- Vector:
- Bitmap Format: SCAN
- Scan Type: B&W
- Field Chart: 12

Buttons at the bottom: OK, Add, Close.

5. In the Name field, type the new element's name.
6. Select **Vector** option if the element is to be vectorized.
7. Select the bitmap format of your element; this list is only available if you did not select the Vector option.

The screenshot shows the Bitmap Format dropdown menu with the following options:

- SCAN (selected)
- SGI
- TGA
- YUV
- DMF
- PSD
- PNG
- JPG
- BMP
- TIF

8. Select a scan type.
 - **Colour**: Creates a colour bitmap element.
 - **Greyscale**: Creates a greyscale bitmap element.
 - **B&W**: Creates a vector-based element that is going to be painted using the Harmony or Paint modules.
9. Select the field chart size of your element.

The screenshot shows the Field Chart dropdown menu with the following options:

- 12 (selected)
- 16
- 24

10. When you're done:
 - Click **OK** to add the element and return to the Database Selector.
 - Click **Add** to add the element and keep the dialog box open to add more.
 - Click **Close** to cancel and return to the Database Selector without adding an element.

Loading Drawings

There are two ways that you can load drawings from the Scan application.

How to load drawings from launch

1. Launch the Scan application and login.
2. The Database Selector dialog box opens, displaying the Environments available from the Harmony database.

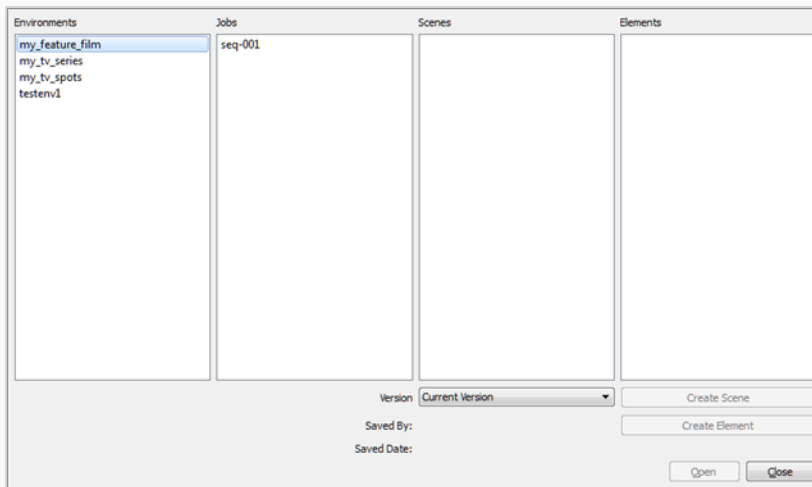

3. Select the Environment, Job, Scene and then the Element you want to scan.

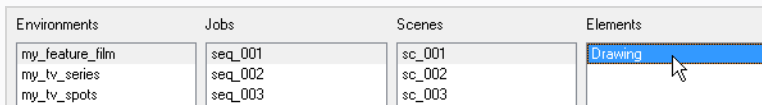

4. Click **Open**.

The Drawings Selector dialog box opens, listing all the drawings contained in the selected element.

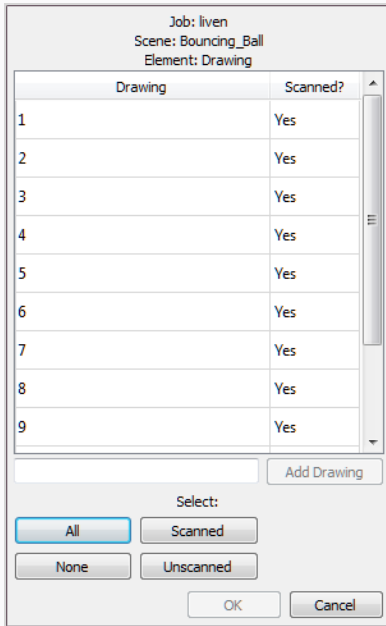

The Drawing column displays the names of the drawings. The Scanned column indicates if the drawing has been scanned.

- If needed, add new drawings to the list by typing in a drawing name in the Add Drawing field and click **Add Drawing**.

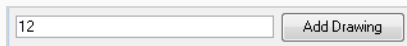

The new drawing appears in the list.

- Select the drawings to scan.
 - Select the specific drawings from the list. You can select several drawing using Shift + click.

Drawing	Scanned?
1	No
2	No
3	No
4	No

- Click **All** to select all the drawings in the list.
 - Click **None** to unselect all drawings.
 - Click **Scanned** to select only the drawings that are indicated as scanned (Yes) in the list.
 - Click **Unscanned** to select only the drawings that are indicated as not scanned (No) in the list.
- Click **OK**.

The selected drawings appear in the Drawing List column.

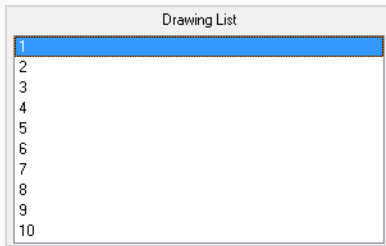

Once your session is started, you can open the Database Selector window at any time to load other drawings.

How to load drawings inside the Scan application

1. Select **File > Open Drawings**.
2. Follow steps 4 to 7 in the previous procedure: "How to start the Scan application and load your scene".

Editing Drawing Lists

There are two ways you can edit a drawing list from the Scan application.

- Editing a drawing list when loading an element or
- Editing a drawing list when the element is already loaded.

How to edit a drawing list

1. In the Scan application, select **Edit > Drawing List**.

The Drawing Selector dialog box opens listing all the drawings contained in the loaded element.

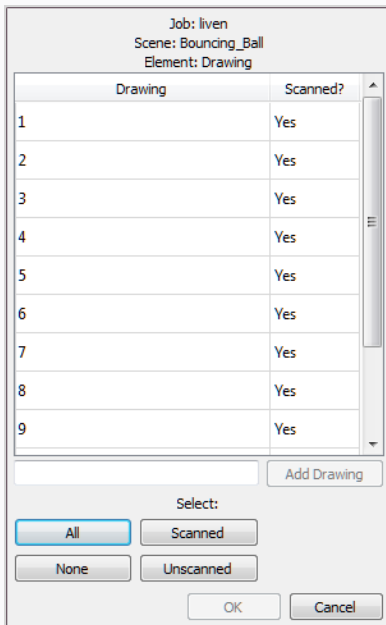

- The Drawing column lists the name of the drawings.
- The Scanned column indicates if the drawing has been scanned.

2. In the **Add Drawing** field, type a drawing name.

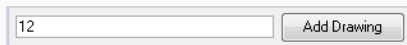

3. Click **Add Drawing**.

The new drawing appears in the list.

4. Select the drawings you want to scan.
 - Select specific drawings from the list. You can select several drawings using Shift + click.

Drawing	Scanned?
1	No
2	No
3	No
4	No

- Click **All** to select all the drawings in the list.
 - Click **None** to unselect all drawings.
 - Click **Scanned** to select only the drawings that are stated as scanned (Yes) in the list.
 - Click **Unscanned** to select only the drawings that are stated as not scanned (No) in the list.
5. Click **OK**.

The selected drawings appear in the Scan application Drawing List.

Drawing List
1
2
3
4
5
6
7
8
9
10

Setting Up Scanning Sessions

Once you have launched the Scan application and loaded your drawing list, you can set up your scan session with the different scanner options in the Control panel.

How to set up the scan session

1. Start the Scan application and load your drawing list.
2. In the Control panel, select a scanner from the Scanner menu.

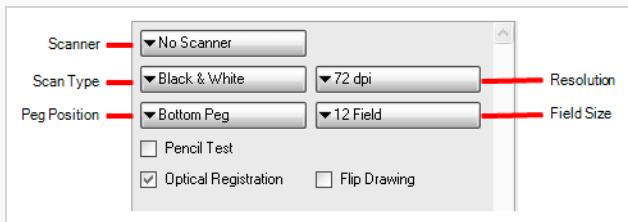

3. From the Scan Type menu, select a scan type. If there is more than one scanner connected to your computer, only the scanners that support the selected scan type are displayed.
 - **Black & White:** Scans a line art drawing that you will paint in the Paint or Harmony modules.
 - **Greyscale:** Captures the shades of grey in drawings.
 - **Colour:** Scans a pre-coloured drawing, such as a background or overlay.

When you select a scan type, additional context-sensitive options appear on the lower part of the Control panel.

4. From the Peg Position menu, set the location of the pegs or registration holes on the paper you are scanning. The images will be automatically rotated based on your selection.
 - **Bottom Peg:** The peg holes appear below the drawing.
 - **Top Peg:** The peg holes appear above the drawing.
 - **Left Peg:** The peg holes appear on the left of the drawing.
 - **Right Peg:** The peg holes appear on the right of the drawing.
5. From the Resolution menu, select a resolution. This determines the quality and size of scanned images. The resolutions that appear in the list depend on the selected scanner.
6. From the Field Size menu, select the size of the paper you are scanning. The different choices appear in field units. Note that the autofeed mode does not support paper larger than 12 field.
7. Select the **Pencil Test** option if you want to perform a line test. A black and white image will be created with no paintable colour art regions. If you select this option, the **Scan: Pencil Test**

Confirmation dialog box opens.

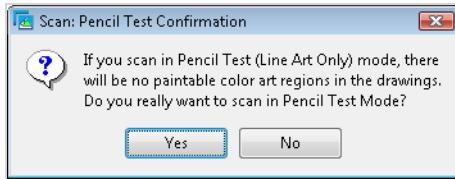

- Press **Yes** to confirm.
 - Press **No** to cancel.
1. Select the **Optical Registration** option to automate the alignment of the drawings using the registration holes on the drawing paper.
 2. Select the **Flip Drawing** option to flip the scanned image horizontally and realign the registration holes.

Once you set up the main scanner options from the Control panel, you are ready for a test scan to calibrate the scanned images.

Displaying Scanner Information

You can display the scanner information, such as the scanner name, device, model and description with the Info command.

To display scanner information

1. From the top menu, select **Scanner > Info**.

The Scanner Information dialog box opens.

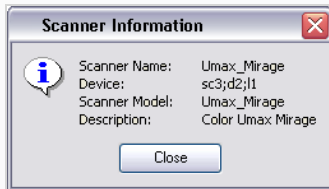

Performing Trial Scans

The Scan application allows you to perform test scans to determine the proper threshold or gamma setting for a drawing. A test scan lets you preview the scanned image without saving it. You can perform a trial scan by auto feeding the drawing through the scanner or by pegging the drawing on the scanner.

How to perform a trial scan

1. Start the Scan application and load your drawing list.
2. Place the drawing on the scanner pegs or in the automatic document feeder (ADF).
3. On the Control panel, select the appropriate feeding type from the Feed menu.

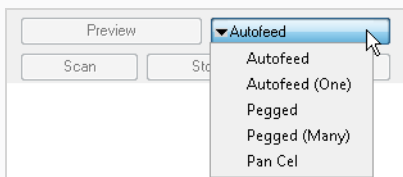

- **Autofeed:** Feeds the drawings through the ADF.
 - **Autofeed (One):** Accepts one drawing from the ADF when the Scan button is pressed.
 - **Pegged:** Scans a drawing from the flatbed each time the Scan button is pressed.
 - **Pegged (Many):** Automatically scan a drawing from the flatbed every five to ten seconds (depending on the time required to process the drawings).
 - **Pan Cel:** Scans a drawing that is bigger than the scanner window in separate sections.
4. Click **Preview**. If you are manually pegging the drawing, make sure to close the scanner cover before you click the **Preview** button. When the scan is complete, the drawing appears in the Frame Preview panel of the Harmony.
 5. Adjust the image parameters. Different options appear on the Control panel depending on the scan type you selected—see [Setting Up Scanning Sessions on page 57](#).

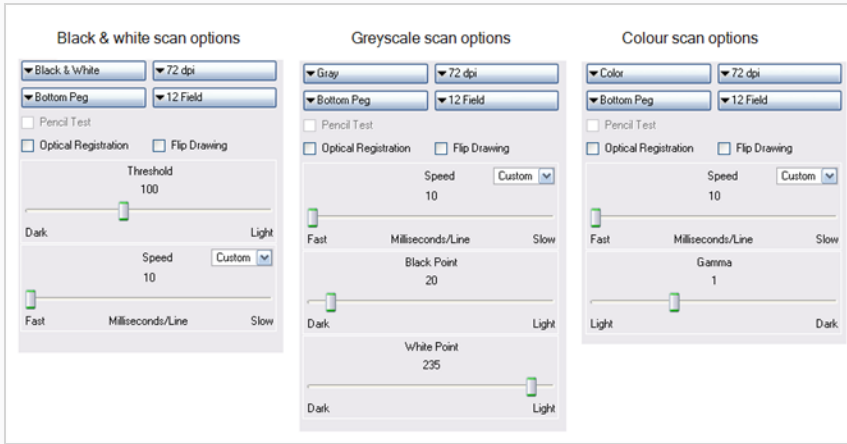

Scan Type	Parameter
All	Speed: Adjusts the time required to scan a line (measured in lines per millisecond) at which to scan drawings, if your scanner supports variable speeds. Use the drop-down menu to set predefined speeds of Fast, Normal, or Custom.
Black & White	Threshold: Adjusts the exposure.
Greyscale	Black Point: Use this slider with the White Point slider to adjust the contrast. Greyscale values that are less than the selected value are converted to black. White Point: Use this slider with the Black Point slider to adjust the contrast. Greyscale values that are greater than the selected value are converted to white.
Colour	Gamma: Adjusts the colour contrast.
Scan Type	Parameter
All	Speed: Adjusts the time required to scan a line (measured in lines per millisecond) at which to scan drawings, if your scanner supports variable speeds. Use the drop-down menu to set predefined speeds of Fast, Normal, or Custom.
Black & White	Threshold: Adjusts the exposure.
Greyscale	Black Point: Use this slider with the White Point slider to adjust the contrast. Greyscale values that are less than the selected value are converted to black.

	White Point: Use this slider with the Black Point slider to adjust the contrast. Greyscale values that are greater than the selected value are converted to white.
Colour	Gamma: Adjusts the colour contrast.

- 6. Click **Preview** to view the changes.
- 7. Keep adjusting these values until you get the effect you want. These values will be applied to all the subsequent drawings you scan.



NOTE

To keep the image from a trial scan without having to rescan the drawing, click **Save** to assign the image to the currently selected drawing name in the Drawing list and mark it as scanned.

Chapter 4: Scanning

After building your exposure sheet, opening the cells in the Harmony, configuring the scanner, fine tuning the scan settings and previewing the scanned drawings, you are now ready to begin the final scanning process.

There are five ways to feed drawings through the scanner:

- **Autofeed:** Scans all drawings in the automatic document feeder (ADF).
- **Autofeed (One):** Scans the drawings in the ADF one at a time, and click Scan for each drawing.
- **Pegged:** Scans a drawing on the scanner. Click Scan each time you change the drawing on the scanner.
- **Pegged (Many):** Automatically scans the drawing in the scanner every five to ten seconds (depending on the time required to process the drawings).
However, this mode does not scan each drawing automatically when you click the **Preview** button.
- **Pan Cel:** Scans a drawing into the system in separate sections because the drawing is bigger than the scan window.

You may find that the Autofeed option is not available on your system, since your scanner may not support it. The field size you select can also determine which mode is available.

- All scanning modes support 12 field.
- The Autofeed modes do not support 16 field or higher.

Drawings are scanned in the order in which they appear in the Drawing list.



NOTE

- If you want to reverse the order of the drawings, select **Edit > Reverse List Order**.
- If you want to make any other sorting changes, reselect the drawings from the Drawing Selector dialog box.
- You may need to re-enter your list of drawings using the **File > Build Manual List** command.

Scanning with the Automatic Document Feeder	65
Scanning Manually	68
Scanning Pan Cels	70
Stopping the Scanning Process	72

Scanning with the Automatic Document Feeder

If the selected scanner supports an automatic document feeder (ADF), you can set your scanner to automatically feed the drawings for scanning. There are two options for doing this: automatically scanning the drawings or scanning drawings one at a time.

You can use the ADF to scan a stack of drawings continuously on a black and white scanner. Many scanner models support up to A3-sized paper in the ADF (15 field). If you are scanning a 16-field drawing, you may have to manually peg it on the scanner.

Since you must splice multiple drawings in a pan cel together once you have scanned them all, you cannot feed pan drawings through the ADF. When you use the black and white scanner's ADF to scan a stack of drawings, the scanner optically detects the peg holes on the drawing and registers the image accordingly.

How to scan your drawing using the automatic document feeder (ADF)

1. Start the Harmony and load your drawing list.
2. In the Control panel, select a feed type from the Feed menu:

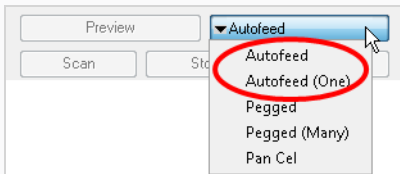

- **Autofeed:** Scans all the drawings in the automatic document feed (ADF).
 - **Autofeed (One):** Accepts one drawing from the ADF when the Scan button is pressed.
3. Sort the paper drawings in your scanner in the same order as they appear in the Drawing List.

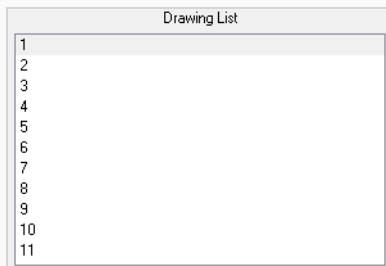

The Scan application uses the Drawing list order to scan the drawings.

4. If need be, reorder the Drawing list:
 - To reselect the drawings you want to scan, select **Edit > Drawing List**.
 - To reverse the Drawing list order, select **Reverse List Order**

5. Before placing the drawings in the ADF paper chute, position the paper guide closest to the back of the scanner as far out as it can go (towards the back of the scanner).
6. Place the drawings in the ADF paper chute (either face up or face down, depending on the type of scanner you have).
 - The first drawing to scan must be at the bottom of the stack once you put it on the scanner, with the registration holes towards the back of the scanner (where the pegs are).
 - When you place the drawings in the ADF paper chute, insert them so that they are slightly touching the paper guide closest to the back of the scanner, and the edge of the drawings lightly touch the inside of the ADF.

**NOTE**

Do not insert the drawings too tightly on the inside of the ADF or multiple drawings may feed through at the same time, causing registration errors.

1. Slide the other paper guide over (closest to the front of the scanner) so that it slightly touches the drawings. You are now ready to scan the drawings.
2. Select a scanning mode from the Feed menu:
 - **Autofeed:** Scans all the drawings in the automatic document feed (ADF).
 - **Autofeed (One):** Accepts one drawing from the ADF when the Scan button is pressed.
3. Click **Scan**.

The scanner begins to capture the drawings. You can interrupt the scan by clicking the **Stop** button—see [Stopping the Scanning Process on page 72](#).

As the scanner captures the drawings:

- The drawing appears in the Image panel.
- You should check the drawings as the scanner captures them to ensure that the line quality is consistent from drawing to drawing. If necessary, adjust the threshold for a drawing.
- You can modify the scale to better view the drawings.
- If you selected the Autofeed option, the animator's label for the drawing you just scanned appears in the Last Scanned panel, which appears only when using the Autofeed or Autofeed (One) modes. A portion of the entire scanned image appears in this window. Scroll to the animator's label using the scroll bars.
- The entire drawing appears in **Frame Preview** panel.

- When the scan is complete, the Drawing List tags the drawing as Scanned and highlights the next drawing.
- If an optical registration error occurs, a dialog box appears.
 - Make sure to place the drawing correctly in the ADF and there are no tears or rips on the drawing's registration holes. Try feeding and scanning the drawing again by clicking **Retry**.
 - The size of the paper you used may not be close enough to a standard 12-field paper size. Harmony looks for the centre peg hole at a specific distance from the leading edge of the paper (give or take an inch).
 - To correct this error, you must scan these drawings on a flatbed scanner instead of using an ADF scanner.
 - To continue scanning and fix the drawing later, click **Skip Drawing**. The scanner marks the drawing as "Not Scanned" and the autofeed takes the next drawing.

When the scanner captures the last drawing in the Drawing List, the Scan and Preview buttons become active again.

4. If you want to rescan a drawing, simply select the cell name from the Drawing List and click **Scan**.
 - Remember to change the feed mode you selected before clicking the Scan button. If you are scanning one drawing, select **Autofeed (One)** from the Feed menu.
 - If you are rescanning more than one drawing, select **Edit > Drawing List**, type the names of the drawings you want to rescan, and click OK.



NOTE

If a paper jam occurs in the ADF (with the compatible scanners), use the Eject Page command to eject the jammed page. Select **Scanner > Eject Page**. If the option is not compatible with your scanner, the command will be greyed out.

Scanning Manually

You can scan a drawing by placing it on the scanner registration pegs yourself. If the drawings you want to scan are too large to fit in the scanner's automatic document feeder or do not feed properly due to rips, wrinkles, or folds in the drawing, you can manually peg the drawings.

However, this mode does not scan each drawing automatically when you click the Preview button.

How to scan by manually pegging drawings

1. Select one of the following options from the Feed menu:
 - **Pegged**: Scans the drawing from the flatbed. Click **Scan** for each drawing.
 - **Pegged (Many)**: Scans the drawing from the flatbed every five to ten seconds (depending on the time required to process the drawings).
2. Check the Drawing List to see which drawing you are scanning next. It will appear highlighted.
 - You can select the drawing you want to scan by pointing to the desired drawing in the Drawing list, and clicking **Scan**.
 - You can reverse the order of the Drawing list by selecting **Edit > Reverse List Order**.

The Drawing list sorts the cell names from your exposure sheet alphanumerically. You should keep this in mind when assigning names to these cells, otherwise, you may need to resort your drawings so the Harmony can assign them in the correct order.

3. Lift the scanner cover and place the drawing face down on the scanner glass with the peg holes of the drawing positioned on the registration pegs bar on the scanner. This should be the paper drawing that corresponds to the drawing highlighted in the Drawing List.

You can place both 12 field and 16 field paper on the same registration pegs on the scanner. The Field menu in the scanner's setup options defines the paper size being scanned.

4. Close the scanner cover, making sure the paper lays flat against the glass, free of wrinkles and folds. You are now ready to scan the drawing.



WARNING

Never scan a drawing while the scanner cover is open. If you do, large black areas can appear around the edges (similar to a photocopier with the lid open). The scanner interprets this extra black area as part of the drawing, which drastically slows the vectorization process. If by mistake you do scan a drawing with the cover open, you can go to the vectorize queue and delete the entry before it starts processing. Refer to the Toon Boom Server Guide to learn more about this.

5. Click **Scan**.

- If you set the scan mode to Pegged, the scanner scans the drawing, then stops and waits for you to change the drawing and click the **Scan** button again.
- If you set the scan mode to Pegged (Many), the scanner continues to capture a drawing every five to ten seconds (depending on how long it takes to process each drawing).

While the scanner captures the drawing, the Scan button becomes inactive.

You can interrupt the scan by clicking **Stop**—see [Stopping the Scanning Process on page 72](#).

When the scan is complete, the captured image appears in the Harmony. In the Drawing list, the drawing is indicated as 'scanned' and the next drawing to scan appears highlighted.

6. If you set the scan mode to Pegged (Many), wait for the scanner to stop after each drawing and place the next one before it starts again.

Scanning Pan Cels

Pan cels are drawings that contain more than one set of registration holes. Because pan cels are large, you cannot scan the entire image with one pass on the scanner.

Therefore, you must scan pan cels one section at a time (one set of registration holes at a time). After you scan each section of the pan cel, the sections are spliced together to create the original pan cel image.

There must be exactly eight inches (2.54 centimetres) between the centre peg holes (the round holes) for each pan cel and the peg holes must all align exactly. This is important if the Harmony must make slight seaming adjustments to compensate for angle differences when it joins all the pan cels to form one drawing.

How to scan a pan cel

1. Start the Harmony and load your drawing.
2. In the Control panel, select **Pan Cel** from the Feed menu.

The Peg Hole panel appears below the Image panel.



- By default, two pegs appear in the Peg Hole panel. If your pan cel has more than two peg holes, use the **New** button to add more.
 - If you added too many peg holes, simply select a different format from the Feed menu and reselect **Pan Cel** again. The two peg holes reappear by default.
3. Determine where peg hole A appears on your pan cel.



WARNING

The Scan application considers peg hole A to be the leftmost peg position on horizontal pan cels, and the topmost peg position for vertical pan cels.

4. Place the pan cel face down on the scanner glass with the round A peg hole placed on the round registration peg on the scanner or position it in the optical registration search area as defined earlier. Close the scanner cover.
5. Select the peg hole you are scanning first from the Peg Hole panel.

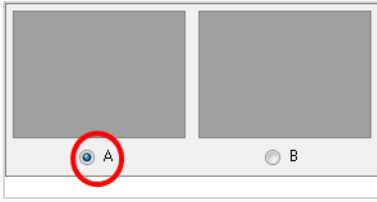

- This procedure assumes you are scanning peg hole A first, then continuing scanning the rest of the peg holes in sequence.
 - You can actually scan the peg holes in any order, as long as you select the lettered button in the Peg Hole panel that corresponds to the peg position you are scanning.
6. Click on the **Scan (A)** button. To interrupt scanning at any time, click **Stop**—see [Stopping the Scanning Process on page 72](#).

The scanner scans the first section of the panel and displays a preview of the scanned image above the A button in the Peg Hole panel.

7. On the scanner, move the panel so that peg hole B is on the round registration peg on the scanner or position it in the optical registration search area as defined earlier and close the scanner cover.
8. Select the **B** option from the Peg Hole panel and click the **Scan (B)** button.
The scanner inputs the second section of the panel and displays a preview of the scanned image above the B button in the Peg Hole panel.
9. Repeat these steps until you have scanned all the panels of your panel.
10. When you have scanned all the drawings for the panel to form a single drawing, click **Save**.

Stopping the Scanning Process

You can use interrupt scanning at any time. When you do, the scanner may not stop immediately since the Scan application must finish its current process.

How to stop the scanning process

1. Click **Stop**.

The Stop Scanning dialog box opens.

2. Select one of the following:
 - **Stop Immediately:** Stops the scanner from finishing the current drawing scan. The Scan application marks the drawing as "Not Scanned".
 - **Finish This Drawing button:** Continues the scanning, saves the current drawing, and then stops the scan process.

Chapter 5: Advanced Scanning Techniques

In most cases, you only need to scan your drawings into empty cells in your exposure sheet. Harmony is flexible enough to allow you to add drawings in other ways. These other methods include:

- Scanning paper drawings without matching cells in the exposure sheet
- Loading previously scanned images into matching cells in the exposure sheet
- Setting the vectorization style

Scanning Drawings without Matching Frames	75
Loading Previously Scanned Drawings	78
Setting the Vectorization Style	79

Scanning Drawings without Matching Frames

If you want to preview one or more drawings that don't have a corresponding list of cells in the **Control Center's** database yet, you don't have to go through the whole procedure of creating an environment, defining the jobs, scenes, and elements, and then creating an exposure sheet. These would be a list of cells that were not entered in the exposure sheet and do not appear in the **Database Element Selector** dialog box.

To scan these new drawings, you must specify the path and file names for the drawings to be saved.



NOTE

The Scan application does not vectorize these types of digital drawings and you cannot view them in Control Center. If you do decide to use these drawings, you must follow the standard procedure for scanning drawings for a regular scene (with the Control Center and Harmony modules).

How to manually build a list of drawings to scan

1. Select **File > Build Manual List**.

The Manual List dialog box opens.

The screenshot shows the 'Manual List' dialog box. It contains three input fields: 'Path', 'Prefix', and 'Drawings'. To the right of the 'Drawings' field is an 'Add' button. At the bottom of the dialog are 'OK' and 'Cancel' buttons.

2. In the Path field, type in an existing directory path where you want to store the scanned drawings.

This screenshot shows the 'Manual List' dialog box with the 'Path' field containing the text 'C:\Users\Documents\MyProject'. The 'Prefix' and 'Drawings' fields are empty, and the 'Add' button is visible.

3. Type in a name in the **Prefix** field that appears at the beginning of the scanned files that correspond to the drawing names you subsequently add to the manual list.

This screenshot shows the 'Manual List' dialog box with the 'Path' field containing 'C:\Users\Documents\MyProject' and the 'Prefix' field containing 'Joe'. The 'Drawings' field is empty, and the 'Add' button is visible.

Delete this text and replace it with your own content. For example, if you enter the name of the character **joe** in the **Prefix** field, then add the drawing names **01** and **02**, the Drawing List would display 01 and 02, but once you scan the drawings, the files would appear as follows:

- joe-01
- joe-02

**NOTE**

The prefix and a dash automatically appear in front of the drawing names you add when the Harmony creates the files of the scanned drawings.

4. Type the name of the drawing you want to scan in the Drawings field and click **Add**.

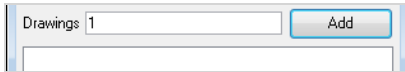

The name of your drawing appears in the Drawings panel. Repeat for every drawing you add.

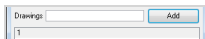

- For a quick way to create a series of drawings, type the first and last number with a colon (:) between them.

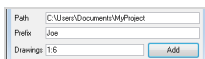

For example, if you want to create a series of drawings numbered from one to six, type the following in the Drawings field and click **Add**:

- 1:6

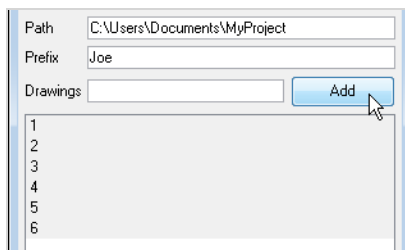

5. Select the drawings you want to add to the Drawing List. By default, all the entries appear selected, but you can select the drawing(s) you want to scan.

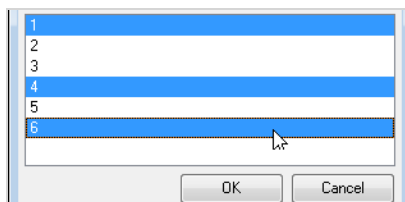

6. Click **OK**.

The selected drawings appear in the Drawing List of the Harmony Control panel.

Drawing List	
1	
4	
6	



NOTE

To modify the manual entries in the Drawing List, you must reopen the Manual List dialog box and go through the process of building the manual entries again.

Loading Previously Scanned Drawings

The Load From File command allows you to load a previously scanned drawing into the Scan application. This is useful if you want to view a drawing you already scanned.

How to load a previously scanned drawing

1. Select **File > Load From File**.

The Select File To View dialog box displays the directories and files in the current directory. You can load graphics in any of the following bitmap formats:

- **OMF**: Open Media Framework image format. This format is compatible with Avid applications.
 - **OPT**: An optimized version of the SCAN image format. This format retains the alpha channel information for the image. It also preserves the quality of the image while keeping the file size low.
 - **RCI**: The drawings are in Recognition Concepts Inc. image format.
 - **Scan**: The scan image format, which retains the image's scanning information (resolution in dpi, drawing registration) that the Harmony uses.
 - **SGI**: The drawings are in the Silicon Graphics Inc. image format, which retains the image's alpha channel information.
 - **TGA**: The drawings are in the Generic Targa image format, which the image's alpha channel information and is widely compatible (cross-platform).
 - **VAR**: The drawings are in the Variable header image format.
 - **YUV**: The drawings are in a graphic type for animations that appear in National Television System Committee (NTSC) image format.
 - **PAL**: The drawings are in a graphic type for animations that appear in Phase Alternating Line (PAL) image format.
2. Browse to the folder where your scanned drawings are saved.
 3. Select a file to view and click **OK**.

Setting the Vectorization Style

You can set the vectorization style you want to apply to any subsequent drawings that will be sent to the Vectorize Queue in the Control Center.

How to set the vectorization style

1. Select **Edit >Vectorize Style**.

The Vectorization Styles dialog box opens.

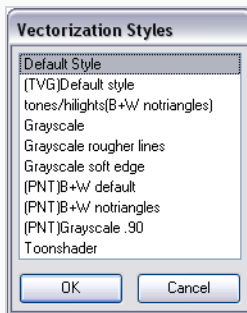

2. Select the desired vectorization style from the list and click OK.

To learn more about the Vectorize Queue and Control Center, refer to the Harmony Server Guide.